



**HAL**  
open science

# Influence of the processes parameters on the properties of the polylactides based bio and eco-biomaterials

Arfan Ul Haq Subhani

► **To cite this version:**

Arfan Ul Haq Subhani. Influence of the processes parameters on the properties of the polylactides based bio and eco-biomaterials. Mechanical engineering [physics.class-ph]. Institut National Polytechnique de Toulouse - INPT, 2011. English. NNT : 2011INPT0057 . tel-04238911

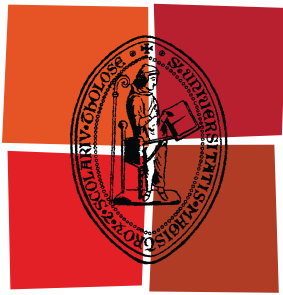
**HAL Id: tel-04238911**

**<https://theses.hal.science/tel-04238911v1>**

Submitted on 12 Oct 2023

**HAL** is a multi-disciplinary open access archive for the deposit and dissemination of scientific research documents, whether they are published or not. The documents may come from teaching and research institutions in France or abroad, or from public or private research centers.

L'archive ouverte pluridisciplinaire **HAL**, est destinée au dépôt et à la diffusion de documents scientifiques de niveau recherche, publiés ou non, émanant des établissements d'enseignement et de recherche français ou étrangers, des laboratoires publics ou privés.



Université  
de Toulouse

# THÈSE

En vue de l'obtention du  
**DOCTORAT DE L'UNIVERSITÉ DE TOULOUSE**

**Délivré par :**

Institut National Polytechnique de Toulouse (INP Toulouse)

**Discipline ou spécialité :**

Science et Génie des Matériaux

---

**Présentée et soutenue par :**

Arfan UI Haq SUBHANI

**le :** vendredi 22 juillet 2011

**Titre :**

Influence of the Processes Parameters on the Properties of  
The Polylactides Based Bio and Eco-Materials  
Influence des paramètres de procédés sur les  
propriétés et éco-composites à base de polylactides

---

**Ecole doctorale :**

Sciences de la Matière (SDM)

**Unité de recherche :**

Centre Interuniversitaire de Recherche et d'Ingénierie des Matériaux

**Directeur(s) de Thèse :**

Professeur A. LAMURE

**Rapporteurs :**

Professeur E. BADENS, Pr. Université Aix-Marseille  
B. CHARRIER, MC. Université Pau

**Membre(s) du jury :**

E. BADENS, Pr. Université Aix-Marseille, Rapporteur  
B. CHARRIER, MC Université Pau, Rapporteur  
M. VERT, Dr. Université Montpellier I, Examineur  
N. LE BOLAY, Pr. INP Toulouse, Examineur  
V. SANTRAN, D.G. ICELLTIS, Examineur  
A. LAMURE, Pr. INP Toulouse, Directeur de thèse

***“It is not difficult really-  
The secret is in knowing how”***

*(Edward Leedskalnin)*





*Dedicated to  
My Father and Mother  
&  
My Wife and Sons*



## Acknowledgements

There are many who have contributed in small and large ways to the completion of this dissertation and to whom I give special thanks for what they have given and what I have learned from them. I thank my Lord and Savior for his grace and mercy that has blessed me since before I was born.

The research subject of this thesis was performed in the laboratory Institute Carnot - Centre Interuniversitaire de Recherche Ingénierie Matériaux, the team " SURF / Surfaces : Réactivité-Protection. I am first of all very grateful to Francis MAURY, Director and CIRIMAT Raja Chatila, LAAS director, for having me in their respective laboratory.

I wish to thank Francis and Alain for welcoming me in their team and for offering me this PhD exciting subject. I am deeply indebted to my supervisor Prof. Alain Lamure, who provided me an opportunity to perform this work and for his constant support, guidance and fellowship to carry out this Ph.D thesis in his supervision, and also for helping me to have better perspective in my scientific thinking. Alain, thanks for giving me your trust. Thank you for the freedom that you left me appropriating for this research topic and for your support in all circumstances. Thank you also and especially for your friendliness and the way you always focus on human relationships. I would like to express my deep appreciation for his availability even passing through a critical health condition, many valuable suggestions and discussions that led to the progress and my personal growth. Francis, I want to thank you for the advice you've provided throughout three and half years.

I would also like to express my gratitude to my two informal co-supervisors present in the jury: first, Veronique SANTARN, DG ICELLTIS, allowed me to work with her and expand my knowledge in tissue engineering biotechnology. A lot of thanks, not only to participate in my thesis committee but also for her widespread availability throughout the thesis tenure. Thank you for your help, your invaluable advice, your encouragement, time and resources you have spent. I take along a part of your optimism. On the other hand, Nadine LE BOLAY, professor at LGC, who introduced me into the world of powder technology and size reduction processes in a very active way, consulting has always been welcome.

None of this research would have been possible without the financial support of Higher Education Commission of Pakistan and CNRS Toulouse.

I would also like to thank those who agreed to judge my work:

| Ms.Nadine LE BOLAY, professor at Université Paul Sabatier, Laboratoire de Genie Chimique for her interest in this work and to honor us by accepting it to chair the commission thesis,

| Ms Elisabeth BADENS, Génie Chimique Génie des procédés and Responsable Equipe Procédés & Fluides Supercritiques Université Paul Cézanne (Aix-Marseille III) for the interest in this work by agreeing to be reporters,

| Mr.Bertrand Charrier, *Maitre de conférence*, at Université de Pau et des Pays de l'Adour, for agreeing to review the manuscript.

I express my gratitude to both the reporters, for their interest in this work whose memory critically and benevolent permit to improve the content.

A lot of thanks to all individuals, with those I had worked in CIRIMAT, LGC and LAAS for their instant help and kindness. This work was mainly carried out within the SURF team. I want to express how

pleased I was to work with all members of SURF team, I am very grateful to the permanent (Constantin VAHLAS, François SENOCQ, Alain GLEIZES, Nadine PEBER, Corinne Lacaze-DUFAURE, Claire TENDERO, Maelen AUFRAY, Diane SAMELOR, Daniel SADOWSKI) and all other non-permanent doctoral students.

The geographical position of my office also allowed me to mix several PPB and MEMO team members and enjoy their support as a scientific point of view that morale. In this team I really enjoyed the discussions with Christian REY, Christèle COMBES, Christophe DROUET, David GROSSIN, Olivier MARSAN, Gerard DECHAMBRE, Cedric CHARVILLAT, Françoise BOSCH, Dominique BONSIRVEN. I thank them for their availability in the daily routine. In this team, I also express my sympathy to Solène TADIER, Ahmed AL KATTAN, Imane DEMNATI and other members for their friendly guidance.

Within CIRIMAT, I also had the opportunity to be in contact with members of other teams at different floors. I want to thank them for their cordial welcome and assistance Bernard VIGUIER, Jacques LACAZE, Christine BLANCK, Jeanne Marie ALCARAZ, Aline PERIES, Christine Marie LAFONT, Dominique POQUILLON, Julitte HUEZ, Djar OQUAB, Eric ANDRIEU, Jean-Claude SALABURA, Ronan MAINGUY, Yannick THEBAULT, Alexander FREUND and many researchers and students. Thank you to for your availability and efficiency whenever I need you in difficulty. I will never forget the beautiful moments

I shared with my friends at CIRIMAT during these 3 years especially useful discussions with Ahmed, Lyasin, solene, and many others. I thank you for useful discussions and the interaction we shared on a daily basis. My abilities as a researcher and professional have grown from working with all of you. I have made many valuable friendships during my stay in the SURF group. I would first like to say a great thank you to Jaime Puig-Pey GONZÁLEZ and Christel AUGUSTIN, Lyacine ALOUI, Guillaume BOISSELIER, Sabrina MARCELIN and Aneesha VARGHESE. I was also well received and much learned in the lab than at home. I really appreciate your friendship and I keep firmly in mind that "we can get in the way of happiness." It will not be fair to mention here Revathi BACSA who had always provided a moral support in difficult situations during my stay in laboratory.

During my experimentations in LAAS, my work would not have been possible without the unconditional support of the clean room team, and more particularly Laurent RABBIA and Vincent PERRUT, Their cooperation helped me working with supercritical equipment. In LGC, I would be thankful to Séverine CAMY and Jean-Stéphane CONDORET for facilitating and helping in conducting the foaming process on supercritical CO<sub>2</sub> pilot plant. Their technical knowledge and skill enhance my abilities while working on this system.

I was also very pleased to have participated in the supervision of several projects of engineering students in ENSIACET: Selmi Erim BOZBAG, Sandrine AUSSET, Tristan DESPLECHIN, Arnaud VIEYRES, Rodrigues TIAGO, Capdevielle MARION, Hochman LÉA, Pasco OLIVIER, Alexandre FRANCOIS, Cyril BESNARD, Sophie RISSE, Erika Martínez PÉREZ and Nora GALLEGO LEIS through their internship on various projects related to polymers and foaming. Moreover, I want to thank all of INP, ENSIACET, LGC, LAAS and more especially Claude, Max, Sylvia, Ahmid, the guys in the shop, cleaning women for their hospitality, their friendliness and good humor.

Special thanks to Usman ASHRAF, Rameez KHALID, Umer HAYAT, Nadeem MIRZA and Muhammad ILYAS for your hospitality in Toulouse and moments of relaxation and discussion I had the pleasure to share with you. Rameez and Usman offered me a piece of "Sooth" when I came here and I look forward to see you again and to collect more in the coming years ...Ali, Saad and Umar Farooq, I

appreciated your availability and the time we spent talking, to think or laugh. Passing time with you has been a pleasure and I learned a lot of your experience. A very special recognition to Adeel AHMED for his solving the software problem during my thesis report writing. I would also like to thank one of my very good friend Chaudhry Tanveer AHMED who had always helped me in awkward times. I take this opportunity to express my profound gratitude to all my teachers from school to university because of whose blessings I have come so far.

Finally I would like to thank all my paternal and maternal family members and especially grateful to my parents, my sister and my brothers who always supported me and comforted in my choices. A lot of thanks to my cousins and family members back in my country. My father and mother have been counting days for many years for my return to home. My father will be very happy for realization of his dream for his son. Thank you for the example you have shown. You provided me with inspiration and instruction for how I live my life. My Mother's continuous prayers had always given me hidden support and confidence. I am thankful for special attachment of my brothers and specially the sacrifice of Farman ul Haq Subhani, who had always been special in all respect. I thank all those without whose encouragement and support, my PhD would have been an unfilled dream.

I would not like to forget the sacrifices of my grandfather (RIP), if was alive, would have been very happy to see his grandson at his peak. If my uncle Saeed Subhani had not sacrificed for the whole family when he was young, I am sure I would have not achieved this position. Special thanks to my Cousin Ikram ul Haq Subhani for his assistance, cooperation and guidance in my university education in Lahore.

Last but not the least, special thanks to my dear wife, who shared in my thesis and my life, thoughts and my heart ... that made me laugh, smile, work, think ... and most importantly, motivated me. She had supported me in all respect during all the difficult times. My sons Shehryar and Shahmeer have been making my days happier and cheerful during my studies. It will not be appropriate if I forget to say special thanks to Kiran Sabih, the unwavering support that I have received from her and always been greatly appreciated. My success is a tribute to love and encouragement. In the end thanks to all my in-laws family and friends, near and far, who gave me friendship, prayers and moral support. I love you and I thank you for being in my life.



## Publications and Conferences

The work presented in the thesis was done in collaboration with ICELLTIS a company dealing with biomaterial scaffolds for tissue and bone regeneration engineering. The physical and chemical testing of biomaterials and analysis of end product was done in the laboratory Institute Carnot - Centre Interuniversitaire de Recherche Ingénierie Matériaux (CIRIMAT).

Manufacturing of biomaterials pellets was conducted in Université Paul Sabatier CIRIMAT-Physique des Polymeres . Processing of the scaffold was done at two different ScCO<sub>2</sub> equipments at Laboratoire de Genie Chimique and Laboratoire d'Analyse et d'Architecture des Systèmes.

During the thesis following patent, publications and communications were done.

### Patent

- **Title:** “Procédé de fabrication d’un matériau poreux-[Fr]”, “Process for manufacturing a porous material-[Eng]” **Courrier :** 035/10TB/EF/MG **Date Deposited :** 5<sup>th</sup> January, 2010  
**Nr. of Deposit:** 1050037
- **Inventors:** Alain LAMURE, Arfan ul Haq SUBHANI, Jean Stéphane CONDORET, Nadine LE BOLAY, Selmi BOZBAG, Séverine CAMY and Véronique SANTRAN.

**Owners:** ICELLTIS, Cap Delta- Parc technologique Delta Sud, 09340 Verniolle, FRANCE.

Tel : +33.5.34.32.34.24

INPT, Institut National Polytechnique de Toulouse - 6 allée Emile Monso - ZAC du Palays - BP 34038 - 31029 Toulouse cedex 4, Tel : (+33) 5 34 32 30 00 / E-mail : inp@inp-toulouse.fr

### Publications

- ✍ Publication, 13<sup>eme</sup> Journées de Formulation de la Société Française de Chimie, Procédés et formulations au service de la santé, Nancy, France, 4<sup>th</sup> ~5<sup>th</sup> Dec., 2008, “*Development of Bio-composite Foam in Supercritical Environment: Influence of Process Parameters on the Distribution of Pores of Biomaterial.*”, Arfan SUBHANI, Selmi Erim BOZBAG, Veronique SANTRAN, Jean-Stéphane CONDORET, Severine CAMY and Alain LAMURE.
- ✍ Publication (Accepted in Chemical Engineering and Processing: Process Intensification) Mar., 2011. “*How To Combine A Hydrophobic Matrix and a Hydrophilic Filler Without Adding a Compatibilizer. Co-Grinding Enhances Use Properties of Renewable PLA-Starch Composites*”. Nadine LE BOLAY, Alain LAMURE, Nora GALLEGO LEIS, Arfan ul Haq SUBAHNI.

### Posters

- Elaboration de Mousses Nano-Bio-composites en Milieu Supercritique : Influence des Paramètres du Procédé sur la Distribution des Pores du Biomatériau PLGA<sub>85:15</sub>, 3e Workshop of ITAV (Institute des Technologies Avancées en sciences du Vivant) axed on the "Nanobiotechnologies", 25<sup>th</sup> Sep, 2008, Toulouse, France.
- Elaboration de Mousses Nano-Bio-composites en Milieu Supercritique : Influence des Paramètres du Procédé sur la Distribution des Pores du Biomatériau PLGA<sub>50:50</sub>, 13<sup>eme</sup> Journées de Formulation de la Société Française de Chimie, 4<sup>th</sup>~5<sup>th</sup> Dec, 2008, Nancy, France.
- Improvement in Renewable Polymer PLA and Amylopectin Blends Characteristics by the Co-grinding Process, 5<sup>th</sup> annual European symposium on biopolymers, 18<sup>th</sup>~20<sup>th</sup> Nov, 2009, Madeira, Portugal.

## Conference Papers/Oral Presentation

- ✎ *Distribution of Pores in PLGA<sub>85:15</sub> and PLGA<sub>50:50</sub> Foams Manufactured by the scCO<sub>2</sub> Process*, Arfan Ul Haq SUBHANI, Selmi Erim BOZBAG, Nadine Le Bolay, Jean-Stéphane CONDORET, Severine CAMY Veronique SANTRAN, and Alain LAMURE, 9th International Symposium on Supercritical Fluids, New Trends in Supercritical fluids: Energy, Materials, Processing, 18<sup>th</sup> ~20<sup>th</sup> May, 2009, Arcachon, France.
- ✎ *Influence of scCO<sub>2</sub> Process Parameters and Polymer Structure On the Pore Distribution of Scaffolds and the Cells Adhesion*, A.H Subhani, A Lamure, J.S Condoret, S Camy, J Bordere and V Santran, Second Chinese European Symposium on Biomaterials in Regenerative Medicine, 17<sup>th</sup> ~20<sup>th</sup> Nov, 2009, Barcelona, Spain.
- ✎ *Elaboration of Polyester Foams by the scCO<sub>2</sub> Process*, Arfan Ul Haq SUBHANI, Selmi Erim BOZBAG, Veronique SANTRAN, Jean-Stéphane CONDORET, Severine CAMY, and Alain LAMURE, Workshop on Supercritical Fluid Processing of Biopolymers and Biomedical Materials, 16<sup>th</sup> ~17<sup>th</sup> Nov, 2009, Madeira, Portugal.
- ✎ *Influence of Process Parameters and Polymer Structure On the Cells Adhesion*, Arfan Ul Haq SUBHANI, Veronique SANTRAN, Alain LAMURE 5<sup>th</sup> annual European symposium on biopolymers, 18<sup>th</sup>~20<sup>th</sup> Nov, 2009, Madeira, Portugal.
- ✎ *Preparation of Biopolymers Foams by Supercritical CO<sub>2</sub> Process*, Arfan Ul Haq SUBHANI, Selmi Erim BOZBAG, Veronique SANTRAN, Jean-Stéphane CONDORET, Severine CAMY, and Alain LAMURE, Journées Groupe Français d'Études et d'Applications des Polymères, GFP Sud-Ouest, 25<sup>th</sup>~26<sup>th</sup> Mar 2010, Samatan, France.
- ✎ *Improvement by Co-grinding of the Use Properties of Renewable Polylactic Acid – Starch Composites*, Nadine Le BOLAY, Alain LAMURE, Nora Gallego LEIS, Arfan ul Haq SUBHANI, 2<sup>nd</sup> international Conference on Natural Polymers, 24<sup>th</sup> ~26<sup>th</sup> Sep, 2010, Kottayam, Kerala, India.



## Nomenclature and Abbreviations

Abbreviation	
INPT	Institut National Polytechnique de Toulouse
CIRIMAT	Centre Interuniversitaire de Recherche et d'Ingénierie des Matériaux
LAAS	Laboratoire d'Architecture et d'Analyse des Systèmes
LGC	Laboratoire de Génie Chimique
2 D	Two Dimensions
3 D	Three Dimensions
ASTM	American Society of Testing and Materials
SS	Stainless Steel
CO <sub>2</sub>	Carbon dioxide
scCO <sub>2</sub>	Supercritical carbon dioxide
TIPS	Thermally Induced Phase Separation
FTIR	Fourier transform infrared
UV	Ultraviolet radiation
SEM	Scanning electron microscopy
TEM	Transmission electron microscopy
μ-CT	Micro-computer tomography
DSC	Differential Scanning Calorimetry
SL-EOS	Sanchez and Lacombe' Equation of State
MHR	Mark Houwink' Relationship
BME	Basement membrane extract
ECM	Extracellular matrix
PLA	Poly(lactic acid)
P <sub>L,D</sub> LA	Poly D-Lactic acid
P <sub>L,DL</sub> LA	Poly D,L-Lactic acid
PLGA	Poly(lactic-co-glycolic acid)
PCL	Poly(ε-caprolactone)
PGA	Poly(glycolic acid)
PI	polyimide
PC	polycarbonate
AMPEG	α-amino-ω-methoxy-polyethylene glycol
HA	Hyaluronic acid
GlcA	Glucuronic acid
Am-CP	Amorphous calcium phosphate
Ap-TCP	Apatitic tricalcium phosphate
ATCP	Amorphous tricalcium phosphate
BCP	Biphasic calcium phosphate
αTCP	α-Tricalcium phosphate
βTCP	β-Tricalcium phosphate
CaP	calcium phosphate
DCPA	Dibasic calcium phosphate anhydrate
DCPD	Dibasic calcium phosphate dihydrate
HAp	Hydroxyapatite
OCP	Octocalcium phosphate
TCP	Tricalcium phosphate
TEA	Triethylamine
THF	Tetrahydrofurane

<b>Abbreviations</b>		<b>Classical Unit</b>
$P_c$	Critical Pressure	bar
$P_{sat}$	Saturation Pressure	bar
$T_c$	Critical Temperature	°C
$T_{sat}$	Saturation Temperature	°C
$T_g$	Glass transition temperature	°C
$T_m$	Melting temperature	C
$t_{co}$	Co-grinding time	minute
$t_{sat}$	Saturation time	minute
$dP/dt$	Depressurization rate	bar/s
$\Delta H_m$	Melting enthalpy	$J.g^{-1}$
$\Delta H_m^\infty$	Melting enthalpy of the totally crystallised polymer	$J.g^{-1}$
$\Delta H_c$	Crystallization enthalpy	$J.g^{-1}$
$\chi$	Degree of crystallinity	
$\Delta C_p$	Variation of heat capacity	$J.g^{-1}.mol^{-1}$
$D$	Diffusivity	$m^2.s^{-1}$
$D_{dg}$	Desorption diffusion coefficient at plasticized state	$m^2.s^{-1}$
$D_{dp}$	Desorption diffusion coefficient at glassy state	$m^2.s^{-1}$
$Z$	Zeldovich factor	
$[\eta]$	Intrinsic Viscosity	$dL.g^{-1}$
$\eta_{inh}$	Inherent Viscosity	$dL.g^{-1}$
$\eta_{rel}$	Relative Viscosity	
$M_n$	Number average mass molecular	Dalton
$M_w$	Weight average mass molecular	Dalton
$M_{vis}$	Viscosity average mass molecular	Dalton
$K$	Mark Houwink' constant	$dL.g^{-1}$
$a$	Mark Houwink' constant	
$\theta$	Liquid-Solid Contact Angle	°
$\gamma_L$	Surface Tension of Liquid	$mJ/m^2$
$\gamma_S$	Surface Tension of Solid	$mJ/m^2$
$\gamma_{SL}$	Solid-liquid interfacial tension	$mJ/m^2$
$\gamma_{SV}$	Solid-vapour interfacial tension	$mJ/m^2$
$\gamma_S^P$	Polar component of surface energy	$mJ/m^2$
$\gamma_S^d$	Dispersive component of surface energy	$mJ/m^2$
$\gamma_S^{LW}$	Lifshitz–van der Waals component of surface energy	$mJ/m^2$
$\gamma_S^{AB}$	Acid–Base component of surface energy	$mJ/m^2$
$\gamma_S^-$	Basic Component of Surface	$mJ/m^2$
$\gamma_S^+$	Acid Component of Surface	$mJ/m^2$
$\delta_t$	Hildebrand' solubility parameter	$(M Pa)^{1/2}$
$\delta_d$	Dispersive Hansen' solubility parameter	$(M Pa)^{1/2}$
$\delta_H$	Hydrogen Hansen' solubility parameter	$(M Pa)^{1/2}$
$\delta_p$	Polar Hansen' solubility parameter	$(M Pa)^{1/2}$
$\emptyset_f$	Foam thickness	mm
$\emptyset_p$	Pellet thickness	mm
$d_f$	Foam diameter	mm
$d_p$	Pellet diameter	mm
$m_f$	Foam mass	mg
$m_p$	Pellet mass	mg
$\rho_f$	Foam density	

$\rho_p$	Pellet density	
$\sigma$	Splitting (Brazilian) tensile stress	MPa
$\sigma_s$	Limit stress between elastic and plastic domains	MPa
$\varepsilon$	Strain (Elongation)	
$\varepsilon_B$	Elongation at break	
E	Young' Modulus	MPa
$E_T$	Tensile Modulus	MPa

### Subscripts

dg	Desorption at glassy state
dp	Desorption at plasticized state
i	Component i
j	Component j
mix	Mixture
R	Reduced

### Superscripts

*	Characteristic
G	fluid phase
P	polymer phase



## Table of Contents

List of Figures.....	xxi
List of Tables.....	xxix
Introduction .....	1
<b>Chapter 1.....</b>	<b>5</b>
1 Introduction to Bio Composites .....	5
1.1 Bio-composites for 3D Model of Connective Tissues .....	6
1.1.1 Tissue Engineering and Concept of Scaffold.....	6
1.1.2 Different Types of Scaffolds.....	6
1.1.2.1 Cells Grown in Pellets or in Spheroids.....	6
1.1.2.2 Cells Embedded into Hydrogels Derived from Natural or Synthetic Polymers .....	6
1.1.2.3 Cells Grown in a Biomaterial of Large-size on Different Polymers (PLGA, Agarose).....	6
1.1.2.4 Cells Grown in a Biomaterial at a Micrometer-Scale (Thickness ~200 $\mu\text{m}$ ) .....	7
1.2 Bio-Composites for Calcified Tissue Engineering .....	7
1.2.1 Composition of Scaffolds.....	7
1.2.2 Mechanical Properties of 3D Porous Scaffolds.....	8
1.3 Biodegradable Polymers.....	9
1.3.1 What is Biodegradable? .....	10
1.3.1.1 Aerobic Biodegradation .....	10
1.3.1.2 Anaerobic Biodegradation.....	10
1.3.2 Biodegradable Polymer Materials.....	11
1.3.2.1 Biodegradable Polyesters .....	11
1.3.2.2 Synergistic or Hybrid Polymers .....	12
2 Polyesters Based Bio-materials .....	13
2.1 Polylactides (PLA).....	13
2.1.1 Structure of Polylactic Acid .....	13
2.1.2 Synthesis of Polylactic Acid .....	13
2.1.3 Properties of Polylactic Acid .....	15
2.2 Poly(lactide-co-glycolide acid) (PLGA).....	16
2.2.1 General Structures of PLGA Copolymers.....	16
2.2.2 Properties of PLGA Copolymers .....	17
3 Adjuvant and Fillers .....	18
3.1 Adjuvant .....	18
3.1.1 Structure of Hyaluronic Acid (HA).....	18
3.1.2 Physicochemical and Biological Properties of HA .....	19
3.2 Calcium Phosphates and Tricalcium Phosphates .....	20
3.2.1 Structures of Calcium Phosphate .....	20
3.2.2 Synthesis of Different Calcium Phosphate Phases.....	20
3.2.2.1 Amorphous TriCalcium Phosphate (ATCP).....	20
3.2.2.2 Addition of Strontium .....	21
3.2.2.3 Effect of Isomorphous Substitution of Strontium in the $\beta\text{TCP}$ .....	22
3.2.2.4 Physicochemical Properties of TCP Phases .....	23
3.2.2.5 Thermal Treatment in Air of the TCP Phases .....	23
3.2.2.6 Aqueous Evolution of TCP Phases.....	24
3.2.2.7 Surface Properties .....	25
3.2.3 Application of $\alpha$ and $\beta$ -tricalcium Phosphates in Biomaterials .....	25
4 Conclusion.....	25

<b>Chapter 2</b> .....	<b>27</b>
1 Generalities on Polymer Foams.....	27
2 Manufacturing of Porous Materials by Wet Methods .....	28
2.1 Solvent Casting/Particulate Leaching.....	28
2.2 Ice Particle-Leaching.....	29
2.3 Gas-Foaming/Salt-Leaching Technique .....	30
2.4 Gel-Pressing Technique.....	31
2.5 PLGA Microspheres for Tissue-Engineered Scaffold.....	32
2.6 Particle-Aggregated Scaffolds Technique .....	33
2.7 Freeze-Drying Method .....	33
2.8 Thermally Induced Phase Separation (TIPS) Technique.....	34
2.9 Centrifugation Method .....	35
2.10Injectable Thermosensitive Gel Technique .....	36
2.11Liquid-Liquid Phase Separation Technique .....	37
2.12Solid-Liquid Phase Separation Technique.....	38
2.13Fibre Mesh/Fibre Bondong Technique.....	38
2.14Hydrocarbon Templating Technique.....	38
2.15Microspheres Bonding Technique.....	39
2.16Rapid Prototyping Techniques .....	39
2.16.1 Three Dimensional Printing (3 DP).....	40
2.16.2 Stereolithography (SLA).....	40
2.17Other Derivated Techniques.....	41
2.17.1 Combination of Leaching of a Fugitive Phase and Polymer Precipitation .....	41
2.17.2 Phase-Change Jet Printing .....	42
3 Polymer Processing by Supercritical Fluids.....	42
3.1 Bases on Supercritical Fluids .....	42
3.2 Basic Techniques in Supercritical Fluids Technology .....	44
3.3 Scaffolds Prepared by Phase Inversion using scCO <sub>2</sub> as Anti-solvent.....	45
3.4 Scaffolds Prepared by scCO <sub>2</sub> Foaming.....	46
4 Theoretical Background of Gas Foaming.....	48
4.1 Diffusion.....	48
4.2 Plasticization of Polymers by CO <sub>2</sub> .....	51
4.3 Nucleation .....	53

4.4	Distribution of Pores.....	54
5	Manufacturing of the Composite Biomaterials .....	56
5.1	Fundements of Co-grinding Process .....	56
5.1.1	Mechanism of Size Reduction .....	56
5.1.2	Fragmentation Mechanisms .....	57
5.1.3	Agglomeration Phenomena.....	57
5.2	Obtention of Composites by the Co-grinding Process.....	58
6	Conclusion.....	60
<b>Chapter 3</b>	.....	<b>61</b>
1	Differential Scanning Calorimetry (DSC).....	61
1.1	Generalities on Thermal Transitions of Polymers .....	61
1.2	First Order Transitions.....	62
1.3	Second Order Transition.....	63
2	Intrinsic Viscosity .....	64
2.1	Molecular Mass of Polymer and Viscosity .....	64
2.2	General Principle of Viscosity Measurement .....	64
2.3	The Mark-Houwink Relationship (MHR).....	66
2.4	The Mark-Houwink Constants of Polylactides and Hyaluronic Acid.....	66
3	Laser Granulometry Method .....	67
3.1	Granulometry .....	67
3.2	Principle of Laser Analysis.....	67
3.2.1	Rayleigh' Theory .....	68
3.2.2	Lorenz-Mie' Theory.....	68
3.2.3	Fraunhofer' Theory.....	69
4	Sorption Analysis .....	70
5	Microscopic Methods to Analyze Porous Structures .....	70
5.1	Methods to Determine Porosity .....	70
5.1.1	Geometric Porosity .....	70
5.1.2	Mercury Porosimetry .....	71
5.1.3	X-ray Microtomography .....	72
5.2	Scanning Electron Microscopy Observations .....	72
5.2.1	Bases of Image Analysis .....	73
5.2.2	Morphological Filtering .....	74
6	Macroscopic Methods .....	75
6.1	Mechanical Brazilian Tests.....	75
6.1.1	Principle of the Test .....	75
6.1.2	Compression of Porous Materials .....	76
6.2	Surface Energy Experiments .....	77

6.2.1	Surface Tensions of Liquids .....	78
6.2.1.1	Du Noüy Ring Method.....	79
6.2.1.2	Wilhelmy Plate Method .....	79
6.2.1.3	Lucas-Washburn' Method.....	80
6.2.1.4	Surface Tensions of Classical Liquids .....	80
6.2.2	Surface Energy of Solids .....	80
6.2.2.1	Young-Dupré' Equation.....	80
6.2.2.2	Model of Owens-Wendt : Two Components Theory .....	81
6.2.2.3	Model of Good-Van Oss : Three Components Theory .....	83
7	Designs of Experiments.....	84
7.1	Modelization Plans: Doehlert's Design.....	84
7.2	Screening Plans: Taguchi' Design.....	85
8	Conclusion .....	86
<b>Chapter 4</b>	.....	<b>87</b>
1	Procedure for Size Reduction .....	87
1.1	Size Reduction.....	87
1.1.1	Size Reduction by Knife Mill .....	87
1.1.2	Tumbling Ball Mill Grinding.....	88
1.2	Sieving of Ground Material.....	89
1.3	Mixing of Polymer Powder with Fillers .....	89
1.3.1	Simple Mixing of Polymer Powder with Fillers .....	90
1.3.2	Co-grinding in the Tumbling Ball Mill.....	90
1.4	Preparation of Pellets by Dry Method .....	91
1.4.1	Evacuable Pellet Die.....	91
1.4.2	Procedure to Prepare Pellets .....	92
1.4.2.1	Preparation of the Die .....	93
1.4.2.2	Loading the Die.....	93
1.4.2.3	Processing the Pellets.....	93
1.4.2.4	Removing the Pellets .....	93
1.5	Preparation of Pellets by Wet Method.....	93
2	ScCO <sub>2</sub> Foaming Process .....	94
2.1	SEPAREX™ SF200 scCO <sub>2</sub> Pilot Plant .....	94
2.1.1	Experimental Device .....	94
2.1.2	Setup One: Filling the Chamber with Teflon® .....	96
2.1.3	Setup Two: Filling the Chamber with Glass Beads .....	96
2.2	SEPAREX™ SFC6 scCO <sub>2</sub> Laboratory Plant.....	96
2.2.1	Experimental Device .....	96
2.2.2	Experimental Procedure.....	96
2.2.2.1	Initial Filling of Chamber with CO <sub>2</sub> .....	97
2.2.2.2	Variations of Saturation Pressure and Temperature Holding For Time t.....	98
2.2.2.3	Depressurization of CO <sub>2</sub> .....	98
3	Protocols for Analysis .....	99
3.1	Granulometry.....	99
3.2	Differential Scanning Calorimetry .....	100



3.3 Contact Angle Measurement .....	101
4 Protocols for Porosity and Pore Size Measurement .....	102
4.1 Average Geometric Porosity .....	102
4.2 2D Image Analysis .....	103
4.2.1 Sputter Coater .....	103
4.2.2 SCION® Image Analysis .....	104
4.3 3D Hg Intrusion Porosity .....	107
4.4 3D Micro Computer Tomography .....	108
4.4.1 Acquisition .....	109
4.4.2 Corrections .....	109
4.4.3 Reconstruction .....	109
4.4.4 Viewing Results .....	109
4.4.5 Wide Variety of Post Processing .....	109
5 Mechanical Tests on Foams .....	110
5.1 Experimental Conditions of Test .....	110
5.2 Principle of Curve Analysis .....	110
6 Conclusion .....	111
<b>Chapter 5 .....</b>	<b>112</b>
1 Characterization of Biomaterials .....	113
1.1 Characterization of Polylactide Powders .....	113
1.1.1 Experiments on Polylactide Powders by Viscosimetry .....	115
1.1.2 Discussion on the Molecular Mass .....	116
1.1.3 Characterization of Polylactide Powders by DSC .....	116
1.1.4 Discussion on the Transitions .....	118
1.1.4.1 Effect of L and DL Ratio on Thermal Property of Polylactide Acid .....	118
1.1.4.2 Effect of LA/GA Ratio on T <sub>g</sub> of Polylactides .....	119
1.2 Characterization of Biomaterials Pellets .....	119
1.2.1 Mechanical Experiments .....	119
1.2.2 Discussion on Mechanical Modulus .....	119
2 Kinematics and Thermodynamics Experiments .....	120
2.1 Sorption-Diffusion Kinetics .....	120
2.2 Desorption-Diffusion Kinetics .....	121
2.3 The Sorption Isotherm .....	123
3.1.2 Discussion on the Blends of P <sub>L,DL</sub> LA and PLGA <sub>50:50</sub> .....	125
3.1.3 P <sub>L,DL</sub> LA and PLGA <sub>85:15</sub> Blend .....	125
3.1.4 Discussion on the Blends of P <sub>L,DL</sub> LA and PLGA <sub>85:15</sub> .....	126
3.2 Influence of the Parameters of the scCO <sub>2</sub> Process .....	126
3.2.1 Model with a 2 <sup>4</sup> Complete Design .....	126
3.2.2 Model with a Taguchi' Design for PLGA <sub>50:50</sub> Foaming .....	128
3.2.3 Model with a Doehlert' Design for PLGA <sub>50:50</sub> Foaming .....	130
3.2.3.1 Experiments with a Doehlert' Design .....	130
3.2.3.2 Discussion on the Effect of the Various CO <sub>2</sub> Process Parameters .....	132
4 Factors Affecting on Pores Size and Porosity .....	135

4.1 Effect of the Polymer Composition .....	135
4.2 Effect of Depressurization Rates .....	135
4.3 Effect of Saturation Pressure ( $P_{sat}$ ) .....	137
4.4 Effect of Saturation Temperature ( $T_{sat}$ ) .....	138
4.5 Effect of Saturation Time ( $t_{sat}$ ).....	139
4.6 Effect of the $dP/dt$ and $dT/dt$ .....	139
4.7 Effect of the Geometry of the Pressure Chamber .....	140
4.8 Interconnectivity and Coalescence Behaviour of the Scaffolds.....	141
4.9 Influence of Pellet Thickness on Foaming .....	142
4.9.1 Porosity and Cell Density .....	142
4.9.2 Pores Size Distribution .....	143
4.9.3 Correlation Between Effects of Pellet Thickness and Process Parameters .....	143
4.10 Discussion on Foam Morphology.....	144
5 Conclusion .....	146
<b>Chapter 6 .....</b>	<b>147</b>
1 Optimization of PLA's Foams Processed by Wet and Dry Methods .....	147
1.1 Experimental Procedure .....	147
1.1.1 Preparation of Pellets by Wet and Dry Methods.....	147
1.1.2 Taguchi' Design for Foaming.....	148
1.2 $P_{L,D}$ LA Foams Processed by Wet and Dry Methods: Initial Taguchi Plan .....	148
1.2.1 Effect of Process Parameters on Equivalent Pore Diameter ( $d_e$ ) .....	150
1.2.2 Effect of Process Parameters on Geometric Porosity .....	150
1.3 $P_{L,D}$ LA Foams Processed by Wet and Dry Methods: Complementary Taguchi' Plan.....	151
1.3.1 Effect of Process Parameters on Equivalent Pore Diameter ( $d_e$ ) .....	153
1.3.2 Effect of Process Parameters on Geometric Porosity .....	153
1.4 $P_{L,DL}$ LA Foams Processed by Wet and Dry Methods: Initial Taguchi Plan.....	154
1.4.1 Effect of Process Parameters on Equivalent Pore Diameter ( $d_e$ ) .....	155
1.4.2 Effect of Process Parameters on Geometric Porosity .....	156
1.5 $P_{L,DL}$ LA Foams Processed by Wet and Dry Methods: Complementary Taguchi' Plan .....	156
1.5.1 Effect of Process Parameters on Equivalent pore diameter ( $d_e$ ).....	158
1.5.2 Effect of Process Parameters on Geometric Porosity .....	158
1.6 Comparison Between Both PLAs.....	159
2 Optimization of PLGA's Foams by Wet and Dry Method.....	161
2.1 PLGA <sub>50:50</sub> Foams Processed by Wet and Dry Methods.....	161
2.1.1 Effect of Process Parameters on Equivalent Pore Diameter ( $d_e$ ) .....	162
2.1.2 Effect of Process Parameters on Geometric Porosity .....	163
2.2 PLGA <sub>50:50</sub> Foams by Wet and Dry Methods by Complementary Taguchi' Plan.....	163
2.2.1 Effect of Process Parameters on Equivalent Pore Diameter ( $d_e$ ) .....	165
2.2.2 Effect of Process Parameters on Geometric Porosity .....	165

2.3	PLGA <sub>85:15</sub> Foams Processed by Wet and Dry Methods: Initial Taguchi' Plan .....	166
2.3.1	Effect of Process Parameters on Equivalent Pore Diameter ( $d_e$ ).....	167
2.3.2	Effect of Process Parameters on Geometric Porosity.....	168
2.4	PLGA <sub>85:15</sub> Foams by Wet and Dry Methods by Complementary Taguchi Plan .....	169
2.4.1	Effect of Process Parameters on Equivalent Pore Diameter ( $d_e$ ).....	170
2.4.2	Effect of Process Parameters on Geometric Porosity.....	171
2.5	Comparison Between Both PLGAs .....	171
2.6	Pore Morphology and Anisotropy of Foams by Both Methods.....	173
2.7	Interconnectivity of Pores in Foams by Both Methods.....	176
2.8	Mechanical Properties of the Foams by Wet and Dry Methods .....	178
2.9	General Discussion .....	178
3	Modification of the Surface by Adding Hyaluronic Acid .....	179
3.1	Granulometry Analysis of PLGA and HA Before and After Co-grinding.....	179
3.2	Contact Angle Measurement and Surface Energy on Pellets.....	181
3.2.1	Results.....	181
3.2.1.1	Contact Angles with Water and Pellets of PLGA, HA and PLGA/HA Blends.....	181
3.2.1.2	Surface Energy of PLGA, HA and PLGA/HA blends .....	182
3.2.2	Origin of the Increase of Surface Energy.....	183
4	Foams of PLGA <sub>85:15</sub> /HA Blends.....	185
4.1	Preparation of Pellets.....	185
4.2	Effect of scCO <sub>2</sub> Parameters on the Microstructure of Foams .....	185
4.2.1	Effect of Depressurization Rate on the Microstructure of Foams .....	185
4.2.2	Effect of Saturation Temperature on the Microstructure of Foams.....	187
5	General Discussion.....	188
6	Conclusion.....	189
	<b>Chapter 7.....</b>	<b>190</b>
1	Characterization of Composites .....	190
1.1	Fillers and Adjuvant .....	190
1.1.1	Sr Calcium Phosphate .....	191
1.1.1.1	Synthesis and Characterization of Calcium Phosphates .....	191
1.1.1.2	Calcium Phosphate Characterization.....	191
1.1.1.3	Calcium Phosphate Granulometry.....	193
1.2	Adjuvant: Porogen Agent .....	194
1.2.1	Industrial Waxes .....	194
1.2.2	Thermal Degradation .....	195
2	Experiments on Polylactides/Tri-calcium Phosphate Scaffolds.....	195
2.2	Experiments on Polylactides/Tri-calcium Phosphate.....	195
2.3	Analysis of Experiments on Polylactides/Tri-calcium Phosphate .....	197
3	Foams of Polylactides/Calcium Phosphates Blends and Composites .....	198

3.2 Experiments on PLA/Waxes Scaffolds .....	198
3.2.1 Preliminary Experimentation with Wax as Porogen Agent .....	198
3.2.2 SEM Analysis of Foams .....	199
3.2.3 Effect of Wax on the Equivalent Pore Size and Geometric Porosity .....	201
3.3 Experiments on Polylactides/Tri-Calcium Phosphate/Wax Scaffolds .....	203
3.3.1 Effect of the Ratio of Wax on the Geometric Porosity and Equivalent Pore Size .....	203
3.3.2 Effect of Co-grinding Filler and PLGA on the Pore Morphology .....	205
3.4 Complementary Experiments on PLGA <sub>85:15</sub> /Tri-calcium Phosphate/Wax Scaffolds .....	206
4 Conclusion .....	209
<b>Chapter 8 .....</b>	<b>210</b>
1 Semi-industrial Production of Bone Scaffolds .....	210
1.1 Matrix: Polylactides .....	211
1.1.1 Experiments with Different Polylactides .....	211
1.1.2 Polylactide with Higher D,L Contents .....	212
1.2 Effect of Polymer Particle Size on Foaming .....	213
1.2.1 Foaming of PLGA <sub>85:15</sub> with Different Particle Size .....	214
2 Filler: Tri-calcium phosphate Doped by Sr .....	215
2.1 Experimentation on Blends and Composite Foams .....	215
2.1.1 Experimentation on Composite Foaming with Different Co-grinding Times .....	216
2.1.2 Foaming of Fine Powder and Filler Blend by Simple Mixing .....	217
2.1.3 Mixing Experimentation on Composite Foaming with Different Polymer Particle Size .....	218
3 Process Control for Composite Foaming .....	220
3.1 Semi-Industrial Foaming .....	220
3.1.1 Pellet Positions in scCO <sub>2</sub> Chamber .....	220
3.2 Final Experiments .....	222
3.2.1 Multi Pellet Formation in a Batch and Effect on Foaming .....	222
3.2.2 Preparation of Foams .....	224
3.2.2.1 Filling, Soaking and Depressurization Time of CO <sub>2</sub> in Chamber .....	224
3.2.2.2 Temperature Variation During Soaking of CO <sub>2</sub> .....	224
3.2.2.3 Dual Depressurization Rate .....	225
3.2.2.4 Temperature Variation During Depressurization of CO <sub>2</sub> .....	225
3.2.2.5 Retention Time after the Depressurization Step .....	225
3.2.3 Final foam experiments .....	225
3.2.4 Discussion on the Rugdness of the Process .....	226
4 Mechanical Properties of Scaffolds .....	229
4.1 Mechanical Characteristics of PLGA <sub>85:15</sub> Foam .....	229
4.2 Compressive Properties of Optimized PLGA <sub>85:15</sub> Composite Foams .....	231
4.3 Co-grinding time Effect on Compressive Properties of Composite Foams .....	231
4.4 Effect of Different Fillers and Wax-A Ratio on Compressive Properties of PLGA <sub>85:15</sub> Composite Foam .....	232
5 Interconnectivity of Pores by $\mu$ CT .....	233
5.1 PLGA <sub>85:15</sub> Scaffold .....	233
5.2 PLGA <sub>85:15</sub> Composite Scaffold .....	235

6 General Discussion.....	236
7 Conclusion.....	237
General Conclusion and Perspective .....	238
BIBLIOGRAPPHY .....	242
ANNEXES .....	264
Annex-A-1 .....	266
Annex A-2 .....	270
Annex A-3 .....	271



## List of Figures

Figure 1.1: Structures of selected biodegradable polymers.....	12
Figure 1.2: Stereo-forms of lactides. ....	13
Figure 1.3: Ring opening polymerization of lactide to polylactide. ....	14
Figure 1.4: Different ways of producing PLA.....	14
Figure 1.5: Schemaic synthesis of poly(lactide-co-glycolide).....	17
Figure 1.6: Electron micrograph and chemical HA structure. ....	19
Figure 2.1: Procedure of solvent casting/particulate leaching.....	29
Figure 2.2: Procedure of ice particle–leaching. ....	30
Figure 2.3: Procedure of gas foaming/salt-leaching method. ....	31
Figure 2.4: Procedure of scaffolds by gel-pressing method. ....	32
Figure 2.5: Schematic procedure of the processing of PLGA microsphere scaffolds. ....	33
Figure 2.6: Schematic procedure for manufacturing of scaffolds with the particle-aggregated technique. ....	33
Figure 2.7: Schematic preparation processing of scaffold by the freeze-drying method. ....	34
Figure 2.8: Schematic preparation processing of thermally induced phase separation method. ....	35
Figure 2.9: Schematic procedure showing the fabrication of scaffolds by centrifugation method and photographs of variously shaped scaffolds. ....	36
Figure 2.10: Reaction of injectable thermosensitive gel.....	37
Figure 2.11: Schematic stepwise representation of the polymeric foaming using hydrocarbon porogen. ....	39
Figure 2.12: Schematic diagram of the fused deposition modelling (FDM) system. ....	40
Figure 2.13: Schematic diagram of the 3D Bioplotter™ system.....	40
Figure 2.14: Schematic diagram of the Stereolithography (SLA) system. ....	41
Figure 2.15: Schematic diagram of the phase change jet printing system, the Model-Maker II. ....	42
Figure 2.16: Phase diagrams P-T and $\rho$ -P for a pure CO <sub>2</sub> . ....	43
Figure 2.17: ScCO <sub>2</sub> experimental apparatus (A) CO <sub>2</sub> tank, (B) syringe pump and (C) pressure vessel. ....	45
Figure 2.18: Schematic representation of the supercritical fluid foaming process.....	46
Figure 2.19: Schematic presentation for scaffold generation during scCO <sub>2</sub> foaming. ....	47
Figure 2.20: Evolution of process parameters and the occurring phenomena during the foaming with time. ....	48
Figure 2.21: Schematic of the phenomenon of fragmentation in the co-grinding.....	59
Figure 2.22: Different stages of agglomeration during the co-grinding: (a) adhesion, (b) coating and (c) agglomeration. ....	59
Figure 3.1: Differential scanning calorimetry. ....	62
Figure 3.2: Thermograms of two P <sub>L</sub> LAs of different Mw. ....	63
Figure 3.3: Characteristic variation of glass transition in PLGA. ....	63
Figure 3.4: Schematic representation of the Ubbelohde viscosimeter.....	65
Figure 3.5: Variation with concentration of reduced specific and inherent viscosities of P <sub>L,D</sub> LA (LR 704)...	66
Figure 3.6: (A) Mastersizer® 2000 (Malvern Instruments™) (B) Schematic diagram showing the main components of a laser diffraction particle size analyzer. ....	67
Figure 3.7: Scheme of laser diffraction of a spherical particle. ....	68
Figure 3.8: Three dimensional model of scattering from a dipole.....	68
Figure 3.9: Scattering patterns of two particles of a different size. ....	69
Figure 3.10: Principles of Fresnel' diffraction (A) and Fraunhofer' diffraction (B and C).....	69
Figure 3.11: Desorption of CO <sub>2</sub> from PLGA <sub>50:50</sub> with time.....	70

Figure 3.12: (A): Hg porosimeter apparatus and (B): Pore size distribution of P <sub>L</sub> LA samples.....	71
Figure 3.13: $\mu$ CT principle and images of P <sub>L</sub> LA/Silica sample. ....	72
Figure 3.14: Schematic representation of interactions beam on specimen surface.....	73
Figure 3.15: SCION <sup>®</sup> Image processing and pore data retrieval. ....	74
Figure 3.16: (A): A binary image and a structuring element (top left corner).(B): Erosion (C): Dilation (D): Opening (E): Closing of the original image.....	74
Figure 3.17: H25KS Brazilian testing equipment.....	75
Figure 3.18: (A): Principle, (B): Load geometry, (C): Simulation and (D): Cleavage of a Brazilian disk test. .....	76
Figure 3.19: Compression testing equipment for foams and result. ....	77
Figure 3.20: Wetting of hydrophilic and hydrophobic samples.....	78
Figure 3.21: The Du Noüy' ring method. ....	79
Figure 3.22: The Wilhelmy' plate method with a platinum plate.....	79
Figure 3.23: Principle of the absorption Washburn' method.....	80
Figure 3.24: Vectorial equilibrium for a drop of a liquid resting on a solid surface to balance three forces. .	81
Figure 3.25: Example of determination of surface energy components of a blend PLGA + 5 % HA.....	83
Figure 3.26: Example of determining the surface energy components with Good-Van Oss' method .....	84
Figure 3.27: Distribution of experimental points for a Doehlert's design of 2-variables. ....	85
Figure 4.1: Polylactide granulates size reduction by knife mill.....	88
Figure 4.2: Milling process in tumbling ball mill. ....	88
Figure 4.3: Cataract movement of grinding media. ....	89
Figure 4.4: AFNOR and ASTM 3 ½ in diameter sieves.....	90
Figure 4.5: Magnetic stirrer mixing for composite materials. ....	90
Figure 4.6: Multistep size reduction of composite.....	91
Figure 4.7: Schematic diagram to produce pellets in semi-industrial quantities. ....	92
Figure 4.8: Schematic representation to process pellets by using hydraulic press. ....	92
Figure 4.9: Schematic representation of processing pellets by wet method. ....	94
Figure 4.10: SEPAREX <sup>™</sup> Pilot SF200 Process Flow Diagram. ....	95
Figure 4.11: Details of equipment (SEPAREX <sup>™</sup> Pilot SF200). ....	95
Figure 4.12: Schematic representation of the cross section of the supercritical CO <sub>2</sub> .....	96
Figure 4.13: Details of equipment (SEPAREX <sup>™</sup> Pilot SFC-6). ....	97
Figure 4.14: SEPAREX <sup>™</sup> Pilot SFC-6 Process Flow Diagram. ....	97
Figure 4.15: Variation of chamber temperature during 20 minutes of scCO <sub>2</sub> process for PLGA <sub>50:50</sub> foam....	98
Figure 4.16: Graph presenting the drop in pressure during 40 sec of depressurization step. ....	98
Figure 4.17: Size distribution of P <sub>L,D</sub> LA particle after 30 minutes of grinding .....	99
Figure 4.18: Variation of Particle Diameter with Grinding time for P <sub>L,D</sub> LA.....	99
Figure 4.19: DSC analysis flow sheet of polymer material and foam. ....	100
Figure 4.20: Goniometer GBX used for contact angle measurement. ....	101
Figure 4.21: (A): Schematic diagram and (B): Two methods for determining the contact angle.....	101
Figure 4.22: Sputter coating and SEM processing flow diagram. ....	103
Figure 4.23: SEM Images of cross sectional foam. ....	104
Figure 4.24: Various steps of transformation of SEM image by Scion <sup>®</sup> .....	105
Figure 4.25: Graphs obtained from the initial data of SCION <sup>®</sup> image analysis. ....	106
Figure 4.26: Pore distribution comparison in a foam with different aspects. ....	107
Figure 4.27: Autopore analyzer for porosity.....	108



Figure 4.28: Incremental Intrusion vs Pore size. ....	108
Figure 4.29: Set up of $\mu$ CT and Flow chart of $\mu$ CT measurement process. ....	109
Figure 4.30: $\mu$ CT slice view from different direction for different bone scaffold presenting the interconnectivity. ....	110
Figure 4.31: Stress strain graph of PLGA foam obtained showing the three regions. ....	111
Figure 5.1: Courbe size distribution of various PLAs after knife mill grinding. ....	115
Figure 5.2: Thermograms of various PLAs. ....	116
Figure 5.3: Thermograms of PLGA <sub>50:50</sub> . ....	117
Figure 5.4: Thermograms of 3 different PLGA <sub>85:15</sub> . ....	117
Figure 5.5: Stress strain curve obtained from Brazilian Test for P <sub>L,D</sub> LA (PAB RL 68). ....	119
Figure 5.6: (A)-Kinetics and modelling of the sorption of CO <sub>2</sub> in PLGA <sub>50:50</sub> at 125 bar and 36.5°C, (B) Desorption of CO <sub>2</sub> from PLGA <sub>50:50</sub> of CO <sub>2</sub> in PLGA <sub>50:50</sub> at 125 bars and 36.5°C. ....	121
Figure 5.7: Desorption of CO <sub>2</sub> from PLGA <sub>50:50</sub> after 100 and 200 bars, at T <sub>sat</sub> = 36.5°C and t <sub>sat</sub> = 120 min. ....	122
Figure 5.8: Sorption isotherm of CO <sub>2</sub> into PLGA <sub>50:50</sub> . ....	123
Figure 5.9: The depression of PLGA <sub>50:50</sub> T <sub>g</sub> as a function of the weight fraction of sorbed CO <sub>2</sub> : (♦) 100 bars; (●) 200 bars. ....	124
Figure 5.10: Micrographs of the P <sub>L,D</sub> LA and PLGA <sub>50:50</sub> blend scaffolds. ....	125
Figure 5.11: Average pore diameter of polymer blends as a function of P <sub>L,D</sub> LA ratio. ....	125
Figure 5.12: Average pore diameter of polymer blends as a function of P <sub>L,D</sub> LA ratio. ....	126
Figure 5.13: Average pore diameter as a function of PLGA <sub>50:50</sub> ratio in the PLGA <sub>50:50</sub> /PLGA <sub>85:15</sub> blends. ..	128
Figure 5.14: Variation of foam porosity. ....	130
Figure 5.15: Average pore diameters of PLGA <sub>50:50</sub> scaffolds as a function of the process parameters. ....	130
Figure 5.16: Micrographs of the cross-section of the foams processed at P = 125 bars. ....	131
Figure 5.17: Variation of the porosity of the foams as a function of depressurization rate. ....	132
Figure 5.18: Influence of dP/dt on the pore size of the foams processed at scCO <sub>2</sub> condition P <sub>sat</sub> = 100 bars, T <sub>sat</sub> = 36.5°C and t <sub>sat</sub> = 60 min. ....	133
Figure 5.19: (A) Variation of pore diameter of the PLGA <sub>50:50</sub> scaffolds as the function of P <sub>sat</sub> ; (B) Variation of the energy barrier for PLGA <sub>50:50</sub> -CO <sub>2</sub> system. ....	134
Figure 5.20: T <sub>g</sub> -w diagram of the P <sub>L,D</sub> LA (---) and PLGA <sub>50:50</sub> (—); (●) and (♦), are the weight fraction of CO <sub>2</sub> in P <sub>L,D</sub> LA and PLGA <sub>50:50</sub> at 100 bars, respectively. The value for the weight fraction of P <sub>L,D</sub> LA at 100 bars and 35°C is taken from [Pini <i>et al.</i> , 2008]. ....	136
Figure 5.21: Micrographs of scaffolds processed at P <sub>sat</sub> = 200 bars; T <sub>sat</sub> = 36.5°C, t <sub>sat</sub> = 20 min. and dP/dt = 20 bar /s. ....	137
Figure 5.22: Micrographs revealing the effect of P <sub>sat</sub> on pore size. ....	138
Figure 5.23: Micrographs revealing the effect of T <sub>sat</sub> on pore size. ....	138
Figure 5.24: Micrographs revealing the effect of t <sub>sat</sub> on pore size. ....	139
Figure 5.25: Micrographs revealing the effect of dP/dt and dT/dt on pore size. ....	140
Figure 5.26: Representation of the effect of the geometry of the pressure chamber on the porous structure. ....	140
Figure 5.27: Micrographs depicting coalescence and collapse of pores. ....	141
Figure 5.28: Porosity of PLGA <sub>50:50</sub> foams for pellets with different initial thickness. ....	142
Figure 5.29: Pore density of PLGA <sub>50:50</sub> foams with different initial pellet thickness. ....	142
Figure 5.30: PLGA <sub>50:50</sub> foams obtained with different initial pellet thicknesses. ....	143
Figure 5.31: Different distribution of pores in PLGA <sub>50:50</sub> foams. ....	143
Figure 5.32: Variation in PLGA <sub>50:50</sub> foams geometric porosity for different process parameters. ....	144

Figure 5.33: Distribution of pores at different process condition.....	145
Figure 5.34: Cell densities of pores produced at different process condition.....	145
Figure 5.35: Percentage of surface area for Distribution of Pores.....	145
Figure 5.36: Effective pore diameter for each process parameter. ....	145
Figure 6.1: Micrographs of $P_{L,D}$ LA foams processed by wet and dry methods.....	149
Figure 6.2: Average effect of each parameter on equivalent pore diameter of $P_{L,D}$ LA foams.....	150
Figure 6.3: Average effect of each parameter on variation of porosity of $P_{L,D}$ LA foams.....	150
Figure 6.4: Micrographs of $P_{L,D}$ LA foams processed by wet and dry methods.....	152
Figure 6.5: Average effect of each parameter on equivalent pore diameter of $P_{L,D}$ LA foams.....	153
Figure 6.6: Average effect of each parameter on variation of geometric porosity of $P_{L,D}$ LA foams.....	153
Figure 6.7: Micrographs of $P_{L,DL}$ LA foams processed by wet and dry methods.....	155
Figure 6.8: Average effect of each parameter on equivalent pore diameter of $P_{L,DL}$ LA foams. ....	155
Figure 6.9: Average effect of each parameter on variation of geometric porosity of $P_{L,DL}$ LA foams. ....	156
Figure 6.10: Micrographs of $P_{L,DL}$ LA foams processed by wet and dry methods.....	158
Figure 6.11: Average effect of each parameter on equivalent pore diameter of $P_{L,DL}$ LA foams. ....	158
Figure 6.12: Average effect of each parameter on variation of porosity of $P_{L,DL}$ LA foams. ....	159
Figure 6.13: Average effect of each parameter on variation of equivalent pore diameter and porosity of $P_{L,D}$ LA and $P_{L,DL}$ LA foams by wet and dry methods from initial Taguchi plan.....	159
Figure 6.14: Average effect of each parameter on variation of equivalent pore diameter and porosity of $P_{L,D}$ LA and $P_{L,DL}$ LA foams by wet and dry methods from complementary Taguchi plan. ....	160
Figure 6.15: Micrographs of PLGA <sub>50:50</sub> foams processed by wet and dry methods.....	162
Figure 6.16: Average effect of each parameter on equivalent pore diameter of PLGA <sub>50:50</sub> foams.....	162
Figure 6.17: Average effect of each parameter on variation of geometric porosity of PLGA <sub>50:50</sub> foams. ....	163
Figure 6.18: Micrographs of PLGA <sub>50:50</sub> foams processed by wet and dry methods.....	165
Figure 6.19: Average effect of each parameter on equivalent pore diameter of PLGA <sub>50:50</sub> foams.....	165
Figure 6.20: Average effect of each parameter on variation of porosity of PLGA <sub>50:50</sub> foams. ....	166
Figure 6.21: Micrographs of PLGA <sub>85:15</sub> foams processed by wet and dry methods.....	167
Figure 6.22: Average effect of each parameter on equivalent pore diameter of PLGA <sub>85:15</sub> foams.....	168
Figure 6.23: Average effect of each parameter on variation of porosity of PLGA <sub>85:15</sub> foams.....	168
Figure 6.24: Micrographs of PLGA <sub>85:15</sub> foams processed by wet and dry methods.....	170
Figure 6.25: Average effect of each parameter on equivalent pore diameter of PLGA <sub>85:15</sub> foams. ....	170
Figure 6.26: Average effect of each parameter on variation of porosity of PLGA <sub>85:15</sub> foams.....	171
Figure 6.27: Average effect of each parameter on variation of equivalent pore diameter and porosity of PLGA <sub>50:50</sub> and PLGA <sub>85:15</sub> foams by wet and dry method for initial Taguchi plan.....	172
Figure 6.28: Average effect of each parameter on variation of equivalent pore diameter and porosity of PLGA <sub>50:50</sub> and PLGA <sub>85:15</sub> foams for complementary Taguchi plan.....	173
Figure 6.29: PLGA <sub>50:50</sub> scaffold pore morphology with detail inside view obtained by dry method and foams processed at 50°C-150 bars-25 min-6 bar/s.....	174
Figure 6.30: Pore Morphology of different types of scaffold processed by wet and dry methods.....	175
Figure 6.31: Comparison of pore morphology for PLAs and PLGAs foams processed at $T_{sat} = 50^{\circ}C$ , $P_{sat} = 100$ bars, $t_{sat} = 20$ min and $dP/dt = 3$ bar/s.....	176
Figure 6.32: Slice images of $P_{L,D}$ LA foams structure by $\mu$ CT analysis.....	176
Figure 6.33: Slice images of $P_{L,DL}$ LA foams structure by $\mu$ CT analysis. ....	176
Figure 6.34: Slice images of PLGA <sub>50:50</sub> foam structure by $\mu$ CT analysis.....	177
Figure 6.35: Slice images of PLGA <sub>85:15</sub> foam structure by $\mu$ CT analysis.....	177

Figure 6.36: Micrographs of particle before grinding.....	179
Figure 6.37: Evolution of the particle size distribution for PLGA+HA co-grinding.....	180
Figure 6.38: Micrographs of blend PLGA+ HA after different co-grinding time.....	181
Figure 6.39: Surface evolution of blend PLGA <sub>85:15</sub> + 10% HA pellets with co-grinding time.....	182
Figure 6.40: Influence of the co-grinding and the ratio of HA on the dispersive component of the blend surface energy.PLGA/HA.....	183
Figure 6.41: Influence of co-grinding time and the ratio of HA on the components Acid-Base of surface energy.....	184
Figure 6.42: Influence of co-grinding time and the ratio of HA on $\gamma_s^{nd}$ and $\gamma_s$ .....	184
Figure 6.43: Micrographs of PLGA <sub>85:15</sub> foams at $P_{sat} = 120$ bars, $t_{sat} = 20$ min and $T_{sat} = 35^\circ\text{C}$ , [50 $\times$ ].	185
Figure 6.44: Micrographs of blends PLGA <sub>85:15</sub> /HA 10% foams processed at $P_{sat} = 120$ bars, $t_{sat} = 20$ min, $T_{sat} = 35^\circ\text{C}$ , [100 $\times$ ].	186
Figure 6.45: Micrographs of blend PLGA/HA 10% foams processed at $P_{sat} = 120$ bars, $t_{sat} = 20$ min and $dP/dt = 3$ bar/s.	187
Figure 7.1: IR absorption spectrum of amorphous tricalcium phosphate (ATCP) doped with 10% Sr. ....	192
Figure 7.2: IR absorption spectrum of amorphous calcium phosphate (ACP) doped with 10% Sr after calcination 24 h.	192
Figure 7.3: IR absorption spectrum of tricalcium phosphate doped with 10% Sr after 2 hours of calcination.	193
Figure 7.4: Particles size of two different tricalcium phosphates analyzed by granulometry.	194
Figure 7.5: Melting and crystallisation of the wax A (TERHELL-907).	194
Figure 7.6: TGA curve of the wax-A (907).	195
Figure 7.7: Micrographs of PLGA <sub>85:15</sub> (8523) + tricalcium phosphate processed at scCO <sub>2</sub> conditions- $T_{sat} = 50^\circ\text{C}$ , $t_{sat} = 20$ min, $dP/dt = 3$ bar/s and varying $P_{sat}$ .	196
Figure 7.8: Micrographs of $P_{L,D}$ LA + tricalcium phosphate processed at scCO <sub>2</sub> conditions- $T_{sat} = 50^\circ\text{C}$ , $t_{sat} = 20$ min, $dP/dt = 3$ bar/s and varying $P_{sat}$ .	197
Figure 7.9: Micrographs of $P_{L,DL}$ LA foams at different process conditions.	199
Figure 7.10: Micrographs of $P_{L,DL}$ LA +(10%) wax-A foams at different process conditions.	199
Figure 7.11: Micrographs of $P_{L,DL}$ LA +(20%) wax-A foams at different process conditions.	200
Figure 7.12: Micrographs of $P_{L,DL}$ LA +(30%) wax-A foams at different process conditions.	200
Figure 7.13: Average effect of wax-A on the equivalent pore diameter for polymer wax blends.	202
Figure 7.14: Average effect of wax-A on the geometric porosity for polymer wax blends.	202
Figure 7.15: Micrographs of foams obtained by simple mixing of polymer and wax and processed - at [ $T_{sat} = 45^\circ\text{C}$ , $P_{sat} = 120$ bars, $t_{sat} = 20$ min, $dP/dt = 3$ bar/s].	204
Figure 7.16: Micrographs of foams obtained by simple mixing of polymer and wax and processed at [ $T_{sat} = 45^\circ\text{C}$ , $P_{sat} = 100$ bars $t_{sat} = 20$ min, $dP/dt = 3$ bar/s].	204
Figure 7.17: Micrographs of foams obtained by co-grinding polylactide and fillers processed at $T_{sat} = 45^\circ\text{C}$ , $P_{sat} = 120$ bars, $t_{sat} = 20$ min and $dP/dt = 3$ bar/s.	205
Figure 7.18: Micrographs of foams obtained by co-grinding polylactide and fillers processed at.....	206
Figure 7.19: Micrographs of foams containing different percentages of wax A.	208
Figure 7.20: Effect of particle size of polymer and different % of wax on foam pore diameter and porosity.	209
Figure 8.1: Micrographs of pure polymer and polymer with filler foams processed at scCO <sub>2</sub> condition $T_{sat} = 50^\circ\text{C}$ , $P_{sat} = 100$ bars, $t_{sat} = 20$ min, $dP/dt = 3$ bar/s.	211

Figure 8.2: Micrographs of PLGA <sub>85:15</sub> (RG 858 S) processed at P <sub>sat</sub> =100 bars, t <sub>sat</sub> =20 min and dP/dt =3 bar/s.	213
Figure 8.3: Size distributions of the ground and sieved particles of PLGA <sub>85:15</sub> .	213
Figure 8.4: Comparison of micrographs of foams with different polymer particle size range processed at scCO <sub>2</sub> condition T <sub>sat</sub> = 48°C, t <sub>sat</sub> = 20 min, dP/dt = 3 bar/s, P <sub>sat</sub> = 120 bars or P <sub>sat</sub> = 100 bars.	214
Figure 8.5: Effect of particle size on equivalent pore size and geometric porosity of PLGA <sub>85:15</sub> foams processed at T <sub>sat</sub> =48°C, t <sub>sat</sub> = 20 min and dP/dt = 3bar/s	215
Figure 8.6: Size distribution of composite formulation at different co-grinding time.	216
Figure 8.7: Micrographs of PLGA <sub>85:15</sub> composites foams processed at T <sub>sat</sub> = 50°C, P <sub>sat</sub> = 100 bars, t <sub>sat</sub> = 20 min, and dP/dt = 3 bar/s with different co-grinding times.	216
Figure 8.8: Micrographs of foams with different filler ratio processed at five different scCO <sub>2</sub> conditions.	218
Figure 8.9: Micrographs of foams of polymer with different particle size range +5% βTCP <sub>(sr)</sub> + 5% ATCP <sub>(sr)</sub> processed at. T <sub>sat</sub> = 45°C, P <sub>sat</sub> = 100 bars, t <sub>sat</sub> = 20 min and, dP/dt = 3 bar/s.	219
Figure 8.10: Effect of particle size on Pore diameter and porosity of foams containing 90% PLGA <sub>85:15</sub> +5%βTCP <sub>(sr)</sub> and 5%ATCP <sub>(sr)</sub> processed at--[45°C-100 bar-20 min-3 bar/s]	220
Figure 8.11: ScCO <sub>2</sub> Foaming installation with 3 perforated stainless steel plates stage.	220
Figure 8.12: Foams of polymer composite blend on 3 SS plates stage.	220
Figure 8.13: Micrographs of foams obtained from each plate processed at sc CO <sub>2</sub> process condition T <sub>sat</sub> =45°C, P <sub>sat</sub> = 100 bars, t <sub>sat</sub> = 20 min and dP/dt = 3bar/s.	221
Figure 8.14: Equivalent pore size and geometric porosity of foams at different places in the chamber.	221
Figure 8.15: Foams of pellets prepared in one batch.	222
Figure 8.16: Pore equivalent size and geometric porosity of composite foam in the same batch.	223
Figure 8.17: Percentage of pores in composite foams in the same batch.	223
Figure 8.18: Surface area of pores in composite foams in the same batch.	223
Figure 8.19: 90% PLGA <sub>85:15</sub> +5%ATCP <sub>(sr)</sub> +5%βTCP <sub>(sr)</sub> foams randomly selected from different batches processed at - T <sub>sat</sub> =45°C, P <sub>sat</sub> = 100 bar t <sub>sat</sub> = 20 min and dual dP/dt = 1 and 3bar/s.	225
Figure 8.20: SEM micrographs of 90 % PLGA <sub>85:15</sub> + 5 % ATCP <sub>(sr)</sub> + 5 % βTCP <sub>(sr)</sub> foams sected from different batches and processed at: T <sub>sat</sub> =48°C, P <sub>sat</sub> = 100 bars, t <sub>sat</sub> = 20 min and dual dP/dt = 1 and 3bar/s	226
Figure 8.21: Equivalent pore size and geometric porosity of 90% PLGA <sub>85:15</sub> + 5% ATCP <sub>(sr)</sub> + 5% βTCP <sub>(sr)</sub> foams from different batches.	227
Figure 8.22: Pore frequency and cumulative total pore area as a function of average pore diameter for 90% PLGA <sub>85:15</sub> +5%ATCP <sub>(sr)</sub> +5%βTCP <sub>(sr)</sub> foams selected randomly from different runs.	227
Figure 8.23: Equivalent pore diameter vs pore numbers for selected.	228
Figure 8.24: Pore diameter and porosity of composite foams from different batches	228
Figure 8.25: Pore morphology of selected polymer composite foams.	229
Figure 8.26: Internal morphology of 90% PLGA <sub>85:15</sub> +5%ATCP <sub>(sr)</sub> +5%βTCP <sub>(sr)</sub> foams	229
Figure 8.27: Some typical stress–strain curves of PLGA <sub>85:15</sub> porous scaffolds with internal macropores at different porosities produced at different process conditions.	230
Figure 8.28: Compressive properties of pure PLGA <sub>85:15</sub> foams with different porosities.	231
Figure 8.29: Compressive properties of foams containing 90 % PLGA <sub>85:15</sub> + 5 % βTCP <sub>(sr)</sub> + 5 % ATCP <sub>(sr)</sub> processed at T <sub>sat</sub> =48°C, P <sub>sat</sub> = 100 bars, t <sub>sat</sub> = 20 min, dual and dP/dt = 1 bar/s and 3 bar/s.	231
Figure 8.30: Compressive properties of foams containing 90 % PLGA <sub>85:15</sub> + 5 % βTCP <sub>(sr)</sub> + 5 % ATCP <sub>(sr)</sub> obtained after co-grinding.	232
Figure 8.31: Compressive properties of 90%PLGA <sub>85:15</sub> + 5%βTCP <sub>(sr)</sub> +5%ATCP <sub>(sr)</sub> foams with different fillers ratios	233

Figure 8.32: Slice images of pure PLGA <sub>85:15</sub> foams by $\mu$ CT analysis processed at $T_{\text{sat}} = 48^{\circ}\text{C}$ , $P_{\text{sat}} = 100$ bars, $t_{\text{sat}} = 20$ min and $dP/dt = 3\text{bar/s}$ .....	233
Figure 8.33: $\mu$ CT Slice images at intervals of $500\mu\text{m}$ of pure PLGA <sub>85:15</sub> foams structure showing interconnectivity processed at $T_{\text{sat}} = 48^{\circ}\text{C}$ , $P_{\text{sat}} = 100$ bars, $t_{\text{sat}} = 20$ min and $dP/dt = 3\text{bar/s}$ .....	234
Figure 8.34: Slice images of 90 % PLGA <sub>85:15</sub> + 5 % ATCP <sub>(sr)</sub> + 5 % $\beta$ TCP <sub>(sr)</sub> foams structure by $\mu$ CT analysis processed at $T_{\text{sat}} = 48^{\circ}\text{C}$ , $P_{\text{sat}} = 100$ bars, $t_{\text{sat}} = 20$ min and $dP/dt = 3\text{bar/s}$ .....	235
Figure 8.35: $\mu$ CT Slice images at intervals of $500\mu\text{m}$ of 90 % PLGA <sub>85:15</sub> + 5 % ATCP <sub>(sr)</sub> + 5 % $\beta$ TCP <sub>(sr)</sub> foams processed at $T_{\text{sat}} = 48^{\circ}\text{C}$ , $P_{\text{sat}} = 100$ bars, $t_{\text{sat}} = 20$ min, and $dP/dt = 3\text{bar/s}$ .....	236
Figure A-7.1: Mergers and crystallization of wax - B (C80) during the 1 <sup>st</sup> and 2 <sup>nd</sup> scans.....	271
Figure A-7.2: Fusion and crystallization of wax-C (H1) during the 1 <sup>st</sup> and 2 <sup>nd</sup> scans.....	271
Figure A-7.3: Micrographs of P <sub>L,DL</sub> LA +(20%) Wax-C foams at different process conditions .....	272
Figure A-7.4: Micrographs of P <sub>L,DL</sub> LA +(30%) Wax-B foams at different process conditions .....	272
Figure A-7.5: Average effect of waxB and Wax-C on the pore diameter variations for polymer wax blends .....	273
Figure A-7.6: Average effect of wax-B and Wax-C on the relative porosity variations for polymer wax blends .....	273



## List of Tables

Table 1.1: Summary of mechanical properties of osteoporotic (OP) bone and normal bone.....	9
Table 1.2: Main physical properties of different PLAs. ....	15
Table 1.3: Main physical properties of PGA and several PLGAs. ....	17
Table 1.4: Degradation times of common polylactides. ....	18
Table 1.5: Solubility products of TCP phases in water at 25°C. ....	23
Table 2.1: Typical values of physical properties of gas, supercritical fluid and liquid. ....	43
Table 2.2: Critical conditions of several substances. ....	44
Table 2.3: SL-EOS characteristic parameters for CO <sub>2</sub> and PLGA <sub>50:50</sub> . ....	51
Table 2.4: Parameters used to calculate the depression of T <sub>g</sub> according to Chow's model.....	52
Table 4.1: Sieving mesh for different powder particles.....	89
Table 4.2: Dimensional data of PLGA <sub>50:50</sub> pellets and foams for geometric porosity. ....	102
Table 4.3: Example of data obtained from SCION® image analysis.....	105
Table 4.4: Example of pore distribution data, pore morphology and final SCION® image. ....	106
Table 5.1: Polylactide origin and physical state. ....	114
Table 5.2: Mean diameters of the polymers after knife mill grinding by granulometry. ....	115
Table 5.3: Viscosity values of PLGA <sub>50:50</sub> . ....	115
Table 5.4: Comparison between molecular weight of various polylactides. ....	116
Table 5.5: Glass transitions parameters of the various polylactides. ....	118
Table 5.6: Mechanical Properties of the polymer used. ....	119
Table 5.7: Desorption-diffusion coefficients and sorption of CO <sub>2</sub> after different saturation times at saturation pressure 125 bars and saturation temperature 36.5°C. ....	122
Table 5.8: Desorption-diffusion coefficients of CO <sub>2</sub> from PLGA <sub>50:50</sub> for plasticized and glassy states, after different saturation pressures at 36.5°C for 120 min. of saturation time. ....	122
Table 5.9: Sorption data for PLGA <sub>50:50</sub> at 36.5°C.....	123
Table 5.10: Blends of PLGA <sub>50:50</sub> and P <sub>L,DL</sub> LA. ....	124
Table 5.11: Blends of PLGA <sub>85:15</sub> and P <sub>L,DL</sub> LA. ....	125
Table 5.12: Variation domain of the various factors. ....	127
Table 5.13: 2 <sup>4</sup> design of experiments: levels of factors and average size of pores. ....	127
Table 5.14: Coefficients of the 2 <sup>4</sup> model for the PLGA <sub>85:15</sub> and the PLGA <sub>50:50</sub> . ....	128
Table 5.15: Domain of definition for the Taguchi' design. ....	128
Table 5.16: Experiments with the Taguchi design and the average diameter of pores for PLGA <sub>50:50</sub> . ....	129
Table 5.17: Average diameter of pores for all factors and their effects. ....	129
Table 5.18: Doehlert' design and the results for the average diameter of pores. ....	130
Table 5.19: Repetitions experiments of Doehlert' design (P <sub>sat</sub> = 100 bars and dP/dt = 5 bar/s).....	131
Table 5.20: Variation in the average size of pores with different dP/dt values at P <sub>sat</sub> = 100 bars. ....	132
Table 5.21: Complementary Doehlert' design experiments. ....	133
Table 5.22: Analysis of the Doehlert design: coefficients of the model.....	133
Table 5.23: Analysis of the Doehlert design: research of the optimum of the pore dimension.....	134
Table 5.24: Hidebrand' and Hansen' parameters of the PLA and the PGA in (MPa) <sup>1/2</sup> . ....	135
Table 5.25: Pellets of variable thickness and their foam data. ....	142
Table 5.26: ScCO <sub>2</sub> process conditions for foaming of PLGA <sub>50:50</sub> . ....	144



Table 6.1: Initial Taguchi plans for scCO <sub>2</sub> foaming of pellets prepared by wet and dry method. ....	148
Table 6.2: P <sub>L,D</sub> LA foams pore data of wet and dry method by initial Taguchi' plan.....	148
Table 6.3: Complementary Taguchi plans for scCO <sub>2</sub> foaming of pellets prepared by wet and dry method. .	151
Table 6.4: P <sub>L,D</sub> LA foams pore data of wet and dry method by complementary Taguchi plan. ....	151
Table 6.5: P <sub>L,DL</sub> LA foams pore data of wet and dry method by initial Taguchi' plan. ....	155
Table 6.6: P <sub>L,DL</sub> LA foams pore data of wet and dry method by complementary Taguchi plan. ....	156
Table 6.7: P <sub>L,D</sub> LA equivalent pore diameter and geometric porosity results for both methods and plans.....	159
Table 6.8: P <sub>L,DL</sub> LA equivalent pore diameter and geometric porosity results for both methods and plans. .	159
Table 6.9: PLGA <sub>50:50</sub> foams pore data of wet and dry method by initial Taguchi plan. ....	162
Table 6.10: PLGA <sub>50:50</sub> foams pore data of wet and dry method by complementary Taguchi plan. ....	163
Table 6.11: PLGA <sub>85:15</sub> foams pore data of wet and dry method by initial Taguchi plan. ....	167
Table 6.12: PLGA <sub>85:15</sub> foams pore data of wet and dry method by complementary Taguchi plan. ....	169
Table 6.13: PLGA <sub>50:50</sub> equivalent pore diameter and porosity results for both methods and plans.....	171
Table 6.14: PLGA <sub>85:15</sub> equivalent pore diameter and porosity results for both methods and plans.....	172
Table 6.15: Comparison of foam porosities obtained by two different methods.....	177
Table 6.16: Compressive modulus and compressive strength of polymer foams by both methods. ....	178
Table 6.17: Contact Angle between water and pellets constituted by HA, PLGA or HA-PLGA blends. ....	181
Table 6.18: Angle measured by different liquids on PLGA pellet .....	182
Table 6.19: Comparison of energies by two different methods for PLGA and PLGA/HA blends .....	183
Table 6.20: scCO <sub>2</sub> process conditions for PLGA/HA foams. ....	185
Table 6.21: Pore analysis for PLGA <sub>85:15</sub> foams processed at P <sub>sat</sub> = 120 bars, t <sub>sat</sub> = 20 min and T <sub>sat</sub> = 35°C. .	186
Table 6.22: Pore analysis data for blends PLGA <sub>85:15</sub> /HA 10% foams. ....	186
Table 6.23: Blend PLGA <sub>85:15</sub> /HA 10% foams processed at P <sub>sat</sub> =120 bars, t <sub>sat</sub> =20 min. and dP/dt = 3 bar/s. .	188
Table 6.24: PLGA <sub>85:15</sub> /10%HA composite foams pore data process at P <sub>sat</sub> =120 bars and t <sub>sat</sub> =20 min. ....	188
Table 7.1: Position of resulting bands in the FTIR analysis. ....	191
Table 7.2: Position of bands in FTIR for amorphous calcium phosphate (ACP). ....	192
Table 7.3: Position of bands in FTIR for other groups. ....	193
Table 7.4: Position of bands in FTIR for pyrophosphate.....	193
Table 7.5: Thermodynamics transitions and thermal properties of the waxes.....	195
Table 7.6: Levels selected for each parameter of the scaffold and foaming process with supercritical CO <sub>2</sub> at (T <sub>sat</sub> = 50°C, dP/dt = 3 bar/min and t <sub>sat</sub> = 20 min).....	196
Table 7.7: PLGA <sub>85:15</sub> and P <sub>L,D</sub> LA Foams pore data with different % of tricalcium phosphate. ....	197
Table 7.8: Mass ratio of polymer and different waxes and Taguchi' plan (L <sub>9</sub> ) for polymer-wax blend foams. .....	198
Table 7.9: Equivalent pore diameter of pure P <sub>L,DL</sub> LA and polymer-wax blend foams. ....	201
Table 7.10: Geometric porosity of pure P <sub>L,DL</sub> LA and polymer-wax blend foams. ....	201
Table 7.11: Pure P <sub>L,DL</sub> LA and polymer-wax blend equivalent pore diameter and porosity results. ....	202
Table 7.12: Equivalent pore diameter and geometric porosity of foams of composite plus wax by simple mixing processed at T <sub>sat</sub> =45°C, t <sub>sat</sub> = 20 min, and dP/dt = 3bar/s.....	204
Table 7.13: Equivalent pore diameter and geometric porosity of foams of composite plus wax by co-grinding processed at two saturation pressures. ....	206
Table 7.14: Composition of pellets of different polymer particle size and with variable % of wax. ....	207
Table 7.15: Pore diameter of foams with different particle size and with variable % of wax. ....	207



Table 8.1: Polymers with different $T_g$ 's and LA/GA ratios.....	211
Table 8.2: Pore size of polymers and polymer plus filler.....	212
Table 8.3: Effect of polymer and process temperature on equivalent pore diameter and geometric porosity. .....	212
Table 8.4: Mean particles sizes of PLGA samples.....	214
Table 8.5: Pore size and porosity of PLGA foams with different particle size range for two scCO <sub>2</sub> -conditions with different $P_{sat} = 120$ bars, or $P_{sat} = 100$ bars.....	215
Table 8.6: Mean particle size of composite matrix after different co-grinding time.....	216
Table 8.7: Equivalent pore diameter and porosity of foams processed at different co-grinding time at $T_{sat} =$ $50^\circ\text{C}$ , $P_{sat} = 100$ bars, $t_{sat} = 20$ min, and $dP/dt = 3$ bar/s.....	217
Table 8.8: Pores diameter and porosity of selected [PLGA <sub>85:15</sub> +ATCP <sub>(sr)</sub> + $\beta$ TCP <sub>(sr)</sub> ] foams. ....	217
Table 8.9: Equivalent pore diameter and geometric porosity of PLGA + 5% $\beta$ TCP <sub>(sr)</sub> + 5% ATCP <sub>(sr)</sub> foams with different particle size range processed at $T_{sat} = 45^\circ\text{C}$ , $P_{sat} = 100$ bars, $t_{sat} = 20$ min and $dP/dt$ $= 3$ bar/s.....	219
Table 8.10: Dimmensions of foams placed onto 3 SS plates stage .....	221
Table 8.11: Weight and percentages of polymer grinding and sieving for different particle size ranges. ....	223
Table 8.12: Pore diameter and porosity of PLGA <sub>85:15</sub> foams.....	230
Table 8.13: PLGA <sub>85:15</sub> foam compressive test data obtained from stress strain curves.....	230
Table 8.14: Polymer matrix with variation in fillers and wax A ratio.....	232

# Introduction

Over the past decade, the use of polymeric materials for the administration of pharmaceuticals and as biomedical devices has increased exponentially. The most important biomedical applications of biodegradable polymers are in the areas of controlled drug delivery systems and in the form of implants and devices for fracture repairs, cartilage replacement, ligament reconstruction, tissue regeneration surgical dressings, dental repairs, artificial heart valves, contact lenses, cardiac pacemakers, vascular grafts, tracheal replacements, and organ regeneration [Dumitriu, 1994].

Indeed tissue engineering is an extremely important area. It generally involves the use of materials and cells with the goal of trying to understand tissue function and some day enabling virtually any tissue or organ on the body to be made *de novo*. To achieve this very important long-range objective requires research in many areas. For the last few years, tissue engineering is proving to be a great hope for regenerating or repairing damaged tissues. Recent technological advancement in 21<sup>st</sup> century has opened a new era for the production of artificial organs by means of tissue engineering and regenerative medicine to repair or replace damaged/diseased tissues and organs. An increase in the average age of the human beings as well as in the incidence of age-related “wear-and-tear” conditions and traumatic injuries/diseases, the shortage of healthy donor organs has led to the emergence of tissue engineering and regenerative medicine. To cope with this sensitive engineering materials are required that are biodegradable and compatible with the *in vivo* conditions [Khang *et al.*, 2007].

To reconstruct a new tissue by tissue engineering, triad, (a) cells which are harvested and dissociated from the donor tissue; (b) biomaterials as scaffold substrates in which cells are attached and cultured, resulting in implantation at the desired site of the functioning tissue; and (c) growth factors which promote and/or prevent cell adhesion, proliferation, migration, and differentiation, are needed:

(1) As cells adhere to the extracellular matrix material in the body, this matrix has an enormous effect on how the cells behave,

(2) Scaffolds play a critical role in the reorganization of neo-tissues and neo-organs. However, to try to recreate extracellular matrix is a difficult task and therefore various biodegradable polymers have been explored to provide substrates for cell growth which can be tried *in vivo*. Scaffold matrices can be used to achieve cell delivery with high loading and efficiency to specific sites.

There are numerous types of manufacturing protocols for tissue-engineered scaffolds that are adapted for various applications. Each manufacturing methods have its limitation [Khang *et al.*, 2007]. Scaffold design and fabrication are discussed so that the reader may have a better understanding of how to develop and manufacture these systems [Blitterswijk and Thomsen, 2008]. Porous biodegradable scaffolds, filled with appropriate type of cells, proteins or drugs, are used as grafts of tissue engineering. These scaffolds can be implanted to the desired tissue of body (bone, cartilage, muscles, nerves, *etc.*) to provide a template for tissue regeneration by controlled releasing its content and by slowly resorbing or degrading, and finally leaving no foreign components in the body, hence decreasing the risk of inflammation [Mathieu, 2004; Hile *et al.*, 2000; Mooney *et al.*, 1996].

The scaffold for supporting 3D cell culture must meet various criteria to function appropriately and to promote cell growth. These criteria include both mechanical parameters as well as parameters of

biological performance. Biocompatibility of the scaffold is critical and must not damage cells and alter their functions or lead to significant scarring.

A number of biodegradable scaffolds are described in the literature. Most of these scaffolds come from the family of polyesters. Poly( $\alpha$ -hydroxy acids) like poly(lactic acid) (PLA), poly(glycolic acid) (PGA), and the co-polymer, known as poly(lactic-co-glycolic acid) (PLGA) are a part of tissue engineering studies. The common use of these polymers is basically related to their degradation behaviour. Polymer degradation takes place mostly through scission of the main chains or side-chains of polymer molecules, induced by their thermal activation, oxidation, photolysis, radiolysis, or hydrolysis. Some polymers undergo degradation in biological environments when living cells or microorganisms are present around the polymers. PLA degrades into lactic acid, and PLGA degrades into lactic and glycolic acid. Also, for PLGA, the degradability rate can be controlled by changing the co-monomer composition. Furthermore, PLA and PLGA are approved by United States Food and Drug Administration for biomedical uses [Ikada and Tsuji, 1999; Steinbüchel, 2003].

Supercritical CO<sub>2</sub> (scCO<sub>2</sub>) foaming was first proposed by Mooney *et al.* [1996] to create porous PLGA and PLA scaffolds by the pressure quench method, which was first proposed by Goel and Beckman [1994] to manufacture microcellular PMMA foams. There have been a number of followers, which worked on foaming of biodegradable polymers to create porous scaffolds by this method [Reverchon and Cardea, 2007a; Tsivintzelis *et al.*, 2007a; Quirk *et al.*, 2004a; Goel and Beckman, 1994a, 1995; Khang *et al.*, 2007].

Supercritical CO<sub>2</sub> is a green solvent and this method consists in using CO<sub>2</sub> as a blowing agent for the polymer to create porous material. CO<sub>2</sub> is used because it is relatively non-toxic, relatively inert, and non combustible. Also, it has relatively reachable critical points ( $T_c = 31^\circ\text{C}$  and  $P_c = 73.8$  bars). Thus it can be used to prepare microcellular foams using supercritical fluids as foaming agents. It has many advantageous properties, which enable their use as foaming agents; these include a tuneable solvent power, the plasticization of glassy polymers (as a consequence of glass transition temperature depression) and enhanced diffusion rates. The low critical temperature of CO<sub>2</sub> allows an easy and complete separation from the polymer, without a vapour-liquid transition during the expansion. General principle of foaming method is the following: saturation of pellets with CO<sub>2</sub> at desired temperature and high pressure, followed by a rapid depressurization which causes the super saturation. As a result of the super saturation, the creation of the nuclei occurs and the depressurization induced desorption from the polymer matrix and the phase change of CO<sub>2</sub> provides the pore growth.

The solubility of CO<sub>2</sub> increases with pressure, which leads to work at supercritical pressures. Moreover, since the critical temperature of CO<sub>2</sub> is 31°C, it can be used to process thermally sensitive materials. Sorption of CO<sub>2</sub> into the polymers depresses their glass transition temperature which results in a polymer/gas solution.

On the other hand, in the tissue engineering field, as CO<sub>2</sub> replaces the chemical solvents, it provides the complete disappearance of the residual amounts of undesired substances in the scaffolds of biomedical use. The manufacturing methods are very important for the specific organs because the physicochemical properties of scaffold matrices — such as porosity, equivalent pore diameter, and specific area — are determined by the manufacturing methods.

This research study has been carried out at the "Centre Interuniversitaire de Recherche et d'Ingénierie des Matériaux" (CIRIMAT) of the "Institut National Polytechnique de Toulouse" in collaboration with two other laboratories of Toulouse: the "Laboratoire de Génie Chimique de Toulouse" (LGC) and the "Laboratoire d'Analyse et d'Architecture des Systèmes" (LAAS). In the framework of this study, the production of porous biodegradable polymer scaffolds for connective and calcified tissues by supercritical CO<sub>2</sub> foaming technique is investigated. Physical and mechanical properties of polymer used, glass transition temperature and crystallinity are important factors to define the final properties of the scaffolds. Therefore, the primary factor is to control the equivalent pore size and porosity of the scaffolds.

In the thesis, different types of polylactides and poly (*D*, *L*-lactide-co-glycolide) with different Lactide/Glycolide ratio were used. Some of the (co)polymers are amorphous while others are semi-crystalline. Polylactides have been blended with different adjuvants (wax, hyaluronic acid) and/or fillers (calcium phosphate doped strontium). Comparison between blends and composites obtained after co-grinding biomaterials has been studied in detail. Insertion of hyaluronic acid has been performed with the aim of increasing the surface adhesion property, tricalcium phosphate (amorphous and  $\beta$ ) to improve the mechanical properties and wax as porogen agent. Ratio of different components and time of co-grinding have been analyzed in function of the final porous structure (equivalent pore diameter and porosity) of the scaffold. Finally, a comparative study of foams processed either by the dry or wet pellet preparation method, was realized.

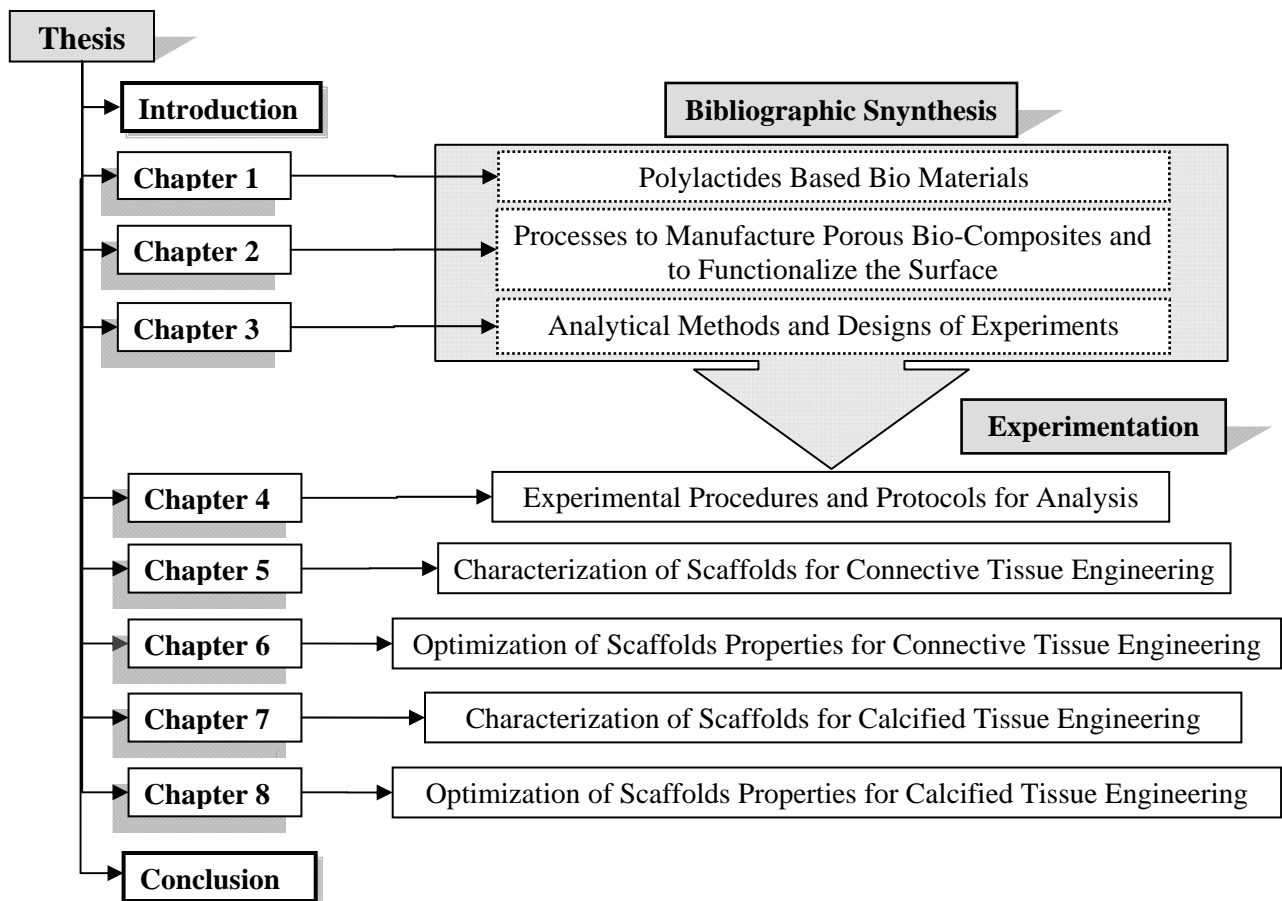
The main objectives of the present study are:

- Selection of appropriate polymer for connective tissue and bone regeneration.
- Optimization of co-grinding process conditions (time, ratio) for fillers, hyaluronic acid and wax with polylactides.
- Optimization of scCO<sub>2</sub> foaming parameters (saturation pressure, saturation temperature, saturation time and depressurization rate).

With the aim of attaining these objectives, the following studies have been realized:

- Analysis of surface energy of the pellets.
- Analysis of the pore morphology (equivalent pore size, pore size distribution and interconnectivity of micro, meso and macro pores, anisotropy of pores).
- Analysis of mechanical properties of the foamed structure.

Thus, in this work, the first three chapters correspond to a bibliographic synthesis on studied biomaterials, used processes and analytical methods. The five following chapters correspond to experimental results and analysis of the processed scaffolds for either connective tissue or calcified tissue substitution. In both cases, optimization of properties has been achieved. The structure of the thesis is defined as follows:



# Chapter 1

## Polylactides Based Bio-Materials

*In this chapter, we present a bibliographic synthesis divided in three parts. The first one deals with generalities on bio-composites, their uses in tissue engineering and bone regeneration applications. The second one concerns polyester based biomaterials, and in particular those used in this study polylactides such as polylactic acid and poly (lactide-co-glycolide acid). Finally, the third part deals with adjuvant and fillers. We focus on hyaluronic acid, amorphous calcium phosphate and  $\beta$ - calcium phosphate which are the fillers retained for the study.*

### 1 Introduction to Bio Composites

A bio-composite is a material formed by a matrix (resin) and a reinforcement of natural fibres or particles (usually derived from plants or cellulose). Their application has wide-range uses from environment-friendly biodegradable composites to biomedical composites for drug/gene delivery, tissue engineering applications and cosmetic orthodontics. They often mimic the structures of the living materials involved in the process in addition to the strengthening properties of the matrix that was used but still providing biocompatibility, e.g. in creating scaffolds in bone and cartilage tissue engineering. Such markets are significantly rising, mainly because of the increase in oil price, and recycling and environment necessities. Bio-composites are characterised by the fact that:

- the petrochemical resin is replaced by a vegetable or animal resin, and/or
- the bolsters (fibreglass, carbon fibre or talc) are replaced by natural fibres (wood fibres, hemp, flax, sisal, jute etc.).

In biomaterials, it is important that each constituent of the composite must be biocompatible and biodegradable. Moreover, the interface between constituents should not be degraded by the body environment. Normally, bio-composite materials can be classified into three groups:

- Particulate composites,
- Fibrous composites,

- Porous materials.

## 1.1 Bio-composites for 3D Model of Connective Tissues

### 1.1.1 Tissue Engineering and Concept of Scaffold

The scaffold for supporting 3D cell culture must meet a number of criteria to function appropriately and to promote tumour growth. These criteria include both mechanical parameters as well as parameters of biological performance. Biocompatibility of the scaffold is critical and must not damage cells and alter their functions or lead to significant scarring. To minimize undesirable effects, it is better to use inert scaffolds such as silk or chitin for example. Furthermore cells or matrices from different species can be used. For example, the use of a murine matrix together with human cells will allow studying the production and deposition of matrix proteins produced by tumour cells. Furthermore, differences in tensional forces may impact the phenotype of cancer cells. Thus, it is critical to minimize these differences in specific experimental conditions.

### 1.1.2 Different Types of Scaffolds

Different types of three dimensional *in vitro* cancer models exist.

#### 1.1.2.1 Cells Grown in Pellets or in Spheroids

Cells cultured as spheroids are formed by self-assembly. They mimic vascular tumours and micro-metastases. Tedious procedures required for formation, maintenance, and culture conditions are still holding back the industry from using a validated spheroid model more widely. Spheroid preparations on a chip using micro-fluid devices have been reported [Hsiao *et al.*, 2009]. However, these methods suffer from problems with regard to spheroid formation, long-term culture, control of spheroid size and uniform distribution of small numbers of co-culture cell types across all spheroids.

#### 1.1.2.2 Cells Embedded into Hydrogels Derived from Natural or Synthetic Polymers

Naturally derived polymers (alginates, agarose or collagen) frequently demonstrate adequate biocompatibility, while synthetic polymers may be problematic. During gelling, ionic interference could occur with multivalent counter ions that exchange with other ionic molecules resulting in an uncontrolled deterioration of the hydrogel. Toxicity of cross-linking molecules must also be considered [Mooney and Silva, 2007]. Another approach to form hydrogel is the utilization of phase transition behaviour of certain polymers, which may help to overcome these problems [Castelló-Cros and Cukierman, 2009]. The interaction of cells with hydrogels significantly affects their adhesion as well as migration and differentiation. The adhesion is dependent on the interaction of specific cell surface receptors with ligands that may be integrated into the material. Inappropriate interactions in the hydrogel may cause non-adequate growth behaviour. Collagen that may be integrated in the gel has many of the biological properties of a natural environment. However, variations between collagen batches may be found. Its derivative, gelatine, easily forms gels by changes in the temperature of the solution. The chemical modification methods to improve the mechanical properties of gelatine gels may also interfere with cell behaviour.

#### 1.1.2.3 Cells Grown in a Biomaterial of Large-size on Different Polymers (PLGA, Agarose)

Tumour cells cultured in porous PLGA (poly(lactide-co-glycolide)) scaffolds proliferate and form cohesive tumour cell aggregates *in vitro*. The final scaffold is about one cm in diameter and one mm in thickness. Cells in the scaffold must be cultured on an orbital shaker for up to 15 days. Comparison with standard 3D-Matrigel<sup>®</sup> culture show that tumour cells proliferate much more rapidly inside the scaffold and

that secretion of some specific growth factors is up-regulated. Other requirements are a good porosity and the need of bioreactors and gas exchanges during culture. Tumour cells may also be implanted in the scaffold subcutaneously in the back of mice. This method is limited because no up-scaling of this procedure is possible and no observation is possible during culture. These models seem to be restricted to research laboratories.

#### 1.1.2.4 Cells Grown in a Biomaterial at a Micrometer-Scale (Thickness ~200 $\mu\text{m}$ )

This material has its limitation because cells may behave differently depending on the batch of reconstituted basement membrane extract (BME) called Matrigel<sup>®</sup>, they are grown on. Because BME is a natural product made from extracts of mouse sarcomas, it is difficult to get uniform, consistent preparations, even from the same manufacturer. The solution is to test and to stock validated batches of BME. There are several other methods such as matrix production by fibroblasts or mixture of tumour cells and matrix. For the former, alkaline treatment removes cells that leave behind complex substrates of fibronectin, collagen, and other proteins. Progression of the tumours deriving from these matrices laid down normal fibroblasts [Fischbach *et al.*, 2007]. For the latter, a gel mixture is prepared by mixing an extracellular matrix (ECM) with tumour cells and Matrigel<sup>®</sup> (volume to volume 1:1) that allows the solution to polymerize. The resulting 3D scaffold on which tumour cells are cultured is not the pure ECM, they would encounter *in vivo*.

Another alternative is to use commercial 3D matrices. These are, for example, reconstituted basement membrane extract such as Matrigel<sup>®</sup> (Sigma). Matrigel<sup>®</sup> is used to support growth and differentiation of cells and tissues. It recapitulates the morphology and visco-elasticity of the extracellular matrix and can be remodelled by cells. The drawbacks are that it is expensive and the composition is variable. Alternatively, interstitial matrix components such as collagen, fibrin, etc may be used. They are frequently employed to study migration and invasion. These matrix proteins can be remodelled by cells, and are often used in combination. However, their use may be problematic because glycosylation and solubility may vary by source and the properties between native and denatured proteins may differ. There are other commercially available matrices such as (semi)-synthetic hydrogels proposed by BD<sup>™</sup> (PuraMatrix peptide hydrogel). It often polymerizes in combination with bioactive peptides. The drawbacks are that it shows some bioactivity with certain cells and it cannot be remodelled or degraded by cells. Other ready-to-use systems are the algiMatrix3D<sup>®</sup> culture system (invitrogen<sup>™</sup>) that comes as sponges in 96-well plates or InsertTM-PCL<sup>™</sup> (3D Biotek<sup>®</sup>), a biodegradable polycaprolactone scaffold. These systems are quite expensive. Other authors Castelló-Cros and Cukierman [2009] have used 3D agarose colony formation and GelCount<sup>™</sup> technology with GelCount<sup>™</sup> scan and image acquisition for high-resolution scanner allowing the calculation of half maximal inhibitory concentration (IC<sub>50</sub>). This system provides quantitative data (log dose and time-dependent effects of drugs). However, no description of the gel (thickness) and of the quality of colonies formed is reported for this model (size of the colony, interactions between cells, and the distribution of the cells across the colony).

## 1.2 Bio-Composites for Calcified Tissue Engineering

### 1.2.1 Composition of Scaffolds

The principal calcified tissue of vertebrates is bone. Other calcified tissues in vertebrates include calcified cartilage, which is present to some extent in most bones and the dental tissues - enamel, cementum, and dentin. Bone develops by the process of ossification, osteogenesis, as a specialized connective tissue. During ossification, osteoblasts secrete an amorphous material, gradually becoming densely fibrous - osteoid. Calcium phosphate crystals are deposited in the osteoid (i.e. mineralization), thereby becoming bone matrix. Osteoblasts become surrounded during the mineralization process, and the cells become osteocytes.



Osteoblast secretion does not become entirely fibrous. The secretion also forms an amorphous adhesion between the fibres [Lee and Chuong, 2009].

Many studies can be found in the literature pursuing the aim to produce biomimetic artificial bone-like tissue involving hydroxyapatite (HAp) and collagen as fibre, gel or gelatine [Kim *et al.*, 2005; Kikuchi *et al.*, 2004; Tampieri *et al.*, 2003a; Itoh *et al.*, 2001]. Testing two methods of preparation of apatite/collagen composite materials (dispersion of HAp in collagen gel or direct nucleation of HAp into collagen fibres), Tampieri *et al.* [2003b] have shown that the bio-inspired method based on the direct nucleation of apatite leads to composites analogous to calcified tissue and exhibiting strong interactions between HAp and collagen.

The replacement and healing of damaged hard tissues have always been a concern for human beings as shown by the examination of mummies. It is however known that calcium phosphates have been used for bone substitution and repair [Jarcho *et al.*, 1979]. The first to be used were stoichiometric hydroxyapatite and  $\beta$  tricalcium phosphate ( $\beta$ TCP) which are stable calcium phosphates at high temperature and can be easily sintered into ceramics. They are still the major industrial calcium phosphates biomaterials.  $\beta$ TCP was shown to be bio-absorbable and replaced by bone whereas HAp constituted non-degradable materials.  $\beta$ TCP is mainly used as a bio-ceramic whereas HAp is also being processed for other biomaterials uses such as the coating of metallic prostheses where it was found to considerably improve bone repair as an "osteo-conductive" material or composite ceramic/polymer materials showing strong mechanical analogies with bone tissues and excellent bone bonding abilities [De Groot *et al.*, 1987]. Biphasic calcium phosphates, associating these two high-temperature calcium phosphates allow a controlled resorption rate and have been reported to offer superior biological properties [Daculsi *et al.*, 2003; LeGeros, 2002]. They are progressively replacing  $\beta$ TCP ceramics in Europe. A new technological step was made with the development of calcium phosphates cements [Brown and Chow, 1987]. These materials are able to set and harden in a living body and most can be injected. Despite their poor mechanical properties they offer a number of advantages and are increasingly used for several applications. More recently biomimetic coatings involving low temperature nano-crystalline calcium phosphates have been proposed, some have been claimed to exhibit osteo-inductive properties [Habibovic *et al.*, 2006].

## 1.2.2 Mechanical Properties of 3D Porous Scaffolds

The scaffold for tissue engineering should have a 3D porous structure with a porosity of no less than 70% and a pore size ranging from 50 to 900  $\mu\text{m}$  [Salgado *et al.*, n.d.]. High scaffold porosity facilitates oxygen, nutrient and metabolic product exchange. The literature results showed that with the optimization design, the porosity of the scaffolds was  $82.0 \pm 3.8\%$ . It was composed of the designed interconnectivity macro-pores and micro-pores. The interconnectivity macro-pores in 3D scaffold would help develop the skeletal network and facilitate the internal mineralized bone formation [Cerroni *et al.*, 2002]. The micro-pores less than 50  $\mu\text{m}$  on the walls of the macro-pores would help in factors like fluid diffusion and cell attachment. Additionally, the scaffold for bone tissue engineering should also have high mechanical strength as close as possible to the strength of natural bone [Hutmacher, 2000]. In this study, the compressive strength and elastic modulus of the calcium phosphate/PLGA scaffolds were significantly higher than those of the pure PLGAs scaffolds. This result was consistent with some studies that improved the mechanical properties of biodegradable polymers by adding inorganic materials [Zhang and Zhang, 2001; Thomson *et al.*, 1998]. However, co-grinding with calcium phosphate increased the mechanical properties and structural quality but the porosity and pore diameter of the scaffolds was decreased.

Compressive modulus values of human trabecular bone range from 1 to 5000 MPa, with strength values ranging from 0.10 to 27.3 MPa reported by Langer and Tirrell [2004]; Porter *et al.* [2000]; Lang *et*

al. [1988] with mean values of approximately 194 and 3.55 MPa as reported by *Goulet et al.* [1994]. Various parts of the bones in the human body have different mechanical properties. Compact bone is known to have a compressive strength of 150–250 MPa due to variability in bone density [*Natali and Meroi*, 1989; *Carter*, 1976]. Although the ideal mechanical strength of biomaterial scaffolds has not yet been determined, previously researched scaffold compressive strengths have fallen within a 2–45 MPa range [*Ghosh et al.*, 2008; *Gomes et al.*, 2008; *Xiong*, 2002]. The compressive modulus for bone has been measured to be 5–20 GPa while biomaterial scaffolds vary from 60 MPa to 15 GPa [*Xiong*, 2002]. Although polymeric scaffolds have lower compressive strength and modulus than other biobased scaffolds and natural compact bones, it is not fully understood to what extent scaffolds must mimic natural bone mechanical properties. They have, however, demonstrated to be a promising substrate for cell growth and bone regeneration as shown by the cellular studies and sponge-like characteristics of the scaffolds. The results from their experiments gave modulus at a low level (cf. Table 1.1).

**Table 1.1:** Summary of mechanical properties of osteoporotic (OP) bone and normal bone.

Material Property	OP Bone	Normal Bone
$E$ (MPa)	247 50 – 410	310 40 – 460
Yield strength (MPa)	2.5 0.6 – 5.	3.3 8 0.4 – 9.0
Energy absorbed to yield ( $\text{kJ}\cdot\text{m}^{-3}$ )	16.3 2 – 52	21.8 2 – 90

[*Li and Aspen*, 1997]

Median values and approximate ranges of the 5% – 95% confidence limits as given by *Li and Aspen* [1997] on the mechanical properties of human cancellous bone specimen (diameter: 9 mm, mean cylinder length: 7.7 mm) from OP femoral heads.

### 1.3 Biodegradable Polymers

During the last years, a large number of articles and publications have been published which cover biodegradable polymers of the different material groups (e.g., polysaccharides, polypeptides, polyesters, and polyisoprenoides), as well as their copolymers and blends. PLA (polylactic acid) and PLGA poly (lactide-co-glycolide) are mainly used in medical engineering as biodegradable polymers, because these are naturally occurring polymers. Degradable/resorbable polymers have been well established in the field of medicine, for example, as surgical sutures, implants, and bone plates, since 1960s and 1970s [*Schmack*, 2009]. It is not easy to classify biodegradable polymers. They can be sorted according to their chemical composition, synthesis method, processing method, economic importance, application, etc. Each of these classifications provides different and useful information. In the present overview, we have chosen to classify biodegradable polymers (hereafter called biopolymers) according to their origin: natural polymers, polymers coming from natural resources and synthetic polymers, polymers synthesised from crude oil. Biopolymers from natural origins include, from a chemical point of view, six sub-groups:[*Clarival and Halleux*, 2005]

1. polysaccharides (e.g., starch, cellulose, lignin, chitin).
2. proteins (e.g., gelatine, casein, wheat gluten, silk and wool).
3. lipids (e.g., plant oils including castor oil and animal fats).
4. polyesters produced by micro-organism or by plants (e.g., polyhydroxy-alcanoates, poly-3-hydroxybutyrate).
5. polyesters synthesised from bio-derived monomers (polylactic acid).

6. a final group of miscellaneous polymers (natural rubbers, composites).

### 1.3.1 What is Biodegradable?

Biodegradation is degradation caused by biological activity, particularly by enzyme action leading to significant changes in the material's chemical structure, or by UV radiations which are natural and participate also to biodegradation. In essence, biodegradable plastics should breakdown cleanly, in a defined time period, to simple molecules found in the environment such as carbon dioxide and water. The American Society of Testing and Materials (ASTM) defines 'biodegradability' as: "capable of undergoing decomposition into carbon dioxide, methane, water, inorganic compounds, or biomass in which the predominant mechanism is the enzymatic action of microorganisms, that can be measured by standardized tests in a specified period of time, reflecting available disposal conditions."

During this process of biodegradation, the large molecules of the substance are transformed into smaller compounds by enzymes and acids that are naturally produced by microorganisms. Once the molecules are reduced to a suitable size, the substances can be absorbed through the organism cell walls where they are metabolized for energy. Most naturally occurring materials such as yard waste, food scraps, etc., contain these large molecules and biodegrade in this way.

#### 1.3.1.1 Aerobic Biodegradation

*Aerobic biodegradation* is the breakdown of an organic substance by microorganisms in the presence of oxygen. Almost all organic materials can be metabolized in an oxidative environment by aerobic organisms. The organism has secreted enzymes that breakdown substances into smaller organic molecules which are then absorbed into the cells of the microbes and used for cellular respiration. During the respiration process, the organic molecules absorbed into the cells are broken down in steps, where a molecule known as adenosine-5-triphosphate (ATP) is used to store and transport energy for cells, for life processes such as motility and cell division. In biochemistry, this chemical reaction sequence is known as Electron Chain Transfer. In the case of aerobic metabolism, oxygen is used at the end of the chain as the final electron acceptor, producing the main by products of carbon dioxide and water. The chemistry of the key degradation process is represented by Equation 1.1, where  $C_{\text{Polymer}}$  represents either a polymer or a fragment from any of the degradation processes defined earlier [Bastioli, 2005]:

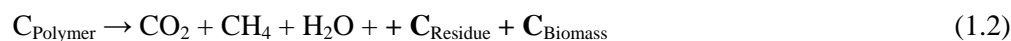


*Composting* is a well known and common use of aerobic biodegradation, during which the volume of organic material is typically reduced by about 50%, where the remaining, slow-decaying humus material left over can be used as a rich planting medium. The ASTM defines a compostable plastic material as being: "capable of biological decomposition in a compost site as part of an available program, such that the plastic is not visually distinguishable and breaks down to carbon dioxide, water inorganic compounds and biomass (humus) at a rate consistent with known compostable materials". The bioactivity in active compost will generate heat that further enhances the rate of microbial growth and metabolism. However, for the purpose of the ASTM definition, the available program is an industrial compost facility where heat and moisture are artificially added to the mass to maximize the degradation rate. As we will see, this artificial environment becomes critical for degradation of some biodegradable plastic materials.

#### 1.3.1.2 Anaerobic Biodegradation

*Anaerobic biodegradation* occurs in the absence of oxygen where anaerobic microbes are dominant. In the absence of oxygen, the organism must use some other atoms as the final electron acceptor. Hydrogen, methane, nitrogen and sulphur are common along with oxidizing minerals. Thus, the effluent

from anaerobic digestion is biogas, consisting of mostly methane and carbon dioxide, with trace gasses such as ammonia and hydrogen sulphide. Often, the complete digestion will require several different types of bacteria where one type partially processes the waste to a point where another bacterium strain takes over. Most biodegradation of solid waste in landfill occurs under anaerobic conditions by design because it is typically much slower than aerobic degradation. In the absence of oxygen, the reaction of degradation is given by equation 1.2:



Complete biodegradation occurs when no residue remains, and complete mineralisation is established when the original substrate ( $C_{\text{Polymer}}$  in this example) is completely converted into gaseous products and salts. However, mineralisation is a very slow process under natural conditions because some of the polymer undergoing biodegradation will initially be turned into biomass [Bastioli, 2005]. Most biodegradable substances come from plant and animal matter, or from artificial materials that are very similar in molecular structure to these naturally occurring substances. As the naturally occurring substances evolved, micro-organisms also evolved to use the substances as a food source, carbon in particular, used as a building block for life-sustaining compounds. Simple sugars are readily absorbed into the cell to be metabolized. However, larger and more complex molecules such as starches, proteins and cellulose, require enzymes and acids to reduce their size enough to be absorbed. Living organisms have developed the ability to secrete specific digestive compounds so as to best utilize the available food supply. For example, the enzyme amylase, found in human saliva, is used to breakdown long-chain starch molecules into smaller simple sugars.

### 1.3.2 Biodegradable Polymer Materials

Currently available degradable polymer materials can be broken down into two main groups:

- Polyester polymers,
- Synergistic and hybrid polymers.

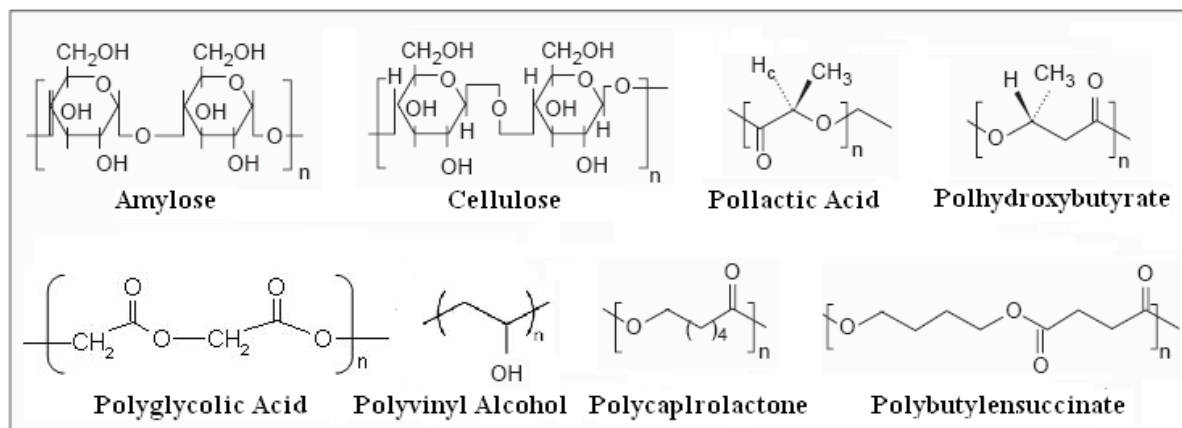
#### 1.3.2.1 Biodegradable Polyesters

Biodegradable polyesters which do not contain six-carbon rings are known as aliphatic polyesters. They will typically react with moisture at elevated temperatures to breakdown the long polymer chains. This process, called chemical hydrolysis, reduces the higher molecular weight polymer to much smaller hydrocarbon compounds. The resulting molecules can then be absorbed by microorganisms and metabolized for energy. Since it is a chemical reaction, the hydrolysis occurs at a much higher rate than one would expect for a purely biological process, and as a result, relatively quick degradation is observed.

Aliphatic polyesters have attracted interest as biodegradable plastic materials; however they typically have poor physical and mechanical properties like strength, flexibility, heat resistance, etc. [Chen *et al.*, 2008]. Some common biodegradable polyester polymers in commercial use include poly(caprolactone), poly(glycolic acid) and poly(butylene succinate) (cf. chemical formula reported on Figure 1.1). Although expensive to make, these biodegradable polymers are ideal for use in specialized, high margin applications such as medical devices (e.g. dissolving, drug delivery systems, tissue engineering scaffolds and bone repair etc.) [Ikada and Tsuji, 1999].

Another well known aliphatic polyester is poly(lactic acid). PLA is a synthetic polymer made from fermented sugars extracted primarily from food crops such as corn, beets or sugarcane. The resulting lactic acid monomer is chemically processed and then polymerized, in the presence of a metal catalyst, to form the high molecular weight plastic material. Like petroleum-based biodegradable polyesters, PLA has

many of the same undesirable mechanical properties, such as low heat deflection temperature. The polymer is also very brittle and has a low-melt strength leading to difficulty in processing. Consequently, most commercial applications using PLA require a synthetic rubber and/or acrylic additive to compensate for these deficiencies.



**Figure 1.1:** Structures of selected biodegradable polymers.

[Gross and Kalra, 2002]

Degradation of PLA occurs quickly through a multistep process of chemical depolymerization, followed by dissolution of the intermediate lactic acid in the presence of moisture, and the absorption into the cells of microorganisms with subsequent metabolization [Dunja Manal Abou Zeid, 2001]. Initiation of this chain of events typically occurs at elevated temperatures (above heat deflection temperatures), such as conditions existing in an industrial compost operation. The relatively fast chemical reaction at the beginning of the chain of events explains the surprisingly quick degradation of polymer in an industrial compost environment. This mechanism of chemical attack followed by cell metabolism does not meet the true definition of a biodegradable material.

### 1.3.2.2 Synergistic or Hybrid Polymers

Synergistic polymers are typically intimate mixtures of oil-based and naturally occurring polymers where the two have some chemical affinity for each other. When mixed, there is intimate contact between the two polymer chains so as to create a homogenous single phase. In other words, once mixed they could not be mechanically separated. A good example of a commercial, synergistic, biodegradable material is thermoplastic starch. The key to this blend of the two natural starch polymers, amylose and amylopectin, and the synthetic polymer, polyvinyl alcohol (PVOH), is their natural affinity to each other, due to the large number of hydroxyl (OH) groups present in the compounds (cf. Figure 1.1). This hybrid can be made into foamed articles, plastic films or moulded parts such as cutlery.

The intimate mixing of the natural and synthetic polymers can be taken one step further: where the attraction of the synthetic and natural polymers is enhanced by grafting other chemically compatible groups along the chains of the natural and/or synthetic polymers. Initiation of the process begins with the formation of a bio-film on the surface of the polymer, which is facilitated by the inclusion of the compatible natural polymers. These films of microorganisms have been shown to efficiently biodegrade petroleum based polymers [Seneviratne et al., 2006].

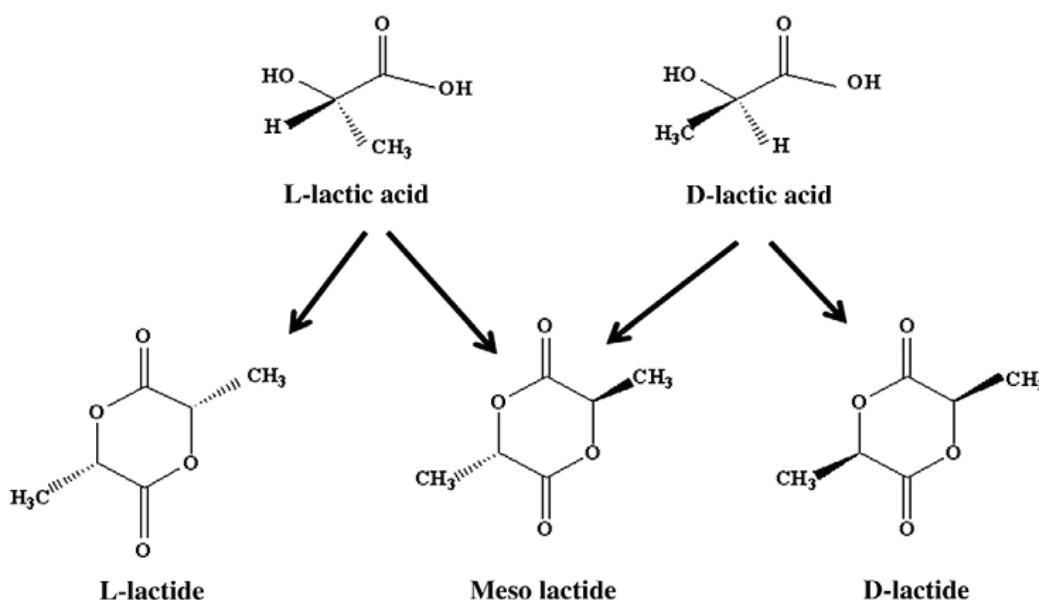
## 2 Polyesters Based Bio-materials

### 2.1 Poly lactides (PLA)

#### 2.1.1 Structure of Polylactic Acid

The term "Bio-polyester" can be understood in several different ways. Bio-polyesters can be interpreted as polyesters of strictly biological origin. Poly(lactic acid) belongs to the family of aliphatic polyesters commonly made from acid, and are considered as biodegradable and compostable [Kaplan, 1998]. One can also interpret bio-polyesters as polyesters that have been synthesized by biological means, for instance by enzyme-catalyzed polymerization reactions. Moreover, there are hybrids between these two strict definitions of bio-polyesters. For example, monomer synthesis for poly(lactic acid) came from a biological process in which lactic acid is produced microbially by the fermentation of a renewable polysaccharide-based resource, mostly corn. Lactic acid is subsequently polymerized chemically into poly(lactic acid) by a condensation reaction. It is one of the few polymers in which the stereo-chemical structure can easily be modified by polymerizing a controlled mixture of the *L*- or *D*-isomers to produce high molecular weight amorphous or semi-crystalline polymers that can be used for food contact and are generally recognized as safe [Conn *et al.*, 1995].

The structural formulas of poly(lactic acid) are given in Figure 1.2. As PLA contains an asymmetrical carbon atom in its structural unit, iso-tactic  $P_L$ LA and  $P_D$ LA polymers are optically active. Consequently, the meso-lactide  $P_{D,L}$ LA is a syndio-tactically alternating *D,L*-copolymer or a copolymer having *L*-units and *D*-units and is non optically active [Van de Velde and Kiekens, 2002]. Latter findings have been gathered under 'PLAs' and are thought to be mostly non-syndio-tactic  $P_{D,L}$ LA. All polyesters, of natural and synthetic origins, are characterized by the common formula presented in Figure 1.2.



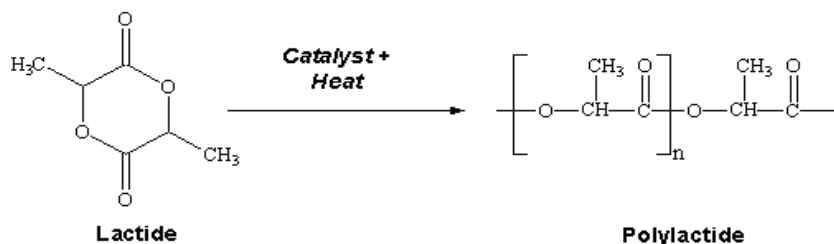
**Figure 1.2:** Stereo-forms of lactides.

[Madhavan Nampoothiri *et al.*, 2010]

#### 2.1.2 Synthesis of Polylactic Acid

It can be easily produced in a high molecular weight form through ring-opening polymerization (cf. Figure 1.3) using most commonly a stannous octoate catalyst (sometimes tin (II) chloride).



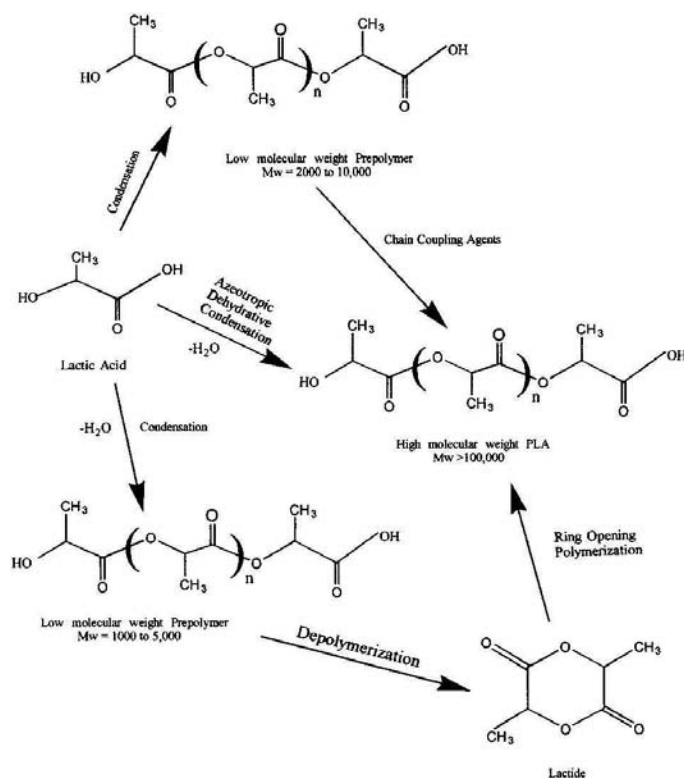


**Figure 1.3:** Ring opening polymerization of lactide to polylactide.

Lactic acid is obtained by the fermentation of engineered microbes of the genus *Lactobacilli*. These microorganisms are highly efficient sources of lactic acid. *Lactobacilli* can be subdivided into strains that produce either the *L* (+) or the *D* (-) isomer. A variety of different sugars is used as carbon sources in the fermentation process. These sugars are either specifically prepared enzymatically from starch for lactic acid production, or are by products from fruit processing.

In addition, lactose, a by-product in the cheese industry, can also be used as a carbon source for lactic acid production. In all cases sugars from renewable resources are transformed into a value-added product by an enzymatic whole-cell catalysis process. The subsequent steps in the production of PLA are based on synthetic chemistry and involve the formation of the dimer by a self-condensation reaction that results in a low molecular weight prepolymer. Depolymerization of the prepolymer gives lactide, which is then polymerized through ring-opening polymerization. The prepolymer can also be polymerized into high molecular weight PLA by the action of chain coupling agents. In contrast to lactic acid, glycolic acid is produced in an industrial scale by a chemical process. The different ways of producing PLA are gathered in

Figure 1.4.



**Figure 1.4:** Different ways of producing PLA.

[Garlotta, 2001]

### 2.1.3 Properties of Polylactic Acid

Commercially available PLA grades are copolymers of poly(*L*-lactide) with meso-lactide or *D*-lactide. The *D/L* ratio is known to affect the properties of PLA (melting temperature, degree of crystallinity and so on). PLA has a balance of mechanical properties, thermal plasticity, and biodegradability and is readily processed [Fang and Hanna, 1999]. Different properties of PLA are summarized in Tables 1.1. The homopolymer of *L*-lactide ( $P_L$ LA) is a semi-crystalline polymer. These types of materials exhibit high tensile strength and low elongation and consequently have a high modulus that makes them more suitable for load-bearing applications such as in orthopaedic fixation and sutures [Van de Velde and Kiekens, 2002]. The racemic  $P_{D,L}$ LA is an amorphous polymer exhibiting a random distribution of both isomeric forms of lactic acid, and accordingly is unable to arrange into an organized crystalline structure. This material has lower tensile strength, higher elongation, and a much more rapid degradation time, making it more attractive as a drug delivery system. Poly(*L*-lactide) is about 37% crystalline, with a melting point of 173–178°C and a glass-transition temperature of 60–65°C. The degradation time of  $P_L$ LA is much slower than that of  $P_{D,L}$ LA, requiring more than 2 years to be completely absorbed. Copolymers of *L*-lactide and *D,L*-lactide have been prepared to disrupt the crystallinity of *L*-lactide and accelerate the degradation process [Middleton and Tipton, 1998].

The densities of  $P_L$ LA and  $P_{D,L}$ LA are reported in Table 1.2. They are mostly based on standards such as ASTM D792. Density can be a very important design parameter since elevated density values imply high transportation costs. Density is often used for the calculation of ‘specific properties’, i.e. dividing mechanical properties by the appropriate density. All other properties can be compared among each other. Tensile properties are clearly best for the densest reported polymers. Varying the molecular weight from 50 over 150 to 200 kDaltons will increase tensile strengths for  $P_L$ LA of 15.5, 80 and 150 MPa, respectively [Van de Velde and Kiekens, 2002].

**Table 1.2:** Main physical properties of different PLAs.  
[Van de Velde and Kiekens, 2002]

Properties	Unit	$P_L$ LA	$P_{D,L}$ LA
Molecular weight ( $M_w$ )	Dalton	100–300	–
Density $\rho$	-	1.24–1.30	1.25–1.27
Tensile strength $\sigma$	MPa	15.5–150	27.6–50
Specific tensile strength $S^*$	Nm/g	40–66.8	22.1–39.4
Tensile modulus $E$	GPa	2.7–4.1	1–3.5
Specific tensile modulus $E^*$	kNm/g	2.2–3.8	0.8–2.4
Strength at break	MPa	44–66	–
Flexural strength	MPa	88–119	–
Ultimate strain $\epsilon$	%	3–6	2–10
Elongation at break	%	100–180	–
Glass transition temperature $T_g$	°C	60–65	55–60
Melting point $T_m$	°C	173–178	amorphous
Heat of melting $\Delta H_m$	J/g	8.1–93.1	–
Degree of crystallinity, $\chi$	%	10–40	–
Surface energy $\delta$	J/m <sup>2</sup>	38	–
Solubility parameter $\delta_H$	(J/ml) <sup>1/2</sup>	19–20.5	–

Polylactic acid can be processed like most thermoplastics into fibre (for example by using conventional melt spinning processes) and film. The melting temperature of  $P_L$ LA can be increased 40–50°C by physically blending the polymer with  $P_D$ LA.  $P_L$ LA and  $P_D$ LA are known to form a highly regular stereo-complex with increased crystallinity. The maximum effect in temperature stability is achieved when a 50-50 blend is used, but even at lower concentrations of 3–10% of  $P_D$ LA a substantial effect is achieved. In the



latter case  $P_D$ LA is used as a nucleating agent, thereby increasing the crystallization rate. Due to the higher crystallinity of this stereo-complex, the biodegradability will become slower. The interesting feature is that the polymer blend remains transparent.

Even when burned, PLA produces no nitrogen oxide gases and only one-third of the combustion heat generated by polyolefins; it does not damage the incinerator and provides significant energy savings. The increasing appreciation of the various intrinsic properties of PLA, coupled with knowledge of how such properties can be improved to achieve compatibility with thermoplastics processing, manufacturing, and end-use requirements, has fuelled technological and commercial interest in PLA. Over the last few years, a wealth of investigations have been undertaken to enhance the mechanical properties and the impact resistance of PLA. It can therefore compete with other low-cost biodegradable/biocompatible or commodity polymers.

These efforts have made use of biodegradable and non-biodegradable fillers and plasticizers or blending of PLA with other polymers [Martin and Avérous, 2001]. In recent years the nano-scale has afforded unique opportunities to create revolutionary material combinations. Nano-structured materials or nano-composites based on polymers have been an area of intense industrial and academic research over the past one and a half decades [Sinha Ray and Okamoto, 2003; Biswas and Ray, 2001; Alexandre and Dubois, 2000; Zanetti *et al.*, 2000; LeBaron *et al.*, 1999]. In principle, nano-composites are an extreme case of composite materials in which interfacial interactions between two phases are maximized. In the literature, the term nano-composite is generally used for polymers with submicrometer dispersions. In polymer-based nano-composites, nanometer-sized particles of inorganic or organic-materials are homogeneously dispersed as separate particles in a polymer matrix. This is one way of characterizing this type of material. There is, in fact, a wide variety of nano-particles and of ways to differentiate them and to classify them by the number of dimensions they possess. Their shape varies and includes:

- i. needlelike or tubelike structures regarded as one-dimensional particles (for example, inorganic nano-tubes, carbon nano-tubes, or sepiolites);
- ii. two-dimensional platelet structures (for example, layered silicates); and
- iii. spheroidal three-dimensional structures (for example, silica or zinc oxide).

To date, various types of nano-reinforcements such as nano-clay, cellulose nano-whiskers, ultrafine layered titanate, nano-alumina, and carbon nano-tubes have been used for the preparation of nano-composites with PLA [Yu, 2009; Mark, 2006; Kim *et al.*, 2006; Nishida *et al.*, 2005; Nazhat *et al.*, 2001; Dumitriu, 1994].

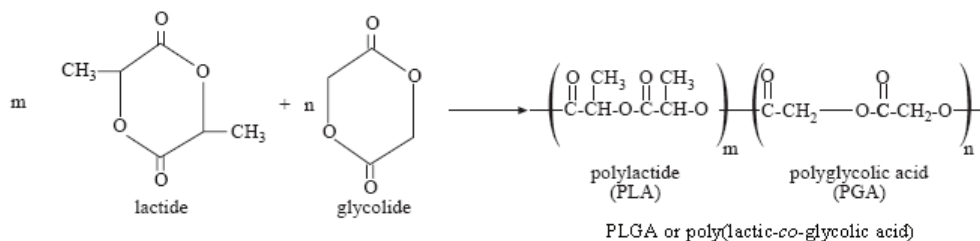
## 2.2 Poly(lactide-co-glycolide acid) (PLGA)

### 2.2.1 General Structures of PLGA Copolymers

Glycolic acid is present in small amounts in a wide variety of fruits and vegetables. It accumulates during photosynthesis in a side path of the Krebs cycle. So far, economically viable methods to produce glycolic acid in photosynthetic biological systems do not exist. At an industrial scale, carbon monoxide, formaldehyde and water are reacted at elevated temperature and pressure to produce glycolic acid. PLGA is synthesized by means of random ring-opening co-polymerization of the two different monomers, the LA and the GA (cf. Figure 1.5).

Common catalysts used in the preparation of this polymer include Tin (II) 2-Ethylhexanoate, Tin (II) Alkoxides or aluminum isopropoxide. During polymerization, successive monomeric units (of glycolic

or lactic acid) are linked together in PLGA by ester linkages, thus resulting in linear, aliphatic polyester as a product [Middleton and Tipton, 1998]. Using the polyglycolide and polylactide properties as a starting point, it is possible to copolymerize the two monomers to extend the range of homopolymer properties. Copolymers of glycolide with both *L*-lactide and *D,L*-lactide have been developed for both device and drug delivery applications.



**Figure 1.5:** Schematic synthesis of poly(lactide-co-glycolide).  
[Middleton and Tipton, 1998]

To tailor the processability and to enhance biodegradation, these copolymers are further modified by copolymerizing with linear dicarboxylic acids (e.g. adipic acid) and glycol components with more than four methylene groups (e.g. hexanediol) [Sublett, 1983]. To enhance the environmentally benevolent aspect of these materials and to broaden the range of their use, aliphatic-aromatic co-polyesters blended with cellulose esters have been processed into useful fibres, films and moulded objects [Buchanan *et al.*, 1994, 1995].

### 2.2.2 Properties of PLGA Copolymers

Physical properties of poly(glycolic acid), as well as different PLGAs, are gathered in Table 1.3.

**Table 1.3:** Main physical properties of PGA and several PLGAs.

Properties	Unit	PGA	$P_{D,L}LGA_{50:50}$	$P_{D,L}LGA_{75:25}$	$P_{D,L}LGA_{85:15}$
Density $\rho$	gm/cm <sup>3</sup>	1.5–1.7	1.3–1.4	1.3	1.25
Tensile strength $\sigma$	MPa	60–99.7	41.4–55.2	41.4–55.2	45–52
Tensile modulus $E$	GPa	6–7	1–4.3	1.4–4.1	2.0*
Ultimate strain $\epsilon$	%	1.5–20	2–10	2.5–10	–
Specific tensile strength $S^*$	Nm/g	40–45.1	30.9–41.2	31.8–42.5	–
Specific tensile modulus $E^*$	kNm/g	4–4.5	8–2.1	1.1–2.1	–
Glass transition temperature $T_g$	°C	35–40	45–50	50–55	55–55
Melting point $T_m$	°C	225–230	amorphous	amorphous	amorphous

[Van de Velde and Kiekens, 2002]

Polyglycolide has a glass transition temperature between 35 and 45°C and its melting point is reported to be in the range of 225–230°C. PGA also exhibits a higher degree of crystallinity than PLA (~ 45–55 %), thus resulting in better mechanical properties but insolubility in water [Middleton and Tipton, 1998]. The solubility of this polyester is somewhat unique, in that its high molecular weight form is insoluble in almost all common organic solvents (acetone, dichloromethane, chloroform, ethyl acetate, tetrahydrofuran). The exceptions are highly fluorinated organics such as HFIP (hexafluoroisopropanol) while low molecular weight oligomers sufficiently differ in their physical properties to be more soluble. Sutures of PGA lose about 50% of their strength after 2 weeks and 100% at 4 weeks, and are completely absorbed in 4–6 months. Glycolide has been copolymerized with other monomers to reduce the stiffness of the resulting fibres [Middleton and Tipton, 1998].

It is important to note that there is not a linear relationship between the copolymer PLGA composition and the mechanical and degradation properties of the materials. For example, a copolymer of 50% glycolide and 50% *D,L*-lactide degrades faster than either homopolymer (cf. Table 1.4). All PLGAs are rather amorphous than crystalline and show a glass transition temperature in the range of 40–60°C. Unlike the homo-polymers of polylactide and polyglycolide which show poor solubilities, PLGA can be dissolved by a wide range of common solvents, including chlorinated solvents, tetrahydrofuran, acetone or ethyl acetate.

**Table 1.4:** Degradation times of common polylactides.

Polymer	T <sub>g</sub> (°C)	Degradation Time (Months)
PGA	35 – 40	6 to 12
P <sub>L</sub> LA	60 – 65	>24
P <sub>D,L</sub> LA	55 – 60	12 to 16
P <sub>D,L</sub> LGA <sub>85:15</sub>	50 – 55	5 to 6
P <sub>D,L</sub> LGA <sub>75:25</sub>	50 – 55	4 to 5
P <sub>D,L</sub> LGA <sub>50:50</sub>	45 – 50	1 to 2

[Adhikari and Gunatillake, 2003]

PLGAs are approved copolymers which are used in a host of therapeutic devices, owing to its biodegradability and biocompatibility as a major component in biodegradable sutures, bone fixation nails and screws [Moghimi *et al.*, 2001; Gombotz and Pettit, 1995]. They are well-characterized copolymers, their degradation sub-products are non toxic and they provide controlled drug release profiles by changing the PLGA copolymer ratio [Ghosh, 2004; Bala *et al.*, 2004; Moghimi *et al.*, 2001; Anderson and Shive, 1997; Gombotz and Pettit, 1995]. PLGAs of different molecular weights (from 10 kDa to over 100 kDa) and different copolymer molar ratios (50:50, 75:25 and 85:15) are available on the market. Molecular weight and copolymer molar ratio influence the degradation process and release profile of the drug entrapped. In general, low molecular weight PLGA with higher amounts of glycolic acid offers faster degradation rates [Anderson and Shive, 1997].

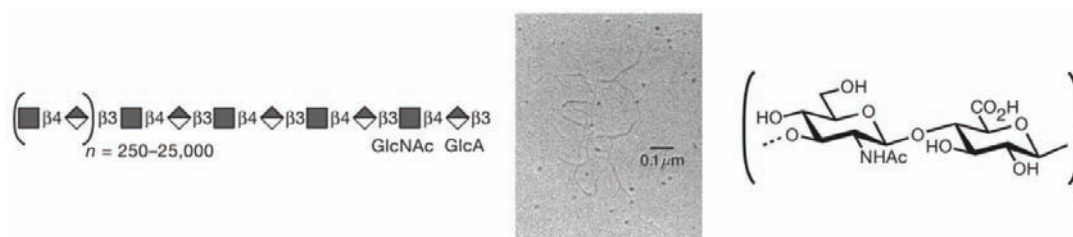
### 3 Adjuvant and Fillers

#### 3.1 Adjuvant

##### 3.1.1 Structure of Hyaluronic Acid (HA)

Hyaluronic acid was first biochemically purified in 1934 by Meyer and Palmer, who discovered this unique ‘polysaccharide acid of high molecular weight’ from the vitreous body of bovine eyes [Garg and Hales, 2004c]. Since it is believed that the molecule they isolated consisted of ‘an uronic acid, an amino sugar, and possible a pentose, they so named the substance ‘hyaluronic acid’ (HA) [Garg and Hales, 2004b]. They also reported that HA was not sulfonated; this meant that the molecule could be reproduced by a cell that synthesizes HA, including animals and bacteria [Varki *et al.*, 1999].

Interestingly, HA also differs from other structurally related GlycosAminoGlycans (Chondroitin 4 and 6 Sulfate, Heparan Sulfate, etc) in that it can be synthesized without attachment to proteins [Garg and Hales, 2004c]. Hyaluronic acid also labelled hyaluronan is a simple, linear glycosaminoglycan composed of repeating disaccharide units of  $\beta$ -1,4-glucuronic acid (GlcA) and  $\beta$ -1,3-N-acetylglucosamine (GlcNAc) [Garg and Hales, 2004c]. Figure 1.6 shows the alternating  $\beta$ -1,3 and  $\beta$ -1,4 glycosidic linkages between GlcA and GlcNAc. Polymers of hyaluronan can range in size from 5 to 20 000 kDa *in vivo* [Saari *et al.*, 1993].



**Figure 1.6:** Electron micrograph and chemical HA structure.  
[Varki *et al.*, 1999]

### 3.1.2 Physicochemical and Biological Properties of HA

The inherent physicochemical structure and properties of HA—high molecular weight,  $\beta$ -glycosidic linkages, internal hydrogen bonds, and interactions with the solvent - enable the molecule to behave in a highly non-newtonian, gel-like manner, even in dilute solutions of HA [Chong *et al.*, 2004]. The result is a unique water-binding and high retention capacity – for example, one gram of HA is capable of holding up to 6 litres of water.

As a natural conjunction to its physicochemical properties, HA also has various roles at the biological level [Garg and Hales, 2004a]. As an essential structural component in the extracellular matrix of vertebrate tissues, HA regulates water balance and fills space, interacting with a variety of extracellular molecules [Garg and Hales, 2004b]. HA is also known to activate intracellular signalling pathways and to induce proliferative and migratory responses [Garg and Hales, 2004b].

Hyaluronic acid is fairly stable, partially because of the way that its disaccharide components are positioned. The bulkier parts of the molecule are spaced far apart. By lowering this crowding, which is also known as "steric hindrance," the molecule is able to be flexible, but also resistant to break down.

Hyaluronan is found in many tissues of the body, such as skin, cartilage, and the vitreous humour. Therefore, it is well suited to biomedical applications targeting these tissues. The first hyaluronan biomedical product, Healon®, was developed in the 1970s and 1980s and is approved for use in eye surgery (i.e., corneal transplantation, cataract surgery, glaucoma surgery, and surgery to repair retinal detachment).

Hyaluronan is also used to treat osteoarthritis of the knee [Puhl and Scharf, 1997]. Such treatments, called viscosupplementation, are administered as a course of injections into the knee joint, and are believed to supplement the viscosity of the joint fluid, thereby lubricating the joint, cushioning the joint, and producing an analgesic effect. It has also been suggested that hyaluronan has positive biochemical effects on cartilage cells. However, some placebo-controlled studies have cast doubt on the efficacy of hyaluronan injections, and hyaluronan is recommended primarily as a last alternative before surgery [Karlsson *et al.*, 2002; Holmes *et al.*, 1988].

HA is an important component of skin, where it is involved in tissue repair. The skin needs an optimum proportion of water to retain its softness and suppleness. Hydro regulative ingredients incorporated into cosmetic emulsions provide the skin with moisture. Hyaluronic acid is a gel-like, water-holding molecule that is the space filler and cushioning agent for skin. The remarkable ability of hyaluronic acid to hold moisture ensures soft, smooth, hydrated and elastic skin with the desired sensory effect. Many cosmetic products contain HA as a moisturiser and claim to have anti-ageing and anti-wrinkle effect via topical applications. Due to the molecular size of the HA used in topical creams, it is unlikely and unproven that any penetration of the dermis occurs. HA acts as a free radical scavenger, absorbing and degrading them. When skin is excessively exposed to UV B (wavelength 290 to 320 nm) rays and becomes inflamed (sunburn), the

cells in the dermis stop producing as much HA and increase the rate of its degradation. HA degradation products also accumulate in the skin after UV exposure [Averbeck *et al.*, 2006].

Due to its high biocompatibility and its natural presence in the extracellular matrix of tissues, HA is gaining popularity as a biomaterial scaffold in tissue engineering research. In some cancers, HA levels correlate well with malignancy and poor prognosis. HA is thus often used as a tumor marker for prostate and breast cancer. It may also be used to monitor the progression of the disease.

## 3.2 Calcium Phosphates and Tricalcium Phosphates

Seventy percent of bone is made up of hydroxyapatite [ $\text{Ca}_{10}(\text{PO}_4)_6(\text{OH})_2$ ], tooth enamel is also largely calcium phosphate. Like other apatites, it has a calcium and phosphate component in a ratio of 1.67 (Ca/P ratio) but is associated with a hydroxyl group. There are several other non-apatitic calcium phosphates that are distinguished from one another by their molecular formulae, Ca/P ratios that differ from 1.67, crystal structures and solubilities, which have higher dissolution rates than stoichiometric hydroxyapatite.

### 3.2.1 Structures of Calcium Phosphate

Calcium phosphate  $\text{Ca}_3(\text{PO}_4)_2$  is the name given to a family of minerals containing calcium ions ( $\text{Ca}^{2+}$ ) together with orthophosphates ( $\text{PO}_4^{3-}$ ). Tricalcium phosphates (TCP) are among the most commonly-used calcium phosphates compounds in implant materials. They are found in ceramic bone substitutes, metallic prosthesis coatings, cements and composite materials. From a strict chemical point of view, 'tricalcium phosphate' refers to a composition, even though, in the minds of many users, this term is used to describe a structure, generally that of  $\beta$  tricalcium phosphate ( $\beta$ TCP). Tricalcium phosphates exist in four different forms:

- ATCP will hereby designate amorphous tricalcium phosphate;
- Ap TCP: apatitic tricalcium phosphate:  $\text{Ca}_9(\text{HPO}_4)(\text{PO}_4)_5(\text{OH})$ ;
- $\beta$ TCP: the most widely used member of the TCP family having a crystalline structure:  $\beta\text{-Ca}_3(\text{PO}_4)_2$ ;
- $\alpha$ TCP: the metastable high-temperature crystalline structure:  $\alpha\text{-Ca}_3(\text{PO}_4)_2$ .

Amorphous tricalcium phosphate (ATCP) and apatitic tricalcium phosphate (Ap TCP) are low temperature, unstable phases generally obtained by precipitation, whereas  $\alpha$  and  $\beta$  tricalcium phosphates ( $\alpha$  and  $\beta$  TCP) are high-temperature crystalline phases.

### 3.2.2 Synthesis of Different Calcium Phosphate Phases

The production of tricalcium phosphate-based ceramics generally involves TCP powder preparation and, in a successive stage, powder processing in order to obtain cohesive biomaterials in the form of dense or macro-porous ceramics, coatings, cements or composites for bone filling, substitution and/or reconstruction applications. In several cases, however, calcium phosphate phases form during processing, as, for example, in the case of hydroxyapatite (HAp) plasma spraying. We will focus on the elaboration of the different tricalcium phosphate phases (amorphous,  $\alpha$  and  $\beta$  polymorphic forms), their structure, and main physicochemical properties and their processing.

#### 3.2.2.1 Amorphous TriCalcium Phosphate (ATCP)

One of the most convenient preparation methods is double decomposition between a calcium salt solution and a hydrogen phosphate salt solution in aqueous media, at ambient temperature and at a pH close to 10 [Somrani *et al.*, 2005; Heughebaert and Montel, 1982]. It can also be obtained in hydroalcoholic



solution [Rodrigues and Lebugle, 1998; Lebugle et al., 1986]. The presence of ethanol in the precipitation medium influences the composition of the amorphous phase and especially its  $\text{HPO}_4^{2-}$  content and Ca/P ratio.

The main difficulties in the preparation of ATCP are related to its instability and reactivity. Generally, ATCP cannot be obtained at neutral or slightly acidic pH. However, it can be stabilised by various mineral ions or organic molecules which can be added to the precipitating and/or washing solutions. For example, ATCP can be prepared under more acidic conditions (around pH 6) and in the presence of magnesium or citrate ions, known as crystal growth inhibitors of apatite phase [Holt et al., 1989]. Owing to its reactivity and rather high water content, precipitated ATCP is generally freeze-dried and stored at  $\sim 18^\circ\text{C}$  to prevent any further evolution. Dry, heated ATCP can, however, be stored at room temperature in dry atmosphere. In contrast with synthesis methods in solution, ATCP can also be obtained via a dry, high-temperature route through rapid quenching of melted calcium phosphate. In the absence of ions other than  $\text{Ca}^{2+}$  and  $\text{PO}_4^{3-}$ , the amorphous phase which is forming is analogous to anhydrous precipitated ATCP [Ranz, 1996]. However, in practice, other anions such as  $\text{O}^{2-}$  are also observed in the high-temperature amorphous phase, increasing its Ca/P atomic ratio ( $> 1.5$ ). Observed by transmission electron microscopy (TEM), ATCP morphology is mostly spherical, although these particles generally tend to agglomerate into larger, irregularly shaped, branched clusters [Chow and Eanes, 2001]. The size of the spheroid particles varies in a large range (20 to 200 nm). Amjad [1997] reported that spheroidal particles of 25 nm in size were the dominant and most stable morphology of ATCP.

Eanes [1970] also investigated ATCP through thermo-chemical experiments and concluded that such amorphous tricalcium phosphate corresponds to a hydrated tri-calcium phosphate phase, suggesting a  $\text{Ca}_3(\text{PO}_4)_2 \cdot n(\text{H}_2\text{O})$  chemical formula. The presence of water is an intrinsic feature of ATCP. Even freeze-dried, amorphous calcium phosphate still contains around 15–20 wt. % of water. Sedlak and Beebe [1974] concludes from temperature-programmed dehydration of ATCP that two types of bound water exist in this compound: loosely held water, and tightly bound water held inside the amorphous particles. ATCP can also easily incorporate ‘foreign’ ions through ionic substitutions. Interestingly, ATCP can trap carbonate ions from the preparation solutions [Greenfield and Eanes, 1972], and the carbonate content tends to increase with the solution pH. Other substitutions have also been reported, including  $\text{Mg}^{2+}$  and  $\text{PO}_4^{3-}$  pyrophosphate ions. More generally, ATCP can trap several mineral ions exhibiting biological activity ( $\text{Sr}^{2+}$ ,  $\text{Zn}^{2+}$ ,  $\text{Mg}^{2+}$ ,  $\text{Mn}^+$ ,  $\text{Cu}^+$ , etc.). The incorporation of silver was recently shown to bring antimicrobial performances to ATCP [Aimanova et al., 2005].

### 3.2.2.2 Addition of Strontium

Strontium has been subject of study in recent years due to its relation to the prevention and treatment of osteoporosis. It is a very widespread in nature with a chemical structure quite similar to that of calcium. Indeed, strontium is an element belongs to group IIA of the periodic table of elements and therefore it presents chemical properties very similar to calcium.

In the human body strontium is accumulated mainly in the bone, so 99% of its content is in this tissue. The extraordinary similarity to the calcium to that strontium is metabolic routes are the same as those of calcium, that is to say, absorption takes place in the intestine, the accumulation in bone and excretion occur through urine [Cohen-Solal, 2002].

The major route of exposure is by ingestion of food or water. Compared to the amount of strontium ingested only 25–30% is absorbed by the intestine. Distribution strontium bone is proportional to plasma levels (between 0.11 – 0.31 mmol / l), duration of exposure and gender. The passage of strontium in

bone replacement is conditioned bone. Therefore, cortical bone has a smaller content in strontium than the trabecular bone.

Although strontium at high doses can produce undesirable effects in the body as human bone alterations, rickets, mineralization defects and change profile of mineralization in low doses poses no health risk. Indeed, ATSDR (Agency of Toxic Substances and Disease Registry) said explicitly in his paper Toxicological strontium that exposure to low doses of stable strontium affects not the health of adult men.

In addition to hand administration of the compounds of strontium (strontium ranelate) as therapeutic method for treatment of osteoporosis has been well studied in the past years and the results were positive in relation to bone regeneration. The in-vitro experiments showed that strontium produces an increase in training and decreased bone resorption.

The influence of the addition of certain cations to materials based on the CPA to improve interfacial interaction of polymer composites has been studied for some number of cations ( $\text{Ag}^+$ ,  $\text{Fe}^{+2}$ ,  $\text{Zn}^{+2}$ ,  $\text{Al}^{+3}$ ,  $\text{Fe}^{+3}$ ) [O'Donnell *et al.*, 2009]. Other studies have shown the role of divalent cations strontium and zinc as preventive agents of dental caries [Baig *et al.*, 1999].

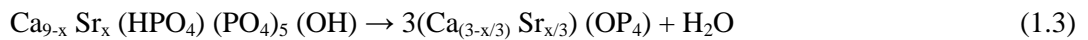
### 3.2.2.3 Effect of Isomorphous Substitution of Strontium in the $\beta$ TCP

The effect of isomorphous substitution of strontium in calcium-deficient apatite was already studied [Baig *et al.*, 1999]. These studies confirm that the crystal structure of beta phosphate can accommodate up to 80% of strontium atoms, causing a widening of the unit cell. This fact agrees with the largest ionic radius strontium relative calcium.

We can define these calcium-deficient apatite resulting from the substitution of formula non-stoichiometric following:



Furthermore, the incorporation of strontium causes the shift of the absorption bands of the phosphate group to minor frequencies. In addition, the presence of divalent ions which replace the calcium appears to play an important role in the competition between HA and  $\beta$ TCP just described in previous sections. When you submit substituted apatite strontium heat treatment acts as a stabilizer of the  $\beta$  phase agree with:



The presence of foreign ions can alter some structural and physicochemical properties of  $\beta$ TCP, such as lattice parameter and the crystallinity, solubility and thermal stability.

Through the study of Baig *et al.* [1999] and the resulting relationship between lattice parameters as concentration of strontium added (equations 1.4 and 1.5), we can estimate the effect of addition of strontium in  $\beta$ TCP on our experiment. Since the structures of  $\beta$ TCP and  $\alpha$  ( $\text{Sr}_3 (\text{PO}_4)_2$ ) are very similar. The lattice parameters follow the linear relationship:

$$a = 10.434 + 0.00373x \text{ \AA} \quad \sigma = 8.3 \times 10^{-3} \text{ \AA} \quad (1.4)$$

$$c = 37.211 + 0.00250x \text{ \AA} \quad \sigma = 7 \times 10^{-2} \text{ \AA} \quad (1.5)$$

As in our case the atomic concentration of strontium is 10% atomic then the lattice parameters are:

$$a = 10.4713 \text{ \AA} \quad c = 37.236 \text{ \AA}$$

The cell volume changes with composition in agreement with the equation:

$$V = 3507 + 4.9x\text{\AA}^3 \quad \sigma = 13 \text{\AA}^3$$

So, in our case the volume of the unit cell is:  $V = 3556 \text{\AA}^3$

### 3.2.2.4 Physicochemical Properties of TCP Phases

The solubility in water of  $\alpha$  and  $\beta$ TCP has been fully investigated and reported in the literature [Fowler and Kuroda, 1986; Gregory *et al.*, 1974]. As a general trend, the solubility of these phases was found to decrease in the order  $\alpha$  TCP >  $\beta$ TCP > Ca-deficient apatites > HAp [Ducheyne *et al.*, 1993]. It may exhibit metastable solubility equilibrium, as recorded by Baig *et al.* [1999] in the case of bone mineral and non-stoichiometric apatites. Table 1.5 gathers the solubility products of the different components.

**Table 1.5:** Solubility products of TCP phases in water at 25°C.

Phase	Chemical Formula	PK <sub>sp</sub> (25 °C)	References
$\alpha$ TCP	$\alpha$ -Ca <sub>3</sub> (PO <sub>4</sub> ) <sub>2</sub>	25.5	[Fowler and Kuroda, 1986]
$\beta$ TCP Ca-deficient apatite	$\beta$ -Ca <sub>3</sub> (PO <sub>4</sub> ) <sub>2</sub> Ca <sub>10-x</sub> (PO <sub>4</sub> ) <sub>6-x</sub> (HPO <sub>4</sub> ) <sub>x</sub> (OH) <sub>2-x</sub>	28.9–85.1	[Gregory <i>et al.</i> , 1974] [Ratner, 2004]
ATCP	Ca <sub>3</sub> (PO <sub>4</sub> ) <sub>2</sub> ·n(H <sub>2</sub> O)	24.2	[Somrani <i>et al.</i> , 2005]
HAp	Ca <sub>10</sub> (PO <sub>4</sub> ) <sub>6</sub> (OH) <sub>2</sub>	117.2	[Ratner, 2004]

### 3.2.2.5 Thermal Treatment in Air of the TCP Phases

No variation of the Ca/P ratio of TCP phases can occur on heating in air. Among the tricalcium phosphate phases,  $\alpha$  TCP is known as the high-temperature stable form. Its stability region ranges from 1125 to 1430°C [Welch and Gutt, 1961]. Under 1125°C,  $\beta$ TCP is the stable tricalcium phosphate phase. Rapid quenching from temperatures higher than 1125°C, however, permits the preservation of the  $\alpha$ -TCP phase at room temperature. The transition temperature between the  $\beta$  and  $\alpha$  TCP phases may vary depending on ion impurities such as Mg, Zn and Fe which stabilise  $\beta$ TCP. Apatitic TCP can be considered as the low-temperature crystalline form of ATCP (e.g. upon drying at 80°C). On heating at temperatures higher than 800°C, this phase transforms into  $\beta$ TCP [Destainville *et al.*, 2003]. Pure ATCP remains amorphous when heated up to 630°C [Eanes, 1970]. Above this temperature, it crystallises first into the metastable  $\alpha$  TCP generally associated with small fractions of  $\beta$ TCP and, around 850°C, into pure  $\beta$ TCP. However, ATCP containing Mg ions (or containing other elements stabilising the  $\beta$ TCP phase such as Fe and Zn) transforms directly into the  $\beta$ TCP phase without the intermediary formation of  $\alpha$  TCP. It has been suggested, based on thermodynamic and nuclear magnetic resonance studies, that  $\alpha$  TCP formed by thermal crystallization of ATCP could be more stable and contains fewer defects than the  $\alpha$  TCP phase obtained by quenching from temperatures above the  $\beta$  to  $\alpha$  TCP transition [Somrani *et al.*, 2003; Belgrand, 1993].

Thermal treatment in air of the low-temperature phases, ATCP and Ap TCP, at 900°C, for several hours does indeed lead to the formation of  $\beta$ TCP, and this is a way to prepare this phase with high purity. When TCP's Ca/P atomic ratio is not exactly 1.5, impurities appear. The main impurities, hydroxyapatite (corresponding to a Ca/P atomic ratio above 1.5) and  $\beta$  calcium pyrophosphate (corresponding to a Ca/P atomic ratio under 1.5), can be detected, respectively, by XRD and FTIR spectroscopy.  $\alpha$  TCP is generally obtained by heating  $\beta$ TCP above 1125°C (the allotropic transition temperature for  $\beta \rightarrow \alpha$ ), followed by rapid quenching. It is interesting to note that  $\alpha$  TCP can also be obtained transitorily by heating ATCP at temperatures lower than 1125°C (between 630 and 850°C), but this method generally leads to a product containing traces of  $\beta$ TCP [Somrani *et al.*, 2003; Eanes, 1970].

Both  $\alpha$  and  $\beta$ TCP can also be prepared from other starting powders and, more conveniently, from mixtures of Ca-P phases with the adequate global Ca/P ratio of 1.5. For example, they can be obtained by



heating an intimate mixture of  $\text{CaHPO}_4$  (di-calcium phosphate anhydrous) and  $\text{CaCO}_3$  (calcium carbonate) in the molar ratio 2/1, between 1150 – 1200°C, for at least one day.  $\alpha$  TCP is then obtained by quenching in liquid nitrogen whereas prolonged heating at about 900°C (until complete disappearance of  $\alpha$  TCP) leads to the production of  $\beta$ TCP. Several authors also reported the synthesis of pure  $\beta$ TCP by heating a di-calcium phosphate dihydrate, calcium carbonate mixture in the molar ratio 2/1 at 930°C, for 2 hours [Yang and Wang, 1998] or, at 900°C, for 14 hours [Vallet-Regí *et al.*, 1997].

From a structural point of view,  $\beta$ TCP is a stable anhydrous tricalcium phosphate phase. It crystallises in the rhombohedral system with 21 formula units  $\text{Ca}_3(\text{PO}_4)_2$  per hexagonal unit cell [Dickens *et al.*, 1974]. A thorough structural description of this phase is given in the literature based mainly on a comparison with the phase  $\text{Ba}_3(\text{VO}_4)_2$  and it will therefore not be reported here [Elliott, 1994]. An interesting structural feature of  $\beta$ TCP is, however, the presence of columns of ions (anions and cations) which can be distinguished parallel to the *c*-axis.

### 3.2.2.6 Aqueous Evolution of TCP Phases

In aqueous medium, it is worthwhile reminding that the first precipitates obtained under given conditions (pH, temperature and ion concentrations) from calcium phosphate solutions do not necessarily correspond to the thermodynamically most stable phase. For example, phases such as ATCP or  $\text{Ca}_8\text{H}_2(\text{PO}_4)_6 \cdot 5\text{H}_2\text{O}$  (octocalcium phosphate) may form transiently in solution, somewhat analogous to precursor phases prior to their progressive hydrolysis into apatite [Tung, 1998]. In particular, ATCP is generally the first solid phase that spontaneously precipitates upon mixing alkaline calcium and phosphate solutions [Chow and Eanes, 2001].

When immersed in solution, the most soluble TCP phases,  $\alpha$  TCP and ATCP, show a strong tendency to evolve towards a more stable phase through a hydrolysis process. At alkaline and neutral pH, ATCP progressively transforms into non-stoichiometric hydroxylated apatites [Eanes and Meyer, 1977]. According to Heughebaert [1977], in this process ATCP is generally found to remain amorphous up to half hydrolysis corresponding to the composition  $\text{Ca}_9(\text{PO}_4)_5(\text{HPO}_4)(\text{OH})$  and apatite structure crystallisation. The apatite obtained by hydrolytic conversion of ATCP may, however, evolve differently in the solution depending on pH, temperature, maturation time and ion content. Generally, an increase in the Ca/P ratio of the solid is noticed, associated with a decrease in  $\text{HPO}_4^{2-}$  content and an increase in  $\text{OH}^-$  content [Somrani *et al.*, 2005]. It was found that an increase in the Ca/P ratio in the starting solutions led to faster crystallisation into hydroxyapatite [Kim *et al.*, 2004]. Interestingly, the addition of some ionic species such as  $\text{Mg}^{2+}$ ,  $\text{CO}_3^{2-}$ , and  $\text{P}_2\text{O}_7^{4-}$  which inhibit apatite crystal growth was shown to delay this hydrolysis process [LeGeros *et al.*, 2005; Boskey and Posner, 1974]. Considering heated ATCP, the conversion rate into apatite has been shown to be related to the residual water content and rehydration of the powder appears as a determining stage [Somrani *et al.*, 2005].

$\alpha$  TCP also hydrolyses rapidly in aqueous solution [Monma *et al.*, 1981; Monma, 1980]. The hydrolysis products are generally  $\text{Ca}_8\text{H}_2(\text{PO}_4)_6 \cdot 5\text{H}_2\text{O}$  (octocalcium phosphate) and non-stoichiometric apatite, although  $\text{CaHPO}_4$  (di-calcium phosphate anhydrous or monetite) and  $\text{CaHPO}_4 \cdot 2\text{H}_2\text{O}$  (di-calcium phosphate dihydrate or brushite) can also form. The transformation mechanism is generally identified with dissolution–reprecipitation reactions. Although less investigated than the hydrolysis of Am-CP, the hydrolysis of  $\alpha$ -TCP is believed to depend on the same physicochemical factors (temperature, pH, hydrolysis time, solution composition and presence of ionic impurities).

In contrast,  $\beta$ TCP does not show a tendency to hydrolyse rapidly in solution, at physiological temperatures. However, pure  $\beta$ TCP has been shown to hydrolyse completely into relatively well-crystallised

non-stoichiometric apatitic phases in boiling aqueous suspensions within 24 hours [Rey, 1984]. Faster hydrolysis of  $\beta$ TCP into apatite also occurs under hydrothermal conditions (e.g. 120°C, in the presence of water vapour). These reactions have been found to depend strongly on the purity of  $\beta$ TCP as they are strongly inhibited in the presence of traces of  $Mg^{2+}$  ions.

### 3.2.2.7 Surface Properties

Although the understanding of surface interactions between biomaterials and body fluids is of utmost importance for following bio-integration and bioactivity, few data are available to date on the surface properties of TCP phases, despite their high involvement in the biomaterials field.

Among the indications reported in the literature concerning the surface properties or reactivity of tri-calcium phosphates, most deal either with adsorption or ion exchange processes. However, elucidation of the corresponding mechanisms and the relationship with intrinsic surface properties of the TCP phases involved, are only rarely addressed.

Adsorption of recombinant human transforming growth factor- $\beta_1$  on tricalcium phosphate-coated titanium-based implants has been investigated in dogs [Lind *et al.*, 2001]. In this article, authors pointed out a clear increase in the bone volume formed around the implant coated with TCP with adsorbed recombinant human transforming growth factor- $\beta_1$ , thus showing the potential importance of adsorption phenomena on TCP phases. Adsorption of various proteins on  $\beta$ TCP and other calcium phosphates has been investigated by Ohta *et al.*, [2001]. Two kinds of adsorption sites were distinguished: positively charged sites (Ca sites) capable of adsorbing acidic proteins (e.g. bovine serum albumin,) and negatively charged sites (P sites) which adsorb alkaline proteins. Also, the total number of calcium sites on  $\beta$ TCP was then found to be significantly lower than on the other calcium phosphates tested, including hydroxyapatite.

### 3.2.3 Application of $\alpha$ and $\beta$ -tricalcium Phosphates in Biomaterials

Macro-porous composite scaffolds can be processed using different methods: solvent casting/particulate leaching, emulsion freeze drying or thermally induced phase separation. Biodegradable composite including resorbable polymer such as polylactic acid (PLA) and/or polyglycolic acid (PGA) and a resorbable apatite can be prepared at ambient temperature [Chen *et al.*, 2001a; Linhart *et al.*, 2001]. Recently, Mathieu *et al.* [2006] reported the use of a supercritical  $CO_2$  foaming process to prepare porous PLA-HAp and/or PLA-TCP composites exhibiting mechanical behaviour analogous to bone (anisotropy in compressive and viscoelastic properties).

Finally, the formation of a polymer-apatite composite can also correspond to a first step in the preparation of nano-crystalline apatite porous ceramic. For example, Tadic *et al.* [2004] reported the processing of nano-crystalline apatites-based biomaterials porous bio-ceramics using both sodium chloride salt and polyvinyl alcohol fibres as water-soluble pore agents and cold isostatic pressing without sintering.

## 4 Conclusion

In this chapter, we have discussed extensively different types of polymers to be used for composite materials with different industrial applications, then application of polymers with different types of fillers and surface modifiers for tissue and bone engineering. The physical, mechanical and thermal properties have been under consideration as they have great impact on the resulting product. Biodegradable polymers from renewable resources have been attracting ever-increasing attention over the past two decades, predominantly for two reasons: the first being environmental concerns and the second being the realization that our petroleum resources are finite. Biodegradable polymers and their products will play an important

role for transplantation in the coming era. Polylactides are currently used in a number of biomedical applications, such as sutures, stents, dialysis media and drug delivery devices. Also polylactides are used for tissue, cartilage and bone regeneration. Hyaluronic acid is hydrophilic in nature and using it with polylactide will enhance the surface adhesion property of the scaffold produced. As a result it will augment the adhesion, differentiation and proliferation of human cell on the scaffold to be transplanted. Tri-calcium phosphate is added as mineral in the polymer matrix to increase the mechanical properties of the scaffold. The percentage of TCP added depends upon the nature and mechanical property of scaffold required to be transplanted.

# Chapter 2

## Processes to Manufacture Foams and to Functionalize the Surface

*Tissue engineering offers an alternative technique to tissue transplantation for diseased or malfunctioned organs. Adequate porosity and equivalent pore size as well as interconnected pore structure are crucial to allow for easy dispersion of cells throughout the scaffold structure. Scaffold structure is directly related to fabrication methods, which are presented in this chapter one by one. We adopted the technique using supercritical CO<sub>2</sub> in our experiments. This process is a green technology which provides adequate porosity and pore size with no loss of bioactive mass in the scaffold matrix. The surface and mechanical properties of the scaffold will be enhanced by adapting the mixing and co-grinding of polymer matrix with surface modifier and filler. Hyaluronic acid (HA) has a number of potential biomedical applications in drug delivery and tissue engineering. By co-grinding, it coats the surface of polylactide and being hydrophilic in nature thus improves the adhesion energy of the polymer matrix. Similarly filler having higher mechanical properties than polymer enhance the modulus and strength of matrix.*

### 1 Generalities on Polymer Foams

The production of polymeric-foam materials can be carried out by either mechanical, chemical, or physical means. Some of the most commonly used methods are the following [Landrock, 1995]:

- Thermal decomposition of chemical blowing agents generating either nitrogen or carbon dioxide, or both, by application of heat, or as the result of the exothermic heat of reaction during polymerization.
- Mechanical whipping of gases (frothing) into a polymer system (melt, solution or suspension) which hardens, either by catalytic action or heat, or both, thus entrapping the gas bubbles in the polymer matrix.
- Volatilization of low-boiling liquids such as fluorocarbons or methylene chloride within the polymer mass as the result of the exothermic heat of reaction, or by application of heat.
- Volatilization of gases produced by the exothermic heat of reaction during polymerization such as occurs in the reaction of isocyanate with water to form carbon dioxide.

- Expansion of dissolved gas in a polymer mass on reduction of pressure in the system.
- Incorporation of hollow microspheres into a polymer mass. The microspheres may consist of either hollow glass or hollow plastic beads or salts.
- Expansion of gas-filled beads by application of heat or expansion of these beads in a polymer mass by the heat of reaction, e.g. expansion of polystyrene beads in a polyurethane or epoxy resin system.

The production of foams can take place by many different techniques. These may include [Landrock, 1995]:

- Continuous slab-stock production by pouring or impingement, using multi-component foam machines.
- Compression molding of foams.
- Reaction-injection molding (RIM), usually by impingement.
- Foaming-in-place by pouring from a dual- or multi-component head.
- Spraying of foams.
- Extrusion of foams using expandable beads or pellets.
- Injection molding of expandable beads or pellets.
- Rotational casting of foams.
- Frothing of foams, either by introduction of air or of a low-boiling volatile solvent (e.g. dichlorodifluoromethane, F-12).
- Lamination of foams (foam-board production).
- Production of foam composites.
- Precipitation foam processes where a polymer phase is formed by polymerization or precipitation from a liquid which is later allowed to escape.

## 2 Manufacturing of Porous Materials by Wet Methods

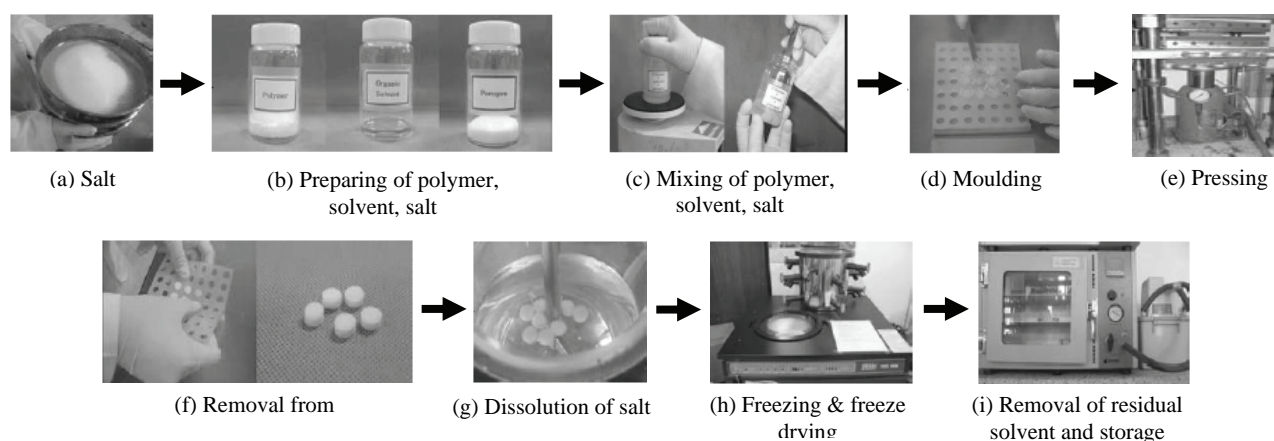
An ideal scaffold should be biocompatible, biodegradable, and highly porous with interconnected pores with adequate mechanical properties depending upon the application.

### 2.1 Solvent Casting/Particulate Leaching

To prepare three-dimensional biodegradable porous scaffolds, a method that incorporates salt particles as the porogen material can be used [Ma and Choi, 2001; Mikos *et al.*, 1994]. The porogen leaching method provides easy control of the pore structure. The pore structure, porosity, and pore size can be easily controlled by regulating the amount and size of salt. This method involves casting a mixture of polymer solution (polymer/chloroform or polymer/methylene chloride) and porogen in a mould, and then leaching out the porogen with water to generate the pores and freeze-drying the mixture. Water-soluble particulates, such as salts and carbohydrates, are used as the porogen materials. Solvent casting / particulate leaching (SC/PL) involves the use of water-soluble porogen, such as gelatine microspheres or sodium chloride.

The procedure is shown in Figure 2.1 and is applied as follows [Devin *et al.*, 1996; Mooney *et al.*, 1995; Mikos *et al.*, 1994]:

- (a) Salt particulates are prepared by sieving. The sizes of the salt particulates are controlled by the desirable sieving.
- (b) Polymer solutions are prepared by dissolving different amounts and types of polymers in solvent (e.g. methylene chloride or chloroform).
- (c) Sieved salt particulates are added to the polymer solution, and the dispersion is gently vortexed.
- (d) The solution is poured into the designed silicon mould.
- (e) Subsequently, the mould with dispersion is pressed ( $\sim 6$  MPa) by pressure apparatus.
- (f) The formed samples are taken out of the mould.
- (g) Samples are dissolved for a desirable time (48 h) in deionised water.
- (h) Salt-removed samples are freeze-dried for a desirable time (about 48 h) at low temperature and reduced pressure (around 8 Pa,  $-55^{\circ}\text{C}$ ).
- (i) The scaffolds are dried in a vacuum oven at  $25^{\circ}\text{C}$  for 1 week to remove the residual solvent. Scaffolds are kept under vacuum until use.



**Figure 2.1:** Procedure of solvent casting/particulate leaching.  
[Khang *et al.*, 2007]

Porosity is independent of particle diameters, but increases with the quantity of salt. A minimum of 70% of salt particles is needed to create interconnected pores [Mikos *et al.*, 1994]. When particle diameter increases, pore size increases. Mechanical properties, such as compressive strength or modulus, are independent of pore size but decrease when porosity increases. Porosity up to 90-95%, with varying pore size, and a compressive modulus of 0.15 to 150 MPa, depending on porosity can be achieved. This method is only applicable to the preparation of thin films since all the salt particles on the bulk must be leached out completely. To obtain thicker scaffolds of desired shape, an improved porogen salt-leaching technique has been proposed [Gross and Rodríguez-Lorenzo, 2004]. By adding small hydroxyapatite (HAp) fibres to a PLGA solution, it is possible to create composite foams with a controlled porosity [Hou *et al.*, 2003; Chen *et al.*, 2001b; Thomson *et al.*, 1998; Widmer *et al.*, 1998].

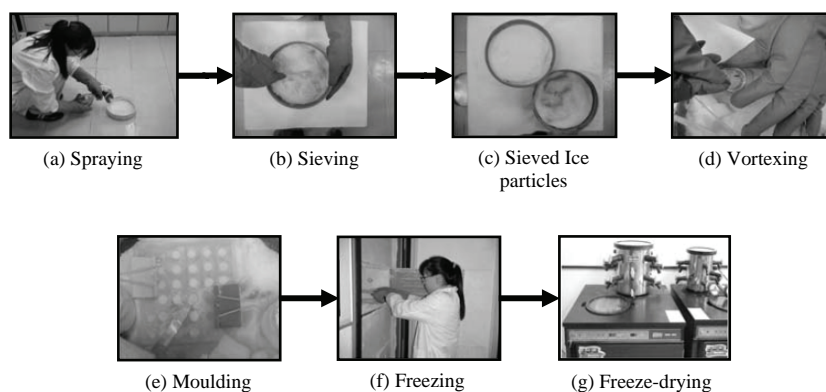
## 2.2 Ice Particle-Leaching

Previous scaffold manufacturing usually involves (1) dissolving the polymer in organic solvent, (2) incorporating porogens, and (3) leaching porogens. Despite these advantages, the problem of residual



porogen used to prepare 3D scaffolds remains. Therefore, the conventional method of porogen leaching by washing with water is replaced by freeze-drying, facilitating the removal of the porogen and making removal more complete. The method of porogen leaching by using ice particulates as the porogen material can be employed to fabricate porous 3D scaffolds for tissue engineering. Using ice particulates as the porogen material, scaffolds are prepared by mixing a polymer solution in a solvent with ice particulates, freezing the mixture in liquid nitrogen, and freeze-drying. This method can be applied to biodegradable polymers like polylactides that are soluble in a solvent such as chloroform or methylene chloride. Sieved ice particles are dispersed in a polymer/chloroform solution. The ice particles are eventually leached out by selective dissolution in water or by freeze-drying to produce a porous 3D scaffold as described in Figure 2.2:

- (a) Ice particulates are prepared by spraying deionised water into liquid nitrogen [Figure a].
- (b) Polymer solutions of various concentrations are prepared by dissolving different amounts of polymer in solvent (e.g. methylene chloride or chloroform) and cooling. The sizes of the ice particulates are controlled by the desirable sieving of the solution to  $-20^{\circ}\text{C}$  [Figures b and c]. Ice particulates are added to the precooled polymer solution.
- (c) The dispersion is gently vortexed [Figure d].
- (d) It is then poured into a precooled designed mould [Figure e].
- (e) Subsequently, the mould with dispersion is frozen by placing at low temperature [Figure f].
- (f) The mould with dispersion is freeze-dried for a desirable time under low temperature [Figure g]. Often, further drying at elevated temperatures is required to completely remove the solvent after freeze-drying.



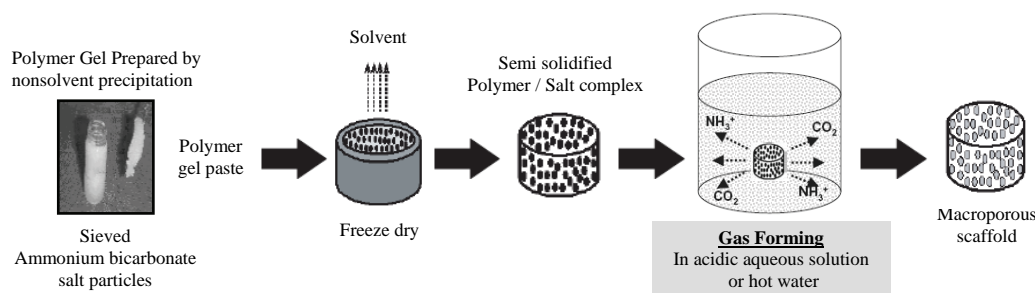
**Figure 2.2:** Procedure of ice particle-leaching.  
[Kim *et al.*, 2007b]

### 2.3 Gas-Foaming/Salt-Leaching Technique

The biodegradable scaffolds prepared by the particulate-leaching method often exhibit a dense surface skin layer, which hampers *in vitro* cell seeding into the scaffolds and tissue ingrowth after *in vivo* implantation. Additionally, poor interconnectivities between macropores lower cell viability and result in non-uniform distribution of seeded cells throughout the matrix. Sodium bicarbonate salt or ammonium bicarbonate salt with acidic excipients such as citric acid has been used for effervescent gas-evolving oral tablets, due to its carbon dioxide – evolving property upon contact in acidic aqueous solution. Thus, various alkalising analgesic oral tablets are commercially available. In particular, ammonium bicarbonate salt – upon contact in an acidic aqueous solution and/or incubated at elevated temperature – evolves gaseous ammonia and carbon dioxide by itself.

The gas-foaming/salt-leaching method is based on the idea that sieved salt particles of ammonium bicarbonate dispersed within a polymer–solvent mixture can generate ammonia and carbon dioxide gases within solidifying matrices upon contact with hot water or aqueous acidic solution, thereby producing highly porous structures (cf. Figure 2.3). These scaffolds show macro-pore structures over 200  $\mu\text{m}$  with no visible surface skin layers, thus permitting sufficient cell seeding within the scaffolds. In addition, porosities can be controlled by the amount of ammonium bicarbonate incorporated into the polymer solution. It is possible to make various scaffolds with different geometries and sizes by a hand-shaping or moulding process because the polymer–salt mixture becomes a gel paste after partial evaporation of the solvent.

Poly lactides must be completely dissolved in chloroform. An excess volume of cold ethanol is then added to the polymer solution. The whole is then mixed homogeneously. A gel-like slurry precipitates immediately in the solvent/non solvent mixture. The turbid solution is removed and the gel slurry is recovered. Ammonium bicarbonate is added to the solution which is mixed to make a homogeneous gel paste mixture of polymer/salt. A small volume of chloroform can be added to the slurry as a plasticizer. The paste mixture is then casted into a disc-shaped Teflon<sup>®</sup> mould or manipulated to the desired shape. The gel paste mixture is dried by partial evaporation of ethanol, under atmospheric pressure, to obtain the semi-solidified mixture. A polymer/salt complex is removed from the mould and wetted with cold ethanol. The matrix is immersed into supersaturated citric acid solution to effervesce from embedded salt particles. After complete effervescence, the scaffolds are washed with  $\text{H}_2\text{O}$  then freeze-dried and finally stored at  $-80^\circ\text{C}$  with desiccant until use.



**Figure 2.3:** Procedure of gas foaming/salt-leaching method.  
[Park, 2007b]

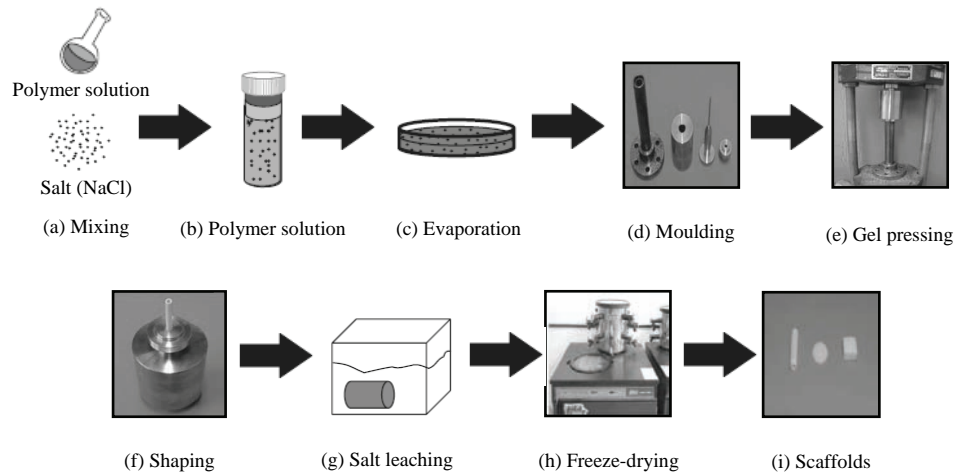
## 2.4 Gel-Pressing Technique

The particulate-leaching process dissolves the polylactide in chloroform, and then casts it onto a dish filled with the porogen. After evaporation of the solvent, the polymer/salt composite is leached in water to remove the porogen. The process is easy to carry out. The pore size can be controlled by the size of the salt crystals, and the porosity by the salt/polymer ratio. However, certain critical variables such as pore shape, limited membrane thickness (3 mm), plastic operation, and interpore openings are not controllable. To overcome these shortcomings, a method to fabricate porous, biodegradable scaffolds using a combined gel-pressing method and salt-leaching technique has been developed (cf. Figure 2.4):

- (a) A polymer/salt composite is firstly prepared by dissolution process in a solvent.
- (b) The polymer is dissolved in a solvent and then mixed with salts.
- (c) The solvent is evaporated under air condition to form gels.
- (d) Gels are put inside moulds.
- (e) Polymer gels are pressed.



- (f) Scaffolds are processed to fabricate a tubular or sheet-types.
- (g) After evaporation of the solvent, the salt particles in the construct are leached out to make an open-pore structure.
- (h) Scaffolds are freeze-dried for a desired time under low temperature.
- (i) Scaffolds are obtained by finally under the return to the room temperature.



**Figure 2.4:** Procedure of scaffolds by gel-pressing method.  
[Kim, 2007]

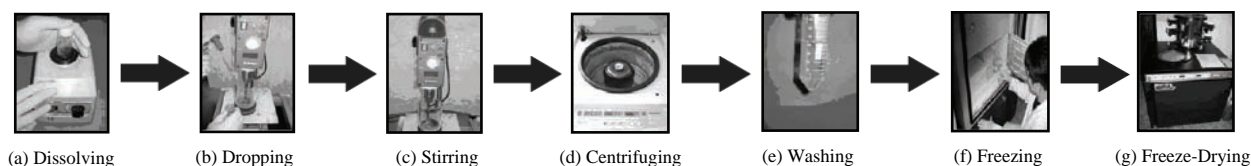
## 2.5 PLGA Microspheres for Tissue-Engineered Scaffold

PLGA-based microspheres are biodegradable particulate delivery systems providing both drug protection, encapsulated inside a polymeric matrix, and its release at a slow and continuous rate. Microsphere manufacturing usually involves (1) the controlling of a disintegrated polymer, (2) cell toxicity, and (3) a suitable environment for cell culture. The size and degradable profile can be easily managed by controlling the molecular weight of the polymer and the process of fabrication.

PLGA microspheres are particularly attractive for tissue regeneration approaches either as an injectable system or as the integral part of a replacement clinical construct. The small, spherical nature of these polymers enables the encapsulation of growth factors or other drugs, and their subsequent delivery to a specific and designated area. Controlled release of bioactive molecules, such as cytokines and growth factors, has become an important aspect of tissue engineering because it allows modulation of cellular function and tissue formation at the afflicted site. Cell cultures using microspheres have an advantage of passage abbreviation to improve cell activity. The PLGA microspheres regulate many aspects of cellular activity, including cell proliferation, cell differentiation, and extracellular matrix metabolism, in a time- and concentration-dependent fashion. The procedure to prepare PLGA microsphere scaffolds is presented in Figure 2.5.

- (a) The polymer is dissolved in a solvent, and is ready to add to a solution in surfactant.
- (b) The polymer solution is dropped into an aqueous solution in surfactant by a pipette.
- (c) This solution is stirred at 400 rpm for 7 h using a mechanical stirrer.
- (d) The fabricated microspheres are collected from the bottom by a centrifugal separator.
- (e) The hardened microspheres are centrifuged, washed with deionised water.

- (f) And then put into a freezer.
- (g) The manufactured microspheres are freeze-dried under low temperature and pressure.

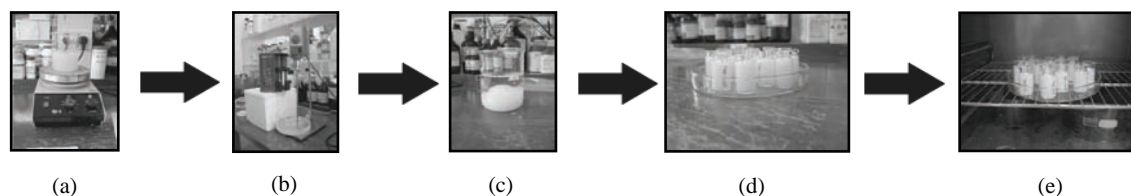


**Figure 2.5:** Schematic procedure of the processing of PLGA microsphere scaffolds.  
[*Ko et al.*, 2007]

## 2.6 Particle-Aggregated Scaffolds Technique

The particle aggregation method described herein allows one to obtain scaffolds with high mechanical properties (thus assuring scaffold stability) and full three-dimensional interconnectivity, which is assured in a 3D perspective by the contact points between the particles. The described technique is based on the random packing of prefabricated microspheres with further aggregation by physical or thermal means to create a three-dimensional porous structure. The polymer (at desired concentration) is dissolved in a good solvent. For the production of composite particles, hydroxyapatite (HAp) is added at an adequate concentration to the solution and dispersed homogeneously. The detailed procedure (cf. Figure 2.6) is the following:

- (a) The polymer or composite (polymer plus HAp) solution is left overnight to assure complete dissolution [Figure a]. The polymer/composite solution is filtered to eliminate any residual particles.
- (b) The polymer/composite solution is extruded through a syringe in a dispenser (syringe pump) at a controlled and constant rate in order to shape the particles into a NaOH solution [Figure b]. The particle size can be controlled by tailoring the polymer solution concentration, needle diameter, and dispensing rate.
- (c) The particles are then exhaustively washed to remove all exceeding reagents, namely from the precipitation bath [Figure c]. To produce composite particles, cross-linking can be used with appropriate polymer cross-linkers. The particles are immersed in the cross-linking solution for a determined short period and then washed again.
- (d) For production of scaffolds, appropriate particles are press-fitted into a specific mould [Figure d].
- (e) And left in the oven for a necessary time for aggregation to take place [Figure e].



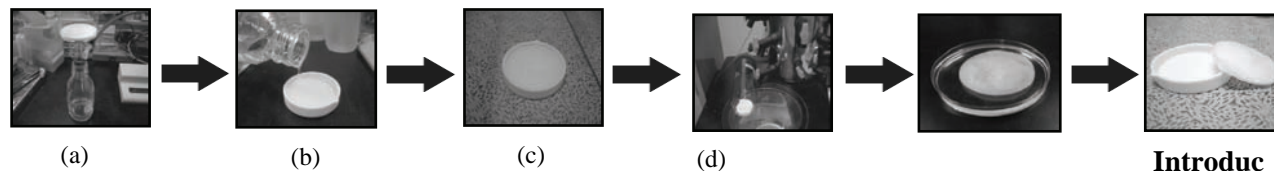
**Figure 2.6:** Schematic procedure for manufacturing of scaffolds with the particle-aggregated technique.  
[*Malafaya and Reis*, 2007]

## 2.7 Freeze-Drying Method

Porosity can be acquired in the first step of freeze-drying (lyophilising) the solution containing polymeric biomaterials, when the ice crystals of the solvents are formed within the solution. The ice crystals serve as a porogen whose size can be easily controlled by adjusting the freezing temperature and the

concentration of the solution. Structural integrity of the porous sponge-like structure should also be maintained, even after wetting in the interstitial fluid or culture medium. If the scaffold is made from water-soluble materials without cross-linkage or if only the 3D frame is maintained by the ionic interaction, then the 3D sponge structure can be easily resolved or turned into a gel-like structure in the aqueous environment. This structural integrity in the aqueous environment is determined mainly by the degree of water accessibility within the frames of the scaffold and the presence of degradation enzymes, which is more importantly regulated by the ionic status, water solubility, and innate property of the biomaterial itself. Therefore, the concentration of solution, ionic status of biomaterials, solvents, and freezing temperature are important factors to be considered in the manufacturing of suitable tissue engineering scaffolds. The procedure for freeze-drying is (cf. Figure 2.7):

- (a) The polymer is solubilized in a good solvent. The insoluble materials are removed by filtration through sintered glass filter. The filtered solution is stored overnight at room temperature to remove entrapped air bubbles. The solution is neutralised.
- (b) The solution is poured into a Teflon-coated mould. The solution is freeze at  $-70^{\circ}\text{C}$  or  $-196^{\circ}\text{C}$ , for 12 h.
- (c) The solution is freeze-dried by lowering the pressure below 7 mTorr, for 48 h.
- (d) The solution is neutralized by removing excess acid within the scaffold by washing with absolute ethanol for 1 h. and with water for 3 h.
- (e) The scaffold is soaked in the solution containing growth factors or matrix proteins. The scaffold is freeze at  $-70^{\circ}\text{C}$  and lyophilised in order to maintain the original form of the scaffold.



**Figure 2.7:** Schematic preparation processing of scaffold by the freeze-drying method.  
[Kim *et al.*, 2007a]

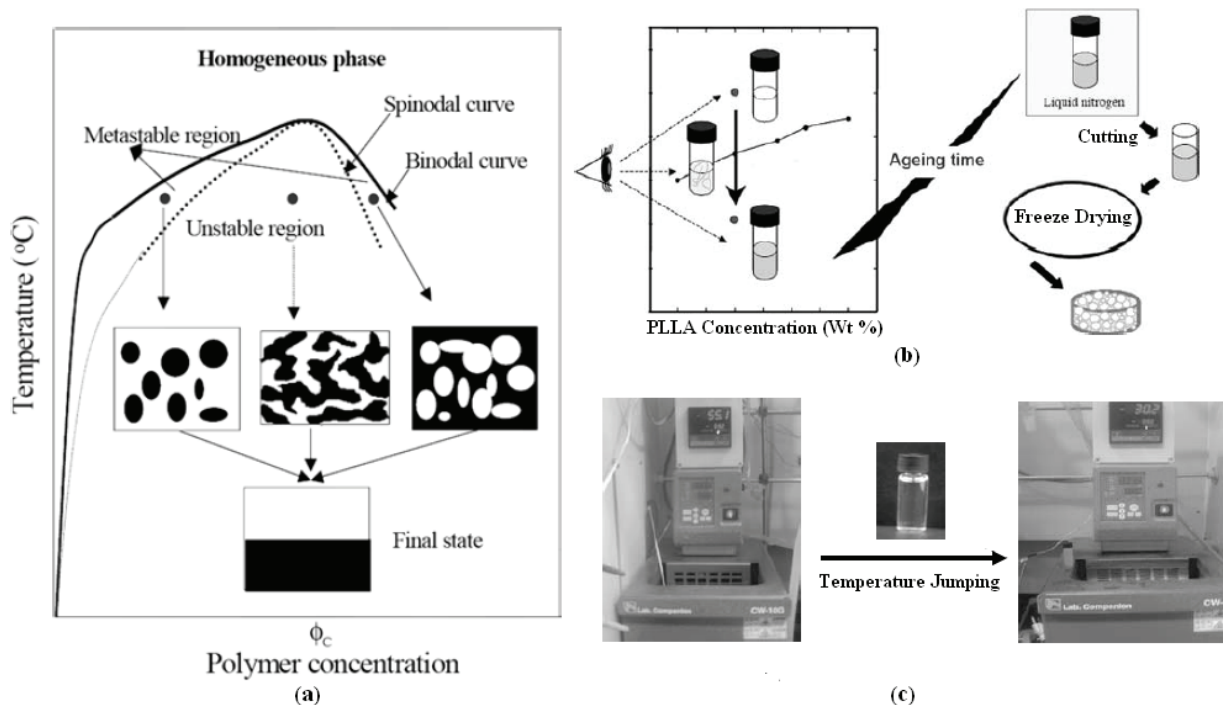
## 2.8 Thermally Induced Phase Separation (TIPS) Technique

Freeze-drying via TIPS has received much attention in industrial applications for the production of isotropic, highly interconnected, and porosity-designed membranes. Figure 2.8.a represents a schematic temperature–composition phase diagram for a binary polymer/solvent system. Above the binodal curve, a single polymer solution phase is formed; and if cooling below the curve, polymer-rich and polymer-poor phases are separated in a thermodynamic equilibrium state. The spinodal curve is defined as the line at which the second derivative Gibbs free energy of mixing is equal to zero, and it divides the two-phase region into unstable and metastable regions. If the system is quenched into the metastable region, phase separation occurs in a nucleation and growth mechanism, leading to a bead-like isolated cellular structure. On the other hand, if the system temperature is quenched into the unstable region, phase separation takes place in a spinodal decomposition mechanism (liquid–liquid phase separation), resulting in a micro-porous interconnected structure. The phase separation and freeze-drying method appears as a versatile technique to prepare highly porous three-dimensional polymer scaffolds that fulfil all of the requirements for cell transplantation. Porosity can be controlled in terms of pore size and morphology by a suitable choice of processing conditions and by a strict control of phase separation conditions such as quenching temperature,

quenching depth, ageing time, polymer concentration, molecular weight, solvent/non solvent composition, and additives.

The schematic procedure for thermally induced phase separation is given in Figure 2.8. Polylactide solution with a mixture of good and bad solvent is prepared [Figure a]. The sample is reheated to 15°C above the measured cloud point temperature, and then placed in a water bath preheated to the quenching temperature. It is kept for 2, 10, 30, 60 or 120 min, at the quenching temperature. The annealed sample is directly immersed in liquid nitrogen to be fast-frozen for 1 h, and then a small hole is cut in the vial cap to release the solvent [Figure b].

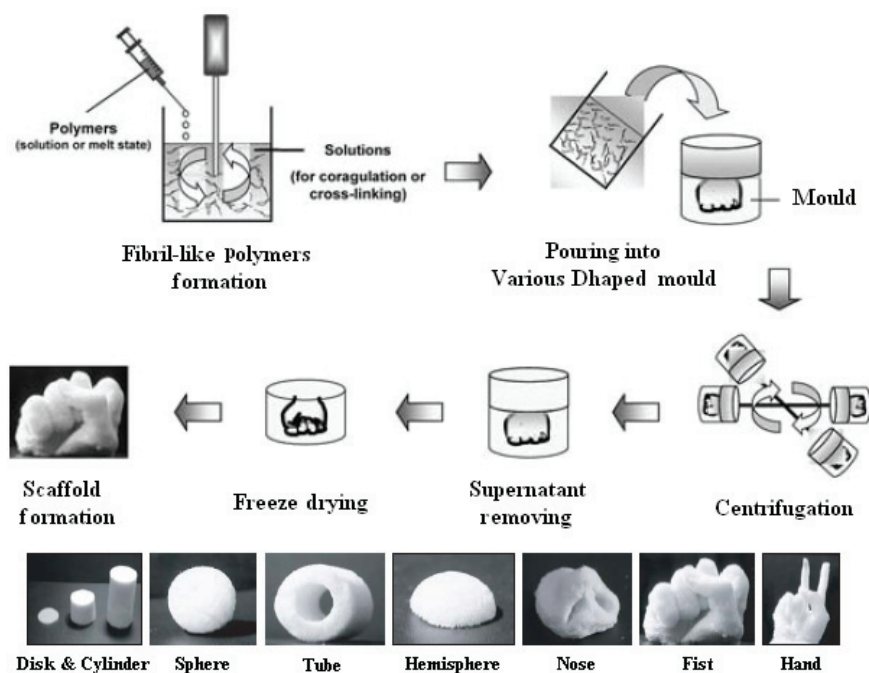
Freeze-drying is performed in a freeze-dryer at -77°C and 7 mTorr for 3 days in order to remove the solvent and obtain the macroporous scaffolds [Figure c]. The dry scaffolds are cut into cubes with a surgical blade. Prior to cell seeding, 3D scaffolds are pre-wetted with 70% ethanol for 3 h to sterilise them and enhance their water uptake. The ethanol is removed by soaking with agitation for 1 h in six changes of PBS, and then the scaffolds are left overnight in the culture media.



**Figure 2.8:** Schematic preparation processing of thermally induced phase separation method. [Kim and Doo, 2007a]

## 2.9 Centrifugation Method

Recently, a centrifugation method has been introduced as an effective method to fabricate scaffolds that have various shapes with a uniform surface and inside pore structures. The scaffolds can be fabricated in various shapes from many different natural and synthetic polymers by the centrifugation method (cf. Figure 2.9).



**Figure 2.9:** Schematic procedure showing the fabrication of scaffolds by centrifugation method and photographs of variously shaped scaffolds. [Oh and Lee, 2007b]

1. The polymer solution is solubilized in a good solvent and poured into a syringe. A NaOH/CaCl<sub>2</sub> aqueous solution is prepared into a beaker. The polymer solution is slowly dropped into the NaOH solution with vigorous agitation using a homogenizer. The fibril-like polymer is obtained by precipitation (suspension in NaOH solution). The fibril-like polymer is washed in excess phosphate buffered saline solution (PBS, pH ~7.4) and the following distilled water to remove residual solvent and NaOH. A neutralized fibril-like polymer suspension [in distilled water (pH ~7.0)] is obtained.
2. The fibril-like polymer-suspended solution is poured into a cylindrical (or various-shaped) mould.
3. The fibril-like polymer is centrifuged for accumulation in the mould and the following fibril bonding.
4. Supernatant is discarded from the mould.
5. The fibril-like polymer accumulation is frozen in the mould at ~70°C for 12 h and then lyophilised.
6. The cylindrical (or various-shaped) scaffold is obtained.

## 2.10 Injectable Thermosensitive Gel Technique

One of the simplest and most convenient approaches in tissue engineering applications is to inject the polymer–cell or polymer–drug entity into the body. Injectable systems offer specific advantages over preformed scaffolds, including easy application, site-specific delivery, and improved compliance and comfort for patients. Water-soluble, thermosensitive, or pH-sensitive polymers exhibiting reversible sol–gel transition and photopolymerisable hydrogels have been tailor-made as injectables.

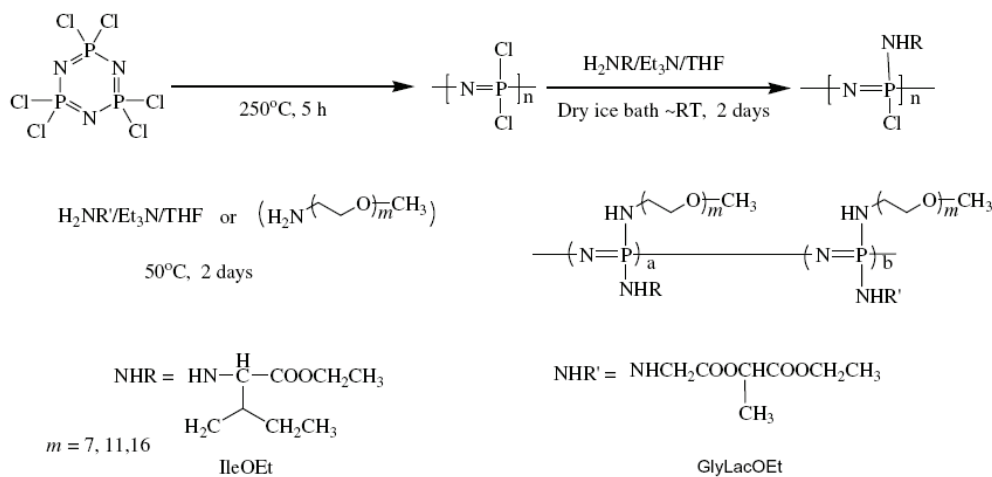
Thermosensitive hydrogels can be formed either by physical gelation without covalent bonding (e.g. ionic interaction, hydrophobic association, hydrogen bonding between polymer chains in an aqueous solution) or by chemical gelation caused by thermosensitive chemical cross-linkers. The former may go through sol–gel phase transitions in response to changes in temperature, but the latter may undergo



swelling/shrinking. Thermo-sensitive hydrogels made by physical cross-links between polymer chains are very useful for injectable tissue engineering because no toxic organic cross-linkers are usually employed.

Polyphosphazenes are a new class of inorganic backbone polymers that are superior to many other organic systems in term of their molecular structural diversity and property variations. These polymers can be used as a reactive macromolecular intermediary by replacing chlorine atoms with organic side groups to give various hydrolytically stable polymers.

The schematic reactions of injectable thermosensitive gel are presented in Figure 2.10. Before the reaction, L-isoleucine ethyl ester (IleOEt), glycolic or lactic acid ester and  $\alpha$ -amino- $\omega$ -methoxy-polyethylene glycol (AMPEG) are respectively dried for 1 day, at 50°C in vacuum, for moisture removal. Tetrahydrofuran (THF) is dried by reflux over sodium/benzophenone under nitrogen atmosphere. Triethylamine (TEA) and acetonitrile are distilled over baryum oxide (BaO) under nitrogen atmosphere. L-isoleucine ethyl ester hydrochloride suspended in dry THF containing triethylamine is slowly added to poly(dichloro-phosphazene) dissolved in dry THF. The reaction is performed for 4 hr at 4°C, and then for 20 hr at room temperature. TEA and ethyl-2-(O-glycol)lactate (GlyLacOEt) oxalic salt dissolved in acetonitrile are added to this mixture, and the reaction mixture is stirred for 19 h at room temperature.



**Figure 2.10:** Reaction of injectable thermosensitive gel.  
[Song and Lee, 2007]

After AMPEG dissolved in dry THF-containing TEA is added to the polymer solution, the reaction mixture is stirred for 2 days at 40°C–50°C. The above reaction mixture is filtered. After the filtrate is concentrated, it is poured into n-hexane to obtain precipitate, which is reprecipitated twice in the same solvent. The re-precipitated polymer is concentrated. The polymer product is further purified by dialysis in methanol for 4 days and then in distilled water for 4 days at 4°C. The final dialysed solution is freeze-dried to obtain the final polymer.

## 2.11 Liquid-Liquid Phase Separation Technique

A non solvent such as water is added to a polylactide solution in order to create an emulsion by homogenizing these two immiscible phases. A liquid-liquid phase separation occurs at a temperature higher than the solvent crystallization temperature. Quenching then locks in the emulsion liquid state structure. Solvent and water are then removed by freeze-drying to create porosity. Various factors, such as viscosity, interfacial energy, polymer microstructure and concentration, must be controlled to stabilize the emulsion with a continuous polymer-rich phase and a dispersed water phase [Schugens *et al.*, 1996].

Liquid-liquid phase separation gives rise to scaffolds with porosity up to 90% and an average pore size of 15 to 35  $\mu\text{m}$  depending on the processing parameters and the thermodynamics of the polymer/solvent system. In comparison to the previous technique, this method leads to scaffolds with a much larger surface area. However, the overall pore size is smaller, and organic solvents are still required. Both limit the use of liquid-liquid phase separation in the field of bone tissue engineering [van de Witte *et al.*, 1996].

### 2.12 Solid-Liquid Phase Separation Technique

A polylactide-solvent solution is quenched below the melting point of the solvent and dried under vacuum to remove the solvent by sublimation. Solid-liquid phase separation, with solvent crystallization, leads to ladder or sheet-like anisotropic morphologies, which strongly depend on the quenching rate [Ma and Choi, 2001; Lo *et al.*, 1995]. The ladder-like structure results from the forward progress of solvent crystallization front [Schugens *et al.*, 1996]. When the polymer concentration increases, pore diameter and porosity tend to decrease. Porosity of 80–95%, with a pore size mainly between 20 and 100  $\mu\text{m}$  and a compressive modulus up to 20 MPa in the longitudinal direction could be obtained.

This technique was also used to manufacture composite scaffolds, either with hydroxyapatite [Zhang and Ma, 1999b] or Bioglass<sup>®</sup> particles [Maquet *et al.*, 2004; Boccaccini and Maquet, 2003]. Fillers were added to the polymer solution before quenching and solvent removal. Similar ladder-like anisotropic morphology was obtained, becoming more heterogeneous as filler content was increased.

### 2.13 Fibre Mesh/Fibre Bonding Technique

Fibres, produced by textile technology, have been used to make non-woven scaffolds from PGA and P<sub>L</sub>LA [Cima *et al.*, 1991]. The lack of structural stability of these nonwoven scaffolds, often resulted in significant deformation due to contractile forces of the cells that have been seeded on the scaffold. This led to the development of a fibre bonding technique to increase the mechanical properties of the scaffolds [Mikos *et al.*, 1993]. This is achieved by dissolving polylactide in methylene chloride and casting over the polyglycolide mesh. The solvent is allowed to evaporate and the construct is then heated above the melting point of PGA. Once the PGA-P<sub>L</sub>LA construct has cooled, the P<sub>L</sub>LA is removed by dissolving in methylene chloride again. This treatment results in a mesh of PGA fibres joined at the cross-points [Sachlos and Czernuszka, 2003].

Bonded PGA fibre structures with high and open porosity, a high area-to-volume ratio and pore diameters up to 500  $\mu\text{m}$  were thus produced. These biocompatible matrices, with structural integrity, are suitable as scaffolds for organ regeneration. In addition, the technique does not lend itself to easy and independent control of porosity and pore size. Finally the combination of toxic chemicals and high temperature presents difficulties if cells or bioactive molecules, such as growth factors or proteins, are to be included in the scaffold during processing.

### 2.14 Hydrocarbon Templating Technique

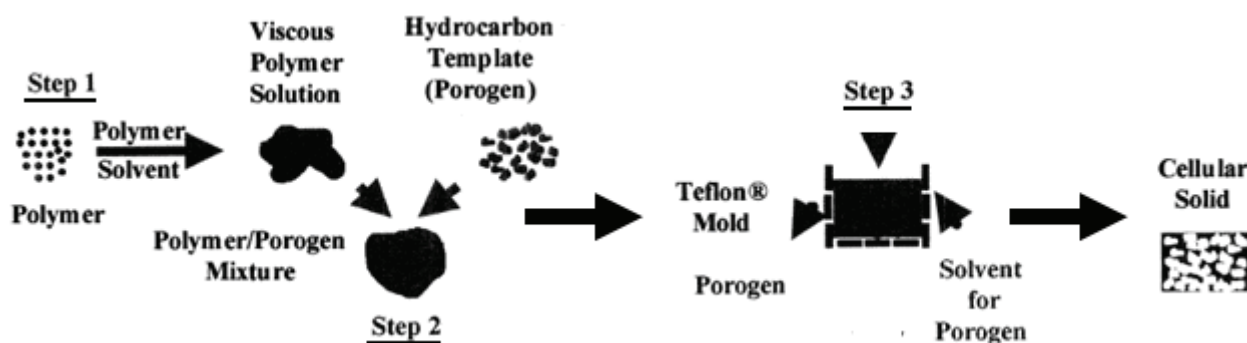
By using a hydrocarbon particulate phase as a template it is also possible to form pore for a wide range of polymers. The use of hydrocarbon template allows for enhanced control over pore structure, porosity, and other structural and bulk characteristics of the polymer foam. Polymer foams have been produced with densities as low as 0.120, porosity as high as 87% and high surface areas (20  $\text{m}^2/\text{g}$ ). Foams of polylactides produced by this process have been used to engineer a variety of different structures, including tissues with complex geometries such as in the likeness of a human nose [Gibson and Ashby, 1999; Yoda, 1998; Szycher and Lee, 1992; Guidoin *et al.*, 1988; Suh and Webb, 1988; Alsbjörn, 1984; Pruitt and Levine,

1984; Bruck, 1982; Lindenauer *et al.*, 1976]. A schematic representation of the steps involved in the preparation of polymeric foams is given in Figure 2.11.

Step 1: The polymer is dissolved in a suitable solvent and then mixed with the hydrocarbon porogen (e.g. paraffin, beeswax, bonewax) to yield a mouldable mixture.

Step 2: This mixture is then compacted in a Teflon<sup>®</sup> mould.

Step 3: The polymer/porogen mixture in the mould is then immersed in an aliphatic hydrocarbon solvent (pentane, hexane), which is a nonsolvent for the polymer. During this step, the porogen and polymer solvent are extracted with concurrent precipitation of the polymer phase. To improve the efficiency of solvent penetration, the mould is equipped with small openings on all faces. Residual porogen is removed by repeating the last step. The foam obtained is then dried under vacuum to remove any trace of solvents.



**Figure 2.11:** Schematic stepwise representation of the polymeric foaming using hydrocarbon porogen. [Shastri *et al.*, 2000]

## 2.15 Microspheres Bonding Technique

PLGA has been also sintered with microspheres of varying sizes [Borden *et al.*, 2003]. These authors manufactured foams with porosity ranging between 30 and 40%, and an elastic modulus ranging between 135 and 300 MPa. They presented their scaffold as a reverse template of trabecular bone, since scaffold resorption would leave a porosity of about 70%, corresponding to bone void volume.

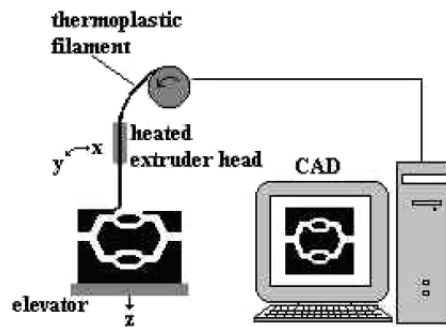
## 2.16 Rapid Prototyping Techniques

Rapid prototyping technologies aim at producing complex free-form parts directly from a computer aided design model. 2D printing or 3D prototyping and fused deposition modelling were tested to obtain porous structures in the biomedical field. 3D prototyping consists of printing a binder through a print head nozzle onto a powder bead [Cima *et al.*, 1991]. Removing the excess powder leads to the porous structure. The part is built sequentially in layers, at room temperature. The main problem with bio-resorbable polymers is the use of organic solvents.

In the fused deposition modelling process, parts are also fabricated in layers, where a layer is built by extruding the material in a particular lay-down pattern, directly defined from a computer aided design (CAD) file [Hutmacher, 2000]. A drawback of these techniques is that they are cost-effective, and require the use of complex and specific equipment. Fused deposition modelling uses a moving nozzle to extrude a fibre of polymeric material (x- and y-axis control) from which the physical model is built layer-by-layer. The model is lowered (z-axis control) and the procedure repeated. Although the fibre must also produce external structures to support overhanging or unconnected features that need to be manually removed, the



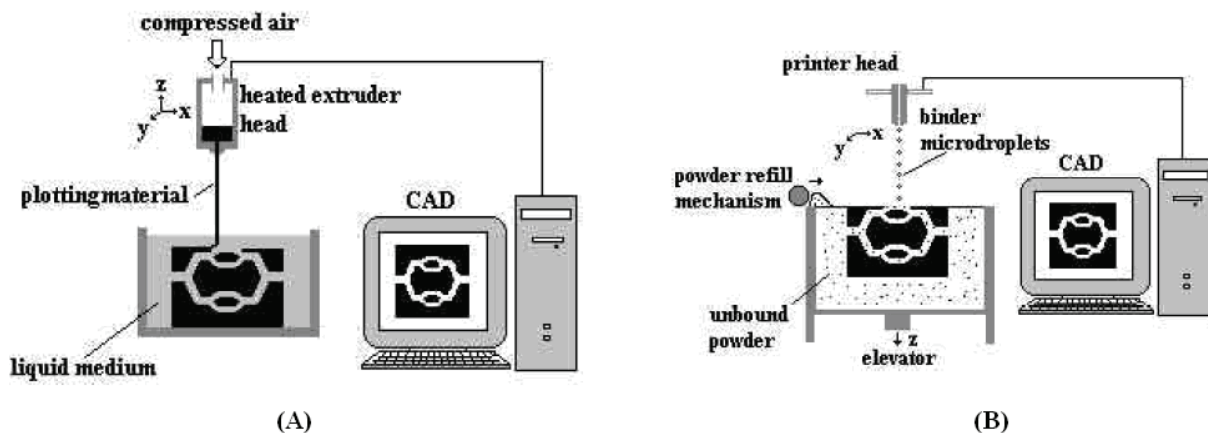
pore sizes in tissue engineering scaffolds are sufficiently small enough for the fibre strand to bridge across without additional support structures. Figure 2.12 shows this system.



**Figure 2.12:** Schematic diagram of the fused deposition modelling (FDM) system.  
[Sachlos and Czernuszka, 2003; Scott, 1992]

### 2.16.1 Three Dimensional Printing (3 DP)

This system, developed by researchers at the University of Freiburg, [Landers and Mühlaupt, 2000] involves a moving extruder head (x-, y- and z-axis control) and uses compressed air to force out a liquid or paste-like plotting medium. The extruder head can be heated to the required temperature. The medium solidifies when it comes in contact with the substrate or previous layer. Figure 2.13-A shows the general principle of this system.



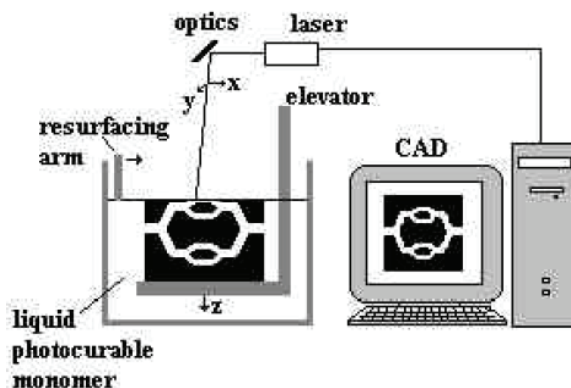
**Figure 2.13:** Schematic diagram of the 3D Bioplotter™ system.  
[Sachlos and Czernuszka, 2003]

In Figure 2.13-B, 3DP incorporates conventional ink jet printing technology (x- and y-axis control) to eject a binder from a jet head, which moves in accordance to the CAD cross-sectional data, onto a polymer powder surface [Sachs *et al.*, 1998]. The binder dissolves and joins adjacent powder particles. The piston chamber is lowered (z-axis control) and refilled with another layer of powder and the process is repeated. The unbound powder acts to support overhanging or unconnected features and needs to be removed after component completion.

### 2.16.2 Stereolithography (SLA)

The process involves selective polymerisation of a liquid photo-curable monomer by an ultraviolet laser beam [Hull, 1990]. The UV beam is guided (x- and y-axis control) onto the liquid monomer surface in accordance to the CAD cross-sectional data. After the first layer is built, the elevator holding the model is lowered into the vat (z-axis control) so as to allow the liquid photopolymer to cover the surface. A wiper

arm is then displaced over the liquid to flatten the surface. The procedure is repeated until the model is completed. This system requires support structures to be added to the model, to prevent any overhanging or unconnected features from falling to the bottom of the liquid-filled vat. After completion, the model is raised and any support structures are removed manually. Figure 2.14 shows the principle of this system.



**Figure 2.14:** Schematic diagram of the Stereolithography (SLA) system.  
[Sachlos and Czernuszka, 2003]

## 2.17 Other Derivated Techniques

Each of the techniques presented has its advantages, but none can be considered as ideal processing method for a scaffold to be employed for all tissues [Murphy and Mikos, 2007]. Macro-porous polymeric foams have been produced by dispersion of a gaseous phase in a fluid polymer phase, leaching of water-soluble inorganic fugitive phase, phase separation, polymer precipitation, particle sintering, extrusion, and injection moulding [Gibson and Ashby, 1999; Suh and Webb, 1988; Frisch and Saunders, 1972]. Air drying phase inversion has been also tested [Park *et al.*, 1997]. However, these processes do not generally offer optimal control over pore structure (cell diameter and pore interconnectivity) and bulk characteristics (density, void volume, mechanical and electrical properties). Since P<sub>L</sub>LA is partially crystalline, it is not possible to obtain uniform porous structures with the gas foaming technique at temperatures lower than the melting point [Quirk *et al.*, 2004].

### 2.17.1 Combination of Leaching of a Fugitive Phase and Polymer Precipitation

By combining two distinct foaming processes, (i) leaching of a fugitive phase with (ii) polymer precipitation, one could attain enhanced control over both porosity and bulk properties of polymer foam. This was achieved by using a non-water-soluble particulate hydrocarbon fugitive phase derived from waxes, which allowed for the formation of pores with concomitant precipitation of the polymer phase. The macro-porosity of the polymer foam was determined by the hydrocarbon fugitive phase (porogen), which also functioned as a template for the rapid precipitation of the polymer. Bulk properties of the foam could be manipulated independently of the macro-porosity and pore size by incorporation of inorganic and organic fillers into the highly viscous polymer phase.

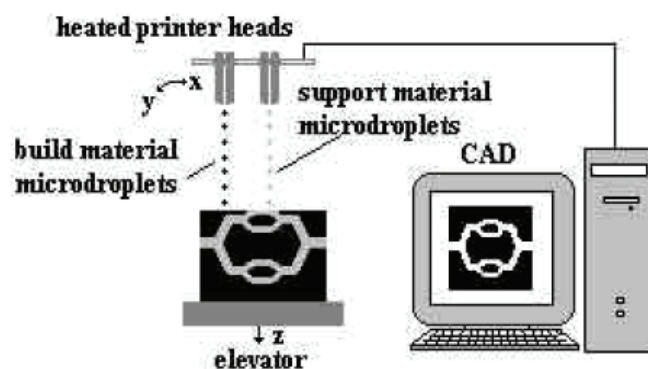
The process is applicable to a wide range of polymer systems including water-soluble polymers, as long as the following conditions are satisfied [Shastri *et al.*, 2000]:

- The hydrocarbon porogen is extracted below the melting temperature of the polymer, to ensure isotropy in the properties of the resulting foam.
- The polymer has good solubility (at least 100 mg/ml) in a solvent that is a poor solvent for the porogen, to obtain a viscous polymer solution wherein the porogen can be distributed uniformly.

- The polymer has a molecular weight of at least 40 kDa, to ensure structural stability of the resulting foam.

### 2.17.2 Phase-Change Jet Printing

This system comprises two ink-jet print heads; each delivering a different material, one material for building the actual model and the other acting as support for any unconnected or overhanging features [Sanders *et al.*, 1996]. Molten micro-droplets are generated by the jet heads, which are heated above the melting temperature of the material, and deposited in a drop-on-demand fashion. The micro-droplets solidify on impact to form a bead. Overlapping of adjacent beads forms a line and overlapping of adjacent lines forms a layer. After layer formation, a horizontal rotary cutter arm can be used to flatten the top surface and control the layer thickness. The platform is lowered and the process is repeated to build the next layer, which adheres to the previous, until the shape of the model is complete. Once built, the model can then be immersed in a selective solvent for the support material, but a non-solvent for the build material, so as to leave the physical model in its desired shape. Figure 2.15 shows this system.



**Figure 2.15:** Schematic diagram of the phase change jet printing system, the Model-Maker II. [Sachlos and Czernuszka, 2003]

## 3 Polymer Processing by Supercritical Fluids

Solvents that have interesting potential as environmentally benign alternatives to organic solvents include water, ionic liquids, fluoruous phases, and supercritical or dense phase fluids [Anastas *et al.*, 2002; DeSimone, 2002]. Obviously, each of these approaches exhibits specific advantages and potential drawbacks. Ionic liquids (room-temperature molten organic salts), for example, have a vapour pressure that is negligible. Because they are non-volatile, commercial application would significantly reduce the volatile organic component emission. Recently, various supercritical fluid processing methods have been developed for the production of polymer-based materials such as foams, micro-particles, and fibres. Microcellular polymers can be foamed with no use of organic solvents through the gas foaming technique.

### 3.1 Bases on Supercritical Fluids

In 1822, Baron Cagniard de la Tour discovered the critical point of a substance in his famous cannon barrel experiments [Kemmere and Meyer, 2005]. Listening to discontinuities in the sound of a rolling flint ball, in sealed cannon, he observed the critical temperature. Above this temperature, the distinction between the liquid phase and the gas phase disappears, resulting in a single supercritical fluid phase behaviour. In 1875, Andrews discovered the critical conditions of CO<sub>2</sub> [Kemmere and Meyer, 2005]. The reported values were a critical temperature of 304.05 K and a critical pressure of 7.40 MPa, which are in close agreement with today's accepted values of 304.1 K and 7.38 MPa.

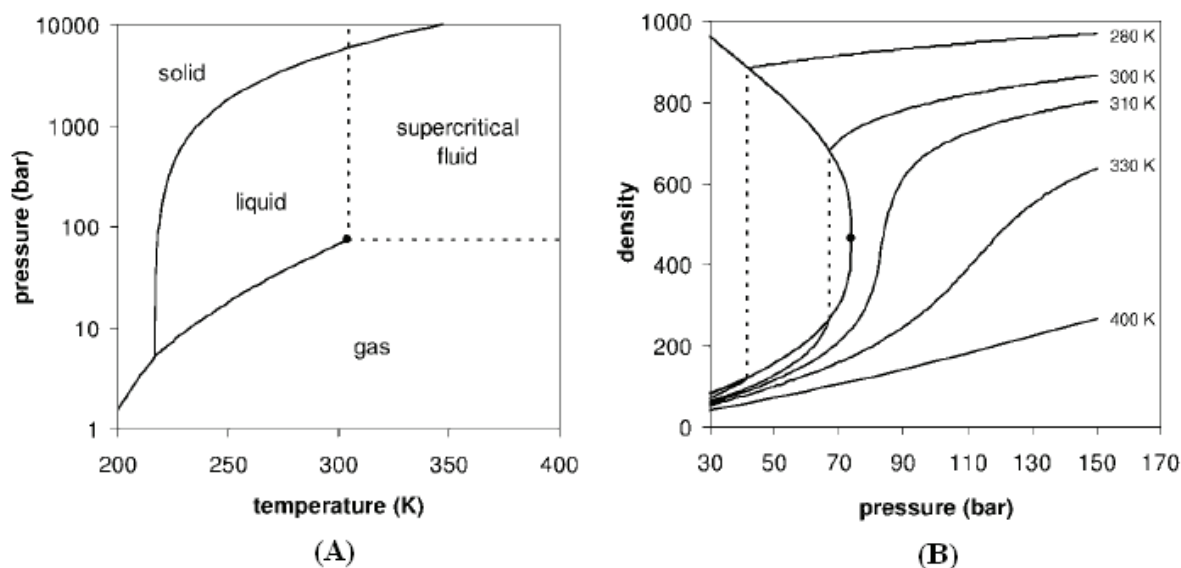
A supercritical fluid is defined as a substance for which the temperature and pressure are above their critical values and which has a density close to or higher than its critical density [Darr and Poliakoff, 1999; Span and Wagner, 1996; Angus et al., 1976]. Above the critical temperature, the vapour-liquid coexistence line no longer exists. Therefore, supercritical fluids can be regarded as “hybrid solvents” because the properties can be tuned from liquid-like to gas-like without crossing a phase boundary by simply changing the pressure or the temperature. Although this definition gives the boundary values of the supercritical state, it does not describe all the physical or thermodynamic properties. Baldyga et al. [2004] explain the supercritical state differently by stating that on a characteristic microscale of approximately 10–100Å, statistical clusters of augmented density define the supercritical state, with a structure resembling that of liquids, surrounded by less dense and more chaotic regions of compressed gas. The number and dimensions of these clusters vary significantly with pressure and temperature, resulting in high compressibility near the critical point. To illustrate the “hybrid” properties of supercritical fluids, Table 2.1 gives some characteristic values for density, viscosity, and diffusivity. The unique properties of supercritical fluids as compared to liquids and gases provide opportunities for a variety of industrial processes.

**Table 2.1:** Typical values of physical properties of gas, supercritical fluid and liquid.

[Poling et al., 2001]

Properties	Gas	Supercritical Fluid	Liquid
Density $\rho$	1	100 – 800	1000
Viscosity $\eta$ (Pa.s)	0.001	0.005 – 0.01	0.05–0.1
Diffusivity $D$ ( $\text{m}^2\text{s}^{-1}$ )	$1.10^{-5}$	$1.10^{-7}$	$1.10^{-9}$

In Figure 2.16, two projections of the phase behaviour of carbon dioxide are presented: the pressure-temperature (Figure A) and the density-pressure (Figure B) diagrams. The critical point at the  $T_c$  critical temperature and the  $P_c$  critical pressure marks the end of the vapour-liquid equilibrium line and the beginning of the supercritical fluid region. Density of  $\text{CO}_2$  as a function of pressure at different temperatures (solid lines) and at the vapor-liquid equilibrium line (dashed line). At the critical point, the densities of the equilibrium liquid phase and the saturated vapour phases become benefits. Supercritical carbon dioxide has also desirable physical and chemical properties.



**Figure 2.16:** Phase diagrams P-T and  $\rho$ -P for a pure  $\text{CO}_2$ .

[Span and Wagner, 1996; Angus et al., 1976]

In Table 2.2, the critical properties of some compounds which are commonly used as supercritical fluids are shown. Of these, carbon dioxide and water are the most frequently used in a wide range of applications.

**Table 2.2:** Critical conditions of several substances.  
[Leitner and Jessop, 1999]

Solvent	$T_c$ (K)	$P_c$ (MPa)	Solvent	$T_c$ (K)	$P_c$ (MPa)
Acetone	508.1	4.70	Hexafluoroethane	293.0	3.06
Ammonia	405.6	11.3	Methane	190.4	4.60
Carbon dioxide	304.1	7.38	Methanol	512.6	8.09
Cyclohexane	553.5	4.07	<i>n</i> -hexane	507.5	3.01
Diethyl ether	466.7	3.64	Propane	369.8	4.25
Difluoromethane	351.6	5.83	Propylene	364.9	4.60
Difluoroethane	386.7	4.50	Sulfur hexafluoride	318.7	3.76
Dimethyl ether	400.0	5.24	Tetrafluoromethane	227.6	3.74
Ethane	305.3	4.87	Toluene	591.8	41.1
Ethylene	282.4	5.04	Trifluoromethane	299.3	4.86
Ethyne	308.3	6.14	Water	647.3	22.1

Recently, various supercritical fluid processing methods have been developed for the production of polymer-based materials such as foams, micro-particles, and fibres. Microcellular polymers can be formed with no use of organic solvents through the gas foaming technique. In this process the polymer is saturated, first, with carbon dioxide (CO<sub>2</sub>) at high pressure. Then, the system is quenched in supersaturated state either by reducing pressure or by increasing temperature resulting in the nucleation and growth of pores—cells inside the polymer matrix [Goel and Beckman, 1994a]. This technique is adapted to PLGA because it is an amorphous polymer. In the case of semi-crystalline polymers, the final porous structure obtained by this technique is non-uniform, since the diffusion of the fluid is different in the crystallites and in the amorphous zones [Fages *et al.*, 2003; Lucien and Foster, 2000; Doroudiani *et al.*, 1996]. With respect to dense phase fluids, supercritical water has been shown to be a very effective reaction medium for oxidation reactions [Thomason and Modell, 1984; Modell, 1982].

### 3.2 Basic Techniques in Supercritical Fluids Technology

Classification of SCFs based techniques can be proposed according to the role played by the SCFs in the process. Various SCFs processes include [Sekhon, 2010]:

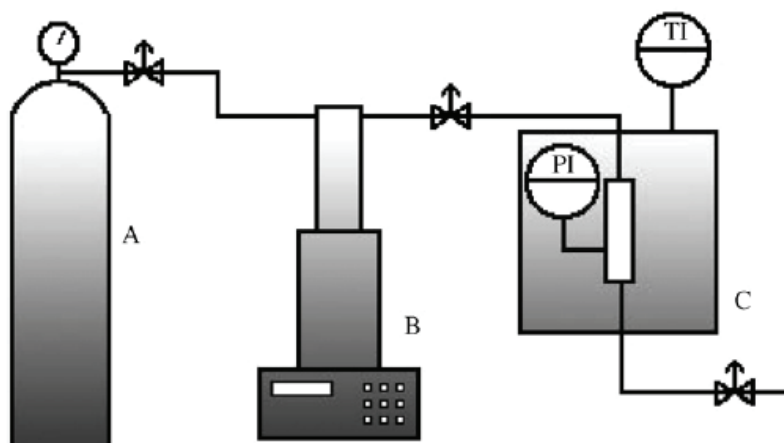
1. Rapid expansion of supercritical solutions,
2. Supercritical anti-solvent precipitation technique,
3. Particles from gas saturated solutions,
4. Gas antisolvent system,
5. Precipitation using compressed antisolvent,
6. Aerosol solvent extraction system,
7. Solution enhanced dispersion by supercritical fluids,
8. Supercritical antisolvent system with enhanced mass transfer,
9. Impregnation or infusion of polymers with bioactive materials.

Super critical fluid Technologies, although environmentally friendly and suitable for mass production, requires specially designed equipment and is more expensive. In the early days, supercritical fluids were mainly used in extraction and chromatography applications [Smith, 1999; Dean, 1998; Vandenburg *et al.*, 1997; McNally, 1995; Brunner, 1994; Hedrick *et al.*, 1992]. A well-known example of supercritical fluid extraction is caffeine extraction from tea and coffee [McHugh and Krukonis, 1994]. Supercritical chromatography was frequently used to separate polar compounds [Berger, 1997; Cantrell and Blackwell, 1997]. Nowadays, an increasing interest is being shown in supercritical fluid applications for reaction, catalysis, polymerization, polymer processing, and polymer modification [Eckert *et al.*, 1996]. SCF technologies are now emerging as an alternative to conventional materials processing methods in the area of tissue engineering [Duarte *et al.*, 2009a; Duarte *et al.*, 2009b]. ScCO<sub>2</sub> processing may be used to form foamed scaffolds in which the escape of CO<sub>2</sub> from a plasticized polymer melt generates gas bubbles that shape the developing pores.

### 3.3 Scaffolds Prepared by Phase Inversion using scCO<sub>2</sub> as Anti-solvent

Phase inversion using supercritical CO<sub>2</sub> as anti-solvent is analogous to traditional phase inversion with immersion precipitation. This technique consists of immersing a thin film of the polymer solution in a bath containing a non-solvent (with respect to the polymer). The properties of the final porous structure are mainly controlled by the precipitation temperature, the strength of the non-solvent bath and the composition of the casting solution. The use of a supercritical fluid as an antisolvent allows for the tuning of the antisolvent strength simply by regulating the pressure. As a consequence, the pressure is an additional parameter for tailoring the final structure [Tsvintzelis *et al.*, 2007a].

The use of CO<sub>2</sub> as an antisolvent for the production of porous structures with polymers has not been thoroughly investigated. Since the majority of foaming methods applied in the semicrystalline polymers involve the use of organic solvents, there is an important advantage of using phase inversion in the presence of supercritical CO<sub>2</sub>. With this technique, it is possible to dry the final polymer structure simply by flashing the pressure vessel with fresh CO<sub>2</sub>. Thus, there is no need for additional post-treatment in order to remove the residual organic solvent [Tsvintzelis *et al.*, 2007a]. Dichloromethane can be selected as solvent since it is completely miscible with CO<sub>2</sub> at pressures higher than 95 bars and temperatures up to 55°C [Tsvintzelis *et al.*, 2004]. Additionally, the solubility of P<sub>L</sub>LA in CO<sub>2</sub> at these conditions is negligible, making the CO<sub>2</sub> an appropriate antisolvent for this system. Figure 2.17 represents a schematic diagram of the system.



**Figure 2.17:** ScCO<sub>2</sub> experimental apparatus (A) CO<sub>2</sub> tank, (B) syringe pump and (C) pressure vessel. [Tsvintzelis *et al.*, 2007a]

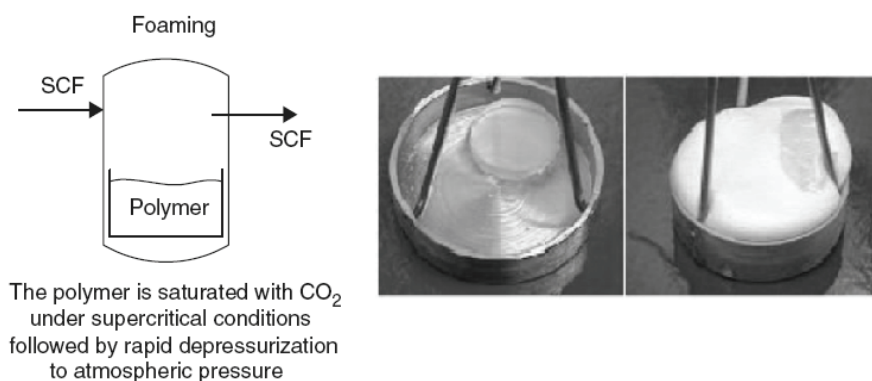


### 3.4 Scaffolds Prepared by scCO<sub>2</sub> Foaming

Mooney and co workers [Harris *et al.*, 1998; Mooney *et al.*, 1996] were the first to describe the use of supercritical foaming for the preparation of macro-porous scaffolds for tissue engineering applications. Interconnected porous structures of P<sub>D,L</sub>LGA were successfully produced [Tai *et al.*, 2007a; Singh *et al.*, 2004]. Bioresorbable ceramic–polymer composites were also prepared and are described by Mathieu *et al.*, [2005] and Georgiou *et al.*, [2007]. The ability to process composite matrixes of ceramics and polymers or blends of different polymers demonstrates the versatility of this technology and shows the potential to develop materials with the desired morphological and mechanical properties. The gas foaming process has also proven to be a very promising technique for the preparation of scaffolds loaded with growth factors and cells. Howdle *et al.*, [2001] have encapsulated proteins in biocompatible and biodegradable polymers, such as PLA, PLGA, and Polycaprolactone (PCL), at relatively low temperatures and moderate pressures.

CO<sub>2</sub> exhibits unique features and benefits, such as appreciable solubility in polymer melt and fast diffusivity that ensures an efficient mixing process, as well as environmental advantages and low cost. On the other hand, the challenges of CO<sub>2</sub> as a foaming agent are mainly associated with the higher-pressure operation, dimensional instability during the foam shaping process, and paradoxically the high diffusivity of CO<sub>2</sub> out of the foam resulting in a quick loss of R-value (resistance to heat flow).

The volumic variation between the pellets and the foams are illustrated in Figure 2.18. This technique has the potential to be used to prepare 3D materials having high porosity and interconnected pores with a wide range of applications in the field of tissue engineering and regenerative medicine.



**Figure 2.18:** Schematic representation of the supercritical fluid foaming process.

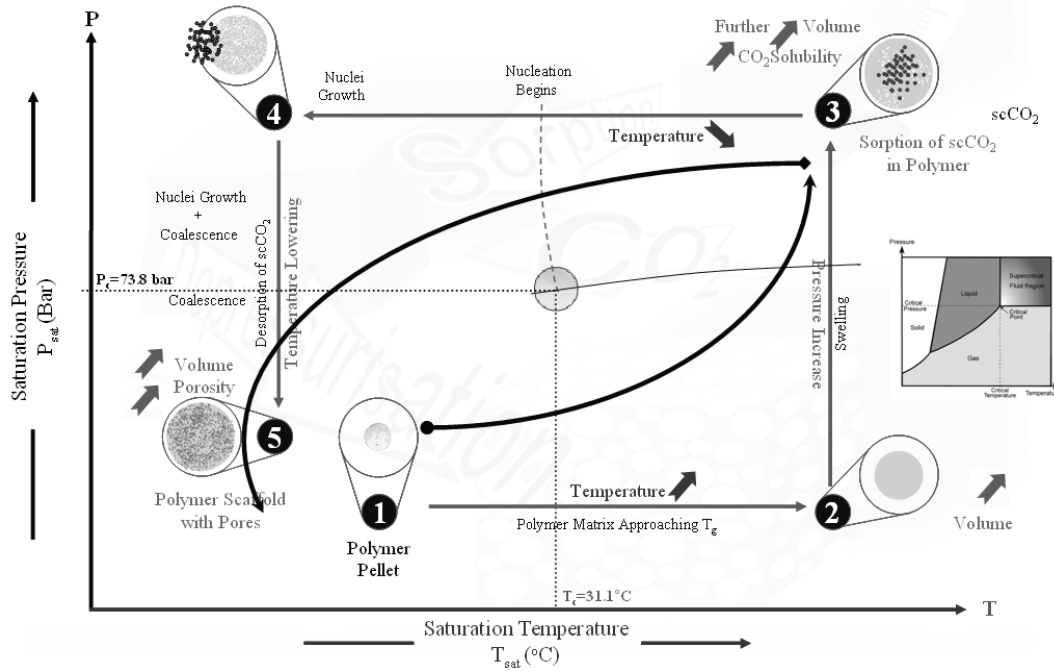
[Duarte *et al.*, 2009b]

A foaming process can be carried out in a batch system where the pre-shaped samples are placed in a pressurized autoclave to be saturated with CO<sub>2</sub> [Kumar and Weller, 1994a, 1994b; Park *et al.*, 1994]. Nucleation and cell growth are controlled by the pressure-release rate and foaming temperature. The introduction of nano-particles to foams provides a novel solution to further sharpen the operation window and the product performance in weight, mechanics, insulation and barrier. Because of the similarity of foamed porous structure to some human tissues, CO<sub>2</sub> is also proposed to foam biodegradable or biocompatible polymers to produce porous scaffolds or other medical devices. Since CO<sub>2</sub> can easily escape, the prepared products are always assured to be solvent-free and non-toxic.

The principles of the scCO<sub>2</sub> foaming by pressure quench method by supercritical carbon dioxide (scCO<sub>2</sub>) were first described by Goel and Beckman [1994a]. Schematically, the foaming effect can be separated in five stages (cf. Figure 2.19). The pellets ❶ were exposed to carbon dioxide for few minutes

( $t_{sat}$ ). An increase of temperature ( $T_{sat}$ ) above  $T_c$  ② enhances the free volume and the increase of the pressure ( $P_{sat}$ ) above  $P_c$  ③ causes the sorption of  $scCO_2$ . The decrease of the temperature is ④ at the origin of the departure of  $CO_2$  molecules and the depressurization of the chamber ⑤ causes the pore formation inside the polymer. Evolution of this phenomenon can be further explained as under.

- **Period I:** The  $CO_2$  is compressed to a pressure vessel where a polymer sample had already been placed (Part I of the Figure 2.20). Generally, the process is carried out until a value above the critical pressure ( $P_c$ ). Pressure and temperature increase with the compression until desired values called saturation pressure ( $P_{sat}$ ) and saturation temperature ( $T_{sat}$ ). The sorption-diffusion of  $CO_2$  begins but since the time of this period takes maximum 2 minutes, it can be neglected.
- **Period II:** The sorption-diffusion of  $CO_2$  takes places. The solubility (phase equilibrium) is the limiting factor of the sorption-diffusion of  $CO_2$  into the polymer since the polymer is not soluble in  $CO_2$ . Moreover, under high pressure, the sorption of  $CO_2$  into the polymer brings the structural phase transition of polymer. Polymer swells as the  $CO_2$  sorbed and the transition occurs from glassy to plasticized (rubbery) state, by lowering the glass transition temperature of the polymer. This period is called the saturation time ( $t_{sat}$ ) (Part II of the Figure 2.20).

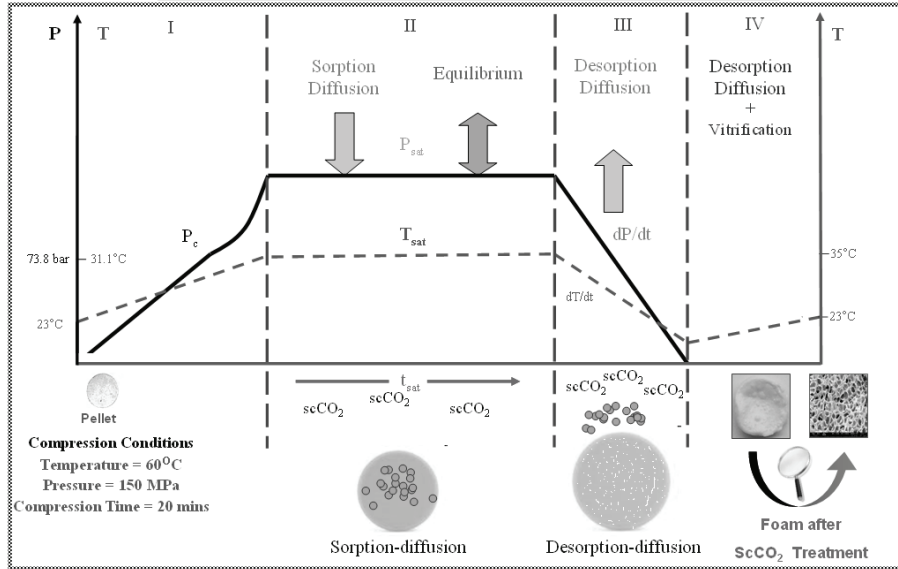


**Figure 2.19:** Schematic presentation for scaffold generation during  $scCO_2$  foaming. Modified from [Cooper, 2003]

- **Period III:** Period II is followed by the depressurization of the pressure chamber (III). The rate of the depressurization ( $dP/dt$ ) can be controlled. With the pressure drop of the pressure chamber comes the temperature drop ( $dT/dt$ ). The temperature drop is proportional to the pressure drop. When the pressure is reduced from the equilibrium state, the formation of nuclei occurs as a result of supersaturation. These nuclei grow by the desorption-diffusion of the gas from the polymer matrix. We can state that the pressure difference between the two sides of the pore interface is the driving force of the pore growth. One must remember that, during the depressurization, the  $CO_2$  is not supercritical anymore, and its molecular volume is greater than that of the supercritical state. Actually, the pore growth is provided by the expansion of  $CO_2$  (Part III of the Figure 2.20).



- *Period IV:* The growth of the pores (the swelling of the polymer) continues until the vitrification (IV) where the amount of CO<sub>2</sub> inside polymer is not sufficient to maintain the plasticized state. In the first moments, the pore growth is controlled by the diffusion and then the viscosity comes more significant and finally controls the end of the foaming process. Moreover, the growing pores can coalesce and reduce the global pore density (Part IV of the Figure 2.20).



**Figure 2.20:** Evolution of process parameters and the occurring phenomena during the foaming with time. (Continuous and dotted lines correspond to P and T variations respectively).

## 4 Theoretical Background of Gas Foaming

The modelling of scCO<sub>2</sub> foaming of polymers by pressure quench method requires the resolution of the diffusion equation as well as the degree of depression of the glass transition of polymer as a function of the amount of CO<sub>2</sub> sorbed. Indeed, the isothermal sorption data and its modelling are required for such study.

### 4.1 Diffusion

The aim of studying the diffusion phenomenon is to calculate diffusion coefficients for the sorption-diffusion and the desorption-diffusion of CO<sub>2</sub>. These coefficients provide information of diffusion behaviour of CO<sub>2</sub> into or from the polymer with different conditions. The diffusion is vital to understand CO<sub>2</sub>-polymer interactions. The diffusion of CO<sub>2</sub> into polymers results in several changes in the polymer such as lowering the glass transition point, manipulating the chain mobility, swelling etc. Rubbery polymers (above T<sub>g</sub>) obey simply the Fickian diffusion since they have a homogenous liquid-like behaviour. Non-Fickian diffusion occurs in the glassy polymer and will be modelled by the rules of Fickian diffusion. For Fickian diffusion, unsteady state one dimensional equation is given by:

$$\frac{\partial C}{\partial t} = \frac{\partial}{\partial x} \left( D \frac{\partial C}{\partial x} \right) \quad (2.1)$$

Where  $C$  is the concentration of the gas,  $x$  is the distance that the gas diffuses,  $D$  is the diffusion constant and  $t$  is the time. This equation has been solved by Crank [1975] for constant diffusion coefficient inside a plane sheet:

$$\frac{M_t}{M_\infty} = 1 - \sum_{n=0}^{\infty} \frac{8}{(2n+1)^2 \pi^2} \exp\left(\frac{-D(2n+1)^2 \pi^2 t}{4a^2}\right) \quad (2.2)$$

where  $a$  is the semi-thickness of the polymer pellet,  $M_t$  denotes the total amount of diffusing substance which has entered the polymer during time  $t$ , and  $M_\infty$  the corresponding quantity after infinite time. On the other hand, in the case of the desorption-diffusion,  $M_\infty$  denotes the amount of CO<sub>2</sub> at zero time,  $M_t$  the quantity of CO<sub>2</sub> which remains in the polymer at time  $t$  and  $n$  is gas molecules per cm<sup>3</sup>.

The reduced version of Equation (2.2) for short times is also given by [Crank, 1975].

$$\frac{M_t}{M_\infty} = 2\left(\frac{Dt}{a^2}\right)^{\frac{1}{2}} \left( \pi^{\frac{1}{2}} + 2 \sum_{n=1}^{\infty} (-1)^n \operatorname{ierfc} \frac{na}{\sqrt{Dt}} \right) \quad (2.3)$$

Literature and experimental work revealed that, during the sorption and desorption of CO<sub>2</sub> into the polymer, the diffusion coefficient is not constant. It depends on the concentration of CO<sub>2</sub> sorbed by polymer. One can say that the more CO<sub>2</sub> absorbed, the more CO<sub>2</sub> can diffuse easily into or from the polymer. The dependency of the diffusion coefficient on the concentration is due to the several effects caused by the sorption of the CO<sub>2</sub> into the polymer matrix such as manipulation of the polymer matrix, swelling (decreasing the bulk polymer density), lowering the glass transition point, lowering the interfacial tension and the viscosity of the polymer. Also, by activated state theory the diffusion coefficient is also temperature dependent and it increases with the increasing temperature [Koros and Madden, 2004].

As proposed by Crank, the average diffusivity of CO<sub>2</sub> in polymers can be measured in a desorption experiment. For early stages of diffusion (sorption or desorption), the amount of gas remaining in a plane sample at any time is related to the diffusion coefficient. This procedure has been applied to analyze the sorption of CO<sub>2</sub> into the polymers [Kumar and Weller, 1994b; Berens and Huvar, 1989b], and it can be used when the sorption curve is plotted against  $\sqrt{t/l^2}$ , where  $l$  is the thickness of sample, if it is approximately linear as far as  $M_t/M_\infty = 0.5$ .

The Sanchez-Lacombe's equation of state (SL-EOS) has been used to predict the behaviours of polymer-gas mixtures [Sanchez and Lacombe, 1976]. SL-EOS is a well defined statistical mechanical model which is not a physical model of sorption of a gas into a polymer but an equation of state which defines the capacity of sorption as well as the swelling of the polymer. The SL-EOS is known as a lattice-gas model since the P-V-T properties of a pure component are calculated assuming that the component is broken into parts or "mers" that are placed into a lattice and are allowed to interact with a mean-field-type intermolecular potential. To obtain the correct system density, an appropriate number of holes is also put into specific lattice sites, hence the name lattice-gas model [McHugh and Krukoni, 1994]. We have to underline that this equation can be used for rubbery and glassy states of the amorphous or liquid-like polymers. In its basic form, the SL-EOS is given by:

$$\rho_R^2 + P_R + T_R \left[ \ln(1 - \rho_R) + \left(1 - \frac{1}{r}\right) \rho_R \right] = 0 \quad (2.4)$$

where  $T_R$ ,  $P_R$ ,  $\rho_R$  are reduced temperature, pressure and density respectively and  $r$  represents the number of lattice sites occupied by one molecule.

The reduced parameters can be calculated by:

$$T_R = T/T^* \quad P_R = P/P^* \quad \rho_R = \rho/\rho^* \quad r = \frac{MP^*}{RT^*\rho^*} = \frac{M}{\rho^*v^*} \quad (2.5)$$

where  $T^*$ ,  $P^*$ ,  $\rho^*$  et  $v^*$  are respectively characteristic temperature, pressure, density and volume which characterize the pure component;  $R$  is the gas constant and  $M$  is the molecular weight.

Different mixing rules have been applied in the literature in order to evaluate the characteristic parameters of mixtures [Liu and Tomasko, 2007a; Kiszka et al., 1988]. We have used the following so-called van der Waals-1 mixing rules in order to calculate the characteristic parameters for binary mixture:

$$P^* = \sum_i \sum_j \phi_i \phi_j P_{ij}^* \quad (2.6)$$

$$P_{ij}^* = (1 - k_{ij})(P_i^* P_j^*)^{0.5} \quad (2.7)$$

$$T^* = P^* \sum_i \frac{T_i^*}{\phi_i P_i^*} \quad (2.8)$$

$$\rho^* = \frac{1}{\frac{m_1}{\rho_1^*} + \frac{m_2}{\rho_2^*}} \quad (2.9)$$

$$r = \frac{1}{\frac{\phi_1}{r_1} + \frac{\phi_2}{r_2}} \quad (2.10)$$

where the subscripts 1 and 2 denote the properties for components 1 and 2, respectively,  $\phi$  is the volume fraction of a component in the mixture,  $m$  is the weight fraction of the component in the mixture, and  $k_{ij}$  is the binary interaction parameter.

As can be seen from the equation 2.7, the mixing rule for  $P_{ij}^*$  carries the geometrical average of the characteristic pressure of the two component. The presence of the binary interaction parameter in this equation is providing a correction of the deviation of the mixture characteristic pressure from the geometric average. The value of  $(1 - k_{ij})$  typically diverges  $\pm 20\%$  from the geometric average.

Polymer-gas system has been solved by assuming that the polymer is non-volatile and insoluble in the gas phase and the sorption (w/w) CO<sub>2</sub>/polymer is computed through a non-linear *Levenberg-Marquardt* algorithm (the *Minerr* function of *Mathcad*) until the equilibrium is reached, which means in both phases, temperature, pressure and chemical potentials are to be equal:

$$\mu_1^G(T, P) = \mu_2^P(T, P, \phi_i) \quad (2.11)$$

In equation 2.11,  $G$  and  $P$  represent gas and polymer phases, respectively, subscripts 1 and 2 represent the CO<sub>2</sub> and the polymer respectively, and  $\phi_i$  represents the volume fraction for the component  $i$ . According to SL-EOS, the chemical potential of component  $i$  in the polymer, is given by:

$$\frac{\mu_1^P}{RT} = \ln \phi_1 + (1 - \frac{r_1}{r_2})\phi_2 + r_1 \rho_R X_1 \phi_2^2 + r_1 \left[ -\frac{\rho_R}{T_{1R}} + \frac{P_{1R}}{T_{1R}} + \frac{(1 - \rho_R) \ln(1 - \rho_R)}{\rho_R} + \frac{\ln \rho_R}{r_1} \right] \quad (2.12)$$

where X is given by:

$$X_1 = \frac{v_1^*}{RT} (P_1^* + P_2^* - 2P_{12}^*) \quad (2.13)$$

For a pure component, where  $\phi = 1$ , the chemical potential can be reduced to:

$$\frac{\mu_1^p}{RT} = r_1 \left[ -\frac{\rho_R}{T_{1R}} + \frac{P_{1R}}{T_{1R}} + \frac{(1 - \rho_R) \ln(1 - \rho_R)}{\rho_R} + \frac{\ln \rho_R}{r_1} \right] \quad (2.14)$$

Equations neglecting the solubility of polymer in CO<sub>2</sub>, have been solved for the chemical potential of CO<sub>2</sub> in the fluid phase. As mentioned above, the values of three characteristic parameters for each pure component and of one binary interaction parameter for polymer-CO<sub>2</sub> mixture are required in the SL model. The pure component parameter values were all found in the literature, as reported in Table 2.3.

**Table 2.3:** SL-EOS characteristic parameters for CO<sub>2</sub> and PLGA<sub>50:50</sub>.

Component	$P^*$ (bar)	$T^*$ (K)	$\rho^*$ (kg / m <sup>3</sup> )	Reference
CO <sub>2</sub>	5745.0	305	1.510	[Kiszka <i>et al.</i> , 1988]
PLGA <sub>50:50</sub>	5727.4	649.63	1.4516	[Liu and Tomasko, 2007a]

Below the critical point, the behaviour predicted by SL equation of state is that typical of a cubic equation of state: at a given pressure, up to three roots, those are density values, and can be found from equation 2.4. The *Mathcad* program proposed by Kennedy [2003] has been used to solve the equation set 2.4–13 and it is presented in Annex A-1.1

## 4.2 Plasticization of Polymers by CO<sub>2</sub>

With the exception of a few polymers, such as poly(dimethylsiloxane) and some specially synthesized fluoropolymers, most high molecular weight polymers show poor dissolution in supercritical CO<sub>2</sub> [Adamsky and Beckman, 1994; Desimone *et al.*, 1992]. In those circumstances, carbon dioxide acts as a diluent rather than a solvent. As the content of CO<sub>2</sub> is increased in the polymer phase, the sorption and subsequent swelling of an amorphous polymer can cause the depression of glass-to-rubber transition temperature ( $T_g$ ) of a polymer by 30°C or more [Tomasko *et al.*, 2003; Condo *et al.*, 1992; Wissinger and Paulaitis, 1987].

Gas foaming takes advantage of the plasticizing properties of carbon dioxide. It is qualitatively known for many years that the compression of solid materials with gases alter the phase equilibrium of pure component, in particular, the dissolution of carbon dioxide lowers the  $T_g$  of amorphous polymers, and in some cases, significantly. The reduction of glass transition temperature is a thermodynamic effect due to intermolecular interactions between carbon dioxide and the polymer. Stronger interactions enhance  $T_g$  depression, as does chain flexibility. The use of this technique is, however, limited to amorphous polymers or semi-crystalline polymers with low  $T_g$ .

It was assumed that polymer segments remain completely immobile below  $T_g$ , while small plasticizers (e.g., gas molecules) are able to move and fill the holes within the polymer matrix. Tomasko *et al.* [2003] have shown that if a polymer is exposed to a pressurized gas, the glass transition temperature of this one decreases monotonically. This analysis is based on the assumption of Wissinger and Paulaitis [1991 and Dimarzio and Gibbs [1963] that the conformation entropy is zero.

The basic approach developed by Chow in 1980, is very useful in order to estimate the depression of  $T_g$  of polymer as a function of the weight fraction of diluent sorbed:

$$\ln\left(\frac{T_g}{T_{g0}}\right) = \beta[(1-\theta)\ln(1-\theta) + \theta\ln\theta] \quad (2.15)$$

where  $T_{g0}$  is the glass transition temperature of the polymer without a diluent and the parameters  $\beta$  and  $\theta$  are given by:

$$\beta = \frac{zR}{M_m \Delta C_{p(T_g)}} \quad (2.16-a) \quad \text{and} \quad \theta = \frac{M_m}{zM_d} \frac{w}{1-w} \quad (2.16-b)$$

where,  $z$  is the number of coordination,  $R$  is the gas constant,  $M_m$  is the molecular weight of the monomer,  $M_d$  is the molecular weight of the diluent,  $\Delta C_{p(T_g)}$  is the change in the heat capacity of polymer at glass transition and  $w$  is the mass fraction of the diluent.

In Table 2.4, we have presented the parameters used for the predictions of the depression of glass transition point using Chow's model. A basic *Mathcad* program is coded, and presented in Annex A.1.2, which calculates and plots the depressed  $T_g$  as a function of  $w_{CO_2}$  sorbed.

**Table 2.4:** Parameters used to calculate the depression of  $T_g$  according to Chow's model.

Polymer	$M_m$ (g/mol)	$T_{g0}$ (°C)	$\Delta C_{pT_g}$ (J/g°C)	References for $T_{g0}$ and $\Delta C_p$
$P_{L,DL}LA$	72	60.1	0.347	Measured via DCS
PLGA <sub>85:15</sub>	70	53.1	0.451	Measured via DCS
PLGA <sub>50:50</sub>	65	49.2	0.499	Measured via DCS

The Chow's model provides a reasonable explanation for the reduction in  $T_g$  for polystyrene plasticized with high-pressure gases [Wang *et al.*, 1982]. A similar approach was used by *Barbari and Conforti* [1992], who also reviewed recent theories of gas sorption in glassy polymers. The Flory–Huggins lattice fluid theory developed by *Panayiotou and Vera* [1982] and *Sanchez and Lacombe* [1978, 1977] appears to be particularly useful in applications to polymers plasticized with high pressure gases and supercritical fluids. A statistical thermodynamic approach was developed by *Dong and Fried* [1997] to take account for the mixing of polymers, small molecules, and holes, which are different in size. They conclude that plasticizing efficiency is largely determined by polymer–plasticizer interactions and plasticizer segment size. This approach shows that highly soluble  $CO_2$  is expected to be a highly efficient plasticizer due to its small size although its interactions with polymer are quite weak.

The plasticization of polymers induced by  $scCO_2$  is characterized by increased segmental and chain mobility and by an increase in interchain distance. The plasticizing effect of  $CO_2$  is the result of the ability of  $CO_2$  molecules to interact with the basic sites in polymer molecules. It has also been shown experimentally that such interactions between  $CO_2$  and polymer functional groups reduce chain–chain interactions and increase the mobility of polymer segments [Kazarian *et al.*, 1997]. High viscosity is a major obstacle in processing high molecular weight polymers. To overcome this obstacle, one option is processing at higher temperatures since viscosity decreases with increasing temperature. However, at elevated temperatures the degradation of polymers occurs. Thus, the use of  $CO_2$  which in turn results in a reduction in the viscosity, allows processing of polymers at low temperatures and polymer degradation is avoided [Flichy *et al.*, 2001].

### 4.3 Nucleation

As we have explained earlier, when the pressure is reduced from the equilibrium state, the formation of nuclei occurs as a result of supersaturation. This number of nuclei can be calculated by using the classical nucleation theory of the physical chemistry. The number of pores generated can be modeled by calculating the number of nuclei generated.

In the classical nucleation theory, the free energy of the formation of a cluster of radius  $r$  in a closed isothermal system in chemical equilibrium is given by *Tsivintzelis et al.* [2007a] and *Adamson and Gast* [1997]:

$$\Delta G = -\frac{4\pi r^3}{3} \Delta P + 4\pi r^2 \gamma \quad (2.17)$$

where  $r$  is the radius of the spherical cluster,  $\gamma$  is the interfacial tension and  $\Delta P$  is the pressure between the two sides of the interface.

When  $\Delta G$  is plotted against cluster size, one obtains a curve that shows a maximum at a critical radius  $r_c$ :

$$\frac{d\Delta G}{dr} = 0 \Rightarrow r_c = \frac{2\gamma}{\Delta P} \quad (2.18)$$

Equation 2.18 is the *Young-Laplace* equation. The maximum value of  $\Delta G$  for homogenous nucleation is obtained by substituting equation 2.17 into equation 2.19):

$$\Delta G_{\text{hom}}^* = \frac{16\pi\gamma^3}{3\Delta P^2} \quad (2.19)$$

The interfacial tension of the mixture is calculated by the following equation given by *Goel and Beckman* [1994a]:

$$\gamma_{\text{mix}} = \gamma_{\text{polymer}} \left( \frac{\rho_{\text{mix}}}{\rho_{\text{polymer}}} \right)^4 (1 - w_{\text{CO}_2})^4 \quad (2.20)$$

where  $\rho$  are the densities and  $w_{\text{CO}_2}$  is the weight fraction of  $\text{CO}_2$  absorbed by the polymer.

The surface tension of PLGA<sub>50:50</sub> can be taken as 35.3 N/m as reported by *Vargha-Butler et al.* [2001]. The interfacial tension of  $\text{CO}_2$  is essentially zero at supercritical state, thus it will not be introduced in the equation. A more complicated model which predicts the depression of interfacial tension of a polymer as a function of  $\text{CO}_2$  sorption is proposed by *Harrison et al.* [1996]. Unfortunately, this model requires experimental data for the depression of the interfacial tension as a function of  $\text{CO}_2$  and will not be considered here.

Steady state rate of nucleation can be described by the following equation [*Goel and Beckman*, 1994a]:

$$N_0 = -Cf_0 \exp\left(\frac{-\Delta G_{\text{hom}}^*}{kT}\right) \quad (2.21)$$

where  $C$  is the concentration of the dissolved fluid inside the polymer matrix (number of molecules per volume),  $k$  is the Boltzmann constant,  $T$  is the temperature and  $f_0$  the frequency factor for the gas molecules, which describes the rate at which nuclei with critical radius are transformed into stable bubbles.

Frequency factor  $f_0$  can be expressed as a function of the critical radius [Goel and Beckman, 1994a]:

$$f_0 = -ZR_{imp}(4\pi r_c^2) \quad (2.22)$$

where  $Z$  is the Zeldovich factor and  $R_{imp}$  is the impingement rate of the gas molecules per unit area.  $ZR_{imp}$  can be used as a one time fitter parameter within the calculations.

Since foaming is an unsteady state process, we have to take into consideration time as a variable and integrate the nucleation rate in order to calculate total number of nuclei generated within the nucleation time:

$$N_{total} = \int_0^{t,vitr} N_0 dt = \int_{P,sat}^{P,vitr} N_0 \frac{dP}{dP/dt} \quad (2.23)$$

where *sat* and *vitr* denotes the saturation and vitrification respectively.

It is in our knowledge that the foaming of polymers occurs while the CO<sub>2</sub> is desorbs. Hence, one can say that the dissolved amount of fluid in the polymer matrix is not constant within the foaming time and it decreases. Also, while foaming occurs, polymer swells as the CO<sub>2</sub> changes its state from supercritical to gas (the volume of CO<sub>2</sub> increases). So, one can say that in the presence of these two effects the concentration of CO<sub>2</sub> in the matrix decreases. This concentration dependency must be placed in the nucleation rate equation and nucleation rate must be integrated with time. One can model the decrease of mass within the foaming time by using equation 2.3 and fitting it to the desorption data. The change within the volume can be expressed with a linear relationship between initial and final volumes. One can assume that there is no volume change after vitrification. The variation of CO<sub>2</sub> concentration is not considered in the existing model.

#### 4.4 Distribution of Pores

Scaffolds must meet certain fundamental characteristics such as high porosity, appropriate pore size, biocompatibility, biodegradability and proper degradation rate [Ma and Choi, 2001]. Scaffolds for tissues require specific properties such as an interconnected porosity higher than 75% to provide a high void volume for nutrient diffusion [Temenoff et al., 2000]. Furthermore an optimal pore size necessary to promote cell adhesion must be in the range of 100–300 μm [Boyan et al., 1996]. Finally, mechanical properties should approximate those of native cartilage bone, in order to support body load and avoid excessive micro-motions at the scaffold/bone interface [Büchler et al., 2003; Temenoff et al., 2000].

Ideally a scaffold should possess the following characteristics containing the desired biologic response [Hutmacher, 2001]:

- three-dimensional and highly porous with an interconnected pore network for cell/tissue growth and flow transport of nutrients and metabolic waste,
- biodegradable or bioresorbable with a controllable degradation and resorption rate to match cell/tissue growth in vitro and/or in vivo,
- suitable surface chemistry for cell attachment, proliferation and differentiation,



- mechanical properties matching those of tissues at the site of implantation,
- easily processable to form a variety of shapes and sizes.

In batch foaming, a polymer in disc or powder form is subjected to supercritical CO<sub>2</sub> flow without mixing. After venting the CO<sub>2</sub> by depressurization, thermodynamic instability causes supersaturation of the CO<sub>2</sub> dissolved in the polymer matrix and hence, nucleation of cells occurs. The growth of the cells continues until the polymer vitrifies. The saturation pressure, the saturation temperature and the depressurization rate are the critical parameters in determining the number of cells and the cell size distribution. To predict the pore size of foams created, in the literature, there is several numbers of influential studies on diffusion-induced pore growth. These models consider the polymer as a Maxwell fluid and solve systems of partial differential equations by numerical methods [Goel and Beckman, 1995; Arefmanesh and Advani, 1991].

The cell number density increased and the cell size decreased with increasing pressure and decreasing temperature. A high degree of super-saturation of dissolved CO<sub>2</sub> at high pressure and low temperature are responsible for such results. Classical homogeneous nucleation theory is generally used to calculate the nucleation rate in foaming with supercritical CO<sub>2</sub>. The energy barrier for nucleation in the theory can be calculated as a function of the interfacial tension of the binary mixture and the magnitude of the pressure drop. The theory suggests that the energy barrier and the interfacial tension decrease as the pressure drop increases. Consequently, the nucleation rate increases and a large number of small cells is obtained. In fact, both the pressure drop rate and the magnitude of the pressure drop determine the cell density and cell size in microcellular foaming. The higher the pressure drop rate, the greater the nucleation rate due to the high supersaturation rate. This allows only a short time for existing cells to grow and, consequently, is in favour of formation of small cells. Classical nucleation theory fails to incorporate the effect of the pressure drop rate. Moreover, a noteworthy study on CO<sub>2</sub>-assisted microcellular foaming of PLGA is reported by Sparacio and Beckman [1998], in which a minimum in cell size with increasing pressure was found instead of the levelling off according to theory. A plausible explanation is low resistance to cell growth due to a large decrease in the melting point of the polymer and very low interfacial tension at high pressure.

Detailed studies of the glassy polymer – CO<sub>2</sub> system by Wessling *et al.* [1994] suggest that the nucleation mechanism underlying the foaming process is heterogeneous in nature. The significant advance made by [Wessling *et al.*, 1994] was that they were able to detect and explained the appearance not only of the porous structure in the polymer film after saturation with CO<sub>2</sub> but also of a dense layer next to the porous layer. They provided a physical explanation and a mathematical model to predict the thickness of this dense layer. The studies of McCarthy and coworkers [Stafford *et al.*, 1999; Arora *et al.*, 1998a] on the effect of the residual oligomer in polystyrene on its foaming with scCO<sub>2</sub> have shown that its presence affects the cell size in these foams. This work also questioned the ability of classical nucleation theory to explain the foaming mechanism in these systems, and the authors suggest a spinodal mechanism as an alternative route of cell formation [Stafford *et al.*, 1999]. Foaming of polypropylene has also been studied extensively by Park and Cheung [1997], with the most recent report by Liang and Wang [1999], who highlighted the effect of temperature drop during depressurization of the polymer in equilibrium with high-pressure CO<sub>2</sub>. Handa and Zhang [2000] used the existence of a rubbery state in the PMMA at low temperatures to generate foams by saturating the polymer with CO<sub>2</sub> at 24°C to 90°C. They demonstrated that the solubility of CO<sub>2</sub> in the polymer plays an important role in controlling cell density and cell size. Thus, the solubility of CO<sub>2</sub> at 34 bars and temperature of – 0.2°C is 22.5% (w/w), while at the same pressure but at 24°C, the solubility is just 7.9% (w/w).



Another approach to create microcellular materials was demonstrated by *Shi et al.* [1999]. First, they synthesized a number of chemicals soluble in scCO<sub>2</sub> or liquid CO<sub>2</sub>. These chemicals comprise a number of “monomers” containing one or two urea groups and fluorinated “tail” groups that enhance solubility of these compounds in CO<sub>2</sub>. When these compounds were dissolved in CO<sub>2</sub>, their self-association led to the formation of gels. The removal of CO<sub>2</sub> via depressurization resulted in the formation of foams with cells with an average diameter of less than 1 μm. *Shi et al.* [1999] reported that the bulk density reduction of these foams was 97% compared to the parent materials. *Sheridan et al.* [2000] studied the effects of several processing parameters (such as polymer composition, molecular mass, and gas type) on preparing three-dimensional porous matrices from copolymers of lactide and glycolide and demonstrated that crystalline polymers did not produce foamed materials via this approach, while gas treatment of amorphous copolymers produced matrices with porosity up to 95%. This work also demonstrated that only CO<sub>2</sub> among the other gases used (e.g., N<sub>2</sub> and He) created highly porous polymer structures in these copolymers [*Sheridan et al.*, 2000] and explained this by the possible interactions between CO<sub>2</sub> and carbonyl groups in PLGA [*Kazarian et al.*, 1996a].

## 5 Manufacturing of the Composite Biomaterials

### 5.1 Fundamentals of Co-grinding Process

#### 5.1.1 Mechanism of Size Reduction

The properties of a material may be considerably influenced by the particle size and, for example, the chemical reactivity of fine particles is greater than that of coarse particles. In addition, far more intimate mixing of solids can be achieved if the particle size is small [*Richardson et al.*, 2002]. Practically every solid material undergoes size reduction at some point in its processing cycle.

Also reduction in size causes [*Richardson et al.*, 2002]:

- Both an increase in area and a reduction in the distance.
- Separation of constituents, especially where one is dispersed in small isolated pockets.
- Properties of a material may be considerably influenced by the particle size.
- Chemical reactivity of fine particles is greater than that of coarse particles.
- In addition, far more intimate mixing of solids can be achieved if the particle size is small.

The mechanism of the process of fragmentation is extremely complex. If a single lump of material is subjected to a sudden impact, it will generally break so as to yield a few relatively large particles and a number of fine particles, with relatively few particles of intermediate size. If the energy in the blow is increased, the larger particles will be of a rather smaller size and more numerous and, whereas the number of fine particles will be appreciably increased, their size will not be much altered. It therefore appears that the size of the fine particles is closely connected with the internal structure of the material.

During the course of the size reduction processes, much energy is expended in causing plastic deformation and this energy may be regarded as a waste as it does not result in fracture. Only part of it is retained in the system as a result of elastic recovery. It is not possible, however, to achieve the stress levels necessary for fracture to occur without first passing through the condition of plastic deformation and, in this sense, this must be regarded as a necessary state which must be achieved before fracture can possibly occur [*Richardson et al.*, 2002].

The method of application of the force to the particles may affect the breakage pattern. Four basic patterns may be identified, though it is sometimes difficult to identify the dominant mode in any given machine [Richardson *et al.*, 2002].

- Impact: particle concussion by a single rigid force.
- Compression: particle disintegration by two rigid forces.
- Shear: produced by a fluid or by particle–particle interaction.
- Attrition: arising from particles scraping against one another or against a rigid surface.

### 5.1.2 Fragmentation Mechanisms

The reduction of the material in small fragments or in powder is obtained by the operation of grinding. The mechanism of grinding can be explained by the theory of the fracture mechanics and finally the fracture of particles subjected to the mechanical forces.

The resulting stress field generally depends on, as reported by Zapata-Massot [2004]:

- Intrinsic parameters to the materials: they determine its behaviour at the time of the deformation. The field of constraints determines the dimension, the form of the fragments and the new created surfaces.
- The required energy to break the material: the necessary energy to the rupture is additional energy for the propagation of a fissure is energy consumer. It is proportional to the section of the grain while the energy stored is proportional to the volume.
- Rate of deformation: it conditions the behaviour of the material.
- Reduction of the dimensions of the material: it is not limitless and necessitates most of the time of the successive phases implying typical different of devices working mass.

The fragmentation process is a part of the size reduction process. Granular materials submitted to fine grinding may be subject to several modes of fragmentation (abrasion, chipping, cleavage, breakage) [Render, 1990]. The size evolution is not sufficient to clearly explain the grinding mechanisms. Thus other properties such as morphology have to be considered. Indeed, it is recognized that the end-use properties of a powder are influenced not only by the size but also by the shape of the particles. Qualitative SEM observations have been used to explain assumptions on phenomena appearing in the mills. However, the knowledge of particle fragmentation has been limited. Thus, a quantification of the morphology evolution during grinding is needed. Experimental studies, carried out using various materials, have shown that the size decrease occurs in steps, which suggests that the fragmentation mechanism is complex [Molina-Boisseau *et al.*, 2002].

### 5.1.3 Agglomeration Phenomena

The agglomeration phenomena occur during the co-grinding of amorphous polymer material and powder filler.

**Size enlargement** is any process whereby small particles are gathered into larger, relatively permanent masses in which the original particles can still be distinguished.

**Agglomeration** is the formation of aggregates through the sticking together of feed and/or recycle material [Perry *et al.*, 1997].

The stability of the aggregates is due to the effects of mechanical interlocking that may occur, especially between particles in the form of long fibres. Wide size distributions generally lead to close packing requiring smaller amounts of binder and, as a result, the formation of strong aggregates. The size distribution of particles in an agglomeration process is essentially determined by a population balance that depends on the kinetics of the various processes taking place simultaneously, some of which result in particle growth and some in particle degradation.

In general, starting with a mixture of particles of uniform size, the following stages may be identified:

- *Nucleation* in which fresh particles are formed, generally by attrition.
- *Layering* or *coating* as material is deposited on the surfaces of the nuclei, thus increasing both the size and total mass of the particles.
- *Coalescence* of particles which results in an increase in particle size but not in the total mass of particles.
- *Attrition*. results in degradation and the formation of small particles, thus generating nuclei that re-enter the cycle again [Richardson *et al.*, 2002].

## 5.2 Obtention of Composites by the Co-grinding Process

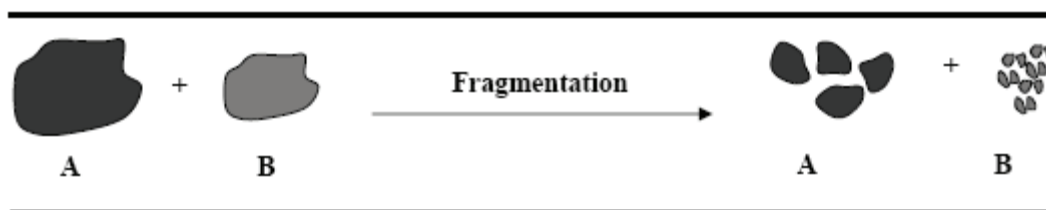
Currently, there are two main methods of obtaining composite materials. The first and most common are to extrude various raw materials. The second is to chemically synthesize the desired composite. Currently a third method of synthesis of composite materials is under development: co-grinding.

The products from Extrusion are preheated and introduced upstream of an extrusion screw. Within the extruder, the temperature gradually increases, leading to a change of state products. The use of screw extrusion of various morphologies can perform an intimate mixture between different compounds and disperse within one another seamlessly. This technique is widely used for many industrial applications by using materials in the form of powder, flakes and granules.

A second method of obtaining composite is to synthesize chemically. In this case, the matrix is dissolved or suspended in a solvent and the load is activated in situ using an oxidizing agent often. The composite particles are then filtered and dried. This method is often used to obtain electrical conducting polymers [Cassignol *et al.*, 1998; Pouzet *et al.*, 1993]. In However, it is rarely used for composites widely because it requires facilities very expensive.

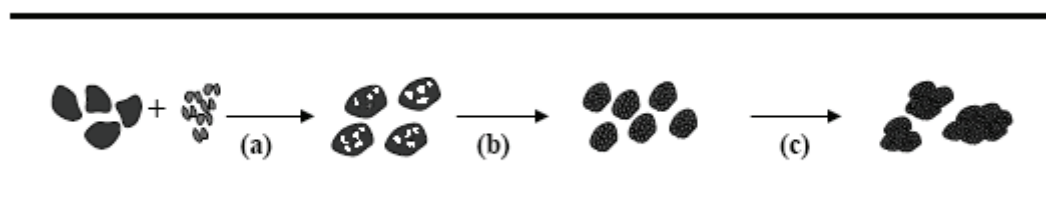
Each of the two techniques for implementing composite materials cited earlier, has limitations which may be thermal, in the case of extrusion, or chemical, in the case of chemical synthesis. In addition, both techniques have one thing in common is the difficulty of dispersing the filler in the matrix. For the first, if the operating conditions are not well understood, there has appearance of agglomerates, whereas the second technique, agitation alone does not to obtain particle size small enough so as to have properties homogeneous. Therefore, we decided to explore a new synthetic pathway to obtain composite materials: co-grinding.

This technique consists of co-grinding two materials A (polymer) and B (adjuvant/filler) together. In the beginning, there occurs a phenomenon of fragmentation of particles of different constituents (cf. Figure 2.21) to a size limit. One of the two components is much more fragmented quickly, here component reaches its size limit before fragmentation of A.



**Figure 2.21:** Schematic of the phenomenon of fragmentation in the co-grinding.

The fine particles of component B will have a tendency, because of interparticle forces to stick to larger particles. More continuous grinding, the more phenomenon is growing. Different stages of agglomeration will be encountered: the simple bonding between two or more particles, then the stage of coating particles and finally the agglomeration stage of particles together. The type of observed phenomenon will depend, among across the duration of the operation and products affinity. Figure 2.22 shows changes in the different stages of agglomeration during the co-grinding.



**Figure 2.22:** Different stages of agglomeration during the co-grinding: (a) adhesion, (b) coating and (c) agglomeration.

This technique was developed accidentally in 1968 to manufacture metal alloys. The metals were co-milled in a strongly energetic ball mill, producing a fine powder as an alternative mechanism of fractures and cold welds. *Gilman and Benjamin* [1983] were interested in the mechanisms of alloys formation and have applied the technique to a large number of metallic elements to create a data library. Currently in the process of mechanical alloying is no longer reserved solely for metals. Indeed, *Yenikolopyan* [1988] studied the system polypropylene / polyethylene low density in a ball mill. The co-grinding increases the surface specific powder consisting of small clusters whose size varies between 100 nm and few microns. An X-ray analysis showed that the crystallinity of the mixture increases with time of co-grinding. The use of milling for the formation of mixed polymer can thus produce very homogeneous powders. Other studies by *Pan and Shaw* [1994, 1995] showed that both polymers semi-crystalline and thermoplastic (polyamid 6,6 polymer and high density) can be co-ground as a fine powder using a vibrating ball mill operating in the dry process. The mechanical alloying to produce a material with one hand, a more homogeneous charge consisting of grains less than 1 micron and the other improved mechanical properties. Nevertheless, this study was conducted in a small mill (a few tens of millilitres) whose dimensions are difficult to extrapolate, by technological complexity resulting from the vibrating system. Few studies have examined the production of composite materials by co-grinding and even on co-grinding in general. Aspects of training methods and mechanisms of materials have mostly been obscured in favour of the characterization of the materials obtained. A similar study was done Zapata-Massot [2004] by Zapata for brittle polymer Poly vinyl acetate and a mineral filler calcium carbonate to improve the properties of the composite formed.

In another study by *Seyni* [2009] shows the interest to implement vegetable biodegradable filler in composite materials. The incorporation of starch as filler in the polymeric matrix was carried out by co-grinding, process supporting the dispersion of a component in the other as well as the homogeneity of the composite properties. Co-grinding makes it possible to improve the mechanical and the optical properties, as

well as the resistance to water of the material, not only from the improvement of the dispersion homogeneity of the filler in the matrix, but also thanks to a modification of the interface quality.

## **6 Conclusion**

Different processes for manufacturing scaffolds were discussed in detail with advantages and disadvantages. Scaffolds obtained by each technique possess typical structure and morphology and can be used as per requirement. Scaffolds for tissue engineering should encourage the growth, migration, and organization of cells, providing support while the tissue is forming the scaffolds will be replaced with host cells and a new extracellular matrix which in turn should provide functional and mechanical properties, similar to native tissue. The material and the 3-D structure of scaffolds have a significant effect on cellular activity. Depending on the tissue of interest and the specific application, the required scaffold material and its properties will be quite different. Gas foaming technique to manufacture scaffolds discussed with reference to kinetics and thermodynamic approach. Diffusion, plasticization of polymer, nucleation and desorption phenomena theory play an important role during scaffold forming by gas foaming. The experimental results obtained by this technique will be discussed extensively in the later chapters.

# Chapter 3

## Analytical Methods and Designs of Experiments

*This chapter is primarily devoted to the theoretical description of experimental facilities and analytical techniques employed during the experimental work. Differential scanning Calorimetry (DSC) was used to measure the glass transition temperature and the melting temperature of the polymers and other thermal data. Viscosimetry and laser granulometry were used for the polymer viscosity and particle size characterization. Various microscopic techniques such as porosity analysis, X-ray microtomography and scanning electron micrography (SEM) were used. Macroscopic methods such as Brazilian test, surface energy analysis were applied.*

### 1 Differential Scanning Calorimetry (DSC)

Phase transition analysis techniques are based on the ability to transfer heat to a material and monitor its effects. This class of techniques is known as thermal analysis. Several techniques can be used to determine the glass transition temperature ( $T_g$ ), of bio-polymeric materials, including differential scanning calorimetry (DSC), and dynamic mechanical thermal analysis (DMTA).

#### 1.1 Generalities on Thermal Transitions of Polymers

Thermal analysis encompasses a wide variety of techniques such as:

- the measurement of heating curves,
- dynamic adiabatic calorimetry,
- differential thermal analysis, DTA
- differential scanning calorimetry, DSC
- thermogravimetry, TG
- thermal mechanical analysis, TMA
- dynamic mechanical thermal analysis, DMTA

Differential scanning calorimetry (DSC) is a thermoanalytical technique in which the difference in the amount of heat required to increase the temperature of a sample and reference is measured as a function of temperature. Both the sample and reference are maintained at nearly the same temperature throughout the experiment. Generally, the temperature program for a DSC analysis is designed such that the sample holder temperature increases linearly as a function of time.

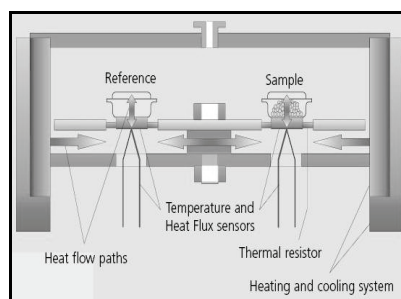
The technique was developed by *Watson and O'neill* [1962] and was introduced commercially at the 1963, Pittsburgh Conference on Analytical Chemistry and Applied Spectroscopy [ISO - International Organization for Standardization, 1963]. Heat-flux DSC and power-compensated DSC are the two types of DSC that have been widely used.

One of the big advantages of DSC is that samples are very easily encapsulated, usually with little or no preparation, ready to be placed in the DSC cell, so that measurements can be quickly and easily made [Gabbott, 2008]. The specific heat of a material changes slowly with temperature in a particular physical state, but alters discontinuously at a change of state. As well as increasing the sample temperature, the supply of thermal energy may induce physical or chemical processes in the sample, e.g. melting or decomposition, accompanied by a change in enthalpy, the latent heat of fusion, heat of reaction etc.

In a heat flux DSC, the sample material, enclosed in a pan and an empty reference pan are placed on a thermoelectric disk surrounded by a furnace. The furnace is heated at a linear heating rate and the heat is transferred to the sample and reference pan through thermoelectric disk (cf. Figure 3.1). The temperatures of the two thermometers are compared, and the electrical power supplied to each heater adjusted, so that the temperatures of both the sample and the reference remain equal to the programmed temperature, i.e. any temperature difference which would result from a thermal event in the sample is 'zero'. The analogical signal, the rate of energy absorption by the sample (e.g. W/s), is proportional to the specific heat of the sample since the specific heat at any temperature determines the amount of thermal energy necessary to change the sample temperature by a given amount. In other words, the measuring principle is to compare the rate of heat flow to the sample and to an inert material which are heated or cooled at the same rate.



(A)-Apparatus



(B)-Principle

**Figure 3.1:** Differential scanning calorimetry.

## 1.2 First Order Transitions

Changes in the sample, which are associated with absorption or evolution of heat, cause a change in the differential heat flow which is then recorded as a peak. The area under the peak is directly proportional to the enthalpy change and its direction indicates whether the thermal event is endothermic or exothermic. Analysis of a DSC thermogram enables the determination of two important parameters: the transition temperature peak (taken at the maximum  $T_m$  or at the onset  $T_{onset}$ ), and the enthalpy of melting/crystallization ( $\Delta H_m/\Delta H_c$ ). The extrapolated onset temperature ( $T_{onset}$ ) corresponding to the transition temperature at zero heating rate can be obtained by plotting peak temperatures as a function of heating rate [Ruegg *et al.*, 1977].



The  $T_m$  value depends on the molecular weight of the polymer. So, lower grades will have lower melting points (cf. Figure 3.2). The crystallinity ratio of a polymer can also be found using DSC from the following equation:

$$\chi_c = (\Delta H_m - \Delta H_c) / \Delta H_m^\infty \quad (3.1)$$

where  $\Delta H_m$  is the melting enthalpy,  $\Delta H_c$  is the crystallization enthalpy and  $\Delta H_m^\infty$  the melting enthalpy of the totally crystallised PLA sample.

According to Fischer *et al.* [1973],  $\Delta H_m^\infty = 93 \text{ J.g}^{-1}$  but according to Miyata and Masuko [1998]  $\Delta H_m^\infty = 135 \text{ J.g}^{-1}$ . It can be found from the crystallization peak from the DSC graph since the heat of melting can be calculated from the area under an absorption peak as shown on Figure 3.2. Ahmed *et al.* [2008] and Wunderlich [2005] observed that both  $P_L$ LA exhibits an endothermic melting peak during thermal run.  $P_L$ LA samples exhibit crystallinity. However, for low molecular mass ( $M_n < 1500$ ) crystallization occurs during negative scan and for higher molecular mass, it is observed during positive run.

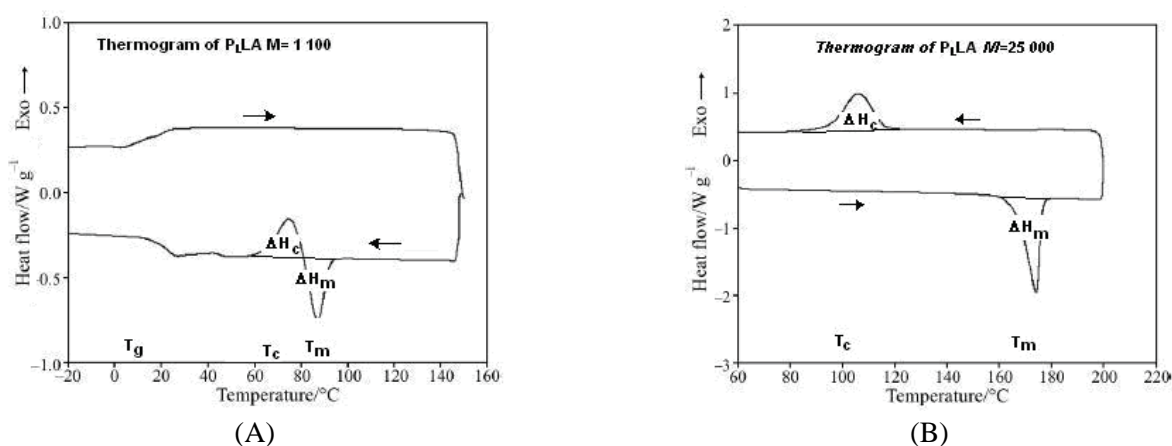


Figure 3.2: Thermograms of two P<sub>L</sub>LAs of different Mw.

[Ahmed *et al.*, 2008]

### 1.3 Second Order Transition

The glass transition is a much more subtle transition than melting or evaporation: glass transition is athermic. In Figure 3.3, the change in heat capacity on going through the glass transition temperature is drawn for a typical semi-crystalline PLGA polymer. There is only a jump in the heat capacity in the range 20 to 190 °C.

The increase in heat capacity,  $\Delta C_p$ , generally occurs over a temperature range of 5 to 20 K, and the jump is often  $11 \text{ J.K}^{-1}.\text{mol}^{-1}$  for mobile units in the liquid. This means that the decrease in heat capacity at the glass transition is  $\approx 11 \text{ J.K}^{-1}.\text{mol}^{-1}$ , for a monatomic liquid.

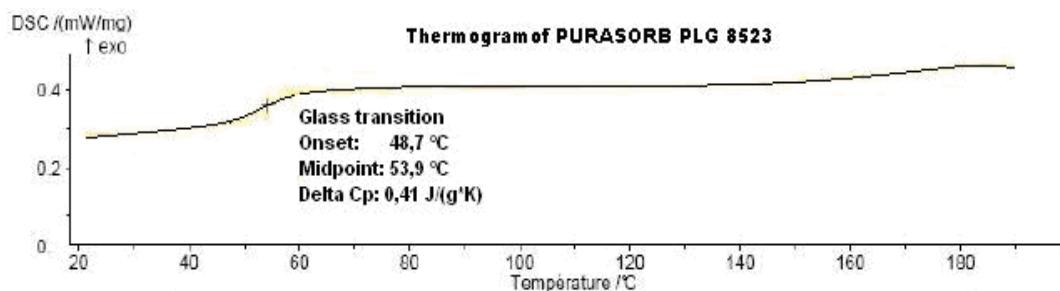


Figure 3.3: Characteristic variation of glass transition in PLGA.



To describe the glass transition, the temperature of half-vitrification,  $T_g$ , should be specified, i.e., the temperature at which the heat capacity is midway between that of the liquid and glassy states (cf. Figure 3.3). This temperature usually corresponds closely to the point of inflection in the heat capacity, and also to the breaks in the enthalpy or volume versus temperature curves at the glass transition. The onset temperature,  $T_{\text{onset}}$ , is often given.

## 2 Intrinsic Viscosity

### 2.1 Molecular Mass of Polymer and Viscosity

The  $M_n$  number average molecular mass is the simple arithmetical average of each molecule as a summation, divided by the number of molecules. Another measurement of average is the  $M_w$  'weight' average, and is an expression of the fact that the higher molecular mass fractions of a polymer play a greater role in determining the properties than do the fractions of lower molecular mass.

Mathematically, this is given by:

$$M_w = \frac{\sum w_1 M_1}{\sum w_1} \quad (3.2)$$

where,  $w_1$  represents the overall weight of molecules of molecular mass  $M_1$ . The  $M_w$  weight average molecular mass is invariably greater than the  $M_n$  number average as its real effect is to square the weight.

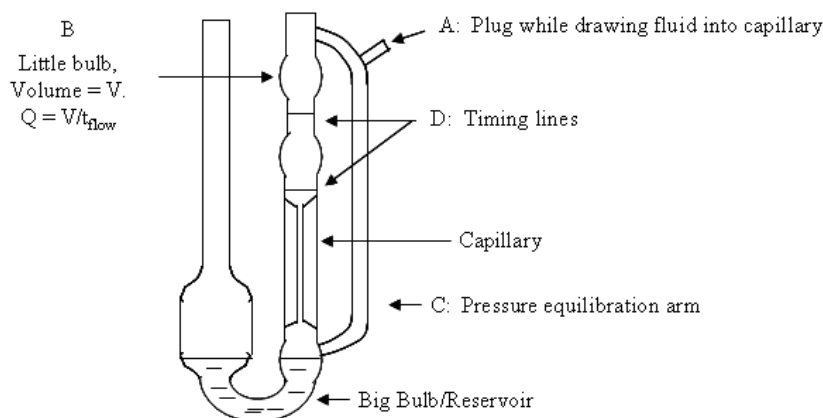
Several methods of measuring molecular weight are used and are summarized here:

- **Osmometry.** This is a vapour pressure method, useful for polymers of molecular mass up to about 25 000; membrane osmometry is used for molecular mass from 20 000 to 1 000 000. These are number average methods.
- **Light scattering.** This is a weight average method.
- **Gel permeation chromatography.** This is a direct fractionation method using molecular mass. It is relatively rapid and has proved to be one of the most valuable modern methods.
- **Viscometry.** This is a relative method, but the simplest, and its application is widespread in industry. Viscometry is the technique to measure the viscosity of materials noting the flow rate/efflux time by using different kinds of viscosimeters [Warson and Finch, 2001].

The absolute value of  $M_w$  (molecular mass average) can only be determined by complex analytical methods such as light scattering. For linear and un-branched polymers, the viscosity average of molecular weight ( $M_{\text{vis}}$ ) is approximately equal to the demi-sum of the  $M_w$  molecular mass average and the  $M_n$  number average molecular mass.

### 2.2 General Principle of Viscosity Measurement

Intrinsic viscosity, which is measured from the flow time of a solution through a simple glass capillary, has considerable historical importance for establishing the very existence of polymer molecules. The most useful kind of viscometer for determining intrinsic viscosity is the "suspended level" or Ubbelohde viscometer, sketched *Figure 3.4*.



**Figure 3.4:** Schematic representation of the Ubbelohde viscosimeter.

The viscometer is called “suspended level” because the liquid initially drawn into the small upper bulb is not connected to the reservoir as it flows down the capillary during measurement. The capillary is suspended above the reservoir. In conjunction with the pressure-equalization tube, this ensures that the only pressure difference between the top of the bulb and the bottom of the capillary is that due to the hydrostatic pressure, i.e. the weight of the liquid.

Capillary viscometry is conceptually simple: the time it takes a volume of polymer solution to flow through a thin capillary is compared to the time for a solvent flow. It turns out that the flow time is proportional to the viscosity, and inversely proportional to the density. The so called inherent viscosity or logarithmic viscosity number are defined by the following relationships:

$$t_{\text{solvent}} = \frac{\eta_{\text{solvent}}}{\rho_{\text{solvent}}} \quad \text{and} \quad t_{\text{sol'n}} = \frac{\eta_{\text{sol'n}}}{\rho_{\text{sol'n}}} \quad (3.3)$$

The inherent viscosity is defined by the ratio:

$$\eta_{\text{inh}} = \frac{\ln \eta_{\text{rel}}}{C} \quad \text{with} \quad \eta_{\text{rel}} = \frac{t_{\text{solution}}}{t_{\text{solvent}}} \quad (3.4)$$

where  $C$  = concentration of polymer in solution (in g/dL) and  $t$  = corrected flow time.

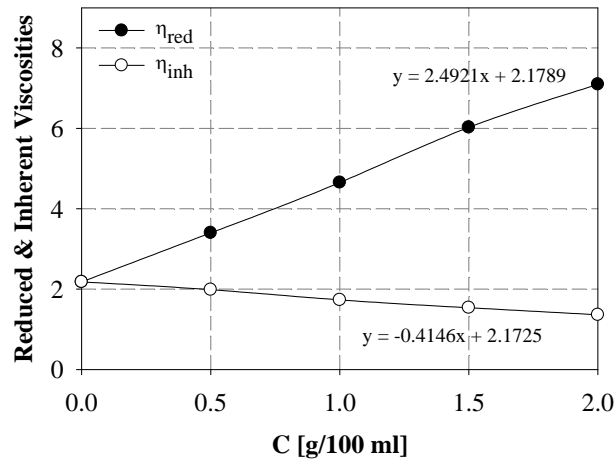
For most polymer solutions at low concentrations,  $\rho_{\text{solution}}/\rho_{\text{solvent}} \approx 1$ . Thus, to a very good approximation, the relative viscosity is a simple time ratio:  $\eta_{\text{rel}} = t_{\text{solution}}/t_{\text{solvent}}$ .

“Specific viscosity” represents the fractional change in viscosity upon addition of polymer:

$$\eta_{\text{sp}} = \frac{\eta_{\text{solution}} - \eta_{\text{solvent}}}{\eta_{\text{solvent}}} \quad (\text{Unitless}) \quad (3.5)$$

Both  $\eta_{\text{rel}}$  and  $\eta_{\text{sp}}$  depend on the polymer concentration, so to extract the “intrinsic” properties of the polymer chain itself, one must extrapolate to zero concentration. Measuring at zero concentration ( $C = 0$ ) would be useless, but this concept of extrapolating to  $C = 0$  is very important in polymer characterization and in thermodynamics generally. As shown on Figure 3.5, the  $[\eta]$  intrinsic viscosity corresponds to the intercept to  $C = 0$  of the two quantities: the reduced viscosity ( $\eta_{\text{sp}}/C$ ) and the inherent viscosity ( $C^{-1} \cdot \ln \eta_{\text{rel}}$ ). The intrinsic viscosity is given by the relation [Russo *et al.*, 1986]:

$$[\eta] = \lim_{C \rightarrow 0} \frac{\eta_{\text{sp}}}{C} \equiv \lim_{C \rightarrow 0} C^{-1} \ln \eta_{\text{rel}} \quad (3.6)$$



**Figure 3.5:** Variation with concentration of reduced specific and inherent viscosities of  $P_{L,D}LA$  (LR 704).

The units of  $[\eta]$  are inverse concentration. Intrinsic viscosity has “grown up” around some fairly unconventional units regarding concentration. The most commonly used concentration is g/dL, so  $[\eta]$  is usually expressed as dL/g. As suggested by the units  $[\eta]$  represents essentially the volume occupied by a polymer per unit mass:

$$[\eta] \propto \frac{R^3}{M} \quad (3.7)$$

where  $M$  is the polymer molecular mass and  $R$  is the hydrodynamic radius of the statistical Gaussian coil model. Thus,  $[\eta]^{-1}$  is approximately the concentration within the polymer, or the “overlap concentration”. At concentrations exceeding about  $[\eta]^{-1}$  polymer molecules will touch and interpenetrate. The “semi dilute” regime of polymers begins here.

### 2.3 The Mark-Houwink Relationship (MHR)

More importantly is the scaling relationship between  $[\eta]$  and molecular weight known as the Mark-Houwink Relationship. For linear and un-branched polymers the viscosity of a diluted polymers solution is directly correlated to the viscosity average of the molecular mass  $M_{vis}$  by following MHR.

$$[\eta] = K.M_{vis}^a \quad (3.8)$$

Thus, the log-log plots of  $[\eta]$  against molecular mass have the intercept  $\log(K)$  and slope  $a$ . The slope contains information about the shape of molecules: the values of the Mark-Houwink parameters,  $a$  and  $K$ , depend on the particular polymer-solvent system. Viscosity measurements are extremely sensitive to temperature. For a given couple solvent/polymer:

- A value of  $a = 0.5$  is indicative of a theta  $\theta$  solvent or limit condition between a single and two phases.
- For most flexible polymers in "good" solvents *i.e.* solvents forming a single phase,  $0.5 < a < 0.8$ .

### 2.4 The Mark-Houwink Constants of Polylactides and Hyaluronic Acid

Different Mark-Houwink parameters are available from literature [Välilä and Laaksovirta, 2004; Rak *et al.*, 1985; Schindler and Harper, 1979]. As for polylactides, one can find:

- Poly(L lactide):  $K = 5.45 \times 10^{-4}$  dL/g and  $a = 0.73$  in chloroform at  $30^\circ\text{C}$ .
- Poly(D,L lactide):  $K = 2.21 \times 10^{-4}$  dL/g and  $a = 0.77$  in chloroform at  $30^\circ\text{C}$ .
- Poly(D,L lactide-co- L lactide):  $K = 1.29 \times 10^{-5}$  dL/g and  $a = 0.82$  in chloroform at  $25^\circ\text{C}$ .
- Poly(D,L lactide-co-glycolide):  $K = 5.45 \times 10^{-4}$  dL/g and  $a = 0.73$  in chloroform at  $25^\circ\text{C}$ ;

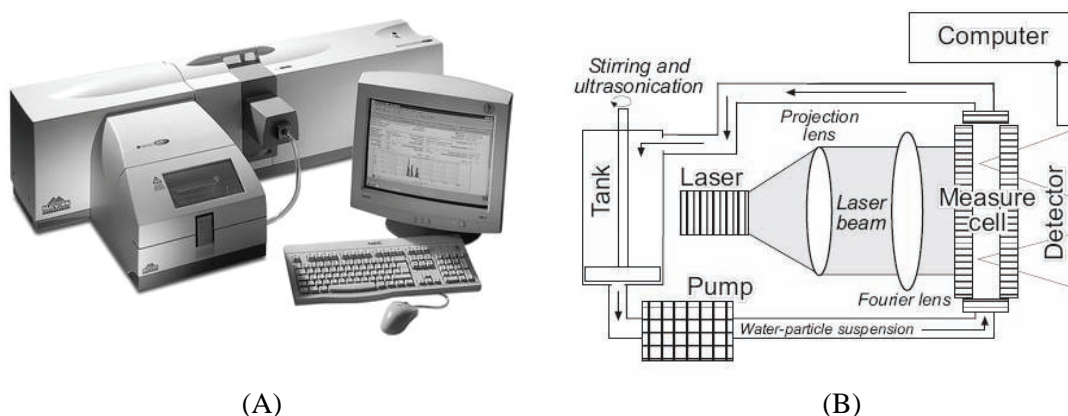
For hyaluronic acid, the Mark-Houwink constants are  $K = 5.075 \times 10^{-5}$  dL/g and  $a = 0.716$ , in 200 mM NaCl at  $20^\circ\text{C}$  [Gura *et al.*, 1998] and  $K = 2.226 \times 10^{-5}$  dL/g and  $a = 0.796$ , in chloroform at  $25^\circ\text{C}$  [Source Javene]..

### 3 Laser Granulometry Method

#### 3.1 Granulometry

Laser granulometry dates back to the 1970s. It is a technique for measuring the size distribution of particles contained in a powder. If this one contains particles of different sizes, it permits to determine the proportion of each size class.

The measure is based on the theory of single scattering and laser diffraction. Beam laser is obtained by collimating a beam from Helium – Neon gas tube. This beam is sent to a sensor in which the particles are kept in constant movement so that each particle passes at least once in front of the laser beam during the measurement time (cf. Figure 3.6).



**Figure 3.6:** (A) Mastersizer® 2000 (Malvern Instruments™) (B) Schematic diagram showing the main components of a laser diffraction particle size analyzer.

[Storti and Balsamo, 2009]

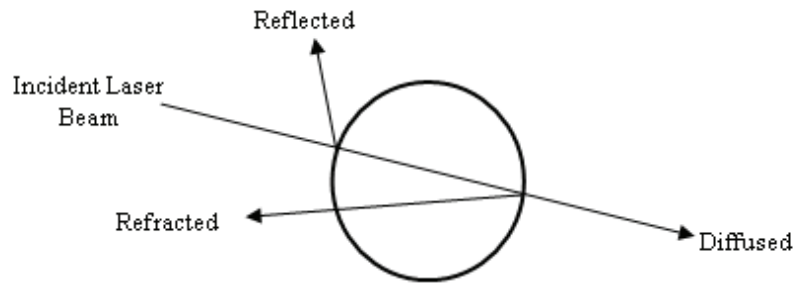
#### 3.2 Principle of Laser Analysis

It uses the following hypotheses: spherical particles are considered to be non porous and non opaque at laser radiation and these particles have a diameter superior to their wave length, are in constant random motion and diffract light efficiently regardless of their size.

When a laser beam sheds light on a particle, diffraction patterns can be observed. The intensity of the diffracted radiation and the deviation angle differ according to the size of the particles (cf. Figure 3.7).

Thus, particles with large sizes diffract large light quantities on small angles, while small particles diffract small light quantities on large angles. The light angle and intensity permit to

obtain the particle size distribution. Three theories may be used for that: Rayleigh' theory, Lorenz-Mie' theory and Fraunhofer' theory;

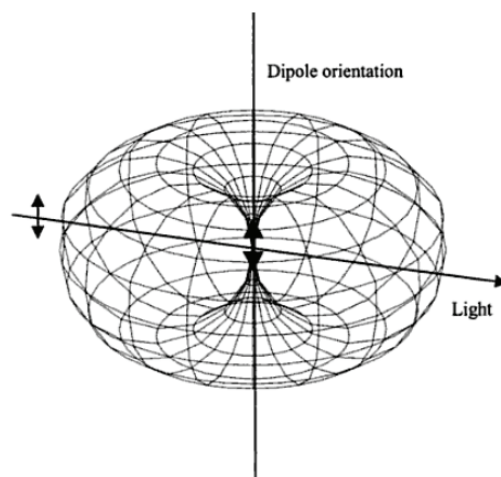


**Figure 3.7:** Scheme of laser diffraction of a spherical particle.

### 3.2.1 Rayleigh' Theory

Rayleigh' theory demands that the particle size is much smaller than the wavelength of incident light. In that case, the whole particle behaves similarly in a homogeneous electric field. The incident light penetrates the particle due to the polarizability  $\alpha$  of the particle. The penetration time is short compared to the period of incident light. Induced dipole moment is formed when electric charges of non polar particle are forced apart by subjecting the particle to electromagnetic wave. Like so, the polarized particle is created. The electric field and the dipole moment oscillate synchronously and the axis of the dipole moment is downright to the incident light as in Figure 3.8, which also describes the intensity of scattering to different directions [Xu, 2000].

According to this theory, the laser beam is assumed to not only be diffracted by the particles, but is also reflected and diffused. The light will spread until there is a variation in the refraction index of the propagation environment. This index variation will create a refraction of the monochromatic beam; the laser will reach the detector having been subjected to several variations in its propagation direction.

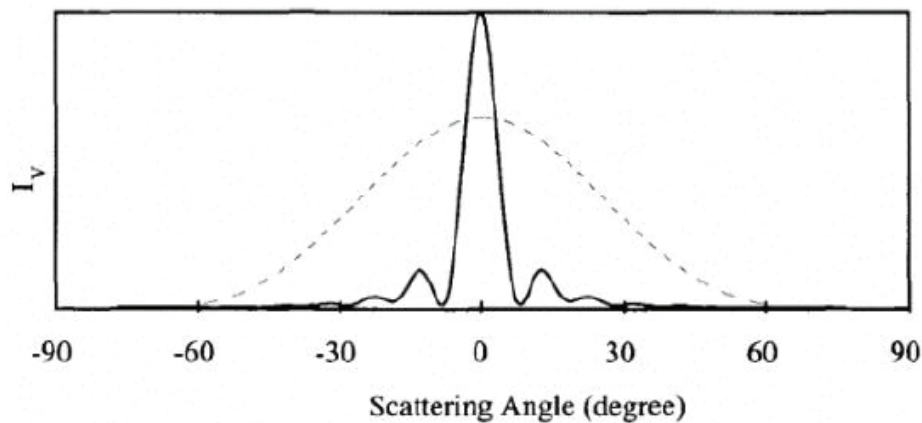


**Figure 3.8:** Three dimensional model of scattering from a dipole.  
[Xu, 2000]

### 3.2.2 Lorenz-Mie' Theory

Lorenz-Mie' theory (or Mie' theory) is more detailed and wider theory of the light scattering than Rayleigh' theory. It can be used for spherical particles which can be small, large, transparent or opaque. According to Lorenz-Mie theory, the intensity of scattering from the surface of the particle (primary scattering) can be predicted with the refractive indexes of the particle and the medium. Lorenz-Mie' theory

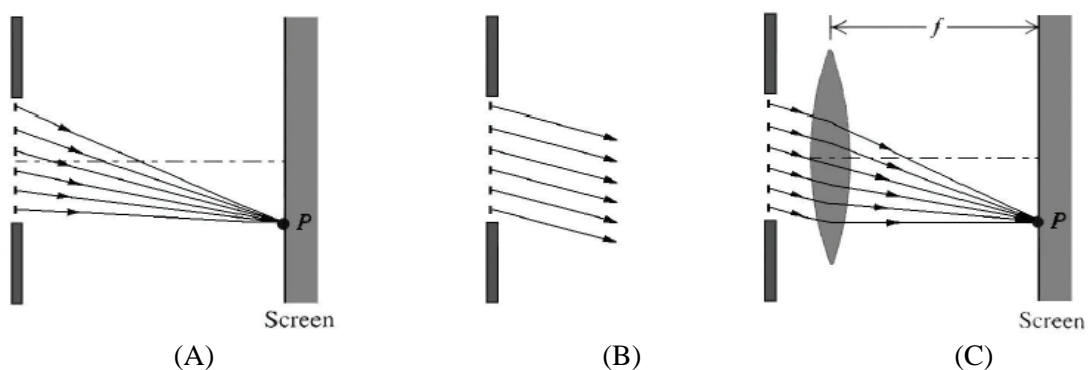
also caters the light refraction with the particle (secondary scattering) which is very important when particle diameter is below 50  $\mu\text{m}$ . This is also mentioned in the standard for laser diffraction measurements (ISO 133201) [Kippax, 2005]. According to Lorenz-Mie' theory the scattering patterns of spheres are symmetric with axis of the incident light. Scattering minima and maxima are in different angles, if the properties of the particles vary. Figure 3.9, shows the diffraction patterns of two particles with different sizes [Xu, 2000]. With large particle (solid line) the peak of intensity is stronger than with small particle (dashed line) and the minimum intensity is much closer to axis of the incident light. The intensity peaks are in the same locations in the both positive and negative angles because the symmetrical nature of scattering. Very illustrative way of displaying the intensity distribution is also a radial graph as in Figure 3.9. The bold trace describes the intensity of scattered light in different angles [Xu, 2000].



**Figure 3.9:** Scattering patterns of two particles of a different size.  
[Xu, 2000]

### 3.2.3 Fraunhofer' Theory

Fraunhofer' theory covers the light diffraction in the aperture which is described in Fresnel-Kirchoff' diffraction integral [Brittain, 2003]. In Fresnel diffraction (Figure 3.10-A), distances from the point source and the screen to the obstacle forming the diffraction pattern are relatively short. In Fraunhofer' diffraction (Figure 3.10-B), the distances are much longer and all lines from the source to the obstacle and forward to the screen can be considered parallel. In Figure 3.10-C, the lens forms smaller image of the same diffraction pattern which would be formed on the screen extremely far without the lens [Young and Freedman, 2000].



**Figure 3.10:** Principles of Fresnel' diffraction (A) and Fraunhofer' diffraction (B and C).  
[Young and Freedman, 2000]

Fraunhofer' diffraction assumes that the measured particles are opaque and scatter light at narrow angles. Therefore it is applied only with the large particles and gives incorrect results with the fine particles [Kippax, 2005].

## 4 Sorption Analysis

Sorption analyses have been carried out in order to study the amount of CO<sub>2</sub> sorbed by the polymers at different pressures. The method used, which is proposed by *Berens and Huvard* [1989a] involves the sorption of CO<sub>2</sub> into the polymer pellets, followed by very rapid venting of the chamber and transfer of the pellets to a precision balance for recording the weight variation during desorption. Recording with a video camera gives kinetic data of desorption, and since the early stages of desorption are linear (cf. Figure 3.11 for example for P = 125 bars), it allows to extrapolate to t = 0 sec (which is the end of the saturation period). This extrapolation gives the total amount of CO<sub>2</sub> sorbed by the polymer in the end of the saturation period. Sorption of CO<sub>2</sub> is then calculated by:

$$s = \frac{w - w_0}{w} \quad (3.9)$$

where  $s$  is the sorption (g CO<sub>2</sub>/g polymer),  $w$  is the extrapolated weight of polymer and  $w_0$  is the polymer weight before the experiment.

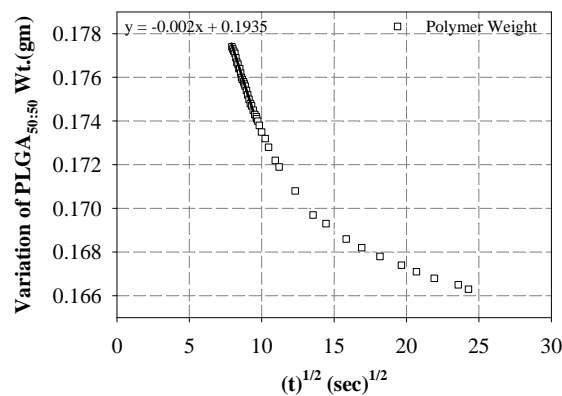


Figure 3.11: Desorption of CO<sub>2</sub> from PLGA<sub>50:50</sub> with time.

By changing the saturation time, kinetics of diffusion of CO<sub>2</sub> into the polymer samples can be calculated.

## 5 Microscopic Methods to Analyze Porous Structures

### 5.1 Methods to Determine Porosity

#### 5.1.1 Geometric Porosity

The porosity of a porous medium describes the fraction of void space in the material, where the void may contain, for example, air or water. It is defined by the relationship:

$$\phi = \frac{V_v}{V_T} \quad (3.10)$$

where  $V_v$  is the volume of void-space (such as fluids) and  $V_T$  is the total or bulk volume of material, including the solid and void components.



In our analyses, the diameter and thickness of pellets and foams have been measured using a standard engineering caliber. The volume of the polymers is evaluated by  $v = \pi r^2 h$ , where  $r$  is the radius and  $h$  is the thickness of pellets and scaffolds. The P(%) porosity is calculated by:

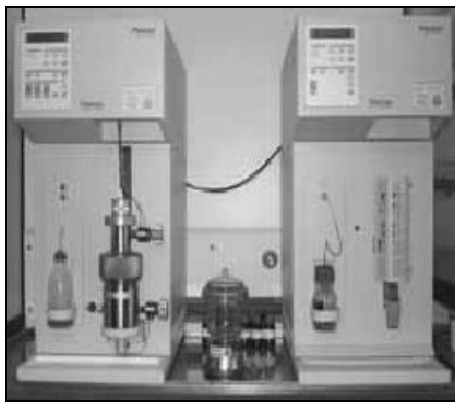
$$P(\%) = \left(1 - \frac{\rho_{\text{foamed}}}{\rho_{\text{unfoamed}}}\right) \times 100 \quad (3.11)$$

where  $\rho_{\text{unfoamed}}$  and  $\rho_{\text{foamed}}$  are the density of pellets and foams respectively.

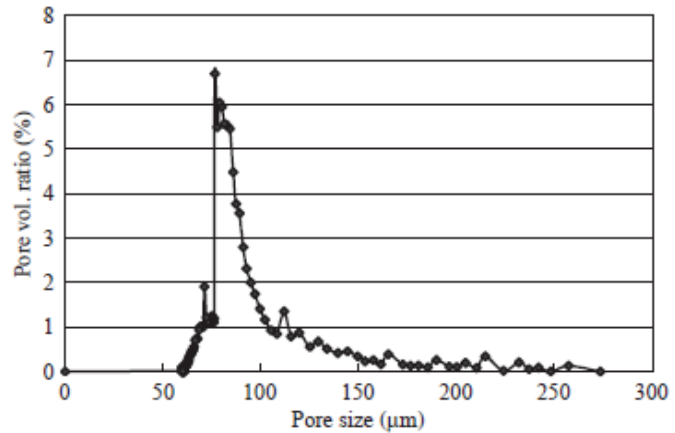
### 5.1.2 Mercury Porosimetry

The number of pores that exist in a typical porous sample is usually of the order of millions, billions or even trillions of them per unit mass of solid. These pores are generally interconnected to each other by way of a sinuous 3-D pathway. In lattice models *Mayagoitia et al.*, [1994], the porous space is distributed between two types of elements: the sites (cavities) and the bonds (necks).

The technique involves the intrusion of a non-wetting liquid (mercury) at high pressure into a material through the use of a porosimeter (cf. Figure 3.12-A). Hg porosimetry experiments comprise two stages. The first stage (intrusion) starts with the immersion of a porous sample in Hg. As the pressure of Hg is increased, the pore entities are penetrated sequentially, i.e. from the largest to the smaller ones according to the current value of the external pressure. The second stage (retraction) consists in the withdrawal of Hg from the pores. Since this last process involves the gradual decrease of the external pressure, the succession by which pores are emptied goes from the smallest to the largest ones.



(A)



(B)

**Figure 3.12:** (A): Hg porosimeter apparatus and (B): Pore size distribution of PLGA samples. [Ho et al., 2004]

The pore size can be determined based on the external pressure needed to force the liquid into a pore against the opposing force of the liquid's surface tension. A force balance equation known as Washburn's relationship (equation 3.12), for the above material having cylindrical pores is given as:

$$P_L - P_G = \frac{4\sigma \cos\theta}{D_p} \quad (3.12)$$

where  $P_L$  = pressure of liquid,  $P_G$  = pressure of gas,  $\sigma$  = surface tension of liquid,  $\theta$  = contact angle of intrusion liquid (i.e. mercury) and  $D_p$  = pore diameter.

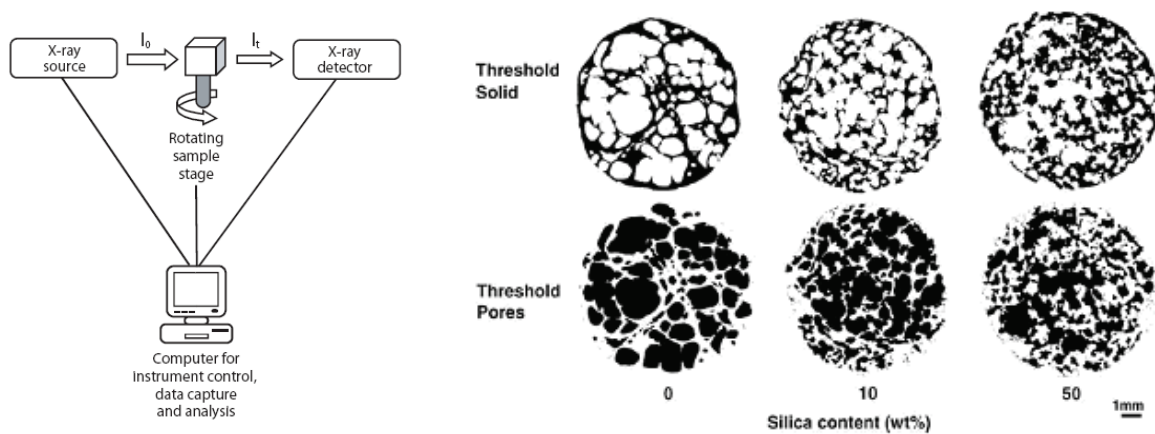
As pressure increases, so does the cumulative pore volume. From the cumulative pore volume, one can find the pressure and the pore diameter where 50% of the total volume has been added to give the



median pore diameter. As example for  $P_L$ LA, a Hg typical distribution of pores is presented in Figure 3.12-B [Ho *et al.*, 2004].

### 5.1.3 X-ray Microtomography

Trater *et al.* [2005] have investigated the use of non-invasive 3-D X-ray microtomography (XMT) for microstructure characterization. Moreover, XMT generated images were more conducive to digital image processing than SEM images because of ‘razorthin’ depth of focus and sharp contrast between solid and void areas. This technique has been widely used for the *in vivo* imaging of plants, insects, animals and humans. X-ray microtomography is a non destructive technique that provides a reasonable level of resolution ( $\sim 5 - 20 \mu\text{m}$ ). The X-ray microtomography approach is an extension of the computer aided tomography ( $\mu\text{CT}$ ) medical imaging technique. X-rays are directed from a high-power source toward a sample, and a detector on the opposite side of the sample measures the intensity of the transmitted X-rays (see Figure 3.13-A).



(A)-Schematic representation of  $\mu\text{CT}$ .

(B)-Example of analysis with  $P_L$ LA/Silica.

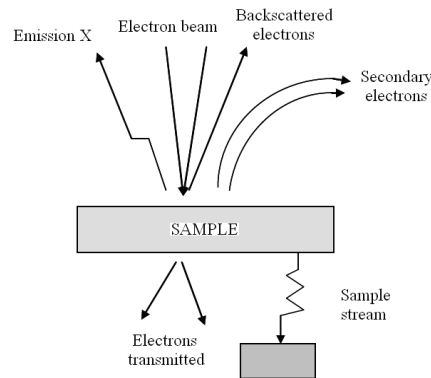
**Figure 3.13:**  $\mu\text{CT}$  principle and images of  $P_L$ LA/Silica sample.

[Collins *et al.*, 2010; Hancock and Mullarney, 2005]

A two-dimensional “shadow” image is produced by accurately rastering the X-ray beam across the sample. The sample then is carefully moved relative to the X-ray beam, and the process is repeated to produce additional two-dimensional images from various view points. Using a Fourier transform algorithm, the two-dimensional images then are combined to generate a complete three-dimensional map of the sample. The intensity of the X-rays reaching the detector is controlled by the sample path length and the X-ray attenuation coefficient of the material that it encounters on that path [Cao *et al.*, 2003]. The varying levels of signal intensity provide a gray-scale in the images (see Figure 3.13-B) from which information about the thickness, and attenuation properties of the sample can be deduced.

## 5.2 Scanning Electron Microscopy Observations

Electron microscopy is a technique based on the principle of electron-matter interactions, capable of producing high-resolution images of the surface of a sample. A focused electron beam is deflected through electromagnetic lenses, scans the surface of the sample for analysis which, in response, re-emits different types of emissions (cf. Figure 3.14). The signals that derive from electron-sample interactions reveal information about the sample including external morphology (texture), chemical composition, and pore size, pore structure and orientation of materials making up the sample. In most applications, data are collected over a selected area of the surface of the sample, and a 2-dimensional image is generated that displays spatial variations in these properties. magnification ranging from  $20\times$  to approximately  $30,000\times$ .



**Figure 3.14:** Schematic representation of interactions beam on specimen surface.

### 5.2.1 Bases of Image Analysis

SCION<sup>®</sup> Image was originally developed for the National Institutes of Health, a federal government agency. Basic image properties like contrast, brightness and gamma can be optimized. For particle analysis the most important property is the grey level of the image which can be segmented to reduce different shades [Niemistö, 2006].

Segmentation means the separation of different parts of the image; a foreground objects like particles from a background of image. In the pore size and shape analysis segmentation has to be done with very high accuracy because the area of the particle is dependent of the accuracy of segmentation and the results of analysis have to be reliable [Niemistö, 2006]. Segmentation can base on either discontinuity or similarity of intensity values. Discontinuity methods find abrupt changes in the intensity and separate various regions on that way. Methods of similarity needs predefined criteria of the intensity value and separate regions based on that.

Thresholding, clustering, region growing, region merging and region splitting are methods which are included in the category of similarity methods [Niemistö, 2006]. Thresholding is a central method of segmentation due to its simple and intuitive properties. It separates bright foreground objects on a dark background and can be defined as:

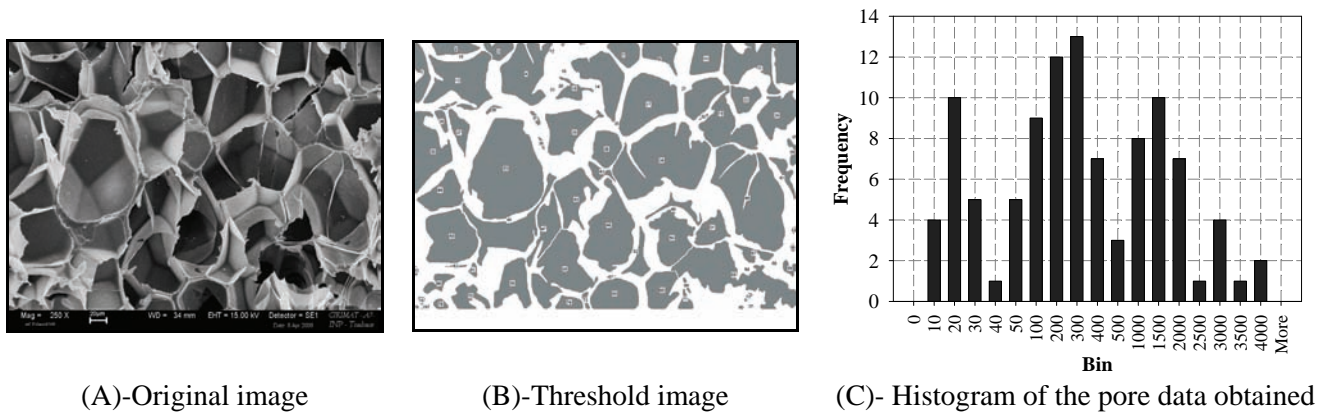
$$f_T(x) = \begin{cases} 1 & \text{if } f(x) > T \\ 0 & \text{if } f(x) \leq T \end{cases} \quad (3.13)$$

where  $f(x)$  = grey level of the point  $x$ ,  $f_T(x)$  = the respective point in the thresholded image and  $T$  is the threshold.

If a pixel in  $f_T$  gets value 1, it is called a foreground (or object point) and if it gets value 0, it is called a background. Threshold  $T$  can be the same for the whole image (global threshold) or there can be different thresholds in different parts of the image (local threshold) [Niemistö, 2006]. The transition between the object point and the background may be so unsteady that a human can't decide where the borders between the object and the background exactly go.

Many papers are published on the automatic selection of the threshold since 1960's. The most commonly used method is created by *Otsu* [1979]. That method maximizes the class variance of the grey levels between the objects and the background and minimizes the intra-class variance. Usually threshold is selected from a histogram of the image. If the histogram is bimodal threshold should be selected between the modes because supposedly a one mode represents the foreground and the other one represents the

background. Otsu's method can be used if the histogram has even one or two modes. Figure 3.15 shows an example of thresholding [Niemistö, 2006].

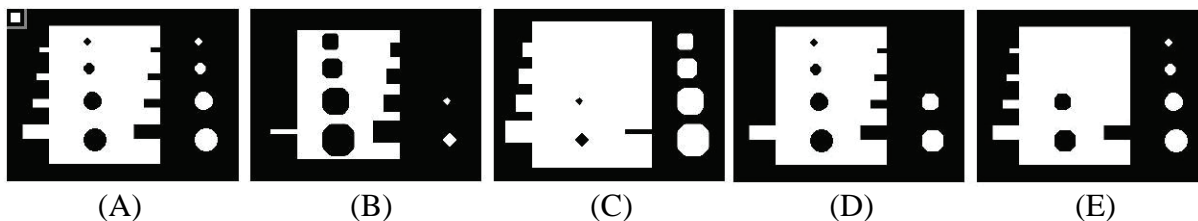


**Figure 3.15:** SCION® Image processing and pore data retrieval.

### 5.2.2 Morphological Filtering

The two fundamental morphological operations are erosion and dilation. Erosion is thus equivalent to the minimum filter having a sliding window that is equivalent to the structuring element. Dilation is thus equivalent to the maximum filter having a sliding window that is equivalent to the structuring element. In the case of binary images, the output of erosion is zero unless all the samples in the sliding window are ones, whereas the output of dilation is one unless all the samples are zeros. Erosion shrinks foreground objects and expands their background, whereas dilation expands the foreground objects and shrinks their background.

Figure 3.16 (A) depicts a binary image and a square-shaped structuring element (top left corner). Figure 3.16 (B) and (C) show the erosion and dilation of this image by the square-shaped structuring element. The morphological opening and closing are morphological operations that are very useful in image processing. Erosion first removes all objects in the image that cannot contain the structuring element and shrinks all the other objects. When the obtained image is dilated by the reflected structuring element, the objects that have been removed are naturally not recovered. The objects that have not been removed by erosion are restored in such a way that protrusions that cannot contain the structuring element remain removed. The morphological opening can thus be used to remove small objects and to smoothen the contours of larger objects. An example is shown in Figure 3.16 (D).



**Figure 3.16:** (A): A binary image and a structuring element (top left corner). (B): Erosion (C): Dilation (D): Opening (E): Closing of the original image.

The morphological closing of the structuring element is defined as the dilation followed by erosion by the reflected structuring element. Dilation first fills all background structures that cannot contain the structuring element and expands all objects. When the obtained image is eroded by the reflected structuring element, the filled background structures naturally remain filled. The expanded objects are restored in such a way that indentations that cannot contain the structuring element remain filled. The

morphological closing can thus be used to fill small holes in the objects and to smooth the object contours. An example is shown in Figure 3.16 (E) [Niemistö, 2006].

The morphological opening completes first erosion by the structural element and then dilation by the reflected structuring element. Erosion shrinks objects which can contain the structural element and removes other objects. If some object is removed in erosion, it is not recovered in dilation. Opening operation can be used to remove small foreground objects and to smooth the larger objects. The morphological closing completes first the dilation and then the erosion. Dilation expands all the foreground objects and fills the background structure, if it is smaller than the structural element. Therefore the closing operation can be used to fill small holes and to smooth the objects [Niemistö, 2006].

## 6 Macroscopic Methods

### 6.1 Mechanical Brazilian Tests

#### 6.1.1 Principle of the Test

The direct testing of the tensile strength of brittle materials is very complex. Their disadvantage is the low part of volume that is actually charged with the load and the strong dependency of the samples surface and their dimensions. Brazilian Test is an indirect measure of the tensile strength and the resistance to uniaxial tensile loads without yielding or fracture of brittle materials. The equipment comprises:

- A loading frame, 25 kN capacity, having a base and a cross head joined together with two solid pillars with nuts. At the top, the pillars have long threads for height adjustment. On the base, a 25 kN hydraulic jack is controlled by a computer. This jack has an integral pumping unit and oil reservoir. A 25 kN capacity pressure gauge is fixed to the jack for indicating the load on the specimen (cf. Figure 3.17).



**Figure 3.17:** H25KS Brazilian testing equipment.

- A Brazilian specimen, cylinder with approximately thickness half the diameter or at least 2 mm. The sample was clamped into two jaws of the machine.

*Fairhurst* [1964] and *Wijk* [1978] looked at the validity of the method from a theoretical perspective and favoured this method to that of the point-load test. *Clarke* [1992] found that the crack initiates in the centre of the specimen and that stress concentrations built up around the loading plates effectively hindering crack propagation in that area. *Yu et al.* [2006] have investigated the method both practically and theoretically and have concluded that results given by the two methods are comparable. The method of breakage is well documented and has the term ‘hourglasses’ associated with it.

This leads to the special advantages, summarized as follows:

- Simple sample geometry low effort, cost reduction.

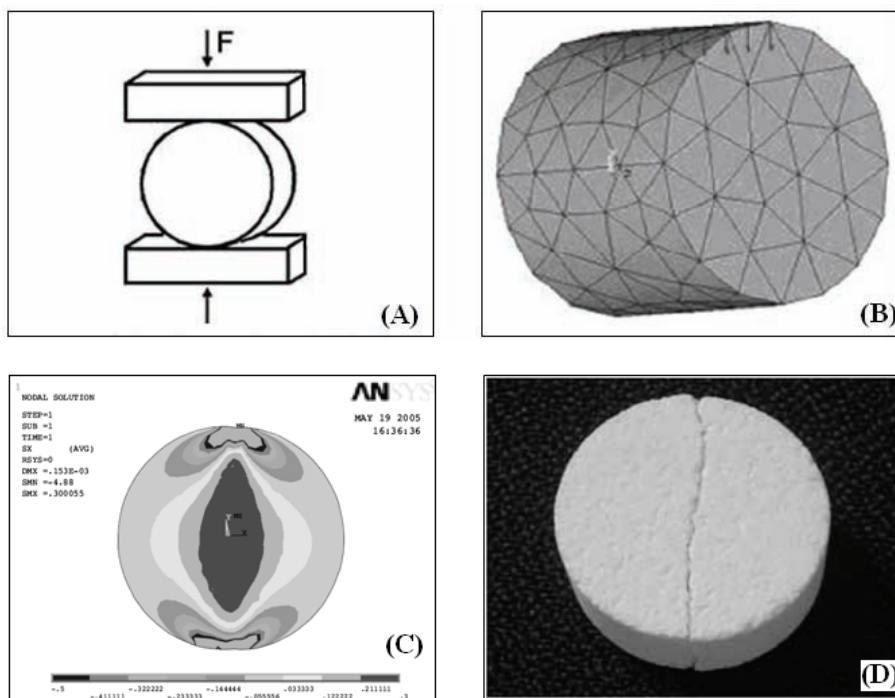
- Small influence of the surface quality: cost reduction, time reduction.
- Small samples: more samples per volume; testing of fragments possible.
- Large effectively loaded volume.
- Low variation: higher precision of the single values, required number of samples is lower, higher reproducibility of the measured values.

The relationship between applied forces and yield loads is given by:

$$\sigma_t = - 2.F/\pi.D.t \quad (3.14)$$

where  $\sigma_t$  = splitting (brazilian) tensile strength (MPa),  $F$  = load at (splitting) failure (N),  $t$  = average specimen thickness (mm), and  $D$  = diameter (mm) [Yu *et al.*, 2006].

Figure 3.18 shows the principle of Brazilian test (A) and the modelling by the finite elements method (B). Figure 3.22 (C) is representative of stress concentrations and (D) of a typical fracture pattern.



**Figure 3.18:** (A): Principle, (B): Load geometry, (C): Simulation and (D): Cleavage of a Brazilian disk test.

[Rasch *et al.*, 2005]

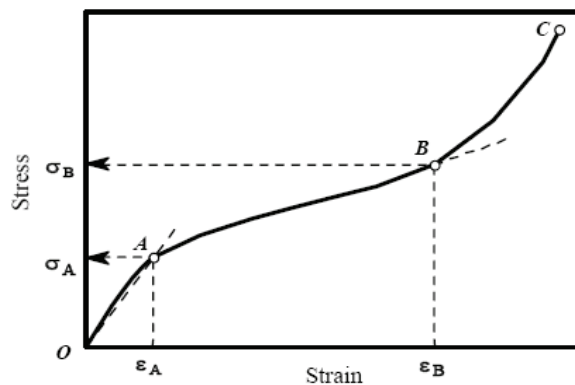
### 6.1.2 Compression of Porous Materials

In bone and tissue engineering applications, porous scaffolds depending upon applications must have sufficient mechanical strength to restrain their initial structures after implantation *in vivo*. The ASTM terminology for porous materials is classified into three groups: interconnecting pores (open pores), non-connecting pores (closed pores) or a combination of both, the scaffold falling in each group has specific properties [Hutmacher *et al.*, 2008]. When pores are open, the foam material is usually drawn into struts forming the pore edges through open faces forming a low density solid. When the pores are closed, a network of interconnected plates produces a high density solid. The closed pores are sealed off from the neighbouring pores. The interconnecting pores are critical parameter in designing a tissue engineering scaffold. The interconnecting pores should be large enough to support cell migration and proliferation in the initial stages [Hutmacher *et al.*, 2008]. A large interconnection means a low density solid, and therefore low mechanical structure.



There is often a compromise between porosity and scaffold mechanical characteristics. Therefore, the biomechanical challenge in designing a scaffold is to achieve sufficient stiffness and strength in a highly porous structure to provide mechanical integrity [Zhang and Ma, 1999a]. The biostability of many implants depends on factors such as strength, stiffness, absorption at the material interface and chemical degradation [Hutmacher et al., 2008]. The review by Gibson and Ashby [1999], concluded the mechanical characteristics of a porous solid depended mainly on its relative density, the properties of the material that made up the pore edges or walls and anisotropic nature cause of processing technique.

The type of deformation and failure of foam depends on the structure and physical characteristics of the used materials and on the macrostructure behaviour under compression. The macrostructure of glassy foam consists of closed cells. The main part of its mass is concentrated at the nodes and junctions of the cells. The deformations and the failure of the material under compression occur according to the stress-strain diagram. Three mechanical states are marked by points A, B, C on the graph representing the compression of foam sample (cf. Figure 3.19). A corresponds to the end point of the elastic region; B marked the end of the plastic region and C the failure of the foam. The compressive elastic (plastic) modulus can be deduced from the slope of the corresponding curve.



**Figure 3.19:** Compression testing result output for foams  
[Gnip et al., 2004]

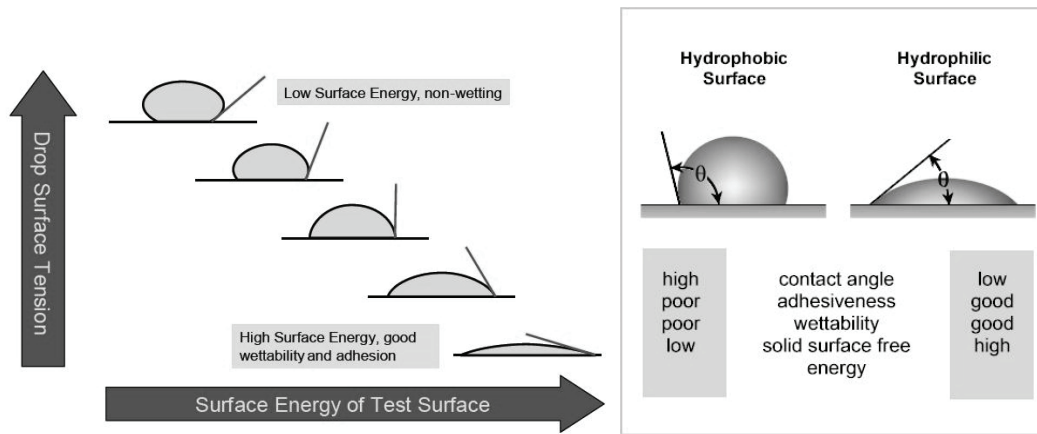
Compression is one of the main stressed states of foam used in a number of medical applications.

The yielding point  $\sigma_A$  describes compressive strength. For the foams with a stress peak,  $\sigma_A$  is defined as the peak value. In the case of no stress peak, at highly porous foams,  $\sigma_A$  can be obtained from the intersection point of two tangent lines besides the flexure region. Two alternative parameters were also used to characterize compressive strength. For instance,  $\sigma_5$  is defined as the intersection of the stress–strain curve with the modulus slope at an offset of 1% strain adopting the guidelines for compression testing of bone cement set in ASTM F451-99a, and  $\sigma_{10}$  is defined as the stress at 10 % strain according to ISO 844-2004 for determination of compressive properties of rigid cellular foams. The compression stress  $\sigma_B$  corresponds to the attenuation of flexural deformations of cell walls when their stability is lost [Gnip et al., 2004]. It can also be denoted as stress corresponding to maximum possible compaction  $\sigma_{comp}$  of the damaged elements of foam macrostructure.

## 6.2 Surface Energy Experiments

Surface tension of a liquid is the force required per unit length to stretch a pre-existing surface (N/m) while the surface energy of a solid is the work required per unit area to create a new surface ( $J/m^2$ ). The surface tension is an intensely sensitive indicator that provides a lot of information about the characteristics (e.g. wetting, foaming, emulsification...) of a liquid. It is obvious that a high liquid surface

tension causes low wetting properties. A high solid surface energy (mostly hydrophilic), on the other hand, means that the interfaces between the solid material and the air are not favourable in a thermodynamic sense. Therefore, high surface energy solids are easily wetted by liquids (cf. Figure 3.20). Wetting of a solid eliminates the solid-air interface in favour of the solid-liquid interface. Interactions between the solid surface and the liquid are resulting in a lowering of energy state, which is a more favourable state [Lazghab *et al.*, 2005; Shaw, 1992].



**Figure 3.20:** Wetting of hydrophilic and hydrophobic samples.

### 6.2.1 Surface Tensions of Liquids

Different liquids may be used in surface tension measurements but in general chosen liquids have relatively low viscosity and low volatility. Van der Waals forces result to the addition of different components:  $\gamma^d$  dispersive and  $\gamma^{nd}$  non dispersive or attractive forces (polar forces and hydrogen bonds). We can write:  $\gamma = \gamma^d + \gamma^{nd}$ .

In some apolar molecules, there exist important intermolecular forces but no permanent dipolar moment. When two molecules are in the proximity, instantaneous dipoles interact via London forces. In polar molecules, permanent attractive forces create special arrangement increasing stability of the couple (Debye and Keesom forces). Interactions between apolar molecules and polar surface are limited to these attractive interactions and  $\gamma_L^{nd}$  polar forces are constituted by the sum of these two forces. A special attention must be paid when a hydrogen atom is linked to an electronegative atom. The electronegative atom exerts an important attractive force on the unique hydrogen atom and forms hydrogen bonds. Also, even if these types of relationships fit for the dispersion forces, and possibly also for some polar (Debye and Keesom forces), they are not so good for acid/base and hydrogen bonding.

For this, Oss [2006, 1994] have proposed other combinations of surface energies. The argument is that often, the polar (Keesom and Debye) forces are weak, and can be included in the dispersive contribution. The "combined" contribution is denoted by LW (Lifschitz-van der Waals). In addition, there is a short-range interaction that is caused by acid-base interactions (hydrogen bonding is a type of Acid-Base). In that case, we write:  $\gamma = \gamma^{LW} + \gamma^{AB}$ .

There are several common methods described in the literature for measuring the surface tension of liquids. The surface tensions of liquids can be directly determined by measuring the surface force with a Du Noüy ring or a Wilhelmy plate for example. The determination of surface energy is necessary indirect. In literature, there are several methods to measure their contact angle with a liquid [Petrie, 2000]. By using a given model, we only can estimate their surface energy.

### 6.2.1.1 Du Noüy Ring Method

In this method, a clean platinum ring (cf. Figure 3.21) is placed under the surface of the test liquid, and the liquid is slowly moved downward until the ring or plate breaks through the liquid surface. The force is recorded, and by means of appropriate conversion factors, the surface tension of the liquid is calculated.

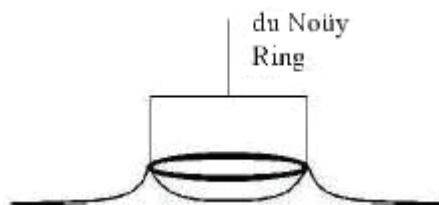


Figure 3.21: The Du Noüy' ring method.

### 6.2.1.2 Wilhelmy Plate Method

A second method to measure the liquid surface tension involves the use of a pre-weighed plate and the measurement of wetting forces. The level of the liquid is raised until contact between the liquid surface and the plate is registered. Contact between the liquid and the plate induces a change of working forces on the plate, which is measured by the tensiometer. There are 3 forces acting on the plate: the force due to (1) vertical gravity, (2) wetting and (3) buoyancy. By using a pre-weighed plate, the tensiometer can exclude the gravity force and by extrapolating the measured forces back to zero depth of immersion, the buoyancy force can also be excluded. The only force left, the wetting force ( $F_w$ ), is then easily measured by the tensiometer [Mykhaylyk *et al.*, 2003; Gaonkar and Neuman, 1984].

A high surface energy (platinum plate) is used in this approach, with the assumption that the contact angle ( $\theta$ ) liquid-platinum plate is  $0^\circ$  (Figure 3.22). As a consequence, the liquid-vapour surface tension can be calculated as follows:  $F_w = \gamma_{LV} L \cos \theta$ , where  $\gamma_{LV}$  is the liquid-vapour surface tension,  $L$  the wetted length of the plate (twice the width and length of the plate) and  $\theta$  the plate-liquid contact angle [Mykhaylyk *et al.*, 2003; Gaonkar and Neuman, 1984].

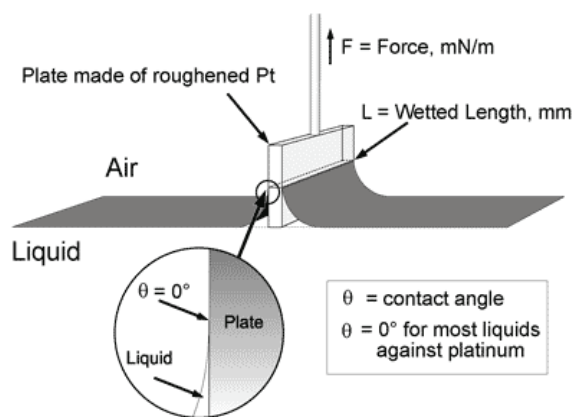


Figure 3.22: The Wilhelmy' plate method with a platinum plate.

Its biggest advantage is that the liquid surface tension is analyzed at a fixed point, resulting in a static determination method. After the plate is immersed in the liquid and equilibrium has settled, there is no movement of the plate or liquid which results in a higher accuracy. Furthermore the Wilhelmy' plate method allows determining the surface tension of viscous liquids [Mykhaylyk *et al.*, 2003; Gaonkar and Neuman, 1984].

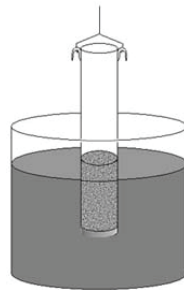


### 6.2.1.3 Lucas-Washburn' Method

This approach is also known as the capillary rise method. It determines the contact angle by analyzing the capillary rise of liquids into a porous powder. It is a very simple and universally applicable method and is therefore commonly used. The set up of the experiment is done by adding a porous powder to a glass tube with a filter on the bottom. The glass tube with powder is densified and attached to the tensiometer. The liquid with known density ( $\rho$ ), viscosity ( $\eta$ ), and surface tension ( $\gamma_{LV}$ ) is placed at the bottom of the tensiometer and its level is subsequently raised until contact with the filter of the glass tube is registered (cf. Figure 3.23). Via capillary forces, the liquid rises through the porous powder and the increase in weight is measured by the tensiometer, resulting in a graph of the square mass plotted against the time. The equation that fits this graph is [Dang-Vu and Hupka, 2005; Kiesvaara and Yliruusi, 1993].

$$l^2/t = (\sigma_1 r \cdot \cos\theta)/2\eta \quad (3.15)$$

where  $l^2$  is the front of the liquid;  $t$  is the time;  $\sigma_1$  is the superficial tension of the liquid,  $r$  is the capillary radius;  $\theta$  is the contact angle and  $\eta$  is the liquid viscosity.



**Figure 3.23:** Principle of the absorption Washburn' method.

### 6.2.1.4 Surface Tensions of Classical Liquids

The liquids used must be characterized such that the polar and dispersive components of their surface tensions are known. Classical liquids chosen in experiments are either polar as pure water and ethylene glycol or apolar as  $\alpha$ -bromonaphtalene (cf. Table 3.1).

**Table 3.1:** Surface tensions of various liquids.

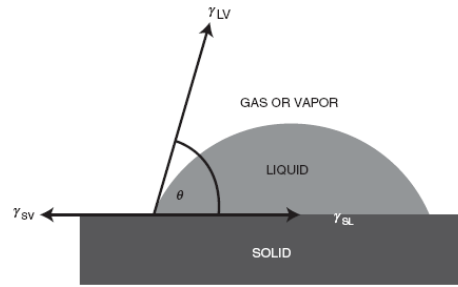
Liquids	$\gamma_L$ (mJ/m <sup>2</sup> )	$\gamma_L^d$ (mJ/m <sup>2</sup> )	$\gamma_L^{nd}$ (mJ/m <sup>2</sup> )	$\gamma_L^-$ (mJ/m <sup>2</sup> )	$\gamma_L^+$ (mJ/m <sup>2</sup> )
Water	72.75	21.75	51.00	25.20	25.50
Glycerol	64	34	30	3.92	57.4
Formamide	58.00	39.00	19.00	2.28	39.60
Ethylene Glycol	48.00	29.00	19.00	1.92	47.00
Diiodomethane	50.80	50.80	0.00	0.00	0.00
$\alpha$ bromonaphtalene	44.40	44.40	0.00	0.00	0.00

[Oss, 2006, 1994]

## 6.2.2 Surface Energy of Solids

### 6.2.2.1 Young-Dupré' Equation

The determination of the surface energy of a solid sample ( $\gamma_{SV}$ ) is difficult since there is no direct method to measure it. The result will remain an estimation of the actual value [Mykhaylyk et al., 2003]. In 1805, Young described the relation between the contact angle and the different surface tensions (Figure 3.24 and equation 3.19):



**Figure 3.24:** Vectorial equilibrium for a drop of a liquid resting on a solid surface to balance three forces.

$$\gamma_{SV} = \gamma_{SL} + \gamma_{LV} \cos \theta \quad (3.16)$$

$$\cos \theta = \frac{\gamma_{SV} - \gamma_{SL}}{\gamma_{LV}} \quad (3.17)$$

where  $\gamma_{LV}$  denotes the interfacial tension due to the liquid-gas surface,  $\gamma_{SL}$  refers to the interfacial tension due to the solid-liquid surface and  $\gamma_{SV}$  indicates the interfacial tension of the solid-gas surface.

In Young-Dupré equation, two parameters can be measured directly: the liquid surface tension ( $\gamma_{LV}$ ) and the contact angle ( $\theta$ ). The two other parameters ( $\gamma_{SV}$  and  $\gamma_{SL}$ ) have to be derived. The contact angle measurements give 3 informations:

- The affinity of a liquid to a solid surface: if water is used to measure the contact angle, one can deduce the hydrophobic (great angle) or hydrophilic (small angle) character of the surface.
- If several reference liquids are used, the surface energy of the solid can be calculated, discriminating between polar and dispersive components. The most common models used are the Good & Van Oss and the Owens & Wendt models.
- The measure of the hysteresis between advancing angle and receding angle give informations on non homogeneity of the surface (roughness , contamination, etc.).

Theoretically, the Young-Dupré' equation is correct, but as it is based on ideal surfaces (homogeneous, pure, smooth), it is experimentally difficult to obtain. Considering this, a range of contact angles is obtained, depending on the smoothness of the surface and with a maximum and minimum possible value. The difference between the maximum contact angle ( $\theta_A$ ) and the minimum or receding contact angle ( $\theta_R$ ) is referred as the contact angle hysteresis ( $\Delta\theta = \theta_A - \theta_R$ ) [Possart and Kamusewitz, 2003].

### 6.2.2.2 Model of Owens-Wendt : Two Components Theory

Owens and Wendt [1969] considered that the surface energy is expressed in the form:

$$\gamma_S = \gamma_S^d + \gamma_S^p \quad (3.18)$$

with  $\gamma_S^d$  dispersive (or apolar) and  $\gamma_S^p$  polar (or non-dispersive) components.

Following the work that Fowkes pioneered in 1962, [Fowkes, 1962] the different surface energy of solid ( $\gamma_{SV}$ ,  $\gamma_{SL}$  and  $\gamma_{LV}$ ) can be split into two components: polar and dispersive fractions. Based on the assumption that only the same type of interaction (polar and/or dispersive) can occur between both phases. Owens and Wendt [1969] proposed the following equation:

$$\gamma_{12} = \gamma_1 + \gamma_2 - 2[(\gamma_1^d \cdot \gamma_2^d)^{1/2} + (\gamma_1^p \cdot \gamma_2^p)^{1/2}] \quad (3.19)$$

where  $\gamma_{12}$  is the surface energy of contact region between phase 1 and 2,  $\gamma_1$  ( $\gamma_2$ ) is the surface energy of the phase 1 (phase 2) and the exponents  $\gamma^d$  ( $\gamma^p$ ) correspond to the dispersive fraction and the polar fraction of the surface energy.

The force needed to extend the contact region between two immiscible phases relies on the force needed to extend each phase separately minus the interaction that they have with each other. Thermodynamically this equation can be interpreted as follows: each substance is seeking for the lowest energy possible. Since a surface has a higher energy state, each phase tries to reduce its surface area. When two immiscible liquids are combined, a contact region is formed between both. To extend this region, energy is needed. This energy depends on the energy needed to break the bindings of each phase separately minus the interactions they have with each other. This negative sign is explained since, by creating two new surfaces, new interactions between the different phases will occur, causing a lower energy and therefore a more favourable state. Considering equation 3.19, the following equation can be set up in order to describe the interaction of a solid sample with a liquid:

$$\gamma_{SL} = \gamma_{SV} + \gamma_{LV} - 2[(\gamma_{SV}^d \cdot \gamma_{LV}^d)^{1/2} + (\gamma_{SV}^p \cdot \gamma_{LV}^p)^{1/2}] \quad (3.20)$$

where  $\gamma_{SL}$  = solid-liquid surface energy,  $\gamma_{SV}$  = solid-vapour surface energy,  $\gamma_{LV}$  = liquid-vapour surface tension,  $\gamma^d$  = dispersive fraction and  $\gamma^p$  = polar fraction of the surface energy.

This equation is, next to the Young-Dupré' equation, the second equation needed for calculating the surface free energy of a solid sample [Rudawska and Jacniacka, 2008; Owens and Wendt, 1969; Fowkes, 1962]. By combining equations 3.20 and 3.17, a final mathematical statement can be made in order to calculate the surface energy of a solid sample ( $\gamma_{sv}$ ). [Rudawska and Jacniacka, 2008; Mykhaylyk et al., 2003]:

$$\gamma_{SV} = \gamma_{SL} + \gamma_{LV} \cos \theta \Rightarrow \gamma_{SV} + \gamma_{LV} - \gamma_{SL} = \gamma_{LV} (\cos \theta + 1) \quad (3.21)$$

$$\gamma_{SV} + \gamma_{LV} - \gamma_{SL} = 2[(\gamma_{SV}^d \cdot \gamma_{LV}^d)^{1/2} + (\gamma_{SV}^p \cdot \gamma_{LV}^p)^{1/2}] \quad (3.22)$$

By substituting value from equation 3.21 into equation 3.22, we get:

$$\gamma_{LV} (\cos \theta + 1) = 2[(\gamma_{SV}^d \cdot \gamma_{LV}^d)^{1/2} + (\gamma_{SV}^p \cdot \gamma_{LV}^p)^{1/2}] \quad (3.23)$$

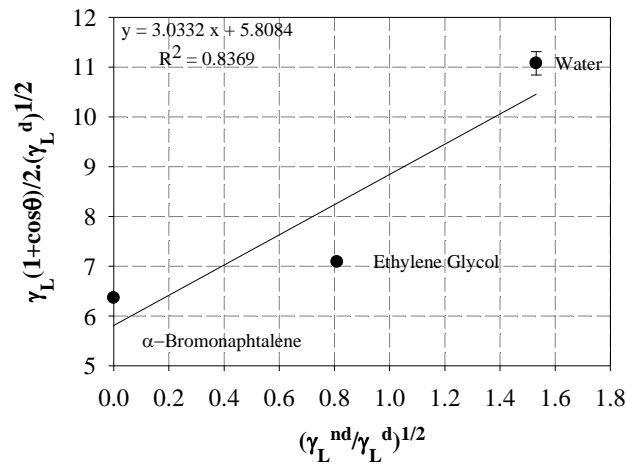
where  $\gamma_{LV}$  = liquid-vapour surface energy,  $\theta$  = contact angle,  $\gamma_{sv}$  = solid-vapour surface energy,  $\gamma^d$  = dispersive fraction and  $\gamma^p$  = polar fraction of the surface energy.

By using a liquid that only interacts on a dispersive level (diiodomethane or  $\alpha$ -bromonaphtalene) with other phases, equation 3.23 can be simplified by excluding the polar interactions. The liquid vapor surface energy and the contact angle can be directly measured. The dispersive tension of the liquid vapour surface energy ( $\gamma_{LV}^d$ ) of the diiodomethane is equal to the total liquid vapour surface energy ( $\gamma_{LV}$ ) since the polar interactions are null (cf. Table 3.1). Consequently, the only unknown parameter ( $\gamma_{sv}^d$ ) can be calculated.

Extrapolating the  $\gamma_{sv}^d$  value and using a second liquid having dispersive and polar interactions with the solid sample, the only unknown parameter ( $\gamma_{sv}^p$ ) can be determined. The sum of both calculated fractions of the solid material ( $\gamma_{sv}^p$  and  $\gamma_{sv}^d$ ) gives the total surface free energy of a solid sample [Wu, 2001;

Andrade, 1985]. The Liquid-Vapour tension and the Solid-Vapour energy are generally approximated by the liquid tension and the surface energy.

Selected liquids need to have suitable properties in order to interact in the best possible way to determine the surface energy. Firstly, the liquids have to carry a wide range of intermolecular interactions from polar to apolar. In addition, the liquid surface tension has to be higher than the solid surface energy: the working forces on the surface of the solid sample are superior to the forces needed to create the drop, resulting in a high wettability. The latter makes it impossible to determine a contact angle [Mykhaylyk *et al.*, 2003]. By drawing  $\gamma_L(1 + \cos\theta)/(\gamma_L^d)^{1/2}$  versus  $(\gamma_L^{nd})^{1/2}/(\gamma_L^d)^{1/2}$ , the slope will be  $(\gamma_S^{nd})^{1/2}$  and the origin intercept will be  $(\gamma_S^d)^{1/2}$  (cf. Figure 3.25).



**Figure 3.25:** Example of determination of surface energy components of a blend PLGA + 5 % HA with the Owens-Wendt' method.

In this model, the measure of contact angle between two different liquids and the solid is necessary to calculate the surface energy. However, it is an approximation to consider that the solid surface energy is the simple geometrical mean of  $\gamma_S^p$  and  $\gamma_S^d$  (equation 3.15). This approximation can not predict the behaviour of polar polymer in aqueous environment.

### 6.2.2.3 Model of Good-Van Oss : Three Components Theory

In the model of Good-Van Oss [Owens and Wendt, 1969], surface energy is written:

$$\gamma_S = \gamma_S^d + 2\sqrt{\gamma_S^+ \cdot \gamma_S^-} \quad (3.24)$$

where  $\gamma_S^d$  is the dispersive component and  $\gamma_S^+$  and  $\gamma_S^-$  are the acid-base components respectively.

Van Oss *et al.* [1988] proposed the so-called Lifshitz–Van der Waals approach in which the total surface tension is divided in Lifshitz–Van der Waals ( $\gamma^{LW}$ ) and acid-base ( $\gamma^{AB}$ ) components. The last one is decomposed in acid ( $\gamma^+$ ) and basic ( $\gamma^-$ ) components. Young-Dupré equation can be expressed as:

$$(1 + \cos \theta)\gamma_L = -\Delta G_{SL}^{LW} - \Delta G_{SL}^{AB} \quad (3.25)$$

$$\text{where } \Delta G_{SL}^{LW} = -2(\gamma_S^{LW} \cdot \gamma_L^{LW})^{1/2} \quad (3.26)$$

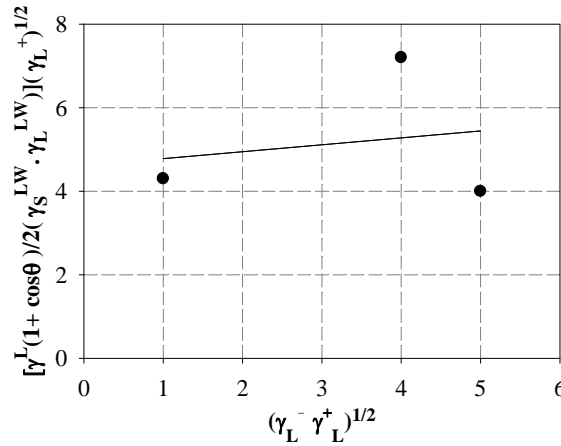
We may define the AcidBase free energy of interaction between two substances in the condensed state [van Oss *et al.*, 1987].

$$\Delta G_{SL}^{AB} = -2(\gamma_S^+ \cdot \gamma_L^-)^{1/2} - 2(\gamma_S^- \cdot \gamma_L^+)^{1/2} \quad (3.27)$$

The expression used in this model is thus:

$$(1 + \cos \theta) \gamma_L = 2 \cdot \sqrt{\gamma_S^{LW} \cdot \gamma_L^{LW}} + 2(\sqrt{\gamma_S^+ \cdot \gamma_L^-} + \sqrt{\gamma_S^- \cdot \gamma_L^+}) \quad (3.28)$$

By drawing  $[\gamma_L \cdot (1 + \cos \theta) / 2 - (\gamma_S^{LW} \cdot \gamma_L^{LW})] (\gamma_L^+)^{1/2}$  versus  $(\gamma_L^- / \gamma_L^+)^{1/2}$  the slope will be  $(\gamma_S^+)^{1/2}$  and the origin intercept will be  $(\gamma_S^-)^{1/2}$ . An example of application of the model is presented in Figure 3.26.



**Figure 3.26:** Example of determining the surface energy components with Good-Van Oss' method for pure P<sub>L</sub>LA.

By depositing a drop of three different liquids, one can obtain the surface energy of the solid. This method thus requires the use of 3 liquids of reference with given  $\gamma_L^{LW}$  (Lifshitz-van der Waals) and  $\gamma^{AB}$  acid-base components. The  $\gamma_L^{LW}$  component is generally approximated with the  $\gamma_L^{nd}$  component [Zenkiewicz, 2007a, 2007b; Wu, 2001; Van Oss et al., 1988; van Oss et al., 1987; Owens and Wendt, 1969; Neumann et al., 1974].

## 7 Designs of Experiments

The aim of the experimental designs is to investigate the possible cause-and-effect relationship by manipulating one independent variable to influence the other variable(s) in the experimental group, and by controlling the other relevant variables, and measuring the effects of the manipulation by some statistical means. By manipulating the independent variable, the researcher can see if the treatment makes a significant difference on the factors.

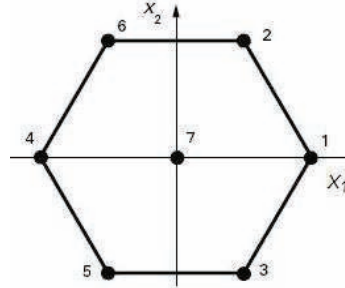
### 7.1 Modelization Plans: Doehlert's Design

Doehlert's designs are quadratic plans with some interesting properties, i.e., they can be built upon and extended to other factor intervals. These designs allow the estimation of all main effects, all first-order interactions and all quadratic effects without any confounding effects [Eriksson, 2008].

Geometrically, the Doehlert' designs are polyhedrons based on hyper-triangles with a hexagonal structure, in the simplest case (cf. geometry of the two factors presented in Figure 3.27). This means they have uniform space-filling properties with an equally spaced distribution of points lying on concentric spherical shells. With the Doehlert' plan of two variables; the model chosen *a priori* is the second degree. In the case of two variables, the Y response depends on the reduced variables  $X_1$  and  $X_2$  according to the equation:

$$Y = a_0 + a_1X_1 + a_2X_2 + a_{12}X_1X_2 + a_{11}X_1^2 + a_{22}X_2^2 \quad (3.29)$$

where  $a_0$  is the average value of the centre of the domain,  $a_1$  and  $a_2$  are the effects of the two factors,  $a_{12}$  represents the interaction between the two factors and  $a_{11}$  and  $a_{22}$  are the quadratic effects of both variables. The five levels of factor 1 correspond to lines 2 to 8 in Table 3.2.



**Figure 3.27:** Distribution of experimental points for a Doehlert's design of 2-variables.

**Table 3.2:** Matrix of experiments X.

I	$X_1$	$X_2$	$X_1X_2$	$X_1^2$	$X_2^2$
1	1.000	0.000	0.000	0.000	0.000
1	0.500	0.866	0.433	0.250	0.750
1	-0.500	0.866	-0.433	0.250	0.750
1	-1.000	0.000	0.000	1.000	0.000
1	-0.500	-0.866	0.433	0.250	0.750
1	0.500	-0.866	-0.433	0.250	0.750
1	0.000	0.000	0.000	0.000	0.000

The multi-linear regression analysis of the experimental points controls these five coefficients minimizing the error adjustment of the mathematical model. The relationship matrix that correlates these factors together in the vector of coefficients  $\hat{a}$  to the vector of response  $\mathbf{Y}$  is given by

$$\hat{a} = (\mathbf{X}^t \cdot \mathbf{X})^{-1} \cdot \mathbf{X}^t \cdot \mathbf{Y} \quad (3.30)$$

where  $\mathbf{X}$  is the matrix of experiments defined in Table 3.2.

The numerical values of the coefficients of the vector  $\hat{a}$ , determine what factors and interactions are the more influent. To clarify whether coefficients are significant or not, we calculated the experimental standard deviation  $\sigma_S$  from three tests at the centre of the experimental domain. The standard deviation on the various coefficients can be determined from the relationship:

$$\Delta \hat{a} = \sigma_S (\text{diagonal of the dispersion matrix})^{1/2} \quad (3.31)$$

in which the dispersion matrix  $(\mathbf{X}^t \cdot \mathbf{X})^{-1}$  represents the inverse matrix of the product of the transposed matrix of  $\mathbf{X}$  by  $\mathbf{X}$ . Each coefficient  $a_i$  can be considered significant, if it has a numeric value greater than three times its uncertainty  $\Delta a_i$ .

## 7.2 Screening Plans: Taguchi' Design

The method, created by Taguchi [Roy, 1990], aims to simplify the implementation of experimental designs. It offers a collection of tables and tools to help to choose the most appropriate table. Collection of Taguchi' tables are actually three types of information related to each other:

- Taguchi' Tables: they specify the content of the matrix of experience, and were chosen based on the number of terms, factors, interactions.

- Linear Graph: they are used to verify that the selected table is equipped to represent the problem (can you represent all factors and all interactions) and specify how to assign the columns of the Taguchi' table.
- Interaction Table: it allows to precise in which columns are the influent interactions.

When a non linearity of the response is assumed, there are tables of experiments configured according to a finite number of experiments. For example, the chosen table  $L_9$  ( $3^4$ ) need to perform nine experiments to study 4 factors at 3 levels. In Taguchi' notation, it is important to note that the three levels do not correspond to the American notation (-1, 0, 1) but an increasing variation (1, 2, 3). By consulting tables which respect the principle of orthogonality, which means that all factors vary evenly on each level (cf. Table 3.3).

Table 3.3: Table Taguchi  $L_9$ .

Experiment Nr	1	2	3	4
1	1	1	1	1
2	1	2	2	2
3	1	3	3	3
4	2	1	2	3
5	2	2	3	1
6	2	3	1	2
7	3	1	3	2
8	3	2	1	3
9	3	3	2	1

To determine the effect of one factor, we calculate the average response of each factor in a given level (e.g.  $a_1$  corresponds to the demi-difference between the average responses when the A factor is at the up and down levels) and plot the evolution of this factor when it goes from low (1) to high (3). The variation factor between the extreme levels 1-3 will be aware of the influence factor (little variation for a neglectable factor) and to compare the effects of each factor.

Similarly, interactions between factors are obtained by calculating the system response when the factors are in certain levels (for example  $a_1b_1$  it counts only the values corresponding to low levels of two factors A and B). By convention, the interaction effects are taken equal to half the difference between the two effects.

## 8 Conclusion

The purpose of this chapter was to describe the analytical methods that are available for detecting, and/or measuring, and/or monitoring surface, physical and mechanical properties of the polymers and foams. The main intention was to identify well-established methods that are used as standard methods of analysis. The glass transition temperature of the materials used is determined by the DSC principle, which further gives results about the physical and chemical nature of the polymeric material. Granulometry gives particle morphology of polymer, fillers and modifier used. Brazilian test is a parameter to calculate the structural aspects of the raw material. Molecular weight of the polymer is determined by taking into account intrinsic viscosity. Scanning electron microscopy, image analysis, mercury porosimetry, microtomography, compression test provides information about the morphology and structural properties of the end product. Experimental designs were used with the aim of minimizing number of experiments when we are confronted to a great number of variables. The experiment, based on a statistic plan that was inferred from research, must be repeatable.

# Chapter 4

## Experimental Procedures and Protocols for Analyses

*This chapter will be devoted to the description of various experimental procedures and techniques applied for the raw materials and products used in the entire thesis. Procedures such as mixing of materials, pre-grinding by knife mill, co-grinding by tumbling ball mill and preparation of pellets by wet and dry methods will be laid down step by step. The specific conditions of various analysis techniques used to characterize the properties of the raw materials, intermediate products and final products will be presented. Procedures for laser granulometry to verify particle size, scanning electron microscopy (SEM) for observing the pore morphology and SCION<sup>®</sup> Image analysis for pore structure and their distribution will be explained extensively. Finally, Brazilian test to identify the mechanical properties of the raw materials and compression test will be revealed with the help of schematic diagrams.*

### 1 Procedure for Size Reduction

Reduction of size of polymers and composites was realized in the laboratory: "Laboratoire de Génie Chimique". Biopolymers, adjuvants and fillers mixtures were prepared by two different methods, called dry and wet method. Some initial steps were common for both methods, such as size reduction, co-grinding and mixing.

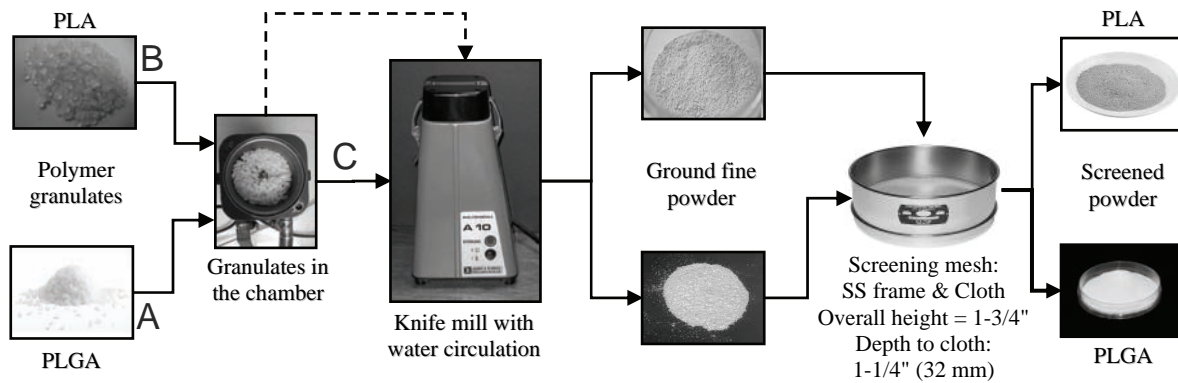
#### 1.1 Size Reduction

##### 1.1.1 Size Reduction by Knife Mill

Since some polylactides were supplied in the form of granules of one to several millimeters or in the form of long fibres, they were first fragmented and reduced to powders or small fibres with a laboratory knife mill (Janke and Kunkel<sup>™</sup> IKA A-10 (115 Volts), Labortechnik, Staufen, Germany).

The mill in Figure 4.1 was used for rapid, high-speed grinding of small samples from 10 to 25 gms. This apparatus can grind samples down to few hundreds of  $\mu\text{m}$  in seconds depending upon the nature of material. Stainless steel or hard-faced blade rotates at speeds up to 20000 rpm. Temperature is maintained by means of built-in heat exchangers and the control panel has an overload protection reset button and a pilot light. Tubing connections 6.4 mm on the cover and housing accept tubes for circulating water.





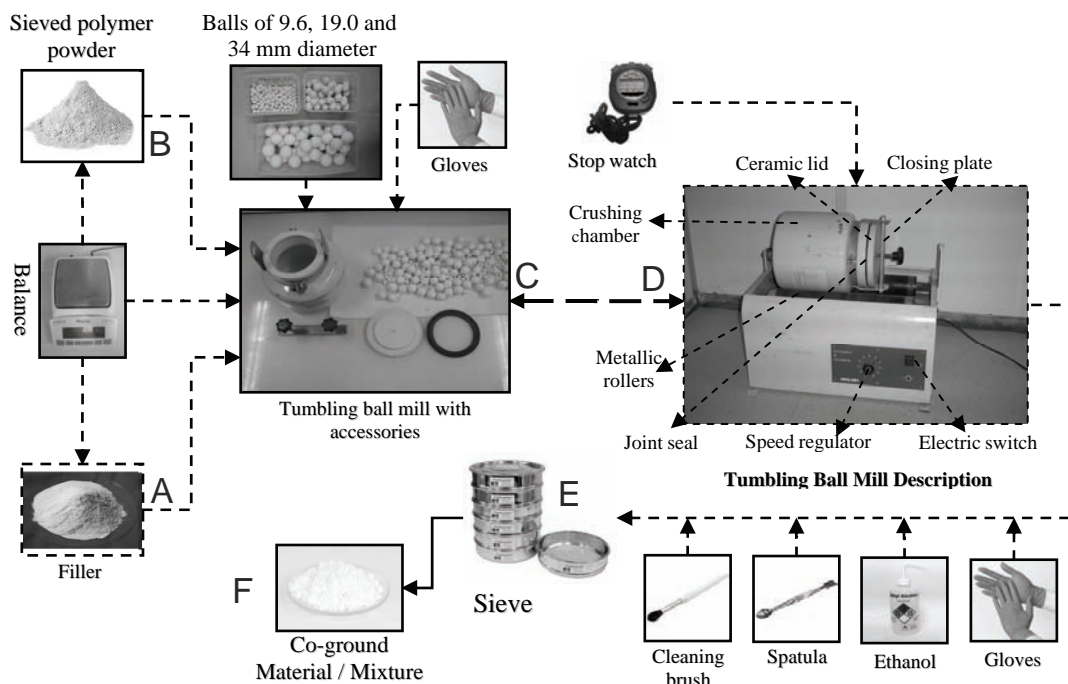
**Figure 4.1:** Poly lactide granulates size reduction by knife mill.

Few tens of grams of the chosen polymers were introduced in the knife mill which was then closed. Cold water was allowed to circulate in the mill double jacket. Copolymers such as PLGA<sub>85:15</sub> (PLG , PLG 8531, LG 857 S, ... ) are granules, that must be initially pre-ground in batches, in the knife mill for a specified time that more than 95% of the ground material is recovered. Each material was ground in the knife mill for alternative time On/Off of 60 s to avoid melting or degradation. Times required to recover 95% of the initial polymer depends on its inherent viscosity. Then, the pre-ground product was recovered and sieved according to the procedure presented.

Waxes used were pre-ground in knife mill but only for 30 s. The wax obtained was very fine that 100% of wax removed after pre-grinding passed through 500 mesh sieve. This wax will be utilized latter on as porogen for preparing a mixture with polymer to obtain better scaffolds.

### 1.1.2 Tumbling Ball Mill Grinding

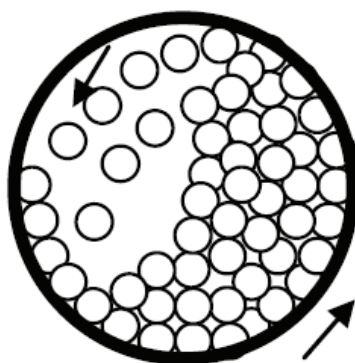
The pre-ground and sieved product was ground in a tumbling ball mill Prolabo<sup>®</sup> (cf. Figure 4.2) to several tens of micrometers, value of the size that could not be reached with the knife mill. The tumbling ball mill has a grinding chamber with a capacity of 5 liters, a height of 32 cm and a diameter of 27 cm.



**Figure 4.2:** Milling process in tumbling ball mill.

The chamber, a cylindrical shape, is closed with a ceramic lid fixed by a stainless steel bar having two screws. A rubber gasket, placed underneath the ceramic jar lid to ensure the tightness of the system. High purity Alumina ( $\text{Al}_2\text{O}_3$ ) ceramic balls were used as grinding media. Three diameters (5.5, 9.3, and 17.5 mm) were used to be suitable for all particle sizes. Their respective proportions were respectively set at  $\frac{3}{4}$ ,  $\frac{1}{8}$ , and  $\frac{1}{8}$  and in volume. We used a ball filling rate of 20% of the volume of the chamber. The product filling rate was set at 10% of interstitial volume between the balls.

The process of dry grinding begins when one places the filled jar on the rotating rolls of the mill. Speed rotation is set at  $100 \text{ rpm}^{-1}$  and represents 75% of the critical speed, to obtain a cataract movement of grinding media (cf. Figure 4.3). The critical velocity is the rotation speed of the grinding chamber from which the centrifugal force imposes a permanent veneer of balls against the wall.



**Figure 4.3:** Cataract movement of grinding media.

Different milling times were applied as per requirement of the material and experiments. After grinding the material is highly electrostatic so ethanol was sprayed in milling chamber to collect the fine particles stuck with the walls of chamber, then the whole product was removed from the chamber and kept at cool temperature for further analyses and uses.

## 1.2 Sieving of Ground Material

The product obtained from knife mill or ball mill is powder with particles having a wide range of diameter. To make pellets from the pre-ground fibres and ground powders, it is necessary to have homogeneous particles. Sieves with different mesh sizes were used (cf. Table 4.1 and Figure 4.4). Manual vibration was done for 7 ~ 10 minutes to collect the sieved powder.

**Table 4.1:** Sieving mesh for different powder particles.

Mesh Size	Sieve
125 $\mu\text{m}$	AFNOR NF ISO 3310
250 $\mu\text{m}$	ASTM E11#
400 $\mu\text{m}$	AFNOR NF ISO 3310
500 $\mu\text{m}$	AFNOR NF ISO 3310
600 $\mu\text{m}$	ASTM E11#
800 $\mu\text{m}$	AFNOR NF ISO 3310

The material left on 600 and 800 mesh due to large particle size were knife mill again to reduce the particle size. This material was again sieved by using appropriate sieve. The sieved powder was further used for making pellets by using the hydraulic press.



Figure 4.4: AFNOR and ASTM 3 1/2 in diameter sieves.

### 1.3 Mixing of Polymer Powder with Fillers

#### 1.3.1 Simple Mixing of Polymer Powder with Fillers

After obtaining polymer powder of the desired particle size, it was mixed with the filler by using a magnetic stirrer. The polymer powder and filler were weighed and placed in a plastic jar along an appropriate size (1, 2, 3 cm) magnetic bar. The powder was mixed for 10 minutes for perfect mixing. Schematic flow sheet of the procedure is shown in Figure 4.5.

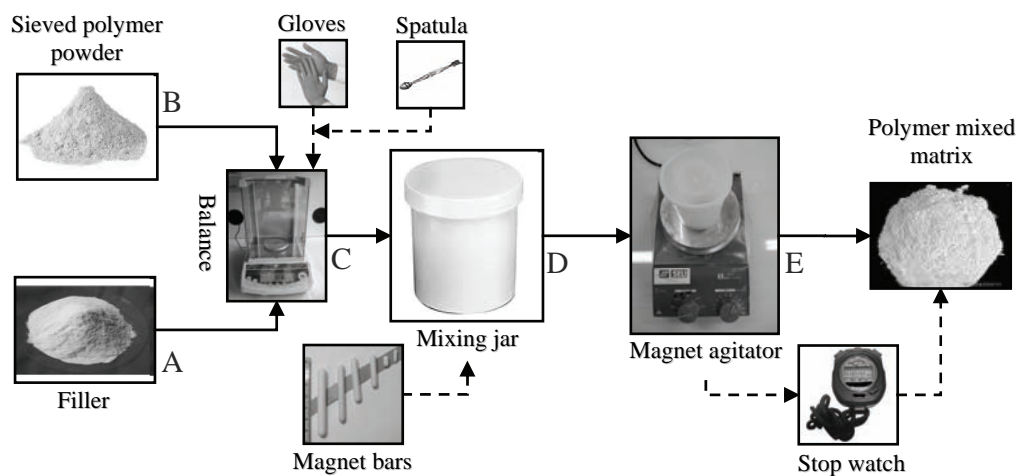


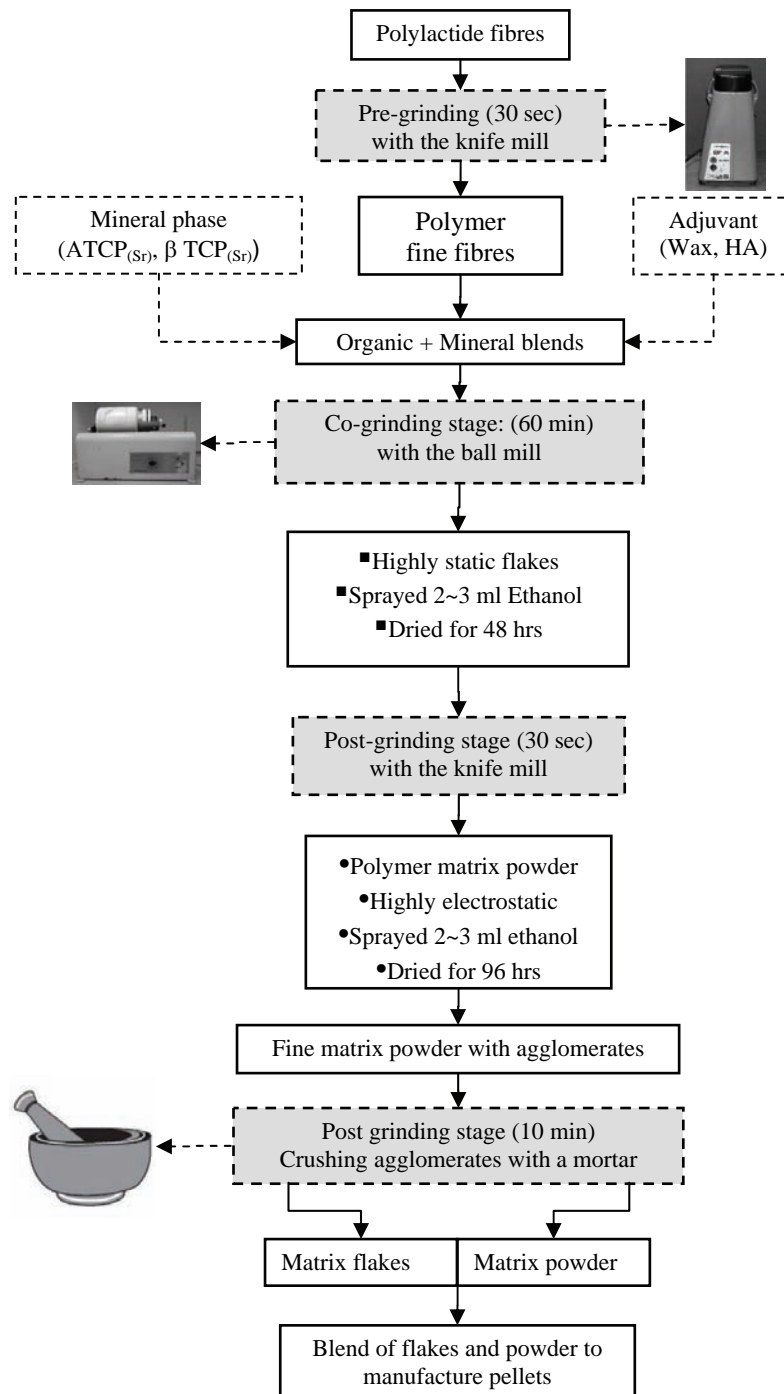
Figure 4.5: Magnetic stirrer mixing for composite materials.

#### 1.3.2 Co-grinding in the Tumbling Ball Mill

Multi step processing has been used for fibrous polymers. First, the polymer fibres were reduced into small fibres using knife mill. Then co-grinding process was applied when polymers were under a powder form. Thus, the polymer powder and the filler particles and/or adjuvants (wax, hyaluronate acid) were introduced in the chamber of the tumbling ball mill in proportion defined by chosen design of experiment. The same procedure as the one presented in section 1.1.2 for a single product was then applied.

Finally, agglomerates may be found after drying and it was necessary to post-ground the composites and to crush the agglomerates. 30 sec knife mill grinding followed by 10 min in the mortar were

applied. The schematic representation of the preparation method is given in the Figure 4.6. Ethanol was used for reducing electrostatic charge at each grinding step during the process.



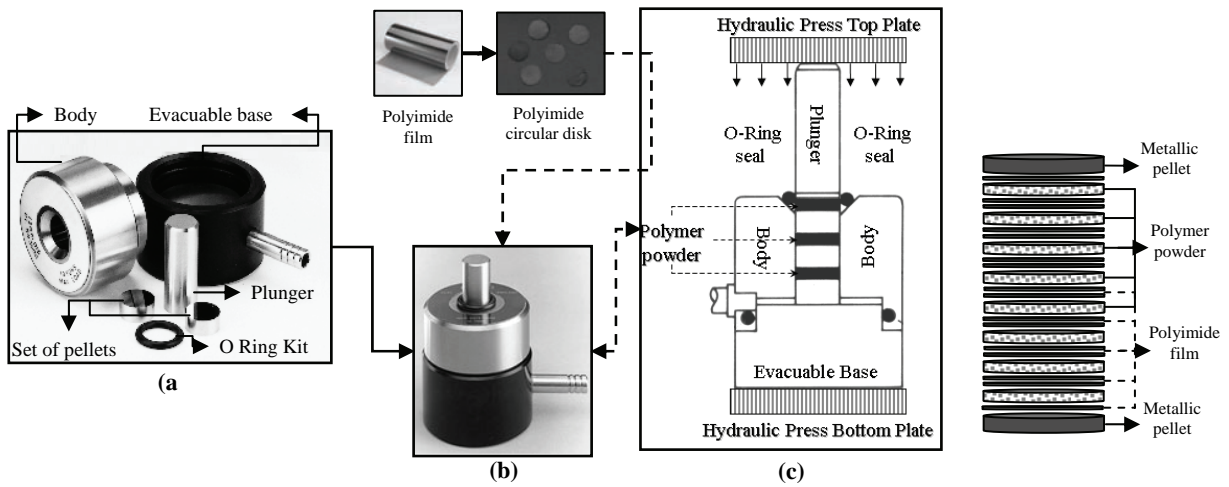
**Figure 4.6:** Multistep size reduction of composite.

## 1.4 Preparation of Pellets by Dry Method

### 1.4.1 Evacuable Pellet Die

Evacuable pellet dies were used to produce circular pellets of 13 mm in diameter as standard. All parts were manufactured from hardened stainless steel, and surfaces that come in contact with the sample were highly polished. Each pellet die comprises an evacuable base (50.8 mm base diameter), body, plunger (34.8 mm height), set of pellets, extractor ring, and O Ring Kit. As shown in Figure 4.7, polyimide film is

also used during the pellet forming process. Without using polyimide film some of the polylactides stick on the stainless steel plunger at elevated temperature. Moreover to make multiple pellets in one batch the pellets are separated by polyimide.

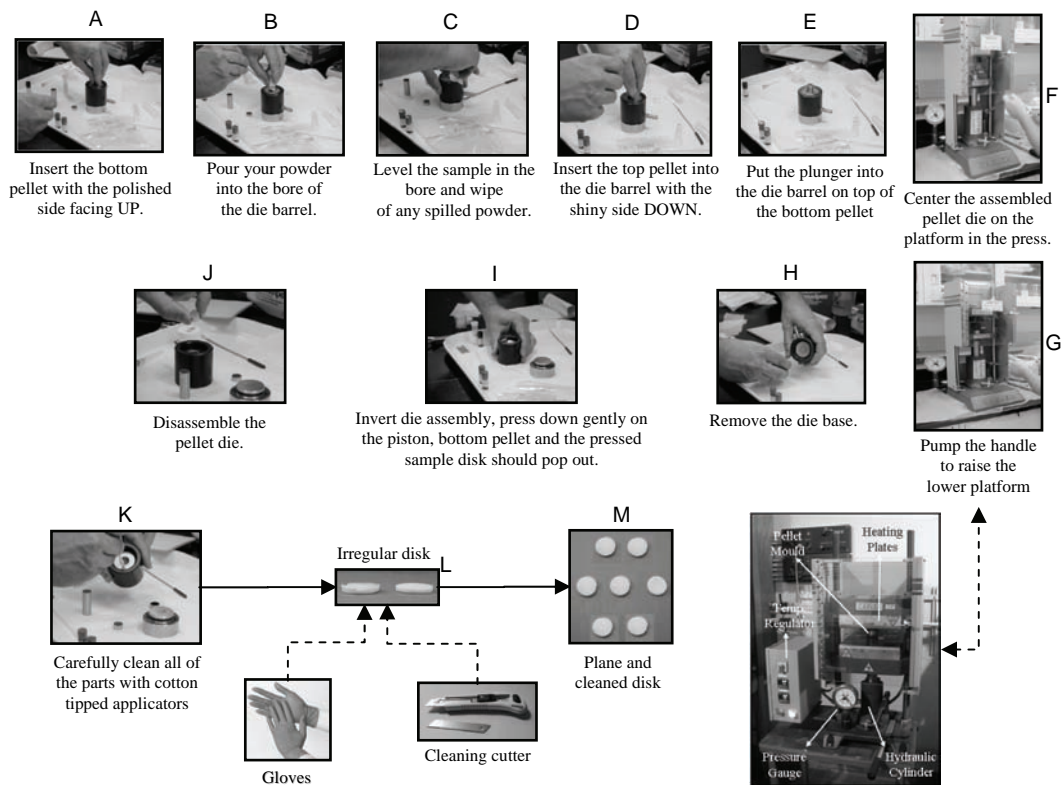


(a) Evacuatable pellet die accessories (b) Assembled pellet die (c) Schematic representation of assembled mould (d) Cross sectional view of multi-pellets/batch.

**Figure 4.7:** Schematic diagram to produce pellets in semi-industrial quantities.

### 1.4.2 Procedure to Prepare Pellets

The procedure to process pellets is described stepwise as under shown in **Figure 4.8**.



**Figure 4.8:** Schematic representation to process pellets by using hydraulic press.

#### 1.4.2.1 Preparation of the Die

- The base must be placed on the bench top. It must be carefully checked that the bottom O-Ring seal is properly positioned in its groove. The body is assembled on base.
- One of the metallic pellets was carefully placed, polished face up and a polyimide circular film was placed in the bore of the body. The evacuation tube was connected to a vacuum pump capable of providing a pressure of less than two mm Hg. If vacuum setup is not available then manual CARVER™ hydraulic press is used for compression.

#### 1.4.2.2 Loading the Die

- Using a funnel, the powder mixture is poured into the bore of the body. The side of the die is tapped lightly to be sure that the powder is evenly distributed. Completely even powder distribution is accomplished by inserting the plunger into the bore and rotating it lightly a few times. The plunger is then withdrawn slowly.
- A second metallic pellet is inserted, polished face down, into the upper half of the bore followed by the plunger. If more than one pellet is required, a polyimide film is put on the metallic pellet and then powder on it. The procedure is repeated till 3 sample pellets are required. One must be sure that the top O-Ring seal is in place around the plunger and properly seated in the chamber.

#### 1.4.2.3 Processing the Pellets

- The die assembly must be placed in the hydraulic press. Without applying pressure, the die must be evacuated for 2 - 5 minutes (depending on the dryness of the sample).
- With continued evacuation, 150 bars pressure is applied to the die for 20 minutes and the temperature (45–60°C) is maintained as per requirement.
- The pressure is released slowly and the vacuum removed.

#### 1.4.2.4 Removing the Pellets

- The base is removed from the body leaving the plunger in position.
- The assembly is inverted on the plate of the hydraulic press and the polycarbonate ring is placed on the centre of the body opposite the plunger end. Using the hydraulic press, pressure is applied slowly until the plunger moves the lower pellet and disc clear of the bore.

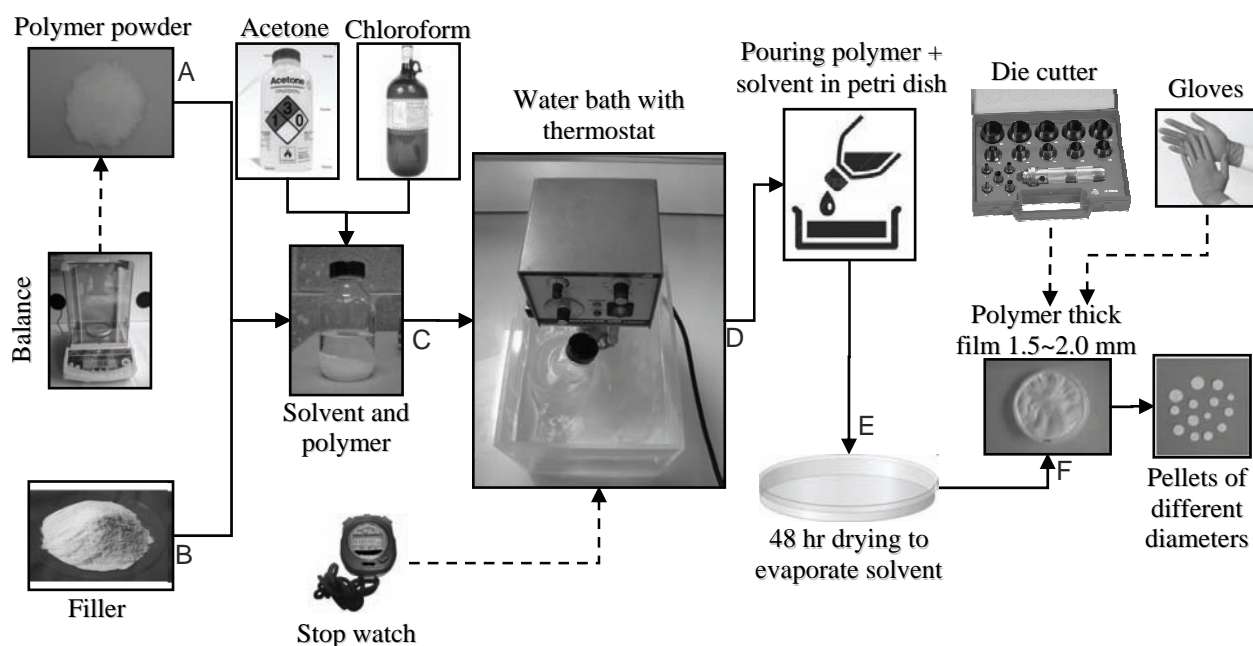
In the preliminary experiments polymer powders of ~ 0.150 g of weight have been moulded by compression at 150 bars and 60°C for 20 minutes. Our compression moulding setup has initially allowed 3 pellets of polymer to be prepared simultaneously. Finally, pellets have a thickness of 0.9 – 1.1 mm. In order to prepare pellets in bulk quantity, a modified procedure is further adopted. We prepare 12, 15 or 18 pellets, by varying the weight of polymer powder taken into account, in one batch by using polyimide film as shown in Figure 4.9-d.

### 1.5 Preparation of Pellets by Wet Method

In the wet method, pellets have been prepared by dissolving composite powder in a good solvent (acetone or chloroform). Polymer and filler powder have been ground by knife mill, tumbling ball mill and then sieving as described earlier. The solution mixture is heated for minimum 10 minutes in a water bath at temperature 5°C above the polymer or composite  $T_g$ . When the solution mixture becomes homogenous, it is



poured into a petri dish. The petri dish is kept at room temperature for 48 hours, so that the solvent may evaporate completely. After complete drying, thick film of polymer matrix is peeled off from the petri dish. By using die cutter pellets of the polymer matrix of required diameter (8, 10, 12 and 14 mm) are processed (cf. Figure 4.9).



**Figure 4.9:** Schematic representation of processing pellets by wet method.

## 2 ScCO<sub>2</sub> Foaming Process

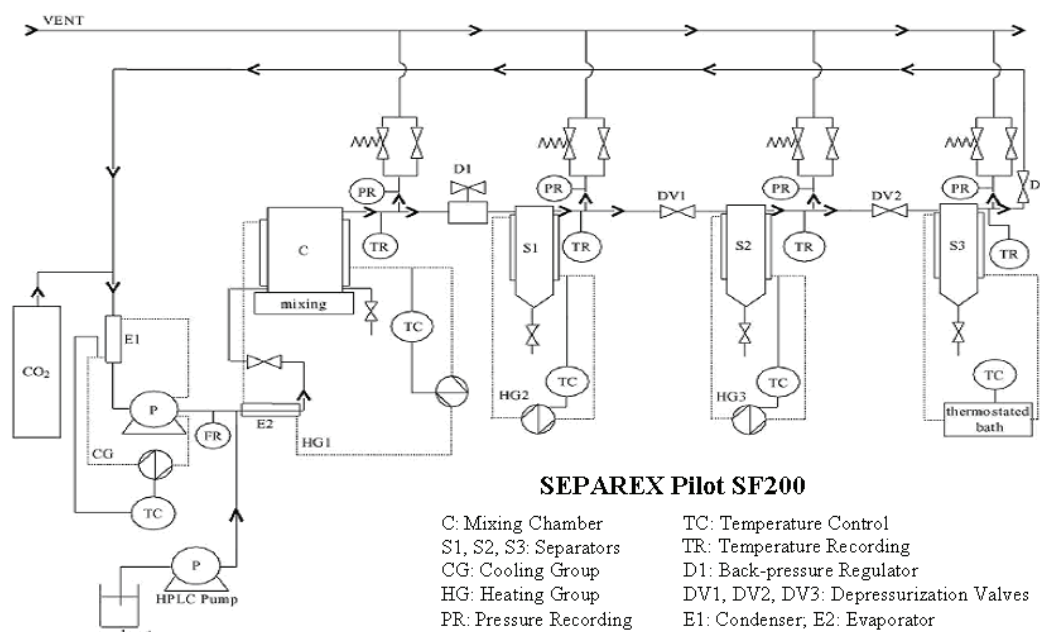
Foaming of polymers and composites was processed in two different laboratories: the "Laboratoire de Génie Chimique" and the "Laboratoire d'Automatisme et d'Analyse des Systèmes" of Toulouse.

### 2.1 SEPAREX™ SF200 scCO<sub>2</sub> Pilot Plant

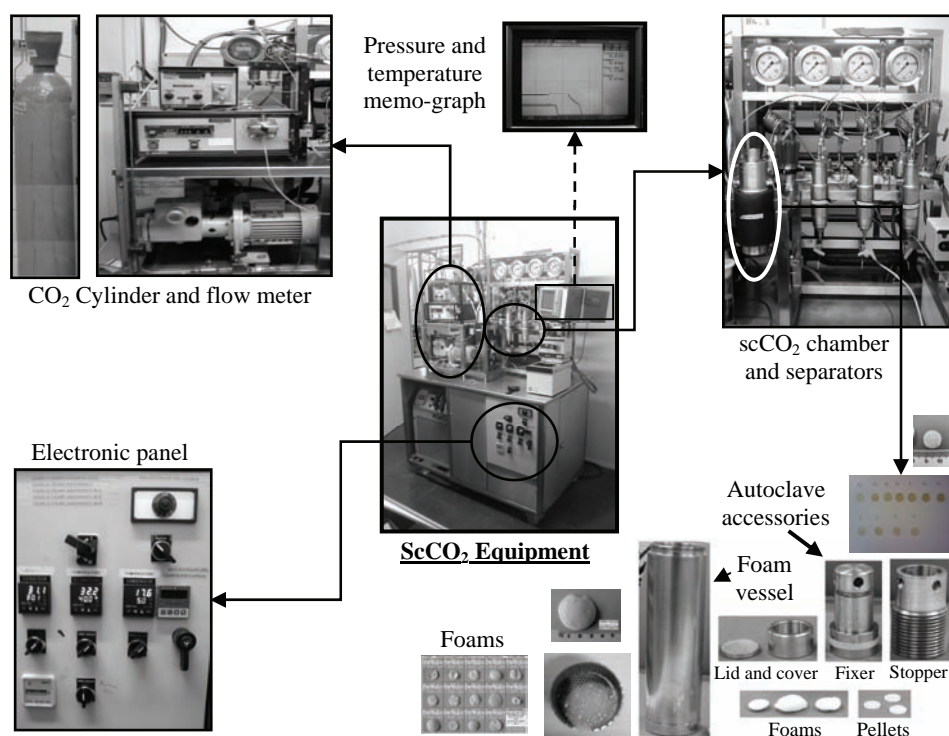
#### 2.1.1 Experimental Device

Runs were first carried out in a SEPAREX SF200 pilot (Separex™ Company, Nancy, France) represented in Figure 4.10 and Figure 4.11. Briefly, this apparatus is composed of a 200 mL extractor chamber, which is used for foaming process in which CO<sub>2</sub> is being injected. Basically this is a setup for extraction purpose. Indeed a metallic vessel was placed inside the extractor, in order to reduce its volume from 200 to 20 mL. Further a Teflon roll is also inserted in the metallic roll so that pellets may not fall during the foaming process. A cascade of three 15 mL cyclonic separators is connected to the mixing chamber outlet. Pressure in the mixing chamber is adjusted by a backpressure regulator and, in each separator, by depressurization valves. Sub-cooled liquid CO<sub>2</sub> is pumped by a volumetric membrane pump (Milton Roy™, maximum 5 kg/h), then heated until the desired temperature and continuously introduced into the mixing chamber. Experiments can be carried out in open-loop or closed-loop configuration, in which case, after condensation, CO<sub>2</sub> is recycled to the pump. Temperatures and pressures are controlled in each unit of the pilot, pressure being limited to 300 bars and temperature around 333 K. Before starting an experiment, the pilot is filled with CO<sub>2</sub> at bottle pressure (about 5.5 MPa) and air is flashed out.





**Figure 4.10:** SEPAREX™ Pilot SF200 process flow diagram.



**Figure 4.11:** Details of equipment (SEPAREX™ Pilot SF200).

Polymer/composite pellets are placed inside the autoclave chamber. Then, CO<sub>2</sub> is pumped and heated into the contactor. Temperature of CO<sub>2</sub> is adjusted by the heating fluid circulation in the jacket of the mixing chamber. At the outlet, the CO<sub>2</sub> undergoes three successive depressurizations. Each depressurization stage is composed of a valve and a cyclonic separator with a heating jacket. Temperature and pressure sensors are placed at each vessel outlet and measured values are recorded by a digital recorder (Memo-graph, Endress plus Hauser™). Finally CO<sub>2</sub> is depressurized, by back pressure regulating valves and

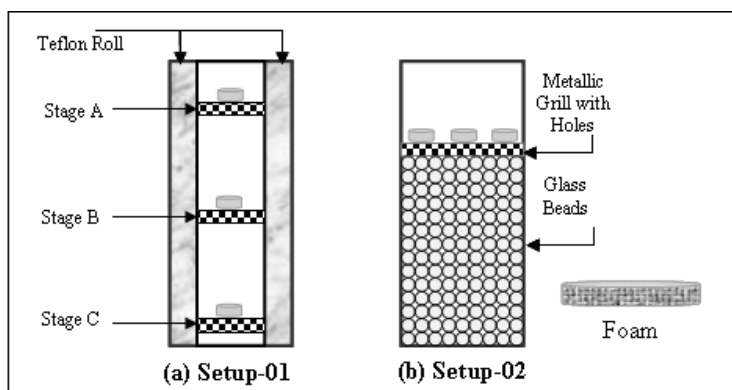
depressurizing valves or by the combination of both types of valves. The  $dP/dt$  procedure is quite tricky and requires great skill.  $\text{CO}_2$  is supplied by Air Liquid™ and is 99.5% pure.

### 2.1.2 Setup One: Filling the Chamber with Teflon®

In this setup, three pellets are placed in the pressure chamber on perforated metal stages which are encircled by a Teflon® isolation material (cf. Figure 4.12-a). The pellets of upper, centre and bottom compression moulding position (A, B and C) are placed in the upper, centre and bottom position in the pressure chamber (A, B and C), respectively. Teflon® material is placed into the pressure chamber in order to decrease their volume which facilitates the depressurization rate.

### 2.1.3 Setup Two: Filling the Chamber with Glass Beads

The second procedure consists of filling the pressure chamber (until the  $\sim 1/3$  or  $\sim 2/3$  of the height of the pressure chamber) with small glass balls (diameter 3 mm) and then a perforated grill (hole diameter 2 mm) is placed above them. After that, the pellet is placed on the grill. This setting was adopted to study the pore size difference at the top of the chamber as compared to three different points in the chamber (cf. Figure 4.12-b).



**Figure 4.12:** Schematic representation of the cross section of the supercritical  $\text{CO}_2$  chamber with two different configurations.

For both procedures, after placement of the pellets, the temperature and pressure have been raised to the required value. Then, pellets have been saturated with supercritical  $\text{CO}_2$  during a desired time. After that, the chamber has been depressurized with a given depressurization rate.

## 2.2 SEPAREX™ SFC6 $\text{scCO}_2$ Laboratory Plant

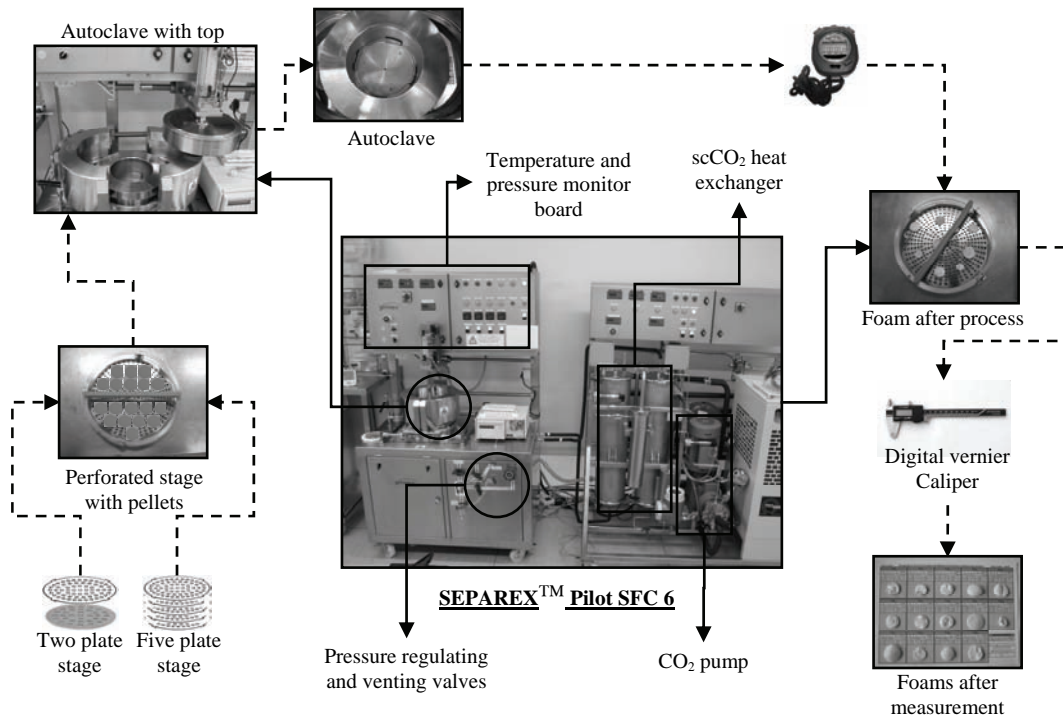
### 2.2.1 Experimental Device

The bigger volume of the chamber (6 L) allows increasing the number of samples (up to 15) in one batch (cf. Figure 4.13). The process flow diagram is given in Figure 4.14.

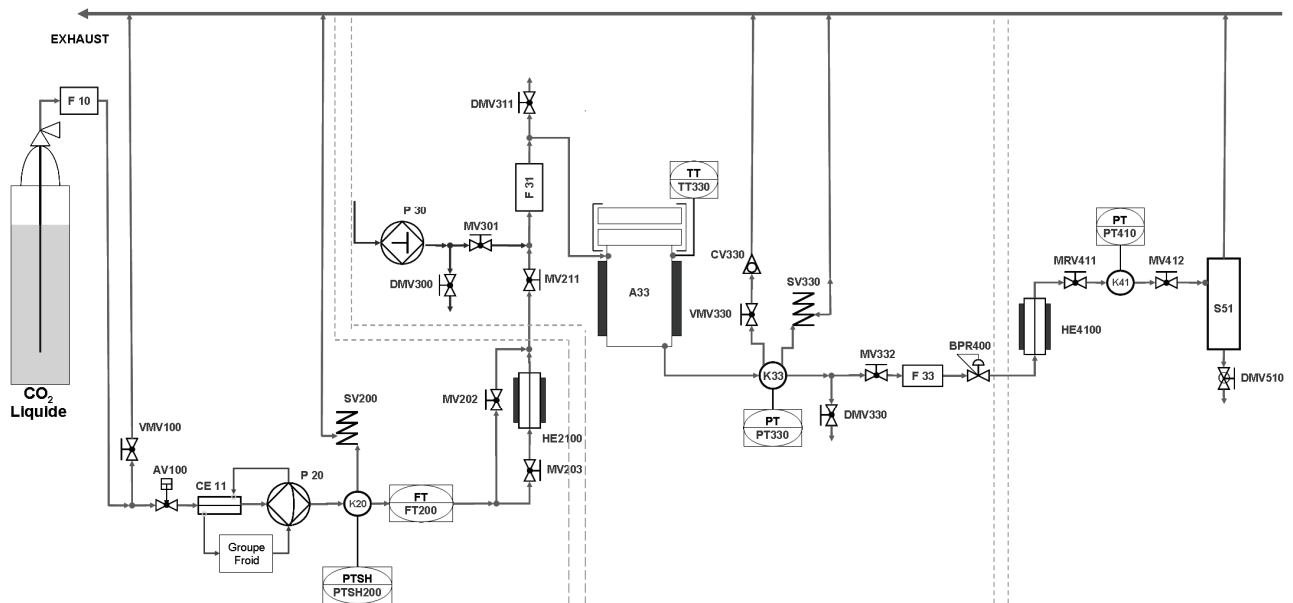
### 2.2.2 Experimental Procedure

To begin experimentation the system is started four hours before the foaming process so that the entire system might attain an equilibrium temperature. Sub-cooled liquid  $\text{CO}_2$  is pumped by a volumetric membrane pump (Milton Roy™, maximum 5 kg/h), then heated until the desired temperature and continuously introduced into the mixing chamber. Experiments can be carried out in open-loop or closed-loop configuration, in which case, after condensation,  $\text{CO}_2$  is recycled to the pump. Normally open loop experimentation is carried out in this pilot plant. Temperatures and pressures are controlled, pressure being

limited to 300 bars and temperature around 60°C. Before starting an experiment, the pilot is filled with CO<sub>2</sub> at bottle pressure (about 5.5 MPa) and air is flashed out.



**Figure 4.13:** Details of equipment (SEPAREX™ Pilot SFC-6).



**Figure 4.14:** SEPAREX™ Pilot SFC-6 process flow diagram.

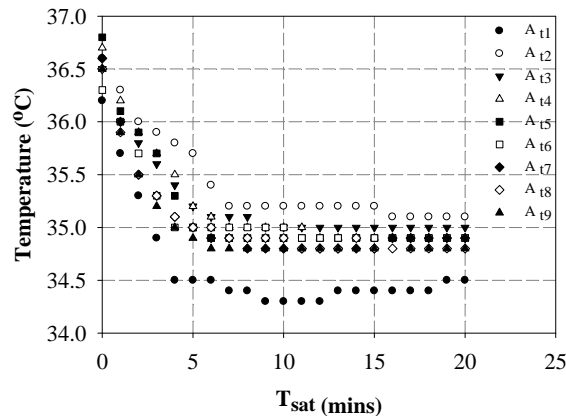
### 2.2.2.1 Initial Filling of Chamber with CO<sub>2</sub>

Polymer/composite pellets are placed in the chamber upon a perforated plate. Then, CO<sub>2</sub> is pumped and heated into the chamber. Temperature of CO<sub>2</sub> is adjusted by the heating fluid circulation in the jacket of the mixing chamber. At  $t_0$  the pressure of the chamber is at the atmospheric pressure. CO<sub>2</sub> pump is started and the flow rate is maintained at 0.5 bar/s. To equalize the pressure of chamber and line, it takes approximately 2.5 – 3 minutes and at that time the pressure of the whole system is about 60 bars. Then flow

rate is raised to 3 bar/s till the required saturation pressure is attained. Once required pressure is attained CO<sub>2</sub> pump is switched off.

### 2.2.2.2 Variations of Saturation Pressure and Temperature Holding For Time t

When the desired pressure in chamber is attained, stop watch is started to begin the saturation time. During this time, fluctuations in pressure and temperature (cf. Figure 4.15) are observed. The fluctuation is adjusted by opening pressure regulating valve and varying temperature set point. Variation in temperature is calculated by noting temperature after each minute and considering the average value for the entire process. Normally after 5 minutes, the pressure and temperature approximately attains stable value.

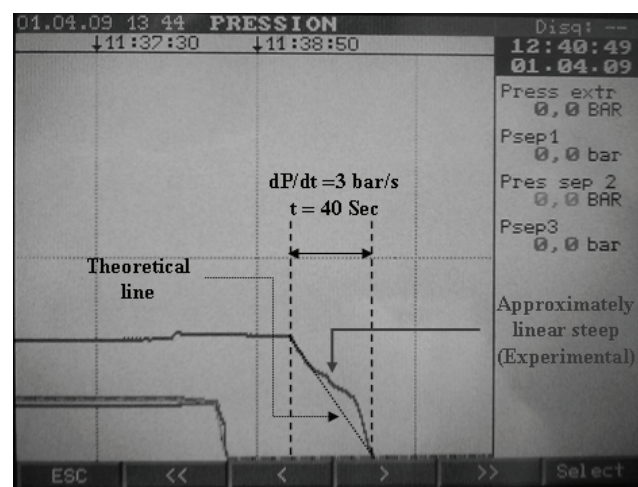


**Figure 4.15:** Variation of chamber temperature during 20 minutes of scCO<sub>2</sub> process for PLGA<sub>50:50</sub> foam.

As example, PLGA<sub>50:50</sub> foam processing data collected in the first 5 minutes, temperature fluctuation was abrupt but after that it was quite normal and close to the process temperature.

### 2.2.2.3 Depressurization of CO<sub>2</sub>

At the end of saturation time, depressurization of CO<sub>2</sub> is done. Pressure regulating valve is closed and the vent valve is opened gradually keeping in view the rate of depressurization. This step is manually handled with a great skill so that we get a linear line between time and pressure drop. During depressurization the temperature of the chamber decreases  $\sim 10^{\circ}\text{C}$ . It takes 40 seconds to release the pressure, if the depressurization rate is 3 bar/s and the initial pressure is 120 bars (cf. Figure 4.16).



**Figure 4.16:** Graph presenting the drop in pressure during 40 sec of depressurization step.

### 3 Protocols for Analysis

#### 3.1 Granulometry

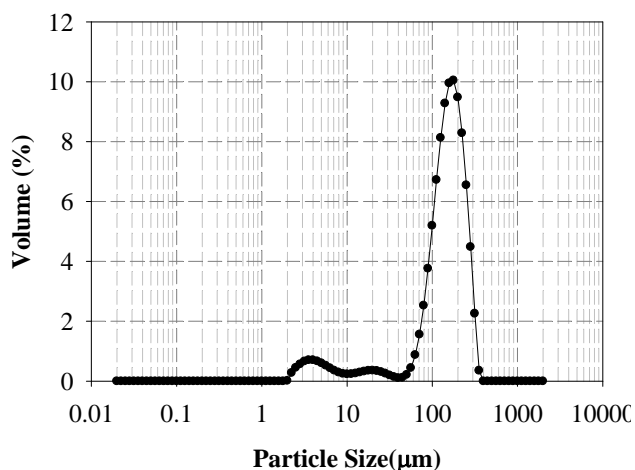
Experiments have been performed at the "Laboratoire de Génie Chimique de Toulouse"

The software proposed by Malvern™ with the granulometer Mastersizer® 2000 uses the Mie theory and permits to limit artefacts at small sizes of the size distributions. Experimentally, the particles pass through the Scirocco™ composed of a vibrating hopper where particles are placed. A compressed air supply is out of the hopper and creates depression causing the particles to the sensor. Vacuum allows the recovery of particles at the end of the circuit. The particles diffract light at an angle. A lens Fourier can be reduced into a single optical diffracting each source. Image result of diffraction of a light beam is a set of concentric rings. The value of the deflection angle and the amount of light can be accessed respectively to particle size and quantity. The deflection angle of all smaller particles is large. The light diffracted by the sample is recorded which can be traced back to the size distribution, and the percentage volume in each size class. The size range available is between 0.05 and 2000 microns.

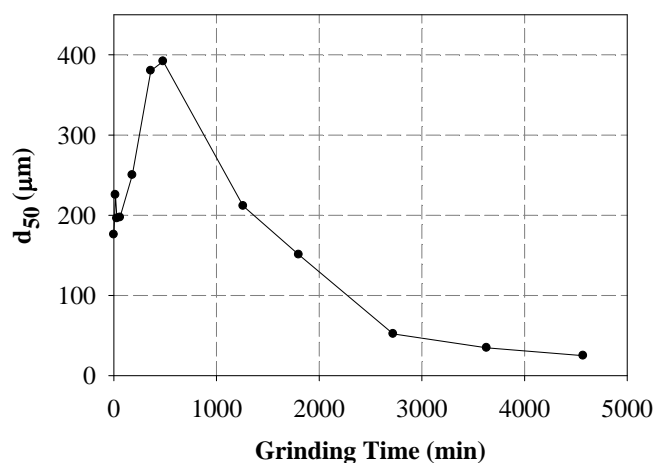
Approximately a mass of 200 to 300 mg of powder material is placed inside the inlet pan. It tracks the evolution of total grain size during milling. The parameters that affect the measure are the amplitude of vibration of the hopper that controls the flow of particles introduced into the measuring cell and the pressure of compressed air that plays on the velocity of passage of particles to the laser beam. After various trials for analysis, we found better reproducibility of measurements for 70% of the maximum amplitude of vibration of the hopper and a pressure of 2 bars. Its measure range in dry dispersion is 0.1 to 2 000 microns. Typical measurement time is 5 seconds.

The size distributions of the polymer powders after pre-treatment (just sieving or grinding in the knife mill and sieving) are presented in Figure 4.17. Most of the particles of different materials used have mean diameter between 100 and 175 μm. The mean diameter ( $d_{50}$ ) of a grinded polymer is 89.54 μm.

The median diameter ( $d_{50}$ ) is a very important characteristic of this distribution because it represents a cumulative frequency of 50%, which divides the size distribution into two parts of equal area. This parameter permits to follow easily the evolution of particle size during a treatment of a powder. As an illustration, Figure 4.18 presents the variation of the median size of  $P_{L,D}LA$  particles submitted to a grinding treatment in a tumbling ball mill.



**Figure 4.17:** Size distribution of  $P_{L,D}LA$  particle after 30 minutes of grinding.



**Figure 4.18:** Variation of particle diameter with grinding time for  $P_{L,D}LA$



### 3.2 Differential Scanning Calorimetry

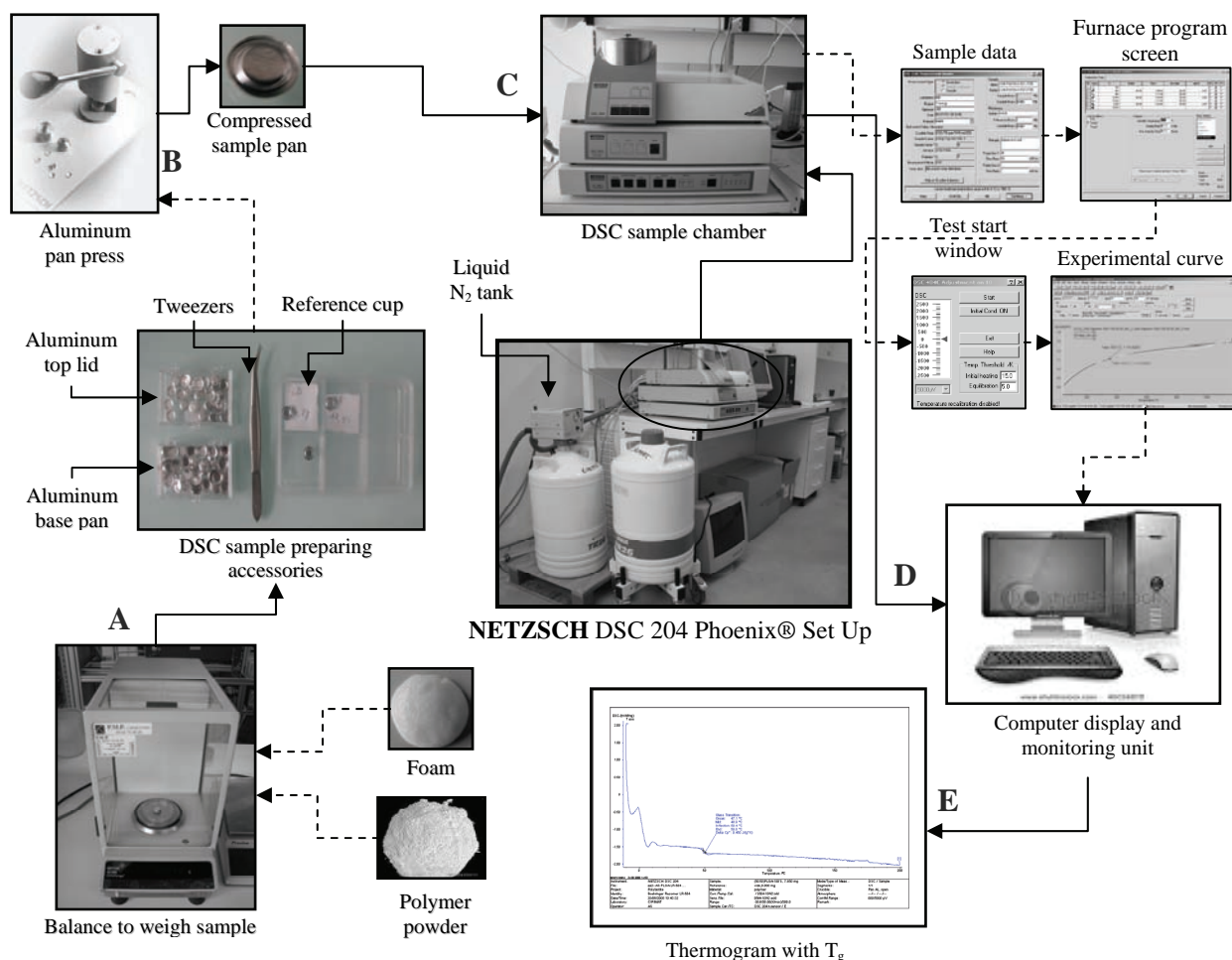
The transition temperature and change in specific heat capacity were measured by a NETZSCH DSC 204 Phoenix® Set Up under a N<sub>2</sub> atmosphere. The DSC measuring cell consists of a cylindrical high-conductivity silver block with an embedded heating coil for broad thermal symmetry (3D symmetry) in the sample chamber, the cooling ports for liquid nitrogen or compressed air cooling and a cooling ring for connection of the intra-cooler (also with simultaneous liquid nitrogen cooling).

For all the experiments, 3 – 10 mg were accurately weighed by a digital microbalance and sealed into an aluminium sample pan (pans are crimped close with sample press). An empty aluminium pan was used as the reference sample. The DSC heating and cooling rates were controlled at 10°C/min, and all experiments were carried out under a nitrogen purge.

Following steps are made during the analysis,

- Calibrating the instrument with indium
- Selecting the pan type and material and preparing the sample
- Creating or choosing the test procedure and entering sample and instrument information through the TA instrument control software
- Setting the purge gas flow rate, then loading the sample and closing the cell lid
- Starting the experiment and then obtaining the data and thermograms.

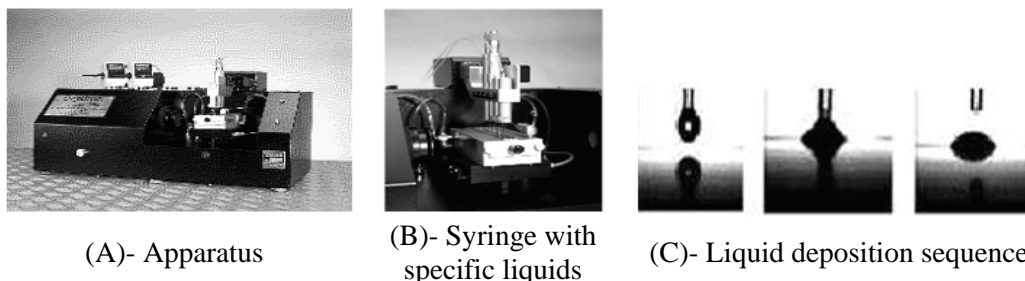
Schematic presentation of the thermal analysis is presented in Figure 4.19



**Figure 4.19:** DSC analysis flow sheet of polymer material and foam.

### 3.3 Contact Angle Measurement

The used apparatus Digidrop Contact Angle GBX (cf. Figure 4.20) makes it possible to carry out measurements of contact angle per drop posed on substrate by recording image per image of the sessile drop. The drop is allowed to flow and equilibrate with the surface.



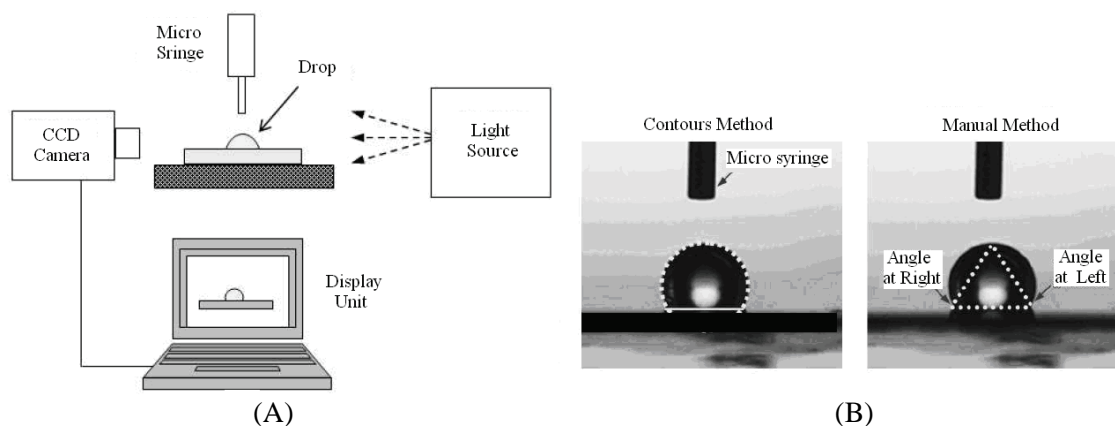
**Figure 4.20:** Goniometer GBX used for contact angle measurement.

This goniometer is constituted by:

- A motorized movable plate on which a compressed powder pellet is deposited,
- A light source and a digital CCD camera that can acquire photographs of the system drop / solid at equilibrium (24 frames/sec),
- A motorized syringe to deposit a liquid drop, volume controlled from the surface of the solid sample to be analyzed,
- An acquisition system to record wetting angle and process photographs using the software on digital images DIGIDROP.

Two different fitting procedures have been used to determine the best shape of the drop and thus the correct contact angle (cf. Figure 4.21). The contour method together with the height-width approach, are appropriate for small contact angle measurements. The circle-method shapes the drop in the form of a circular arc, while the height-width-method determines the height and the width of a rectangle that surrounds the drop.

A manual method, the tangent-method or the conic section method, fits a conic section equation on the drop shape where  $\theta$  acts as the angle at the three-phase contact point. A benefit here is that the contact angle range is much wider (between 10 and 100°), and that the fitting procedure does not assume that contact angles on both sides are equal, resulting in two different contact angles ( $\theta_{\text{left}}$  and  $\theta_{\text{right}}$ ).



**Figure 4.21:** (A): Schematic diagram and (B): Two methods for determining the contact angle.



In the Sessile drop technique, the solid surface is wetted by single drops of the probe liquid. A high resolution camera captures the shape of the drop and processes this by image analyzing software. The  $\theta$  contact angle is linked to the surface energy and so, one can estimate the surface energy and discriminate between polar and apolar interactions. Organic liquids have surface tensions that are in a similar range as solid polymer.

Advantages of this optical approach are the precision and quickness. In addition, placing drops at different positions gives the opportunity to explore the diversity of the surface. The disadvantages of this method are solid sample preparation, camera resolution, together with the investigation of only two contact points. Especially the camera angle to obtain a perfect baseline image is important. Baseline inaccuracy is the primary contributor of a lower repeatability [Lander *et al.*, 1993]. Contact angle was measured, by using a contact angle meter (GBX Digidrop™) apparatus, by a liquid at six different points on the surface on both sides of polylactide or composite pellets. Contact angles were measured on the surface for 4 minutes as after 3 minutes, it was observed that measured angle remained stable.

Contact angle measurements are influenced by several factors. First, the shape of the drop is an important influence. Measurement should take place immediately after the drop is placed on the solid material. This should cover the errors made due to interaction with the material which must be chemically and physically homogeneous. It is assumed that the liquid does not react with the solid and that the solid surface is perfectly smooth and rigid. Secondly, surface roughness and surface impurities are influential parameters. As a result the drop can have various metastable states, which automatically influence the contact angle. Finally, relative humidity and temperature are factors that provide contact angle variance [Rudawska and Jacniacka, 2008].

## 4 Protocols for Porosity and Pore Size Measurement

### 4.1 Average Geometric Porosity

The thickness and diameter of pellets and scaffold dimensions were measured at eight different points with an electronic vernier caliper. Mass of the pellets and foams was measured on an electronic digital balance to four decimal points. The observed dimensional data values were used to calculate radius and volume and then utilize the mass obtained to calculate density of the pellet or foam. Then finally relative density and geometric porosity of the foam was calculated. As example, we present in Table 4.2 measured data of PLGA<sub>50:50</sub> pellets and foam before and after sc CO<sub>2</sub> foaming.

**Table 4.2:** Dimensional data of PLGA<sub>50:50</sub> pellets and foams for geometric porosity.

S/N	Pellet				Foam				Geometric Porosity
	Diameter	Thickness	Mass	Density	Diameter	Thickness	Mass	Density	
	$d_p$ (mm)	$\varnothing_p$ (mm)	(mg)		$d_f$ (mm)	$\varnothing_f$ (mm)	(mg)		P(%)
1	12.9	0.6	85.0	1074.0	25.0	1.9	96.0	101.1	90.6
2	13.0	0.6	91.6	1103.4	23.5	2.1	84.2	93.1	91.6
3	12.9	0.6	96.0	1184.2	25.1	2.1	96.1	94.4	92.0
4	12.9	0.6	94.0	1137.6	31.6	1.9	93.5	62.7	94.5
5	12.9	0.6	83.8	1066.5	27.7	1.7	84.6	83.5	92.2
6	12.9	0.7	100.0	1171.2	24.9	2.0	100.4	101.1	91.4
7	12.9	0.6	95.8	1144.8	25.9	1.7	84.0	96.3	91.6
8	12.9	0.6	101.0	1242.1	26.3	2.3	100.1	81.2	93.5
9	13.0	0.6	84.2	1022.7	32.0	2.0	90.7	55.7	94.6

The foams obtained after process are mostly in circular shape, the diameter variations in not very high, however thick varies to some extent. Porosity obtained by geometric method compared with mercury intrusion porosimetry produced results 5 to 7% higher.

## 4.2 2D Image Analysis

The scanning electron microscope (SEM) used in our study was a, LEO 435 VP model. The sections of the foams were mounted on an aluminum stub with a carbon adhesive and then coated with silver/gold (120 sec, Argon atmosphere). The SEM micrographs were digitized on a matrix of 1024×1024 pixels with 256 gray levels. In order to study the foams porosity, image analysis was performed using the SCION<sup>®</sup> image software. The first stage is to obtain conductive materials by using a device called a "sputter coater."

### 4.2.1 Sputter Coater

If powder particles were to be analyzed, they were dispersed on double-sided carbon conductive adhesive tape attached to the studs. Double sided adhesive tape permits quick mounting of samples without using liquid or colloidal adhesives. These studs are fixed on the sample holder.

For foams after being frozen in liquid nitrogen for 2 min, the specimens were fractured using a razor blade and tweezers in the directions parallel and perpendicular to the surface, then placed on the holder with the help of isopropanol base graphite paint. The resulting transverse and longitudinal sections were sputter-coated with platinum/gold. The holder mounted with samples is placed in the chamber. Sputter coater uses an electric field and argon gas. The metalizing chamber is closed and placed under vacuum. A stream of argon eliminates the oxygen in the chamber. Gold or gold-palladium is preferred if the sample has a very irregular surface.

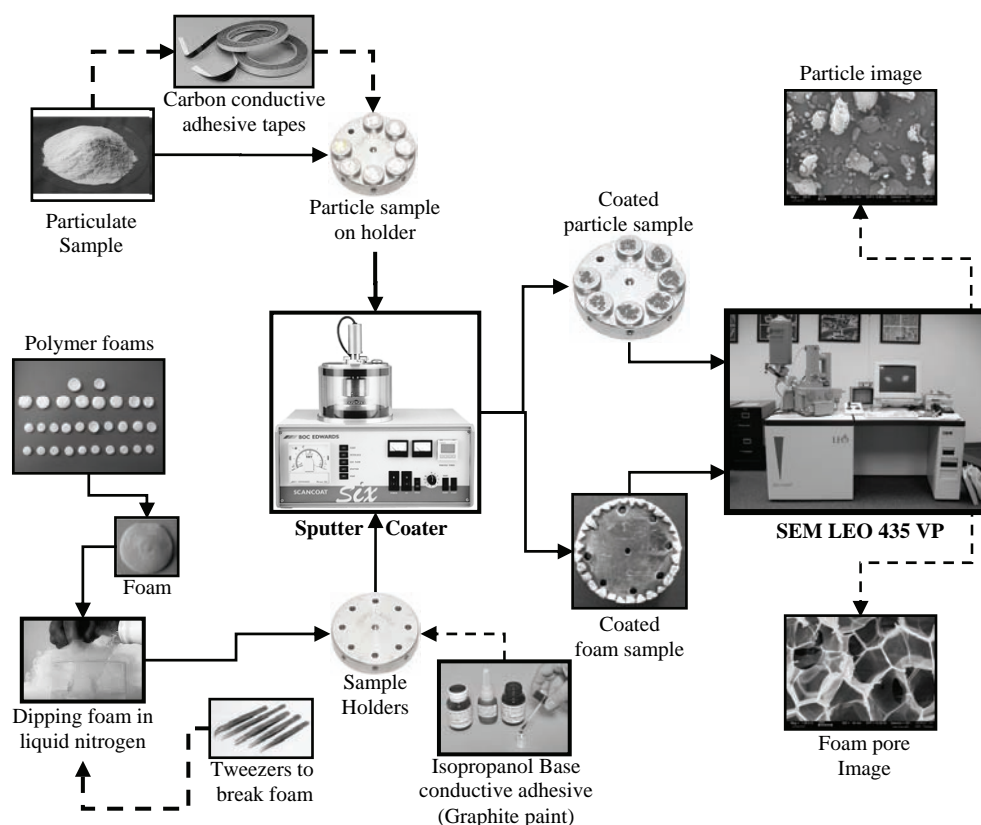


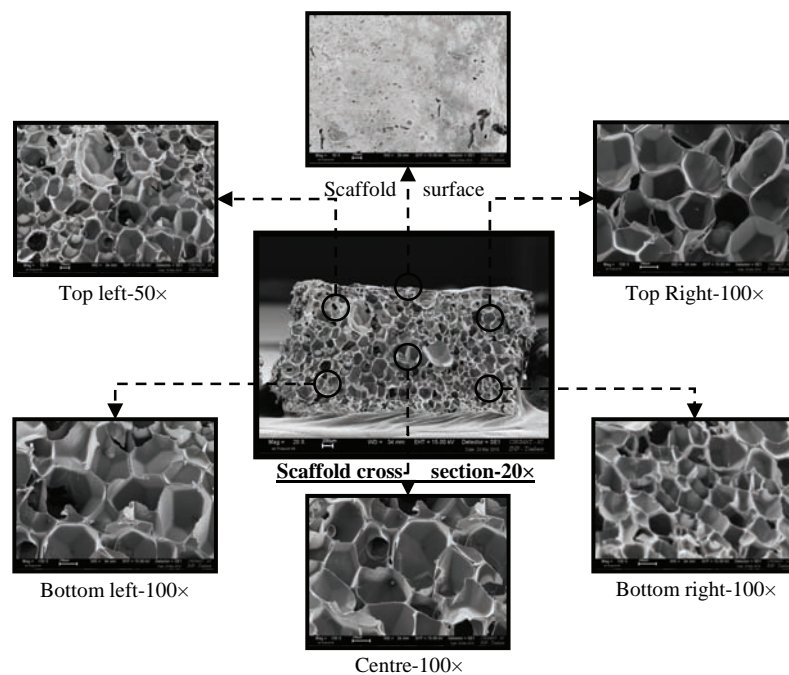
Figure 4.22: Sputter coating and SEM processing flow diagram.

During the commissioning of the metalizing high voltage, low current passes through a gold foil, ionize the atoms and they are deposited on the surface of the sample. The thickness of the gold layer deposited depends on the time of filing but does not exceed 10 Å. The gas pressure was less than 50 mTorr and the current was about 40 mA. The coating time was 120 s. The metalizing chamber is then reduced to atmospheric pressure and then the samples are introduced into the microscope chamber. Complete schematic procedure is shown in Figure 4.22. A working distance between the bottom of the barrel and the sample between 30 and 37 mm is recommended. An acceleration voltage of electrons between 10 and 15 kV is generally accepted, and a probe current of between 50 and 150 Å.

#### 4.2.2 SCION® Image Analysis

Image analysis of SEM micrographs was used for the observation of the internal pore morphology of the freeze-dried foams. Polymeric and composite foams images are taken on the surface, at the cross section and inside the pores. Cross sectional images are taken at five different points (the centre, top left, bottom left, top right and bottom right) to verify homogeneity of pores and their distribution (cf. Figure 4.23). Normally magnifications of image are (25, 40, 100, 200, 300, 400, 500) depending on the pore size. Higher magnification up to 1K, 2K and 3K is recorded, if internal surface of the pores walls is to be observed.

The SEM micrographs were treated and statistically analyzed using the software SCION® Image analysis. The images were digitized on a matrix of 1024 × 1024 pixels with 256 gray levels. The foams were duplicated and five images of different areas of the same foam were analyzed. Effect of the successive image transformations can be seen in Figure 4.24.



**Figure 4.23:** SEM Images of cross sectional foam.

An example of the data obtained after SCION® image analysis is presented in Table 4.3. From the data, it is possible to define three pores categories (cf. Table 4.4): Micro, meso and macro pores are pores with dimension of equivalent diameter less than 25 μm, 25–150 μm and above 150 μm respectively. The micro pores are necessary for movement of the liquids and nutrients in the scaffold. Meso pores are for the accommodation of the human mesenchymal stem cells, as their size varies from 100–150 μm. Macro pores

are necessary for the movement of the mesenchymal cells. Data of pores was extracted from SCION® images software and calculation was done by using MS Excel calculation sheets. The retrieved data is presented in Table 4.3.

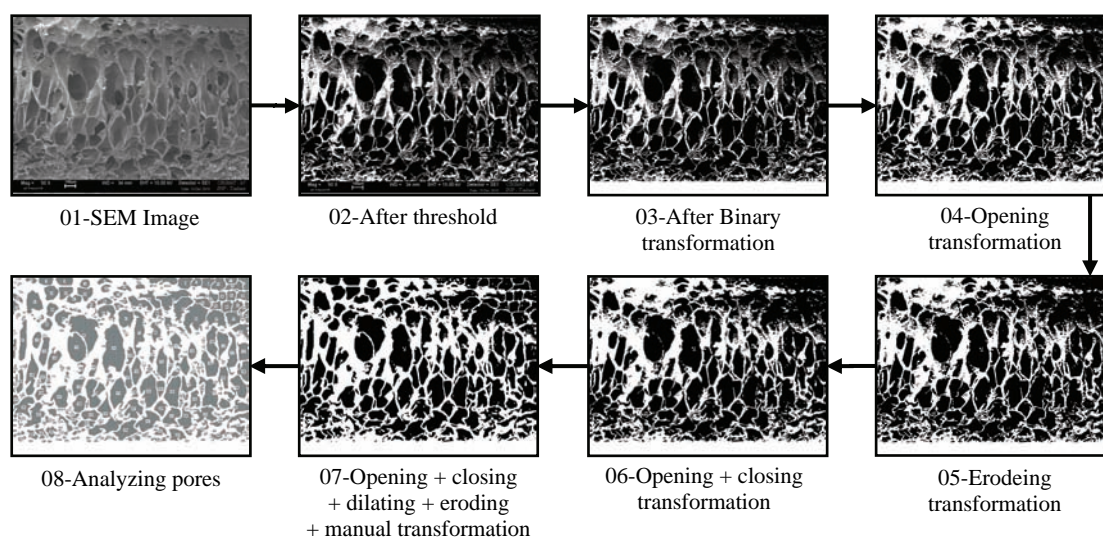


Figure 4.24: Various steps of transformation of SEM image by SCION®.

Table 4.3: Example of data obtained from SCION® image analysis.

SCION Pore Data										
S/N	Pore Area	Frequency	Pore Eq. Dia	Cumulative % Area	Average Area	Total Area	Pore Area %	Total Vol.	Volume %	Cumulative % Volume
	Bin Range	Pore	$d_e = (4A/\pi)^{1/2}$			Pore Freq × Avg. Area		V = $4/3 \cdot \pi \cdot (D/2)^3$	V/V <sub>total</sub>	
1	0	0	0.00	0.000	0	0	0.000	0.00	0.000	0.000
2	5	0	2.52	0.000	2.5	0	0.000	8.41	0.000	0.000
3	10	0	3.57	0.000	5	0	0.000	23.79	0.000	0.000
4	15	0	4.37	0.000	7.5	0	0.000	43.70	0.000	0.000
-	-	-	-	-	-	-	-	-	-	-
-	-	-	-	-	-	-	-	-	-	-
25	300	20	19.54	3.136	150	3000	0.514	3908.82	0.002	0.007
26	350	13	21.11	3.526	175	2275	0.390	4925.68	0.002	0.009
27	400	10	22.57	3.869	200	2000	0.343	6018.02	0.003	0.012
28	450	8	23.94	4.177	225	1800	0.308	7180.96	0.003	0.015
29	500	7	25.23	4.477	250	1750	0.300	8410.44	0.004	0.018
30	550	8	26.46	4.854	275	2200	0.377	9703.04	0.004	0.022
31	600	5	27.64	5.111	300	1500	0.257	11055.81	0.005	0.027
32	650	4	28.77	5.333	325	1300	0.223	12466.19	0.005	0.032
-	-	-	-	-	-	-	-	-	-	-
-	-	-	-	-	-	-	-	-	-	-
84	9000	3	107.05	28.900	4500	13500	2.313	642284.68	0.272	3.219
85	9500	1	109.98	29.714	4750	4750	0.814	696545.05	0.295	3.514
86	10000	0	112.84	29.714	5000	0	0.000	752252.78	0.319	3.833
87	17000	7	147.12	38.709	7500	52500	8.995	1381976.60	0.585	4.418
88	20000	4	159.58	45.562	10000	40000	6.853	2127692.16	0.901	5.319
89	25000	7	178.41	60.553	12500	87500	14.991	2973540.19	1.259	6.578
-	-	-	-	-	-	-	-	-	-	-
-	-	-	-	-	-	-	-	-	-	-
103	95000	1	347.79	90.963	47500	47500	8.138	22026688.40	9.327	79.011
104	100000	0	356.82	90.963	50000	0	0.000	23788321.55	10.073	89.084
105	105500	1	366.51	100.000	52750	52750	9.037	25777600.56	10.916	100.000
		<b>Numbers</b>	<b>Avg. <math>d_e</math></b>	<b>Total</b>	<b>Area</b>	314325	<b>%</b>	80230646.84	<b>%</b>	
Micro Pores		<b>58</b>	14		<b>Micro</b>	10825	3	30520	0	
Meso Pores		<b>28</b>	80.0		<b>Meso</b>	75750	24	3506284	4	
Macro Pores		<b>13</b>	281.8		<b>Macro</b>	227750	72	76693843	96	

The frequency of pores and respective areas of the pores obtained (cf. Table 4.3) thus helps in calculating the pore equivalent circular diameter ( $d_e$ ). Pore morphology and pore area ratios, pore volume ratios, minimum and maximum equivalent pore diameter.



A graphs obtained from the SCION® data is depicted in Figure 4.25-A. The average pore diameter, area and volume have been calculated by assuming that the pores are perfect circles. Average cell densities are investigated by the following equation:

$$N_c = \frac{6}{\pi} \frac{1}{d_e^2} \left(1 - \frac{\rho_{foamed}}{\rho_{unfoamed}}\right) \tag{4.1}$$

where  $\rho_{foamed}$  is the density of foams,  $\rho_{unfoamed}$  is the density of pellets,  $d_e$  is the pore equivalent circular diameter, obtained by SCION® image analysis. (cf. Figure 4.25-B).The types of pores in the foams are calculated by the following formula that gives the circularity.

$$c = 4\pi A/P^2 \tag{4.2}$$

where A is the area of the pores and P is the perimeter.

Solving equation 4.2 if the results are in the range of [0.0–0.2], [0.2–0.5] and [0.5–1.0] the pores are elongated, irregular and regular in shape respectively.

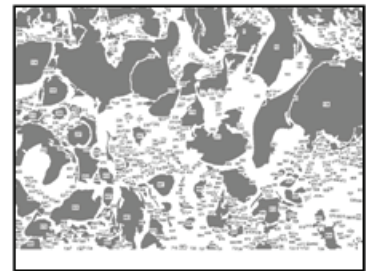
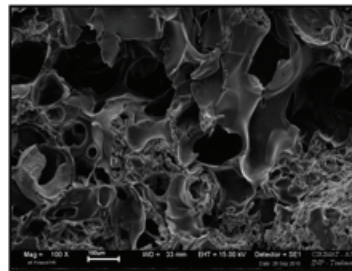
**Table 4.4:** Example of pore distribution data, pore morphology and final SCION® image.

Pores Number Ratio			
	Micro	Meso	Macro
#	366	139	20
%	69.71	26.48	3.81
Pores Area Ratio			
	Micro	Meso	Macro
#	26130.00	199807.50	357750.00
%	4.48	34.23	61.29
Pores Volume Ratio			
	Micro	Meso	Macro
#	43325.77	10389725.68	225720043.30
%	0.02	4.40	95.58

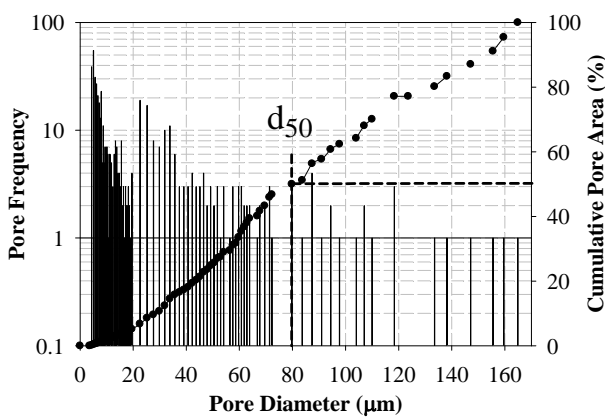
$d_e$	Max- $d_e$	Min- $d_e$
80	170	3

Pores Morphology			
	Elongated	Irregular	Regular
#	24	137	364
%	5	26	69

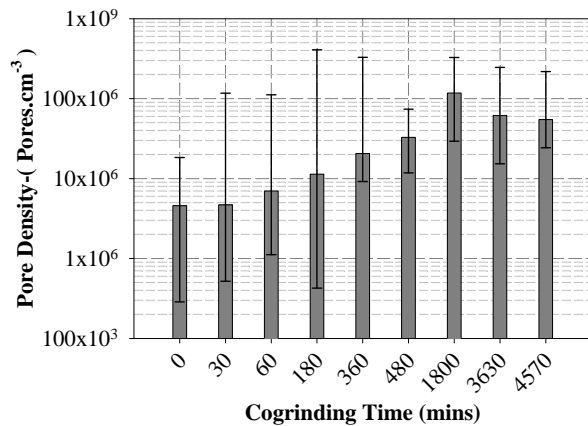


SEM Image

SCION Image



(A)-Pore frequency and cummulative pore area as function of pore diameter.



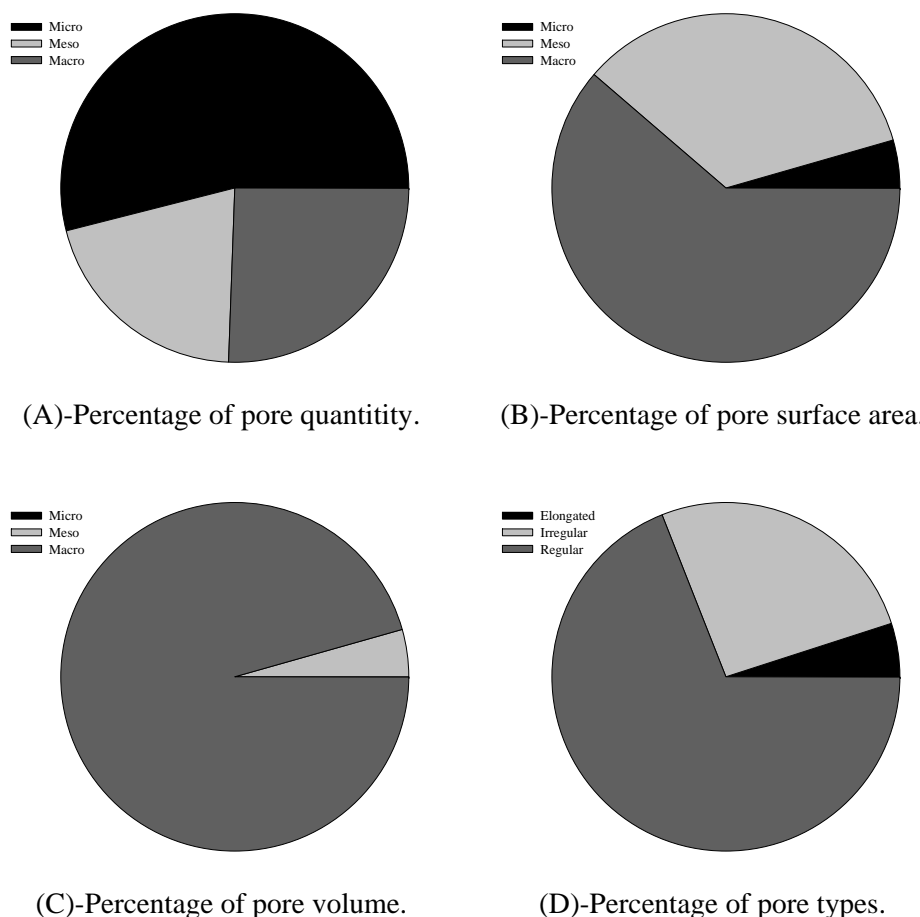
(B)-pore density as a function of polymer filler cogrinding time.

**Figure 4.25:** Graphs obtained from the initial data of SCION® image analysis.

The pore numbers does not represent a realist image of the heterogenous pores in foam, so we calculate percentage of pore numbers, area and volume % of micro, meso and macro pores. Different types

of pores in the foams are present in function of the nature of polymers ( $P_{L,D}LA$ ) under the same  $scCO_2$  conditions  $T_{sat} = 55^\circ C$ ,  $P_{sat} = 80$  bar,  $t_{sat} = 30$  min,  $dP/dt=4.5$  bar/s (cf. Figure 4.26).

Comparing all the graphs provide a clearer picture about the foam morphology SEM image is in 2D and it is already supposed that the pore diameter obtained from SCION<sup>®</sup> image analysis is of a circular pore, so if we consider pore volume the calculation of equivalent pore diameter, there will be another hypothesis that the pores are sphere which is not possible. Hence to make the result more close to the real foam pore surface area is considered for calculations. SCION<sup>®</sup> image analysis also provide information about the nature of the pores either they are elongated, regular or irregular. Figure 4.26 (A) presents the percentage of micro, meso and macro pores in a scaffold while Figure 4.26 (B) presents the percentage of pore surface area. The number of macro pores are though in less percentage but the area of macro pores has highest value. Figure 4.26 (C) presents the volume of each pore and we can see that macro pores almost consist of 95% of total scaffold volume. The shape of pores is calculated by equation 4.2 and for  $P_{L,D}LA$  regular, irregular and elongated pores are 68%, 23% and 9% as presented in Figure 4.26 (D).

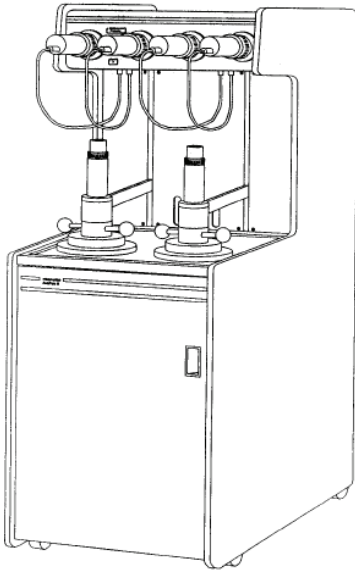


**Figure 4.26:** Pore distribution comparison in a foam with different aspects.

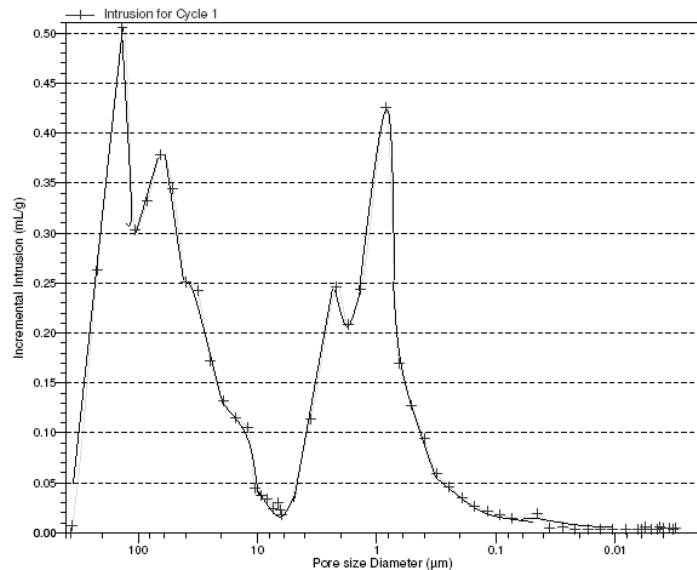
### 4.3 3D Hg Intrusion Porosity

Porosity and pore diameter of randomly selected foams were determined by AutoPore<sup>®</sup> IV 9500 (cf. Figure 4.27) mercury porosimeter located at the CIRIMAT/UPS and analysis were performed by Sophie Cazalbou. Mercury intrusion porosimeter (Pascal 140, Thermo- Quest) was used to study the pore structure of the PLGA scaffolds. For each different pore diameter scaffolds, three measurements were performed. Dimensions of the porous scaffolds with mass approximately 0.1 g were first measured and placed in the ultramapopore dilatometer for out-gassing. The dilatometer was then filled with mercury up to 1800 mm<sup>3</sup>

for analysis. With increasing pressure up to 400 kPa, at a approximately rate of 0.07 kPa/s, the mercury penetrated through the open pores of the sample scaffolds. By measuring the quantity of the sample pores and the equilibrium pressure at which intrusion occurs, experimental data of the pore volume distribution as a function of their diameter were obtained using the Washburn equation as described in chapter 3. It should be noted that the pore diameters obtained are assumed to be in cylindrical shape. Porosimetry data were then corrected for compression by subtracting the blank analysis curve of mercury compression. The median pore diameter, the surface to volume ratio and the porosity of the PLGA/PLA scaffolds were available from the data. After 6 hrs of long experimental procedure, median pore diameter, median pore diameter (Area), average pore diameter (4V/A), bulk density at 0.0034 MPa, apparent (skeletal) density, porosity and interstitial porosity was obtained. The result obtained in the form of graph for incremental intrusion vs pore size is presented in Figure 4.28.



**Figure 4.27:** Autopore analyzer for porosity.



**Figure 4.28:** Incremental intrusion vs pore size.

#### 4.4 3D Micro Computer Tomography

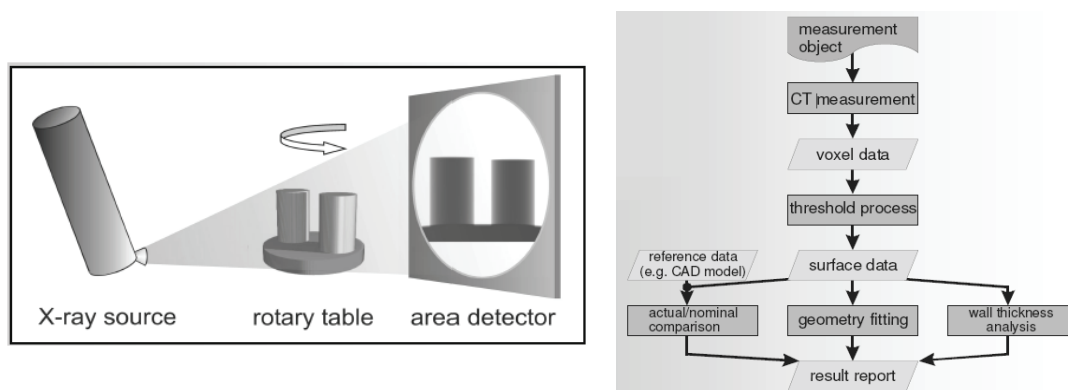
Experiments on Micro-Computer Tomography ( $\mu$ CT) have been performed at the CIRIMAT/UPS laboratory.

$\mu$ CT has two distinct properties that set it apart from conventional measurement techniques:

1. As X-rays can “see through” material, computer tomography is able to reveal hidden features that touch probes can’t reach and laser and vision systems can’t see.
2. The magnification capability of X-ray imaging makes it possible to inspect components that only measure a few millimetres with micrometer resolution.

As shown on Figure 4.29, computer tomography is the process of imaging an object from many different directions using penetrating radiation and using a computer to calculate the interior structure of that object from these projected images. Computer tomography allows the complete structure of an object to be stored and examined to give all internal dimensions and the precise size, shape and location of any internal feature or defect.





**Figure 4.29:** Set up of  $\mu$ CT and flow chart of  $\mu$ CT measurement process.

#### 4.4.1 Acquisition

The sample is rotated through 360 degrees on a precision turntable and a set of high resolution digital radiographs are acquired at regular (typically 0.5 degree) increments. The accuracy of this data set determines the ultimate quality of the final 3D data.

#### 4.4.2 Corrections

Each projected image from the data set undergoes geometric and shading correction, to remove spatial and intensity non linearities introduced by the imaging device.

#### 4.4.3 Reconstruction

By combining all of the individually corrected images and using a cone beam back projection technique, a geometrically correct, three dimensional data cloud is computed. The patented software has a real-time viewer that shows the reconstruction progressing in parallel with the x-ray images being captured.

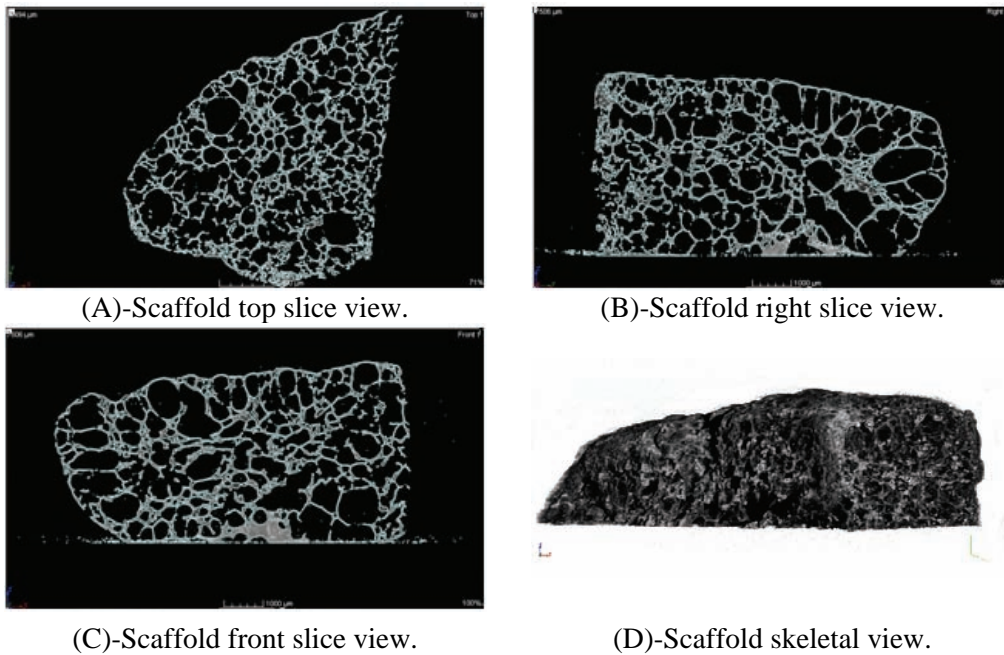
#### 4.4.4 Viewing Results

The CT data collection, reconstruction and display are presented to the operator via the X-Tek graphical user interface. This has been developed to provide ease of use with the highest performance for systems to fit users' budgets without compromise. The data cloud can be sliced open in any direction to reveal internal detail, surface rendering software similar to that used in 3D CAD systems is used to visualise the exposed features.

#### 4.4.5 Wide Variety of Post Processing

The data cloud can be output as a stereo lithography file, a format accepted by most CAD packages. Once imported into a CAD system, the radiographic information can be compared directly with the original design file to highlight differences when checking first off manufactured parts, or if the original design is not available, then the radiographic data is used to create a new CAD file for rapid prototyping and reverse engineering.

Micro CT of different scaffolds was taken from different angles and views. Slices were taken to observe the interconnectivity and porosity of the scaffold structure. An example of a polymer skeletal structure along the top, front and right views are taken (cf. Figure 4.30). These images can be further used for porosity and pore size distribution analysis.  $\mu$ CT can directly provide the porosity and interconnectivity in tested foam. The results obtained from  $\mu$ CT are real results compared to the results obtained from calculations and other derived analysis such as images analysis.



Scaffold 95% PLGA+2.5% ATCP+2.5%  $\beta$ TCP processed at  $P_{\text{sat}}=100$  bars,  $T_{\text{sat}}=48^{\circ}\text{C}$ ,  $T_{\text{sat}}=20$  min,  $dP/dt=3$  bar/s

**Figure 4.30:**  $\mu$ CT slice view from different direction for bone scaffold showing the interconnectivity of pores

## 5 Mechanical Tests on Foams

### 5.1 Experimental Conditions of Test

Brazilian tests were conducted by Gerard Dechambre (CIRIMAT) on computerized universal testing machine (Hounsfield™ H25KS). The compressive modulus  $E_c$  and the compressive strength  $\sigma_c$  are easy to measure for foams by uni-axial compression tests.

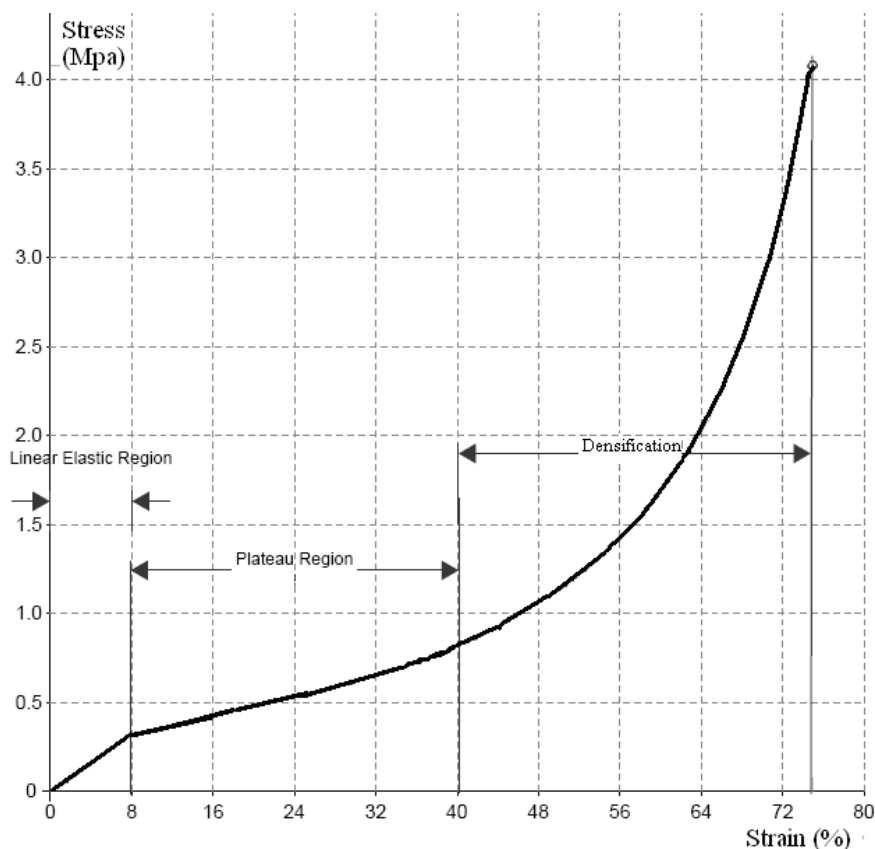
A loading frame, 25kN capacity, having a base and a cross head joined together with two solid pillars with nuts. At the top, the pillars have long threads for height adjustment. On the base, a 25 kN hydraulic jack is centrally fixed between the pillars. This jack has an integral pumping unit and oil reservoir. A 25 kN capacity pressure gauge is fixed to the jack for indicating the load on the specimen.

Samples used in this investigation were discs of 10 mm diameter and 3 mm thickness. Tests were performed at room temperature. Each sample was tested three times and the average value was incorporated. The composite foams were cut into circular flat-bottom disks (~ 10 mm in diameter) for mechanical testing. The top layer of the disk was removed to achieve the desired thickness (~3 mm) and ensure a flat surface. Once the system calibrated/tared and the crosshead was in the correct position, samples were loaded and were compressed in z – direction of scaffold fabrication process at cross speed of 0.5 mm/min between two steel platens up to a strain level of approximately 75%.

### 5.2 Principle of Curve Analysis

The data was converted to Microsoft Excel format then and the force-displacement data was converted to stress-strain curves. Strain was determined from the values for displacement and the original height of the scaffolds. Strain was determined from the values for displacement and the original height of the scaffolds. The slope of the initial linear portion, elastic region, of the stress-strain curve was then used to determine the modulus. The compressive strength was estimated by determining the stress at an offset of 1%

just after the initial linear portion, elastic region, of the stress-strain curve. (cf. Figure 4.31). The compressive modulus was defined as the initial linear modulus. The compressive strength ( $\sigma_{10\%}$ ) was estimated by determining the stress at 10% deformation.



**Figure 4.31:** Stress strain graph of PLGA foam obtained showing the three regions.

## 6 Conclusion

In this chapter, all the experimental procedures and their limitations have been discussed in detail with respect to the equipment used for the experimentation. For size reduction of the polymeric granulates or fibres we introduced knife mill, tumbling ball mill and mortar used in our studies. The procedures to make pellets by dry method using the hydraulic press and wet method preparation has been described. Two different types of supercritical fluid equipment were under utilization to produce biopolymer foams. One of the equipment was bound for limited number of foams per batch due to low chamber volume while other was used to process foams in semi-industrial quantities. We then presented the various protocols of analysis techniques for characterizing the physicochemical and use properties of initial, ground and co-ground products such as granulometry for particle size and their distribution.

Analytical techniques such as differential scanning calorimetry for glass transition temperature and other thermal properties, sieving for powder gradation, mixing of materials for homogenization, SEM for size morphology, geometric and Hg intrusion porosimetry for pore size and distribution and contact angle for surface properties were discussed. SCION<sup>®</sup> image analysis technique has been explained with an example to calculate the number of pores, pore distribution and types of pores. Then micro-CT protocol for the structural assessment of polymer foam and to elaborate the interconnectivity has been presented. Finally, mechanical properties of the polymer by using Brazilian testing and compression testing of the foamed product are elaborated.



# Chapter 5

## Characterization of Scaffolds for Connective Tissue Engineering

*In this chapter, we present characterization of different biopolymers such as  $P_LLA$ ,  $P_{L,DL}LA$ ,  $PLGA_{50:50}$  and  $PLGA_{85:15}$  for a comparative study. Particular attention has been focused on amorphous and semi-crystalline polymers. The modelling of  $scCO_2$  foaming of polymers by pressure quench method requires the resolution of the diffusion equation as well as the degree of depression of the glass transition of polymer as a function of the amount of  $CO_2$  sorbed. Indeed, certain isothermal sorption data and its modelling are required for such study. In this chapter, after explaining the principles of the foaming phenomenon precisely, we have focused on the resolution of diffusion equation, the thermodynamics of phase equilibrium, the depression of  $T_g$  as a function of the  $CO_2$  sorption. Finally, we have derived the nucleation equation, which is based on the use of the classical nucleation theory.*

*Then characterization of the foams obtained by supercritical  $CO_2$  process by varying the ratios of LA/GA contents were taken into account to correlate solubility of the  $scCO_2$  of pellets and equivalent pore size and porosity in scaffolds. A focus on pore morphology, structure anisotropy and their characteristics will be emphasized as it plays an important role in cell seeding, differentiating and growth in the scaffold.*

## 1 Characterization of Biomaterials

### 1.1 Characterization of Polylactide Powders

All the polymers in powder form were used directly by sieving through 500  $\mu m$  mesh to avoid any foreign particles or agglomerate. Others in granules and pellet form were ground in knife mill as described in chapter 4. The physical appearance and composition of each polymer is stated as under:

- $P_{L,D}LA$  (PABR L 68) is L,D polylactic acid containing approximately 12% of D-lactic acid. They are available in brownish yellow granules form.
- $P_{L,DL}LA$  (LR 704) is a poly (L-lactide-co-D,L-lactide) with a L-lactide : D,L-lactide molar ratio of 67:33 to 73:27. It is white to off-white granules.

- PLGA<sub>85:15</sub> (RG 858 S) is a poly (D, L-lactide-co-glycolide) with a D,L-lactide : glycolide molar ratio of 83-87 : 13-17 and initially it was white to off-white solid fibres.
- PLGA<sub>85:15</sub> (DL-PLG) is a poly(D,L-lactide-co-glycolide) with a D,L-lactide : glycolide molar ratio of 85:15. It is white to off-white solid.
- PLGA<sub>50:50</sub> (PLG 8523) is a poly(L-lactide-co-glycolide) with a L-lactide : glycolide molar ratio of 50:50. It is white to light tan granules.
- PLGA<sub>85:15</sub> (PLG 8531) is a poly (L-lactide-co-glycolide) with a L-lactide : glycolide molar ratio of 84:16. It is white to light tan granules.
- PLGA<sub>85:15</sub> (RG 857 S) is a poly (L-lactide-co-glycolide) with a L-lactide: glycolide molar ratio of 82-88 : 12-18 and initially it was white to off-white granules. L-lactide co glycolide were difficult to convert in powder form due to higher modulus of L-lactide contents, while copolymers containing D,L-Lactide were easily converted into powder.
- PLGA<sub>50:50</sub> (RG 504) is a poly (D,L-lactide-co-glycolide) with a D,L-lactide : glycolide molar ratio of 48:52 to 52:48 and initially it was white to off-white solid.
- PLGA<sub>50:50</sub> (PDLG 5010) is a poly(D,L-lactide-co-glycolide) with a D,L-lactide : glycolide molar ratio of 52:48, It is white to light tan granules.

They have been purchased from BOEHRINGER™ Ingelheim (Germany), LACTEL™ (USA), GALACTIC (Belgium) and PURAC™ (Netherlands) (cf. Table 5.1).

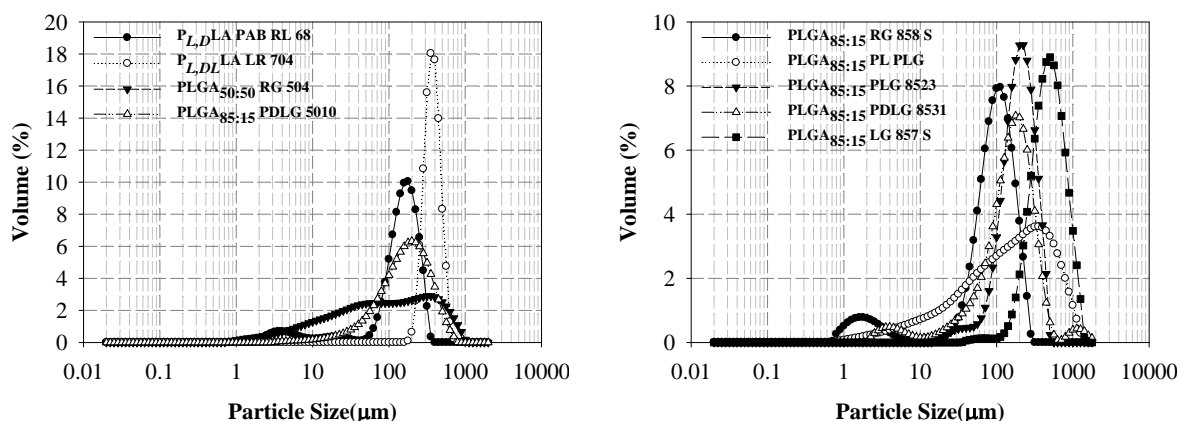
**Table 5.1:** Polylactide origin and physical state.

Origin	Biopolymer	Physical state
GALACTIC™	P <sub>L,D</sub> LA (PABR L 68)	Amorphous
BOEHRINGER™	P <sub>L,DL</sub> LA (Resomer® LR 704)	Semi Crystalline
BOEHRINGER™	PLGA <sub>85:15</sub> (Resomer® RG 858S)	Amorphous
LACTEL™	PLGA <sub>85:15</sub> (DL-PLG)	Amorphous
PURAC™	PLGA <sub>50:50</sub> (PLG 8523)	Semi Crystalline
PURAC™	PLGA <sub>85:15</sub> (PLG 8531)	Semi Crystalline
BOEHRINGER™	PLGA <sub>85:15</sub> (LG 857 S)	Amorphous
BOEHRINGER™	PLGA <sub>50:50</sub> (Resomer® RG 504)	Amorphous
PURAC™	PLGA <sub>50:50</sub> (PDLG 5010)	Amorphous

Some of the polymers were initially in powder form while others were in granules by source. Amorphous polymers were easy to ground in the knife mill and they had mean size distribution ~150 µm but those which were semi-crystalline took longer time and their mean particle size increased as the crystallinity increased (agglomeration). Granulometry of the polymer powder analysis after different time of grinding is presented in Figure 5.1. The mean size distribution of each polymer is presented in Table 5.2. To prevent degradation, polymers have been stored at 4°C in their powder-like form.

**Table 5.2:** Mean diameters of the polymers after knife mill grinding by granulometry.

Polymer	$d_{(50)}$ ( $\mu\text{m}$ )	Polymer	$d_{(50)}$ ( $\mu\text{m}$ )
$P_{L,DL}$ LA (PABR L 68)	161.5	PLGA <sub>85:15</sub> (PLG 8531)	166.1
$P_{L,DL}$ LA LR 704)	389.5	PLGA <sub>85:15</sub> (LG 857 S)	506.4
PLGA <sub>85:15</sub> (RG 858 S)	99.7	PLGA <sub>50:50</sub> (RG 504)	89.5
PLGA <sub>85:15</sub> (DL-PLG)	167.7	PLGA <sub>50:50</sub> (PDLG 5010)	178.2
PLGA <sub>50:50</sub> (PLG 8523)	207.7		

**Figure 5.1:** Size distribution of various PLAs and PLGAs after knife mill grinding.

### 1.1.1 Experiments on Polylactide Powders by Viscosimetry.

As example, we present in detail results obtained with PLGA<sub>50:50</sub> (RG 504) in solution in  $\text{CCl}_4$  at 25°C. Variation of efflux times with the polymer concentration and corresponding viscosity values are reported on Table 5.3, where  $t_0$  is the flow time of pure chloroform and  $t$  is time for polymer solution in the Ubbelohde apparatus type 3C.

**Table 5.3:** Viscosity values of PLGA<sub>50:50</sub>.

C (g/dl)	Average Time t (sec)	Relative Viscosity $\eta_{rel} = t/t_0$	Specific Viscosity $\eta_{sp} = (t - t_0)/t_0$	Reduced Viscosity $\eta_{red} = \eta_{sp}/C$	Inherent Viscosity $\ln \eta_{rel}/C$
0.00	129.65	1.00	0.00	—	—
0.50	172.78	1.33	0.33	0.67	0.57
1.00	226.65	1.75	0.75	0.75	0.56
1.50	295.23	2.28	1.28	0.85	0.55
2.00	359.98	2.78	1.78	0.89	0.51

Variations of efflux times with polymer concentration (C) and reduced specific viscosity ( $\eta_{sp}$ ) and inherent viscosity ( $\ln \eta_{rel}/C$ ) were plotted and from the graph the point of intersection of reduced viscosity and inherent viscosity at the Y-axis gives the intrinsic viscosity  $[\eta] = 0.60$ . By using the Mark-Houwink Relationship (MHR)  $[\eta] = KM^a$  with  $K = 5.43 \cdot 10^{-4}$  dl/g and  $a = 0.73$ , we obtain:  $M = 14\,756$  g/mol.

Commercial Sodium hyaluronate, or Hyaluronic acid (HA) is commonly its sodium salt form. It was purchased from Javene™, France. Viscosity given by the supplier in the data sheet is 2.4- 3.2 m<sup>3</sup>/kg, molecular weight 2.0-3.0×10<sup>6</sup> Dalton and measured intrinsic viscosity as per procedure is  $[\eta] = 2.92$ . By



using the Mark-Houwink Relationship (MHR) with  $K = 2.26 \times 10^{-5}$  dl/g and  $a = 0.796$ , the molecular weight we obtain:  $M_{vis} = 2\,637\,540$  g/mol.

### 1.1.2 Discussion on the Molecular Mass

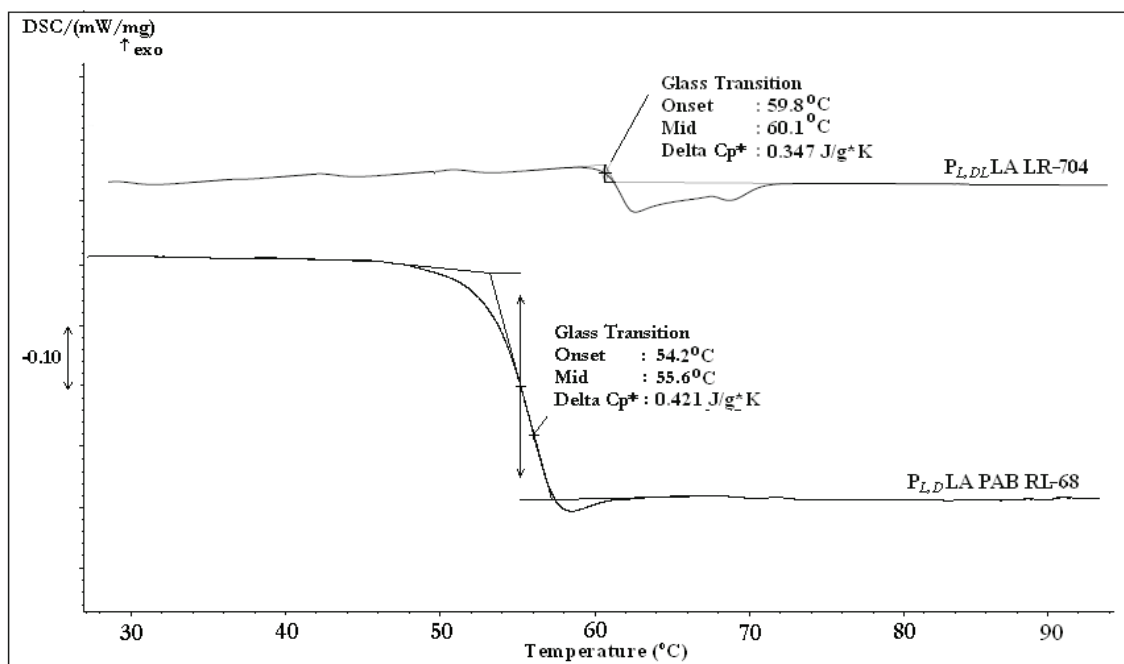
Experimental results have been compared with values given in data sheets with the different polylactides. All the values, reported on Table 5.4, are in the range of the specifications. Moreover, the separation between the two main medical applications of the polylactides seems to be governed by the intrinsic viscosity range of the polymers. Below a certain molecular mass (*i.e.* the critical mass), oligomers are used as controlled release and above this critical mass polymers can be used as medical device. As shown on Table 5.4, differences between polylactides of the same inherent viscosities range are not significant; they can be chosen whatever their origin (Lactel, Purac, Boehringer).

**Table 5.4:** Comparison between molecular weight of various polylactides.

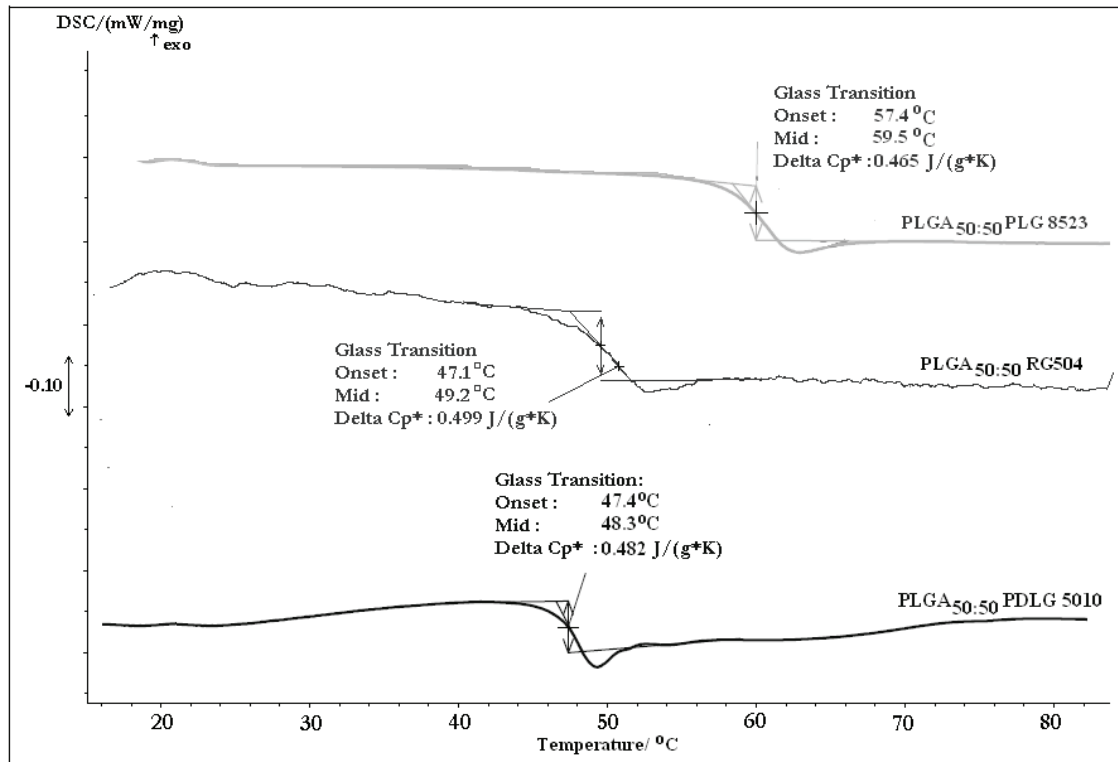
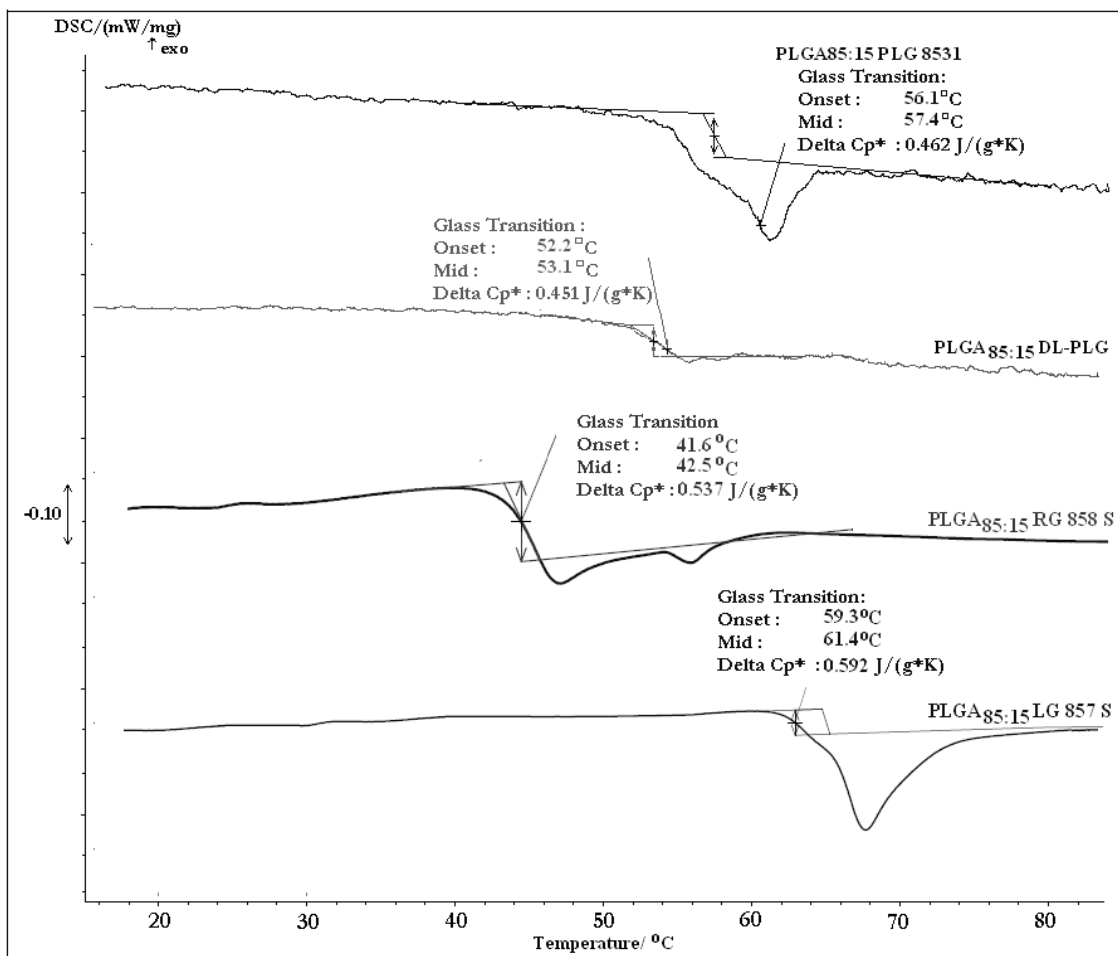
Poly lactides	Data Sheet* $\eta_{inh}(dL/g)$	Experiments $\eta_{inh}(dL/g)$	$M_w$ Deduced from MHR	Applications
$P_{L,D}LA$ (PABR L 68)	2.33	2.24	163 971	Packaging
$P_{L,DL}LA$ (Resomer <sup>®</sup> LR 704)	2.0 – 2.8	2.68	201 169	Medical device
PLGA <sub>85:15</sub> (Resomer <sup>®</sup> RG 858S)	1.3 – 1.7	1.62	57 529	Controlled release
PLGA <sub>85:15</sub> (DL-PLG)	0.55 – 0.75	0.72	18 943	Controlled release
PLGA <sub>50:50</sub> (PLG 8523)	2.27	2.21	88 033	Medical device
PLGA <sub>85:15</sub> (PLG 8531)	3.11	2.96	131 366	Medical device
PLGA <sub>85:15</sub> (LG 857 S)	5.0 – 7.0	6.63	396 495	Medical device
PLGA <sub>50:50</sub> (Resomer <sup>®</sup> RG 504)	0.45 – 0.60	0.59	14 756	Controlled release
PLGA <sub>50:50</sub> (PDLG 5010)	1.03	0.97	28 494	Medical device

### 1.1.3 Characterization of Polylactide Powders by DSC

The thermograms of the different PLAs and PLGAs are presented in the Figure 5.2, Figure 5.3 and Figure 5.4. The thermograms are representative of the second scan run.



**Figure 5.2:** Thermograms of various PLAs.

Figure 5.3: Thermograms of different PLGA<sub>50:50</sub>.Figure 5.4: Thermograms of different PLGA<sub>85:15</sub>.

### 1.1.4 Discussion on the Transitions

The parameters of the observed glass transition measured by DSC are reported on Table 5.5, determined by the DSC technique.

**Table 5.5:** Glass transitions parameters of the various polylactides.

Poly lactide	T <sub>Onset</sub> (°C)	T <sub>Midpoint</sub> (°C)	ΔC <sub>p</sub> (J/g.K)	T <sub>g</sub> (°C) (supplier)
P <sub>L,D</sub> LA (PABR L 68)	54.2	55.6	0.421	54.9
P <sub>L,DL</sub> LA (Resomer <sup>®</sup> LR 704)	59.8	60.1	0.347	56–62
PLGA <sub>85:15</sub> (Resomer <sup>®</sup> RG 858S)	41.8	42.7	0.388	43
PLGA <sub>85:15</sub> (DL-PLG)	52.2	53.1	0.451	50–55
PLGA <sub>50:50</sub> (PLG 8523)	57.4	59.5	0.465	55–60
PLGA <sub>85:15</sub> (PLG 8531)	56.1	57.4	0.462	55–60
PLGA <sub>85:15</sub> (LG 857 S)	59.3	61.4	0.392	57–63
PLGA <sub>50:50</sub> (Resomer <sup>®</sup> RG 504)	47.1	49.2	0.499	46–50
PLGA <sub>50:50</sub> (PDLG 5010)	47.7	49.1	0.524	46–50

Polymer molecules are often partially crystalline, with crystalline regions dispersed within amorphous material. Chain disorder or misalignment, which is common, leads to amorphous material since twisting, kinking and coiling prevent strict ordering required in the crystalline state. Thus, linear polymers with small side groups, which are not too long form crystalline regions easier than branched, network, atactic polymers, random copolymers, or polymers with bulky side groups. Crystalline polymers are denser than amorphous polymers, so the degree of crystallinity can be obtained from the measurement of density.

Crystallinity is indicative of amount of crystalline region in polymer with respect to amorphous content. Crystallinity influences many of the polymer properties such as hardness, modulus, tensile, stiffness, and melting point. The ratio of glycolide to lactide at different compositions allows control of the degree of crystallinity of the polymers [Park *et al.*, 1995; Cohn *et al.*, 1987]. When the crystalline PGA is co-polymerized with PLA, the degree of crystallinity is reduced and, as a result, this leads to increase in rates of hydration and hydrolysis. It can therefore be concluded that the degradation time of the copolymer is related to the ratio of monomers used in synthesis. In general, the higher the glycolide content, the quicker the rate of degradation has been observed [Park, 1995].

#### 1.1.4.1 Effect of L and DL Ratio on Thermal Property of Polylactide Acid

For thermal properties, it can be observed that P<sub>L,DL</sub>LA copolymers showed T<sub>g</sub> glass transition temperature ranging 55–60°C. However, only P<sub>L,D</sub>LA copolymers containing 10 mol % D,LLA showed T<sub>g</sub> of 54°C; similarly the T<sub>m</sub> melting point of these two polymers were also at 154 and 143°C, respectively. These copolymers had lower degree of crystallinity than that of P<sub>L</sub>LA homopolymer (~50%). Buchatip *et al.* [2008] also produced similar type of results explaining that T<sub>g</sub> glass transition, T<sub>m</sub> melting temperature as well as crystallinity of the copolymers decreased as mol% of D,LLA comonomer increased. Melting peak and crystallinity can not be observed in P<sub>D,L</sub>LA homopolymer and copolymers with more than 10 mol % of D,LLA suggesting the amorphous nature of these polymers.

Apart from this discussion, it may be noted that the different processes used for the copolymerization (polycondensation/open ring polymerization/copolymerization) and the nature of catalyst used also plays an important role in the crystallinity and other properties of the final copolymer.

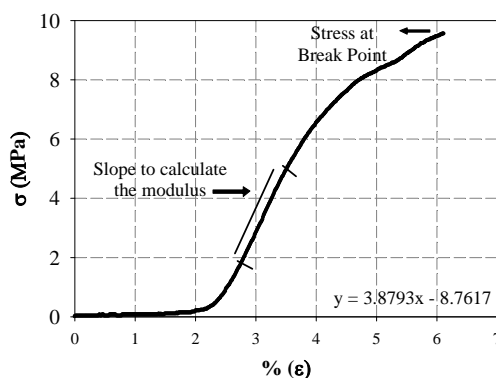
### 1.1.4.2 Effect of LA/GA Ratio on $T_g$ of Polylactides

The LA/GA ratio plays an important role on the properties of copolymer. GA content has a great effect on the molecular weight of the resulting PLGA copolymers. The  $M_w$  of the copolymer increases and the  $M_w/M_n$  decreases with an increased GA content. The PLA homopolymer has the lowest  $M_n$  and the largest polymolecularity. Every polymer exhibits only one  $T_g$  glass transition temperature which indicate that all these PLGA copolymers are amorphous. Literature survey revealed that the degree of crystallinity in cast polymer was controllable by the copolymerization of glycolide with lactide at different compositions, with those of 22 – 66 wt % glycolide being fully amorphous [Gilding and Reed, 1979]. PLGA<sub>85:15</sub> and PLGA<sub>50:50</sub> with different LA/GA copolymers ratio show glass transitions in the range of 52–60°C and ~ 47.5°C, respectively. The decrease of  $T_g$  may result from the increase of the GA component in the PLGA copolymers.

## 1.2 Characterization of Biomaterials Pellets

### 1.2.1 Mechanical Experiments

The mechanical properties of the polymer used were measured by performing the Brazilian test as per procedure described in chapter 4. The data obtained from the test is transformed into stress strain graph and from the graph we obtain the modulus, stress at break and elongation (cf. Figure 5.5).



**Figure 5.5:** Stress strain curve obtained from Brazilian test for  $P_{L,D}LA$  (PAB RL 68).

Three pellets were tested for each polymer for the Brazilian test and mean value for the results were taken into account.

### 1.2.2 Discussion on Mechanical Modulus

The results of the Brazilian test carried out on the polymers are tabulated in Table 5.6.

**Table 5.6:** Mechanical Properties of the polymer used.

Polylactide	Degree of Crystallinity $\chi_c$	Stress at Break (MPa)	Elongation (%)	Young Modulus (GPa)
$P_{L,D}LA$ (PAB RL 68)	Amorphous	9.6	8.7	3.80
$P_{L,DL}LA$ (Resomer <sup>®</sup> LR 704)	12.4%	4.3	2.8	2.93
PLGA <sub>85:15</sub> (Resomer <sup>®</sup> RG 858S)	Amorphous	4.1	1.67	2.10
PLGA <sub>85:15</sub> (DL-PLG)	Amorphous	3.7	14.8	1.96
PLGA <sub>50:50</sub> (PLG 8523)	18.4%	5.3	1.9	2.73
PLGA <sub>85:15</sub> (PLG 8531)	26.8%	8.7	1.5	3.12
PLGA <sub>85:15</sub> (LG 857 S)	Amorphous	6.8	2.7	3.91
PLGA <sub>50:50</sub> (Resomer <sup>®</sup> RG 504)	Amorphous	2.9	11.2	1.41
PLGA <sub>50:50</sub> (PDLG 5010)	Amorphous	4.3	9.16	1.86

Crystallization, crystallinity degree, and thermal properties of P<sub>L</sub>LA depend on the polymer molecular weight, polymerization conditions, thermal history, purity, and so on. As reported by *Ikada et al.* [1987], blending of P<sub>L</sub>LA and P<sub>D</sub>LA results in the formation of a stereo-complex with a crystalline structure different from that of each homopolymer and melting temperatures that reach 230°C. Contradictory data are reported about P<sub>L</sub>LA melting enthalpy, ranging in the literature from 40 to 203 J/g. To calculate the degree of crystallinity, we have used the most common value adopted for the melting enthalpy of the totally crystallised P<sub>L</sub>LA, [*Auras et al.*, 2010].

$$\chi_c \% = 100 (\Delta H_m - \Delta H_c)/93.6$$

Poly(lactic acid) (PLA) is a glassy, high modulus thermoplastic polymer with properties comparable to polystyrene (PS). The mechanical properties of the polylactides depends upon the manufacturing method, the crystallinity factor, the T<sub>g</sub> and ratio of L-lactide, D-lactide or racemic D,L-lactide contents. In case of poly(lactic -co-glycolic) acid the properties are intermediate between those of poly lactic acid and polyglycolic acid. There is increase in the mechanical properties but a decrease in the T<sub>g</sub> due to the addition of PGA structure.

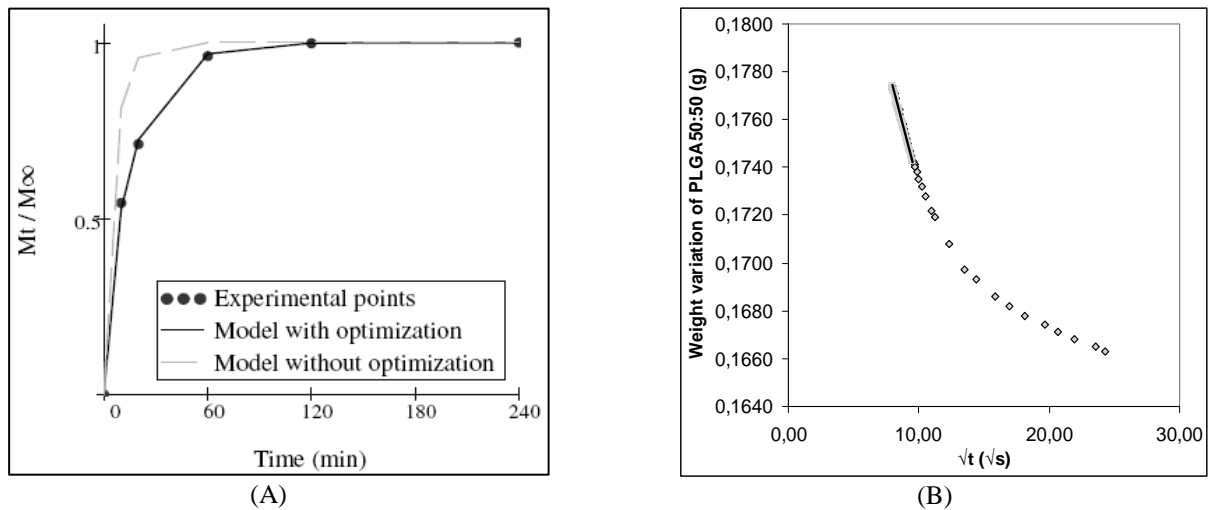
## 2 Kinematics and Thermodynamics Experiments

The aim of the sorption-desorption studies was to be able to consider the foaming phenomenon more precisely. Thus, in this part, we have realized experiments to achieve the sorption kinetics by using the desorption data. As we have mentioned earlier, the sorption behaviour of CO<sub>2</sub> into the polymer determines the number of nuclei generated and it deserves a proper investigation. We have also investigated the desorption phenomenon which has influence both on the pore growth and the final structure of the polymer.

### 2.1 Sorption-Diffusion Kinetics

The aim to plot kinetic curves was to determine the time of saturation of the polymer by CO<sub>2</sub>. To obtain kinetic curves, experiments of 10, 20, 60, 120 and 240 minutes have been performed. As shown in Figure 5.6-(A), the sorption curve is reaching to a plateau after 60 minutes of processing which means that the polymer can be considered to be quiet saturated by CO<sub>2</sub> after 60 minutes at 125 bars and 36.5°C. In Figure 5.6-(B), M<sub>t</sub> denotes the weight of CO<sub>2</sub> inside the polymer at time t, and M<sub>∞</sub> is the maximum sorbed amount of CO<sub>2</sub>. Here, all M<sub>t</sub> values are the extrapolated data (to t = 0) of the initial linear parts of the desorption curves as presented in Chapter 3, section 4. Each M<sub>t</sub> value is analyzed after different experiments. M<sub>∞</sub> has been taken as the value of 240 minutes, where the equilibrium is supposed to be completely reached.

The sorption behaviour is modelled using one dimensional diffusion equation from a plane sheet (Eq.2,2), chapter 2. The *Minerr* function of *Mathcad* has been used to optimize the modelling and to calculate the average sorption-diffusion coefficient. Thus, the sorption diffusion coefficient was found as  $3.64 \times 10^{-10} \text{ m}^2\text{s}^{-1}$  for P<sub>sat</sub> = 125 bars, T<sub>sat</sub> = 36.5°C and t<sub>sat</sub> = 120 min. Indeed, the capacity of sorption of CO<sub>2</sub>, thus the diffusion coefficient must increase with the increasing amount of CO<sub>2</sub> solubilized in the polymer, but to simplify the calculations, we have considered an average sorption-diffusion coefficient all across the time interval. *Mathcad* programs for diffusion are presented in Annex A-2. The the model is in very good agreement with experimental data as show in Figure 5.6-(A).



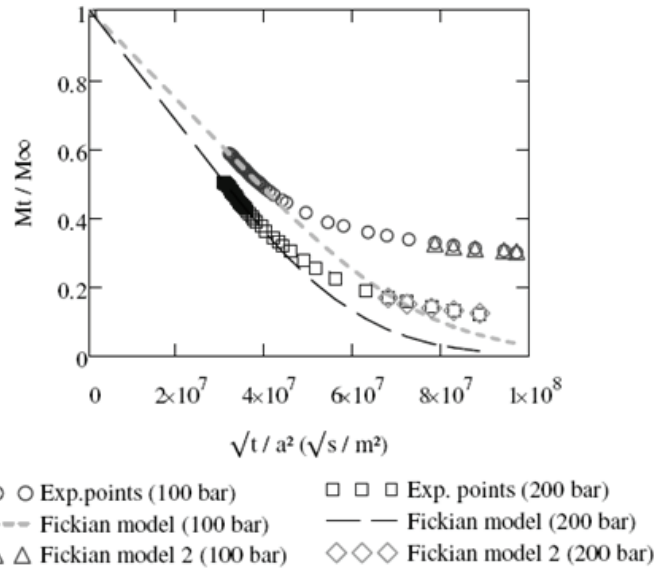
**Figure 5.6:** (A)-Kinetics and modelling of the sorption of CO<sub>2</sub> in PLGA<sub>50:50</sub> at 125 bar and 36.5°C, (B) Desorption of CO<sub>2</sub> from PLGA<sub>50:50</sub> of CO<sub>2</sub> in PLGA<sub>50:50</sub> at 125 bars and 36.5°C.

## 2.2 Desorption-Diffusion Kinetics

Desorption kinetics of CO<sub>2</sub> from PLGA<sub>50:50</sub> have been studied in order to analyze the amount of CO<sub>2</sub> sorbed, but also to provide diffusion data with different saturation times and pressures. We must remember that the  $M_t$  values used in desorption studies are different from the ones in sorption kinetics. In desorption kinetics, during the decrease of CO<sub>2</sub> weight,  $M_t$  denotes the quantity of CO<sub>2</sub> present in the polymer at time  $t$ , and it has been analyzed by the desorption method described previously. Only the  $M_\infty$  value is found by the extrapolation of the initial parts of desorption curve. On the other hand, the desorption-diffusion coefficients are calculated using Fickian diffusion from a plane sheet.

Figure 5.7 presents desorption data as  $M_t/M_\infty$  which is plotted against the  $\sqrt{t/a^2}$  after processed with different saturation pressures, 100 and 200 bars. Here, the factor “a” is corresponding to the semi-thickness of the polymer pellet and  $t = 0$  s is the end of the saturation period. It is obvious that the desorption shows a linear behaviour until approximately 65% of the total amount of CO<sub>2</sub> sorbed. After that value, the experimental data diverges from the Fickian model. In the literature, this kind of behaviour is generally attributed to the vitrification of the polymer and the non-Fickian diffusion behaviour of the CO<sub>2</sub> from glassy polymers. This divergence is greater for the values of 100 bars than for the values of 200 bars. Additionally, the  $M_t/M_\infty$  value of the desorption curve from 200 bars is smaller than of the 100 bars all across the time scale.

Thus, the Fickian model of diffusion has been applied for the regions of divergence. The model plotted (cf. Figure 5.7) is in a very good agreement with the experimental data. This behaviour can be explained by the double Fickian diffusion. When the polymer changes its state from rubbery to glassy, the diffusion coefficient changes but the behaviour of diffusion is assumed Fickian. As of this moment, we consider that the intersection of the extrapolation of the second curve with the initial curve gives the vitrification point of the polymer. This point reflects the glass transition temperature of the polymer as the drop of the temperature and the desorption curve of CO<sub>2</sub>. At 100 bars and 200 bars, we have 0.35 and 0.19 for the  $M_t/M_\infty$ , respectively. These data correspond, to the weight fraction of CO<sub>2</sub> in PLGA<sub>50:50</sub> of 0.082 and 0.057, respectively. Hence, the corresponding vitrification time is 2.72 s and 2.64 s for 100 bars and 200 bars, respectively. So, we have used the data and the model shown in Figure 5.7, to calculate the diffusion coefficients.



**Figure 5.7:** Desorption of CO<sub>2</sub> from PLGA<sub>50:50</sub> after 100 and 200 bars, at T<sub>sat</sub> = 36.5°C and t<sub>sat</sub> = 120 min.

Table 5.7 shows that the desorption-diffusion coefficient of CO<sub>2</sub> is increasing, in the range between 10<sup>-11</sup> and 10<sup>-9</sup>, with the increase of the saturation time. The desorption-diffusion coefficient, D<sub>dp</sub>, has an increasing trend and finally reaches a plateau after 60 minutes for P<sub>sat</sub> = 125 bar and T<sub>sat</sub> = 36.5°C with a value of 2.10<sup>-9</sup> m<sup>2</sup>/s. These data proves the change in the diffusion coefficient with the variation of CO<sub>2</sub> sorption inside the polymer matrix. We can observe from Table 5.7 that the sorption of CO<sub>2</sub> into the polymer increases with increasing time until it reaches a plateau after 60 minutes. One can say that the capacity of sorption increases with the sorption of CO<sub>2</sub> into the polymer.

**Table 5.7:** Desorption-diffusion coefficients and sorption of CO<sub>2</sub> after different saturation times at saturation pressure 125 bars and saturation temperature 36.5°C.

t <sub>sat</sub> (min)	D <sub>dp</sub> (m <sup>2</sup> / s)	Sorption of CO <sub>2</sub> into the PLGA <sub>50:50</sub> (g CO <sub>2</sub> / g Polymer)
10	7.29 x 10 <sup>-11</sup>	0.153
20	1.62 x 10 <sup>-10</sup>	0.195
60	2.01 x 10 <sup>-9</sup>	0.270
120	2.05 x 10 <sup>-9</sup>	0.281
240	2.06 x 10 <sup>-9</sup>	0.281

Also, as shown in Table 5.8, the desorption-diffusion coefficient increases with increasing saturation pressure. Since the density of CO<sub>2</sub> increases with the pressure, it is expected that the sorption capacity increases with the increasing pressure. On the other hand, the desorption-diffusion coefficients calculated for rubbery states, D<sub>dp</sub>, are always greater than the diffusion coefficients after vitrification, D<sub>dg</sub>.

**Table 5.8:** Desorption-diffusion coefficients of CO<sub>2</sub> from PLGA<sub>50:50</sub> for plasticized and glassy states, after different saturation pressures at 36.5°C for 120 min of saturation time.

P <sub>sat</sub> (bar)	D <sub>dp</sub> (m <sup>2</sup> / s)	D <sub>dg</sub> (m <sup>2</sup> / s)
55	1.437 x 10 <sup>-10</sup>	-
80	1.734 x 10 <sup>-10</sup>	-
100	2.140 x 10 <sup>-9</sup>	2.321 x 10 <sup>-11</sup>
125	2.050 x 10 <sup>-9</sup>	7.727 x 10 <sup>-11</sup>
150	2.606 x 10 <sup>-9</sup>	1.753 x 10 <sup>-10</sup>
200	3.321 x 10 <sup>-9</sup>	2.854 x 10 <sup>-10</sup>



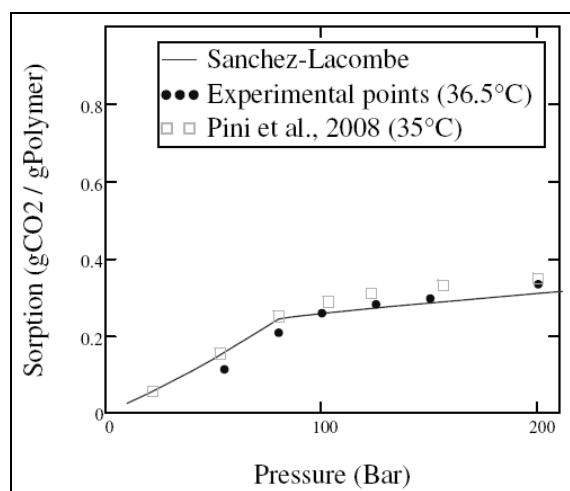
## 2.3 The Sorption Isotherm

By using desorption kinetics, the initial points of desorption have been extrapolated to  $t = 0$  s and the amount of  $\text{CO}_2$  sorbed by the polymer is analyzed. We underline that here,  $t = 0$  s is the end of the saturation period. One can remember that the nucleation rate is related to the  $\text{CO}_2$  at the end of the saturation period. Thus, we must know how much  $\text{CO}_2$  is sorbed by the polymer to calculate the nucleation rate. All experiments have been carried out at  $36.5^\circ\text{C}$  during 120 minutes with different pressure conditions. The pressure conditions and the corresponding sorption data is presented in Table 5.9. It has been observed that the sorption increases monotonically with the pressure.

**Table 5.9:** Sorption data for PLGA<sub>50:50</sub> at  $36.5^\circ\text{C}$ .

P (bar)	Average Sorption Data (gCO <sub>2</sub> /g Polymer)
55	0.112
80	0.207
100	0.258
125	0.281
150	0.296
200	0.333

Experimental results and model predictions are presented with the literature data in Figure 5.8. A significant change in slope is appeared within the interval of 70-80 bars. The change in the slope can be explained by the transition of the  $\text{CO}_2$  rich phase from gas to the much denser supercritical state.



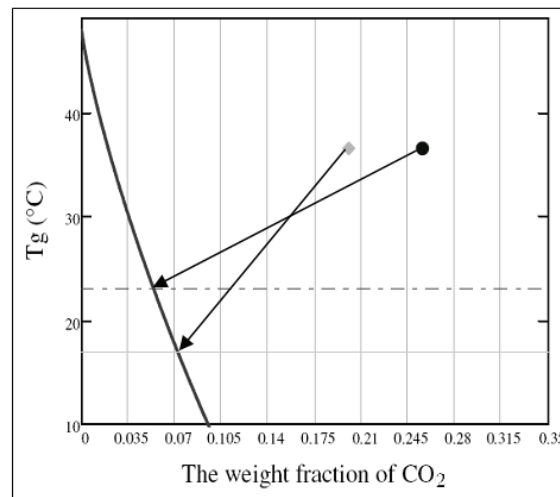
**Figure 5.8:** Sorption isotherm of  $\text{CO}_2$  into PLGA<sub>50:50</sub>.  
[Pini et al., 2008]

Our sorption isotherm and modelling with SL-EOS, is in agreement with those reported by Pini et al. [2008]. Our experimental points were always approximately 5% lower than the literature data which can be attributed to the small temperature difference. Indeed, the density of  $\text{CO}_2$ , so the sorption decreases with the temperature. Additionally, under the critical point of  $\text{CO}_2$ , SL-EOS diverges from the experimental data. But, it has good estimations above critical point for the sorption.

Furthermore, since we have investigated the sorption kinetics earlier, we have also a sorption kinetic data. This evaluation was presented in Table 5.8 and found to increase with time until it reaches a plateau after 60 minutes. If we interpolate the isothermal sorption data for 120 minutes (Figure 5.8 and Table 5.9) between 55 and 80 bars, a sorption value of 0.195 can be found for 76.2 bars. This value is equal to the

sorption value at 125 bars and 20 minutes (cf. Table 5.8). Thus, we can state that there is not any difference to process a PLGA<sub>50:50</sub> at 125 bars for 20 minutes or at 76.2 bars for 120 minutes.

One of the most important issues of the foaming phenomena is the depression of the glass transition of the polymer by the sorption of CO<sub>2</sub>. As presented in the Figure 5.9, as the weight fraction of CO<sub>2</sub> is greater than 0.02 at ~36.5°C, the saturation process is happening in plasticized state. We have observed that, when the same depressurization rate is applied to the system (5 bar/s), the temperature at the gas output of the pressure chamber is dropping to approximately 17°C and ~26°C when 100 bars and 200 bars of saturation pressure are applied respectively. According to the T<sub>g</sub>-w diagram and the desorption data, the polymer saturated at 200 bars is closer to the vitrification point when the depressurization is finished. However, the polymer processed at 100 bars remains in plasticized state until the end of the depressurization. On the other hand, we have experimented that the swelling continues approximately 2-3 minutes after finishing the depressurization of the chamber which correspond to the plasticized state of the polymer.



**Figure 5.9:** The depression of PLGA<sub>50:50</sub> T<sub>g</sub> as a function of the weight fraction of sorbed CO<sub>2</sub>: (◆) 100 bars; (●) 200 bars.

### 3 Influence of the Process Parameters on the Microstructure of Scaffolds

#### 3.1 Effect of Polymer Blend Compositions

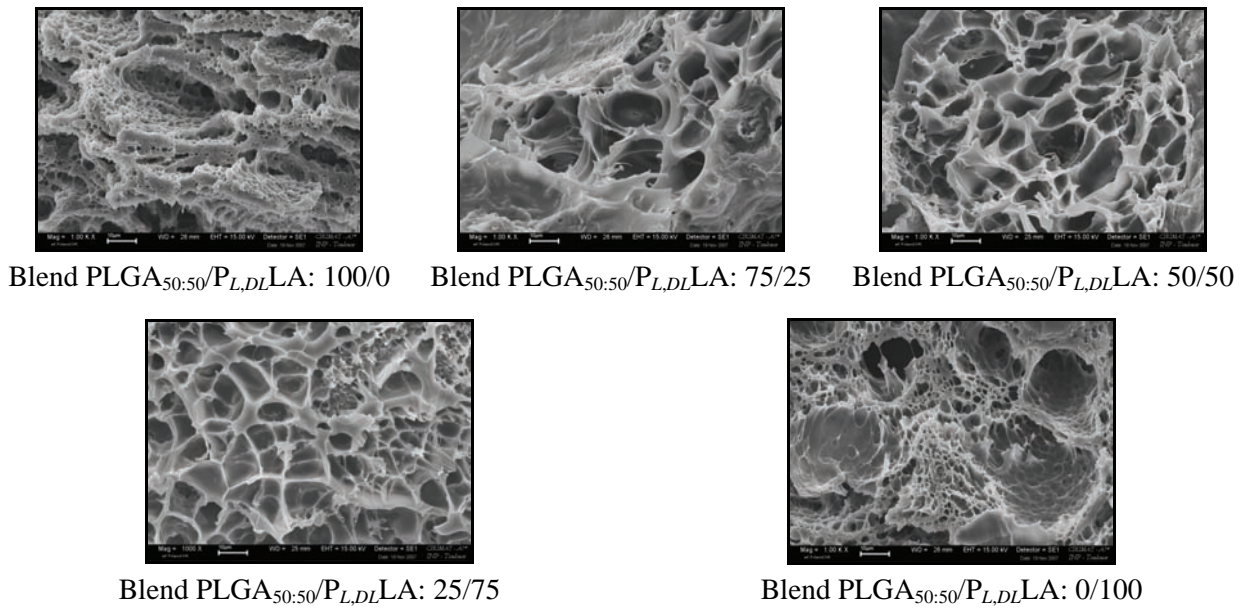
##### 3.1.1 Blends of P<sub>L,DL</sub>LA and PLGA<sub>50:50</sub>

First experiments on polylactides were carried out to understand which polymer is more suitable to use in tissue engineering. Foaming experiments are performed on blends of P<sub>L,DL</sub>LA (LR-704) and PLGA<sub>50:50</sub> (RG-504), with different ratios, as given in the Table 5.10.

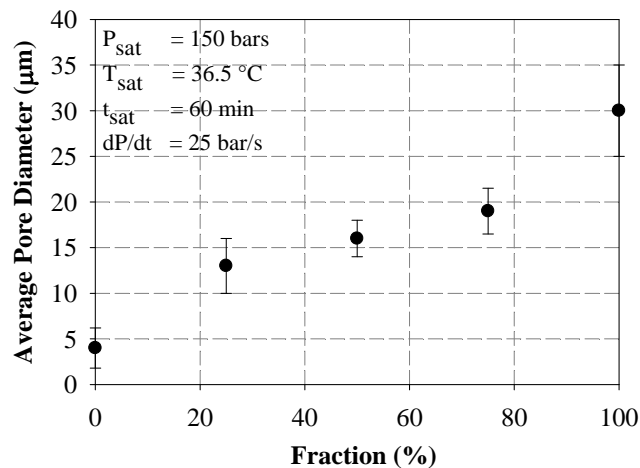
**Table 5.10:** Blends of PLGA<sub>50:50</sub> and P<sub>L,DL</sub>LA.

Blend	w/w	w/w	w/w	w/w	w/w
PLGA <sub>50:50</sub>	100%	75%	50%	25%	0%
P <sub>L,DL</sub> LA	0%	25%	50%	75%	100%

The following scCO<sub>2</sub> parameters are kept constant: saturation pressure P<sub>sat</sub> = 150 bars, saturation time t<sub>sat</sub> = 60 minutes, saturation temperature T<sub>sat</sub> = 36.5°C and depressurization rate dP/dt = 25 bar/sec and the SEM images of the corresponding scaffolds are presented in Figure 5.10.



**Figure 5.10:** Micrographs of the P<sub>L,DL</sub>LA and PLGA<sub>50:50</sub> blend scaffolds.



**Figure 5.11:** Average pore diameter of polymer blends as a function of P<sub>L,DL</sub>LA ratio.

### 3.1.2 Discussion on the Blends of P<sub>L,DL</sub>LA and PLGA<sub>50:50</sub>

The results revealed that the pore diameter is increasing linearly with increasing amount of LA in the blend (cf. Figure 5.11). This behaviour is conforming to the literature [Liu and Tomasko, 2007b]. The first reason, for the decrease in pore size, can be explained by a better affinity to CO<sub>2</sub> of LA than GA in the polymer blend. Secondly, low pores size can be due to high saturation pressure and low saturation temperature with comparison to the T<sub>g</sub> of both polymers (cf Table 5.5).

### 3.1.3 P<sub>L,DL</sub>LA and PLGA<sub>85:15</sub> Blend

In the previous experiments pore sizes obtained were not very large for medical application, so we replaced PLGA<sub>50:50</sub> with PLGA<sub>85:15</sub> in order to increase the lactic acid contents in the blend (cf. Table 5.11).

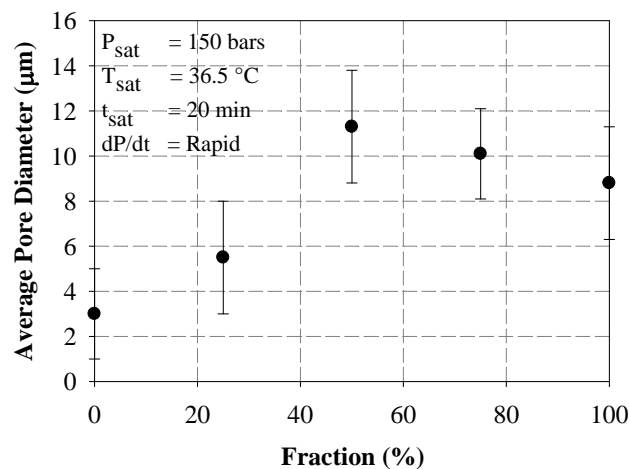
**Table 5.11:** Blends of PLGA<sub>85:15</sub> and P<sub>L,DL</sub>LA.

Blend	w/w	w/w	w/w	w/w	w/w
PLGA <sub>85:15</sub>	100%	75%	50%	25%	0%
P <sub>L,DL</sub> LA	0%	25%	50%	75%	100%

The processing parameters are: saturation pressure  $P_{\text{sat}} = 150$  bars, saturation time  $t_{\text{sat}} = 20$  minutes, saturation temperature  $T_{\text{sat}} = 36.5^\circ\text{C}$  and rapid depressurization rate  $dP/dt$  ( $dP/dt$  time less than 3 sec). The saturation time for PLGA<sub>85:15</sub> has been reduced from 60 minutes to 20 minutes because we have increased the LA/GA ratio. Pini *et al.* [2008] have proved that the concentration of  $\text{CO}_2$  inside PLGA<sub>85:15</sub> is greater than inside PLGA<sub>50:50</sub> during the foaming process.

### 3.1.4 Discussion on the Blends of $P_{L,DL}LA$ and PLGA<sub>85:15</sub>

Foaming experiments on blends of  $P_{L,DL}LA$  and PLGA<sub>85:15</sub> revealed that the pore diameter is first increased and then decreased with increasing amount of PLGA<sub>85:15</sub> in the blend. As shown in Figure 5.12, there is one composition (50%  $P_{L,DL}LA$  + 50% PLGA<sub>85:15</sub>), at which the average pore size is maximum. Moreover, the average pore size is lower than with the previous blends with the PLGA<sub>50:50</sub>.



**Figure 5.12:** Average pore diameter of polymer blends as a function of  $P_{L,DL}LA$  ratio.

These preliminary experiments on (PLGA<sub>50:50</sub> +  $P_{L,DL}LA$ ) blends and (PLGA<sub>85:15</sub> +  $P_{L,DL}LA$ ) blends confirm the literature works [Goel and Beckman, 1994b] concerning the influence of the  $\text{scCO}_2$  parameters on the pore size. Various process parameters (i.e. the pressure, the temperature and the time of the saturation, but also the rate of depressurization) have an influence on the final pore size. The drop of the temperature acts differently on the polymers foaming behaviours. For these reasons, we have carried on different experimental designs.

Our experimental study showed that the solubility of  $\text{CO}_2$  into the polymer increases while the LA content increases in a PLGA co-polymer. Also, the solubility of  $\text{CO}_2$  into  $P_{D,L}LA$  is higher than in PLGA, whatever its composition. This behaviour has been explained by the existence of an extra apolar  $\text{CH}_3$  methyl group in LA than GA [Liu and Tomasko, 2007b], which, according to the authors, can drive to two opposites phenomena: firstly, it decreases the effect of the  $\text{CO}_2$ 's interaction with the carbonyl group of the polymer and secondly, it creates more available free volume for  $\text{CO}_2$  to solubilise. Besides, Kazarian *et al.* [1996b] have found that the interaction of  $\text{CO}_2$  with polymers can also be explained by chemical interactions and  $\text{CO}_2$  can behave like a Lewis acid.

## 3.2 Influence of the Parameters of the $\text{scCO}_2$ Process

### 3.2.1 Model with a $2^4$ Complete Design

We have started with the most basic experimental design, a complete plan with 4 parameters and 2 levels. As listed in Table 5.12, PLGA 100/0 or 0/100 represents the pure PLGA<sub>50:50</sub> or PLGA<sub>85:15</sub> respectively and on the Table 5.13. 25/75, 50/50 and 75/25 denominations are representative of the blends.

**Table 5.12:** Variation domain of the various factors.

Level	T <sub>sat</sub> (°C)	P <sub>sat</sub> (bars)	dP/dt (bar/s)	t <sub>sat</sub> (min)	PLGA <sub>50:50</sub> /PLGA <sub>85:15</sub>
- 1	36.5	100	1	20	100/0
+ 1	60	250	20	20	0/100

**Table 5.13:** 2<sup>4</sup> design of experiments: levels of factors and average size of pores.

Experiment	X <sub>1</sub>	X <sub>2</sub>	X <sub>3</sub>	X <sub>4</sub>	T (°C)	P (bar)	dP/dt (bar/s)	PLGA <sub>50:50/85:15</sub>	Pore Diameter (µm)
1	-1	-1	-1	-1	36.5	100	1	100/0	153
2	-1	-1	-1	1	36.5	100	1	0/100	264
3	1	-1	-1	-1	60	100	1	100/0	130
4	1	-1	-1	1	60	100	1	0/100	187.5
5	-1	1	-1	-1	36.5	250	1	100/0	30.3
6	-1	1	-1	1	36.5	250	1	0/100	72.5
7	1	1	-1	-1	60	250	1	100/0	27
8	1	1	-1	1	60	250	1	0/100	59
9	-1	-1	1	-1	36.5	100	20	100/0	367.5
10	-1	-1	1	1	36.5	100	20	0/100	71
11	1	-1	1	-1	60	100	20	100/0	151.5
12	1	-1	1	1	60	100	20	0/100	108
13	-1	1	1	-1	36.5	250	20	100/0	4
14	-1	1	1	1	36.5	250	20	0/100	25
15	1	1	-1	-1	60	250	1	100/0	23
16	1	1	-1	1	60	250	1	0/100	36
17	-1	1	-1	-1	36.5	250	1	100/0	47
18	1	1	-1	1	60	250	1	0/100	61
19	-1	-1	-1	0	36.5	100	1	50/50	258
20	1	-1	-1	0	60	100	1	50/50	60
21	-1	-1	1	0.5	36.5	100	20	25/75	93.5
22	1	-1	1	0.5	60	100	20	25/75	110
23	-1	1	1	-0.5	36.5	250	20	75/25	3
24	1	1	-1	-0.5	60	250	1	75/25	23
25	-1	1	-1	0.5	36.5	250	1	25/75	30
26	-1	1	-1	0	36.5	250	1	50/50	36
27	-1	1	-1	-0.5	36.5	250	1	75/25	22.5
28	-1	-1	1	0	36.5	100	20	50/50	222
29	-1	-1	1	-0.5	36.5	100	20	75/25	275

The first 2<sup>4</sup> = 16 values allow us to calculate the coefficients of the two first order models reported on the Table 5.14, the other values play a role to valid the first order model:

$$\tilde{y} = a_0 + a_1 X_1 + a_2 X_2 + a_3 X_3 + a_4 X_4 + a_{12} X_1 X_2 + a_{13} X_1 X_3 + a_{23} X_2 X_3$$

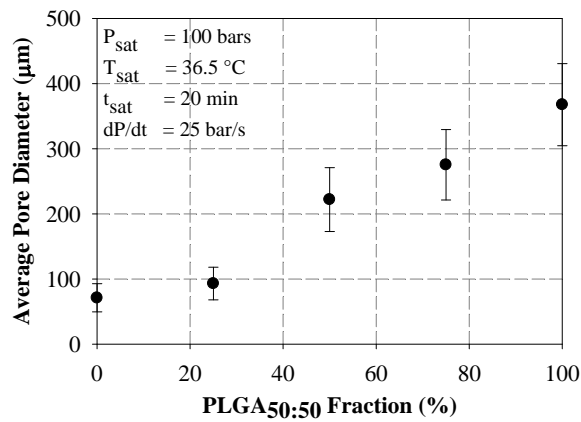
For both blends, it is important to note that the most influent factor is the pressure (a<sub>2</sub>). For PLGA<sub>50:50</sub> the saturation temperature (a<sub>1</sub>) is also an influent effect while it is non influent for the PLGA<sub>85:15</sub>. It is the contrary for factor 3, as the detail given in Table 5.14.

The variation of average pore diameter as a function of PLGA<sub>50:50</sub> fractions in the blends (cf. Figure 5.13), for experiments performed in the same operating conditions, shows that with increasing amount of PLGA<sub>50:50</sub>, the average pore size increases when high depressurization rate (20 bar/s) is applied. Analysis of the average diameter of pores presented in Table 5.13, showed us that to have a trend for bigger

pore size, PLGA<sub>50:50</sub> must be used instead of PLGA<sub>85:15</sub>. These results are in conformation with the observations of *Tai et al.* [2007b]. These authors found that when greater depressurization times are applied (actually very low, approximately 1 to 2 hours), the pore size is increasing with increasing LA composition of the PLGA co-polymer.

**Table 5.14:** Coefficients of the  $2^4$  model for the PLGA<sub>85:15</sub> and the PLGA<sub>50:50</sub>.

	$\hat{a}_{50-50}$	$\hat{a}_{85-15}$
$a_0$	83.4	111.1
$a_1$	-55.3	3.0
$a_2$	-117.1	-46.5
$a_3$	-1.2	-31.8
$a_{12}$	4.4	12.9
$a_{13}$	-48.3	28.4
$a_{23}$	-60.2	36.4



**Figure 5.13:** Average pore diameter as a function of PLGA<sub>50:50</sub> ratio in the PLGA<sub>50:50</sub>/PLGA<sub>85:15</sub> blends.

The comparison between the first order model theory and experimental data has been realized and the Fisher-Snedecor test has been applied. The critical value with the error probability alpha of 5% and one degree of liberty at both the numerator and the denominator variance give  $F_c = 161.4$ . The average pore value is equal, in the PLGA<sub>50:50</sub> model to 222.4 and the PLGA<sub>85:15</sub> model to 1.1. This first order model is not statistically well suited in the PLGA<sub>50:50</sub> model. As various process parameters are correlated, it is necessary to control their effects by using a multifactor design.

### 3.2.2 Model with a Taguchi' Design for PLGA<sub>50:50</sub> Foaming

Taguchi' design is a screening plan which helps at the determination of the more influent parameters for the experimental plan. We have chosen a  $L_9$  table and decided to continue only with the PLGA<sub>50:50</sub>. Thus, it has left us 4 process parameters to optimize: the pressure, the temperature, the time of saturation and the rate of depressurization. The domain of definition of this Taguchi design is presented in Table 5.15.

**Table 5.15:** Domain of definition for the Taguchi' design.

Factors	$T_{sat}$ (°C)	$P_{sat}$ (bar)	$t_{sat}$ (min)	$dP/dt$ (bar/s)
Level 1	36.5	120	20	3
Level 2	45	150	45	5
Level 3	60	200	90	10

Figure 5.15 represents the variation of the effects of the four process factors on the corresponding pore diameter. The pore diameter at a given level is estimated by taking the average of the average pore

diameters. Except for the experiment P9, all produced foams have porosity higher than 75%, the maximum being reached for conditions P4 and P6. (cf. Figure 5.14).

On the Table 5.16, A, B and C represent the position of polymer pellet in the chamber, top, centre and bottom position respectively (cf. Figure 4.12-a, Filling the chamber with Teflon). The effects shown in Table 5.17 have global meanings in two ways. The effects of a level are calculated by taking the difference of pore diameter and the global average pore diameter of all experiments. Firstly, if the effect is negative (positive respectively), that means that this factor has a negative (positive) effect and resulting pore diameter will be smaller (bigger). Second, the value is indicative of the importance of the effect.

**Table 5.16:** Experiments with the Taguchi design and the average diameter of pores for PLGA<sub>50:50</sub>.

Experiment	T <sub>sat</sub> (°C)	P <sub>sat</sub> (bar)	t <sub>sat</sub> (min)	dP/dt (bar/s)	Average Pore Diameter			Average* (µm)
					A	B	C	
Nr.								
P1	36.5	120	20	3	549.88	535.02	268.32*	542.45
P2	36.5	150	45	5	9.66	12.54*	9.19	9.42
P3	36.5	200	90	10	4.31	3.66*	4.29	4.30
P4	45	120	45	10	18.82	152.68*	18.25	18.53
P5	45	150	90	3	19.08	11.96*	21.66	20.37
P6	45	200	20	5	9.98	13.19	7.62	10.26
P7	60	120	90	5	127.83	87.50*	101.56	114.70
P8	60	150	20	10	113.23	105.81	80.66*	109.52
P9	60	200	45	3	10.72*	14.15	13.94	14.05

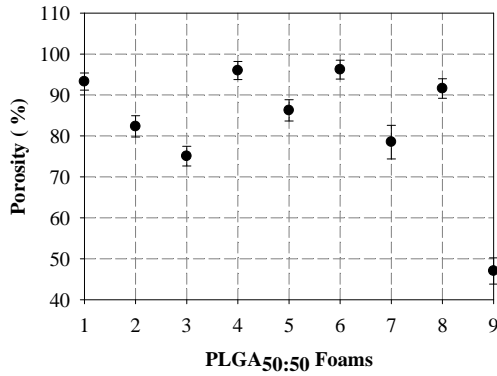
\* values eliminated in the calculation of the average because varying more than 10%

**Table 5.17:** Average diameter of pores for all factors and their effects.

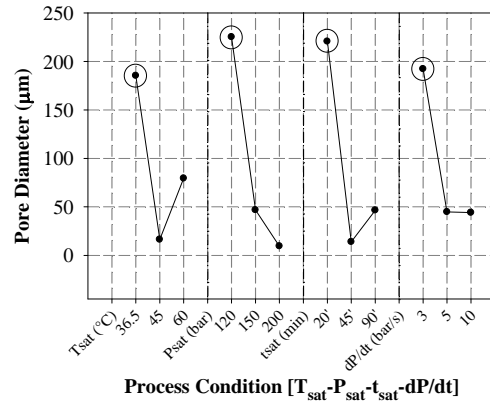
Factor	Variation	<Pore Diameter> (µm)	Effect
T <sub>sat</sub> (°C)	36.5	185.39	91.66
	45	16.39	-77.35
	60	79.42	-14.31
P <sub>sat</sub> (bar)	120	225.22	131.49
	150	46.84	-47.3
	200	9.54	-84.2
t <sub>sat</sub> (min)	20	220.74	127.01
	45	14.0	-79.73
	90	46.46	-47.28
dP/dt (bar/s)	3	192.29	98.55
	5	44.79	-48.94
	10	44.12	-49.62

Figure 5.15 shows that different variations with process parameters are not linear. We can say that the decrease in the saturation pressure, results with an increase in the pore size. The same effect can be seen for the rate of depressurization. For the temperature of saturation, when the temperature is increased, the pore size is first decreased but after a minimum point begin to increase. These behaviours are also reported by Krause *et al.* [2001]. An identical behaviour is observed for the curve of the time of saturation: first a decrease but after 45 minutes, an increase of pore size with time.





**Figure 5.14:** Variation of foam porosity.



**Figure 5.15:** Average pore diameters of PLGA<sub>50:50</sub> scaffolds as a function of the process parameters.

It is possible to obtain a distribution of large pores with PLGA<sub>50:50</sub> either by decreasing the saturation temperature, or the saturation pressure, or the saturation time, or the depressurization rate. However, the interactions between factors are not considered in the Taguchi plan. The effects calculated can only give general ideas on the influences of these factors. Thus, we have decided to fix the process conditions  $T_{sat} = 36.5^{\circ}\text{C}$  and  $t_{sat} = 60$  min for the following experiments.

### 3.2.3 Model with a Doehlert’ Design for PLGA<sub>50:50</sub> Foaming

#### 3.2.3.1 Experiments with a Doehlert’ Design

We have decided to fix two parameters ( $T_{sat}$  at  $36.5^{\circ}\text{C}$  and  $t_{sat}$  at 60 minutes) as the same conditions to be fixed for the thermodynamics experimentations and to continue experiments with a second order model and to use a Doehlert’ design:  $y \sim a_0 + a_1 X_1 + a_2 X_2 + a_{12} X_1 X_2 + a_{11} X_1^2 + a_{22} X_2^2$

The values of  $X_1$  (depressurizing rate) and  $X_2$  (saturation pressure) are reported in Table 5.18. The pellets of PLGA have been placed in the pressure chamber on metal stages with holes which are encircled by a Teflon isolation material (cf. Figure 4.12-a: Filling the chamber with Teflon).

**Table 5.18:** Doehlert’ design and the results for the average diameter of pores.

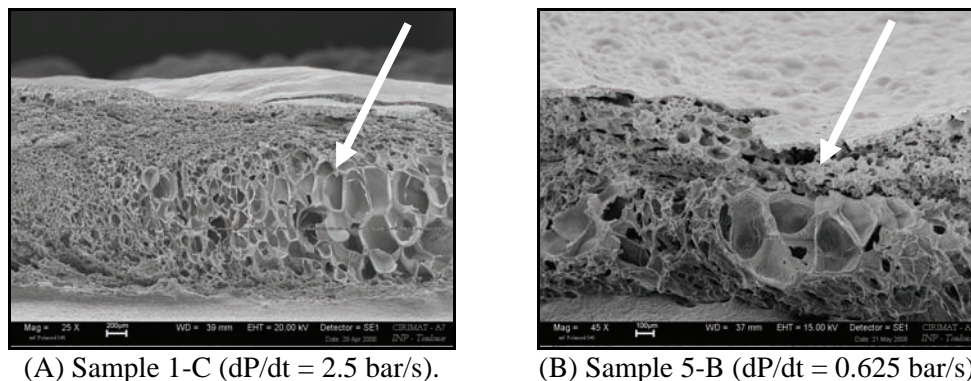
Experiment	Nr	$X_1$	$X_2$	dP/dt (bar/s)	$P_{sat}$ (bars)	Average Pore Diameter			Average* (µm)
						A	B	C	
1	0	0	2.5	125	19.00*	27.03	20.88	23.96	
2	1	0	10	125	11.46	16.55	10.89*	13.85	
3	0.5	0.866	5	150	4.24*	11.75	12.25	12.00	
4	-0.5	0.866	1.25	150	-	13.13	16.91	15.02	
5	-1	0	0.625	125	25.71	30.44	498.45*	28.08	
6	-0.5	-0.866	1.25	100	120.04	304.77	31.13	151.98	
7	0.5	-0.866	5	100	128.14*	223.44	180.87	202.16	

\*values eliminated in the calculation of the average because varying more than 10%

We have observed that, after depressurization, the temperature at the bottom part of the pressure chamber is always colder than at the upper part. This behaviour is in agreement with the variation of the results for the scaffolds placed at different stages. As shown in Table 5.18, for the same experiment, there is always an important variation within the pore size of the scaffolds which were placed at different stages (A, B and C).

It has been observed that when low dP/dt is applied, the pores which are close to the borders of the samples are bigger than the pores which are in the centre of the scaffold. An example to this phenomenon is shown in Figure 5.16. We believe that this phenomenon is due to the volume constraint of the pressure

chamber. Since the polymer swells during desorption of CO<sub>2</sub>, when the polymer has swelled approximately by 50%, the edges of the polymer contact the wall of the chamber. Since the polymer is very soft, due to the depression of the glass transition, the chamber walls block desorption of CO<sub>2</sub> from the edges of polymer, which results in the expanding of the pores in that region. Indeed, this expansion corresponds to the increase of molecular volume of CO<sub>2</sub> molecules which are no longer in supercritical state.



**Figure 5.16:** Micrographs of the cross-section of the foams processed at  $P = 125$  bars.

One can say that there is a significant difference of pore size depending on where the pellet is positioned. In the same Doehler's experiment (Nr 7), we have obtained a pore diameter ranging between 128 and 223  $\mu\text{m}$ . If the pellet is positioned in the low position, the average pore diameter and the porosity are found smaller than in the upper position. It can be explained by the faster vitrification of the polymer in the low position which stops the growth of the pores. As explained earlier, the bottom part of the pressure chamber is always colder than the upper part after depressurization.

Since, we have noticed that two supplementary factors affect the pore size (the constraint of volume of the experimental setup and the position of the pellet in the chamber), we have decided to remove the circle of Teflon which was placed in the pressure chamber. After that, we have filled the pressure chamber with small glass marbles as described in chapter 4, Figure 4.12, setup-02. Then, a pellet of PLGA<sub>50:50</sub> has been placed in the chamber. The carried out repetitions experiments and corresponding results are reported in Table 5.19. For the repetitions, we have obtained 52.4 and 26.5  $\mu\text{m}$ , as the average diameter of pores.

**Table 5.19:** Repetitions experiments of Doehler's design ( $P_{\text{sat}} = 100$  bars and  $dP/dt = 5$  bar/s).

Height of the Glass Balls in the Chamber	Pore Diameter ( $\mu\text{m}$ )	Average Diameter of Pores ( $\mu\text{m}$ )
~ 1/3	24.3	26.5
	28.7	
~ 2/3	50.7	52.4
	54.0	

The variation of the pore diameter with  $dP/dt$  is reported in Table 5.20 and illustrated by the series of micrographs given in Figure 5.18. We have found that the pore size is decreasing with the increasing rate of depressurization.

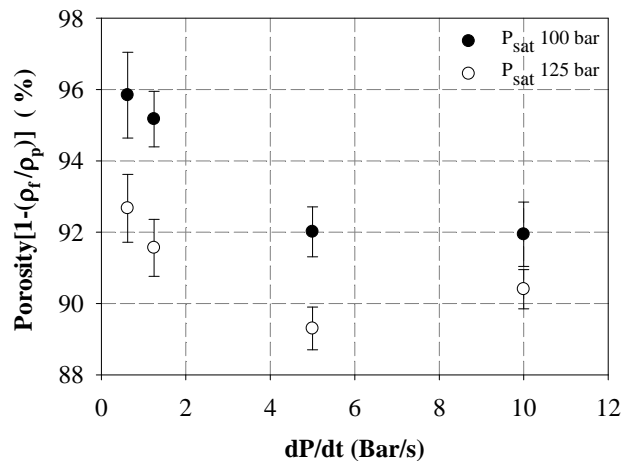
The variation to the pore size estimated by image analysis, is ranging from 18.9  $\mu\text{m}$ , for  $dP/dt = 10$  bar/s to 255.7  $\mu\text{m}$ , for  $dP/dt = 0.625$  bar/s. These experiments were carried out at high depressurization rate (10 bar/s). Thus, we expect to find smaller pores. However, we have observed small (10–20  $\mu\text{m}$ ) and big pores [ $\sim 150 - 200$   $\mu\text{m}$ ] together. So that, we can state that there is a coalescence phenomenon occurring during the pore growth.

**Table 5.20:** Variation in the average size of pores with different  $dP/dt$  values at  $P_{\text{sat}} = 100$  bars.

Height of the glass balls in the chamber	$dP/dt$ (bar/s)	Pore Diameter ( $\mu\text{m}$ )	Average Diameter Pore ( $\mu\text{m}$ )
~2/3	10	19.0	18.9
		18.9	
~2/3	5	50.7	52.4
		54.0	
~2/3	1,25	138.0	133.0
		127.9	
~2/3	0,625	255.7	255.7

### 3.2.3.2 Discussion on the Effect of the Various $\text{CO}_2$ Process Parameters

As shown in Figure 5.17, for  $dP/dt = 5$  bar/s, the estimated geometrical porosity (equation 3.11) is decreasing when the  $dP/dt$  is increasing and it reaches a plateau at 92%, and 89.3% for saturation pressures of 100 and 125 bars. The very close porosity values at 5 bar/s and 10 bar/s can also be explained by the coalescence of the pores during  $\text{CO}_2$  desorption. Our observations on pore size and the porosity (the swelling) of the polymer has shown us that with great pore sizes comes great porosity and with small pore size comes small porosity. This behaviour is in agreement with the literature [Beckman, 2004]. To our knowledge, it is impossible to create big pores with small polymer volume or small pores with important polymer swelling.

**Figure 5.17:** Variation of the porosity of the foams as a function of depressurization rate.

The physical shapes of the scaffolds prepared without volume constraint were perfectly circled and visually homogenous. On the other hand, the shape of the scaffolds processed with volume constraint was corrupted. We have also observed homogeneity on the SEM images. As shown in Figure 5.18, the pore size is smaller in high rates of depressurization and it increases with  $dP/dt$  increases. On the other hand, according to micrographs the interconnectivity and homogeneity are observed in the cross-section micrographs of the scaffolds. However, the SEM images are not sufficient to have a real characterization of interconnectivity.

As mentioned previously, we have observed that both the volume of the pressure chamber and the position of the pellet are important factors, which affect the pore size. For this reason, the 5 remaining experiments are carried out in order to re-complete the Doehler's plan according to the new experimental setup with glass balls. The height of the glass balls was at ~2/3 of the height of the pressure chamber for all

of the new experiments of the Doehlert' plan. All repeated results of the new Doehlert plan with the volume constraint are presented in Table 5.21.

**Table 5.21:** Complementary Doehlert' design experiments.

Exp.	X <sub>1</sub>	X <sub>2</sub>	dP/dt (bar/s)	P <sub>sat</sub> (bar)	Pore Diameter (μm)
1	0	0	2.5	125	8.4
2	1	0	10	125	3.6
3	0.5	0.866	5	150	5.0
4	-0.5	0.866	1.25	150	26.9
5	-1	0	0.625	125	187.25
6	-0.5	-0.866	1.25	100	133.0 ; 127.9 ; 135.0
7	0.5	-0.866	5	100	52.35 ; 51.0 ; 54.0

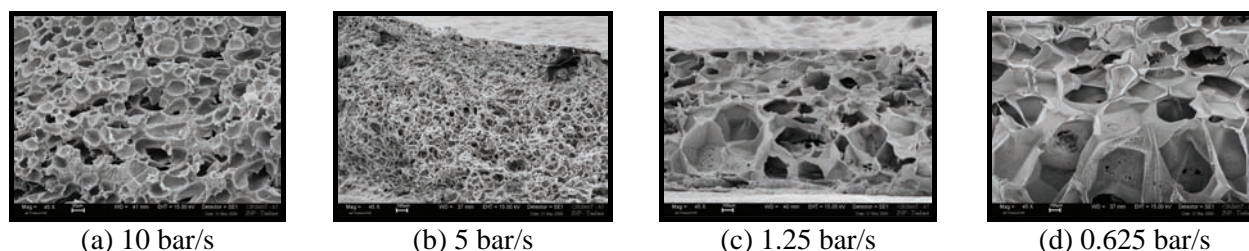
In all cases, we have observed significant changes from the results of the initial Doehlert experiments. These differences can be attributed to the change in the experimental setup. However, the general observed behaviour for P<sub>sat</sub> and dP/dt is the same for initial and repetition experiments. The maximum pore size is calculated according to the analysis of the Doehlert plan, and it has been found 255.7μm. P<sub>sat</sub> = 100 bar and dP/dt = 0.625 bar/s have been taken as the parameters which give the maximum. This result is confirmed by the experiment that we had been carried out and presented in Table 5.20 for the last sample. As shown in Table 5.22, we have found that the effect of all factors is statically significant but the predominant factor is the factor 1 (dP/dt). The effect of the depressurization rate on the foams, reported in Figure 5.18, is an example.

**Table 5.22:** Analysis of the Doehlert design: coefficients of the model.

	$\hat{a}$	$\Delta\hat{a}$	
a <sub>0</sub>	8.4	5.3	
a <sub>1</sub>	- 74.4	2.8	Significant
a <sub>2</sub>	- 44.3	2.5	Significant
a <sub>12</sub>	20.5	4.6	Significant
a <sub>11</sub>	87.0	6.5	Significant
a <sub>22</sub>	32.3	6.2	Significant

The modelling study was also carried out and the homogenous nucleation theory presented in chapter 2 has been used. As explained earlier, the total number of nuclei generated can be calculated as a function of the saturation pressure. Once we have calculated the number of nuclei, we can calculate the average pore diameter by using Equation (4.1). We have used the measured porosity data to convert the number of nuclei to the average pore diameter.

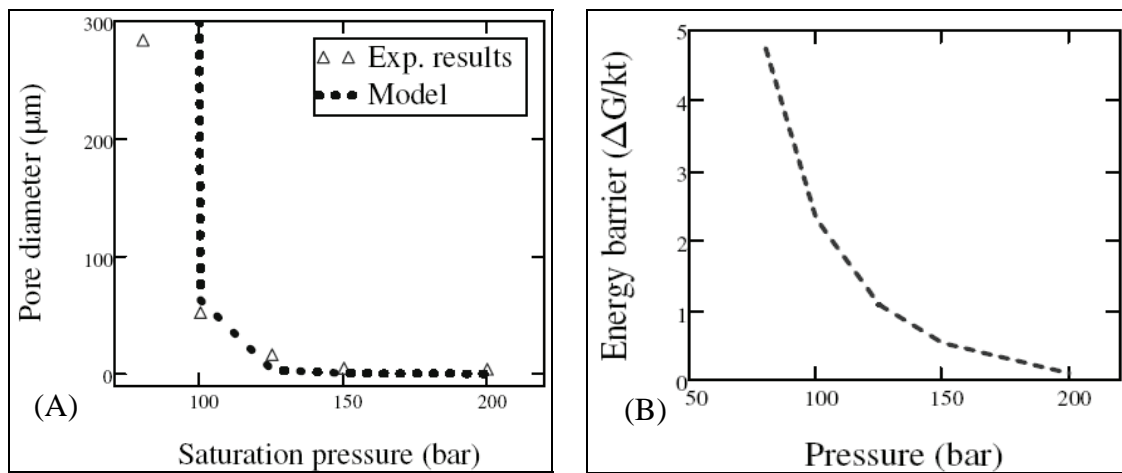
These results are plotted in Figure 5.19-(A), together with the experimental results of average pore diameter. Figure 5.18 depicted as example for t<sub>sat</sub> = 60 min, T<sub>sat</sub> = 36.5°C and dP/dt = 5 bar/s, the variations with saturation pressure together experimental results and model of average pore diameter.



**Figure 5.18:** Influence of dP/dt on the pore size of the foams processed at scCO<sub>2</sub> condition P<sub>sat</sub> = 100 bars, T<sub>sat</sub> = 36.5°C and t<sub>sat</sub> = 60 min.

The primary approximation of this model is that the pressure difference between the two sides of the bubble interface is equal to the pressure initial and final pressures of the chamber before and after depressurization. On the other hand the energy barrier to create nuclei decreases with the increasing pressure difference and it is represented in Figure 5.19-B. The exponentially decrease of the energy barrier with the pressure means that more nuclei can be generated at high pressures. Since the interfacial tension is an affecting parameter of the  $\Delta G$ , it has a great influence on the nuclei density of the polymer. The plateau after 150 bars can be explained by the smaller pore size (great number of pore) at higher pressure.

As shown in Figure 5.19, the model is in agreement with the experimental data for the pressures greater than 100 bars and diverges significantly for 80 bars where the number of nuclei is smaller than that of the greater pressures. One must remember that this model is considering the homogenous nucleation theory. Thus, this divergence for low pressures can be attributed to the heterogeneous nucleation and the coalescence of the growing pores at lower pressures. Indeed, at low pressures, the sorption of  $\text{CO}_2$  into the PLGA<sub>50:50</sub> is also lower and  $\text{CO}_2$  is not completely distributed across the pellet by the sorption-diffusion.



**Figure 5.19:** (A) Variation of pore diameter of the PLGA<sub>50:50</sub> scaffolds as the function of  $P_{\text{sat}}$ ; (B) Variation of the energy barrier for PLGA<sub>50:50</sub>- $\text{CO}_2$  system.

By using the matrix formula:  $X_s = -0.5 A^{-1} a_k$  where  $a_k$  is the vector of the first order coefficients and  $A$  the matrix of the second order coefficients, reported on the Table 5.23, we obtain the following values: As both coefficients  $a_{11}$  and  $a_{22}$  are positive, the stationary point is a minimum. The pressure  $P_{\text{sat}} = 100$  bars and the depressurization rate  $dP/dt = 0.625$  bar/s have been chosen as the parameters which give the maximum. The diameter of pores, at this point, is equal to 250 μm.

**Table 5.23:** Analysis of the Doehlert design: research of the optimum of the pore dimension.

								Reduced	natural	
$a_k =$	- 74.4		$A =$	87.0	10.25		$X_1$	- 1	0.625	$dP/dt$
	- 44.3			10.25	32.3		$X_2$	- 0.87	100	$P_{\text{sat}}$

Results obtained from our experimentations has shown that when pore size is large higher porosity is observed while pores with small pore diameter reflects small porosity. *Beckman*, 2004 have also shown similar behaviours in his experimentations . As per our understanding , it is impossible to create pores of large diameter with small polymer volume or small pores with important polymer swelling.



## 4 Factors Affecting on Pores Size and Porosity

### 4.1 Effect of the Polymer Composition

The Hildebrand's solubility parameters can be separated into three Hansen' components by the relationship given in following equation 5.1.

$$\delta_t^2 = \delta_d^2 + \delta_p^2 + \delta_H^2 \quad (5.1)$$

where  $\delta_t$  is the Hildebrand's parameter (cf. Table 5.24),  $\delta_d$  is the dispersive component,  $\delta_p$  is the polar component and  $\delta_H$  is the hydrogen bond component [Risanen, 2010; Schenderlein et al., 2004].

In the case of supercritical fluids the relationship linking the  $\delta$  Hildebrand' parameter to the  $P_c$  critical pressure is the following [Li. and Perrut, 1991].

$$\delta = 1,25 \sqrt{P_c \rho / \rho_1} \quad (5.2)$$

where  $\rho$  and  $\rho_1$  are corresponding to the density to the fluid in their supercritical and liquid state respectively.  $\text{ScCO}_2$  is a apolar fluid ( $14,3 < \delta < 18,4$ ).

**Table 5.24:** Hildebrand' and Hansen' parameters of the PLA and the PGA in  $(\text{MPa})^{1/2}$ .

	$\delta_d$	$\delta_p$	$\delta_H$	$\delta_t$	$\delta_t^*$
PLA	18.5	9.7	6.0	21.7	20.2
PGA	11.7	6.21	12.5	18.2	24.8

\*Calculations with the Small' group contribution method.

Normally both amorphous PLAs and PLGAs produce scaffolds of higher porosity and large pore diameters. Increase in the LA content in the PLGA co-polymer increases the solubility of  $\text{CO}_2$  in the polymers. The solubility of  $\text{CO}_2$  is always higher in all poly D,L-lactides than poly(lactides co-glycolide). The extra apolar group in polylactide acid is responsible for higher solubility in the polylactide which eventually generates highly porous foams depending upon the process conditions. According to Liu and Tomasko [2007b] the extra apolar group which is not present in glycolic acid, leads to two opposite and different phenomenon. The effect of  $\text{CO}_2$  interaction with the carbonyl group of the polymer is decreased due to the apolar group first and secondly, more available free volume for  $\text{CO}_2$  to solubilise is created. Kazarian et al. [1996b] has also found that the interaction of  $\text{CO}_2$  with polymers can also be explained by the  $\text{CO}_2$  behaviour as a Lewis acid, an electron pair acceptor.

LA/GA ratio of a PLGA co-polymer is an important parameter to control the pore diameter in a foaming process. Foaming of PLGA with different LA and GA contents, has given different results. In our study, with the same foaming conditions ( $P_{\text{sat}}$ ,  $T_{\text{sat}}$ ,  $t_{\text{sat}}$ ,  $dT/dt$ ), we have experienced different pore size behaviours when processed with rapid or slow depressurizations. Secondly, low pores size can be due to high saturation pressure and low saturation temperature with comparison to the  $T_g$  of both polymers (cf. Table 5.5).

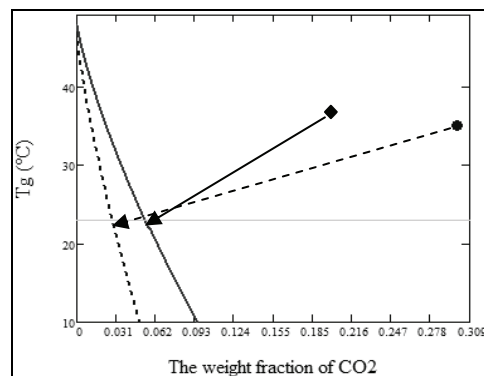
### 4.2 Effect of Depressurization Rates

*For low depressurization rates* (0.625 to 1.25 bar/s), when the lactic acid content increases in PLGA, the pore size increases as well. This behaviour can be attributed to the greater capacity of solubilized  $\text{CO}_2$  inside the polymer with the increasing amount of LA. Actually, one can expect that since the  $\text{CO}_2$  concentration is greater in a high lactic acid containing PLGA, the nucleation rate must be greater (which means lower pore size). However, even if the number of pores is determined by the saturation period and the

concentration of CO<sub>2</sub> inside the polymer, the final pore size of the scaffold is mostly related to desorption period. During desorption, a number of phenomena occurs; the desorption-diffusion, the swelling of the polymer due to the growing of the pores, the coalescence of growing pores, the vitrification and the increasing of the glass transition temperature of the polymer which is related to the desorption of CO<sub>2</sub>. Furthermore, during the saturation period, when more CO<sub>2</sub> is sorbed into the polymer, the more depression of T<sub>g</sub> occurs. The more plasticized polymer, which carries more CO<sub>2</sub>, will take more time to desorb and will vitrify later than a polymer which sorbed less CO<sub>2</sub>. Indeed, one must consider that the T<sub>g</sub>-w diagram of different polymers is different as shown in Figure 5.20. The T<sub>g</sub> curve of the polymer with low LA content (PLGA<sub>50:50</sub> in our case) is closer to the corresponding weight fraction of the CO<sub>2</sub> in this polymer. On the other hand, since the weight fraction of CO<sub>2</sub> in P<sub>D,L</sub>LA is higher, the distance between the weight fraction and the vitrification point (on T<sub>g</sub> curve) at ambient temperature is supposed to be greater than that of the PLGA<sub>50:50</sub>.

Consequently, the polymer which tends to sorb less CO<sub>2</sub> will vitrify sooner, which will stop the growth of the pores. On the other hand, we must underline that, different co-polymers like PLGA<sub>50:50</sub>, PLGA<sub>85:15</sub> or the P<sub>D,L</sub>LA have different glass transition temperatures and also different  $\Delta C_p$  at the glass transition, which affects the depression of T<sub>g</sub> during the saturation, and the increase of T<sub>g</sub> during the desorption. These values are presented in Table 2.4. These differences in T<sub>g</sub> and  $\Delta C_{p(T_g)}$  must have been considered in order to achieve a proper analysis of the phenomena. Moreover, the diffusion coefficient of CO<sub>2</sub> into polymers is concentration dependent and increases with the increasing concentration of CO<sub>2</sub>. During the saturation period, the weight of sorbed CO<sub>2</sub> into a polymer and the more important effect (swelling of the polymer) is observed into the (co)polymer containing a higher LA proportion.

The work of *Pini et al.* [2008] revealed that the swelling behaviour of PLGA is linear with the weight of sorbed CO<sub>2</sub>, and the concentration of CO<sub>2</sub> inside PLGA<sub>85:15</sub> must be greater than inside PLGA<sub>50:50</sub>. In this case, we expect that the desorption-diffusion coefficient increases with the increasing lactic acid content. However, when a slow depressurization occurs, the desorption-diffusion is limited due to the small driving force ( $\Delta P$ ), and the CO<sub>2</sub> is blocked inside polymer. Thus, the vitrification is delayed, and one must point out that this is the primer effect which restricts the growth of the pores.

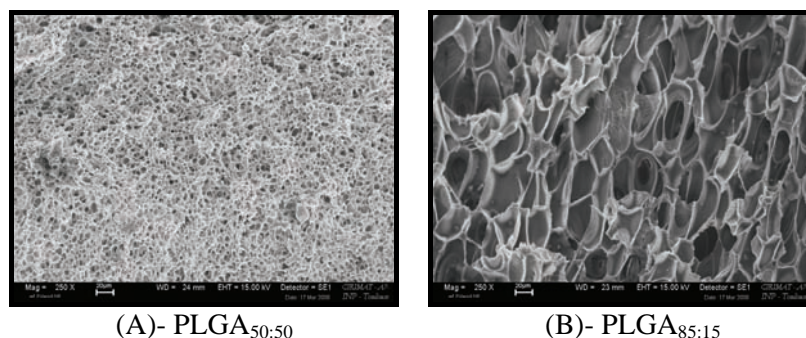


**Figure 5.20:** T<sub>g</sub>-w diagram of the P<sub>D,L</sub>LA (---) and PLGA<sub>50:50</sub> (—); (●) and (◆), are the weight fraction of CO<sub>2</sub> in P<sub>D,L</sub>LA and PLGA<sub>50:50</sub> at 100 bars, respectively. The value for the weight fraction of P<sub>D,L</sub>LA at 100 bars and 35°C is taken from *Pini et al.* [2008].

**For rapid depressurization rates**, the phenomenon is different. We have experienced that for higher depressurization rates, (5 – 20 bar/s), the final average pore size of the scaffolds is increasing with the increasing content of GA in the PLGA copolymers and it has the smallest value for P<sub>L,D</sub>LA. We have assumed that when a rapid depressurization occurs, the polymer is quickly vitrified due to a high desorption-diffusion which is caused by a great driving force ( $\Delta P$ ). However, in the cross-sections presented in Figure



5.21, we have observed an opposite behaviour for a high saturation pressure value of 200 bars. This can be attributed to the high CO<sub>2</sub> sorption of PLGA<sub>85:15</sub> at high pressure, which leads to high glass transition depression.



**Figure 5.21:** Micrographs of scaffolds processed at  $P_{\text{sat}} = 200$  bars;  
 $T_{\text{sat}} = 36.5^{\circ}\text{C}$ ,  $t_{\text{sat}} = 20$  min. and  $dP/dt = 20$  bar /s.

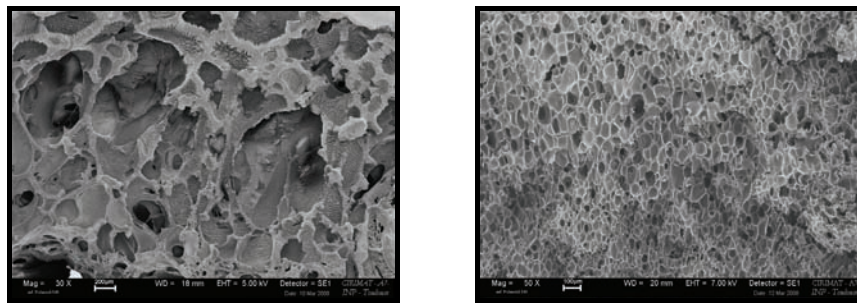
### 4.3 Effect of Saturation Pressure ( $P_{\text{sat}}$ )

We have observed that the pressure of saturation is an important parameter to understand the foaming phenomena. Indeed, the saturation pressure determines the amount of CO<sub>2</sub> sorbed into the polymer matrix. At low pressure range, the amount of CO<sub>2</sub> sorbed by the polymer is inferior to that of the high pressure ranges. It must have been noticed that the plasticization effect of the CO<sub>2</sub> for the polymer (and the depression of the glass transition point) increases with the amount of CO<sub>2</sub> sorbed. As explained previously, the vitrification point is found to be earlier with a  $P_{\text{sat}}$  of 200 bars than 100 bar (cf. Figure 5.9). Since the vitrification point determines the end of the pore growth, a polymer saturated at 100 bars has greater time for the pore growth during depressurization and desorption. This behaviour can be explained by the diffusion coefficient of CO<sub>2</sub> which increases with the increasing concentration of CO<sub>2</sub> (the sorption) in the polymer matrix. So, one can say that since the diffusion coefficient and the plasticization is greater at higher pressures, during depressurization and the following desorption, the CO<sub>2</sub> will desorb faster than for the lower saturation pressures. At lower saturation pressures, the time for CO<sub>2</sub> to provide the expansion of CO<sub>2</sub> and the desorption-diffusion induced growth of the pores is greater and yields to greater pores. The results presented in Table 5.8 and Figure 5.9, are confirming our hypothesis.

On the other hand, nucleation theory that we have used to model the pore size as a function of the saturation pressure, must not have been forgotten. Nucleation theory includes the energy barrier for a generation of new nuclei. This energy barrier is given by Eq. 2.23 in Chapter 2 and according to that when the pressure increases, the energy barrier and consequently the number of pores that can be generated by unit volume, increases. We can look to the phenomena from the window of Gibbs free energy. According to which  $\Delta G = \Delta H - T\Delta S$ ,  $\Delta G$  decreases with the increase of change in entropy  $\Delta S$ , which is true for all systems available in the universe. In our case, when we increase the pressure, we increase the entropy change of the system (we increase greater than that we could increase with lower pressures), and consequently decrease the  $\Delta G$  greater than that we could decrease with lower pressures. Consequently, the energy barrier that determines the capacity to generate new nuclei decreases, which means that we can create more pores per unit volume at elevated pressures.

On the other hand, the difference found between the vitrification times were not significantly different (2.64 and 2.72 s. for 100 and 200 bars, respectively). Thus, we can conclude that generation of nuclei is the dominant factor which affects the increase of the number of pores with the increasing saturation pressure and the coalescence phenomenon may be effective at lower saturation pressures. We finally have to

mention that when the number of pore increases with the increasing pressure, the pore size will absolutely decrease (cf. Figure 5.22).



(A)- $P_{\text{sat}} = 100 \text{ bar/s}$

PLGA<sub>85:15</sub>,  $d_e = 264 \mu\text{m}$

Scaffold Manufactured at,  $T_{\text{sat}} = 35^\circ\text{C}$  ;  $t_{\text{sat}} = 60 \text{ min}$  ;  $dP/dt = 1 \text{ bar/s}$

(B)- $P_{\text{sat}} = 300 \text{ bar/s}$

PLGA<sub>85:15</sub>,  $d_e = 89 \mu\text{m}$

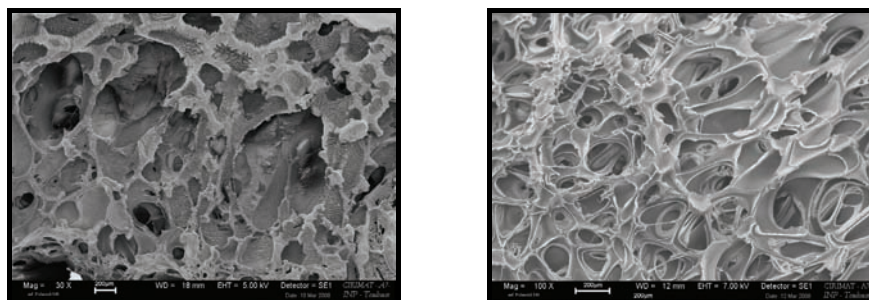
**Figure 5.22:** Micrographs revealing the effect of  $P_{\text{sat}}$  on pore size.

The number of the pores increases with the augmentation of the  $P_{\text{sat}}$  as at higher pressure more  $\text{scCO}_2$  is saturated in the polymer thus size of the pores decreases.

#### 4.4 Effect of Saturation Temperature ( $T_{\text{sat}}$ )

In first experiments concerning the complete  $2^4$  design, we observed a decrease of pore diameter as the temperature is increasing from  $36.5$  to  $60^\circ\text{C}$ . This trend was unexpected because of the decreasing density of  $\text{CO}_2$  at higher temperatures which must have lead to lower nucleation rates, consequently greater pore diameter. It is also not in agreement with experimental results of literature [Tsivintzelis *et al.*, 2007b]. According to these authors, the pore sizes of the scaffolds increase with increasing saturation temperature. They relate it to the decrease of the energy barrier of nucleation. On the other hand, we have observed another behaviour in Taguchi design experiments. Pore diameter of the PLGA<sub>50:50</sub> scaffolds decreased from  $36.5$  to  $45^\circ\text{C}$ , where it reached a minimum and increased until  $60^\circ\text{C}$ . We believe that, since the diffusion coefficient is related to the temperature, there must be a competition between the decreasing solubility and increasing diffusion of  $\text{CO}_2$  with temperature to yield the nucleation rate.

As mentioned by Krause *et al.* [2001], it exists an optimal foaming region which describes the number of nuclei which starts with a  $T_{\text{lower}}$  and exponentially increases with  $T$ , then, reaches a maximum in  $T_{\text{max}}$  and shows a decreasing behaviour until  $T_{\text{upper}}$ . Between  $T_{\text{lower}}$  and  $T_{\text{max}}$  the increasing effect of sorption-diffusion is dominant on the decreasing solubility of  $\text{CO}_2$ . Hence, the number of nuclei is increasing as the temperature increased. Once  $T_{\text{max}}$  is reached, temperature is so high that the decreasing solubility effect is becoming high enough to decrease the nucleation rate and consequently the generated number of nuclei decreases which means that the pore size decreases. An experimental result is presented in Figure 5.23.



(A)- $T_{\text{sat}} = 35^\circ\text{C}$

PLGA<sub>85:15</sub>,  $d_e = 264 \mu\text{m}$

Scaffold processed at,  $P_{\text{sat}} = 100 \text{ bar}$  ;  $t_{\text{sat}} = 60 \text{ min}$  ;  $dP/dt = 1 \text{ bar/s}$

(B)- $T_{\text{sat}} = 60^\circ\text{C}$

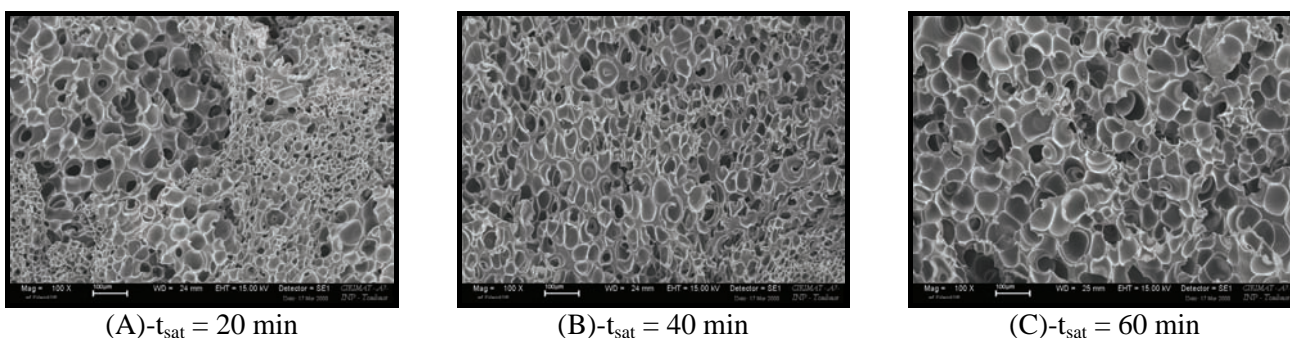
PLGA<sub>85:15</sub>,  $d_e = 187 \mu\text{m}$

**Figure 5.23:** Micrographs revealing the effect of  $T_{\text{sat}}$  on pore size.

The number of the pores increases with  $T_{\text{sat}}$  as at elevated temperature more  $\text{scCO}_2$  is saturated in the polymer and thus the pore size decreases. Since our experiments with different  $T_{\text{sat}}$  values were carried out with the volume constraint, the interpretation of these results is not easy. Further investigation is needed in order to present proper conclusions on the effect of saturation temperature.

#### 4.5 Effect of Saturation Time ( $t_{\text{sat}}$ )

The effect of saturation time on foaming is related by the amount of sorbed  $\text{CO}_2$  in the polymer during that time. When the saturation time increases, the concentration of  $\text{CO}_2$  inside the polymer is increased until the equilibrium is reached, this consequently increased the number of nuclei created. For 125 bars and  $36.5^\circ\text{C}$ , the kinetics of sorption is investigated in order to know how much time is needed to reach the equilibrium. It has been found that after approximately one hour, the PLGA<sub>50:50</sub> –  $\text{CO}_2$  system reaches the equilibrium and the capacity of sorption is determined (cf. Figure 5.6-A). On the other hand, our experiments show (cf. Figure 5.24) that smaller saturation time increases the heterogeneity within the pore size distribution across the scaffold, so it is important to work at equilibrium conditions to achieve homogeneity by providing a good diffusion and distribution of  $\text{CO}_2$  into the polymer matrix.



$d_e = 15\mu\text{m}$ , Heterogeneous pores.     $d_e = 30\mu\text{m}$ , Less heterogeneous pores.     $d_e = 50\mu\text{m}$ , Homogeneous pores.

PLGA<sub>50:50</sub> scaffold processed at,  $P_{\text{sat}} = 250$  bar ;  $T_{\text{sat}} = 60^\circ\text{C}$  ;  $dP/dt = 1$  bar/s

**Figure 5.24:** Micrographs revealing the effect of  $t_{\text{sat}}$  on pore size.

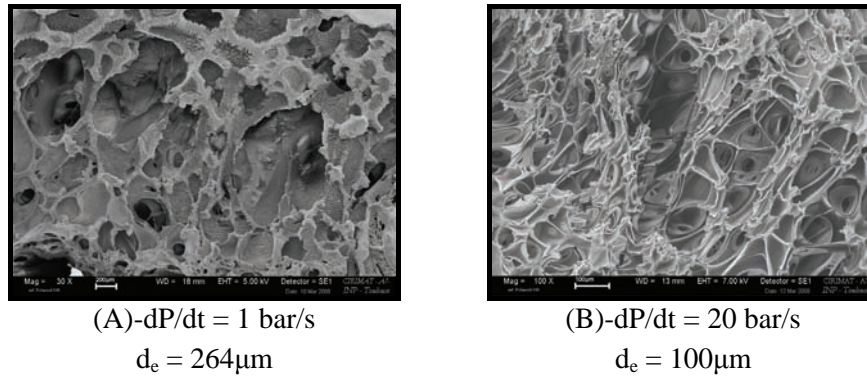
The homogeneity of the pores increases with the augmentation of the  $t_{\text{sat}}$  as by increasing the time, more  $\text{scCO}_2$  is diffused and distribution in the polymer, approaching the equilibrium and increasing thus homogeneity of the pores.

#### 4.6 Effect of the $dP/dt$ and $dT/dt$

As we have mentioned before the pore size of the scaffolds decreases with an increase of the depressurization rate when all other parameters are constant. This is in agreement with the literature [Arora *et al.*, 1998b]. This behaviour can be explained by the increasing driving force change which leads the  $\text{CO}_2$  to desorb from the polymer matrix. When a rapid depressurization occurs, it creates greater pressure difference between the inside of the pore and the environment which results in a rapid desorption-diffusion. When the amount of  $\text{CO}_2$  inside the polymer is smaller, there is not enough  $\text{CO}_2$  for the pore growth which results in smaller pores (cf. Figure 5.25).

On the other hand, a rapid depressurization always causes a rapid temperature drop,  $dT/dt$ . For example, in our experimental setup, when a  $dP/dt$  of 5 bar/s is applied from  $P_{\text{sat}} = 100$  bars, the  $dT/dt$  is approximately  $1^\circ\text{C/s}$ , while  $dT/dt \approx 0.01^\circ\text{C/s}$  when a  $dP/dt$  of 0.056 bar/s is applied. Hence, a rapid temperature drop provides faster vitrification of the polymer which stops the pore growth.





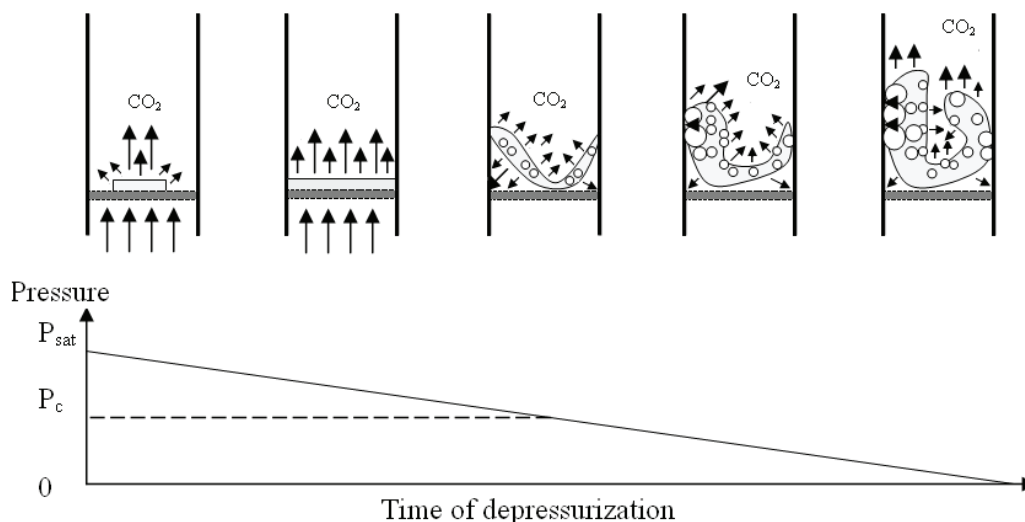
PLGA<sub>85:15</sub> scaffold manufactured at,  $T_{\text{sat}} = 35^\circ\text{C}$  ;  $t_{\text{sat}} = 60 \text{ min}$  ;  $P_{\text{sat}} = 100 \text{ bar}$

**Figure 5.25:** Micrographs revealing the effect of  $dP/dt$  and  $dT/dt$  on pore size.

Pore size decreases with increasing the  $dP/dt$ . A rapid drop in temperature implies faster vitrification of polymer that blocks the growth of pores and the average pore diameter decreases. It remains one important phenomenon which deserves a proper consideration. As mentioned previously in section 2.3, when the same  $dP/dt$  is applied from two different saturation pressures, a difference occurs between the final temperatures measured at the gas output. This can be explained by the increasing heating effect. Indeed, the same rate of depressurization from different saturation pressures, does not give the same depressurization time. Thus, the depressurization time from a high saturation pressure is greater and it causes an increase of the heating time of the pressure chamber. Hence, the vitrification of the scaffolds is encouraged by the sudden temperature drop from smaller saturation pressures. This can be the reason why the effect of the saturation pressure is found to be smaller than the effect of the depressurization rate in the analysis of the Doehler's design. On the other hand, since the desorption-diffusion coefficients are lower with lower saturation pressures than higher saturation pressures (cf. Table 5.8), the polymer processed with lower saturation pressures vitrifies later.

#### 4.7 Effect of the Geometry of the Pressure Chamber

We have to remember that the PLGA<sub>50:50</sub> exposed to high pressurized  $\text{CO}_2$ , changes its state from glassy to rubbery. When the depressurization occurs from high pressurized saturation of the polymer, the polymer swells as the  $\text{CO}_2$  desorbs and expands as a result of the phase separation.



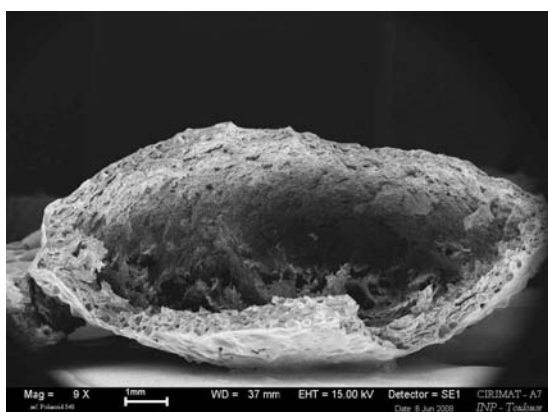
**Figure 5.26:** Representation of the effect of the geometry of the pressure chamber on the porous structure.

Actually, this swelling is the result of the pore growth. When a slow depressurization happens, the polymer swells slowly and since the temperature drop is also slow, the vitrification happens later. Thus, when the polymer swells enough to touch the edges of the pressure chamber, the edges are behaving like a volume constraint and the pores which are closer to the edges is growing more than the pore which are in the centre of the scaffold, indeed, due to the blocking of desorption of the CO<sub>2</sub> by the wall edges (cf. Figure 5.26). The CO<sub>2</sub> inside the pores expands as the pressure and the temperature decreases which results in the growth of these pores. This behaviour is mostly related to the much plasticized state of the polymer.

For this reason, we have changed our experimental setup. We have removed the Teflon isolation which was restricting the diameter of the working area inside the chamber. We have replaced the volume by small glass balls with 3 mm of diameter, and we have placed a metal grill with holes on these glass balls. As a result, we have gained approximately 50% more area which was sufficiently enough to prevent the volume constraint.

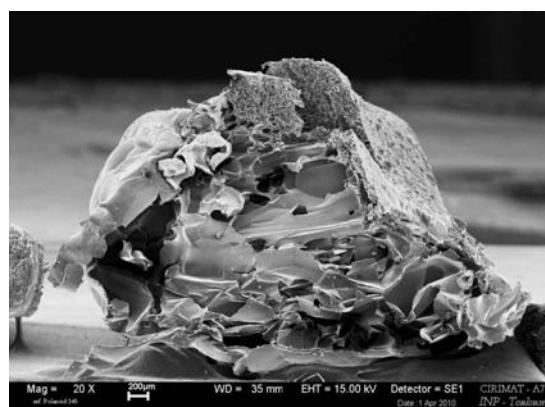
#### 4.8 Interconnectivity and Coalescence Behaviour of the Scaffolds

Our image analysis on micrographs and calculations shows the decrease of the average pore density per unit volume, with the increasing pore size. This trend is in agreement with the literature work [Barry *et al.*, 2006]. The coalescence phenomenon is the master bone of the interconnectivity of the pores. During the growth, two pores join to create one, and reduce the pore density. This decrease in the pore density confirms the bubble coalescence theory proposed in the literature [Rodeheaver and Colton, 2001]. Since the pore density is decreasing with the increasing depressurization time (foaming time), longer foaming times results in more pores to coalesce. An example to this phenomenon is presented in Figure 5.27-(A). A  $dP/dt$  of 0.056 bar/s has been applied to create this scaffold and it has been observed that there is only one giant pore. An other example in Figure 5.27-(B),  $dP/dt$  of 1 bar/s was applied to create scaffold but a collapse of large pores was observed in SEM micrograph. On the other hand, we must admit, it is not easy to interpret the interconnectivity behaviour only by SEM micrographs. Thus, further investigation is necessary in order to quantify the degree of interconnectivity. Procedures like mercury porosimetry or  $\mu$ -tomography can be considered for such analysis.



(A)- PLGA<sub>50:50</sub>

$P_{\text{sat}} = 100 \text{ bar}$ ,  $T_{\text{sat}} = 36.5^\circ\text{C}$ ,  
 $t_{\text{sat}} = 60 \text{ min.}$  and  $dP/dt = 0.056 \text{ bar /s.}$



(B)- PLGA<sub>85:15</sub>

$P_{\text{sat}} = 200 \text{ bar}$ ,  $T_{\text{sat}} = 45^\circ\text{C}$ ,  
 $t_{\text{sat}} = 20 \text{ min.}$  and  $dP/dt = 1 \text{ bar /s.}$

**Figure 5.27:** Micrographs depicting coalescence and collapse of pores.

## 4.9 Influence of Pellet Thickness on Foaming

To study the effect of polymer mass and other parameters pellets of different thickness ranging between (0.2 – 1.8 mm) were made (cf. Table 5.25).

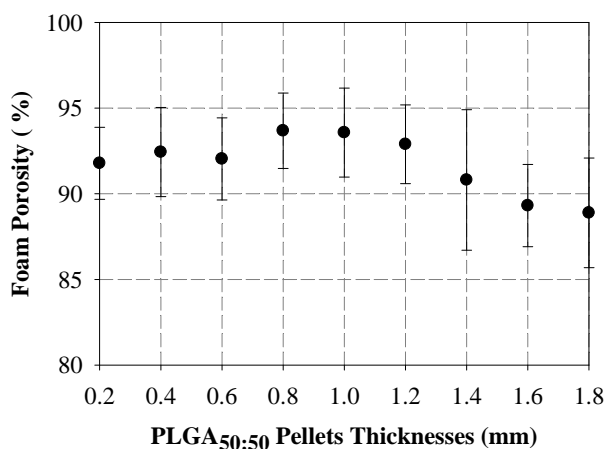
**Table 5.25:** Pellets of variable thickness and their foam data.

Pellet Dimensions			Foam Dimensions			Porosity
Diameter $d_p$ (mm)	Thickness $\phi_p$ (mm)	Mass $m_p$ (mg)	Diameter $d_f$ (mm)	Thickness $\phi_f$ (mm)	Mass $m$ (mg)	(%)
12.93	0.25	28.60	23.63	0.92	28.90	91.8
12.85	0.43	63.30	25.05	1.49	63.10	92.4
12.90	0.62	96.00	25.08	2.06	96.10	92.0
12.94	0.83	126.70	32.13	2.12	126.10	93.7
12.92	1.10	165.00	24.59	4.72	164.90	93.6
13.00	1.23	203.00	23.00	5.52	202.80	92.9
12.94	1.37	230.70	20.81	5.76	230.70	90.8
12.90	1.62	273.10	20.23	6.14	272.20	89.3
12.95	1.82	298.60	20.79	6.33	297.60	88.9

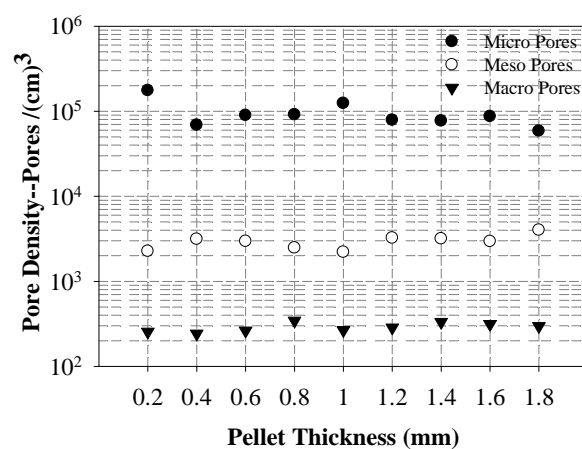
The pellets were prepared at  $P = 150$  bars,  $T = 60^\circ\text{C}$  and  $t = 20$  min as per procedure described in section 4.3 and illustrated in Figure 4.9-(B). Before and after  $\text{scCO}_2$  treatment, the pellets and foams diameter and thickness was measured by using a digital vernier caliper at eight different points (cf. Table 5.25). The mean values were considered during the calculation and analysis. Pellets were treated at following supercritical  $\text{CO}_2$  conditions:  $P_{\text{sat}} = 120$  bars,  $t_{\text{sat}} = 20$  min,  $T_{\text{sat}} = 35^\circ\text{C}$  and  $dP/dt = 3$  bar/s. Experiments were carried out in the SEPAREX<sup>®</sup> SF200 pilot plant by adopting the setup-02 as described in (cf. chapter 4, Figure 4.12-B).

### 4.9.1 Porosity and Cell Density

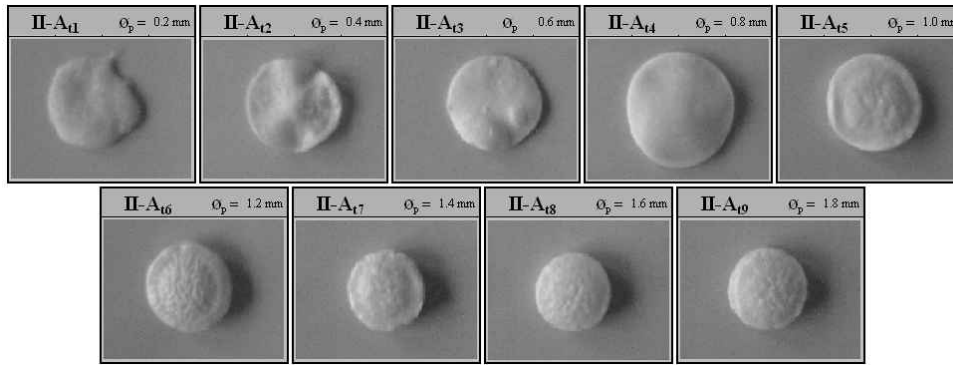
By using the dimensions of pellets and foams, geometric porosity of the foam was calculated. It was above 88% for all the samples. Average porosity was calculated from the diameter, thickness and mass of pellets and foams, then data was considered for the calculation of cell density. (cf. Table 5.25 and Figure 5.28). Cell densities of the foams are presented in Figure 5.29 and corresponding images of obtained foams are represented in Figure 5.30.



**Figure 5.28:** Porosity of PLGA<sub>50:50</sub> foams for pellets with different initial thickness.



**Figure 5.29:** Pore density of PLGA<sub>50:50</sub> foams with different initial pellet thickness.



**Figure 5.30:** PLGA<sub>50:50</sub> foams obtained with different initial pellet thicknesses.

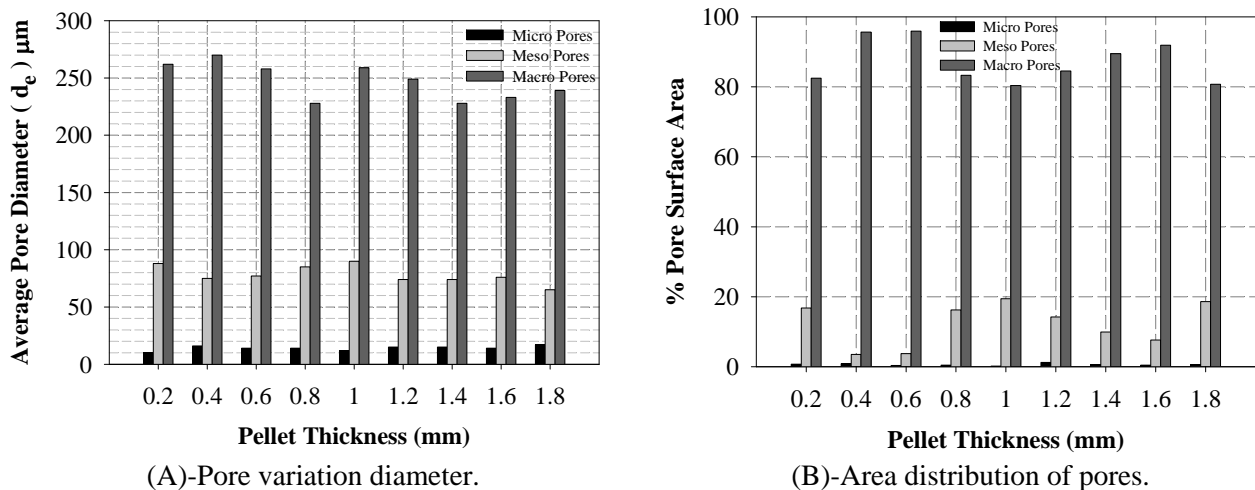
Best foams have thickness ranging between 0.6 and 1.2 mm. They are characterized by:

- Porosity of foam greater than 90%.
- Cell density around  $25 \times 10^3$  and  $12 \times 10^6$  pores /cm<sup>3</sup> for macro and micro pores.
- Macro pores surface area ranging between 80 and 96%.

Pellet of 0.6 mm thickness seems to be the best trade-off between quality and price of the foam.

#### 4.9.2 Pores Size Distribution

We have used the measured porosity data to estimate the number of nuclei to the average pore diameter. Average pore diameter for the 9 samples was calculated by using the SCION<sup>®</sup> image analysis. Figure 5.31-(A) depicts the micro, meso and macro pores diameter for the 9 previous different pellets of PLGA<sub>50:50</sub> foamed at  $P_{\text{sat}} = 120$  bars,  $t_{\text{sat}} = 20$  min,  $T_{\text{sat}} = 35^\circ\text{C}$  and  $dP/dt = 3$  bar/s.



**Figure 5.31:** Different distribution of pores in PLGA<sub>50:50</sub> foams.

As shown on Figure 5.31-(B), in these experimental foaming conditions, the relative ratio of pores surface area seems to be stable: around 0.2 to 0.3% for the micro-pores, between 4 and 20 % for the meso-pores and the complement for the macro-pores.

#### 4.9.3 Correlation Between Effects of Pellet Thickness and Process Parameters

Earlier, we concluded that pellets of thickness of 0.6 mm produced foams with porosity of 93% and maximum surface area of macro pores along micro and meso pores, thus a foam of better quality as it



fulfills the requirement for tissue engineering applications. A Taguchi' plan will be applied to see the effect of process parameters on the foam.

To study the effect of different parameters, we opted to make complementary pellets of 0.6 mm diameter by weighing ~100 mg of PLGA<sub>50:50</sub>. The pellets were prepared at P = 150 bars, T = 60°C and t = 20 min as per procedure described in chapter 4. Before and after scCO<sub>2</sub> treatment, the pellets and foams diameter and thickness was measured and mean dimensional values were considered during the calculation and analysis.

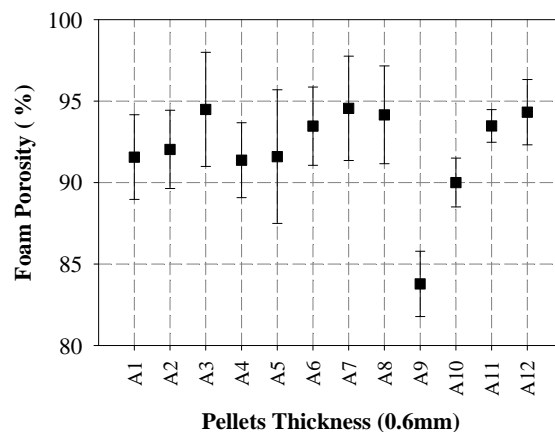
Twelve pellets of same diameter were manufactured. Experiments were carried out in the SEPAREX SF200 pilot. Pressure chamber without Teflon isolation material was filled with small glass marbles to the ~2/3 of the height as described in setup-02 and presented in Figure 4.12-B. The four process parameters P<sub>sat</sub>, t<sub>sat</sub>, T<sub>sat</sub> dP/dt were varied (cf. Table 5.26) and geometric porosity was determined. The ratio of the micro, meso and macro pores of the corresponding foams was obtained by SCION<sup>®</sup> image analysis. In this chapter, for the Taguchi plan for PLGA<sub>50:50</sub> (RG 504) best process conditions was P<sub>sat</sub> = 120 bars, t<sub>sat</sub> = 20 min, T<sub>sat</sub> = 35°C and dP/dt = 3 bar/s. A special experimental plan was not applied; however values of the four parameters were changed slightly to see their effects further on the foam porosity and pore size. During the experimentation variation in temperature a, pressure and dP/dt was observed which can slightly affect the final results obtained.

**Table 5.26:** ScCO<sub>2</sub> process conditions for foaming of PLGA<sub>50:50</sub>.

Parameters	A <sub>1</sub>	A <sub>2</sub>	A <sub>3</sub>	A <sub>4</sub>	A <sub>5</sub>	A <sub>6</sub>	A <sub>7</sub>	A <sub>8</sub>	A <sub>9</sub>	A <sub>10</sub>	A <sub>11</sub>	A <sub>12</sub>
P <sub>sat</sub> (bar)	120	120	120	120	120	120	110	120	130	120	120	120
t <sub>sat</sub> (min)	20	20	20	20	20	20	20	20	20	15	20	25
T <sub>sat</sub> (°C)	35	35	35	32.5	35	37.5	35	35	35	35	35	35
dP/dt (bar/s)	4	3	2	3	3	3	3	3	3	3	3	3

#### 4.10 Discussion on Foam Morphology

Porosity of the foams obtained under the different conditions has been calculated and is presented. Three foams were made for each condition, average values were taken into account and is presented in Figure 5.32. Geometric porosity was above 90% except in one case where the P<sub>sat</sub> was 130 bar, it was 84%. We can see that as dP/dt decreases from A1-A3 the porosity increases gradually. While from A4-A6 the porosity increases gradually as saturation temperature increases. From A7-A9, by increasing saturation pressure, porosity drop trend is visible. In the last three samples there is again a slight increase in porosity due to an increase in saturation time.



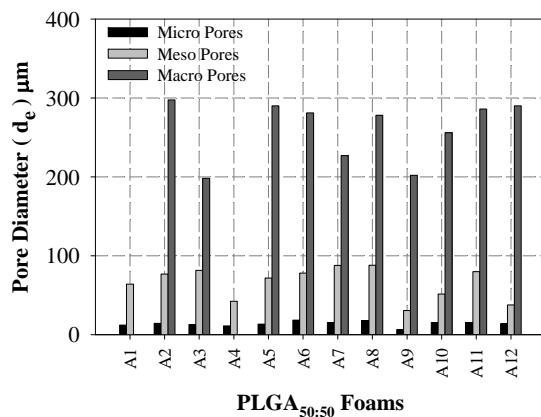
**Figure 5.32:** Variation in PLGA<sub>50:50</sub> foams geometric porosity for different process parameters.

SCION<sup>®</sup> image analysis of SEM micrograph was done for each condition. No macro pores were observed for sample A1 due to high  $dP/dt$ , A4 due to low  $T_{sat}$ . For the other samples in A2, A5, A6, A8, A10, A11 and A12 macro pores had average diameter above  $275\mu m$ . A13 had maximum macro pores of diameter  $298\mu m$  along micro and meso pores. It was quite difficult to maintain  $35^\circ C$  of temperature during the experimentation. Because of temperature variations, we had to repeat the experiments thrice to attain  $T_{sat}$ , data of all the samples were recorded for calculations and analysis.

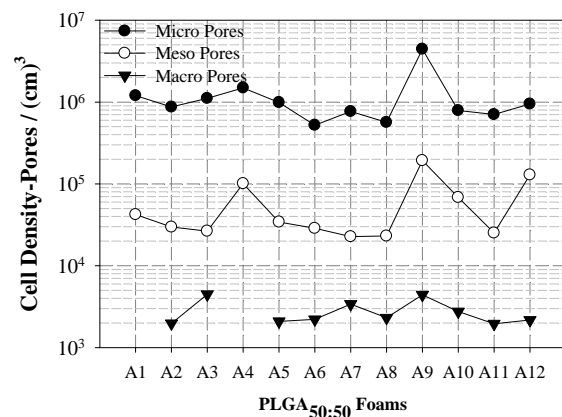
Figure 5.33 and Figure 5.34 reveal that samples A3 and A9 produce pores of diameter  $\sim 200\mu m$  while samples with higher macro pore diameter produced cell density above  $1 \times 10^3$ , while cell densities for micro and meso pores are also satisfactory.

Figure 5.35 compares the % of surface area of three types of pores. We can see that samples A2, A5, A6, A7, A8, A10, A11 and A12 consist of more than 80% of surface area of macro pores produced. In A2, A11 and A12 the percentage is above 95%. These three foams are quite close to each other. In others cases, there are variations in the three types of pore distribution.

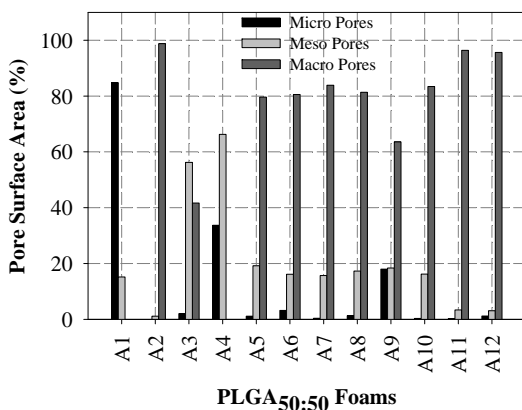
Figure 5.36 reveals the optimum values of process parameters at which pores of maximum diameters can be produced. In our finding with PLGA<sub>50:50</sub>, we have found that a combination of,  $T_{sat} = 37.5^\circ C$ ,  $P_{sat} = 120$  bars,  $t_{sat} = 25$  min, and  $dP/dt = 3$  bar/s, produce scaffold of optimum porosity, cell density and pore distribution.



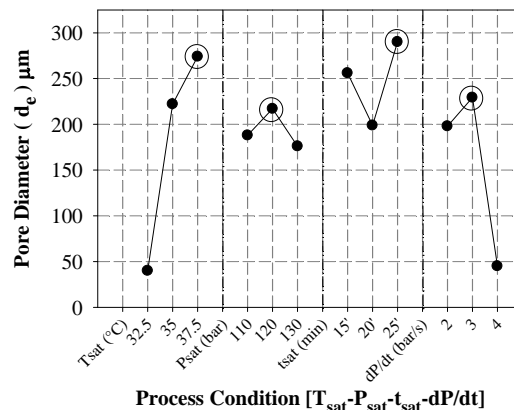
**Figure 5.33:** Distribution of pores at different process condition.



**Figure 5.34:** Cell densities of pores produced at different process condition.



**Figure 5.35:** Percentage of surface area for distribution of pores.



**Figure 5.36:** Effective pore diameter for each process parameter.

One can see the effects of all the process parameters on the pore size. Increasing  $T_{\text{sat}}$  ultimately improves the pore diameter, and pore diameter is decreased by increment of  $P_{\text{sat}}$  and  $dP/dt$ . There was a slight increase in the pore diameter of foam by increment of  $t_{\text{sat}}$ . So the process parameters have been improvised by performing these experiments. A foam was then produced at this optimized condition and from analysis, the porosity obtained was 93% and diameters for micro, meso and macro pore was 14 $\mu\text{m}$ , 97  $\mu\text{m}$  and 276  $\mu\text{m}$  respectively.

## 5 Conclusion

Different types of polylactides including polylactic acid and poly(lactic co-glycolic acid) have been characterized in details. The composition of each polymer was also discussed as it has a pivotal role on the properties of the final porous scaffolds produced. Foams were made with pure polylactic acid and with blends of polylactic acid and polylactic co-glycolic acid in order to analyze the effect of LA/GA composition during the foaming process and porosity of the foam. Different experimental designs were used to attain optimized porosity and pore size distribution.

Firstly, we must admit that the consideration of the results of the  $2^4$ , Taguchi and initial Doehlert plan is difficult. During these experiments, we have not noticed the important effect of the volume constraint and the position of the pellet. Indeed, these two parameters affect the pore size. We have encountered important heterogeneities within the cross-sections micrographs and very different pore sizes for the scaffolds which were processed in the same chamber. For this reason, we have decided to change the experimental setup. We have removed the Teflon isolation to gain volume and we have filled the chamber with small glass balls. After that, only one pellet has been placed on the holed grill which has been positioned above the glass balls. For the following experiments, we have found that the pore size increases with decreasing saturation pressure and depressurization rate. Best results have been achieved within the range of 128 and 138 $\mu\text{m}$  for  $P_{\text{sat}} = 100$  bar,  $T_{\text{sat}} = 36.5^\circ\text{C}$ ,  $t_{\text{sat}} = 60$  min. and  $dP/dt = 1.25$  bar /s.

Finally, detailed emphasis was laid down on the effect of process parameters such as saturation pressure, saturation temperature and saturation time and depressurization rate during foaming process. Optimum thickness of the pellet was finalized for the experimentation process.

# Chapter 6

## Optimization of Pore Morphology of Scaffolds for Connective Tissue Engineering

*This chapter consist of two parts, first two PLAs and two PLGAs were foamed by using the wet and dry method techniques in order to see the difference in pore morphology, structure and anisotropy. The influence of scCO<sub>2</sub> foaming parameters was studied in detail with respect to each polymer and process. The effect of each process parameter was taken into account to analyze the scaffolds and optimize their porosity and equivalent pore diameter. The mechanical properties of the optimized foams were also tested. Second we will present the optimized foaming results obtained by adding surface modifier to the polymer by co-grinding to improve the surface adhesion of the blend foam. A focus on pore morphology and their characteristics will be emphasized as it plays an important role in cell seeding, differentiating and growth in the scaffold.*

### **1 Optimization of PLA's Foams Processed by Wet and Dry Methods**

In this chapter, we have used P<sub>L,D</sub>LA (PABR L 68), P<sub>L,DL</sub>LA (Resomer<sup>®</sup> LR 704), PLGA<sub>85:15</sub> (DL-PLG), and PLGA<sub>50:50</sub> (PDLG 5010). These polymers have been characterized in detail in chapter 5.

First, pellets prepared by both methods were foamed with supercritical fluid to make scaffolds. Secondly, a comparative study was made to analyze the porosity and pore morphology created by wet and dry method. In the first part, we will discuss the two PLAs in which, one is amorphous while the other is semi-crystalline.

#### **1.1 Experimental Procedure**

##### **1.1.1 Preparation of Pellets by Wet and Dry Methods**

A soluble solvent, acetone, was used to make a homogenous solution with polymer powders. Transparent solution was poured in petri dish of 7cm diameter. The solution was dried for 48 hrs and then pellets of 12mm diameter and ~1 – 1.2mm thickness was cut with die cutter. Further details of the wet

method pellet preparation are reported in chapter 4 section 1.5. In parallel pellets of 13 mm diameter and ~1.2 mm thickness were also prepared by dry method as described earlier in section 1.4, chapter 4.

### 1.1.2 Taguchi' Design for Foaming

Taguchi' design was considered for these experimentations. We have chosen L<sub>9</sub> table. As a result, 4 process parameters were optimized: the pressure, the temperature, the time of saturation and the rate of depressurization. The domain of definition of this Taguchi design is presented in Table 6.1. A wide range of all the four parameters were kept in the initial plan.

**Table 6.1:** Initial Taguchi plans for scCO<sub>2</sub> foaming of pellets prepared by wet and dry method.

Nr	1	2	3	4	5	6	7	8	9
T <sub>sat</sub> (°C)	40	40	40	45	45	45	50	50	50
P <sub>sat</sub> (bar)	100	200	300	100	200	300	100	200	300
t <sub>sat</sub> (min)	30	40	20	40	20	30	20	30	40
dP/dt (bar/s)	1	3	5	5	1	3	3	5	1

SEPAREX<sup>®</sup> SFC6 scCO<sub>2</sub> laboratory plant was used for foaming scaffold during this experimentation. As the pressure chamber capacity is 6 liters, multiple pellets were placed inside the chamber for one process condition. Single perforate plate was adopted for foaming process by placing 4 pellets (2 wet plus 2 dry) for one process condition.

## 1.2 P<sub>L,D</sub>LA Foams Processed by Wet and Dry Methods: Initial Taguchi Plan

Foams of P<sub>L,D</sub>LA pellets, prepared by wet and dry methods, were produced by adapting initial Taguchi plan. After making the dimensional observations for geometric porosity calculations, SEM analysis for all the foams was done. Four to six micrographs were taken for each foam at different magnifications at different positions on the sample.

The equivalent pore diameter obtained from SCION<sup>®</sup> Image analysis of the SEM micrographs and the geometric porosity calculated from the dimensional data of pellets and foams are reported on Table 6.2. The highlighted and underlined values in the table are the optimum values. SEM micrographs of P<sub>L,D</sub>LA foams are presented in Figure 6.1. The process conditions for foams in the micrograph are saturation temperature, saturation pressure, saturation time and depressurization rate.

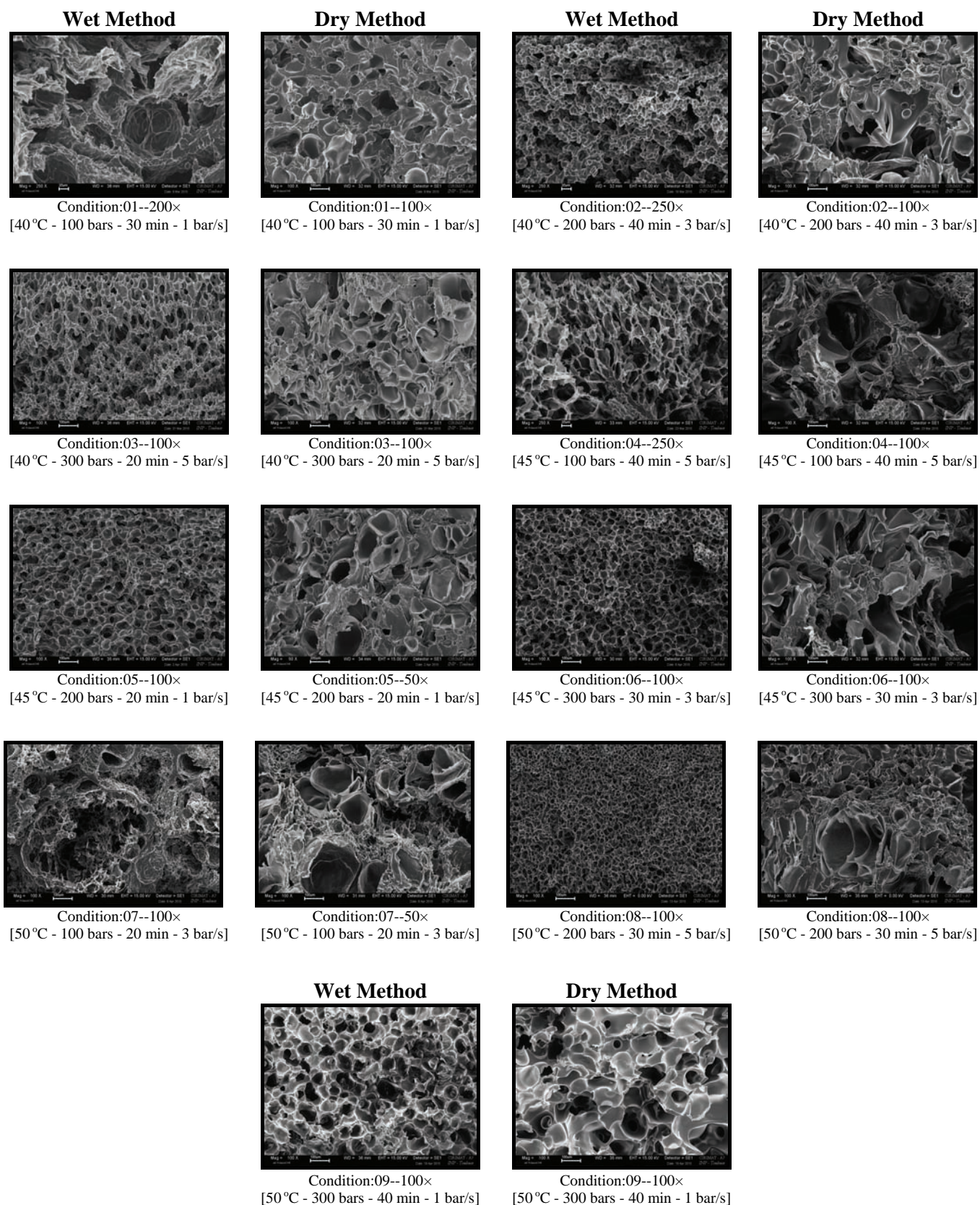
**Table 6.2:** P<sub>L,D</sub>LA foams pore data of wet and dry method by initial Taguchi' plan.

P <sub>L,D</sub> LA	scCO <sub>2</sub> Parameters				Geometric Porosity P (%)		Equivalent Pore Diameter d <sub>e</sub> (μm)	
	T <sub>sat</sub>	P <sub>sat</sub>	t <sub>sat</sub>	dP/dt	Wet	Dry	Wet	Dry
	(°C)	(bar)	(min)	(bar/s)				
<b>P1</b>	40	100	30	1	56.5	55.8	50	60
<b>P2</b>	40	200	40	3	59.1	63.3	15	40
<b>P3</b>	40	300	20	5	69.3	68.9	20	25
<b>P4</b>	45	100	40	5	63.5	<u>83.6</u>	25	65
<b>P5</b>	45	200	20	1	74.4	57.1	20	50
<b>P6</b>	45	300	30	3	75.2	59.5	10	80
<b>P7</b>	50	100	20	3	77.2	72.5	<u>100</u>	<u>125</u>
<b>P8</b>	50	200	30	5	<u>91.6</u>	57.8	10	50
<b>P9</b>	50	300	40	1	64.8	63.0	20	25

The pore diameter was heterogeneous (small and large) in the foams obtained hence the magnification was different for some of the foams. Higher and low magnification was done for foam



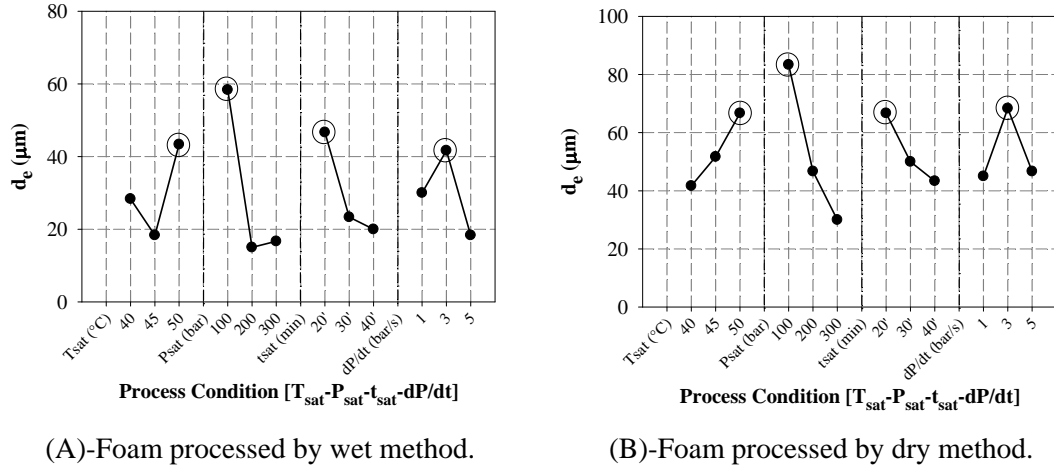
micrographs with small and large pore diameters. Most of the images presented in Figure 6.1 are of magnification 100 $\times$  and 250 $\times$ .



**Figure 6.1:** Micrographs of  $P_{LD}LA$  foams processed by wet and dry methods.

**1.2.1 Effect of Process Parameters on Equivalent Pore Diameter ( $d_e$ )**

The effect of each process parameter on equivalent pore diameter and porosity was calculated for both wet and dry methods. Figure 6.2 presents a comparison between average effect on the equivalent pore diameter for wet and dry methods.



**Figure 6.2:** Average effect of each parameter on equivalent pore diameter of  $P_{LD}$ LA foams.

From these graphs (cf. Figure 6.2-A and B), the optimized parameters on equivalent pore diameter for both methods are as follows.

Wet method:  $T_{\text{sat}} = 50^\circ\text{C}$ ,  $P_{\text{sat}} = 100$  bars,  $t_{\text{sat}} = 20$  min and  $dP/dt = 3$  bar/s

Dry method:  $T_{\text{sat}} = 50^\circ\text{C}$ ,  $P_{\text{sat}} = 100$  bars,  $t_{\text{sat}} = 20$  min and  $dP/dt = 3$  bar/s

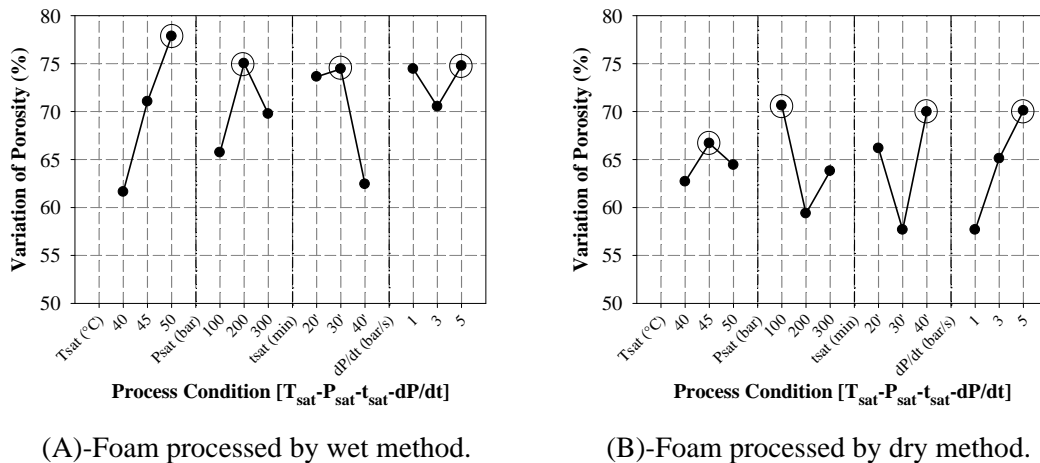
The equivalent pore diameter of scaffolds is comparable between both methods (125  $\mu\text{m}$  for wet method and 100  $\mu\text{m}$  for dry method). Optimal conditions are same for both wet and dry methods.

**1.2.2 Effect of Process Parameters on Geometric Porosity**

Taking into account the average effect of each process parameter on geometric porosity (cf. Figure 6.3-A and B), the optimized parameters for both methods are as follows.

Wet method:  $T_{\text{sat}} = 50^\circ\text{C}$ ,  $P_{\text{sat}} = 200$  bars,  $t_{\text{sat}} = 30$  min and  $dP/dt = 5$  bar/s

Dry method:  $T_{\text{sat}} = 45^\circ\text{C}$ ,  $P_{\text{sat}} = 100$  bars,  $t_{\text{sat}} = 40$  min and  $dP/dt = 5$  bar/s



**Figure 6.3:** Average effect of each parameter on variation of porosity of  $P_{LD}$ LA foams.



For wet method foam maximum geometric porosity is 91.6%, while for dry method it is 83.6%. The optimized scCO<sub>2</sub> foaming conditions for equivalent pore diameter and geometric porosity for both wet and dry methods are different.

### 1.3 P<sub>L,D</sub>LA Foams Processed by Wet and Dry Methods: Complementary Taguchi' Plan

After analysis of the results of initial plan, it was decided to make a complementary plan with modified process parameters to obtain maximum pore size and porosity. Complementary plan with different process parameters is presented in Table 6.3. The saturation pressure range was narrowed and moved to lower values as high pressures generates small pore diameters, the saturation temperature was kept unchanged, the time of saturation range was also narrowed and moved to lower values. The rate of depressurization ranges was broaden to analyze the effect of high and low dP/dt rates on the equivalent pore diameter, porosity and pore morphology of P<sub>L,D</sub>LA foams.

**Table 6.3:** Complementary Taguchi plans for scCO<sub>2</sub> foaming of pellets prepared by wet and dry method.

Nr	1	2	3	4	5	6	7	8	9
T <sub>sat</sub> (°C)	40	40	40	45	45	45	50	50	50
P <sub>sat</sub> (bar)	75	100	150	75	100	150	75	100	150
t <sub>sat</sub> (min)	20	25	15	25	15	20	15	20	25
dP/dt (bar/s)	6	2	4	4	6	2	2	4	6

The equivalent pore diameter obtained from SCION<sup>®</sup> image analysis of the SEM micrographs and the geometric porosity calculated from the dimensional data of pellets and foams are reported on

Table 6.4.

**Table 6.4:** P<sub>L,D</sub>LA foams pore data of wet and dry method by complementary Taguchi plan.

P <sub>L,D</sub> LA	scCO <sub>2</sub> Parameters				Geometric Porosity P (%)		Equivalent Pore Diameter d <sub>e</sub> (μm)	
	T <sub>sat</sub>	P <sub>sat</sub>	t <sub>sat</sub>	dP/dt	Wet	Dry	Wet	Dry
	(°C)	(bar)	(min)	(bar/s)				
<b>P1</b>	40	75	20	6	51.4	84.3	5	40
<b>P2</b>	40	100	25	2	47.6	84.5	15	50
<b>P3</b>	40	150	15	4	41.0	72.1	5	30
<b>P4</b>	45	75	25	4	51.4	78.0	5	40
<b>P5</b>	45	100	15	6	43.2	74.0	30	30
<b>P6</b>	45	150	20	2	55.1	65.6	60	65
<b>P7</b>	50	75	15	2	67.3	82.8	40	50
<b>P8</b>	50	100	20	4	74.9	88.3	25	100
<b>P9</b>	50	150	25	6	84.1	75.3	25	40

SEM micrographs of P<sub>L,D</sub>LA foams obtained for complementary plan are presented in Figure 6.4. Observing the micrographs of these foams and Comparing to the micrographs of initial Taguchi plan, we found that at low pressure and temperature ranges the pores generated are of very small diameter. At higher temperature ranges the pore diameter observed is higher. Comparing the results of porosities of wet method

foams they are comparatively at lower side to the initial Taguchi plan values. Comparison of both plans will give a more comprehensive picture about the effect of each process parameter on the equivalent pore diameter and geometric porosity.

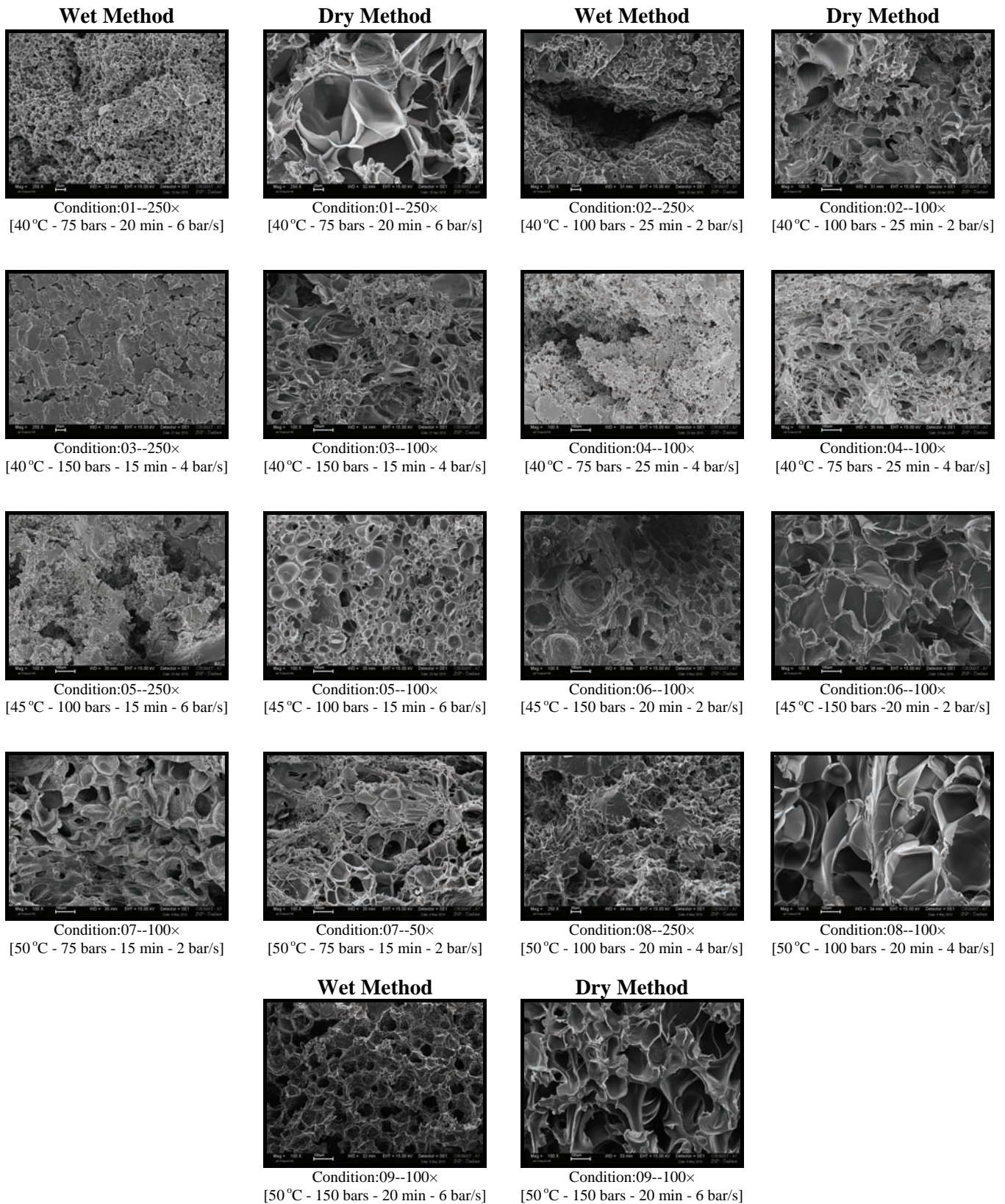
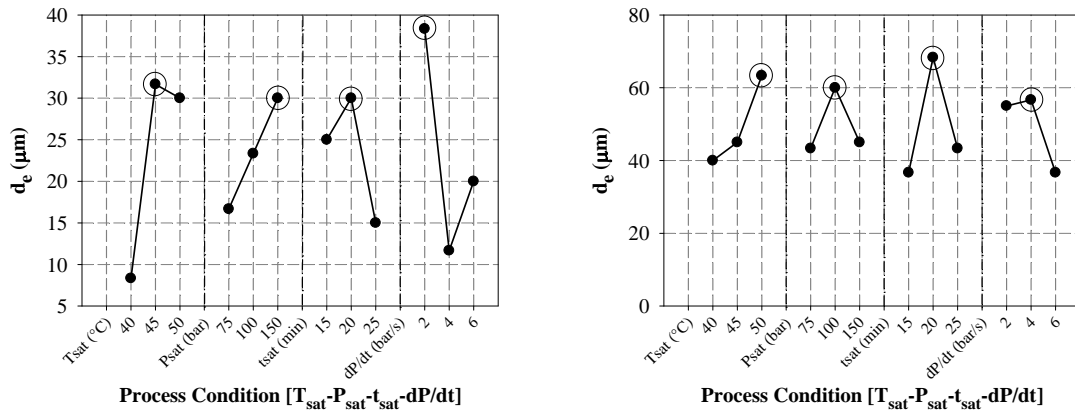


Figure 6.4: Micrographs of PLD/LA foams processed by wet and dry methods.

### 1.3.1 Effect of Process Parameters on Equivalent Pore Diameter ( $d_e$ )

Figure 6.5 presents a comparison between the average effect on equivalent pore diameter for wet and dry methods.



(A)-Foam processed by wet method.

(B)-Foam processed by dry method

**Figure 6.5:** Average effect of each parameter on equivalent pore diameter of  $P_{L,D}$ LA foams.

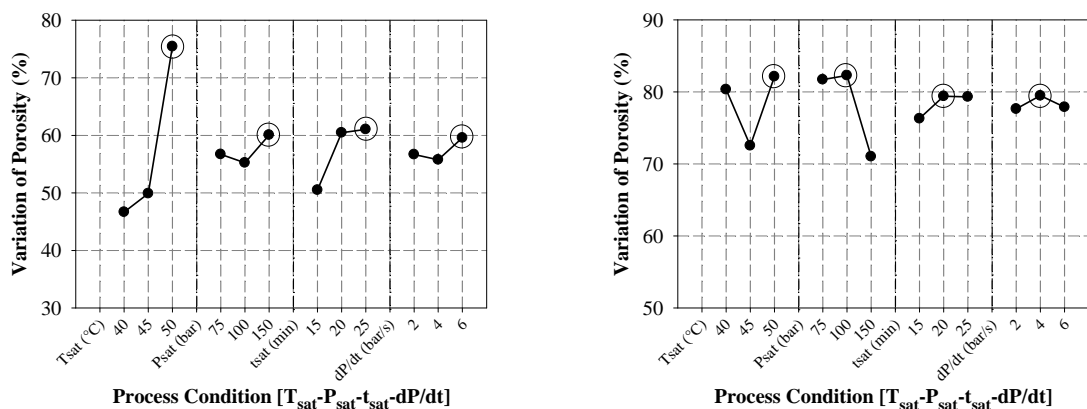
The maximum and optimized value of average equivalent pore diameter is 60  $\mu\text{m}$  for wet method and 100  $\mu\text{m}$  for dry one. The value is higher in dry than in wet method. The conditions are stated as follows.

Wet method:  $T_{\text{sat}} = 45^\circ\text{C}$ ,  $P_{\text{sat}} = 150$  bars,  $t_{\text{sat}} = 20$  min and  $dP/dt = 2$  bar/s

Dry method:  $T_{\text{sat}} = 50^\circ\text{C}$ ,  $P_{\text{sat}} = 100$  bars,  $t_{\text{sat}} = 20$  min and  $dP/dt = 4$  bar/s

### 1.3.2 Effect of Process Parameters on Geometric Porosity

The average effect of each process parameter on porosity (cf. Figure 6.6-A and B), is obtained for the following  $\text{scCO}_2$  process conditions.



(A)-Foam processed by wet method.

(B)-Foam processed by dry method.

**Figure 6.6:** Average effect of each parameter on variation of geometric porosity of  $P_{L,D}$ LA foams.

Wet method:  $T_{\text{sat}} = 50^\circ\text{C}$ ,  $P_{\text{sat}} = 150$  bars,  $t_{\text{sat}} = 25$  min and  $dP/dt = 6$  bar/s

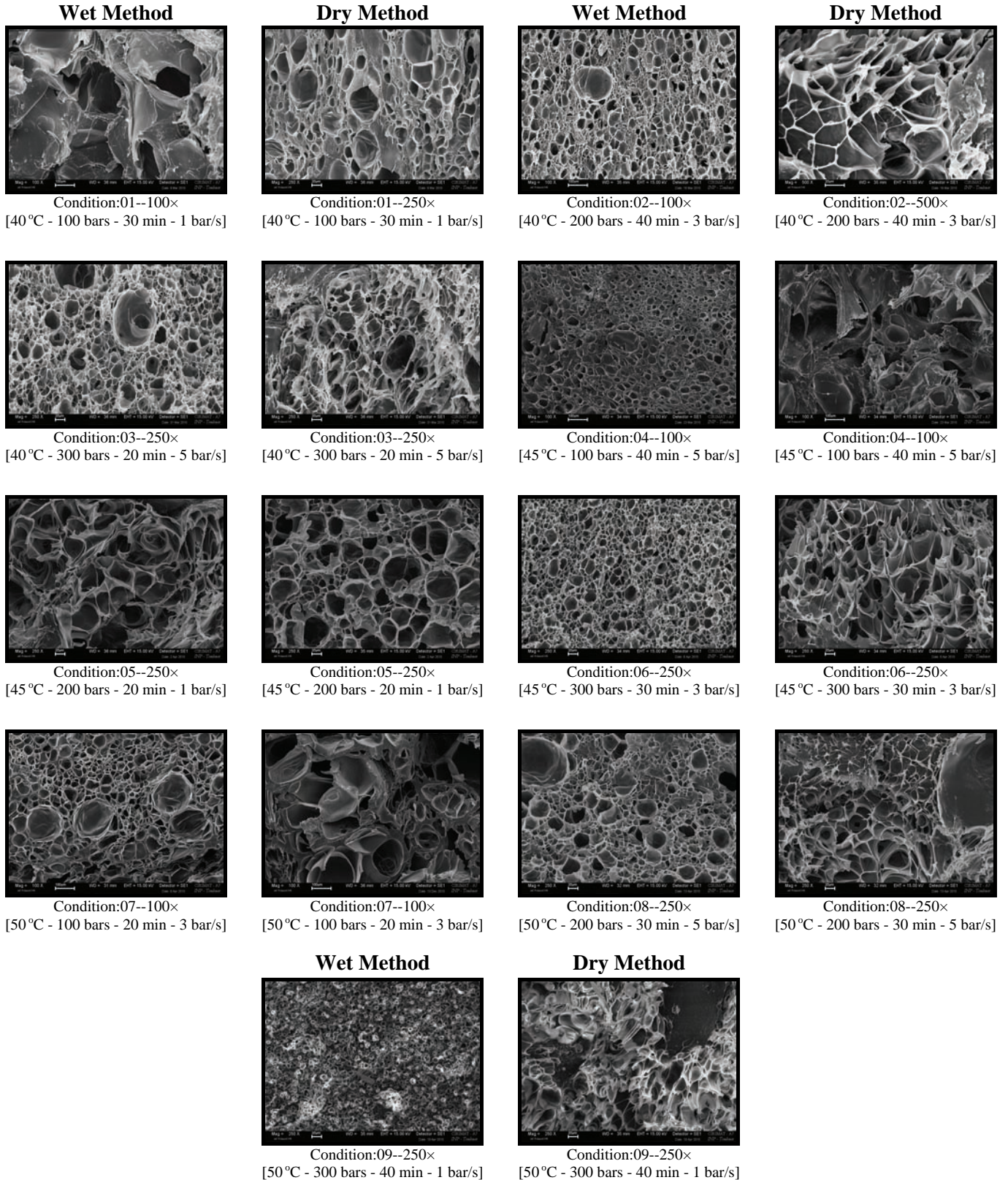
Dry method:  $T_{\text{sat}} = 50^\circ\text{C}$ ,  $P_{\text{sat}} = 100$  bars,  $t_{\text{sat}} = 20$  min and  $dP/dt = 4$  bar/s



The maximum values obtained are 84.1% and 88.3% for wet and dry method. The highest values of porosities for both methods are obtained at higher temperature and higher dP/dt values.

#### 1.4 P<sub>L,DL</sub>LA Foams Processed by Wet and Dry Methods: Initial Taguchi Plan

SEM micrographs of foams processed by initial plan are presented in Figure 6.7.



**Figure 6.7:** Micrographs of  $P_{L,DL}LA$  foams processed by wet and dry methods.

The equivalent pore diameter obtained from SCION<sup>®</sup> image analysis on the SEM micrographs, and porosity data by geometric method from the dimensional observations of the  $P_{L,DL}LA$  pellets and foams are presented in Table 6.5.

**Table 6.5:**  $P_{L,DL}LA$  foams pore data of wet and dry method by initial Taguchi' plan.

$P_{L,DL}LA$	scCO <sub>2</sub> Parameters				Geometric Porosity P (%)		Equivalent Pore Diameter $d_e$ ( $\mu\text{m}$ )	
	$T_{\text{sat}}$	$P_{\text{sat}}$	$t_{\text{sat}}$	$dP/dt$	Wet	Dry	Wet	Dry
	( $^{\circ}\text{C}$ )	(bar)	(min)	(bar/s)				
<b>P1</b>	40	100	30	1	80.0	63.8	15	30
<b>P2</b>	40	200	40	3	82.8	68.7	20	25
<b>P3</b>	40	300	20	5	83.1	65.4	5	15
<b>P4</b>	45	100	40	5	78.9	94.3	15	50
<b>P5</b>	45	200	20	1	85.8	66.9	20	35
<b>P6</b>	45	300	30	3	83.9	97.8	5	20
<b>P7</b>	50	100	20	3	82.7	85.4	30	75
<b>P8</b>	50	200	30	5	88.9	85.1	10	15
<b>P9</b>	50	300	40	1	82.3	83.0	5	20

#### 1.4.1 Effect of Process Parameters on Equivalent Pore Diameter ( $d_e$ )

The effect of each process parameter on equivalent pore diameter and porosity was calculated for both wet and dry methods and the graph is presented below.

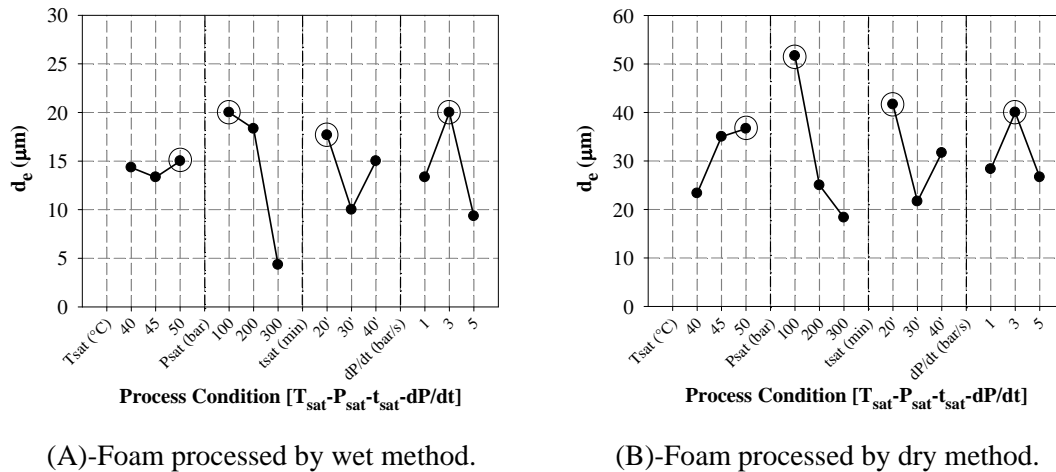
**Figure 6.8:** Average effect of each parameter on equivalent pore diameter of  $P_{L,DL}LA$  foams.

Figure 6.8 presents the comparison between the equivalent pore diameter effect for wet and dry methods. The optimized parameters obtained on the basis of equivalent pore diameter for both methods are stated as follows.

Wet method:  $T_{\text{sat}} = 50^{\circ}\text{C}$ ,  $P_{\text{sat}} = 100$  bars,  $t_{\text{sat}} = 20$  min and  $dP/dt = 3$  bar/s

Dry method:  $T_{\text{sat}} = 50^{\circ}\text{C}$ ,  $P_{\text{sat}} = 100$  bars,  $t_{\text{sat}} = 20$  min and  $dP/dt = 3$  bar/s

The value of equivalent pore diameter at these optimum conditions is  $30 \mu\text{m}$  for wet method and  $75 \mu\text{m}$  for dry method. For both the methods we can observe that optimum condition is same. However the pore diameter in wet method is even less than half of pore diameter in dry method. In wet method after being

saturated with scCO<sub>2</sub> during the depressurization step, desorption phenomenon is for a very short time in the polymer leading in low pore diameter as compared to dry method.

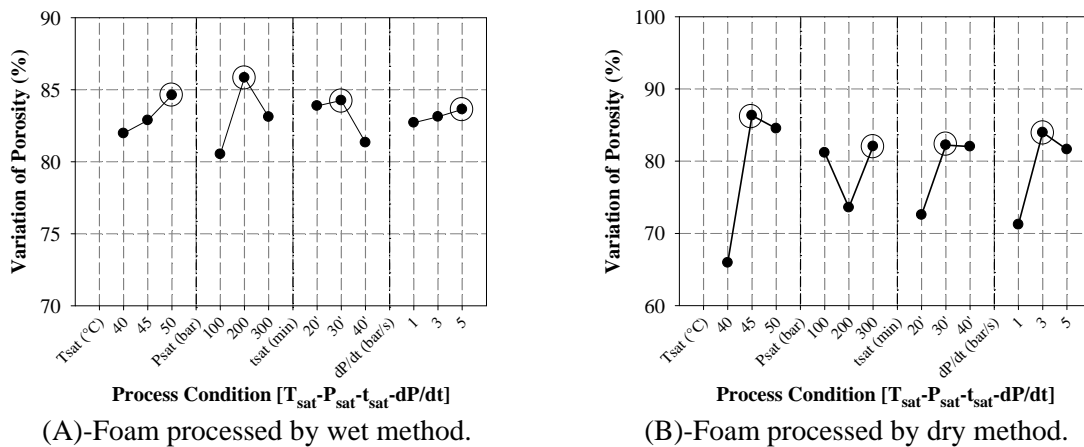
#### 1.4.2 Effect of Process Parameters on Geometric Porosity

Taking into account the effect of each process parameter on geometric porosity (cf. Figure 6.9-A and B), the optimized parameters for both methods are as follows:

Wet method:  $T_{\text{sat}} = 50^{\circ}\text{C}$ ,  $P_{\text{sat}} = 200$  bars,  $t_{\text{sat}} = 30$  min and  $dP/dt = 5$  bar/s

Dry method:  $T_{\text{sat}} = 45^{\circ}\text{C}$ ,  $P_{\text{sat}} = 300$  bars,  $t_{\text{sat}} = 30$  min and  $dP/dt = 3$  bar/s

There is a difference in the optimized parameter for wet and dry methods. We obtain maximum foam porosity value of 88.9% and 97.8% for wet and dry method.



**Figure 6.9:** Average effect of each parameter on variation of geometric porosity of P<sub>L,DL</sub>LA foams.

### 1.5 P<sub>L,DL</sub>LA Foams Processed by Wet and Dry Methods: Complementary Taguchi<sup>®</sup> Plan

The equivalent pore diameter obtained from SCION<sup>®</sup> image analysis on the SEM micrographs and geometric porosity calculated from the dimensional data of pellets and foams are reported on Table 6.6.

**Table 6.6:** P<sub>L,DL</sub>LA foams pore data of wet and dry method by complementary Taguchi plan.

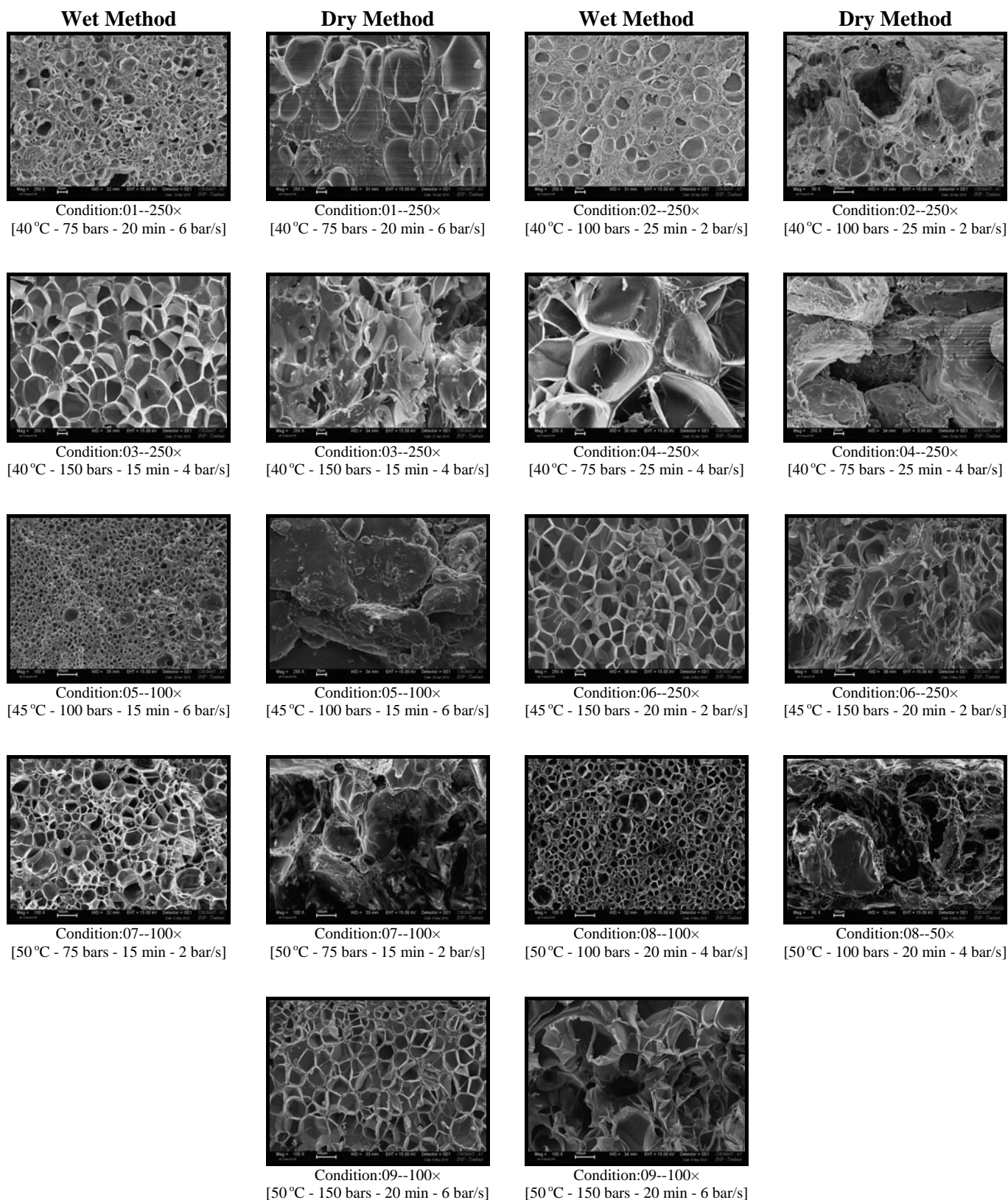
P <sub>L,DL</sub> LA	scCO <sub>2</sub> Parameters				Geometric Porosity P (%)		Equivalent Pore Diameter d <sub>c</sub> (μm)	
	T <sub>sat</sub>	P <sub>sat</sub>	t <sub>sat</sub>	dP/dt	Wet	Dry	Wet	Dry
	(°C)	(bar)	(min)	(bar/s)				
P1	40	75	20	6	70.8	55.7	5	50
P2	40	100	25	2	76.2	73.1	15	75
P3	40	150	15	4	83.2	65.4	25	30
P4	45	75	25	4	<u>90.8</u>	72.8	55	20
P5	45	100	15	6	58.2	56.1	10	5
P6	45	150	20	2	85.5	<u>79.5</u>	15	55
P7	50	75	15	2	83.8	63.2	<u>80</u>	40
P8	50	100	20	4	72.0	67.5	20	<u>125</u>
P9	50	150	25	6	78.2	53.3	40	75

It can be observed from the data of geometric porosity that in wet method porosities of foams obtained is higher than the porosities of foams in dry method. Whereas the pore diameter



obtained is compareably higher in the dry method. In this plan the optimum conditions for both wet and dry methods are different for equivalent pore diameter and porosity.

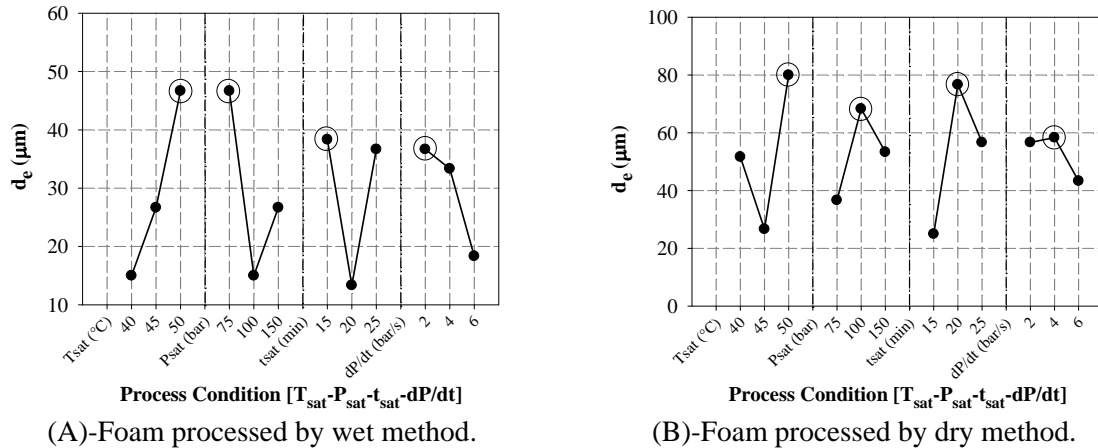
SEM micrographs of  $P_{L,DL}LA$  foams processed by complementary plan are presented in Figure 6.10.





**Figure 6.10:** Micrographs of  $P_{L,DL}LA$  foams processed by wet and dry methods.**1.5.1 Effect of Process Parameters on Equivalent pore diameter ( $d_e$ )**

Average effect of each process parameter on equivalent pore diameter and geometric porosity for both methods are presented in Figure 6.11 and Figure 6.12.

**Figure 6.11:** Average effect of each parameter on equivalent pore diameter of  $P_{L,DL}LA$  foams.

From Figure 6.11 we deduced the  $\text{scCO}_2$  parameters which permit to optimize the average equivalent pore diameter for both methods.

Wet method:  $T_{\text{sat}} = 50^\circ\text{C}$ ,  $P_{\text{sat}} = 75$  bars,  $t_{\text{sat}} = 15$  min and  $dP/dt = 2$  bar/s

Dry method:  $T_{\text{sat}} = 50^\circ\text{C}$ ,  $P_{\text{sat}} = 100$  bars,  $t_{\text{sat}} = 20$  min and  $dP/dt = 4$  bar/s

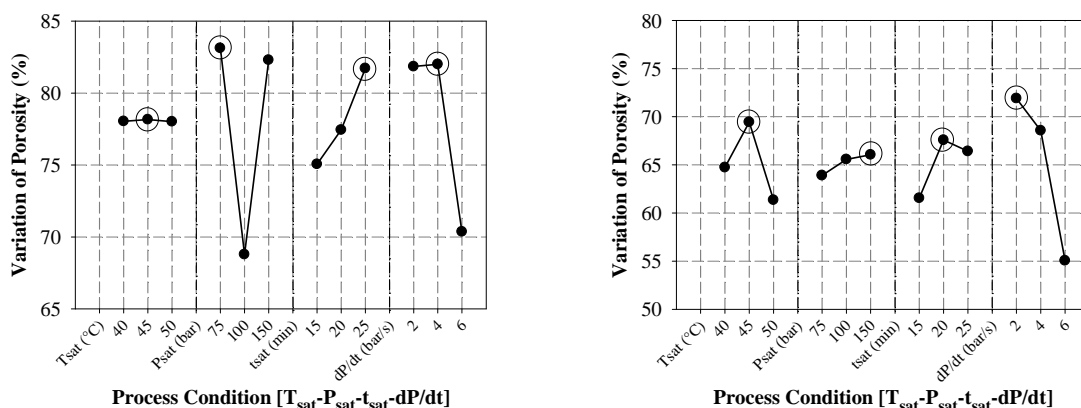
From these values we obtain equivalent pore diameter of  $80 \mu\text{m}$  for wet method and  $125 \mu\text{m}$  for dry method.

**1.5.2 Effect of Process Parameters on Geometric Porosity**

Taking into account the effect of each process parameter on geometric porosity (cf. Figure 6.12-A and B), 90.8%, for wet method and 79.5% for dry method foam porosity obtained at the following conditions.

Wet method:  $T_{\text{sat}} = 45^\circ\text{C}$ ,  $P_{\text{sat}} = 75$  bars,  $t_{\text{sat}} = 25$  min and  $dP/dt = 4$  bar/s

Dry method:  $T_{\text{sat}} = 45^\circ\text{C}$ ,  $P_{\text{sat}} = 150$  bars,  $t_{\text{sat}} = 20$  min and  $dP/dt = 2$  bar/s



(A)-Foam processed by wet method.

(B)-Foam processed by dry method.

**Figure 6.12:** Average effect of each parameter on variation of porosity of  $P_{L,DL}LA$  foams.

## 1.6 Comparison Between Both PLAs

The initial characterization gave the results that  $P_{L,D}LA$  was amorphous and  $P_{L,DL}LA$  was semi crystalline with 12.4% crystallinity. The molecular weight for both polylactides was approximately equivalent (163,971 and 201,169 respectively), and  $T_{gs}$  are of the same range (55.6°C and 60.1°C respectively). So, crystallinity ratio is the factor that plays a major role on the geometric porosity and equivalent pore diameter of the foams processed. By blocking the diffusion of  $scCO_2$  crystallites decreases the solubility of PLAs. The optimum results of both wet and dry methods for both polylactides are presented in Table 6.7 and Table 6.8 respectively.

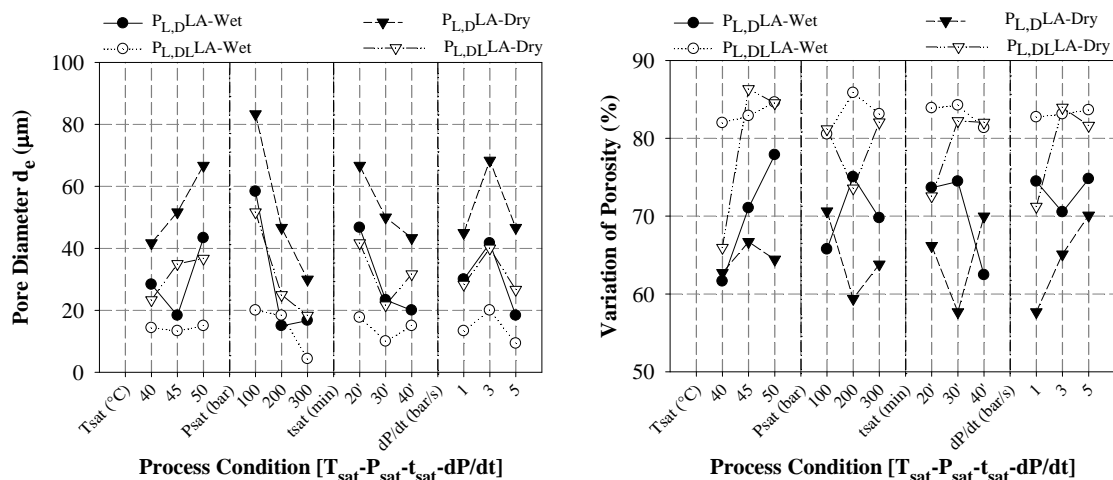
**Table 6.7:**  $P_{L,D}LA$  equivalent pore diameter and geometric porosity results for both methods and plans.

Wet Method			Dry Method		
Initial Taguchi Plan			Initial Taguchi Plan		
[50°C-100 bars-20 min-3 bar/s]	$d_e(\mu m)$	100	[50°C-100 bars-20 min-3 bar/s]	$d_e(\mu m)$	125
[50°C-200 bars-30 min-5 bar/s]	P(%)	91.6	[45°C-100 bars-40 min-5 bar/s]	P(%)	83.6
Complementary Taguchi Plan			Complementary Taguchi Plan		
[45°C-150 bars-20 min-2 bar/s]	$d_e(\mu m)$	60	[50°C-100 bars-20 min-4 bar/s]	$d_e(\mu m)$	100
[50°C-150 bars-25 min-6 bar/s]	P(%)	84.1	[50°C-100 bars-20 min-4 bar/s]	P(%)	88.3

**Table 6.8:**  $P_{L,DL}LA$  equivalent pore diameter and geometric porosity results for both methods and plans.

Wet Method			Dry Method		
Initial Taguchi Plan			Initial Taguchi Plan		
[50°C-100 bars-20 min-3 bar/s]	$d_e(\mu m)$	30	[50°C-100 bars-20 min-3 bar/s]	$d_e(\mu m)$	75
[50°C-200 bars-30 min-5 bar/s]	P(%)	88.9	[45°C-300 bars-30 min-3 bar/s]	P(%)	97.8
Complementary Taguchi Plan			Complementary Taguchi Plan		
[50°C-75 bars-15 min-2 bar/s]	$d_e(\mu m)$	80	[50°C-100 bars-20 min-4 bar/s]	$d_e(\mu m)$	125
[45°C-75bars-25 min-4 bar/s]	P(%)	90.8	[45°C-150 bars-20 min-2 bar/s]	P(%)	79.5

The comparison of effective equivalent pore diameter and porosity variation for  $P_{L,D}LA$  and  $P_{L,DL}LA$  for the initial Taguchi plan is presented in Figure 6.13. It is clear that foams of  $P_{L,D}LA$  being amorphous produced pores of larger diameter than  $P_{L,DL}LA$  in both wet and dry method.



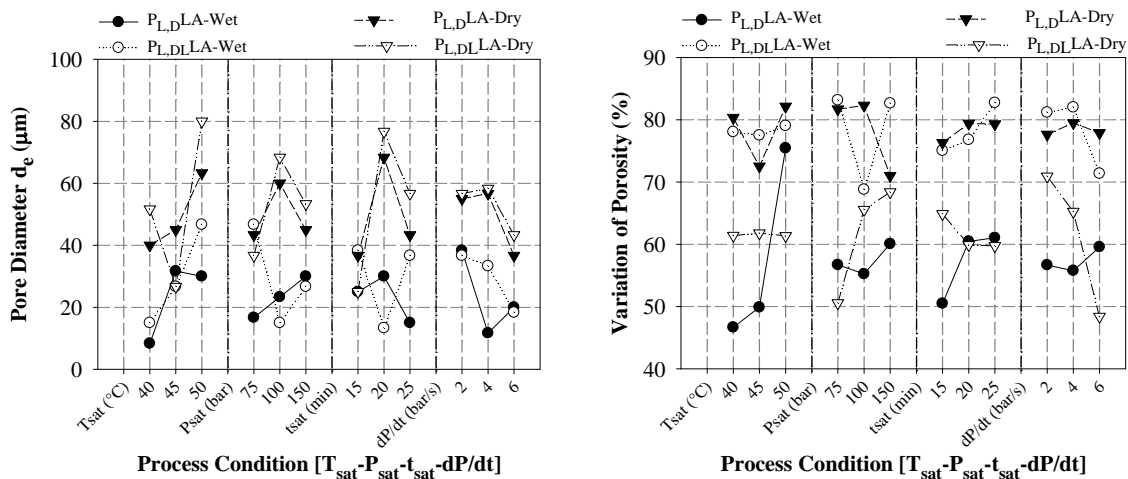
(A)- Equivalent pore diameter of foams.

(B)- Geometric porosity of foams.

**Figure 6.13:** Average effect of each parameter on variation of equivalent pore diameter and

porosity of  $P_{L,D}LA$  and  $P_{L,DL}LA$  foams by wet and dry methods from initial Taguchi plan.

Figure 6.14 presents the comparison of effective equivalent pore diameter and porosity variation for  $P_{L,D}LA$  and  $P_{L,DL}LA$  for the complementary Taguchi plan. Again we see the same trend that foams of  $P_{L,D}LA$  being amorphous produced pores of larger diameter than  $P_{L,DL}LA$  in both wet and dry pellet preparation method. Also if the initial and complementary Taguchi plan are compared, foams of larger diameter and higher porosity are produced in  $P_{L,D}LA$  foams in initial plan as compared to the  $P_{L,DL}LA$  foams. In complementary plan the phenomenon is unexpectedly reverse due to coalescence of pores.  $P_{L,D}LA$  and  $P_{L,DL}LA$  in dry method produced larger pore diameter than wet method indicating that proper nucleation and pore growth in dry method.



(A)- Equivalent pore diameter of foams.

(B)- Geometric porosity of foams.

**Figure 6.14:** Average effect of each parameter on variation of equivalent pore diameter and porosity of  $P_{L,D}LA$  and  $P_{L,DL}LA$  foams by wet and dry methods from complementary Taguchi plan.

$P_{L,DL}LA$  though produced foam with high porosity but the equivalent pore diameter was very low. The effect of each process parameter on equivalent pore diameter and porosity was calculated for both wet and dry methods.  $P_{L,D}LA$  is an amorphous polymer with 12% D-Lactide, while  $P_{L,DL}LA$  is a semi crystalline with 12.4% crystallinity. *Ma et al.* [2010] concluded from the experiments that amorphous PLA was found to have a better  $CO_2$  absorption whereas the crystalline regions in L-PLA impede the penetration of  $CO_2$  molecule. The solubility of carbon dioxide in both polymers shows the same trend, increasing with pressure and decreasing with temperature. The possible explanation for this behaviour is that the presence of crystallites in semicrystalline PLA can restrict the chain mobility in the amorphous phase, acting as virtual crosslinks, thus reducing the volume that can be used for the penetrant to make a diffusional jump and also avoiding the swelling. *Oliveira et al.* [2006] made a study showing that the apparent Langmuir capacity is very large for amorphous PLA while in semi-crystalline PLA, it is almost negligible. Also, the apparent Langmuir capacity diminishes as temperature approaches the glass transition temperature. This observation is consistent with the fact that the Langmuir capacity is directly related to the effective free volume that tends to zero at  $T_g$ . These results show that the different content of L:D isomers in PLA does influence not only the solubility but also the solubility mechanism.

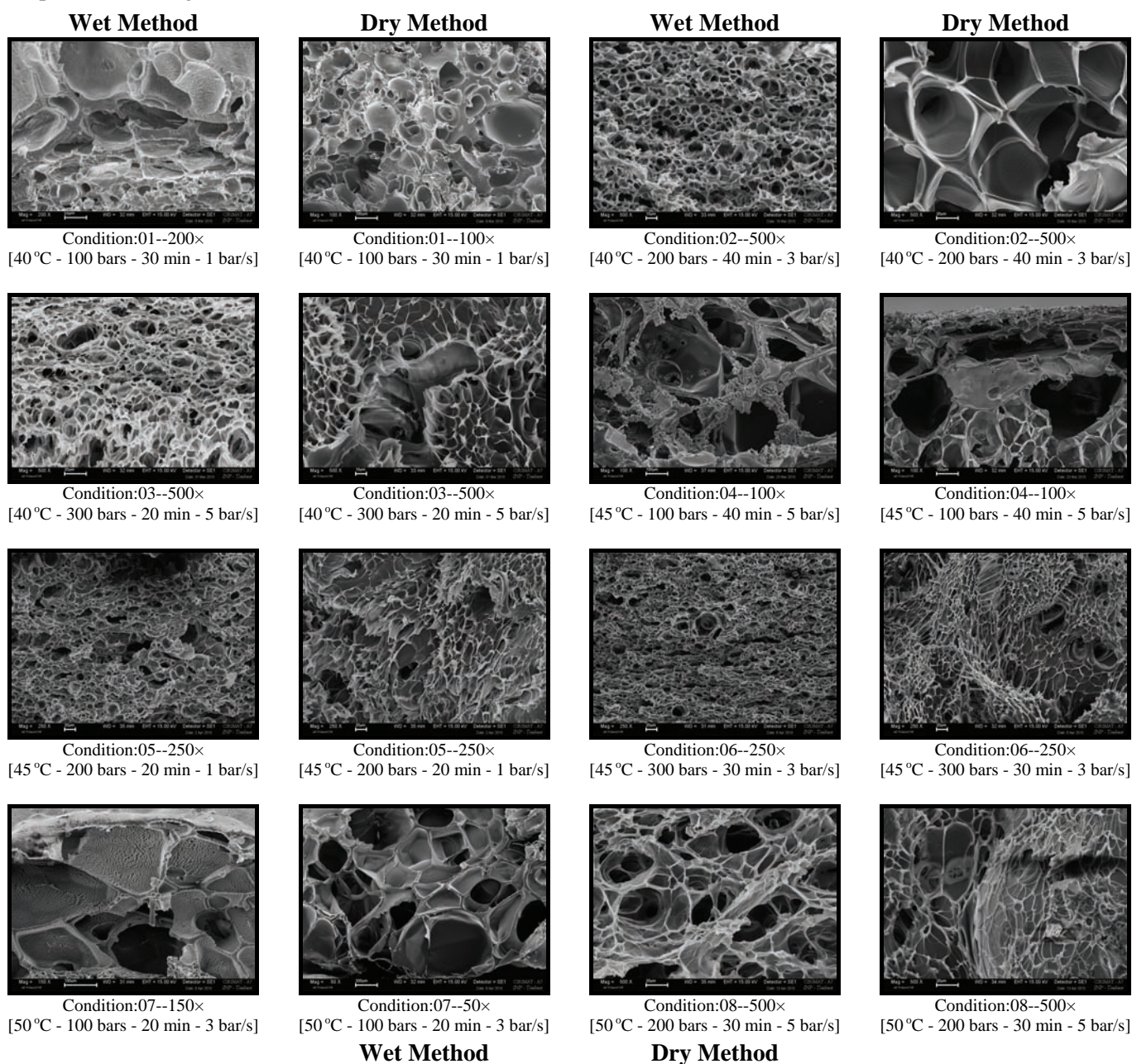
The possible reason for generation of high porosity and low pore diameter in wet method as compared to the dry method can be that in wet method more  $CO_2$  is sorbed as the polymer is more elastic due to the solvent. Then during the depressurization step  $CO_2$  is desorbed without resistance and there is not enough time for the pore to grow thus leading to highly porous but pores with small diameter.

Wet method can be applicable to the semi-crystalline polymers which are difficult at low temperatures to be processed in dry state. The application of wet method process can be limited for medical application due to the presence of solvent traces in the final product, however it can be used for commercial purpose where foams of small diameters and high porosity is required.

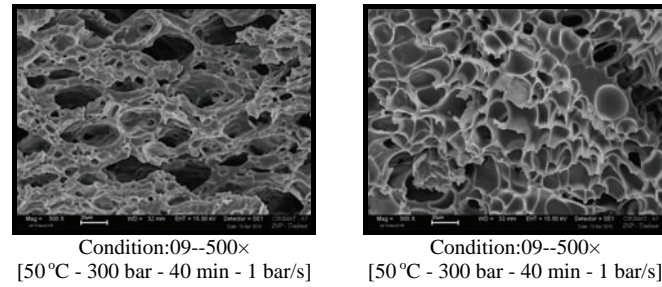
## 2 Optimization of PLGA's Foams by Wet and Dry Method.

### 2.1 PLGA<sub>50:50</sub> Foams Processed by Wet and Dry Methods

Two poly(lactic-co-glycolic acids) were used to produce foams by wet and dry methods. The initial Taguchi' plan has been used for these studies. The SEM micrographs of PLGA<sub>50:50</sub> foams are presented in Figure 6.15.







**Figure 6.15:** Micrographs of PLGA<sub>50:50</sub> foams processed by wet and dry methods.

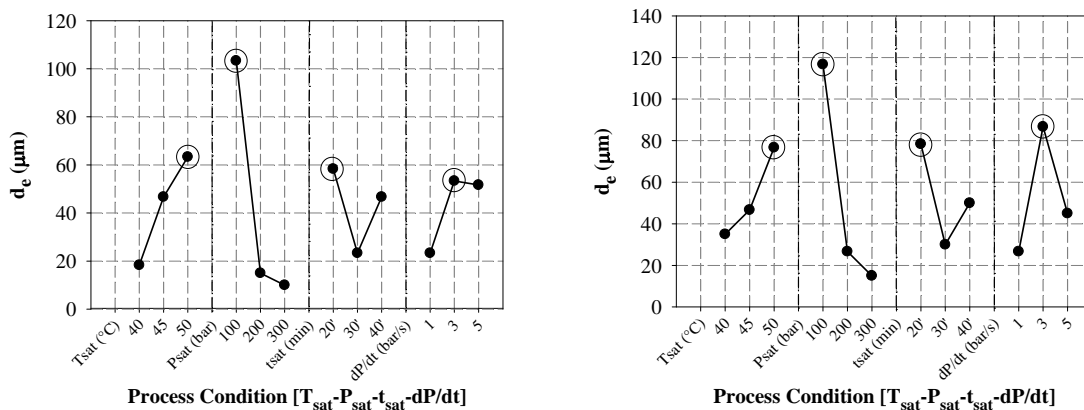
The equivalent pore diameter obtained from SCION<sup>®</sup> image analysis of SEM micrographs of PLGA<sub>50:50</sub> foams and geometric porosity calculated from the pellet and foam dimensional data by geometric method are presented in Table 6.9.

**Table 6.9:** PLGA<sub>50:50</sub> foams pore data of wet and dry method by initial Taguchi plan.

PLGA <sub>50:50</sub>	scCO <sub>2</sub> Parameters				Geometric Porosity P (%)		Equivalent Pore Diameter d <sub>e</sub> (μm)	
	T <sub>sat</sub>	P <sub>sat</sub>	t <sub>sat</sub>	dP/dt	Wet	Dry	Wet	Dry
	(°C)	(bar)	(min)	(bar/s)				
P1	40	100	30	1	87.6	73.6	40	50
P2	40	200	40	3	78.8	86.2	5	40
P3	40	300	20	5	81.8	81.6	10	15
P4	45	100	40	5	<u>97.5</u>	93.7	120	100
P5	45	200	20	1	84.4	72.4	15	20
P6	45	300	30	3	83.0	82.8	5	20
P7	50	100	20	3	86.1	<u>98.3</u>	<u>150</u>	<u>200</u>
P8	50	200	30	5	80.3	81.2	25	20
P9	50	300	40	1	78.2	71.5	15	10

### 2.1.1 Effect of Process Parameters on Equivalent Pore Diameter (d<sub>e</sub>)

Effect of each process parameter on pore diameter for both methods is presented in Figure 6.16. PLGA<sub>50:50</sub> is copolymer with LA/GA ratio of 50/50 and contains *D,L* lactide.



(A)-Foam processed by wet method.

(B)-Foam processed by dry method.

**Figure 6.16:** Average effect of each parameter on equivalent pore diameter of PLGA<sub>50:50</sub> foams.

From Figure 6.16, we deduced the scCO<sub>2</sub> parameters which permit to optimize the average equivalent pore diameter for both methods.

Wet method:  $T_{\text{sat}} = 50\text{ }^{\circ}\text{C}$ ,  $P_{\text{sat}} = 100\text{ bars}$ ,  $t_{\text{sat}} = 20\text{ min}$  and  $dP/dt = 3\text{ bar/s}$

Dry method:  $T_{\text{sat}} = 50\text{ }^{\circ}\text{C}$ ,  $P_{\text{sat}} = 100\text{ bars}$ ,  $t_{\text{sat}} = 20\text{ min}$  and  $dP/dt = 3\text{ bar/s}$

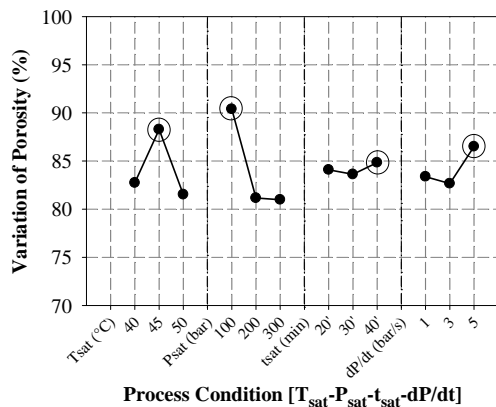
From these values we obtain equivalent pore diameter of 150  $\mu\text{m}$  for wet method and 200  $\mu\text{m}$  for dry method. For PLGA<sub>50:50</sub> the pore diameter for wet and dry method have the same optimum condition. For each condition the pore diameter for dry method is at higher values indicating that there was proper swelling and pore growth in saturated polymer in dry method, where as in wet method less resistance was offered by the saturated polymer during pore growth leading to low pore diameter.

### 2.1.2 Effect of Process Parameters on Geometric Porosity

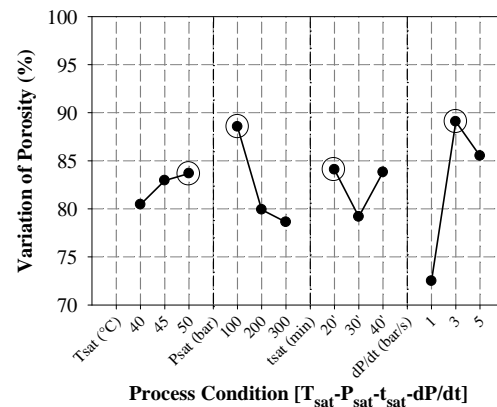
The effect of each process parameter on geometric porosity is presented in Figure 6.17. The maximum value of geometric porosity for wet and dry methods is 97.5% and 98.3%. The optimized parameters for both methods are as follows.

Wet method:  $T_{\text{sat}} = 45\text{ }^{\circ}\text{C}$ ,  $P_{\text{sat}} = 100\text{ bars}$ ,  $t_{\text{sat}} = 40\text{ min}$  and  $dP/dt = 5\text{ bar/s}$

Dry method:  $T_{\text{sat}} = 50\text{ }^{\circ}\text{C}$ ,  $P_{\text{sat}} = 100\text{ bars}$ ,  $t_{\text{sat}} = 20\text{ min}$  and  $dP/dt = 3\text{ bar/s}$



(A)-Foam processed by wet method.



(B)-Foam processed by dry method.

**Figure 6.17:** Average effect of each parameter on variation of geometric porosity of PLGA<sub>50:50</sub> foams.

## 2.2 PLGA<sub>50:50</sub> Foams by Wet and Dry Methods by Complementary Taguchi' Plan

The complementary Taguchi plan followed for the processing of foams is presented in Table 6.10. The equivalent pore diameter obtained from SCION<sup>®</sup> image analysis of the SEM micrographs and geometric porosity calculated from the dimensional data of pellets and foams are reported on Table 6.10.

**Table 6.10:** PLGA<sub>50:50</sub> foams pore data of wet and dry method by complementary Taguchi plan.

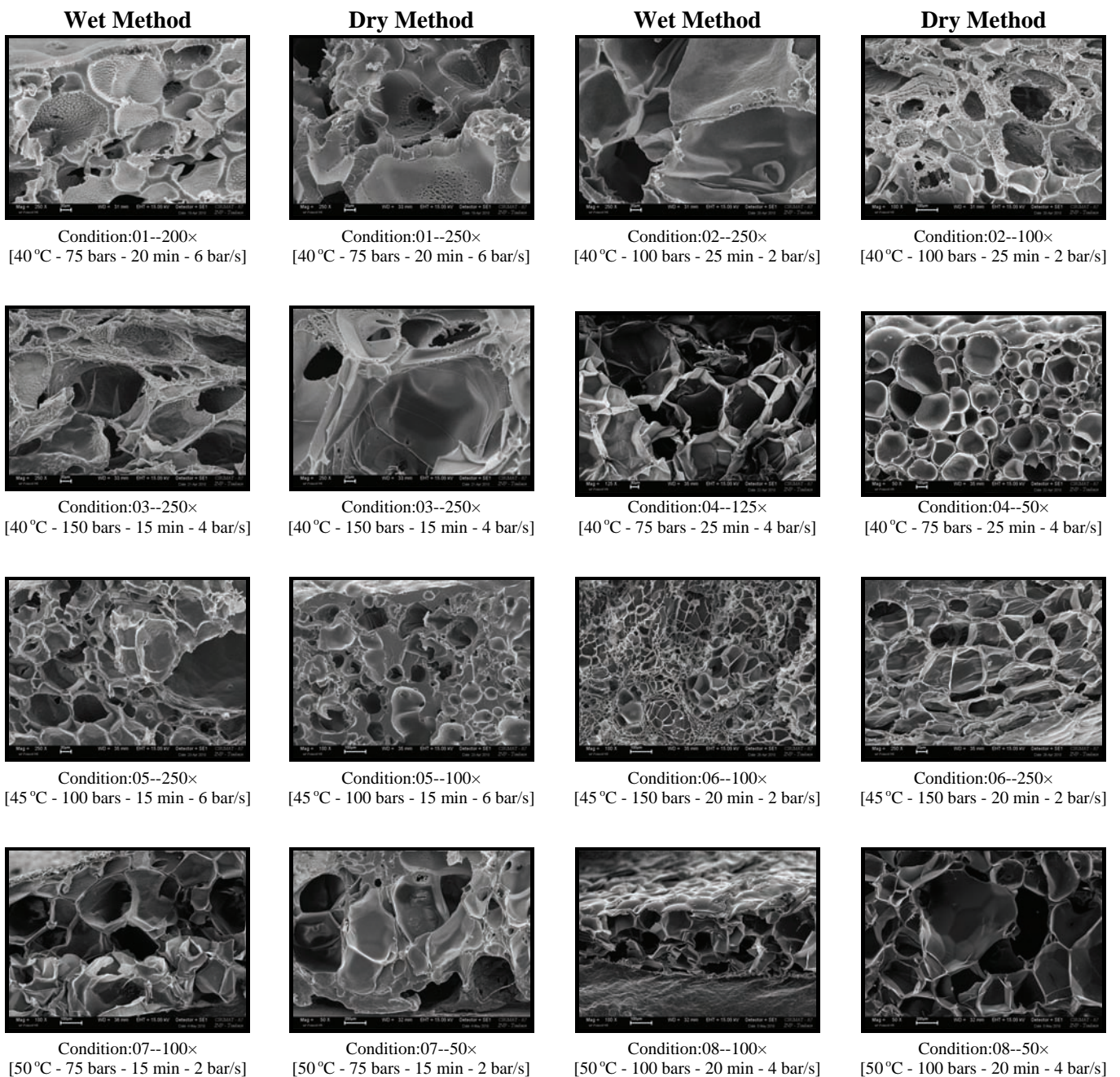
PLGA <sub>50:50</sub>	sc CO <sub>2</sub> Parameters				Geometric Porosity P (%)		Equivalent Pore Diameter d <sub>e</sub> (μm)	
	T <sub>sat</sub>	P <sub>sat</sub>	t <sub>sat</sub>	dP/dt	Wet	Dry	Wet	Dry
	(°C)	(bar)	(min)	(bar/s)				
<b>P1</b>	40	75	20	6	85.1	87.5	40	60
<b>P2</b>	40	100	25	2	92.8	81.7	80	100
<b>P3</b>	40	150	15	4	78.1	81.4	70	60
<b>P4</b>	45	75	25	4	74.9	80.2	100	125

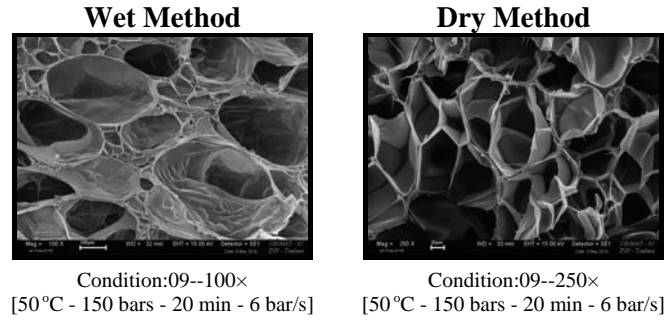


<b>P5</b>	45	100	15	6	<u>95.2</u>	<u>94.3</u>	50	75
<b>P6</b>	45	150	20	2	88.0	77.6	30	40
<b>P7</b>	50	75	15	2	83.4	71.4	125	200
<b>P8</b>	50	100	20	4	82.3	79.4	60	<u>250</u>
<b>P9</b>	50	150	25	6	87.8	82.6	<u>175</u>	60

In the complementary Taguchi plan the porosities of the foams obtained in most of the conditions are above 80%. In the initial Taguchi plan porosities were at higher value while porosity was not too high. The results of pore diameter comparable to initial Taguchi plans are on higher. It can also be revealed from the data that at higher pressures, higher dP/dt and at low temperature the pore size obtained is small.

SEM micrographs of PLGA<sub>50:50</sub> wet and dry method foams processed by following complementary Taguchi plan are presented in Figure 6.18.

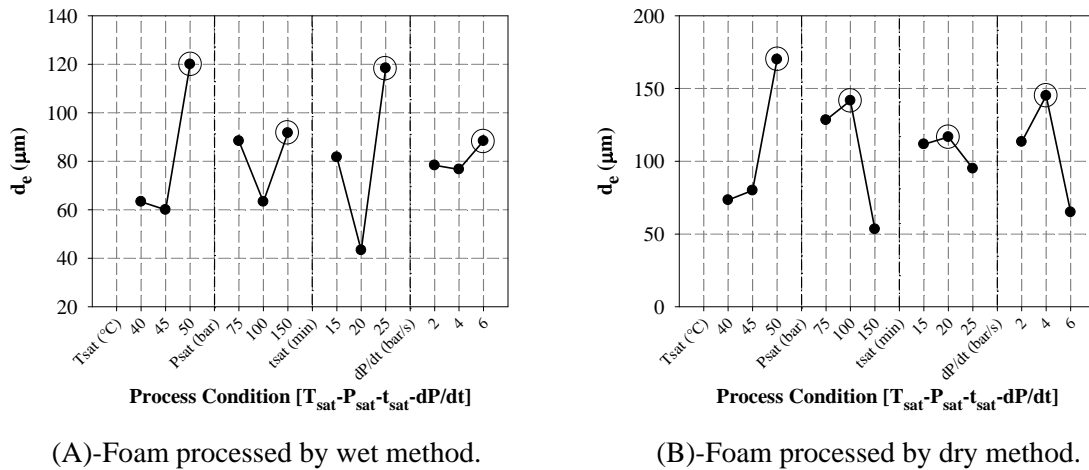




**Figure 6.18:** Micrographs of PLGA<sub>50:50</sub> foams processed by wet and dry methods.

### 2.2.1 Effect of Process Parameters on Equivalent Pore Diameter ( $d_e$ )

The effect of each process parameter on pore diameter and porosity for both methods is presented in Figure 6.19.



**Figure 6.19:** Average effect of each parameter on equivalent pore diameter of PLGA<sub>50:50</sub> foams.

From Figure 6.19, we deduced the scCO<sub>2</sub> parameters which permit to optimize the average equivalent pore diameter for both methods.

Wet method:  $T_{\text{sat}} = 50$  °C,  $P_{\text{sat}} = 150$  bars,  $t_{\text{sat}} = 25$  min and  $dP/dt = 6$  bar/s

Dry method:  $T_{\text{sat}} = 50$  °C,  $P_{\text{sat}} = 100$  bars,  $t_{\text{sat}} = 20$  min and  $dP/dt = 4$  bar/s

At optimized conditions we obtain equivalent pore diameter of 175 $\mu\text{m}$  for wet method and 250  $\mu\text{m}$  for dry method.

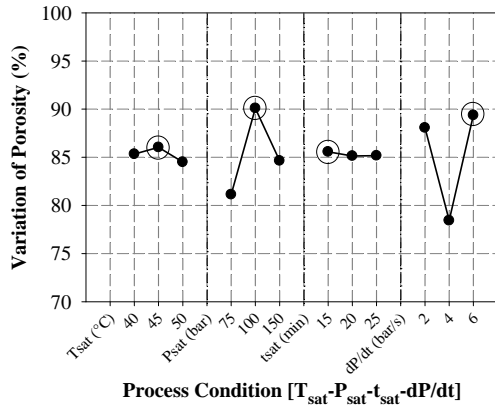
### 2.2.2 Effect of Process Parameters on Geometric Porosity

Maximum value for wet and dry method is 95.2% and 94.3%. Taking into account the effect of each process parameter on geometric porosity (cf. Figure 6.20), we obtain optimized conditions as follows,

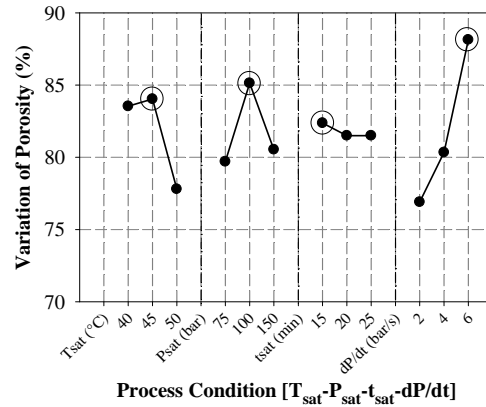
Wet method:  $T_{\text{sat}} = 45$  °C,  $P_{\text{sat}} = 100$  bars,  $t_{\text{sat}} = 15$  min and  $dP/dt = 6$  bar/s

Dry method:  $T_{\text{sat}} = 45$  °C,  $P_{\text{sat}} = 100$  bars,  $t_{\text{sat}} = 15$  min and  $dP/dt = 6$  bar/s





(A)-Foam processed by wet method.

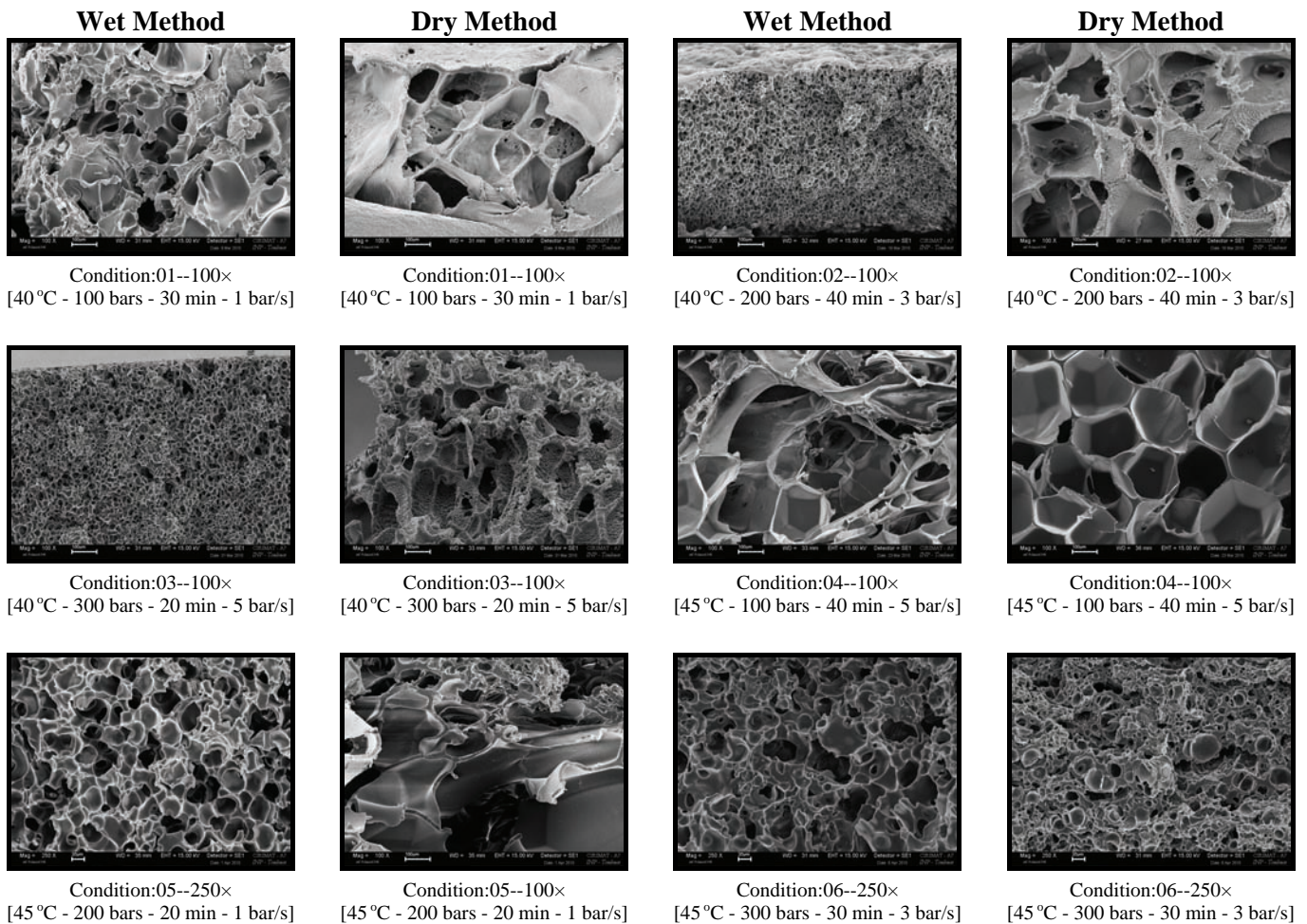


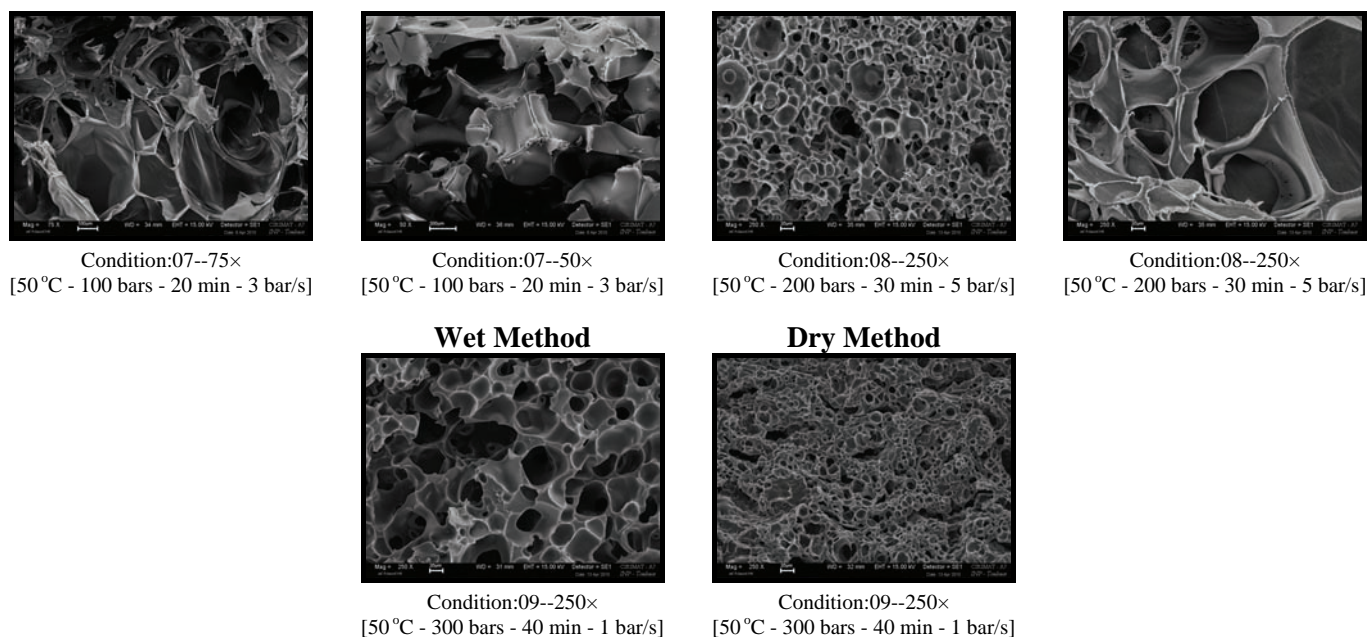
(B)-Foam processed by dry method.

Figure 6.20: Average effect of each parameter on variation of porosity of PLGA<sub>50:50</sub> foams.

### 2.3 PLGA<sub>85:15</sub> Foams Processed by Wet and Dry Methods: Initial Taguchi' Plan

The second poly(lactic-co-glycolide) used was PLGA<sub>85:15</sub>. The SEM micrographs of PLGA<sub>50:50</sub> foams are presented in Figure 6.21.





**Figure 6.21:** Micrographs of PLGA<sub>85:15</sub> foams processed by wet and dry methods.

The equivalent pore diameter obtained from SCION<sup>®</sup> image analysis of the SEM micrographs, porosity data by geometric method for PLGA<sub>85:15</sub> foams are presented in

Table 6.11.

**Table 6.11:** PLGA<sub>85:15</sub> foams pore data of wet and dry method by initial Taguchi plan.

PLGA <sub>50:50</sub>	scCO <sub>2</sub> Parameters				Geometric Porosity P (%)		Equivalent Pore Diameter d <sub>e</sub> (μm)	
	T <sub>sat</sub>	P <sub>sat</sub>	t <sub>sat</sub>	dP/dt	Wet	Dry	Wet	Dry
	(°C)	(bar)	(min)	(bar/s)				
<b>P1</b>	40	100	30	1	94.5	82.4	50	100
<b>P2</b>	40	200	40	3	69.6	82.0	10	125
<b>P3</b>	40	300	20	5	72.0	81.9	10	50
<b>P4</b>	45	100	40	5	93.7	84.9	125	150
<b>P5</b>	45	200	20	1	71.0	88.4	20	125
<b>P6</b>	45	300	30	3	84.0	80.2	20	10
<b>P7</b>	50	100	20	3	<u>96.2</u>	<u>94.2</u>	<u>250</u>	<u>225</u>
<b>P8</b>	50	200	30	5	72.9	86.3	15	60
<b>P9</b>	50	300	40	1	81.8	83.1	25	10

The corresponding SEM micrographs for PLGA<sub>85:15</sub> foams are presented in Figure 6.21.

### 2.3.1 Effect of Process Parameters on Equivalent Pore Diameter (d<sub>e</sub>)

Effect of each process parameter on pore diameter and porosity for both methods is presented in Figure 6.22.

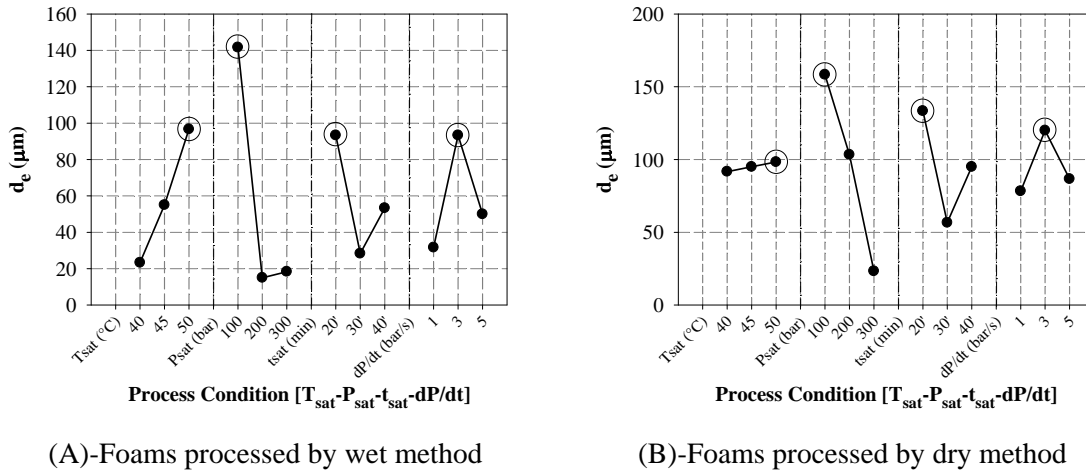


Figure 6.22: Average effect of each parameter on equivalent pore diameter of PLGA<sub>85:15</sub> foams.

From Figure 6.22, we deduced the scCO<sub>2</sub> parameters which permit to optimize the average equivalent pore diameter for both methods.

Wet method:  $T_{\text{sat}} = 50$  °C,  $P_{\text{sat}} = 100$  bars,  $t_{\text{sat}} = 20$  min and  $dP/dt = 3$  bar/s

Dry method:  $T_{\text{sat}} = 50$  °C,  $P_{\text{sat}} = 100$  bars,  $t_{\text{sat}} = 20$  min and  $dP/dt = 3$  bar/s

From these conditions, we obtain equivalent pore diameter of 250 $\mu\text{m}$  for wet method and 225 $\mu\text{m}$  for dry method.

### 2.3.2 Effect of Process Parameters on Geometric Porosity

Taking into account the effect of each process parameter on geometric porosity (cf. Figure 6.23), the wet and dry method foam porosity optimum are at the following conditions:

Wet method:  $T_{\text{sat}} = 50$  °C,  $P_{\text{sat}} = 100$  bars,  $t_{\text{sat}} = 20$  min and  $dP/dt = 3$  bar/s

Dry method:  $T_{\text{sat}} = 50$  °C,  $P_{\text{sat}} = 100$  bars,  $t_{\text{sat}} = 20$  min and  $dP/dt = 3$  bar/s

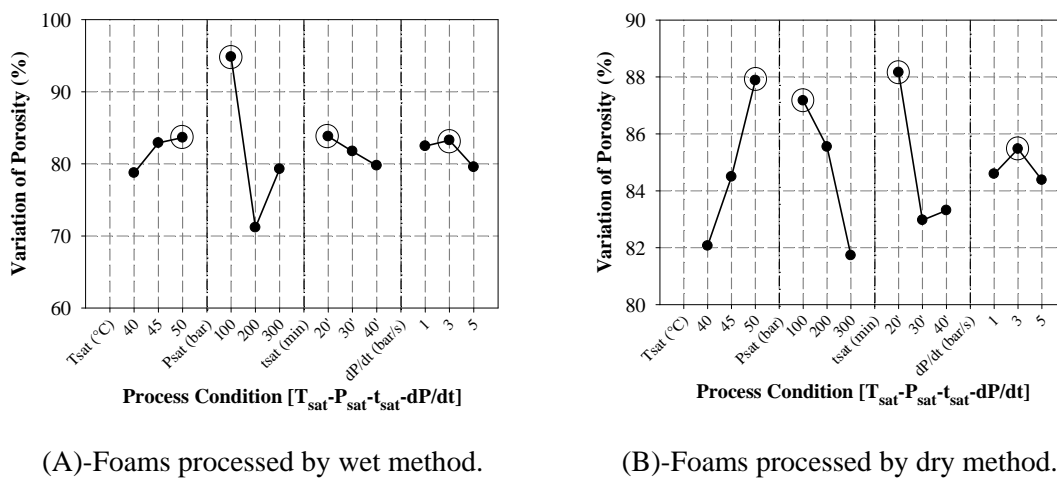


Figure 6.23: Average effect of each parameter on variation of porosity of PLGA<sub>85:15</sub> foams



From these conditions, we obtain optimum porosity 96.2% and 94.2% for wet and dry method. PLGA<sub>85:15</sub> produced pores of maximum diameters and maximum porosity for both the method at the same condition. The results of wet method are slightly at higher side than the dry method.

## 2.4 PLGA<sub>85:15</sub> Foams by Wet and Dry Methods by Complementary Taguchi Plan

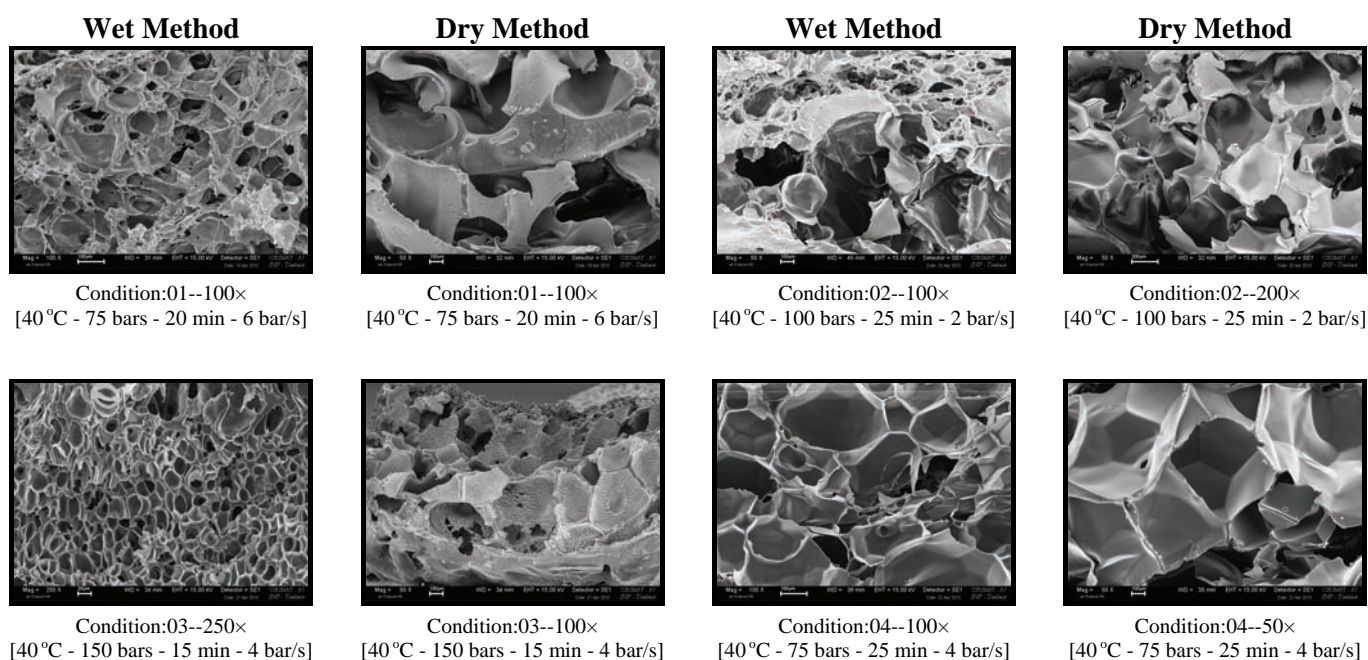
The equivalent pore diameter obtained from SCION<sup>®</sup> image analysis of the SEM micrographs, porosity data by geometric method using the pellet and PLGA<sub>50:50</sub> foams dimensional data are presented in

Table 6.12.

**Table 6.12:** PLGA<sub>85:15</sub> foams pore data of wet and dry method by complementary Taguchi plan.

PLGA <sub>50:50</sub>	sc CO <sub>2</sub> Parameters				Geometric Porosity P (%)		Equivalent Pore Diameter d <sub>e</sub> (μm)	
	T <sub>sat</sub>	P <sub>sat</sub>	t <sub>sat</sub>	dP/dt	Wet	Dry	Wet	Dry
	(°C)	(bar)	(min)	(bar/s)				
<b>P1</b>	40	75	20	6	95.8	88.2	50	250
<b>P2</b>	40	100	25	2	95.0	86.4	100	200
<b>P3</b>	40	150	15	4	86.8	81.6	15	175
<b>P4</b>	45	75	25	4	94.2	88.2	100	350
<b>P5</b>	45	100	15	6	73.8	93.5	20	20
<b>P6</b>	45	150	20	2	88.9	96.1	25	500
<b>P7</b>	50	75	15	2	74.8	84.8	400	60
<b>P8</b>	50	100	20	4	89.3	85.1	75	225
<b>P9</b>	50	150	25	6	83.6	90.7	50	80

The corresponding SEM micrographs for PLGA<sub>85:15</sub> foams are presented in Figure 6.24.





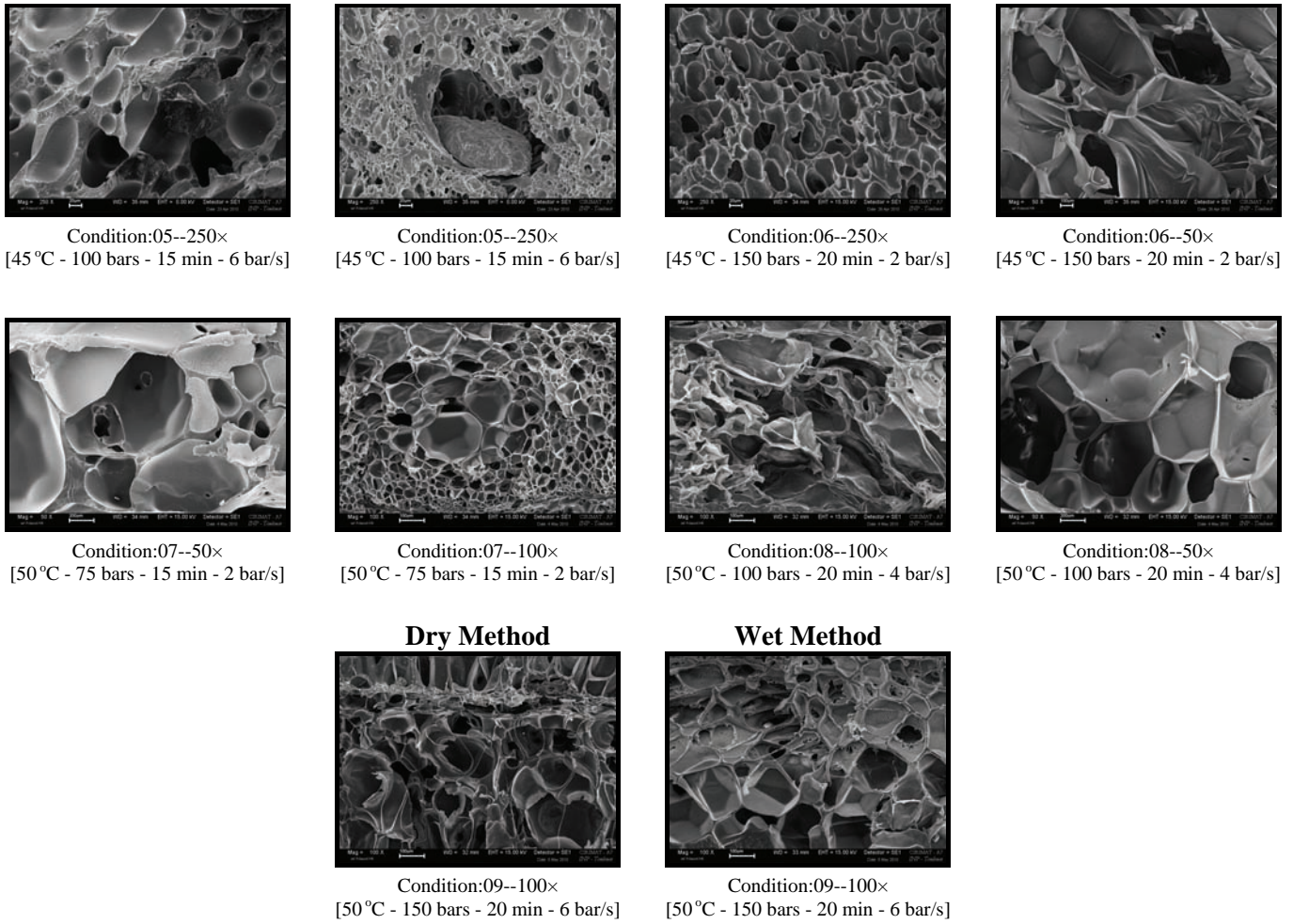


Figure 6.24: Micrographs of PLGA<sub>85:15</sub> foams processed by wet and dry methods.

### 2.4.1 Effect of Process Parameters on Equivalent Pore Diameter ( $d_e$ )

Effect of each process parameter on pore diameter and porosity for both methods is presented in Figure 6.25.

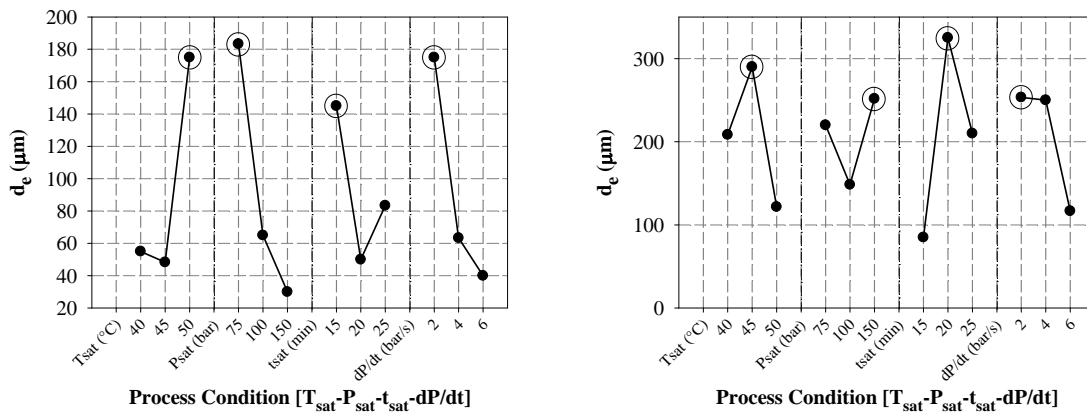


Figure 6.25: Average effect of each parameter on equivalent pore diameter of PLGA<sub>85:15</sub> foams.

From Figure 6.25, we deduced the scCO<sub>2</sub> parameters which permit to optimize the average equivalent pore diameter for both methods.

Wet method:  $T_{\text{sat}} = 50^{\circ}\text{C}$ ,  $P_{\text{sat}} = 75$  bars,  $t_{\text{sat}} = 15$  min and  $dP/dt = 2$  bar/s

Dry method:  $T_{\text{sat}} = 45^{\circ}\text{C}$ ,  $P_{\text{sat}} = 150$  bars,  $t_{\text{sat}} = 20$  min and  $dP/dt = 2$  bar/s

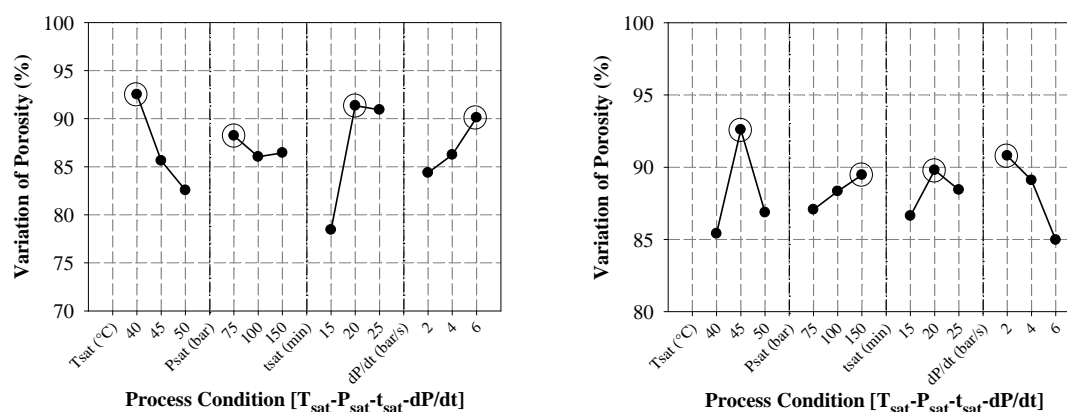
From these values we obtain equivalent pore diameter of 400 and 500  $\mu\text{m}$  for wet and dry method.

#### 2.4.2 Effect of Process Parameters on Geometric Porosity

The maximum porosity for wet and dry method obtained is 95.8 and 96.1%. Taking into account the effect of each process parameter on geometric porosity (cf. Figure 6.26-A and B), for wet and methods foam porosity have optimum values at the following conditions.

Wet method:  $T_{\text{sat}} = 40^{\circ}\text{C}$ ,  $P_{\text{sat}} = 75$  bars,  $t_{\text{sat}} = 20$  min and  $dP/dt = 6$  bar/s

Dry method:  $T_{\text{sat}} = 45^{\circ}\text{C}$ ,  $P_{\text{sat}} = 150$  bars,  $t_{\text{sat}} = 20$  min and  $dP/dt = 2$  bar/s



(A)-Foams processed by wet method.

(B)-Foams processed by dry method.

**Figure 6.26:** Average effect of each parameter on variation of porosity of PLGA<sub>85:15</sub> foams.

## 2.5 Comparison Between Both PLGAs

Recalling the characteristics of PLGA<sub>50:50</sub> and PLGA<sub>85:15</sub>, both contain D,L- Lactide and glycolic acid in the ratio 50:50 and 85:15 respectively. Both poly(lactic-co-glycolic) acids are amorphous. The molecular weight for both polymers is 28,494 and 18,848, while  $T_g$  is 49.1°C and 53.1°C respectively. Apart from the process parameters, molecular weight,  $T_g$  and LA/GA ratio of the polymer are major factors that affect on the porosity and pore diameter of the foams obtained.

The optimum results of both wet and dry methods for both poly(lactic-co-glycolic) acids are presented in Table 6.13 and Table 6.14 respectively.

**Table 6.13:** PLGA<sub>50:50</sub> equivalent pore diameter and porosity results for both methods and plans.

Wet Method			Dry Method		
Initial Taguchi Plan			Initial Taguchi Plan		
[50°C-100 bars-20 min-3 bar/s]	$d_e$ ( $\mu\text{m}$ )	150	[50°C-100 bars-20 min-3 bar/s]	$d_e$ ( $\mu\text{m}$ )	200
[45°C-100 bars-40 min-5 bar/s]	P(%)	97.5	[50°C-100 bars-20 min-3 bar/s]	P(%)	98.3
Complementary Taguchi Plan			Complementary Taguchi Plan		
[50°C-150 bars-25 min-6 bar/s]	$d_e$ ( $\mu\text{m}$ )	175	[50°C-100 bars-20 min-4 bar/s]	$d_e$ ( $\mu\text{m}$ )	250
[45°C-100 bars-15 min-6 bar/s]	P(%)	95.2	[45°C-100 bars-15 min-6 bar/s]	P(%)	94.3

In both the plans, we have seen that equivalent pore diameters of dry method were higher than the wet method although the porosity was in the same ranges. These process conditions can be further optimized by complementary experiments. Moreover the optimized results of equivalent pore diameters for this polymer are obtained at a temperature close to the  $T_g$  indicating that at this temperature there was complete sorption, swelling and then pore growth.

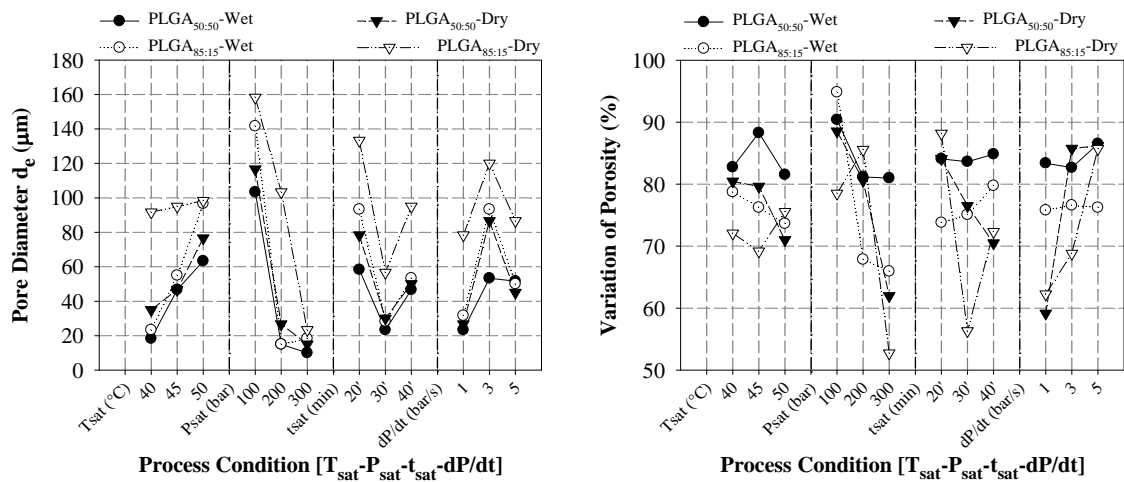
Table 6.14 depicts that PLGA<sub>85:15</sub> equivalent pore diameters are higher for dry pellet preparation in both the Taguchi plans. Moreover, in the complementary Taguchi plan, we have achieved optimized value for the equivalent pore diameter and porosity ( $d_e = 500\mu\text{m}$  and porosity = 96.1%) at the same process conditions.

**Table 6.14:** PLGA<sub>85:15</sub> equivalent pore diameter and porosity results for both methods and plans.

Wet Method			Dry Method		
Initial Taguchi Plan			Initial Taguchi Plan		
[50°C-100 bars-20 min-3 bar/s]	$d_e(\mu\text{m})$	250	[50°C-100 bars-20 min-3 bar/s]	$d_e(\mu\text{m})$	225
[50°C-100 bars-20 min-3 bar/s]	P(%)	96.2	[50°C-100 bars-20 min-3 bar/s]	P(%)	94.2
Complementary Taguchi Plan			Complementary Taguchi Plan		
[50°C-75 bars-15 min-2 bar/s]	$d_e(\mu\text{m})$	400	[45°C-150 bars-20 min-2 bar/s]	$d_e(\mu\text{m})$	500
[40°C-75bars-20 min-6 bar/s]	P(%)	95.8	[45°C-150 bars-20 min-2 bar/s]	P(%)	96.1

The comparison of effective equivalent pore diameter and porosity variation for PLGA<sub>50:50</sub> and PLGA<sub>85:15</sub> for the initial Taguchi plan are presented in Figure 6.27. It is clear that foams of PLGA<sub>85:15</sub> produced pores of larger diameter than PLGA<sub>50:50</sub> in both wet and dry pellet preparation method. As LA/GA ratio is higher in PLGA<sub>85:15</sub> comparable to PLGA<sub>50:50</sub>, due to this fact the earlier polymer produced pores of larger diameter. We can also see that increasing the saturation pressure decreases the pore diameter, while increasing the temperature and decreasing the  $dP/dt$  increases the pore diameter. However, the optimum  $dP/dt$  is mostly 2 or 3bar/s.

From the point of view of porosity for both the polymers, it is always at higher side in wet method. However, the morphology of the pores in the wet method is heterogeneous, irregular and elongated.



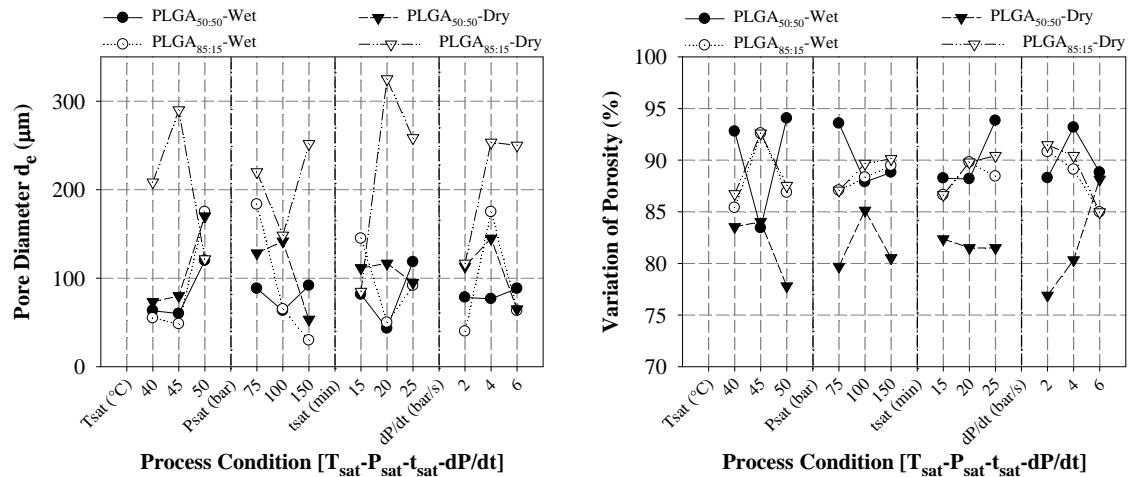
(A)- Equivalent pore diameter of foams.

(B)- Geometric porosity of foams.

**Figure 6.27:** Average effect of each parameter on variation of equivalent pore diameter and porosity of PLGA<sub>50:50</sub> and PLGA<sub>85:15</sub> foams by wet and dry method for initial Taguchi plan.

Figure 6.28 presents the comparison of effective equivalent pore diameter and porosity variation for PLGA<sub>50:50</sub> and PLGA<sub>85:15</sub> for the complementary Taguchi plan. One can observe that foams of PLGA<sub>85:15</sub>

produced pores of larger diameter than PLGA<sub>50:50</sub> in both wet and dry method. Also if the two Taguchi plan are compared, foams of larger diameter and higher porosity (PLGA<sub>85:15</sub> foams  $d_e \sim 500 \mu\text{m}$  and porosity 96.1%) were produced in the complementary Taguchi plan as compared to initial Taguchi plan (PLGA<sub>85:15</sub> foams  $d_e \sim 250 \mu\text{m}$  and porosity 93.7%).



(A)-Equivalent pore diameter of foams.

(B)-Geometric porosity of foams.

**Figure 6.28:** Average effect of each parameter on variation of equivalent pore diameter and porosity of PLGA<sub>50:50</sub> and PLGA<sub>85:15</sub> foams for complementary Taguchi plan.

LA/GA ratio of a PLGA co-polymer is an important parameter to control the pore diameter in a foaming process. Our previous experimental study depicts that the solubility of CO<sub>2</sub> into the polymer increases while the LA content increases in a PLGA co-polymer. The presence of an extra apolar CH<sub>3</sub> methyl group in LA than GA explains this behaviour [Liu and Tomasko, 2007b]. Secondly the molecular weight of PLGA<sub>50:50</sub> is higher than that of PLGA<sub>85:15</sub>, which is also a reason of low pore diameter for PLGA<sub>50:50</sub> foams. Glass transition temperature of PLGA<sub>50:50</sub> < PLGA<sub>85:15</sub> as the  $T_g$  also effect the solubility of CO<sub>2</sub> in polymer, ultimately affecting the porosity and pore diameter.

## 2.6 Pore Morphology and Anisotropy of Foams by Both Methods

The design and engineering of suitable biodegradable scaffolds are central to the field of tissue engineering and organ regeneration. Parallel fabrication strategies have also been improved and developed to improve and control biocompatibility, pore size, porosity, and pore connectivity [Murphy *et al.*, 2002].

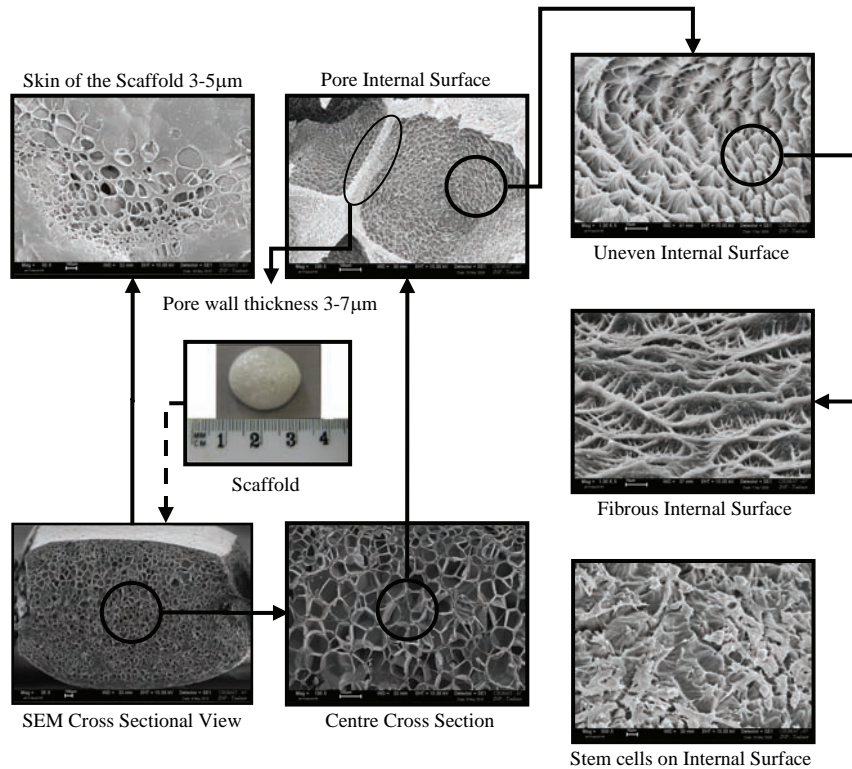
In tissue engineering, a wide range of pore size is required depending upon the application and organ such that a minimum pore size of 100  $\mu\text{m}$  was required to allow cell tissue ingrowth in scaffolds. Further investigations were carried out to understand the pore size requirement for bone tissue engineering. Although the optimal pore size varied with scaffold material and other parameters, such as tortuosity, the general consensus is that larger pore sizes (e.g., >100  $\mu\text{m}$ ) may favor cell growth [Karageorgiou and Kaplan, 2005; Tsuruga *et al.*, 1997].

Cell transport and vascularization as a result of scaffold pore size can also affect the tissue types and tissue formation process in scaffolds. In addition to pore size, cell transport within a scaffold such as diffusion, attachment, and migration are controlled by porosity (the fraction of pore volume), pore interconnectivity, and available surface area in scaffolds. While a high porosity is often desired, it is inversely related to the surface area available for cell attachment in 3D scaffolds. Achieving an optimal cell density in scaffolds therefore necessitates a high surface-area-to-volume ratio. In order to facilitate the



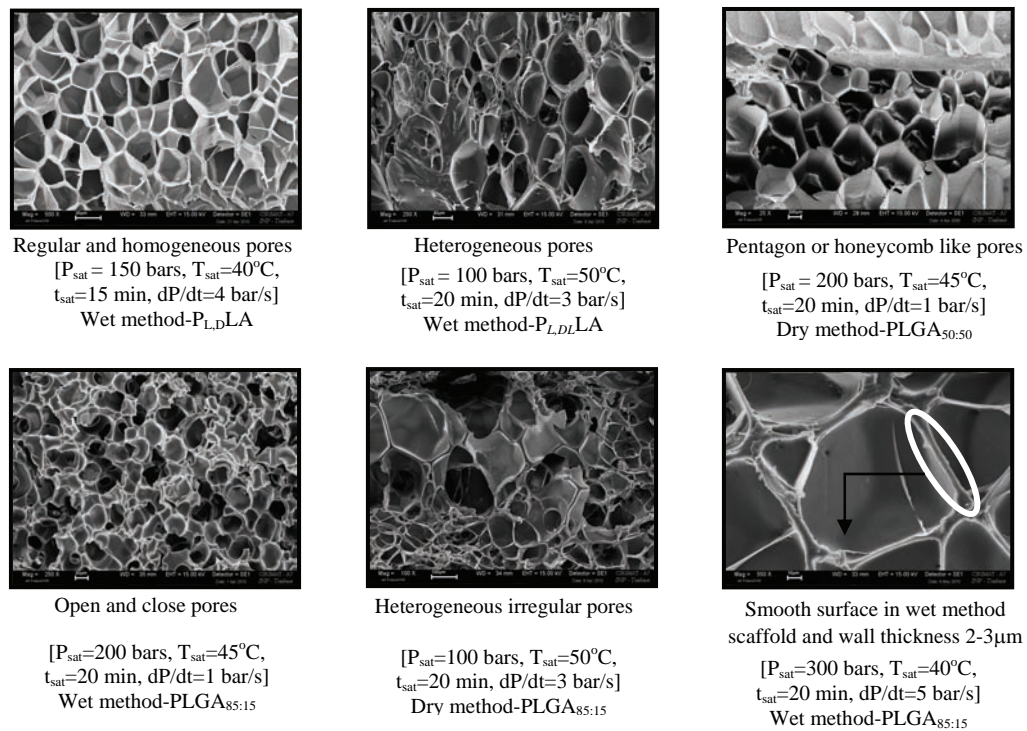
transport of cells and bioactive chemicals, scaffolds may also need to have pores at both macro and micro scales, features that may be difficult to obtain via traditional scaffold fabrication techniques, such as particle leaching and phase separation. Studies have been carried out to compare scaffolds processed by controlled processes with those containing irregular structures fabricated by conventional methods.

In the experimentation of scaffold obtained by wet and dry method, we achieved all the possible minimum requirements of a good scaffold. As example PLGA<sub>50:50</sub> scaffold is presented in Figure 6.29.



**Figure 6.29:** PLGA<sub>50:50</sub> scaffold pore morphology with detail inside view obtained by dry method and foams processed at 50°C-150 bars-25 min-6 bar/s.

A global view of the cross sectional area is shown, it is quite evident that the entire scaffold skeletal structure was homogeneous. The external skin of the scaffold varies upon the process conditions, anyhow the range was 5-15 µm and it has patches of pores on the entire surface. The internal surface of the pore are also rough, to enhance surface wettability and possibly the potential for increased cellular adhesion and proliferation. Reports in the literature have shown that cellular adhesion and proliferation are closely dependent on the topographical nature of the biomaterial surface [Brett *et al.*, 2004]. Studies have shown that an increase in surface area or roughness of scaffold matrices enhance osteoblast response, which can lead to an improved osteoconductivity of the biomaterial. Osteogenetic process is enhanced on surfaces with larger surface roughness. This is due to the fact that higher cell density is reached on rougher surface and demonstrate “pile up” phenomenon at early stages of cell cultivation [Price *et al.*, 2004; León y León, 1998]. The stem cells on the inter-rough surface can also be seen in the micrograph attached in Figure 6.29. Internal walls thickness of the pores observed was 3-7 µm in most of the cases where porosity and average pore diameter was 86% and 205 µm respectively.

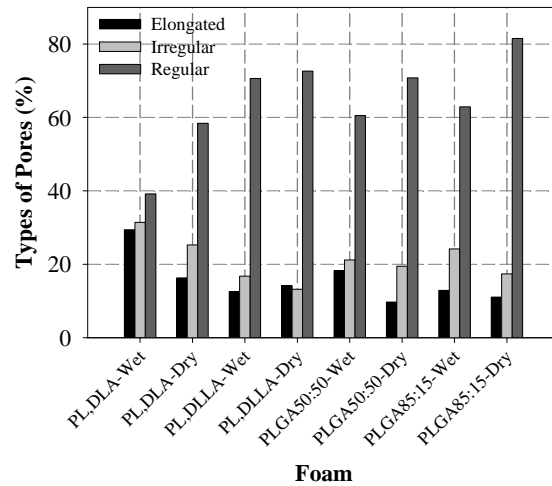


**Figure 6.30:** Pore Morphology of different types of scaffold processed by wet and dry methods.

In the wet method, the morphology of the pores observed was quite varied. There were regular homogeneous, heterogeneous, irregular pores depending on the material selected and the process condition (cf. Figure 6.30). The intersurface as shown in the micrograph is smooth and wall thickness of the pores was  $2\text{-}3\mu\text{m}$ .

A comparison of pore morphology for selected foams from both PLAs and PLGAs processed at  $T_{\text{sat}} = 50^\circ\text{C}$ ,  $P_{\text{sat}} = 100$  bars,  $t_{\text{sat}} = 20$  min and  $dP/dt = 3$  bar/s is presented in Figure 6.31. Comparing the wet and dry method, one can see that in wet method there is more percentage of elongated and irregular pores as compared to the dry method. Similar behaviour is also observed in case of both PLGAs. If we compare  $P_{L,D}LA$  and  $P_{L,DL}LA$  the regular pore are more in the latter polymer. In  $PLGA_{50:50}$  and  $PLGA_{85:15}$  the elongated and irregular pores are minimum. Regular pores are maximum in  $PLGA_{85:15}$ . The possible reason for higher percentage of regular pores in both PLGAs is that there is maximum equilibrium between the pore walls and the  $\text{CO}_2$  sorbed and during the  $dP/dt$  step the pores do not rupture. While in the foams where elongated and irregular pores are at higher percentages during the  $dP/dt$  they are either ruptured or they do not attain spherical shape.

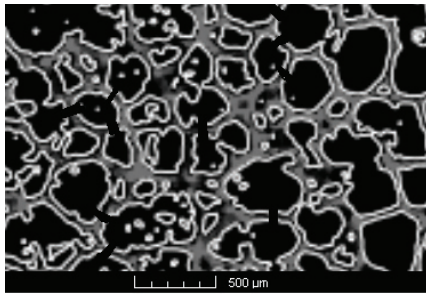




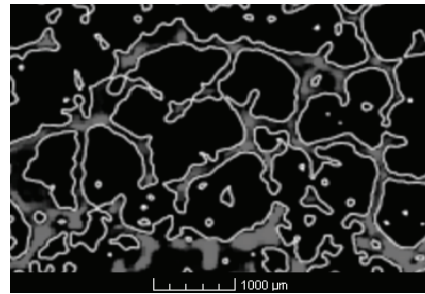
**Figure 6.31:** Comparison of pore morphology for PLAs and PLGAs foams processed at  $T_{\text{sat}} = 50^{\circ}\text{C}$ ,  $P_{\text{sat}} = 100$  bars,  $t_{\text{sat}} = 20$  min and  $dP/dt = 3$  bar/s.

## 2.7 Interconnectivity of Pores in Foams by Both Methods

$\mu\text{CT}$  of one foam sample with maximum pore diameter or porosity was done for each polymer for wet and dry pellet preparation methods. Slices image of  $P_{L,D}$ LA foams are presented in Figure 6.32.



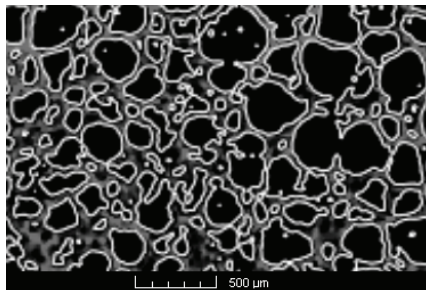
(A)-Foam processed by wet method at [50°C-100 bars-20 min-3 bar/s]  
 $d_e = 100\mu\text{m}$ , Geometric porosity = 73%



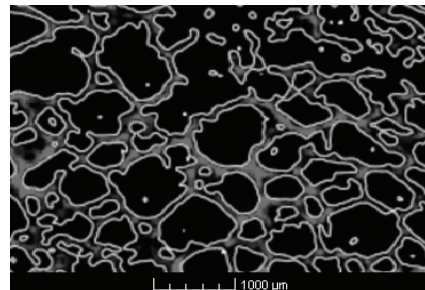
(B)-Foams processed by dry method at [45°C-100 bars-40 min-5 bar/s]  
 $d_e = 65\mu\text{m}$ , Geometric porosity = 84%

**Figure 6.32:** Slice images of  $P_{L,D}$ LA foams structure by  $\mu\text{CT}$  analysis.

Slice images of  $P_{L,DL}$ LA foams are presented in Figure 6.33.



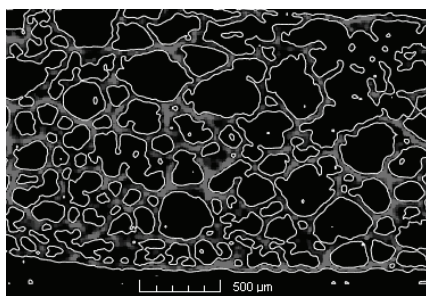
(A)-Foam processed by wet method at [45°C-75 bars-25 min-4 bar/s]  
 $d_e = 55\mu\text{m}$ , Geometric porosity = 91%



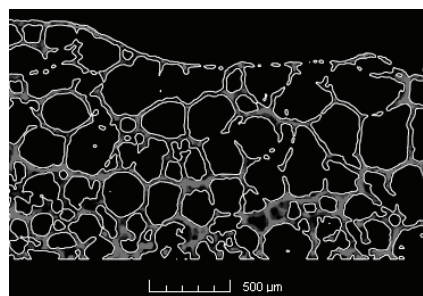
(B)-Foam processed by dry method at [50°C-100 bars-20 min-3 bar/s]  
 $d_e = 75\mu\text{m}$ , Geometric porosity = 85%

**Figure 6.33:** Slice images of  $P_{L,DL}$ LA foams structure by  $\mu\text{CT}$  analysis.

Slice images of PLGA<sub>50:50</sub> foam are presented in Figure 6.34.



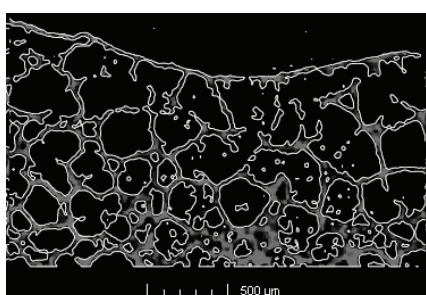
(A)-Foam processed by wet method at  
[50°C-100bars-20 min-3 bar/s]  
 $d_e = 150\mu\text{m}$ , Geometric porosity = 86%



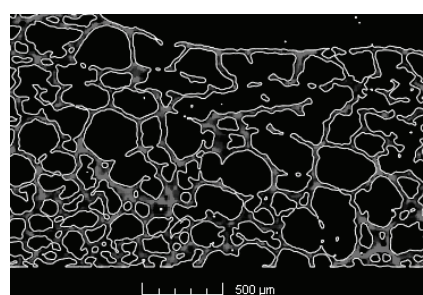
(B)-Foam processed by dry method at  
[50°C-100 bars-20 min-3 bar/s]  
 $d_e = 200\mu\text{m}$ , Geometric porosity = 98%

**Figure 6.34:** Slice images of PLGA<sub>50:50</sub> foam structure by  $\mu\text{CT}$  analysis.

Slice images of PLGA<sub>85:15</sub> foam are presented in Figure 6.35.



(A)-Foam processed by wet method at  
[50°C-75bars-15 min-2 bar/s]  
 $d_e = 400\mu\text{m}$ , Geometric porosity = 75%



(B)-Foam processed by dry method at  
[45°C-150 bars-20min-2 bar/s]  
 $d_e = 500\mu\text{m}$ , Geometric porosity = 96%

**Figure 6.35:** Slice images of PLGA<sub>85:15</sub> foam structure by  $\mu\text{CT}$  analysis.

All micrographs show pores interconnectivity. The porosities of selective foams with maximum pore diameter or porosity were compared. Comparison of porosity results between geometric method and Hg intrusion porosimetry is reported on Table 6.15.

**Table 6.15:** Comparison of foam porosities obtained by two different methods.

Polymer Foam	$T_{\text{sat}}$ (°C)	$P_{\text{sat}}$ (bar)	$t_{\text{sat}}$ (min)	$dP/dt$ (bar/s)	Geometric Porosity	Hg Intrusion Porosimetry	Hg Intrusion Open Porosity
Wet- $P_{L,D}LA$	50	100	20	3	77%	72%	47%
Dry- $P_{L,D}LA$	50	100	20	4	88%	83%	69%
Wet- $P_{L,DL}LA$	50	200	30	5	89%	81%	62%
Dry- $P_{L,DL}LA$	45	150	20	2	80%	69%	58%
Wet-PLGA <sub>50:50</sub>	50	100	20	3	93%	88%	61%
Dry-PLGA <sub>50:50</sub>	50	100	20	3	98%	93%	73%
Wet-PLGA <sub>85:15</sub>	50	100	20	3	94%	89%	64%
Dry-PLGA <sub>85:15</sub>	50	100	20	3	96%	92%	76%

The results obtained from the tables are:

- Porosity of wet foams is normally less than foams prepared by dry method.
- PLGA<sub>85:15</sub> foams produce maximum porosity.
- The open porosity for the foams selected is above 50%.

## 2.8 Mechanical Properties of the Foams by Wet and Dry Methods

The mechanical properties of the porous material are related to its structure and to the properties of the material of which the cell walls are made. The salient structural feature of a porous material is its relative density ( $\rho_f / \rho_p$ ), the degree to which the cells are open or closed and their structural anisotropy. The compression modulus and compressive strength at 10% deformation was tested for selected foams by compression test and results are reported on Table 6.16.

**Table 6.16:** Compressive modulus and compressive strength of polymer foams by both methods.

Polymer Foam	Relative Density	Pore Diameter $d_e$ ( $\mu\text{m}$ )	Porosity Hg Intrusion Method	Compression Modulus $E_c$ (MPa)	Compressive Strength $\sigma_{10\%}$ (KPa)
Wet- $P_{L,D}$ LA	0.23	100	72%	0.243	193
Dry- $P_{L,D}$ LA	0.12	100	83%	0.610	452
Wet- $P_{L,DL}$ LA	0.20	10	81%	0.448	269
Dry- $P_{L,DL}$ LA	0.27	15	69%	0.829	644
Wet-PLGA <sub>50:50</sub>	0.07	150	88%	0.198	70
Dry-PLGA <sub>50:50</sub>	0.02	200	93%	0.362	187
Wet-PLGA <sub>85:15</sub>	0.06	250	89%	0.114	56
Dry-PLGA <sub>85:15</sub>	0.12	225	92%	0.245	117

The compression modulus of porous polylactide foams as compared to those of the polylactic co-glycolide foams is significantly higher. The data in Table 6.16 demonstrates that the higher crystallinity produces less porosity and low pore diameter which eventually leads to high modulus. In less porous and low pore diameter scaffolds, the wall thickness is high thus more force is required to compress thick walls as compare to thin walls. Data reveals that compressive modulus for the foam prepared by wet pellet preparation method is quite low as compared to the foams prepared by dry pellet preparation method.

In this work, a novel wet method pellet preparation technique was used to create highly porous biodegradable poly( $\alpha$ -hydroxyl acids) scaffolds. It is demonstrated that the porosity, pore size, and pore morphology of these composite foams can be controlled by the polymer composition, chemical structure of the polymer, LA/GA ratio in the copolymer and the four process parameters (saturation temperature, saturation pressure, saturation time and depressurization rate) for scCO<sub>2</sub> foaming. The high porosity is expected to better satisfy the cell penetration and mass transport requirements (for nutrient, metabolites, and soluble signals) for scaffolding for tissue engineering [Ma and Langer, 1998; Ma et al., 1995]. Wet method for producing porous foams can be applicable to the equipment where high temperature is a constraint. For future perspective polymers with higher molecular weight and semi-crystalline in nature can be focused for even more better results. Specially foams with higher porosities for various commercial applications can be generated by this method.

## 2.9 General Discussion

Conducting the two pellet preparation methods and adapting the two Taguchi' plans for two PLAs and two PLGAs with different LA/GA ratio, a number of conclusions can be drawn.

- In case of wet method pellet preparation, saturation temperature close to the  $T_g$  produce favourable pore diameter and porosity, while in the case of dry method pellet preparation even temperature  $10^\circ\text{C}$  less than  $T_g$  produced pore diameter and porosity of maximum values for both PLAs and PLGAs.
- Depressurization rate of neither very high value nor very low value was favourable for both porosity and pore diameter. In most of the optimized conditions, the values for  $dP/dt$  was 1–4 bar/s.

Hence we can conclude that in wet and dry methods to achieve maximum geometric porosity of (>85% in both PLAs and PLGAs) and equivalent pore diameter (>150 $\mu\text{m}$  for PLAs and >200 $\mu\text{m}$  for PLGA<sub>50:50</sub> and >400 $\mu\text{m}$  for PLGA<sub>85:15</sub>), the process conditions can be as follows,

Wet method--[ $T_{\text{sat}} \sim T_g - P_{\text{sat}}=100 \text{ bars} - t_{\text{sat}}=20 \text{ min} - dP/dt = 3 \text{ bar/s}$  ]

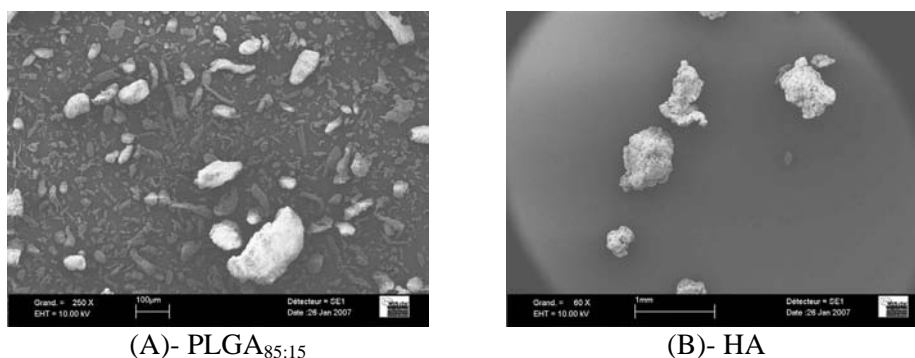
Dry method--[ $T_{\text{sat}} \sim T_g - 10^\circ\text{C} - P_{\text{sat}}=100 \text{ bars} - t_{\text{sat}}=20 \text{ min} - dP/dt = 3 \text{ bar/s}$  ]

### 3 Modification of the Surface by Adding Hyaluronic Acid

Two series of studies were realized: first a simple mixing between PLGA<sub>85:15</sub> (DL PLG) with sodium hyaluronate salt, and secondly by co-grinding the two products. Hyaluronate sodium salt is hydrophilic in nature as compared to PLGA, so the addition of HA either by co-grinding or simple mixing will increase the hydrophilicity of the HA/PLGA biomaterials.

#### 3.1 Granulometry Analysis of PLGA and HA Before and After Co-grinding

Granulometry will help us to differentiate both PLGA<sub>85:15</sub> and HA and the behaviour of particles after different intervals of time. Hyaluronate sodium salt, HA, was pre-ground in the knife mill, as described in chapter 4, for 30 minutes to obtain fine powder. PLGA and HA were then co-ground, for different time intervals and samples were collected after each specified time for analysis. The micrographs of PLGA and HA unground are presented in Figure 6.36.



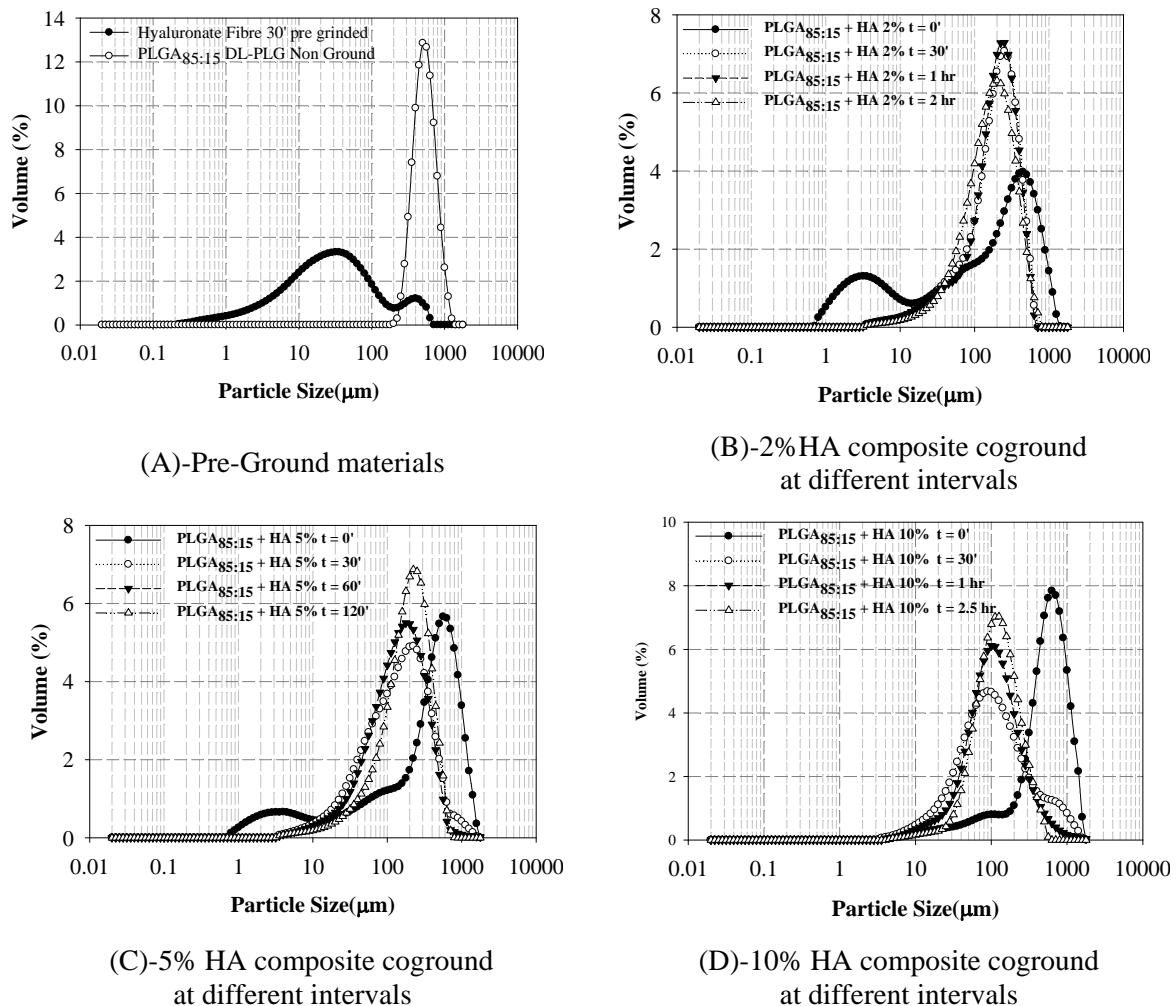
**Figure 6.36:** Micrographs of particle before grinding.

For each series of co-grinding, we introduced 4 grams of blends of PLGA<sub>85:15</sub>- HA. The ratio of HA salt in the mixture was 10%, 5% and 2%.).

With the aim to assist the comprehension of SEM images, granulometry analysis before and after co-grinding was also done. As for PLGA, we can say that it is a material with particles from 150 $\mu\text{m}$  to 1000 $\mu\text{m}$  and the peak centered at 500 $\mu\text{m}$ , while pre-ground HA during 30 minutes is a material with dual

distribution of particles. The first peak with a wide distribution is centered at 40  $\mu\text{m}$  and second centered at 400  $\mu\text{m}$  with narrow distribution (cf. Figure 6.37-A).

As for the blend PLGA/2% HA during the first 2 hours, the particles break up gradually. Before grinding, at time  $t = 0$  minute the size distribution of poly(lactic-co-glycolide) and hyaluronic acid pre-ground 30 minutes are represented by dual peaks the first having a range from 0.6  $\mu\text{m}$  to 10  $\mu\text{m}$  with a peak centered at 2  $\mu\text{m}$ , while the second distribution from 100 to 1050  $\mu\text{m}$  with a peak at 450  $\mu\text{m}$ . A plateau of particle between 20 to 100  $\mu\text{m}$  is also visible (cf. Figure 6.37-B). After 30 minutes of co-grinding the first peak out of the two disappears and only one peak centred at 150  $\mu\text{m}$  can be seen. The peak has shifted from 450 to 250  $\mu\text{m}$  indicating that co-grinding has reduced the particle size of polymer/HA matrix. The disappearance of small peak reveals that the HA particles are coated on the polymer particles or they have turned into agglomerates. After 1 hour of co-grinding almost a similar behaviour to 30 minutes is observable. For 2 hours of extensive co-grinding the peak is shifted toward 200  $\mu\text{m}$  (cf. Figure 6.37-B).



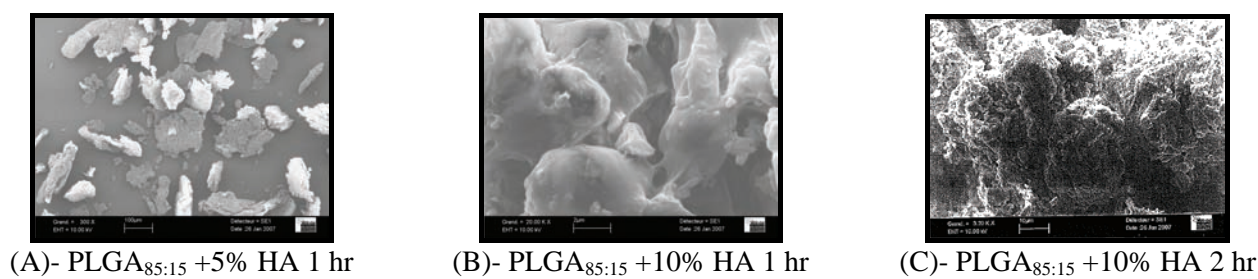
**Figure 6.37:** Evolution of the particle size distribution for PLGA+HA co-grinding.

From Figure 6.37-C, we can observe that for blend PLGA/5% HA at  $t = 0$  minute dual peak is observed at 3 and 550  $\mu\text{m}$ . After 30 minutes of co-grinding due to the disappearance of initial smaller peak and size reduction the peak has shifted to the left centered at 210  $\mu\text{m}$ . After 1 hour it is further shifted to left with a peak centered at 190  $\mu\text{m}$ . Then at 2 hours of co-grinding due to agglomeration phenomenon particle size is increased and can be seen by the curve centered at 250  $\mu\text{m}$  reflecting that the particle size is increasing.



Granulometry of the third composition of blend PLGA+10% HA at different time intervals is presented in Figure 6.37-D. It was co-ground for 2.5 hours. At time  $t=0$  a small peak at  $100\mu\text{m}$  and other at  $600\mu\text{m}$  can be seen. After 30 minutes of co-grinding particles ranging from 10 to  $400\mu\text{m}$  can be observed with a peak centered at  $90\mu\text{m}$ . Another smaller distribution or particles can be seen from 400 to  $1100\mu\text{m}$ . In the first 30 minutes the particles has reduced to a great extent but simultaneously agglomeration phenomenon occurred providing the second distribution. After 1 hr of co grinding only one peak is observed centered at  $100\mu\text{m}$ , while for 2.5 hrs of co grinding the peak remains almost unchanged with a slight difference in the peak shifted to the right indicating slight agglomeration of particles.

Initially, we have two types of particles having different size ranges. Thus, the size distribution of the mixture is composed of two peaks. As co-grinding occurs, the peak of HA disappears, due to an agglomeration/coating of HA particles on PLGA. Moreover, the peak corresponding to PLGA shifts towards the smaller sizes due to a fragmentation of the composite particles. We can also observe that after co-grinding, the peak of the mixture containing 2 % of HA has a mode which is higher than 5% and 10 % HA. It means that HA plays the role of fragmentation accelerator for PLGA.



**Figure 6.38:** Micrographs of blend PLGA+ HA after different co-grinding time.

For blend PLGA/10% HA after 1 hr of co-grinding, particles size is reduced to a great extent and PLGA is homogenized with HA hence, it was decided that to produce foams of PLGA/HA we opt for co-grinding time of 1 hr. It can be seen that from Figure 6.38-A co-grinding of PLGA/HA not only reduces the particle size of both materials but also HA is blended with PLGA particle for which co-grinding was done. In Figure 6.38-B, we can see that after 1 hr of co-grinding PLGA and HA are completely homogenized. In Figure 6.38-C, by increasing the time to 2 hours the co-ground mixture is completely homogenized and agglomerates are formed.

## 3.2 Contact Angle Measurement and Surface Energy on Pellets

Powder PLGA/HA was thermo-pressed in a uniaxial press for pellets with the conditions:  $P = 150$  bars,  $T = 60^\circ\text{C}$  and  $t = 20$  min. We obtained pellets of smooth surface, diameter 13 mm and thickness approximately of 3 mm.

### 3.2.1 Results

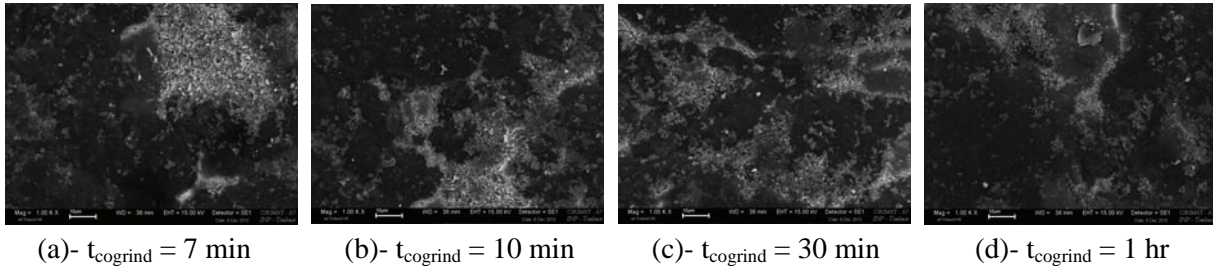
#### 3.2.1.1 Contact Angles with Water and Pellets of PLGA, HA and PLGA/HA Blends

Evolution of contact angle with different percentages of HA and different co-grinding time can be observed in Table 6.17. It can be revealed from the Table 6.17 that the two materials (PLGA and HA) surfaces can be easily screened by measuring the contact angle of their surface by using water. The contact angle of water with pure PLGA pellets is high comparatively to the one of pure HA, so by co-grinding both PLGA and HA, contact angle of blend are comprised between those of the two separate products. A decrease of contact angle of blends shows that hydrophilicity of surface is improved.

**Table 6.17:** Contact Angle between water and pellets constituted by HA, PLGA or HA-PLGA blends.



S/N	HA fibres	HA fibres $t_{\text{grind}} = 30$ min	PLGA Powder	Blend- PLGA + 5 % HA	Blend- PLGA + 10 % HA	HA $t_{\text{grind}} = 30$ min + PLGA + 5 % HA, $t_{\text{co}} = 1\text{hr}$	HA $t_{\text{grind}} = 30$ min + PLGA + 10 % HA, $t_{\text{co}} = 1\text{hr}$
$\langle\theta\rangle$	59.3	51.7	67.2	66.3	65.4	62.0	54.7
<b>Cos <math>\theta</math></b>	0.510	0.620	0.387	0.402	0.416	0.469	0.578
<b>Max</b>	0.557	0.691	0.408	0.455	0.475	0.522	0.620
<b>Min</b>	0.458	0.566	0.362	0.344	0.337	0.428	0.537
<b>S.D.</b>	0.047	0.071	0.021	0.053	0.060	0.033	0.042



**Figure 6.39:** Surface evolution of blend PLGA<sub>85:15</sub> + 10% HA pellets with co-grinding time.

In Figure 6.39, we noticed that for low co-grinding time HA is not completely blend with PLGA. HA particles are found in patches on the surface of the blend. The patches can be seen in Figure (a), (b) and (c). After 30 minutes of co-grinding, the surface of the pellet is quite homogeneous and after 1 hr co-grinding, more homogeneity can be observed. Localized HA on the pellet surface produces variation in contact angle measurements as when a water is dropped on the HA localized area, it will be more hydrophilic. Homogeneity in the pellet will decrease the error in measured contact angle

Grinding of HA decreases the contact angle  $\theta$ . We have observed that value of  $\cos \theta$  of PLGA is less than  $\cos \theta$  of HA which implies that adhesion energy of HA is higher than PLGA. After co-grinding polymer with HA the value of contact angle further decreases that gives a clue that PLGA particles are coated with HA particles. From our experimentation by changing the % of HA in simple mixing and in co-grinding  $\cos \theta$  values increase and in case of co-grinding, it improved till 60 minutes of co-grinding

### 3.2.1.2 Surface Energy of PLGA, HA and PLGA/HA blends

Three different liquids (Water,  $\alpha$ -Bromonaphthalen, Ethylene Glycol) were used to measure the contact angle. Results are reported in table Table 6.18.

**Table 6.18:** Angle measured by different liquids on PLGA pellet

Water			a-Bromonaphtalen			Etylene Glycol		
$\langle\theta\rangle$	Cos $\theta$	$\langle\cos\theta\rangle$	$\langle\theta\rangle$	Cos $\theta$	$\langle\cos\theta\rangle$	$\langle\theta\rangle$	Cos $\theta$	$\langle\cos\theta\rangle$
67.2	0.38	0.03	35.9	0.81	0.005	64.5	0.43	0.01

After drop deposition of  $\alpha$ -Bromonaphthalen for calculation  $\gamma_s^{\text{LW}}$ , we used and pure water to determine  $\gamma_s^{\text{AB}}$  and to estimate the non-dispersive components  $\gamma^+$  and  $\gamma^-$  (reflecting the polar interactions at the surface in accord with the Good-Van Oss theory).

Surface energy for both co-ground blends was determined by using the Owens Wendt' method at two components (cf. equation 3.18 and following). As example, we detailed calculations on pure HA: the solid dispersive and non dispersive components can be easily deduced from the slope and the origin of the

line of Owens Wendt  $\gamma_s^d = 40.2 \text{ mJ/m}^2$  and  $\gamma_s^{nd} = 17.0 \text{ mJ/m}^2$ . By the Owens Wendt method the surface solid tension is:  $\gamma^S = \gamma_s^d + \gamma_s^{nd} = 57.2 \text{ mJ/m}^2$ .

Solid dispersive components can also be estimated from the slope of the line of Good  $\gamma_s^d = 45.4 \text{ mJ/m}^2$ . As the solid non dispersive component, it is deduced from the difference between the experimental value for water and the corresponding Good' value:  $\gamma_s^{nd} = (I_{SL}^{nd})^2/4 = 17.4 \text{ mJ/m}^2$ . So the surface solid tension can be approximated by the Good' method to  $62.8 \text{ mJ/m}^2$  and an average of both methods gives  $60 \text{ mJ/m}^2$

As for the adhesion energy given by:  $W_a = 2(\gamma_s^d \cdot \gamma_L^d)^{1/2} + 2(\gamma_s^{nd} \cdot \gamma_L^{nd})^{1/2} = 120.3 \text{ mJ/m}^2$ . Analogous calculations on pure PLGA and blends PLGA/HA 2, 5 and 10% are reported in Table 6.19

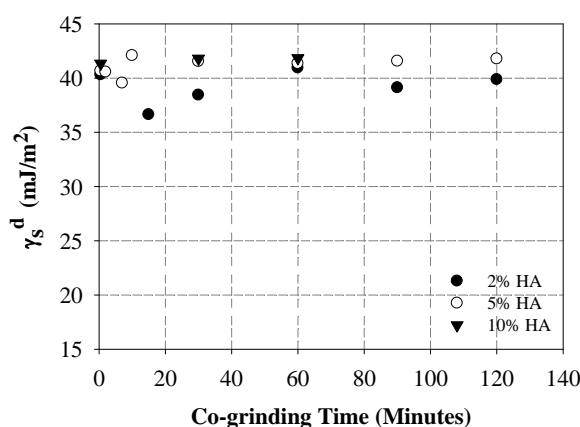
As expected the coating of PLGA by HA increases the solid tension and the surface energy of PLGA/HA particles: the more HA ratio, the more surface energy of the blend PLGA/HA.

**Table 6.19:** Comparison of energies by two different methods for PLGA and PLGA/HA blends

Pellet	Method	PLGA	HA	PLGA/HA 2%	PLGA/HA 5%	PLGA/HA 10%
$\gamma_s^d$	Owens-Wendt	35.6	40.2	38.1	38.4	39.8
	Good	40.6	45.4	43.8	44.3	43.9
$\gamma_s^{nd}$	Owens-Wendt	9.4	17.0	10.5	11.7	12.7
	Good	9.6	17.4	13.4	14	14.7
$\langle \gamma_s \rangle$		47.6	60.0	52.9	54.2	55.6
$W_a$		101.6	120.3	109.2	111.2	113.8

### 3.2.2 Origin of the Increase of Surface Energy

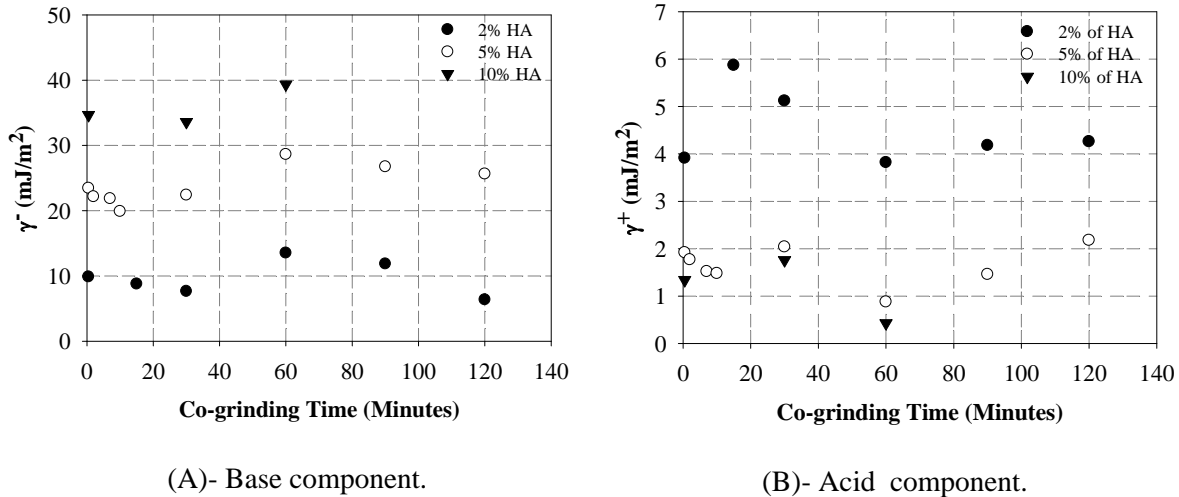
To precise the nature of interactions it is necessary to decompose into three components the surface energy; We used  $\alpha$ -bromonaphtalen for  $\gamma^{LW}$  calculation and ethylene glycol and pure water to determine  $\gamma_s^{AB}$  and to estimate the non-dispersive components Acid-Base  $\gamma^+$  and  $\gamma^-$  reflecting the polar interactions at the surface in accord with the Good-Van Oss theory. The variation of the dispersive component of the surface energy with co-grinding time is represented in Figure 6.40. It shows that this value is practically constant.



**Figure 6.40:** Influence of the co-grinding and the ratio of HA on the dispersive component of the blend surface energy. PLGA/HA.

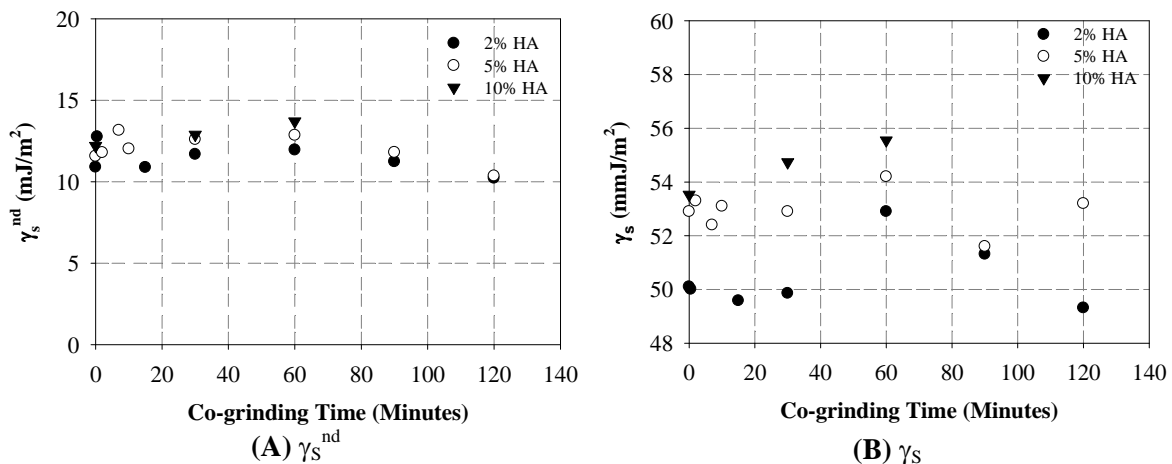
The following two graphs (cf. Figure 6.41) show us that these two parameters vary with increasing time of co-grinding. For  $\gamma^-$  base component, one passes through a maximum at about 60 minutes for the pellets containing 2%, 5% and 10% HA and then the energy decreases after 1 hour. This means that the

polarity of the surface has changed: it becomes donor driven electronic. The optimal time for this change is achieved in 1 hour. The  $\gamma^+$  component was lower for pellets containing 5% HA than for containing 2% HA. This is logical because more of HA is coated around the PLGA and the hyaluronate sodium salt is in excess on the surface. At 1hr 10% HA composite mixture depict optimum value.



**Figure 6.41:** Influence of co-grinding time and the ratio of HA on the components Acid-Base of surface energy.

For  $\gamma^+$  component is the opposite: the  $\gamma^+$  component is higher for the pellets containing 2% HA than for HA with 5% and 10%. We also note that we obtain a minimum for  $\gamma^+$  after 1 hour. The  $\gamma^+$  and  $\gamma^-$  parameters vary from one-way contrary which makes sense because surface can provide electrons, it draws and the  $\gamma^-$  component is always greater than  $\gamma^+$  parameter. The effect of co-grinding time on  $\gamma_s^{nd}$  and total surface energy is presented on Figure 6.42 respectively.



**Figure 6.42:** Influence of co-grinding time and the ratio of HA on  $\gamma_s^{nd}$  and  $\gamma_s$ .

By increasing the hydrophilic nature of PLGA surface, the surface energy will increase thus it can improve the adhesion energy. Adhesion of the cells on the scaffold require more hydrophilic surface so that cells can adhere to the surface and proliferate.

Grinding of HA increases the contact angle  $\theta$  which eventually increases the adhesion energy. We have observed that value of  $\cos \theta$  of PLGA is less than  $\cos \theta$  of HA which implies that adhesion energy of HA is higher than PLGA. After co-grinding polymer with HA the value of contact angle further decreases

that gives a clue that PLGA particles are coated with HA particles. From our experimentation by changing the % of HA in simple mixing and in co-grinding  $\cos \theta$  values increase and in case of co-grinding, it improved till 60 minutes of co-grinding.

## 4 Foams of PLGA<sub>85:15</sub>/HA Blends

### 4.1 Preparation of Pellets

PLGA<sub>85:15</sub> (DL-PLG) powder was taken to manufacture pellets. Nine pellets of pure PLGA and nine pellets of blends (PLGA + 10% HA 1 hr co-ground) were pressed in the thermo-hydraulic press at ( $P = 150$  bars,  $T = 50^\circ\text{C}$  and  $t = 20$  min). Pure PLGA foams were processed as reference to compare their morphology with blend foams.

### 4.2 Effect of scCO<sub>2</sub> Parameters on the Microstructure of Foams

#### 4.2.1 Effect of Depressurization Rate on the Microstructure of Foams

Foaming of the pellets was processed in SEPAREX<sup>®</sup> SFC6 scCO<sub>2</sub> 6L laboratory plant. ScCO<sub>2</sub> process conditions were as follows:

$$T_{\text{sat}} = 35^\circ\text{C}, \quad P_{\text{sat}} = 120 \text{ bars}, \quad t_{\text{sat}} = 20 \text{ min}, \quad dP/dt = 1, 3 \text{ and } 6 \text{ bar/s}$$

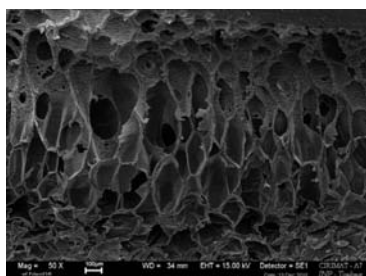
In these experiments, only depressurization rate was varied keeping other parameters constant. 3 foams were made for each condition to see the reproducibility of results (cf. Table 6.20).

**Table 6.20:** scCO<sub>2</sub> process conditions for PLGA/HA foams.

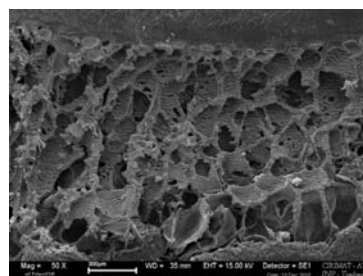
<b>P<sub>sat</sub> (bar)</b>	120	120	120	120	120	120	120	120	120
<b>t<sub>sat</sub> (min)</b>	20	20	20	20	20	20	20	20	20
<b>T<sub>sat</sub> (°C)</b>	35	35	35	35	35	35	35	35	35
<b>dP/dt (bar/s)</b>	6	6	6	3	3	3	1	1	1

During the thermodynamics experimentations the optimum parameters for poly(lactic co-glycolide) was  $T_{\text{sat}} = 35^\circ\text{C}$ ,  $P_{\text{sat}} = 120$  bars,  $t_{\text{sat}} = 20$  min,  $dP/dt = 3$  bar/s and  $dP/dt$  was the most effective parameter so keeping other parameters same only  $dP/dt$  was manipulated.

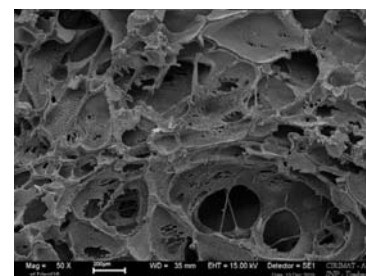
Micrographs for  $dP/dt$  6, 3 and 1 bar of PLGA and blend PLGA/HA 10% foams are reported in Figure 6.43 and Figure 6.44.



$dP/dt = 6$  bar/s

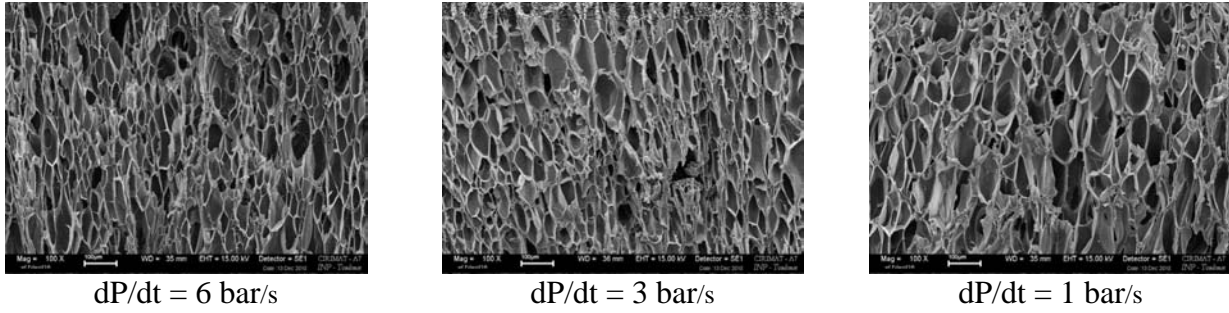


$dP/dt = 3$  bar/s



$dP/dt = 1$  bar/s

**Figure 6.43:** Micrographs of PLGA<sub>85:15</sub> foams at  $P_{\text{sat}} = 120$  bars,  $t_{\text{sat}} = 20$  min and  $T_{\text{sat}} = 35^\circ\text{C}$ , [50 $\times$ ].



**Figure 6.44:** Micrographs of blends PLGA<sub>85:15</sub>/HA 10% foams processed at  $P_{\text{sat}} = 120$  bars,  $t_{\text{sat}} = 20$  min,  $T_{\text{sat}} = 35^{\circ}\text{C}$ , [100 $\times$ ].

After successful foaming of both pure and composite mixture pellets, porosity calculation was completed then SEM analysis was done. Finally, SCION<sup>®</sup> image analysis was carried out to find out pore size and then compared the data. In Table 6.21, we can report analysis of all the PLGA foams and noted that all are above 89%. The comparison of geometric porosities of PLGA/HA composite foams (cf. Table 6.22) are ranging between 82 and 87%. At  $dP/dt$  of 6 bars/s and 1 bar/s, the produced pores were comparatively small. The surface area of macro pores was highest when  $dP/dt$  was 3 bar/s.

**Table 6.21:** Pore analysis for PLGA<sub>85:15</sub> foams processed at  $P_{\text{sat}} = 120$  bars,  $t_{\text{sat}} = 20$  min and  $T_{\text{sat}} = 35^{\circ}\text{C}$ .

dP/dt (bar/s)	Pore Diameter			Surface Area/ $(\mu\text{m})^2$			Porosity
	Micro	Meso	Macro	Micro	Meso	Macro	P
	$d_e$ ( $\mu\text{m}$ )	$d_e$ ( $\mu\text{m}$ )	$d_e$ ( $\mu\text{m}$ )	(%)	(%)	(%)	(%)
6	19.45	82.96	209.92	7.59	26.43	65.98	91.5
6	17.17	78.79	216.88	6.87	27.13	66.00	89.8
6	17.38	87.51	217.59	7.45	26.10	66.45	92.1
3	19.42	91.64	271.78	4.65	24.30	71.05	90.4
3	15.11	94.09	264.57	6.67	20.82	72.51	89.1
3	18.68	97.77	260.45	3.56	24.21	72.23	93.4
1	15.52	82.71	181.79	3.43	48.21	48.36	92.5
1	19.32	77.16	185.85	4.98	43.57	51.45	93.6
1	17.59	76.10	175.88	3.98	46.24	49.78	92.9

However unfortunately there were no macro pores found in the scaffolds. As we have co-ground polymer with HA and after co-grinding polymer is coated with HA layer, which makes difficult for  $\text{CO}_2$  to sorb in a short saturation time of  $t_{\text{sat}}=20$  min. The pore diameter can also be increased by increasing the saturation time or saturation temperature.

**Table 6.22:** Pore analysis data for blends PLGA<sub>85:15</sub>/HA 10% foams.

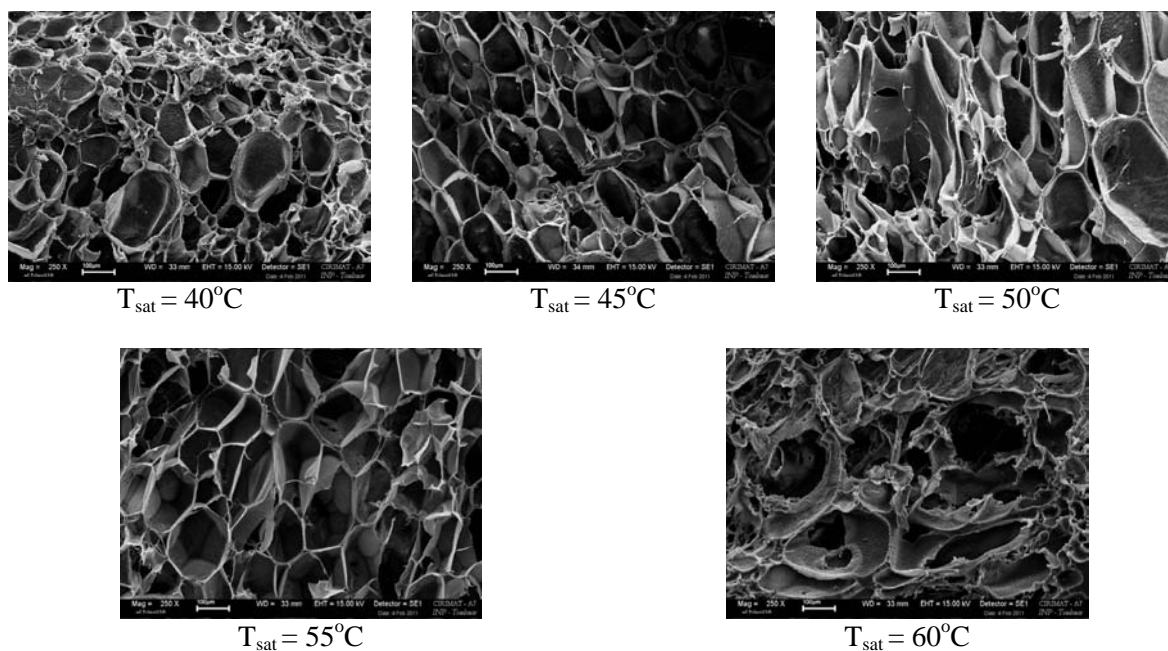
dP/dt (bar/s)	Pore Diameter			Surface Area/ $(\text{mm})^2$			Porosity
	Micro	Meso	Macro	Micro	Meso	Macro	P
	$d_e$ ( $\mu\text{m}$ )	$d_e$ ( $\mu\text{m}$ )	$d_e$ ( $\mu\text{m}$ )	(%)	(%)	(%)	(%)
6	22.5	51.9	0.0	17.4	82.6	0.0	83.5
6	18.5	57.4	0.0	24.7	75.3	0.0	83.0
6	20.0	54.8	0.0	18.4	81.6	0.0	83.0
3	14.6	61.8	0.0	9.8	90.2	0.0	83.8
3	13.9	63.8	0.0	11.6	88.4	0.0	82.8
3	12.5	60.5	0.0	11.7	88.3	0.0	82.3
1	13.1	52.0	0.0	26.3	73.7	0.0	86.1
1	12.9	54.9	0.0	30.3	69.7	0.0	87.0
1	14.4	53.6	0.0	28.3	71.7	0.0	85.3



#### 4.2.2 Effect of Saturation Temperature on the Microstructure of Foams

The results obtained from previous foams on blend PLGA/HA 10% did not produce high diameter pores and unfortunately there were no macro pores found. However pure PLGA produced an appreciable pore size in the scaffold. In order to increase the solubility of CO<sub>2</sub> in the polymer blend, we have increased the saturation temperature to produce pores of larger diameter. Therefore, in the next experiments we will increase the  $T_{\text{sat}}$  while blocking other parameters. Five pellets were pressed and foaming of the pellets was performed in SEPAREX<sup>®</sup> SFC6 scCO<sub>2</sub> 6L Laboratory plant. ScCO<sub>2</sub> process conditions were as follows.

$T_{\text{sat}} = 40, 45, 50, 55, 60^{\circ}\text{C}$ ,  $P_{\text{sat}} = 120$  bars,  $t_{\text{sat}} = 20$  min,  $dP/dt = 3$  bar/s



**Figure 6.45:** Micrographs of blend PLGA/HA 10% foams processed at  $P_{\text{sat}} = 120$  bars,  $t_{\text{sat}} = 20$  min and  $dP/dt = 3$  bar/s.

The micrographs obtained are presented in Figure 6.45. Porosity of the foam was calculated, SCION<sup>®</sup> image analysis was done for the pore diameter and data is tabulated in Table 6.23 and Table 6.24.

Geometric porosity of the foam was calculated, SCION<sup>®</sup> image analysis was done for the equivalent pore size and data is tabulated in Table 6.23. In all foams obtained geometric porosity is above 90%, pores in the foams processed at 40, 50 and 60°C were heterogeneous in size and have irregular pore boundaries and walls while at 45°C and 55°C pores are homogeneous in size and walls are regular. At higher temperatures in comparison to 35°C there are macro pores also in the foam obtained. By increasing the saturation temperature more CO<sub>2</sub> was absorbed thus leading to higher pore diameter and porosity.

Pore diameter of PLGA/HA 10% foams can also be increased by increasing the saturation time. This practice will minimize the chances of hyaluronic acid structure damage. It can be seen that at 60°C though the porosity and pore diameter is high but pore morphology is elongated and heterogeneous because this is temperature quite above the  $T_g$  of polymer and above the glass transition temperature the polymer is cross the rubbery state and is like semi molten foam. In this form though more CO<sub>2</sub> is absorbed but during the depressurization step very less time is available for the pore to grow because of less resistance of pore walls.



**Table 6.23:** Blend PLGA<sub>85:15</sub>/HA 10% foams processed at  $P_{\text{sat}}=120$  bars,  $t_{\text{sat}}=20$  min and  $dP/dt = 3$  bar/s

$T_{\text{sat}}$ (°C)	Pore Diameter			Surface Area/(mm) <sup>2</sup>			Porosity
	Micro	Meso	Macro	Micro	Meso	Macro	P
	$d_e$ (μm)	$d_e$ (μm)	$d_e$ (μm)	(%)	(%)	(%)	(%)
40	19.85	77.43	151.76	6.84	31.04	62.12	92.1
45	14.85	82.93	165.34	14.14	37.74	48.12	91.5
50	15.47	91.33	171.65	11.65	29.04	59.31	93.3
55	16.15	87.33	168.45	9.78	38.64	51.58	90.6
60	16.55	78.33	231.78	13.25	21.84	64.91	91.7

**Table 6.24:** PLGA<sub>85:15</sub>/10%HA composite foams pore data process at  $P_{\text{sat}}=120$  bars and  $t_{\text{sat}}=20$  min and  $dP/dt = 3$  bar/s

Saturation temperature (°C)	Pore Geometry	
	$d_e$ (μm)	P (%)
40	75	92.1
45	92	91.5
50	127	93.3
55	153	90.6
60	207	91.7

## 5 General Discussion

Polymers such as PLAs and PLGAs with various physical and mechanical properties were under study. Doehlert' and Taguchi' designs of experiments were applied to various process parameters. Controlled pore size and porosity enabled to use the foams for tissue engineering in cartilage regeneration. For PLGA<sub>50:50</sub>, we have obtained a macro pore diameter range of 228–270μm, with porosity of 92% and macro pores surface area 96% for the conditions  $P_{\text{sat}} = 120$  bars,  $t_{\text{sat}} = 20$  min,  $T_{\text{sat}} = 35^\circ\text{C}$  and  $dP/dt = 3$  bar/s.

A comparative study was performed by studying pellets processed by dry method (compression of polymer powder in a thermo-hydraulic press) and wet method (polymer dissolved in an good solvent before compression). This approach was adapted to have an in-depth sight of pore size and distribution, pore morphology and pore structure difference between both methods. Results revealed that in dry method amorphous polylactic acid produced pore of higher porosity and pore diameter than semi-crystalline poly lactic acid. Moreover dry pellet preparation method results are better than the wet pellet preparation method. In dry method the pore are homogeneous in size while wet method pore are heterogeneous. The internal surface of foams by dry method is rough while for wet method the surface is smooth.

On the similar basis, foams with higher porosity and pore diameter were produced by poly(lactide-co-glycolide) with higher LA/GA contents. The pore diameter in PLGA<sub>85:15</sub> in dry method is almost 20% higher than wet method for PLGA<sub>85:15</sub> and almost double than the value for PLGA<sub>50:50</sub> in dry method. The pore morphology in the dry method was quite better than in the wet method. In dry method the pores were circular, homogeneous and had regular pore walls as compared to wet method where elongated and irregular pore boundaries were seen.

Compressive modulus and compressive strength were determined and compared with the foams manufactured at different processing conditions and having different porosities. Compression modulus and compression strength at 10% deformation for  $P_{L,DL}LA$  was at higher value than  $P_{L,D}LA$  both in dry and wet method. PLGA<sub>85:15</sub> foams had lower  $E_c$  and  $\sigma_{10\%}$  as compared to PLGA<sub>50:50</sub> because it is more porous

Characterization by  $\mu$ CT analysis of the foams provided an idea of interconnectivity among the pores. Hg intrusion method also indicated that foams with higher porosity had comparatively higher percentage of open pores thus indicating more interconnectivity.

The entire work was done by pressure quench method in which during the depressurizing step in the process chamber temperature drops gradually, that affects on the anisotropy and pore structure of the foam. Future work must be carried out in order to control the temperature drop during the depressurization. Indeed, the temperature drop is an important parameter which affects the vitrification of the polymer and the thermodynamics of  $\text{CO}_2$ . A proper thermodynamic analyze of the venting process of the pressure chamber deserves further investigation. This kind of analyze can provide vital information in order to create scale-up rules. Comparative thermodynamics studies must be done for polymers with different  $T_g$ , molecular mass and degree of crystallinity.

Hyaluronic acid was incorporated as surface modifier for the tissue regeneration applications. Co-grinding phenomenon was advantageous to improve the surface adhesion of the desired scaffold for tissue regeneration. Different percentages (2, 5 and 10%) of hyaluronic acid were co-ground with PLGA<sub>85:15</sub>. Composite PLGA<sub>85:15</sub>/HA 10% produced foams with optimum porosity and pore diameter. After 1 hr of co-grinding time foams of macro pore size  $250 \pm 50 \mu\text{m}$  and porosity 92% at  $P_{\text{sat}} = 120 \text{ bars}$ ,  $t_{\text{sat}} = 20 \text{ min}$ ,  $T_{\text{sat}} = 60^\circ\text{C}$  and  $dP/dt = 3 \text{ bar/s}$  were obtained.

## 6 Conclusion

Optimization of process parameters, different types of polymer compositions and nature leads us to understand, which polymer will be suitable for processing foams of low or high porosity, small or large pore diameter and mechanical properties. Two different methods, wet pellet preparation and dry pellet preparation method were used to process four different types of polylactides. Semi-crystalline polymers can be processed by wet method to produce foam of higher porosity and satisfactory pore diameter as compared to dry pellet.

Surface modifier like HA eventually improves the adhesion energy of the foam by co-grinding the polymer with this adjuvant. However, for future perspective, saturation time of the process can be explored keeping the saturation temperature around the  $T_g$  temperature.

# Chapter 7

## Characterization of Scaffolds for Calcified Tissue Engineering

*In this chapter, we discuss on different fillers and adjuvant to be used to produce scaffold for bone regeneration. The purpose of the fillers is to increase the mechanical properties of the scaffold, while adjuvant will be used to facilitate foaming process. We present the results obtained with systems consisting of different composite constituted by polylactides and Sr-tricalcium phosphates. The preparation and characterization of fillers and adjuvant is described in detail. The objectives of this chapter are to precise the influence of incorporating a mineral phase or/and wax as porogen agent by either simple mixing or co-grinding, on the distribution of pores processed by scCO<sub>2</sub>, to characterize foaming properties. The percentage of mineral phase and co-grinding time influence on the scaffold will be elaborated step wise. The morphologies of the porous scaffold are also analyzed in detail.*

### 1 Characterization of Composites

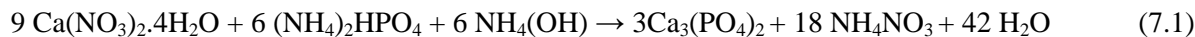
#### 1.1 Fillers and Adjuvant

In medical applications, bone graft substitutes include metals, ceramics, polymers and composites. Each of these has its own advantages and pitfalls. Ceramics are commonly used for specific application where minimum load bearing strength is needed while metals are used in load-bearing applications. Among ceramics, calcium phosphate is extensively used as bone fillers to heal small defects and these materials are also of prime choice as scaffold for bone tissue engineering for their known osteo-inductive capacity in ectopic sites and possess good cell adhesion properties [Yuan *et al.*, 2001]. Normally the percentage of fillers in polymer matrix is limited depending upon the required properties of the end products and its applications in the body. In our study, we have used amorphous tri-calcium phosphate and  $\beta$ -tricalcium phosphate as fillers. The purpose of using these fillers is to enhance the structural properties of the scaffold. Both amorphous tricalcium phosphate and  $\beta$ -tricalcium phosphate will be used with variable percentages so that optimal properties of the composite scaffold can be achieved for bone regeneration.

### 1.1.1 Sr Calcium Phosphate

#### 1.1.1.1 Synthesis and Characterization of Calcium Phosphates

The synthesis of amorphous tri calcium phosphate(ATCP) results of a double decomposition reaction between calcium nitrate and ammonium phosphate:



This reaction takes place in conditions of high basicity avoiding the presence of metal pollutants such as  $\text{Mg}^{+2}$  and  $\text{Cl}^-$ . The steps taken to optimize the precipitation of amorphous calcium phosphate powders until final are as follows.

To prepare solution A, we have put  $\text{Ca}(\text{NO}_3)_2$  calcium nitrate (41.3 grams) and  $\text{Sr}(\text{NO}_3)_2$  strontium nitrate (4.14 grams) into a one liter Erlenmeyer and added water (550 ml) to dissolve them. For solution B, we have weighted  $\text{NH}_4(\text{H}_2\text{PO}_4)$  di-ammonium phosphate (27.3 grams) in a three liters Erlenmeyer and added water (1300 ml).

For the filtration system, we have prepared three Büchner funnels connected to vacuum vials and vacuum system. Just before precipitating, we have added concentrated  $\text{NH}_4(\text{OH})$  ammonia solution (40 ml) in each vial. Rapidly we have poured solution A into solution B and agitated, filtered immediately and distributed the suspension evenly in the three filtration systems. We have washed the precipitate on each system with 2 liters of water containing 5 ml of concentrated ammonia solution per liter. At the end, we have added 250 ml of distilled water to remove the ammonia solution. The precipitate was immediately Lyophilized for 2 days at following conditions:  $T < -50^\circ\text{C}$  and  $P < 0.120$  mbar.

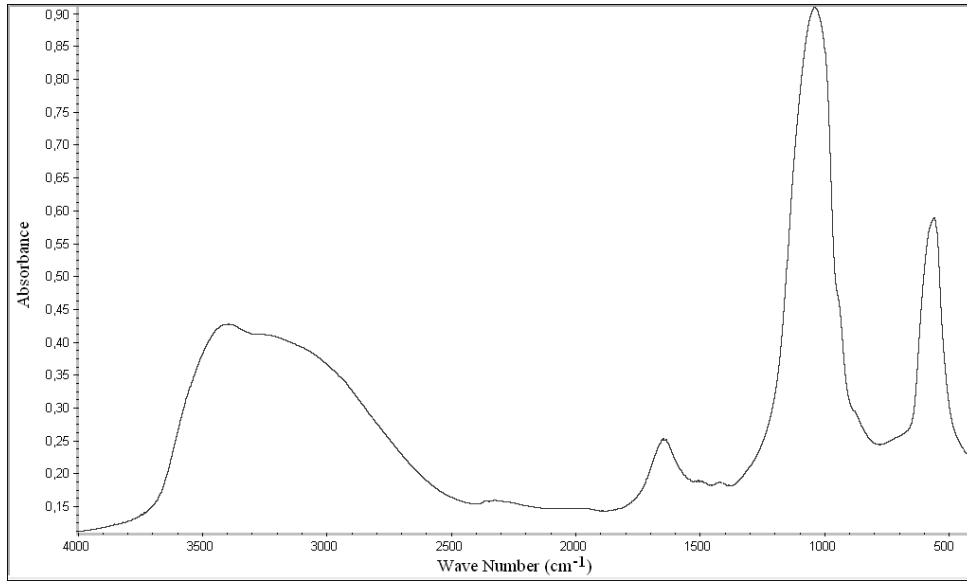
With this procedure, we prepared two samples because the tri-calcium phosphate (TCP) commercial sales were not pure enough for our application and did not contain any  $\text{Sr}^{+2}$  ions. So we decided to synthesize our own TCP from the ATCP. About 22 g were obtained for each product. For the sample of the ATCP, a small fraction (1 g) was calcined at  $900^\circ\text{C}$  in order to analyze the composition and crystallinity by FTIR. The second sample was completely burned at  $900^\circ\text{C}$ . In a first test, calcination was carried out overnight and the result was a powder composed of relatively large particles, which highlights the sintering of particles during calcination. To avoid sintering and obtain a finer powder easier to disperse in our polymer matrix, a second test was performed. This time, calcination was performed for 1 h and it was checked by FTIR that the conversion of amorphous calcium triphosphate to the beta phase was complete. The powder was stored in a freezer until use.

#### 1.1.1.2 Calcium Phosphate Characterization

The samples have been checked by X-ray diffraction (for the Ca/P determination, and after heating the samples at  $900^\circ\text{C}$  for 2 hours) and by FTIR (for verifying the presence of  $\text{P}_2\text{O}_7^{-4}$  pyrophosphate groups). In our case, all samples are amorphous strontium tri-calcium phosphate (ATCP)<sub>Sr</sub> (cf. Figure 7.1 and Figure 7.2). The peak positions obtained in the FTIR analysis of two samples of amorphous tricalcium phosphate are reported in Table 7.1. The broad lines at 1650 and around 3400 can be assigned to water molecules attached to the amorphous phase.

**Table 7.1:** Position of resulting bands in the FTIR analysis.

Position	Peak	Position	Peak
1	559.5	2	1039.3
3	1652.8	4	3396.0



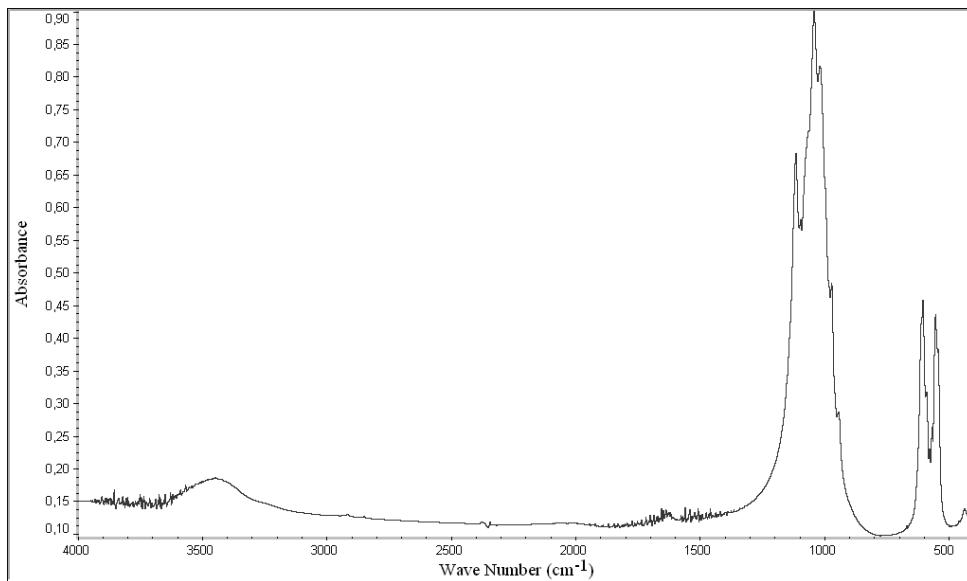
**Figure 7.1:** IR absorption spectrum of amorphous tricalcium phosphate (ATCP) doped with 10% Sr.

In the literature [Elliott, 1994], we can find for the family of phosphates the characteristic wavelength or place where the peaks are as follows (cf. Table 7.2).

**Table 7.2:** Position of bands in FTIR for amorphous calcium phosphate (ACP).

Vibration modes of PO <sub>4</sub> Group (cm <sup>-1</sup> )			
V <sub>1</sub>	V <sub>2</sub>	V <sub>3</sub>	V <sub>4</sub>
966	475	1020-1120	609-574

Thermal treatment of the low-temperature phases (ATCP)<sub>Sr</sub> in air at 900°C for several (24) hours does indeed lead to the formation of β-(TCP)<sub>Sr</sub> and this is a way to prepare this phase with high purity. When TCP's Ca/P atomic ratio is not exactly 1.5, impurities appear. The main impurities, hydroxyapatite (Ca/P atomic ratio above 1.5) and β-calcium pyrophosphate (corresponding to a Ca/P atomic ratio under 1.5), can be detected, by XRD and FTIR spectroscopy respectively (cf. Figure 7.2).

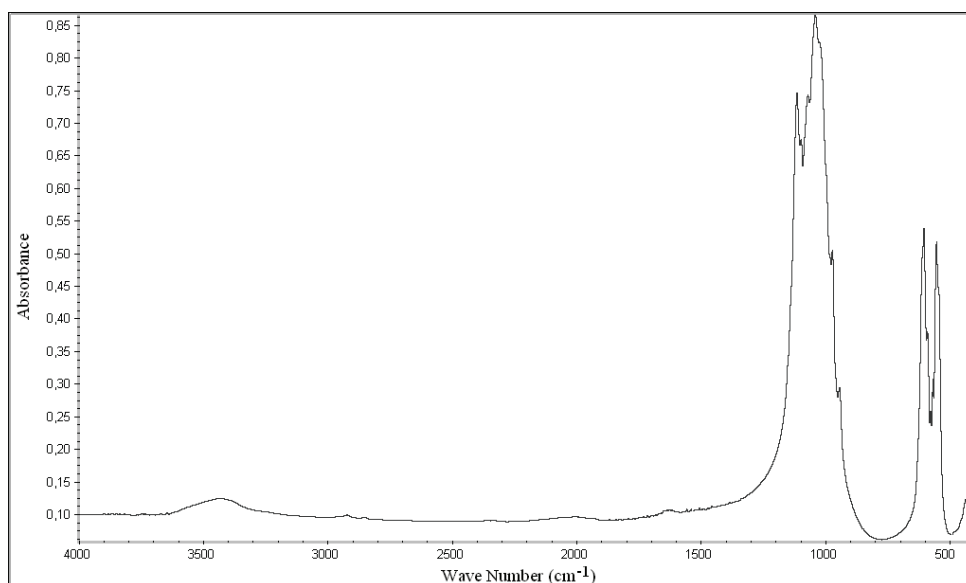


**Figure 7.2:** IR absorption spectrum of amorphous calcium phosphate (ACP) doped with 10% Sr after calcination 24 h.

In addition to the peaks of phosphate ions in, un-calcined samples' peaks can be found resulting from carbonate and nitrate ions even in the case where the washing of the precipitate is inadequate. These peaks would appear at a wavelength between the values given in Table 7.3. The absence of the peaks, OH and water, in our spectra testifies for the purity of our sample.

**Table 7.3:** Position of bands in FTIR for other groups.

Position of bands in FTIR		
Carbonate	1660	
Nitrate	1320	1480



**Figure 7.3:** IR absorption spectrum of tricalcium phosphate doped with 10% Sr after 2 hours of calcination.

We have checked on X-ray diffraction patterns that no lines due to hydroxy apatite were found. The FTIR spectrum (cf. Figure 7.2 and Figure 7.3) is characteristic of  $\beta$ -Tricalcium phosphate and no pyrophosphate impurities were detected.

**Table 7.4:** Position of bands in FTIR for pyrophosphate.

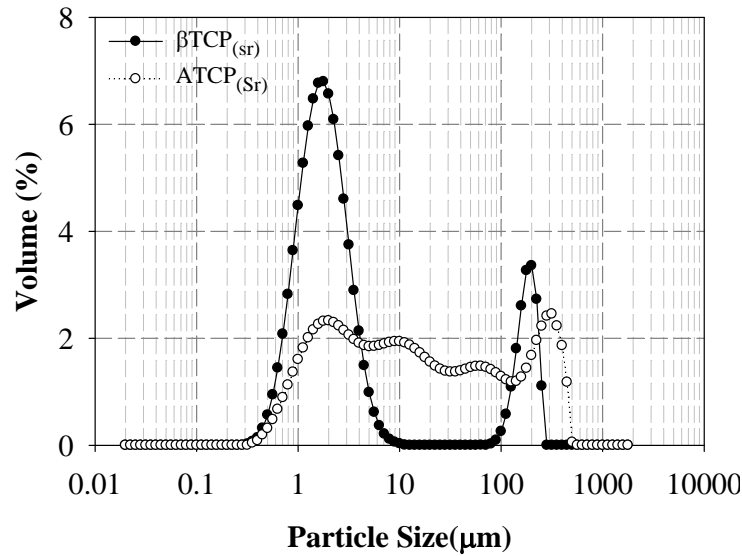
Pyrophosphates $P_2O_7^{4-}$ vibration modes ( $cm^{-1}$ )	
Stretching ( $PO_3$ ) asymmetric	1121–1141
Stretching (POP) asymmetric	725–728

If we compare our experimental data with the literature [Combes and Rey, 2010], we can conclude the samples prepared, correspond to pure amorphous strontium calcium phosphate with a (Ca+Sr)/P ratio of 1.5 (cf. Table 7.4)

### 1.1.1.3 Calcium Phosphate Granulometry

Size distributions of amorphous (ATCP) tricalcium phosphate doped with 10% Sr before and after calcination ( $\beta$ TCP) are presented in Figure 7.4. A very large distribution is observed for  $ATCP_{(sr)}$  ranging from 1 to 800  $\mu m$ . Two peaks are visible for crystallized  $\beta$ TCP<sub>(sr)</sub> depicting two types of particles ranging respectively from 1 to 10  $\mu m$  and from 100 to 500  $\mu m$ .





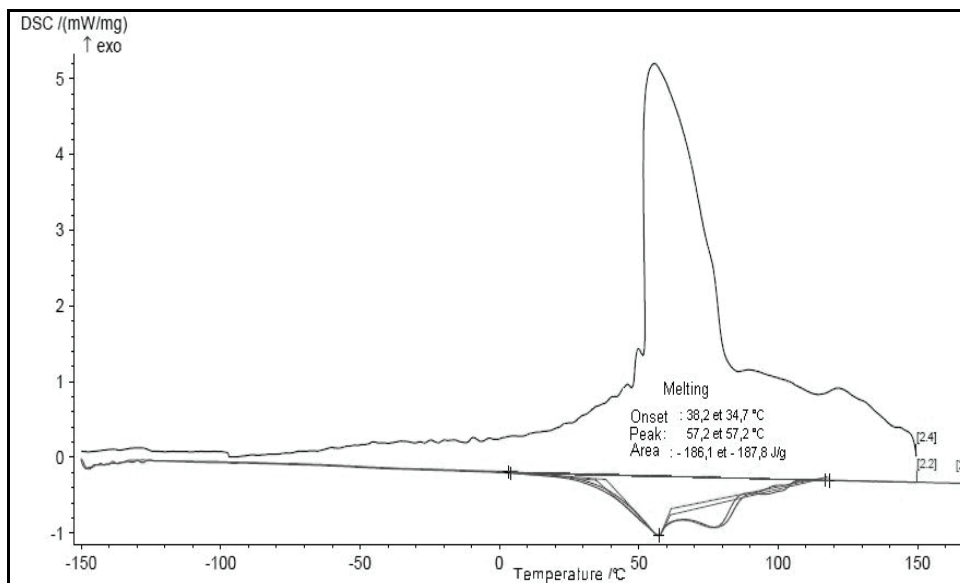
**Figure 7.4:** Particles size of two different tricalcium phosphates analyzed by granulometry.

## 1.2 Adjuvant: Porogen Agent

Addition of calcium phosphate as filler in polymer matrix reduces the sorption of  $\text{CO}_2$  in the polymer during the foaming process. To try and increase the solubility of  $\text{CO}_2$  in the polymer matrix and making it more plasticize to facilitate pore generation wax has been added as foaming agents. It is expected that wax will be evacuated during the foaming process.

### 1.2.1 Industrial Waxes

Three samples have been used in the formulation as a pore foaming agent. The first wax (sample labeled A), was graciously given by Esprit composite<sup>®</sup> (reference TERHELL 907) and the two others furnished by Sasol Wax<sup>®</sup> (C8007 P606 and H106 1036 referenced in this work as C80 and H1). They have been first analyzed by DSC and Thermogravimetry. As example we present on Figure 7.5, the thermograms and the degradation curve corresponding to the sample TERHELL 907. Other DSC and thermogravimetric curves have been reported in Annex A-3 (cf. Figure A-3.1 and Figure A-3.2)



**Figure 7.5:** Melting and crystallisation of the wax A (TERHELL-907).

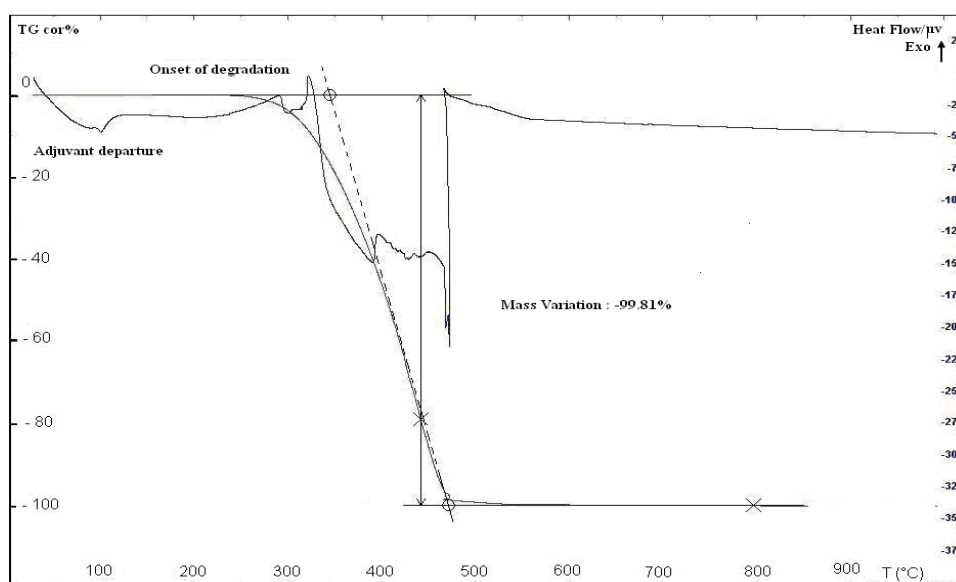
The thermodynamic transitions and thermal properties of three waxes are reported on Table 7.5.

**Table 7.5:** Thermodynamics transitions and thermal properties of the waxes.

Wax Type	1 <sup>st</sup> Scan			2 <sup>nd</sup> Scan			T <sub>degradation onset</sub> (°C)	Mass Loss (%) During Degradation
	T <sub>onset</sub> (°C)	T <sub>Max</sub> (°C)	ΔH <sub>M</sub> (J.g <sup>-1</sup> )	T <sub>onset</sub> (°C)	T <sub>Max</sub> (°C)	ΔH <sub>M</sub> (J.g <sup>-1</sup> )		
A TERHELL (907)	38.2	57.2	186.1	34.7	57.2	187.8	143	99.81
	42.0	57.6	192.1	49.2	54.5	146.3		
B (C80)	93.0	96.7	242.8	72.2	87.6	235.4	208	99.41
C (H1)	104.7	111.7	279.0	72.4	92.5	259.1	211	100

### 1.2.2 Thermal Degradation

As shown on the Figure 7.6, the degradation of the waxes is complex and curves present generally in two steps. Moreover, the melting transitions are always preceded by a departure of small molecules around 100°C.



**Figure 7.6:** TGA curve of the wax-A (907).

## 2 Experiments on Polylactides/Tri-calcium Phosphate Scaffolds

### 2.2 Experiments on Polylactides/Tri-calcium Phosphate

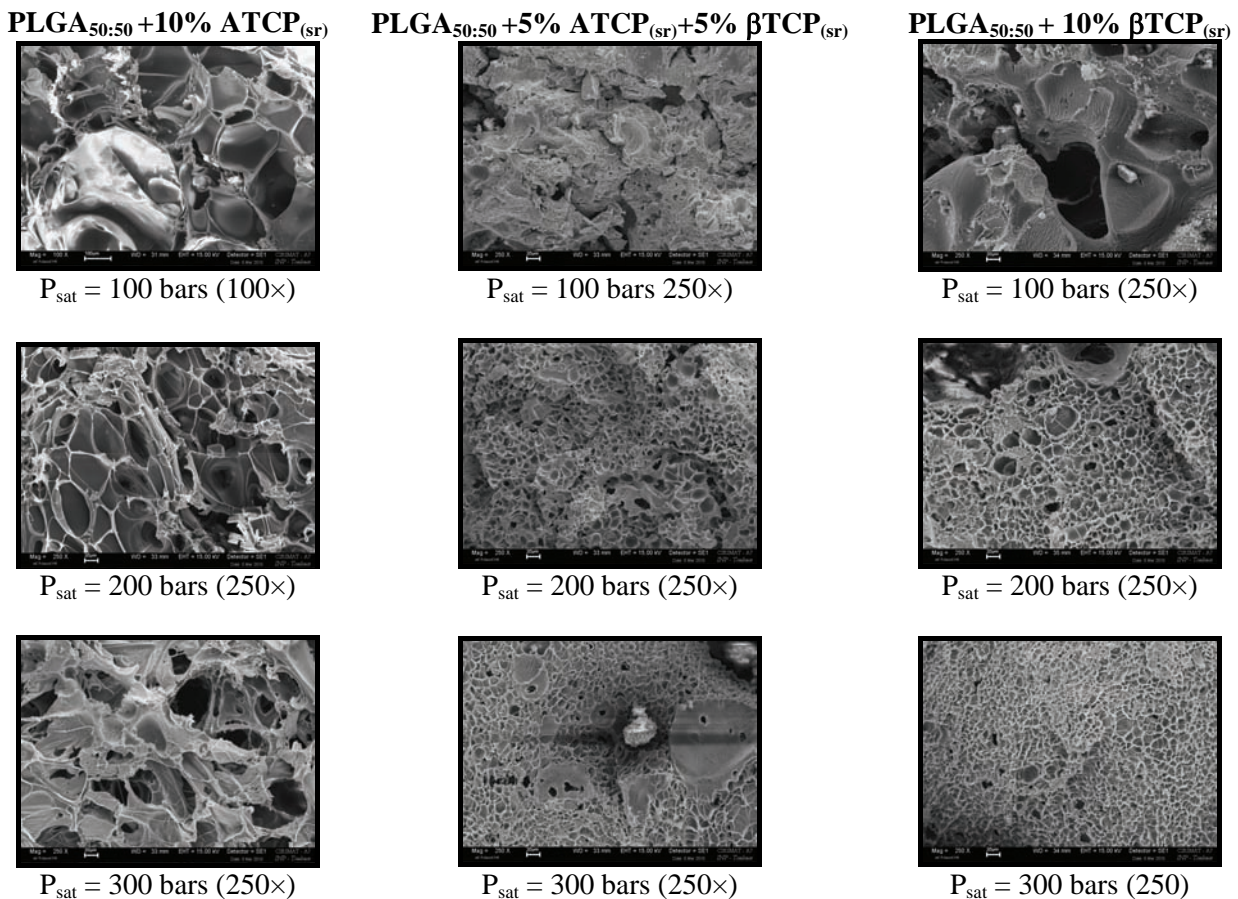
First foaming experiments have been performed on three different polylactides: PLGA<sub>85:15</sub> (PLG 8531), PLGA<sub>50:50</sub> (PLG 8523), which are semi crystalline and P<sub>L,D</sub>LA (PABR-L 68) which is amorphous. The conditions for the Taguchi' experimental design, are reported on the Table 7.6. It was developed 3 sets of 9 samples of 200 mg each. In this case, only the saturation pressure was changed and three levels of pressure were considered for each sample. As the T<sub>g</sub> of PLGA<sub>85:15</sub> and P<sub>L,D</sub>LA is ~55°C and that of, PLGA<sub>50:50</sub> ~ 47°C, so it was decided to adopt a temperature of 50°C for foaming.

PLGA<sub>85:15</sub> was ground in the knife cutter grinder and final powder obtained passed through a 500 μm mesh sieve. The pellets were made as per prescribed conditions. However, after making pellets, they were still erosive on handling. Pellets 1- 3 were again prepared by wet method using acetone. While samples 4-9 were used as solid pellets. The ratio of ATCP<sub>(sr)</sub> and βTCP<sub>(sr)</sub> in the composite blend was 5 or 10 %.

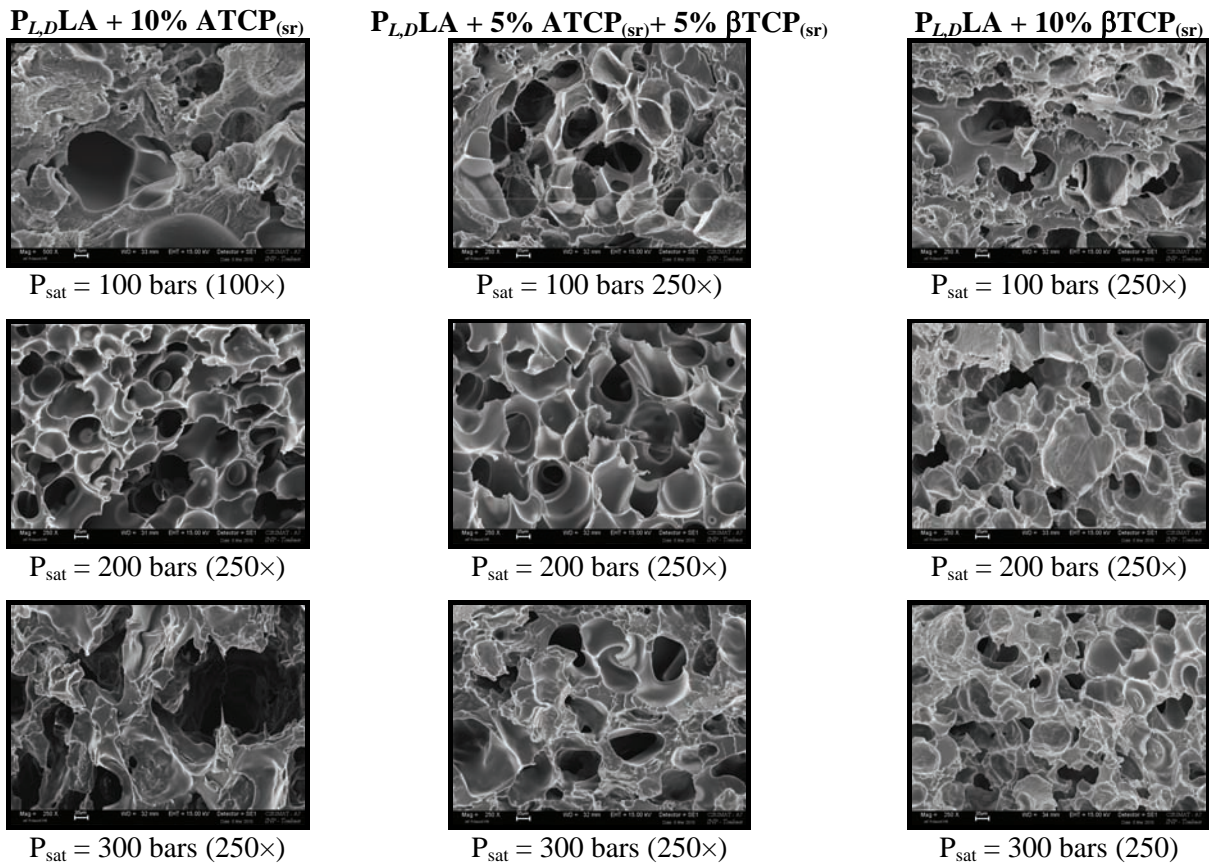
**Table 7.6:** Levels selected for each parameter of the scaffold and foaming process with supercritical CO<sub>2</sub> at ( $T_{\text{sat}} = 50^{\circ}\text{C}$ ,  $dP/dt = 3 \text{ bar/min}$  and  $t_{\text{sat}} = 20 \text{ min}$ ).

Polymer Type	Sample	Poly lactide	$\beta\text{TCP}_{(\text{sr})}$	$\text{ATCP}_{(\text{sr})}$	$P_{\text{sat}}$ (bars)
PLGA <sub>85:15</sub> (PDLG 8531)	P <sub>1~3</sub>	90	0	10	100,200,300
	P <sub>4~6</sub>	90	5	5	100,200,300
	P <sub>7~9</sub>	90	10	0	100,200,300
PLGA <sub>50:50</sub> (PLG 8523)	P <sub>10~12</sub>	90	0	10	100,200,300
	P <sub>13~15</sub>	90	5	5	100,200,300
	P <sub>16~18</sub>	90	10	0	100,200,300
P <sub>L,D</sub> LA (PABR L 68)	P <sub>19~21</sub>	90	0	10	100,200,300
	P <sub>22~24</sub>	90	5	5	100,200,300
	P <sub>25~27</sub>	90	10	0	100,200,300

The geometric porosity of the resulting foams was deduced from the procedure given in chapter 4. SEM micrographs were obtained for the foams of the three copolymers at each condition to analyze the pore size. Micrographs of PLGA<sub>50:50</sub> and P<sub>L,D</sub>LA (PABR L 68) are presented in Figure 7.7 and Figure 7.8 respectively. As PLGA<sub>85:15</sub> (PLG 8531) is highly crystalline, we did not succeed in producing foams. After foaming process pellets of PLGA<sub>85:15</sub> (PLG 8531) were turned into powder like material. Pellet was changed into tiny spherical balls and was difficult to handle for SEM micrograph analysis.

**Figure 7.7:** Micrographs of PLGA<sub>85:15</sub> (8523) + tricalcium phosphate processed at scCO<sub>2</sub> conditions-  $T_{\text{sat}} = 50^{\circ}\text{C}$ ,  $t_{\text{sat}} = 20 \text{ min}$ ,  $dP/dt = 3 \text{ bar/s}$  and varying  $P_{\text{sat}}$ .

The reason that PLGA<sub>85:15</sub> (PLG 8531) did not produced foam is because if its high crystallinity which did not permit CO<sub>2</sub> to absorb in the crystal lattice during the foaming phenomenon.



**Figure 7.8:** Micrographs of  $P_{L,D}LA$  + tricalcium phosphate processed at  $scCO_2$  conditions-  
 $T_{sat}=50^\circ C$ ,  $t_{sat}=20$  min,  $dP/dt=3$  bar/s and varying  $P_{sat}$ .

### 2.3 Analysis of Experiments on Polyactides/Tri-calcium Phosphate

Experiments were done by changing the percentages of the tricalcium phosphate in the polymer matrix. ATCP and  $\beta$ TCP were varied from 0 to 10 % to see the effect on the scaffold. Equivalent pore diameter obtained by SCION<sup>®</sup> image analysis and geometric porosities only for PLGA<sub>50:50</sub> and  $P_{L,D}LA$  polymer wax blend are reported on Table 7.7.

**Table 7.7:** PLGA<sub>50:50</sub> and  $P_{L,D}LA$  Foams pore data with different % of tricalcium phosphate.

Foam No.	ScCO <sub>2</sub> Condition	Polymer with Composite Composition	PLGA <sub>50:50</sub>		$P_{L,D}LA$	
	[ $T_{sat}$ - $P_{sat}$ - $t_{sat}$ - $dP/dt$ ]		Pore Diameter $d_c(\mu m)$	Geometric Porosity (%)	Pore Diameter $d_c(\mu m)$	Geometric Porosity (%)
1	[50-100-20-3]	10% ATCP <sub>(sr)</sub>	100	87.9	40	60.6
2	[50-200-20-3]	10% ATCP <sub>(sr)</sub>	60	75.3	30	44.8
3	[50-300-20-3]	10% ATCP <sub>(sr)</sub>	50	81.3	80	53.2
4	[50-100-20-3]	5% ATCP <sub>(sr)</sub> +5% $\beta$ TCP <sub>(sr)</sub> √	20	88.3	50	68.2
5	[50-200-20-3]	5% ATCP <sub>(sr)</sub> +5% $\beta$ TCP <sub>(sr)</sub> √	15	87.1	30	38.0
6	[50-300-20-3]	5% ATCP <sub>(sr)</sub> +5% $\beta$ TCP <sub>(sr)</sub> √	10	88.3	40	57.8
7	[50-100-20-3]	+5% $\beta$ TCP <sub>(sr)</sub> √	100	87.8	60	77.3
8	[50-200-20-3]	+5% $\beta$ TCP <sub>(sr)</sub> √	20	98.4	20	50.1
9	[50-300-20-3]	+5% $\beta$ TCP <sub>(sr)</sub> √	10	90.3	10	56.7

A comparison of pore diameter for each polymer shows that as the saturation pressure increases, micro pores gradually decrease. The results obtained show that the pore size decreases with increasing saturation pressure; macrospores were only obtained for a pressure of 100 bars. According to *Tai et al.*



[2007] the diffusion coefficients and equilibrium concentration of CO<sub>2</sub> in PLGA increases with pressure in a nearly linear relationship. In addition, greater pressure can cause increment of the dissolution of CO<sub>2</sub> and consequently the glass transition temperature decreases. For these reasons, at higher pressures, the amount of CO<sub>2</sub> incorporated into the polymer increases and yet the material is supersaturated when depressurizing the system. The result is then a nucleation density of larger pore size is low.

The crystallinity of PLGA<sub>85:15</sub> (8531) and PLGA<sub>50:50</sub> (8523) is respectively 26.8% and 18.4% while P<sub>L,D</sub>LA is amorphous. The porosity obtained for PLGA<sub>85:15</sub> 8531 is the lowest and apparently no pores were produced in the foams. As for PLGA<sub>50:50</sub> 8523 which is less crystalline the porosity is higher than for PLGA<sub>85:15</sub> 8531. The two poly(L-lactide-co-glycolide) which contains only L-lactide behaves like semi-crystalline material, thus due to the presence of crystal lattice sorption of CO<sub>2</sub> is less, leading to low solubility and swelling hence producing foams with less pore size. While in P<sub>L,D</sub>LA contain both L and D lactide with the ratio of 88:12. In P<sub>L,D</sub>LA polymer due to more D-lactide as compared to PLGA<sub>85:15</sub>, the sorption and swelling of CO<sub>2</sub> in polymer is more so the porosity and pore diameter should be more than the two Poly(L-lactide-co-glycolide) as also investigated by *Pini et al.* [2008], *Liu and Tomasko* [2007], *Oliveira et al.* [2006]. The results obtained by these authors indicate that, CO<sub>2</sub> is slightly more soluble in polylactide containing less percentage of L-lactide in the polymer. In our case P<sub>L,D</sub>LA possesses 88% of L-Lactide ratio as compared to Poly(L-lactide-co-glycolide). In addition, if one compares the porosity as a function of the filler ratio 0-10% (ATCP<sub>sr</sub> / βTCP<sub>sr</sub>), it is obvious that the highest porosities were obtained for the Sr-βtricalcium phosphate. The behaviour of the filler composed by β-tricalcium phosphate and amorphous presents an intermediate behaviour.

### 3 Foams of Polylactides/Calcium Phosphates Blends and Composites

#### 3.2 Experiments on PLA/Waxes Scaffolds

##### 3.2.1 Preliminary Experimentation with Wax as Porogen Agent

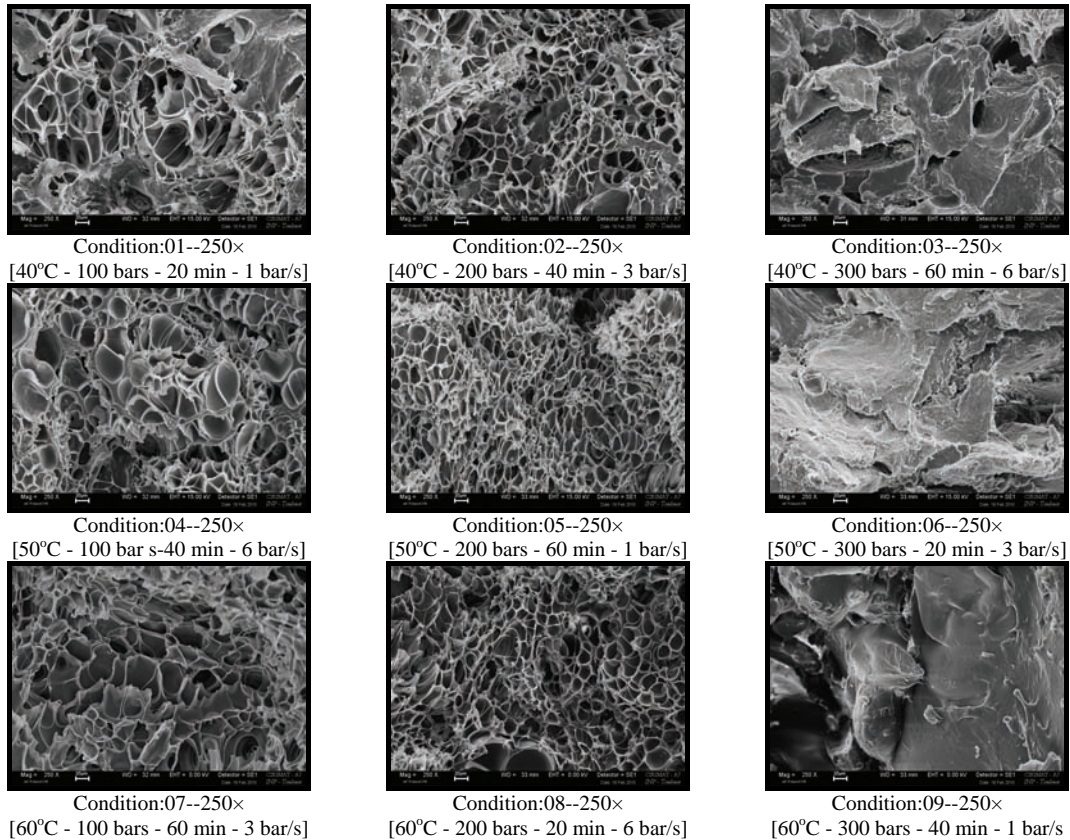
The aim of these studies was to try and increase the pore diameter of P<sub>L,DL</sub>LA foams by adding a porogen agent in the formulation. Indeed, in previous studies, dry and wet methods were used to produce P<sub>L,DL</sub>LA foams with larger pore diameter and porosity but results were not still appropriate. A porogen agent (wax), being apolar in nature, has been added to the polymer to facilitate CO<sub>2</sub> sorption thus trying to increase the possibility of pore generation. In that way, 36 pellets containing wax manually blended with polymer were manufactured with the manual press, as described by the procedure in chapter 4, at following process conditions: T = 60°C, P = 150 bars and t = 20 min. Blends of P<sub>L,DL</sub>LA polymer and different waxes (A, B or C) with the four mass ratios and were foamed with conditions as reported in Table 7.8.

**Table 7.8:** Mass ratio of polymer and different waxes and Taguchi' plan (L<sub>9</sub>) for polymer-wax blend foams.

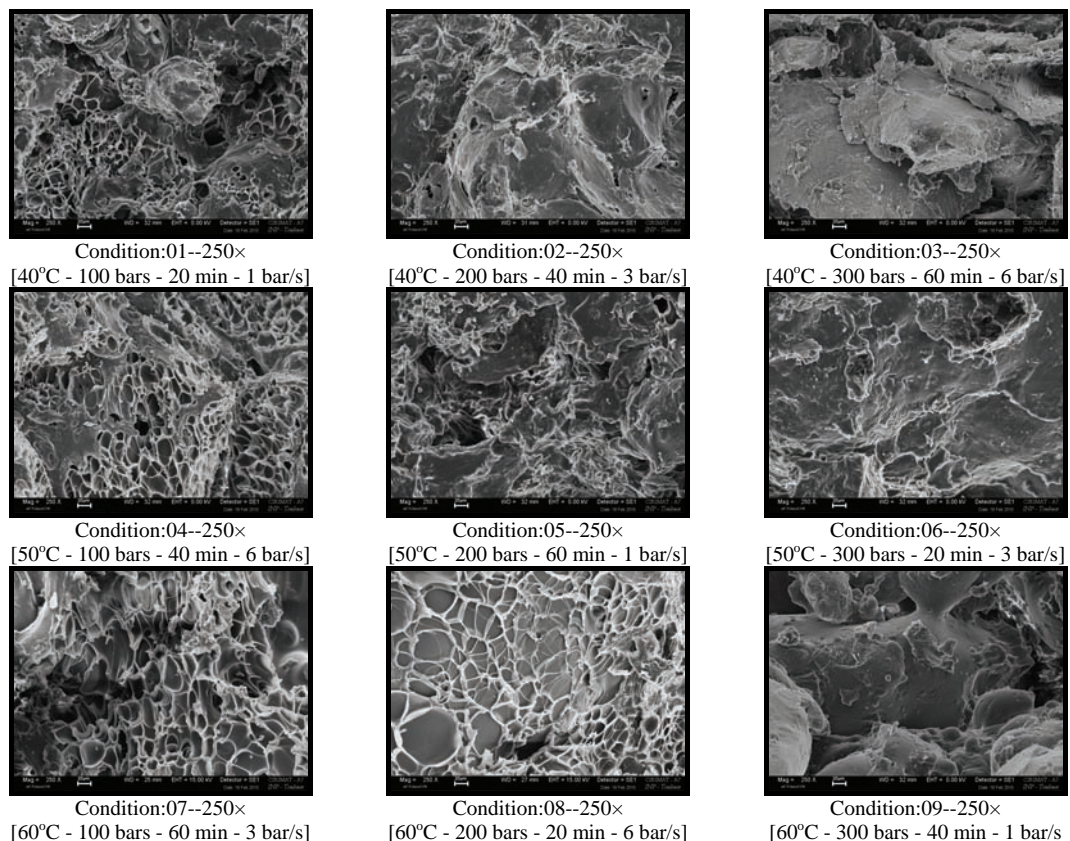
PLA (LR 704) (w/w)			100%	90%	80%	70%
+ Wax A or B or C (w/w)			0	10%	20%	30%
Conditions	T <sub>sat</sub> (°C)	P <sub>sat</sub> (bar)	t <sub>sat</sub> (min)		dP/dt (bar/s)	
1	40	100	20		1	
2	40	200	40		3	
3	40	300	60		6	
4	50	100	40		6	
5	50	200	60		1	
6	50	300	20		3	
7	60	100	60		3	
8	60	200	20		6	
9	60	300	40		1	

### 3.2.2 SEM Analysis of Foams

Foams processed according to Taguchi' plan (cf. Table 7.8) are presented in the micrographs of Figure 7.9 for pure  $P_{L,DL}LA$  foams and of Figure 7.10 for  $P_{L,DL}LA + 10\%$  Wax-A.



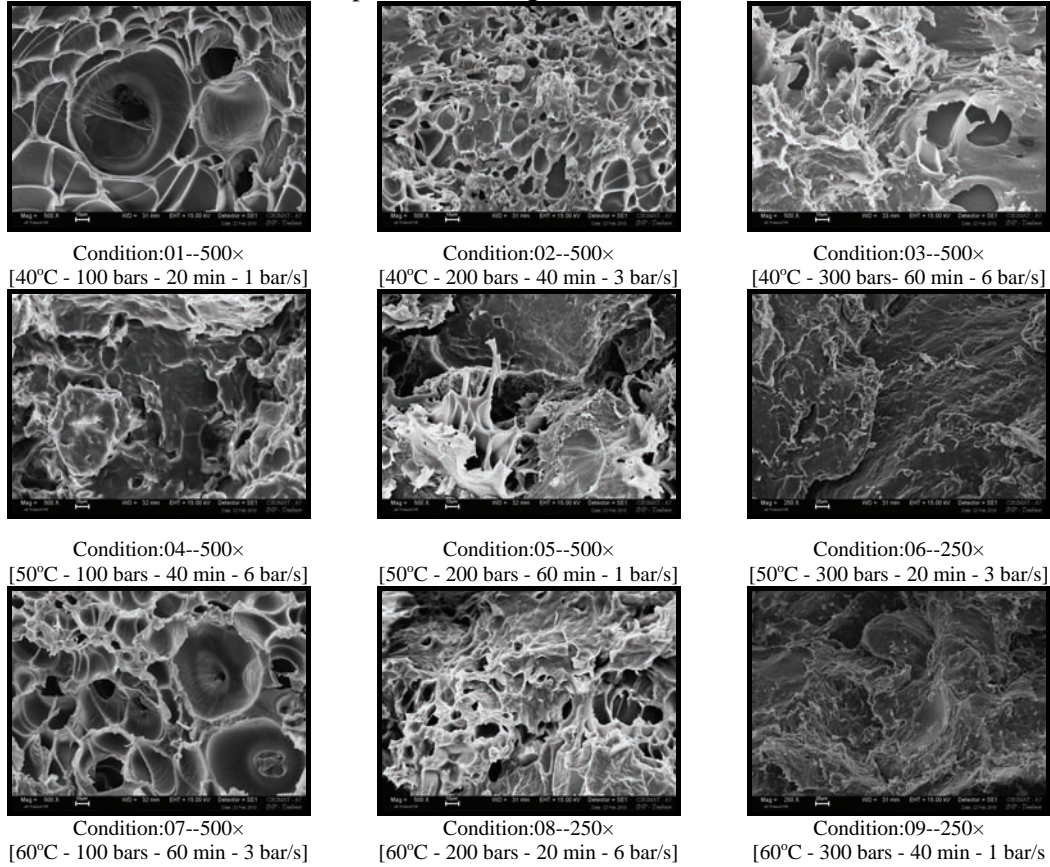
**Figure 7.9:** Micrographs of  $P_{L,DL}LA$  foams at different process conditions.



**Figure 7.10:** Micrographs of  $P_{L,DL}LA + (10\%)$  wax-A foams at different process conditions.

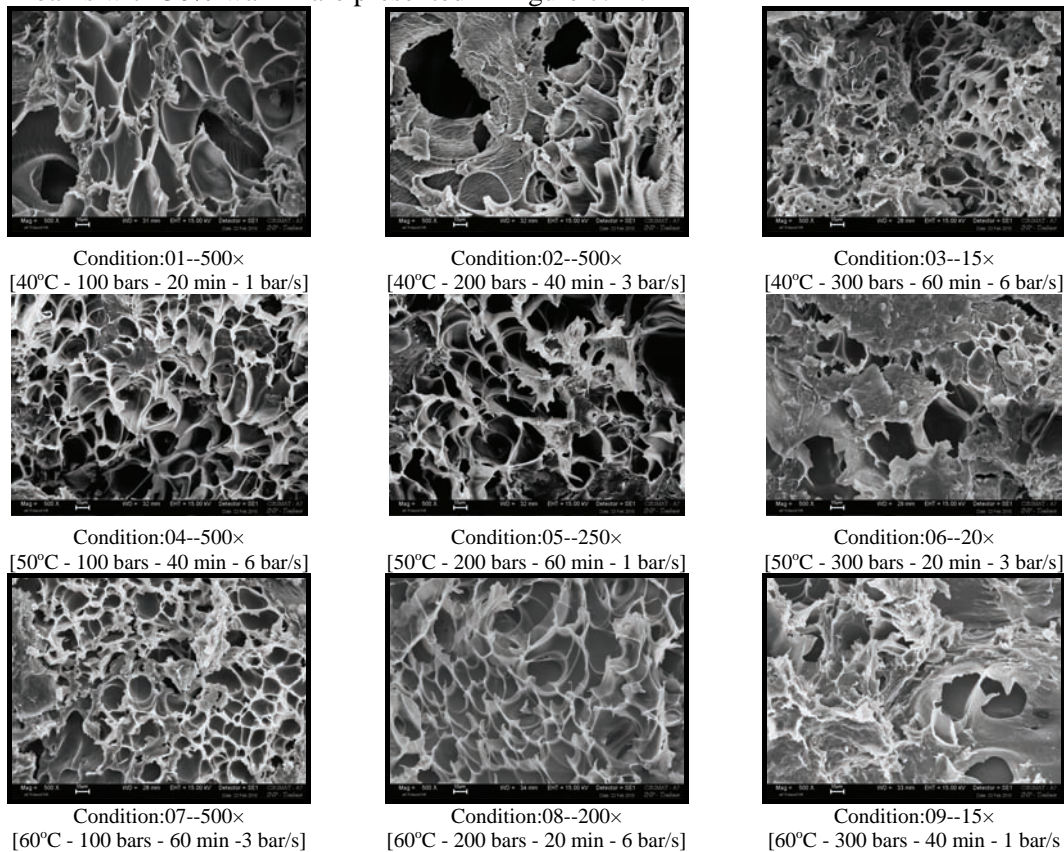


Foams with 20% Wax-A are presented in Figure 7.11.



**Figure 7.11:** Micrographs of P<sub>LDL</sub>LA +(20%) wax-A foams at different process conditions.

Foams with 30% wax-A are presented in Figure 7.12.



**Figure 7.12:** Micrographs of P<sub>LDL</sub>LA +(30%) wax-A foams at different process conditions.

There was not an effective change in pore size by increasing the percentage of wax. All these foams were processed according to Taguchi' plan. In Majority of the foams the pore size was 5 to 25 $\mu$ m and were elongated, heterogeneous and irregular in shape. Micrographs of foams P<sub>L,DL</sub>LA +30% wax-B and P<sub>L,DL</sub>LA +20% wax-C are presented in Annex-A-3, (cf. Figure A-3.3 and Figure A-3.4)

### 3.2.3 Effect of Wax on the Equivalent Pore Size and Geometric Porosity

The equivalent pore diameter and geometric porosity of the polymer and polymer blend foams are presented in Table 7.9 and Table 7.10 respectively. The values highlighted and underlined represent the maximum values for the respective foaming conditions.

**Table 7.9:** Equivalent pore diameter of pure P<sub>L,DL</sub>LA and polymer-wax blend foams.

Foam Nr.	Pure P <sub>L,DL</sub> LA	P <sub>L,DL</sub> LA + 10% Wax			P <sub>L,DL</sub> LA + 20% Wax			P <sub>L,DL</sub> LA + 30% Wax		
		A	B	C	A	B	C	A	B	C
	( $\mu$ m)	( $\mu$ m)	( $\mu$ m)	( $\mu$ m)	( $\mu$ m)	( $\mu$ m)	( $\mu$ m)	( $\mu$ m)	( $\mu$ m)	( $\mu$ m)
1	<u>45</u>	15	15	15	15	10	7	10	7	10
2	35	<u>25</u>	7	10	10	7	10	25	20	15
3	15	10	5	7	15	15	15	25	30	<u>35</u>
4	35	10	7	3	<u>20</u>	15	10	15	5	7
5	30	20	15	10	15	20	10	25	25	25
6	15	15	10	15	15	<u>25</u>	<u>25</u>	<u>30</u>	30	20
7	5	5	5	5	15	15	10	10	7	10
8	20	15	<u>20</u>	10	5	5	7	5	<u>35</u>	20
9	40	20	<u>25</u>	<u>20</u>	15	10	20	15	30	25

**Table 7.10:** Geometric porosity of pure P<sub>L,DL</sub>LA and polymer-wax blend foams.

Foam Nr.	Pure P <sub>L,DL</sub> LA	P <sub>L,DL</sub> LA + 10% Wax			P <sub>L,DL</sub> LA + 20% Wax			P <sub>L,DL</sub> LA + 30% Wax		
		A	B	C	A	B	C	A	B	C
	(%)	(%)	(%)	(%)	(%)	(%)	(%)	(%)	(%)	(%)
1	28.1	14.8	22.4	14.1	19.0	11.3	14.3	18.1	12.0	15.2
2	<u>69.3</u>	44.2	48.7	63.5	67.8	29.3	50.6	33.1	37.0	45.4
3	47.7	32.0	33.5	19.8	29.2	27.9	35.6	21.4	27.1	33.9
4	25.4	19.5	12.8	45.7	23.8	31.1	12.8	18.8	18.2	14.3
5	51.1	34.2	37.5	54.8	31.3	31.5	43.3	27.3	34.5	37.2
6	62.5	48.0	56.1	54.0	48.9	41.0	42.6	49.8	40.2	41.8
7	44.0	46.5	51.1	46.1	49.6	49.6	41.9	47.2	50.1	30.0
8	67.0	<u>69.3</u>	69.7	65.1	<u>70.8</u>	66.5	61.1	<u>70.9</u>	63.4	62.5
9	68.6	67.0	<u>72.8</u>	<u>72.4</u>	69.5	<u>71.0</u>	<u>68.0</u>	64.2	<u>69.0</u>	<u>64.0</u>

In all the polymer wax blend foams, equivalent pore diameter did not exceed 35 $\mu$ m and maximum porosity was ~70%. Effect of each process parameter on equivalent pore diameter and porosity for polymer wax-A blend are presented in Figure 7.13 and Figure 7.14 respectively. Comparing the porosities of polymer/wax blend foams with pure P<sub>L,DL</sub>LA foams, in blend foam the values was always less. However in condition 8 and 9, the porosities for all percentages of polymer/wax blends and pure polymer were almost same. The equivalent pore diameter for these two conditions was not same for pure polymer and polymer wax blend foams.

Examining Figure 7.13, one can observe that as the percentage of wax-A increases from 10% to 30% there is slight increase in the pore diameter of the polymer wax blend. Similar trend is seen for wax-B and wax-C blend. The decrease in trend of pore diameter for three types of wax is as follows.

Optimum pore dia in polymer/wax-A blend > polymer wax-B blend > polymer wax-C blend

The possible reason for this trend is due to the fact that melting point of wax-A < wax-B < wax-C.

If the foam processing temperature is increased making it more closer to the melting point of the wax pore diameter can be increased.

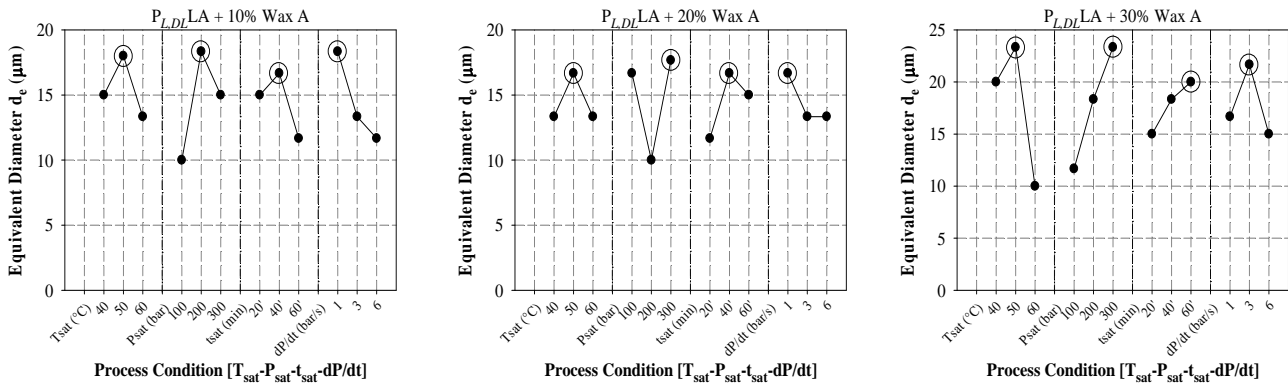


Figure 7.13: Average effect of wax-A on the equivalent pore diameter for polymer wax blends.

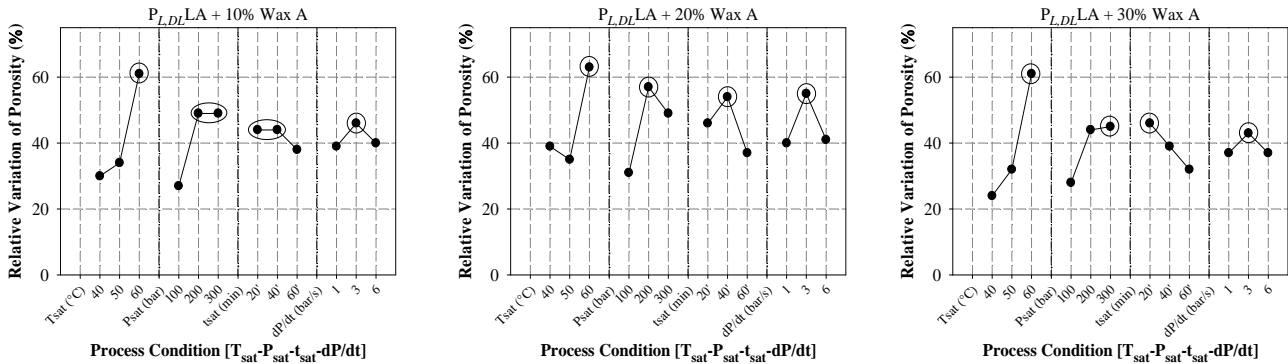


Figure 7.14: Average effect of wax-A on the geometric porosity for polymer wax blends.

Average effect of wax-B and wax-C on the equivalent pore diameter and porosity variation are presented in Annex A-3, Figure A-3.5 and Figure A-3.6. Optimum values of equivalent pore diameter and geometric porosity of the pure polymer and polymer-wax blend foams are summarized in Table 7.11.

Table 7.11: Pure  $P_{L,DL}LA$  and polymer-wax blend equivalent pore diameter and porosity results.

Equivalent Pore Diameter		( $\mu\text{m}$ )	Geometric Porosity	P(%)
Pure $P_{L,DL}LA$	[40 $^{\circ}\text{C}$ -100 bars-20 min-1 bar/s]	45	[40 $^{\circ}\text{C}$ -200 bars-40 min-3 bar/s]	69.3
10% wax-A	[40 $^{\circ}\text{C}$ -200 bars-40 min-3 bar/s]	25	[60 $^{\circ}\text{C}$ -200 bars-20 min-6 bar/s]	69.3
10% wax-B	[60 $^{\circ}\text{C}$ -300 bars-40 min-1 bar/s]	25	[60 $^{\circ}\text{C}$ -300 bars-40 min-1 bar/s]	72.8
10% wax-C	[60 $^{\circ}\text{C}$ -300 bars-40 min-1 bar/s]	20	[60 $^{\circ}\text{C}$ -300 bars-40 min-1 bar/s]	72.4
20% wax-A	[50 $^{\circ}\text{C}$ -100 bars-40 min-6 bar/s]	20	[60 $^{\circ}\text{C}$ -200 bars-20 min-6 bar/s]	70.8
20% wax-B	[60 $^{\circ}\text{C}$ -300 bars-20 min-3 bar/s]	25	[60 $^{\circ}\text{C}$ -300 bars-40 min-1 bar/s]	71.0
20% wax-C	[60 $^{\circ}\text{C}$ -300 bars-20 min-3 bar/s]	25	[60 $^{\circ}\text{C}$ -300 bars-40 min-1 bar/s]	68.0
30% wax-A	[60 $^{\circ}\text{C}$ -300 bars-20 min-3 bar/s]	30	[60 $^{\circ}\text{C}$ -200 bars-20 min-6 bar/s]	70.9
30% wax-B	[60 $^{\circ}\text{C}$ -200 bars-20 min-6 bar/s]	35	[60 $^{\circ}\text{C}$ -300 bars-40 min-1 bar/s]	69.0
30% wax-C	[40 $^{\circ}\text{C}$ -300 bars-60 min-6 bar/s]	35	[60 $^{\circ}\text{C}$ -300 bars-40 min-1 bar/s]	64.0



For pure  $P_{L,DL}LA$ , we can see that at lower pressure and saturation temperature, the pore size and porosity obtained is comparatively high. Results from  $P_{L,DL}LA$  +10% wax-A, 20% wax-C and 30% wax-B produces foams of low porosity and pore diameter. Considering all the graphs in Figure 7.13 it can be deduced that the equivalent pore diameters for each polymer wax blend does not exceed  $\sim 35\mu\text{m}$ .

The maximum values for all the polymer wax blends are obtained at the highest process temperature,  $60^\circ\text{C}$ . Values encircled in each graph present the optimum process parameter condition. The three types of wax produced foams of porosity ranging from  $\sim 10\%$  to  $70\%$ . It was expected that wax being apolar in nature and is more inclined for solubility of  $\text{scCO}_2$  will improve the pore structure and morphology. The three types of waxes used at low process temperatures produced pores with low diameter. However at higher temperatures, improvements in porosity and pore diameter were found. At higher temperature, the pore size was increased but not to a great extent. wax-A, wax-B and wax-C have melting temperature  $\sim 40, 93$  and  $104^\circ\text{C}$  respectively. For wax-A at higher temperature due to the melting of wax, the pore generation phenomenon was slightly increased hence pore diameter was slightly higher. Similarly at higher  $dP/dt$ , the pore diameter and porosity observed was also at minimum.

The possible reason for low pore size in the polymer –wax blend can be due to certain reasons. First of all, the polymer used was semi crystalline which itself produces low porosity and pore diameters as experimented earlier. Then the wax-B and C used had melting point  $\sim 100^\circ\text{C}$ , which was not converted into semi molten state at  $60^\circ\text{C}$  hence there is less possibility of  $\text{CO}_2$  absorption at this temperature, minimizing the chances of pore generation in the blend. Wax has affinity to absorb  $\text{CO}_2$  but as it does not have elastic property so there are less chances of pore generation. The pore structure and morphology in all the foams obtained were heterogeneous. The pores were irregular, heterogeneous in size and mostly elongated.

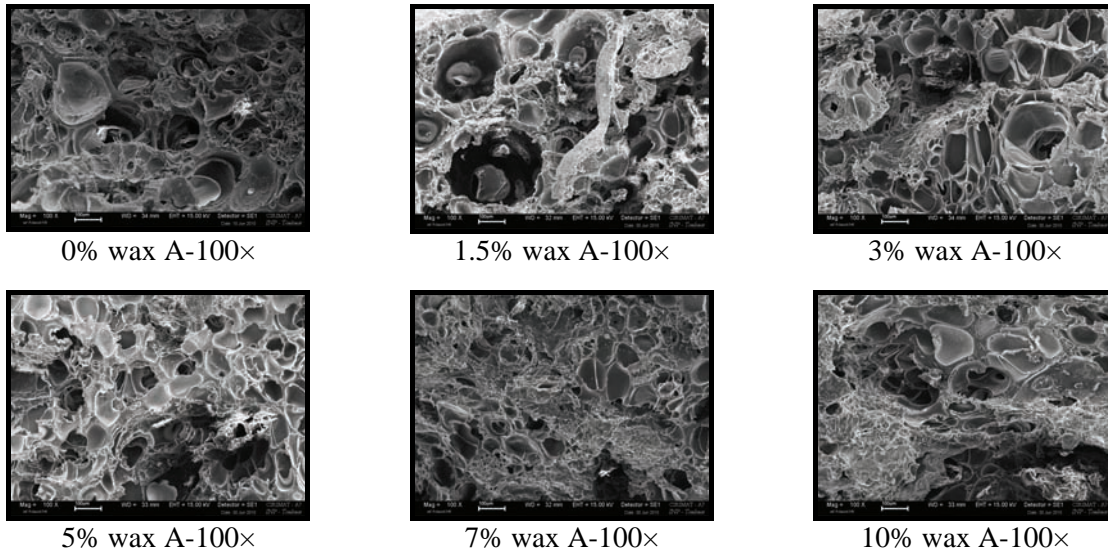
### 3.3 Experiments on Polyactides/Tri-Calcium Phosphate/Wax Scaffolds

#### 3.3.1 Effect of the Ratio of Wax on the Geometric Porosity and Equivalent Pore Size

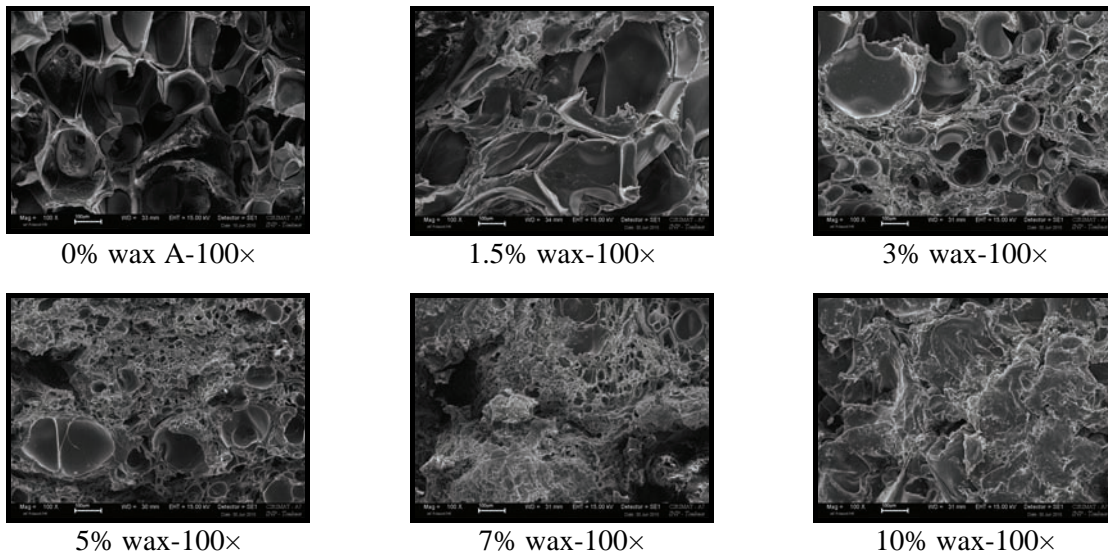
In spite of adding a porogen agent in  $P_{L,DL}LA$ , there was not an appreciable increase in the pore diameter. As  $P_{L,DL}LA$  is semi-crystalline so it was replaced with an amorphous polymer poly(DL-lactic co-glycolide). In the experiments with  $P_{L,DL}LA$ /wax blend foams were processed at higher temperature  $50$  and  $60^\circ\text{C}$ . The melting point of wax is located between  $\sim 40$  and  $100^\circ\text{C}$  and as wax-A has lowest melting point so maximum pore diameter obtained was  $\sim 30\mu\text{m}$ . Hence to process foams with  $PLGA_{85:15}$ /wax blends process temperature was kept  $45^\circ\text{C}$  close to the melting temperature of wax-A, secondly the  $T_g$  of  $PLGA_{85:15}$ ,  $43^\circ\text{C}$ .

$PLGA_{85:15}$  (RG-858 S) fine fibres were obtained by using the knife mill. These fine fibres were then ground alone in the tumbling ball mill for 30 minutes. White flakes were obtained which were again ground in the knife mill to get powder. The filler rates (5%  $\beta\text{TCP}$  and 5% amorphous  $\text{ATCP}$  doped with Sr) have been maintained constant. As for wax, its ratio has been chosen as follows: 0, 1.5, 3, 5, 7 and 10%, the polymer serving as complement. However, two pressure values were implied. The two process conditions with their results are reported on Table 7.12. The conditions selected are  $T_{\text{sat}} = 45^\circ\text{C}$ ,  $t_{\text{sat}} = 20$  min,  $dP/dt = 3\text{bar/s}$  while  $P_{\text{sat}} = 100$  and  $120$  bars. In most of the experimentations the optimized conditions for a polymer in our system is  $P_{\text{sat}} = 120$  bars,  $t_{\text{sat}} = 20$  min,  $dP/dt = 3\text{bar/s}$  and  $T_{\text{sat}} =$  close to the value of polymer  $T_g$ . We varied only one parameter to see its effect on the pore morphology.

The micrographs of  $PLGA_{85:15} + 5\% \text{ATCP}_{(\text{sr})} + 5\% \beta\text{TCP}_{(\text{sr})}$  co-ground and with different ratios of wax are presented for the two process conditions in Figure 7.15 and Figure 7.16.



**Figure 7.15:** Micrographs of foams obtained by simple mixing of polymer and wax and processed - at [ $T_{\text{sat}}=45^{\circ}\text{C}$ ,  $P_{\text{sat}}=120$  bars,  $t_{\text{sat}}=20$  min,  $dP/dt=3\text{bar/s}$ ].



**Figure 7.16:** Micrographs of foams obtained by simple mixing of polymer and wax and processed at [ $T_{\text{sat}}=45^{\circ}\text{C}$ ,  $P_{\text{sat}}=100$  bars,  $t_{\text{sat}}=20$  min,  $dP/dt=3\text{bar/s}$ ].

**Table 7.12:** Equivalent pore diameter and geometric porosity of foams of composite plus wax by simple mixing processed at  $T_{\text{sat}}=45^{\circ}\text{C}$ ,  $t_{\text{sat}}=20$  min, and  $dP/dt=3\text{bar/s}$ .

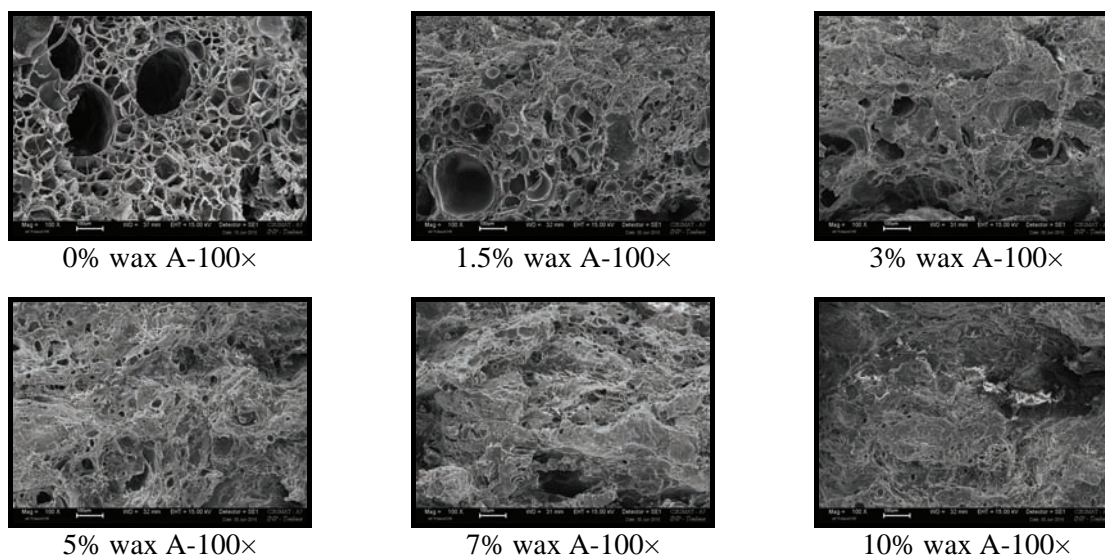
Foam No.	5%ACP <sub>(sr)</sub> +5%βTCP <sub>(sr)</sub>	P <sub>sat</sub> = 120 bars		P <sub>sat</sub> = 100 bars	
	+ Complement PLGA <sub>85:15</sub> + % Wax A	Pore Diameter d <sub>e</sub> (μm)	Geometric Porosity (%)	Pore Diameter d <sub>e</sub> (μm)	Geometric Porosity (%)
1	Pure PLGA	95	71.4	135	72.1
2	1.5% wax A	145	81.4	170	86.1
3	3% wax A	65	75.3	90	83.1
4	5% wax A	45	70.7	50	82.4
5	7% wax A	20	67.2	20	80.3
6	10% wax A	15	77.1	5	68.6

Changing the polymer from  $P_{L,DL}LA$  to  $PLGA_{85:15}$  and reducing the percentage of porogen wax improved the pore diameter and porosity of the composite scaffold. Reducing the pressure from 120 bars to 100 bars gives even better results. Pore diameter decreased as the percentage of wax increased. Maximum pore diameter was attained at 1.5% of wax with a porosity of 86%. From these results, it is obvious that increasing the amount of wax in the polymer blend decreases the pore growth thus forming foams of smaller diameter and less porosity. However only at 1.5% wax ratio in the blend produced higher pore diameter and higher porosity in comparison to polymer composite blend without wax. Thus minor percentage of wax facilitates the pore generation phenomenon during foaming. With larger percentages of wax in the blend, no doubt the sorption of  $CO_2$  in the blend is increased but presence of wax in the blend do not facilitate pore generation.

### 3.3.2 Effect of Co-grinding Filler and PLGA on the Pore Morphology

To achieve scaffold of higher mechanical properties, co-grinding is an effective phenomenon as it improves the properties of the product attained, discussed earlier in bibliography. Purpose of this study was to analyze the effect of co-grinding polymer with filler and see its effect on the processed foam. Wax was again added separately by simple mixing as a porogen.  $PLGA_{85:15} + 5\% ACP_{(sr)}$  and  $5\% \beta TCP_{(sr)}$  were co-ground in the tumbling ball mill for 30 minutes. Off white flakes were obtained which were further ground in knife mill for 30 sec to obtain powder of polymer matrix. This powder was passed through 800 mesh screen to separate larger particles and agglomerates. After adding additional amount of wax, 15 minutes of magnetic mixing was done. As for wax, its ratio has been chosen as follows: 0, 1.5, 3, 5, 7 and 10%, the polymer serving as complement. The two process conditions with their results are reported on Table 7.13.

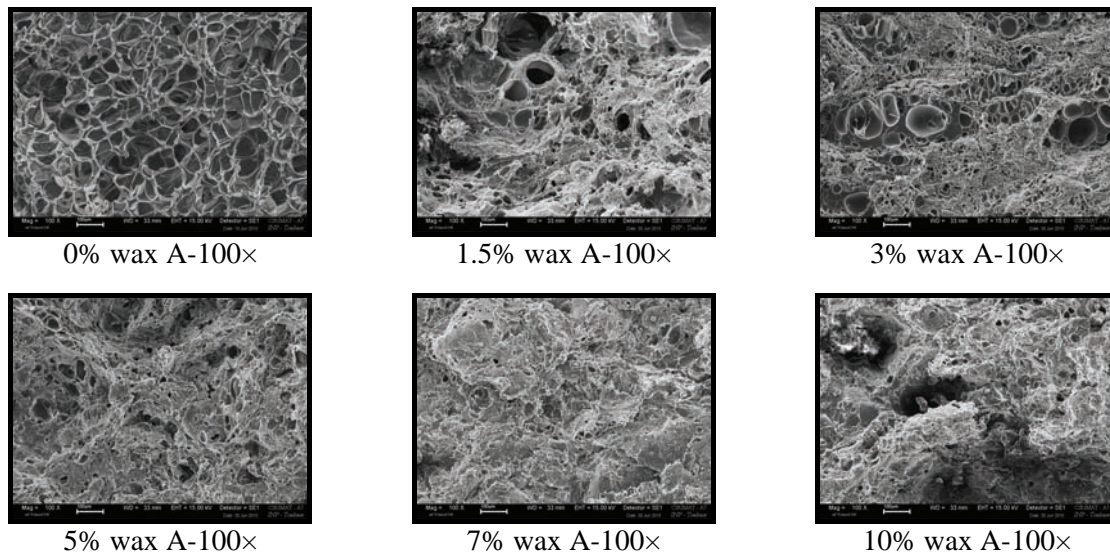
The micrographs of  $PLGA_{85:15} + 5\% ACP_{(sr)} + 5\% \beta TCP_{(sr)}$  co-ground and with different ratios of wax for the two process conditions are presented in Figure 7.17 and Figure 7.18 respectively.



**Figure 7.17:** Micrographs of foams obtained by co-grinding polylactide and fillers processed at  $T_{sat} = 45^\circ C$ ,  $P_{sat} = 120$  bars,  $t_{sat} = 20$  min and  $dP/dt = 3$  bar/s.

Comparing the results of foams produced at 120 bars and 100 bars, it can be seen that with higher percentages of wax (above 5%) there were not appreciable pores. With 1.5% of wax there were pores but not in appreciable size and quantity as in pure polymer foam.





**Figure 7.18:** Micrographs of foams obtained by co-grinding polylactide and fillers processed at  $T_{\text{sat}}=45^{\circ}\text{C}$ ,  $P_{\text{sat}} = 100$  bars,  $t_{\text{sat}} = 20$  min and,  $dP/dt = 3\text{bar/s}$ .

**Table 7.13:** Equivalent pore diameter and geometric porosity of foams of composite plus wax by co-grinding processed at two saturation pressures.

Foam No.	5%ACP <sub>(sr)</sub> +5%βTCP <sub>(sr)</sub>	$T_{\text{sat}} = 45^{\circ}\text{C}$ , $P_{\text{sat}} = 120$ bars $t_{\text{sat}} = 20$ min, $dP/dt = 3\text{bar/s}$		$T_{\text{sat}} = 45^{\circ}\text{C}$ , $P_{\text{sat}} = 100$ bars $t_{\text{sat}} = 20$ min, $dP/dt = 3\text{bar/s}$	
	+ Complement PLGA <sub>85:15</sub> + % wax A	Pore Diameter $d_e$ ( $\mu\text{m}$ )	Geometric Porosity (%)	Pore Diameter $d_e$ ( $\mu\text{m}$ )	Geometric Porosity (%)
1	0% wax A	25	68.4	40	74.7
2	1.5% wax A	40	72.2	50	77.2
3	3% wax A	25	64.5	30	66.1
4	5% wax A	20	56.4	10	62.7
5	7% wax A	5	52.3	5	61.4
6	10% wax A	Nil	54.3	5	54.3

Purpose of cogrinding the polymer and filler was to elevate the mechanical properties of composite. Comparing the results reported on Table 7.13, one can find that again foam generated without porogen produced pores with small diameter and less porosity as compared to 1.5% of wax-A blend. By adding wax-A till 1.5%, it facilitates pore generation but increasing the amount in blend decreases pore generation leading to reduced pore diameter and less porosity. Also there was decrease in the pore diameter and porosity as compared to the foams with similar composition but with simple mixing. Maximum pore diameter and porosity was obtained at  $P_{\text{sat}} = 100$  bars. Thus higher percentage of wax and co-grinding phenomenon reduce the pore generation in a foam.

### 3.4 Complementary Experiments on PLGA<sub>85:15</sub>/Tri-calcium Phosphate/Wax Scaffolds

Previous results obtained from semi-crystalline poly(L-lactide-co-glycolide) composite produced foams with high porosity but low pore size compel us to use an amorphous poly(D,L-lactide-co-glycolide) PLGA<sub>85:15</sub> (LG 858 S). The objective was to generate scaffold of higher porosity and large pore diameter so an amorphous Poly(D,L-lactide-co-glycolide) was replaced with semicrystalline one. PLGA<sub>85:15</sub> is in fibrous foam and before using it for further processing, it is knife milled and turned into fine fibres and then these fine fibres are ground in ball mill. From the ball mill, we get flakes which are finally knife milled again to

transfoam them into powder. The powder obtained is passed through series of sieves 250,400,500 and 600 mesh. Thus we get particles of polymers in 4 different ranges/category described as follows.

$$\begin{aligned}
 &[\text{PLGA}_{85:15} \text{ particles} < 250\mu\text{m}] && [250 < \text{PLGA}_{85:15} \text{ particles} < 400\mu\text{m}], \\
 &[400 < \text{PLGA}_{85:15} \text{ particles} < 600 \mu\text{m}] \text{ and} && [\text{PLGA}_{85:15} \text{ particles} > 600 \mu\text{m}]
 \end{aligned}$$

Polymer blend will be made from these four categories of particles with 5 % ATCP<sub>(sr)</sub> and 5 %  $\beta$  TCP<sub>(sr)</sub>. In our previous results co-grinding of the polymer and filler blend showed results with lower values of porosity and pore diameter, hence now simple mixing of polymer filler blend will be done. Higher percentage of wax also hinders generation of pores during foaming, so wax-A will be added with different ratios (0, 0.5 and 1 %). Blends of all the components, polymer particles+5 % ATCP<sub>(sr)</sub> and 5 %  $\beta$  TCP<sub>(sr)</sub>+ wax were done for 15 minutes in a jar with a magnetic stirrer.

The detailed compositions of pellets are given in Table 7.14. For category [PLGA<sub>85:15</sub> < 250 $\mu$ m] four pellets were processed to test them at different plates in the chamber. Similarly pellets were processed for category [250 < PLGA<sub>85:15</sub> < 400 $\mu$ m], [400 < PLGA<sub>85:15</sub> < 600  $\mu$ m] and [PLGA<sub>85:15</sub> > 600  $\mu$ m].

**Table 7.14:** Composition of pellets of different polymer particle size and with variable % of wax.

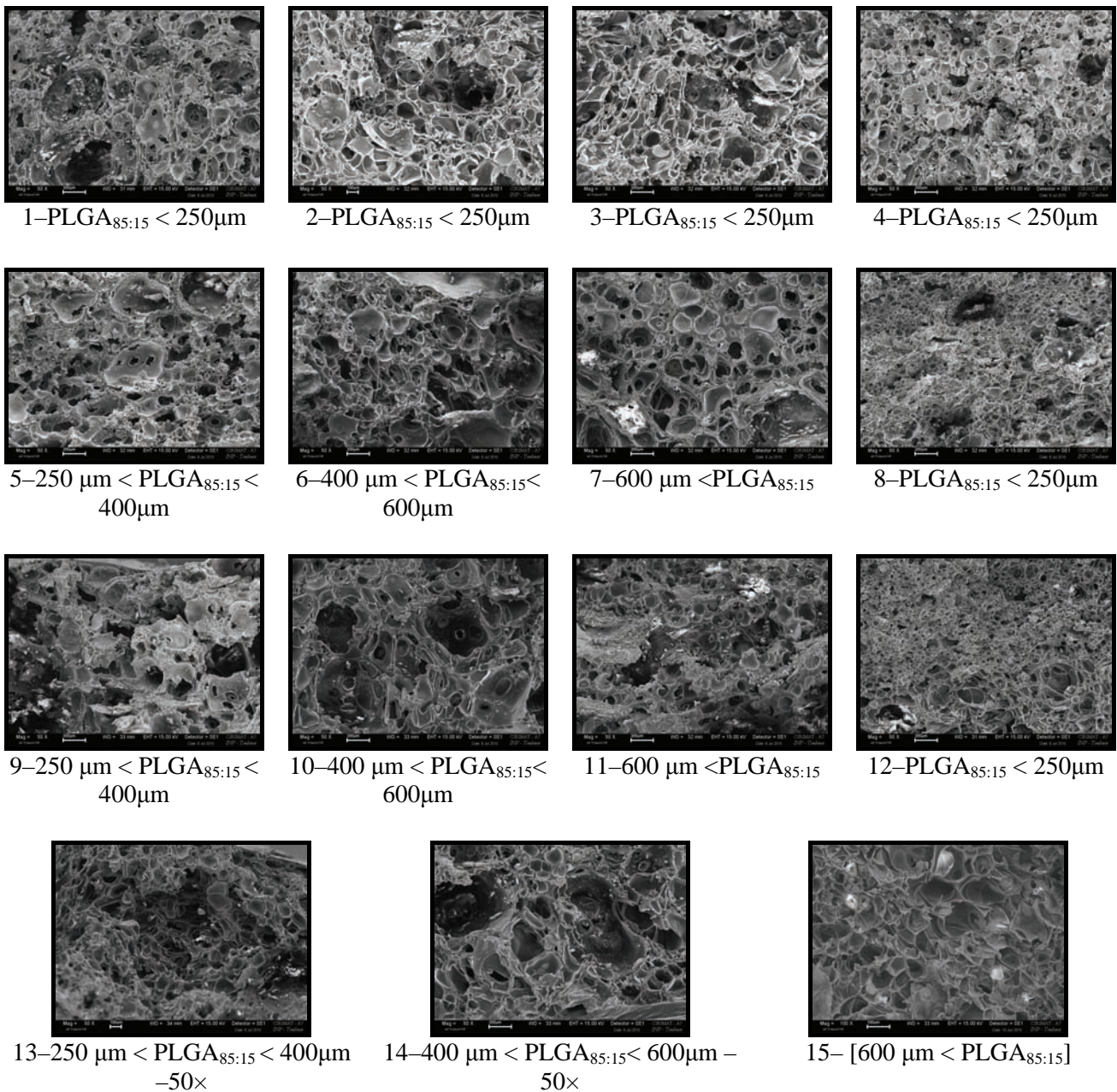
Powder Category Type	5 % ATCP <sub>(sr)</sub> + 5 % $\beta$ TCP <sub>(sr)</sub> + Complement % PLGA <sub>85:15</sub>			
	< 250 $\mu$ m	[250 – 400 $\mu$ m]	[400 – 600 $\mu$ m]	> 600 $\mu$ m
<b>1</b>	90	90	90	90
% wax A	0	0	0	0
<b>2</b>	89.5	89.5	89.5	89.5
% wax A	0.5	0.5	0.5	0.5
<b>3</b>	89	89	89	89
% wax A	1	1	1	1

By using the hydraulic press with conditions P = 150 bars, T = 47°C, t = 20 min, 255 mg of powder was used to make each pellet and processed 15 pellets. The pore diameter and geometric porosity of the generated foams are tabulated in Table 7.15.

**Table 7.15:** Pore diameter of foams with different particle size and with variable % of wax.

Foam No.	5% $\beta$ TCP <sub>(sr)</sub> +5%ATCP <sub>(sr)</sub> + % Wax A + Complement PLGA <sub>85:15</sub>	Pore Diameter d <sub>e</sub> ( $\mu$ m)	Porosity (%)
1-4	[PLGA <sub>85:15</sub> < 250 $\mu$ m]	125, 100, 107, 97	84.2, 85.4, 81.8, 82.7
5	0% wax A	[250 < PLGA <sub>85:15</sub> < 400 $\mu$ m]	125
6		[400 < PLGA <sub>85:15</sub> < 600 $\mu$ m]	150
7		[600 $\mu$ m < PLGA <sub>85:15</sub> ]	125
8		[PLGA <sub>85:15</sub> < 250 $\mu$ m]	80
9	0.5% wax A	[250 < PLGA <sub>85:15</sub> < 400 $\mu$ m]	100
10		[400 < PLGA <sub>85:15</sub> < 600 $\mu$ m]	125
11		[600 $\mu$ m < PLGA <sub>85:15</sub> ]	75
12	1% wax A	[PLGA <sub>85:15</sub> < 250 $\mu$ m]	30
13		[250 < PLGA <sub>85:15</sub> < 400 $\mu$ m]	150
14		[400 < PLGA <sub>85:15</sub> < 600 $\mu$ m]	200
15		[600 $\mu$ m < PLGA <sub>85:15</sub> ]	125

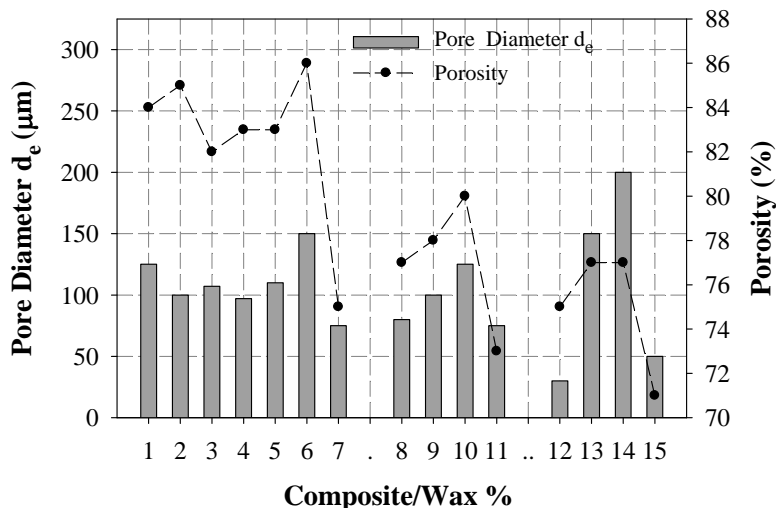
Their respective micrographs are presented in Figure 7.19.



**Figure 7.19:** Micrographs of foams containing different percentages of wax A.

From Figure 7.20 and the SEM micrographs (cf. Figure 7.19), one can find that by using polymer particles less than 250µm the pore size generated in the foam is ~100µm also for the particles >600µm produced foam of low pore diameter. Particles between 400 and 600µm generated comparatively larger pores. The porosity was ~ 84% except the last category fell to 75%. By adding 0.5% wax in the polymer matrix, there was apparently not much difference in the pore diameter however, the porosity was reduced for each category. By adding 1% wax increased the pore diameter in the category (250 < PLGA<sub>85:15</sub> < 400µm) and (400 < PLGA<sub>85:15</sub> < 600 µm) with reduction in porosity. Further investigation is required to study the behaviour of particles and their effects on foaming. Thus, fine particles less than 250µm and larger particles greater than 600µm are not suitable for generating a scaffold of higher porosity and pore diameter neither with nor without wax. To study the effect of particle size of polymer on pore morphology further investigation can be done.





**Figure 7.20:** Effect of particle size of polymer and different % of wax on foam pore diameter and porosity.

## 4 Conclusion

After characterizing fillers and adjuvant, foams were made by  $P_{L,DL}LA$  mixed with three different types of waxes. Due to higher percentages of waxes, results were not very appreciable. By altering the percentage of amorphous and  $\beta TCP$  composites were made by using three different polymers. Then foams of  $PLGA_{85:15} + 5\% ACP_{(sr)} + 5\% \beta TCP_{(sr)}$  with variable percentages of wax (1 to 10%) by simple mixing and by co-grinding were produced. As the melting point of wax-A is very low and it creates hindrance in producing pores in the polymer blend so its percentage in composite was reduced to 1.0 %. Finally, it was concluded that adding wax in composite blend did not facilitate pore generation in  $scCO_2$  foaming technique.

# Chapter 8

## Optimization of Pore Morphology of Scaffolds for Calcified Tissue Engineering

*The purpose is to produce industrially applicable scaffolds for bone replacement. To produce a scaffold with optimum porosity, equivalent pore diameter and mechanical properties, PLGA and Sr-calcium phosphates blends will be used. Semi-industrial fabrication of porous composite scaffolds involves scale up production and we have studied the capability of the process to produce foams. Therefore, a major challenge for scaffold fabrication is to maintain mechanical strength with vital porous structure in addition to a specified composition. The objectives of this chapter are to precise the influence of incorporating a mineral phase by either simple mixing or co-grinding, on the distribution of pores processed by  $scCO_2$ , to characterize foaming properties and the mechanical properties of the resulting scaffolds.*

### 1 Semi-industrial Production of Bone Scaffolds

The purpose for the following experiments was to produce industrially scaffolds for application in bone regeneration. In bone engineering, earlier studies by *Hulbert et al.*, [1970] showed that a minimum pore size of 100  $\mu\text{m}$  was required to allow bone tissue ingrowth in ceramic scaffolds. Further investigations were carried out to understand the pore size requirement for bone tissue engineering. Although the optimal pore size varied with scaffold material and other parameters, such as tortuosity, the general consensus is that pore sizes (e.g., > 100  $\mu\text{m}$ ) may favour higher alkaline phosphatase activity and more bone formation [*Karageorgiou and Kaplan*, 2005b; *Tsuruga et al.*, 1997b].

Cell transport and vascularization because of scaffold pore size can also affect the tissue types and tissue formation process in scaffolds. When bone morphogenetic proteins were loaded into honeycomb-shaped hydroxyapatite scaffolds to induce osteogenesis, it was found that smaller diameters (90–120  $\mu\text{m}$ ) induced cartilage formation followed by bone formation, whereas those with larger diameters (350  $\mu\text{m}$ ) induced bone formation directly [*Kuboki et al.*, 2001]. The difference was likely caused by the different onset time of vascularization and cell differentiation.

## 1.1 Matrix: Polylactides

### 1.1.1 Experiments with Different Polylactides

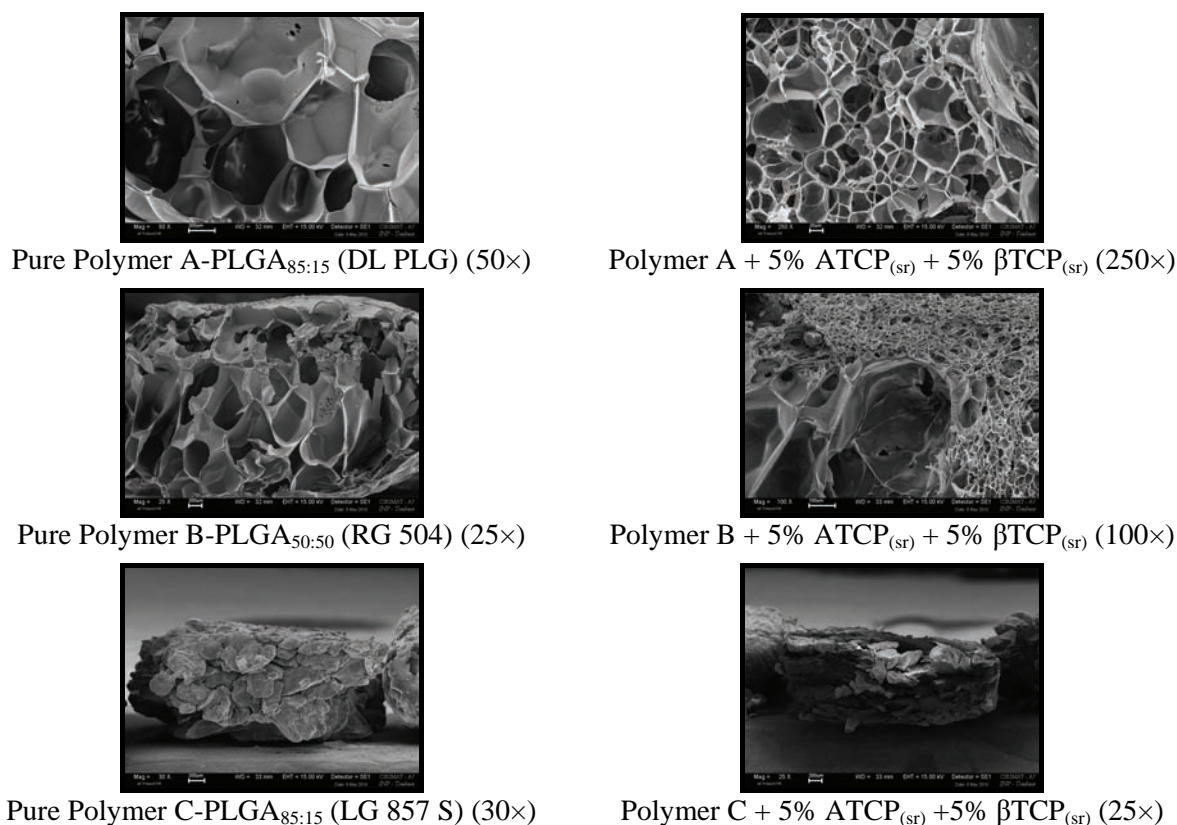
The aim of this design of experiments was to compare the effect of the nature and composition of polylactide on the porosity, pore size and pores size distribution of foams manufactured by scCO<sub>2</sub> process.

Before further experimentations, we will test different polylactides of various glass transition temperature and LA/GA ratios. Also the effect of fillers will be taken into account. The polymers used for testing are stated as under in Table 8.1.

**Table 8.1:** Polymers with different T<sub>g</sub>'s and LA/GA ratios.

S/N	Polymer	LA/GA	T <sub>g</sub> (°C)	Degree of Crystallinity $\chi_c$	M <sub>vis</sub>
A	PLGA <sub>85:15</sub> (DL PLG) Poly (D,L-lactide-co-glycolide)	85/15	50–55	Amorphous	18 943
B	PLGA <sub>50:50</sub> (RG 504) Poly (D,L-lactide-co-glycolide)	50/50	46–50	Amorphous	14 756
C	PLGA <sub>85:15</sub> (LG 857 S) Poly (L-lactide-co-glycolide)	85/15	57–63	Amorphous	396 495

Fillers were mixed manually to make a homogeneous blend. Pellets of pure polymers blend with 5% ATCP<sub>(sr)</sub> + 5%  $\beta$  TCP<sub>(sr)</sub> were processed by compression (P = 150 bars, T = 60°C, t = 20 min.). Foams for the pure polylactide and composite biomaterial were manufactured at P<sub>sat</sub> = 100 bars, T<sub>sat</sub> = 50°C, t<sub>sat</sub> = 20 min and dP/dt = 3bar/s. The SEM images of foams obtained are presented in Figure 8.1. The micrographs are of different magnification because pore size varies largely. The equivalent pore size of pure Poly (lactide-co-glycolide) foams and composite foams are reported on Table 8.2.



**Figure 8.1:** Micrographs of pure polymer and polymer with filler foams processed at scCO<sub>2</sub> condition  
T<sub>sat</sub> = 50°C, P<sub>sat</sub> = 100 bars, t<sub>sat</sub> = 20 min, dP/dt = 3 bar/s.



**Table 8.2:** Pore size of polymers and polymer plus filler.

Polymer	Pure Polymer		Composite	
	$d_e$	P (%)	$d_e$	P (%)
PLGA <sub>85:15</sub> (DL PLG)	350	91%	60	81%
PLGA <sub>50:50</sub> (RG 504)	260	88%	150 and 20	84%
PLGA <sub>85:15</sub> (LG 857 S)	No pore	44%	No pore	32%

The SEM images reveal that the equivalent pore size of PLGA<sub>85:15</sub> (DL PLG) is higher than with PLGA<sub>50:50</sub> (RG-504). No pore was observed in PLGA<sub>85:15</sub> (LG 857S), It is probably linked to its higher value of molecular mass and higher glass transition temperature (cf. Table 8.1). The two other polymers at  $T_{sat} = 50^\circ\text{C}$  are in rubbery state while the third one is in a glassy state indicating that  $\text{CO}_2$  cannot penetrate and consequently pores cannot be formed. All these reasons created hindrance to make a scaffold of negligible porosity and pore diameter at possessing conditions of  $T_{sat} = 50^\circ\text{C}$  and  $t_{sat} = 20$  min. Adding a mineral phase in each polymer, we observed a relative decrease in pore size and geometric porosity. By adding filler in the polymer, modification of polymer surface implies variation in the  $\text{CO}_2$  solubility. Addition of fillers also stiffens the polymer and blocks the penetration of  $\text{CO}_2$ . PLGA<sub>85:15</sub> (LG 857S) having the maximum molecular weight did not produce pores neither in pure state nor by adding mineral phase. It seems more easy to make foams with copolymers containing D,L-lactide than with copolymers containing only L-lactide as shown by *Tai et al.* [2007]. In the above two polymers where pores were formed, it was observed that in both cases they were open and closed and heterogeneous in size. Pores observed in the composite (PLGA<sub>50:50</sub> (RG-504) + 5% ATCP<sub>(sr)</sub> + 5%  $\beta$ TCP<sub>(sr)</sub>) were quite heterogeneous as compared to composite (PLGA<sub>85:15</sub> (DL PLG) + 5% ATCP<sub>(sr)</sub> + 5%  $\beta$ TCP<sub>(sr)</sub>). A decrease in the geometric porosity and equivalent pore size by adding fillers can be attributed to the hindrance of  $\text{CO}_2$  sorption in the composite.

### 1.1.2 Polylactide with Higher D,L Contents

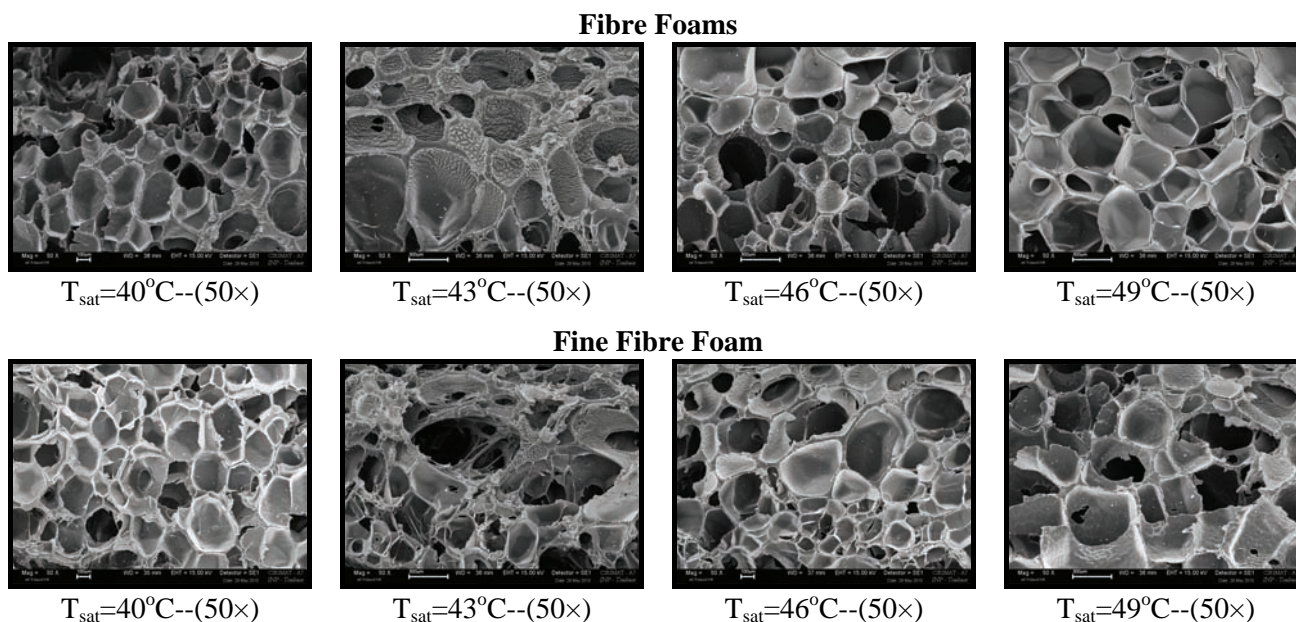
As previous results of different poly(lactide-co-glycolide) foams showed heterogeneous pore size another type of polymer (PLGA<sub>85:15</sub> RG 858 S) was tried. It is a poly(D, L-lactide-co-glycolide) with 85% of D,L lactide and low  $T_g$ . Initially it was in a fibrous form, so we changed its physical shape as the ultimate goal was to mix the fillers with polymer and that is only possible if polymer is in powder or fine fibres form. To study the effect on pore size and porosity, 4 pellets for each fibrous and fine-fibrous were manufactured.

The grinding of fibres was done in the knife mill for 20 sec on/off mode and pellets were made as per procedure described earlier in chapter 4. The  $T_g$  of polymer PLGA<sub>85:15</sub> (RG 858 S) is  $\sim 43^\circ\text{C}$  so we manipulated the foaming process above and below the  $T_g$ . The aim of these experimentations was to prove that when a polymer is in a rubbery state, the solubility of supercritical  $\text{CO}_2$  increases and consequently so do the pore size and the porosity. Keeping the temperature  $5^\circ\text{C}$  above the  $T_g$  of polymer produces optimum porosity and pore diameter, inference draw from previous experimentations, four different saturation temperatures were selected. The optimized conditions obtained by previous experimentation for majority of poly (lactide-co-glycolides) were followed. The sc $\text{CO}_2$  conditions at which the foams were processed are  $T_{sat} = 40/43/46/49^\circ\text{C}$ ,  $P_{sat} = 100$  bars,  $t_{sat} = 20$  min,  $dP/dt = 3$  bar/s. We changed only the temperature keeping other process parameters constant. Data of the pellets and foams obtained are presented in (c.f Table 8.3).

**Table 8.3:** Effect of polymer and process temperature on equivalent pore diameter and geometric porosity.

$T_{sat}$ ( $^\circ\text{C}$ )	Fibre (few cm)		Fine Fibres (2 – 4 mm)	
	$d_e$ ( $\mu\text{m}$ )	P (%)	$d_e$ ( $\mu\text{m}$ )	P (%)
40	197	80.2	211	90.1
43	202.	84.3	234	91.4
46	216	88.9	249	92.7
49	223	90.7	275	93.5

The micrographs of foams of non-ground fibres and ground fine fibres are presented in Figure 8.2. It is evident that in fine fibre polymer foams, there are more meso and macro pores compared to fibre polymer foam. It has been observed that there is gradual increase in the pore diameter and porosity in both cases, as the saturation temperature increases (cf. Table 8.3).

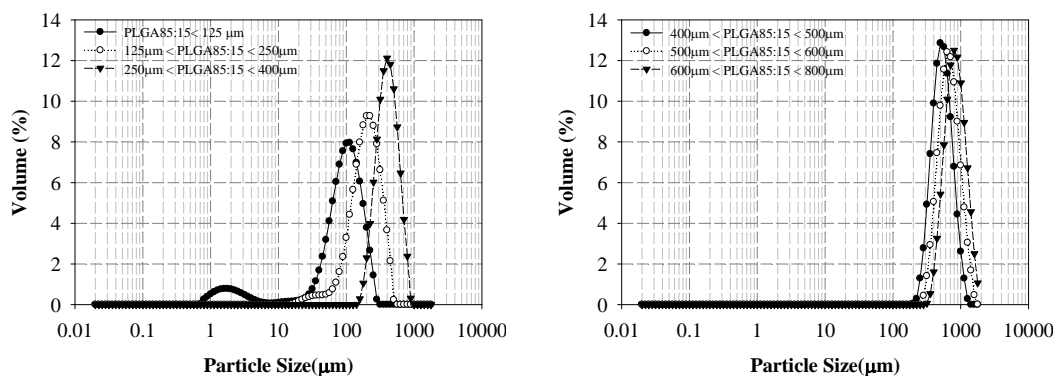


**Figure 8.2:** Micrographs of PLGA<sub>85:15</sub> (RG 858 S) processed at  $P_{\text{sat}}=100$  bars,  $t_{\text{sat}}=20$  min and  $dP/dt=3$  bar/s.

The pore diameter of fibre and fine fibre foams increased gradually as the temperature was increased. The effect to grind fibres is not significant for the geometric porosity and slightly influent on the equivalent pore size. Comparing equivalent pore diameter for fine fibre polymer, it has highest values at 49°C operated temperature. The first three polymers used for the processing of foams had  $T_g \geq 46^\circ\text{C}$ , that is why at  $T_{\text{sat}}=50^\circ\text{C}$  PLGA<sub>85:15</sub> (DL PLG) foam produced foam of maximum diameter and porosity. Adding fillers reduced the pore diameter and porosity in polymer A and B because filler stiffen the polymer. The results obtained with PLGA<sub>85:15</sub> (RG 858 S) were also appreciable because this polymer has the lowest  $T_g$  value. So this polymer was preferred to be used for future experiments.

## 1.2 Effect of Polymer Particle Size on Foaming

After the fibres were ground in the ball mill, they turned into flakes, which were again ground in the knife mill to make fine powder with different particle size. The size distributions of all the samples are presented in Figure 8.3 and the mean particle diameter in each range is given in Table 8.4.



**Figure 8.3:** Size distributions of the ground and sieved particles of PLGA<sub>85:15</sub>.



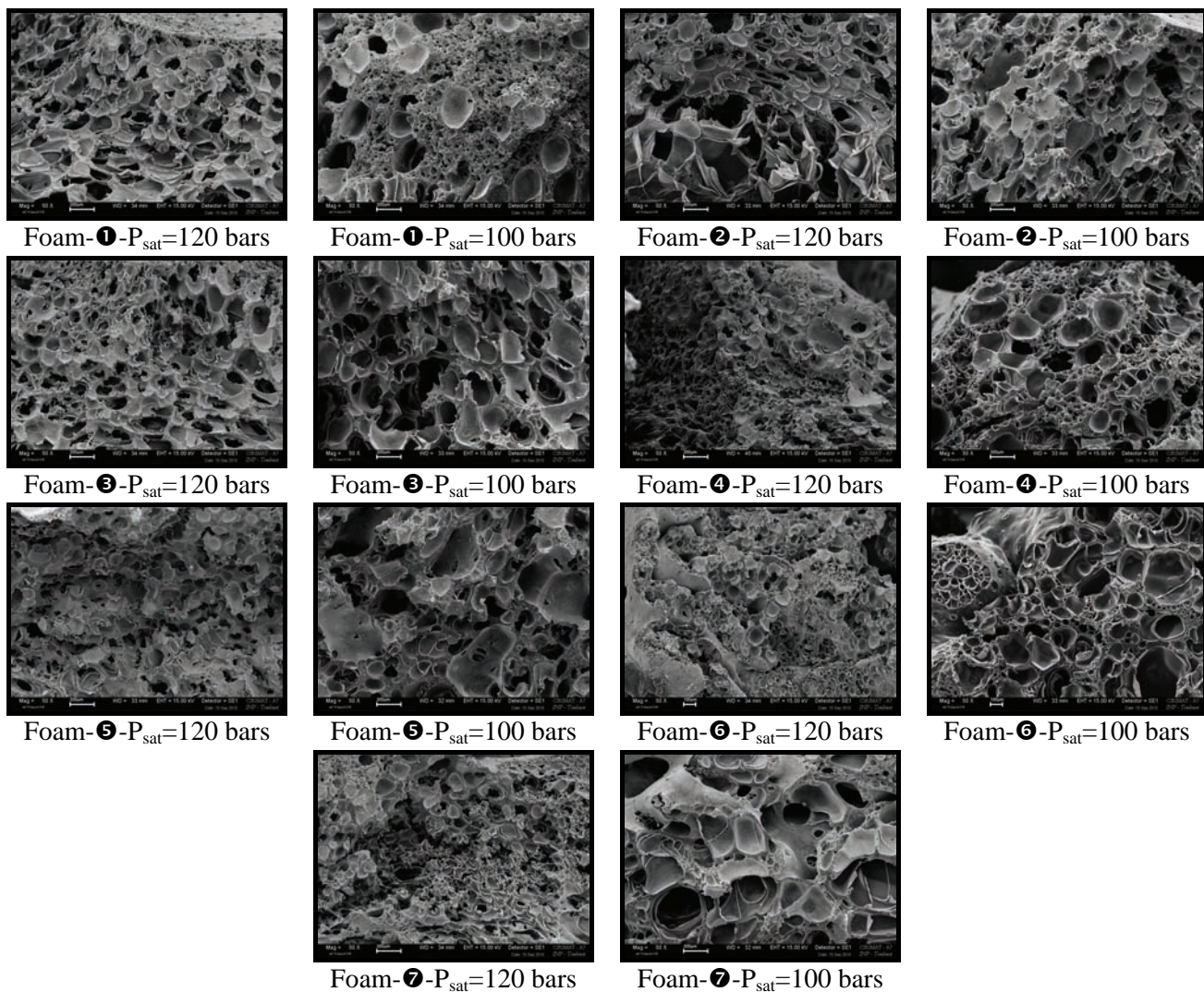
A plan was made to do an extensive study to investigate the effect of the particle size of the ground polymer powder on the pore size of foams. The powder was passed through a set of six sieves (800, 600, 500, 400, 250 and 125  $\mu\text{m}$ ). These sieves were placed on a vibrating stand for 5 minutes for complete screening. Powder collected from each sieve was utilized to make foam by scCO<sub>2</sub> foaming. It can be seen that the mean particle size increases gradually on each screen. The elongated particles in the mixture affect the mean particle size and the value is more than the larger sieve in a range.

**Table 8.4:** Mean particles sizes of PLGA samples.

Mean Particle Size	PLGA <sub>85:15</sub> Particle Ranges					
	1	2	3	4	5	6
Sieve Range	< 125 $\mu\text{m}$	[125-250 $\mu\text{m}$ ]	[250-400 $\mu\text{m}$ ]	[400-500 $\mu\text{m}$ ]	[500-600 $\mu\text{m}$ ]	[600-800 $\mu\text{m}$ ]
d <sub>50</sub>	99.7	207.7	425.1	557.0	702.8	868.1

### 1.2.1 Foaming of PLGA<sub>85:15</sub> with Different Particle Size

Foams of pure PLGA<sub>85:15</sub> were made with different particle sizes at two different conditions. SEM images for both conditions [ $T_{\text{sat}} = 48^\circ\text{C}$ ,  $P_{\text{sat}} = 100/120$  bars,  $t_{\text{sat}} = 20$  min,  $dP/dt = 3\text{bar/s}$ ] are presented in Figure 8.4.

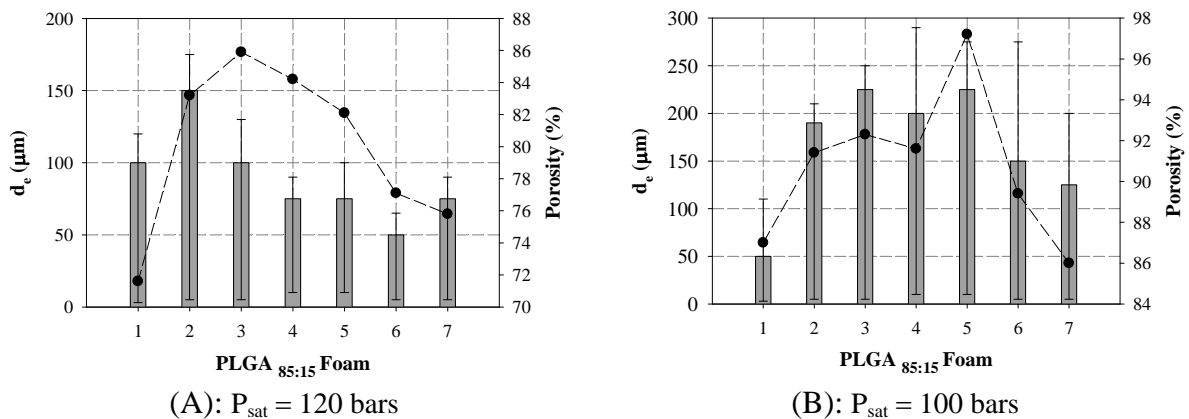


**Figure 8.4:** Comparison of micrographs of foams with different polymer particle size range processed at scCO<sub>2</sub> condition  $T_{\text{sat}} = 48^\circ\text{C}$ ,  $t_{\text{sat}} = 20$  min,  $dP/dt = 3$  bar/s,  $P_{\text{sat}} = 120$  bars or  $P_{\text{sat}} = 100$  bars.

From the previous experiment,  $T_{\text{sat}}$  was increased from  $45^\circ$  to  $48^\circ\text{C}$ , so the first process condition was  $T_{\text{sat}}=48^\circ\text{C}$ ,  $P_{\text{sat}} = 120$  bars,  $t_{\text{sat}} = 20$  min,  $dP/dt = 3$  bar/s and in the second condition, pressure was reduced to 100 bars while the other operating conditions were kept constant.

**Table 8.5:** Pore size and porosity of PLGA foams with different particle size range for two  $\text{scCO}_2$ -conditions with different  $P_{\text{sat}} = 120$  bars, or  $P_{\text{sat}} = 100$  bars.

Foam No.	Polymer Particle Size Range	$T_{\text{sat}}=48^\circ\text{C}$ , $t_{\text{sat}} = 20$ min, $dP/dt = 3$ bar/s			
		$P_{\text{sat}} = 120$ bars		$P_{\text{sat}} = 100$ bars	
		$d_e$ ( $\mu\text{m}$ )	P (%)	$d_e$ ( $\mu\text{m}$ )	P (%)
1	PLGA <sub>85:15</sub> < 125 $\mu\text{m}$	100	71.6	50	87.0
2	125 $\mu\text{m}$ < PLGA <sub>85:15</sub> < 250 $\mu\text{m}$	150	83.2	150	91.4
3	250 $\mu\text{m}$ < PLGA <sub>85:15</sub> < 400 $\mu\text{m}$	100	85.9	225	92.3
4	400 $\mu\text{m}$ < PLGA <sub>85:15</sub> < 500 $\mu\text{m}$	75	84.2	200	91.6
5	500 $\mu\text{m}$ < PLGA <sub>85:15</sub> < 600 $\mu\text{m}$	75	82.1	225	97.2
6	600 $\mu\text{m}$ < PLGA <sub>85:15</sub> < 800 $\mu\text{m}$	50	77.1	150	89.4
7	800 $\mu\text{m}$ < PLGA <sub>85:15</sub>	75	75.8	125	86.0



**Figure 8.5:** Effect of particle size on equivalent pore size and geometric porosity of PLGA<sub>85:15</sub> foams processed at  $T_{\text{sat}}=48^\circ\text{C}$ ,  $t_{\text{sat}} = 20$  min and  $dP/dt = 3$  bar/s

From Figure 8.5 A and B, it is evident that in the condition  $P_{\text{sat}} = 120$  bars the pore size is low (from 50 to 150  $\mu\text{m}$ ) as compared to the second condition  $P_{\text{sat}} = 100$  bars. Moreover almost in all cases, most of the pores are closed. At this lower pressure, pores in foams No. 2, 3, 4, 5 are open and mostly in homogeneous shape and the pore diameter is maximum. On the contrary, in foams 1, 6 and 7 most of the pores are closed and the pore diameter range is also low.

Comparing the porosities of the foams produced in both conditions, we can see that when pressure was 120 bars, the porosity varied between 72% and 86%. Especially for foams with minimum particle size and with maximum particle size porosity was almost at the lowest value. When the pressure was 100 bars, all the foams had porosity above 86%. Thus it is concluded that for future experimentation polymer after grinding in the ball mill particle between 125 – 600  $\mu\text{m}$  will be utilized.

## 2 Filler: Tri-calcium phosphate Doped by Sr

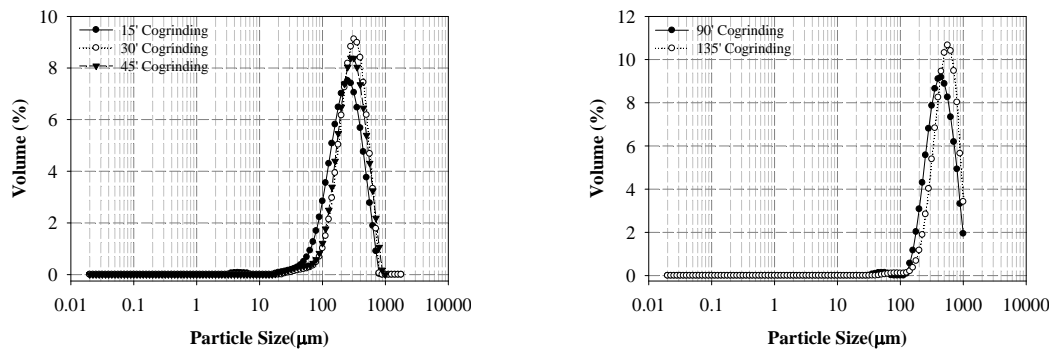
### 2.1 Experimentation on Blends and Composite Foams

Conclusions after first experiments are the following: from a point of view of the geometric porosity and the equivalent pore size, a blend containing the two fillers (ATCP<sub>(sr)</sub> and  $\beta$ TCP<sub>(sr)</sub>) produced better results than using only one of them. So pellets were made with 90% PLGA<sub>85:15</sub> (858-S) + 5%

ATCP<sub>(sr)</sub> + 5%  $\beta$ TCP<sub>(sr)</sub> and 95% PLGA<sub>85:15</sub> (858-S) + 2.5% ATCP<sub>(sr)</sub> + 2.5%  $\beta$ TCP<sub>(sr)</sub>. The purpose was to analyze difference in porosity and pore size and the impact of the filler ratio on mechanical properties.

### 2.1.1 Experimentation on Composite Foaming with Different Co-grinding Times

The purpose was to produce different scaffolds with an objective of an industrial production. First, long PLGA<sub>85:15</sub> (RG 858-S) fibres were reduced into small fibres using the knife mill. It was decided to test five different co-grinding times. Mixture of 90% PLGA<sub>85:15</sub> + 5% ATCP<sub>(sr)</sub> + 5%  $\beta$ TCP<sub>(sr)</sub> were co-ground in the ball mill for 15 to 135 minutes to obtain fine blends. A constant mass (255 mg) of blend powder was taken for each pellet. The granulometry after 15, 30, 45, 90 and 135 minutes co-grinding is shown in Figure 8.6 and the mean particle size is tabulated in Table 8.6. The pellets were pressed at P = 150 bars, T = 50°C and t = 20 min. Diameter of the pellets was 13 ± 0.15 mm and thickness 1.5 ± 0.05 mm.

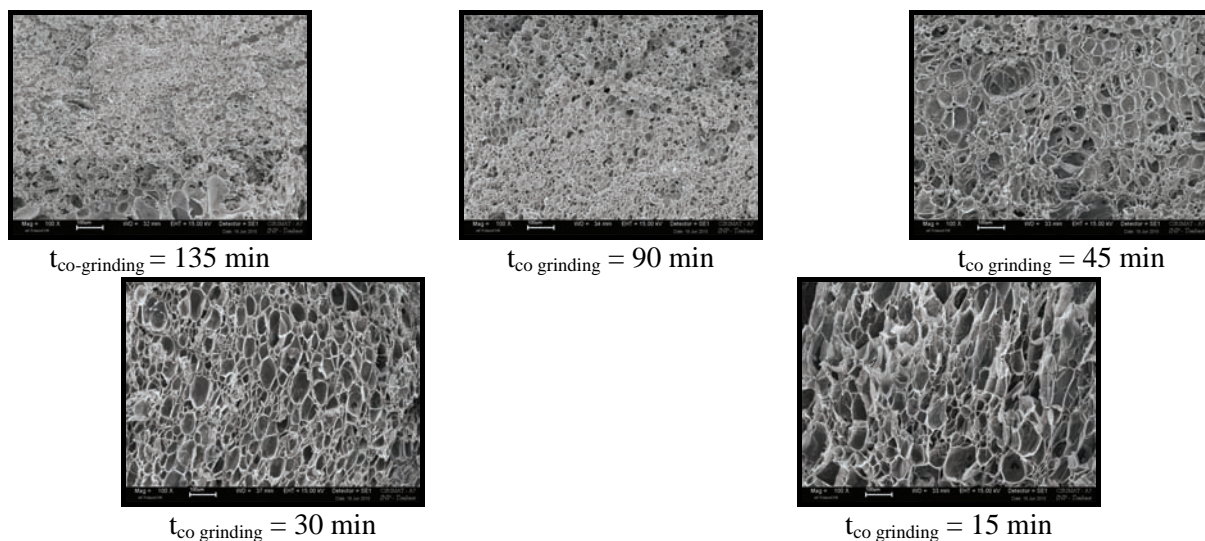


**Figure 8.6:** Size distribution of composite formulation at different co-grinding time.

**Table 8.6:** Mean particle size of composite matrix after different co-grinding time.

Mean Particle Size	Co-grinding Time (min)				
	15	30	45	90	135
$d_{50}$ ( $\mu\text{m}$ )	245.0	316.9	538.1	796.6	977.0

As the co-grinding time increases, it is observed that the particle size increases which indicates that agglomeration phenomenon is taking place during co-grinding. Foams of polymer composite with 5% ATCP<sub>(sr)</sub> and 5%  $\beta$ TCP<sub>(sr)</sub> are presented in Figure 8.7 and their porosities and pore equivalent sizes are presented in Table 8.7.



**Figure 8.7:** Micrographs of PLGA<sub>85:15</sub> composites foams processed at  $T_{\text{sat}} = 50^\circ\text{C}$ ,  $P_{\text{sat}} = 100$  bars,  $t_{\text{sat}} = 20$  min, and  $dP/dt = 3$  bar/s with different co-grinding times.



An effort was made to produce pores with co-ground composite but we obtained foams with very low geometric porosities and equivalent pore size. The foams obtained were very hard, indicating that their mechanical properties are very high. However, as the co-grinding time decreased the geometric porosity and equivalent pore size increased gradually. Such foams can be used where low pore diameter and high mechanical properties are required. Our requirement was to obtain foams with pore diameter above 250  $\mu\text{m}$ . Hence for future experiments, co-grinding will not be preferred and composite blend will be made by simple mixing.

**Table 8.7:** Equivalent pore diameter and porosity of foams processed at different co-grinding time at  $T_{\text{sat}} = 50^\circ\text{C}$ ,  $P_{\text{sat}} = 100$  bars,  $t_{\text{sat}} = 20$  min, and  $dP/dt = 3$  bar/s.

Pore Data	Co-grinding Time (min)				
	15	30	45	90	135
Equivalent pore size $d_e$	58	45	27	19	5
Geometric porosity P (%)	75.8	65.7	56.4	49.3	42.5

One can find that there is direct effect of co-grinding on the equivalent pore diameter and porosity of foams. As the co-grinding time was reduced, there was an increase in pore diameter and porosity. Co-grinding of filler with polymer decreases the sorption of  $\text{CO}_2$  in the polymer matrix thus leading to less swelling and low pore diameter and porosity.

### 2.1.2 Foaming of Fine Powder and Filler Blend by Simple Mixing

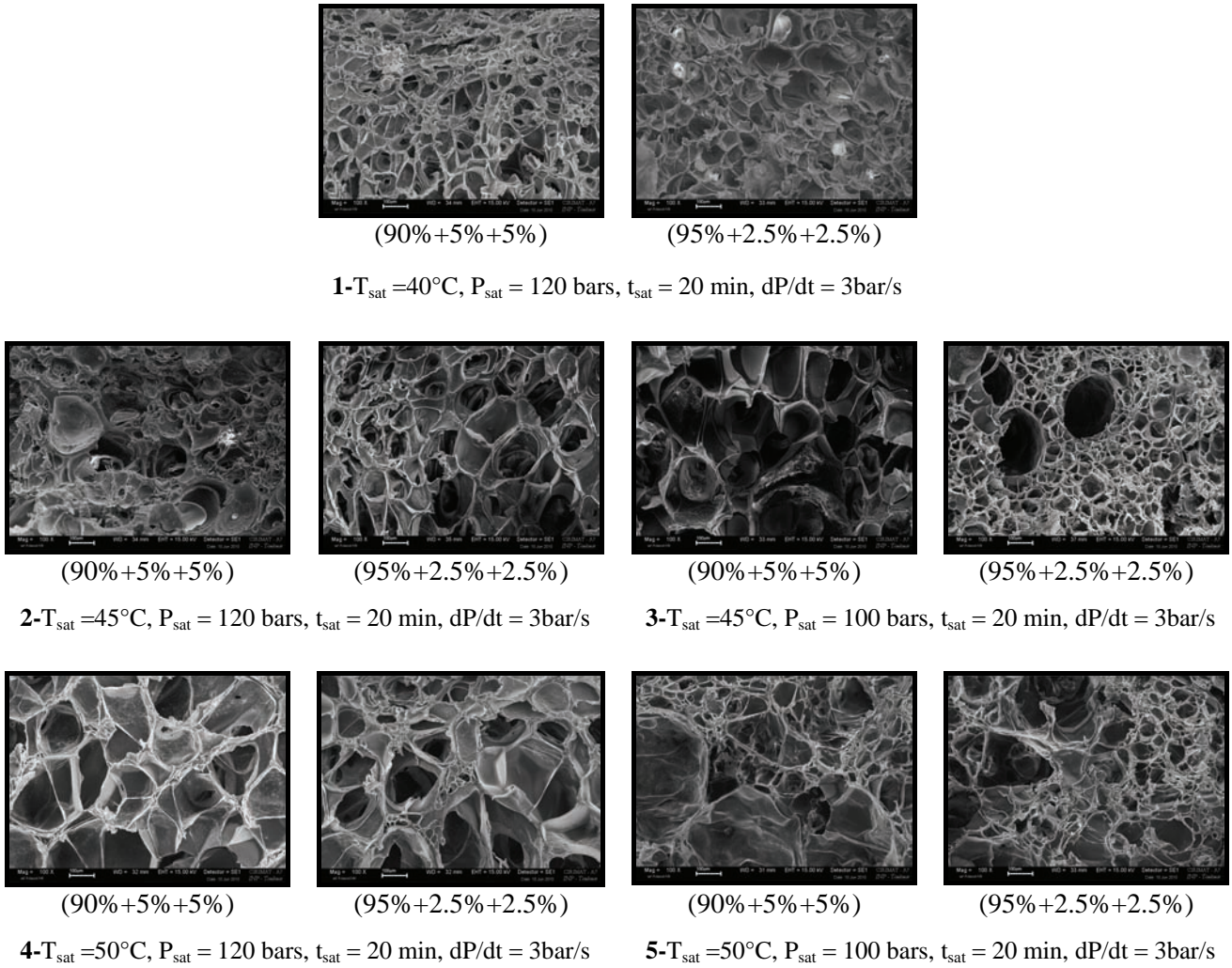
As co-grinding of polymer with filler compelled us to adapt simple mixing so we opted for two different filler ratios and different process temperatures. Foaming of the pellets was done in SEPAREX<sup>®</sup> SFC6 sc- $\text{CO}_2$  6L laboratory plant. Perforated plates were used for foaming. Process conditions for sc $\text{CO}_2$  and ratios of fillers in polymer matrix foam with equivalent pore diameter and porosity are stated in Table 8.8. Foams micrographs are shown in Figure 8.8.

**Table 8.8:** Pores diameter and porosity of selected [PLGA<sub>85:15</sub>+ATCP<sub>(sr)</sub>+  $\beta$ TCP<sub>(sr)</sub>] foams.

N <sup>o</sup>	$T_{\text{sat}}$ ( $^\circ\text{C}$ )	$P_{\text{sat}}$ (Bar)	$t_{\text{sa}}$ (min)	$dP/dt$ (bar/s)	90%PLGA+5%ATCP <sub>(sr)</sub> +5% $\beta$ TCP <sub>(sr)</sub>		95%PLGA+2.5%ATCP <sub>(sr)</sub> +2.5% $\beta$ TCP <sub>(sr)</sub>	
					$d_e$ ( $\mu\text{m}$ )	P (%)	$d_e$ ( $\mu\text{m}$ )	P (%)
1	40	120	20	3	80	69.4	97	72.5
2	45	120	20	3	95	71.4	123	74.4
3	45	100	20	3	135	72.1	130	77.9
4	50	120	20	3	147	76.3	164	80.1
5	50	100	20	3	237	88.3	252	90.4

The results obtained show that at higher temperature, we get maximum value of geometric porosity and equivalent pore size. From  $40^\circ\text{C}$  to  $50^\circ\text{C}$ , there was gradual increase in pore diameter. At  $T_{\text{sat}} = 50^\circ\text{C}$  and  $P_{\text{sat}} = 120$  bars, equivalent pore size and geometric porosity was less when the  $T_{\text{sat}} = 50^\circ\text{C}$  and  $P_{\text{sat}} = 100$  bars. There was not large difference between the equivalent pore diameter and porosity of foams with different filler ratios so 10% polymer filler composite will be preferred over 5% for higher modulus. The compression test comparison will be elaborated later on. Hence for future formulations, 10% fillers will be used to optimize the sc $\text{CO}_2$  process conditions for higher geometric porosity and, equivalent pore size.

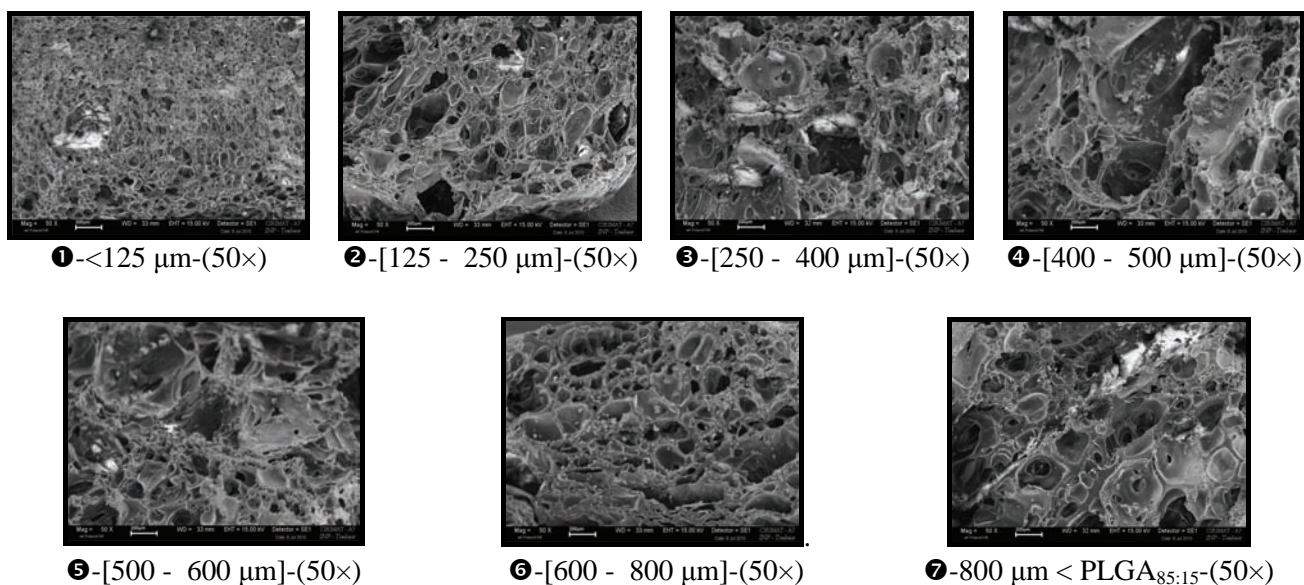




**Figure 8.8:** Micrographs of foams with different filler ratio processed at five different scCO<sub>2</sub> conditions.

### 2.1.3 Mixing Experimentation on Composite Foaming with Different Polymer Particle Size

Pure PLGA<sub>85:15</sub> fibres after grinding in ball mill and then in knife milling collected from each sieve was mixed simply with 5% ATCP<sub>(sr)</sub> + 5% βTCP<sub>(sr)</sub> and then pellets were made and further tested for foaming. The blend components were mixed by using magnetic stirrer for 15 minutes. Hydraulic press was used for pellets with conditions  $P=150$  bars,  $T=47^{\circ}\text{C}$ ,  $t=20$  min. A constant mass (255 mg) of composite powder with 90% PLGA<sub>85:15</sub>, 5% ATCP<sub>(sr)</sub> and 5% βTCP<sub>(sr)</sub> was used to make each pellet. Foaming conditions  $T_{\text{sat}}=45^{\circ}\text{C}$ ,  $P_{\text{sat}}=100$  bars,  $t_{\text{sat}}=20$  min and  $dP/dt=3\text{bar/s}$  were selected. Indeed adapting the temperature close to  $T_g$  permits to have pores with larger diameter. The micrographs of the foams obtained are presented in Figure 8.9.

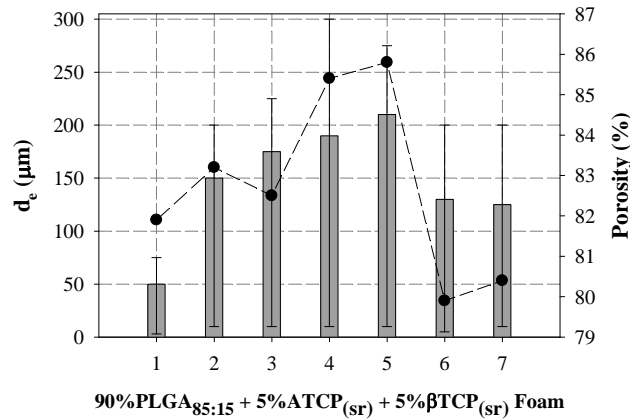


**Figure 8.9:** Micrographs of foams of polymer with different particle size range +5%  $\beta$ TCP<sub>(sr)</sub> + 5% ATCP<sub>(sr)</sub> processed at.  $T_{\text{sat}} = 45^{\circ}\text{C}$ ,  $P_{\text{sat}} = 100$  bars,  $t_{\text{sat}} = 20$  min and,  $dP/dt = 3$  bar/s.

**Table 8.9:** Equivalent pore diameter and geometric porosity of PLGA + 5%  $\beta$ TCP<sub>(sr)</sub> + 5% ATCP<sub>(sr)</sub> foams with different particle size range processed at  $T_{\text{sat}} = 45^{\circ}\text{C}$ ,  $P_{\text{sat}} = 100$  bars,  $t_{\text{sat}} = 20$  min and  $dP/dt = 3$  bar/s.

Foam No.	Polymer Particle Size Range	Equivalent Pore Diameter $d_e$ ( $\mu\text{m}$ )	Geometric Porosity P (%)
1	PLGA <sub>85:15</sub> < 125 $\mu\text{m}$	50	81.9
2	125 $\mu\text{m}$ < PLGA <sub>85:15</sub> < 250 $\mu\text{m}$	150	83.2
3	250 $\mu\text{m}$ < PLGA <sub>85:15</sub> < 400 $\mu\text{m}$	175	82.5
4	400 $\mu\text{m}$ < PLGA <sub>85:15</sub> < 500 $\mu\text{m}$	190	85.4
5	500 $\mu\text{m}$ < PLGA <sub>85:15</sub> < 600 $\mu\text{m}$	210	85.8
6	600 $\mu\text{m}$ < PLGA <sub>85:15</sub> < 800 $\mu\text{m}$	150	79.9
7	800 $\mu\text{m}$ < PLGA <sub>85:15</sub>	150	80.4

In experiments done with pure PLGA<sub>85:15</sub>, we observed that particles between 250  $\mu\text{m}$  to 600  $\mu\text{m}$  produced foams with equivalent pore size ranging from 150 to 210  $\mu\text{m}$  and geometric porosity above 90 % (cf. Table 8.5). Figure 8.10 and Table 8.9 reflect the equivalent pore size and geometric porosities in foams containing fillers. Again, we can observe that category 2, 3, 4 and 5 of powder and blend produce foams with equivalent pore size ranging from 150 to 210  $\mu\text{m}$  and geometric porosity was above ~82 %. The  $T_g$  of the polymer is  $43^{\circ}\text{C}$  and we have kept  $T_{\text{sat}} = 45^{\circ}\text{C}$ . To improve the geometric porosity and equivalent pore diameter for future experiments,  $T_{\text{sat}}$  will be increased and dual  $dP/dt$  shall be applied which will increase the pore size to a great extent. In dual  $dP/dt$ , first a slower rate of  $dP/dt$  is applied then higher rate of  $dP/dt$  is applied for the same foam. Previous extensive experimentations imply that when using higher depressurization rates above 3 bar/s pores generated are small while small depressurization rates below 3 bars cause larger pores because the nucleated pores have sufficient time to grow. Allowing  $\text{CO}_2$  in the swollen polymer to release slowly during  $dP/dt$  enhance the size of the pores. After certain time, the depressurization rate can be increased to achieve pores of required diameter. Hence for future experimentation to obtain scaffolds with larger diameters, polymer powder after screening will be used in the above stated four particle size categories (250  $\mu\text{m}$  to 600  $\mu\text{m}$ ) and dual  $dP/dt$  will be applied.



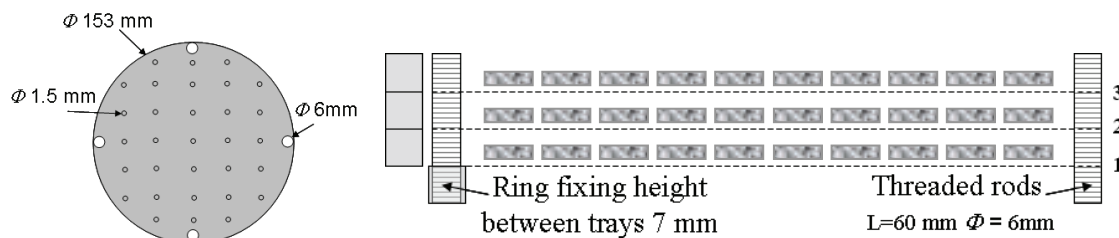
**Figure 8.10:** Effect of particle size on pore diameter and porosity of foams containing 90% PLGA<sub>85:15</sub> + 5%  $\beta\text{TCP}_{(\text{sr})}$  and 5% ATCP<sub>(sr)</sub> processed at  $-[45^\circ\text{C}-100\text{ bar}-20\text{ min}-3\text{ bar/s}]$

### 3 Process Control for Composite Foaming

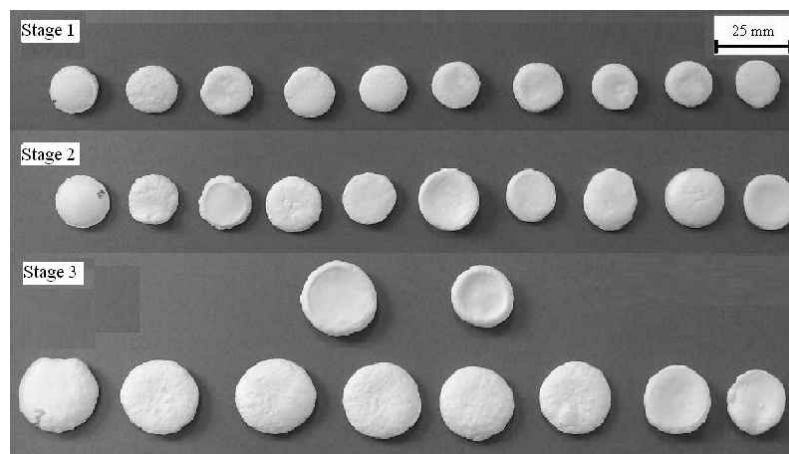
#### 3.1 Semi-Industrial Foaming

##### 3.1.1 Pellet Positions in scCO<sub>2</sub> Chamber

In this first test for scale up production of scaffolds, thirty pellets per batch were placed on each stage inside the scCO<sub>2</sub> chamber. The stage was made of 3 perforated stainless steel (SS) plates as shown in Figure 8.11 and thickness of each plate was 2 mm. Pellets have average diameter  $d_p = 12.9 \pm 0.15\text{ mm}$ , average thickness  $\phi_p = 1.50 \pm 0.05\text{ mm}$  and average weight  $m_p = 247 \pm 0.4\text{ mg}$ . Foaming conditions are:  $T_{\text{sat}} = 45^\circ\text{C}$ ,  $P_{\text{sat}} = 100\text{ bars}$ ,  $t_{\text{sat}} = 20\text{ min}$  and  $dP/dt = 3\text{ bar/s}$ . At the end of foaming experiments, a stabilization time of 2 minutes has been systematically observed before taking out of the chamber.



**Figure 8.11:** ScCO<sub>2</sub> Foaming installation with 3 perforated stainless steel plates stage.



**Figure 8.12:** Foams of polymer composite blend on 3 stainless steel plates stage.



Foam volume and geometric porosity is reported on Table 8.10.

**Table 8.10:** Dimmensions of foams placed onto 3 stailless steel plates stage

Stage	Average Diameter (mm)	Average Thickness (mm)	Average Weight (mg)	Foam Volume (mm <sup>3</sup> )	Porosity P(%)
1	15.6 ± 1.3	3.75 ± 0.65	246.5 ± 0.3	717.04 ± 5.5	33.2 ± 3.6
2	16.19 ± 2.3	3.13 ± 0.40	248.4 ± 0.3	644.62 ± 7.8	37.7 ± 4.1
3	25.33 ± 4.4	3.77 ± 0.60	244.7 ± 0.2	1900.54 ± 18.5	63.4 ± 5.7

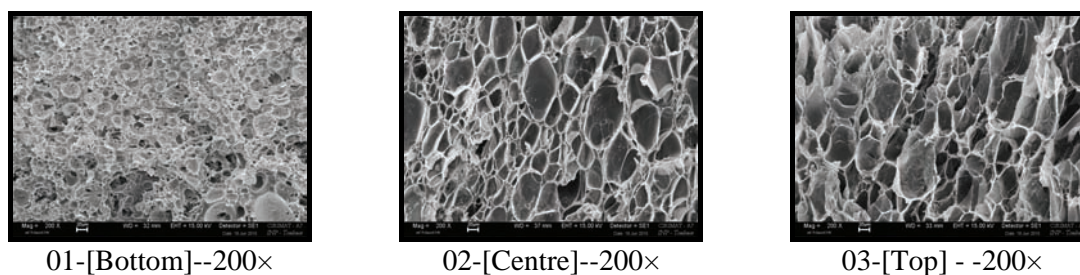
After completion of foaming process foams obtained are presented in Figure 8.12. Visually it can be observed that on

Stage 1: Volume of foams was less as compared to stage 2 and 3

Stage 2: Volume of foams was more than stage 1 but less than stage 3

Stage 3: Volume of foams was maximum.

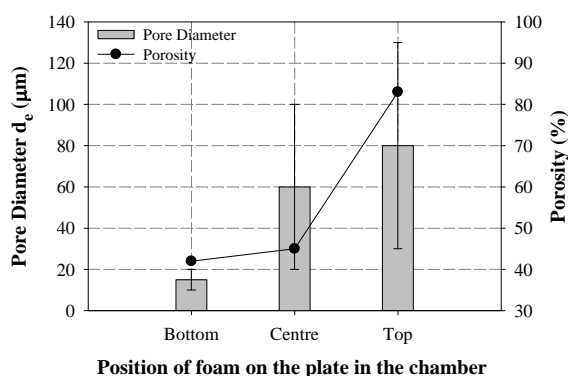
Geometric porosity of foam was, Stage 1 ≈ Stage 2 < Stage 3. The respective SEM micrographs of three stages are presented in Figure 8.13.



**Figure 8.13:** Micrographs of foams obtained from each plate processed at scCO<sub>2</sub> process condition  
 $T_{\text{sat}} = 45^{\circ}\text{C}$ ,  $P_{\text{sat}} = 100$  bars,  $t_{\text{sat}} = 20$  min and  $dP/dt = 3$  bar/s.

It was observed that at the top stage in the chamber, the volume of foams was maximum as compared to the lower stages. Some of the foams were of bowl shape and some had irregular surface when taken out of the chamber. While the other two stages on visual inspection and by SEM analysis show very poor foaming. Hence we decided not to use new stainless steel perforated plates.

The pore diameter on the bottom plate was  $15 \pm 5 \mu\text{m}$ , while in centre and top plate was  $60 \pm 40 \mu\text{m}$  and  $80 \pm 50 \mu\text{m}$  respectively, as shown in SEM images and in Figure 8.14.



**Figure 8.14:** Equivalent pore size and geometric porosity of foams at different places in the chamber.

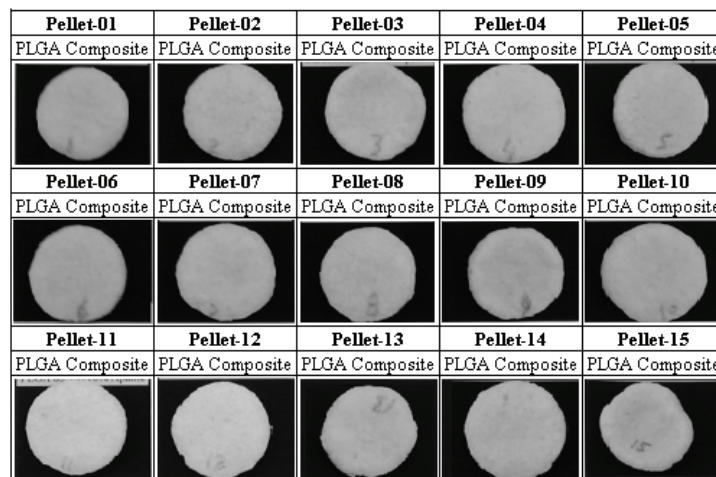
The results of this experiment reveal that temperature inside the chamber was not homogeneous due to the following possible reasons:

- i. The 2 mm thickness stainless steel perforated plates could not reach the desired temperature in 20 minutes. This short time did not allow the polymer pellets to reach a temperature close to the  $T_g$  temperature. When a polymer is at a temperature lower than its  $T_g$ , less  $CO_2$  is absorbed, resulting in less nucleation, pore growth and ultimately less porosity and lower pore.
- ii. The plate at the top of the chamber was comparatively at higher temperature and closer to  $T_g$  than the bottom and centre plates, as a result providing good porosity and pore diameter.
- iii. When a  $dP/dt$  step was done, the  $dT/dt$  of the bottom plate was faster than those of centre and bottom plates. Top plate in the  $dP/dt$  step was at higher temperature thus producing foams with higher porosity and pore diameter.

## 3.2 Final Experiments

### 3.2.1 Multi Pellet Formation in a Batch and Effect on Foaming

Bulk production required pellets in large quantities. Normally three pellets can be pressed in the hydraulic press mould. One of the aim of this study was to see the effect of multiple pellets per batch (15–18 pellets/batch), depending on the polymer/composite mass, was prepared in the mould. In the initial formulation, when some of the pellets did not produced foams of high porosity and pore diameter, it was assumed that may be the pellets made in one batch were not at the same physical state To verify this hypothesis, we prepared 15 pellets in one batch and made foams at the optimized condition. The pellets consist of 90% PLGA<sub>85:15</sub> +5%  $\beta$ TCP<sub>(sr)</sub> and 5% ATCP<sub>(sr)</sub> and were processed at  $T_{sat} = 48^\circ C$ ,  $P_{sat} = 100$  bars,  $t_{sat} = 20$  min and  $dP/dt = 3$  bar/s. The 4 ranges of polymer particles, as deduced earlier to be the best, were selected. Average diameter, thickness and weight of pellets obtained after compression were  $12.9 \pm 0.15$  mm,  $1.5 \pm 0.05$  mm and  $250 \pm 5.0$  mg. The pellets were compressed in a hydraulic press at  $P = 150$  bars,  $T = 47^\circ C$ ,  $t = 20$  min as per procedure described in chapter 4. Pellet P01 was the at the top and pellet P15 was the bottom pellet in the batch.

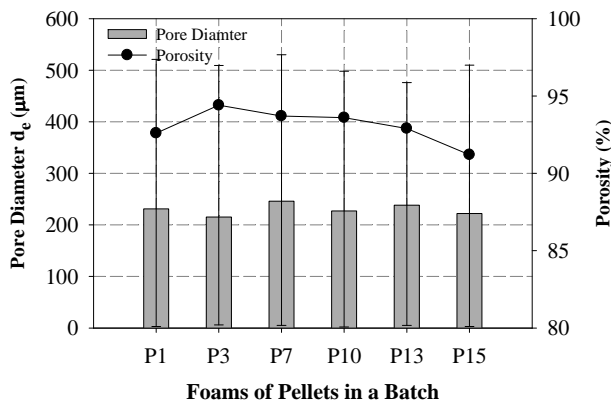


**Figure 8.15:** Foams of pellets prepared in one batch.

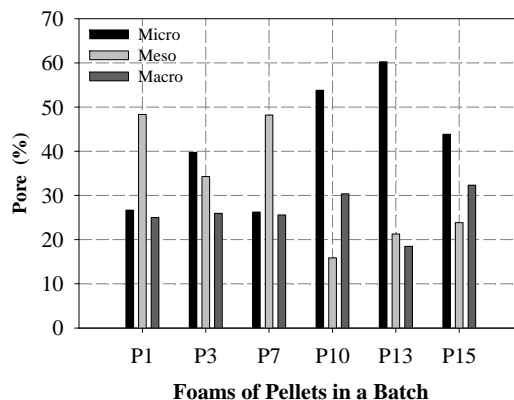
Visually diameter and thickness of the foams obtained from these 15 pellets were approximately the same and we have selected randomly 6 foams for SCION<sup>®</sup> analysis. On SEM analysis, the equivalent pore size is 230  $\mu m$  including the micro and meso pores and the range of pores in a foam was from 5 – 500  $\mu m$  (cf. Figure 8.16). Geometric porosity obtained was between 91.2 and 94.4% in all foams. The percentage of micro, meso and macro pores and their respective surface area in foam are presented in Figure 8.17 and



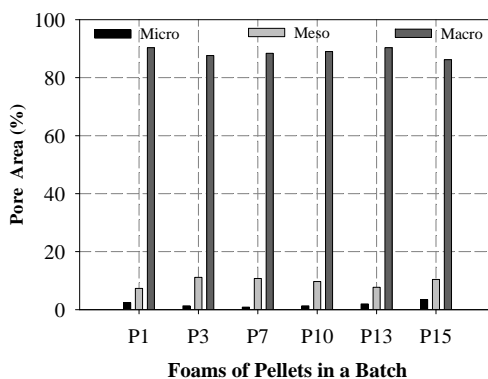
Figure 8.18. The surface area of macro pores is ~ 90% in foam. Thus we can conclude that there is homogeneity in the foams produced by pellets in one batch.



**Figure 8.16:** Pore equivalent size and geometric porosity of composite foam in the same batch.



**Figure 8.17:** Percentage of pores in composite foams in the same batch.



**Figure 8.18:** Surface area of pores in composite foams in the same batch.

Then, the influence of the particle size was analyzed. We recovered 95.4 gm of polymer powder from 100 gm of polymer fine fibres after grinding process. The powder of different particle size obtained at different sieve ranges are presented in Table 8.11. About 5 gm of polymer was wasted during grinding process.

**Table 8.11:** Weight and percentages of polymer grinding and sieving for different particle size ranges.

PLGA <sub>85:15</sub> Grinding		Grinding	
S/N	Powder Particle Size	Amount (g)	Amount (%)
1	PLGA <sub>85:15</sub> < 125 $\mu\text{m}$	6.250	6.55
2	125 < PLGA <sub>85:15</sub> < 250 $\mu\text{m}$	18.310	19.19
3	250 < PLGA <sub>85:15</sub> < 400 $\mu\text{m}$	23.660	24.80
4	400 < PLGA <sub>85:15</sub> < 500 $\mu\text{m}$	18.350	19.23
5	500 < PLGA <sub>85:15</sub> < 600 $\mu\text{m}$	19.537	20.48
6	600 < PLGA <sub>85:15</sub> < 800 $\mu\text{m}$	3.594	3.77
7	800 $\mu\text{m}$ < PLGA <sub>85:15</sub>	5.700	5.97

Polymers with a particle size between 125 and 600  $\mu\text{m}$  were kept for further experiments since it was shown previously that this size range permits to produce foams with a pore mean size above 200  $\mu\text{m}$  and in this range we recovered ~80% of polymer for use. The convenient powder was recovered for sets

with the following ranges: [125 – 250  $\mu\text{m}$ ]; [250 – 400  $\mu\text{m}$ ]; [400 – 500  $\mu\text{m}$ ] and, [500 – 600  $\mu\text{m}$ ]. Powder in the last two ranges can be also be used after further size reduction.

The four ranges of powder was mixed and fillers (5 %  $\beta\text{TCP}_{(\text{sr})}$  and 5 %  $\text{ATCP}_{(\text{sr})}$ ) were added for final polymer matrix blend. The powder was mixed by using magnetic stirrer for 15 minutes. Hydraulic press was used for pellets with conditions  $P = 150$  bars,  $T = 47^\circ\text{C}$  and,  $t = 20$  minutes. A constant mass (255 mg) of powder was used to make each pellet. Keeping in view preliminary results of different stages and plates used, it was decided to use only a single perforated composite material plate, for future foaming. 12 to 15 pellets were placed in one batch for foaming.

For making foams in bulk quantity, results obtained from the experimentation of controlled polymer particle, it was decided to use 4 ranges of particles size as they produced pores of maximum size, porosity above 85% and most of them are open. Nearly 84% of the polymer will be useable.

### 3.2.2 Preparation of Foams

#### 3.2.2.1 Filling, Soaking and Depressurization Time of $\text{CO}_2$ in Chamber

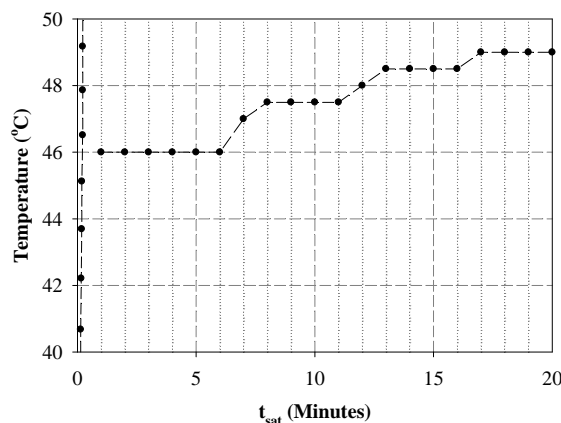
For  $\text{PLGA}_{85:15}$  best results on geometric porosity and equivalent pore diameter of foams are obtained for the following conditions:;

$$T_{\text{sat}} = 48 \pm 2^\circ\text{C} \quad P_{\text{sat}} = 100 \text{ bars} \quad t_{\text{sat}} = 20 \text{ min}$$

First of all, pellets are placed in the autoclave. On closing the chamber the pressure inside is 1 bar whereas pressure in the lines till chamber can be 100 bars.  $\text{CO}_2$  inlet valve is opened to bring the chamber pressure and line pressure at same level. It takes 2 minutes 30 sec to bring the system to equilibrium. At that time, pressure in chamber is 58 – 60 bars. Then  $\text{scCO}_2$  pump is switched on keeping the flow rate at 3 kg/hr to fill the chamber till the required pressure. From 60 bars till 100 bars, it takes about 3 min 45 sec. Hence, total filling time of chamber is 6 min 15 sec. The flow rate of  $\text{CO}_2$  is kept below 5 kg/hr otherwise, pellets fly inside the chamber. The pump is switched and the soaking time 20 minutes starts from here.

#### 3.2.2.2 Temperature Variation During Soaking of $\text{CO}_2$

Initially when pellets were placed inside the chamber the temperature noted was  $48^\circ\text{C}$ . When  $\text{CO}_2$  was filled a temperature decrease of  $2^\circ\text{C}$  was observed inside the chamber. Temperature rises during the soaking time. Observations of the temperature are presented in Figure 8.19. After the initial drop at  $46^\circ\text{C}$ , the temperature increases gradually in steps and the final temperature derives to  $49^\circ\text{C}$ , for a saturation time of 20 min.



**Figure 8.19:** Temperature variation of the chamber during 20 minutes of saturation time.

### 3.2.2.3 Dual Depressurization Rate

In the initial experiments, we fixed  $dP/dt = 3$  bars/s but later on it was evolved to get best porosity and morphology with dual  $dP/dt$ . When  $P_{sat}$  is fixed to 100 bars,  $dP/dt$  is maintained to 1 bar/s, it takes 40 sec to pressure decrease from 100 to 60 bars. After that we increase the depressurization rate  $dP/dt$  from 1 to 3bar/s and the time to return at the atmospheric pressure is 20 sec. First  $dP/dt$  of 1 bar/s initiates the nucleation and pore growth at a slower rate, this gives the polymer longer duration to reach the vitrification point. As a result the pore diameter increased from 250  $\mu\text{m}$  to 320  $\mu\text{m}$  and porosity from 87 % to 93 %. Ratio of open pores was more in the foams obtained by dual  $dP/dt$ .

### 3.2.2.4 Temperature Variation During Depressurization of $\text{CO}_2$

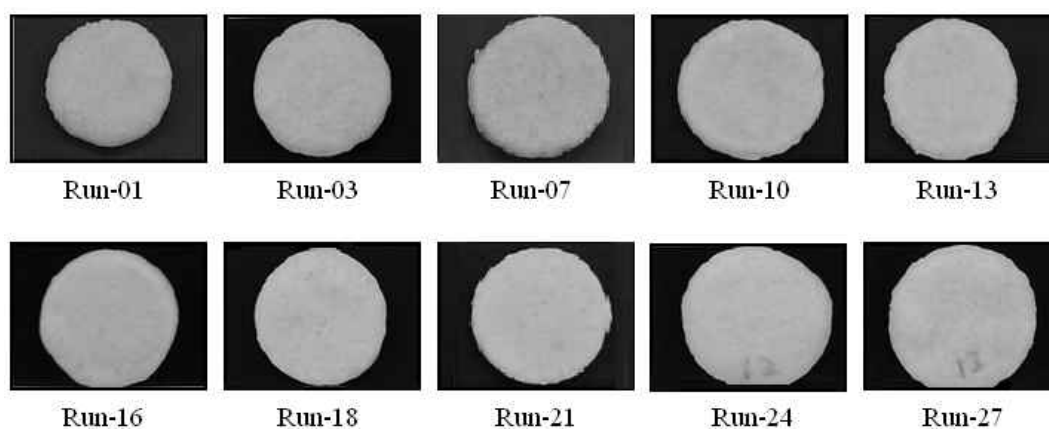
In the depressurization step when  $\text{CO}_2$  is evacuated from the chamber, temperature of chamber falls depending upon the chamber pressure, temperature and  $dP/dt$ . In the case under discussion during  $dP/dt$  steps the temperature of chamber falls from 48 to 44°C. This decrease in temperature hinders the nucleation and growth of pores, which ultimately has an effect on the pore diameter, pore morphology and pore size distribution.

### 3.2.2.5 Retention Time after the Depressurization Step

It was also evolved that after  $dP/dt$  a retention time was necessary to control equivalent pore diameter and geometric porosity. A possible reason for this is a retention time of 60 sec inside the chamber after  $dP/dt$ , for the desorption of some  $\text{CO}_2$  molecules trapped inside the pores. In the 60 sec retention time, an increase of temperature of 2-3°C is observed. This rise in temperature improved the pore diameter, porosity and open pore morphology of scaffold.

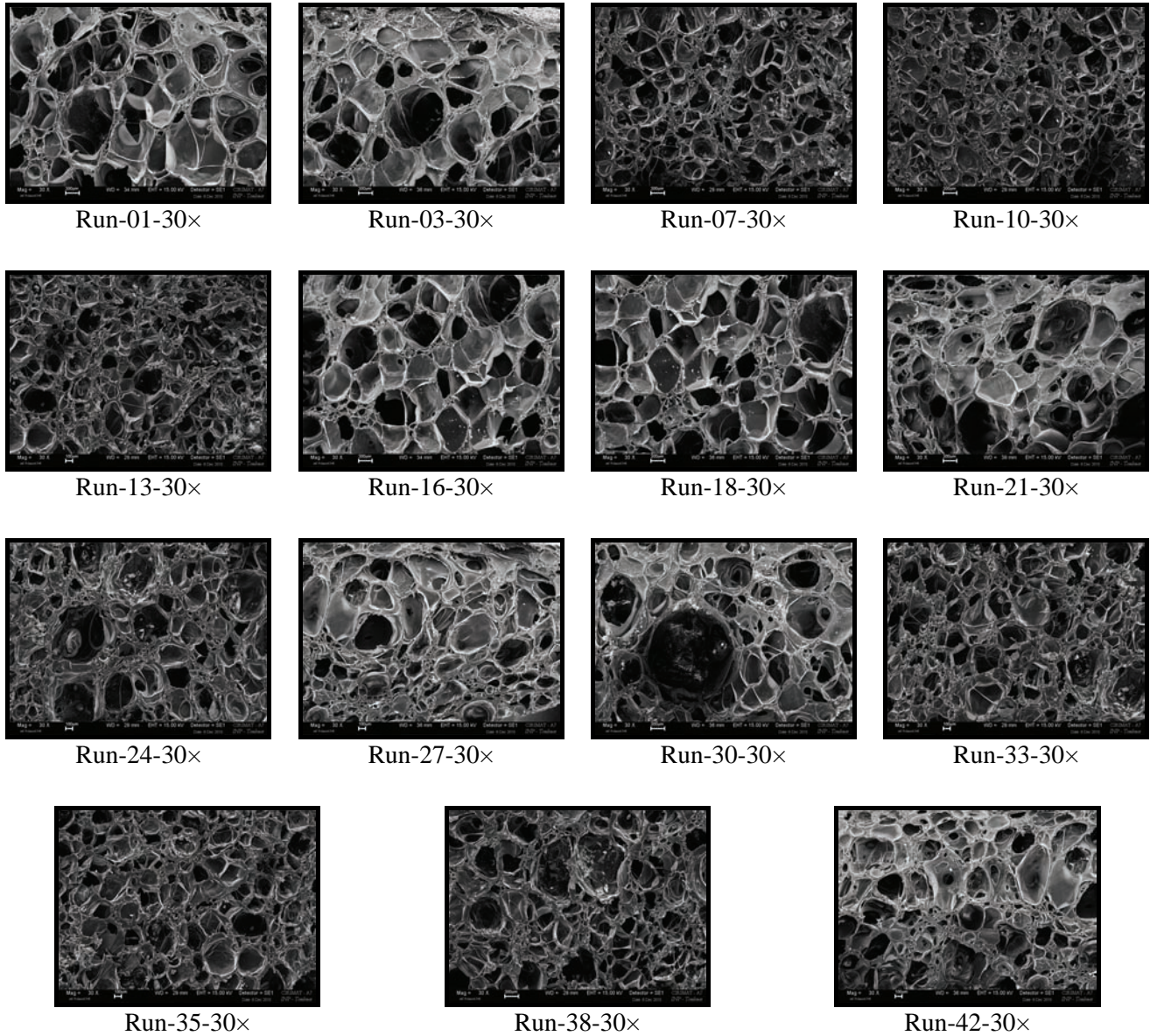
## 3.2.3 Final foam experiments

Foaming was done with the optimized conditions  $T_{sat} = 48 \pm 2^\circ\text{C}$ ,  $P_{sat} = 100$  bars,  $t_{sat} = 20$  min and dual  $dP/dt = 1$  bar/s and 3 bar/s. Nearly 45 runs were made, each containing 15 foams. In the bulk production dual  $dP/dt$  was applied because dual  $dP/dt$  produced best foam with high porosity, pore diameter and good pore morphology. Randomly foams were selected from different batches of all the foams produced and are presented in Figure 8.20. Equivalent pore size was 320  $\mu\text{m}$  and geometric porosity was 90% for all analyzed foams.



**Figure 8.20:** 90% PLGA<sub>85:15</sub> +5%ATCP<sub>(sr)</sub>+5% $\beta$ TCP<sub>(sr)</sub> foams randomly selected from different batches processed at -  $T_{sat} = 48^\circ\text{C}$ ,  $P_{sat} = 100$  bar  $t_{sat} = 20$  min and dual  $dP/dt = 1$  and 3bar/s.

SEM images of the selected foams are presented in Figure 8.21. The inner surface of the pores is rough which is an effective condition for cell adhesion. SCION<sup>®</sup> image analysis was done as per described procedure and porosity of the foams was determined by geometric method. The equivalent pore size, porosity and morphology of pores (% of micro, meso and macro pores, surface area of these three types of pores) was homogeneous.

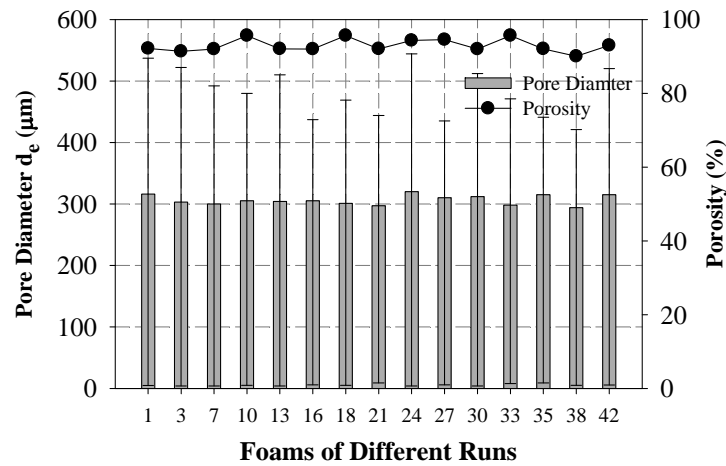


**Figure 8.21:** SEM micrographs of 90 % PLGA<sub>85:15</sub> + 5 % ATCP<sub>(sr)</sub> + 5 %  $\beta$ TCP<sub>(sr)</sub> foams selected from different batches and processed at:  $T_{\text{sat}}=48^{\circ}\text{C}$ ,  $P_{\text{sat}}=100$  bars,  $t_{\text{sat}}=20$  min and dual  $dP/dt=1$  and  $3\text{bar/s}$

### 3.2.4 Discussion on the Rugdness of the Process

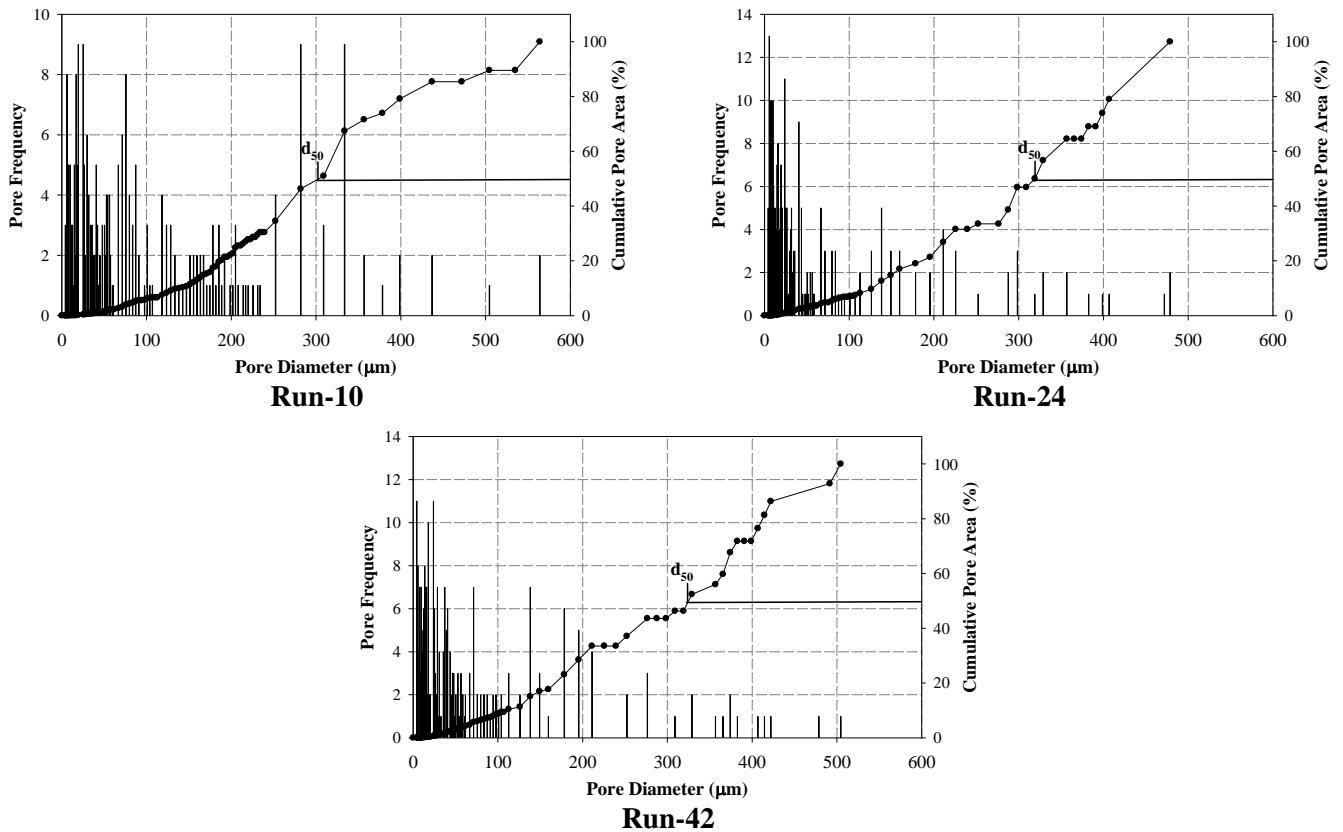
This slight variation in the equivalent pore size can be due to multiple reasons, such as differences in pellets weight, position of the pellets inside the chamber, variation of saturation temperature and saturation pressuring during the 20 minutes of foaming process, manually controlled  $dP/dt$ , and temperature drop in the chamber during the  $dP/dt$  step in each run. The geometric porosity varies from 91.6 to 95.2% for randomly selected foams from 42 batches. The equivalent pore diameter and porosities of the foams selected are presented in Figure 8.22.





**Figure 8.22:** Equivalent pore size and geometric porosity of 90% PLGA<sub>85:15</sub> + 5% ATCP<sub>(sr)</sub>+ 5%  $\beta$ TCP<sub>(sr)</sub> foams from different batches.

A histogram of pore frequency and pore diameter along cummulative pore area is presented in Figure 8.23, although it can be seen that micro and meso pores are higher in frequency but for macro pores the cummulative pore area distribution shows that 85% of the pore area is comprised of pores with average diameters greater than 150  $\mu\text{m}$  for the PLGA composite scaffold. Similar behaviour is almost observed in all foams produced.

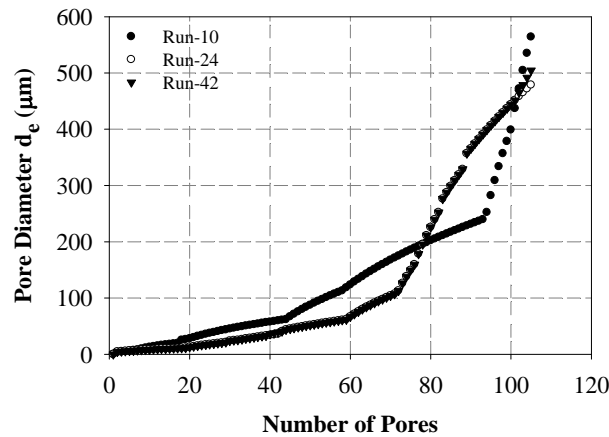


**Figure 8.23:** Pore frequency and cummulative total pore area as a function of average pore diameter for 90% PLGA<sub>85:15</sub> +5% ATCP<sub>(sr)</sub>+5%  $\beta$ TCP<sub>(sr)</sub> foams selected randomly from different runs.

Figure 8.24 presents the equivalent pore size of foams from selected runs against the number of pores obtained from SCION<sup>®</sup> image analysis. It can be observed that similar trend of pore diameter is

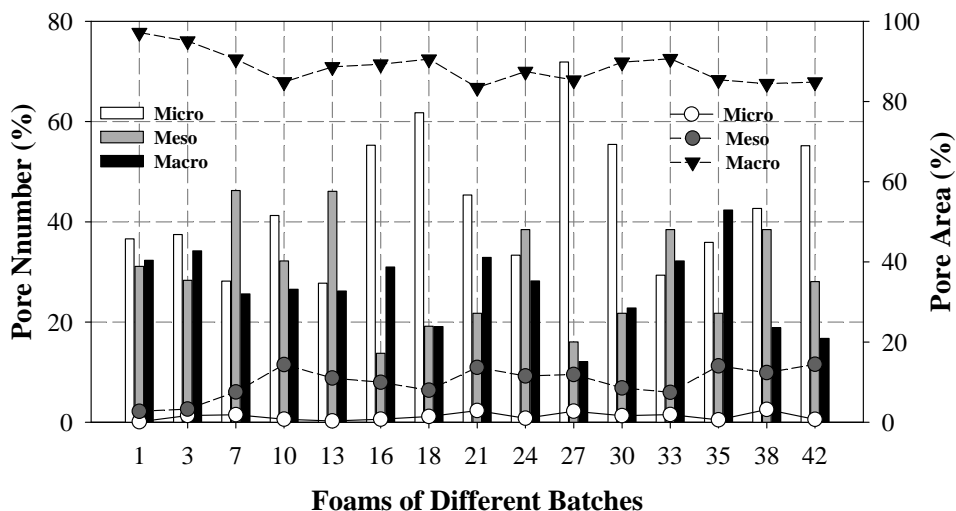


followed. The mean equivalent pore diameter for the randomly selected foams was 320  $\mu\text{m}$  while for each foam the maximum pore diameter can vary as in our case 564, 478 and 504  $\mu\text{m}$  for run 10, 24 and 42.



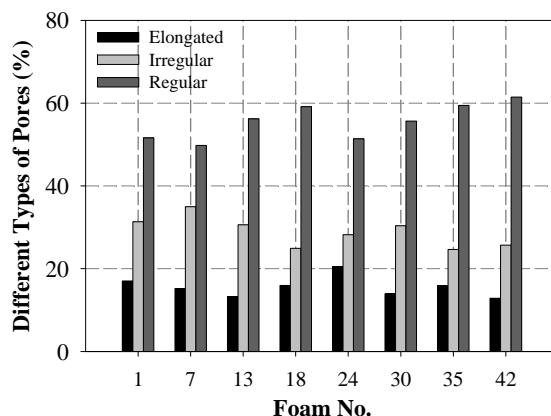
**Figure 8.24:** Equivalent pore diameter vs pore numbers for selected PLGA<sub>85:15</sub> + 5% ATCP<sub>(sr)</sub>+ 5%  $\beta$ TCP<sub>(sr)</sub> foams.

The number percentages of micro, meso and macro-pores for 15 of the selected foams, as well as the pore area percentage for each type of pores are plotted in Figure 8.25. In SCION<sup>®</sup> analysis a SEM micrograph of a certain magnification is analyzed. An attempt is made to analyze all the micrographs for same magnification. However, in each micrograph the number of pore being under analysis can not be constant. On average 250 pores are analyzed. Total number of pores and their respective surface area is also calculated. It is evident from Figure 8.25 that there are micro, meso and macro pores in different percentages, but percentage average area of micro, meso and macro-pores is  $< 0.5\%$ ,  $\sim 15\%$  and  $\sim 85\%$ . The two types of pores are necessary because meso-pores (with a size  $< 150 \mu\text{m}$ ) are useful for the nutrition and adhesion of the stem cell and macro-pores (with a size  $> 150 \mu\text{m}$ ) are used for the movement and proliferation of stem cells on the scaffold.



**Figure 8.25:** Pore diameter and porosity of composite foams from different batches.

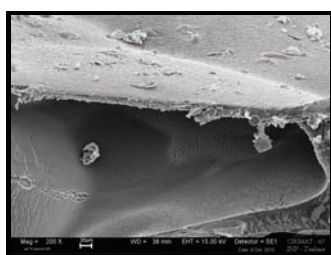
Pore morphology of selected polymer composite foams were processed at  $T_{\text{sat}} = 48^\circ\text{C}$ ,  $P_{\text{sat}} = 100$  bars,  $t_{\text{sat}} = 20$  min and dual  $dP/dt = 1$  and 3 bar/s. The percentage of elongated pores is  $\sim 15\%$ , irregular pores are between 24 to 35% and regular pore are between 50 to 60% (cf. Figure 8.26).



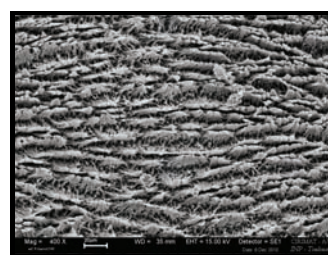
**Figure 8.26:** Pore morphology of selected polymer composite foams.

100 $\mu$ m of pore size allow bone growth in ceramics scaffold. In addition to pore size, cell transport within a scaffold such as diffusion, attachment, and migration is controlled by porosity (the fraction of pore volume), pore interconnectivity, and available surface area in scaffolds. While a high porosity is often desired, it is inversely related to the surface area available for cell attachment in 3D scaffolds. Achieving an optimal cell density in scaffolds, therefore, necessitates a high surface-area-to-volume ratio. In order to facilitate the transport of cells and bioactive chemicals, scaffolds may also need to have pores at both macro and micro scales, features that may be difficult to obtain via traditional scaffold fabrication techniques, such as particle leaching, gas foaming, and phase separation.

At higher magnification (200 $\times$ ), the wall thickness observed was less than 7  $\mu$ m and the internal surface of the pores was found irregular and uneven. The top layer of the foam was thick ranging from 30 to 50  $\mu$ m. The particles of ATCP and  $\beta$ TCP were also visible on the pore walls and internal surface. Such surface is necessary for the cell attachment and strong adhesion (cf. Figure 8.27). The inner surface of the pores was rough which is effective for cell adhesion. This phenomenon was observed in all the foams obtained during the bulk production.



Pore wall thickness



Pore internal surface

**Figure 8.27:** Internal morphology of 90% PLGA<sub>85:15</sub> +5% ATCP<sub>(sr)</sub>+5%  $\beta$ TCP<sub>(sr)</sub> foams.

## 4 Mechanical Properties of Scaffolds

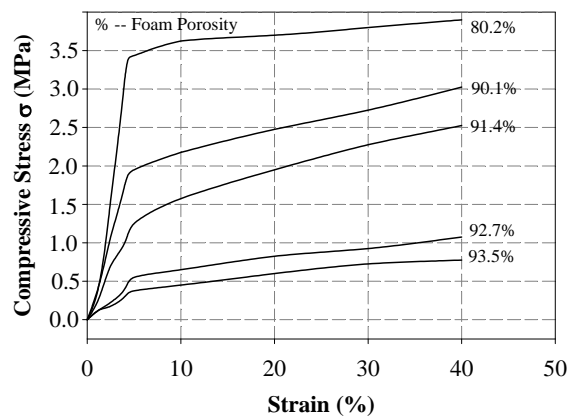
### 4.1 Mechanical Characteristics of PLGA<sub>85:15</sub> Foam

Compressive tests were performed to evaluate the mechanical properties of the pure polymer and composite foams. Some typical stress–strain curves of foams prepared at different process conditions and their equivalent pore diameter and geometric porosity of the foams are reported on Table 8.12. PLGA is basically an elastic-plastic material and the yielding behaviour may happen in a compression experiment. The data generated by the scaffolds for stress –strain exhibited striking yielding behaviours at low porosities, in which a stress peak appeared after an elastic deformation and was followed by a stress plateau. On the contrary the yielding peak disappeared at relative high porosities above approximately 90%, and gave a way

to a flexure point. So, the deformation of these PLGA porous scaffolds has strong dependence upon porosity.

**Table 8.12:** Pore diameter and porosity of PLGA<sub>85:15</sub> foams.

Types	P <sub>sat</sub> (bars)	t <sub>sat</sub> (min)	dP/dt (bar/s)	T <sub>sat</sub> (°C)	Pre Diameter d <sub>e</sub> (μm)	Geometric Porosity P (%)
Fibre	100	20	3	40	197.02	80.2
Fine fibre	100	20	3	40	210.71	90.1
Fine fibre	100	20	3	43	233.58	91.4
Fine fibre	100	20	3	46	248.85	92.7
Fine fibre	100	20	3	49	275.41	93.5



**Figure 8.28:** Some typical stress–strain curves of PLGA<sub>85:15</sub> porous scaffolds with internal macropores at different porosities produced at different process conditions.

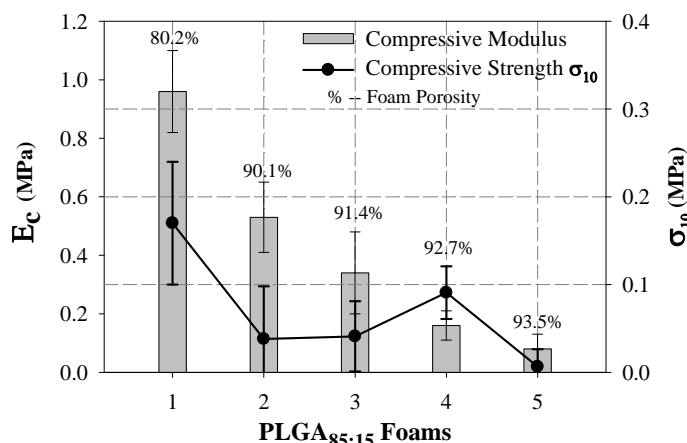
From viewpoint of tissue engineering, the yielding point should be avoided and suitable porosities are around 90% in most of cases. So, the disappearance of yielding peak at high porosities is not an unpleasant behaviour. The slope in the linear elastic region gives compressive modulus  $E_c$ , as discussed earlier in chapter 4. In our experiments with PLGA porous scaffolds, we found that the three parameters described similar trends, mainly due to the presence of yielding or flexure and also due to the fact that the yielding strain or flexure strain was not far away from 10%. Since, the clinically allowed deformation for an orthopaedic implant is usually around 0.7% of strain [Gibson and Ashby, 1999], PLGA scaffold with up to 10% strain in the linear elastic region would be quite good in the future application, as avoidance of yielding or flexure deformation is concerned. Scaling behaviours between mechanical properties of a foam and its relative density have been revealed theoretically based upon simplified models and also confirmed experimentally in various foams [Gibson and Ashby, 1999; Willett and Shogren, 2002; Thomson et al., 1995]. Compressive properties of pure PLGA<sub>85:15</sub> foams are tabulated in Table 8.13.

**Table 8.13:** PLGA<sub>85:15</sub> foam compressive test data obtained from stress strain curves.

Geometric Porosity (%)	80.2	90.1	91.4	92.7	93.5
$E_c$ (MPa)	0.96	0.53	0.34	0.16	0.08
$\sigma_{10}$ (Mpa)	0.170	0.038	0.034	0.0091	0.006

It is difficult to achieve a high compressive strength for porous materials because of the highly porous structure. In this study, when the porosities of the PLGA scaffolds increased from 80% to 93%, the elastic/compressive modulus decreased from 0.96 to 0.08 MPa, and the compressive strength at 10%

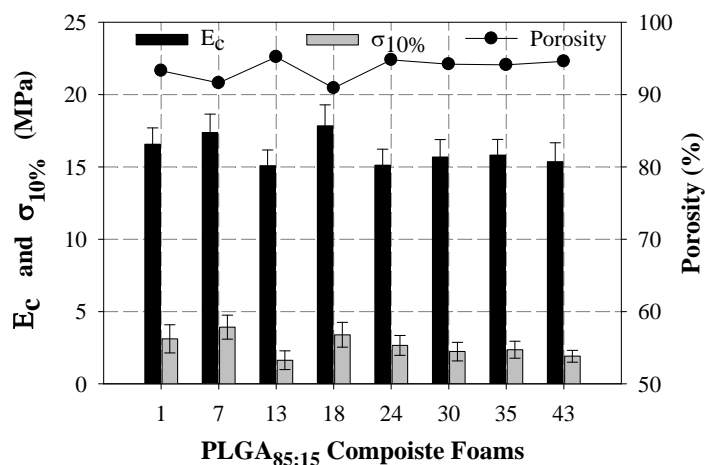
deformation of the scaffolds decreased from 0.170 to 0.006 MPa. Therefore, it is reasonable in this case that the compressive strength and modulus decreased with an increase of the scaffold's porosity (cf. Figure 8.29).



**Figure 8.29:** Compressive properties of pure PLGA<sub>85:15</sub> foams with different porosities.

## 4.2 Compressive Properties of Optimized PLGA<sub>85:15</sub> Composite Foams

These foams were manufactured at  $T_{\text{sat}} = 48 \pm 2^\circ\text{C}$ ,  $P_{\text{sat}} = 100$  bars,  $t_{\text{sat}} = 20$  min and dual  $dP/dt = 1$  and 3 bar/s. The composition was 90% PLGA<sub>85:15</sub> + 5% ATCP(sr) + 5%  $\beta$ TCP(sr). Approximately 500 foams were produced in 44 runs. Randomly 8 foams were selected for compression tests. In all the foams tested, the compressive modulus was in range 15 – 19 MPa. Porosity of all the foams was above 90 %. Compared to the pure polymer, the blends had compressive modulus 15 times more.



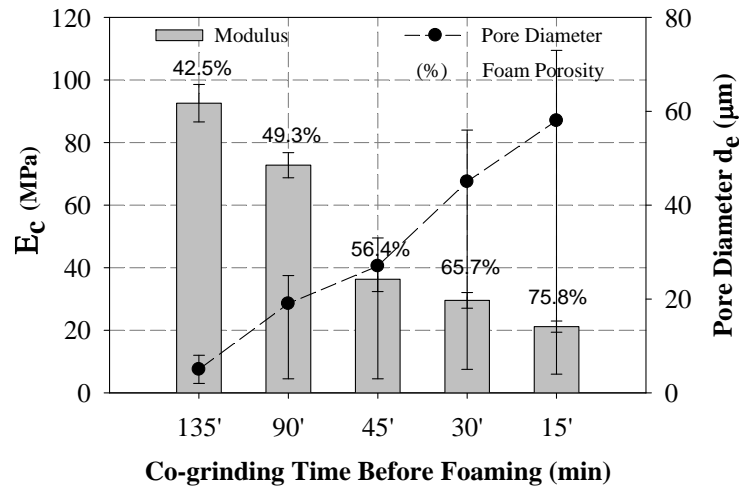
**Figure 8.30:** Compressive properties of foams containing 90% PLGA<sub>85:15</sub> + 5%  $\beta$ TCP<sub>(sr)</sub> + 5% ATCP<sub>(sr)</sub> processed at  $T_{\text{sat}} = 48^\circ\text{C}$ ,  $P_{\text{sat}} = 100$  bars,  $t_{\text{sat}} = 20$  min, and dual  $dP/dt = 1$  bar/s and 3 bar/s.

The rise in compressive modulus was due to the larger filler percentage (10% as compared to pure PLGA). These results show that incorporation of  $\beta$ TCP<sub>(sr)</sub> and ATCP significantly strengthens the composite as compared to PLGA alone.

## 4.3 Co-grinding time Effect on Compressive Properties of Composite Foams

During the entire experimentation before optimization of the process parameters polymer was co-ground with fillers in the tumbling ball mill for different durations. The blend composition was the same

(90% PLGA<sub>85:15</sub> + 5% ATCP<sub>(sr)</sub> + 5%  $\beta$ TCP<sub>(sr)</sub>) and foams were made at  $T_{\text{sat}} = 45^\circ\text{C}$ ,  $P_{\text{sat}} = 100$  bars.,  $t_{\text{sat}} = 20$  min and  $dP/dt = 3$  bar/s. The results obtained of the foam compression test are presented in Figure 8.31.



**Figure 8.31:** Compressive properties of foams containing 90 % PLGA<sub>85:15</sub> + 5 %  $\beta$ TCP<sub>(sr)</sub> + 5 % ATCP<sub>(sr)</sub> obtained after co-grinding.

Compressive test of five types of foams of mixtures coground in tumbling ball mill for 15, 30, 45, 90 and 135 minutes, was done. It can be inferred from Figure 8.31 that as co-grinding time was reduced there was a decrease in compressive modulus. The modulus of the foam was inversely proportional to the pore diameter of the foam. Moreover it was observed that as the porosity of the foam decreased, the modulus increased. The mechanical properties of porous composite foams are compared to those of the corresponding PLGA foam (cf. Figure 8.30 and Figure 8.31). Both the compressive modulus and the compressive yield strength of the composite foam are significantly higher than those of the pure PLGA foam. The data reveals that by co-grinding the filler with polymer, there is an increase in the compressive properties. Increase in porosity and pore diameter decreases the mechanical properties. If the foaming processing parameters such as saturation time or saturation temperature are increased pore diameter and porosity can be increased.

#### 4.4 Effect of Different Fillers and Wax-A Ratio on Compressive Properties of PLGA<sub>85:15</sub> Composite Foam

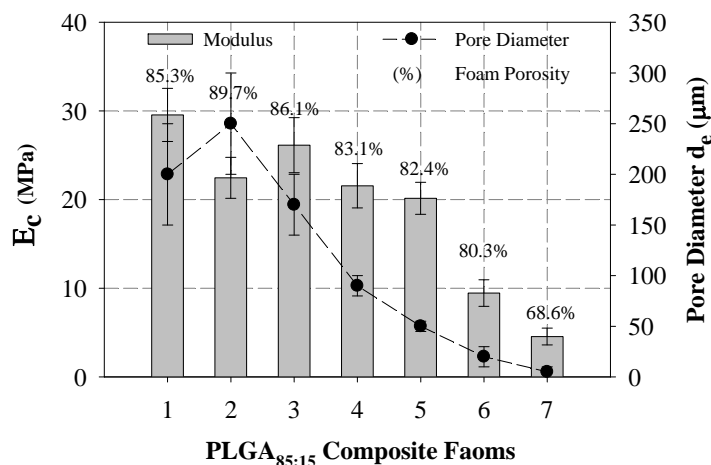
Foams of co-ground composites containing PLGA<sub>85:15</sub> +  $\beta$  TCP<sub>(sr)</sub> + ATCP<sub>(sr)</sub> and with different ratios of wax-A as tabulated in Table 8.14 were tested for their mechanical properties.

**Table 8.14:** Polymer matrix with variation in fillers and wax A ratio

S/N <sup>o</sup>	Polymer Matrix Composition
1	90% PLGA <sub>85:15</sub> + 5% ATCP <sub>(sr)</sub> + 5% $\beta$ TCP <sub>(sr)</sub>
2	95% PLGA <sub>85:15</sub> + 2.5% ATCP <sub>(sr)</sub> + 2.5% $\beta$ TCP <sub>(sr)</sub>
3	88.5% PLGA <sub>85:15</sub> + 5% ATCP <sub>(sr)</sub> + 5% $\beta$ TCP <sub>(sr)</sub> + 1.5% Paraffin
4	87% PLGA <sub>85:15</sub> + 5% ATCP <sub>(sr)</sub> + 5% $\beta$ TCP <sub>(sr)</sub> + 3% Paraffin
5	85% PLGA <sub>85:15</sub> + 5% ATCP <sub>(sr)</sub> + 5% $\beta$ TCP <sub>(sr)</sub> + 5% Paraffin
6	83% PLGA <sub>85:15</sub> + 5% ATCP <sub>(sr)</sub> + 5% $\beta$ TCP <sub>(sr)</sub> + 7% Paraffin
7	80% PLGA <sub>85:15</sub> + 5% ATCP <sub>(sr)</sub> + 5% $\beta$ TCP <sub>(sr)</sub> + 10% Paraffin

Pellets were made as per described procedure and foams were made at  $T_{\text{sat}} = 45^\circ\text{C}$ ,  $P_{\text{sat}} = 100$  bar  $t_{\text{sat}} = 20$  min,  $dP/dt = 3$  bar/s. The foams obtained were tested for compression test and results obtained are presented in Figure 8.32.





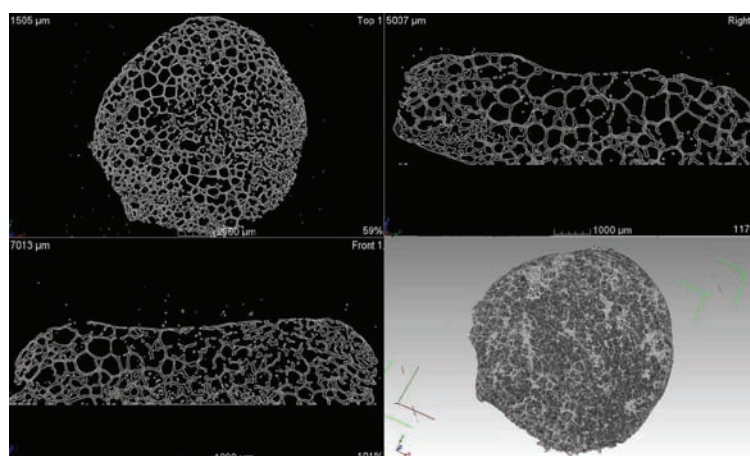
**Figure 8.32:** Compressive properties of 90%PLGA<sub>85:15</sub>+ 5%βTCP<sub>(sr)</sub>+5%ATCP<sub>(sr)</sub> foams with different fillers ratios

It can be inferred from Figure 8.32 that when filler percentage was reduced from 10 % to 5 % compressive modulus dropped from 29.5 to 22.5 MPa, while pore diameter and porosity increased inversely. Adding wax-A in the polymer/calcium phosphate composite reduced the modulus from 26 to 4.5 MPa (depending on the wax-A percentage). The equivalent pore diameter and geometric porosity were also reduced with addition of wax-A. Normally when the porosity and pore diameter is low compressive modulus is at higher values because the pore walls are stiffer. By the addition of wax A decreases the compressive modulus of the foam inspite of decrease in the porosity. The possible reason is wax do not possess high mechanical properties as a consequence the mechanical properties of the composite decrease.

## 5 Interconnectivity of Pores by μCT

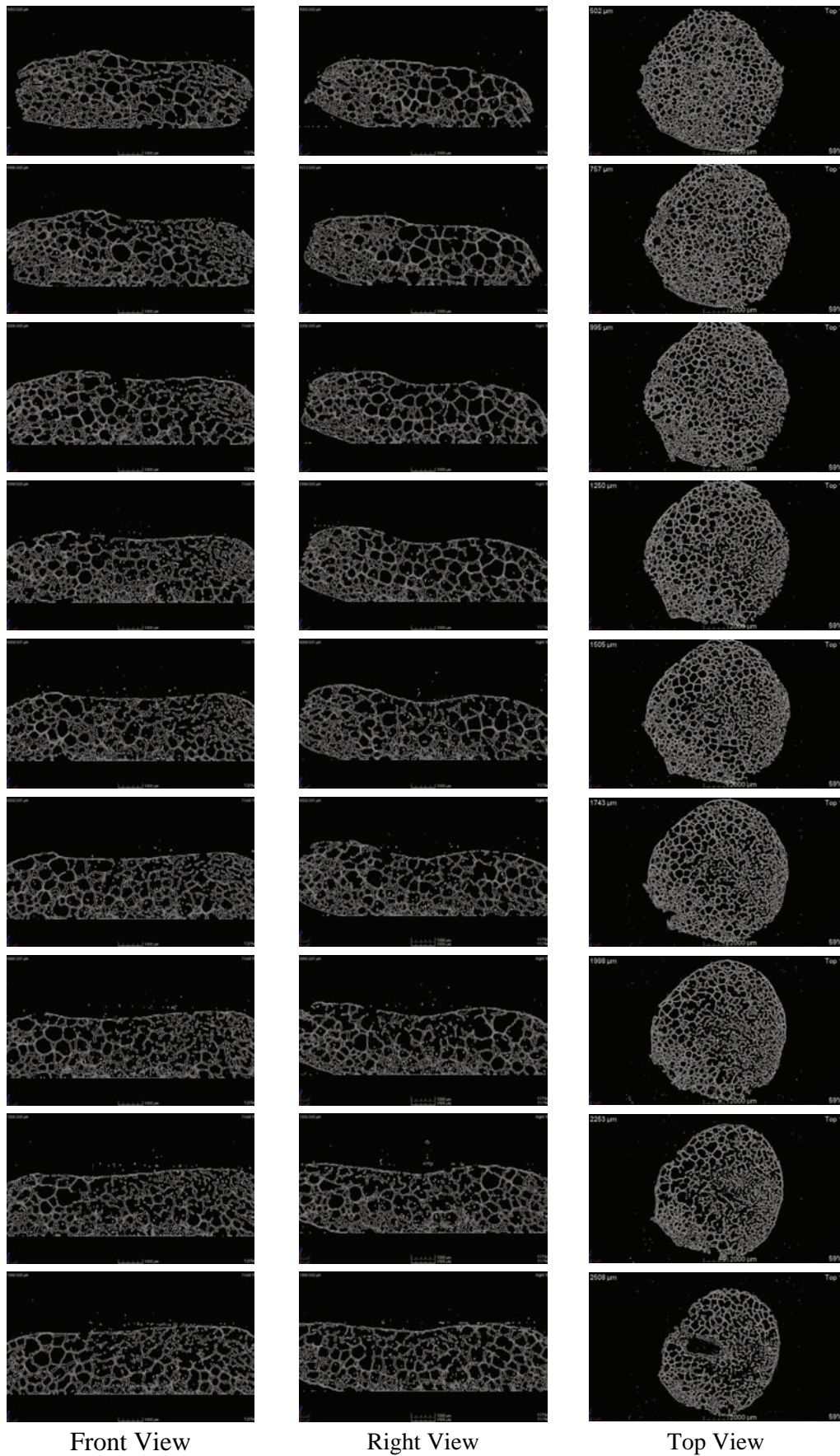
### 5.1 PLGA<sub>85:15</sub> Scaffold

Scaffold of PLGA<sub>85:15</sub> processed at  $T_{sat} = 48^{\circ}\text{C}$ ,  $P_{sat} = 100$  bars,  $t_{sat} = 20$  min and  $dP/dt = 3\text{bar/s}$  was analysed by μCT to visualize the interconnectivity. The structural image and front, right and top view of the internal structure is presented in Figure 8.33.



**Figure 8.33:** Slice images of pure PLGA<sub>85:15</sub> foams by μCT analysis processed at  $T_{sat} = 48^{\circ}\text{C}$ ,  $P_{sat} = 100$  bars,  $t_{sat} = 20$  min and  $dP/dt = 3\text{bar/s}$

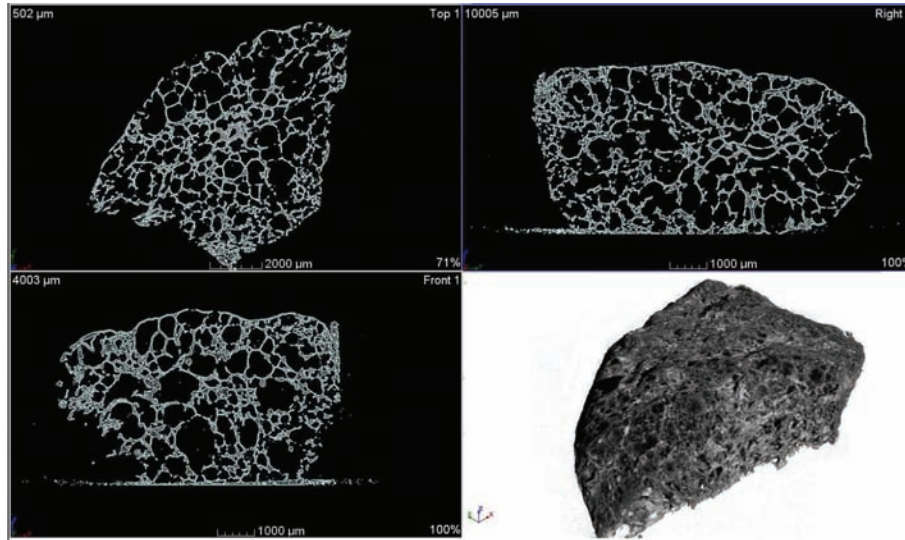
Slice images of the front, right, and top view of the scaffold after every 500 μm were taken and it can be observed that there is interconnectivity between the pores as presented in Figure 8.34.



**Figure 8.34:**  $\mu$ CT Slice images at intervals of  $500\mu\text{m}$  of pure  $\text{PLGA}_{85:15}$  foams structure showing interconnectivity processed at  $T_{\text{sat}} = 48^\circ\text{C}$ ,  $P_{\text{sat}} = 100$  bars,  $t_{\text{sat}} = 20$  min and  $dP/dt = 3\text{bar/s}$

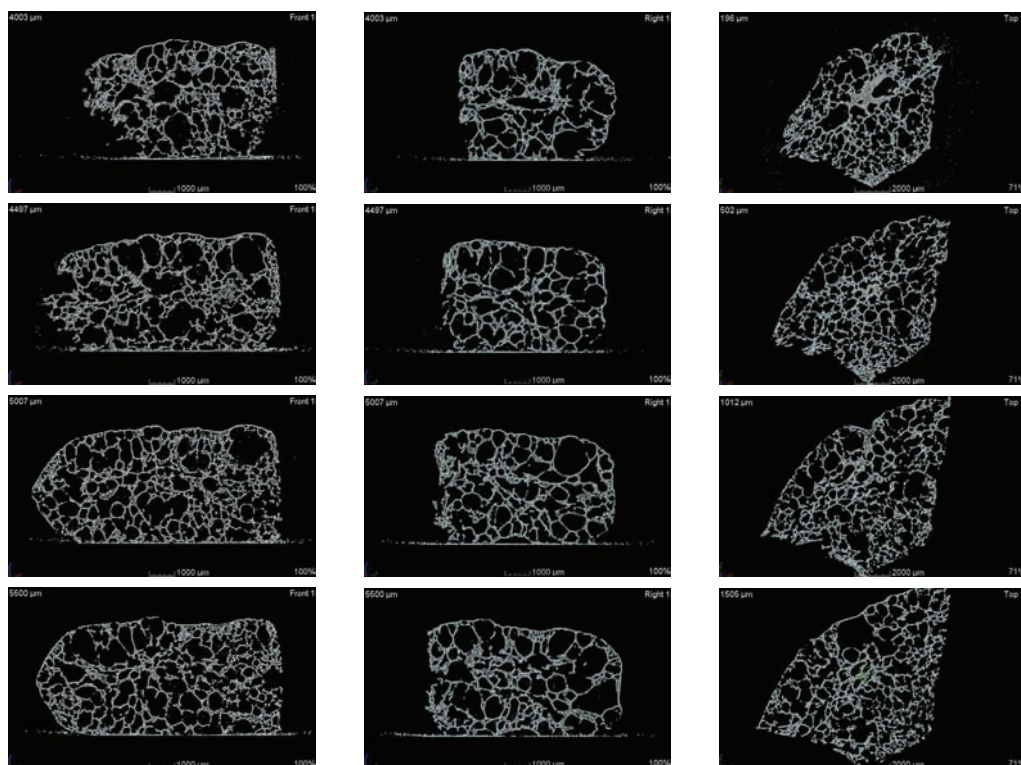
## 5.2 PLGA<sub>85:15</sub> Composite Scaffold

Scaffold of PLGA<sub>85:15</sub> composite processed at  $T_{\text{sat}} = 48^{\circ}\text{C}$ ,  $P_{\text{sat}} = 100$  bars,  $t_{\text{sat}} = 20$  min,  $dP/dt = 3\text{bar/s}$  was tested by  $\mu\text{CT}$  to analyze the interconnectivity. The structural image and front, right and top view of the internal structure is presented in Figure 8.35.

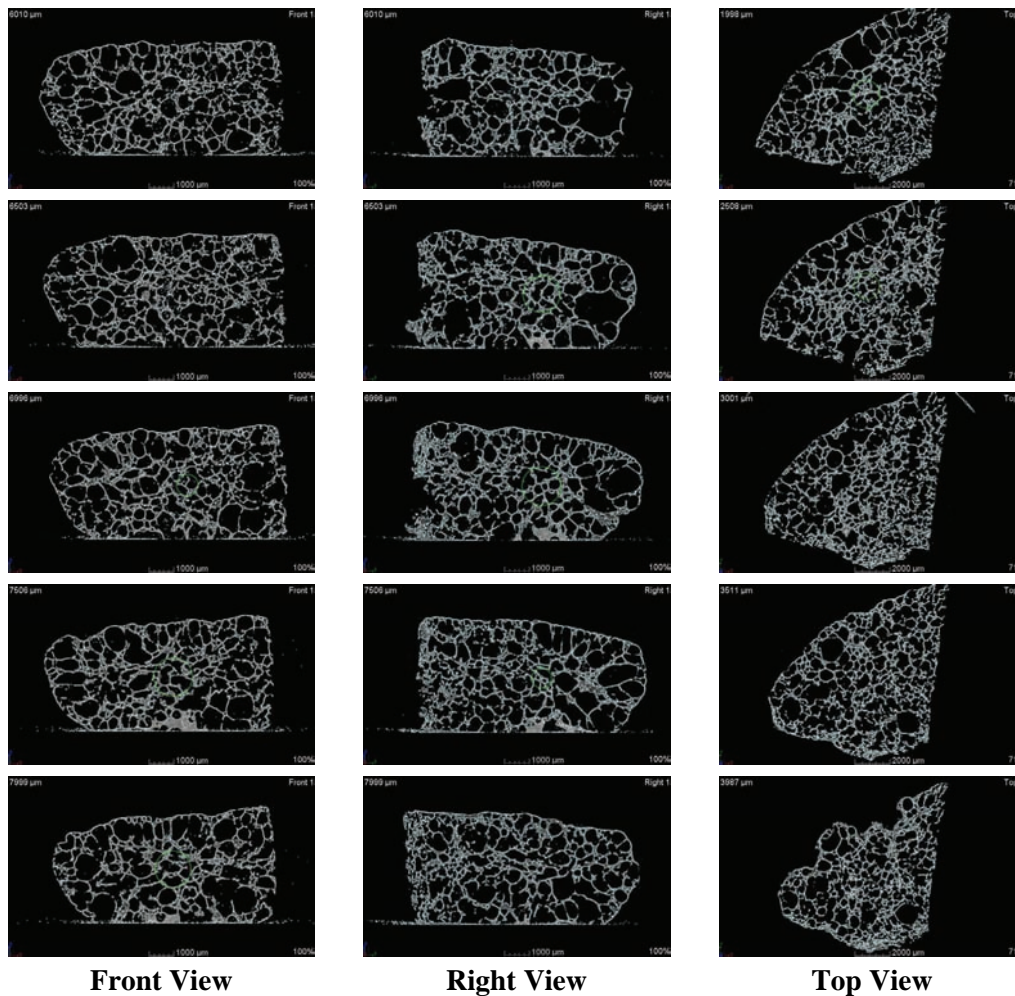


**Figure 8.35:** Slice images of 90 % PLGA<sub>85:15</sub> + 5 % ATCP<sub>(sr)</sub> + 5 %  $\beta$ TCP<sub>(sr)</sub> foams structure by  $\mu\text{CT}$  analysis processed at  $T_{\text{sat}} = 48^{\circ}\text{C}$ ,  $P_{\text{sat}} = 100$  bars,  $t_{\text{sat}} = 20$  min and  $dP/dt = 3\text{bar/s}$ .

Slice images of the front, right, and top view of the scaffold after every 500 $\mu\text{m}$  were taken and it can be observed that there is interconnectivity between the pores as presented in Figure 8.36.







**Figure 8.36:**  $\mu$ CT Slice images at intervals of  $500\mu\text{m}$  of 90 % PLGA<sub>85:15</sub> + 5 % ATCP<sub>(sr)</sub> + 5 %  $\beta$ TCP<sub>(sr)</sub> foams processed at  $T_{\text{sat}} = 48^\circ\text{C}$ ,  $P_{\text{sat}} = 100$  bars,  $t_{\text{sat}} = 20$  min, and  $dP/dt = 3\text{bar/s}$

## 6 General Discussion

Scaffolds required for bone regeneration required high modulus and compressive strength which can be obtained by foaming biopolymers of higher modulus/semi-crystalline polymer or higher molecular weight or by incorporating a mineral phase in a low modulus/low molecular weight polymer. Semi-crystalline polymer shows similar nature of trend. The draw back of high modulus/semi-crystalline polymers is that they produce porous foams of low porosity and pore equivalent diameter at low temperature close to their  $T_g$  in  $\text{scCO}_2$  foaming process. If polymer of high modulus/semi-crystalline is processed at temperature close to the melting temperature then foams of larger pores can be produced. Different poly(lactides co-glycolides) of high and low molecular weights were selected for foaming but as there was a compulsion of low temperature for processing in supercritical chamber, low intrinsic viscosity poly(lactide co-glycolides) of low modulus was finally selected for the thesis study.

Scaffolds obtained with pure poly(lactides co-glycolide) PLGA<sub>85:15</sub> (RG858 S) at optimum processing conditions ( $T_{\text{sat}} = 49^\circ\text{C}$ ,  $P_{\text{sat}} = 120$  bars,  $t_{\text{sat}} = 20$  min and  $dP/dt = 3\text{bar/s}$ .) generated porosity above 95% and equivalent pore diameter  $\sim 275\ \mu\text{m}$ . On the other hand modulus of the scaffold generated was  $\sim 1.0$  MPa which is very low for calcified scaffolds. To enhance the mechanical properties strontium doped filler calcium phosphate (amorphous and  $\beta$ ) were incorporated with variable percentages. 5 % ATCP and 5 %  $\beta$ TCP were the optimum percentages evolved in our study.

Two types of incorporation methods were utilized, co-grinding of fillers with polymer and simple mixing of polymer with filler. While adapting the technique of co-grinding polymer with filler there was an increase in the mechanical properties to a great extent but the porosity and pore diameter was too low than the desired values. A remedy to this problem was addition of a hydrophilic agent (wax) in the polymer filler composite. Adjuvant wax was used to enhance the solubility of CO<sub>2</sub> in the polymer during the foaming process. Wax is hydrophilic but has a very low melting temperature. It did not improve the porosity and pore diameter. Finally it was decided to produce foams by simple mixing of polymer and calcium phosphate. With this combination scaffolds with porosity above 85% and pore equivalent diameter of 320 μm with a compressive modulus ~18MPa were obtained at optimum process condition ( $T_{\text{sat}}=48^{\circ}\text{C}$ ,  $P_{\text{sat}}=100\text{ bar}$ ,  $t_{\text{sat}}=20\text{ min}$  and  $dP/dt=3\text{bar/s}$  )

Effect of polymer particle size on the foaming phenomena was also under study. Ranges of particles after passing through a series of sieves (125, 250, 400, 500, 600, 800μm) were obtained. From experimentation it was concluded that particles of neither less than 250 μm nor larger than 600μm produce scaffolds of appropriate porosity and pore diameter. So for our study particles between 250 and 600 μm were used for making blends with filler and adjuvant.

The porosity of the foams was calculated by geometric method and few selective foams were tested through Hg intrusion porosimetry method for actual results. μCT of the scaffold with best morphology was tested for interconnectivity. Slice images from front, top and right views were taken at interval of 500 μm and it was obvious that there was interconnectivity through out the scaffold.

## 7 Conclusion

In this work, copolymer and fillers were used to create highly porous biodegradable poly(α-hydroxyl acids) composite scaffolds. It is demonstrated that the porosity, pore size, and pore morphology of these composite foams can be controlled by the polymer composition, chemical structure of the polymer, calcium phosphate contents, co-grinding time and process parameters used. The high porosity is expected to better satisfy the cell penetration and mass transport requirements (for nutrient, metabolites, and soluble signals) for scaffolding for tissue engineering. Improved mechanical properties of the composite scaffolds over the pure polymer foams were demonstrated. New highly porous composites composed of biodegradable poly(α-hydroxyl acids) and calcium phosphate have been developed for bone-tissue engineering by scCO<sub>2</sub> foaming. A series of characteristic interconnected opened and closed pore microstructures with pore sizes ranging from 25 μm to 550 μm were created and porosity as high as 95 % was achieved. The compressive modulus and compressive strength at 10% deformation of the pure polymer foam and polymer/filler composite foam prepared from 90 % PLGA<sub>85:15</sub> + 5 % ATCP<sub>(sr)</sub> + 5 % βTCP<sub>(sr)</sub> have been discussed extensively. The properties of the foams can be controlled by (a) polymer composition (b) polymer /filler ratio (c) co-grinding/blending phenomenon and (d) process parameters  $P_{\text{sat}}$ ,  $T_{\text{sat}}$ ,  $t_{\text{sat}}$  and  $dP/dt$ . Semi-industrial production of PLGA filler composites was done with controlled pore morphology and structural properties. Dual  $dP/dt$  was effective to enhance the pore diameter and porosity. The mechanical properties of the composite foams can be increased by using a PLGA with higher modulus. The composite foams showed enhanced mechanical properties over the pure polymer foams. In future the degradation behaviour, detailed structure–property relationships, cell adhesion, and growth onto the composite scaffolds can be investigated for bone and tissue engineering updates



## General Conclusion and Perspective

In the field of medical science, transplantation provides hope for many patients with tissue loss or organ failure, but have inherent limitations such as donor shortage and required immuno-suppression therapy seriously hinder the potential benefits that such an approach can provide for many patients. The problems of current transplantation therapy have stimulated research for alternative solutions. An emerging interdisciplinary and multidisciplinary field aims to recreate biologically functional tissues and organs by using different types of biocompatible and biodegradable materials including a number of polymers. The progress in the investigation of polyester polymers as scaffolds for tissue engineering has been reviewed. Polyesters are attractive biomaterials due to their biocompatibility, biodegradability, and targeted biological activity, and the research results indicate their potential to be used as scaffold transplants for tissue and bone substitution.

Although solubility of  $\text{scCO}_2$  in polymers is very limited, many biodegradable polymers show a substantial sorption and swelling in carbon dioxide. We have carried out foaming experiments on different polylactides using supercritical  $\text{CO}_2$  and created porous polymer scaffolds for connective and calcified tissues. The sorption of  $\text{CO}_2$  is the first and most influent parameter for the fabrication of foams and solubility increases is depending on the chemical affinity and/or  $\text{CO}_2$  process factors. All parameters having an increasing effect on sorption of  $\text{CO}_2$  have an influence on number of generated nuclei. The pore size mostly depends on the depressurization period. During pressure drop, the nuclei grow to create pores and the pores continue to grow as the  $\text{CO}_2$  expands and desorbs. The growth of pores continues until the vitrification of the polymer. We strongly believe that the coalescence phenomenon occur during depressurization time which decrease the pore density and increase the final average pore diameter. Modelling works have also been carried out. All theoretical models (for the diffusion, sorption and nucleation) were in a good agreement with the experimental data.

Different commercial polylactides with various molecular mass, glass transition temperature, L/D configuration and LA/GA content ratio have been studied. Process parameters were applied by using modelling Doehlert' plan and screening Taguchi' design of experiments. We have achieved a control on pore size and finally optimize the pore diameter for the use of tissue engineering for cartilage and bone regeneration. Adjuvants such as hyaluronic acid and wax or fillers like amorphous and  $\beta$ -tricalcium phosphate were incorporated for improve adhesion, porosity and mechanical properties of the scaffolds.

Adjuvants waxes were added in the aim to enhance the solubility of  $\text{CO}_2$  in the polymer during the foaming process. Co-grinding phenomenon was used to modify surface of granulates for different co-grinding times. Foams were processed from these pellets and analysis of pore morphology and mechanical properties was done. Higher co-grinding time increased mechanical properties of the porous scaffolds but decreased porosity and pore diameter. However by manufacturing foams by simple mixing of fillers and polymer matrix produced foams of higher porosity up to 90% and pore diameter  $\sim 320\mu\text{m}$ . The compressive modulus of the foam was about 10 times higher than the pure polymer.

In case of scaffolds for cartilage and composites foams for bone, co-grinding phenomenon played an adverse role. Mechanical and adhesion properties of scaffolds were increased to a huge extent but pore size and porosity was reduced to undesirable limits. Blends of PLGA<sub>85:15</sub> and 10% HA after 1 hr of co-grinding produced foams of  $(250 \pm 50 \mu\text{m})$  equivalent pore size and 92% of geometric porosity at  $P_{\text{sat}} = 120$  bars,  $t_{\text{sat}} = 20$  min,  $T_{\text{sat}} = 60^\circ\text{C}$  and  $dP/dt = 3$  bar/s. In PLGA<sub>50:50</sub>, we have obtained a comparable macro porosity ranging from 228 to 270  $\mu\text{m}$ , and identical geometric porosity of 92% for the conditions  $P_{\text{sat}} = 120$  bars,  $t_{\text{sat}} = 20$  min,  $T_{\text{sat}} = 35^\circ\text{C}$  and  $dP/dt = 3$  bar/s.

On the other side dry method (polymer plus filler/surface modifier mixed or co-ground) and wet method (polymer dissolved in a good solvent) approach were compared. Micrographs showed that they adapted to have an in-depth sight of pore morphology and structure difference. The results revealed that in dry method on amorphous poly lactic acid produced foams with higher porosity and equivalent pore diameter than semi-crystalline poly lactic acid. On the similar basis foams with higher porosity and pore diameter were produced by Poly (lactide-co-glycolide) with higher LA/GA contents. Moreover, in dry method the pores were circular, homogeneous and had regular pore walls as compared to wet one where elongated and irregular pore boundaries were seen. In spite of achieving high percentage of porosity and pore diameter above 150  $\mu\text{m}$  due to a plasticization effect in good solvents of polylactides in the final produced foams might be difficult for application in the tissue transplantation sector but can be used for some other industrial applications. Presence of even slight amount of these solvent can hinder the existence of seeded cells on the porous structure.

The interconnectivity of the pores was confirmed with mercury porosimetry and  $\mu\text{CT}$  technique both for PLGA<sub>50:50</sub> and PLGA<sub>85:15</sub> foams with optimized pore diameters and porosity. The results obtained on equivalent pore diameter by 2D visual deduced from SCION® analysis were close to those measured by Hg porosimetry 3D technic., Finally, mechanical analysis of the foams was carried out by compression test. Compressive modulus and compressive strength were determined and compared with the foams manufactured at different processing conditions and having different porosities.

In conclusion, pore size and porosity of scaffolds can be manipulated by controlling the processes parameters such as the supercritical CO<sub>2</sub> conditions (saturation pressure, temperature and time, depressurization rate) and/or the co-grinding one (time, nature of materials, ...). All foams described in this work have been processed by pressure quench method in which during the depressurizing step in the process chamber temperature drops gradually, that affects on the anisotropy and pore structure of the foam. Future work must be carried out in order to control the temperature drop during the depressurization. Indeed, the temperature drop is an important parameter which affects the vitrification of the polymer and the thermodynamics of CO<sub>2</sub>. A proper thermodynamic analyze of the venting process of the pressure chamber deserves further investigation. This kind of analyze can provide vital information in order to create scale-up rules. Comparative thermodynamics studies must be done for polymers with different  $T_g$ 's, intrinsic viscosities and raw polymer mechanical properties.

The homogeneity of pores can be provided by a slow depressurization which is followed by a very sudden vitrification procedure. This kind of procedure can be difficult to realize, further process design can be proposed. On the other hand, further investigation can be considered in order to create bimodal pore structure by blending two different polymers in which the CO<sub>2</sub> has different sorption behaviours. Bimodal pore size might be of interest for sorting cells and molecules. A depressurization period with two steps can also be considered for such result. A number of works is already present on fabricating biodegradable scaffolds and new ideas have being proposed (Reverchon et al., 2008).

It seems that, in the future, the supercritical carbon dioxide foaming of polymers will continue to be a good trend to create porous polymers.

- A detailed physical and mathematical description of mass and heat transport phenomena occurring during the foaming process.
- Biopolymers with higher intrinsic viscosity may be investigated further to produces cellular structure of higher mechanical properties.

- In vivo testing of the produced porous structure might be applied to confirm the structural stability and application
- Semi-crystalline polymers can be used to produce foams by adapting wet pellet preparation method.



---

---

## BIBLIOGRAPHY

- Adamsky, F. A., and E. J. Beckman, Inverse emulsion polymerization of acrylamide in supercritical carbon dioxide, *Macromolecules*, 27(1), 312-314, **1994**.
- Adamson, A. W., and A. P. Gast, Physical chemistry of surfaces, 5th ed., Wiley, **1997**.
- Adhikari, R., and P. A. Gunatillake, Biodegradable synthetic polymers for tissue engineering., *Eur. Cells. Mater.*, 5(1), 1-16, **2003**.
- Ahmed, J., J.-X. Zhang, Z. Song, and S. K. Varshney, Thermal properties of polylactides Effect of molecular mass and nature of lactide isomer, *J Therm Anal Calorim*, 95(3), 957-964, **2008**.
- Aimanova, O. J., R. Z. LeGeros, and V. A. Sinyayev, Antimicrobiologic Property Hydrated Amorphous Calcium Phosphates Containing Silver, *J.Key Eng. Mater.*, 284-286, 439-444, **2005**.
- Alexandre, M., and P. Dubois, Polymer-layered silicate nanocomposites: preparation, properties and uses of a new class of materials, *Mater. Sci. Eng., R*, 28(1-2), 1-63, **2000**.
- Alsbjörn, B., In search of an ideal skin substitute, *Scand J Plast Reconstr Surg*, 18(1), 127-133, **1984**.
- Amjad, Z. (Ed.), Calcium phosphates in biological and industrial systems, Springer, **1997**.
- Anastas, P. T., L. Moens, and M. A. Abraham, Green chemistry as applied to solvents, In Clean Solvents: Alternative Media for Chemical Reactions and Processing, 819, illustrated edition., An American Chemical Society Publication, **2002**.
- Anderson, J. M., and M. S. Shive, Biodegradation and biocompatibility of PLA and PLGA microspheres, *Adv. Drug Delivery Rev.*, 28(1), 5-24, **1997**.
- Andrade, J. D., Surface and Interfacial Aspects of Biomedical Polymers: Protein Adsorption, Plenum Press, **1985**.
- Angus, S., B. Armstrong, and K. M. de Reuck, International Thermodynamic Tables of the Fluid State. Carbon Dioxide, Pergamon Press, Oxford, **1976**.
- Arefmanesh, A., and S. G. Advani, Diffusion-induced growth of a gas bubble in a viscoelastic fluid, *Rheol Acta*, 30(3), 274-283, **1991**.
- Arora, K. A., A. J. Lesser, and T. J. McCarthy, Compressive behaviour of microcellular polystyrene foams processed in supercritical carbon dioxide, *Polym. Eng. Sci.*, 38(12), 2055-2062, **1998a**.
- Arora, K. A., A. J. Lesser, and T. J. McCarthy, Preparation and Characterization of Microcellular Polystyrene Foams Processed in Supercritical Carbon Dioxide, *Macromolecules*, 31(14), 4614-4620, **1998b**.
- Auras, R. A., L.-T. Lim, S. E. M. Selke, and H. Tsuji, Poly(lactic Acid): Synthesis, Structures, Properties, Processing, and Applications, John Wiley and Sons, **2010**.
- Averbeck, M., C. A. Gebhardt, S. Voigt, S. Beilharz, U. Anderegg, C. C. Termeer, J. P. Sleeman, and J. C. Simon, Differential Regulation of Hyaluronan Metabolism in the Epidermal and Dermal Compartments of Human Skin by UVB Irradiation, *J Invest Dermatol*, 127(3), 687-697, **2006**.
- Baig, A. A., J. L. Fox, Z. Wang, W. I. Higuchi, S. C. Miller, A. M. Barry, and M. Otsuka, Metastable Equilibrium Solubility Behaviour of Bone Mineral, *Calcif. Tissue Int.*, 64(4), 329-339, **1999**.



- Bala, I., S. Hariharan, and M. N. V. R. Kumar, PLGA nanoparticles in drug delivery: the state of the art, *Crit. Rev. Ther. Drug Carrier Syst.*, 21(5), 387-422, **2004**.
- Baldyga, J., M. Henczka, B. Y. Shekunov, P. York, U. B. Kompella, and B. Y. Shekunov, Fluid dynamics, mass transfer and particle formation in supercritical fluids, In: Supercritical fluid technology for drug product development, CRC Press, **2004**.
- Barbari, T. A., and R. M. Conforti, The effect of lattice compressibility on the thermodynamics of gas sorption in polymers, *J. Polym. Sci. B Polym. Phys.*, 30(11), 1261-1271, **1992**.
- Barry, J. J. A., M. M. C. G. Silva, S. H. Cartmell, R. E. Guldberg, C. A. Scotchford, and S. M. Howdle, Porous methacrylate tissue engineering scaffolds: using carbon dioxide to control porosity and interconnectivity, *J Mater Sci*, 41(13), 4197-4204, **2006**.
- Bastioli, C., Handbook of biodegradable polymers, Smithers Rapra Publishing,, **2005**.
- Beckman, E. J., Supercritical and near-critical CO<sub>2</sub> in green chemical synthesis and processing, *The Journal of Supercritical Fluids*, 28(2-3), 121-191, **2004**.
- Belgrand, P., Apport de la R.M.N. de l'état solide à l'étude de biocéramiques de phosphate tricalcique et de pathologies osseuses = Solid-state NMR spectroscopy study of TriCalcium phosphate bioceramics and boneous diseases, Thesis, Université Paris VI, France, *Université Paris VI, France*, **1993**.
- Berens, A. R., and G. S. Huvard, Interaction of Polymers with Near-Critical Carbon Dioxide, In: Supercritical fluid science and technology, edited by K. P. Johnston and J. M. L. Penninger, American Chemical Society, **1989a**.
- Berens, A. R., and G. S. Huvard, Interaction of Polymers with Near-Critical Carbon Dioxide In, Supercritical Fluid Science and Technology, ACS Symposium Series, American Chemical Society, **1989b**.
- Berger, T. A., Separation of polar solutes by packed column supercritical fluid chromatography, *Journal of Chromatography A*, 785(1-2), 3-33, **1997**.
- Biswas, M., and S. S. Ray, New Polymerization Techniques and Synthetic Methodologies, Springer Berlin Heidelberg,, Berlin, Heidelberg, **2001**.
- Blitterswijk, C. A. van, and P. Thomsen, Tissue engineering, Academic Press, **2008**.
- Boccaccini, A. R., and V. Maquet, Bioresorbable and bioactive polymer/Bioglass® composites with tailored pore structure for tissue engineering applications, *Composites Science and Technology*, 63(16), 2417-2429, **2003**.
- Borden, M., S. F. El-Amin, M. Attawia, and C. T. Laurencin, Structural and human cellular assessment of a novel microsphere-based tissue engineered scaffold for bone repair, *Biomaterials*, 24(4), 597-609, **2003**.
- Boskey, A. L., and A. S. Posner, Magnesium stabilization of amorphous calcium phosphate: A kinetic study, *Mater. Res. Bull.*, 9(7), 907-916, **1974**.
- Boyan, B. D., T. W. Hummert, D. D. Dean, and Z. Schwartz, Role of material surfaces in regulating bone and cartilage cell response, *Biomaterials*, 17(2), 137-146, **1996**.
- Brett, P. M., J. Harle, V. Salih, R. Mihoc, I. Olsen, F. H. Jones, and M. Tonetti, Roughness response genes in osteoblasts, *Bone*, 35(1), 124-133, **2004**.

- Brittain, T., Particle-size distribution IV: Determination by laser-light scattering, *Pharmaceutical Technology*, 27(10), 102-104, **2003**.
- Brown, W. E., and L. C. Chow, A new calcium phosphate water-setting cement. In ,Cements Research Progress 1986,P Brown (Ed.), Amer Ceramic Society,, **1987**.
- Bruck, S. D., Medical applications of polymeric materials, *Med Prog Technol*, 9(1), 1-16, **1982**.
- Brunner, G., Gas extraction: an introduction to fundamentals of supercritical fluids and the application to separation processes, Ed. Techniques Ingénieur, **1994**.
- Buchanan, C. M., R. M. Gardner, and A. W. White, Aliphatic-aromatic copolyesters and cellulose ester/polymer blends, , **1995**.
- Buchanan, C. M., R. M. Gardner, M. D. Wood, A. W. White, S. C. Gedon, F. D. Barlow, and Jr, Aliphatic-aromatic copolyesters and cellulose ester/polymer blends, , **1994**.
- Buchatip, S., A. Petchsuk, and K. Kongsuwan, Synthesis and Mechanical Properties of Poly (LLA-co-DLLA) Copolymers, *Journal of Metals, Materials and Minerals*, 18, 175-180, **2008**.
- Büchler, P., D. P. Pioletti, and L. R. Rakotomanana, Biphasic constitutive laws for biological interface evolution, *Biomech Model Mechanobiol*, 1(4), 239-249, **2003**.
- Cantrell, G. O., and J. A. Blackwell, Comparison of 1,1,1,2-tetrafluoroethane and carbon dioxide-based mobile phases for packed column supercritical fluid chromatography, *Journal of Chromatography A*, 782(2), 237-246, **1997**.
- Cao, W., M. P. Mullarney, B. C. Hancock, S. Bates, and K. R. Morris, Modeling of transmitted X-ray intensity variation with sample thickness and solid fraction in glycine compacts, *J. Pharm. Sci.*, 92(12), 2345-2353, **2003**.
- Carter, Bone compressive strength: the influence of density and strain rate, *Science*, 194, 1174–1176, **1976**.
- Cassignol, C., P. Olivier, and A. Ricard, Influence of the dopant on the polypyrrole moisture content: Effects on conductivity and thermal stability, *Journal of Applied Polymer Science*, 70(8), 1567-1577, **1998**.
- Castelló-Cros, R., and E. Cukierman, Stromagenesis during tumorigenesis: characterization of tumor-associated fibroblasts and stroma-derived 3D matrices, *Methods Mol. Biol.*, 522, 275-305, **2009**.
- Cerroni, L., R. Filocamo, M. Fabbri, C. Piconi, S. Caropreso, and S. G. Condò, Growth of osteoblast-like cells on porous hydroxyapatite ceramics: an in vitro study, *Biomolecular Engineering*, 19(2-6), 119-124, **2002**.
- Chen, G., T. Ushida, and T. Tateishi, Poly(DL-lactic-co-glycolic acid) sponge hybridized with collagen microsponges and deposited apatite particulates, *J. Biomed. Mater. Res.*, 57(1), 8-14, **2001a**.
- Chen, G., T. Ushida, and T. Tateishi, Development of biodegradable porous scaffolds for tissue engineering, *Materials Science and Engineering: C*, 17(1-2), 63-69, **2001b**.
- Chen, Y., L. Tan, L. Chen, Y. Yang, and X. Wang, Study on biodegradable aromatic/aliphatic copolyesters, *Braz. J. Chem. Eng.*, 25(2), **2008**.
- Chong, B. F., L. M. Blank, R. McLaughlin, and L. K. Nielsen, Microbial hyaluronic acid production, *Appl. Microbiol. Biotechnol.*, 66(4), 341-351, **2004**.
- Chow, L. C., and E. D. Eanes, Amorphous calcium phosphate in Octacalcium phosphate, Karger Publishers,, **2001**.

- Cima, L. G., J. P. Vacanti, C. Vacanti, D. Ingber, D. Mooney, and R. Langer, Tissue engineering by cell transplantation using degradable polymer substrates, *J Biomech Eng*, 113(2), 143-151, **1991**.
- Clarival, A. M., and J. Halleux, Biodegradable polymers for industrial applications: Classification of biodegradable polymers, in *Classification of biodegradable polymers in. Biodegradable polymers for industrial applications*, edited by R. Smith, p. 3-(552), Woodhead, **2005**.
- Clarke, D. R., Interpenetrating Phase Composites, *J American Ceramic Society*, 75(4), 739-758, **1992**.
- Cohen-Solal, M., Strontium overload and toxicity: impact on renal osteodystrophy, *Nephrol. Dial. Transplant*, 17 Suppl 2, 30-34, **2002**.
- Cohn, D., H. Younes, and G. Marom, Amorphous and crystalline morphologies in glycolic acid and lactic acid polymers, *Polymer*, 28(12), 2018-2022, **1987**.
- Collins, N. J., R. H. Bridson, G. A. Leeke, and L. M. Grover, Particle seeding enhances interconnectivity in polymeric scaffolds foamed using supercritical CO<sub>2</sub>, *Acta Biomaterialia*, 6(3), 1055-1060, **2010**.
- Combes, C., and C. Rey, Amorphous calcium phosphates: Synthesis, properties and uses in biomaterials, *Acta Biomaterialia*, 6(9), 3362-3378, **2010**.
- Condo, P. D., I. C. Sanchez, C. G. Panayiotou, and K. P. Johnston, Glass transition behaviour including retrograde vitrification of polymers with compressed fluid diluents, *Macromolecules*, 25(23), 6119-6127, **1992**.
- Conn, R. E., J. J. Kolstad, J. F. Borzelleca, D. S. Dixler, L. J. Filer Jr, B. N. Ladu Jr, and M. W. Pariza, Safety assessment of polylactide (PLA) for use as a food-contact polymer, *Food Chem. Toxicol.*, 33(4), 273-283, **1995**.
- Cooper, A. I., Porous Materials and Supercritical Fluids, *Advanced Materials*, 15(13), 1049-1059, **2003**.
- Crank, J., The mathematics of diffusion, Clarendon Press, **1975**.
- Daculsi, G., O. Laboux, O. Malard, and P. Weiss, Current state of the art of biphasic calcium phosphate bioceramics, *J. Mater. Sci. Mater. Med.*, 14(3), 195-200, **2003**.
- Dang-Vu, T., and J. Hupka, Characterization of porous materials by capillary rise method., *Physicochemical Problems of Mineral Processing*, 39, 47-65, **2005**.
- Darr, J. A., and M. Poliakoff, New Directions in Inorganic and Metal-Organic Coordination Chemistry in Supercritical Fluids, *Chemical Reviews*, 99(2), 495-542, **1999**.
- De Groot, K., R. Geesink, C. P. A. T. Klein, and P. Serekian, Plasma sprayed coatings of hydroxylapatite, *Journal of Biomedical Materials Research*, 21(12), 1375-1381, **1987**.
- Dean, J. R., Extraction methods for environmental analysis, John Wiley, **1998**.
- Desimone, J. M., Z. Guan, and C. S. Elsbernd, Synthesis of fluoropolymers in supercritical carbon dioxide, *Science*, 257(5072), 945-947, **1992**.
- DeSimone, J. M., Practical approaches to green solvents, *Science*, 297(5582), 799-803, **2002**.
- Destainville, A., E. Champion, D. Bernache-Assollant, and E. Laborde, Synthesis, characterization and thermal behaviour of apatitic tricalcium phosphate, *Mater. Chem. Phys.*, 80(1), 269-277, **2003**.
- Devin, J. E., M. A. Attawia, and C. T. Laurencin, Three-dimensional degradable porous polymer-ceramic matrices for use in bone repair, *J Biomater Sci Polym Ed*, 7(8), 661-669, **1996**.

- Dickens, B., L. W. Schroeder, and W. E. Brown, Crystallographic studies of the role of Mg as a stabilizing impurity in [beta]-Ca<sub>3</sub>(PO<sub>4</sub>)<sub>2</sub>. The crystal structure of pure [beta]-Ca<sub>3</sub>(PO<sub>4</sub>)<sub>2</sub>, *J. Solid State Chem.*, 10(3), 232-248, **1974**.
- Dimarzio, E. A., and J. H. Gibbs, Molecular interpretation of glass temperature depression by plasticizers, *J. Polym. Sci. A Gen. Pap.*, 1(4), 1417-1428, **1963**.
- Dong, Z., and J. R. Fried, Statistical thermodynamics of the glass transition: 1. Effect of pressure and diluent concentration, *Computational and Theoretical Polymer Science*, 7(1), 53-64, **1997**.
- Doroudiani, S., C. B. Park, and M. T. Kortschot, Effect of the crystallinity and morphology on the microcellular foam structure of semicrystalline polymers, *Polym. Eng. Sci.*, 36(21), 2645-2662, **1996**.
- Duarte, A. R. C., J. F. Mano, and R. L. Reis, Supercritical fluids in biomedical and tissue engineering applications: a review, , 54(4), 214-222, **2009a**.
- Duarte, A. R. C., J. F. Mano, and R. L. Reis, Perspectives on: Supercritical Fluid Technology for 3D Tissue Engineering Scaffold Applications, *J. Bioact. Compat. Pol.*, 24(4), 385 -400, **2009b**.
- Ducheyne, P., S. Radin, and L. King, The effect of calcium phosphate ceramic composition and structure on in vitro behaviour. I. Dissolution, *J. Biomed. Mater. Res.*, 27(1), 25-34, **1993**.
- Dumitriu, S., *Polymeric biomaterials*, Marcel Dekker,, **1994**.
- Dunja Manal Abou Zeid, Anaerobic Biodegradation of Natural and Synthetic Polyesters, Von der Gemeinsamen Naturwissenschaftlichen Fakultät der Technischen Universität Carolo-Wilhemina zu Braunschweig, Thesis, p-182, *Von der Gemeinsamen Naturwissenschaftlichen Fakultät der Technischen Universität Carolo-Wilhemina zu Braunschweig*, **2001**.
- Eanes, E. D., Thermochemical studies on amorphous calcium phosphate, *Calc. Tis Res.*, 5(1), 133-145, **1970**.
- Eanes, E. D., and J. L. Meyer, The maturation of crystalline calcium phosphates in aqueous suspensions at physiologic pH, *Calc. Tis Res.*, 23(1), 259-269, **1977**.
- Eckert, C. A., B. L. Knutson, and P. G. Debenedetti, Supercritical fluids as solvents for chemical and materials processing, *Nature*, 383(6598), 313-318, **1996**.
- Elliott, J. C., *General Chemistry of the calcium orthophosphates: Structure and Chemistry of the Apatites and Other Calcium*, Elsevier Science Ltd, **1994a**.
- Elliott, J. C., *Studies in Inorganic Chemistry: Structure and Chemistry of the Apatites and Other Calcium Orthophosphates.*, Elsevier Science BV., Amsterdam, **1994b**.
- Eriksson, L., *Design of experiments: principles and applications*, MKS Umetrics AB, **2008**.
- Fages, J., H. Lochard, E. Rodier, J.-J. Letourneau, and M. Sauceau, La génération de solides divisés par fluides supercritiques, *Can. J. Chem. Eng.*, 81(2), 161-175, **2003**.
- Fairhurst, C., On the validity of the "Brazilian" test for brittle materials, *International Journal of Rock Mechanics and Mining Sciences & Geomechanics Abstracts*, 1(4), 535-546, **1964**.
- Fang, Q., and M. A. Hanna, Rheological properties of amorphous and semicrystalline polylactic acid polymers, *Ind. Crops Prod.*, 10(1), 47-53, **1999**.

- Fischbach, C., R. Chen, T. Matsumoto, T. Schmelzle, J. S. Brugge, P. J. Polverini, and D. J. Mooney, Engineering tumors with 3D scaffolds, *Nat. Methods*, 4(10), 855-860, **2007**.
- Fischer, E. W., H. J. Sterzel, and G. Wegner, Investigation of the structure of solution grown crystals of lactide copolymers by means of chemical reactions, *Kolloid-Z.u.Z.Polymere*, 251(11), 980-990, **1973**.
- Flichy, N. M. B., S. G. Kazarian, C. J. Lawrence, and B. J. Briscoe, Indentation of poly(methyl methacrylate) under high-pressure gases, *J. Polym. Sci. B Polym. Phys.*, 39(23), 3020-3028, **2001**.
- Fowkes, F. M., Determination of interfacial tensions, contact angles, and dispersion forces in surfaces by assuming additivity of intermolecular interactions in surfaces, *Journal of Physical Chemistry*, 66(3), 382, **1962**.
- Fowler, B. O., and S. Kuroda, Changes in heated and in laser-irradiated human tooth enamel and their probable effects on solubility, *Calcif. Tissue. Int.*, 38(4), 197-208, **1986**.
- Frisch, K. C., and J. H. Saunders, Plastic foams, Dekker, **1972**.
- Gabbott, P., Principles and applications of thermal analysis, 1st ed., John Wiley and Sons, **2008**.
- Gaonkar, A. G., and R. D. Neuman, The effect of wettability of wilhelmy plate and du Nouÿ ring on interfacial tension measurements in solvent extraction systems, *Journal of Colloid and Interface Science*, 98(1), 112-119, **1984**.
- Garg, H. G., and C. A. Hales, Medical application of hyaluronan in, Chemistry and biology of hyaluronan, Elsevier, **2004a**.
- Garg, H. G., and C. A. Hales, Methods for analysis of hyaluronan and its fragments in, Chemistry and biology of hyaluronan, Elsevier,, **2004b**.
- Garg, H. G., and C. A. Hales, Solution properties of hyaluronan in, Chemistry and biology of hyaluronan, Elsevier,, **2004c**.
- Garlotta, D., A literature review of poly (lactic acid), *J. Polym. Environ.*, 9(2), 63-84, **2001**.
- Georgiou, G., L. Mathieu, D. P. Pioletti, P.-E. Bourban, J.-A. E. Månson, J. C. Knowles, and S. N. Nazhat, Poly(lactic acid)-phosphate glass composite foams as scaffolds for bone tissue engineering, *J. Biomed. Mater. Res.*, 80B(2), 322-331, **2007**.
- Ghosh, S., V. Gutierrez, C. Fernandez, M. Rodriguezperez, J. Viana, R. Reis, and J. Mano, Dynamic mechanical behaviour of starch-based scaffolds in dry and physiologically simulated conditions: Effect of porosity and pore size, *Acta Biomaterialia*, 4(4), 950-959, **2008**.
- Ghosh, S., Recent Research and Development in Synthetic Polymer-Based Drug Delivery Systems, *Chem Inform*, 35(39), **2004**.
- Gibson, L. J., Biomechanics of cellular solids, *Journal of Biomechanics*, 38(3), 377-399, **2005**.
- Gibson, L. J., and M. F. Ashby, Cellular solids: structure and properties, 2nd ed., Cambridge University Press, **1999**.
- Gilding, D. K., and A. M. Reed, Biodegradable polymers for use in surgery--polyglycolic/poly(lactic acid) homo- and copolymers: 1, *Polymer*, 20(12), 1459-1464, **1979**.
- Gilman, P. S., and U. S. Benjamin, Mechanical alloying., *Annual Revue of Material Science*, 13, 279-300, **1983**.



- Gnip, I. Y., S. Vaitkus, V. Kersulis, and S. Vejelis, Assessment of strength under compression of expanded polystyrene (EPS) slabs, *Mater. Sci.-Medzg.*, 10(4), 326–329., **2004**.
- Goel, S. K., and E. J. Beckman, Generation of microcellular polymeric foams using supercritical carbon dioxide. I: Effect of pressure and temperature on nucleation, *Polym. Eng. Sci.*, 34(14), 1137-1147, **1994a**.
- Goel, S. K., and E. J. Beckman, Generation of microcellular polymeric foams using supercritical carbon dioxide. I: Effect of pressure and temperature on nucleation, *Polym. Eng. Sci.*, 34(14), 1137-1147, **1994b**.
- Goel, S. K., and E. J. Beckman, Nucleation and growth in microcellular materials: Supercritical CO<sub>2</sub> as foaming agent, *AIChE J.*, 41(2), 357-367, **1995**.
- Gombotz, W. R., and D. K. Pettit, Biodegradable Polymers for Protein and Peptide Drug Delivery, *Bioconjugate Chem.*, 6(4), 332-351, **1995**.
- Gomes, M. E., H. S. Azevedo, A. R. Moreira, V. Ellä, M. Kellomäki, and R. L. Reis, Starch–poly( $\epsilon$  caprolactone) and starch–poly(lactic acid) fibre mesh scaffolds for bone tissue engineering applications: structure, mechanical properties and degradation behaviour, *J Tissue Eng Regen Med*, 2(5), 243-252, **2008**.
- Goulet, R. W., S. A. Goldstein, M. J. Ciarelli, J. L. Kuhn, M. B. Brown, and L. A. Feldkamp, The relationship between the structural and orthogonal compressive properties of trabecular bone, *Journal of Biomechanics*, 27(4), 375-389, **1994**.
- Greenfield, D. J., and E. D. Eanes, Formation chemistry of amorphous calcium phosphates prepared from carbonate containing solutions, *Calc. Tis Res.*, 9(1), 152-162, **1972**.
- Gregory, T. M., E. C. Moreno, J. M. Patel, and W. E. Brown, Solubility of Ca<sub>3</sub>(PO<sub>4</sub>)<sub>2</sub>H<sub>2</sub>O in the system Ca(OH)<sub>2</sub>-H<sub>3</sub>PO<sub>4</sub>-H<sub>2</sub>O at 5, 15, 25, and 37 °C, *J Res Natl Bur Stand*, 78A, 667-674, **1974**.
- Gross, K. A., and L. M. L. M. Rodríguez-Lorenzo, Biodegradable composite scaffolds with an interconnected spherical network for bone tissue engineering, *Biomaterials*, 25(20), 4955-4962, **2004**.
- Gross, R. A., and B. Kalra, Biodegradable Polymers for the Environment, *Science*, 297(5582), 803 -807, **2002**.
- Guidoin, R., J. Couture, F. Assayed, and C. Gosselin, New frontiers of vascular grafting, *Int Surg*, 73(4), 241-249, **1988**.
- Gura, E., M. Hückel, and P.-J. Müller, Specific degradation of hyaluronic acid and its rheological properties, *Polymer Degradation and Stability*, 59(1-3), 297-302, **1998**.
- Habibovic, P., T. M. Sees, M. A. van den Doel, C. A. van Blitterswijk, and K. de Groot, Osteoinduction by biomaterials-Physicochemical and structural influences, *J. Biomed. Mater. Res.*, 77A(4), 747-762, **2006**.
- Hancock, B. C., and M. P. Mullarney, X-ray Microtomography of Solid Dosage Forms, *Pharmaceutical Technology*, 9, **2005**.
- Handa, Y. P., and Z. Zhang, A new technique for measuring retrograde vitrification in polymer-gas systems and for making ultramicrocellular foams from the retrograde phase, *J. Polym. Sci. B Polym. Phys.*, 38(5), 716-725, **2000**.

- Harris, L. D., B.-S. Kim, and D. J. Mooney, Open pore biodegradable matrices formed with gas foaming, *J. Biomed. Mater. Res.*, 42(3), 396-402, **1998**.
- Harrison, K. L., K. P. Johnston, and I. C. Sanchez, Effect of Surfactants on the Interfacial Tension between Supercritical Carbon Dioxide and Polyethylene Glycol, *Langmuir*, 12(11), 2637-2644, **1996**.
- Hedrick, J. L., L. J. Mulcahey, and L. T. Taylor, Supercritical fluid extraction, *Mikrochim Acta*, 108(3-6), 115-132, **1992**.
- Heughebaert, J. C., Contribution à l'étude de l'évolution des orthophosphates de calcium précipités amorphes en orthophosphates apatitiques, INP Toulouse, Thesis., Text, *INP Toulouse, France*, **1977**.
- Hile, D. D., M. L. Amirpour, A. Akgerman, and M. V. Pishko, Active growth factor delivery from poly(D,L-lactide-co-glycolide) foams prepared in supercritical CO<sub>2</sub>, *J Control Release*, 66(2-3), 177-185, **2000**.
- Ho, M.-H., P.-Y. Kuo, H.-J. Hsieh, T.-Y. Hsien, L.-T. Hou, J.-Y. Lai, and D.-M. Wang, Preparation of porous scaffolds by using freeze-extraction and freeze-gelation methods, *Biomaterials*, 25(1), 129-138, **2004**.
- Holmes, M. W., M. T. Bayliss, and H. Muir, Hyaluronic acid in human articular cartilage. Age-related changes in content and size., *Biochem.*, 250, 435-41, **1988**.
- Holt, C., M. J. J. M. Van Kemenade, L. S. Nelson Jr, D. W. L. Hukins, R. T. Bailey, J. E. Harries, S. S. Hasnain, and P. L. De Bruyn, Amorphous calcium phosphates prepared at pH 6.5 and 6.0, *Mater. Res. Bull.*, 24(1), 55-62, **1989**.
- Hou, Q., D. W. Grijpma, and J. Feijen, Porous polymeric structures for tissue engineering prepared by a coagulation, compression moulding and salt leaching technique, *Biomaterials*, 24(11), 1937-1947, **2003**.
- Howdle, S. M., M. S. Watson, M. J. Whitaker, M. C. Davies, K. M. Shakesheff, V. K. Popov, F. S. Mandel, and J. D. Wang, Supercritical fluid mixing: preparation of thermally sensitive polymer composites containing bioactive materials, *Chem. Commun.*, (1), 109-110, **2001**.
- Hsiao, A. Y., Y.-suke Torisawa, Y.-C. Tung, S. Sud, R. S. Taichman, K. J. Pienta, and S. Takayama, Microfluidic system for formation of PC-3 prostate cancer co-culture spheroids, *Biomaterials*, 30(16), 3020-3027, **2009**.
- Hulbert, S. F., F. A. Young, R. S. Mathews, J. J. Klawitter, C. D. Talbert, and F. H. Stelling, Potential of ceramic materials as permanently implantable skeletal prostheses, *J. Biomed. Mater. Res*, 4(3), 433-456, **1970**.
- Hull, C. W., Method for production of three-dimensional objects by stereolithography, , 16, **1990**.
- Hutmacher, D. W., Scaffolds in tissue engineering bone and cartilage, *Biomaterials*, 21(24), 2529-2543, **2000a**.
- Hutmacher, D. W., Scaffold design and fabrication technologies for engineering tissues--state of the art and future perspectives, *J Biomater Sci Polym Ed*, 12(1), 107-124, **2001**.
- Hutmacher, D. W., M. E. Hoque, and Y. S. Wong, in *Virtual prototyping & bio manufacturing in medical applications*, edited by B. Bidanda and P. Bártolo, p. 307, Springer, **2008**.
- Hutmacher, D. W., Scaffolds in tissue engineering bone and cartilage, *Biomaterials*, 21(24), 2529-2543, **2000b**.

- Ikada, Y., K. Jamshidi, H. Tsuji, and S. H. Hyon, Stereocomplex formation between enantiomeric poly(lactides), *Macromolecules*, 20(4), 904-906, **1987**.
- Ikada, Y., and H. Tsuji, Biodegradable polyesters for medical and ecological applications, *Macromol. Rapid Commun*, 21(3), 117-132, **1999**.
- ISO - International Organization for Standardization, Plastics. Differential scanning calorimetry (DSC). Determination of oxidation induction time, BS-ISO 11357-6:2002/Amd.1:2007(E), , **1963**.
- Itoh, S., M. Kikuchi, K. Takakuda, Y. Koyama, H. N. Matsumoto, S. Ichinose, J. Tanaka, T. Kawauchi, and K. Shinomiya, The biocompatibility and osteoconductive activity of a novel hydroxyapatite/collagen composite biomaterial, and its function as a carrier of rhBMP 2, *Journal of Biomedical Materials Research*, 54(3), 445-453, **2001**.
- Jarcho, M., R. L. Salsbury, M. B. Thomas, and R. H. Doremus, Synthesis and fabrication of  $\beta$ -tricalcium phosphate (whitlockite) ceramics for potential prosthetic applications, *J Mater Sci*, 14(1), 142-150, **1979**.
- Kaplan, D., [M. H. Hartmann (1998) in, Biopolymers from renewable resources, PP 367-411, Springer, **1998**.
- Karageorgiou, V., and D. Kaplan, Porosity of 3D biomaterial scaffolds and osteogenesis, *Biomaterials*, 26(27), 5474-5491, **2005a**.
- Karageorgiou, V., and D. Kaplan, Porosity of 3D biomaterial scaffolds and osteogenesis, *Biomaterials*, 26(27), 5474-5491, **2005b**.
- Karlsson, J., L. S. Sjögren, and L. S. Lohmander, Comparison of two hyaluronan drugs and placebo in patients with knee osteoarthritis. A controlled, randomized, double-blind, parallel-design multicentre study, *Rheumatology*, 41(11), 1240 -1248, **2002**.
- Kazarian, S. G., N. H. Brantley, B. L. West, M. F. Vincent, and C. A. Eckert, In Situ Spectroscopy of Polymers Subjected to Supercritical CO<sub>2</sub>: Plasticization and Dye Impregnation, *Appl. Spectrosc.*, 51(4), 491-494, **1997**.
- Kazarian, S. G., M. F. Vincent, F. V. Bright, C. L. Liotta, and C. A. Eckert, Specific Intermolecular Interaction of Carbon Dioxide with Polymers, *Journal of the American Chemical Society*, 118(7), 1729-1736, **1996a**.
- Kazarian, S. G., M. F. Vincent, F. V. Bright, C. L. Liotta, and C. A. Eckert, Specific Intermolecular Interaction of Carbon Dioxide with Polymers, *Journal of the American Chemical Society*, 118(7), 1729-1736, **1996b**.
- Kemmere, M. F., and T. Meyer, Supercritical carbon dioxide in polymer reaction engineering, Wiley-VCH, **2005**.
- Kennedy, K. A., Characterization of Phase Equilibrium associated with Heterogeneous Polymerizations in Supercritical Carbon Dioxide, **2003**.
- Khang, G., M. S. Kim, and H. B. Lee, A Manual for Biomaterials/Scaffold Fabrication Technology, World Scientific, **2007**.
- Kiesvaara, J., and J. Yliruusi, The use of the Washburn method in determining the contact angles of lactose powder, *International Journal of Pharmaceutics*, 92(1-3), 81-88, **1993**.
- Kikuchi, M., T. Ikoma, S. Itoh, H. N. Matsumoto, Y. Koyama, K. Takakuda, K. Shinomiya, and J. Tanaka, Biomimetic synthesis of bone-like nanocomposites using the self-organization mechanism of hydroxyapatite and collagen, *Composites Science and Technology*, 64(6), 819-825, **2004**.

- Kim, C. H., S. J. Lee, Y. J. Choi, S. H. Yun, and Y. Son, Protocol for Freeze-Drying Method, in *A Manual for Biomaterials/Scaffold Fabrication Technology*, edited by G. Khang, H. B. Lee, and M. S. Kim, pp. 45-52, World Scientific, **2007**.
- Kim, H.-W., J. C. Knowles, and H.-E. Kim, Porous scaffolds of gelatin-hydroxyapatite nanocomposites obtained by biomimetic approach: Characterization and antibiotic drug release, *J. Biomed. Mater. Res.*, 74B(2), 686-698, **2005**.
- Kim, H.-W., H.-H. Lee, and J. C. Knowles, Electrospinning biomedical nanocomposite fibres of hydroxyapatite/poly(lactic acid) for bone regeneration, *J Biomed Mater Res A*, 79(3), 643-649, **2006**.
- Kim, H. D., and S. L. Doo, Protocol for Thermally Induced Phase Separation (TIPS), in *A Manual for Biomaterials/Scaffold Fabrication Technology*, edited by G. Khang, H. B. Lee, and M. S. Kim, pp. 101-107, World Scientific, **2007**.
- Kim, S., H.-S. Ryu, H. S. Jung, and K. S. Hong, Influence of Ca/P ratios of starting solutions on the crystallization of amorphous calcium phosphate to hydroxyapatite, *Met. Mater. Int.*, 10(2), 171-175, **2004**.
- Kippax, P., Measuring particle size using modern laser diffraction techniques., Malvern Instruments Ltd., Malvern, Worcestershire, UK, **2005**.
- Kiszka, M. B., M. A. Meilchen, and M. A. McHugh, Modeling high-pressure gas-polymer mixtures using the sanchez-lacombe equation of state, *J. Appl. Polym. Sci.*, 36(3), 583-597, **1988**.
- Ko, J. T., Park, B.-H. Min, and G. Khang, Protocol of PLGA Microspheres for Tissue-Engineered Scaffold, in *A Manual for Biomaterials/Scaffold Fabrication Technology*, edited by G. Khang, M. S. Kim, and H. B. Lee, pp. 55-61, World Scientific, **2007**.
- Kojima, Y., K. Sakama, T. Toyama, and T. Yasue, Dehydration of water molecule in amorphous calcium phosphate, *J Invest Dermatol*, 4, 47-52, **1994**.
- Koros, W. J., and W. C. Madden, Transport properties In, *Encyclopedia of Polymer Science and Technology* Volume 12, 3rd Edition, Ed. H. F. Mark and J. I. Kroschwitz, 3rd ed., John Wiley & Sons Incorporated,, **2004**.
- Krause, B., H. J. P. Sijbesma, P. Mönöklü, N. F. A. van der Vegt, and M. Wessling, Bicontinuous Nanoporous Polymers by Carbon Dioxide Foaming, *Macromolecules*, 34(25), 8792-8801, **2001**.
- Kuboki, Y., Q. Jin, and H. Takita, Geometry of Carriers Controlling Phenotypic Expression in BMP-Induced Osteogenesis and Chondrogenesis, *J Bone Joint Surg Am*, 83(1\_suppl\_2), S105-115, **2001**.
- Kumar, V., and J. E. Weller, A model for the unformaed skin on microcellular foams, , 34(3), 169-173, **1994a**.
- Kumar, V., and J. E. Weller, Production of Microcellular Polycarbonate using Carbon Dioxide for Bubble Nucleation, *ASME Journal of Engineering for Industry*,, 116, 413-420, **1994b**.
- Lander, L. M., L. M. Siewierski, W. J. Brittain, and E. A. Vogler, A systematic comparison of contact angle methods, *Langmuir*, 9(8), 2237-2239, **1993**.
- Landers, R., and R. Mülhaupt, Desktop manufacturing of complex objects, prototypes and biomedical scaffolds by means of computer-assisted design combined with computer-guided 3D plotting of polymers and reactive oligomers, *Macromol. Mater. Eng.*, 282(1), 17-21, **2000**.

- Landrock, A. H., in *Handbook of plastic foams: types, properties, manufacture, and applications*, William Andrew, **1995**.
- Lang, S. M., D. D. Moyle, E. W. Berg, N. Detorie, A. T. Gilpin, N. J. Pappas Jr, J. C. Reynolds, M. Tkacik, and R. L. Waldron 2nd, Correlation of mechanical properties of vertebral trabecular bone with equivalent mineral density as measured by computed tomography, *J Bone Joint Surg Am*, 70(10), 1531-1538, **1988**.
- Langer, R., and D. A. Tirrell, Designing materials for biology and medicine, *Nature*, 428(6982), 487-492, **2004**.
- Lazghab, M., K. Saleh, I. Pezron, P. Guigon, and L. Komunjer, Wettability assessment of finely divided solids, *Powder Technology*, 157(1-3), 79-91, **2005**.
- LeBaron, P. C., Z. Wang, and T. J. Pinnavaia, Polymer-layered silicate nanocomposites: an overview, *Applied Clay Science*, 15(1-2), 11-29, **1999**.
- Lee, Y. S., and C. M. Chuong, Adhesion molecules in skeletogenesis: I. transient expression of neural cell adhesion molecules (NCAM) in osteoblasts during endochondral and intramembranous ossification, *J Bone Miner Res*, 7(12), 1435-1446, **2009**.
- LeGeros, R. Z., D. Mijares, J. Park, X.-F. Chang, I. Khairoun, R. Kijkowska, R. Dias, and J. P. LeGeros, Amorphous Calcium Phosphates (ACP): Formation and Stability, *KEM*, 284-286, 7-10, **2005**.
- LeGeros, R. Z., Properties of osteoconductive biomaterials: calcium phosphates, *Clin. Orthop. Relat. Res.*, (395), 81-98, **2002**.
- Leitner, W., and P. G. Jessop, Chemical synthesis using supercritical fluids, Wiley-VCH, **1999**.
- León y León, C. A., New perspectives in mercury porosimetry, *Advances in Colloid and Interface Science*, 76-77, 341-372, **1998**.
- Li, B., and R. M. Aspden, Composition and mechanical properties of cancellous bone from the femoral head of patients with osteoporosis or osteoarthritis, *J. Bone Miner. Res.*, 12(4), 641-651, **1997**.
- Li., H. Z., and M. Perrut, Décharge flash d'un gaz haute pression ou fluide supercritique résultats et modélisation, *2ème colloque Fluid. Supercr*, Paris, 11-27, **1991**.
- Liang, M.-T., and C.-M. Wang, Production of Very Low-Density Microcellular Polypropylene by Supercritical Carbon Dioxide., in *Proceedings of the 6th Meeting on Supercritical Fluids: Chemistry and Materials*, pp. 151-156, Nottingham, United Kingdom, **1999**.
- Lind, M., S. Overgaard, H. Glerup, K. Søballe, and C. Bünger, Transforming growth factor-[beta]1 adsorbed to tricalciumphosphate coated implants increases peri-implant bone remodeling, *Biomaterials*, 22(3), 189-193, **2001**.
- Lindenauer, S. M., T. R. Weber, T. A. Miller, S. R. Ramsburgh, C. A. Salles, S. P. Kahn, and R. S. Wojtalik, The use of velour as a vascular prosthesis, *Biomed Eng*, 11(9), 301-306, **1976**.
- Linhart, W., F. Peters, W. Lehmann, K. Schwarz, A. F. Schilling, M. Amling, J. M. Rueger, and M. Epple, Biologically and chemically optimized composites of carbonated apatite and polyglycolide as bone substitution materials, *J. Biomed. Mater. Res.*, 54(2), 162-171, **2001**.
- Liu, D., and D. L. Tomasko, Carbon dioxide sorption and dilation of poly(lactide-co-glycolide), *The Journal of Supercritical Fluids*, 39(3), 416-425, **2007a**.



- Liu, D., and D. L. Tomasko, Carbon dioxide sorption and dilation of poly(lactide-co-glycolide), *The Journal of Supercritical Fluids*, 39(3), 416-425, **2007b**.
- Lo, H., M. S. Ponticiello, and K. W. Leong, Fabrication of Controlled Release Biodegradable Foams by Phase Separation, *Tissue Engineering*, 1(1), 15-28, **1995**.
- Lucien, F. P., and N. R. Foster, Solubilities of solid mixtures in supercritical carbon dioxide: a review, *The Journal of Supercritical Fluids*, 17(2), 111-134, **2000**.
- Ma, P. X., B. Schloo, D. Mooney, and R. Langer, Development of biomechanical properties and morphogenesis of in vitro tissue engineered cartilage, *Journal of Biomedical Materials Research*, 29(12), 1587-1595, **1995**.
- Ma, P. X., and J.-W. Choi, Biodegradable Polymer Scaffolds with Well-Defined Interconnected Spherical Pore Network, *Tissue Eng*, 7(1), 23-33, **2001**.
- Ma, P. X., and R. Langer, Fabrication of Biodegradable Polymer Foams for Cell Transplantation and Tissue Engineering, in *Tissue Engineering*, vol. 18, pp. 47-56, Humana Press, New Jersey, **1998**.
- Ma, S.-L., Z.-W. Lu, Y.-T. Wu, and Z.-B. Zhang, Partitioning of drug model compounds between poly(lactic acid)s and supercritical CO<sub>2</sub> using quartz crystal microbalance as an in situ detector, *The Journal of Supercritical Fluids*, 54(2), 129-136, **2010**.
- Madhavan Nampoothiri, K., N. R. Nair, and R. P. John, An overview of the recent developments in polylactide (PLA) research, *Bioresource Technology*, 101(22), 8493-8501, **2010**.
- Malafaya, P. B., and R. L. Reis, Protocol for Particle-Aggregated Scaffolds, in *A Manual for Biomaterials/Scaffold Fabrication Technology*, edited by G. Khang, H. B. Lee, and M. S. Kim, pp. 77-86, World Scientific, **2007**.
- Maquet, V., A. R. Boccaccini, L. Pravata, I. Notinger, and R. Jérôme, Porous poly([alpha]-hydroxyacid)/Bioglass® composite scaffolds for bone tissue engineering. I: preparation and in vitro characterisation, *Biomaterials*, 25(18), 4185-4194, **2004**.
- Mark, J. E., Some Novel Polymeric Nanocomposites, *Accounts of Chemical Research*, 39(12), 881-888, **2006**.
- Martin, O., and L. Avérous, Poly(lactic acid): plasticization and properties of biodegradable multiphase systems, *Polymer*, 42(14), 6209-6219, **2001**.
- Mathieu, L. M., M.-O. Montjovent, P.-E. Bourban, D. P. Pioletti, and J.-A. E. Månson, Bioresorbable composites prepared by supercritical fluid foaming, *J Biomed Mater Res A*, 75(1), 89-97, **2005**.
- Mathieu, L. M., T. L. Mueller, P.-E. Bourban, D. P. Pioletti, R. Müller, and J.-A. E. Månson, Architecture and properties of anisotropic polymer composite scaffolds for bone tissue engineering, *Biomaterials*, 27(6), 905-916, **2006**.
- Mathieu, L., Processing of Porous Materials Composites For Bone Tissue Engineering, Thesis, *Ecole Polytechnique Fédérale de Lausanne, Switzerland*, **2004**.
- Mayagoitia, V., F. Rojas, I. Kornhauser, G. Zgrablich, J. Riccardo, F. Rodríguez-Reinoso, and K. K. Unger, Fluid-phase morphologies induced by capillary processes in porous media. In *Characterization of Porous Solids III. Studies in Surface Science and Catalysis*, Elsevier, **1994**.
- McHugh, M. A., and V. J. Krukonis, *Supercritical fluid extraction: principles and practice*, Butterworth-Heinemann, **1994**.

- McNally, M. E. P., Advances in environmental SFE, *Analytical Chemistry*, 67(1), 308A-315A, **1995**.
- Middleton, J. C., and A. J. Tipton, Synthetic Biodegradable Polymers as Medical Devices, *Medical Plastics and Biomaterials Magazine*, **1998**.
- Mikos, A. G., A. J. Thorsen, L. A. Czerwonka, Y. Bao, R. Langer, D. N. Winslow, and J. P. Vacanti, Preparation and characterization of poly(l-lactic acid) foams, *Polymer*, 35(5), 1068-1077, **1994**.
- Mikos, A. G., Y. Bao, L. G. Cima, D. E. Ingber, J. P. Vacanti, and R. Langer, Preparation of poly(glycolic acid) bonded fibre structures for cell attachment and transplantation, *J. Biomed. Mater. Res.*, 27(2), 183-189, **1993**.
- Miyata, T., and T. Masuko, Crystallization behaviour of poly(l-lactide), *Polymer*, 39(22), 5515-5521, **1998**.
- Modell, M., Processing methods for the oxidation of organics in supercritical water, , 1-14, **1982**.
- Moghimi, S. M., A. C. Hunter, and J. C. Murray, Long-Circulating and Target-Specific Nanoparticles: Theory to Practice, *Pharmacological Reviews*, 53(2), 283 -318, **2001**.
- Molina-Boisseau, S., N. Le Bolay, and M.-N. Pons, Fragmentation mechanism of poly(vinyl acetate) particles during size reduction in a vibrated bead mill, *Powder Technology*, 123(2-3), 282-291, **2002**.
- Monma, H., Preparation of octacalcium phosphate by the hydrolysis of  $\beta$ -tricalcium phosphate, *J Mater Sci*, 15(10), 2428-2434, **1980**.
- Monma, H., S. Ueno, and T. Kanazawa, Properties of hydroxyapatite prepared by the hydrolysis of tricalcium phosphate, *J. Chem. Technol. Biotechnol.*, 31(1), 15-24, **1981**.
- Mooney, D. J., S. Park, P. M. Kaufmann, K. Sano, K. McNamara, J. P. Vacanti, and R. Langer, Biodegradable sponges for hepatocyte transplantation, *Journal of Biomedical Materials Research*, 29(8), 959-965, **1995**.
- Mooney, D. J., and E. A. Silva, Tissue engineering: a glue for biomaterials, *Nat Mater*, 6(5), 327-328, **2007**.
- Mooney, D. J., D. F. Baldwin, N. P. Suh, J. P. Vacanti, and R. Langer, Novel approach to fabricate porous sponges of poly(-lactic-co-glycolic acid) without the use of organic solvents, *Biomaterials*, 17(14), 1417-1422, **1996**.
- Murphy, M. B., and A. G. Mikos, Polymer Scaffold Fabrication., Chapter 22, in *Principles of tissue engineering*, edited by R. P. Lanza and J. Vacanti, Academic Press, **2007**.
- Murphy, W. L., R. G. Dennis, J. L. Kileny, and D. J. Mooney, Salt fusion: an approach to improve pore interconnectivity within tissue engineering scaffolds, *Tissue Eng*, 8(1), 43-52, **2002**.
- Mykhaylyk, T. A., S. D. Evans, C. M. Fernyhough, I. W. Hamley, and J. R. Henderson, Surface energy of ethylene-co-1-butene copolymers determined by contact angle methods, *Journal of Colloid and Interface Science*, 260(1), 234-239, **2003**.
- Natali, A. N., and E. A. Meroi, A review of the biomechanical properties of bone as a material, *J Biomed Eng*, 11(4), 266-276, **1989**.
- Nazhat, S. N., M. Kellomäki, P. Törmälä, K. E. Tanner, and W. Bonfield, Dynamic mechanical characterization of biodegradable composites of hydroxyapatite and polylactides, *J. Biomed. Mater. Res*, 58(4), 335-343, **2001**.

- Neumann, A. W., R. J. Good, C. J. Hope, and M. Sejpal, An equation-of-state approach to determine surface tensions of low-energy solids from contact angles, *Journal of Colloid and Interface Science*, 49(2), 291-304, **1974**.
- Niemistö, A., Quantitative Image Analysis Methods for Applications in Biomedical Microscopy, Doctoral dissertation, *Tampere University of Technology, Finland*, **2006**.
- Nishida, H., Y. Fan, T. Mori, N. Oyagi, Y. Shirai, and T. Endo, Feedstock Recycling of Flame-Resisting Poly(lactic acid)/Aluminum Hydroxide Composite to 1,1-lactide, *Industrial & Engineering Chemistry Research*, 44(5), 1433-1437, **2005**.
- O'Donnell, J. N. R., G. E. Schumacher, J. M. Antonucci, and D. Skrtic, Structure-Composition-Property Relationships in Polymeric Amorphous Calcium Phosphate-Based Dental Composites, *Materials*, 2(4), 1929-1954, **2009**.
- Oh, S. H., and J. H. Lee, Protocol for Centrifugation Method, in *A Manual for Biomaterials/Scaffold Fabrication Technology*, edited by G. Khang, H. B. Lee, and M. S. Kim, pp. 111-116, World Scientific, **2007**.
- Ohta, K., H. Monma, and S. Takahashi, Adsorption characteristics of proteins on calcium phosphates using liquid chromatography, *Journal of Biomedical Materials Research*, 55(3), 409-414, **2001**.
- Oliveira, N. S., J. Dorgan, J. A. P. Coutinho, A. Ferreira, J. L. Daridon, and I. M. Marrucho, Gas solubility of carbon dioxide in poly(lactic acid) at high pressures, *Journal of Polymer Science Part B: Polymer Physics*, 44(6), 1010-1019, **2006a**.
- Oliveira, N. S., J. Dorgan, J. A. P. Coutinho, A. Ferreira, J. L. Daridon, and I. M. Marrucho, Gas solubility of carbon dioxide in poly(lactic acid) at high pressures, *J. Polym. Sci. B Polym. Phys.*, 44(6), 1010-1019, **2006b**.
- van Oss, C. J., M. K. Chaudhury, and R. J. Good, Monopolar surfaces, *Advances in Colloid and Interface Science*, 28, 35-64, **1987**.
- Oss, C. J. V., *Interfacial forces in aqueous media*, M. Dekker, **1994**.
- Oss, C. J. V., *Interfacial forces in aqueous media*, Taylor & Francis, **2006**.
- Otsu, N., A threshold selection method from gray-level histograms, *IEEE Transactions on Systems, Man and Cybernetics*, 9(1), 62-66, **1979**.
- Owens, D. K., and R. C. Wendt, Estimation of the surface free energy of polymers, *J. Appl. Polym. Sci.*, 13(8), 1741-1747, **1969**.
- Pan, J., and W. J. D. Shaw, Properties of a mechanically processed polymeric material, *Journal of Applied Polymer Science*, 52(4), 507-514, **1994**.
- Pan, J., and W. J. D. Shaw, Effects of processing parameters on material properties of mechanically processed polyamide, *Journal of Applied Polymer Science*, 56(5), 557-566, **1995**.
- Park, C. B., D. F. Baldwin, and N. P. Suh, Formation and Application of Polymer/Gas Mixtures in Continuous Processing of Microcellular Polymers," In: *Cellular and Microcellular Materials*, V. Kumar and K.A. Sealer, eds., ASME, New York, pp. 109-124, American Society of Mechanical Engineers, **1994**.
- Park, C. B., and L. K. Cheung, A study of cell nucleation in the extrusion of polypropylene foams, *Polym. Eng. Sci.*, 37(1), 1-10, **1997**.

- Park, M. S., Protocol for Gas-Foaming/Salt-Leaching Method, in *A Manual for Biomaterials/Scaffold Fabrication Technology*, edited by G. Khang, M. S. Kim, and H. B. Lee, pp. 35-42, World Scientific, **2007**.
- Park, T. G., Degradation of poly(lactic-co-glycolic acid) microspheres: effect of copolymer composition, *Biomaterials*, 16(15), 1123-1130, **1995**.
- Park, T. G., W. Lu, and G. Crotts, Importance of in vitro experimental conditions on protein release kinetics, stability and polymer degradation in protein encapsulated poly (-lactic acid-co-glycolic acid) microspheres, *Journal of Controlled Release*, 33(2), 211-222, **1995**.
- Park, Y. J., K. H. Nam, S. J. Ha, C. M. Pai, C. P. Chung, and S. J. Lee, Porous poly(-lactide) membranes for guided tissue regeneration and controlled drug delivery: membrane fabrication and characterization, *Journal of Controlled Release*, 43(2-3), 151-160, **1997**.
- Perry, R. H., D. W. Green, and J. O. Maloney, Principles of size reduction, In: Perry's chemical engineers' handbook, 7th ed., McGraw-Hill, **1997**.
- Petrie, E. M., Handbook of adhesives and sealants, McGraw-Hill Professional, **2000**.
- Pini, R., G. Storti, M. Mazzotti, H. Tai, K. M. Shakesheff, and S. M. Howdle, Sorption and swelling of poly(DL-lactic acid) and poly(lactic-co-glycolic acid) in supercritical CO<sub>2</sub>: An experimental and modeling study, *J. Polym. Sci. B Polym. Phys.*, 46(5), 483-496, **2008**.
- Poling, B. E., J. M. Prausnitz, and J. P. O'Connell, The properties of gases and liquids, McGraw-Hill, **2001**.
- Porter, B. D., J. B. Oldham, S.-L. He, M. E. Zobitz, R. G. Payne, K. N. An, B. L. Currier, A. G. Mikos, and M. J. Yaszemski, Mechanical Properties of a Biodegradable Bone Regeneration Scaffold, *J. Biomech. Eng.*, 122(3), 286-288, **2000**.
- Possart, W., and H. Kamusewitz, Wetting and scanning force microscopy on rough polymer surfaces: Wenzel's roughness factor and the thermodynamic contact angle, *Applied Physics A: Materials Science & Processing*, 76(6), 899-902, **2003**.
- Pouzet, S., N. Le Bolay, A. Ricard, and F. Jousse, Chemical synthesis and microwave properties of polypyrrole dispersed in a polycarbonate matrix, *Synthetic Metals*, 55(2-3), 1079-1084, **1993**.
- Price, R. L., K. Ellison, K. M. Haberstroh, and T. J. Webster, Nanometer surface roughness increases select osteoblast adhesion on carbon nanofibre compacts, *Journal of Biomedical Materials Research Part A*, 70A(1), 129-138, **2004**.
- Pruitt, B. A., and N. S. Levine, Characteristics and Uses of Biologic Dressings and Skin Substitutes, *Arch Surg*, 119(3), 312-322, **1984**.
- Puhl, W., and P. Scharf, Intra-articular hyaluronan treatment for osteoarthritis, *Annals of the Rheumatic Diseases*, 56(7), 441, **1997**.
- Quirk, R. A., R. M. France, K. M. Shakesheff, and S. M. Howdle, Supercritical fluid technologies and tissue engineering scaffolds, *Current Opinion in Solid State and Materials Science*, 8(3-4), 313-321, **2004a**.
- Quirk, R. A., R. M. France, K. M. Shakesheff, and S. M. Howdle, Supercritical fluid technologies and tissue engineering scaffolds, *Current Opinion in Solid State and Materials Science*, 8(3-4), 313-321, **2004b**.
- Rak, J., J. L. Ford, C. Rostron, and V. Walters, The preparation and characterization of poly(D,L-lactic acid) for use as a biodegradable drug carrier, *Pharm Acta Helv*, 60(5-6), 162-169, **1985**.

- Ranz, X., Développement et caractérisation de dépôts d'apatite obtenus par projection plasma sur prothèses orthopédiques, Thesis no. 1162,, *INPT, Toulouse, France*, **1996**.
- Rasch, C., W. Kollenberg, and W. R. GmbH, A modified "Brazilian" disk test –an indirect method to determine the tensile strength of ceramics, *48. Internationales Feuerfest-Kolloquium*, 49, 193-196, **2005**.
- Ratner, B. D., *Biomaterials science: an introduction to materials in medicine*, Academic Press, **2004**.
- Render, S., Fragmentation, in *Statistical models for the fracture of disordered media*, edited by H. J. Herrmann and S. Roux, pp. 321-28, North-Holland, **1990**.
- Reverchon, E., and S. Cardea, Production of controlled polymeric foams by supercritical CO<sub>2</sub>, *The Journal of Supercritical Fluids*, 40(1), 144-152, **2007a**.
- Reverchon, E., and S. Cardea, Production of controlled polymeric foams by supercritical CO<sub>2</sub>, *The Journal of Supercritical Fluids*, 40(1), 144-152, **2007b**.
- Rey, C., Etude des relations entre apatites et composés moléculaires = Study of relations between apatites and molecular compounds, Text, *INPT, Toulouse, France*, **1984**.
- Richardson, J. F., J. H. Harker, J. R. Backhurst, and J. M. Coulson, *Coulson and Richardson's chemical engineering: Particle technology and separation processes*, Butterworth-Heinemann, **2002**.
- Rodeheaver, B. A., and J. S. Colton, Open celled microcellular thermoplastic foam, *Polymer Engineering & Science*, 41(3), 380-400, **2001**.
- Rodrigues, A., and A. Lebugle, Influence of ethanol in the precipitation medium on the composition, structure and reactivity of tricalcium phosphate, *Colloids and Surfaces A: Physicochemical and Engineering Aspects*, 145(1-3), 191-204, **1998**.
- Roy, R. K., *A primer on the Taguchi method*, Van Nostrand Reinhold, **1990**.
- Rudawska, A., and E. Jacniacka, Analysis for determining surface free energy uncertainty by the Owen-Wendt method, *International Journal of Adhesion and Adhesives*, 29(4), 451-457, **2008**.
- Ruegg, M., U. Moor, and B. Blanc, A Calorimetric Study of the Thermal Denaturation of Whey Proteins in Simulated Milk Ultrafiltrate, *Journal of Dairy Research*, 44(03), 509-520, **1977**.
- Russo, P. S., S. Siripanyo, M. J. Saunders, and F. E. Karasz, Observation of a porous gel structure in poly(p-phenylenebenzobisthiazole)/97% sulfuric acid, *Macromolecules*, 19(11), 2856-2859, **1986**.
- Saari, H., Y. T. Konttinen, C. Friman, and T. Sorsa, Differential effects of reactive oxygen species on native synovial fluid and purified human umbilical cord hyaluronate, *Inflammation*, 17(4), 403-415, **1993**.
- Sachlos, E., and J. T. Czernuszka, Making tissue engineering scaffolds work. Review: the application of solid freeform fabrication technology to the production of tissue engineering scaffolds, *Eur Cell Mater*, 5, 29-39; discussion 39-40, **2003**.
- Sachs, E., T. Fan, A. Curodeau, J. F. Bredt, M. Cima, and D. Brancazio, Three dimensional printing, , 17, **1998**.
- Salgado, A. J., O. P. Coutinho, and R. L. Reis, Bone tissue engineering : state of the art and future trends, , **n.d.**
- Sanchez, I. C., and R. H. Lacombe, An elementary molecular theory of classical fluids. Pure fluids, *The Journal of Physical Chemistry*, 80(21), 2352-2362, **1976**.



- Sanchez, I. C., and R. H. Lacombe, An elementary equation of state for polymer liquids, *J. Polym. Sci. B Polym. Lett. Ed.*, 15(2), 71-75, **1977**.
- Sanchez, I. C., and R. H. Lacombe, Statistical Thermodynamics of Polymer Solutions, *Macromolecules*, 11(6), 1145-1156, **1978**.
- Sanders, J., C. Royden, K. F. Philbrook, and J. L. Forsyth, 3-D model maker, , **1996**.
- Schenderlein, S., M. Lück, and B. W. Müller, Partial solubility parameters of poly(d,l-lactide-co-glycolide), *International Journal of Pharmaceutics*, 286(1-2), 19-26, **2004**.
- Schindler, A., and D. Harper, Polylactide. II. Viscosity–molecular weight relationships and unperturbed chain dimensions, *J. Polym. Sci. Polym. Chem. Ed.*, 17(8), 2593-2599, **1979**.
- Schmack, G., Biodegradable Polymers: Properties, Possibilities, and Limits Considering the Synthesis, Processing, and Application of Poly(2-Hydroxypropionic Acid) and Poly(3-Hydroxybutyric Acid), in *Polymers - Opportunities and Risks II*, vol. 12, edited by P. Eyerer, M. Weller, and C. Hübner, p. 195-(304), Springer Berlin Heidelberg, Berlin, Heidelberg, **2009**.
- Schugens, C., V. Maquet, C. Grandfils, R. Jerome, and P. Teyssie, Polylactide macroporous biodegradable implants for cell transplantation. II. Preparation of polylactide foams by liquid-liquid phase separation, *J. Biomed. Mater. Res*, 30(4), 449-461, **1996**.
- Scott S., C., Apparatus and method for creating three-dimensional - United States of America Patent., , 15, **1992**.
- Sedlak, J. M., and R. A. Beebe, Temperature programmed dehydration of amorphous calcium phosphate, *Journal of Colloid and Interface Science*, 47(2), 483-489, **1974**.
- Sekhon, B., Supercritical Fluid Technology: An Overview of. Pharmaceutical Applications, *International Journal of PharmTech Research*, 2(1), 810-826, **2010**.
- Seneviratne, G., N. S. Tennakoon, K. A. Nandasena, and M. L. M. A. W. Weerasekara, Polyethylene biodegradation by a developed Penicillium–Bacillusbiofilm, *Current Science Assoc*, 90(1), 20-21, **2006**.
- Seyni, A., Propriétés physico-chimiques et d’usage de matériaux composites à charge dégradables produits par co-broyage, *L’institut National Polytechnique de Toulouse, France*, **2009**.
- Shastri, V. P., I. Martin, and R. Langer, Macroporous polymer foams by hydrocarbon templating, *Proc Natl Acad Sci U S A*, 97(5), 1970-1975, **2000**.
- Shaw, D. J., Introduction to colloid and surface chemistry, Butterworth-Heinemann, **1992**.
- Sheridan, M. H., L. D. Shea, M. C. Peters, and D. J. Mooney, Bioabsorbable polymer scaffolds for tissue engineering capable of sustained growth factor delivery, *Journal of Controlled Release*, 64(1-3), 91-102, **2000**.
- Shi, C., Z. Huang, S. Kilic, J. Xu, R. M. Enick, E. J. Beckman, A. J. Carr, R. E. Melendez, and A. D. Hamilton, The Gelation of CO(2): A Sustainable Route to the Creation of Microcellular Materials, *Science*, 286(5444), 1540-1543, **1999**.
- Singh, L., V. Kumar, and B. D. Ratner, Generation of porous microcellular 85/15 poly (DL-lactide-co-glycolide) foams for biomedical applications, *Biomaterials*, 25(13), 2611-2617, **2004**.
- Sinha Ray, S., and M. Okamoto, Polymer/layered silicate nanocomposites: a review from preparation to processing, *Progress in Polymer Science*, 28(11), 1539-1641, **2003**.

- Smith, R. M., Supercritical fluids in separation science - the dreams, the reality and the future, *Journal of Chromatography A*, 856(1-2), 83-115, **1999**.
- Somrani, S., M. Banu, M. Jemal, and C. Rey, Physico-chemical and thermochemical studies of the hydrolytic conversion of amorphous tricalcium phosphate into apatite, *Journal of Solid State Chemistry*, 178(5), 1337-1348, **2005**.
- Somrani, S., C. Rey, and M. Jemal, Thermal evolution of amorphous tricalcium phosphate, *J. Mater. Chem.*, 13(4), 888-892, **2003**.
- Song, S. C., and J. H. Lee, Injectable Thermosensitive Gel, in *A Manual for Biomaterials/Scaffold Fabrication Technology*, edited by G. Khang, H. B. Lee, and M. S. Kim, pp. 121-128, World Scientific, **2007**.
- Span, R., and W. Wagner, A New Equation of State for Carbon Dioxide Covering the Fluid Region from the Triple-Point Temperature to 1100 K at Pressures up to 800 MPa, *J. Phys. Chem. Ref. Data*, 25(6), 1509, **1996**.
- Sparacio, D., and E. J. Beckman, Generation of Microcellular Biodegradable Polymers Using Supercritical Carbon Dioxide: In-Solvent-free polymerizations and processes: minimization of conventional organic solvents, edited by T. E. Long and M. O. Hunt, American Chemical Society, **1998**.
- Stafford, C. M., T. P. Russell, and T. J. McCarthy, Expansion of Polystyrene Using Supercritical Carbon Dioxide: Effects of Molecular Weight, Polydispersity, and Low Molecular Weight Components, *Macromolecules*, 32(22), 7610-7616, **1999**.
- Steinbüchel, A., Biopolymers, Vol. 3b: Polyesters II: Properties and Chemical Synthesis, Wiley-VCH, **2003**.
- Storti, F., and F. Balsamo, Particle size distributions by laser diffraction &ndash; Part 1: Sensitivity of granular matter strength to analytical operating procedures, *Solid Earth Discuss.*, 1(1), 93-141, **2009**.
- Sublett, B. J., Copolyester adhesives, , **1983**.
- Suh, K., and D. Webb, Encyclopedia of polymer science and engineering: Volume 3, Cellular Materials to Composites, 2nd ed., Wiley, **1988**.
- Szycher, M., and S. J. Lee, Modern Wound Dressings: A Systematic Approach to Wound Healing, *Journal of Biomaterials Applications*, 7(2), 142 -213, **1992**.
- Tadic, D., F. Beckmann, K. Schwarz, and M. Epple, A novel method to produce hydroxyapatite objects with interconnecting porosity that avoids sintering, *Biomaterials*, 25(16), 3335-3340, **2004**.
- Tai, H. et al., Control of pore size and structure of tissue engineering scaffolds produced by supercritical fluid processing, *Eur Cell Mater*, 14, 64-77, **2007a**.
- Tai, H. et al., Control of pore size and structure of tissue engineering scaffolds produced by supercritical fluid processing, *Eur Cell Mater*, 14, 64-77, **2007b**.
- Tampieri, A., G. Celotti, E. Landi, M. Sandri, N. Roveri, and G. Falini, Biologically Inspired Synthesis of Bone-Like Composite: Self-Assembled Collagen Fibres/Hydroxyapatite Nanocrystals., *J Biomed Mater Res Pt A*, 67A(2), 618-625, **2003a**.
- Tampieri, A., G. Celotti, E. Landi, M. Sandri, N. Roveri, and G. Falini, Biologically inspired synthesis of bone like composite: Self assembled collagen fibres/hydroxyapatite nanocrystals, *Journal of Biomedical Materials Research Part A*, 67A(2), 618-625, **2003b**.

- Temenoff, J. S., L. Lu, and A. G. Mikos, Bone-tissue engineering using synthetic biodegradable polymer scaffolds., in *Bone engineering*, edited by J. E. Davies, Rainbow Graphic and Printing Ltd, Toronto, Canada, **2000**.
- Thomason, T. B., and M. Modell, Supercritical Water Destruction of Aqueous Wastes, *Hazardous Waste*, 1(4), 453-467, **1984**.
- Thomson, R. C., M. J. Yaszemski, J. M. Powers, and A. G. Mikos, Fabrication of biodegradable polymer scaffolds to engineer trabecular bone, *J Biomater Sci Polym Ed*, 7(1), 23-38, **1995**.
- Thomson, R. C., M. J. Yaszemski, J. M. Powers, and A. G. Mikos, Hydroxyapatite fibre reinforced poly(alpha-hydroxy ester) foams for bone regeneration, *Biomaterials*, 19(21), 1935-1943, **1998a**.
- Thomson, R. C., M. J. Yaszemski, J. M. Powers, and A. G. Mikos, Hydroxyapatite fibre reinforced poly([alpha]-hydroxy ester) foams for bone regeneration, *Biomaterials*, 19(21), 1935-1943, **1998b**.
- Tomasko, D. L., H. Li, D. Liu, X. Han, M. J. Wingert, L. J. Lee, and K. W. Koelling, A Review of CO<sub>2</sub> Applications in the Processing of Polymers, *Industrial & Engineering Chemistry Research*, 42(25), 6431-6456, **2003**.
- Trater, A. M., S. H. Alavi, and S. S. H. Rizvi, Study of microstructure development in extruded biopolymeric foams: non-invasive image analysis using computer-aided X-ray microtomography, *Food Research International*, 38, 709-719, **2005**.
- Tsivintzelis, I., D. Missopolinou, K. Kalogiannis, and C. Panayiotou, Phase compositions and saturated densities for the binary systems of carbon dioxide with ethanol and dichloromethane, *Fluid Phase Equilibria*, 224(1), 89-96, **2004**.
- Tsivintzelis, I., E. Pavlidou, and C. Panayiotou, Porous scaffolds prepared by phase inversion using supercritical CO<sub>2</sub> as antisolvent: I. Poly(L-lactic acid), *The Journal of Supercritical Fluids*, 40(2), 317-322, **2007a**.
- Tsivintzelis, I., A. G. Angelopoulou, and C. Panayiotou, Foaming of polymers with supercritical CO<sub>2</sub>: An experimental and theoretical study, *Polymer*, 48(20), 5928-5939, **2007b**.
- Tsuruga, E., H. Takita, H. Itoh, Y. Wakisaka, and Y. Kuboki, Pore Size of Porous Hydroxyapatite as the Cell-Substratum Controls BMP-Induced Osteogenesis, *Journal of Biochemistry*, 121(2), 317 -324, **1997a**.
- Tsuruga, E., H. Takita, H. Itoh, Y. Wakisaka, and Y. Kuboki, Pore Size of Porous Hydroxyapatite as the Cell-Substratum Controls BMP-Induced Osteogenesis, *Journal of Biochemistry*, 121(2), 317 -324, **1997b**.
- Tung, M. S., Calcium phosphate: structure, composition, solubility, and stability' in, Calcium phosphates in biological and industrial systems, edited by Z. Amjad, Zahid Amjad, Kluwer Academic Publishers, p3-19(534), **1998**.
- Välilmaa, T., and S. Laaksovirta, Degradation behaviour of self-reinforced 80L/20G PLGA devices in vitro, *Biomaterials*, 25(7-8), 1225-1232, **2004**.
- Vallet-Regí, M., M. Gordo, C. V. Ragel, M. Y. Cabañas, and J. S. Román, Synthesis of ceramic-polymer-drug biocomposites at room temperature, *Solid State Ionics*, 101-103(Part 2), 887-892, **1997**.
- Van de Velde, K., and P. Kiekens, Biopolymers: overview of several properties and consequences on their applications, *Polymer Testing*, 21(4), 433-442, **2002**.

- Van Oss, C. J., R. J. Good, and M. K. Chaudhury, Additive and nonadditive surface tension components and the interpretation of contact angles, *Langmuir*, 4(4), 884-891, **1988**.
- Vandenburg, H. J., A. A. Clifford, K. D. Bartle, J. Carroll, I. Newton, L. M. Garden, J. R. Dean, and C. T. Costley, Analytical Extraction of Additives From Polymers, *Critical Review: Analytical Extraction of Additives From Polymers*, 122(1), 101R-115R, **1997**.
- Vargha-Butler, E. I., E. Kiss, C. N. C. Lam, Z. Keresztes, E. Kalman, L. Zhang, and A. W. Neumann, Wettability of biodegradable surfaces, *Colloid & Polymer Science*, 279(12), 1160-1168, **2001**.
- Varki, A., R. D. Cummings, J. D. Esko, H. H. Freeze, P. Stanley, C. R. Bertozzi, G. W. Hart, and M. E. Etzler, Hyaluronan in, *Essentials of glycobiology*, CSHL Press, **1999**.
- Wang, W.-C. V., E. J. Kramer, and W. H. Sachse, Effects of high-pressure CO<sub>2</sub> on the glass transition temperature and mechanical properties of polystyrene, *J. Polym. Sci. Polym. Phys. Ed.*, 20(8), 1371-1384, **1982**.
- Warson, H., and C. A. Finch, Fundamentals of polymer Chemistry, In: Applications of Synthetic Resin Latices: Fundamental chemistry of latices and applications in adhesives, John Wiley and Sons, **2001**.
- Watson, and O'neill, Differential Microcalorimeter, , 10, **1962**.
- Welch, J. H., and W. Gutt, High-temperature studies of the system calcium oxide?phosphorus pentoxide, *J. Chem. Soc.*, 4442, **1961**.
- Wessling, M., Z. Borneman, T. Van Den Boomgaard, and C. A. Smolders, Carbon dioxide foaming of glassy polymers, *J. Appl. Polym. Sci.*, 53(11), 1497-1512, **1994**.
- Widmer, M. S., P. K. Gupta, L. Lu, R. K. Meszlenyi, G. R. D. Evans, K. Brandt, T. Savel, A. Gurlek, C. W. PatrickJr, and A. G. Mikos, Manufacture of porous biodegradable polymer conduits by an extrusion process for guided tissue regeneration, *Biomaterials*, 19(21), 1945-1955, **1998**.
- Wijk, G., Some new theoretical aspects of indirect measurements of the tensile strength of rocks, *International Journal of Rock Mechanics and Mining Sciences & Geomechanics Abstracts*, 15(4), 149-160, **1978**.
- Willett, J. L., and R. L. Shogren, Processing and properties of extruded starch/polymer foams, *Polymer*, 43(22), 5935-5947, **2002**.
- Wissinger, R. G., and M. E. Paulaitis, Swelling and sorption in polymer-CO<sub>2</sub> mixtures at elevated pressures, *J. Polym. Sci. B Polym. Phys.*, 25(12), 2497-2510, **1987**.
- van de Witte, P., P. J. Dijkstra, J. W. A. van den Berg, and J. Feijen, Phase separation processes in polymer solutions in relation to membrane formation, *Journal of Membrane Science*, 117(1-2), 1-31, **1996**.
- Wu, W., Baseline studies of the clay minerals society source clays: colloid and surface phenomena, *Clays and Clay Minerals*, 49(5), 446-52, **2001**.
- Wunderlich, B., Basics of Thermal Analysis, In: Thermal analysis of polymeric materials, Springer, **2005**.
- Xiong, Z., Fabrication of porous scaffolds for bone tissue engineering via low-temperature deposition, *Scripta Materialia*, 46(11), 771-776, **2002**.
- Xu, R., Particle characterization : light scattering methods, Springer, Netherlands, **2000**.

- Yang, X., and Z. Wang, Synthesis of biphasic ceramics of hydroxyapatite and  $\beta$ -tricalcium phosphate with controlled phase content and porosity, *J. Mater. Chem.*, 8(10), 2233-2237, **1998**.
- Yenikolopyan, N. S., Structure and morphology of powered polymeric materials obtained by elasticdeformation grinding, *Polymer Science*, 11(30), 2569-2576, **1988**.
- Yoda, R., Elastomers for biomedical applications, *J Biomater Sci Polym Ed*, 9(6), 561-626, **1998**.
- Young, H. D., and R. A. Freedman, University Physics with Modern Physics, 10th ed., Addison Wesley Longman, Inc., San Francisco, **2000**.
- Yu, L., Biodegradable polymer blends and composites from renewable resources, John Wiley and Sons, **2009**.
- Yu, Y., J. Yin, and Z. Zhong, Shape effects in the Brazilian tensile strength test and a 3D FEM correction, , 43(4), 623-27, **2006**.
- Yuan, H., Z. Yang, J. D. De Bruij, K. De Groot, and X. Zhang, Material-dependent bone induction by calcium phosphate ceramics: a 2.5-year study in dog, *Biomaterials*, 22(19), 2617-2623, **2001**.
- Zanetti, M., S. Lomakin, and G. Camino, Polymer layered silicate nanocomposites, *Macromol. Mater. Eng.*, 279(1), 1-9, **2000**.
- Zapata-Massot, C., Synthesis of composite materials by dry co-grinding. Characterization of the properties of the produced materials., , **2004**.
- Zenkiewicz, M., Comparative study on the surface free energy of a solid calculated by different methods, *Polymer Testing*, 26(1), 14-19, **2007a**.
- Zenkiewicz, M., Methods for the calculation of surface free energy of solids, *Journal of Achievements in Materials and Manufacturing Engineering*, 24(1), 137-145, **2007b**.
- Zhang, R., and P. X. Ma, Poly(alpha-hydroxyl acids)/hydroxyapatite porous composites for bone-tissue engineering. I. Preparation and morphology, *J. Biomed. Mater. Res*, 44(4), 446-455, **1999a**.
- Zhang, R., and P. X. Ma, Poly(a-hydroxyl acids)/hydroxyapatite porous composites for bone-tissue engineering. I. Preparation and morphology, *J. Biomed. Mater. Res.*, 44(4), 446-455, **1999b**.
- Zhang, Y., and M. Zhang, Microstructural and mechanical characterization of chitosan scaffolds reinforced by calcium phosphates, *Journal of Non-Crystalline Solids*, 282(2-3), 159-164, **2001**.





# **ANNEXES**



## Annex-A-1

A-1.1 SL-EOS for the binary mixture of CO<sub>2</sub>-PLGA50:50

The units for this section are bar for pressure, K for temperature, g/l for density and (bar\*L)/(molK) for the gas constant.

Characteristic Parameters for CO<sub>2</sub>

$$P1star := 5745$$

$$T1star := 305$$

$$\rho1star := 1510$$

$$M1 := 44.01$$

Characteristic Parameters for PLGA50:50

$$P2star := 5727$$

$$T2star := 649.6$$

$$\rho2star := 1452$$

$$M2 := 14500$$

Gas Constant  $R := 8314 \cdot 10^{-5}$

$$T := 310.15$$

$$r2 := \frac{P2star \cdot M2}{R \cdot T2star \cdot \rho2star} \quad r1 := \frac{P1star \cdot M1}{R \cdot T1star \cdot \rho1star}$$

Function  $\rho_{r\_SL}$  calculates the reduced density of a mixture given the pressure (bar), Temperature (K), weight fraction of CO<sub>2</sub> dissolved in the polymer phase, and the binary interaction parameter.

$$\rho_{r\_SL}(P, T, ml, \zeta) := \left\{ \begin{array}{l} \phi1 \leftarrow \frac{\frac{ml}{\rho1star}}{\frac{1-ml}{\rho2star} + \frac{ml}{\rho1star}} \\ Pstar \leftarrow \phi1^2 \cdot P1star + (1-\phi1)^2 \cdot P2star + 2 \cdot \phi1 \cdot (1-\phi1) \cdot (1-\zeta) \cdot \sqrt{P1star \cdot P2star} \\ Tstar \leftarrow \frac{Pstar}{\frac{\phi1 \cdot P1star}{T1star} + \frac{(1-\phi1) \cdot P2star}{T2star}} \\ r \leftarrow \frac{1}{\frac{\phi1}{r1} + \frac{1-\phi1}{r2}} \\ Tred \leftarrow \frac{T}{Tstar} \\ Pred \leftarrow \frac{P}{Pstar} \\ \rho_{r\_inv} \leftarrow 0.9 \\ root \left[ \rho_{r\_inv}^2 + Pred + Tred \cdot \left[ \ln(1 - \rho_{r\_inv}) + \rho_{r\_inv} \cdot \left( 1 - \frac{1}{r} \right) \right], \rho_{r\_inv} \right] \end{array} \right.$$

$$\rho_{r\_SL}(125, 308, 0.217495, 0.9928) = 0.762$$

Function  $\mu_{l\_SL}$  determines the chemical potential of the penetrant carbon dioxide given the pressure (bar), temperature (K), weight fraction of CO<sub>2</sub> dissolved in the polymer phase, and the binary interaction parameter.

$$\mu l_{SL}(P, T, ml, \zeta) := \left\{ \begin{array}{l} \phi l \leftarrow \frac{\frac{ml}{\rho 1star}}{\frac{1 - ml}{\rho 2star} + \frac{ml}{\rho 1star}} \\ \chi \leftarrow \frac{P 1star + P 2star - 2 \cdot (1 - \zeta) \sqrt{P 1star P 2star}}{RT} \\ P 1red \leftarrow \frac{P}{P 1star} \\ T 1red \leftarrow \frac{T}{T 1star} \\ \rho star \leftarrow \frac{1}{\frac{1 - ml}{\rho 2star} + \frac{ml}{\rho 1star}} \\ \rho red \leftarrow \rho r_{SL}(P, T, ml, \zeta) \\ C \leftarrow \frac{-\rho red}{T 1red} + \frac{P 1red}{T 1red \cdot \rho red} + (1 - \rho red) \cdot \frac{\ln(1 - \rho red)}{\rho red} + \frac{\ln(\rho red)}{r 1} \\ \ln(\phi l) + 1 - \phi l + r 1 \cdot \rho red \cdot \frac{Ml}{\rho 1star} \cdot \chi \cdot (1 - \phi l)^2 + C \cdot r 1 \end{array} \right.$$

Function  $wl_{SL}$  determines the solubility of CO<sub>2</sub> in a polymer reported as a weight fraction. Inputs to the function are the pressure (bar), temperature (K), and the binary interaction parameter.

$$wl_{SL}(P, T, \zeta) := \left\{ \begin{array}{l} ml_{inv} \leftarrow 0.1 \text{ if } P \geq 100 \\ ml_{inv} \leftarrow 0.02 \text{ otherwise} \\ \mu pure \leftarrow \mu l_{SL}(P, T, 1, 1) \\ \text{root}(\mu pure - \mu l_{SL}(P, T, ml_{inv}, \zeta), ml_{inv}) \end{array} \right.$$

Function  $sorption$  determines the degree of sorption of CO<sub>2</sub> in the polymer.

Inputs to the function are the pressure (bar) as an array of pressures, temperature (K), and the binary interaction parameter. The output is a matrix,  $w$ , in which the first column is the pressure, the second column is  $\Delta M\%$ , and third column is the weight fraction of carbon dioxide.

$$sorption(p, t, zeta) := \left\{ \begin{array}{l} j \leftarrow 0 \\ \text{for } i \in 0..rows(p) - 1 \\ \left\{ \begin{array}{l} w_{j,0} \leftarrow p_i \\ w_{j,1} \leftarrow \left( \frac{wl_{SL}(p_i, t, zeta)}{1 - wl_{SL}(p_i, t, zeta)} \right) \cdot 100 \\ w_{j,2} \leftarrow wl_{SL}(p_i, t, zeta) \end{array} \right. \\ j \leftarrow j + 1 \end{array} \right. \\ w$$

$P$  and  $s\_exp$  define the array of pressure and experimental sorption results respectively.

$$P := \begin{pmatrix} 55 \\ 80 \\ 100 \\ 125 \\ 150 \\ 200 \end{pmatrix} \quad s\_exp := \begin{pmatrix} 0.112 \\ 0.207 \\ 0.258 \\ 0.281 \\ 0.296 \\ 0.333 \end{pmatrix} \quad sorption(P, T, 0.93) = \begin{pmatrix} 55 & 6.463 \times 10^6 - 0.025i & 1 \\ 80 & 6.07 \times 10^3 & 0.984 \\ 100 & 9.833 \times 10^6 & 1 \\ 125 & 9.78 \times 10^6 & 1 \\ 150 & 9.869 \times 10^6 & 1 \\ 200 & 6.219 \times 10^6 & 1 \end{pmatrix}$$

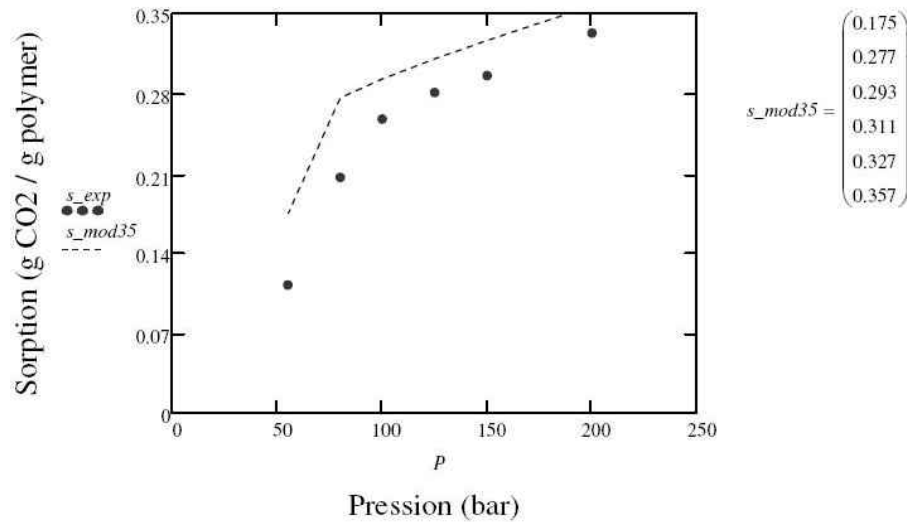
$\overline{C}(P, T, z) := sorption(P, T, z)$



The function  $s\_mod35$  takes into account the second column of the  $w$  matrix. But first, we have to put a arbitrary binary interaction parameter.

$$z := 0$$

$$s\_mod35 := \frac{G(P, T, z)^{\langle 1 \rangle}}{100}$$



$Minerr$  function minimizes the  $z$  function which deeply defines the difference between chemical potent and continues until they reach to zero.

$$ESS(z) := (s\_exp) - \frac{(sorption(P, T, z)^{\langle 1 \rangle})}{100}$$

$$ESS(z) = 0$$

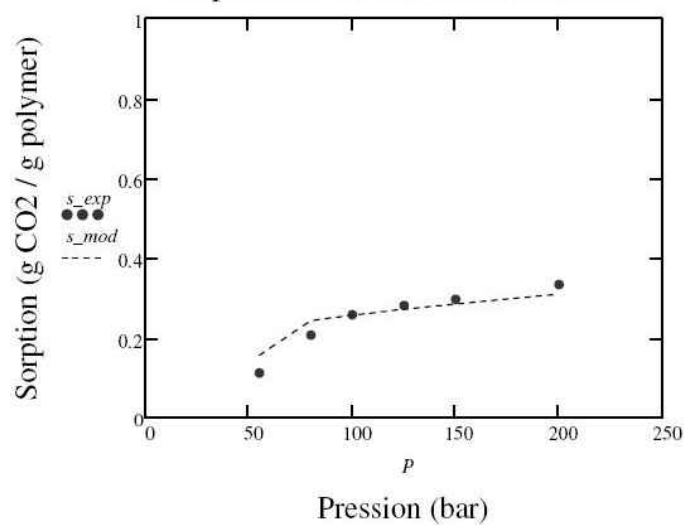
$$\hat{z} := Minerr(z)$$

$$z = 1.037 \times 10^{-3}$$

$$ERR = 0.064$$

$$s\_mod := \frac{G(P, T, z)^{\langle 1 \rangle}}{100}$$

### Sorption de CO<sub>2</sub> dans PLGA5050



### A-1.2 Calculation of glass transition depression as a function of CO<sub>2</sub> weigh fraction

$$T_g := 1 \quad R := 8.314 \frac{\text{J}}{\text{mol} \cdot \text{K}} \quad w := 0.000001, 0.001 \dots 0.5$$

Given

$$\ln\left(\frac{T_g}{T_{g0}}\right) = \beta \cdot (\ln(1 - \theta) - \theta \cdot \ln(1 - \theta) + \theta \cdot \ln(\theta))$$

The function  $Find(T_g)$  calculates the depression of glass transition as the function of CO<sub>2</sub> weight fraction ( $w$ ) by using Chow's equation

$$\text{GlassT}(\beta, T_{g0}, \theta) := \text{Find}(T_g)$$

$$\beta_2 := \frac{2 \cdot R}{56 \frac{\text{g}}{\text{mol}} \cdot 2.432 \frac{\text{J}}{\text{g} \cdot \text{K}}} \quad \beta_3 := \frac{2 \cdot R}{65 \frac{\text{g}}{\text{mol}} \cdot 0.556 \frac{\text{J}}{\text{g} \cdot \text{K}}} \quad \beta_4 := \frac{2 \cdot R}{72 \frac{\text{g}}{\text{mol}} \cdot 0.336 \frac{\text{J}}{\text{g} \cdot \text{K}}} \quad \beta_5 := \frac{2 \cdot R}{70 \frac{\text{g}}{\text{mol}} \cdot 0.445 \frac{\text{J}}{\text{g} \cdot \text{K}}}$$

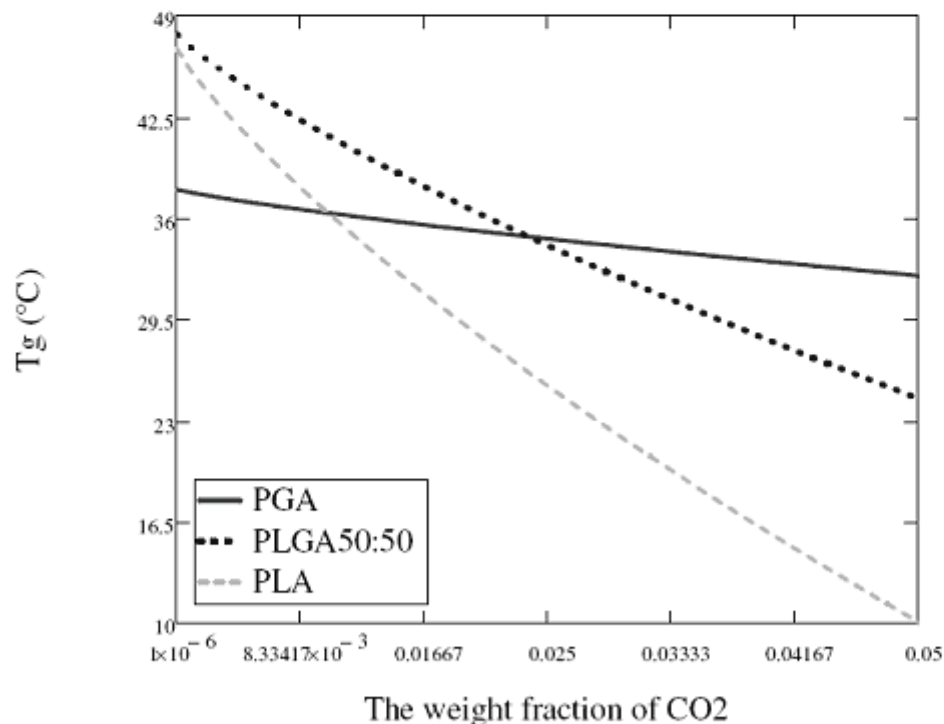
$$\theta_2(w) := \frac{56 \frac{\text{g}}{\text{mol}}}{2.44 \frac{\text{g}}{\text{mol}}} \cdot \frac{w}{1 - w} \quad \theta_3(w) := \frac{65 \frac{\text{g}}{\text{mol}}}{2.44 \frac{\text{g}}{\text{mol}}} \cdot \frac{w}{1 - w} \quad \theta_4(w) := \frac{72 \frac{\text{g}}{\text{mol}}}{2.44 \frac{\text{g}}{\text{mol}}} \cdot \frac{w}{1 - w} \quad \theta_5(w) := \frac{69 \frac{\text{g}}{\text{mol}}}{2.44 \frac{\text{g}}{\text{mol}}} \cdot \frac{w}{1 - w}$$

$$T_{gT2}(w) := \text{GlassT}(\beta_2, 311, \theta_2(w)) - 273.15$$

$$T_{gT4}(w) := \text{GlassT}(\beta_4, 320.05, \theta_4(w)) - 273.15$$

$$T_{gT3}(w) := \text{GlassT}(\beta_3, 321, \theta_3(w)) - 273.15$$

$$T_{gT5}(w) := \text{GlassT}(\beta_5, 328.15, \theta_5(w)) - 273.15$$



Function  $\mu_{SL}$  determines the chemical potential of the penetrant carbon dioxide given the pressure (bar), temperature (K), weight fraction of CO<sub>2</sub> dissolved in the polymer phase, and the binary interaction parameter.

## Annex A-2

A-2 Calculation of sorption-diffusion coefficient of CO<sub>2</sub> in PLGA50:50 at 125 Bar and 36.5 °C by using one dimensional diffusion equation from a plane sheet.

Notations :

a	semi-thickness of the pellet
t	time
D	sorption-diffusion coefficient
C	Mt / M <sub>∞</sub>

Data :

a := 0.0005-m

t =	$\begin{pmatrix} 0\text{-min} \\ 10\text{-min} \\ 20\text{-min} \\ 60\text{-min} \\ 120\text{-min} \\ 240\text{-min} \end{pmatrix}$	$\begin{pmatrix} 0 \\ 0.544 \\ 0.711 \\ 0.961 \\ 0.998 \\ 1 \end{pmatrix}$
		$\frac{C}{M_{\infty}}$

Calculation of the diffusion coefficient D:

i := 0..5      D := 1 · 10<sup>-9</sup> · m<sup>2</sup> · sec<sup>-1</sup>      n := 0..200      E<sub>i</sub> := C<sub>i</sub>

$$Fa(t, D) = 1 - \frac{8}{\pi^2} \left[ \sum_n \left[ \frac{1}{(2n+1)^2} \cdot \exp \left[ -\frac{(2n+1)^2 \cdot \pi^2}{(4a)^2} \cdot D \cdot t \right] \right] \right]$$

j := 0..5      E<sub>j</sub> := Fa(t, D)

$$\text{Given} \quad \sum_j (E_j - Fa(t_j, D))^2 = 0$$

D := Minerr(D)

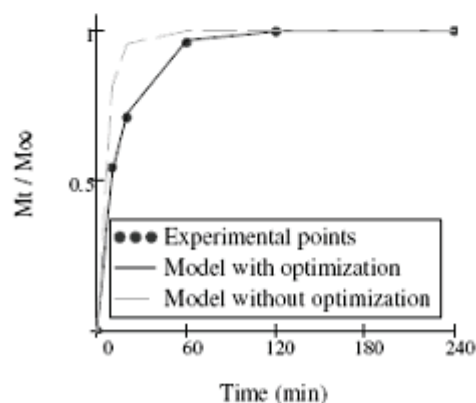
Result:

D = 3.638 × 10<sup>-10</sup> m<sup>2</sup> · s<sup>-1</sup>

Creation of the curve:

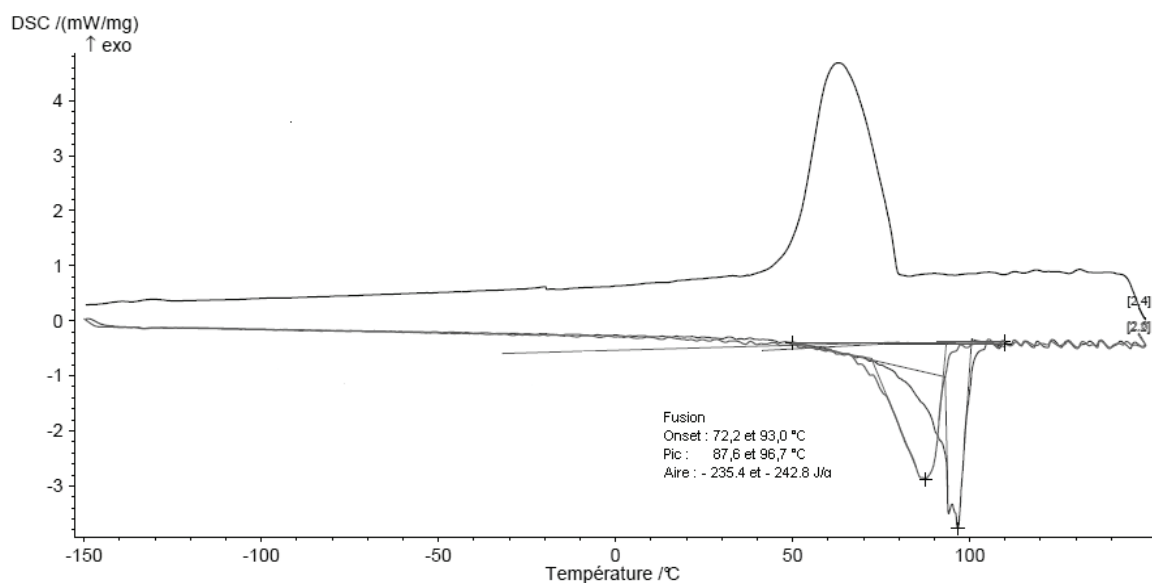
n := 0..200

$$\frac{G}{M_{\infty}} := 1 - \frac{8}{\pi^2} \left[ \sum_n \left[ \frac{1}{(2n+1)^2} \cdot \exp \left[ -\frac{(2n+1)^2 \cdot \pi^2}{(4a)^2} \cdot D \cdot t \right] \right] \right]$$

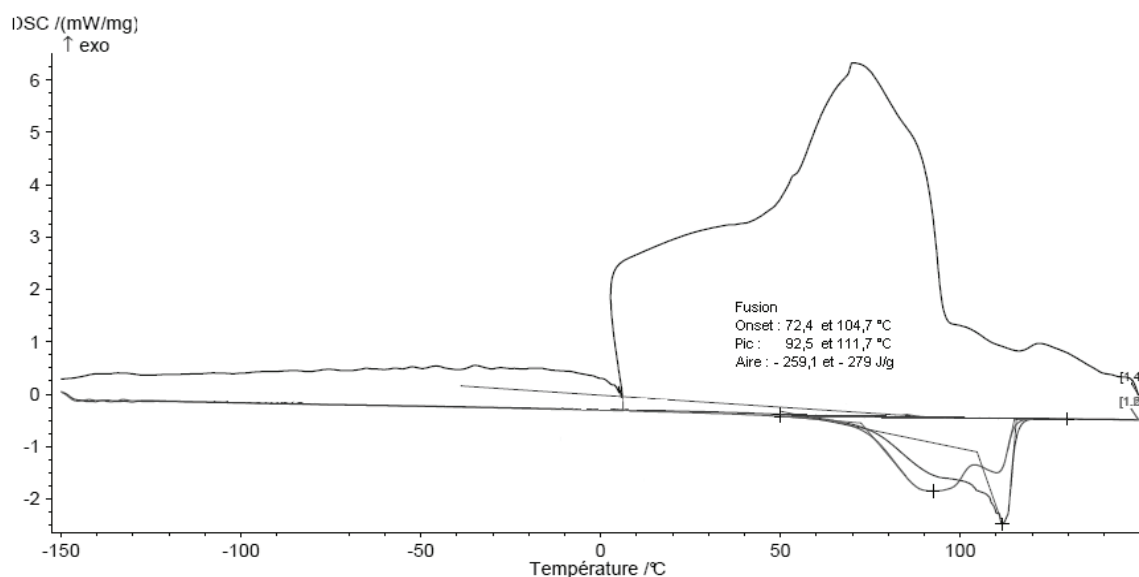


Function  $\mu_{SL}$  determines the chemical potential of the penetrant carbon dioxide given the pressure (bar), temperature (K), weight fraction of CO<sub>2</sub> dissolved in the polymer phase, and the binary interaction parameter.

## Annex A-3



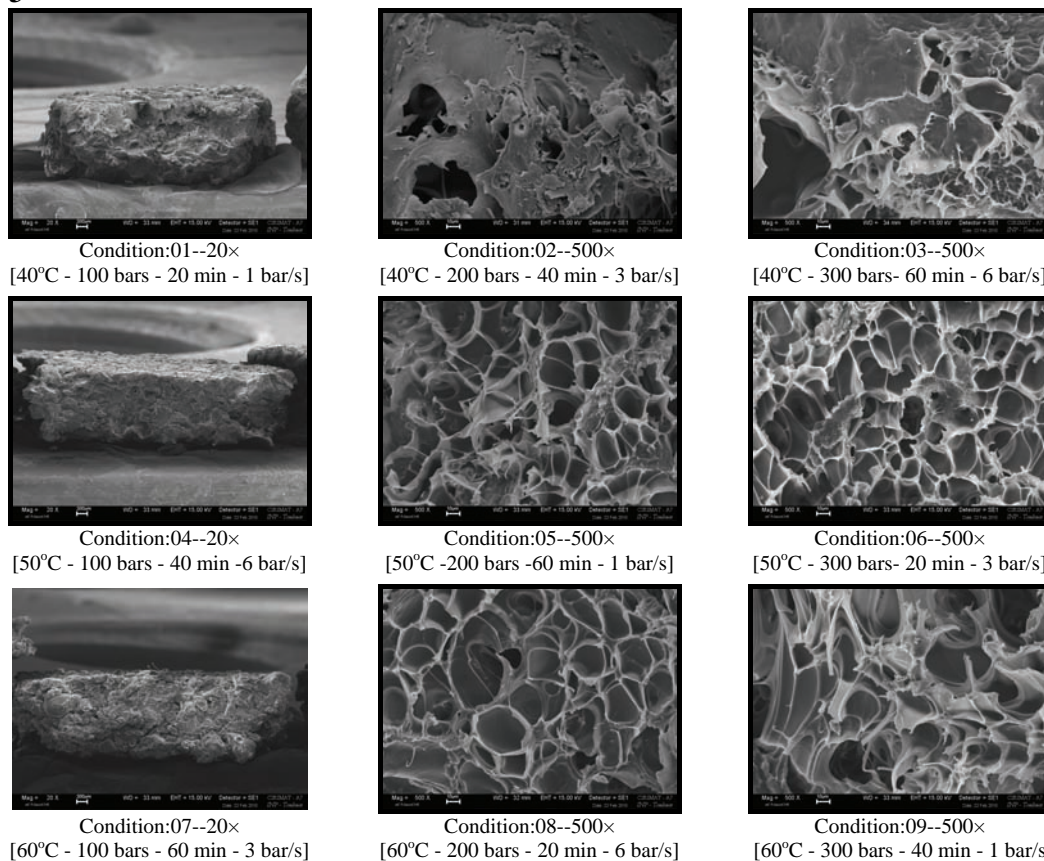
**Figure A-3.1:** Mergers and crystallization of wax - B (C80) during the 1<sup>st</sup> and 2<sup>nd</sup> scans



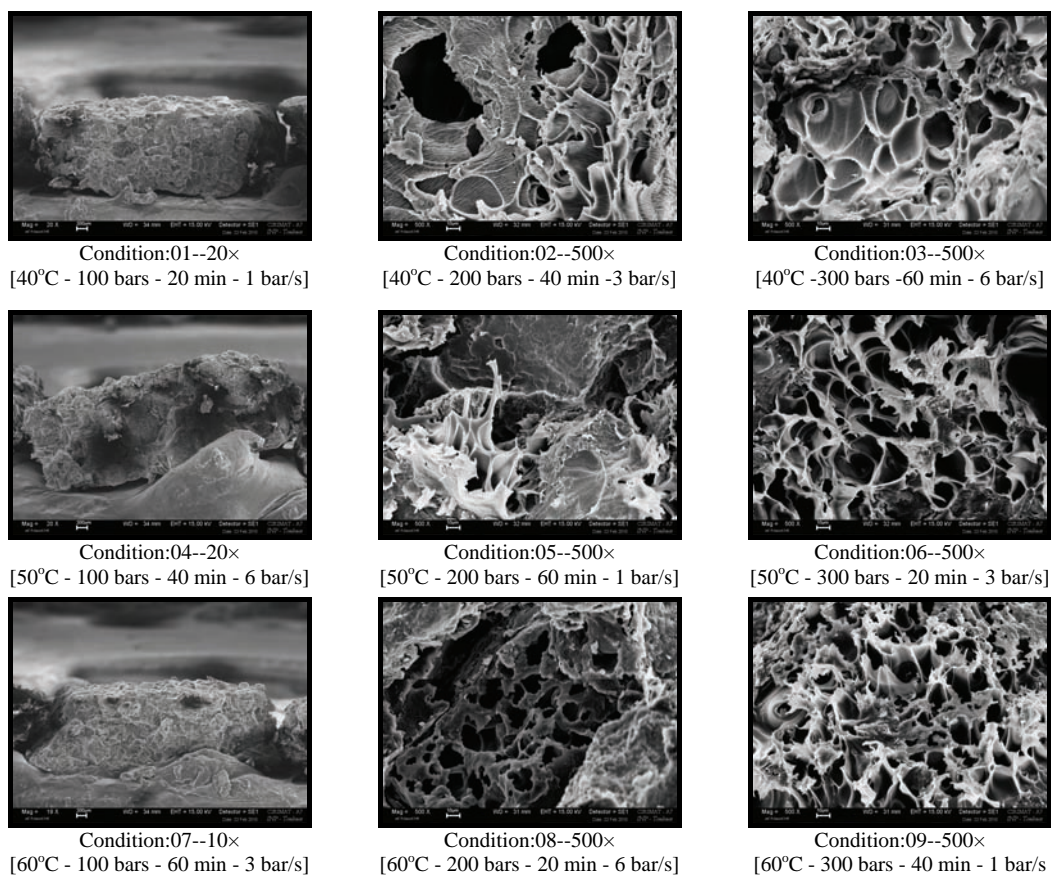
**Figure A-3.2:** Fusion and crystallization of wax-C (H1) during the 1<sup>st</sup> and 2<sup>nd</sup> scans

During cooling wax - B (H1) has a discontinuity at around 0°C characteristic of a phenomenon of supercooling (at transformation of ice water). The amount of water stored in the wax is very sensitive to storage conditions.

## Annex A-3



**Figure A-3.3:**Micrographs of  $P_{LDL}LA + (20\%)$  Wax-C foams at different process conditions



**Figure A-3.4:**Micrographs of  $P_{LDL}LA + (30\%)$  Wax-B foams at different process conditions



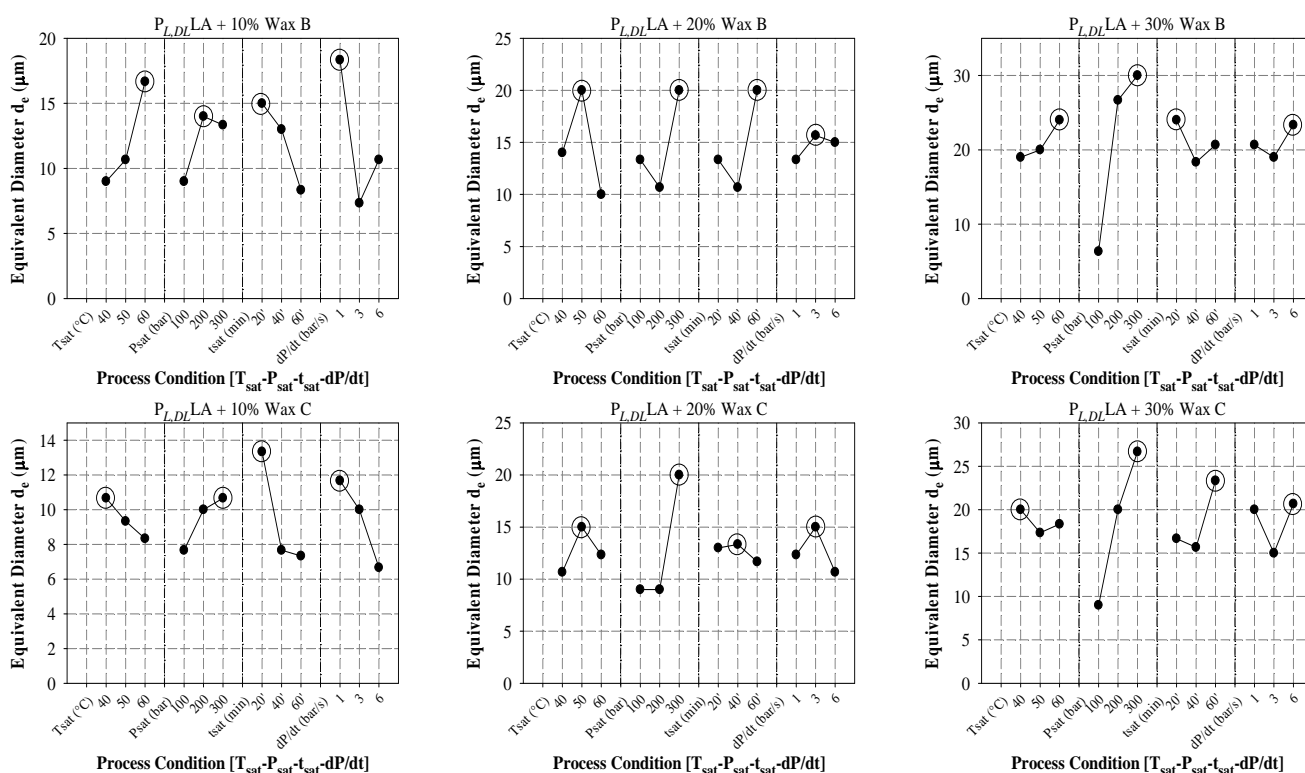


Figure A-3.5: Average effect of waxB and Wax-C on the pore diameter variations for polymer wax blends

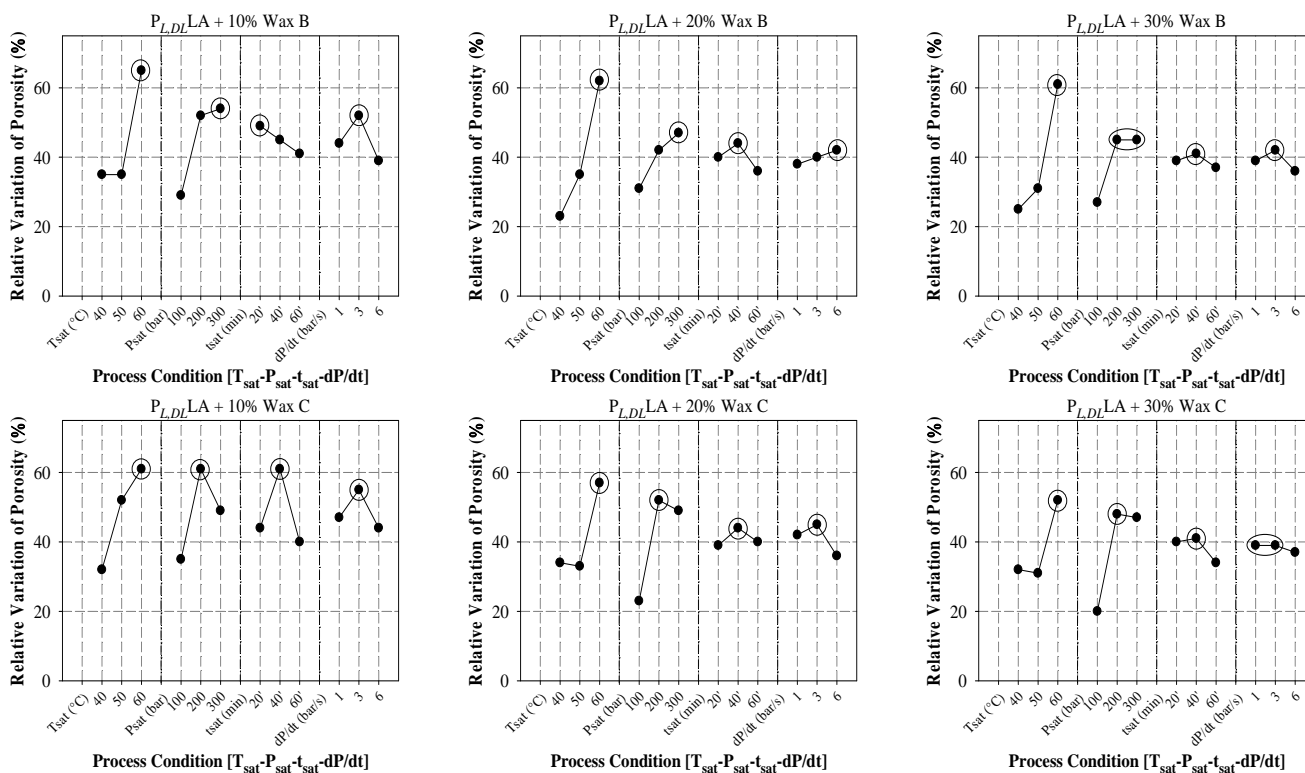


Figure A-3.6: Average effect of wax-B and Wax-C on the relative porosity variations for polymer wax blends

**INFLUENCE DES PARAMETRES PROCEDES SUR LES PROPRIETES  
DES BIOMATERIAUX A BASE D'ACIDE POLYLACTIQUE**

**RÉSUMÉ**

*Le travail présenté dans ce manuscrit concerne la fabrication de biomatériaux poreux à base d'acide polylactique pour les tissus conjonctifs et calcifiés en utilisant des procédés de chimie verte. Le but de cette thèse est de corrélérer l'influence de certains paramètres de procédés à la structure morphologique et les propriétés des mousses générées.*

*Nous avons étudié, d'un côté, les effets de mélange d'acide hyaluronique et d'acides polylactiques afin d'améliorer les propriétés d'adhésion de ces biomatériaux. Nos résultats montrent bien une augmentation de l'énergie d'adhésion mais aussi une diminution de la taille équivalente des pores et de la porosité des biomatériaux poreux après moussage par les fluides supercritiques.*

*D'un autre côté, nous avons étudié les effets de mélanges des triphosphates de calcium et d'acides polylactiques en tant que substitut osseux. L'influence d'un ajout de cires en tant qu'agent porogène a été discutée et les méthodes de préparation des pastilles (voie sèche ou humide) ont été analysées.*

*Dans cette optique la fabrication semi-industrielle de biomatériaux poreux a été testée en fixant les paramètres du procédé de moussage par le CO<sub>2</sub> supercritique (pression, température et temps de saturation, vitesse de dépressurisation) et nous avons contrôlé les mousses de formulations optimisées en termes de porosité et de distribution des pores.*

*En conclusion, ce travail rend possible d'adapter les paramètres des procédés de CO<sub>2</sub> supercritique et de co-broyage aux propriétés des biomatériaux poreux. En perspective, cette ouvre la voie à de nouvelles recherches à la fois dans les domaines des modèles 3D tumoraux et d'ingénierie tissulaire.*

**Mots Clés:** *Polymères d'acide polylactique, Acide hyaluronique/Triphosphate de Calcium, Procédés CO<sub>2</sub> supercritique et co-broyage, Etudes par plans d'expérience, Biomatériaux poreux de substitution des tissus conjonctifs/calcifiés, Taille équivalente des pores et porosité.*

---

**INFLUENCE OF THE PROCESS PARAMETERS ON THE PROPERTIES  
OF POLYLACTIDE BASED BIOMATERIALS**

**ABSTRACT**

The work presented in this manuscript concerns the production of scaffolds based polylactides for connective tissues and bone regeneration by adapting green technology. The aim of this thesis was to correlate the influence of different process parameters on the morphological structures and properties of the scaffold generated.

On one hand, we studied effect of the blending of hyaluronic acid and polylactides to enhance the surface adhesion properties of scaffolds. Our results relate to an increase in surface properties but a decrease of equivalent pore size and porosity after foaming scaffolds by supercritical process.

Calcium Tri-Phosphate On other hand, we studied the effect of the blending of calcium tri-phosphates and polylactides as bone substitute. Influence of adding wax as porogen agent has been discussed and a comparison between wet and dry methods to generate scaffolds has been analyzed.

For this purpose, semi-industrial fabrication of porous biomaterials has been tested by blocking supercritical CO<sub>2</sub> parameters (saturation pressure, temperature and time, depressurization rate) and you have control the optimized formulation composite scaffold, in term of porosity and distribution of pores.

In conclusion, this work made it possible to adapt the process parameters of supercritical CO<sub>2</sub> and co-grinding at the properties of scaffolds. In perspective, this research opens new development ways in scaffolds, in both domains of 3D tumoral model and tissue engineering.

**Key Words:** *Polylactides, Hyaluronic acid/Calcium Tri-Phosphate, Super-critical CO<sub>2</sub>, and co-grinding processes, Studies by Designs of experiment, Scaffolds for connective/calcified tissues, Pore equivalent size and porosity*

---

**DISCIPLINE : SCIENCE ET GÉNIE DES MATÉRIAUX**

**CIRIMAT UMR CNRS 5085 – INPT/ENSIACET 4, allée Emile Monso -31030 TOULOUSE Cedex 04**

---