



HAL
open science

Congestion Control in Vehicular Ad Hoc Networks

Razvan Stanica

► **To cite this version:**

Razvan Stanica. Congestion Control in Vehicular Ad Hoc Networks. Other [cs.OH]. Institut National Polytechnique de Toulouse - INPT, 2011. English. NNT : 2011INPT0130 . tel-04240335

HAL Id: tel-04240335

<https://theses.hal.science/tel-04240335>

Submitted on 13 Oct 2023

HAL is a multi-disciplinary open access archive for the deposit and dissemination of scientific research documents, whether they are published or not. The documents may come from teaching and research institutions in France or abroad, or from public or private research centers.

L'archive ouverte pluridisciplinaire **HAL**, est destinée au dépôt et à la diffusion de documents scientifiques de niveau recherche, publiés ou non, émanant des établissements d'enseignement et de recherche français ou étrangers, des laboratoires publics ou privés.

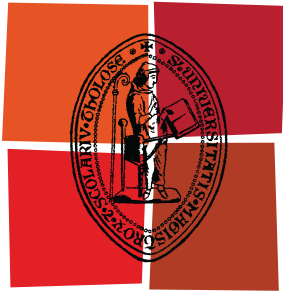

Université
de Toulouse

THÈSE

En vue de l'obtention du
DOCTORAT DE L'UNIVERSITÉ DE TOULOUSE

Délivré par :

Institut National Polytechnique de Toulouse (INP Toulouse)

Discipline ou spécialité :

Réseaux, Télécommunications, Systèmes et Architecture (RTSA)

Présentée et soutenue par :

Razvan STANICA

le : jeudi 17 novembre 2011

Titre :

Contrôle de Congestion dans les Réseaux Véhiculaires

Congestion Control in Vehicular Ad-Hoc Networks

Ecole doctorale :

Mathématiques Informatique Télécommunications (MITT)

Unité de recherche :

Institut de Recherche en Informatique de Toulouse (IRIT)

Directeur(s) de Thèse :

André-Luc BEYLOT - INP Toulouse

Emmanuel CHAPUT - INP Toulouse

Rapporteurs :

Christian BONNET - EURECOM Sophia Antipolis

Paul MÜHLETHALER - INRIA, Le Chesnay

Membre(s) du jury :

Michel DIAZ - LAAS-CNRS Toulouse

Marco FIORE - INSA Lyon

Jérémie LEGUAY - Thales Communications Paris

Contrôle de Congestion dans les Réseaux Véhiculaires

Razvan Stanica

présentée à l'Institut National Polytechnique de Toulouse
pour obtenir le grade de Docteur

Novembre 2011

Encadrants:

André-Luc Beylot

Emmanuel Chaput

Rapporteurs:

Christian Bonnet

Paul Mühlethaler



Resumé

Pendant plus d'un siècle, l'industrie de l'automobile et celle des télécommunications se sont fortement développées en parallèle et constituent aujourd'hui deux des secteurs économiques les plus importants sur le plan mondial. Au cours de ces dernières décennies, l'automobile est devenue une nécessité, même si elle représente aussi de grands dangers pour l'homme en raison des accidents routiers. Dans ce contexte, le développement massif des technologies de communications sans fil a ouvert des possibilités intéressantes en ce qui concerne la création d'un système de transport intelligent, plus sûr et plus écologique. Une des composantes majeures d'un tel système sera constituée par des réseaux véhiculaires ad-hoc, au travers desquels les automobiles vont échanger des messages pour détecter des situations dangereuses et les annoncer aux conducteurs.

Les réseaux VANET ont des propriétés bien différentes des réseaux sans-fil déployés jusqu'à présent, surtout au niveau de la couche MAC. Il est donc nécessaire d'effectuer des études de performances sur ces réseaux afin de comprendre à quel point ils pourront améliorer le trafic routier. Cette thèse s'intéresse au comportement des réseaux VANET dans des scénarios caractérisés par une densité véhiculaire élevée, et en particulier aux capacités de passage à l'échelle du protocole IEEE 802.11p.

Le manuscrit est structuré en quatre chapitres: état de l'art, étude des différentes techniques de contrôle de congestion en IEEE 802.11, description d'un modèle analytique permettant d'étudier les performances de la couche MAC et présentation de trois solutions qui améliorent le comportement du protocole dans un réseau très chargé. Cet ensemble est précédé d'une introduction précisant le contexte de l'étude et se termine par une courte conclusion rappelant les résultats de la thèse et précisant quelques perspectives.

Le premier chapitre porte d'abord sur la présentation des différents types d'applications prévues dans le monde véhiculaire et du contexte actuel au sein des groupes de standardisation. Le protocole

IEEE 802.11p est décrit, ainsi que d'autres propositions fondées sur des méthodes d'accès différentes (CDMA, SDMA, TDMA). Un panorama des hypothèses invalides utilisées dans la littérature du domaine est ensuite proposé, conduisant à une présentation des caractéristiques de la couche MAC dans les communications de sécurité routière.

Un état de l'art concernant les outils et techniques de simulation des réseaux VANET fait aussi l'objet de ce chapitre. Comme les expérimentations avec un nombre important de véhicules sont impossibles, en raison de leur coût, les simulations constituent le moyen le plus utilisé pour ce type d'études. Pourtant, même la simulation d'un réseau véhiculaire n'est pas une tâche évidente, puisque des modèles de communications et de mobilité routière doivent être combinés pour obtenir des résultats fiables. En tenant compte de ces problèmes et des objectifs de l'étude, le simulateur JiST/SWANS a été retenu pour analyser et comparer les différents protocoles et mécanismes. Complété par un modèle microscopique de poursuite qui reproduit de manière réaliste les propriétés du trafic routier, le simulateur JiST/SWANS est utilisé d'abord pour mener une comparaison entre IEEE 802.11p et SoTDMA, une technique TDMA distribuée. L'étude relève des problèmes importants pour les deux protocoles lorsque la densité véhiculaire augmente et, comme les performances sont similaires, le choix de l'IEEE 802.11p pour la suite de la thèse est justifié en raison de la plus grande maturité de la technologie.

Le chapitre 2 présente différentes techniques pour faciliter le passage à l'échelle de la couche MAC dans un réseau VANET. Il s'agit de mécanismes adaptatifs qui contrôlent cinq paramètres: la fréquence des messages périodiques, le débit de transmission, la puissance de transmission, la fenêtre de contention du mécanisme de back-off et le seuil de détection de la porteuse en CSMA. La thèse se concentre ensuite sur les deux derniers paramètres, considérant que les autres sont bien couverts par la littérature scientifique.

La fenêtre de contention est un paramètre essentiel en IEEE 802.11, dictant le temps d'attente avant la transmission du message. La version actuelle du standard utilise une valeur très faible pour CW, en minimisant le délai introduit par la couche MAC. Mais, en même temps, cette valeur conduit à une probabilité élevée de collision, car les temporisations de plusieurs noeuds peuvent expirer simultanément. Plusieurs mécanismes permettant d'adapter la valeur de la fenêtre de contention en fonction de la densité de véhicules sont proposés dans ce chapitre, et leurs performances sont comparées avec celles d'IEEE 802.11p. Toutes ces solutions donnent des résultats supérieurs au standard en ce qui concerne la probabilité de réception des messages de sécurité.

Le deuxième paramètre étudié dans cette partie est le seuil du mécanisme d'écoute de la porteuse *carrier sense*. Cette valeur est statique en IEEE 802.11p et égale à la sensibilité du récepteur. Les résultats des simulations présentés dans ce chapitre montrent que le seuil optimal dépend lui aussi de la densité de véhicules, en augmentant quand le nombre de voisins devient trop important.

Le chapitre suivant est consacré à la proposition d'un nouveau modèle analytique pour les messages périodiques de sécurité routière transmis dans des réseaux VANET. En raison de la complexité de ce type de réseaux, il existe peu de modèles mathématiques. Ils se fondent en général sur l'analyse des transitions dans une chaîne de Markov. Le modèle présenté dans cette thèse utilise une approche différente, en calculant des valeurs moyennes sur une période de transmission. Une caractéristique importante du modèle vient du fait qu'il est le premier de ce type qui tient compte de la probabilité non-négligeable d'expiration d'un message périodique. Malgré quelques approximations, inhérentes à ces modèles analytiques, si l'on veut qu'ils soient exploitables, des propriétés importantes des réseaux véhiculaires sont formulées en s'appuyant sur cet outil. Par exemple, on peut observer que l'adaptation du seuil de *carrier sense* a un effet beaucoup plus important sur le niveau d'interférences que le contrôle de la puissance de transmission. De même, on apprend qu'il existe une relation de proportionnalité inverse entre la taille optimale de la fenêtre de contention et la densité des véhicules, l'opposé de ce qu'on peut trouver dans un réseau WLAN.

Le dernier chapitre du manuscrit est dédié à la présentation de plusieurs propositions destinées à l'amélioration de la couche MAC. Il s'agit d'abord d'un nouveau mécanisme de back-off, spécialement conçu en tenant compte de la probabilité d'expiration d'un message. Le problème du back-off IEEE 802.11 classique dans les réseaux VANET vient du fait que les messages transmis en diffusion ne permettent pas de détecter les collisions. Par conséquent, la fenêtre de contention n'est jamais incrémentée; elle utilise toujours une valeur minimale. Comme montré dans les chapitres précédents, une valeur plus élevée de CW donne des meilleurs résultats si le bon équilibre est trouvé entre le nombre de collisions et le nombre de messages expirés. Puisque les collisions ne sont pas détectables dans ce cas, le mécanisme propose de décrémenter la fenêtre de contention après chaque expiration, une technique analogue à celle fondée sur les collisions. Avec une valeur initiale suffisamment grande de la fenêtre de contention, le mécanisme permet d'atteindre une probabilité de réception des messages proche de la valeur statique optimale de CW et largement supérieure à celle de la version actuelle du standard IEEE 802.11p. De plus, ce nouveau back-off produit une redistribution des pertes, avec une réduction importante du nombre consécutif de messages perdus entre

deux noeuds voisins.

Le deuxième mécanisme proposé concerne le seuil de *carrier sense*. Il est construit pour optimiser la réception des messages de sécurité dans une zone critique autour de chaque véhicule. L'idée est d'estimer la densité des noeuds en comptant le nombre de messages reçus pendant chaque période et de modifier le seuil de détection en fonction de ce nombre de voisins détectés. Une simple relation linéaire est utilisée, avec de très bons résultats sur la probabilité de réception des messages par rapport au seuil fixe utilisé par le standard IEEE 802.11p.

Finalement, la dernière partie de cette thèse est dédiée à la présentation de SR-CSMA, une nouvelle méthode d'accès reposant sur CSMA. SR-CSMA, est bâtie en tenant compte des propriétés les plus significatives des réseaux VANET, et contient plusieurs mécanismes de contrôle de congestion, dont le mécanisme de back-off décrit auparavant et une solution pour le contrôle de puissance. Pourtant, l'innovation majeure apportée par cette nouvelle technique est liée à l'utilisation du seuil de détection. Comme le réseau véhiculaire est extrêmement chargé quand la densité de véhicules dépasse un certain seuil, éviter toutes les collisions devient une tâche impossible. SR-CSMA propose donc de contrôler ces événements et force des collisions entre des noeuds éloignés. En misant sur l'effet de capture, les véhicules situés près de l'émetteur arrivent quand même à récupérer le message. Les pertes se résument donc à des zones intermédiaires, situées relativement loin (à quelques centaines de mètres) des émetteurs. Comme la réutilisation spatiale du support augmente, les véhicules ont davantage d'opportunités de transmission et le nombre de collisions avec des voisins proches diminue. Les différents résultats de simulation indiquent que l'utilisation de SR-CSMA conduit à de meilleures performances que le standard actuel.

Contents

1	Introduction	1
1.1	Motivation	1
1.2	Contributions	3
1.3	Organisation	6
2	Vehicular Safety Communications	8
2.1	Applications	8
2.1.1	Safety Applications	9
2.1.2	Traffic Efficiency Applications	10
2.1.3	Infotainment and Business Applications	11
2.2	Standardization	12
2.2.1	Spectrum Allocation	13
2.2.2	IEEE 802.11p	15
2.2.3	IEEE WAVE Architecture	18
2.2.4	ETSI ITS Architecture	20
2.3	Medium Access Protocol	22
2.3.1	Misconceptions	22
2.3.2	MANET Solutions	32
2.3.3	Code Division Multiple Access	33
2.3.4	Busy Tone Multiple Access	34
2.3.5	Space Division Multiple Access	35
2.3.6	Time Division Multiple Access	36
2.3.7	SoTDMA vs. IEEE 802.11p	37

2.4	Simulation Frameworks	39
2.4.1	VANET Simulation Challenges	40
2.4.2	Simulation Tools	42
2.4.3	JiST/SWANS Framework	43
3	MAC Layer Congestion Control	46
3.1	Beaconing Frequency	47
3.2	Data Rate	48
3.3	Transmission Power	50
3.4	Minimum Contention Window	52
3.5	Physical Carrier Sense	61
4	Analysis of Vehicular Beaconing	67
4.1	Safety Range	68
4.2	Power and Carrier Sense Control	70
4.3	Collision Probability	72
4.4	Numerical Example	81
4.5	Summary	88
5	Practical Framework for Congestion Control	90
5.1	Reverse Back-off Mechanism	91
5.1.1	Optimal Contention Window	91
5.1.2	Back-off Mechanism	93
5.1.3	Summary	97
5.2	Adaptive Carrier Sensing	98
5.2.1	Safety Range Impact	98
5.2.2	Adaptive Carrier Sense Threshold	99
5.2.3	Summary	102
5.3	Safety Range Carrier Sense Multiple Access	104
5.3.1	Protocol Description	104
5.3.2	Transmission Power Control	105
5.3.3	Location and Power Estimation	106

5.3.4	SR-CSMA and the Reverse Back-off Mechanism	107
5.3.5	Performance Evaluation	108
5.3.6	Summary	112
6	Conclusion	114
6.1	Summary	114
6.2	Future Work	115
7	Annex	117
7.1	Simulated Environment	117

List of Tables

- 2.1 IEEE 802.11p parameters 16
- 2.2 IEEE 802.11p EDCA parameters 17
- 2.3 Channel access methods in a safety VANET context 31
- 2.4 Simulation parameters 45

- 3.1 Optimal values for the different parameters of the algorithms 58

- 5.1 Beaconing Reception probability for Fixed and Adaptive CS Thresholds 102

List of Figures

- 2.1 Spectrum allocation in US and Europe 14
- 2.2 IEEE WAVE Architecture 18
- 2.3 ETSI ITS Architecture 21
- 2.4 Internal contention in IEEE 802.11p 26
- 2.5 Hidden and exposed terminal problem 29
- 2.6 Beaconing reception ratio in a low density scenario 38
- 2.7 Beaconing reception ratio in a high density scenario 39
- 2.8 JiST/SWANS graphical user interface 43

- 3.1 Beaconing reception probability for mechanisms adapting the contention window . . . 60
- 3.2 Average contention window as a function of vehicular density 61
- 3.3 PLCP header format 62
- 3.4 Beaconing reception probability for several carrier sense thresholds 64
- 3.5 Beaconing reception probability as a function of the carrier sense threshold 65

- 4.1 System model 69
- 4.2 SIR improvement 71
- 4.3 SIR improvement for different values of the path-loss exponent 73
- 4.4 Different zones around a vehicle 74
- 4.5 A possible scenario for the neighbourhood of a vehicle 75
- 4.6 The size variation of the zones around a vehicle 77
- 4.7 Probability of a synchronised transmission 82
- 4.8 Probability of a concurrent transmission 83
- 4.9 Beaconing expiration probability as a function of the contention window 84

4.10	Beaconing reception probability as a function of the contention window	85
4.11	Collision probability as a function of the number of sensed stations	86
4.12	Collision probability for the nodes inside the safety range	87
4.13	Collision probability as a function of the carrier sense to safety range ratio	88
5.1	Simulation and analytical results for beaconing reception probability	91
5.2	Optimal value of the contention window	93
5.3	Beaconing reception probability using the reverse back-off mechanism	95
5.4	Comparison of the optimal fixed contention window and the reverse back-off mechanism	96
5.5	Number of consecutive beacons lost between neighbours	97
5.6	Optimal carrier sense threshold for different values of the safety range	98
5.7	Beaconing reception probability for the adaptive carrier sense mechanism	101
5.8	Distribution of the carrier sense threshold when using the adaptive mechanism	103
5.9	Different zones in the carrier sense range of a node	107
5.10	Beaconing reception probability in the safety range	109
5.11	Distribution of the reasons for a lost message for CSMA and SR-CSMA	110
5.12	Probability mass function of the used power level	111
5.13	Number of consecutive lost beacons between pairs of neighbours using SR-CSMA	112
5.14	Distribution of the reasons for a lost message with and without the reverse back-off mechanism	113
7.1	Example of one of the maps used in the simulation study described in this thesis.	118

List of Acronyms

3G	Third generation mobile telecommunications
3GPP	Third Generation Partnership Project
4G	Fourth generation mobile telecommunications
ABROAD	Adaptive Broadcast Protocol
ACK	Acknowledgement message
AIFS	Arbitration Inter-Frame Space
ARQ	Automatic Repeat Request
ASDM	Adaptive Space-Division Multiplexing
ASTM	American Society for Testing Materials
ATB	Adaptive Traffic Beacon
BEB	Binary exponential back-off
BSS	Basic Service Set
BTMA	Busy Tone Multiple Access
C2C-CC	Car-2-Car Communication Consortium
CAM	Cooperative Awareness Message
CCA	Clear Channel Assignment
CCH	Control channel

CDMA	Code Division Multiple Access
CPU	Central Processing Unit
CR	Collision Report
CS_r	Carrier Sense range
CS_t	Carrier Sense threshold
CSMA	Carrier Sense Multiple Access
CSMA/CA	Carrier Sense Multiple Access with Collision Avoidance
CTS	Clear-to-Send
CW	Contention window
D-FPAV	Distributed Fair Power Adjustment for Vehicular Environments
D-TDMA	Decentralised Time Division Multiple Access
DCF	Distributed Coordination Function
DEN	Decentralised Environmental Notification
DIFS	DCF Inter-frame Space
DOT	United States Department of Transportation
DSRC	Dedicated Short Range Communications
ED_t	Energy Detection threshold
EDCA	Enhanced Distributed Channel Access
EEBL	Emergency Electronic Brake Lights
EP	Elimination Packet
eSafety	Electronic Safety Initiative
ETSI	European Telecommunications Standards Institute

FCC	United States Federal Communications Commission
FI	Frame Information
FPRP	Five-Phase Reservation Protocol
GLOSA	Green Light Optimal Speed Assistant
GPS	Global Positioning System
GSM	Global System for Mobile Communications
ICW	Intersection Collision Warning
IEEE	Institute of Electrical and Electronics Engineers
IP	Internet Protocol
IPCS	Incremental-Power Carrier-Sensing
ISM	Industrial, Scientific, and Medical radio band
ITS	Intelligent Transportation System
JiST	Java in Simulation Time
LAN	Local Area Network
MAC	Medium Access Control
MANET	Mobile Ad-Hoc Network
MBL	Maximum beaconing load
MCBC	Multi-Carrier Burst Contention
MD	Message Dispatcher
MIB	Management Information Base
MM-SA	Multi-Code Spread Aloha
NAV	Network Allocation Vector

oCSMA	Optimal CSMA
OFDM	Orthogonal Frequency-Division Multiplexing
PATH	Program on Advanced Technology for the Highway
PER	packet error ratio
PHY	physical layer
PLCP	Physical Layer Convergence Protocol
PN	pseudo-noise
PoIN	point of Interest Notification
PROMETHEUS	Program for a European Traffic with Highest Efficiency and Unprecedented Safety
QoS	Quality of Service
QPSK	Quadrature Phase-Shift Keying
R-Aloha	Reservation Aloha
RACS	Japanese Road/Automobile Communication Systems
RB	Reverse back-off
RBAR	Receiver-Based Auto Rate
RBRP	Robust Broadcast Reservation Protocol
RC	Reservation cycle
RR	Reservation request
RR-Aloha	Reliable Reservation Aloha
RRAA	Robust Rate Adaptation Algorithm
RSSI	Received Signal Strength Indicator
RSU	Road Side Unit

RTS	Request-to-Send
SAE	Society of Automotive Engineers
SCH	Service channel
SDMA	Space Division Multiple Access
SeVeCOM	Secure Vehicular Communication
SF _r	Safety range
SINR	Signal-to-Interference-and-Noise Ratio
SIR	Signal-to-Interference Ratio
SoTDMA	Self-organised TDMA
SPAV	Segment-based Power Adjustment for Vehicular Environments
SR-CSMA	Safety Range Carrier Sense Multiple Access
STRAW	Street Random Waypoint
SUMO	Simulation of Urban Mobility
SWANS	Scalable Wireless Ad hoc Network Simulator
TC	Technical committee
TCP	Transmission Control Protocol
TDMA	Time Division Multiple Access
TGp	IEEE 802.11 task group p
TIGER	Topologically Integrated Geographic Encoding and Referencing
TIRI	Traffic Information and Recommended Itinerary
UMTS	Universal Mobile Telecommunications System
V2I	Vehicle-to-Infrastructure

V2V	Vehicle-to-Vehicle
VANET	Vehicular Ad-Hoc Network
VeSoMAC	Vehicular Self-Organising MAC
VMESH	Vehicular Mesh Network
VSC	Vehicle Safety Communications
WAVE	Wireless Access in Vehicular Environments
WG	Working group
WLAN	Wireless Local Area Networks
WSM	WAVE Short Message
WSMP	WAVE Short Messages Protocol

1. Introduction

1.1 Motivation

In a little more than a century, the automotive industry became one of the major economic sectors, with tens of millions of employees all over the world. Over the last 120 years, more and more investments were made in road infrastructure and motor vehicles transformed from mechanical masterpieces into a mix of mechanical and electronic components. The progress of the transportation industry has been an essential factor in the development of our society and it triggered the birth or growth of other economic branches. However, the increase in the number of cars and drivers also brought an increase in the number of motor vehicle accidents and human fatalities. In these conditions, transportation safety has become a very important topic in the last decades. The efforts in this area have mostly been focused on improving and creating safety systems inside the vehicles (e.g security belt, anti-lock braking system, airbag etc.).

These in-vehicle solutions have been very efficient in alleviating the consequences of an accident. With a 50% decrease in the number of fatalities due to motor vehicle accidents in Europe in the last 20 years [ECR07], the embedded electronics seem to have reached their goal. Nevertheless, with more than 1.2 million victims every year all over the world, car accidents are the leading cause of death for humans aged between 1 and 34 in both Europe and the United States [MXK10]. The problem is that these approaches are reactive, dealing with the effect rather than concentrating on the real cause: the accident itself. As the number of possible automatic responses to external factors is highly limited by legal issues, the main solution for accident prevention through a proactive approach is to extend the driver's knowledge about the surrounding environment. The first step towards this was made by adding an impressive number of sensors to the vehicles and road infrastructure. Radars, lidars or video cameras are more and more present in today's cars, making possible systems like

parking assistant [FBVBK04] or adaptive cruise control [VE03].

However, these embedded sensors have a limited action area which could be expanded by equipping vehicles with wireless communication devices. The idea of communicating cars existed in the intelligent transportation systems community for a long time [Jur91] but the wireless technologies that could have made it possible did not exist. In 1999, US Federal Communications Commission allocated 75MHz in the 5.9GHz band for Dedicated Short Range Communications (DSRC). In the same time frame, Wi-Fi technology, based on the IEEE 802.11 standard, became more and more popular and allowed the creation of Wireless Local Area Networks (WLAN). This reinvigorated research on vehicular communications and the IEEE 802.11p Task Group was established to specify a complete set of protocols for Wireless Access in Vehicular Environments (WAVE) [UA09]. A series of projects, task groups and consortia have been created in Europe, North America and Japan [PBHSFRMKKH08] and different protocols and architecture solutions have been proposed for both vehicle-to-vehicle (V2V) and vehicle-to-infrastructure (V2I) communications.

A common idea in all these proposals is to divide the spectrum into multiple channels, from which one should be dedicated solely to the exchange of safety-related messages. While the importance of the other channels can not be neglected, as they will be used by business and entertainment applications that can help extend and monetise the vehicular network, this thesis is focused on the safety-dedicated channel and the medium access protocol that controls it. As mentioned above, the goal of V2V communication is to provide a proactive method for increasing road safety. This can not be achieved using an approach where vehicles transmit messages only when the on-board sensors detect a dangerous situation, in other words a reactive communication system. For this reason, the periodic transmission of special messages by every equipped vehicle, in combination with on-board computation and in time driver warnings, are considered the best solution for a strong reduction in the number of traffic accidents. The U.S. Department of Transportation (DOT) estimates that V2V communication can address up to 82% of all crashes in the United States involving unimpaired drivers, saving thousands of lives and billions of dollars [Ken11].

Several short messages transmitted in a second by a vehicle might not seem an important amount of traffic when compared with the requirements of other types of applications using WLANs or cellular networks. However, these messages would ideally be transmitted by every vehicle, accumulating in an impressive network load in scenarios with dense vehicular traffic. Other particularities, like high mobility, rapidly varying node density, short connectivity duration, the broadcast nature of

the communication, or privacy concerns add up to create a very challenging vehicular environment. The medium access control (MAC) protocol plays a central role in this network, especially in the case of safety applications, where the locally geographical scope of the messages usually translates into one-hop broadcast communication, highly reducing the importance of the other layers.

In a safety-oriented vehicular network, the MAC layer is actually in charge of the timely and reliable distribution of safety messages in the surroundings of each vehicle, regardless of the local node density. While this task is simple in a sparse network where the competition for channel access is not very important, things complicate when the density increases and the MAC layer needs to schedule in a distributed manner the transmissions of tens or hundreds of nodes found in the coverage area of one another. Moreover, the transport layer, usually responsible for congestion control in an end-to-end communication model, has no power in this one-hop broadcast dissemination paradigm. The MAC layer therefore needs to include special mechanisms for congestion control, something not usually required at this level.

The cost of the hardware and the confidence in the technology are also very important arguments for automotive manufacturers, and the choice of IEEE 802.11 for the MAC layer appears logical in these circumstances, considering the availability and maturity of the products based on this standard. Nevertheless, the protocols derived from the IEEE 802.11 family possess very few mechanisms for congestion control, and scalability is one known issue in this case. Moreover, as it will be discussed in detail in this thesis, even these existing mechanisms can not be extended to a vehicular context, because of the particularities displayed by safety applications.

The necessity for new solutions that can be easily integrated in IEEE 802.11 and improve the performance of the channel access method under heavy load is acknowledged in both industry and academia, with standardisation bodies currently working on the issue. The work described in this thesis comes to fill this gap, providing a comprehensive analysis of the one-hop broadcast communication on the safety-dedicated channel, and proposing different adaptive mechanisms focused on two of the most important parameters of the IEEE 802.11 protocol, namely the physical carrier sense threshold and the minimum contention window.

1.2 Contributions

The main contributions of this thesis are resumed below:

- **Identification of common misconceptions regarding safety V2V communications that propagated inside the research community.** With a subject laying at the border between wireless networking and transportation, researchers coming from one of the areas first need to understand the important concepts from the other field. When this stage is skipped, the challenges of the vehicular network are not well understood, and solutions previously described for other scenarios are applied without checking their compatibility with the vehicular environment. A large list of such assumptions with no practical support is drawn in Chapter 2, leading to a detailed description of the safety-dedicated channel.
- **Characterisation of the different approaches that could be used for MAC layer congestion control in IEEE 802.11-based safety vehicular networks.** A number of parameters of the IEEE 802.11 protocol could be optimised to function under heavy load, and different solutions have been proposed in the research literature. Chapter 3 discusses the influence of message frequency, data rate, transmission power, back-off time and carrier sense threshold in the context of the safety-dedicated channel. The main strengths and weaknesses of different adaptive mechanisms focused on these parameters are pointed out.
- **Comparison of several solutions for contention window adaptation in a vehicular environment.** The minimum contention window is one of the most important parameters in IEEE 802.11, dictating the performance of the back-off mechanism. While its influence on the MAC layer performance is well understood in unicast wireless LANs, there are very few studies that analyse different back-off strategies taking into account the properties of V2V communications. In Chapter 3, five adaptive mechanisms are proposed and their performance under medium and heavy vehicular density is compared, showing an important improvement over the current version of the IEEE 802.11 standard.
- **Analysis of the optimum contention window on the safety-dedicated channel.** This study is based on both simulations (in Chapter 3), and analytical modelling (in Chapter 4), and manages to unveil important properties, like the fact that the optimal value of the contention window decreases with node density, unlike in the well-studied case of saturated WLANs.
- **Study of the optimal physical carrier sense threshold for V2V communications.** The standard approach in IEEE 802.11 is to use the receiver sensitivity as a carrier sense

threshold, but the analysis presented in Chapter 4 questions this solution, showing that an important improvement can be obtained by wisely adjusting this parameter.

- **Description of an analytical framework for the study of periodic message transmission in a vehicular network.** The analytical study of vehicular ad hoc networks (VANETs) is a complicated task, as it requires the modelling of both transportation and networking concepts. Previous attempts did not consider important properties of the safety applications, like the fact that messages have a non-negligible expiration probability. The model described in Chapter 4 uses mean values observed during a beaconing period and proves to be a useful tool for the study of the different parameters of the MAC layer.
- **Evaluation of a new back-off mechanism, specially designed for safety VANETs.** The binary exponential back-off mechanism used by the IEEE 802.11 protocol is not an option in the broadcast vehicular environment. As collisions can not be detected, the back-off mechanism proposed in Chapter 5 is based on expired messages, and shows an important improvement when compared with the standard.
- **proposal of an adaptive carrier sense mechanism for IEEE 802.11 networks.** The correlation between the optimal physical carrier sense range and the local node density is proven, pointing out the inadequacy of a fixed carrier sense threshold. A simple mechanism using the number of neighbours for the computation of this threshold is described in Chapter 5, outperforming the classical IEEE 802.11.
- **Definition of a new channel access technique, specially designed for the vehicular environment.** This access method includes mechanisms for transmission power control, carrier sense adaptation and contention window adjustment, and is defined with the special characteristics of V2V communications in mind. By forcing collisions to take place in some well-defined situations, the new protocol is able to increase the reception probability for safety messages in the immediate surroundings of each vehicle, where the awareness needs to be maximised.

1.3 Organisation

This thesis is structured as follows: Chapter 2 presents relevant concepts related to vehicular safety communications. After a general classification of the different types of applications, the specificities of road safety applications are discussed. The standardisation work in this field is summarised afterwards, with a special focus on IEEE 802.11p and the differences between the architectures defined in the United States and in Europe respectively. The existing research literature addressing MAC layer problems is reviewed in this chapter, and a number of misconceptions that flourished throughout the VANET research community are revealed. Finally, the numerous problems that appear when trying to study vehicular networks through simulation are depicted, and the choice of the simulation framework used in this thesis is explained.

Chapter 3 is dedicated to the problem of MAC layer congestion control in vehicular networks. Five different approaches trying to solve this scalability problem are presented, together with the relevant research literature. While message frequency, data rate and transmission power appear to be well studied topics, two other solutions have been neglected so far and their study becomes the object of this thesis: the contention window of the back-off mechanism and the physical carrier sense threshold. The fact that the standard method for setting the value of this parameters leads to poor performance is demonstrated through simulation. Several mechanisms for contention window adaptation are described and compared, all of them proving to be more efficient than the current version of IEEE 802.11p.

An analytical framework that can be used in the study of safety vehicular communications is developed in Chapter 4. The concept of *safety range*, essential throughout this thesis is explained, followed by a discussion concerning the interference model. The importance of the physical carrier sense is underlined using this analytical model, by proving that the adjustment of the carrier sense range reduces the interference more efficiently than when applying transmission power control. Essential properties regarding the contention window are also determined analytically, as for example the relationship between expired messages and the number of collisions.

A new back-off mechanism and an adaptive solution for carrier sense threshold control are described in Chapter 5. The back-off mechanism uses expired beacons to activate the contention window adjustment, increasing the beaconing reception ratio and the overall awareness of the vehicles. The approach used for carrier sense adaptation is built on the relationship between the carrier sense

threshold and the local node density and it also manages to achieve an important improvement in the MAC layer performance. Finally, this chapter integrates transmission power control, contention window adjustment and carrier sense adaptation in a new channel access technique focused on maximising the delivery ratio of safety messages inside the safety-critical range around every vehicle.

The conclusions that can be drawn from this thesis are reported in Chapter 6. This final chapter also includes a discussion concerning directions for future research that remain open at the end of this study.

2. Vehicular Safety Communications

This chapter settles more clearly the context of this thesis by giving an overview of the vehicle-to-vehicle communication system. In Section 2.1, vehicular applications are classified based on their impact on the road traffic, and the requirements of each category of services are discussed, especially those regarding traffic safety. Section 2.2 contains a description of ongoing standardisation efforts, with a focus on the similarities and differences that can be distinguished between the US and European architectures. The IEEE 802.11p standard which forms the basis of both of these architectures is also introduced. Section 2.3 is entirely dedicated to a general review of the research literature related to medium access control in vehicular networks. The selected solutions are classified following the channel access technique they use, and the strengths and weaknesses of each class of protocols are addressed. A special attention is given to a number of unsupported assumptions that proliferate inside the VANET community. Finally, the discussion in Section 2.4 touches the subject of simulation frameworks suitable for the study of V2V communications. The main modelling challenges are pictured and a series of choices made in this study are explained.

2.1 Applications

As a part of a more complex intelligent transportation system, the primary goal of vehicular communications is to increase traffic safety by reducing the number of road accidents and their impact. A significant problem in this context is that safety applications are by definition proactive and collaborative and they usually require a penetration ratio close to 100%. With about 500 million passenger cars currently in use all around the world, efficient safety applications would only be possible in 10-15 years after the auto-makers would include communication equipment inside their new vehicles. While regulations and legal obligations could accelerate the process, a more elegant solution, at least in the early stages, appears to be the addition of other applications, capable of functioning correctly

even under a low penetration ratio. These applications would bring value added features to early adopters and could contribute thriving the demand for hardware that would later also be used for safety purposes.

Two classes of applications have been proposed to this effect, targeting traffic efficiency and infotainment respectively. An impressive number of use-cases have been described for both safety and non-safety applications, with the pre-Drive C2X European programme gathering all these scenarios and their requirements under a unique format [PRE08]. However, it is important to note that these are just guidelines, not standards, and automobile manufacturers will most probably define and implement proprietary versions of the vehicular applications, including the interface with the driver and algorithms for danger assessment. In the following, every type of application is discussed, using meaningful examples and underlying important characteristics, with the amendment that the rest of this study will be centred on problems related to road safety.

2.1.1 Safety Applications

As mentioned above, safety applications represent the objective behind inter-vehicular communications. Their goal is to increase the drivers' awareness about the surrounding environment, providing this way an important assistance in avoiding dangerous situations. For legal liability reasons, automatic actions of the on-board processors can only be used in special circumstances, for example following a crash. While most of the applications in this class are built using direct vehicle-to-vehicle communication, some use-cases as for instance stop sign or signal violation also require special infrastructure.

In this section, two representative safety applications will be detailed, namely the Intersection Collision Warning (ICW) and the Emergency Electronic Brake Lights (EEBL). This choice is based on the fact that most of the requirements that can be met in this class of applications are covered by ICW and EEBL.

Collisions at intersections are the most encountered type of road accidents, especially in urban scenarios where low visibility situations are frequent at crossroads. In order to alleviate this problem, ICW broadcasts periodic status messages, or beacons, containing internal information like geographical location, velocity or acceleration. The relevance area for these messages is considered to be approximately 200 meters around the intersection, and the expected beaconing frequency is $10Hz$. Using ICW, drivers could be warned about the existence of other vehicles outside their line of sight

and they could use this knowledge to take more appropriate decisions. However, such an application could lead to a serious modification of the drivers' behaviour, who would base their actions on ICW messages while gathering less information on their own. In this case, unequipped vehicles would represent a real danger and therefore Intersection Collision Warning should only be introduced when the penetration ratio of the V2V communication equipment approaches 100%.

Chain accidents are another major source of road traffic problems, and they are usually produced by the sudden braking of one vehicle. EEBL targets this particular type of incidents by sending a special notification message when an important deceleration is detected. It is probable that such a message would not be more helpful than the current brake lights for the driver just behind, as the time to react would not be increased in order to avoid the first collision. However, the following drivers do not have a direct line of sight with the vehicle that initially brakes, therefore they are informed of the problem by the means of light signals only when the brake wave reaches the vehicle immediately in front of them. Using EEBL, this information could be propagated in the close neighbourhood ever since the initial braking takes place and, while the accident might be unavoidable, its proportions and consequences could be highly reduced. The area of interest is situated in this case behind the braking vehicle and it has a size of several hundred meters. The importance of the event is limited in time, therefore there is no point on repeating the message more than a few seconds. The application's efficiency also depends on the penetration ratio, but EEBL could prove to be an interesting complement to the existing visual signals even for early adopters.

The list of foreseen safety applications is substantial, with examples like Approaching Emergency Vehicle, Slow Vehicle Warning, Lane Change Assistant or Left-Turn Collision Warning to name just a few. Despite the large number of use-cases, it can be noticed that all the applications in this class can be implemented using either beacons or special notification messages. More details about these messages and their integration in a wider dedicated architecture are given in Section 2.2.4.

2.1.2 Traffic Efficiency Applications

Although they do not play a direct role in reducing the number of accidents, traffic efficiency applications can help achieve this goal by reducing the time spent by the drivers on the road. Another important consequence of an optimised driving behaviour is the reduction in fuel consumption and in pollution.

The advantage of the applications in this class is that they can reach their purpose even under a low penetration ratio, using specialised infrastructure or the already existing 3G/4G networks. This is possible because the delay requirements in these scenarios are much more flexible. On the other hand, installing infrastructure for V2I communications can be an expensive task; therefore the expectation is that traffic efficiency applications will be at first available only in certain zones and the penetration of direct vehicle-to-vehicle communications will help increase the coverage area.

The use-cases belonging to this category can be further divided into two groups, according to the type of information they require, which can have either a strictly local scope or correspond to a larger, even remote area. An example where only local information is used is the Green Light Optimal Speed Assistant (GLOSA), an application using beacons transmitted by a Road Side Unit (RSU) correlated with a traffic light in order to calculate a speed that would allow the driver to reach the traffic light in a green phase. GLOSA would reduce stop time and accelerations, allowing smoother traffic and lower fuel consumption. In this case, the information regarding the traffic light cycle needs to be delivered only to the incoming vehicles situated in a range of a few hundred meters from the RSU. This can be achieved by direct V2I communication or by a hybrid approach where some vehicles could act as relays.

On the contrary, applications like Traffic Information and Recommended Itinerary (TIRI) need to gather data from much larger areas, with a size of tens or even hundreds of kilometres. TIRI is meant to act like a complement to the current navigation systems, including real-time traffic status that could help drivers avoid congested roads. This application is expected to be implemented around a central authority that would collect traffic information from an entire city or region using RSUs or cellular networks. Based on this data, this central entity would try to optimise the traffic flow and suggest the best itinerary to every driver.

2.1.3 Infotainment and Business Applications

The third category of use-cases consists of applications that can bring an important extra-value to the vehicular network, but without any effect on road traffic. Similarly to the traffic efficiency scenarios, infrastructure plays a major role in this context by providing quality services to early adopters.

Infotainment applications will generally make use of local information. Their delay requirements are loose, but the data volume that needs to be transferred is much larger than in the case of safety applications. A typical scenario from this class is the Point of Interest Notification (PoIN),

where a vehicle entering an area where this application is supported can receive information about commercial services or products available in the covered geographical zone. This could prove to be an interesting marketing tool for hotels, restaurants or other similar businesses. The relevance area should be defined by the scope of each advertisement, but a classical value is in the order of a few kilometres.

The business segment plays a very important role in the automotive industry and the adoption of communication devices in this field can be accelerated by the proposal of appropriate applications. However, users in this category are likely to demand highly reliable services, with very precise delay and throughput requirements. One of the best examples in this class is a complement to existing Fleet Management solutions, which could facilitate the on demand access to real-time data like vehicle speed, position, freight or engine status. A hybrid approach combining inter-vehicle communication and existing cellular networks could be appealing for any type of transportation company.

2.2 Standardization

In an extremely heterogeneous automotive industry, a solution for inter-vehicle communication can be successful only if adopted by all the auto manufacturers. This is not necessarily easy to accept for car manufacturers who are accustomed to distinguish themselves from their competitors by proposing proprietary systems. Standardisation work is therefore essential in this context and this section presents the current status in this field.

The first collaborative projects focused on the development of Intelligent Transportation Systems (ITS) were created in the 1980s. In the United States, the program on Advanced Technology for the Highway (PATH) concentrated on gradually automating the highway system. The Japanese Road/Automobile Communication Systems (RACS) studied the combination of real-time traffic information and vehicular navigation. Meanwhile, the program for a European Traffic with Highest Efficiency and Unprecedented Safety (PROMETHEUS) benefited from the implication of 18 European car makers and it was the first to propose vehicle-to-vehicle communication for safety purposes. More details on these ITS projects can be found in a 1991 survey by Jurgen [Jur91].

2.2.1 Spectrum Allocation

Despite these early efforts, vehicular networking took a long time before becoming a serious alternative for road safety. This was mainly due to the immaturity of wireless communications: one must remember that the first Global System for Mobile Communications (GSM) standard was not published until 1990. Besides the lack of compatible technologies, another important problem for V2V communications was the spectrum scarcity, because the reliability expected from safety applications was not compatible with the unlicensed Industrial, Scientific, and Medical (ISM) radio bands.

Following a series of studies launched in the early '90s, in October 1999 the US Federal Communications Commission (FCC) assigned 75 MHz of spectrum in the 5.9 GHz band for Dedicated Short-Range Communications. At that moment DSRC was yet to be defined, but it was presented as an enabling technology for V2V and V2I data transfer. This decision represented a turning point that triggered the revival of research on vehicular networking. A series of projects were initiated soon, the most significant being the US Vehicle Safety Communications (VSC) programme and the German project, FleetNet. In 2002, the European Union established the Electronic Safety Initiative (*eSafety*), with the goal of improving traffic systems. This finally led, in 2008, to a decision of the European Commission to assign the spectrum between 5.875 GHz and 5.905 GHz for ITS road safety applications. This 30 MHz band, known as the ITS-G5A European profile, is likely to be extended with other 20 MHz destined for non-safety applications, as recently recommended by the Electronic Communications Committee (ECC nomenclature ECCElectronic Communications Committee).

An important observation is that in both US and Europe the spectrum dedicated to vehicular communications has been divided in 10 MHz wide channels. As shown in Figure 2.1, the European channels correspond to the first five channels in the DSRC band. However, despite these efforts for interoperability, a few comments are necessary regarding the compatibility between the spectrum assignment on the two continents.

In its 1999 decision, the FCC defined channel 178 as a Control Channel (CCH), while the six others were named Service Channels (SCH). From these SCH, the FCC assigned channel 172 “exclusively for vehicle-to-vehicle safety communications for accident avoidance and mitigation, and safety of life and property applications”, and channel 184 “exclusively for high-power, longer-distance communications to be used for public safety applications involving safety of life and property, including road intersection collision mitigation” [FCC06]. Under these conditions, the role of the DSRC

USA Spectrum Allocation

CH172	CH174	CH176	CH178	CH180	CH182	CH184
5.860	5.870	5.880	5.890	5.900	5.910	5.920
G5SC4	G5SC3	G5SC1	G5SC2	G5CC		

European Spectrum Allocation

Figure 2.1: Spectrum allocation in the United States and Europe

CCH was limited to announcements periodically transmitted by RSUs in order to advertise the applications supported on the other channels.

Meanwhile, the European regulators also decided to create a Control Channel and several SCH. Nevertheless, in the architecture discussed in Section 2.2.4, the CCH has been reserved for safety V2V applications, meaning that, in the US and European allocations respectively, the same name applies to channels with different functions. Moreover, the European CCH corresponds to the DSRC channel 180, a normal service channel, which could raise some important interoperability problems. To make matters even worse, Japanese authorities seem decided not to use the 5.9 GHz band for ITS services, but a part of the 700 MHz band that will be released following the closure of the analogic television service.

As the focus of this work is on vehicular safety scenarios, the rest of this thesis addresses issues related to the communication channel dedicated to this kind of applications. As explained above, such a channel exists in all the proposed architectures under different names. For simplicity reasons, further on in this document, the European meaning and appellation of the CCH will be used unless stated otherwise, but the totality of this work can be applied to the DSRC channel 172.

An essential feature of the control channel is that it can be used solely for safety purposes. As discussed in Section 2.1.1, all the safety applications can be accommodated using only two types of messages: regular beaconing and special notifications. Because the information transported in these messages is relevant to all the surrounding vehicles, the safety messages are transmitted in broadcast mode, making the CCH a 100% broadcast channel. As it will be discussed later, this property is fundamental when analysing the performance of MAC layer protocol designed for vehicular commu-

nications.

2.2.2 IEEE 802.11p

Following the 1999 FCC decision, the American Society for Testing Materials (ASTM) took up the task of developing a communication standard for the DSRC band. With the Universal Mobile Telecommunications System (UMTS) already described by the 3rd Generation Partnership Project (3GPP) and with products already implementing the 802.11 standard of the Institute of Electrical and Electronics Engineers (IEEE), the state of the wireless communications industry suffered a metamorphosis from a decade before. Therefore, in 2003, the specifications of the first standard for roadside to vehicle communications, ASTM E2213-03, were published [ASTM03].

The ASTM standard was in fact based on the already popular IEEE 802.11a [802.11-07], and in 2004 the IEEE established the Task Group p (TGp), in order to improve ASTM E2213-03 and to integrate it in a wider architecture for Wireless Access in Vehicular Environments, which will be discussed in the next section. TGp reached its goal in July 2010, when the IEEE 802.11p amendment was published [802.11-10].

Trying to encourage silicon vendors to integrate support for IEEE 802.11p in their successful and mature Wi-Fi products, the TGp chose to bring only minor modifications to the physical (PHY) layer. The Orthogonal Frequency-Division Multiplexing (OFDM) technique, already described in IEEE 802.11a is reused, with the difference that 10 MHz wide channels were preferred to the “classical” 20 MHz ones as a weapon against the severe multipath environment. However, 10 MHz channels were already defined in IEEE 802.11, hence hardware modifications were minor, and the sole consequence of this adjustment was that the temporal parameters of the protocol have been doubled, as shown in Table 2.1.

On the MAC layer, the efforts of the task group focused on allowing communication between stations that do not belong to the same Basic Service Set (BSS), which was not an option in the original standard. However, the delay imposed by the operations needed to associate to a BSS was not compatible with the small connectivity time of the vehicular network. On all the other major points, IEEE 802.11p uses the mechanisms already defined in the standard by the Distributed Coordination Function (DCF) and the Enhanced Distributed Channel Access (EDCA) method [802.11-07].

Just like in DCF, the access to the medium is based on the Carrier Sense Multiple Access with Collision Avoidance (CSMA/CA) technique. A contending station begins by listening the

Table 2.1: IEEE 802.11p parameters

Channel Width	$10MHz$
Slot duration	$13\mu s$
DCF Interframe Space	$48\mu s$
Short Interframe Space	$32\mu s$
PLCP Header Duration	$8\mu s$
OFDM preamble Duration	$32\mu s$
Minimum Data Rate	$3Mb/s$
Maximum Data Rate	$27Mb/s$

channel for the duration of a DCF Inter-frame Space (DIFS). If the physical Layer Convergence protocol (PLCP), the upper part of the PHY layer, returns a Clear Channel Assessment (CCA) after this period, the message is transmitted. If the channel is detected busy, the station will back off from transmitting for a number of slots uniformly chosen between 0 and the current value of the Contention Window (CW). During the back-off period, the counter is decremented every time a slot is considered idle and it freezes when another activity is sensed on the channel. When the back-off counter reaches 0, the message is transferred to the PHY layer for transmission and the MAC layer initialises another timer, waiting for an acknowledgement (ACK) from the destination. If this second timer expires before the reception of the ACK, the transmission is considered as failed and the entire procedure restarts, this time with a higher value for CW. The mechanism of doubling the contention window after every failed transmission and resetting it to the original value (CW_{min}) when an ACK is received is known as the Binary Exponential Back-off (BEB). Finally, if a transmission does not succeed after a pre-defined number of attempts, the MAC layer drops the considered message.

DCF also describes an optional virtual carrier sense mechanism as a complement to the physical one described above. In this case, two special messages, Request-to-Send (RTS) and Clear-to-Send (CTS), are used to reserve the medium for the transmission of much larger data frames. The RTS/CTS handshake is currently implemented on most of the IEEE 802.11 compliant hardware, and it has been designed as a solution against hidden nodes, stations that can not communicate

Table 2.2: IEEE 802.11p EDCA parameters

Traffic Class	CW_{min}	CW_{max}	AIFS
AC_BK	15	1023	9
AC_BE	15	1023	6
AC_VI	7	15	3
AC_VO	3	7	2

directly but possess common neighbours and therefore need to coordinate their transmissions.

EDCA has been defined in the IEEE 802.11e standard [802.11-07] as a way to provide Quality of Service (QoS) in Wireless LANs. While both the physical and virtual carrier sense operations are inherited directly from DCF, EDCA allocates a certain priority to each message by assigning it to one of the four traffic classes with distinct MAC parameters. This prioritisation is achieved by using different values for the contention window and the Arbitration Inter-Frame Space (AIFS), which replaces the DIFS from the original standard. The values used in IEEE 802.11p for these parameters are shown in Table 2.2.

However, these minor modifications brought by the IEEE 802.11p amendment are not enough to transform a technology optimised for multimedia traffic in a WLAN in a reliable access method in an entirely different vehicular context. This is particularly true in the case of the CCH, where all the messages are transmitted in broadcast mode, which is treated differently by the DCF. Because a broadcast message has multiple, possibly unknown destinations, using ACKs to confirm the reception would result in a high collision probability and important overhead. Therefore, the transmitter cannot use this feed-back in order to schedule retransmissions and a broadcast message is sent only once, using the minimum value for the contention window. The RTS/CTS reservation is also unusable in this case, as CTS messages should be received from all the neighbours.

protocols based on the IEEE 802.11 standard were already known to perform poorly under increased node density even in the case of unicast WLANs networks. This issue is even more serious in the case of a highly mobile, multi-hop vehicular environment, where the two mechanisms designed to alleviate the problem, the BEB and the RTS/CTS handshake cannot be used because of the broadcast nature of the network. Several enhancements have been therefore proposed for IEEE

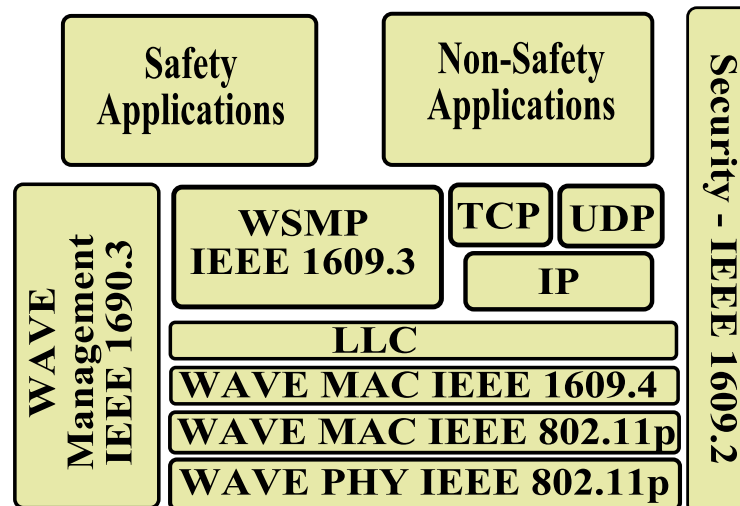

Figure 2.2: IEEE WAVE Architecture

802.11p, particularly with regard to congestion control.

2.2.3 IEEE WAVE Architecture

Despite the multi-channel structure of the DSRC spectrum, IEEE 802.11p describes the operations on a single channel. This is because this standard is only a part of the Wireless Access in Vehicular Environments architecture defined by the IEEE. In WAVE, a series of standards known as the IEEE 1609 family provide the specifications for the upper layers, as shown in Figure 2.2.

A part of these standards have been published as trial-use standards in 2006, followed by revised versions in 2011. However, important issues have been detected, especially in the case of the channel switching operations described in 1609.4 [CJD09] and another modification of the standards is considered at present. In the remaining of this section, the different components of the WAVE architecture will be discussed, with a particular focus on the upper MAC layer defined in IEEE 1609.4.

In order to reduce the cost of the infrastructure needed to provide services in a vehicular network, the idea in WAVE is to install only a basic hardware at the RSU level, concentrating the intelligence in a remote entity. This remote manager, including the format of the messages exchanged with the RSUs and of the data that needs to be stored are the object of the IEEE 1609.1 standard [1609.1-06], not shown in Figure 2.2.

As discussed in Section 2.2.2, stations no longer need to be members of the same BSS in order to communicate. This reduces the overhead, but it also eliminates all the security mechanisms, like those for authentication and authorisation. The IEEE 1609.2 standard [1609.2-06] describes security services in a cross-layer manner, with a focus on the processing and format of secured messages.

The IEEE 1609.3 standard [1609.3-10] presents the WAVE Short Messages Protocol (WSMP), an alternative to the TCP/IP stack that could generate addressing problems and would add large headers to the small safety messages. The special WAVE Short Messages (WSM) can be transmitted on both CCH and SCH. IP-based communications are still allowed for non-safety applications, but they can only use the service channels. The document also provides the specifications of the Management Information Base (MIB) serving the WAVE protocol stack.

Finally, IEEE 1609.4 [1609.4-10] is an extension of the MAC layer for multi-channel coordination. Among other functions, the standard describes the management of the traffic queues and the prioritisation mechanisms. It also specifies rules for channel selection on a per-packet basis. However, the most important procedures in IEEE 1609.4 concern channel coordination among stations. As the use of two radio units is considered too expensive, vehicles will need to periodically switch their radios between CCH and SCH, in order to serve both safety and non-safety applications. The standard defines a *sync interval* of 100 ms that needs to be split in two equal periods. In the first period, all the nodes monitor the CCH and transmit safety messages, while in the second period those willing to access a non-safety service can switch to one of the service channels. Synchronisation between nodes is considered achievable using the Global Positioning System (GPS) interface already available in most new vehicles.

Two important problems can be identified in the latest version of IEEE 1609.4. First of all, these specifications were formulated before the FCC decision discussed in Section 2.2, which moved all safety operations to channel 172. This implies that a third channel needs to be monitored during a sync interval. The second problem, identified in [CJD09], comes from the fact that non-safety messages accumulate during the period when the radio is switched on the safety channel. The collision probability at the beginning of the SCH period is therefore very high and solutions need to be found in order to avoid these synchronised transmissions. For a detailed discussion of the WAVE architecture and the status of the different standardisation efforts in the United States in 2011, the reader is referred to a very complete monograph by John Kenney from Toyota InfoTechnology Center [Ken11].

2.2.4 ETSI ITS Architecture

In 2005, European vehicle manufacturers initiated the Car-2-Car Communication Consortium (C2C-CC), in order to support the creation of a common standard for vehicular networks. C2C-CC has ever since been one of the driving forces of the research on V2V communications in Europe, together with the programmes developed under the *eSafety* framework. Several demonstrations and the specifications of a complete architecture are only a part of the contributions of the consortium.

Therefore, when, in 2009, the European Commission decided to assign a mandate to the European Telecommunications Standards Institute (ETSI) regarding vehicular communications, the newly established Technical Committee on Intelligent Transport Systems (TC ITS) began working closely with C2C-CC. The ETSI TC ITS has been organised in five Working Groups (WG), as follows:

- WG1 - Application Requirements and Services
- WG2 - Architecture and Cross Layer
- WG3 - Transport and Network
- WG4 - Media and Medium Related
- WG5 - Security

The first major milestone in the ETSI standardisation process was the publication of the European ITS Architecture in October 2010. As it can be noticed from Figure 2.3, this architecture has a wider scope than the IEEE WAVE system, integrating multiple communication technologies. However, many concepts are common between the two designs, and WG4 decided to define a European profile for IEEE 802.11p [ETSI10]. The unique difference between the two standards is that the ETSI version has different requirements for spectral power density, in order to comply with European regulations.

At the higher layers, the most notable distinction is represented by the definition of a *facilities* layer, as a support for applications. The introduction of a new layer was motivated by the profile of safety services. While numerous, these applications usually necessitate the same type of information, as discussed in Section 2.1.1. If each application was to acquire this data for itself, as in a classical architecture, the channel would be congested by messages containing the same information but

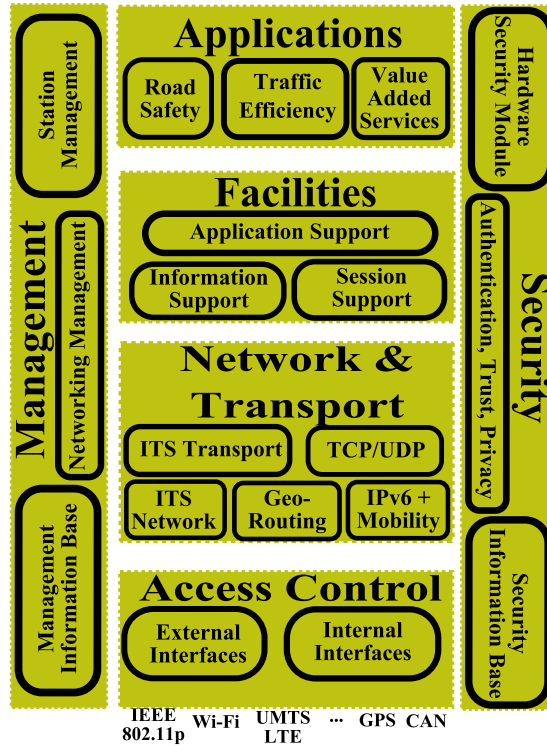

Figure 2.3: ETSI ITS Architecture

issued by different applications. The role of the facilities layer in this context is to gather and store the relevant data from other vehicles and from the on-board sensors and make it accessible to all the applications, without the need of application-to-application communication. In US, the Society of Automotive Engineers (SAE) also defined an entity with similar attributions, called *message dispatcher* (MD) [RCCBLK07]. However, the integration of the MD in the WAVE architecture is currently an ongoing work.

The format of the safety messages has also been standardised by WG1. The regular beaconing, which must be sent with a frequency between 1 Hz and 10 Hz, is named Cooperative Awareness Message (CAM) and it can include a large number of fields [ETSI11]. The facilities layer decides on what information should be shared in every CAM. In the case of special notifications, or Decentralised Environmental Notifications (DENs), the standard [ETSI10a] defines not only the format of the message, but also the conditions that trigger the transmission of a DEN.

Another interesting observation is that, although ETSI chose IEEE 802.11p as the main technology for V2V communication, the IEEE 1609.4 standard is not integrated in the ITS architecture.

This means that there are currently no channel selection and channel switching procedures defined in the European framework. Even assuming that different radios will be used on the CCH and SCH, the selection of a certain SCH remains a complicated task and it is unclear how will this problem be addressed.

A final point, relevant to all the vehicular applications, either safety or non-safety, refers to security problems in general, and to privacy issues in particular. The public acceptance for vehicular services is likely to be much more difficult if they are perceived as a surveillance tool, and these concerns need to be addressed in the design stage of any application or architecture. The approach taken in ETSI ITS WG5 regarding privacy is based on the results of the EU-funded Secure Vehicular Communication (SeVeCOM) project, which proposed the use of pseudonyms, identifiers that change systematically in order to prevent node tracking [PBHSFRMKKH08]. Although this study does not concentrate on privacy concerns, the compatibility of the analysed solutions with the changing pseudonyms mechanism is regularly discussed.

2.3 Medium Access Protocol

The medium access protocol that serves safety applications on the CCH represents the main point of interest of this work. While IEEE 802.11p is clearly the favourite choice of the standardisation bodies, other interesting proposals, covering most of the existing access methods, have been made in this context of vehicle-to-vehicle communication. However, before discussing the most significant MAC layer solutions proposed in the research literature, it is important to understand the specificities of the control channel. Instead of choosing the classical path of presenting each characteristic of the CCH, this work presents a detailed list of misconceptions extracted from different studies, the result being a comprehensive discussion on the role of the medium access control layer in vehicular communications.

2.3.1 Misconceptions

Despite the work of the normalisation bodies, described in Section 2.2, some practical issues regarding the MAC layer still need to be investigated. The major problem is that the V2V MAC layer has to deal with unique requirements and conditions. The design of a protocol that can support high relative speeds, long range communication, mobility, driver privacy and variable node density while

being used by applications that could have an impact on human lives is clearly not an obvious task. If things were not complicated enough, several misconceptions regarding the vehicular MAC protocol flourished inside the VANET research community.

It all started with the acronym, VANET, very similar with the one used for Mobile Ad-Hoc Networks (MANET). This quickly led to the description of the vehicular network as “a special case of MANETpp, although it soon became clear that none of the solutions previously designed in a classical MANET context could be directly applied in inter-vehicle communication, as also observed by Kiess et al. [KRM07]. The remainder of this section gives the example of a number of misconceptions that recurrently appear in the field of V2V communications.

- ***MAC layer unicast is used on the control channel.***

The assumption that safety applications use unicast messages at the MAC layer is usually made by researchers who try to directly apply in the vehicular network MAC solutions initially designed in the context of classical MANET, sensor networks or wireless mesh networks. This type of study usually considers that safety messages are only transmitted in dangerous situations, with a precise destination (equivalent to the sink node), and without considering any congestion problem.

However, as discussed above, vehicular safety applications take a proactive approach, transmitting CAMs that are not meant as danger announcements, but as an instrument to extend the drivers’ knowledge about the surrounding environment, with the hope that this extra-information will help enhancing road safety. Of course, unexpected hazards can still occur and the vehicle detecting such an event should announce it to the other traffic participants. Sometimes the information does not need to be disseminated with very strict temporal requirements and it can simply be added to the next beacon. It is, for example, the case of a modification in weather conditions or in the type of road surface. Nevertheless, in other cases, the duration until the next CAM is produced is too large and the situation must be reported using a DEN. Both CAMs and DENs contain information that is potentially interesting for all the surrounding vehicles. Even in the case of applications like pre-crash warning, where only a small number of network nodes are actually involved, the event has an influence on all the vehicles situated in the close neighbourhood. This implies that safety messages need to be transmitted using MAC layer broadcast. Moreover, because the control channel is entirely dedicated to safety

applications, this means that the CCH is a purely broadcast channel.

While broadcast in wireless networks can be achieved very simply due to the omnidirectional propagation of radio waves, this suggests that MAC layer solutions designed with unicast communication in mind are hardly transposable in the vehicular network, especially in the case of the CCH.

For example, a detailed analysis of the applicability of popular IEEE 802.11 enhancements to a safety VANET is given by Chen et al. [CRM10], the conclusion being that none of the discussed mechanisms can be straightforwardly adapted to meet the requirements of vehicle-to-vehicle safety communications.

Although some solutions originally designed with unicast messages in mind might also be efficient in this new context, such mechanisms and protocols need to be treated with precaution and they have to be revalidated by taking into account the vehicular communication pattern.

- ***Beaconing is just broadcast***

The research studies that do not fall in the trap of using unicast messages for safety purposes simply presume that beacons are no more than simple broadcast messages. Whether we talk about analytical frameworks [MCR07] or simulation results [TMSH09], beaconing is perceived as a periodic broadcast, with no extra-properties.

However, as explained, CAMs contain data from on-board sensors, like vehicle location and speed. If such a message cannot be transmitted before the next beacon is produced, the information it contains is no longer valid. Transmitting an outdated CAM in these circumstances would provide neighbouring nodes with unusable data while also introducing an unnecessary delay for the next message. Therefore, such an expired beacon has to be dropped in order for the CAM containing the updated information to take advantage of the next transmission opportunity.

The fact that safety beacons can expire makes them very different from regular broadcast messages. For example, as it will be shown in Chapter 4.4, the optimal value of the minimum contention window within the IEEE 802.11 back-off mechanism decreases with the node density increase in the case of vehicular beaconing, while showing the opposite effect for pure broadcast.

Although the difference between beaconing and broadcast might not be that radical in other

cases, the studies focusing on the performance of different VANET safety mechanisms should take into account the special characteristics of the messages transmitted on the CCH instead of seeing them from a classical broadcast perspective.

- *Average MAC delay is essential to measure*

In the context of periodic broadcast, one can imagine an IP packet being submitted to the MAC layer for transmission while previous messages are still in the MAC queue(s) waiting to be served. This introduces a MAC layer delay that depends on the number of messages already on the queue and the time needed to serve such a message. The MAC layer delay can be relatively large in some cases, and this could be quite problematic in the case of safety messages that practically have real time requirements. Therefore, many researchers turn their attention to this metric, trying to minimise the average time a beacon spends at the MAC layer.

However, as discussed above, vehicular beaconing is different from regular broadcast in certain aspects, the most important being that safety beacons have a limited time duration before being dropped. Because an expired CAM is not transmitted, the MAC delay is bounded by the beacon's lifetime, and therefore any received safety message contains correct information.

In these conditions, measuring the average MAC delay becomes less significant. Other metrics have recently been described with vehicular safety communications in mind, like the time duration a vehicle remains invisible to another vehicle [EGHKp06], or the distance travelled by a node between two consecutive beacon receptions from a one-hop neighbour [TIISI08]. These metrics are much more interesting in a vehicular context, as they include in one single value information concerning expired beacons, radio propagation problems, and message collision.

- *The control channel needs solutions for internal contention*

Among the two types of vehicular safety messages, DENs contain more valuable information than CAMs. When a special event needs to be communicated to the other traffic participants, the hypothesis is that the rest of the network is not aware of the situation and the information needs to be rapidly disseminated over a certain geographical area. It is therefore essential to grant DENs a higher priority than the simple beacons transmitted by other vehicles. This can be achieved through the use of a higher transmission power [TMSH09] or a smaller back-off

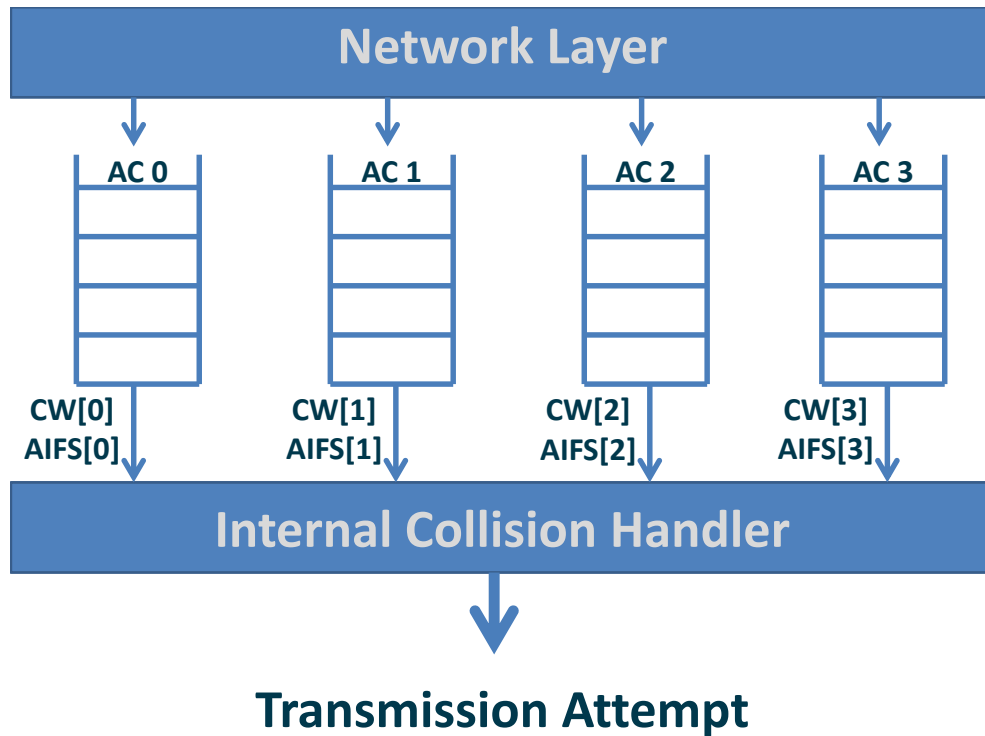

Figure 2.4: Internal contention in IEEE 802.11p as defined by the Enhanced Distributed Channel Access function

time [BUSB09a] for the special notifications.

As a complement to these approaches, some research studies (e.g. [BHG10]) turned their attention to the internal contention between the various types of safety messages. Inspired by the different traffic classes defined in the IEEE 802.11e standard, the proposed solutions suggest the use of multiple queues, each with distinct access parameters, as depicted in Figure 2.4. This idea, successfully used in WLANs to meet the requirements of voice and video traffic, imposed itself in the vehicular community and both the WAVE and ETSI ITS architectures include the EDCA function.

However, at a close inspection, the assumption that forms the starting point of this internal contention problem proves to be unfounded. As already discussed, safety messages are not produced directly by the applications, but by the facilities layer. Also, a safety message can only be a CAM or a DEN. The arrival of a new CAM triggers the expiration of the previous one, hence there can be no internal contention between two or more CAMs. Moreover, the

information included in a beacon (location, speed, etc.) is also present in a special event notification. In these conditions, if a DEN is produced while a CAM is waiting at the MAC layer, the CAM is no longer needed because the data it transports can be found in the DEN and therefore it can simply be dropped from the queue. On the other hand, if a beacon is produced while a special event notification is still being treated, the relevant information can simply be updated in the DEN as there is no need to waste the bandwidth by transmitting both messages. This implies that an internal contention between a CAM and a DEN is also not realistic.

The only possibility to have two safety messages at the same time at the MAC layer is when both of them are special event notifications. Because DENs should be transmitted using a small contention window, such a situation is very implausible. Nevertheless, even if such circumstances might occasionally appear, there is no reason to assign DENs to different traffic classes and the messages can simply use the same queue using a first-in-first-out approach.

In these conditions, the only advantage of a MAC architecture based on the IEEE 802.11e traffic class differentiation is that the safety messages can be quickly assigned a series of parameters (back-off time, transmission power, modulation) by simply being transmitted to the corresponding queue. The EDCA might also be useful for channel access on the SCH, where traffic differentiation is necessary.

- *Collisions can be detected*

MAC protocols in general are designed with the idea of preventing collisions in mind. However, in some cases, such events are unavoidable and fall-back mechanisms are needed, like Automatic Repeat Request (ARQ) or the adjustment of various MAC or PHY layer parameters. An essential property in wireless networks is that the transmitters cannot directly detect a collision and therefore they need to rely on feed-back from the receivers.

With IEEE 802.11 being among the most popular standards for wireless communications, the number of solutions focusing on alleviating the consequences of a collision is impressive, but most of these proposals are based on detecting collisions by the means of missing acknowledgements. As discussed, ACKs are not used on the broadcast CCH, so timer-based mechanisms cannot be implemented in a safety VANET.

Another set of approaches requires the nodes to monitor the channel continuously in order to

detect a collision and to return this information to the transmitter. However, discriminating between a collision and a radio propagation problem is a complicated task, especially in a noisy environment. Some studies have shown that distinct patterns can be detected in these two cases in the evolution of the Received Signal Strength Indicator (RSSI) [RNASB08], but this implies the off-line use of powerful statistical tools and there is currently no real time solution able to detect a collision using this method.

The idea that seems to dominate in the context of V2V communication is to add a sequence number to every beacon. In this case, a receiver could detect missing messages and use this as the foundation of an adaptive mechanism [RYPWO]. Two inadvertences can be underlined in this case. First of all, as explained above, a missing beacon can be produced by signal fading and is not necessarily the result of a collision. Second, this solution fails to take into consideration the mechanisms designed to secure vehicular communications, in particular those focused on privacy. VANET security relies upon the idea of randomised identifiers that are regularly changed by the vehicles, and using sequence numbers would represent a danger in this case as it would facilitate vehicle tracking.

Collisions are clearly undesired events and the vehicular MAC layer should include techniques to alleviate this problem. However, these techniques must be designed while keeping in mind that collisions in a VANET are not only unwanted, but also unavoidable and undetectable.

- ***The balance between hidden and exposed nodes should be found***

The attenuation of propagating radio waves is an important phenomenon allowing spatial reuse in wireless networks. On one hand, this increases the capacity of the network but on the other hand it can lead to the occurrence of hidden nodes, basically stations that cannot directly communicate but whose messages can collide in a certain area of the network.

This hidden node problem has been thoroughly studied in wireless networks and a number of solutions have been designed, the most popular probably being the RTS/CTS handshake. Sadly, these solutions cannot be used in a broadcast environment like the CCH. Moreover, reducing the number of hidden nodes usually triggers a side effect, the exposed node problem, shown in Figure 2.5. An exposed station sees its transmission denied by the mechanism trying to eliminate hidden nodes (or even directly by the carrier sense mechanism), although sending the message would not produce a collision.

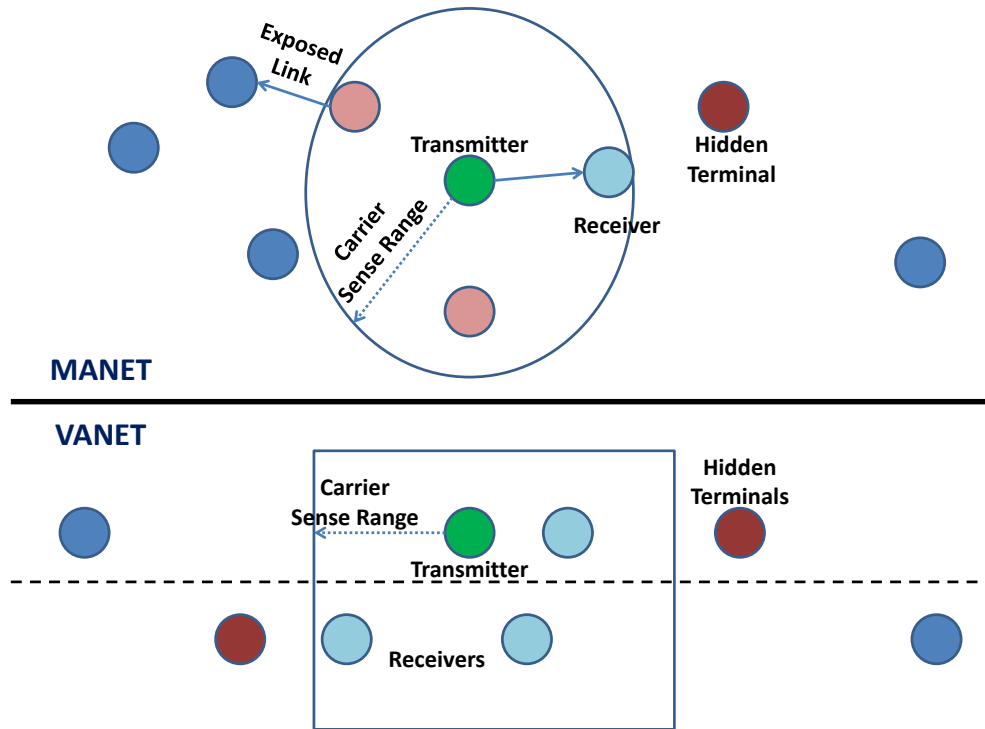

Figure 2.5: Hidden and exposed terminal problem in MANET: a hidden terminal can interfere with a transmission that it is not aware of, while an exposed terminal is blocked by a neighbour, although both nodes could transmit in parallel without creating a collision at the two receivers. In the case of a safety VANET, the broadcast nature of the messages eliminates exposed nodes.

A number of research studies focused on finding the best trade-off between hidden and exposed nodes in MANETs or wireless mesh networks [JL08]. This problem changes completely in a safety VANET, again because of the broadcast nature of the CCH. As a transmission interests all the surrounding stations, the concept of exposed node does not exist in this vehicular context, and the proposed solutions should consider this particularity.

- ***Dissemination of DENs through multi-hop messaging is necessary***

Although special notifications are arguably more important for the performance of safety applications than CAMs, the study of DENs has received less attention than the one of ordinary beaconing. And, with some exceptions (e.g. [TMSH09]), these few studies focused on the multi-hop dissemination of safety messages.

Message forwarding and information dissemination in a certain area have also been thoroughly investigated in the context of vehicular geocast, a communication paradigm used by certain non-safety applications where a message needs to be delivered to all the stations inside a given geographical area. DENs also have to address these spatial requirements, as the information they carry must be shared with all the vehicles that might be influenced by the event. The distance that needs to be covered depends on the application and it can go from a few hundred meters in the case of emergency braking to several kilometres in the case of a blocked road announcement. Moreover, special notifications also add temporal constraints that do not usually exist in the case of non-safety applications.

It is therefore tempting to use similar solutions for DEN and geocast forwarding [CSC11]. However, geocast messages are the only solution to deliver the necessary non-safety data needed by vehicles found outside the coverage range of the information owner. On the other hand, safety applications can always rely on regular beacons to deliver the required data. The vehicle that originally detects the event might consider it important enough to create a special notification instead of waiting until the next beacon is produced, but the one-hop neighbours that become aware of the event do not simply forward it using a dedicated mechanism. The information is in this case delivered to the facilities layer and it is made available to the interested applications. Because multiple vehicles are now in the possession of the news, farther dissemination can be achieved by all these stations announcing the event using regular beaconing, and there is no need to increase the network load with the forwarding of a DEN.

- ***The DENs are uniformly distributed over the entire network***

Another problem that can be detected in the studies related to DENs is the supposition that special notifications are created uniformly over the entire network. However, choosing randomly the source vehicles comes in contradiction with the idea that special notifications announce an event detected by the on-board sensors.

Sudden brakes, ice, blocked roads, vehicles driving on the wrong lane or other situations of this type appear in a certain geographical area and they are detected by vehicles in the respective zone. It is very probable that several nodes simultaneously detect the same event, therefore the origins of the DENs cannot be considered as independent.

This is particularly important in the analysis of congestion control mechanisms, because mul-

Table 2.3: Channel access methods in a safety VANET context

Access Method	Strengths	Weaknesses
MANET Broadcast	High theoretical reception ratio	Complex reservation phase Not adapted to high mobility Low efficiency under severe noise
Code Division Multiple Access	Robust to jamming attacks	Difficult distribution of PN codes Complex receiver
Busy Tone Multiple Access	Can eliminate hidden nodes prioritises messages	Needs a dedicated channel Not implemented on real products
Space Division Multiple Access	Uses existing location information Theoretically ideal for VANETs	Cells must be mapped to the location Deep impact of positioning errors
Time Division Multiple Access	Guaranteed channel access precise limits for MAC delay	Slot assignment under high density Difficulties in managing mobility propagation errors are very harmful

multiple high-priority messages might try to access the medium at the same time and in the same area. This property of the DENs leads to another argument against the idea of a blind multi-hop dissemination of special notifications, because the same information would be uselessly forwarded in messages initiated by different sources. Instead of this, the facilities layer needs to aggregate the information received from its neighbours, and to relay a unique and clear view on the event.

The picture drawn from this large list of incorrect assumptions is surprising, or even staggering if one thinks that the system in question will have a direct impact on human lives. In the following, the most significant proposals regarding the VANET MAC layer will be discussed, with a focus on the way they comply with the requirements presented in this section. The most important characteristics of every class of protocols are summarised in Table 2.3. CSMA-based solutions are usually built on

IEEE 802.11p, described in Section 2.2.2, therefore they are not discussed here. However, a number of mechanisms designed for congestion control on IEEE 802.11p will be presented in Chapter 3.

2.3.2 MANET Solutions

Despite the lack of real applications, MANETs became a very popular research topic in the last decade, and the number of MAC layer solutions proposed in this context is impressive, being probably exceeded only by the number of MANET routing protocols. However, in these networks, broadcast is considered as a communication mode used only for control messages, which represent only a small part of the entire traffic. Therefore, most of these studies analyse only unicast communications and they cannot be transposed in a safety vehicular environment.

Nevertheless, some MAC protocols were proposed with broadcast or multicast in mind. Zhu and Corson [ZC98] described a Five-Phase Reservation Protocol (FPRP), where a frame is divided into two distinct sub-frames, one for reservation and one for data transmission. The number of slots in the two sub-frames must be equal, although the reservation slot is shorter and further divided in Reservation Cycles (RC). In order to reserve an information slot, the contending nodes need to send a Reservation Request (RR) during a RC of the corresponding slot in the reservation sub-frame. A receiver that detects a collision between RRs sends a Collision Report (CR), announcing the colliding stations that they have to retry to reserve the slot in another RC. If no CR is received, the contending station sends a Reservation Confirmation, to notify all the neighbours that it will indeed transmit in the corresponding information slot. The neighbours acknowledge this reservation in order to eliminate hidden nodes. However, so called *deadlocks* can appear if two neighbouring stations with no other common neighbour try to reserve the same slot, as the collision cannot be detected by any node. The fifth phase of the protocol tries to reduce the probability of a deadlock by requiring that stations that confirmed their reservation to send an Elimination Packet (EP) with a certain probability. A node receiving an EP cancels its scheduled transmission and eliminates the deadlock.

This idea of multiple phases was further enhanced in other studies. In FPRP, the reservation sub-frame introduces a large overhead and the authors propose to reserve a slot for multiple data sub-frames. This is not compatible with high mobility networks, where new neighbours that are not aware of the reserved slots appear frequently. Chlamtac et al. propose to reconfirm the reservation before the corresponding slot [CMSZ00]. Their protocol, ABROAD, makes the assumption that the

number of nodes in the network is known, and that every station has a pre-assigned slot, that can be reused by other nodes in the case the initial owner is out of the communication range or it has no information to send. Marina et al. [MKK01] also improve FPRP, by introducing a sixth phase in the protocol. Their solution, named RBRP, reduces the overhead of the reservation sub-frame, by allowing a contending station to schedule a transmission in a certain information slot using any of the slots in the reservation phase, not necessarily a one-to-one correspondence as in FPRP.

These protocols designed in a MANET context are focused on achieving a 100% reception ratio in the one-hop neighbourhood, hence the very rigorous reservation phase. While their efficiency can be theoretically proven in a small-size network, under perfect radio propagation, the multiple exchanges of control messages are difficult to sustain in a noisy, high-density vehicular environment. Moreover, all the solutions described in this section require mechanisms that could distinguish between collisions and propagation errors, which, as discussed in the previous section, are still a challenge to implement.

2.3.3 Code Division Multiple Access

Due to the commercial success of CDMA networks at the beginning of the decade, a number of MAC protocols based on this channel access technique were proposed for other types of wireless networks in general, and for vehicular networks in particular.

These proposals generally come from Japan-based research projects, and the problem they need to solve is the assignment of pseudo-noise (PN) codes in a distributed manner. For this purpose, Widodo and Hasegawa [WH98] proposed the use of special infrastructure situated at the entry of a road segment. Their system uses infra-red communication to detect vehicles that enter or exit the road and to transmit to each vehicle a PN code that can be used on the associated segment. Such a system would not only require installation of the infrastructure, but it would also raise privacy issues, as it is based on the idea of vehicle tracking.

Yomo et al. [YMSOSMO09] take a different approach, where the receiver is equipped with as many matched filters as the number of spreading codes and therefore it can simultaneously decode packets that use different codes. However, the PN codes are assigned randomly in their Multi-Code Spread Aloha (MM-SA) protocol, meaning that concurrent transmissions can still collide.

While very successful in centralised networks, CDMA communication seems difficult to implement in a highly mobile, distributed network, the design of the receiver radio being a particularly

difficult task when the signal needs to be processed using multiple filters.

2.3.4 Busy Tone Multiple Access

BTMA is an access method that uses very short signals, also called tones or pulses in order to coordinate transmissions. Unlike control packets like those described in Section 2.3.2, tones do not contain any information, not even destination or source addresses, their role being only to transport energy that can be detected by the other nodes. Initially developed in a MANET context, the busy tone concept has also been applied to vehicular networks.

peng and Cheng [PC07] propose to use *priopulses*, pulses of different lengths that can be used to give priority to more urgent messages. A priopulse consists of a fixed duration during which energy is transmitted on the channel, and a pause part of random length. After sensing the channel idle for a pre-defined time duration, a contending node chooses a random back-off and continuously listens to the control channel, where tones are transmitted. If no pulse is sensed before the timer expires, the station begins to send the data on a separate channel, while also transmitting priopulses on the control channel. The duration of the active part of the priopulse depends on the message importance, and based on the length of this period, the receivers can calculate the priority of the message. Stations with messages of lower or equal priority will stop their back-off timers, while contenders with more important messages can interrupt the ongoing transmission by sending their own priopulses. If a node hears another priopulse during its pause interval, it aborts any ongoing transmission. Moreover, the protocol can suppress hidden terminals by relaying priopulses, but the efficiency of this mechanism is questionable, as it can lead to the cancellation of harmless transmissions, outside the two-hop neighbourhood. The protocol also requires a dedicated radio receiver and hardware that is not currently produced on the market.

Multi-Carrier Burst Contention (MCBC), proposed by Roman et al. [RWC11] solves this multiple radios problem by using the characteristics of the OFDM PHY layer. Instead of using a separate channel for bursting, MCBC proposes multiple rounds of node elimination during the contention period that takes place before every transmission. Each round is formed by a contention and a feed-back slot and, during this period, each node is either a contender, a nominee or a referee. The stations with data to transmit begin as contenders and, after every round, some of them randomly become nominees, while the others change their status to referee. The nominees choose an OFDM subcarrier on which they transmit a pulse during the contention slot, while the referees

use the feed-back slot to send a burst on the subcarrier with the highest index detected as busy during the previous contending slot. The nominees receive this feed-back, and those that recognise their sub-carrier win the round and are promoted as contenders for the next round, when the process is repeated. The algorithm used in MCBC maximises the probability of a unique winner and a prototype radio was built to show the feasibility of this solution.

BTMA is a theoretically interesting solution, which suffers from the fact that it is not used in any consumer product; therefore its properties and behaviour under different scenarios are not well understood.

2.3.5 Space Division Multiple Access

Space Division Multiple Access (SDMA) is a complement for any channel access technique and it has been designed in the context of vehicular networks by Bana and Varaiya [BV01]. The idea behind SDMA is that, if position information is available at every node, the resources (slots, codes, channels, etc.), also called cells, can be assigned depending on the geographical location of the nodes, in order to maximise the distance between two zones using the same resource. Although SDMA is theoretically the best access method in a mobile ad-hoc network, it has to face three major problems. First of all, every node must have very accurate location information, at the level of a road lane. This is very important, because even a small error might result in the assignment of a wrong cell, most probably belonging to a very close neighbour. The current GPS system used in vehicles cannot provide the required precision. The second problem comes from the fact that resources are reserved even for unoccupied locations. Finally, the third issue is related to the one-to-one mapping that is necessary between cells and the road topology, which can be a very difficult task for roads with irregular shapes, as for example highway entries.

In this context, Blum and Eskandarian [BE07] proposed a protocol named Adaptive Space-Division Multiplexing (ASDM), which takes advantage from the fact that, using communication, a vehicle learns the location of the surrounding nodes. Therefore, the authors propose that a station can use all the empty cells between itself and the preceding vehicle. However, ASDM still requires accurate location information. To alleviate this problem, Nagaosa and Takahashi [NT09] use larger SDMA cells and map each cell to a TDMA slot. Furthermore, every TDMA slot is accessed using CSMA, in order to reduce the collision probability.

If the cell mapping problem can be solved, SDMA can be an efficient technique, that can

enhance any VANET MAC protocol. However, the use of an error-prone positioning system can have quite the opposite effect, by increasing the number of collisions between closely situated vehicles, reducing the reception ratio for safety beacons.

2.3.6 Time Division Multiple Access

A significant number of studies focused on TDMA-based access on vehicular networks, and the approaches chosen to assign slots in a distributed manner are sometimes very different.

One of the most popular protocols is the Reliable Reservation Aloha (RR-Aloha), described by Borgonovo et al. [BCCF04]. This is an enhanced distributed version of Reservation Aloha (R-Aloha), in which a slot used for a successful transmission is implicitly reserved in the following frame and a central repeater is used to announce this reservation. In RR-Aloha, the central repeater is replaced by an additional field, named Frame Information (FI), which is transmitted by every node accessing the channel. FI contains the status of the N previous slots (busy or free), as detected by the transmitter. This feed-back is used by every station to create a local map of the frame. However, because a node can only access a slot that is declared free by all of its neighbours, RR-Aloha does not guarantee channel access in high density scenarios. The same critique applies to Zang et al. [ZSWRB07], who proposed VMESH, a protocol combining R-ALOHA with the concept of reservation sub-frame described in Section 2.3.2, and to Decentralised TDMA (D-TDMA) [TIISI08], another variation of RR-Aloha which assumes that a receiver can distinguish between an empty slot and one containing a collision. .

VeSoMAC, defined by Yu and Biswas, uses a similar feed-back concept as RR-ALOHA. The difference comes from the fact that in VeSoMAC, a vehicle does not randomly choose an empty slot, but it tries to reserve a slot positioned just after the one occupied by the preceding vehicle. The authors show that, after a node joins the network, the protocol reaches a stable state in a small number of frames. However, this could lead to a perpetual convergence phase in a highly mobile vehicular network. Moreover, just as RR-Aloha, VeSoMAC does not integrate any mechanism that could solve the slot assignment in a high density scenario.

A solution to this problem is presented by Bilstrup et al. [BUSB09], who propose the use of Self-Organised TDMA (SoTDMA) in a vehicular network. SoTDMA has several advantages compared with the other protocols discussed in this section. First of all, it is a standardised and proven technology, already in use in the Automatic Identification System, a collision avoidance

system used in maritime environments since 2001 [Kje98]. Secondly, SoTDMA reduces the overhead, by eliminating the Frame Information and only transmitting the safety messages. This is important, because messages with reduced size translate into a higher number of slots in a frame and therefore in an increased capacity. On the other side, not using information regarding the two-hop neighbours makes a transmission prone to collisions with hidden nodes. SoTDMA relies upon the capture effect to alleviate this problem, considering that the geographically close neighbours will still be able to decode the message, despite the increased interference. Finally, using the same property of the capture effect, if a station does not detect any free slots, it reuses the slot reserved by the farthest neighbour, in order to keep a high reception probability for close vehicles.

Collisions and propagation errors are very harmful in SoTDMA, and in all TDMA-based protocols as a matter of fact. Because most of the time the cause of a failed reception cannot be detected, a slot is declared as empty even if it actually contains a collision. If the vehicular density is high, the selection probability for such a *false positive* slot is also high, and this further propagates the collision closer and closer to the transmitters. In this context, Rico Garcia et al. [RLS08] enhance SoTDMA by combining it with an Space Division Multiple Access approach based on CDMA. This way, two-hop neighbours using the same slot do not collide because they use different PN codes. However, collisions between one-hop neighbours are still possible and problematic.

MAC protocols using TDMA represent the biggest competitors for IEEE 802.11p. As a matter of fact, ETSI is still considering the possibility of adopting a second MAC standard for V2V communication, with RR-ALOHA and SoTDMA being the most probable choices.

2.3.7 SoTDMA vs. IEEE 802.11p

Using the simulation environment that will be described in more detail in Section 2.4.3, a comparison has been made between IEEE 802.11p and SoTDMA, selected as an exponent of TDMA-based protocols. The analysed use-case consists of a highway scenario, where each vehicle transmits safety beacons with a frequency of 2 Hz. The beaconing reception probability as a function of the distance from the sender is measured under two different vehicular densities.

Figure 2.6 shows the case of low vehicular densities, with a mean inter-vehicular distance of 50 meters. In this scenario, the traffic is most of the time in a free flow state, but some sporadic accumulations appear at the highway entries. The results indicate that SoTDMA and IEEE 802.11p achieve similar results in these light traffic conditions. A closer inspection of the simulation traces

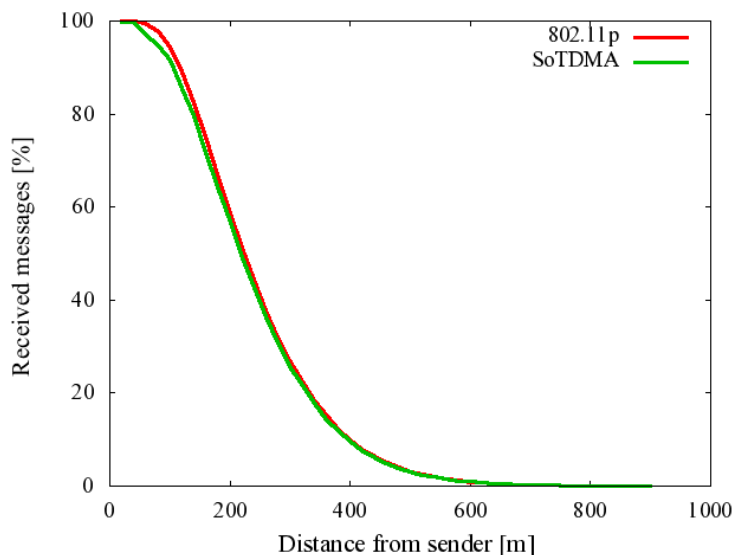

Figure 2.6: Beacons reception probability at different distances from the sender in a low density scenario

shows that in this case most of the missing CAMs are the result of radio propagation errors introduced by the probabilistic model described in Section 2.4.1. In both cases, the reception probability decreases when the receiver is situated farther from the source.

The second round of simulations considers a very dense traffic, with inter-vehicular distances of about 10 meters. The whole road is practically jammed, with vehicles moving at low speed. The results for this scenario are presented in Figure 2.7. Somehow surprisingly, IEEE 802.11p behaves better than SoTDMA in this environment. Although SoTDMA is designed to reuse slots reserved by far neighbours, the reception probability is reduced even in the immediate neighbourhood. From the simulation traces, it can be noticed that most of the time the nodes do not need this reuse mechanism because they detect a number of free slots. However, these slots perceived as idle are sometimes the result of a collision or of a deep fading on the radio channel. As explained in Section 2.3.6, this misinterpretation can slowly propagate the collisions closer to the transmitters. On the other hand, IEEE 802.11p also shows a reduction in the beacons reception probability when compared to the low density scenario, but a less important one.

Considering the results of this comparison, this work chose to follow the path of enhancing IEEE 802.11p, instead of proposing yet another MAC protocol or designing new mechanisms for a different solution, as for instance SoTDMA. An important argument in favour of this decision is the fact that

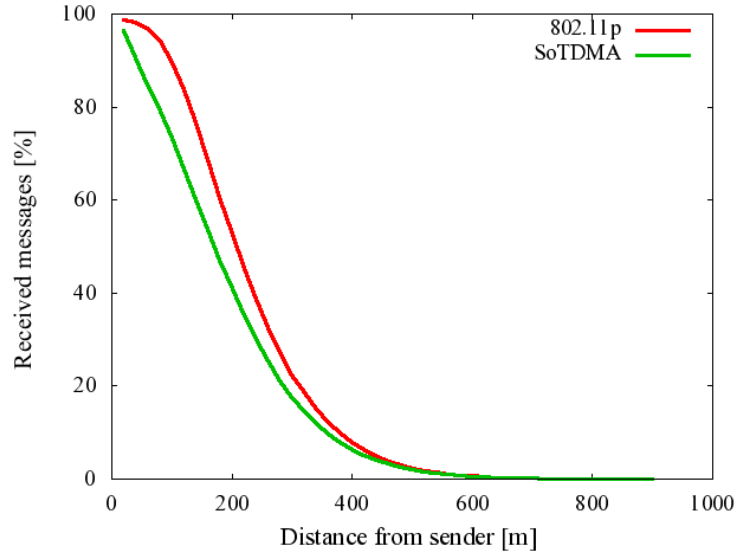

Figure 2.7: Beacons reception probability at different distances from the sender in a high density scenario

the success of IEEE 802.11 products played a major role in the revival of the research on vehicular networks and the standard was endorsed almost unanimously by automakers. The introduction of a novel protocol could only be supported by a significant improvement in performance, which is not yet the case as demonstrated in this section.

2.4 Simulation Frameworks

A future vehicular network will need to manipulate precious information, with a possible impact on driver behaviour and even on human life. Therefore, any solution needs to be thoroughly tested before integration in a real system. Field tests require not only implementing the protocol on real hardware, but also dedicated road infrastructure and equipped vehicles. These high costs have, until now, limited the size of these experiments at no more than 10-20 cars. Even the large-scale deployment scenarios that are currently prepared [SBHMRRV10] will only have the capacity to test a minor proportion from the proposals made by the VANET research community. On the other hand, the vehicular environment is highly complex and analytical models need to take into consideration not only the network, but also the properties of the vehicles and the behaviour of the drivers. In these conditions, computer simulation has become the main tool in VANET research.

2.4.1 VANET Simulation Challenges

While in the case of MANETs we can practically speak of a de facto standard simulator (ns-2 [NS2-11]) and a largely used mobility model (Random Way-point [CK08]), this is not true for VANETs because of the particularities of vehicular communications.

A comparison between the Random Way-point model and real vehicular traces shows important differences in the case of both connectivity and communication metrics [NKG06] and therefore vehicular mobility is probably the most important element that needs to be modelled in a VANET simulation framework.

In the transportation community, traffic models are usually classified based on their level of detail [LR05]:

- *Macroscopic models* do not consider cars individually. Closely related to fluid dynamics, these models aggregate vehicles at a specific level (e.g a road, a lane) and can only provide access at mean values for the properties of the traffic stream.
- *Mesoscopic models* generally describe single entities in high detail but ignore the interactions between vehicles. The example used in [LR05] to explain the properties of this model is the one of lane changing. In the case of a mesoscopic model, this decision would be based on lane density and not on the exact positions of the surrounding vehicles.
- *Microscopic models* represent both entities and interactions with a high level of details. The behaviour of a vehicle depends on the state of the neighbouring cars and even on the characteristics of the driver.

Simulating vehicular communications requires every node to be treated individually. Moreover, the different interactions between the cars are very important for network-level metrics like connectivity. Therefore, all the different solutions for VANET simulation have until now adopted a microscopic model.

Of course, a number of other elements could be modelled in order to increase the accuracy: real road maps, stop signs, traffic lights, driver behaviour, lane changing, etc. Implementing all these features would drastically increase the complexity of the microscopic model and it would result in a much longer simulation duration. However, this level of detail is not needed for every simulation

and, based on the objectives of the study, one can decide to take into account only a part of these factors.

Another challenge for VANET simulation is the channel model. Several research projects investigated the V2V communication channel and the results of their field measurements are summarised by Wang et al. [WLL04]. The main property of the vehicular environment is the high relative speed that can be noticed between nodes. In this case, the Doppler effect can not be ignored. Another important characteristic comes from the important number of obstacles that could interfere with the radio wave propagation. This is particularly true in the case of an urban scenario, where buildings and trees surround the road, but it is also valid for highways where the interference can come from tunnels or from other cars.

The most common method for handling radio propagation in network simulators is to apply a series of additions and subtractions to the transmission power in order to compute the signal power at the receiver. This power is afterwards compared with a certain threshold and the decision whether or not to accept the frame is taken. The easiest way to calculate the signal power at the receiver is to consider that this power depends only on the distance between the communicating entities. This *free space* model can be enhanced with a multi-path propagation which causes self-interference, like the *two ray ground* model. A *shadowing* model also adds a random component in the signal quality for each frame.

Dhoutaut et al. [DRS06] proposed a modified shadowing model for VANETs, where the fast fading factor is not completely random, but depends on the vehicular density. This model is based on the idea that more vehicles bring more reflections for the signal and, hence, a higher level of interference. The idea is backed-up by experimental results, but the tests have been made using a Wi-Fi network card working on the 2.4GHz frequency while V2V communications will use the 5.9GHz band.

VANET simulators also need to address the problem of the large number of nodes that must be modelled. In the case of most simulation frameworks, the memory and CPU consumption of network simulators grow linearly with the number of nodes even if the number of communicating pairs remains constant [WLW09]. This is due to the fact that in a wireless simulation, the receivers need to be searched among all the other entities. In the case of V2V networks, every node is also a source, therefore the number of communications is not constant and the resource consumption grows in this case with the square of the number of cars. Some traffic management applications foreseen

for the vehicular network will operate at the scale of a city or even a region and sometimes require to model more than 10,000 nodes. The study of such solutions is very difficult using the current simulation software.

2.4.2 Simulation Tools

Several approaches can be distinguished among the simulation frameworks used for VANET research. The first one is to feed real vehicular traces to a network simulator [NBG06]. This solution has the advantage that it only needs a very simple mobility model. No computation is involved and the network simulator only needs to read from a file the geographical position of the vehicle. However, there are also some important negative aspects about real traces. First of all, such data is very rare. While some highway operators regularly gather this type of information, there are very few dedicated campaigns at the level of a city or region. Even when the traces exist, they are rarely available for this kind of research. Moreover, existing data only covers certain areas and specific dates and therefore it is very difficult to use them for tests that require different environments or conditions. A second aspect is the fact that the movement of the vehicles is pre-established and it can not be modified by information received through vehicular communications. This makes real traces unusable for a series of scenarios, like traffic management.

Mobility traces can also be synthesised from a microscopic traffic simulator. The strength of this solution is that it can provide data for any type of conditions. However, the traces are still pre-defined and there is no interaction between the network module and the vehicular traffic simulator. There are three possible ways to solve the problem of the lack of communications between the two simulation modules:

- Develop a third module for this special role. This strategy requires a deep understanding of both the network and traffic simulators. The three modules can be easily distributed over different machines, but because the two frameworks need to be synchronised, the speed of the simulation is dictated by the more complex model. A good example from this category is the iTetris framework [ITP-11], which interlinks the ns-3 network simulator [NS3-11] and the SUMO traffic simulator [SUMO-11]
- Add a new mobility model in a network simulator (e.g. STRAW [CB05]) or a communication module to a traffic simulator (e.g. VCOM [KSHRVAB07]). This option requires an important

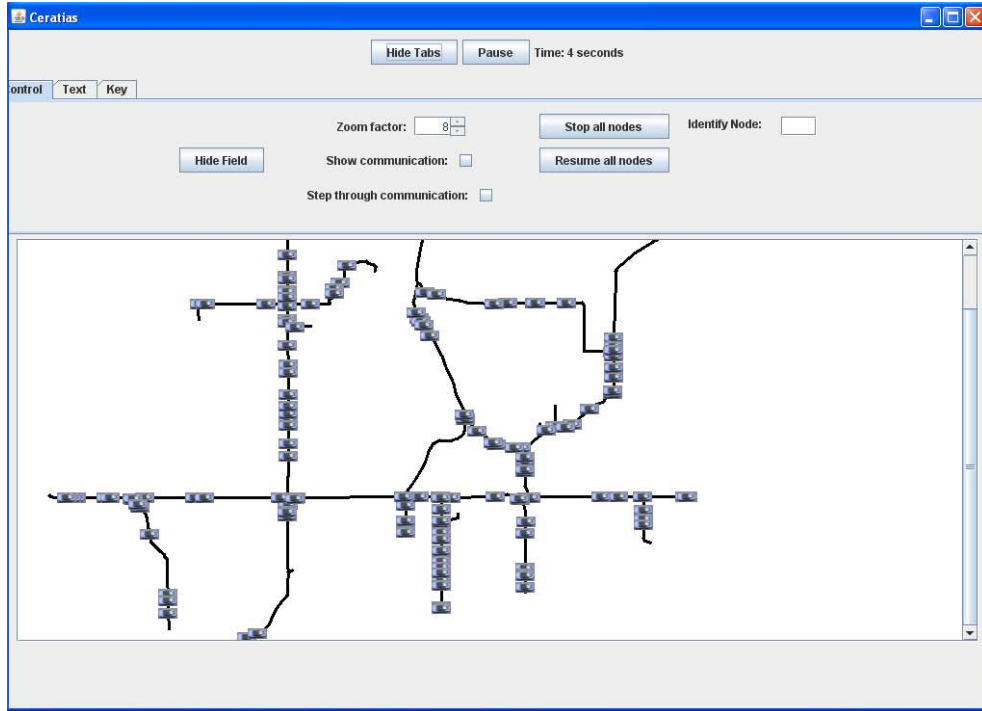

Figure 2.8: The graphical user interface of the JiST/SWANS simulator showing the road topology used in one of the three scenarios.

work of verification and validation of the proposed model.

- Create a dedicated VANET simulator. This solution can optimise memory and processor utilisation, but developing simulator-specific modules, like event schedulers, adds a totally different layer of complexity. The best example in this class is probably GrooveNet, a hybrid simulator developed at the Carnegie Mellon University [MWRMB06].

2.4.3 JiST/SWANS Framework

All the simulations in this thesis are conducted using the Java in Simulation Time (JiST) environment [JIST-11]. JiST is a general purpose discrete-event simulator built in Java. A framework dedicated to wireless network simulation, the Scalable Wireless Ad hoc Network Simulator (SWANS), is also available on top of JiST. The JiST/SWANS platform has been extensively tested in by Weingartner et al. [WLW09] and it is considered one of the best solutions for the study of large scale wireless networks.

Accurate vehicular mobility is provided by the Street Random Waypoint (STRAW) package,

developed by Choffnes and Bustamante at the University of Ohio [CB05]. The software creates real topologies from US Census Bureau's TIGER data files and it accurately describes stop signs and traffic lights. STRAW contains three different modules. One of them is dedicated to intra-segment mobility, the second one to inter-segment mobility and the last one to route planning. The vehicular movement is described using a car-following model, which is designed using a leader-follower logic. If the distance between a car and the next vehicle on the lane is larger than a certain threshold, the car movement is described only by its maximum speed and acceleration. When the distance to the vehicle in front decreases under the threshold, the follower starts decelerating until it matches the speed of the next car. When a car accelerates, its follower will do the same thing until it reaches its own maximum speed.

Regarding the radio propagation, the model discussed in Section 2.4.1 and described by Dhoutaut et al. [DRS06] was implemented in JiST/SWANS. However, simulating realistic urban scenarios still remains a difficult task, as it would require an accurate knowledge of the topology and the alterations introduced by buildings. As a consequence, the results presented throughout this study are issued from simulations in highway and rural scenarios.

In order to avoid boundary effects, the results were always gathered only from a central region of the map. The vehicles outside this area of interest participated in the communication, but their receptions were not taken into account in the final results. For example, in Figure 2.8, statistics coming from vehicles situated at less than $1km$ from the border were not used when computing the results.

Also to remove any bias introduced by a particular topology, all the simulations discussed in this document, with the exception of the results presented in Section 2.3.7, were repeated using three different maps with a size of $5km \times 5km$. The total road length in these three cases varied from $11.3km$ to $18.9km$. A number of 30 runs, using different random seeds, were conducted for each road topology. The initial positioning of the vehicles on the map was random, but a *warming* period of 10 minutes was used at the beginning of every simulation. During this time, the communication module was turned off and only the vehicular mobility was simulated, in order to eliminate any transient phase introduced by the mobility. After these 10 minutes, the safety application was launched on every node and the communications began for another 10 minutes. However, only the messages transmitted in the final 5 minutes, when the system already reached a steady-state, were used to compute the statistics.

Table 2.4: Simulation parameters

parameter	Value
Simulation Duration	1200 <i>s</i>
Channel Frequency	5.9 <i>GHz</i>
Channel Width	10 <i>MHz</i>
Transmission Power	33 <i>dBm</i>
Antenna Gain	0 <i>dBm</i>
Receiver Sensitivity	-91 <i>dBm</i>
Energy Detection Threshold	-65 <i>dBm</i>
SINR Required to Decode a Message	10 <i>dB</i>
Ambient Noise Level	-95 <i>dBm</i>
Mean Shadowing Model Exponent	2.8
Mean Shadowing Model Standard Deviation	6

Unless stated otherwise, the values from Table 2.4 were used in all the simulations discussed in the rest of this thesis.

3. MAC Layer Congestion Control

In this chapter, five different approaches for MAC layer congestion control are discussed. The first one, beaconing frequency adaptation, is presented in Section 3.1 and reduces the number of transmitted safety messages in a dense network, speculating the relationship between high density and reduced speed in vehicular traffic. In the second solution, as explained in Section 3.2, increased data rates can be achieved by using more complex modulations and result in a lower occupancy of the CCH. Other proposals make the object of Section 3.3 and are based on the fact that transmission power control has an important impact on the number of hidden nodes, and can increase the spatial reuse, and hence the channel capacity, in a congested network. The fourth element, analysed in Section 3.4, is the minimum contention window, a parameter with a major importance for collision probability in an IEEE 802.11 network. Finally, the role of the physical carrier sense in congestion control is underlined, probably for the first time in a vehicular context, in Section 3.5.

The first three solutions examined in this chapter received a lot of attention from the VANET research community and the most relevant studies in this area are summarised below. The standardisation bodies also recognised the importance of a decentralised congestion control framework for V2V safety communications and ETSI published a series of technical specifications in this area in July 2011 [ETSI11a]. In the United States, the Society of Automotive Engineers (SAE) is also developing a standard with similar objectives, SAE J2945.1, currently in a draft phase. SAE J2945.1 is expected to be integrated in the WAVE architecture as a complement for the different IEEE standards.

The argument presented in this thesis is that two of these approaches, namely beaconing frequency control and data rate adjustment, have low efficiency and they could even have the opposite effect under high node density, lowering the performance of safety applications. On the other hand, the contention window and/or the physical carrier sense adaptation are only rarely considered, despite the significant improvement they could bring.

3.1 Beaconing Frequency

The most obvious solution for controlling the channel load in a congested environment is to reduce the number of transmitted messages. This can be achieved in a straightforward manner in vehicular networks by adapting the frequency of the safety beaconing. However, such an adaptation mechanism should be designed carefully because sending less messages can easily have the effect of damaging the performance of safety applications instead of improving it.

In this context, Fukui et al. [FKO02] proposed to transmit a CAM every time the vehicle travels a certain distance instead of using a regular time interval. According to a fundamental relationship from traffic theory, the mean speed decreases when the vehicular density increases, thus the consequence of this approach would be that nodes would reduce the beaconing frequency in a dense network where they would travel at low speeds. However, a basic example for which this solution fails is that of a vehicle waiting to make a left turn in normal traffic. Because the vehicle would need to stop, the adaptive mechanism would practically turn off the beaconing transmission, making the Left Turn Assistant application practically unusable.

As a part of the California PATH program, Rezaei et al. [RSK07] take a more complex approach, where vehicles run an estimator to calculate the position of each one-hop neighbour based on the already received messages. The same estimator is used by the node to predict its own position, as it would be calculated by its neighbours. When the difference between the prediction and the actual location becomes larger than a predefined threshold, the node transmits a safety beacon. The problem with this solution is that it is efficient in the predictable free flow traffic, but not in a congested scenario where the acceleration is highly variable. Moreover, this self-estimator approach does not take into account that the error at some of the neighbours might be considerably different because some of the transmitted beacons could be lost. To solve this problem, Huang et al. [HFSK10] further develop this idea using the packet error ratio (PER) measured by a node to predict the losses encountered by its neighbours. Still, measuring a PER in a vehicular network without being able to detect collisions or use feed-back from the receivers is not a straightforward task.

Seo et al. [SYK10] make an analogy between the safety beaconing and the coupon collector problem. The mechanism they design relies upon nodes piggybacking acknowledgments for the received beacons in their own safety message. Every received ACK would further delay the transmission of the next CAM, reducing the beaconing frequency. However, the introduced overhead would

be significant, especially in a dense network (a 4 byte ACK for 50 one-hop neighbours would result in 200 extra-bytes for every safety message). It is also unclear if this approach would be compatible with a security framework based on changing pseudonyms, because the ACK would need to include the identifier of the sender and most probably a sequence number for the acknowledged message.

Adaptive Traffic Beacon (ATB) is a proposal from Sommer et al. [STD11], where the beaconing frequency is calculated based on two metrics: the channel quality and the message utility. The idea is to transmit only the most important messages in a congested network, reducing the offered load. Nevertheless, the channel quality is very sensitive to the number of collisions, which implies that the nodes are somehow supposed to detect such events, clearly a difficult task as discussed in Chapter 2.3.1. Moreover, while message utility could differentiate between CAMs and DENs, safety beaconing would be difficult to prioritise. Finally, ATB reduces the beaconing period to a mean of 3.6s, clearly a value that does not comply with the requirements of most safety applications.

For more details on adaptive beaconing solutions, the reader is referred to the very comprehensive review paper by Schmidt et al. [SLSKS10]. To conclude, while reducing the beaconing frequency is a powerful tool in congestion control, the consequences of this adjustment on every safety application should be taken into account. However, road safety applications will most likely not be standardised, and addressing the constraints imposed by proprietary solutions is a difficult task. For this reason, in the rest of this work a fixed transmission interval of 100ms is considered.

3.2 Data Rate

The standards from the IEEE 802.11 family provide multi-rate capability at the physical layer, but without specifying a particular approach for data rate adaptation. In wireless communications, a more complex modulation results in a higher data rate, but it also requires a higher signal-to-noise ratio at the receiver in order to be correctly decoded. In the continuous fight for increased bandwidth, the search for an efficient data rate control solution in the very lucrative WLAN industry stimulated the research in this area, and two main classes of mechanisms have been designed.

The solutions in the first class base their choice for a certain modulation and coding rate on the success or failure of previously sent messages. For example, the Robust Rate Adaptation Algorithm (RRAA), proposed by Wong et al. [WYLB06], calculates the frame loss ratio in a short time window and compares this value with two predefined thresholds. Too many losses determine

a reduction in data rate, while a high percentage of successful transmissions results in the choice of a more complex modulation. The second type of mechanisms are based on feedback from the receiver regarding signal quality. A representative example in this class is Receiver-Based Auto Rate (RBAR), described by Holland et al. [HVB01]. RBAR relies upon the idea of receivers measuring the channel quality by analysing the RTS message and calculating the highest achievable data rate based on the channel conditions. This information reaches the transmitter through the CTS message and the best modulation is set for the data frame.

The applicability of mechanisms from the two classes discussed above in a unicast vehicular network is studied experimentally by Camp and Knightly [CK08]. They show that, because of the highly variable vehicular channel, decisions based on historical data are not accurate in this environment, while the SNR-based mechanisms need to be trained in the target geographical region in order to cope with the short coherence time (around $300\mu s$ when other vehicles are also present on the road).

In broadcast communications, solutions using feedback from the receivers are clearly unsuitable, therefore the data rate adaptation mechanisms proposed for vehicular safety messages follow the classical path of algorithms based on historical data. Mertens et al. [MWM08] use RRAA in their simulation study, showing a significant improvement in performance when compared with regular IEEE 802.11p. Nevertheless, they do not address the problem of computing the frame loss ratio in a VANET. A more innovative approach is taken by Ruffini and Reumerman [RR05], who propose to use the correctly received CAMs to create a map of the average path loss at different receivers and use this map to estimate the highest data rate that could be successfully used.

However, the data rate adaptation problem is not exactly equivalent in WLAN and in safety vehicular networks. In the first case, the goal is to maximise throughput by choosing the corresponding modulation. While the problem is of course difficult to solve, the existence of a solution can not be questioned. In a VANET, the goal, as described in the different congestion control architectures, is to reduce the transmission time of a message when the vehicular density increases in order to give more stations the chance to access the channel during a beacon period. The choice of the modulation is not dictated in this case by the quality of the channel, but by the number of one-hop neighbours, and there is currently no proof that the assignment of a data rate based solely on the local node density could increase the beaconing reception ratio. Moreover, an experimental study led by General Motors R&D and presented by Bai et al. [BSK10] argues that using Quadrature Phase-Shift Keying

(QPSK) and a data rate of 6Mb/s is the only reasonable choice for V2V communications. In their tests, only two communicating vehicles have been used, ignoring therefore the impact of message collision or interference. Even in these idealistic conditions, any modulation resulting in a higher data rate drastically reduces the reception probability, even at small distances from the transmitter (less than 50% received beacons at 50m using 18Mb/s). Furthermore, even the more robust 3Mb/s Binary Phase-Shift Keying (BPSK) modulation shows lower performance, because in this case the transmission time is larger than the coherence time (found to be around $300\mu\text{s}$, just like in [CK08]).

Considering these results, data rate adaptation does not seem to be an appropriate solution for congestion control in safety vehicular networks. The present work does not study any approach focused on this problem, and does not include any mechanism for choosing a different modulation instead of the recommended QPSK and its 6Mb/s data rate.

3.3 Transmission Power

Transmission power control is one of the most studied topics in the area of VANET congestion control. However, most of the proposed mechanisms are just variants of solutions previously proposed in a MANET context, where the objective of adjusting the transmission power is to minimise energy consumption while keeping a connected network. For example, Chigan and Li [CL07] use a directional-antenna approach originally designed for topology control in MANETs in order to obtain the minimal power needed to transmit messages only to the closest vehicle on each direction. Similarly, Yoon and Kim [YK11] adapt transmission power with the objective of keeping a constant number of one-hop neighbours.

Nevertheless, these solutions are not appropriate for a safety VANET, where messages need to cover a minimal distance, not a certain number of neighbours. With these requirements in mind, Guan et al. [GSKB07] define a *target range* for safety messages. When a node receives a message, it calculates the distance from the sender and verifies if it is positioned inside the target range. Vehicles receiving a beacon despite being outside the safety range include the identifier of the transmitter in a special feed-back field in their own beacon. Using the information in this field, a station can calculate how many nodes outside the target range were reached by its transmission and the goal of the power control mechanism is to keep this number between certain limits.

Another proposal using special feed-back piggybacked in the CAMs is the Distributed Fair

Power Adjustment for Vehicular Environments (D-FPAV) strategy described by Torrent-Moreno et al. [TMSH09]. D-FPAV defines a maximum beaconing load (MBL) that can be accommodated by the CCH while still having spare bandwidth in the eventuality of a special notification. A distributed algorithm ensures an optimal power level assignment, where vehicles use the maximal possible power that still respects the MBL constraint. However, this optimality is achieved only when the power levels used by all the two-hop neighbours are known.

Because the overhead introduced by D-FPAV is significant, especially under high node density when saving bandwidth is the most important, Mittag et al. [MSKHH08] designed Segment-based Power Adjustment for Vehicular Environments (SPAV). SPAV does not achieve an optimal assignment like D-FPAV, but on the other hand it does not require full knowledge about the power levels used by different neighbours, but only an estimate of the local density which can be obtained in a much more inexpensive manner.

The local node density (estimated for example from the received beacons) is also used in the computation of the transmission power by Rawat et. al [RYPWO], but in this case the transmission range is calculated using results from traffic flow theory. Artimy [Art07] manages to entirely eliminate the overhead for transmission power control, using only data from the on-board speedometer to estimate the local density, again using fundamental relationships from traffic flow theory.

While calculating local density based on the CAMs received from the other vehicles is considered a natural property of the safety beaconing, this task might be complicated by the use of changing pseudonyms. Huang et al. [HFSK10] propose a solution that can cope with the VANET security requirements. In their framework, a node simply measures the channel occupancy from the information provided by the CCA function. If the percentage of time the medium is sensed busy in the last beaconing period is under a certain threshold U_{min} , the node uses the highest power level; otherwise a linear mapping between the channel occupancy and transmission power is used.

These are only the most significant proposals regarding power control in vehicular networks. As it can be noticed, this research area is well covered in the VANET research community, therefore it is not the goal of this work to propose another mechanism with the same objective. However, this thesis discusses transmission power adjustment from a theoretical point of view in Chapter 4.2, and power level is one of the parameters controlled in the access method described in Chapter 5.3.1.

3.4 Minimum Contention Window

The minimum contention window (CW_{min}) is one of the most important parameters of the IEEE 802.11 MAC layer. CW_{min} represents the initial value of the contention window (CW), the superior limit of the interval from which the back-off mechanism draws the number of idle slots it has to wait before attempting a transmission. For unicast communication, the value of CW is doubled every time an expected ACK message is not received within a predefined delay and it is reset to CW_{min} for every acknowledged reception, leading to the so-called *binary exponential back-off* (BEB) mechanism.

Even before the release of the first version of the IEEE 802.11 standard, Bianchi et al. [BFO96] showed that the optimal value for CW_{min} depends on the number of contending stations. More exactly, their analysis shows that, in a saturated WLAN, the throughput is maximised when:

$$CW_{min} \approx n_c \sqrt{2T_t} \quad (3.1)$$

where n_c is the number of nodes in the network and T_t is the time needed to transmit the message (acknowledgment included). Building on these results, Cali et al. [CCG00] determined that the protocol's performance peaks when the time the channel is idle due to the back-off mechanism equals the time the channel is occupied by collisions ($T_{idle} = T_{col}$).

Despite this well known property, the IEEE 802.11 standard does not include any mechanism for the adjustment of CW_{min} when the number of contending stations grows. The main reason for this was that the protocol was designed for WLANs, with a central access point and a limited number of client stations (usually no more than 20) in mind. A second argument came from the use of the RTS/CTS handshake. In this case, collisions are limited to the short RTS and CTS messages and therefore the time the channel is busy due to collisions is decreased. This implies that, for an optimal functioning, T_{idle} also needs to be reduced, which requires a lower contention window. Moreover, with the massive success of multimedia services, and with the introduction of the IEEE 802.11e standard, the minimum contention window has been reduced even more, in order to minimise the delay experienced by sensitive video and voice applications. The idea in this case was that most users, especially residential ones, connect only a reduced number of devices to their access points, and generally use only one or two of them simultaneously. A reduced contention window improves the MAC layer performance in this case, while the BEB mechanism is there as a back-up for the cases when the number of contending stations increases.

An impressive number of modified back-off mechanisms have been designed in different WLAN scenarios, and Razafindralambo and Valois [RV06] compare the performance of the most significant of these proposals. Most of the solutions considered in this unicast context still require a fixed value for CW_{min} and only modify the back-off mechanism. For example, Wang et al. [WLL04] argue that when a transmission succeeds after a number of failures it is not correct to reset the contention window to its minimal value, because the congestion will continue to exist on the channel. They propose a slower decrease of CW , and only after several acknowledged transmissions in a row. However, Medepalli and Tobagi [MT06] proved analytically that the impact had by CW_{min} on the throughput of a network is much more significant than the influence of the back-off mechanism.

For more than a decade, all the IEEE 802.11 enhancements related to CW_{min} adaptation in MANETs belonged to one of two categories. The methods in the first class (e.g. [KKS05]) estimate the number of contending stations in the two-hop neighbourhood and use Equation (3.1) or some variants to calculate the optimal contention window. The second type of mechanisms consider the overhead introduced by the local density estimation as prohibitive, and the amount of time the channel is sensed idle and the number of collisions are instead measured. The contention window is adjusted in this case in order to keep valid the equality $T_{idle} = T_{col}$: when there are too many collisions on the channel, the back-off time (and with it the idle time) is increased, while when the channel is idle for long time durations, the contention window is reduced. A notable example from this second class is IdleSense, proposed by Heusse et al. [HRGD05].

Nevertheless, in 2008, Jiang and Walrand [JW10] took a totally different approach concerning the back-off mechanism in CSMA networks, proposing *optimal CSMA* (oCSMA). The idea behind this new protocol is to adapt the contention window of a node as a function of its queue length. In oCSMA, a node begins with an initial value for *contention aggressiveness* (which can be easily translated in a certain CW_{min}) and, when the number of messages in a link queue increases, the transmitter becomes more aggressive in the competition for channel access. In spite of having very low complexity and requiring only local information, oCSMA has been proven to achieve throughput optimality under both continuous-time and discrete-time back-off duration [KNSV11], and was implemented using off-the-shelf IEEE 802.11 hardware [NLLYCKC11].

With all these interesting studies coming from related research fields, one might believe it should be rather straightforward to study and understand the impact of the contention window in V2V communications. However, the particularities of the vehicular network translate once again

into unique properties that modify the problem entirely. In a VANET, the node density is highly variable and a station can go, within a few minutes, from a very sparse environment to several hundred contending neighbours. Adding to this the fact that the RTS/CTS handshake can not be implemented and the BEB mechanism is deactivated by the lack of ACK messages, none of the properties that allowed the use of a small contention window in IEEE 802.11 WLANs holds in this scenario.

An adaptive mechanism is therefore needed, but a rapid analysis of the compatibility between the solutions described above and the safety VANET shows that the design of this mechanism is not exactly a simple formality. The Bianchi relationship is true for a unicast saturated one-hop WLAN cell, while a safety vehicular network uses broadcast and is neither saturated nor fully connected. As discussed in Chapter 2.3.1, collisions remain difficult to detect in V2V communication, therefore IdleSense and other similar approaches cannot be directly transposed in a vehicular environment. Finally, because expired beacons are dropped, the MAC layer always has at most one safety message to transmit (cf. Chapter 2.3.1), and the queue length cannot determine the contention window as proposed in oCSMA. Moreover, the goal of all these mechanisms is to maximise throughput, an objective that is not shared by a safety vehicular network.

Sadly, the few proposals for contention window adaptation issued from the VANET research community failed to consider these important differences. Rawat et al. [RYPWO] propose a heuristic based on the number of detected collisions, where the contention window is increased if the number of collided messages is higher than a predefined threshold. However, the threshold does not depend on the local node density and the technique used for collision detection is not described. The same critique applies to Mertens et al. [MWM08], who, in a first phase, estimate the local node density and directly use this result in Equation (3.1). Then, they further refine the value of the contention window by increasing CW_{min} when the percentage of lost beacons becomes higher than a target PER. Balon and Guo [BG06] address this issue of measuring the percentage of lost beacons by using the sequence numbers inside the safety messages, which is not compatible with a privacy framework based on pseudonyms.

In a similar manner, Wang et al. [WAKP08] design a heuristic relying upon the channel busy time measured by the CCA function during a predefined time period. In their solution, if the channel busy time increases between two consecutive measures, the contention window grows linearly with the observed difference. In the opposite case, CW is reduced, also using a linear relationship. Although

the efficiency of this mechanism depends on the initial value of the contention window, the authors do not provide any guidelines for the choice of this parameter.

Meanwhile, Jang and Feng [JF10] establish a relationship between the number of contending stations and the optimal back-off time in a vehicular network, but their study is focused on unicast communication using RTS and CTS control messages. Finally, Alapati et al. [APMD10] try to maximise throughput using a type of probing mechanism, where the node tests different values for CW_{min} until an optimum is reached. The problem comes from the fact that this optimum depends on the local density, that might vary faster than the convergence speed of the algorithm.

Based on these observations, five different mechanisms for contention window control in a vehicular environment have been adapted from solutions proposed in the research literature, but not necessarily related to CW_{min} adjustment. The properties and feasibility of these mechanisms are characterised below, followed by the results of a simulation study using the framework described in Chapter 2.4.3.

- ***Beacon-based neighbour estimation.***

Beaconing represents a native method for estimating the number of local neighbours in a VANET. Mertens et al. [MWM08] propose to calculate the number of surrounding vehicles by counting the different sources from which at least a beacon has been received in the last T_{update} seconds. However, as discussed above, the number of neighbours from which a beacon was received, \tilde{n}_c , determined this way, can not be directly applied in Bianchi's equation, even though T_t would be very easy to calculate for fixed-size CAMs. In this case, not only the VANET does not correspond to the original assumptions of a fully-connected saturated network, but also the accuracy of the estimation \tilde{n}_c depends on the beaconing reception ration.

Therefore, instead of using directly Equation (3.1), the first studied mechanism keeps this linear dependency, but uses a more general formula to calculate the contention window:

$$CW = \lambda \tilde{n}_c$$

where λ is a parameter depending on the size of the beacon, and whose optimal value was explored through simulation.

This solution would be relatively simple to implement because the addresses of the neighbours will anyway be stored for routing purposes, therefore a simple counter is needed. Nevertheless,

repeatedly changing the pseudonyms of a node for privacy purposes could have a non-negligible impact on the performance of this solution (and also on the routing protocol).

- ***Collided packets estimation.***

The second mechanism follows the idea of Balon and Guo [BG06] and estimates the packet error ratio (PER) based on a sequence number added to each CAM (if beacons are generated periodically, the same result can be obtained by simply subtracting the number of received messages from the number of one-hop neighbours that can be estimated as described for the previous mechanism). The contention window is initially set to a default value ($CW(0) = CW_{def}$) and, every T_{update} seconds, it is updated using the following algorithm:

$$CW(t) = \begin{cases} \min(2 * CW(t-1), CW_{max}), & \text{if } PER < PER_{min} \\ \max(CW(t-1)/2, CW_{min}), & \text{if } PER > PER_{max} \end{cases}$$

The main advantage of this mechanism is that it tries to optimise directly the percentage of delivered beacons. However, the coexistence of a solution based on sequence numbers and a security protocol using changing pseudonyms appears to be extremely difficult. When a vehicle would change its identifiers, it would also need to reset its sequence counter and, therefore, tracking the lost beacons at the receiver level would become an important problem.

- ***Idle time counting.***

The next studied solution aims at preserving the equality $T_{idle} = T_{col}$. In order to estimate T_{col} in a broadcast environment where collisions can not be detected, the number of lost beacons, calculated as in the previous mechanism, is used. However, not all the missing beacons are lost because of a collision. A radio propagation problem on the channel or node mobility can produce a similar effect. Because of this, in order to achieve a better estimation of T_{col} , only the beacons sent by vehicles situated at a distance of less than d_{col} are taken into consideration. Missing messages sent from a geographically close node have a high probability to be lost due to a collision.

As in the previous algorithm, $CW(0) = CW_{def}$ and a new value is computed every T_{update}

seconds:

$$CW(t) = \begin{cases} \min(2 * CW(t-1), CW_{max}), & \text{if } T_{col} > \alpha * T_{idle} \\ \max(CW(t-1)/2, CW_{min}), & \text{if } T_{idle} > \alpha * T_{col} \end{cases}$$

where $\alpha > 1$ is a parameter whose value was explored through simulation.

The simple idea behind this solution is that if there are too many colliding messages, the contention window should be increased, while CW should be decremented when the channel is idle for an important amount of time. This proposal presents the same advantages and drawbacks as the previous one. A supplementary implementation problem could come from the fact that the station requires the capacity to measure T_{idle} , a feature which is not currently available in all IEEE 802.11 devices.

- ***Stop time neighbour estimation.***

Although VANETs are built on top of the already existing transportation system, very few V2V communication solutions attempt to profit from ideas investigated in related vehicular research fields, as for example traffic flow theory. The fundamental relationship explored in traffic flow theory describes the dependency between vehicular flow (vehicles/hour/lane), vehicular density (vehicles/km/lane) and speed (km/hour). Local density could therefore be estimated using this type of calculation, which does not require the exchange of any message.

The next algorithm is inspired by the approach taken in [Art07] for transmission power control, where the vehicular density is estimated based on the time the car is stopped in traffic. Therefore, the vehicle needs to measure the stop time (T_{stop}) in the last T_{update} time window. If $T_{stop} = 0$, the traffic is in a free-flow state and the contention window is set to CW_{min} . If $T_{stop} = T_{update}$, the vehicle is considered to be a part of a traffic jam and $CW = CW_{max}$. For intermediate values, the following formula is used:

$$CW = (T_{stop}/T_{update})(CW_{max} - CW_{min}) + CW_{min}$$

The mechanism could be implemented without any additional hardware, as the stop time can already be calculated using data from the speedometer. The problem could lie in the fact that a vehicle might be stopped for several other reasons than a traffic jam, especially in an urban scenario.

Table 3.1: Optimal values for the different parameters of the algorithms

parameter	Tested Values	Optimal Value
T_{update}	1s, 5s, 10s, 20s	5s
λ	0.25, 0.5, 1, 2	0.5
PER_{min}/PER_{max}	5%/10% , 10%/15%, 15%/20%	5%/10%
α	1, 1.1, 1.2, 1.3, 1.4	1.1
d_{col}	100m, 150m, 200m, 250m	200m
CW_{max}	40, 50, 60	50
D_{max}	2, 2.5, 3, 3.5	3

- ***Speed-based neighbour estimation.***

A more accurate estimation of local density based on traffic-flow theory is proposed by Shirani et al [SHG09], who use vehicle speed and jerk (the derivative of acceleration with respect to time) to adjust the transmission power. Therefore, this final mechanism calculates the local density and the contention window as follows:

$$CW = \frac{D_l}{D_{max}}(CW_{max} - CW_{min}) + CW_{min}$$

where $D_l = |jerk|/speed$, and D_{max} is the predefined upper threshold.

Although this approach uses more information than the previous one, it still lacks the ability to handle, without any delay, some situations common to city traffic, which result in a low speed without necessarily implying a high vehicular density (e.g. left-turn, stop sign). Moreover, jerk is not currently measured on a regular basis in vehicles.

The behaviour of these five mechanisms has been compared with the original IEEE 802.11p under medium and high vehicular density, with a traffic volume varying between 40 vehicles/km and 80 vehicles/km. In a first phase, simulations were run in order for each of the above algorithms to be optimised with regard to the different parameters that have an impact on their performance. The

tested values and those that achieved the best performance for each parameter are shown in Table 3.1. In the case of IEEE 802.11p, a value of 7 has been used for CW_{min} . This is equivalent to the value mentioned in the standard for the access category with the second highest priority [802.11-10].

The metric used for this optimisation and for the comparison was the beaconing reception probability at a distance of less than 200 meters from the source vehicle. This metric is considered to be particularly suitable because it includes in a single value both the probability of collision and the probability of an expired beacon. Moreover, because a beacon that can not be sent with the required time delay expires, all the received messages respect the imposed time constraints and therefore the analysis of the average delay becomes less important.

The beaconing reception probabilities for the studied solutions can be observed in Figure 3.1. In order to better understand the behaviour of each mechanism, Figure 3.2 shows the average contention window as a function of vehicular density.

The first thing that can be noticed from the data is that all the five solutions show better performance than the basic mechanism, with a difference that can reach more than 10%. Estimating the number of neighbours using the received beacons gives the best results for a vehicular density under 60 cars/km. The idle time approach also gives similar results, showing that the estimation used for T_{col} is quite accurate. However, even though the beacon-based and idle time algorithms show similar results for the CAM reception probability, they achieve this through different means, as it can be seen from the dissimilar average values of the contention window. As expected, the beacon-based approach shows a linear increase of CW with the number of vehicles. Therefore, under high density, the nodes back off for an important amount of time, which leads to an increased number of expired beacons. On the other hand, when using the idle time mechanism, the contention window converges to an average value of only 36. In this case, the majority of lost messages are due to collisions and the number of expired CAMs is much lower.

An interesting result is obtained when adjusting CW based on the number of lost packets. When the PER is below PER_{max} (10% in this case), the algorithm almost always uses the default value for CW ($CW_{average} = 7.5$) and its results are similar with those of the basic IEEE 802.11p. However, when the vehicular density increases and more beacons start colliding, the mechanism starts increasing the contention window and its performance drastically improves, showing the best results for a density of 80 vehicles/lane/km. Using a lower value for PER_{max} increases the efficiency of this solution in low density, but it also highly degrades its performance when the number of vehicles

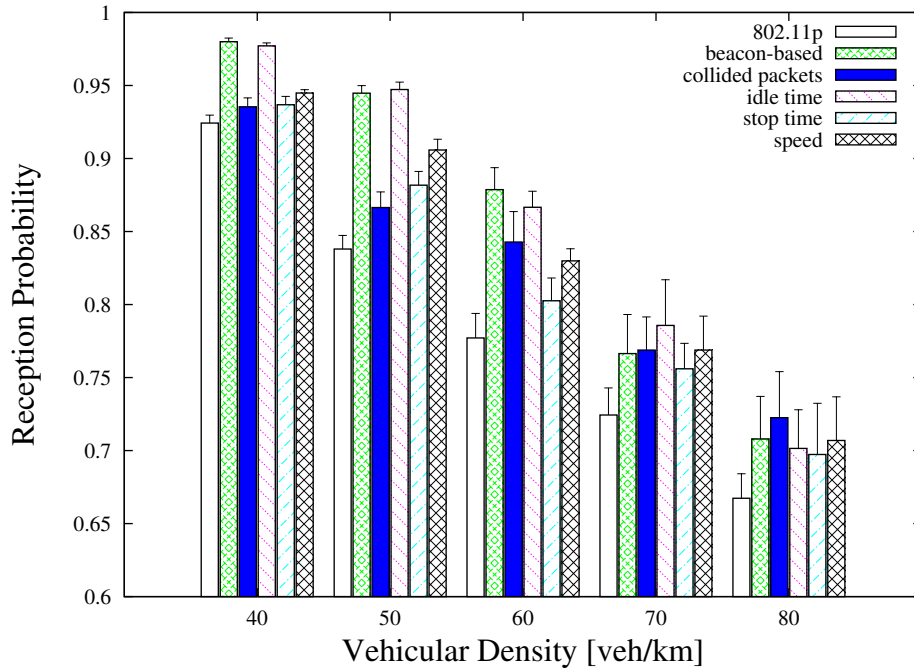

Figure 3.1: Beacons reception probability (including expired beacons) using IEEE 802.11p and the five mechanisms described in this thesis for different vehicular densities (the 95% confidence interval is also shown)

becomes more important, indicating that dynamic thresholds would be an interesting approach in this case.

The two solutions inspired from traffic-flow theory also perform better than IEEE 802.11p. However, for the lower values of the vehicular density, their results are not as good as those of the beacon-based or idle sense mechanisms. This is because, in these traffic conditions, vehicles are usually in a free-flow state and they rarely stop or modify their speed in order to increase their contention window. Nevertheless, when the number of cars increases, the mobility pattern is also altered and the two algorithms show similar results with the other strategies. It is also important to notice that the approach based on cars' speed and jerk always achieves a better reception probability than the one based on stop time, because it uses a more detailed relationship between car movement and density. Moreover, a very significant property of these two mechanisms is that they can be used together with security solutions based on pseudonyms.

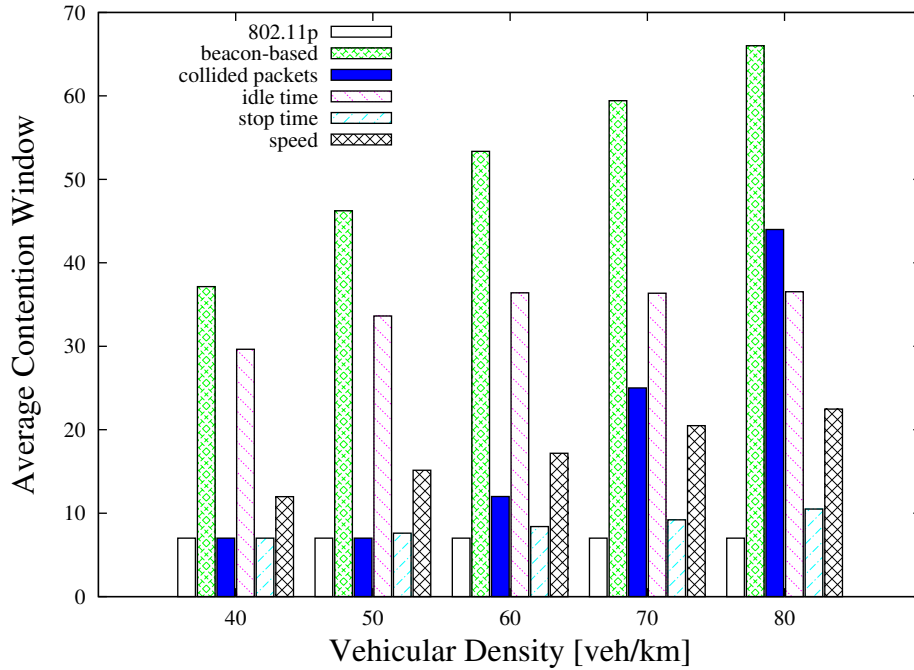

Figure 3.2: Average contention window as a function of vehicular density for the analysed mechanisms

This comparative study shows the importance the contention window has on the MAC layer performance. This parameter is also central to this thesis, therefore its impact on the safety V2V communications is studied analytically in Chapter 4 and a new back-off mechanism is proposed in Chapter 5.

3.5 Physical Carrier Sense

The physical carrier sense mechanism is the core of any CSMA-based channel access technique, including the protocols from the IEEE 802.11 family. The concept is well-known and it is used in both wired and wireless networks: before a transmission, a node has to first *sense* the channel to make sure that it is not already occupied by another station.

The carrier sense method described in the IEEE 802.11 standard is based on two functions: Clear Channel Assignment (CCA) and Network Allocation Vector (NAV). NAV is also known as

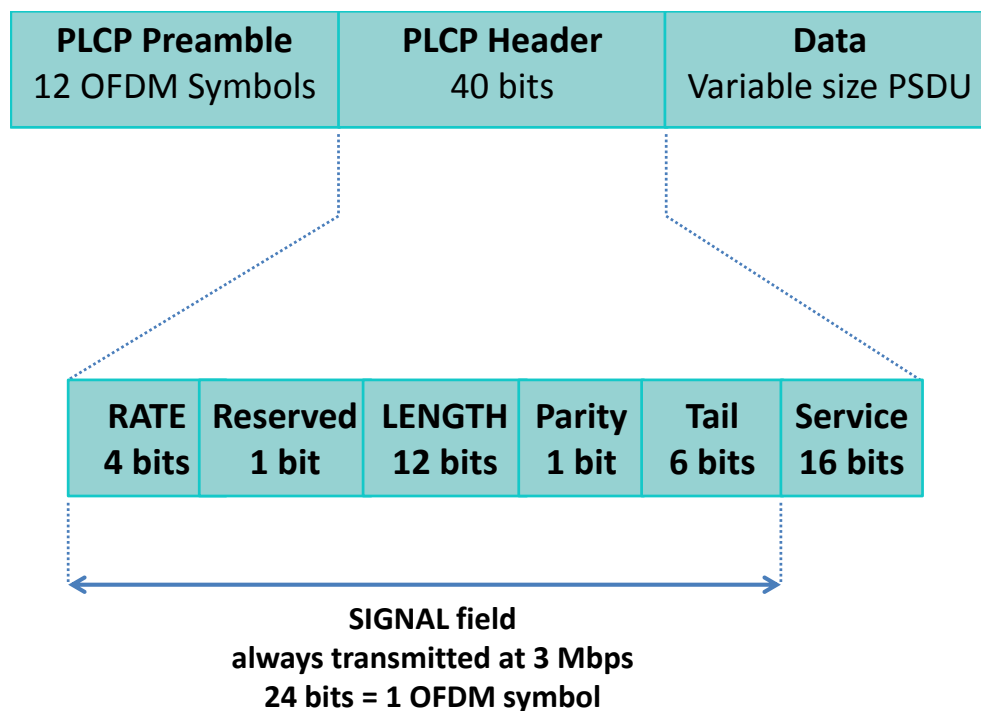

Figure 3.3: Physical Layer Convergence Procedure (PLCP) header format

virtual carrier sense and it is a MAC layer mechanism that uses special control messages - RTS and CTS - in order to reserve the medium for data transmission. CCA is a function of the PLCP layer and it is in charge of physical carrier sensing.

In the case of the OFDM physical layer, CCA uses two mechanisms to assess the state of the channel: header detection and energy detection. The PLCP header, shown in Figure 3.3, is always sent using the most robust combination of modulation and coding rate. It contains information on the data rate used for the rest of the message and a LENGTH field indicating the number of bytes to be transmitted. A node capable to decode the PLCP header calculates the time duration the channel will be occupied by this transmission and declares the channel busy for this entire duration, even if the reception of the rest of the message fails. If no PLCP header is detected, the CCA function measures the energy level present on the channel and compares it with a predefined value, named Energy Detection threshold (ED_t). If the perceived energy level is larger than ED_t , CCA declares the channel busy and denies any MAC layer transmission. To give a numerical example, in the IEEE 802.11p OFDM PHY, the receiver must have the capacity to detect any PLCP header arriving with a power level over $-85dBm$ and, if the PLCP header is missed, an ED_t of $-65dBm$ is used.

Despite the fact that the physical carrier sensing lays the foundation of an entire category of channel access methods, its impact on the MAC layer performance has received only little attention, at least compared with the recognition received by other parameters, like transmission power or data rate.

One of the first studies focused on physical carrier sensing in multi-hop networks was proposed by Zhu et al. [ZGYC04], who calculate the optimal carrier sense range for different networks with regular topologies. Their results demonstrate a relationship between the sensing threshold and the signal-to-interference ratio needed to decode the message. Soon afterwards, Yang and Vaidya [YV05] pointed out that the value of this optimal carrier sense threshold is higher if the fact that the PLCP header is transmitted using the minimum data rate is considered. An essential finding came from Kim et al. [KLH08], who discovered that the capacity of a multi-hop wireless network depends only on the ratio between transmission power and carrier sense threshold. In a follow-up of this study, Yang et al. [YHK07] propose a mechanism for topology control through joint transmission power and carrier sense adaptation.

Nevertheless, all these studies have been conducted under the assumption of a pairwise interference model, unrealistic for safety V2V communications. Recently, Fu et al. [FLH10] calculated a safe carrier-sensing range that guarantees interference-safe transmissions under the cumulative interference model. The authors also propose a new mechanism, Incremental-Power Carrier-Sensing (IPCS), where the CCA is based on the history of the sensed power level and the medium is declared idle if a sufficient drop in the energy level is detected on the channel. Finally, following an experimental study with an indoor IEEE 802.11 testbed, Brodsky and Morris [BM09] conclude that a fixed carrier sense threshold is sufficient in short range networks (under 100m wide) but it highly degrades MAC layer performance in long range networks, category that clearly includes VANETs.

Just like in the case of the other congestion control mechanism, all these ideas are focused on maximising throughput in wireless networks that do not exhibit the same properties as a safety VANET. The only existing results in the case of a vehicular network come from Schmidt et al. [SLBS10], who consider that in the case of safety communications the receivers should be more sensitive, using a lower carrier sense threshold that would allow them to detect even transmissions from vehicles situated far away. However, this assumption is not supported by any theoretical argument. An increased sensitivity would result in a higher carrier sense range, and therefore in more contending neighbours. The nodes would sense the channel busy for a longer period and simultaneous

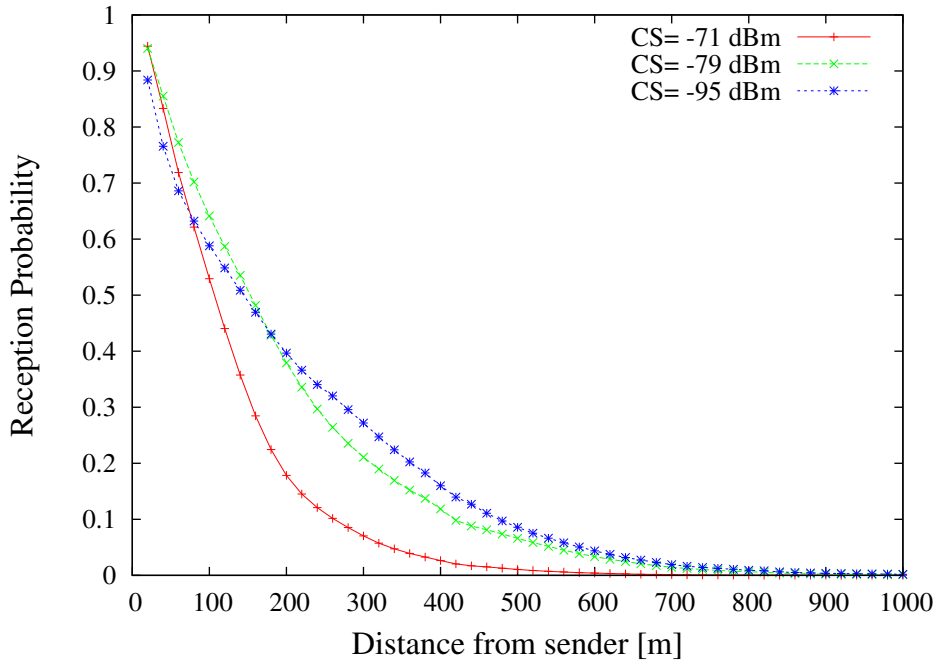

Figure 3.4: Beacons reception probability as a function of the distance from the sender for several carrier sense thresholds. The mean vehicular density in this case is 35 veh/lane/km. The 95% confidence interval has about the same size as the symbols and has not been included for visibility purposes

transmissions would also be more probable. All these effects are thoroughly analysed in Chapter 4, the remainder of this section being dedicated to a series of simulation results demonstrating the impact of the physical carrier sense threshold on the CAM reception ratio.

This simulation study measures the beacons reception ratio for three different mean vehicular densities (25 veh/lane/km, 35 veh/lane/km and 45 veh/lane/km) while varying the carrier sense threshold (CS_t) between $-95dBm$ and $-55dBm$. The noise level in these simulations peaks at $-98dBm$, and a signal-to-noise ratio of at least $3dB$ is necessary for decoding the PLCP header, hence the minimal value of $-95dBm$ for CS_t . This noise level can be considered relatively high, and the VANET physical channel is indeed very noisy, as it has been confirmed by experimental studies (e.g. [BSK10]).

In Figure 3.4 the results obtained for a vehicular density of 35 veh/lane/km and for three

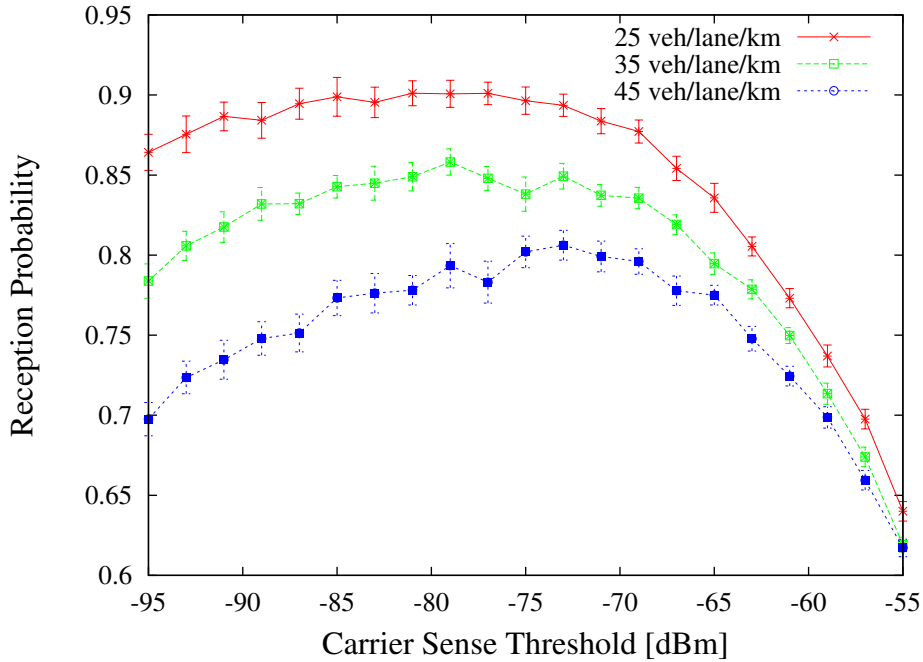

Figure 3.5: Beacons reception probability as a function of the carrier sense threshold for different vehicular densities at a distance of $50m$ from the sender. The 95% confidence intervals are also shown

different carrier sense thresholds ($-95dBm$, $-79dBm$ and $-71dBm$) are shown. As expected, in all the cases the beacons reception probability decreases with the distance from the sender. However, comparing what happens when CS_t is modified from $-95dBm$ to $-79dBm$, it can be observed that the reception ratio increases at a distance of less than $200m$ from the sender and it decreases beyond this distance.

This behaviour can be explained by understanding that a collision can be the consequence of a simultaneous transmission (beginning exactly in the same slot) with a station from the carrier sense range, or the result of a concurrent transmission (the messages superpose on at least a slot) with a hidden node. A higher CS_t reduces the number of sensed vehicles, and therefore the probability to consider the medium as busy. This allows more transmission opportunities to every node and reduces the number of simultaneous transmissions. However, on the negative side, because the carrier sense range is reduced, the degree of spatial reuse is increased and therefore concurrent transmission can

occur from closer vehicles. This has little effect in the immediate neighbourhood due to the capture effect, but produces collisions at higher distances.

This phenomenon is exacerbated by further increasing CS_t (from $-79dBm$ to $-71dBm$ in Figure 3.4). As the physical carrier sense covers less and less space, the interferer gets closer to the sender and the SIR increases, reducing the beaconing reception probability even for closely situated vehicles.

In order to better understand the influence of the carrier sense threshold on the reception of safety messages, the beaconing reception ratio at $50m$ from the transmitter as a function of CS_t for different vehicular densities is shown in Figure 3.5. It can be noticed that the number of received beacons slowly increases with CS_t , it reaches an optimal point and then drops quite sharply.

Two other important observations need to be made at this point, challenging the current view of using the minimum receiver sensitivity as a carrier sense threshold [SLBS10] and arguing in favour of a more elaborate solution. First of all, the difference between the peak value of the reception probability and the one obtained using the lowest possible value for CS_t ($-95 dBm$ in this case) can be significant, reaching almost 10% in the scenario with the highest density. Second, the optimal carrier sense threshold varies with the vehicular density, increasing when the number of neighbours becomes larger. This confirms the ideas formulated earlier in this section and shows the necessity of an adaptive mechanism for physical carrier sense control, which is one of the objectives of this work, further detailed in Chapter 5.

4. Analysis of Vehicular Beaconing

This chapter provides an analytical study of the safety beaconing, with a special focus on the way the contention window and the carrier sense range influence the message collision probability. Section 4.1 defines the concept of *safety range* used throughout the entire analysis, and describes an interference model specially designed for this vehicular context. A comparison between the improvement brought by adjusting the carrier sense threshold and the one obtained by adapting the transmission power is provided in Section 4.2, concluding that the carrier sense has a more significant impact on the signal-to-interference ratio at a given receiver. Section 4.3 studies the relationship between the probability of sensing a busy slot, the probability of experiencing an expired beacon, and the collision probability (distinguishing between collisions with sensed nodes and collisions involving hidden terminals). Finally, Section 4.4 gives a numerical example, close to an IEEE 802.11p network, and applies the results obtained in the other sections to demonstrate that the current standard settings for the contention window and the carrier sense threshold are not appropriate, underlying the necessity for specially designed mechanisms that take into account the characteristics of the vehicular network and the particularities shown by the control channel.

Before continuing with the remainder of this chapter, a short review of related work is necessary in order to underline the novelty of the approach used in this thesis. First of all, a VANET interference model is proposed in Section 4.1. The interference models described in the research literature with wireless multi-hop networks in mind can be divided in two major classes. The first one, the *pairwise interference model* considers interfering links one by one. If the interference from each of the other links on the link concerned does not cause a collision, then it is assumed that there is no collision overall. Models from this class include, for example, the *node-exclusive model* [MSZ06], where the transmission is successful if both the transmitter and the receiver have only one active link, or the *two-hop interference model* [EOM07], where an active link is forbidden for all the one-hop

neighbours of the two communicating stations. The second possibility of modelling interference is the *cumulative interference model* [FLH10], where the influence of all the other links in the network is considered. However, both of these classes of models imply the existence of links and of one-to-one communication. This is not the case of the broadcast safety VANET, therefore a different approach is needed. The solution described below tries to solve this problem by proposing an equivalent model of the vehicular network, where cumulative interference can be applied.

Second, the complexity of a VANET, where vehicular traffic and special network properties need to be considered, has dissuaded researchers from proposing analytical frameworks that could be used in the study of MAC layer performance. The two exceptions come from Ma et al. [MCR07] and Vinel et. al [VVK08]. However, even these models are only extensions of previously proposed unicast frameworks based on Markov chain analysis, and fail to take into account essential properties of the safety beaconing, as for example the limited lifetime of the messages. The model described in this chapter takes a different approach, concentrating on mean values observed during a beaconing period and, despite making, like any other model, some simplifying assumptions, it proves to be a decent tool that can help assess the impact of different MAC layer parameters.

4.1 Safety Range

Instead of focusing on the overall performance of vehicular beaconing, this thesis concentrates on a limited area around every node, denoted as *the safety range* (SF_r). This area is included in the carrier sense range, as it is shown in Figure 4.1a. The reason behind this new threshold comes from the long range profile of the vehicular network. Actually, a full power transmission using the parameters proposed in the IEEE 802.11p amendment [802.11-10] could reach vehicles situated 1km away. This large coverage area is important because it allows an increase connectivity in sparse environments.

However, congestion control is mainly needed in scenarios with high vehicular density and, in these cases, a spatial reuse in the order of kilometers is not practical. While any received safety beacon is important because of the information it carries, the messages coming from vehicles in the close neighbourhood are clearly more interesting from this point of view. This analysis is therefore focused on this critical zone, covering a distance of SF_r around every transmitter.

Unlike the carrier sense range, whose value depends on the power level used by the transmitting

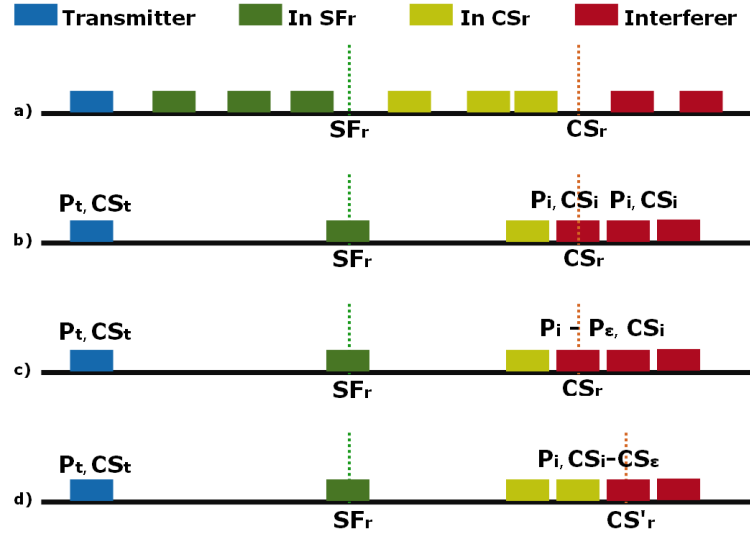

Figure 4.1: System model. a) Safety range and carrier sense range in a vehicular scenario. b) Substitute simplified model. c) Effect of power control. d) Effect of carrier sense threshold adjustment

vehicle and the carrier sense threshold of the other nodes, SF_r is the same regardless the network state. A value of 100-200m is considered to be fairly realistic for the safety range.

In order to simplify the analysis, a substitute scenario is proposed, shown in Figure 4.1b. Instead of taking into account all the vehicles inside SF_r and CS_r , only two vehicles are considered: *i*) a receiver located at the limit of the safety range and *ii*) an interferer situated just outside the carrier sense range. This can be thought of as a worst case situation, but it is quite possible in a high density VANET.

Within this simplified scenario, the signal-to-interference ratio (SIR) at the receiver can be calculated as:

$$SIR = \frac{P_{tr}}{P_{ir}}$$

where P_{tr} is the power sensed by the receiver coming from the transmitter, and P_{ir} is the perceived power level of the message sent by the worst-case interferer. Other potential interferers would have to be situated outside the carrier sense range of both the transmitter and the worst-case interferer, therefore their influence is considered negligible.

If θ is the exponent of the path-loss radio propagation model, with an usual value between 2

and 4, a message coming from the transmitter arrives with the following power level:

$$P_{tr} = \frac{P_t}{SF_r^\theta}$$

with P_t being the power level used by the transmitter. If P_i is the power used by the interferer, by following an analogous reasoning, the effect of such a transmission is:

$$P_{ir} = \frac{P_i}{(CS_r - SF_r)^\theta}$$

The ratio of carrier sense range to safety range is defined to be:

$$X = \frac{CS_r}{SF_r} \tag{4.1}$$

Therefore, the SIR can be written as:

$$SIR = \frac{P_t}{P_i}(X - 1)^\theta$$

4.2 Power and Carrier Sense Control

Because every vehicle must reach at least all the other nodes inside SF_r , a minimum power level P_{min} needed to cover this area is considered. This also translates into a maximum carrier sense threshold CS_{max} chosen in order to make sure that any transmission from a vehicle closer than SF_r can be received, regardless the transmission power used. The upper limit for the transmission power P_{max} is given by the requirements of the regulatory bodies. The values of P_{max} are currently $44.8dBm$ in the United States and $33dBm$ in Europe [802.11-10]. Finally, the lower value of the carrier sense threshold CS_{min} depends on the quality of the receiver in distinguishing a transmission from ambient noise. The specifications of the OFDM receiver in the IEEE 802.11 standard set this minimum sensitivity limit at -85 dBm [802.11-10], while European regulations ask for a threshold of -104 dBm [ETSI10].

Assuming that $P_i > P_{min}$ and $CS_i > CS_{min}$, the analysis below is focused on the influence of transmission power control at the interferer.

When controlling the power level, the supposition is that all the nodes outside the carrier sense range of the transmitter decrease their power level by P_ϵ . However, the worst-case interferer remains the same, because its position is determined solely by its carrier sense range and the power level of the transmitter. In this new scenario, shown in Figure 4.1c, the interference level becomes:

$$P_{ir} = \frac{P_i - P_\epsilon}{(CS_r - SF_r)^\theta}$$

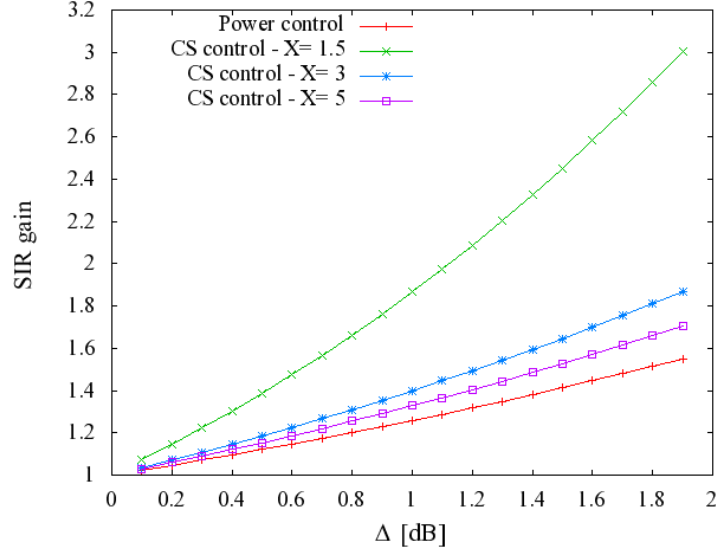

Figure 4.2: SIR improvement following transmission power control and carrier sense threshold adjustment ($\theta = 2$)

and consequently, the new signal-to-interference ratio is:

$$SIR_{P_\epsilon} = \frac{P_t}{P_i - P_\epsilon} (X - 1)^\theta$$

The gain obtained by reducing the transmission power at the interferer can be calculated:

$$G_{P_\epsilon} = \frac{SIR_{P_\epsilon}}{SIR} = \frac{P_i}{(P_i - P_\epsilon)}$$

Things are slightly more complicated when the carrier sense threshold of the vehicles outside CS_r is adjusted. All these vehicles were using a threshold of CS_i , that is now reduced with CS_ϵ . This means that the worst case interferer in the previous examples can now sense the transmitter and the message collision is avoided, as shown in Figure 4.1d. The new carrier sense range becomes $CS'_r > CS_r$ and the new worst-case interferer is situated just outside of it.

Considering the worst case interferer is initially situated exactly at CS_r , the old carrier sense threshold used by the nodes is given by the following relationship:

$$CS_i = \frac{P_t}{CS_r^\theta} \quad (4.2)$$

After decreasing the threshold with CS_ϵ , the new worst case interferer is situated at a distance CS'_r and its new carrier sense threshold can be calculated as:

$$CS_i - CS_\epsilon = \frac{P_t}{CS'_r{}^\theta} \quad (4.3)$$

The new carrier sense range can now be found using Equation (4.2) and Equation (4.3):

$$CS'_r = CS_r \left(\frac{CS_i}{CS_i - CS_\epsilon} \right)^{\frac{1}{\theta}}$$

In this case the interference level at the considered receiver, situated at the border of the safety range, is:

$$P_{ir} = \frac{P_i}{(CS'_r - SF_r)^\theta}$$

and a new signal-to-interference ratio can be calculated after reducing the carrier sense threshold of the interferer:

$$SIR_{CS_\epsilon} = \frac{P_t}{P_i} \left[X \left(\frac{CS_i}{CS_i - CS_\epsilon} \right)^{\frac{1}{\theta}} - 1 \right]^\theta$$

The gain obtained in this second case is:

$$G_{CS_\epsilon} = \frac{SIR_{CS_\epsilon}}{SIR} = \frac{\left[X \left(\frac{CS_i}{CS_i - CS_\epsilon} \right)^{\frac{1}{\theta}} - 1 \right]^\theta}{(X - 1)^\theta}$$

In Figure 4.2 the SIR gains in the case of transmission power and carrier sense control are shown. For the x-axis, $\Delta = P_\epsilon = CS_\epsilon$ has been considered. In the case of power control, the SIR gain is only influenced by P_ϵ . On the other hand, the results of carrier sense control are influenced by X , the ratio of the carrier sense threshold to the safety distance. From Figure 4.2, it can be noticed that adjusting the physical carrier sense of an interferer has a much more important impact than reducing its transmission power. Moreover, the SIR gain increases for lower values of X , when the difference between SF_r and CS_r becomes smaller.

The path-loss exponent θ also has an influence on the performance of carrier sense control. However, as it can be seen from Figure 4.3, its impact is marginal, specially for low values of CS_ϵ . These minor differences suggest that an adaptive carrier sense mechanism does not need an extremely accurate characterisation of the radio channel and it can be simply based on the value of X .

4.3 Collision Probability

However, modifying the transmission power or the carrier sense at the interferer also produces other outcomes than increasing the signal-to-interference ratio. The fact that the interferer in question is also a vehicle sending its own safety information needs to be taken into account. While reducing the transmission power can benefit other nodes using the channel at the same time, it is detrimental for

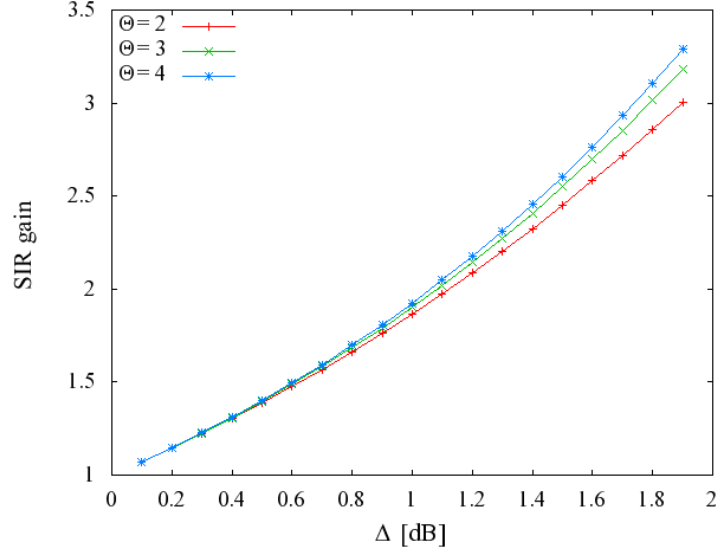

Figure 4.3: SIR improvement following carrier sense threshold control with different values for the path-loss exponent

the vehicle taking this action. First of all, this reduces the area covered by the node, bringing its own interferers closer. Secondly, it increases the exposure of its transmission to the multiple radio propagation problems that can appear on the V2V communication channel.

On the other hand, a larger carrier sense range increases the number of contending neighbours and, with it, the collision probability and the probability to sense a busy channel. The latter can be at the origin of a rise in expired beacons, messages that cannot be transmitted during a beaconing period and need to be dropped when the next CAM, containing fresh information, arrives at the MAC layer for transmission.

To better understand the effect of an adaptation mechanism on the collision probability, a different view of the substitute model is taken, as presented in Figure 4.4. The transmitter, node W , is no longer central to the analysis, which is instead focused on node V , the receiver situated at the border of W 's safety range.

Considering a beaconing period consisting of N_T slots, vehicle V will sense as busy, on average, $E[N_b]$ from these slots. The busy slot probability seen by vehicle V can be expressed as:

$$p_b = \frac{E[N_b]}{N_T} \quad (4.4)$$

Ideally, because of the periodic nature of the safety beaconing, the number of busy slots would

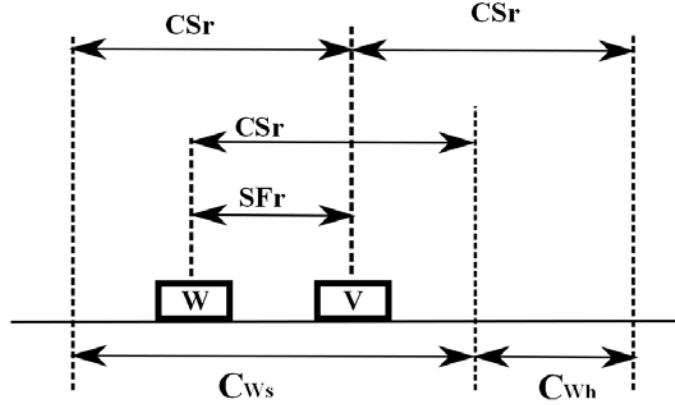

Figure 4.4: Different zones around vehicle V

only be given by the mean number of sensed stations ($E[n_c]$), and the duration of a beacon in slots (N_s). However, in a real scenario, some of the neighbours experience collisions (with probability p_{col}), while others do not transmit during a given beaconing period because their safety messages expire (with probability p_{exp}). In this case, $E[N_b]$ can be calculated as follows:

$$E[N_b] = E[n_c]N_s - E[n_c]p_{exp}N_s - E[n_c]p_{col}\frac{E[N_{col}]}{E[n_i]} \quad (4.5)$$

where N_{col} is the number of slots occupied by a collision and n_i is the number of nodes involved in the collision.

If we assume that the number of nodes involved in a collision $n_i \approx 2$, which is a reasonable hypotheses, especially in the case of a one-dimensional network, there are two situations capable of producing a collision at node V . In the first case, the collision is produced between two nodes that are in the carrier sense range of one another (with probability p_{cs}). This scenario, denoted in the following by a *type A collision*, can happen only if both vehicles transmit simultaneously. The duration of the collision in these circumstances is equal to the duration of a beacon, N_s . The second possibility, or *type B collision*, is that the colliding stations are hidden from each other, and the two CAMs can therefore superpose with probability p_{ch} at node V on a number of slots uniformly distributed between 1 and N_s . More explanations regarding the different types of events that can occur during a beaconing period are given in Figure 4.5.

It is important to understand that, in this model, a collision does not necessarily imply a

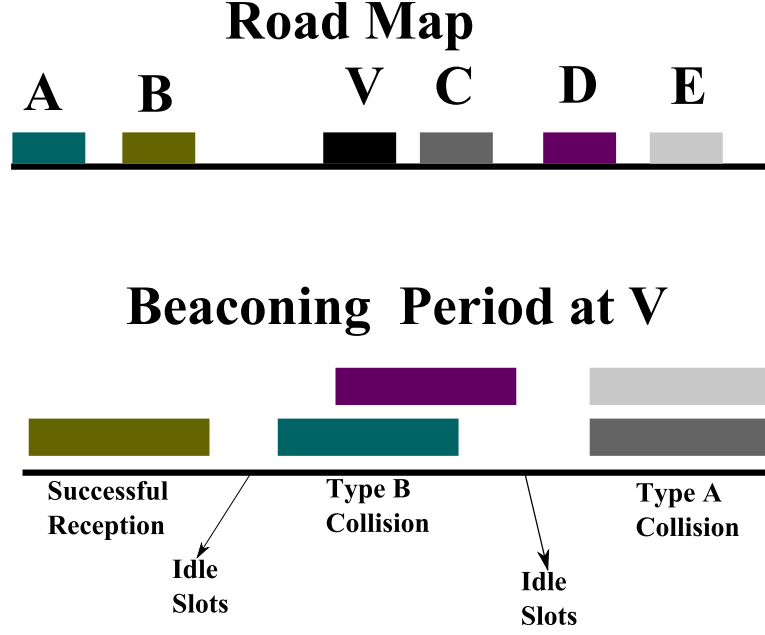

Figure 4.5: A possible scenario for vehicle V . The five neighbours transmit their messages during a beaconing period. While node B is successful, the other transmissions collide. Vehicles D and A are hidden terminals, therefore they can produce a type B collision by transmitting concurrently on at least one slot. Vehicles C and E can sense one another, but they can still produce a type A collision by beginning their transmissions simultaneously. Vehicle V also senses idle slots during a beaconing period, and it can use them to decrement its back-off timer or to begin its own transmission.

lost message, but only the simultaneous reception of more than one signal by node V . Using the capture effect or advanced decoding techniques, some of these messages might be correctly received. Nevertheless, the messages would concurrently use the same slots and this should be considered in the computation of N_b . This leads to the following relationship:

$$p_{col}E[N_{col}] = p_{cs}N_s + p_{ch}\frac{N_s}{2}$$

Replacing the terms in Equation (4.5), it gives:

$$E[N_b] \approx E[n_c]N_s\left(1 - p_{exp} - \frac{p_{cs}}{2} - \frac{p_{ch}}{4}\right)$$

In order to start transmitting its CAM in a slot k of the beaconing period, node V must not experience an expired beacon phenomenon. If this prerequisite is accomplished, the first slot is

uniformly chosen among the N_T slots of the beaconing period, and therefore the probability of node V beginning its transmission in slot k is:

$$p_k = (1 - p_{exp})/N_T \quad (4.6)$$

To help understand the significance of the two probabilities p_{cs} and p_{ch} the representation shown in Figure 4.4 is used. C_V denotes the set of nodes that can be sensed by V . A formal definition in this case is:

$$C_V = \{v_i | d(v_i, V) \leq CS_r\}$$

where $d(v_i, V)$ is the distance between nodes V and v_i . Using the same notation as above, $|C_V| = n_c$.

Choosing a vehicle $W \in C_V$, C_{W_s} is defined as the set of nodes that can be sensed by both V and W ($C_{W_s} = C_V \cap C_W$), while C_{W_h} is formed by the stations that can be sensed by V , but not by W ($C_{W_h} = C_V \setminus C_W$). More details about these two sets of nodes are given in Figure 4.6.

Under the assumption of a unique carrier sense threshold, and using the notations $n_{cs} = |C_{W_s}|$ and $n_{ch} = |C_{W_h}|$, the probability that node W transmits a beacon without producing a type A collision at node V , knowing that W and V have j common neighbours, is

$$p_{noA|j} = (p_{noA} | n_{cs} = j) = \sum_{k=0}^{N_T-1} p_k (1 - p_k)^j$$

$$p_{noA|j} = N_T p_k (1 - p_k)^j \quad (4.7)$$

A type A collision can only occur if two nodes start transmitting in the same slot. On the other hand, a type B collision takes place if any of the i nodes belonging to C_{W_h} begins a transmission during one of the N_s slots occupied by W , or even in one of the $N_s - 1$ preceding slots. Therefore, the probability of a type B collision knowing that there are i vehicles that can be sensed by V , but not by W , is:

$$p_{noB|i} = (p_{noB} | n_{ch} = i) = \sum_{k=0}^{N_T-1} p_k (1 - p_k)^{i(2N_s-1)}$$

$$p_{noB|i} = N_T p_k (1 - p_k)^{i(2N_s-1)} \quad (4.8)$$

Assuming that W is situated at distance r from node V , with $-CS_r < r < CS_r$, and that vehicles are uniformly distributed in the carrier sense range, the probability that a neighbour of V belongs to C_{W_s} is:

$$\tau_r = 1 - \frac{|r|}{2CS_r} \quad (4.9)$$

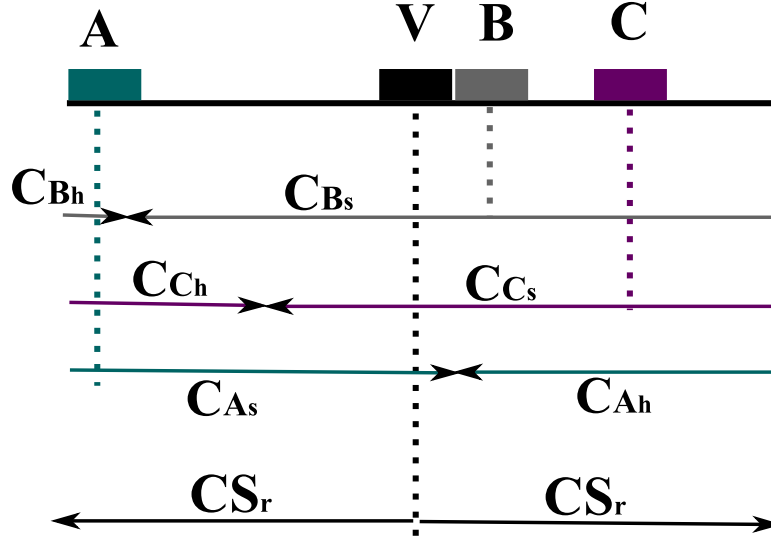

Figure 4.6: The size variation of the two zones around vehicle V as a function of its neighbour position (A , B , or C). The first zone contains nodes sensed by both V and its neighbour (e.g. C_{As}), while the second zone contains nodes that can be sensed only by V (e.g. C_{Ah}). One can notice that the size of the first zone varies from CS_r (when the neighbour is situated at the border of V 's carrier sense range, as in the case of node A) to $2CS_r$ (when the neighbour is positioned close to V , as for example node B). On the other hand, the size of the second zone varies from practically 0 in the case of node B to CS_r when neighbour A is considered.

and the probability of having $n_{cs} = j$ when r is known becomes:

$$p_{j|r} = p(n_{cs} = j|r) = \binom{n_c - 1}{j} \tau_r^j (1 - \tau_r)^{n_c - j - 1} \quad (4.10)$$

For symmetry reasons, the probability that a type A collision does not happen can be written as:

$$p_{noA} = \int_{r=0}^{CS_r} \frac{1}{CS_r} \sum_{j=0}^{n_c - 1} p_{noA|j} p_{j|r} dr$$

Using (4.10) and (4.7), this gives:

$$p_{noA} = \frac{N_T p_k}{CS_r} \int_{r=0}^{CS_r} \binom{n_c - 1}{j} [\tau_r (1 - p_k)]^j (1 - \tau_r)^{n_c - j - 1} dr$$

$$p_{noA} = \frac{N_T p_k}{C S_r} \int_{r=0}^{C S_r} (1 - \tau_r + \tau_r (1 - p_k))^{n_c - 1} dr$$

which, after replacing the terms from Equation (4.9) becomes

$$p_{noA} = \frac{N_T p_k}{C S_r} \int_0^{C S_r} \left(1 - p_k + \frac{r p_k}{2 C S_r}\right)^{n_c - 1} dr$$

Finally, after solving the integral, the result is

$$p_{noA} = \frac{N_T p_k}{C S_r} \frac{2 C S_r}{p_k n_c} \left[\left(1 - p_k + \frac{C S_r p_k}{2 C S_r}\right)^{n_c} - (1 - p_k)^{n_c} \right]$$

and, after simplifications

$$p_{noA} = \frac{2 N_T}{n_c} \left[\left(1 - \frac{p_k}{2}\right)^{n_c} - (1 - p_k)^{n_c} \right] \quad (4.11)$$

Similarly, the probability that a neighbour of V belongs to C_{Wh} is:

$$\phi_r = |r|/2 C S_r \quad (4.12)$$

and the probability of having $n_{ch} = i$ when r is known can be written as:

$$p_{i|r} = p(n_{ch} = i|r) = \binom{n_c - 1}{i} \phi_r^i (1 - \phi_r)^{n_c - i - 1} \quad (4.13)$$

The probability that a type B collision does not appear is:

$$p_{noB} = \int_{r=0}^{C S_r} \sum_{i=0}^{n_c - 1} \frac{1}{C S_r} p_{noB|i} p_{i|r} dr$$

Using (4.13) and (4.8), this becomes

$$p_{noB} = \frac{N_T p_k}{C S_r} \int_{r=0}^{C S_r} \binom{n_c - 1}{i} [\phi_r (1 - p_k)^{(2N_s - 1)}]^j (1 - \phi_r)^{n_c - j - 1} dr$$

$$p_{noB} = \frac{N_T p_k}{C S_r} \int_{r=0}^{C S_r} (1 - \phi_r + \phi_r (1 - p_k)^{(2N_s - 1)})^{n_c - 1} dr$$

and, after replacing the terms from Equation (4.12):

$$p_{noB} = \frac{N_T p_k}{C S_r} \int_0^{C S_r} \left[1 - r \left(\frac{1 - (1 - p_k)^{(2N_s - 1)}}{2 C S_r} \right) \right]^{n_c - 1} dr$$

Finally, the result after solving the integral is:

$$p_{noB} = \frac{2 N_T p_k}{n_c [1 - (1 - p_k)^{2N_s - 1}]} \left[1 - \left(\frac{1 + (1 - p_k)^{2N_s - 1}}{2} \right)^{n_c} \right]$$

The probabilities for a type A and a type B collision respectively can be written as:

$$p_{cs} = 1 - p_{noA} \quad (4.14)$$

$$p_{ch} = 1 - p_{noB} \quad (4.15)$$

However, the beaconing expiration probability p_{exp} still needs to be calculated in order to solve Equation (4.5). In order to experience an expired message, a station first needs to find the channel busy when the beacon is passed from the network layer. This triggers a back-off of b , and the condition for the CAM to expire is that the node senses less than b idle slots in the next beaconing period. The probability of this last event can be expressed as:

$$p_{idle}(b) = \sum_{j=0}^{b-1} \binom{N_T}{j} (1 - p_b)^j p_b^{N_T - j}$$

Finally, assuming the backoff is uniformly chosen between 0 and $CW - 1$, the expiration probability is

$$p_{exp} = p_b \sum_{b=1}^{CW} \frac{1}{CW} p_{idle}(b) \quad (4.16)$$

However, as discussed above, the collisions involving nodes from the safety range of a vehicle are much more important in this scenario. If W is inside the safety range of node V , the same approach used in the computation of p_{noA} and p_{noB} can be used, with the difference that the upper limit of the integral is SF_r instead of CS_r . Using this, the probability of a type A collision (p_{SRs}) involving at least one node from inside the safety range is:

$$p_{SRs} = 1 - \int_0^{SF_r} \frac{1}{SF_r} \sum_{j=0}^{n_c - 1} p_{noA|j} p_{j|r} dr$$

After replacing all the terms, this leads to:

$$p_{SRs} = 1 - \frac{N_T p_k}{SF_r} \int_0^{SF_r} \left(1 - p_k + \frac{r p_k}{2CS_r} \right)^{n_c - 1} dr$$

Finally, using Equation (4.1), the final result is:

$$p_{SRs} = 1 - \frac{2N_T X}{n_c} \left[\left(1 - p_k + \frac{p_k}{2X} \right)^{n_c} - (1 - p_k)^{n_c} \right]$$

The probability of a type B collision (p_{SRh}) involving at least one node from inside the safety range can be expressed as:

$$p_{SRh} = 1 - \int_0^{SF_r} \sum_{i=0}^{n_c - 1} \frac{1}{SF_r} p_{noB|i} p_{i|r} dr$$

which, after replacing the terms becomes:

$$p_{SRh} = 1 - \frac{N_T p_k}{S F_r} \int_0^{S F_r} \left[1 - r \left(\frac{1 - (1 - p_k)^{(2N_s - 1)}}{2C S_r} \right) \right]^{n_c - 1} dr$$

The final result in this case is:

$$p_{SRh} = 1 - \frac{2N_T p_k X}{n_c [1 - (1 - p_k)^{(2N_s - 1)}]} \left[1 - \left(\frac{2X - 1 + (1 - p_k)^{(2N_s - 1)}}{2X} \right)^{n_c} \right]$$

The system formed by equations (4.4), (4.6), (4.14), (4.15) and (4.16) can be solved, and other results, especially those relevant to the safety area can be calculated afterwards. By using mean values in the computation of p_b , the model manages to eliminate most of the complexity introduced by other analytical tools, as for example Markov chains, and uses only the following simplifications:

- The interference model considers only the worst case interferer. While this is a reasonable assumption for a linear topology like a highway, the interference level could be much higher in more complex urban or intersection scenarios.
- The computation of p_b assumes a collision involves only two nodes. This hypothesis could be easily removed using a different value for $E[n_i]$ (perhaps one issued from field tests), and it is not used when calculating the different collision probabilities, but only for the busy slot probability. Moreover, simulation traces confirm that the situations when more than two transmissions collide are very rare in the studied vehicular scenario ($E[n_i] = 2.03$).
- The model does not take into account the fact that a receiver might still be able to decode one of the messages involved in a collision if the energy difference between the two (or more) signals is high enough (this phenomenon is known as *the capture effect*).
- The busy slot probability p_b is considered to be independent for every slot. This assumption is common for most analytical frameworks, but it is not valid in reality, because a transmission occupies more than one slot, and therefore the probability for a slot to be busy depends on the state of the previous slot. The consequence of this simplification in the described model is that the set of nodes that find the channel occupied when trying to transmit is uniformly distributed over the beaconing period. This means that the number of nodes choosing a random back-off period at a certain moment is also uniformly distributed, unlike in reality where the number of contending nodes accumulates during a message transmission. This leads to an underestimation of the collision probability, especially for low values of CW_{min} .

4.4 Numerical Example

In a network where all the nodes use a data rate of 6Mb/s and a beaconing period of 100ms , a maximum of 150 messages with a size of 500 bytes each can be received by vehicle V . This scenario assumes perfect transmission synchronisation, and it is not possible for example in an IEEE 802.11 network, where an inter-frame space needs to be inserted after every message and the use of a random back-off leads to a non-zero collision probability. However, this perfect sequence of events is used in this section as a reference, helping construct a similar example that can be studied using the framework detailed in the previous sections.

Following this line of reasoning, the VANET analysed below uses a beaconing period of 1500 slots, with a single transmission taking 10 slots, leading to the same network capacity of 150 messages during one period. It should be noticed that the size and the meaning of a slot is not the same as in the IEEE 802.11 case, where the time slot is calculated as the duration necessary not only for symbol transmission, but also for signal propagation in the desired coverage area. In this example, a slot is simply the smallest time unit, which, under the assumption of a 10Hz beaconing frequency, has a duration of $66.7\mu\text{s}$, much larger than the $13\mu\text{s}$ slot time in IEEE 802.11. This difference is especially important when trying to interpret the results obtained in the proposed model for a certain value of the contention window to the corresponding IEEE 802.11 scenario, because a back-off of b slots translates in distinct temporal values in the two situations. Including the $32\mu\text{s}$ DIFS period when the channel needs to be idle before the station begins or resumes the back-off in IEEE 802.11, one idle slot in the studied scenario corresponds in average to about four IEEE 802.11 slots. Considering this observation, and in order to facilitate the interpretation of the results, the value of the contention window in the results shown below is always given in the equivalent number of IEEE 802.11 slots.

Because the goal is to test the performance of the MAC protocol in medium and high density scenarios, the number of nodes sensed by vehicle V , n_c , is varied between 150 and 250. While this final value might seem exaggerated, in a classical two-way highway with three lanes for each direction and a carrier sense range of 1 km, as predicted for IEEE 802.11p, this produces a density of 42 veh/lane/km, or an inter-vehicular distance of 24 meters, not uncommon in most urban areas for rush hour traffic. The number of contending stations also results in a network load ρ that can be calculated as:

$$\rho = \frac{n_c N_s}{N_T} = \frac{10n_c}{1500}$$

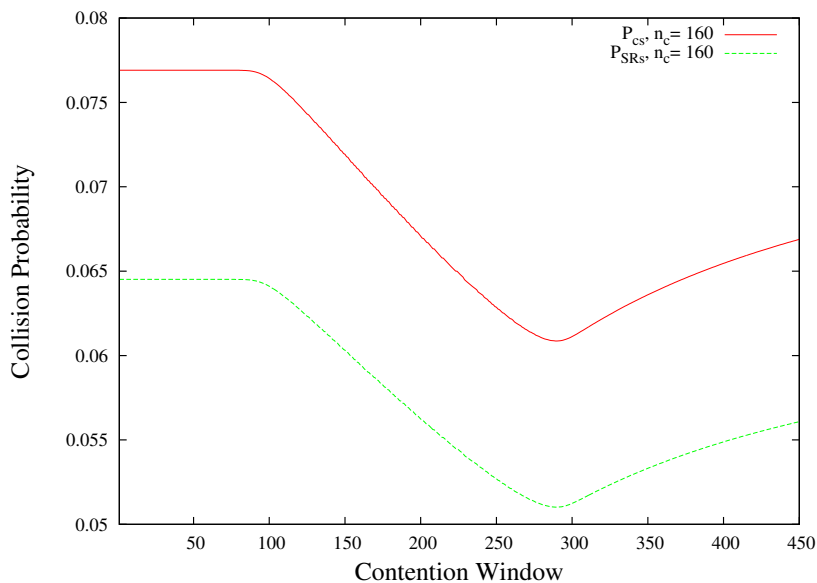

Figure 4.7: Probability that node V experiences a collision between two nodes situated inside each other's carrier sense range (synchronised transmissions) as a function of the contention window (the unit on the x-axis is an IEEE 802.11 slot). The number of neighbours sensed by vehicle V is $n_c = 160$. The lower curve shows the probability that at least one of the colliding stations is located inside the safety range of node V

The system of equations discussed in Section 4.3 is solved using an iterative method where p_b is initially set to $p_{bo} = \min(1; \rho)$. The expiration and collision probabilities are computed using p_{bo} , and a new value for the busy slot probability p_{bn} is also calculated. In the following iteration p_{bo} takes the value of p_{bn} and the process is repeated until $|p_{bn} - p_{bo}| < 10^{-4}$.

The impact the contention window has on the collision probability is first discussed. Figure 4.7 presents the probability of a type A collision (p_{cs}) at node V for $n_c = 160$ and $X = CS_r/SF_r = 2$. This implies that two of V 's neighbours, also situated inside each other's carrier sense range, begin transmitting at the same time, following the expiration of the back-off timer, or because the medium is idle when a safety message arrives from the network layer. The collision probability when at least one of these two neighbours is located inside V 's safety range (p_{SRs}) is also shown in the figure. The behaviour of p_{cs} and p_{SRs} is similar and it can be divided in three phases. In the first phase, increasing the contention window has no impact whatsoever on the collision probability. In the

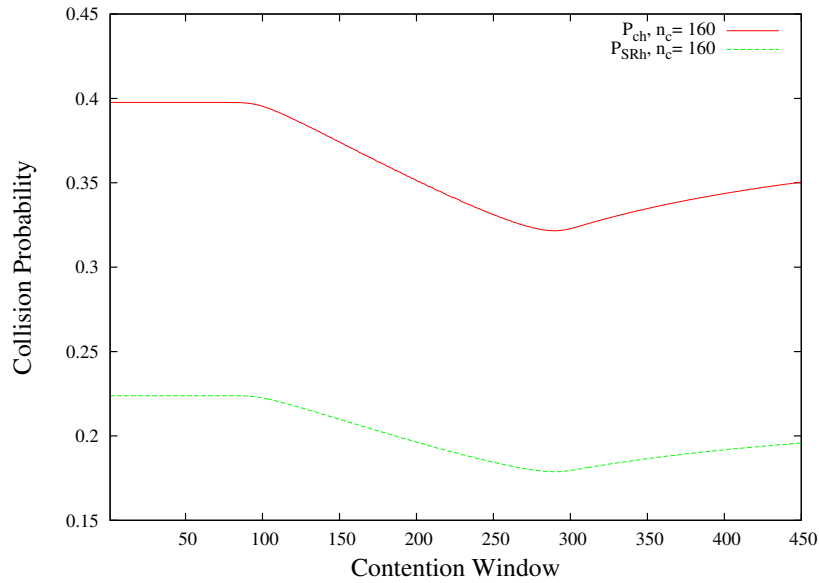

Figure 4.8: Probability that node V experiences a collision between two nodes situated outside each other’s carrier sense range (concurrent transmissions) as a function of the contention window (the unit on the x-axis is an IEEE 802.11 slot). The number of neighbours sensed by vehicle V is $n_c = 160$. The lower curve shows the probability that at least one of the colliding stations is located inside the safety range of node V

second stage, the number of collisions decreases steadily, until reaching a minimum where the third phase, a slower increase, begins.

The same observations can be made in the case of type B collisions shown in Figure 4.8. In this case, a collision is the result of concurrent transmissions by two of node V ’s neighbours that are hidden from one another.

These results can be better understood by observing Figure 4.9, where the beaconing expiration probability under the same scenario is depicted. Initially, the contention window is too small to produce any expiration. This translates in the phase with the highest collision probability in Figure 4.7 and Figure 4.8. When CW_{min} becomes large enough, more and more messages begin expiring, which reduces the network load and, with it, the collision probability. However, these modifications also have an impact on the probability of sensing a busy slot. Under the influence of an increased number of expired messages, p_b slowly decreases, the reduced number of collisions not being able to

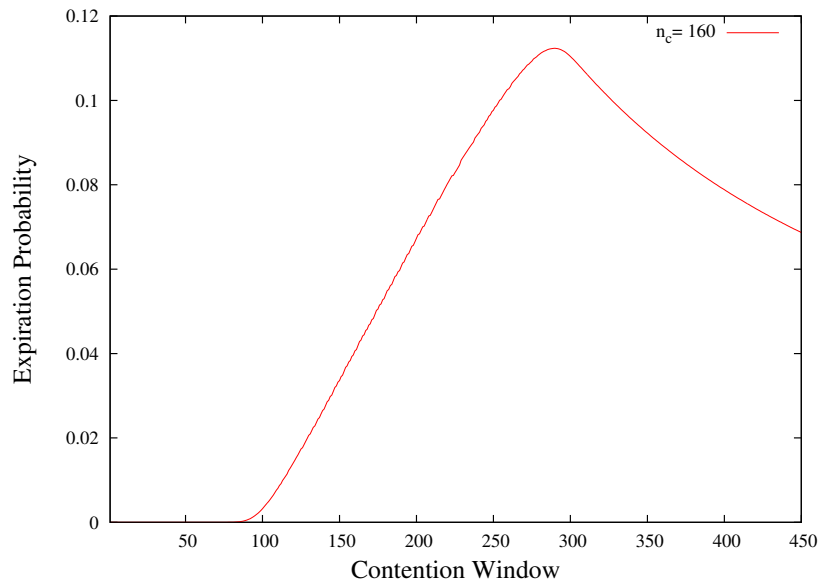

Figure 4.9: Beaconing expiration probability as a function of the contention window with $n_c = 160$ contending nodes

fill up all the extra-bandwidth obtained from reducing the channel load. However, from Equation (4.16), it can be noticed that the expiration probability (p_{exp}) also depends on p_b . Reducing p_b under a certain threshold leads to a reduction in p_{exp} and therefore to the third phase appearing on all these figures.

While the results shown above are obtained for a particular number of contending stations ($n_c = 160$), the same trend can be noticed for other vehicular densities. Because the beaconing reception probability takes into account both expired and collided messages, a balance needs to be found between the two quantities. Achieving this trade-off is not a simple task considering the fact that a collision is a local event, that only takes place at some of the neighbours, whereas an expired beacon is lost for all the possible receivers. Although the model described in the previous section does not take into account the capture effect, making the study of this optimal point even more difficult, Figure 4.10 tries to portray the importance of the contention window, showing the *reception probability* (in fact the probability that a beacon does not expire and does not experience any kind of collision) for different network loads.

These results show that initially the gain from the avoided collisions compensates the loss

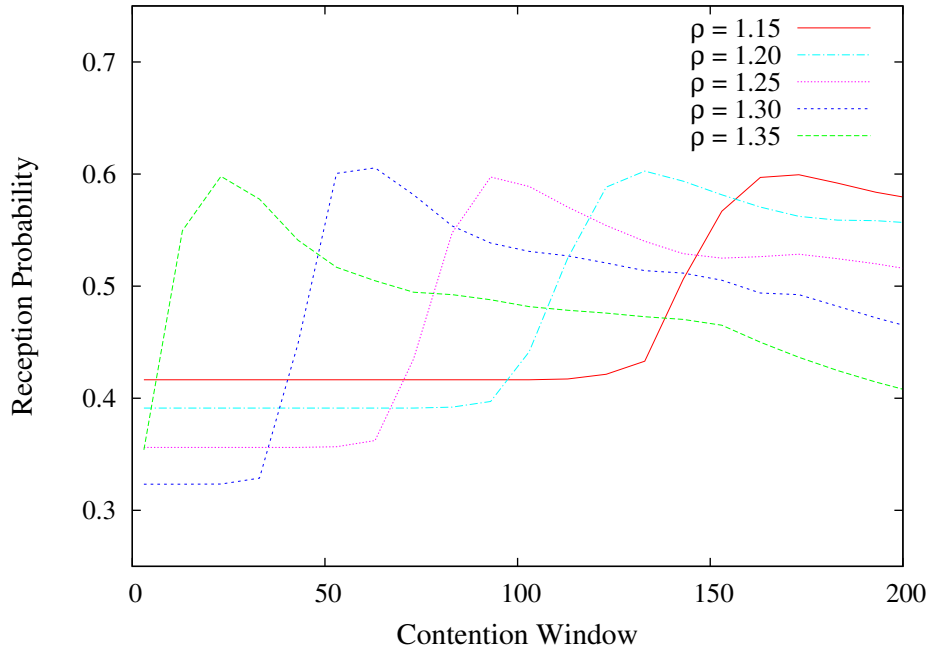

Figure 4.10: Reception probability for safety beaconing as a function of the contention window for different values of the network load

produced by the expired messages, resulting in a sharp increase of the reception probability. After a certain point, the number of expired beacons begins to prevail and the reception probability starts a slower, but steady, decrease. When p_{exp} goes beyond its peak (and the number of collisions starts increasing again), the reception probability goes through another phase, where its value remains almost constant. Finally, when the expiration probability becomes low enough, the effect of the collisions is again predominant and the number of total receptions starts decreasing once more.

Another interesting result that can be observed from Figure 4.10 is that the optimal value of the contention window decreases when the network load becomes higher. This behaviour is the opposite of the one described by the Bianchi relationship [BFO96], where the optimal CW_{min} is in direct proportionality with the number of contending nodes. A similar trend can be observed when considering the reception probability only for stations situated inside the safety range. Of course, in this case, the probability of receiving a safety beacon is higher, as expected from the lower number of collisions observed in Figure 4.7 and in Figure 4.8, but the same observations can be made regarding

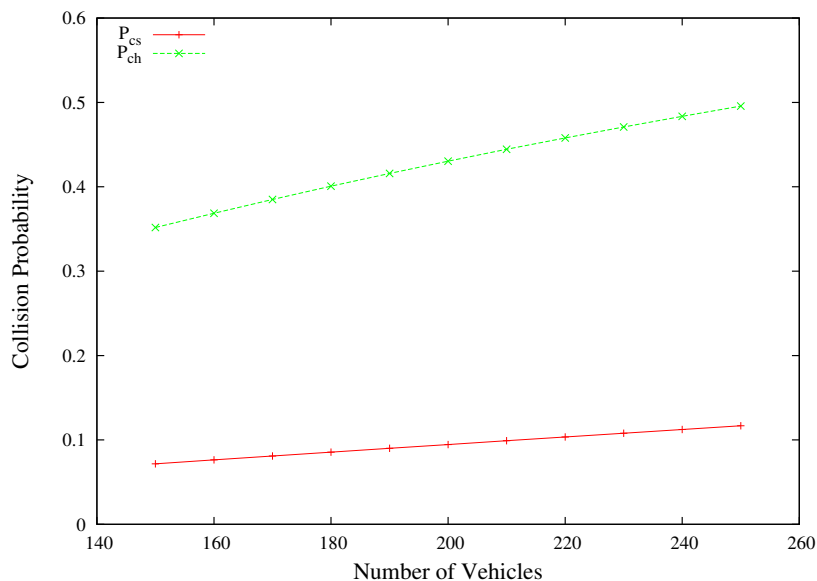

Figure 4.11: Collision probability as a function of the number of sensed stations

the influence of the contention window.

The second part of this analysis is focused on the impact the number of sensed stations has on the collision probability. Using a constant contention window of 31 IEEE 802.11 slots, Figure 4.11 shows the probability for node V to sense a type A (simultaneous transmission) or a type B (concurrent transmission) collision when the number of vehicles in the carrier sense range varies between 150 and 250.

From these results, it can be noticed that the probability of both types of collisions increases with the number of one-hop neighbours. Using a larger carrier sense range reduces therefore the interference level resulted from the spatial reuse, as shown in Figure 4.2, but leads to an increased number of sensed collisions, especially if the terminals involved in this event are hidden from one another (p_{ch} increases faster than p_{cs}).

Another important parameter in the model is the size of the safety range, which is expressed by the CS_r to SF_r ratio, X . As it can be observed comparing the results from Figure 4.7 with those shown in Figure 4.8, for $X = 2$, the difference between type A (p_{SRs}) and type B (p_{SRh}) collisions inside the safety range is significant (more than 15%). However, a different situation can be noticed in Figure 4.12 for $X = 5$, where a collisions with a hidden node has a similar probability with a

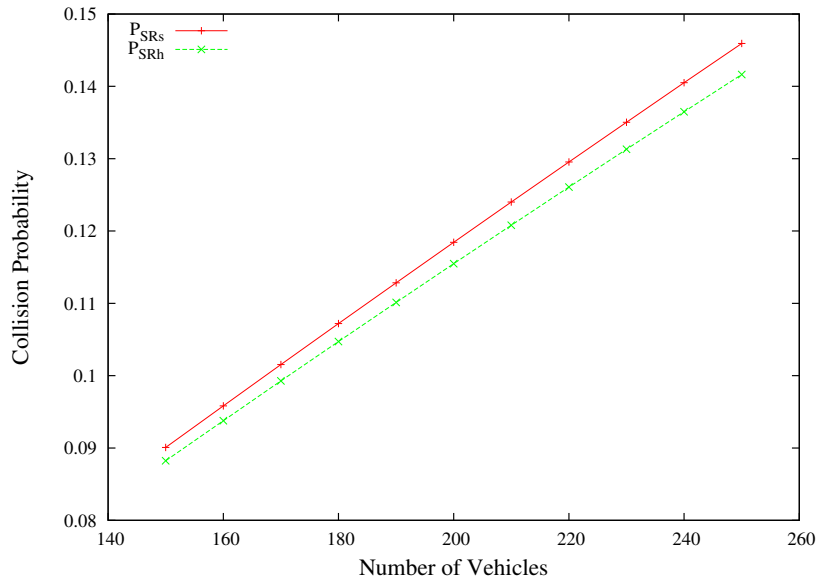

Figure 4.12: Collision probability for the nodes inside the safety range as a function of the number of sensed stations for $X = 5$

collision involving a sensed node.

This result demonstrates the impact of the required safety range in a vehicular network, and it is also confirmed by Figure 4.13, where the collision probability as a function of the ratio between the carrier sense range and the safety range is depicted.

It can be noticed that when the ratio between the carrier sense range and the safety range increases, the impact of hidden nodes becomes even less significant, especially if considering that, even in the case of a collision, capturing the message transmitted from the safety range should still be possible most of the time because the hidden nodes are situated much farther, outside the safety range. This means that in a VANET where nodes have a carrier sense range of 1 km and a reasonable SF_r of 100 meters, the majority of the lost beacons transmitted by vehicles located inside the safety range are the result of simultaneous transmissions, and not the consequence of collisions with hidden terminals. In the light of this analysis, it is clear that the conception of a vehicular congestion control framework should begin with a precise definition of the safety area and its requirements on beaconing reception ratio.

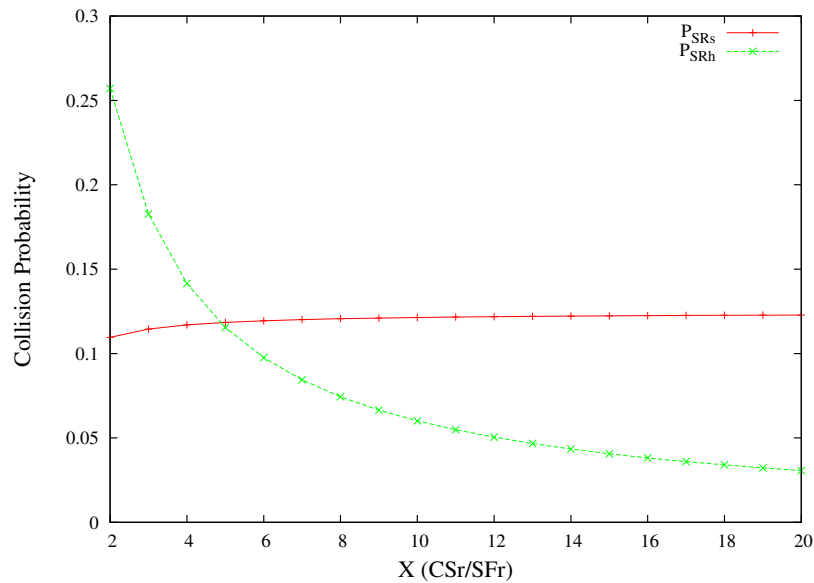

Figure 4.13: Collision probability as a function of the ratio between the carrier sense range and the safety range for $n_c = 200$

4.5 Summary

This chapter discussed from a theoretical point of view the implications of adjusting the carrier sense threshold and the contention window in a safety vehicular network. The main conclusions issued from this analysis are summarised below:

- Adapting the carrier sense threshold has a deeper impact on the signal-to-interference ratio than modifying the transmission power. Of course, in the ideal scenario, both parameters would be adjusted by a congestion control mechanism.
- Increasing the carrier sense range also increases the number of sensed stations. Contending with more neighbours decreases the probability of sensing an idle slot and leads to an increased number of collisions.
- The impact of the contention window on the collision probability is significant. A higher contention window initially reduces the number of collisions, while increasing the number of expired messages. When the busy slot probability becomes too low, further increasing the contention

window has the opposite effect, creating longer idle periods and less expired messages.

- A trade-off exists between the expired and collided messages, as it can be noticed from the evolution of the reception probability. A small number of expired beacons can be compensated by the avoided collisions and increase the reception probability, but, after a certain threshold, the expiration phenomenon becomes dominant and less beacons are received.
- An inverse proportionality relationship exists between the optimal value of the contention window and the number of contending neighbours.
- While collisions with hidden nodes are the principal reason for lost messages when considering the entire carrier sense range, the impact of hidden terminals is reduced in the safety range, where collisions are mainly the result of synchronised transmissions coming from two nodes that can sense each other.

5. Practical Framework for Congestion Control

This chapter explains the details behind three solutions that target the MAC layer congestion control problem on the VANET CCH. Section 5.1 discusses a new back-off mechanism designed to find the correct balance between expired beacons and collided messages. Because the broadcast communication forbids the choice of the classical path where the contention window is increased once a collision is detected, the proposed mechanism uses an expired beacon as an activator of the *CW* adjustment. Simulation results are provided, showing this approach can increase the awareness a vehicle possesses about its surrounding environment. Section 5.2 presents a solution for carrier sense adaptation, where the goal is to maximise the beaconing reception ratio in the safety-critical area around every vehicle. The mechanism uses a simple relationship between the carrier sense threshold and the local node density to achieve an important improvement over the current version of the standard. Finally, Section 5.3 integrates carrier sense adaptation, transmission power control and back-off mechanism in a new channel access method, specially designed for the vehicular control channel. This new technique is developed starting from the observation that collisions are practically unavoidable in a dense vehicular network, and, in this case, the only option of the nodes is to try to control these collisions. The carrier sense mechanisms associated with the method increase the collision probability with vehicles situated farther away, while protecting the safety-critical area. Simulation results indicate that the delivery ratio and the vehicular awareness is highly improved when compared with basic IEEE 802.11p, especially when the back-off mechanism from Section 5.1 is also integrated in this framework.

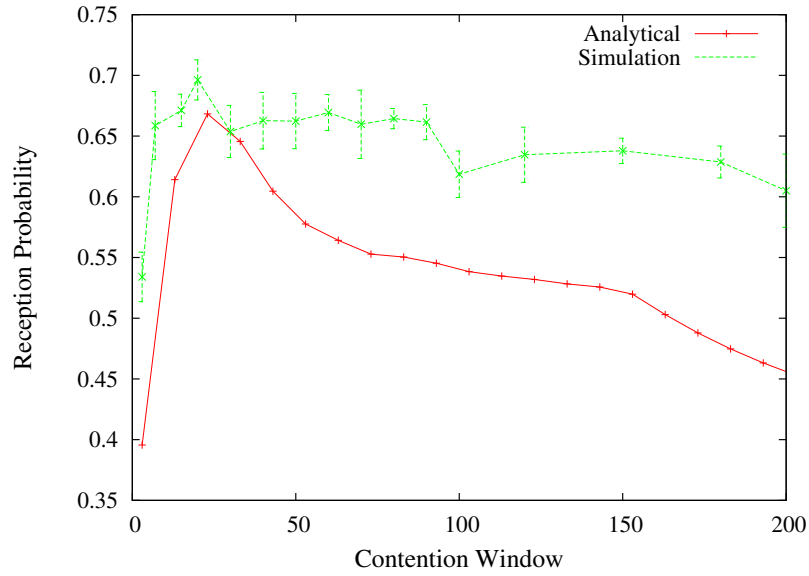

Figure 5.1: Simulation and analytical results for beaconing reception probability at 200m from the sender as a function of CW_{min} for a network load of 1.35 (95% confidence intervals are also shown for simulation results)

5.1 Reverse Back-off Mechanism

The simulation study in Section 3.4 and the analytical results in Section 4.4 indicate that the binary exponential back-off mechanism and the small value of the initial contention window proposed in IEEE 802.11p would not be suitable for safety V2V communications. This section begins with a study of the optimal contention window, meant to validate the analytical model described in Chapter 4.3. Based on this insight, a back-off mechanism specially designed for the VANET control channel is proposed.

5.1.1 Optimal Contention Window

The JiST/SWANS simulation framework described in Section 2.4.3 was used in the first place to estimate the beaconing reception probability for different values of the contention window. Then, the optimal CW_{min} obtained in the case of safety beaconing was compared with the contention window that gave the best results when the vehicular network transported saturated broadcast traffic.

The comparative study was conducted for several values of the mean vehicular density, and therefore, of the network load. Because the focus of this thesis is on high density scenarios, a network load between 1 and 1.5 has been used. As the same conclusions can be formulated from all the result sets obtained after these simulations, Figure 5.1 only presents one such example. In this scenario, where the vehicular density is 51 veh/lane/km, which, correlated with a beaconing frequency of 10Hz, leads to a network load of 1.35, the reception probability for safety messages at 200m from the sender is measured while varying the value of the contention window. As explained, the analytical results obtained after introducing this value in the framework detailed in the previous chapter are also shown in the figure, for comparative purposes.

Observing the two sets of results, it can be noticed that, while not identical, they present a similar behaviour. A reduced reception probability can be noticed for small values of CW_{min} , followed by a sharp increase and slow decrease. The reason for this phenomenon has been already discussed above: increasing the contention window reduces the probability of synchronised transmissions. However, after a certain point, having to wait for a long back-off time produces more and more expired beacons and the gain obtained by having fewer collisions is not enough anymore, resulting in a slow reduction of the reception probability.

The differences between the simulation and the analytical frameworks come from the simplifications made in the latter (see Section 4.3), especially from the capture effect accurately modelled in the simulator, but not considered in the analytical results. Also, the fact that the analytical model assumes the busy slot probability is independent for every slot, while the simulations can be more realistic on this point, is responsible for a significant part of the differences observed for low values of the contention window.

Nevertheless, despite this differences, the optimal value of the contention is the same in both cases. The same conclusions can be drawn by comparing the results for different vehicular densities: while the analytical model can not be used for exact quantitative measures, it is an efficient tool in comparative studies, where the influence of a certain parameter in a VANET needs to be understood before a more detailed experiment using real hardware or complex simulations.

This observation is confirmed by the results depicted in Figure 5.2, where the optimal contention window for safety beaconing and saturated broadcast at 200m from the sender are shown. By comparing the evolution of the CW_{min} for safety messages with the predictions made using the analytical model in Figure 4.10, the same steady decrease of the optimal contention window when

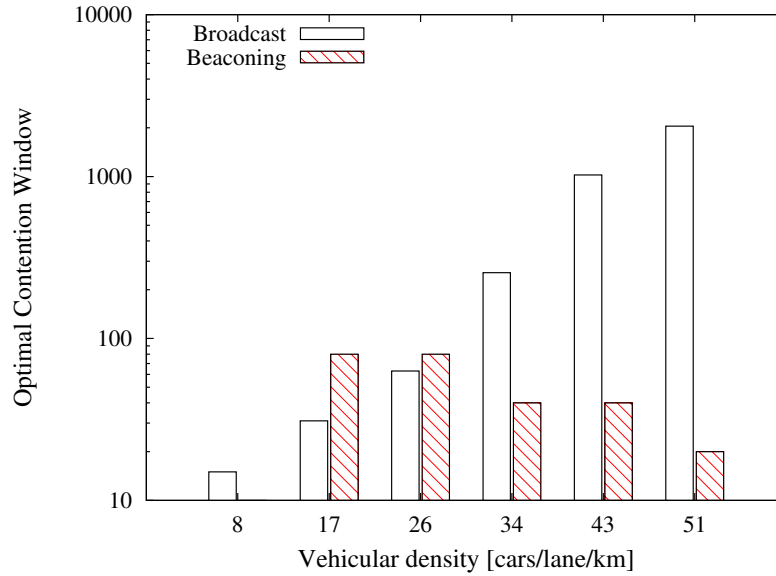

Figure 5.2: Optimal value of CW_{min} for saturation broadcast (with no expiration deadline) and beaconsing (please notice the log-scale of the y-axis)

the vehicular density increases can be noticed. The saturated beaconsing scenario also behaves as predicted by the Bianchi relationship [BFO96], the best CW_{min} being directly proportional to the number of neighbours.

Another interesting property that can be noticed in this figure is that the optimal CW_{min} can be found in a relatively small interval (between 20 and 100) for a large range of vehicular densities. These findings seem to question the assumptions behind the different CW adaptation mechanisms discussed in Section 3.4 and represent the basis of the new back-off approach detailed below.

5.1.2 Back-off Mechanism

All the results presented so far in this thesis point out that using an improper value for the contention window can result in a significant drop in MAC layer performance. Despite this, both WAVE and ETSI ITS architectures are based on the IEEE 802.11e access method and use relatively low values for CW_{min} (between 3 and 15, depending on the access class, as shown in Table 2.2. However, these values belong to the interval resulting in the worst beaconsing reception probability.

A different approach is therefore needed regarding the back-off mechanism. The solutions described in Section 3.4 attempt to solve this problem, but they are based on properties that are valid for classic unicast or broadcast communication, and that were proven to be false when the nature of the safety messages is considered.

The new back-off mechanism proposed below does not try to achieve optimality using an estimation of the number of neighbours, although this would be perhaps possible using the insight gained from the analytical study discussed above. Instead, it is based on the observation that the most successful proposals in this field (e.g. IEEE 802.11 binary exponential back-off, optimal-CSMA contention aggressiveness) rely on internal information, accurate and easy to interpret. However, as already stated, the state of the queues is not relevant for safety vehicular communications, and collisions remain undetectable in this broadcast environment. Another parameter is therefore needed in the computation of the contention window, and it can be found by recalling that, in a VANET, the optimal CW finds the correct balance between collided and expired messages. While collisions can not be used, expired messages can be detected with no effort and they can form the basis of a back-off mechanism.

There are two ideas behind this mechanism:

- A larger contention window than the one proposed in IEEE 802.11p is needed in order to cope with medium and high vehicular densities
- An expired beacon produces important consequences, because the information it carries will not be received by any neighbour, and therefore needs to be counterbalanced by an increased priority of the next beacons.

Therefore, instead of beginning with a small CW_{min} that would be increased after every failed transmission, as in IEEE 802.11 BEB, the *reverse back-off mechanism* starts with a fairly large initial contention window (CW_i) and decreases it for every expired beacon. While different approaches could be taken, the results shown in this section consider CW is halved after every expired CAM and it returns to the original value CW_i after $n_t = 1$ transmitted beacons.

Figure 5.3 compares, for a vehicular density of 43 veh/lane/km, the beaconing reception probability achieved when using a fixed value for the contention window and the reverse back-off mechanism for several CW_i . It can be observed that the differences are not significant and that the reverse back-off manages to match the results obtained by the optimal fixed CW when $CW_i = 60$. Other traffic

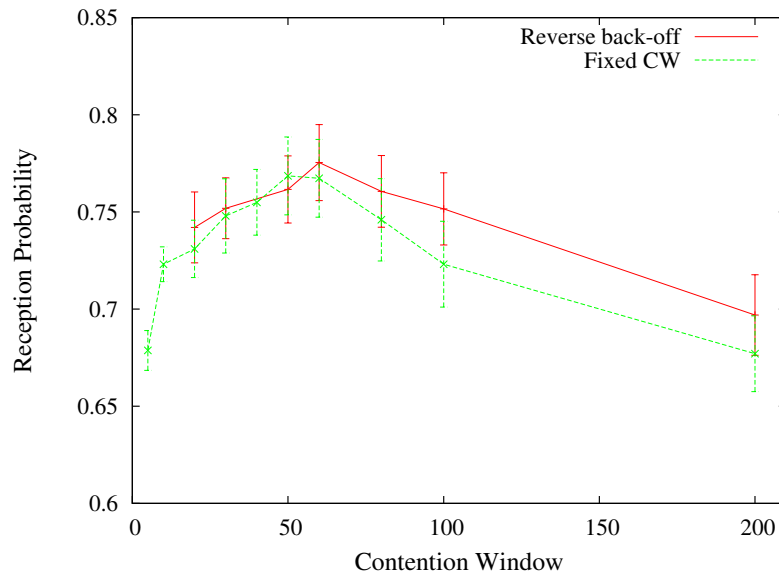

Figure 5.3: Beacons reception probability at less than $200m$ from the source as a function of the initial contention window using a fixed contention window and the reverse back-off mechanism with a vehicular density of 43 veh/lane/km (the 95% confidence interval is also shown). The x-axis represents the value of CW_{min} for the fixed CW approach and the value of CW_i for the reverse back-off

densities have been tested and the best value for CW_i is always between 50 and 80, with a CAM reception probability close to the optimal fixed scenario.

This can be seen in Figure 5.4, where a different representation of the results is presented. The beacons reception probability when using the CW value proposed in the IEEE 802.11p standard for the access class with the second highest priority ($CW_{min} = 7$) is compared with the performance achieved by the optimal value of CW_{min} and the one realised by the reverse back-off mechanism with $CW_i = 63$. The reverse back-off and the optimal fixed CW have similar results, while bringing an improvement of around 10% when compared with the current version of the standard. However, a relevant observation needs to be made: while the optimal fixed contention window is different in the two cases ($CW_{min} = 50$ for 43 veh/lane/km, and $CW_{min} = 30$ for 51 veh/lane/km), the reverse back-off mechanism uses the same parameters in both situations. This is important, because no further adaptation taking into account the number of contending stations needs to be made.

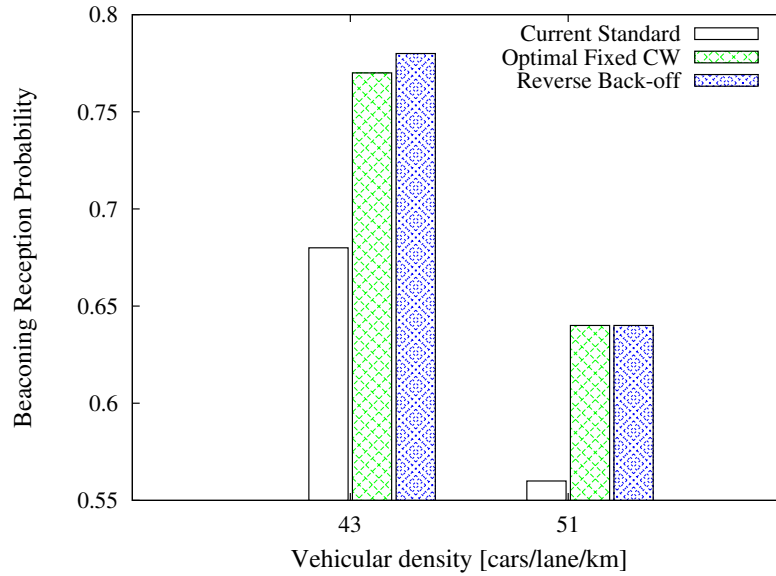

Figure 5.4: Comparison of the beaconing reception probability when using the CW value currently proposed in the standard, the optimal fixed contention window and the reverse back-off mechanism under two different vehicular densities.

Moreover, an even more significant difference can be noticed in Figure 5.5, depicting the number of consecutive beacons lost between pairs of vehicles situated at less than $100m$ from one another. This can be seen as a measure of the awareness a vehicle has on the state of the safety critical area around it. While, as seen above, the number of losses is similar for the optimal fixed CW and the reverse back-off mechanism, the distribution of these losses is highly different. Using the reverse back-off, there are 18% more cases when a node misses between 1 and 9 consecutive beacons from one of its neighbours than when using a fixed contention window. The probability of losing between 10 and 20 consecutive beacons is similar in both cases (2% less cases for the reverse back-off). Finally, an event where more than 20 consecutive beacons are lost appears 40% less often when using the new back-off mechanism. This metric is essential for safety applications, where *invisible* neighbours represent a danger and their existence must be minimised. Increasing the priority of a node following an expired beacon, as proposed in the reverse back-off mechanism, manages to reduce the probability of such *ghost* nodes, a very important property in a vehicular environment.

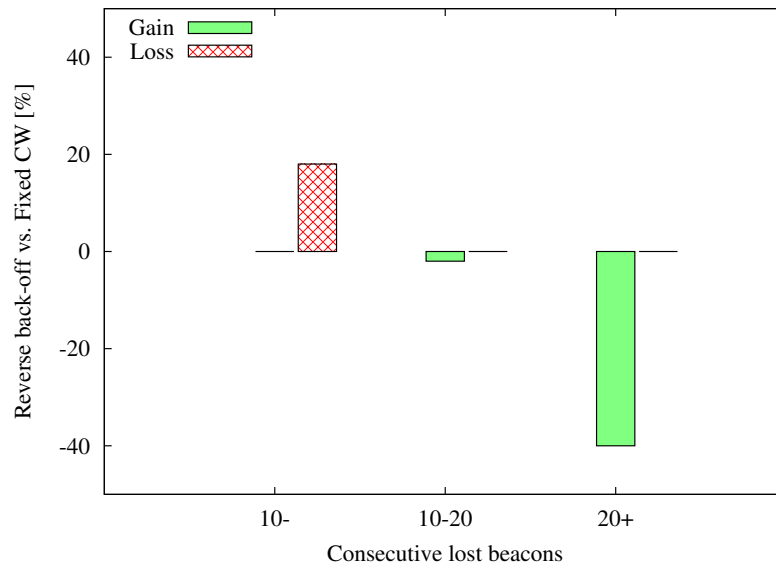

Figure 5.5: Comparative representation of the number of consecutive beacons lost between nodes situated at less than $100m$ from each other for a density of 51 veh/lane/km

5.1.3 Summary

This section described a new back-off mechanism, based on the idea that monitoring expired messages can help control the size of the contention window. A higher value for the initial contention window translates in an increased beaconing reception probability, similar with the one obtained by the optimal fixed CW . By assigning a higher priority to vehicles having suffered an expiration, the mechanism manages to redistribute the losses, reducing the number of consecutive lost CAMs between two neighbours.

The reverse back-off mechanism is simple to implement, requiring only minor software modifications of the IEEE 802.11 drivers. Moreover, it is fully compatible with an IEEE 802.11e architecture, where the four traffic classes could be assigned different values for CW_{min} (e.g. 7, 15, 31 and 63). Beacons would be normally transmitted using the class with the highest contention window, and their priority would be increased after an expiration by assigning them to a different access class. This would also allow differentiation between regular beacons and special event notifications, by giving higher priorities to the latter.

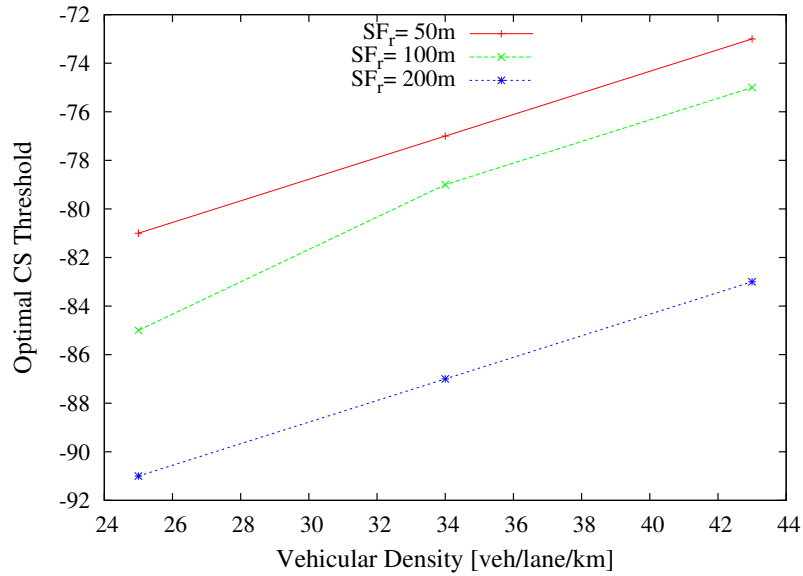

Figure 5.6: Optimal carrier sense threshold as a function of the vehicular density for different values of the safety range

5.2 Adaptive Carrier Sensing

The disadvantages of a fixed carrier threshold have been studied in Chapter 3.5, showing a decrease in MAC layer performance and pleading for an adaptive mechanism for the carrier sense threshold. The analysis presented in Chapter 4.2 proves that a larger carrier sense zone results in a higher signal-to-interference ratio, while trading off with an increased busy slot probability. This section is focused on an adaptive solution based on local node density, after an initial discussion on the role had by the safety range in the choice of the carrier sense threshold.

5.2.1 Safety Range Impact

Before describing an adaptive mechanism for the carrier sense threshold, the impact of the safety range needs to be addressed. As discussed, the goal of a MAC layer congestion control framework should be to preserve a high delivery ratio for safety messages in the immediate neighbourhood, even with the risk of losing more messages at higher distances. However, the notion of *immediate neighbourhood* is not very precise, and this thesis introduced the concept of *safety range* to better

measure the performance of the MAC layer.

Concerning the impact of the physical carrier sense, Figure 3.5 only presents results for a safety range of $50m$, without taking into account the influence of this parameter. Therefore, Figure 5.6 shows the best carrier sense threshold for different vehicular densities and safety ranges. It can be noticed that a receiver must use a higher sensitivity if the goal is to have a large safety range. However, it is important to understand that, by doing this, the average reception probability inside this larger SF_r is increased but more beacons are missed by really close vehicles.

This emphasises once more the necessity of establishing the size of the safety range before proposing different mechanisms, especially in the case of congestion control. Not only the optimal values would usually change with the dimension of the safety range, but the entire approach behind the mechanism might become invalid when this area of interest is modified. The solutions proposed in this work have been tested with values of SF_r ranging between $50m$ and $200m$, and their behaviour is similar in all the cases (although, as mentioned, the optimal values are in general different when the safety range is modified).

5.2.2 Adaptive Carrier Sense Threshold

The importance of physical carrier sensing on the performance of safety oriented vehicular networks emerges from all the points discussed so far in this thesis. Moreover, the analysis presented in Chapter 4.2 suggests that the optimal carrier sense range depends on the vehicular density, and the simulation results presented in Chapter 3.5 confirm this dependence.

In a sparse network, a large carrier sense range allows the reception of messages from vehicles situated farther away and increases the connectivity time. At the same time, in this scenario, the beaconing expiration probability and simultaneous transmissions are kept under control by the small number of neighbours. Nevertheless, when the network becomes denser, a low detection threshold can not sustain an efficient safety message delivery as a result of a high number of expired beacons or simultaneous transmissions.

With this in mind, a mechanism for carrier sense control is proposed and its performance is evaluated by an extensive simulation study whose results are presented below. The mechanism is fully compatible with other proposed solutions like transmission power control or adaptive contention window and it could be a powerful complement for them in a more general congestion control framework.

The idea is based on the native capacity of a vehicular network to measure the local node density by the means of beacons. By counting the number of messages received in a beaconing period, a vehicle has a close estimation of the number of neighbours. Moreover, safety beacons include location information and therefore the node can easily determine the vehicular density in its surroundings. To further increase the accuracy of this estimation, when calculating this density only the beacons received from inside the safety range, where the reception probability is the highest, are taken into consideration. This approach does not need any information regarding the identity of the neighbours, as only the number of received messages is used. Therefore, the mechanism is fully compatible with privacy-preserving solutions that might also be implemented at the MAC layer.

Starting from a certain size of the safety range, a maximum value can be defined for the carrier sense threshold (CS_{max}) in order to make sure that the physical carrier sense mechanism covers at least this highly important area. The lower limit in this case, CS_{min} , is given by the minimum receiver sensitivity imposed by regulations. The mechanism also uses two boundaries of the vehicular density, λ_{min} and λ_{max} . When the density estimated by the node, $\tilde{\lambda}$, is under λ_{min} , the vehicle uses CS_{min} . On the other hand, if $\tilde{\lambda} > \lambda_{max}$, the vehicle sets its carrier sense threshold at CS_{max} .

In the interesting case, when $\lambda_{min} < \tilde{\lambda} < \lambda_{max}$, a simple linear dependence between the carrier sense threshold, CS_t , and the node density is used. Therefore, CS_t is calculated as follows:

$$CS_t = CS_{min} + \frac{\tilde{\lambda} - \lambda_{min}}{\lambda_{max} - \lambda_{min}}(CS_{max} - CS_{min}) \quad (5.1)$$

Other local density estimation techniques, as those described in Chapter 3.4 in the case of contention window adaptation, could be used, but the solution proposed here is very simple to implement and shows no compatibility problem with other mechanisms from the VANET framework, like changing pseudonyms.

In a preliminary phase, the parameters needed to calculate CS_t in Eq. 5.1 are determined. As discussed above, the minimum value of the carrier sense threshold is $CS_{min} = -95dBm$ because of the high ambient noise level experienced in the vehicular environment. The superior limit CS_{max} depends on the safety range that needs to be covered. The results provided below are issued from simulations with $SF_r = 100m$, which leads to a value of $CS_{max} = -65dBm$. The vehicular density $\tilde{\lambda}$ is estimated by using the beacons received from inside this safety range and the two thresholds were $\lambda_{min} = 10veh/km$ and $\lambda_{max} = 300veh/km$.

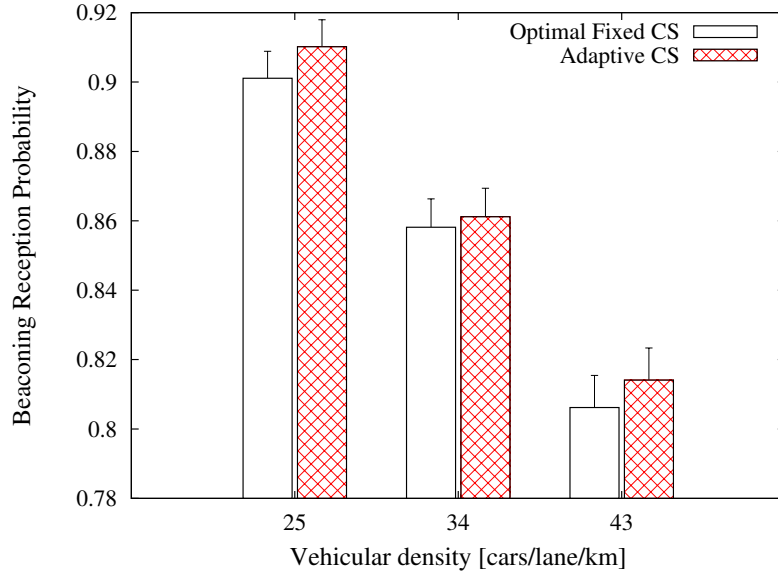

Figure 5.7: Beaconsing reception probability for the best fixed carrier sense threshold and the proposed adaptive mechanism for three different vehicular densities. The 95% confidence intervals are also shown

Figure 5.7 compares the beaconsing reception probability obtained for the optimal fixed value of CS_t with the reception ratio of the adaptive mechanism. It can be noticed that adjusting the carrier sense threshold gives slightly better results, regardless of the vehicular density. However, the main strength of the mechanism does not come from this marginal improvement. The power of the adaptive approach becomes clear when these results are analysed together with those from Figure 5.6. What can be observed in this case is that the optimal values for CS_t are $-85dBm$, $-81dBm$, and $-75dBm$ respectively for the three studied vehicular densities, while on the other hand the carrier sense control mechanism is the same in all the scenarios.

A more detailed analysis is given in Table 5.1, where the reception probability of the adaptive mechanism is compared with the one achieved using three fixed thresholds. These results show that it always exists a fixed carrier sense threshold with a result close to the proposed solution. However, any CS_t achieves this performance only in a particular scenario and it can not compete with the adaptive mechanism under all these different vehicular densities.

It is also important to point out that, for $CS_t = -95dBm$, the reception ratio is considerably

Table 5.1: Beacons Reception probability for Fixed and Adaptive CS Thresholds

Vehicular Density	Adaptive Mechanism	$CS_t =$ $-95dBm$	$CS_t =$ $-85dBm$	$CS_t =$ $-75dBm$
25 veh/lane/km	91.02	86.42	89.88	88.64
35 veh/lane/km	86.12	78.38	84.27	81.81
45 veh/lane/km	81.41	69.76	76.32	80.20

lower than the one obtained by adjusting the physical carrier sense, reaching more than 10% in the case of 45 vehicles/lane/km. This shows once again the limits of using the receiver sensitivity for carrier sensing in VANETs, as currently proposed by the IEEE 802.11p standard.

The behaviour of the adaptive carrier sense mechanism is further analysed in Figure 5.8, where the distribution of CS_t for different node densities is depicted. The interval used for the carrier sense threshold was divided into four sub-intervals (I to IV in Figure 5.8). The percentage of vehicles using a CS_t belonging to each of these categories during all the simulation runs was calculated for different values of the average vehicular density. The heterogeneity of the local density is clearly demonstrated by these results, as the values of the carrier sense threshold are distributed over the entire interval. As expected, this local density increases with the average vehicular density, and therefore nodes switch from what is called category III or IV (CS_t under $-75dBm$) to the categories with a higher carrier sense threshold. It is interesting to notice that the percentage of vehicles belonging to the lowest density category remains high, a sign that unsaturated roads exist even under heavy vehicular traffic.

5.2.3 Summary

This section focused on the role played by the physical carrier sense in a safety vehicular network. The standard way of functioning in this area is to use a receiver as sensitive as possible, minimising therefore the interference with other nodes. This approach could be justified by the fact that the broadcast nature of safety communications practically eliminates exposed terminals, and in these conditions the hidden node problem can be solved by using a low carrier sense threshold. However, this solution does not consider the correlation between the carrier sense range and the number of

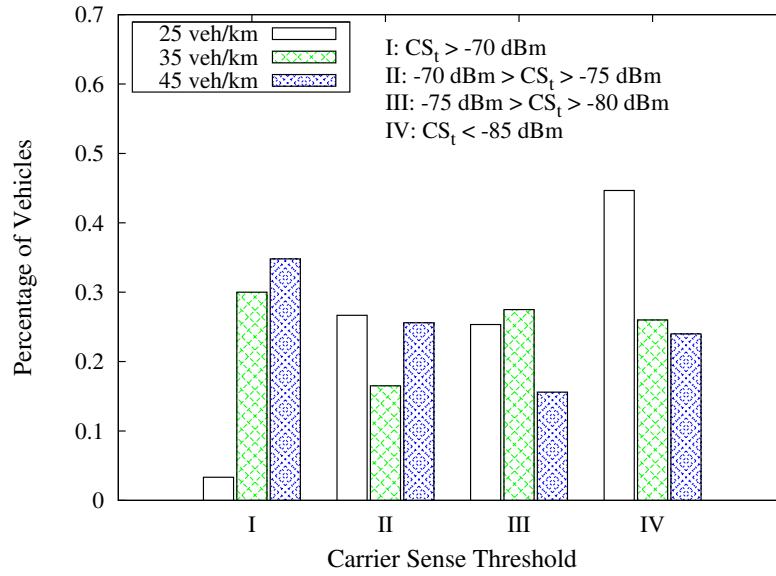

Figure 5.8: Distribution of the carrier sense threshold determined by the adaptive mechanism under different average vehicular densities

contending neighbours, which has been shown in Chapter 5.1 to be an essential parameter of the back-off mechanism. Actually, the use of a highly sensitive receiver reduces the spatial reuse and increases the probability of simultaneous transmissions, resulting in a lower performance of the IEEE 802.11p MAC layer in high density scenarios.

The mechanism proposed in this section takes into account the local node density and selects an appropriate carrier sense threshold for every vehicle. Starting from a precise definition of the safety-critical area where the beacon dissemination needs to be optimised, and building on the native VANET capacity to estimate the number of neighbours, this adaptive mechanism uses a linear relationship to adjust the carrier sense threshold. Although very simple, the solution proves to be very efficient, improving the beaconing reception ratio by more than 10% in the studied scenario with the highest density.

5.3 Safety Range Carrier Sense Multiple Access

The two mechanisms proposed in this chapter demonstrate the gain that could be achieved by taking into consideration the properties and requirements of the safety V2V communication on the control channel. This section goes even further in the search for a MAC layer solution to the congestion control problem, and describes a new channel access technique, called *Safety Range Carrier Sense Multiple Access* (SR-CSMA).

The objective of this CSMA-based method is to increase the reception probability for beacons transmitted by vehicles located within the safety range, leading to a higher reliability of the vehicular network. The idea behind SR-CSMA is to take advantage of the capture effect and to force collisions with nodes situated farther away, while reducing the collision probability with close neighbours. In order to achieve this, SR-CSMA incorporates adaptive mechanisms for the physical carrier sense threshold, the transmission power and the contention window.

5.3.1 Protocol Description

The functioning of SR-CSMA is based on the carrier sense mechanism, just like classical CSMA. When a message reaches the MAC layer for transmission, the state of the channel is checked. If the medium is idle, the message is sent with no delay. The difference from CSMA appears when another activity is detected on the channel. Normally this would automatically lead to a back-off, but SR-CSMA introduces an intermediary phase.

The contending node V first determines the location of station W currently occupying the channel. If the intersection of the safety ranges of the two nodes is not empty, meaning that there could exist stations that would consider both transmission as extremely valuable, the medium is declared busy. Otherwise, V estimates what level of interference would produce its transmission on a station S situated at the border of the safety range of the already transmitting W . Using this information, the signal-to-interference ratio at node S can be calculated. If the estimated SIR is larger than a certain threshold, V decides that the transmission can take place and declares an idle channel. The message is sent and the capture effect allows all the stations in the safety range of one of the transmitters to receive the most important of the two messages.

The same concept applies in the case of the back-off mechanism. When using CSMA, any sensed transmission blocks the timer and the countdown is restarted when the channel becomes idle

again. In SR-CSMA, if the received message is not close enough to delay a transmission, then it is not considered strong enough to block the back-off timer.

In a vehicular network where the load can easily rise above the channel capacity, collisions are imminent and the goal of SR-CSMA is to control these undesired, but also unavoidable events. By forcing simultaneous transmissions from distant nodes, the channel is able to accommodate an increased number of nodes, and the probability of unwanted collisions is reduced, keeping a high beaconing delivery ratio in the immediate neighbourhood and preserving the efficiency of the safety applications.

5.3.2 Transmission Power Control

A transmission power control mechanism can be straightforwardly integrated in SR-CSMA. Assuming vehicle V can use any power level between P_{min} and P_{max} , when a message is sensed on the channel two power thresholds are calculated by V beginning from a target SIR, β_t . First of all, a maximum power is estimated in order to respect the SIR constraint in the safety range of the ongoing transmitter W . Knowing the signal power W achieves at the border of its safety range P_{SRW} , this maximum threshold can be calculated as

$$T_{max} = \frac{P_{SRW}}{\beta_t}$$

Second, a minimum threshold T_{min} is estimated to ensure that vehicles inside the safety range of node V can decode its message using the capture effect. A node situated at the border of this zone, between V and W , detects a power level P_{SRV} coming from node W . Therefore, vehicle V needs to transmit using at least a signal power calculated as follows:

$$T_{min} = P_{SRV}\beta_t$$

Of course, if $T_{min} > T_{max}$ or if $T_{min} > P_{max}$, a transmission that respects both constraints is impossible and the channel is declared as busy. Otherwise, any power level between the two thresholds can be chosen.

In order to reduce the interference, we propose to always use T_{min} in this case, or P_{min} if $T_{min} < P_{min}$. This latter situation can appear quite often, because a rather high value for P_{min} should be used to lower the probability for radio propagation errors.

5.3.3 Location and Power Estimation

Regarding its compatibility with existing IEEE 802.11 hardware, SR-CSMA does not modify the energy detection mechanism of the CCA function, although the 20 dB difference between the minimum receiver sensitivity and the energy detection threshold has been defined in the context of the ISM band shared by multiple radio technologies and it might be exaggerated in the conditions of the dedicated DSRC spectrum. On the other hand, to put into practice the ideas described above, the new access method requires minor modifications of the PLCP header and the header detection function of the CCA.

Inspired from the existence of the RATE field (as discussed in Chapter 3.5), the proposal is to add a POWER field to the PLCP header where the sender could share information about the power level used for transmitting the message. A four bits field would be adequate for this purpose and these bits could be obtained without increasing the size of the PLCP header, by a simple redesign of the various fields (a 12 bits LENGTH field is clearly disproportionate for the small safety messages).

However, knowing the power level used for transmission (P_t) is not enough for SR-CSMA. As discussed in Section 5.3.1, the location of the ongoing transmitter W and power levels at different distances from node V need to be estimated. A cross-layer mechanism using information from both MAC and PLCP layers is used for this purpose.

For a vehicular safety message, the location of the transmitter is already a part of the MAC header. A simple and accurate solution would be to move this information from the MAC to the PLCP header. However, it will be shown that SR-CSMA does not need extremely accurate location information and this modification would introduce an undesired overhead because the MAC part is usually transmitted at a higher data rate than the PLCP part. Therefore, a different approach is taken to estimate the distance between nodes V and W . As discussed, when a safety message is correctly received with power level P_r and it reaches the MAC layer, the vehicle can determine the distance d where the transmitter is situated. Any radio propagation model can be used at this point to estimate the channel conditions. As an example, in the following we will use the model already described in Chapter 4.2, but a different representation can be easily integrated.

Assuming that $d^\theta = P_t/P_r$, the instantaneous path-loss exponent θ can be determined and an estimated value $\tilde{\theta}$ can be easily kept up to date by the MAC protocol using the large number of received beacons. The PLCP can not directly fetch the location of node W from the MAC header, but

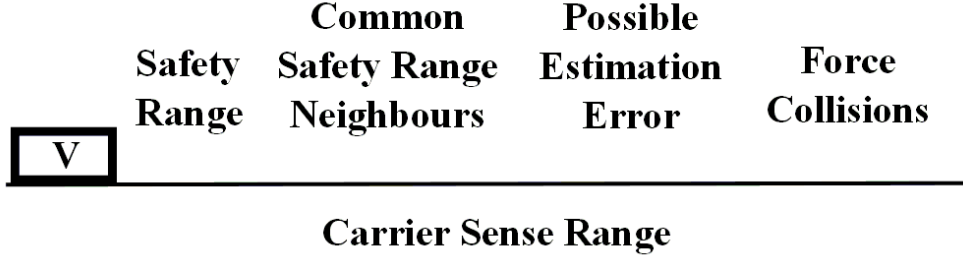

Figure 5.9: Different zones in the carrier sense range of a node

knowing the transmitted and received power levels and having access to the value of the estimated path-loss exponent, the distance between the receiver and the sender can be estimated as

$$\tilde{d} = \sqrt{\frac{P_t}{P_r}}$$

A similar approach is used to estimate the various power levels described in Sections 5.3.1 and 5.3.2 (e.g. P_{SRW} , P_{SRV}). For example, to calculate the power of a signal transmitted by node W at a distance d_t from node V , the latter would estimate the distance between V and W , \tilde{d}_{WV} , and would calculate

$$\tilde{P}_{d_t} = \frac{P_t}{(\tilde{d}_{WV} - d_t)^{\tilde{\theta}}}$$

Of course, in the quickly varying vehicular channel, these estimations might not be very accurate. For this reason, SR-CSMA uses a value for the SIR target β_t that is much larger than the SIR level required by the capture effect. A high value for β_t can mask most estimation errors and, as shown in Figure 5.9, ensures that only transmissions from far vehicles are used for intentional collisions.

5.3.4 SR-CSMA and the Reverse Back-off Mechanism

In order to describe a complete congestion control framework, the reverse back-off (RB) mechanism proposed in Chapter 5.1 is integrated in SR-CSMA. As discussed above, the reverse back-off mechanism has two major advantages when compared to the classical BEB. First of all, by using a larger value for the contention window, it reduces the collision probability, especially between nodes that can sense each other. Second, by reducing the back-off time after an expired message, it distributes

these losses in a much more uniform manner, and it manages to significantly lower the number of consecutive lost beacons between any two vehicles in the network. The only inconvenience could come from the fact that a larger back-off time increases the MAC layer delay, which could be problematic in the case of safety messages where short latency is essential. However, the lifetime of the beacon already sets a tight threshold for the delay and therefore the expiration probability takes into account the delay requirements.

This integration raises two problems. First of all, SR-CSMA does not declare the medium busy when it senses a transmission from nodes situated outside the zone that could create collisions in the safety range. This translates into a back-off timer that is frozen less often and a shorter total back-off time. This decreases the expiration probability and, because the reverse back-off mechanism needs a certain number of collisions to function properly, the initial value of the contention window needs to be further increased. Second, an essential property of SR-CSMA is that it is *CSMA-friendly* and the two access techniques can be used in the same network. However, this is not true for the reverse back-off mechanism, and nodes implementing RB can not compete with stations using BEB.

An important observation is that most of the modifications required by both SR-CSMA and RB are software-based. The new carrier sense mechanism can be described in the CCA function of the PLCP layer, while the RB mechanism should replace the BEB at the MAC layer, where a small database facilitating the location and power level estimation would also be necessary. The single mechanism involving hardware-based operations is transmission power control, which is already required by ETSI regulations with a granularity of 0.5 dB for all IEEE 802.11p radios.

Of course, a sensible problem could be that all these new mechanisms would require a revision of the standard, which is a laborious task and does not guarantee the modifications would also propagate in real products. However, there is a general consensus between automakers and hardware manufacturers regarding the necessity for a MAC layer congestion control framework and standardisation work in this area is already under way [ETSI11a].

5.3.5 Performance Evaluation

To evaluate SR-CSMA, the JiST/SWANS simulation framework, together with the Street Random Waypoint car-following mobility model were used, as described in Chapter 2.4.3. The results shown below were obtained for a safety range of 100 meters, but similar results were observed for $SF_r = 50m$ and $SF_r = 150m$.

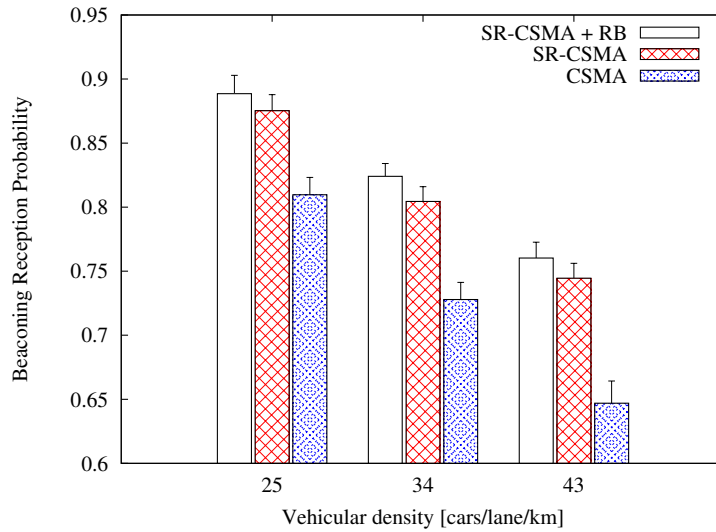

Figure 5.10: Beaconing reception probability in the safety range for different vehicular densities. 95% confidence intervals are also shown.

The beaconing reception probability inside the safety range for CSMA and SR-CSMA with and without the RB mechanism are presented in Figure 5.10, for several vehicular densities. From this figure, it can be noticed that SR-CSMA can achieve a significant gain over CSMA, a gain that can reach 10% in the most challenging scenario.

To better understand how SR-CSMA works, Figure 5.11 presents the distribution of the reasons that can lead to a lost safety message at different distances from the sender in the case of both CSMA and SR-CSMA. For example, at 20 meters from the sender, more than 90% of the messages lost using CSMA are the consequence of simultaneous transmissions with nodes located inside the carrier sense range, and less than 10% are due to collisions with hidden nodes. Two common characteristics can be identified for CSMA and SR-CSMA. First, because both approaches use a small contention window, there are no expired beacons. Second, both transmission techniques show a similar trend concerning the proportion of messages lost following a radio propagation error, which increases rapidly with the distance from the transmitted. However, as predicted by the model described in Chapter 4.3, for CSMA the losses inside the safety range are mostly a consequence of simultaneous transmissions with nodes from within the carrier sense range. SR-CSMA modifies this distribution, using forced

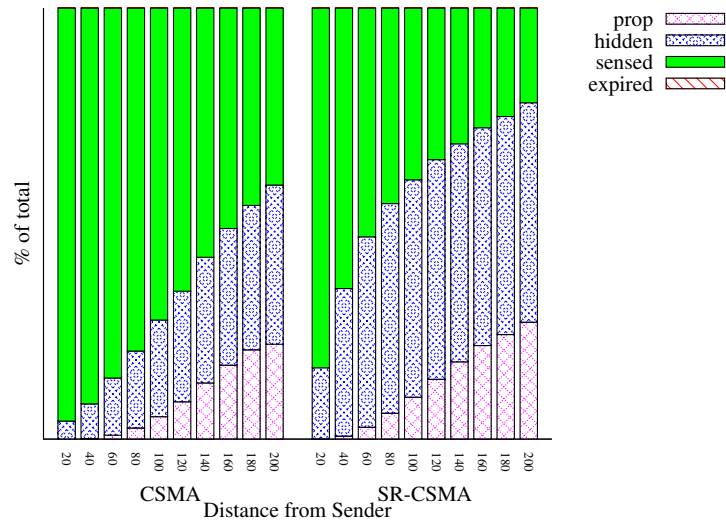

Figure 5.11: Distribution of the reasons for a lost message at different distances from the sender for CSMA and SR-CSMA.

collisions with distant nodes that can still be recovered inside the safety range because of the capture effect. These results confirm that the gain noticed in Figure 5.10 is achieved by reducing the collision probability with close neighbours.

An interesting observation is that SR-CSMA produces this effect by using the power control mechanism on only 5% of the transmitted messages. Figure 5.12 shows the distribution of the used power level (the rest of the messages are transmitted using $P_{max} = 40$ dB and they are not shown on the figure for visibility reasons). Because P_{min} is used when $T_{min} < P_{min}$ (see Section 5.3.2), almost 3% of all the beacons are sent using the minimum power level, while the distribution between the other power levels is uniform.

The next step is to analyse the effect of the reverse back-off mechanism on SR-CSMA. From Figure 5.10, it can be noticed that combining RB with SR-CSMA brings an even more significant improvement for the beaconing reception probability inside the safety range. However, the most important achievement of the new back-off mechanism can be seen in Figure 5.13, where the number of consecutive lost beacons between pairs of vehicles situated in the safety range of one another is depicted. The figure shows this number with respect to CSMA, and the results should be interpreted

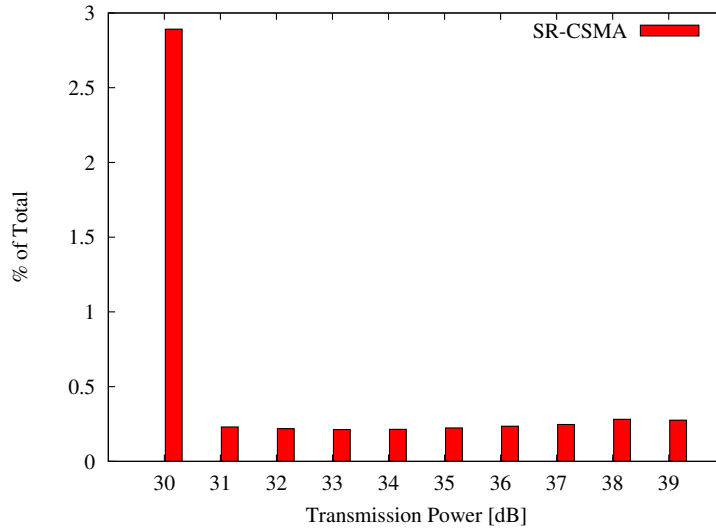

Figure 5.12: Probability mass function of the messages transmitted with a power level different from p_{max} .

as follows. When using SR-CSMA instead of CSMA, there are 9% more cases of vehicles missing less than 10 consecutive messages from a neighbour inside its safety range. However, SR-CSMA reduces with 27% the probability of having between 10 and 20 consecutive lost beacons and with 79% the cases when more than 20 messages are lost in a row. The addition of the RB mechanism further reduces the probability of having more than 10 consecutive losses (including the expired beacons that are not actually transmitted). This property is very important, because it alleviates the *ghost node* problem where two vehicles, although situated in the safety range of one another, remain invisible for a long time period.

Figure 5.14 shows the impact of the reverse back-off on the events that result in a lost message. It can be observed that, as expected, expired beacons appear when using RB and their importance is significant, especially for very close neighbours. The large initial contention window of the reverse back-off mechanism (127 in these simulations) manages to reduce even more the probability of colliding with a node inside the carrier sense range, and the hidden terminals become the main reason for the losses. It must be pointed out that, in these simulations, a hidden terminal is not necessarily situated outside the carrier sense zone, but it can also be the result of bad channel

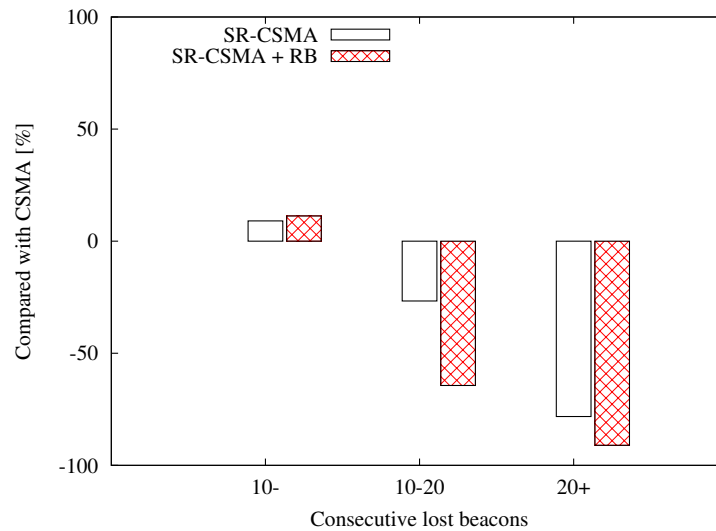

Figure 5.13: Number of consecutive lost beacons between pairs of vehicles situated in the safety range of one another. The results are presented as a relative gain/loss with respect to CSMA.

conditions, as modelled by the radio propagation module. When the channel conditions are so poor that the header detection function of the CCA fails, SR-CSMA can not avoid the collision, even if the node affected by fast fading is located closely.

5.3.6 Summary

This section presents SR-CSMA, a new channel access technique for vehicular networks, specially designed with the requirements of safety applications in mind. SR-CSMA modifies the physical carrier sensing mechanism in order to force collisions with distant nodes in congested networks. By introducing this controlled collision concept, the proposed method reduces the probability of a simultaneous transmission with a closely located station, and, taking advantage of the capture effect, manages to increase the beaconing reception probability in the immediate neighbourhood.

A reverse back-off approach and a transmission power control mechanism are also integrated with SR-CSMA, resulting in a complete MAC layer protocol specifically designed to function on the control channel of a future VANET. The concepts behind this congestion control framework

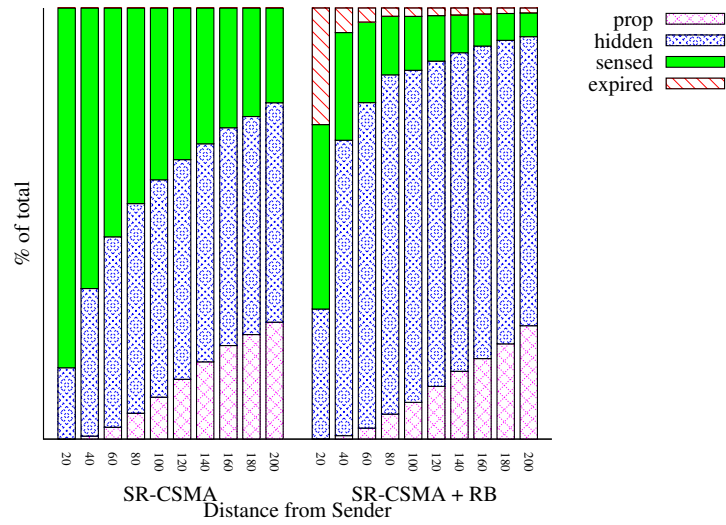

Figure 5.14: Distribution of the reasons for a lost message at different distances from the sender for SR-CSMA with and without the reverse back-off mechanism.

are supported by the analytical study of the carrier sense mechanism in a vehicular environment presented in Chapter 4.3, and their efficiency is confirmed by an extensive set of simulations showing a significant performance gain over classical CSMA.

6. Conclusion

6.1 Summary

Reducing the number of accidents, and improving the safety and comfort of drivers and passengers are one of the main objectives in future intelligent transportation systems. Wireless communications can help achieve these goals, allowing vehicles to exchange important safety information or to share data susceptible of interesting the passengers. This thesis addresses the reliability of vehicle-to-vehicle communication for safety purposes, especially under high density scenarios, when transmissions need to be carefully scheduled to keep a high awareness level among the surrounding vehicles.

This work is based on the assumption that IEEE 802.11p or a similar technology will be used for inter-vehicle communication, and that a high penetration ratio of the equipments will exist. In this context, the major challenges raised by vehicular safety communication are identified, using both simulations and analytical modelling. Different congestion control approaches are discussed, and two of them are selected for further investigation: the adaptation of the minimum contention window and the adjustment of the physical carrier sense threshold. The thesis is therefore focused on the impact of these two parameters on the performance of the MAC layer, by carefully taking into account all the special properties of the safety applications.

The analysis of the minimum contention window outlines an interesting trade-off that needs to be achieved between the number of collisions and the number of expired messages. The existing back-off solutions do not take into consideration this essential property, and, because of the broadcast nature of the safety-dedicated control channel, they have no activating mechanism and a constant contention window is used. This approach can not cope with increased node density and results in a high number of simultaneous transmissions. The reverse back-off mechanism proposed in this work is based on the original idea of using expired messages to compute the size of the contention window,

and manages to increase the level of awareness that vehicle poses concerning their neighbours.

The physical carrier sense mechanism is the core of any CSMA-based protocol. The results presented in this thesis challenge the current method of statically setting the carrier sense threshold at the lowest possible level (also known as *receiver sensitivity*). While this solution gives excellent results when trying to solve the hidden terminal problem, it also reduces the spatial reuse and forces a node to compete with more neighbours for channel access. A detailed analysis shows that the optimal threshold actually depends on the node density, a higher threshold being necessary in high density scenarios. Therefore, this thesis describes an adaptive mechanism for carrier sense control and evaluates its performance using realistic vehicular mobility. By increasing the number of transmission opportunities, this solution protects the safety-critical area around each vehicle. Despite the increased number of collisions with hidden nodes produced by the mechanism, a high reception ratio is obtained in the immediate neighbourhood as a result of the capture effect.

Furthermore, all the principles learned from the study of the contention window and the carrier sense were applied in the conception of a new CSMA-based channel access method, SR-CSMA. From the early design phases, SR-CSMA is built to improve the delivery ratio and the vehicular awareness in the safety zone. This objective is achieved by realising that collisions can not be avoided in high vehicular densities, and a control-focused approach should be preferred in these circumstances. Therefore, this access technique forces collisions with far neighbours, and highly reduces the simultaneous transmissions with vehicles situated in the safety zone. Combining transmission power control, carrier sense adaptation and a new back-off mechanism, SR-CSMA can be seen as a complete framework for congestion control in safety vehicular networks.

6.2 Future Work

The analysis and results presented in this thesis show an appreciable improvement in MAC layer performance can be obtained in safety-oriented vehicular networks using simple mechanisms. Once the impact of the different parameters is well understood, several future research directions open up.

First of all, it is clear that the 99% message reception ratio required by a number of safety applications is not feasible using IEEE 802.11p not even in the safety-critical zone. This will most probably remain true, regardless of the enhancements brought to the access method. In this case, the automotive manufacturers have two choices: they can propose only applications with achiev-

able requirements based on an evolution of IEEE 802.11p, or they can continue looking for more appropriate MAC layer solutions, with the risk of an increased hardware cost. This second choice can create the premises for the definition of new MAC protocols, but will also postpone the actual hardware introduction, and even jeopardise entirely the creation of a vehicular network.

This work is mainly focused on regular safety beaconing using CSMA-based techniques. However, the efficiency of special notifications, messages transmitted when an important event is detected, is also essential for the success of road safety applications. While the aggregation of such messages, or their multi-hop dissemination are interesting topics at higher layers, the MAC protocol must include mechanisms capable of assigning higher priority to this type of messages, but without neglecting the efforts of the congestion control framework.

Concerning the Cooperative Awareness Messages, the ideas evaluated in this thesis show promising results. However, in the ideal case, the losses inside the safety-critical area would be uniquely the result of propagation problems. A better coordination of the transmissions is still possible, and the complementarity of mechanisms focused on the optimisation of different parameters needs to be better understood.

Finally, another important point comes from the fact that this work makes the assumption that all the vehicles are equipped and able to communicate. This will most probably not be true in the first years, or even decades, after the initial decision to include radio hardware in new vehicles. An evaluation of the performance that can be achieved by a road safety system under different penetration ratios would bring important information in this case. However, this would also require the definition of new metrics and analytical models, as an accident could involve both equipped and non-equipped vehicles.

7. Annex

7.1 Simulated Environment

The analytical results presented in Chapter 4 are obtained under the assumption of a one-dimensional linear network. While this is reasonably close to a highway scenario, the mechanisms and protocols proposed in a vehicular context need to be efficient regardless of the road topology.

In order to test the solutions described in this thesis in conditions as close to reality as possible, three different maps were used in the tests. However, as discussed in Chapter 2.4, simulating an urban scenario is currently a major challenge in the VANET research community, because the radio propagation model heavily depends on the environment in this case. Therefore, the selected road topologies avoid this particular urban context, but still try to remain as general as possible.

Figure 7.1 shows one of the three maps used in the simulations. In Figure 7.1(a), a screen-shot of the JiST/SWANS graphical user interface is presented. It can be seen that the road topology is very far from a simple highway scenario, with numerous crossings and multiple possibilities for the path choice.

Several vehicles are also represented, in the format currently allowed by the simulator. However, it must be pointed out that the size of the vehicles is not adapted to the size of the map. This can be better noticed using Figure 7.1(b), the view of the same region (near Westville, Oklahoma), this time extracted from Google Maps. The figure shows that the map has a $10km \times 10km$ size, representing a mix of rural, highway and suburban areas. This leads to a total of almost 70 linear kilometres of road in the simulation. As already discussed, different vehicular densities have been used in this study, going up to 3000 simulated vehicles (equivalent to 43 vehicles/km).

The two other maps have similar dimensions, but they are issued from different United States regions, using the US Census Bureau's TIGER database.

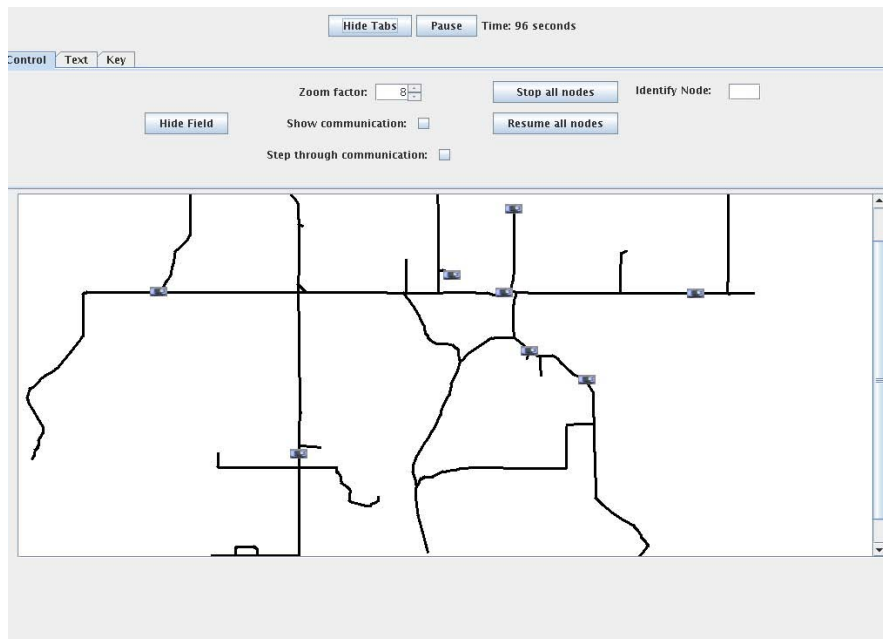

(a) Screenshot of the map in the JiST/SWANS graphical user interface

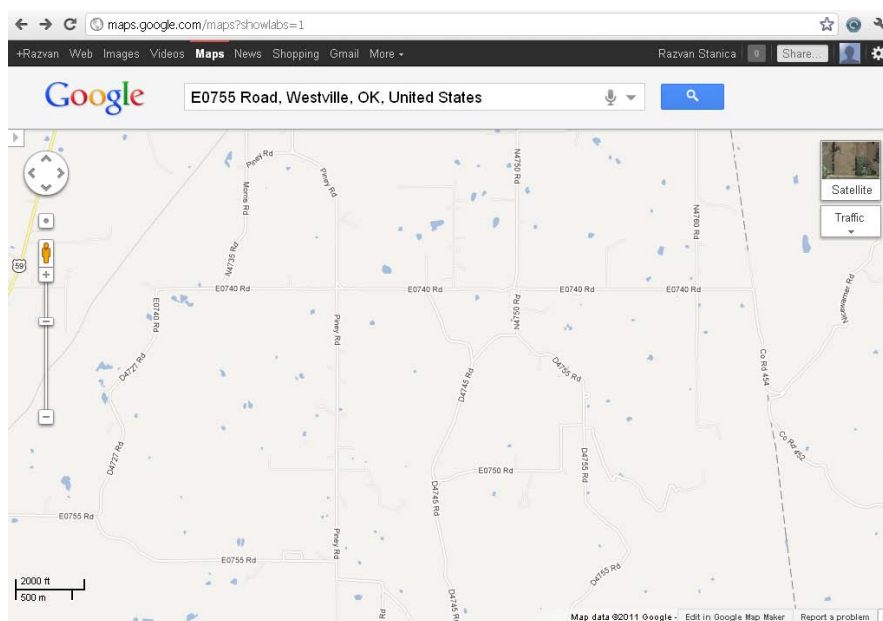

(b) View from Google Maps

Figure 7.1: Example of one of the maps used in the simulation study described in this thesis.

Bibliography

- [1609.1-06] The Institute of Electrical and Electronics Engineers *IEEE Trial-Use Standard for Wireless Access in Vehicular Environments (WAVE) - Resource Manager*, October 2006
- [1609.2-06] The Institute of Electrical and Electronics Engineers *IEEE Trial-Use Standard for Wireless Access in Vehicular Environments (WAVE) - Security Services for Applications and Management Messages*, July 2006
- [1609.3-10] The Institute of Electrical and Electronics Engineers *IEEE Standard for Wireless Access in Vehicular Environments (WAVE) - Networking Services*, September 2010
- [1609.4-10] The Institute of Electrical and Electronics Engineers *IEEE Standard for Wireless Access in Vehicular Environments (WAVE) - Multi-channel Operation*, September 2010
- [802.11-07] The Institute of Electrical and Electronics Engineers *IEEE Standard for Information Technology - Telecommunications and Information Exchange Between Systems - Local and Metropolitan Area Networks - Specific Requirements. Part 11: Wireless LAN Medium Access Control (MAC) and Physical Layer (PHY) Specifications*, June 2007
- [802.11-10] The Institute of Electrical and Electronics Engineers *IEEE Standard for Information Technology - Telecommunications and Information Exchange Between Systems - Local and Metropolitan Area Networks - Specific Requirements. Part 11: Wireless LAN Medium Access Control (MAC) and Physical Layer (PHY) Specifications - Amendment 6: Wireless Access in Vehicular Environments*, July 2010
- [APMD10] J. Alapati, B. Pandya, S. Merchant, U. Desai, *Back-off and Retransmission Strategies for Throughput Enhancement of Broadcast Transmissions in 802.11p*, Proceedings of the 21st IEEE Intelligent Vehicles Symposium (IV 2010), pp. 700-705, San Diego, June 2010

- [Art07] M. Artimy, *Local Density Estimation and Dynamic Transmission-Range Assignment in Vehicular Ad Hoc Networks*, IEEE Transactions on Intelligent Transportation Systems, vol. 8, no. 3, pp. 400-412, September 2007
- [ASTM03] American Society for Testing and Materials, *ASTM E2213-03 - Standard Specification for Telecommunications and Information Exchange Between Roadside and Vehicle Systems - 5 GHz Band Dedicated Short Range Communications (DSRC) Medium Access Control (MAC) and Physical Layer (PHY) Specifications*, September 2003
- [BCCF04] F. Borgonovo, A. Capone, M. Cesana, L. Fratta, *ADHOC MAC: New MAC Architecture for Ad Hoc Networks Providing Efficient and Reliable Point-to-Point and Broadcast Services*, Wireless Networks, vol. 10, no. 4, pp. 359-366, July 2004
- [BE07] J. Blum, A. Eskandarian, *A Reliable Link-Layer Protocol for Robust and Scalable Intervehicle Communications*, IEEE Transactions on Intelligent Transportation Systems, vol. 8, no. 1, pp. 4-13, March 2007
- [BFO96] G. Bianchi, L. Fratta, M. Oliveri, *Performance Evaluation and Enhancement of the CSMA/CA MAC Protocol for 802.11 Wireless LANs*, Proceedings of the 7th IEEE International Symposium on Personal, Indoor and Mobile Radio Communications (PIMRC 1996), pp. 392-396, Taipei, October 1996
- [BG06] N. Balon, J. Guo, *Increasing Broadcast Reliability in Vehicular Ad Hoc Networks*, Proceedings of the 3rd ACM International Workshop on Vehicular Ad Hoc Networks (VANET 2006), pp. 104-105, Los Angeles, September 2006
- [BHG10] M. Barradi, A. Hafid, J. Gallardo, *Establishing Strict Priorities in IEEE 802.11p WAVE Vehicular Networks*, Proceedings of the 53rd IEEE Global Telecommunications Conference (GLOBECOM 2010), pp. 1-6, Miami, December 2010
- [BM09] M. Brodsky, R. Morris, *In Defense of Wireless Carrier Sense*, Proceedings of the ACM SIGCOMM Conference on Data Communication (SIGCOMM 2009), pp. 147-158, Barcelona, August 2009
- [BSK10] F. Bai, D. Stancil, H. Krishnan, *Toward Understanding Characteristics of Dedicated Short Range Communications (DSRC) From a Perspective of Vehicular Network Engineers*, Proceed-

- ings of the 16th ACM Annual International Conference on Mobile Computing and Networking (MOBICOM 2010), pp. 329-340, Chicago, September 2010
- [BUSB09a] K. Bilstrup, E. Uhlemann, E. Strom, U. Bilstrup, *On IEEE 802.11p and STDMA and their Ability to Support Predictable Channel Access*, Proceedings of the 16th World Congress and Exhibition on Intelligent Transport Systems and Services (ITS 2009), pp. 1-10, Stockholm, September 2009
- [BUSB09] K. Bilstrup, E. Uhlemann, E. Strom, U. Bilstrup, *On the Ability of the 802.11p MAC Method and STDMA to Support Real-Time Vehicle-to-Vehicle Communication*, EURASIP Journal on Wireless Communications and Networking, vol. 2009, pp. 1-13, January 2009
- [BV01] S. Bana, P. Varaiya, *Space Division Multiple Access (SDMA) for Robust Ad hoc Vehicle Communication Networks*, Proceedings of the IEEE 4th International Conference on Intelligent Transportation Systems (ITSC 2001), pp. 962-967, Oakland, August 2001
- [CB05] D. Choffnes, F. Bustamante, *An Integrated Mobility and Traffic Model for Vehicular Wireless Networks*, Proceedings of the 2nd ACM International Workshop on Vehicular Ad Hoc Networks (VANET 2005), pp. 69-78, Cologne, September 2005
- [CCG00] F. Cali, M. Conti, E. Gregori, *Dynamic Tuning of the IEEE 802.11 Protocol to Achieve a Theoretical Throughput Limit*, IEEE/ACM Transactions on Networking, vol. 8, no. 6, pp. 785-799, December 2000
- [CJD09] Q. Chen, D. Jiang, L. Delgrossi, *IEEE 1609.4 DSRC Multi-Channel Operations and its Implications on Vehicle Safety Communications*, Proceedings of the 1st IEEE Vehicular Networking Conference (VNC 2009), pp. 1-8, Tokyo, October 2009
- [CK08] J. Camp, E. Knightly, *Modulation Rate Adaptation in Urban and Vehicular Environments: Cross-layer Implementation and Experimental Evaluation*, Proceedings of the 14th ACM Annual International Conference on Mobile Computing and Networking (MOBICOM 2008), pp. 315-326, San Francisco, September 2008
- [CL07] C. Chigan, J. Li, *A Delay-Bounded Dynamic Interactive Power Control Algorithm for VANETs*, Proceedings of the 42nd IEEE International Conference on Communications (ICC 2007), pp. 5849-5855, Glasgow, June 2007

- [CMSZ00] I. Chlamtac, A. Myers, V. Syrotiuk, G. Zaruba, *An Adaptive Medium Access Control (MAC) Protocol for Reliable Broadcast in Wireless Networks*, Proceedings of the 35th IEEE International Conference on Communications (ICC 2000), pp. 1692-1696, New Orleans, June 2000
- [CRM10] X. Chen, H. Refai, X. Ma, *On the Enhancements to IEEE 802.11 MAC and their Suitability for Safety-Critical Applications in VANET*, Wiley's Journal of Wireless Communications & Mobile Computing, vol. 10, no. 9, pp. 1253-1269, September 2010
- [CSC11] J. Cho, S. Shin, J. Copeland, *Fast Broadcast at the Intersection in VANET*, Proceedings of the 3rd IEEE Intelligent Vehicular Communications System Workshop (IVCS 2011), pp. 65-69, Las Vegas, January 2011
- [DRS06] D. Dhoutaut, A. Regis, F. Spies, *Impact of Radio propagation Models in Vehicular Ad Hoc Networks Simulations*, Proceedings of the 3rd ACM International Workshop on Vehicular Ad Hoc Networks (VANET 2006), pp. 40-49, Los Angeles, September 2006
- [ECR07] European Commission Report, *Road Accident Statistics in Europe*, 2007
- [EGHKp06] T. ElBatt, S. Goel, G. Holland, H. Krishnan, J. parikh, *Cooperative Collision Warning using Dedicated Short Range Wireless Communications*, Proceedings of the 3rd ACM International Workshop on Vehicular Ad Hoc Networks (VANET 2006), pp. 1-9, Los Angeles, September 2006
- [EOM07] A. Eryilmaz, A. Ozdaglar, E. Modiano, *Polynomial Complexity Algorithms for Full Utilization of Multi-Hop Wireless Networks*, Proceedings of the 26th IEEE Annual International Conference on Computer Communications (INFOCOM 2007), pp. 499-507, Anchorage, May 2007
- [ETSI10] The European Telecommunications Standards Institute, *ETSI ES 202 663 v1.1.0 - Intelligent Transport Systems (ITS) - European Profile Standard for the Physical and Medium Access Control Layer of Intelligent Transport Systems Operating in the 5 GHz Frequency Band*, January 2010

- [ETSI10a] The European Telecommunications Standards Institute, *ETSI TS 102 637-3 v1.1.1 - Intelligent Transport Systems (ITS) - Vehicular Communications - Basic Set of Applications - Part 3: Specifications of Decentralized Environmental Notification Basic Service*, September 2010
- [ETSI11] The European Telecommunications Standards Institute, *ETSI TS 102 637-2 v1.2.1 - Intelligent Transport Systems (ITS) - Vehicular Communications - Basic Set of Applications - Part 2: Specification of Cooperative Awareness Basic Service*, March 2011
- [ETSI11a] The European Telecommunications Standards Institute, *ETSI TS 102 687 v1.1.1 - Intelligent Transport Systems (ITS) - Decentralized Congestion Control Mechanisms for Intelligent Transport Systems Operating in the 5 GHz Range - Access Layer Part*, July 2011
- [FBVBK04] K. Fintzel, R. Bendahan, C. Vestri, S. Bougnoux, T. Kakinami, *3D Parking Assistant System*, Proceedings of the 15th IEEE Intelligent Vehicles Symposium (IV 2004), pp. 881-886, parma, June 2004
- [FCC06] US Federal Communications Commission, *Amendment of the Commission's Rules Regarding Dedicated Short-Range Communications Services in the 5.850-5.925 GHz (5.9 GHz Band)*, September 2006
- [FKO02] R. Fukui, H. Koike, H. Okada, *Dynamic Integrated Transmission Control (DITRAC) over Inter-Vehicle Communications in ITS*, Proceedings of the IEEE 55th Vehicular Technology Conference (VTC Spring 2002), pp. 483-487, Birmingham, May 2002
- [FLH10] L. Fu, S. Liew, J. Huang, *Effective Carrier Sensing in CSMA Networks under Cumulative Interference*, Proceedings of the 29th IEEE Annual International Conference on Computer Communications (INFOCOM 2010), pp. 1-9, San Diego, March 2010
- [FWC10] G. Feng, W. Wang, J. Cai, *Reliable Busy Tone Multiple Access protocol for Safety Applications in Vehicular Ad Hoc Networks*, Proceedings of the 45th IEEE International Conference on Communications (ICC 2010), pp. 1-5, Cape Town, May 2010
- [GSKB07] X. Guan, R. Sengupta, H. Krishnan, F. Bai, *A Feedback-Based Power Control Algorithm Design for VANET*, Proceedings of the 1st IEEE Workshop on Mobile Networks for Vehicular Environments (MOVE 2007), pp. 67-72, Anchorage, May 2007

- [HFSK10] C. Huang, Y. Fallah, R. Sengupta, H. Krishnan, *Adaptive Intervehicle Communication Control for Cooperative Safety Systems*, IEEE Network, vol. 24, no. 1, pp. 6-13, January 2010
- [HRGD05] M. Heusse, F. Rousseau, R. Guillier, A. Duda, *Idle Sense: An Optimal Access Method for High Throughput and Fairness in Rate Diverse Wireless LANs*, Proceedings of the ACM SIGCOMM Conference on Data Communication (SIGCOMM 2005), pp. 121-132, Philadelphia, August 2005
- [HVB01] G. Holland, N. Vaidya, P. Bahl, *A Rate-Adaptive MAC Protocol for Multi-Hop Wireless Networks*, Proceedings of the 7th Annual International Conference on Mobile Computing and Networking (MOBICOM 2001), pp. 236-251, Rome, July 2001
- [ISMH11] K. Ito, N. Suzuki, S. Makido, H. Hayashi, *Periodic Broadcast Timing Reservation Multiple Access for Inter-Vehicle Communication*, Journal of Information Processing, vol. 19, pp. 141-152, March 2011
- [ITP-11] iTetris Project: <http://www.ict-itetris.eu/>
- [JF10] H.-C. Jang, W.-C. Feng, *Network Status Detection-Based Dynamic Adaptation of Contention Window in IEEE 802.11p*, Proceedings of the IEEE 71st Vehicular Technology Conference (VTC Spring 2010), pp. 1-5, Taipei, May 2010
- [JIST-11] Java in Simulation Time Framework (JiST) - The Scalable Wireless Ad hoc Network Simulator (SWANS): <http://jist.ece.cornell.edu/>
- [JL08] L.B. Jiang, S.C. Liew, *Improving Throughput and Fairness by Reducing Exposed and Hidden Nodes in 802.11 Networks*, IEEE Transactions on Mobile Computing, vol. 7, no. 1, pp. 34-49, January 2008
- [Jur91] R. Jurgen, *Smart Cars and Highways Go Global*, IEEE Spectrum, vol. 28, no. 5, pp. 26-36, May 1991
- [JW10] L. Jiang, J. Walrand, *A Distributed CSMA Algorithm for Throughput and Utility Maximization in Wireless Networks*, IEEE/ACM Transactions on Networking, vol. 18, no. 3, pp. 960-972, June 2010

- [Ken11] J. Kenney, *Dedicated Short-Range Communications (DSRC) Standards in the United States*, Proceedings of the IEEE, vol. 99, no. 7, pp. 1162-1182, July 2011
- [Kje98] R. Kjellberg, *Capacity and Throughput using a Self Organized Time Division Multiple Access VHF Data Link in Surveillance Applications*, Master Thesis, The Royal Institute of Technology, Stockholm, Sweden, 1998
- [KKS05] M.-S. Kim, D.-H. Kwon, Y.-J. Suh, *Adaptive Window Mechanism for the IEEE 802.11 MAC in Wireless Ad Hoc Networks*, Proceedings of the 19th International Conference on Information Networking (ICOIN 2005), pp. 31-40, Jeju, February 2005
- [KLH08] T.-S. Kim, H. Lim, J. Hou, *Understanding and Improving the Spatial Reuse in Multihop Wireless Networks*, IEEE Transactions on Mobile Computing, vol. 7, no. 10, pp. 1200-1212, October 2008
- [KNSV11] T. Kim, J. Ni, R. Srikant, N. Vaidya, *On the Achievable Throughput of CSMA under Imperfect Carrier Sensing*, Proceedings of the 30th IEEE Annual International Conference on Computer Communications (INFOCOM 2011), pp. 1674-1682, Shanghai, April 2011
- [KRM07] W. Kiess, J. Rybicki, M. Mauve, *On the Nature of Inter-Vehicle Communication*, Proceedings of the 4th Workshop on Mobile Ad-Hoc Networks (WMAN 2007), pp. 493-502, Bern, March 2007
- [KSHRVAB07] M. Killat, F. Schmidt-Eisenlohr, H. Hartenstein, C. Rossel, P. Vortisch, S. Assenmacher, F. Busch, *Enabling Efficient and Accurate Large-Scale Simulations of VANETs for Vehicular Traffic Management*, Proceedings of the 4th ACM International Workshop on Vehicular Ad Hoc Networks (VANET07), pp. 29-38, Montreal, September 2007
- [LR05] E. Lieberman, A. Rathi, *Traffic Simulation*, United States Transportation Research Board Revised Monograph on Traffic Flow Theory, Chapter 10, pp. 1-23, 2005
- [LWWLL09] N. Lu, X. Wang, P. Wang, P. Lai, F. Liu, *A Distributed Reliable Multi-channel MAC Protocol for Vehicular Ad Hoc Networks*, Proceedings of the 20th IEEE Intelligent Vehicles Symposium (IV 2009), pp. 1078-1082, Xian, June 2009

- [MCR07] X. Ma, X. Chen, H. Refai, *Unsaturated Performance of IEEE 802.11 Broadcast Service in Vehicle-to-Vehicle Networks*, Proceedings of the 66th IEEE Vehicular Technology Conference (VTC Fall 2007), pp. 1957-1961, Baltimore, October 2007
- [MKK01] M. Marina, G. Kondylis, U. Kozat, *RBRP: A Robust Broadcast Reservation Protocol for Mobile Ad Hoc Networks*, Proceedings of the 36th IEEE International Conference on Communications (ICC 2001), pp. 878-885, Helsinki, June 2001
- [MSKHH08] J. Mittag, F. Schmidt-Eisenlohr, M. Killat, J. Haerri, H. Hartenstein, *Analysis and Design of Effective and Low-Overhead Transmission Power Control for VANETs*, Proceedings of the 5th ACM International Workshop on Vehicular Inter-Networking (VANET 2008), pp. 39-48, San Francisco, September 2008
- [MSZ06] E. Modiano, D. Shah, G. Zussman, *Maximizing Throughput in Wireless Networks via Gossiping*, Proceedings of the ACM Joint International Conference on Measurement and Modeling of Computer Systems (SIGMETRICS 2006), pp. 27-38, Saint Malo, June 2006
- [MT06] K. Medepalli, F. Tobagi, *Towards Performance Modeling of IEEE 802.11 based Wireless Networks: A Unified Framework and its Applications*, Proceedings of the 25th IEEE Annual International Conference on Computer Communications (INFOCOM 2006), pp. 1-12, Barcelona, April 2006
- [MWM08] Y. Mertens, M. Wellens, P. Mahonen, *Simulation-based Performance Evaluation of Enhanced Broadcast Schemes for IEEE 802.11-based Vehicular Networks*, Proceedings of the IEEE 67th Vehicular Technology Conference (VTC Spring 2008), pp. 3042-3046, Singapore, May 2008
- [MWRMB06] R. Mangharam, D. Weller, R. Rajkumar, P. Mudalige, F. Bai, *GrooveNet: A Hybrid Simulator for Vehicle-to-Vehicle Networks* Proceedings of the 2nd International Workshop on Vehicle-to-Vehicle Communications (V2VCOM 2006), pp. 1-8, San Jose, July 2006
- [MXK10] A. Minino, J. Xu, K. Kochanek, *Deaths: preliminary Data for 2008*, U.S. National Vital Statistics Report, vol. 59, no. 2, December 2010
- [NBG06] V. Naumov, R. Baumann, T. Gross, *An Evaluation of Inter-Vehicle Ad Hoc Networks Based on Realistic Vehicular Traces*, Proceedings of the 7th ACM International Symposium on Mobile Ad Hoc Networking and Computing (MobiHoc 2006), pp. 108-119, Florence, May 2006

- [NLLYCKC11] B. Nardelli, J. Lee, K. Lee, Y. Yi, S. Chong, E. Knightly, M. Chiang, *Experimental Evaluation of Optimal CSMA*, Proceedings of the 30th IEEE Annual International Conference on Computer Communications (INFOCOM 2011), pp. 1188-1196, Shanghai, April 2011
- [NS2-11] The Network Simulator - ns-2 <http://www.isi.edu/nsnam/ns/>
- [NS3-11] The Network Simulator - ns-3: <http://www.nsnam.org/>
- [NT09] T. Nagaosa, N. Takahashi, *Performance Evaluation of a Media Access Control Scheme using Vehicle Position Information for an Inter-Vehicle Communication System*, Proceedings of the 9th International Conference on ITS Telecommunications (ITST 2009), pp. 516-519, Lille, October 2009
- [PBHSFRMKKH08] P. Papadimitratos, L. Buttyan, T. Holczer, E. Schoch, J. Freudiger, M. Raya, Z. Ma, F. Kargl, A. Kung, J.-P. Hubaux, *Secure Vehicular Communication Systems: Design and Architecture* IEEE Communications Magazine, vol. 46, no. 11, pp. 100-109, November 2008
- [PC07] J. Peng, L. Cheng, *A Distributed MAC Scheme for Emergency Message Dissemination in Vehicular Ad Hoc Networks*, IEEE Transactions on Vehicular Technology, vol. 56, no. 6, pp. 3300-3308, November 2007
- [PDOO02] A. Pal, A. Dogan, F. Ozguner, U. Ozguner, *A MAC Layer Protocol for Real-Time Inter-Vehicle Communication*, Proceedings of the IEEE 5th International Conference on Intelligent Transportation Systems (ITSC 2002), pp. 353-358, Singapore, September 2002
- [PRE08] PREparation for DRIVING implementation and Evaluation of C-2-X communication technology, *Detailed description of selected use-cases and corresponding technical requirements*, pre-Drive C2X Deliverable D4.1, September 2008
- [RCCBLK07] C. Robinson, D. Caveney, L. Caminiti, G. Baliga, K. Laberteaux, P. Kumar, *Efficient Message Composition and Coding for Cooperative Vehicular Safety Applications*, IEEE Transactions on Vehicular Technology, vol. 56, no. 6, pp. 3244-3255, November 2007
- [RMASB08] S. Rayanchu, A. Mishra, D. Agrawal, S. Saha, S. Banerjee, *Diagnosing Wireless Packet Losses in 802.11: Separating Collision from Weak Signal*, Proceedings of the 27th IEEE Annual International Conference on Computer Communications (INFOCOM 2008), pp. 735-743, phoenix, April 2008

- [RLS08] C. Rico Garcia, A. Lehner, T. Strang, *COMB: Cell based Orientation aware MANET Broadcast MAC Layer*, Proceedings of the IEEE 51st Global Telecommunications Conference (GLOBECOM 2008), pp. 1-5, New Orleans, December 2008
- [RR05] M. Ruffini, H.-J. Reumerman, *Power-Rate Adaptation in High-Mobility Distributed Ad-Hoc Wireless Networks*, Proceedings of the IEEE 61st Vehicular Technology Conference (VTC Spring 2005), pp. 2299-2303, Stockholm, May 2005
- [RSK07] S. Rezaei, R. Sengupta, H. Krishnan, *Reducing the Communication Required by DSRC-based Vehicle Safety Systems*, Proceedings of the IEEE 10th International Conference on Intelligent Transportation Systems (ITSC 2007), pp. 361-366, Seattle, October 2007
- [RV06] T. Razafindralambo, F. Valois, *Performance Evaluation of Backoff Algorithms in 802.11 Ad-Hoc Networks*, Proceedings of the 3rd ACM International Workshop on Performance Evaluation of Wireless Ad Hoc, Sensor and Ubiquitous Networks (PE-WASUN 2006), pp. 82-89, Malaga, October 2006
- [RWC11] B. Roman, I. Wassell, I. Chatzigeorgiou, *Scalable Cross-Layer Wireless Access Control using Multi-Carrier Burst Contention*, IEEE Journal on Selected Areas in Communications, vol. 29, no. 1, pp. 113-128, January 2011
- [RYPWO] D. Rawat, G. Yan, D. Popescu, M. Weigle, S. Olariu, *Dynamic Adaptation of Joint Transmission Power and Contention Window in VANET*, Proceedings of the IEEE 70th Vehicular Technology Conference (VTC Fall 2009), pp. 1-5, Anchorage, September 2009
- [SBHMRRV10] H. Stubing, M. Bechler, D. Heussner, T. May, I. Radusch, H. Rechner, P. Vogel, *simTD: A Car-to-X System Architecture for Field Operational Tests*, IEEE Communications Magazine, vol. 48, no. 5, pp. 148-154, May 2010
- [SHG09] R. Shirani, F. Hendessi, A. Gulliver *Store-Carry-Forward Message Dissemination in Vehicular Ad-Hoc Networks with Local Density Estimation* Proceedings of the 70th IEEE Vehicular Technology Conference (VTC Fall 2009), pp. 1-6, Anchorage, September 2009
- [SLBS10] R. Schmidt, T. Leinmuller, B. Boddeker, G. Schafer, *Adapting the Wireless Carrier Sensing for VANETs*, Proceedings of the 7th International Workshop on Intelligent Transportation (WIT 2010), pp. 1-6, Hamburg, March 2010

- [SLSKS10] R. Schmidt, T. Leinmuller, E. Schoch, F. Kargl, G. Schafer, *Exploration of Adaptive Beaconing for Efficient Intervehicle Safety Communication*, IEEE Network, vol. 24, no. 1, pp. 14-19, January 2010
- [SUMO-11] Simulation of Urban MObility (SUMO): <http://sumo.sourceforge.net>
- [STD11] C. Sommer, O. Tonguz, F. Dressler, *Traffic Information Systems: Efficient Message Dissemination via Adaptive Beaconing*, IEEE Communications Magazine, vol. 49, no. 5, pp. 173-179, May 2011
- [SYK10] H. Seo, S. Yun, H. Kim, *Solving the Coupon Collector's Problem for the Safety Beaconing in the IEEE 802.11p WAVE*, Proceedings of the IEEE 72nd Vehicular Technology Conference (VTC Fall 2010), pp. 1-6, Ottawa, September 2010
- [TIISI08] Y. Tadokoro, K. Ito, J. Imai, N. Suzuki, N. Itoh, *A Performance Evaluation of Safe Driving Support Systems using the Autonomous Decentralized TDMA Protocol*, Proceedings of the 15th World Congress on Intelligent Transportation Systems (ITSWC 2008), pp. 1-12, New York, November 2008
- [TMSH09] M. Torrent-Moreno, J. Mittag, P. Santi, H. Hartenstein, *Vehicle-to-Vehicle Communication: Fair Transmit Power Control for Safety-Critical Information*, IEEE Transactions on Vehicular Technology, vol. 58, no. 7, pp. 3684-3703, September 2009
- [UA09] R. Uzcategui, G. Acosta-Marum, *Wave: A Tutorial*, IEEE Communications Magazine, vol. 47, no. 5, pp. 126-133, May 2009
- [VE03] A. Vahidi, A. Eskandarian, *Research Advances in Intelligent Collision Avoidance and Adaptive Cruise Control*, IEEE Transactions on Intelligent Transportation Systems, vol. 4, no. 3, pp. 143-153, September 2003
- [VVK08] A. Vinel, V. Vishnevsky, Y. Koucheryavy, *A Simple Analytical Model for the Periodic Broadcasting in Vehicular Ad-Hoc Networks*, Proceedings of the IEEE 4th Broadband Wireless Access Workshop (BWA 2008), pp. 1-5, New Orleans, December 2008
- [WAKP08] Y. Wang, A. Ahmed, B. Krishnamachari, K. Psounis, *IEEE 802.11p Performance Evaluation and Protocol Enhancement*, Proceedings of the 4th IEEE International Conference on Vehicular Electronics and Safety (ICVES 2008), pp. 317-322, Columbus, September 2008

- [WH98] A. Widodo, T. Hasegawa, *A New Inter-Vehicle Communication System for Intelligent Transport Systems and an Autonomous Traffic Flow Simulator*, Proceedings of the IEEE 5th International Symposium on Spread Spectrum Techniques and Applications (ISSSTA 1998), pp. 82-86, Sun City, September 1998
- [WLL04] C. Wang, B. Li, L. Li, *A New Collision Resolution Mechanism to Enhance the Performance of IEEE 802.11 DCF*, IEEE Transactions on Vehicular Technology, vol. 53, no. 4, pp. 1235-1246, July 2004
- [WLW09] E. Weingartner, H. von Lehn, K. Wehrle, *A Performance Comparison of Recent Network Simulators*, Proceedings of the 44th IEEE International Conference on Communications (ICC 2009), pp. 1-5, Dresden, May 2009
- [WYLB06] S. Wong, H. Yang, S. Lu, V. Bharghavan, *Robust Rate Adaptation for 802.11 Wireless Networks*, Proceedings of the 12th Annual International Conference on Mobile Computing and Networking (MOBICOM 2006), pp. 146-157, Los Angeles, September 2006
- [YB07] F. Yu, S. Biswas, *Self-Configuring TDMA Protocols for Enhancing Vehicle Safety With DSRC based Vehicle-to-Vehicle Communications*, IEEE Journal on Selected Areas in Communications, vol. 25, no. 8, pp. 1526-1537, October 2007
- [YHK07] Y. Yang, J. Hou, L. Kung, *Modeling the Effect of Transmit Power and Physical Carrier Sense in Multi-Hop Wireless Networks*, Proceedings of the IEEE 26th Annual International Conference on Computer Communications (INFOCOM 2007), pp. 2331-2335, Anchorage, May 2007
- [YK11] Y. Yoon, H. Kim, *Resolving Distributed Power Control Anomaly in IEEE 802.11p WAVE*, IEICE Transactions on Communications, vol. E94-B, no. 1, pp. 290-290, January 2011
- [YMSOSMO09] H. Yomo, M. Miyamoto, O. Shagdar, T. Ohyama, M. Shirazi, R. Miura, S. Obana, *Supporting Safety Driving with Inter-Vehicle CDMA Networks under Realistic Accident Scenarios*, Proceedings of the 2nd IEEE Vehicular Networks and Applications Workshop (Vehi-Mob 2009), pp. 1-5, Dresden, June 2009

- [YV05] X. Yang, N. Vaidya, *On Physical Carrier Sensing in Wireless Ad Hoc Networks*, Proceedings of the 24th IEEE Annual International Conference on Computer Communications (INFOCOM 2005), pp. 2525-2535, Miami, March 2005
- [ZC98] C. Zhu, S. Corson, *A Five-Phase Reservation Protocol (FPRP) for Mobile Ad Hoc Networks*, Proceedings of the 17th IEEE Annual International Conference on Computer Communications (INFOCOM 1998), pp. 322-331, San Francisco, April 1998
- [ZGYC04] J. Zhu, X. Guo, L. Yang, S. Conner, *Leveraging Spatial Reuse in 802.11 Mesh Networks with Enhanced Physical Carrier Sensing*, Proceedings of the 39th IEEE International Conference on Communications (ICC 2004), pp. 4004-4011, Paris, June 2004
- [ZSWRB07] Y. Zang, L. Stibor, B. Walke, H. Reumerman, A. Barroso, *A Novel MAC Protocol for Throughput Sensitive Applications in Vehicular Environments*, Proceedings of the IEEE 65th Vehicular Technology Conference (VTC Spring 2007), pp. 2580-2584, Dublin, April 2007

Publication List

International Journal Articles

- R. Stanica, E. Chaput, A.-L. Beylot, *Simulation of Vehicular Ad-Hoc Networks: Challenges, Review of Tools and Recommendations*, Elsevier Journal of Computer Networks, vol. 55, no. 14, pp. 3179-3188, October 2011

International Conference Articles

- R. Stanica, E. Chaput, A.-L. Beylot, *Physical Carrier Sensing in Vehicular Ad-Hoc Networks*, IEEE International Conference on Mobile Ad-hoc and Sensor Systems (MASS 2011), Valencia, October 2011
- R. Stanica, E. Chaput, A.-L. Beylot, *Local Density Estimation for Contention Window Adaptation in Vehicular Networks*, IEEE International Symposium on Personal, Indoor and Mobile Radio Communications (PIMRC 2011), Toronto, September 2011
- R. Stanica, E. Chaput, A.-L. Beylot, *Why VANET Beaconing is More than Simple Broadcast*, IEEE Vehicular Technology Conference (VTC Fall 2011), San Francisco, September 2011
- R. Stanica, E. Chaput, A.-L. Beylot, *Enhancements of IEEE 802.11p Protocol for Access Control on a VANET Control Channel*, IEEE International Conference on Communications (ICC 2011), Kyoto, June 2011
- R. Stanica, E. Chaput, A.-L. Beylot, *Broadcast Communication in Vehicular Ad-Hoc Network Safety Applications*, IEEE Consumer Communications and Networking Conference (CCNC 2011), Las Vegas, January 2011

-
- R. Stanica, E. Chaput, A.-L. Beylot, *Comparison of CSMA and TDMA for a Heartbeat VANET Application*, IEEE International Conference on Communications (ICC 2010), Cape Town, May 2010

National Workshop Articles

- R. Stanica, E. Chaput, A.-L. Beylot, *Minimum Contention Window Adaptation for VANET Control Channel*, Pôle ResCom Vehicular Networks Day, Lyon, November 2010
- R. Stanica, E. Chaput, A.-L. Beylot, *Evaluation of Channel Access Techniques in Vehicular Ad-Hoc Networks*, Pôle ResCom Summer School, Giens, June 2010