



**HAL**  
open science

# Real Structures of Phase Tropical Surfaces

Antoine Toussaint

► **To cite this version:**

Antoine Toussaint. Real Structures of Phase Tropical Surfaces. Algebraic Geometry [math.AG]. Sorbonne Université, 2023. English. NNT : 2023SORUS246 . tel-04247853

**HAL Id: tel-04247853**

**<https://theses.hal.science/tel-04247853>**

Submitted on 18 Oct 2023

**HAL** is a multi-disciplinary open access archive for the deposit and dissemination of scientific research documents, whether they are published or not. The documents may come from teaching and research institutions in France or abroad, or from public or private research centers.

L'archive ouverte pluridisciplinaire **HAL**, est destinée au dépôt et à la diffusion de documents scientifiques de niveau recherche, publiés ou non, émanant des établissements d'enseignement et de recherche français ou étrangers, des laboratoires publics ou privés.



École Doctorale Sciences Mathématiques de Paris Centre

# THÈSE DE DOCTORAT

Discipline : Mathématiques

présentée par

**Antoine TOUSSAINT**

---

## Real Structures of Phase Tropical Surfaces

---

dirigée par Ilia ITENBERG

Soutenue le 29 septembre 2023 devant le jury composé de :

Antoine DUCROS	Sorbonne Université	examineur
Ilia ITENBERG	Sorbonne Université	directeur
Hannah MARKWIG	Universität Tübingen	examineur
Diego MATESSI	Università degli studi di Milano	rapporteur
Patrick POPESCU-PAMPU	Université de Lille	président du jury
Dhruv RANGANATHAN	University of Cambridge	rapporteur
Kris SHAW	Universitetet i Oslo	examineur

Institut de mathématiques de Jussieu-  
Paris Rive gauche. UMR 7586.  
Boîte courrier 247  
4 place Jussieu  
75 252 Paris Cedex 05

Sorbonne Université.  
École doctorale de sciences  
mathématiques de Paris centre.  
Boîte courrier 290  
4 place Jussieu  
75 252 Paris Cedex 05

## Remerciements

J'ai eu l'honneur et le plaisir de travailler ces trois dernières années sous la direction d'Ilia Itenberg. J'ai énormément appris auprès de lui et je ne peux que le remercier de m'avoir fait découvrir des mathématiques qui m'ont tant intéressées, de sa bienveillance et de sa patience à toute épreuve à mon égard, de toutes les idées qu'il m'a suggérées, mais aussi de l'intérêt qu'il a porté aux miennes.

Grâce à Ilia, j'ai également pu découvrir la communauté mathématique autour de la géométrie tropicale et de la géométrie algébrique réelle. J'ai pu y rencontrer des personnes sympathiques, bienveillantes et intéressantes. Je dois notamment un immense merci à Kris Shaw pour les discussions enrichissantes que nous avons pu avoir, qui m'ont beaucoup inspiré et qui ont ouvert la voie à de nombreux résultats de ma thèse. J'aimerais par ailleurs citer ici, dans une liste loin d'être exhaustive, quelques personnes de cette communauté dont j'ai apprécié à divers titres la discussion et les idées mathématiques ou personnelles : Thomas Blomme, Benoit Bertrand, Erwan Brugallé, Arthur Renaudinau, Omid Amini, Johannes Rau, Anh Nguyen, Jules Chenal, Aloïs Demory, Samuel Dentan et Edvard Aksnes.

Je remercie les rapporteurs Diego Matessi et Dhruv Ranganathan de leur intérêt pour mon travail. Merci aussi aux autres membres du jury : Antoine Ducros, Hannah Marwig, Patrick-Popescu-Pampu, et Kris Shaw.

Une bonne ambiance de travail est essentielle pour un travail de qualité et je remercie donc les doctorants de l'IMJ, et particulièrement ceux du couloir 15-16, 5<sup>e</sup> étage, dont je me rappellerai comme des gens sympathiques, ouverts à la discussion et toujours prêts à parler de maths ou d'autres sujets. Merci à Germain de son aide à propos de la combinatoire des polytopes et des démarches administratives. Merci à Pietro d'avoir ramené un échiquier, à Maxime d'avoir ramené un goban. Merci à Sebastian d'avoir partagé mon bureau et mes incertitudes lors d'une première année encore sous le signe de la pandémie. Merci à ceux qui ont partagé mon bureau depuis : Adrien, Gaétan et Jiasheng. Merci aussi à Thomas G. avec qui j'ai aimé partager sur des sujets divers et à Adam pour l'invitation à Strasbourg et le partage de passions communes. J'aimerais également citer dans une liste non exhaustive, ceux qui font, ou ont fait vivre ce couloir par leur présence et leur investissement : Raphaël, Jacques, Perla, Thomas L., Mathieu, Eva, Camille, Arnaud, Nelson, Chenyu et Lucas. Merci à Francesco, Matija et bien sûr Clément pour les groupes de travail sur l'homologie de Morse et les courbes pseudo-holomorphes. Enfin, je souhaite remercier l'ensemble des personnels administratifs de l'IMJ-PRG qui nous permettent de pouvoir nous consacrer à notre passion dans une relative sérénité.

Ma passion des maths n'aurait pas pu naître et se développer sans des professeurs charismatiques, et sachant transmettre cette passion avec enthousiasme. Je remercie donc ceux qui m'ont successivement amené à me diriger vers les mathématiques : Valérie Rajot, Nicolas Hubert et Pierre Guérini.

Avant les maths, les échecs sont ma première passion. Ceux qui en sont à l'origine sont les membres du club d'échecs des Tours de Chabannes. J'ai toujours été accueilli dans une ambiance conviviale et rafraîchissante tout au long des (presque) 20 dernières années et durant ces trois dernières années, le club et ses membres ont été un des repères sur lequel je pouvais me reposer. En particulier, je remercie Haïk, Sylvain, Jean-Claude, Denis et Roda.

Je remercie mes colocos Samy et Valentin avec qui j'ai eu le plaisir de partager ces trois dernières années et qui m'ont beaucoup apporté tant sur le plan personnel que scientifique. J'aimerais aussi remercier des amis que j'apprécie et avec qui je prends toujours beaucoup de plaisir à refaire le monde : Hugo, Caroline, Ridha et Anthony.

Merci à ma famille de m'avoir soutenu et encouragé. Être libre de ses choix de vie est une chance. En particulier, je remercie mes parents sur qui je sais que je pourrai toujours compter.

Enfin, merci à Précieux pour son affection et son soutien qui m'ont tant aidé lors de mes passages à vide. J'ai été heureux de partager tous ces moments privilégiés avec toi et j'espère bien en passer encore beaucoup d'autres à l'avenir.

## Introduction

Real algebraic varieties are complex algebraic varieties endowed with an anti-holomorphic involution. The early study of the topological properties of this involution dates back at least to A. Harnack and F. Klein in 1876 [12, 22] and is now better known as "topology of real algebraic varieties". D. Hilbert formulated one of the main questions of this topic in the 16<sup>th</sup> of his famous 23 problems in 1900. Tropical geometry is a way more recent subject and studies piecewise affine objects called tropical varieties. One of the principal ideas of tropical geometry is that these tropical varieties encode combinatorially certain important data of classical algebraic varieties. In fact, some interesting geometric and topological properties of algebraic varieties can be described on their tropical analogs.

There are two complementary approaches to the study of topology of real algebraic varieties: finding topological restrictions and constructing examples with prescribed topological properties. Introduced in the late 1970's, Viro's patchworking method [38] has established itself as the preeminent approach for constructing real algebraic varieties with prescribed topology. O. Viro notably applied his method to complete the classification of topological types in the real projective plane, realizable by non-singular real curves of degree 7. Viro's method is intimately connected to tropical geometry. In particular, the simplest case of this method, called "primitive combinatorial patchworking", is based on combinatorial data that are partially dual to a *non-singular* tropical variety. The primitive case of combinatorial patchworking is very restrictive in terms of topology of real algebraic varieties [14, 6, 34], however, this method has the advantage of being much easier to manipulate than the general case, while already producing some interesting examples. Therefore, in order to study a topological property of real algebraic varieties, a first attempt is to try to understand what happens in the case of real algebraic varieties obtained by primitive combinatorial patchworking. This is the approach adopted in this text.

The property we want to study is the type of real algebraic surfaces, together with the associated complex orientations, as introduced by O. Viro in the 1980's [39]. The notion of type (*I* or *II*) for real algebraic curves dates back to F. Klein [22]. The type of a real algebraic surface is a generalization of this notion. A real algebraic curve of type *I* admits so-called *complex orientations* on its real locus, which give rise to additional restrictions, when the curve is embedded in a real algebraic surface. For instance, Rokhlin's complex orientations formula provides a topological restriction for the non-singular real curves of type *I* in the real projective plane. More recently, S. Orevkov found algebraically unrealizable complex orientations on real plane pseudo-holomorphic curves of type *I* [31]. Returning to patchworking and tropical geometry, the real structures arising from a primitive combinatorial patchworking were described by B. Haas in his Ph.D. thesis [11], more than twenty-five years ago. This description is given in terms of *twisted edges* on a non-singular tropical curve and provides a very simple combinatorial criterion for the curves of type *I*. More importantly, B. Haas found a combinatorial criterion for the *M-curves*, that is, maximal curves in the sense of the Harnack inequality. An interesting approach to Haas's theorem has been proposed more recently by B. Bertrand, E. Brugallé and A. Renaudineau in [7]. This new point of view emphasizes that the results are not specific to an embedding in the projective plane or any other toric surface, but rather rely on the decomposition into pairs-of-pants of the curve. The combinatorics of this decomposition is encoded by a non-singular tropical curve. Their approach depends decisively on the lifting of tropical cycles in the tropical curve, to homology classes of the curve decomposed into pairs-of-pants. The

authors notably mention that they hope that this new point of view is easier to generalize to higher dimensions than B. Haas's original approach. This is exactly what is done in this thesis.

The results of this text are proven in the context of phase tropical surfaces  $(S_X, X)$ , playing the role of real algebraic surfaces obtained by primitive combinatorial patchworking, forgetting about the embedding in a toric variety of dimension 3. The tropical surface  $X$  is assumed to be *hypersmooth* and have a *polyhedral combinatorial stratification*. Briefly, a phase tropical surface  $(S_X, X)$  is then defined as a topological manifold admitting a decomposition into higher-dimensional pairs-of-pants and the combinatorics of the gluings is encoded by the tropical surface  $X$ . The main results of the text are as follows. First, we exhibit local restrictions for real structures of phase tropical surfaces (Propositions 3.9, 3.10 and 3.11). We then describe a particular class of real structures of a phase tropical surface and show that, up to certain isomorphisms, they form a  $\mathbb{Z}_2$ -affine space, whose direction is the first tropical cohomology group of the wave space  $H_{cell}^1(X; W_{\mathbb{Z}})$ , quotiented by the even elements (Theorem 3.3). By lifting tropical cycles, we construct morphisms from the tropical homology groups of the tropical surface  $X$  to the homology of  $S_X$ . We show that the successive images of these morphisms induce a filtration of the homology of  $S_X$  with  $\mathbb{Z}_2$ -coefficients (Equation 4.2). Using the above results on real structures of a phase tropical surface  $(S_X, X)$  and the lifting of tropical cycles, we formulate a necessary criterion for the maximality of the surface  $S_X$ , endowed with a real structure (Corollary 5.2). This criterion is formulated in tropical terms as the vanishing of a certain tropical homology class and is local, in the sense that a representative of this homology class has support contained in a single topological surface embedded in the tropical surface. We also formulate a necessary and sufficient criterion for the type  $I$  of  $S_X$  (and more generally for the type  $I_{wu}$ ) (Proposition 5.5 and Corollary 5.4). As for the previous criterion, this latter one is local, however it is not yet formulated in purely tropical data. In fact, it depends on the value of the intersection product between the lift of an orientable topological surface with the real locus of  $S_X$ . We then give a value for this intersection product and this value depends only on the combinatorics of the tropical surface and on the set of twisted edges of the orientable topological surface which is lifted (Proposition 5.7). By combining the two previous results, we obtain a local combinatorial criterion for the type  $I_{wu}$  of a phase tropical surface endowed with a real structure.

The text is composed of five chapters. Chapter 1 reviews some basics of topology of real algebraic varieties and presents the notion of real algebraic surfaces of type  $I$  (Section 1.2), as introduced by O. Viro in [39]. At the end of this chapter we briefly describe a new perspective on the type of real algebraic surfaces, using real pencils of curves (Section 1.3).

Chapter 2 recalls some classical and less classical definitions of tropical geometry. We also introduce new definitions relative to our setup (*e.g.* hypersmooth tropical manifolds in Section 2.1.3). Among the tools that we recall, tropical homology as well as cohomology reveal crucial in this work (Section 2.2). Tropical homology was introduced by I. Itenberg, L. Katzarkov, G. Mikhalkin and I. Zharkov in [15], as the homology of the multi-tangent space defining a cosheaf on the tropical surface  $X$ . We also use the cohomology of a sheaf, called wave space (Section 2.2.2). The wave space was introduced by G. Mikhalkin and I. Zharkov in [26]. The tropical homology of a tropical manifold comes with a tropical intersection theory, as introduced and studied by K. Shaw in [36] (Section 2.3). Using a Poincaré isomorphism proven by P. Jell, J. Rau and K. Shaw in [16], we show that this tropical intersection form is non-degenerate with  $\mathbb{Z}_2$ -coefficients (Section 2.3.3).

Chapter 3 is the core of our work. We begin with some context and motivation by briefly

presenting results of G. Mikhalkin in [27] on the decomposition of algebraic hypersurfaces in toric varieties into pairs-of-pants (Section 4.1.1). We then introduce the central notion, in this text, of phase tropical manifold (Section 3.1.2). We try to find a balance in the definition between assumptions easy to satisfy and not too technical proofs in the following. The main idea is that all the properties required for a phase tropical hypersurface are satisfied by the stratified fibration constructed in [27]. As a warm-up, we specialize our approach to the case of the dimension 1, which coincides with the setup of B. Bertrand, E. Brugallé and A. Renaudineau (Section 3.2). We recall the already existing results and we present a slightly different point of view, which generalizes better for our purpose to dimension 2. In Section 3.3, we study the intrinsic properties of a real structure of a phase tropical surface. More precisely, in Section 3.3.1, we deal with the restrictions along an edge of the tropical surface  $X$  and we show that the behavior of a real structure along an edge of  $X$  is constrained by the combinatorics of the tropical surface. In particular, we introduce the notion of *twisted edges* along a pair of adjacent faces. We then study the behavior of the real structure along a face of the tropical surface and we find some cellular co-cycle condition, with coefficients in the wave space  $W_{\mathbb{Z}_2}$ . To the contrary of the previous section, in Section 3.4 the real structure is not fixed anymore and we study the difference between two real structures. We show that a certain class of real structures of a phase tropical surface form a  $\mathbb{Z}_2$ -affine space whose direction is the first tropical cohomology group of the wave space  $H_{cell}^1(X; W_{\mathbb{Z}})$ . A similar result has been announced by D. Matessi and A. Renaudineau in an ongoing work.

Chapter 4 makes a connection between tropical and classical homology by lifting the tropical cycles to the phase tropical surface in Section 4.1. In particular, Section 4.1.3 uses in a crucial way the results of Section 3.4 concerning the affine space of real structures, in order to lift singular tropical  $(0, 2)$ -cycles. We also show that the lifting of tropical cycles is compatible, in some sense, with the tropical and classical intersection products. We then show that the lifting morphisms are injective, using the non-degeneracy of the tropical intersection form, allowing us to filtrate the  $\mathbb{Z}_2$ -homology of the phase tropical surface in Section 4.2.

Finally, Chapter 5 contains applications of the results of Chapters 3 and 4 in order to find tropical descriptions of topological properties of real structures of a phase tropical surface. By studying the action of the conjugation on the filtered  $\mathbb{Z}_2$ -homology in Section 5.1, we prove a local obstruction to the maximality of a phase tropical surface endowed with a real structure. Note that ongoing work by E. Brugallé, A. Renaudineau and K. Shaw also gives local obstructions to the maximality of a real algebraic surface obtained by primitive combinatorial patchworking. By studying the intersection number of the real part of the phase tropical surface with the filtered  $\mathbb{Z}_2$ -homology and the self intersection of lifts of tropical cycles, we are able to obtain a necessary and sufficient criterion for the type  $I_{wu}$  of a phase tropical surface endowed with a real structure in Section 5.2.





# Contents

<b>1</b>	<b>Complex Orientations: from Curves to Surfaces</b>	<b>11</b>
1.1	Some basics on Topology of Real Algebraic Varieties . . . . .	11
1.2	Complex Orientations of Surfaces . . . . .	16
1.3	Investigating Complex Orientations with Pencils of Curves . . . . .	19
<b>2</b>	<b>Tropical Geometry</b>	<b>25</b>
2.1	Tropical Varieties and Tropical Manifolds . . . . .	25
2.1.1	Tropical Polynomials and Tropical Subvarieties of the tropical torus . . . . .	25
2.1.2	Tropical Toric Varieties . . . . .	29
2.1.3	Tropical Manifolds . . . . .	31
2.2	Tropical Homology and Cohomology . . . . .	33
2.2.1	Wave Space . . . . .	33
2.2.2	Multi-Tangent Space and Tropical Homology . . . . .	39
2.2.3	Cellular Tropical Homology and Cohomology . . . . .	41
2.3	Tropical Intersection Theory and Poincaré Duality . . . . .	42
2.3.1	Intersecting Tropical Chains . . . . .	42
2.3.2	Intersection Pairing on a Smooth Tropical Surface . . . . .	43
2.3.3	Poincaré Duality . . . . .	45
<b>3</b>	<b>Real Structures of Phase Tropical Surfaces</b>	<b>49</b>
3.1	Phase Tropical Surfaces . . . . .	49
3.1.1	Pairs-of-Pants Decomposition . . . . .	49
3.1.2	Phase Tropical Manifolds . . . . .	51
3.1.3	Real Structure of a Phase Tropical Manifold . . . . .	61
3.2	Real Structures of Phase Tropical Curves . . . . .	62
3.2.1	Affine Space of Real Structures . . . . .	63
3.2.2	Lifting Tropical Cycles . . . . .	65
3.2.3	Type and Maximality of a Phase Tropical Curve . . . . .	67
3.3	First properties of a Real Structure . . . . .	68
3.3.1	Real structure along an edge . . . . .	68
3.3.2	Real Structure along a Face . . . . .	75
3.4	Affine Space of Real Structures . . . . .	79
<b>4</b>	<b>Filtration of the Homology of a Phase Tropical Surface</b>	<b>89</b>
4.1	Lifting Tropical Cycles . . . . .	89
4.1.1	Lifting (2,0)-cycles . . . . .	89
4.1.2	Lifting (1,1)-cycles . . . . .	91
4.1.3	Lifting (0-2)-cycles . . . . .	95
4.2	Obtaining a Filtration . . . . .	99
<b>5</b>	<b>Type and Maximality of a Real Structure of a Phase Tropical Surface</b>	<b>101</b>
5.1	Action of the Conjugation on the filtered Homology . . . . .	101
5.2	A Combinatorial criterion for Type I . . . . .	105



# 1 Complex Orientations: from Curves to Surfaces

## 1.1 Some basics on Topology of Real Algebraic Varieties

In this first section, we review some classical facts about topology of real algebraic varieties. We refer to [21] for a more complete exposure and to [40] for a less complete but more self-contained exposure. In this text, we restrict to projective varieties for simplicity. A *real projective subvariety* of  $\mathbb{P}^n$  is a proper homogeneous ideal of the ring  $\mathbb{R}[x_0, \dots, x_n]$  of homogeneous polynomials in  $n$  variables with real coefficients, where  $n$  is a non-negative integer. Since the ring  $\mathbb{R}[x_0, x_1, \dots, x_n]$  is Noetherian, a projective subvariety can be written as a finitely generated ideal  $(f_1, \dots, f_k)$ , where  $k$  is a positive integer. Given a real projective subvariety  $V$  of  $\mathbb{P}^n$ , we denote by  $\mathbb{R}V$  the *real locus* of  $V$ , that is, the set of points  $x = [x_0 : \dots : x_n]$  in the real projective space  $\mathbb{R}P^n$  such that  $f(x_0, \dots, x_n) = 0$  for all homogeneous polynomials  $f \in V$ . Similarly, the *complex locus* is the set of points  $z = [z_0 : \dots : z_n]$  in the complex projective space  $\mathbb{C}P^n$  such that  $f(z_0, \dots, z_n) = 0$  for all homogeneous polynomial  $f \in V$ . The complex and real loci are endowed with the topology of complex and real analytic spaces, respectively. We say that a real projective variety  $V$  is non-singular if the complex locus  $\mathbb{C}V$  is a complex manifold. If  $V$  is non-singular, then the complex conjugation acts on the complex locus  $\mathbb{C}V$  as an anti-holomorphic involution. The real locus  $\mathbb{R}V$  coincides with the set of fixed points of this involution and is a differentiable manifold of dimension  $\dim(\mathbb{R}V) = \dim_{\mathbb{C}}(\mathbb{C}V)$  (if the real locus is non-empty). One of the main problems in topology of real algebraic varieties is to classify the possible topologies realizable by a non-singular real algebraic hypersurface  $V$  of degree  $d$  in the projective space  $\mathbb{P}^{n+1}$ . In that case, the real projective variety  $V$  is given by a single homogeneous polynomial with real coefficients of degree  $d$  in the  $n+2$  homogeneous coordinates of  $\mathbb{P}^{n+1}$ . The word "topologies" is voluntary vague, and can refer to several topological questions. The simplest question is to classify, up to homeomorphism, the topology of the real locus  $\mathbb{R}V$ . In dimension  $n = 1$ , the real locus  $\mathbb{R}V$  is homeomorphic to a disjoint union of circles, so the problem boils down to know how many connected components does the real locus have. This problem was solved in 1876 by A. Harnack.

**Theorem 1.1.** [12] *Let  $C$  be a non-singular real curve of degree  $d \in \mathbb{Z}_{>0}$  in  $\mathbb{P}^2$ . The real locus  $\mathbb{R}C$  has at most  $\frac{1}{2}(d-1)(d-2) + 1$  connected components. Moreover, if the degree  $d$  is even, then every integer number between 0 and  $\frac{1}{2}(d-1)(d-2) + 1$  is realizable as the number of connected components of a non-singular real curve of degree  $d$  in  $\mathbb{P}^2$ . If the degree  $d$  is odd, then every integer number between 1 and  $\frac{1}{2}(d-1)(d-2) + 1$  is realizable as the number of connected components of a non-singular real curve of degree  $d$  in  $\mathbb{P}^2$ .*

Note that in the theorem above, the quantity  $\frac{1}{2}(d-1)(d-2)$  corresponds to the genus of the Riemann surface defined by the complex locus of the curve  $C$ . As a consequence, every non-singular real curve  $C$  of degree  $d$  in  $\mathbb{P}^2$  satisfies the so-called *Harnack inequality*

$$\dim H_0(\mathbb{R}C; \mathbb{Z}_2) \leq \frac{1}{2} \dim H_1(\mathbb{C}C; \mathbb{Z}_2) + 1, \quad (1.1)$$

where  $\mathbb{Z}_2$  is the field with two elements. Equation (1.1) above is a particular case of the more general *Smith-Thom inequality* below (see for instance [40], Corollary A2).

**Theorem 1.2.** *Let  $c$  be a continuous cellular involution on a finite CW-complex  $X$ . Then, one has*

$$\sum_{i \geq 0} \dim H_i(\text{Fix}(c); \mathbb{Z}_2) \leq \sum_{i \geq 0} \dim H_i(X; \mathbb{Z}_2). \quad (1.2)$$

*Moreover, the difference  $\sum_i \dim H_i(X; \mathbb{Z}_2) - \sum_i \dim H_i(\text{Fix}(c); \mathbb{Z}_2)$  is even and if Equation (1.2) is an equality, then  $c_*$  acts trivially on  $H_i(X; \mathbb{Z}_2)$  for all non-negative integers  $i$ .*

This very general restriction applies in particular to real projective varieties. We say that  $(X, c)$  is *maximal* if Equation (1.2) is an equality. When  $X$  is a differentiable manifold, we say that  $X$  is an  $M$ -manifold if  $(X, c)$  is maximal. More generally, we say that  $(X, c)$  is an  $(M - k)$ -manifold if the difference  $\dim H_*(X; \mathbb{Z}_2) - \dim H_*(\text{Fix}(c); \mathbb{Z}_2)$  is equal to  $2k$ , where  $k$  is a non-negative integer.

In dimension  $n = 2$ , the question of the topology of the real locus  $\mathbb{R}V$  of a real surface  $V$  of degree  $d$  in  $\mathbb{P}^3$  is much harder to tackle than the  $n = 1$  case. When the degree is at most 3 the question is relatively easy and well understood. In degree 4, the complex locus is a  $K3$ -surface and the topology of the real locus is also well understood. An interesting phenomenon occurs in degree 4: there are three different topological types for the real locus  $\mathbb{R}V$ , such that  $\mathbb{C}V$  is an  $M$ -manifold for the complex conjugation. Already in degree  $d = 5$  the classification of the possible topologies of the real locus  $\mathbb{R}V$  of a non-singular real surface of degree  $d$  in  $\mathbb{P}^3$  is still open. Since the complex locus of a real algebraic surface  $V$  in  $\mathbb{P}^3$  is a compact Kähler manifold of complex dimension 2, a lot of tools can be used in order to obtain topological restrictions on the real locus. One of them is the intersection form on the second homology group  $H_2(\mathbb{C}V; \mathbb{R})$  of  $\mathbb{C}V$ . This intersection form is symmetric and non-degenerate, because  $\mathbb{C}V$  is a compact orientable manifold of dimension 4, so one can consider the signature of this form, denoted by  $\sigma(\mathbb{C}V)$ . If  $M$  is a compact orientable manifold of dimension  $4m$ , we denote by  $a \circ b$  the intersection product of two homology classes  $a$  and  $b$  in the homology group  $H_{2m}(M; \mathbb{R})$ . In order to obtain information about the complex conjugation, one can consider the *form of the complex conjugation* as defined below.

*Definition 1.1.* Let  $m$  be a positive integer and let  $M$  be a compact orientable  $4m$ -manifold endowed with a continuous involution  $c$ . The *form of the involution  $c$*  is defined on  $H_{2m}(M; \mathbb{R}) \times H_{2m}(M; \mathbb{R})$  by

$$(a, b) \mapsto a \circ (c_* b).$$

This new form is a symmetric bilinear form and we call its signature the *signature of the involution*.

If  $M$  is a compact orientable manifold of dimension  $2n$  and  $F$  is a smooth submanifold of dimension  $n$ , one can consider a section  $s : F \rightarrow N_M(F)$  of the normal bundle  $N_M(F)$  of  $F$  in  $M$ , intersecting transversally the zero section  $s_0 : F \rightarrow N_M(F)$  of  $F$ . Since the corestriction of the section  $s : F \rightarrow s(F)$  is a homeomorphism, a local orientation of  $F$  at  $x$  induces a local orientation of the image  $s(F)$  at  $s(x)$ . In the same way, a local orientation of  $F$  at the point  $x$  induces a local orientation of the image of the zero section  $s_0(F)$  at  $(x, 0)$ . Note also that the orientation of  $M$  induces an orientation of the normal bundle  $N_M(F)$ . One can then count the number of zeros  $x$  of the section  $s$ , with a positive sign if the concatenation of local orientations of  $s_0(F)$  and  $s(F)$  at the point  $(x, 0)$ , induced by a same local orientation of  $F$  at  $x$ , yields the orientation of  $M$  and a negative sign otherwise. Note that the sign does not

depend on the chosen local orientations. The *self-intersection of  $F$  in  $M$*  is defined as the signed count of the zeros of any section of  $N_F(M)$ , intersecting transversally the zero section  $s_0 : F \rightarrow N_M(F)$ . If the submanifold  $F$  is orientable, then the self-intersection of  $F$  in  $M$  coincides with the self-intersection  $[F] \circ [F]$  of the homology class  $[F] \in H_n(M; \mathbb{R})$ . We denote by  $F \circ F$  the self-intersection of  $F$  in  $M$ , even if  $F$  is not orientable. By convention, if  $F$  is empty, the self-intersection  $F \circ F$  is zero. The form of an involution contains a lot of information about the involution. The following theorem shows that already the signature of the involution is interesting. It can be obtained as an application of the much more general Atiyah–Singer index theorem (see [5], Proposition (6.15)) or by a more self-contained proof (see [18]).

**Theorem 1.3** (Atiyah, Singer). *[5, 18] Let  $m$  be a positive integer, let  $M$  be a compact almost complex manifold of dimension  $4m$ , and let  $c$  be conjugation on  $M$ . The signature of the involution  $c$  is the self-intersection  $F \circ F$  of the fixed locus  $F$  of  $c$ .*

As mentioned at the beginning of the section, by definition, the complex locus of a non-singular real projective variety is a complex manifold. In particular, the tangent bundle is a complex vector bundle, so that the multiplication by  $i$  in the tangent bundle defines an almost complex structure  $J$ , that is, an endomorphism  $J$  of the tangent bundle satisfying  $J^2 = -1$ .

*Definition 1.2.* Let  $M$  be a compact orientable manifold of dimension  $2n$  with an almost complex structure  $J \in \text{End}(TM)$ . A smooth orientation preserving involution  $c : M \rightarrow M$  is a *conjugation* on  $M$  if it satisfies  $c_*J = -Jc_*$ . In this situation,  $c$  is also called an anti-holomorphic involution.

There is a nice feature about the normal bundle of the fixed locus  $\text{Fix}(c)$  of a conjugation  $c$  in an almost complex manifold  $M$  of (real) dimension  $2n$ : the multiplication by  $i$  yields an isomorphism between the normal and tangent bundles of the fixed locus. This isomorphism preserves the orientation if and only if  $\frac{1}{2}n(n-1)$  is even (recall that, as an almost complex manifold,  $M$  is naturally oriented by bases of the form  $(x_1, Jx_1, \dots, x_n, Jx_n)$ ). Since the self-intersection number  $\text{Fix}(c) \circ \text{Fix}(c)$  can be computed as the number of zeros (counted with signs) of a section of the normal bundle of  $\text{Fix}(c)$ , and the Euler characteristic of  $\text{Fix}(c)$  is equal to the number of zeros (counted with signs) of a section of the tangent bundle of  $\text{Fix}(c)$ , both sections intersecting transversally the zero section, we obtain a proof of the following classical lemma.

**Lemma 1.1.** *Let  $n$  be a positive integer, let  $M$  be an almost complex manifold of (real) dimension  $2n$  and let  $c$  be a conjugation on  $M$ . The self-intersection number of the fixed locus  $\text{Fix}(c)$  is equal, up to a sign, to the Euler characteristic of  $\text{Fix}(c)$ , more precisely*

$$\text{Fix}(c) \circ \text{Fix}(c) = (-1)^{\frac{1}{2}n(n-1)} \chi(\text{Fix}(c)). \quad (1.3)$$

Combining Theorem 1.3 with Lemma 1.1 above, one obtains that the signature of a conjugation on an almost complex manifold is equal, up to a sign, to the Euler characteristic of the fixed locus. In the case where the almost-complex manifold is an  $M$ -manifold, one can obtain the following theorem, due to V. Rokhlin (we refer to [40], Theorem 3.3, for the proof).

**Theorem 1.4** (Rokhlin). *Let  $m$  be a positive integer, let  $M$  be a compact almost-complex manifold of dimension  $4m$  and let  $c$  be a conjugation on  $M$ . If  $(M, c)$  is maximal, then one has*

$$\chi(\text{Fix}(c)) = \sigma(M) \pmod{16}.$$

The theorem above applies to any non-singular real surface  $V$  of degree  $d$  in  $\mathbb{P}^3$  and gives an important restriction for the possible maximal topological types. In fact, the signature of the complex locus depends only on the degree  $d$  and is equal to  $\sigma(\mathbb{C}V) = \frac{d}{3}(4 - d^2)$  (more generally, the complex loci of two non-singular real algebraic surfaces of the same degree in  $\mathbb{P}^3$  are isotopic, so in particular they share the same topological invariants). This restriction helps us to understand the topology of the real locus of  $V$ , and one can read [40] and [21] for many other results about the topology of the real locus. However, this restriction does not give any information on the embedding  $\mathbb{R}V \subset \mathbb{R}P^3$ . The classification of the possible embeddings  $\mathbb{R}V \subset \mathbb{R}P^{n+1}$ , where  $V$  is a non-singular real hypersurface of degree  $d$  in  $\mathbb{P}^{n+1}$ , is the other meaning of the word "topologies" in the question we stated at the beginning of this section. The main question about this embedding is to classify the possible pairs  $(\mathbb{R}P^{n+1}, \mathbb{R}V)$ , up to homeomorphism. Of course, one can ask about finer classification, *e.g.* up to rigid isotopy, that is, up to isotopy in the class of non-singular real projective hypersurfaces, but the classification up to homeomorphism is already a difficult problem. We refer to the survey [21] for more on rigid isotopy classification. Even in the case  $n = 1$  of real algebraic curves in  $\mathbb{P}^2$ , the problem of the classification of the topological pairs  $(\mathbb{R}P^2, \mathbb{R}V)$  is still open in degree 8. For degree 6, the classification was completed by D. Gudkov in 1969 and in degree 7 by O. Viro in 1979. One of the tools that can be used to obtain informations on the embedding  $\mathbb{R}V \subset \mathbb{R}P^2$  is, when they exist, the *complex orientations* of the curve.

*Definition 1.3.* Let  $C$  be a non-singular real curve in  $\mathbb{P}^2$ . The curve  $C$  is said to be of *type I*, or *dividing*, or *separating*, if the real locus  $\mathbb{R}C$  cuts the complex locus into two halves. Otherwise,  $\mathbb{C}C \setminus \mathbb{R}C$  is connected and the curve  $C$  is said to be of *type II*.

*Definition 1.4.* Let  $C$  be a non-singular real curve in  $\mathbb{P}^2$  of type *I*. The *complex orientations* are the orientations of the (non-empty) real locus  $\mathbb{R}C$  of the curve, induced as a boundary orientation, by the choice of one of the connected components of  $C \setminus \mathbb{R}C$ , endowed with the orientation induced by the complex curve  $\mathbb{C}C$ , naturally oriented by the bases of the form  $(x, ix)$ .

*Remark 1.1.* The definitions above make sense for any almost-complex manifold of (real) dimension 2, endowed with a conjugation  $c$ . They also make sense in the singular case, as long as the singular points do not lie on the fixed locus  $\text{Fix}(c)$  of the involution.

*Remark 1.2.* There is always a pair of opposite complex orientations on the real locus of a curve  $C$  of type *I*. They come from the two possible choices of a component of  $\mathbb{C}C \setminus \mathbb{R}C$ . Note also that both connected components are images of one another by the conjugation. As a consequence, these connected components are homeomorphic.

*Example 1.1.* A real projective line is of type *I*. A non-singular real projective conic has at most one connected component in its real locus (Harnack inequality) and is of type *I* if and only if the real part is non-empty. A non-singular real projective cubic has either 1 or 2 components in its real locus and is of type *I* if and only if the number of connected components is 2.

**Proposition 1.1.** *Let  $C$  be a non-singular real curve in  $\mathbb{P}^2$ . If the curve  $C$  is maximal, then  $C$  is of type *I*.*

One can find an elementary proof of the proposition above in [37] (see Section 2.6). The converse of the statement is false: many curves of type *I* are not maximal (see for instance Example 1.2 of the maximally-nested curves). The complex orientations on the real locus are not particularly interesting, when one considers them inside the complex locus of the curve.

However, the idea is to compare them *via* the embedding  $\mathbb{R}C \subset \mathbb{R}S$ , when  $C$  is a curve in a non-singular real projective surface  $S$  (e.g.  $\mathbb{P}^2$ ). One of the main topological restrictions that we can obtain is known as Rokhlin's complex orientations formula. Let us introduce some terminology before stating this formula.

*Definition 1.5.* Let  $C$  be a non-singular real curve in  $\mathbb{P}^2$ . A connected component  $l$  of the real locus  $\mathbb{R}C$  is called an *oval* if the homology class of  $l$  is zero in  $H_1(\mathbb{R}P^2; \mathbb{Z})$ . When the homology class of  $l$  is the (only) non-zero element of  $H_1(\mathbb{R}P^2; \mathbb{Z})$ , we say that the component  $l$  is a *pseudo-line*. An oval cuts the real projective plane into two connected components. One of them is homeomorphic to a disk and is called the *interior* of the oval, while the complement of the interior is homeomorphic to a Möbius band and is called the *exterior* of the oval. A pair of ovals  $(l, l')$  is *injective* if  $l$  is contained in the interior of  $l'$ .

*Remark 1.3.* Note that curves of even degree do not have any pseudo-line, while the curves of odd degree always have exactly one.

*Definition 1.6.* Let  $C$  be a non-singular real curve in  $\mathbb{P}^2$  and of type  $I$ . An injective pair  $(l, l')$  is said to be *positive* if the complex orientations on  $l \cup l'$  coincide with the boundary orientations coming from the cylinder in  $\mathbb{R}P^2$  bounded by  $l$  and  $l'$ . Otherwise, the injective pair is said to be *negative*.

**Theorem 1.5** (Rokhlin). *Let  $C$  be a non-singular real curve of even degree  $d$  in  $\mathbb{P}^2$  and of type  $I$ . Denoting by  $L$  the number of ovals of  $C$ , by  $\Pi_+$  the number of positive injective pairs and by  $\Pi_-$  the number of negative injective pairs, one has*

$$2(\Pi_+ - \Pi_-) = L - \frac{d^2}{4}.$$

*Remark 1.4.* The statement above should be slightly modified in odd degree. The difference with even degree is that in odd degree, one needs additionally to compare the complex orientations of an oval and the pseudo-line. See the introductory text [37], Section 2.7, for a complete statement and a nice proof using the intersection form on  $H_2(\mathbb{C}P^2; \mathbb{Z})$ .

Let us now present an alternative point of view on the type of a non-singular real algebraic curve.

*Definition 1.7.* Let  $C$  be a non-singular real curve in  $\mathbb{P}^2$ . We say that a real morphism  $f : C \rightarrow \mathbb{P}^1$  (i.e. equivariant under complex conjugation) is *separating* if  $f^{-1}(\mathbb{R}P^1) \subset \mathbb{R}C$ .

**Proposition 1.2.** *Let  $C$  be a non-singular real curve in  $\mathbb{P}^2$ . The curve  $C$  is of type  $I$  if and only if  $C$  admits a separating morphism  $f : C \rightarrow \mathbb{P}^1$ .*

*Remark 1.5.* One of the implications of the above equivalence is straightforward: if  $f : C \rightarrow \mathbb{P}^1$  is a separating morphism, then  $\mathbb{C}C \setminus \mathbb{R}C = f^{-1}(\mathbb{C}P^1 \setminus \mathbb{R}P^1)$  and the result follows. The other implication is not easy to obtain. As explained in [23], the result above is a consequence of chapter 4.2 in [1]. A more recent and elementary proof can be found in [10] (Theorem 7.1, text in french). This point of view provides a nice proof for one the simplest examples of real algebraic plane curves of type  $I$ : the curves with a nest of maximal depth.

*Example 1.2.* A nest of depth  $k \in \mathbb{Z}_{>0}$  is a sequence  $(l_1, \dots, l_k)$  of ovals, such that  $(l_j, l_{j+1})$  forms an injective pair for all  $j \in \{1, \dots, k-1\}$ . By Bézout's theorem, a nest of a non-singular real curve of degree  $d$  in  $\mathbb{P}^2$  has depth at most  $\lfloor \frac{d}{2} \rfloor$ , where  $\lfloor \frac{d}{2} \rfloor$  is the greatest integer smaller



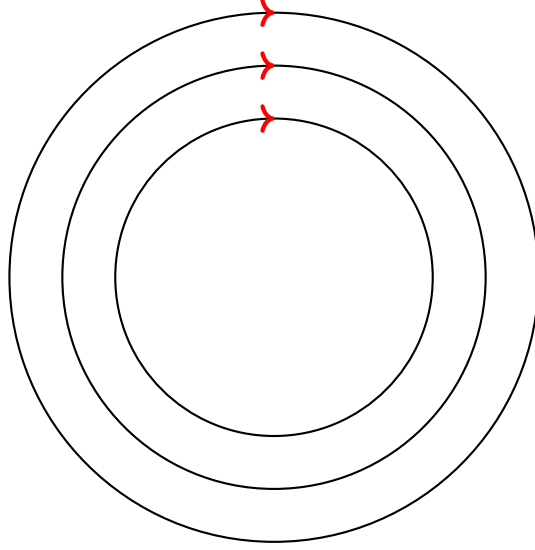

Figure 1.1: Real locus of a non-singular real projective curve of degree 6, with a nest of depth 3 and one of the two complex orientations in red.

than or equal to  $\frac{d}{2}$  (consider a line passing through a point in the interior of the deepest oval). Moreover, a non-singular real curve  $C$  of degree  $d$  in  $\mathbb{P}^2$ , with a nest of maximal depth  $k = \lfloor \frac{d}{2} \rfloor$ , does not have any other oval and is of type  $I$ . Indeed, take a point  $x$  in the interior of the deepest oval of the nest. Consider the pencil of lines  $(D_t)_{t \in \mathbb{C}P^1}$  passing through the point  $x$ . For every point  $y \in \mathbb{C}C$ , there is exactly one value  $t \in \mathbb{C}P^1$ , denoted by  $f(y)$ , such that  $y$  lies in the complex locus  $\mathbb{C}D_{f(y)}$ . This map defines a morphism  $C \rightarrow \mathbb{P}^1$ , which is real because the base point of the pencil of lines is real. For any  $t \in \mathbb{R}P^1$ , the real locus of the line  $D_t$  intersects the real locus  $\mathbb{R}C$  in  $d$  real points ( $2k$  points on the ovals of the nest and one on the pseudo-line if  $d$  is odd). Thus, the inverse image  $f^{-1}(t)$  is contained in the real locus  $\mathbb{R}C$ , so the real morphism  $f$  is separating. Therefore, the curve  $C$  is of type  $I$  by the easy implication of Proposition 1.2. Using Rokhlin's complex orientations formula (Theorem 1.5), one can show that the complex orientations on the ovals are such that all the injective pairs are negative (see Figure 1.1).

## 1.2 Complex Orientations of Surfaces

In the previous section, we mention two points of view on the type of non-singular real algebraic curves. The first condition for type  $I$  (see Definition 1.4) is topological and can be stated as  $[\mathbb{R}C] = 0 \in H_1(\mathbb{C}C; \mathbb{Z}_2)$  and  $\mathbb{R}C$  is non-empty. The second one (see Proposition 1.2), is algebraic and asks for the existence of a separating real morphism  $C \rightarrow \mathbb{P}^1$ . Both points of view are interesting. For instance, S. Orevkov in [31], successfully combines the second point of view with Abel-Jacobi theorem, in order to prove that some specific complex orientations on a real plane pseudo-holomorphic curve cannot be realized in the same degree by real plane projective curves. In the text, we adopt a topological point of view and we consider a generalization of the notion of type  $I$  introduced by O. Viro in [39]. Our references for this section are [39], [9] and

the survey [21].

*Definition 1.8.* Let  $c$  be a continuous involution on a compact manifold  $M$  of dimension  $2n$ . The  $\mathbb{Z}_2$ -form of the involution  $c$  is defined as

$$\begin{aligned} H_n(M; \mathbb{Z}_2) \times H_n(M; \mathbb{Z}_2) &\rightarrow \mathbb{Z}_2 \\ \alpha, \beta &\mapsto \alpha \circ c_* \beta. \end{aligned}$$

*Definition 1.9.* Let  $V$  be a finite-dimensional  $\mathbb{Z}_2$ -vector space. The *characteristic element* of a non-degenerate symmetric bilinear form  $b : V \times V \rightarrow \mathbb{Z}_2$  is the vector  $r \in V$ , such that for any  $v \in V$ , one has

$$b(v, v) = b(v, r).$$

**Lemma 1.2.** [4] *Let  $M$  be an almost complex compact manifold of dimension  $2n$  and let  $c$  be a conjugation on  $M$  such that the fixed locus of  $c$  is non-empty. Then the fixed locus of  $c$  realizes the characteristic element of the  $\mathbb{Z}_2$ -form of the involution  $c$ .*

*Definition 1.10.* Let  $M$  be an almost complex manifold of dimension  $2n$  and let  $c$  be a conjugation on  $M$  such that the real locus is non-empty. We say that  $(M, c)$  is of *type I* if

$$[\text{Fix}(c)] = 0 \in H_n(M; \mathbb{Z}_2).$$

More generally, for any  $u \in H_n(M; \mathbb{Z}_2)$ , we say that  $(M, c)$  is of *type  $I_u$* , or *of type I relatively to  $u$* , if

$$[\text{Fix}(c)] = u \in H_n(M; \mathbb{Z}_2).$$

There are several interesting homology classes that the fixed locus can realize in the group  $H_n(M; \mathbb{Z}_2)$ . In particular, in the case where  $M$  is the complex locus of a real projective surface, the classes of the complex loci of curves yield orientations on  $\mathbb{R}S \setminus \mathbb{R}C$ . More precisely, given a non-singular real algebraic surface  $S$  which satisfies  $H_1(\mathbb{C}S; \mathbb{Z}_2) = 0$ , and of type  $I_{[\mathbb{C}C]}$ , O. Viro constructed a pair of opposite orientations on  $\mathbb{R}S \setminus \mathbb{R}C$ . O. Viro presented two equivalent constructions in [39]: the first one relies on the existence of a double covering of  $\mathbb{C}S$  ramified along  $\mathbb{R}S \cup \mathbb{C}C$  and the second one uses linking numbers with the 2-chain  $\mathbb{R}S + \mathbb{C}C$ . We present here the one with linking numbers, which has the advantage not to require to work in any other space than the complex locus  $\mathbb{C}S$ . The assumption that  $H_1(\mathbb{C}S; \mathbb{Z}_2) = 0$  is reasonable since it holds for any non-singular real surface in  $\mathbb{P}^3$ . Indeed, it is a consequence of the Lefschetz hyperplane theorem that for any non-singular real surface, the first homology group of the complex locus with  $\mathbb{Z}$ -coefficients vanishes, hence the result with  $\mathbb{Z}_2$ -coefficients.

*Construction 1.1.* Let us assume that  $S$  is a non-singular real projective surface such that  $H_1(\mathbb{C}S; \mathbb{Z}_2) = 0$ . Consider a real curve  $C$  in  $S$  such that  $S$  is of type  $I_{[\mathbb{C}C]}$ . The 2-cycle  $\mathbb{R}S + \mathbb{C}C$  with  $\mathbb{Z}_2$ -coefficients is homologous to zero, so there exists a 3-chain  $\eta$  in  $\mathbb{C}S$  such that  $\partial\eta = \mathbb{R}S \cup \mathbb{C}C$ . Since the first  $\mathbb{Z}_2$ -homology group  $H_1(\mathbb{C}S; \mathbb{Z}_2)$  of the complex locus  $\mathbb{C}S$  vanishes, the  $\mathbb{Z}_2$ -linking number of any 1-cycle  $\alpha$  with  $\mathbb{R}S + \mathbb{C}C$  is well defined as the number of intersection points in  $\mathbb{C}S$  between  $\eta$  and  $\alpha$  (one can always perturb  $\alpha$  so that the intersections are transverse). Now consider two points  $x$  and  $x'$  in  $\mathbb{R}S \setminus \mathbb{R}C$  and fix local orientations of  $\mathbb{R}S \setminus \mathbb{R}C$  at  $x$  and  $x'$ . Consider a tubular neighborhood of  $\mathbb{R}S$  in  $\mathbb{C}S$ . Since a tubular neighborhood of  $\mathbb{R}S$  in  $\mathbb{C}S$  is homeomorphic to the normal bundle of  $\mathbb{R}S$  in the complex locus  $\mathbb{C}S$ , one can always assume that the fibers of that tubular neighborhood are stable by the conjugation  $\text{conj}$ . Consider now two fibers  $D$  and  $D'$  of this tubular neighborhood at the points  $x$  and  $x'$  respectively. The boundaries

of  $D$  and  $D'$  are circles, denoted respectively by  $\partial D$  and  $\partial D'$ , on which the conjugation acts as  $-\text{id}$ . Choose two points  $y$  and  $y'$  on the circles  $\partial D$  and  $\partial D'$  respectively. Note that the local orientations of  $\mathbb{R}S$  at  $x$  and  $x'$  induce, by multiplication by  $i$ , orientations of the fibers  $D$  and  $D'$ . One can then consider two paths  $u : [0, 1] \rightarrow \partial D$  and  $u' : [0, 1] \rightarrow \partial D'$  following the boundary orientation on  $\partial D$  and  $\partial D'$ , and connecting respectively the point  $y$  to  $\text{conj}(y)$  and the point  $y'$  to the point  $\text{conj}(y')$ . Now, since  $\mathbb{R}S \cup \mathbb{C}C$  is a finite union of manifolds of codimension at least 2, the complement  $\mathbb{C}S \setminus (\mathbb{R}S \cup \mathbb{C}C)$  is connected. Thus, there exists a path  $s$  connecting  $y$  to  $y'$  in  $\mathbb{C}S \setminus (\mathbb{R}S \cup \mathbb{C}C)$ . This construction yields a 1-cycle, depending on the local orientations at  $x$  and  $x'$  and defined by the concatenation of paths

$$\alpha_x^{x'} := su'(\text{conj} \circ s)^{-1} u^{-1}.$$

The linking number of the 1-cycle  $\alpha_x^{x'}$  with the 2-cycle  $\mathbb{R}S \cup \mathbb{C}C$  does not depend on the chosen path  $s$ . In fact, if  $t$  is another path from  $y$  to  $y'$  in  $\mathbb{C}S \setminus (\mathbb{R}S \cup \mathbb{C}C)$ , then there exists a 2-chain  $B$  in  $C_2(\mathbb{C}S; \mathbb{Z}_2)$ , bounding the 1-cycle  $s+t$ . The sum of the 1-cycles  $\alpha_x^{x'}$  and  $tu'(\text{conj} \circ t)^{-1} u^{-1}$  is thus equal to  $B + \text{conj}_* B$ , so that by choosing the 2-chain  $B$  to be transverse to  $\mathbb{R}S \cup \mathbb{C}C$ , the sum of the corresponding linking numbers is equal to the number of intersection points between  $B + \text{conj}_* B$  and  $\mathbb{R}S \cup \mathbb{C}C$ . This number of points is even because  $\mathbb{R}S \cup \mathbb{C}C$  is stable by the conjugation  $\text{conj}$ . We then define the *complex orientations of  $S$  modulo the curve  $C$*  as the pair of opposite orientations on  $\mathbb{R}S \setminus \mathbb{R}C$ , such that for any pairs of points  $x$  and  $x'$  in  $\mathbb{R}S \setminus \mathbb{R}C$ , the local orientations at the points  $x$  and  $x'$ , given by one of the complex orientations, yield a 1-cycle  $\alpha_x^{x'}$  whose linking number with  $\mathbb{R}S \cup \mathbb{C}C$  is zero.

As in the case of curves, the M-surfaces are of a specific type, but not necessary of type  $I$ . In the case of a real algebraic surface in  $\mathbb{P}^3$ , it depends on the parity of the degree as stated by the proposition below (see Theorems 2.2.F and 4.1.B in [39]).

**Proposition 1.3.** [39] *Let  $S$  be a non-singular real surface of degree  $d$  in  $\mathbb{P}^3$  and such that  $(\mathbb{C}S, \text{conj})$  is maximal. If the degree  $d$  is even, then  $S$  is of type  $I$ , while if the degree is odd, the surface is of type  $I_{hp}$ , that is, the type relative to the complex locus of a plane section of  $S$ .*

In order to conclude this section, let us mention a topological restriction on almost-complex 4 manifolds  $(M, c)$  of type  $I_{wu}$ , meaning that  $[\text{Fix}(c)] = wu(M)$ , where  $wu(M) \in H_2(M; \mathbb{Z}_2)$  is the  $Wu$ -class of  $M$ , that is, the characteristic element of the intersection form on  $H_2(M; \mathbb{Z}_2)$ .

**Proposition 1.4** (Generalized Arnold's congruence). [21] *Let  $(M, c)$  be an almost complex 4-manifold endowed with a conjugation  $c$  of type  $I_{wu}$ . One has*

$$\chi(\text{Fix}(c)) = \sigma(M) \pmod{8}.$$

*Remark 1.6.* This statement applies to the complex locus  $\mathbb{C}S$  of a non-singular real projective surface  $S$  endowed with the complex conjugation (the statement is formulated in this way in [21], Result 2.7.2). In the case where  $S$  is of type  $I$ , the statement is also mentioned in [39] as *Kharlamov's congruence* (Theorem 3.3.A). An almost-complex 4-manifold  $(M, c)$  is of type  $I_{wu}$  if and only if the characteristic element of the  $\mathbb{Z}_2$ -form of the involution  $c$  is also a characteristic element of the usual  $\mathbb{Z}_2$ -intersection form. In particular, if  $(M, c)$  is maximal, then  $(M, c)$  is of type  $I_{wu}$ . This statement is a direct corollary of the fact that for maximal  $(M, c)$  the involution  $c$  acts trivially on the  $\mathbb{Z}_2$ -homology. From that perspective, Proposition 1.3 is a consequence of the fact that the  $Wu$ -class of a non-singular real surface of degree  $d$  in  $\mathbb{P}^3$  is equal to 0 if  $d$  is even and to the class of the hyperplane section if  $d$  is odd.

In the case of a maximal non-singular real surface  $S$  of degree  $d$  in  $\mathbb{P}^3$ , one finds back the statement of Theorem 1.4, but only with a congruence modulo 8 instead of 16. This result is interesting, but it gives no information about the topology of the pair  $(\mathbb{R}P^3, \mathbb{R}S)$ . The next result, proved by O. Viro in [39] (Theorem 4.2.B), provides a better understanding of the complex orientations of a real algebraic surface modulo a curve.

**Theorem 1.6.** [39] *Let  $S$  be a real projective surface of type  $I_{[CC]}$ , where  $C$  is a real algebraic curve in  $S$ . If the real locus  $\mathbb{R}C$  is non-empty, then a complex orientation on  $\mathbb{R}S \setminus \mathbb{R}C$  does not extend to an orientation of  $\mathbb{R}S$ .*

From the theorem above, O. Viro deduces the following result about the topology of the pair  $(\mathbb{R}P^3, \mathbb{R}S)$ , where  $S$  is a non-singular real projective surface of even degree.

**Corollary 1.1.** *Let  $S$  be a non-singular real projective surface of type  $I_{hp}$  and of even degree in  $\mathbb{P}^3$ . Then, the real locus of  $\mathbb{R}S$  is contractible in  $\mathbb{P}^3$ .*

*Proof.* By contradiction, assume that the real locus  $\mathbb{R}S$  is not contractible, hence the existence of a non-contractible loop  $l$  in  $\mathbb{R}S$ . Consider a real projective plane  $P$  in  $\mathbb{P}^3$ . The homology class of  $l$  realizes the non-zero element of  $H_1(\mathbb{R}P^3; \mathbb{Z}_2)$ , so there is an odd number of points of intersection of the loop  $l$  with  $\mathbb{R}P$ . Since  $S$  is of type  $I_{hp}$ , one can choose a complex orientation on  $\mathbb{R}S \setminus \mathbb{R}(P \cap S)$ . This orientation induces local orientations at  $x$  for all points  $x$  in  $l \setminus \mathbb{R}P$ . Since the local orientations changes to their opposite an odd number of times among  $l$  (at each point of  $l \cap \mathbb{R}P$ ), the restriction of the tangent bundle of  $\mathbb{R}S$  to  $l$  is non-orientable, so  $\mathbb{R}S$  is non-orientable. Yet, the non-singular real projective surface  $S$  is of even degree so the real locus  $\mathbb{R}S$  is orientable.  $\square$

*Example 1.3.* A non-singular real surface of degree 2, whose real part is homeomorphic to a sphere, is of type  $I_{hp}$ . One can find a proof in [39]. We give a more geometric point of view using pencils of plane sections in Example 1.6.

### 1.3 Investigating Complex Orientations with Pencils of Curves

We already made use of a pencil of lines in Example 1.2 in order to determine the type of a maximally nested real algebraic curve in  $\mathbb{P}^2$ . Pencils of lines seem, in fact, to have more general connection with complex orientations as suggested by *Fiedler's alternation of orientations* (see [37]). So it should not be surprising that pencils also show up for the type of a non-singular real projective surface. Let  $S$  be a non-singular real projective surface. Given a morphism  $f : S \rightarrow \mathbb{P}^1$ , one can consider the family of curves  $(C_t)_{t \in \mathbb{C}P^1}$ , where for all  $t \in \mathbb{C}P^1$ , the complex locus  $\mathbb{C}C_t$  is equal to the fiber  $f^{-1}(t)$ . A family arising in this way is called a *pencil of curves* on  $S$  and if the morphism  $f$  is real, then the pencil of curves is said to be *real*. Let  $(C_t)_t$  be a real pencil of curves, such that for every  $t \in \mathbb{R}P^1$ , the real locus  $\mathbb{R}C_t$  is non-singular and the curve  $C_t$  is of type  $I$ . In particular, for any  $t \in \mathbb{R}P^1$ , one can choose a complex orientation on the real locus  $\mathbb{R}C_t$ , corresponding to one of the two connected components  $\eta_t$  of  $\mathbb{C}C_t \setminus \mathbb{R}C_t$ . Let us denote by  $0$  the point  $[0 : 1] \in \mathbb{R}P^1$ . Note that the choice of complex orientations on  $\mathbb{R}C_t$  for  $t \in \mathbb{R}P^1$  induces a choice of complex orientations on the real loci  $\mathbb{R}C_s$  for  $s$  in a small neighborhood of  $t$ . Since  $\mathbb{R}P^1 \setminus \{0\}$  is contractible, one can make a choice of complex orientations on the real loci  $\mathbb{R}C_t$  for  $t \in \mathbb{R}P^1 \setminus \{0\}$ , such that the complex orientation on  $\mathbb{R}C_t$  induces the complex orientations on  $\mathbb{R}C_s$  for any  $t \in \mathbb{R}P^1 \setminus \{0\}$  and  $s$  in a neighborhood of  $t$  in  $\mathbb{R}P^1 \setminus \{0\}$ .

We call such a choice of complex orientations *coherent complex orientations relative to  $C_0$*  on the real pencil  $(C_t)_t$ . There are now two complex orientations that one can consider on the real locus  $\mathbb{R}C_0$ : the one induced by the curves  $\mathbb{R}C_s$  for  $s \in \mathbb{R}_{>0}$  and the one induced by the curves  $\mathbb{R}C_s$  for  $s \in \mathbb{R}_{<0}$ , where we identified the connected components of  $\mathbb{R}P^1 \setminus \{[0 : 1], [1 : 0]\}$  with  $\mathbb{R}_{>0}$  and  $\mathbb{R}_{<0}$ . The question is now whether or not these orientations coincide. If they coincide, we say that the real pencil  $(C_t)_t$  is of *type I*, while if they coincide with the opposite orientation, we say that the real pencil is of *type  $I_{rel}$* .

**Proposition 1.5.** *Let  $S$  be a non-singular real projective surface. Assume that  $S$  admits a real pencil  $(C_t)_{t \in \mathbb{C}P^1}$ , such that for every  $t \in \mathbb{R}P^1$ , the real locus  $\mathbb{R}C_t$  is non-singular and the curve  $C_t$  is of type I. If the pencil is of type I, then the real projective surface  $S$  is of type I, while if the pencil is of type  $I_{rel}$ , then the real projective surface is of type  $I_{[\mathbb{C}C_0]}$ .*

*Proof.* Let us fix coherent complex orientations relatively to  $C_0$  on the pencil  $(C_t)_t$ . For every  $t \in \mathbb{R}P^1 \setminus \{0\}$ , let us denote by  $\eta_t$  the half of  $\mathbb{C}C_t \setminus \mathbb{R}C_t$  inducing the chosen complex orientations. Denote by  $\eta_0^+$  and  $\eta_0^-$  the halves of  $\mathbb{C}C_0 \setminus \mathbb{R}C_0$  inducing the same complex orientations on  $\mathbb{R}C_0$  as the real loci  $\mathbb{R}C_s$  of the pencil, for  $s$  in  $\mathbb{R}_{>0}$  and  $\mathbb{R}_{<0}$  respectively. The union for all  $t \in \mathbb{R}P^1 \setminus \{0\}$  of the 2-chains  $\eta_t$  with the 2-chains  $\eta_0^\pm$  form a 3-chain with  $\mathbb{Z}_2$ -coefficients, denoted by  $\eta$ . By coherence of the orientations, the boundary of  $\eta$  is equal to  $\mathbb{R}S + \eta_0^+ + \eta_0^-$ . Yet, the pencil is of type I if and only if  $\eta_0^+ + \eta_0^- = 0$ , hence the result.  $\square$

*Remark 1.7.* This proposition is stated in a more geometric way than the definition of the type of a non-singular real projective surface. In fact, with the assumptions of the proposition, one can obtain a separating real morphism  $f : S \setminus C_0 \rightarrow \mathbb{A}^1$ , where  $\mathbb{A}^1$  is the real affine line, so that this result seems connected to both points of view on the type of curves, presented in Section 1.1.

*Example 1.4.* The real projective plane is an  $M$ -surface, so we already know by Remark 1.6 that the real projective plane is of type  $I_{wu}$ . The Wu-class  $wu(\mathbb{C}P^2)$  is the homology class of the complex locus of a line. Indeed, the only non-zero element of the  $\mathbb{Z}_2$ -space  $H_2(\mathbb{C}P^2; \mathbb{Z}_2)$  is the class of the complex locus of a line, and the self intersection of this element is 1 by Bézout's theorem. The proposition above offers a more geometric proof. Take any point  $x$  in  $\mathbb{R}P^2$  and consider the real pencil of lines  $(D_t)_{t \in \mathbb{C}P^1}$  passing through  $x$ . A real projective line is a non-singular real curve and is of type I. As illustrated by Figure 1.2, the real pencil  $(C_t)_t$  is of type  $I_{rel}$ . In order to prove that the pencil is effectively of type  $I_{rel}$ , one just has to consider the real loci of the lines of the pencil in a neighborhood of the point  $x$  and to notice that the orientation on a line is reversed by a rotation of angle  $\pi$ .

*Example 1.5.* A non-singular real surface  $S$  of degree 2 in  $\mathbb{P}^3$ , whose real locus is homeomorphic to a 2-dimensional torus is of type I. We already know it because  $S$  is an  $M$ -surface. Let us illustrate this statement using Proposition 1.5. Take a real line  $D$  in  $\mathbb{P}^3$  which does not intersect the hyperboloid  $\mathbb{R}S$  and consider the real pencil of planes  $(P_t)_t$  containing the line  $D$ . Define the curve  $C_t$  on  $S$  as the plane section of  $S$  by the plane  $P_t$ , for all  $t \in \mathbb{C}P^1$ . The curves  $(C_t)_t$  then form a real pencil of curves. For any  $t \in \mathbb{R}P^1$ , the real curve  $C_t$  is a conic in the plane  $P_t$  and the real locus is non-empty (and non-singular), so the curve  $C_t$  is of type I. Coherent complex orientations on the pencil  $(C_t)_t$  glue together at  $C_0$ , since we already know that the surface is of type I, as illustrated by Figure 1.3.

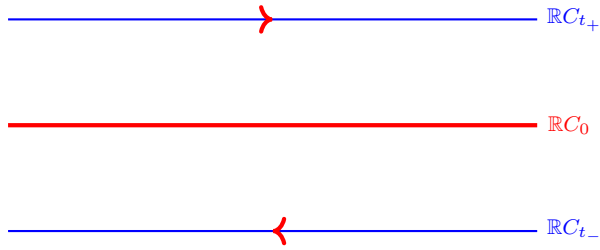

Figure 1.2: A real pencil of lines of type  $I_{rel}$  in the real projective plane and a choice of coherent complex orientations.

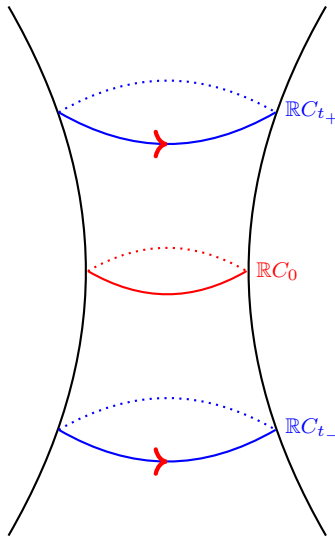

Figure 1.3: A real pencil of type  $I$  in a real quadric in  $\mathbb{P}^3$  whose real locus is a hyperboloid and a choice of coherent complex orientations.

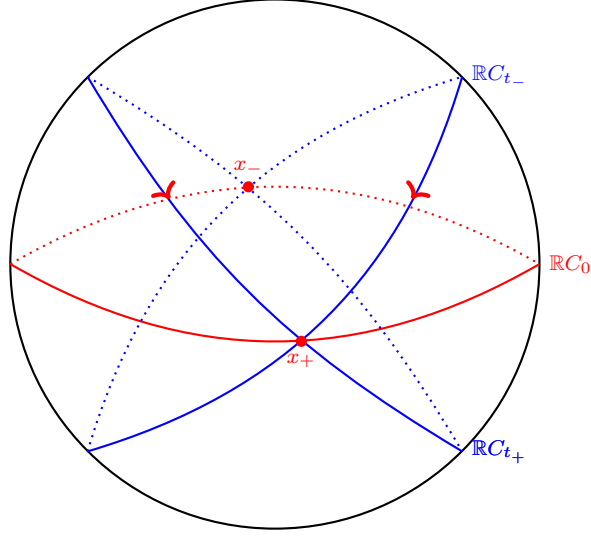

Figure 1.4: A real pencil of type  $I_{rel}$  in a real quadric in  $\mathbb{P}^3$  whose real locus is a sphere and a choice of coherent complex orientations.

*Example 1.6.* A non-singular real surface of degree 2 in  $\mathbb{P}^3$ , whose real locus is homeomorphic to a sphere, is of type  $I_{hp}$ . Take a real line  $D$  in  $\mathbb{P}^3$  which intersects  $\mathbb{R}S$  in two real points,  $x_+$  and  $x_-$ , and consider the real pencil of planes  $(P_t)_t$  containing the line  $D$ . Define the curve  $C_t$  on  $S$  as the plane section of  $S$  by the plane  $P_t$ , for all  $t \in \mathbb{C}P^1$ . The curves  $(C_t)_t$  then form a real pencil of curves. For any  $t \in \mathbb{R}P^1$ , the real curve  $C_t$  is a conic in  $P_t$  and the real locus is non-empty (and non-singular), so the curve  $C_t$  is of type  $I$ . In a neighborhood of  $x_+$ , the situation is the same as in a neighborhood of a the point  $x$  in Example 1.4. The situation is shown in Figure 1.4

We see that exhibiting pencils of type  $I$  and type  $I_{rel}$  offers a more geometric point of view on the type of non-singular real projective surfaces. This point of view also provides us with new examples of families of real algebraic surfaces of arbitrarily high degree and specific type.

*Definition 1.11.* Let  $S$  be a non-singular real projective surface in  $\mathbb{P}^3$  and let  $k$  be a positive integer. We say that  $k$  spherical components  $\Sigma_1, \dots, \Sigma_k$  of the real locus  $\mathbb{R}S$  form a *nest of spheres of depth  $k$* , if for all  $j \in \{1, \dots, k\}$ , the spheres  $\Sigma_1, \dots, \Sigma_{j-1}$  are contained in the contractible component of  $\mathbb{R}P^3 \setminus \Sigma_j$ . We say that  $k$  hyperboloids (that is, non-contractible tori of dimension 2)  $\Sigma_1, \dots, \Sigma_k$  form a *nest of hyperboloids of depth  $k$* , if for all  $j \in \{1, \dots, k\}$ , the hyperboloids  $\Sigma_1, \dots, \Sigma_{j-1}$  are contained in a same component of  $\mathbb{R}P^3 \setminus \Sigma_j$  (note that in this case, we are not able to distinguish between the two components of the complementary).

*Remark 1.8.* By Bézout's theorem, one can show that nests of spheres and nests of hyperboloids have depth at most  $\lfloor \frac{d}{2} \rfloor$ , where  $d$  is the degree of the surface.

**Proposition 1.6.** *Let  $d$  be an even positive integer. A non-singular real surface  $S$  of degree  $d$  in  $\mathbb{P}^3$ , whose real locus is homeomorphic to  $\frac{d}{2}$  nested hyperboloids, is of type  $I$ .*

*Proof.* Let us denote by  $\Sigma_1, \dots, \Sigma_{\frac{d}{2}}$  the hyperboloids of the nest. Take a line  $D$  in the component

of  $\mathbb{R}P^3 \setminus \Sigma_1$  which does not contain any hyperboloids of the nest. Consider the real pencil of planes  $(P_t)_t$  containing that line. The intersections of the planes  $P_t$  of the pencil with the real surface  $S$ , for  $t \in \mathbb{C}P^1$ , yield a real pencil of curves  $(C_t)_t$  on  $S$ . For any  $t \in \mathbb{R}P^1$ , the curve  $C_t$  is a real curve of degree  $d$  in the plane  $P_t$  and the real locus  $\mathbb{R}C_t$  is a (non-singular) nest of depth  $\frac{d}{2}$ , implying that the curve  $C_t$  is of type  $I$ . One can then choose coherent complex orientations relatively to  $C_0$ . Since the chosen orientation on any hyperboloid  $\Sigma_j$  for  $j \in \{1, \dots, k\}$  is the same as in Example 1.5 for a real surface of degree 2, the pencil is of type  $I$ . By Proposition 1.5, the real surface  $S$  is then of type  $I$ .  $\square$

Proposition 1.6 above describes a family of non-singular real surfaces of arbitrary high even degree  $d$  in  $\mathbb{P}^3$ , which are of type  $I$  but not maximal for  $d \geq 4$ . In fact, one can obtain a non-singular real surface of degree  $d$  in  $\mathbb{P}^3$  having a nest of  $\frac{d}{2}$  hyperboloids, by multiplying and then slightly perturbing the defining polynomials of  $\frac{d}{2}$  real surfaces  $S_1, \dots, S_{\frac{d}{2}}$  of degree 2, whose real locus  $\mathbb{R}S_1, \dots, \mathbb{R}S_{\frac{d}{2}}$  are hyperboloids such that for all  $k \in \{2, \dots, \frac{d}{2}\}$ , the hyperboloids  $\mathbb{R}S_1, \dots, \mathbb{R}S_{k-1}$ , are contained in a same component of  $\mathbb{R}P^3 \setminus (\mathbb{R}S_k)$ .

**Proposition 1.7.** *Let  $d$  be an even positive integer. A non-singular surface  $S$  of degree  $d$  in  $\mathbb{P}^3$ , whose real part is homeomorphic to  $\frac{d}{2}$  nested spheres, is of type  $I_{hp}$ .*

*Proof.* Let us denote by  $\Sigma_1, \dots, \Sigma_{\frac{d}{2}}$  the spheres of the nest. Take a line  $D$  intersecting the spheres  $\Sigma_j$  in two points  $x_{\pm}^j$ , for all  $j \in \{1, \dots, k\}$ . Consider the real pencil of planes  $(P_t)_t$  containing that line  $D$ . The intersections of the pencil  $P_t$  with the real surface  $S$  yield a real pencil of curves  $(C_t)_t$  on  $S$ . For any  $t \in \mathbb{R}P^1$ , the curve  $C_t$  is a real curve of degree  $d$  in the plane  $P_t$  and the real locus  $\mathbb{R}C_t$  is a (non-singular) nest of depth  $\frac{d}{2}$ , implying that the curve  $C_t$  is of type  $I$ . One can then choose coherent complex orientations relatively to  $C_0$ . Since the chosen orientation on any sphere  $\Sigma_j$  for  $j \in \{1, \dots, k\}$  is the same as in Example 1.6 for a real surface of degree 2, the pencil is of type  $I_{rel}$ . By Proposition 1.5, the real surface  $S$  is then of type  $I_{[\mathbb{C}C_0]}$ , in other words, of type  $I_{hp}$ .  $\square$

Similarly to Proposition 1.6, Proposition 1.7 above describes a family of non-singular real surfaces of arbitrary high even degree  $d$  in  $\mathbb{P}^3$ , which are of type  $I_{hp}$ . Using a similar pencil as in the proof above, one obtains a family of non-singular real surfaces of arbitrarily high odd degree in  $\mathbb{P}^3$ , which are of type  $I_{hp}$ , but not maximal for  $d \geq 5$ .

**Proposition 1.8.** *Let  $d$  be an odd positive integer. A non-singular real surface  $S$  of degree  $d$  in  $\mathbb{P}^3$ , whose real part is homeomorphic to the disjoint union of  $\frac{d-1}{2}$  nested spheres and a component homeomorphic to a real projective plane, is of type  $I_{hp}$ .*

*Proof.* One can use similar pencil and arguments to the ones of the proof of Proposition 1.8.  $\square$

In general, a non-singular real projective surface does not have real pencils of type  $I$  or  $I_{rel}$ , however, such a pencil sometimes does exist on specific examples and can be used in order to help us understand the behavior of complex orientations of surfaces.





## 2 Tropical Geometry

### 2.1 Tropical Varieties and Tropical Manifolds

In the first part of this chapter, we recall some basics of tropical geometry and define the tropical spaces that we are going to work with in the following chapters. These spaces are defined as a specific kind of 2-dimensional tropical manifolds and they naturally arise as non-singular tropical surfaces in tropical toric varieties of dimension 3.

#### 2.1.1 Tropical Polynomials and Tropical Subvarieties of the tropical torus

We define the *tropical semi-field* as the set  $\mathbb{T} = \mathbb{R} \cup \{-\infty\}$  endowed with the tropical addition " $a + b$ " =  $\max(a, b)$  and the tropical multiplication " $a \cdot b$ " =  $a + b$ . We consider the euclidean topology on  $\mathbb{R}$  and extend it on  $\mathbb{T}$  with the open sets of the form  $[-\infty, a)$  for  $a \in \mathbb{R}$ , so that  $\mathbb{T}$  is homeomorphic to an interval  $[0, 1)$ . The neutral element for the tropical addition is  $-\infty$ , and for the tropical multiplication it is 0. Therefore, the *tropical torus* of dimension  $n \geq 0$  is  $(\mathbb{T} \setminus \{-\infty\})^n = \mathbb{R}^n$ , and this torus is dense in  $\mathbb{T}^n$  for the product topology.

A tropical polynomial in  $n$  variables is given by  $P \in \mathbb{T}[x_1, \dots, x_n]$ , and we write  $P = \sum_{k \in (\mathbb{Z}_{\geq 0})^n} a_k x^k$ , with only a finite number of  $a_k \in \mathbb{R}$  and " $x^k$ " = " $x_1^{k_1} \dots x_n^{k_n}$ ". If  $P$  is non-

trivial, meaning it has at least one coefficient different from  $-\infty$ , it defines a convex piecewise

affine function  $f_P : \mathbb{R}^n \rightarrow \mathbb{R}$ , given by  $f_P(x) = \max_{k \in (\mathbb{Z}_{\geq 0})^n} \left( a_k + \sum_i k_i x_i \right)$ . As for a polynomial

over any field, there is a variety associated with a tropical polynomial. However, this variety it is not defined as the zero locus of the polynomial, but rather as the corner-locus of the function  $f_P : \mathbb{R}^n \rightarrow \mathbb{R}$  that it defines. In fact, the tropical zero being  $-\infty$ , one can immediately see that  $f_P^{-1}(-\infty)$  is empty, as soon as  $P$  is non-trivial.

Given a non-trivial tropical polynomial  $P = \sum_{k \in (\mathbb{Z}_{\geq 0})^n} a_k x^k$ , the domains where  $f_P : \mathbb{R}^n \rightarrow \mathbb{R}$

is affine, yield the  $n$ -cells of a polyhedral decomposition of  $\mathbb{R}^n$ , such as in figure 2.1, for the tropical conic " $x^2 + 1xy + y^2 + x + y + (-2)$ ". The *corner-locus* of  $f_P$  is the set of all points where  $f_P$  is not differentiable. This corner-locus is the  $(n-1)$ -skeleton of the polyhedral decomposition of  $\mathbb{R}^n$  given by  $P$ . In particular, the corner-locus is a *polyhedral complex*, that is, a union of polyhedral domains  $\bigcup_D D$ , such that  $D_i \cap D_j$  is either empty or a face of both  $D_i$  and  $D_j$ . One can show that this polyhedral complex is *pure dimensional* of dimension  $n - 1$ , meaning that the maximal faces for inclusion, called *facets*, are all of the same dimension  $n - 1$ . Moreover, each  $n$ -cell corresponds to a unique monomial " $a_k x^k$ " of  $P$ , which satisfies, for every  $x$  in this  $n$ -cell, the equality  $f_P(x) = a_k x^k = a_k + k \cdot x$ .

The example " $0 + x + x^2$ " = " $0 + x^2$ " shows that not every monomial of the tropical polynomial induces an  $n$ -cell. However, one can show that the extremal monomials, meaning the ones that are not convex combinations of other monomials, always appear. In fact, the above polyhedral decomposition of  $\mathbb{R}^n$  is dual to a subdivision of the *Newton polytope*  $\Delta(P)$  of  $P$ , where  $\Delta(P) := \text{Conv}(\{k \in (\mathbb{Z}_{\geq 0})^n \mid a_k \neq -\infty\})$ . Let  $F$  be a cell of this polyhedral decomposition. We define the dual cell  $\Delta_F \subset \Delta(P)$  by  $\Delta_F := \text{Conv}(\{k \in (\mathbb{Z}_{\geq 0})^n \mid f_P(x) = a_k x^k\})$  for any  $x \in F$ . These cells  $\Delta_F$  yield a polyhedral decomposition of the Newton polytope of  $P$ , called the *dual subdivision*. This terminology is justified by the following proposition.

**Proposition 2.1.** [8] *One has*

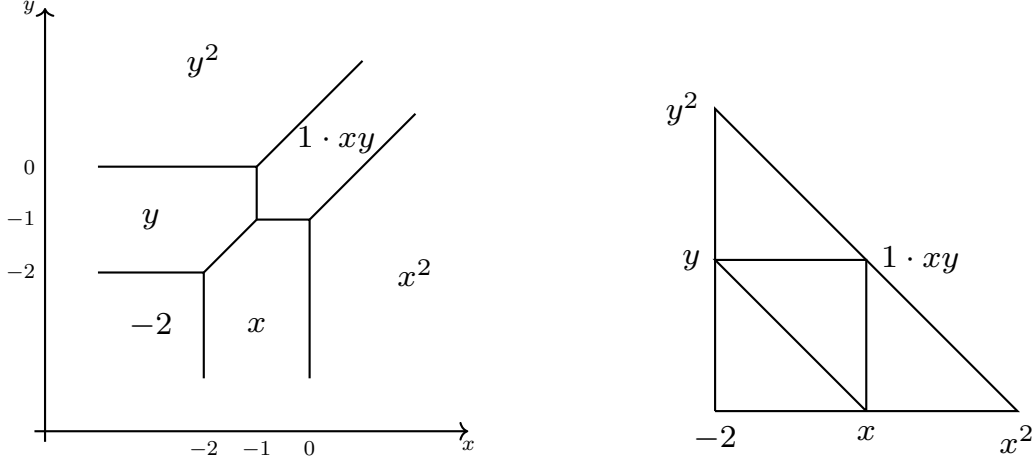

Figure 2.1: Polyhedral subdivision of  $\mathbb{R}^2$  arising from the tropical conic " $x^2 + 1xy + y^2 + x + y + (-2)$ " and the dual subdivision of its Newton polytope.

- $\Delta(P) = \bigcup_F \Delta_F$ , where the union is taken over all cells  $F$  of the polyhedral subdivision of  $\mathbb{R}^n$  induced by  $P$ ;
- $\dim F = \text{codim} \Delta_F$ , for every cell  $F$  of the polyhedral subdivision;
- $F$  and  $\Delta_F$  are orthogonal, in the sense that the directions of their affine spans are orthogonal, for every cell  $F$  of the polyhedral subdivision;
- $F \subset F'$  if and only if  $\Delta_{F'} \subset \Delta_F$  and in that case,  $\Delta_{F'}$  is a face of  $\Delta_F$ ;
- $F$  is unbounded if and only if  $\Delta_F \subset \partial \Delta(P)$ , for every cell  $F$  of the polyhedral subdivision.

The above proposition enables us to associate a weight to every  $(n-1)$ -cell of the polyhedral subdivision of  $\mathbb{R}^n$  (recall that they are top-dimensional cell of the corner-locus). Such a cell  $F$ , is in fact dual to an edge  $\Delta_F$  of the dual subdivision of  $\Delta(P)$ . The *weight* of  $F$ , denoted by  $w(F)$  is defined as the number of integer points in  $\Delta_F$  minus 1, that is

$$w(F) := \text{Card}(\Delta_F \cap (\mathbb{Z}_{\geq 0})^n) - 1.$$

*Definition 2.1.* For  $P = \sum_{k \in \mathbb{Z}^n} a_k x^k$  a tropical polynomial, the *tropical hypersurface*,  $(V(P), w)$ , associated with  $P$ , is the corner-locus of  $f_P : \mathbb{R}^n \rightarrow \mathbb{R}$ , denoted by  $V(P)$ , endowed with the weight function  $w$  defined above.

*Remark 2.1.* The corner-locus  $V(P)$  alone is often referred to as the tropical hypersurface by other references (see for instance [29, 24]). In the next sections, all weights are equal to one, so it does not make any difference here.

*Example 2.1.* The tropical curve associated with " $x^2 + 1xy + y^2 + x + y + (-2)$ " has only weights 1 on its edges. The tropical polynomial " $0 + x^2$ " in one variable defines a tropical variety reduced

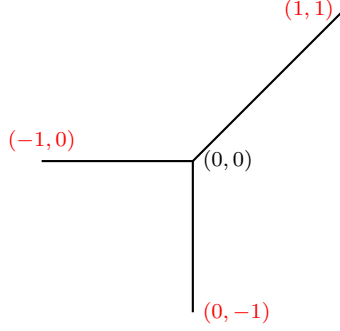

Figure 2.2: The standard tropical line in  $\mathbb{R}^2$  given by " $0 + x + y$ ". The primitive directions of the rays are in red.

to the point 0, but with multiplicity 2. The linear tropical polynomial " $0 + x_1 + \dots + x_n$ " has the standard  $n$ -simplex as Newton polytope and the associated tropical hypersurface is the  $(n - 1)$ -skeleton of the normal fan to this polytope. We call  $V("0 + x_1 + \dots + x_n")$  the *standard tropical hyperplane* in  $\mathbb{R}^n$  (see figures 2.2 and 2.3 for a standard tropical line and a standard tropical plane).

The above definition introduces tropical hypersurfaces as pure-dimensional weighted polyhedral complexes. These complexes satisfy two additional properties. Firstly, the tangent vector spaces to the faces are defined by equations with rational coefficients (implying they can be reformulated with integer coefficients). We say that these complexes are *rational*. Secondly, they satisfy the so-called *balancing-condition*. Let  $\sigma$  be a codimension 1 face of a rational polyhedral complex, with  $l \in \mathbb{Z}_{>0}$  adjacent facets (*i.e.* faces of maximal dimension), denoted by  $F_1, \dots, F_l$ . For any  $j \in \{1, \dots, l\}$ , the tangent vector space of  $\sigma$ , denoted by  $T\sigma$ , is a codimension 1 subspace of the tangent vector space of  $F_j$ , therefore, the quotient space  $TF_j/T\sigma$  is of dimension 1. Moreover, the rationality hypothesis implies that the quotient lattice  $T_{\mathbb{Z}}F_j/T_{\mathbb{Z}}\sigma$  is a 1-dimensional lattice of  $TF_j/T\sigma$ . Recall that a vector  $v \in \mathbb{Z}^n$  is said to be *primitive* if  $v = \lambda\tilde{v}$  with  $\lambda \in \mathbb{Z}$  and  $\tilde{v} \in \mathbb{Z}^n$ , implies that  $\lambda = \pm 1$ . The balancing condition is satisfied at  $\sigma$  if, for any primitive vectors  $v_1, \dots, v_l$ , such that for any  $j \in \{1, \dots, l\}$ , the vector  $v_j$  generates the quotient lattice  $T_{\mathbb{Z}}F_j/T_{\mathbb{Z}}\sigma$ , one has

$$\sum_j w(F_j)v_j \in T\sigma.$$

A pure-dimensional rational weighted polyhedral complex is said to be *balanced*, if all its codimension 1 faces satisfy the balancing condition.

**Proposition 2.2.** [8] *Tropical hypersurfaces in  $\mathbb{R}^n$  are balanced  $(n - 1)$ -dimensional weighted rational polyhedral complexes.*

There is a lot to say about tropical hypersurfaces and we refer to [25] for more detailed exposures. The rest of this work mainly focuses on non-singular tropical hypersurfaces, defined below.

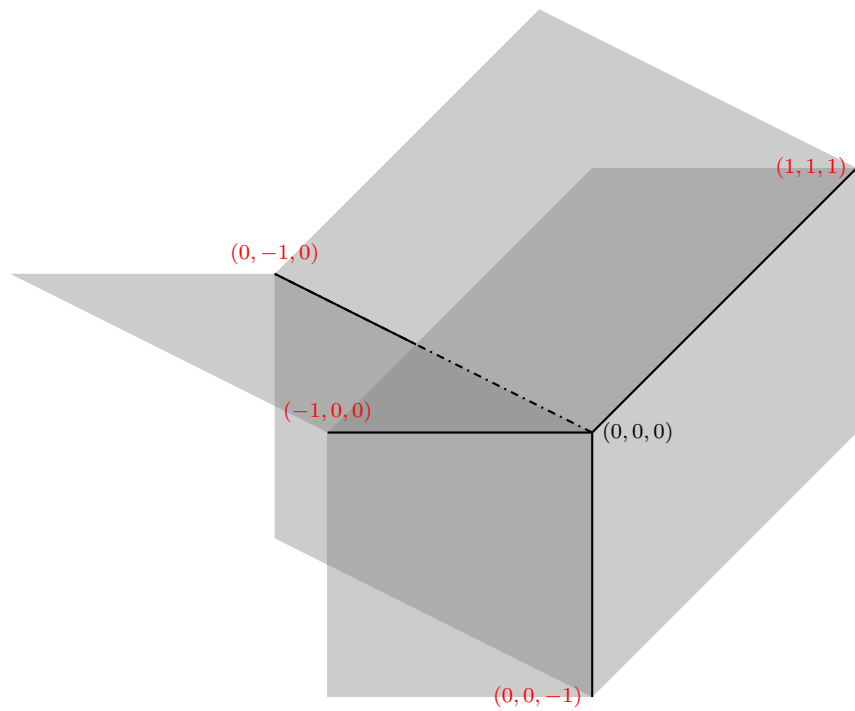

Figure 2.3: The standard tropical plane in  $\mathbb{R}^3$  given by " $0 + x + y + z$ ". The primitive directions of the rays are in red.

*Definition 2.2.* Let  $\Delta \subset \mathbb{R}^n$  be a polytope of dimension  $n$ , with integer vertices. A rectilinear triangulation of  $\Delta$  with integer vertices, is said to be *primitive*, if every  $n$ -simplex of the triangulation is of minimal possible volume  $\frac{1}{n!}$ . A tropical hypersurface is said to be *non-singular*, if the dual subdivision is primitive.

Non-singular tropical hypersurfaces appear as a special kind of tropical manifolds, as we introduce them in Section 2.1.3. It is a direct consequence of the definition that a non-singular tropical hypersurface has only weights equal to 1. Therefore, it is equivalent to speak of a non-singular tropical hypersurface or of the corner-locus of a defining tropical polynomial. Moreover, a neighborhood of a vertex of a non-singular hypersurface always looks like the normal fan of a standard  $n$ -simplex, because the dual cell is a standard  $n$ -simplex, up to an action of  $GL_n(\mathbb{Z})$ . This statement is precised with the foregoing definition of tropical manifold in Section 2.1.3.

*Example 2.2.* The tropical curve  $V("x^2 + 1xy + y^2 + x + y + (-2)")$  of Example 2.1 is non-singular. As every non-singular tropical curve in  $\mathbb{R}^2$ , the underlying topological space is a trivalent graph with some unbounded edges. The tropical hyperplane  $V("1 + x_1 + \dots + x_n")$  a non-singular tropical hypersurface in  $\mathbb{R}^n$ . Figures 2.2 and 2.3 show a tropical line in  $\mathbb{R}^2$  and a tropical plane in  $\mathbb{R}^3$ . The tropical hypersurface arising from such a linear polynomial is a first occurrence of *fan tropical linear space*.

There is an equivalence between  $(n - 1)$ -dimensional weighted rational polyhedral complexes in  $\mathbb{R}^n$  and tropical hypersurfaces (see for instance [30] or [25]). Therefore, a  $d$ -dimensional *tropical subvariety* of  $\mathbb{R}^n$  is defined as a  $d$ -dimensional weighted rational polyhedral complex.

*Example 2.3.* In  $\mathbb{R}^n$ , the one-dimensional fan with edges  $\mathbb{R}_{\geq 0}(-e_1), \dots, \mathbb{R}_{\geq 0}(-e_n)$  and  $\mathbb{R}_{\geq 0}e_0$  defines a tropical line. One can view it as the 1-skeleton of the standard hyperplane (see Section 2.1.2 for the definition of a (rational) fan and Section 2.1.3 for more details about tropical subvarieties coinciding with fan in  $\mathbb{R}^n$ ).

### 2.1.2 Tropical Toric Varieties

As mentioned in the previous section,  $\mathbb{R}^n$  can be seen as the tropical torus. We present the construction of tropical toric varieties only in the smooth case, that is to say the ones constructed with unimodular fans. These varieties are obtained in the same way as in the classical case, gluing affine patches together. We follow the exposure and the notations of [30] (section 3.2). The construction of tropical toric varieties, not necessarily smooth is also mentioned there, and is briefly detailed for instance in [2].

The first two smooth toric tropical varieties are of course the tropical torus  $\mathbb{R}^n$  and the tropical affine space  $\mathbb{T}^n$ . The patches that are glued together are affine, so one needs first to understand these patches in  $\mathbb{T}^n$ . One crucial difference between the classical affine spaces and the tropical ones, is that, in the tropical case, all points do not behave topologically in the same way. In fact, a point  $(x_1, \dots, x_n) \in \mathbb{T}^n$  can have some of its coordinates equal to  $-\infty$ . These points are on the boundary of the topological manifold  $\mathbb{T}^n$ , so there are some directions along which they are not able to move freely. That is why they are called *sedentary points*. We denote by  $[n]$  the set  $\{1, \dots, n\}$ .

*Definition 2.3.* Let  $x = (x_1, \dots, x_n) \in \mathbb{T}^n$ . The *sedentarity* of  $x$  is the subset  $sed(x) \subseteq [n]$  defined by the integers  $i \in [n]$  such that  $x_i = -\infty$ . The *order of sedentarity* of  $x$  is the cardinal  $|sed(x)|$  of the sedentarity of  $x$ .

Given a subset  $I \subseteq [n]$ , one can define the subset of points of  $\mathbb{T}^n$  having sedentarity  $I$ . We denote this subset by  $\mathbb{R}_I := \{x \in \mathbb{T}^n \mid \text{sed}(x) = I\}$ . The closure of  $\mathbb{R}_I$  in  $\mathbb{T}^n$  is denoted by  $\mathbb{T}_I$  and equals the subset of points which contains  $I$  in their sedentarity. Note that, forgetting the sedentary coordinates produces a homeomorphism  $\mathbb{R}_I \simeq \mathbb{R}^{n-|I|}$ . There is then a natural stratification of  $\mathbb{T}^n$  by

$$\mathbb{T}^n = \bigsqcup_{I \subseteq [n]} \mathbb{R}_I.$$

As in the classical case, the gluing maps used for toric varieties are monomial transformations. The tropical monomial transformations  $x \mapsto ({}^n x^{a_j})_j$  with  $a_j \in \mathbb{Z}$  for all  $j \in [n]$ , are integer linear maps, since  ${}^n x^{a_j} = \sum_i a_{ij} x_i$  with  $a_j = (a_{ij})_{i \in [n]}$ . How do they act on  $\mathbb{T}^n$  and on the strata  $\mathbb{R}_I$ ? These maps are always well defined on  $\mathbb{R}_\emptyset = \mathbb{R}^n$ , but not necessarily on the other strata of  $\mathbb{T}^n$ . In fact, it is possible to define  $(-\infty)^a = a \times (-\infty)$  as  $-\infty$  if  $a > 0$  or  $0$  if  $a = 0$ , but not as  $+\infty$  when  $a < 0$ , because  $\mathbb{T}$  does not contain  $+\infty$ . Therefore, given a tropical monomial map  $x \rightarrow Ax$  with  $A = (a_{ij})_{ij} \in \mathcal{M}_n(\mathbb{Z})$ , it can be extended from  $\mathbb{R}^n$  to  $\bigsqcup_{I \subseteq I(A)} \mathbb{R}_I$ ,

where  $I(A)$  is defined as the subset of all integers  $i \in [n]$  such that for all  $j \in [n]$ , one has  $a_{ij} \geq 0$ .

Now, let us briefly recall some basics on rational polyhedrons, cones and fans in  $\mathbb{R}^n$ . In the following, a *rational polyhedron* in  $\mathbb{R}^n$  is the intersection of a finite number of subsets of the form  $H_\kappa = \kappa^{-1}(\mathbb{R}_{\leq 0})$ , where  $\kappa : \mathbb{R}^n \rightarrow \mathbb{R}$  is an affine map, whose linear part has integer coefficients (or equivalently rational coefficients). A *face* of a polyhedron  $\sigma$  is the intersection of  $\sigma$  with  $\kappa^{-1}(\{0\})$ , where  $\kappa$  is an affine map such that  $\sigma \subset H_\kappa$ . The *boundary*  $\partial\sigma$  of a rational polyhedron is the union of all proper faces of  $\sigma$ . It coincides with the relative boundary of  $\sigma$  for the topology on  $\sigma$  induced by the euclidean topology on  $\mathbb{R}^n$ . A *rational cone* is a rational polyhedron where the defining equations  $\kappa$  are linear. In particular, a rational cone always contains  $0 \in \mathbb{R}^n$ . The *span* of a cone  $\sigma$  is denoted by  $L(\sigma)$  and is the smallest vector subspace of  $\mathbb{R}^n$  containing  $\sigma$ , and the *dimension*  $\dim(\sigma)$  of  $\sigma$  is the dimension of  $L(\sigma)$ . We say that a rational cone  $\sigma$  is *generated* by a family of vectors  $(v_1, \dots, v_N)$  of  $\mathbb{R}^n$ , for some  $N \geq 0$ , if  $\sigma$  is equal to the set of non-negative linear combinations of the vectors  $v_i$ . Finally, we put  $L_{\mathbb{Z}}(\sigma) := L(\sigma) \cap \mathbb{Z}^n$ . Because the coefficients of the defining equations are integer, it is possible to find a generating family of  $\sigma$  by integer vectors which also generate  $L_{\mathbb{Z}}(\sigma)$  as a lattice.

A *rational fan* in  $\mathbb{R}^n$  is a collection of rational cones, closed by intersection and taking faces. A rational fan  $\Xi$  is *unimodular*, if every cone  $\sigma \in \Xi$  admits a generating family of cardinal  $\dim \sigma$ , which forms a lattice basis of  $L_{\mathbb{Z}}(\sigma)$ . Finally, if  $\Delta \subset \mathbb{R}^n$  is a convex polytope with non-empty interior, the *normal fan* of  $\Delta$  is defined in the following way. For each  $(n-1)$ -dimensional face  $F$ , denote by  $\sigma_F$  the half-line of vectors normal to  $F$  and pointing outwards the polytope  $\Delta$ . For each lower dimensional face  $G$ , denote by  $\sigma_G$  the convex hull of all the rays  $\sigma_F$  such that  $G \subset F$ . The normal fan of  $\Delta$ , denoted by  $\Xi(\Delta)$ , is the union of the cones  $\sigma_G$  for all faces  $G$  of the polytope  $\Delta$ . It is a *complete fan*, that is, the union of all its cones is  $\mathbb{R}^n$ .

Let us now construct a smooth tropical variety (e.g a tropical manifold whose Definition is introduced in Section 2.1.3) from a unimodular fan  $\Xi$ . For every  $\sigma \in \Xi$  of dimension  $k \in \mathbb{Z}_{\geq 0}$ , choose a basis  $(e_i^\sigma)_{1 \leq i \leq n}$  of  $\mathbb{Z}^n$ , such that  $\sigma$  is generated by  $(-e_i^\sigma)_{1 \leq i \leq k}$ . Put  $U_\sigma := \mathbb{T}^k \times \mathbb{R}^{n-k}$ . The sets  $U_\sigma$  are the patches of our tropical toric variety. Let us define the gluing morphisms. For two cones  $\sigma, \sigma' \in \Xi$ , let  $A^{\sigma, \sigma'} \in GL_n(\mathbb{Z})$  be the coordinate change matrix from  $(e_i^{\sigma'})_i$  to  $(e_i^\sigma)_i$ . The associated linear map  $\phi_{\sigma, \sigma'}$  is a tropical linear map and goes from  $\mathbb{R}^n$  to itself.

The following lemma explains when this map can be extended to some other strata of  $\mathbb{T}^n$ . By convention,  $e^{\{0\}}$  is the canonical basis of  $\mathbb{R}^n$ .

**Lemma 2.1.** [30] *If  $\tau$  is a face of  $\sigma \in \Xi$ , then the map  $\phi_{\sigma,\tau}$  extends to an open embedding  $\phi_{\sigma,\tau} : U_\tau \rightarrow U_\sigma$ . Its image is denoted by  $U_\sigma^\tau$ . If  $\tau$  is a common face of  $\sigma$  and  $\sigma'$ , then  $\phi_{\sigma',\sigma}$  extends to a homeomorphism  $U_\sigma^\tau \simeq U_{\sigma'}^\tau$ . Moreover, when it is defined, one has  $\phi_{\sigma,\sigma'} \circ \phi_{\sigma',\sigma''} = \phi_{\sigma,\sigma''}$ .*

The above lemma makes sure that the gluing morphisms  $\phi_{\sigma,\sigma'}$  define an equivalence relation, denoted by  $\sim$ , on  $\bigsqcup_{\sigma \in \Xi} U_\sigma$ , by  $x \sim \phi_{\sigma,\sigma'}(x)$  whenever it is defined.

*Definition 2.4.* The *smooth tropical toric variety* associated with a unimodular fan  $\Xi$  of  $\mathbb{R}^n$  is defined as the quotient space

$$X_\Xi := \bigsqcup_{\sigma \in \Xi} U_\sigma / \sim.$$

The *dimension* of  $X_\Xi$  is  $n$ .

*Example 2.4.* As mentioned before,  $\mathbb{R}^n$  and  $\mathbb{T}^n$  are smooth tropical toric varieties of dimension  $n$ . In fact, for every  $I \subset [n]$ , the union  $\bigsqcup_{J \subseteq I} \mathbb{R}_J$  is a smooth tropical toric variety. In order to see

this, one can consider the fan in  $\mathbb{R}^n$ , whose  $k$ -dimensional cones are generated by  $k$  vectors of the family  $(-e_i)_{i \in I}$ .

*Example 2.5.* The *tropical projective space*  $\mathbb{T}P^n$  is a smooth tropical toric variety of dimension  $n$ . It can be defined using the same complete fan as in the classical case, that is to say the complete fan, whose 1-dimensional cones are  $\mathbb{R}_{\geq 0}(-e_1), \dots, \mathbb{R}_{\geq 0}(-e_n)$  and  $\mathbb{R}_{\geq 0}e_0$  where  $e_0 = \sum_{1 \leq i \leq n} e_i$ . One can also define  $\mathbb{T}P^n$  as

$$\mathbb{T}P^n := (\mathbb{T}^{n+1} \setminus \{-\infty, \dots, -\infty\}) / \mathbb{R},$$

where  $\mathbb{R}$  acts by simultaneous addition (*i.e.* tropical multiplication) on each coordinate. Topologically,  $\mathbb{T}P^n$  is homeomorphic to an  $n$ -simplex.

Every smooth tropical toric variety  $X$  is endowed with a natural open dense embedding of  $\mathbb{R}^n = U_{\{0\}}$ . Let  $P$  be a non-trivial tropical polynomial in  $n$  variables. Since the corner-locus  $V(P)$  of the function  $f_P$  is a subset of  $\mathbb{R}^n \subset X$ , one can define  $V_X(P)$  as the closure of  $V(P)$  in  $X$ . Thus, it makes sense to speak about tropical subvarieties of a smooth tropical toric variety. Since  $X$  is defined by gluing maps, it may not have a sense to speak of the sedentarity of a point in terms of some subset  $I \subset [n]$ , but the order of sedentarity of a point of a smooth tropical toric subvariety still makes sense, since this is preserved by affine integer invertible maps. We also extend the notion order of sedentarity to any cell of a tropical hypersurface  $V_X(P)$  in a smooth tropical toric variety  $X$ . The order of sedentarity of a cell  $\sigma$  in  $V_X(P)$ , is the order of sedentarity of any point in the relative interior of  $\sigma$  inside  $V_X(P)$ . Note that the balancing condition holds only for codimension 1 faces of sedentarity 0.

### 2.1.3 Tropical Manifolds

As usual when defining an object such as a manifold, we need to specify what are the local models. The local models of a tropical manifold are *fan tropical linear spaces*. A nice reference for the definitions and lemma of this section is K. Shaw's PhD thesis [36].

There are several equivalent ways of defining matroids, all of them being equivalent. Here we define matroids via their *rank* function. Our use of matroids is limited to the definition of a tropical manifold.



*Definition 2.5.* A *matroid*  $M$  is given by the data of a finite set  $E$  equipped with a *rank function*  $r : \mathcal{P}(E) \rightarrow \mathbb{Z}_{>0}$ , where  $\mathcal{P}(E)$  is the set of all subsets of  $E$ . The rank function  $r$  has to satisfy the two followings properties:

- for all  $A, B \in \mathcal{P}(E)$ , such that  $A \subset B$  one has  $r(A) \leq r(B) \leq \text{Card}(B)$ ;
- for all  $A, B \in \mathcal{P}(E)$ , one has  $r(A \cup B) \leq r(A) + r(B)$ .

If  $M = (E, r)$  is a matroid, a subset  $F \in \mathcal{P}(E)$  is called a *flat*, if for every  $e \in E$ , one has  $r(F) < r(F \cup \{e\})$ . Endowed with the inclusion of subsets, the flats of  $M$  form a partially ordered set known as the *lattice of flats*. This meaning of "lattice" is only used in this section. In all the other sections of this text, the word lattice is to be understood as lattice group. In order to define tropical manifolds, we restrict to *loopless* matroids without *double points*. An element  $e \in E$  is a *loop* in  $M$ , if  $r(e) = 0$ , and a couple  $\{e, f\} \subset E$  is a *double point* if  $r(\{e, f\}) = 1$ . One associates a polyhedral fan to a loopless matroid without double points, in the following way.

*Definition 2.6.* Let  $M = (E, r)$  be a loopless matroid without double points. For simplicity of notations, assume that  $E = \{1, \dots, n\}$ , also denoted by  $[n]$ . Let  $v_i = -e_i$  for  $i \in [n]$ , where  $(e_i)_i$  is the canonical basis of  $\mathbb{R}^n$ , and  $v_0 = \sum_i e_i$ . For any subset  $I \subset [n]$ , we set  $v_I = \sum_{i \in I} v_i$ . Then, for every maximal (meaning longest) chain of flats  $\emptyset \neq F_1 \subset \dots \subset F_k \neq [n]$ , one defines the cone generated by the family  $(v_{F_1}, \dots, v_{F_k})$ . The union of all these cones, indexed on the maximal chains of flats, is denoted by  $B(M)$ , and is called the *Bergman fan* of  $M$ .

**Lemma 2.2.** *Let  $M$  be a loopless matroid without double points. Then  $B(M)$  is a tropical subvariety of  $\mathbb{R}^n$  of dimension  $r(M)$ .*

*Definition 2.7.* A *fan tropical linear space* in a smooth tropical toric variety  $X$ , is the closure of  $B(M)$  for some matroid  $M$ .

*Example 2.6.* Any  $k$ -skeleton of the normal fan of a primitive  $n$ -simplex in  $\mathbb{R}^n$  is a  $k$ -dimensional fan tropical linear space.

*Definition 2.8.* A Hausdorff topological space  $X$  is a *tropical manifold* of dimension  $n$ , if  $X$  is equipped with an atlas of charts  $\phi_\alpha : U_\alpha \rightarrow V_\alpha \subseteq \mathbb{T}^{N_\alpha}$  such that the following three conditions hold:

- for every  $\alpha$ , the map  $\phi_\alpha$  is an open embedding and  $V_\alpha \subset \mathbb{T}^{N_\alpha}$  is a fan tropical linear space of dimension  $n$ ;
- the overlapping maps  $\phi_\alpha \circ (\phi_\beta)^{-1} : \phi_\beta(U_\alpha \cap U_\beta) \rightarrow \mathbb{T}^{N_\alpha}$  are induced by (extensions of) affine integer maps (as in Section 2.1.2);
- there exists a finite open cover  $\{W_i\}$  of  $X$ , such that for every  $i$ , there exists  $\alpha$  such that  $W_i \subset U_\alpha$  and  $\overline{\phi_\alpha(W_i)} \subset V_\alpha$ .

*Example 2.7.* Smooth tropical toric varieties are tropical manifolds with charts  $\phi_\alpha : U_\alpha \rightarrow V_\alpha = \mathbb{T}^{N_\alpha}$ , such that  $\mathbb{R}^{N_\alpha} \subset \phi_\alpha(U_\alpha)$ . Therefore, it makes sense to speak of tropical toric manifold.

*Remark 2.2.* The charts used in the definition of tropical manifold can only have value in a fan tropical linear space  $V$ . We sometimes refer to more general charts  $\phi : U \rightarrow \mathbb{T}^N$ . It means that  $U$  is an open set of  $X$  and that  $\phi$  is an (extension of) affine integer map seen via any chart of tropical manifold as in Definition 2.8.

As in the case of smooth tropical toric manifolds, it makes sense to define the order of sedentarity of a point of a tropical manifold  $X$  and this order is denoted by  $|\text{sed}(x)|$ . The *boundary* of  $X$ , denoted by  $\partial X$ , is defined as the points  $x$  such that  $|\text{sed}(x)| \geq 1$ . We denote by  $X^\circ = X \setminus \partial X$  the *interior of  $X$* , which are precisely the points of sedentarity 0. The points of  $X^\circ$  are also called *mobile points*. There is much more to say about tropical manifolds and their relationship with matroids and hyperplane arrangements, and we refer to [30] and [36] for a more in-depth exposure. Tropical manifolds are also referred to as *smooth tropical varieties*. The adjective *smooth* is attributed to a notion of *abstract tropical variety*, defined for instance in [30]. In one word, tropical varieties are built on local models, among which fan tropical linear spaces correspond to the smooth ones. It can happen that some of these smooth local models are tropical hypersurfaces of  $\mathbb{T}^n$ . It explains the name given for the following definition.

*Definition 2.9.* A tropical manifold  $X$  is called a *hypersmooth tropical variety* if for every point  $x \in X$  there exists a chart  $U \rightarrow V$  such that  $x \in U$  and  $V = V({}^n 1 + \sum_i x_i {}^n) \subset Y$  where  $Y$  is a tropical toric manifold and the image  $\phi(U) \subset V$  contains the vertex of empty sedentarity of  $V$ . In particular, one can talk of hypersmooth tropical curve or surface when  $X$  is of dimension is 1 or 2.

*Remark 2.3.* Another possibility, to define hypersmooth tropical varieties, is to modify Definition 2.8, by asking for the local models to be of the form  $V({}^n 1 + \sum_i x_i {}^n)$ , and for the image  $\phi_\alpha(U_\alpha)$  to contain the point 0. One can view hypersmooth tropical varieties and smooth tropical toric varieties as the cases  $k = 1$  and  $k = 0$  of a special kind of tropical manifolds modeled on codimension  $k$  fan tropical linear spaces. To be more precise, smooth tropical toric varieties would only be a special case of the case  $k = 0$ . In fact, as mentioned in Example 2.7, for a smooth tropical toric variety, the images  $\phi_\alpha(U_\alpha)$  of the charts contain all mobile points of the fan  $V_\alpha$ . This condition is not required by the above definition and it is possible to construct many examples which satisfy the case  $k = 0$  of Definition 2.9, but are not toric. For instance, a topological circle can be endowed with an atlas of tropical manifold but is not a smooth tropical toric variety (see [26]). More generally, any topological manifold  $X$  (in the usual sense), endowed with an atlas of tropical manifold would satisfy the case  $k = 0$  of the definition. Yet, as long as the interior of  $X$  is not homeomorphic to an open ball, the atlas of tropical manifold on  $X$  cannot define a smooth tropical toric variety.

*Example 2.8.* Any non-singular tropical hypersurface  $X$  in a tropical toric manifold, as mentioned for instance in [36]. Moreover, it is a hypersmooth tropical variety. In fact, one can cover  $X^\circ$  with the open stars of vertices of sedentarity 0. We denote by  $U_\alpha^\circ$  the open sets of this cover, and put  $U_\alpha = U_\alpha^\circ \cup (\overline{U_\alpha^\circ} \cap \partial X)$ . The non-singular tropical hypersurface  $X$  is covered by the  $U_\alpha$ . Furthermore, each of them is homeomorphic, by a translation, to a relatively open set  $V_\alpha$ , in the normal fan of a primitive  $n$ -simplex, compactified in  $\mathbb{T}P^n$ . There is no difficulty in checking that the overlapping maps are integer affine, since they are induced by translations.

## 2.2 Tropical Homology and Cohomology

### 2.2.1 Wave Space

The notion of wave space has been introduced in [26] by G. Mikhalkin and I. Zharkov. We follow their definition. It exists for tropical spaces in general, but here, we restrict ourselves to tropical manifolds. Let  $V \subset \mathbb{T}^N$  be a fan tropical linear space and let  $F$  be a face of  $V$  of sedentarity  $I \subset [N]$ , that is, the relative interior of  $F$ , denoted by  $F^\circ$ , is contained in  $\mathbb{R}_I$ . The

parent face to  $F$  is the face  $G$  of sedentarity 0, such that  $G \cap \mathbb{R}_I = F^o$ . Let  $y \in F^o$  be a point in the relative interior of  $F$ . We denote by  $\Sigma(y)$  the cone of  $\mathbb{R}_I \cong \mathbb{R}^{N-|I|}$  consisting of vectors  $u$  such that for  $\varepsilon > 0$  small enough,  $y + \varepsilon u \in V \cap \mathbb{R}_I$ . We denote by  $W'(y) \subset \Sigma(y)$  the vector subspace contained in  $\Sigma(y)$  and maximal for inclusion. A *nearby mobile point* to  $y$  is defined as a point in the relative interior of the parent face  $G$ .

*Definition 2.10.* We define the *tangent space*  $T(y)$  as the linear span of  $\Sigma(y)$  in  $\mathbb{R}_I$ . The *wave space*  $W(y)$  is  $W'(y_m)$ , where  $y_m$  is a nearby mobile point to  $y$ .

*Definition 2.11.* Let  $X$  be a tropical manifold and  $x \in X$ . Given a chart  $\phi_\alpha : U_\alpha \rightarrow V_\alpha$ , such that  $x \in U_\alpha^o$ , we defined above the tangent space and the wave space of  $\phi_\alpha(x)$  in  $V_\alpha$ . The differentials of the overlapping maps allow us to identify all the cones coming from different charts, and thus to define  $T(x)$ , respectively  $W(x)$ , as  $T(\phi_\alpha(x))$ , respectively  $W(\phi_\alpha(x))$ , for any chart, under the identifications by the differentials of the overlapping maps.

One first thing to say about the wave space  $W(x)$  of a point  $x \in X$ , is that it does not see the sedentarity, since it is always computed at a mobile point. This is the contrary for the tangent space, which loses one dimension when the order of sedentarity drops by one. We denote their intersection with  $\mathbb{Z}^N$  (in any chart) by  $T_{\mathbb{Z}}(x)$  and  $W_{\mathbb{Z}}(x)$ , respectively. Similarly, we denote by  $W'_{\mathbb{Z}}(x)$  the intersection of  $W'(x)$  with  $\mathbb{Z}^N$ . These group lattices are well defined because the differentials of the overlapping maps are constant to a linear map with integral coefficients. The wave space combined with the order of sedentarity allow us to define the following combinatorial stratification on a tropical manifold.

*Definition 2.12.* Let  $X$  be a tropical manifold. Two points  $x, y \in X$  are *combinatorially equivalent* if there exists a path from  $x$  to  $y$  such that the dimension of  $W(z)$  and the order of sedentarity  $|\text{sed}(z)|$  stay constant for any point  $z$  in this path. The *combinatorial strata* of  $X$  are the maximal subsets for inclusion, such that all points of the subset are combinatorially equivalent. Note that a combinatorial stratum  $E$  is always relatively open inside  $X$ . We denote by  $\overline{E}$  the closure of  $E$  in  $X$  and call  $\overline{E}$  a *closed combinatorial stratum*.

For a combinatorial stratum  $E$  and two points  $x$  and  $y$  in  $E$ , one can canonically identify  $T(x) = T(y) =: T(E)$  (see [26] for more details) as well as  $W(x) = W(y) =: W(E)$ . Moreover if  $F \subset \overline{E}$  is another combinatorial stratum, then there exist three maps  $\iota : T(E) \rightarrow T(F)$ ,  $\rho' : W'(F) \rightarrow W'(E)$  and  $\rho : W(F) \rightarrow W(E)$ . The construction is as follows. Consider two points  $x$  and  $y$  respectively in the relative interior of  $E$  and  $F$ , such that  $x$  and  $y$  lie in a same chart  $\phi : U \rightarrow V$ . Since  $\Sigma(\phi(x)) \subset \Sigma(\phi(y))$ , the smallest vector subspace contained in  $\Sigma(\phi(y))$  is included in the smallest one contained in  $\Sigma(\phi(x))$ . That is to say,  $W'(\phi(y)) \subset W'(\phi(x))$ . Moreover, this inclusion commute with the differentials of the overlapping maps, thus there is an induced map from  $W'(y)$  to  $W'(x)$ , denoted by  $\rho'$ . The morphism  $\rho : W(y) \rightarrow W(x)$  is given by the morphism  $\rho' : W'(E') \rightarrow W'(E')$  for the parent faces  $F'$  of  $F$  and  $E'$  of  $E$ . Now, to construct  $\iota$ , first assume that  $E$  and  $F$  have the same order of sedentarity, thus  $\text{sed}(\phi(y)) = \text{sed}(\phi(x))$  and there is an inclusion from the cone  $\Sigma(\phi(x))$  to  $\Sigma(\phi(y))$ . The induced inclusion between the linear spans commute with the differentials of the overlapping maps and  $\iota$  is induced by this inclusion. If  $\text{sed}(\phi(y)) \subsetneq \text{sed}(\phi(x))$ , then there is a map from  $\Sigma(\phi(x))$  to  $\Sigma(\phi(y))$  induced by the *divisorial projection* from  $\mathbb{R}_{\text{sed}(\phi(x))}$  to  $\mathbb{R}_{\text{sed}(\phi(y))}$ , sending every coordinate  $x_i$  to  $-\infty$  for  $i \in \text{sed}(\phi(x)) \setminus \text{sed}(\phi(y))$ . This map induces one between the linear spans of the cones, which commutes with the differential of the overlapping maps, and it induces  $\rho$ . One can check that,  $\rho'$ ,  $\rho$  and  $\iota$  are compatible with the lattice structure that is they restrict to morphisms  $\rho' : W'_{\mathbb{Z}}(y) \rightarrow W'_{\mathbb{Z}}(x)$ ,  $\rho : W_{\mathbb{Z}}(y) \rightarrow W_{\mathbb{Z}}(x)$  and  $\iota : T_{\mathbb{Z}}(x) \rightarrow T_{\mathbb{Z}}(y)$ .

*Example 2.9.* For a non-singular tropical hypersurface of  $\mathbb{T}^n$ , the strata are exactly the (open) cells described in section 2.1.1 for the ones of sedentarity 0, and the intersections of these cells with  $\mathbb{R}_I$  for the combinatorial stratum of sedentarity  $I$ . In particular, these cells are (open) polyhedral domains of some  $\mathbb{R}^n$ .

Polyhedral cells have very nice properties, including being homeomorphic to a ball of the same dimension. This latter fact is particularly convenient, since it makes the use of cellular homology and cohomology possible. However, note that in general, a tropical manifold can have combinatorial strata that are not homeomorphic to open balls. An example is given in [26], with a topological circle endowed with a structure of tropical manifold. The circle is itself a combinatorial stratum, where the order of sedentarity is 0 and the wave space has dimension 1, but it is clearly not a polyhedron, even with an extended definition. Since a polyhedral structure often reveals useful, we introduce the following definition.

*Definition 2.13.* [26] A tropical manifold  $X$  is said to have a *polyhedral structure*  $\mathcal{C}$ , if there exists a finite number of closed subsets  $\Delta_j \subset X$ , indexed by a finite set  $J$ , such that

- $\bigcup_{j \in J} \Delta_j = X$ ;
- for any  $j \in J$ , there exists a chart  $\phi : U \rightarrow Y \subset \mathbb{T}^N$ , where  $Y$  is a tropical subvariety of  $\mathbb{T}^N$ , such that  $\Delta_j \subset U$  and  $\phi(\Delta_j)$  is a facet  $\sigma_j$  of  $Y$ ; then a face  $\Gamma$  of  $\Delta_j$  is defined as the inverse image  $\phi^{-1}(\sigma)$  of a face  $\sigma$  of  $\sigma_j$ ;
- for any  $j \in J$  and any subset  $I \subset J$ , the intersection of the facets  $\Delta_i$  for  $i \in I$  is a face of  $\Delta_j$ .

For any non-negative-integer  $k$ , the faces of dimension  $k$  of  $\Delta_j$  are denoted by  $\mathcal{C}_k(\Delta_j)$ . The union for all  $j \in J$  of the  $\mathcal{C}_k(\Delta_j)$ , is denoted by  $\mathcal{C}_k(X)$ . Sometimes, we do not want to precise the dimension and we simply write  $\mathcal{C}(\Delta_j)$  and  $\mathcal{C}(X)$ . For  $\Gamma, \Gamma' \in \mathcal{C}(X)$ , we also write  $\Gamma' \prec \Gamma$ , if  $\Gamma'$  is a face of  $\Gamma$  of dimension strictly less than the dimension of  $\Gamma$ .

*Remark 2.4.* The notion of polyhedral structures applies in a much broader context than tropical manifolds in [26] and [16]. Note also that in [16], this notion is called "rational polyhedral structure".

As discussed after Definition 2.12 of combinatorial strata, it can happen that the open strata of the combinatorial stratification are not polyhedral. An important case, where these strata are open polyhedral cells, is when the tropical manifold is a smooth tropical subvariety of a tropical toric manifold. Moreover, the closed combinatorial strata form polyhedral structure on  $X$ . In general, if the closed combinatorial strata of  $X$  form a polyhedral structure, we say that  $X$  has a *polyhedral combinatorial stratification*. From Section 3.2 to the end of the text, the tropical manifolds considered are all compact hypersmooth tropical surfaces, with a polyhedral combinatorial stratification.

*Remark 2.5.* One can show, without too much trouble, that the combinatorial stratification of a hypersmooth curve is polyhedral, but it is not true for higher dimensions, especially for surfaces, which is the case that is dealt with in the next chapters. To construct a counterexample in the case of surfaces, it is enough to construct a hypersmooth tropical surface with a strata of dimension 2 that is not homeomorphic to an open disk. For instance, consider a non-singular tropical hypersurface  $V \subset \mathbb{TP}^3$ . Consider a face  $F$  of  $V$  and  $x$  a point in the relative interior of

$F$ . Then  $V \setminus \{x\}$  is also a hypersmooth tropical surface. However,  $V \setminus \{x\}$  admits  $F^\circ \setminus \{x\}$  as a combinatorial stratum of sedentarity 0 and with dimension of the wave space equal to 2. Yet, this stratum is homeomorphic to a cylinder.

*Example 2.10.* The main example of hypersmooth tropical surfaces with polyhedral combinatorial stratification are non-singular tropical surfaces in the tropical projective space  $\mathbb{TP}^3$ . Note, however, that our definition of having a polyhedral combinatorial stratification may seem quite restrictive, since, for example, the tropical projective plane does not satisfy it. However, the tropical projective plane is not a hypersmooth tropical surface since it does not contain a vertex of order 0, so in this case the condition of having a polyhedral combinatorial stratification does not introduce any new restriction.

*Remark 2.6.* Since our main objects of interest admit a natural polyhedral structure, in order to simplify definitions and notations, we often assume that  $X$  is endowed with a polyhedral structure, even when this is not necessary. This is the case in the next two sections 2.2.2 and 2.2.3.

As explained in [26], one of the points of the combinatorial stratification, compared to a polyhedral structure is that it always exists and is unique. However, when possible, it is much more convenient to use a polyhedral structure. One of the nice features of a polyhedral structure  $\mathcal{C}$  on a tropical manifold  $X$ , is that we can construct a first barycentric subdivision  $\mathcal{D}$  of  $\mathcal{C}$ , as explained in the construction below.

*Construction 2.1* (first barycentric subdivision). For simplicity, we restrict ourselves to the case where  $X$  is compact. Let us introduce some standard notations. Let  $q$  be a non-negative integer and denote by  $\Delta_q = [i_0, \dots, i_q]$  the standard  $q$ -simplex, where  $i_0, \dots, i_q$  are the vertices of  $\Delta_q$ . Given  $0 \leq k \leq q$  and  $k+1$  points  $j_0, \dots, j_k$  among  $i_0, \dots, i_q$ , we denote by  $[j_0, \dots, j_k]$  the face of  $\Delta_q$  of dimension  $k$  defined as the convex hull of the points  $\{j_0, \dots, j_k\}$  and oriented such that  $(j_1 - j_0, \dots, j_k - j_0)$  forms a positively oriented basis. For any polyhedral cell  $\Gamma \in \mathcal{C}(X)$ , take a point  $x_\Gamma$  in the relative interior of  $\Gamma$  and call it *barycenter* of  $\Gamma$ . Given  $q+1$  points  $y_0, \dots, y_q$  in a convex subset  $K$ , one can define the singular  $q$ -chain  $[y_0, \dots, y_q] : \Delta_q \rightarrow K$ , by sending  $i_j$  to  $y_j \in K$ , for every  $j$ , and requiring  $[y_0, \dots, y_q]$  to be the restriction of an affine map. Given  $q+1$  points  $x_0, \dots, x_q$  in a  $n$ -cell  $\Gamma \in \mathcal{C}_n(X)$ , one can define a singular  $q$ -simplex  $[x_0, \dots, x_q] = (\phi^{-1})_*([\phi(x_0), \dots, \phi(x_q)])$ , where  $\phi : U \rightarrow Y$  is a chart as in the second point of Definition 2.13 of a polyhedral structure. We denote by  $\mathcal{D}_q(X)$  the set of all simplices of the form  $[x_{\Gamma_0}, \dots, x_{\Gamma_q}]$ , for any flag  $\Gamma_0 \prec \dots \prec \Gamma_q$  of polyhedral faces of  $\mathcal{C}(X)$ . The union of all the  $\mathcal{D}_q(X)$ , denoted by  $\mathcal{D}(X)$ , forms a simplicial subdivision of  $X$ , called a *first barycentric subdivision* of  $\mathcal{C}$ . We often drop the word "first" because this is the only kind of barycentric subdivision that we consider in this text.

Let  $\mathcal{C}$  be a polyhedral structure of  $X$  with a fixed barycentric subdivision  $\mathcal{D}$ . Let  $\Delta \in \mathcal{C}_n(X)$  and  $\phi_\Delta : U \rightarrow Y$  a corresponding chart given by Definition 2.13. For any integer  $0 \leq q \leq n$  and any  $(n-q)$ -simplex  $\delta \in \mathcal{D}_{n-q}(\Delta)$ , the simplex  $(\phi_\Delta)_*\delta$  is affine from  $\Delta_{n-q}$  to  $\phi(\Delta)$ . We denote by  $T_\Delta\delta$  the vector space parallel to  $(\phi_\Delta)_*\delta$ . When  $\delta = [x_{\Gamma_q}, \dots, x_{\Gamma_n}]$  corresponds to the flag  $\Gamma_q \prec \dots \prec \Gamma_n = \Delta$ , the orientation of  $\delta$  induces a positively oriented basis on  $T_\Delta\delta$ . This basis is  $(\phi(x_{\Gamma_{q+1}}) - \phi(x_{\Gamma_q}), \dots, \phi(x_{\Gamma_{n-q}}) - \phi(x_{\Gamma_q}))$ . In the same way, we put  $\Gamma = \Gamma_q$  and we denote by  $T_\Delta\Gamma$  the vector space parallel to  $\phi(\Gamma)$ . Any choice of orientation on  $\Gamma$  induces an orientation on  $T_\Delta\Gamma$ . Note that the tangent space  $T_\Delta[x_{\Gamma_q}, \dots, x_{\Gamma_n}]$  is in direct sum with  $T_\Delta\Gamma$  and the only point of intersection of  $\Gamma$  with  $[x_{\Gamma_q}, \dots, x_{\Gamma_n}]$  is  $x_\Gamma$ . This justifies the following definition.

*Definition 2.14.* Let  $\mathcal{C}$  be a polyhedral structure of  $X$  with a fixed barycentric subdivision  $\mathcal{D}$ . Fix arbitrary orientations of the cells of  $\mathcal{C}(X)$ . We put  $\varepsilon_{\Gamma \subset \Delta}^{\Gamma_q, \dots, \Gamma_n} = +1$ , if the concatenation of a positively oriented basis of  $T_\Delta \Gamma$  and  $T_\Delta[x_{\Gamma_q}, \dots, x_{\Gamma_n}]$  yields a positively oriented basis of  $T_\Delta \Delta$ . If not,  $\varepsilon_{\Gamma \subset \Delta}^{\Gamma_q, \dots, \Gamma_n} = -1$ . The *dual cell* of  $\Gamma$  inside  $\Delta$  is denoted by  $\Gamma_\Delta^*$  and defined by

$$\Gamma_\Delta^* = \sum_{\Gamma = \Gamma_q \prec \dots \prec \Gamma_n = \Delta} \varepsilon_{\Gamma \subset \Delta}^{\Gamma_q, \dots, \Gamma_n} [x_{\Gamma_q}, \dots, x_{\Gamma_n}].$$

*Remark 2.7.* One can show that the boundary of the dual cell of  $\Gamma$  inside  $\Delta$  is supported on the boundary of  $\Delta_\Gamma^{\mathcal{D}}$ , defined as the union of all the simplices  $\Delta' \in \mathcal{D}_n(\Delta)$  such that  $\Gamma \cap \Delta' \neq \emptyset$ . These dual cells come out in the proof of the non-degeneracy of the tropical intersection form at the end of this chapter (Section 2.3.3).

To conclude this section, since hypersmooth tropical surfaces are our main objects of interest, we are going to precise what combinatorial strata these surfaces can have. Since a hypersmooth tropical surface is modeled on fan tropical linear surfaces of the form  $V = V("1 + x + y + z")$  in  $\mathbb{T}^3$ , it is enough to look at the combinatorial strata of this fan, which are the intersections of the closed polyhedral cells of  $V$  with the  $\mathbb{R}_I$ , for  $I \subset \{1, 2, 3\}$ . They are open polyhedral cells of  $V$ . An open polyhedral cell of  $V$  has in total 6 possible values for the couple  $(\dim W, |sed|)$ . The dimension of the wave space ranges from 0 to 2 and the order of sedentarity from 0 to the dimension of the wave space. Here is a summary of the possibilities for a polyhedral cell  $\sigma$  of  $V$ .

- If  $\sigma$  is a face, then it has to be of empty sedentarity and  $W_{\mathbb{Z}}(\sigma) = T_{\mathbb{Z}}(\sigma) \cong \mathbb{Z}^2$ .
- If  $\sigma$  is an edge, then there are two possibilities.
  - The order of sedentarity of  $\sigma$  can be 0, then  $W_{\mathbb{Z}}(\sigma) = \mathbb{Z} \cdot \vec{\sigma} \cong \mathbb{Z}$ , where  $\vec{\sigma}$  is a primitive vector parallel to  $\sigma$ . In that case,  $\sigma$  is adjacent to 3 faces. The edges of (order of) sedentarity 0 are represented in cyan in Figure 2.4.
  - The sedentarity of  $\sigma$  can be of order 1, then  $\sigma$  is the intersection of a face  $F$  with  $\mathbb{R}_{sed(\sigma)}$ , thus  $W_{\mathbb{Z}}(\sigma) = W_{\mathbb{Z}}(F) \cong \mathbb{Z}^2$ . In that case,  $\sigma$  is adjacent to only 1 face. The edges of sedentarity 1 are represented in blue in Figure 2.4.
- If  $\sigma$  is a vertex, then there are three possibilities.
  - The sedentarity of  $\sigma$  can be empty, then  $W_{\mathbb{Z}}(\sigma) = \{0\}$ . In that case,  $\sigma$  is adjacent to 4 edges, all of empty sedentarity. The vertex of sedentarity 0 is represented in cyan in Figure 2.4.
  - The sedentarity of  $\sigma$  can be of order 1, then  $\sigma$  is the intersection of an edge  $e$  of empty sedentarity with  $\mathbb{R}_{sed(\sigma)}$ , and thus  $W_{\mathbb{Z}}(\sigma) = W_{\mathbb{Z}}(e) \cong \mathbb{Z}$ . In that case,  $\sigma$  is also adjacent to 4 vertices, but only one of them is of empty sedentarity. This edge of empty sedentarity is the parent face  $e$  of  $\sigma$ . The vertices of sedentarity 1 are represented in blue in Figure 2.4.
  - The sedentarity of  $\sigma$  can be of order 2, then  $\sigma$  is the intersection of a face  $F$  of empty sedentarity with  $\mathbb{R}_{sed(\sigma)}$ , and thus  $W_{\mathbb{Z}}(\sigma) = W_{\mathbb{Z}}(F) \cong \mathbb{Z}^2$ . In that case,  $\sigma$  is adjacent to 2 edges, both of them being of order of sedentarity 1. The vertices of sedentarity 2 are represented in violet in Figure 2.4.

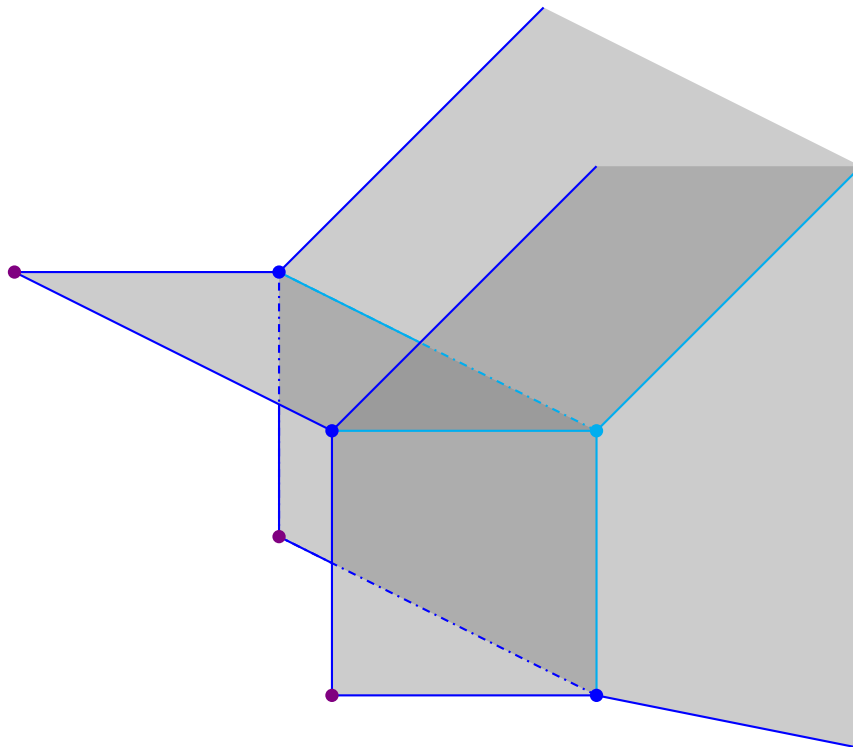

Figure 2.4: The standard tropical plane in  $\mathbb{T}^3$ , with coloration of the combinatorial strata of dimension 0 and 1, depending on the order of sedentarity.

### 2.2.2 Multi-Tangent Space and Tropical Homology

In this section,  $X$  is a compact tropical manifold with a polyhedral structure  $\mathcal{C}$ . The multi-tangent space has been introduced in [15], in order to define singular tropical homology and cohomology. We briefly recall the definitions.

*Definition 2.15.* Let  $X$  be a tropical manifold,  $x \in X$  and  $p \in \mathbb{Z}_{\geq 0}$ . Consider a chart  $\phi : U \rightarrow V$  such that  $x \in U$ . For every  $y$ , such that  $\phi(y)$  lies in an adjacent facet, the morphism  $\iota : T_{\mathbb{Z}}(y) \rightarrow T_{\mathbb{Z}}(x)$  is well defined. Note that, if  $\phi(x)$  itself lies in the relative interior of a facet, then  $\iota = \text{id}$ . The  $p$ -multi-tangent space  $\mathcal{F}_p^{\mathbb{Z}}(x)$  is the subgroup of  $\Lambda^p T_{\mathbb{Z}}(x)$  generated by the products  $\iota(v_1) \wedge \dots \wedge \iota(v_p)$ , where for all  $i \in [p]$ ,  $v_i \in T_{\mathbb{Z}}(y)$  and  $y \in U$  is such that  $\phi(y)$  lies in an adjacent facet (or the facet of  $\phi(x)$  itself, in that case  $\iota = \text{id}$ ). The dual space  $\text{Hom}(\mathcal{F}_p^{\mathbb{Z}}(x), \mathbb{Z})$  is denoted by  $\mathcal{F}_p^{\mathbb{Z}}(x)$ . For any abelian group  $G$ , by tensoring by  $G$ , one obtains the  $p$ -multi-tangent space with coefficients in  $G$ , denoted by  $\mathcal{F}_p^G(x)$ , and the dual, denoted by  $\mathcal{F}_p^G(x)$ .

The  $p$ -multi-tangent space is of course constant along any combinatorial stratum  $E$ , and we denote by  $\mathcal{F}_p^{\mathbb{Z}}(E) \subset \Lambda^p T_{\mathbb{Z}}(E)$  the  $p$ -multi-tangent space of  $E$  defined by  $\mathcal{F}_p^{\mathbb{Z}}(E) := \mathcal{F}_p^{\mathbb{Z}}(x)$  for any  $x \in E$ . In the same way, we define  $\mathcal{F}_p^{\mathbb{Z}}(E) = \text{Hom}(\mathcal{F}_p^{\mathbb{Z}}(E), \mathbb{Z})$ . For a stratum  $F \subset E$ , the map  $\iota : T_{\mathbb{Z}}(E) \rightarrow T_{\mathbb{Z}}(F)$  induces a map from  $\Lambda^p T_{\mathbb{Z}}(E)$  to  $\Lambda^p T_{\mathbb{Z}}(F)$ , which then restricts to a map from  $\mathcal{F}_p^{\mathbb{Z}}(E)$  to  $\mathcal{F}_p^{\mathbb{Z}}(F)$ . As long as  $E$  and  $F$  have the same order of sedentarity, this map is an inclusion. As for the order of sedentarity and the wave space, we give a summary of the possible values of  $\mathcal{F}_p^{\mathbb{Z}}(\sigma)$  for an open polyhedral cell of the fan  $V("0 + x + y + z")$  and  $p \in \{1, 2\}$ . Note that for  $p = 0$ , one has  $\mathcal{F}_0^{\mathbb{Z}}(\sigma) = \Lambda^0 T_{\mathbb{Z}}(\sigma) = \mathbb{Z}$  and for  $p \geq 3$ ,  $\mathcal{F}_p^{\mathbb{Z}}(\sigma) = \{0\}$ .

- If  $\sigma$  is a face, then  $\mathcal{F}_p^{\mathbb{Z}}(\sigma) = \Lambda^p T_{\mathbb{Z}}(\sigma) \cong \Lambda^p \mathbb{Z}^2$ .
- If  $\sigma$  is an edge, then there are two possibilities.
  - If the sedentarity of  $\sigma$  is empty, then  $\mathcal{F}_1^{\mathbb{Z}}(\sigma) = T_{\mathbb{Z}}(\sigma) = \mathbb{Z}^3$  and  $\mathcal{F}_2^{\mathbb{Z}}(\sigma) = \mathbb{Z} \cdot \vec{\sigma}$ .
  - If the sedentarity of  $\sigma$  is of order 1, then  $\mathcal{F}_1^{\mathbb{Z}}(\sigma) = T_{\mathbb{Z}}(\sigma) = \mathbb{Z} \cdot \vec{\sigma} \cong \mathbb{Z}$  and  $\mathcal{F}_2^{\mathbb{Z}}(\sigma) = \{0\}$ .
- If  $\sigma$  is a vertex, then there are three possibilities.
  - If the sedentarity of  $\sigma$  is empty, then  $\mathcal{F}_1^{\mathbb{Z}}(\sigma) = T_{\mathbb{Z}}(\sigma) = \mathbb{Z}^3$  and  $\mathcal{F}_2^{\mathbb{Z}}(\sigma) = \Lambda^2 T_{\mathbb{Z}}(\sigma) \cong \mathbb{Z}^2$ .
  - If the sedentarity of  $\sigma$  is of order 1, then  $\mathcal{F}_1^{\mathbb{Z}}(\sigma) = T_{\mathbb{Z}}(\sigma) = \mathbb{R}_{\text{sed}(\sigma)} \cap \mathbb{Z}^2 \cong \mathbb{Z}^2$  and  $\mathcal{F}_2^{\mathbb{Z}}(\sigma) = \{0\}$ .
  - If the sedentarity of  $\sigma$  is of order 2, then  $\mathcal{F}_p^{\mathbb{Z}}(\sigma) = 0$  for  $p \geq 1$ .

*Definition 2.16.* Let  $\sigma \in \mathcal{C}(X)$  and  $q \geq 0$  be a non-negative integer. Recall the notations introduced in the previous section, used for constructing a barycentric subdivision (see Construction 2.1). Then a singular  $q$ -simplex  $\alpha : \Delta_q \rightarrow \sigma$  is  $\mathcal{C}$ -stratified, if it satisfies

- for each face  $\Delta' \subset \Delta_q$ , there exists a face  $\tau \in \mathcal{C}(\sigma)$  such that  $\alpha(\text{relint}(\Delta')) \subset \text{relint}(\tau)$ , where  $\text{relint}(\Delta')$  is the relative interior of  $\Delta'$  in  $\Delta_q$  and  $\text{relint}(\tau)$  is the relative interior of  $\tau$  in  $X$ ;
- if  $\phi : U \rightarrow V$  is a chart such that  $\alpha(\Delta_q) \subset U$ , then one has

$$\text{sed}(\phi(\alpha(i_q))) \subset \dots \subset \text{sed}(\phi(\alpha(i_0))).$$



The free group generated by the  $\mathcal{C}$ -stratified  $q$ -simplices is denoted by  $C_q(\sigma)$ . The dual group  $\text{Hom}(C_q(\sigma), \mathbb{Z})$  is denoted by  $C^q(\sigma)$ .

*Definition 2.17.* Let  $G$  be an abelian group and  $p, q$  be two non-negative integers. A  $\mathcal{F}_p^G$ -framed singular  $q$ -simplex is a product of the form  $\alpha \otimes v \in C_q(\sigma) \otimes \mathcal{F}_p^G(\sigma)$ , where  $\alpha$  is  $\mathcal{C}$ -stratified. The vector  $v$  is called the *framing*. We denote by  $C_{p,q}(\sigma; G)$  the group  $C_q(\sigma) \otimes \mathcal{F}_p^G(\sigma)$ , whose elements are called *tropical singular  $(p, q)$ -chains*. The dual group  $C^q(\sigma) \otimes \mathcal{F}_G^p(\sigma)$  is denoted by  $C^{p,q}(\sigma; G)$ , and its elements are called *tropical singular  $(p, q)$ -co-chains*.

*Definition 2.18.* Let  $G$  be an abelian group,  $p$  and  $q$  be two non-negative integers. We define the group of *tropical singular  $(p, q)$ -chains* in  $X$  by

$$C_{p,q}(X; G) = \bigoplus_{\sigma \in \mathcal{C}(X)} C_{p,q}(\sigma; G).$$

We define the *tropical boundary operator*  $\partial : C_{p,q}(X; G) \rightarrow C_{p,q-1}(X; G)$  by

$$\partial(\alpha \otimes v) = \sum_{0 \leq j \leq q} (-1)^j \alpha|_{\Delta_q^j} \otimes \iota(v),$$

where  $\Delta_q^j = [i_0, \dots, i_{j-1}, i_{j+1}, \dots, i_q]$  (see Construction 2.1 for the notations about simplices). This operator satisfies  $\partial^2 = 0$ . The  $q^{\text{th}}$  homology group of the chain complex  $(C_{p,\bullet}(X; G), \partial)$  is denoted by  $H_{p,q}(X; G)$  and is called the *singular tropical  $(p, q)$ -homology group* of  $X$ , with coefficients in  $G$ . The group of *singular tropical  $(p, q)$ -cycles* is defined as  $\text{Ker}(\partial) \subset C_{p,q}(X; G)$  and is denoted by  $Z_{p,q}(X; G)$ . The dual complex is denoted by  $(C^{p,\bullet}(X; G), d)$ . The group  $C^{p,q}(X; G)$  is called the group of *tropical singular  $(p, q)$ -co-chains* in  $X$  and  $d$  is called the *tropical co-boundary operator*. The  $q^{\text{th}}$  cohomology group of the complex  $(C^{p,\bullet}(X; G), d)$  is denoted by  $H^{p,q}(X; G)$  and is called the *singular tropical  $(p, q)$ -cohomology group* of  $X$ , with coefficients in  $G$ . The group of *singular tropical  $(p, q)$ -co-cycles* is defined as  $\text{Ker}(d) \subset C^{p,q}(X; G)$  and is denoted by  $Z^{p,q}(X; G)$ .

*Remark 2.8.* As usual for an object endowed with a structure defined via charts, the singular tropical homology and cohomology groups of  $X$  depend *a priori* on a chosen atlas. Here, these groups also depend on the choice of a polyhedral structure. However, as mentioned for example in [26] or [16], choosing a different atlas or a different polyhedral structure yields canonically isomorphic homology and cohomology groups.

*Example 2.11.* Any tropical subvariety  $Y$  of dimension  $k$  of a compact smooth tropical toric variety  $X$ , yields a singular tropical  $(k, k)$ -cycle with  $\mathbb{Z}$  coefficients. In fact, for any polyhedral facet  $\Delta$  of  $Y$ , fix an orientation on  $\Delta$  and consider a basis  $v_1, \dots, v_k$  of the tangent space  $T\Delta$  of determinant 1. Using the compactness assumption and the balancing condition for  $Y$ , one can then show that  $\sum_{\Delta} w(\Delta) \Delta \otimes (v_1 \wedge \dots \wedge v_k)$  is a tropical  $(k, k)$ -cycle. The map from  $k$ -dimensional tropical subvarieties to tropical  $(k, k)$ -cycles is usually called the *cycle class map*. It is an important topic of tropical homology and we refer to [36] or [16] for a detailed expository. Let us just precise that the image of the cycle class map is the tropical analog to algebraic cycles in the complex algebraic setting. This remark plays a role in the interpretation of the results of the last chapter 5, regarding complex orientations modulo a curve.

*Remark 2.9.* In general, a tropical cycle does not look like a classical cycle, when we forget the framings. In fact, these tropical cycles satisfy a condition analogous to the balancing condition

for tropical subvarieties. However, in the case  $p = 0$ , the groups  $\mathcal{F}_0^G$  are constant to  $G$ , for any abelian group  $G$ . Thus, tropical  $(0, q)$ -cycles are classical  $q$ -cycles (by forgetting the trivial framing) and it yields an isomorphism  $H_{0,q}(X; G) \cong H_q(X; G)$ .

### 2.2.3 Cellular Tropical Homology and Cohomology

In this section,  $X$  is a compact tropical manifold of dimension  $n$ , with a polyhedral structure  $\mathcal{C}$ . The polyhedral cells of  $\mathcal{C}(X)$  form the objects of a category with a morphism  $\tau \rightarrow \sigma$  if  $\tau \subset \sigma$ . This category is still denoted by  $\mathcal{C}(X)$ . The category of abelian groups is denoted by  $\text{Ab}$ .

*Definition 2.19.* A *cellular co-sheaf* of abelian groups on  $X$  is a contravariant functor  $\mathcal{F} : \mathcal{C}(X) \rightarrow \text{Ab}$ . Then, for an inclusion of faces  $\tau \subset \sigma$ , there is a corresponding morphism of abelian groups  $\mathcal{F}(\tau \subset \sigma) : \mathcal{F}(\sigma) \rightarrow \mathcal{F}(\tau)$ . A *cellular sheaf* of abelian groups on  $X$  is a covariant functor  $\mathcal{F} : \mathcal{C}(X) \rightarrow \text{Ab}$ . Then, for an inclusion of faces  $\tau \subset \sigma$ , there is a corresponding morphism of abelian groups  $\mathcal{F}(\tau \subset \sigma) : \mathcal{F}(\tau) \rightarrow \mathcal{F}(\sigma)$ .

*Example 2.12.* The tangent space and the multi-tangent spaces induce cellular co-sheaves on  $X$ , where the inclusions between faces are sent to the maps  $\iota$  of Sections 2.2.1 and 2.2.2. The wave space induces a cellular sheaf, where the inclusions between faces are sent to the maps  $\rho$  of Section 2.2.1 .

Let us fix an arbitrary orientation on the cells of  $X$ . For two cells  $\tau, \sigma \in \mathcal{C}(X)$ , respectively of dimension  $q - 1$  and  $q$ , we denote by  $\varepsilon(\sigma, \tau)$  the number which is 0 if  $\tau$  is not a face of  $\sigma$ , +1 if the orientation of  $\tau$  coincide with the boundary orientation induced by  $\sigma$  and  $-1$  if they do not.

*Definition 2.20.* For any cellular co-sheaf  $\mathcal{F}$  on  $X$ , the *cellular chain complex of  $\mathcal{F}$*  is denoted by  $(C_\bullet(X; \mathcal{F}), \partial)$ , where for all  $q \in \mathbb{Z}_{\geq 0}$ ,

$$C_q^{\text{cell}}(X; \mathcal{F}) = \bigoplus_{\dim \sigma = q} \mathcal{F}(\sigma).$$

The boundary operator is given on the component  $v_\sigma$  along a  $q$ -cell  $\sigma$  by

$$\partial v_\sigma = \sum_{\dim \tau = q-1} \varepsilon(\sigma, \tau) \mathcal{F}(\tau \subset \sigma)(v_\sigma).$$

The corresponding homology  $H_\bullet^{\text{cell}}(X; \mathcal{F})$  is called the *cellular homology* of  $\mathcal{F}$ . The same definition applies for a polyhedral sub-complex  $A \subset X$ , so that we can also compute  $H_\bullet^{\text{cell}}(A; \mathcal{F})$ .

Cellular chain complexes are useful in order to compute homology groups. For an abelian group  $G$  and  $p \in \mathbb{Z}_{\geq 0}$ , one can view the elements of  $C_q(X; \mathcal{F}_p^G)$  as framed singular  $q$ -cells. Thus, there is a map of chain complexes  $C_\bullet^{\text{cell}}(X; \mathcal{F}_p^G) \rightarrow C_{p,\bullet}(X; G)$ . As expected, the cellular homology of the co-sheaf  $\mathcal{F}_p^G$  and the singular tropical homology coincide.

**Proposition 2.3.** (*[26], Proposition 2.2*) *For any non-negative integer  $p$ , the map  $C_\bullet^{\text{cell}}(X; \mathcal{F}_p^G) \rightarrow C_{p,\bullet}(X; G)$  is a quasi-isomorphism. In particular, for any non-negative integer  $q$ , the cellular tropical homology group  $H_q^{\text{cell}}(X; \mathcal{F}_p^G)$  is isomorphic to the singular tropical homology group  $H_{p,q}(X; G)$ .*

*Remark 2.10.* As in the case of singular tropical homology, the cellular homology of the co-sheaf  $\mathcal{F}_p^G$  depends *a priori* of the polyhedral structure  $\mathcal{C}$ . However, the above proposition makes sure that it is not the case, since cellular homology of  $\mathcal{F}_p^G$  and singular tropical homology coincide and that the latter is independent of  $\mathcal{C}$  (see Remark 2.8).

We now give the definition for the cohomology of a cellular sheaf. In this text, the cohomology of a cellular sheaf is used only for the cohomology of the wave space  $W_G$ , with  $G = \mathbb{Z}$  and  $G = \mathbb{Z}_2$ .

*Definition 2.21.* For any cellular sheaf  $\mathcal{F}$  on  $X$ , the *cellular co-chain complex* of  $\mathcal{F}$  is denoted by  $(C_{cell}^\bullet(X; \mathcal{F}), d)$ , where for all  $q \in (\mathbb{Z}_{\geq 0})$ ,

$$C_{cell}^q(X; \mathcal{F}) = \bigoplus_{\dim \sigma = q} \text{Hom}(\mathbb{Z}, \mathcal{F}(\sigma)).$$

The co-boundary operator  $d$  is given on the component  $w_\sigma : \mathbb{Z} \rightarrow \mathcal{F}(\sigma)$ , along a  $q$ -cell  $\sigma$ , by

$$dw_\sigma = \sum_{\dim \tau = q+1} \varepsilon(\tau, \sigma) \mathcal{F}(\sigma \subset \tau)^* w_\tau.$$

The corresponding cohomology  $H_{cell}^\bullet(X; \mathcal{F})$  is called the *cellular homology* of  $\mathcal{F}$ . The same definition applies for a sub-polyhedral complex  $A \subset X$ , so that we can also compute  $H_{cell}^\bullet(A; \mathcal{F})$ .

## 2.3 Tropical Intersection Theory and Poincaré Duality

### 2.3.1 Intersecting Tropical Chains

In this section, we recall the definition of the intersection product of transversal tropical cycles as introduced in [36]. Many of the results of the next chapters rely on the intersection of homological classes in a differentiable manifold, as well as on the intersection of tropical homology classes in a tropical manifold. That is why this concept is of primary importance here. In order to define the intersection product of singular tropical chains in a tropical manifold, one first needs to define it on local models. For the rest of this section, we sometimes forget the word "singular", since all tropical chains considered are singular. Let  $V$  be a fan tropical linear space.

*Definition 2.22.* Let  $a = \sum_\alpha \alpha \otimes v_\alpha$  be a tropical  $(p, q)$ -chain in  $V$ . The *support* of  $a$  is the union  $\text{supp}(a) = \bigcup_\alpha \alpha(\Delta_q)$  of the images of the  $q$ -simplex  $\Delta_q$  by all the singular  $q$ -simplices  $\alpha$ .

The support of a tropical chain has no reason to be smooth in the classical sense, even if we ask for the  $\mathcal{C}$ -stratified simplices to be differentiable. Consider for instance the tropical line  $V("0 + x + y")$  in  $\mathbb{TP}^2$ . As explained in Example 2.11, it defines a tropical  $(1, 1)$ -cycle. The support of this cycle is not even a topological manifold as can be seen by looking at a neighborhood of the point  $(0, 0)$ . The set of points where these singularities can occur for a tropical  $(p, q)$ -cycle  $\sum_\alpha \alpha \otimes v_\alpha$  is the union  $\bigcup_\alpha \alpha(\partial(\Delta_q))$ . Furthermore, in order to speak about transverse intersection, one needs a smooth ambient space. That is why, we consider intersections occurring in open facets of a fan tropical linear space  $V$  of dimension  $n$ . These are exactly the subsets where  $V$  is smooth in the classical sense, since it is locally an affine space of dimension  $n$ .

*Definition 2.23.* Let  $a = \alpha \otimes v_\alpha$  be a  $\mathcal{F}_p^{\mathbb{Z}}$ -framed  $q$ -simplex of  $V$  and  $b = \beta \otimes v_\beta$  a  $\mathcal{F}_{n-p}^{\mathbb{Z}}$ -framed  $(n - q)$ -simplex. Let  $x \in \text{supp}(a) \cap \text{supp}(b)$  be a point the relative interior of a facet  $F$  of  $V$ . We say that  $a$  and  $b$  *intersect transversally* at  $x$  if  $\alpha$  and  $\beta$  are smooth at  $x$  and intersect transversally

in the classical sense in the ambient space  $F$ . That is to say,  $T_x\alpha(\Delta_q) \oplus T_x\beta(\Delta_{n-q}) = T_xF$ . In that case, one can define their *intersection product* at  $x$ . Fix an orientation of  $F$ . The classical intersection product at  $x$  of the singular chains  $\alpha$  and  $\beta$ , is given by  $(\alpha \circ \beta)_x$ , which is  $+1$  if the concatenation of positively oriented bases of  $T_x\alpha(\Delta_q)$  and  $T_x\beta(\Delta_{n-q})$  yields a positively oriented basis of  $T_xF$ . Otherwise, the intersection product at  $x$  has value  $(\alpha \circ \beta)_x = -1$ . Write  $v_\alpha = v_\alpha^1 \wedge \dots \wedge v_\alpha^p$  and  $v_\beta = v_\beta^{p+1} \wedge \dots \wedge v_\beta^n$ . The intersection product of  $a$  and  $b$  at  $x$  is given by

$$(a \circ b)_x = (\alpha \circ \beta)_x \det(v_\alpha \wedge v_\beta),$$

where  $\det(v_\alpha \wedge v_\beta) = \det(v_\alpha^1, \dots, v_\alpha^p, v_\beta^{p+1}, \dots, v_\beta^n)$ .

*Remark 2.11.* In the previous definition, the chosen orientation of the facet  $F$  does not matter, because changing the orientation would multiply both factors  $(\alpha \circ \beta)_x$  and  $\det(v_\alpha \wedge v_\beta)$  by  $-1$ .

*Definition 2.24.* Let  $a = \sum_\alpha \alpha \otimes v_\alpha \in C_{p,q}(V; \mathbb{Z})$  and  $b = \sum_\beta \beta \otimes v_\beta \in C_{n-p, n-q}(V; \mathbb{Z})$ . They are said to *intersect transversally*, if for all  $\alpha$  and  $\beta$ , the framed singular chains  $\alpha \otimes v_\alpha$  and  $\beta \otimes v_\beta$  intersect transversally at all points in  $\text{supp}(\alpha) \cap \text{supp}(\beta)$ . In that case, the intersection product  $a \circ b$  is defined by linearity from the intersection product defined on framed simplices in Definition 2.23. This definition extends as usual to tropical chains in a tropical manifold  $X$ .

### 2.3.2 Intersection Pairing on a Smooth Tropical Surface

Let  $X$  be a tropical manifold of dimension  $n$ . In [36], K. Shaw showed that, in the case of surfaces, the intersection product of transversally intersecting tropical  $(1,1)$ -cycles in  $X$ , descends to a symmetric bilinear form on  $H_{1,1}(X; \mathbb{Z})$ . This was generalized by G. Mikhalkin and I. Zharkov to any tropical manifold  $X$  of dimension  $n$  in [26], as a pairing between  $H_{p,q}(X; \mathbb{Z})$  and  $H_{n-p, n-q}(X; \mathbb{Z})$ . In both [36] and [26], the method is similar to the classical case. First, one has to make sure that all  $(p,q)$ -cycles and  $(n-p, n-q)$ -cycles are homologous to tropical cycles intersecting in a "nice way" and then one shows, that the intersection product with a tropical cycle in the image of the tropical boundary operator is zero. However, in the classical case, "nice way" means only *transversal* intersections. While in the tropical case, one has to be a little more careful, since all points of  $X$  are not equivalent. More precisely, they can lie on different combinatorial strata. That is why we need the following definition, generalizing the one of a tropical  $(1,1)$ -cycle *intersecting transversally the skeleton* of a smooth tropical surface, introduced in [36]. By face of a simplex  $\alpha : \Delta \rightarrow X$ , we mean the restriction of  $\alpha$  to a face of  $\Delta$ .

*Definition 2.25.* [26] A tropical  $(p,q)$ -chain  $a = \sum_\alpha \alpha \otimes v_\alpha$  is said to be *transversal to the combinatorial stratification* of  $X$ , if for any  $\alpha$  and any face  $\alpha'$  of  $\alpha$  of codimension  $k$  the support of the relative interior of  $\alpha'$  is contained in strata of dimension at least  $n - k$ .

*Remark 2.12.* There is a second condition stated in terms of "divisorial directions" in [26], but we do not need this condition in this text.

*Definition 2.26.* [26] Two  $(p,q)$ - and  $(p',q')$ -chains  $\sum_\alpha \alpha \otimes v_\alpha$  and  $\sum_\beta \beta \otimes v_\beta$  both transversal to the combinatorial stratification form a *transversal pair*, if the following holds. For any singular simplices  $\alpha, \beta$  in a same combinatorial stratum and for any of their faces  $\alpha', \beta'$ , the relative interiors of  $\alpha'$  and  $\beta'$  are contained in the same combinatorial stratum and intersect transversally in this stratum.

**Lemma 2.3.** [26] *Let  $X$  be a compact tropical manifold of dimension  $n$  and  $G$  an abelian group.*

- Every class in  $H_{p,q}(X; G)$  admits a representative transversal to the combinatorial stratification.
- Every pair of classes in  $H_{p,q}(X; G) \times H_{n-p,n-q}(X; G)$  can be represented by a transversal pair of cycles.
- If moreover two  $(p, q)$ -cycles, denoted by  $a$  and  $a'$ , transversal to the combinatorial stratification are homologous and both form a transversal pair with a  $(n-p, n-q)$ -cycle, denoted by  $b$ , then the intersection product defined in the previous section 2.3.1 does not depend on the transversal pair in the sense that  $a \circ b = a' \circ b$ .

Lemma 2.3, whose proof can be found in [26] (Corollary 6.11), allows us to write the following definition.

*Definition 2.27.* Given a pair  $([a], [b]) \in H_{p,q}(X; G) \times H_{n-p,n-q}(X; G)$ , their *intersection product*  $[a] \circ [b]$ , is defined by taking the intersection product, from Definition 2.24, of a transversal pair of cycles representing  $([a], [b])$ .

*Remark 2.13.* Lemma 2.3 is stated only for  $G = \mathbb{R}$  in [26]. However, the proof uses only local arguments about tropical  $(p, q)$ -chains in a fan tropical linear space  $V$ . Therefore, the proof carries over to any abelian group  $G$ , by simply changing the  $\mathbb{R}$ -coefficients to coefficients in  $G$ . Another important fact mentioned in this article, is that the perturbation of the tropical  $(p, q)$ -cycles can be done locally (see Lemma 6.8 from [26]). More precisely, if two tropical cycles  $a, b$  have supports intersecting only transversally in top-dimensional combinatorial strata, then, they are homologous to a transversal pair  $(\tilde{a}, \tilde{b})$ , which has supports intersecting at the same points and with the same intersection product at these points (see Definition 2.23), as the original pair  $(a, b)$ . In particular, the intersection number of  $(a, b)$  can be directly computed as the sum of the  $(a \circ b)_x$  for all  $x$  in the intersection of the supports of  $a$  and  $b$ , even if  $a$  and  $b$  are not transversal to the combinatorial stratification.

*Remark 2.14.* When  $n = 2k$  is even and  $p = q = n$ , the intersection product defines a bilinear form on  $H_{k,k}(X; G)$ , called the *intersection form*. This intersection form is symmetric. It is enough to notice it for the intersection product at a point  $x$  of two  $\mathcal{F}_k^{\mathbb{Z}}$ -framed  $k$ -simplices intersecting transversally at  $x$ .

The question is now the following. Is this intersection pairing non-degenerate? That is to say, given an abelian group  $G$ , are the induced morphisms  $H_{p,q}(X; G) \rightarrow \text{Hom}(H_{n-p,n-q}(X; G), G)$  injective? Still in [26], G. Mikhalkin and I. Zharkov conjectured that this is the case for any compact tropical manifold in the case of  $G = \mathbb{R}$  coefficients. Moreover, K. Shaw proved that it is the case with  $\mathbb{Z}$  coefficients in the case of (smooth) floor decomposed tropical surfaces. As in the classical case, one cannot expect the form to be non-degenerate with  $\mathbb{Z}$  coefficients, when the tropical homology groups are not torsion-free. However, floor decomposed surfaces are a special case of non-singular tropical hypersurfaces in a smooth tropical toric variety, which do not admit torsion in their tropical homology groups with  $\mathbb{Z}$  coefficients. This is a result of C. Arnal, A. Renaudineau and K. Shaw proved in [3]. It also appears in C. Arnal's PhD thesis [2].

In order to filtrate the second  $\mathbb{Z}_2$ -homology group of a phase tropical surface, by lifting tropical cycles, in Section 4.2, the non-degeneracy is needed with  $\mathbb{Z}_2$  coefficients. The non-degeneracy obviously relies on some form of Poincaré isomorphism with integer coefficients, as we precise in the next section. Fortunately, it turns out that such a duality exists for tropical manifold and that the non-degeneracy can be deduced from it. That is the point of the last section of this chapter.

### 2.3.3 Poincaré Duality

There exist at least two versions of Poincaré Duality for tropical manifolds. The first one has been proved in [17] by P. Jell, K. Shaw and J. Smaka and gives an isomorphism  $H^{p,q}(X; \mathbb{R}) \cong H^{n-p,n-q}(X; \mathbb{R})^*$ . It is based on a non-degenerate pairing given by integration of superforms. However, we are more interested here in the second version proven in [16], by P. Jell, J. Rau and K. Shaw. They give a Poincaré isomorphism  $H^{p,q}(X; \mathbb{Z}) \cong H_{n-p,n-q}(X; \mathbb{Z})$ , induced by the cap product with the fundamental class (see Definition 2.29) of tropical cycles. This latter version of a Poincaré isomorphism is better suited to our purpose of showing the non-degeneracy of the intersection form for two reasons. The first one, is that it is defined directly on singular/simplicial co-cycles and cycles. The second one is that it holds for  $\mathbb{Z}$  coefficients, so that we can derive the duality for  $\mathbb{Z}_2$  coefficients.

*Definition 2.28.* Let  $X$  be a tropical manifold of dimension  $n$ . It is endowed with a combinatorial stratification  $\mathcal{C}$ . A  $\mathcal{C}$ -stratified *simplicial structure*  $\mathcal{D}$  is a usual simplicial structure such that for any  $\Delta \in \mathcal{D}_k$ , there exists  $\Gamma \in \mathcal{C}_k$  such that  $\Delta \subset \Gamma$ .

*Example 2.13.* A first barycentric subdivision of  $\mathcal{C}$  (see Construction 2.1) is a  $\mathcal{C}$ -stratified simplicial structure. Note that the condition about the inclusions of the sedentarities in Definition 2.16 is satisfied, because the order of the vertices in  $[x_{\Gamma_0}, \dots, x_{\Gamma_k}]$  respects the order of the flag  $\Gamma_0 \prec \dots \prec \Gamma_k$ .

Recall that for any  $n$ -dimensional vector space  $V$  and integers  $n \geq p \geq p' \geq 0$ , there exists a *contraction map*  $(\Lambda^{p'}V)^* \times \Lambda^pV \rightarrow \Lambda^{p-p'}V$ , denoted by  $\langle ; \rangle$ , following [16]. In the case  $p = n$ , given  $\alpha \in (\Lambda^{p'}V)^*$ ,  $\Lambda \in \Lambda^nV$ , and  $\beta \in \Lambda^{n-p'}V$ , one has

$$\det(\langle \alpha; \Lambda \rangle \wedge \beta) = (-1)^{n-p'} \alpha(\beta) \det(\Lambda), \quad (2.1)$$

The above equation is the only property of the contraction map that we are using, so we do not precise a definition for cases different than  $p = n$ .

*Definition 2.29.* [16] Let  $X$  be a tropical manifold of dimension  $n$ . It can be endowed with a  $\mathcal{C}$ -stratified simplicial structure  $\mathcal{D}$  (see [26, 16]). The *cap product with the fundamental class* is given on any  $(p, q)$ -cochain  $\alpha$  by

$$\alpha \cap [X] = \sum_{[i_0, \dots, i_n] \in \mathcal{D}_n} [i_q, \dots, i_n] \otimes \langle \alpha([i_0, \dots, i_q]); \Lambda_{[i_0, \dots, i_n]} \rangle,$$

where  $\Lambda_{[i_0, \dots, i_n]} \in \mathcal{F}_n([i_0, \dots, i_n]) \cong \mathbb{Z}$  is the wedge product of the elements of a positively oriented basis of the tangent space  $T_x[i_0, \dots, i_n]$  at any point  $x$  in the relative interior of  $[i_0, \dots, i_n]$ .

The Poincaré isomorphism for tropical manifolds proven by P. Jell, J. Rau and K. Shaw (in [16], Theorem 5.3), which can be stated as follows.

**Theorem 2.1** (Tropical Poincaré Duality). [16] *The cap product with the fundamental class descends to an isomorphism*

$$H^{p,q}(X; \mathbb{Z}) \cong H_{n-p,n-q}(X; \mathbb{Z}).$$

*This induced isomorphism does not depend on the  $\mathcal{C}$ -stratified simplicial structure  $\mathcal{D}$  chosen to compute the cap-product.*

*Remark 2.15.* Tensoring the definition of the cap product by  $G$ , as well as the proofs of [16], yields an isomorphism  $H^{p,q}(X; G) \cong H_{n-p, n-q}(X; G)$ , for any abelian group  $G$ .

In order to prove the non-degeneracy, one has to prove that the below diagram of Lemma 2.4 commutes. The left arrow is given by the pairing on chain level between simplicial cycles and co-cycles. Given  $([a], [b]) \in H^{p,q}(X; G) \times H_{p,q}(X; G)$ , this pairing is defined by  $([a], [b]) = (a, b) = a(b)$ . The upper arrow is given by the cap-product with the fundamental class for the first component and the second component is induced by the quasi-isomorphism  $C_{p,q}^{cell}(X; \mathbb{Z}) \rightarrow C_{p,q}(X; \mathbb{Z})$ . The right arrow is the intersection product. Finally, the map  $G \rightarrow G$  is the multiplication by  $(-1)^{n-p-q}$ . In particular, both the upper and the lower arrows are isomorphisms.

**Lemma 2.4.** *For any abelian group  $G$ , the below diagram commutes.*

$$\begin{array}{ccc} H^{p,q}(X; G) \times H_{p,q}^{cell}(X; G) & \longrightarrow & H_{n-p, n-q}(X; G) \times H_{p,q}(X; G) \\ \downarrow & & \downarrow \\ G & \longrightarrow & G \end{array}$$

Theorem 2.2 below is a straightforward consequence of the commutativity of the diagram of Lemma 2.4. The core of the proof of this result is the Poincaré duality proved in [16], which makes sure that the upper morphism of the diagram is an isomorphism.

**Theorem 2.2.** *For any abelian group  $G$  and for any  $0 \leq p, q \leq n$ , the tropical intersection product  $H_{n-p, n-q}(X; G) \times H_{p,q}(X; G) \rightarrow G$  is non-degenerate if and only if the pairing  $H^{p,q}(X; G) \times H_{p,q}(X; G) \rightarrow G$  is non-degenerate.*

Since  $\mathbb{Z}_2$  is a field, the pairing  $H^{p,q}(X; \mathbb{Z}_2) \times H_{p,q}(X; \mathbb{Z}_2) \rightarrow \mathbb{Z}_2$  is non-degenerate. For instance, one can see it as a consequence of the universal coefficients formula for cohomology, applied to the chain complex  $C_{p,\bullet}(X; \mathbb{Z}_2)$ . Therefore, we can state the following result, which reveals crucial in order to filtrate the homology of a phase tropical surface in Chapter 4.

**Theorem 2.3.** *The tropical intersection product with  $\mathbb{Z}_2$  coefficients on  $X$  is non-degenerate.*

*Proof of Lemma 2.4.* Fix an arbitrary orientation on the cells of  $\mathcal{C}(X)$ . Let  $a \in C^{p,q}(X; \mathbb{Z})$  and  $b \in C_{p,q}^{cell}(X; \mathbb{Z})$ . By definition, one can write  $b = \sum_{\Gamma \in \mathcal{C}_q(X)} \Gamma \otimes \beta^\Gamma$ . The left arrow of the diagram gives

$$(a, b) = \sum_{\Gamma \in \mathcal{C}_q(X)} a(\Gamma)(\beta^\Gamma). \quad (2.2)$$

Now, let us compute the upper arrow. Since  $X$  is compact and admits a polyhedral structure  $\mathcal{C}$ , one can define a first barycentric subdivision (see Construction 2.1) of  $\mathcal{C}$ , denoted by  $\mathcal{D}$ . Since the simplicial subdivision  $\mathcal{D}$  is  $\mathcal{C}$ -stratified, one can use it to compute the cap-product with the fundamental class. Recall that the elements of  $\mathcal{D}_n(X)$  are given by the  $n$ -simplices  $[x_{\Gamma_0}, \dots, x_{\Gamma_n}]$  for all flags of cells  $\Gamma_0 \prec \dots \prec \Gamma_n$  in  $\mathcal{C}(X)$ , so that we can write

$$a \cap [X] = \sum_{\Gamma_0 \prec \dots \prec \Gamma_n} [x_{\Gamma_q}, \dots, x_{\Gamma_n}] \otimes \left\langle a([x_{\Gamma_0}, \dots, x_{\Gamma_q}]); \Lambda_{[x_{\Gamma_0}, \dots, x_{\Gamma_n}]} \right\rangle,$$

$$a \cap [X] = \sum_{\Gamma_q \in \mathcal{C}_q(X)} \sum_{\Gamma_q \prec \dots \prec \Gamma_n} [x_{\Gamma_q}, \dots, x_{\Gamma_n}] \otimes \left( \sum_{\Gamma_0 \prec \dots \prec \Gamma_q} \langle a([x_{\Gamma_0}, \dots, x_{\Gamma_q}]); \Lambda_{[x_{\Gamma_0}, \dots, x_{\Gamma_n}]} \rangle \right).$$

Let us fix a flag of cells  $\Gamma_q \prec \dots \prec \Gamma_n$  with  $\Gamma_k \in \mathcal{C}_q(X)$  for  $q \leq k \leq n$ . We put  $\Gamma = \Gamma_q$  and  $\Delta = \Gamma_n$ . For all flags of cells  $\Gamma_0 \prec \dots \prec \Gamma_q$ , we denote by  $\varepsilon_{\Delta}^{\Gamma_0, \dots, \Gamma_n}$  the number such that  $\Lambda_{\Delta} = \varepsilon_{\Delta}^{\Gamma_0, \dots, \Gamma_n} \Lambda_{[x_{\Gamma_0}, \dots, x_{\Gamma_n}]}$  and  $\varepsilon_{\Gamma}^{\Gamma_0, \dots, \Gamma_q}$  the number which is +1 if the orientation of  $\Gamma$  induces (by restriction) the orientation of  $[x_{\Gamma_0}, \dots, x_{\Gamma_q}]$  and -1 otherwise. Recall also Definition 2.14 of dual cell, where we introduced the number  $\varepsilon_{\Gamma \subset \Delta}^{\Gamma_0, \dots, \Gamma_n}$ . Then, one has  $\varepsilon_{\Delta}^{\Gamma_0, \dots, \Gamma_n} = \varepsilon_{\Gamma \subset \Delta}^{\Gamma_0, \dots, \Gamma_n} \varepsilon_{\Gamma}^{\Gamma_0, \dots, \Gamma_q}$ , and  $\Gamma = \sum_{\Gamma_0 \prec \dots \prec \Gamma_q} \varepsilon_{\Gamma}^{\Gamma_0, \dots, \Gamma_q} [x_{\Gamma_0}, \dots, x_{\Gamma_q}]$ , with orientation. Therefore, one has

$$a \cap [X] = \sum_{\Gamma_q \in \mathcal{C}_q(X)} \sum_{\Delta \in \mathcal{C}_n^{\Gamma}(X)} \left( \sum_{\Gamma_q \prec \dots \prec \Gamma_n = \Delta} \varepsilon_{\Gamma \subset \Delta}^{\Gamma_q, \dots, \Gamma_n} [x_{\Gamma_q}, \dots, x_{\Gamma_n}] \right) \otimes \langle a(\Gamma); \Lambda_{\Delta} \rangle,$$

where for any  $\Gamma$ , we denote by  $\mathcal{C}_n^{\Gamma}(X)$  the  $n$ -cells in  $\mathcal{C}_n(X)$  that are adjacent to  $\Gamma$ . We recognize the definition of the dual cell of  $\Gamma$  inside  $\Delta$ , so one has

$$a \cap [X] = \sum_{\Gamma \in \mathcal{C}_q(X)} \sum_{\Delta \in \mathcal{C}_n^{\Gamma}(X)} \Gamma_{\Delta}^* \otimes \langle a(\Gamma); \Lambda_{\Delta} \rangle.$$

Finally, let us deal with the right arrow, that is to say the intersection product. By definition of  $\mathcal{F}_p(\Gamma)$ , there exists a decomposition  $\beta_{\Gamma} = \sum_{\Delta \in \mathcal{C}_p^{\Gamma}(X)} \iota(\beta_{\Delta}^{\Gamma})$ , where  $\beta_{\Delta}^{\Gamma} \in \mathcal{F}_p^{\mathbb{Z}}(\Delta)$ . Note that this decomposition does not have to be unique and that  $\iota = \text{id}$  if  $\Gamma$  is a  $n$ -cell. The image of  $b$  by the quasi-isomorphism  $C_{p,q}^{\text{cell}}(X) \rightarrow C_{p,q}(X)$  is still denoted by  $b$ . Fix  $\Delta \in \mathcal{C}_n(X)$  and  $\Gamma \in \mathcal{C}_q(\Delta)$ . Now, we want to perturb  $\Gamma$  so that it intersects transversally  $\Gamma_{\Delta}^*$  inside the relative interior of  $\Delta$ . We denote by  $\Delta_{\Gamma}^{\mathcal{D}}$  the union of all simplices  $\Delta' \in \mathcal{D}_n(\Delta)$ , such that  $\dim(\Delta' \cap \Gamma) = \dim(\Gamma)$ . The idea is to keep the perturbation inside  $\Delta_{\Gamma}^{\mathcal{D}}$ , so that there is no intersection with a dual cell coming from another pair of cells  $\Gamma' \subset \Delta'$  in  $\mathcal{C}(X)$ . Let  $\phi : U \rightarrow Y \subset \mathbb{T}^N$  be a chart such that  $\Delta \subset U$  as in Definition 2.13 of a polyhedral structure. For all  $\Sigma \in \mathcal{C}(\Delta)$ , we put  $y_{\Sigma} = \phi(x_{\Sigma})$ . Let us fix a flag  $\Gamma = \Gamma_q \prec \dots \prec \Gamma_n = \Delta$ . To distinguish from the addition of chains denoted by  $+$ , we denote by  $\oplus$  and  $\ominus$  the addition and the subtraction in the vector space  $\mathbb{R}^N \subset \mathbb{T}^N$ . We denote by  $\sigma$  the  $(n - q)$ -simplex  $[y_{\Gamma_q}, \dots, y_{\Gamma_n}]$  and by  $y_{\sigma}$  the convex combination  $y_{\Gamma} \oplus \bigoplus_{q+1 \leq i \leq n} \frac{y_{\Gamma_i} \ominus y_{\Gamma}}{n - q + 1}$ . This point  $y_{\sigma}$  is the barycenter of  $\sigma$  and thus lies in the

relative interior of  $\sigma$ , which is contained in the relative interior of  $\Delta_{\Gamma}^{\mathcal{D}}$ . Therefore, there exists a small enough open neighborhood  $V_{\Gamma}$  of  $y_{\Gamma}$  inside  $\Gamma$ , such that  $V_{\Gamma} \oplus (0, y_{\sigma} \ominus y_{\Gamma})$  is contained in the relative interior of  $\Delta_{\Gamma}^{\mathcal{D}}$ , defined as the union of all simplices of  $\mathcal{D}(\Delta)$  containing  $\sigma$ . By concatenating the orientation of  $[0, y_{\sigma} \ominus y_{\Gamma}]$  with the one of  $\Gamma$ , one can view  $V_{\Gamma} \oplus [0, y_{\sigma} \ominus y_{\Gamma}]$  as a singular  $q + 1$ -chain denoted by  $c_{\Delta}^{\Gamma}$ . We want to compute the intersection of the dual cell  $\Gamma_{\Delta}^*$  with the perturbation  $\Gamma + \partial c_{\Delta}^{\Gamma}$ . Since for any other flag  $\Gamma = \Gamma'_q \prec \dots \prec \Gamma'_n = \Delta$ , the simplex  $[y_{\Gamma'_q}, \dots, y_{\Gamma'_n}]$  does not intersect the relative interior of  $\Delta_{\Gamma}^{\mathcal{D}}$ , nor does it intersect  $V_{\Gamma} \oplus (0, y_{\sigma} \ominus y_{\Gamma})$  either. Moreover, the intersection of the simplex  $[y_{\Gamma'_q}, \dots, y_{\Gamma'_n}]$  with  $V_{\Gamma}$  is made of the single



point  $y_\Gamma$ , thus it does not intersect the boundary  $\partial V_\Gamma$ . This implies that the intersection of  $\Gamma_\Delta^*$  with the chain  $\Gamma + \partial(c_\Delta^\Gamma) = (\Gamma - V_\Gamma) + (\partial V_\Gamma \oplus [0, y_\sigma \ominus y_\Gamma]) + (V_\Gamma \oplus (y_\sigma \ominus y_\Gamma))$  is contained in  $\sigma$ . Since  $y_\sigma \ominus y_\Gamma$  is parallel to  $\sigma$  and  $\partial V_\Gamma$  does not intersect  $\sigma$ , the component  $\partial V_\Gamma \oplus [0, y_\sigma \ominus y_\Gamma]$  does not intersect  $\sigma$ . Therefore, the intersection of  $\phi_* \Gamma_\Delta^*$  with  $\phi_* \Gamma + \partial c_\Delta^\Gamma$  is supported at the point  $y_\sigma$ . This intersection is transverse and the concatenation of a positively oriented basis of the tangent space  $T_\Delta \sigma$  of  $\phi_* \sigma$  with a positively oriented basis of  $T_\Delta \Gamma$  gives a positively oriented basis of  $T_\Delta \Delta$ , up to multiplication by  $(-1)^q$  of one of the vectors. Hence, by pushing forward by  $\phi^{-1}$ , one has  $\Gamma_\Delta^* \circ (\Gamma + (\phi^{-1})_* \partial c_\Delta^\Gamma) = (-1)^q$ .

Now, by summing on all cells  $\Gamma \in \mathcal{C}_q(X)$  fo dimension  $q$  and on all cells  $\Delta \in \mathcal{C}_n^\Gamma(X)$  and by tensoring by the framings  $\beta_\Delta^\Gamma$ , one obtains

$$([a] \cap [X]) \circ [b] = (-1)^q \sum_{\Gamma \in \mathcal{C}_q(X)} \sum_{\Delta \in \mathcal{C}_n^\Gamma(X)} \det(\langle a(\Gamma); \Lambda_\Delta \rangle \wedge \beta_\Delta^\Gamma).$$

Yet, by Equation (2.1), one has  $\det(\langle a(\Gamma); \Lambda_\Delta \rangle \wedge \beta_\Delta^\Gamma) = (-1)^{n-p} a(\Gamma) (\beta_\Delta^\Gamma)$ . Therefore, one can finally deduce

$$([a] \cap [X]) \circ [b] = (-1)^{n-p+q} \sum_{\Gamma \in \mathcal{C}_q(X)} \sum_{\Delta \in \mathcal{C}_n^\Gamma(X)} a(\Gamma) (\beta_\Delta^\Gamma) = (-1)^{n-p-q} \sum_{\Gamma \in \mathcal{C}_q(X)} a(\Gamma) (\beta^\Gamma),$$

which coincides with  $(-1)^{n-p-q}(a, b)$ , by Equation (2.2).  $\square$

**Corollary 2.1.** *Let  $0 \leq p, q \leq n$ . The  $\mathbb{Z}_2$ -vector spaces  $H_{p,q}(X; \mathbb{Z}_2)$  and  $H_{n-p, n-q}(X; \mathbb{Z}_2)$  have the same dimension.*

*Remark 2.16.* The compactness assumption cannot be removed. Consider for instance the tropical torus  $\mathbb{R} \subset \mathbb{T}$ . One has  $H_{0,1}(\mathbb{R}; \mathbb{Z}_2) \cong H_1(\mathbb{R}; \mathbb{Z}_2) = 0$ , thus the intersection product between an element of  $H_{0,1}(\mathbb{R}; \mathbb{Z}_2)$  and an element of  $H_{1,0}(\mathbb{R}; \mathbb{Z}_2)$  is always zero. However, for any  $x \in \mathbb{R}$  the framed point  $x \otimes v$ , represents a non-zero tropical homology class, where  $v$  is the non-zero element of  $\mathcal{F}_1^{\mathbb{Z}_2}(x)$ . Therefore, the intersection product has to be degenerate (otherwise, it would contradict Corollary 2.1 above).

### 3 Real Structures of Phase Tropical Surfaces

#### 3.1 Phase Tropical Surfaces

##### 3.1.1 Pairs-of-Pants Decomposition

In this section, we give a brief summary of [27] by G. Mikhalkin. The main result is the existence of a pairs-of-pants decomposition of any non-singular hypersurface in a smooth toric variety (over  $\mathbb{C}$ ). Here, we focus mainly on the pairs-of-pants decomposition of a generic element of a 1-parameter family of hypersurfaces. Let  $n$  be a positive integer. Given a polynomial  $P$  in  $n$  variables with complex coefficients, the zero set of  $P$  inside  $(\mathbb{C}^*)^n$ , is denoted by  $V_{(\mathbb{C}^*)^n}(P)$ . For any  $t > 1$ , we consider the following map

$$\text{Log}_t : \begin{cases} (\mathbb{C}^*)^n \rightarrow \mathbb{R}^n \\ (z_1, \dots, z_n) \mapsto (\log_t |z_1|, \dots, \log_t |z_n|) \end{cases}$$

*Definition 3.1.* Let  $P$  be a polynomial in  $n$  variables with coefficients in  $\mathbb{C}$ . For any  $t > 1$ , the image  $\text{Log}_t(V_{(\mathbb{C}^*)^n}(P))$  is called the  $\text{Log}_t$ -amoeba of  $P$ .

Now, consider a 1-parameter family of Laurent polynomials  $(P_t)_{t>1}$  in  $n$  variables, where for any positive real number  $t > 1$ , the polynomial  $P_t$  is of the form

$$P_t(z) = \sum_{k \in \Delta \cap \mathbb{Z}^n} a_k t^{-\nu(k)} z^k, \tag{3.1}$$

where  $a_k \in \mathbb{R}$  for any  $k \in \Delta \cap \mathbb{Z}^n$ , the map  $\nu : \Delta \cap \mathbb{Z}^n \rightarrow \mathbb{R}$  is any function and  $\Delta$  is the common Newton polytope of the polynomials of the family.

*Remark 3.1.* A polynomial of the above family is called a *patchworking polynomial* in [27]. This designation refers to Viro's Patchworking method (see [38]). It is important to ask for the coefficients  $a_k$  to be real if we want to be able to speak of real structure as in the property (2) of Theorem 3.2.

*Definition 3.2.* The *tropicalisation* of the family  $(P_t)_{t>1}$  is a tropical polynomial defined as

$$\text{Trop}(P_t)(x_1, \dots, x_n) = \min_{k \in \Delta \cap \mathbb{Z}^n} (-\nu(k)) \cdot x^k.$$

*Remark 3.2.* The tropicalisation of a 1-parameter family of Laurent polynomials with complex coefficients can be seen in the broader context of the tropicalisation of a polynomial over a valued field (see [25]). One needs to be careful to the fact that D. Maclagan and B. Sturmfels use the "min convention" for tropical geometry in [25]. It means that the tropical semi-field is not  $\mathbb{R} \cup \{-\infty\}$  as in Chapter 2, but rather  $\mathbb{R} \cup \{+\infty\}$  and the tropical addition of two numbers is not their maximum, but their minimum. In the above definition, up to the change of the convention from "min" to "max", the field considered for the tropicalisation of  $P_t$  is the field of locally convergent Puiseux series with coefficients in  $\mathbb{C}$ , and the valuation corresponds to taking the lowest exponent.

**Theorem 3.1** (Theorem 5 [27]). *Let  $(P_t)_{t>1}$  be a 1-parameter family of Laurent polynomials in  $n$  variables, with complex coefficients of the same form as 3.1. Then the  $\text{Log}_t$ -amoeba  $\text{Log}_t(V_{(\mathbb{C}^*)^n}(P_t))$  converges, when  $t \rightarrow +\infty$ , with respect to the Hausdorff distance for closed sets in  $\mathbb{R}^n$ , to the tropical hypersurface  $V(\text{Trop}(P_t))$ .*

*Definition 3.3.* Let  $Y$  be a non-singular tropical hypersurface, of dimension  $n$ , in a smooth tropical toric variety  $X$ , and let  $V$  and  $F$  be smooth (differentiable) manifolds. A smooth (differentiable) map  $\lambda : V \rightarrow X$  is a *F-stratified fibration* if the two conditions below hold.

- The restriction of  $\lambda$  to the relative interior of any  $n$ -cell  $\sigma \in \mathcal{C}(Y)$  is a trivial fibration with fiber  $F$ .
- For any non-negative integers  $k, s$ , there exist a smooth (differentiable) manifold, of dimension  $n$ , denoted by  $V_{k,s}$ , and a smooth *model map*  $\lambda_{k,s} : V_{k,s} \rightarrow \mathbb{R}^k \times V_{n-k-s} \times [0, +\infty)^s$ , where  $V_{n-k-s}$  is the standard tropical hyperplane in  $\mathbb{R}^{n-k-s+1}$  from Example 2.1. For any cell  $\sigma \in \mathcal{C}_{k,s}(Y)$  of dimension  $k$  and order of sedentarity  $s$  and for any point  $x$  in the relative interior of  $\sigma$ , there exists an open neighborhood  $U$  of  $x$  inside  $V$ , such that the restriction of  $\lambda$  to the inverse image  $\lambda^{-1}(U)$  is diffeomorphic to  $\lambda_{k,s}$ .

*Definition 3.4.* Let  $Y$  be a non-singular tropical hypersurface, of dimension  $n$ , in a smooth tropical toric variety  $X$ . The *primitive pieces* of  $Y$  are the connected components of  $Y^\circ \setminus |Y^*|$ , where  $|Y^*|$  is the union of all the simplices of the  $(n-1)$ -simplicial sub-complex  $Y^*$  of the first barycentric subdivision, defined in the following way. The vertices of  $Y^*$  are the barycenters of the closed cells  $\sigma \in \mathcal{C}(Y)$  of positive dimension, such that the sedentarity of any point  $x \in \sigma$  is equal to the sedentarity of  $\sigma$ . The simplices of  $Y^*$  are then the simplices of the first barycentric subdivision of  $Y$ , with vertices in  $Y^*$ .

Let  $(P_t)_{t>0}$  be a 1-parameter family of the form of Equation (3.1). Recall that these polynomials come with their Newton polytope  $\Delta \subset \mathbb{R}^n$ . We assume that the (rational) normal fan  $\Xi(\Delta)$  is unimodular (see Section 2.1.2). This assumption is equivalent to asking that, at any vertex  $v$  of  $\Delta$ , the primitive directions of the edges of  $\Delta$  adjacent to  $v$  form a  $\mathbb{Z}$ -basis of  $\mathbb{Z}^n$ . We denote by  $\mathbb{T}\Delta$  the smooth tropical toric variety  $X_{\Xi(\Delta)}$ . Recall also, that one can associate to any unimodular rational fan  $\Xi$ , a smooth toric variety over  $\mathbb{C}$ , denoted by  $X_{\Xi}^{\mathbb{C}}$ , using the same construction as in Section 2.1.2, but with (complex) monomial transformations  $(\mathbb{C}^*)^n \rightarrow (\mathbb{C}^*)^n$  of the form  $z \mapsto (z^{a_j})_j$ , instead of  $x \mapsto (x^{a_j})_j$ . We denote by  $\mathbb{C}\Delta$  the smooth tropical toric variety  $X_{\Xi(\Delta)}^{\mathbb{C}}$ , and given any polynomial  $P$  in  $n$  variables with coefficients in  $\mathbb{C}$ , we denote by  $V_{\mathbb{C}\Delta}(P)$  the closure of  $V_{(\mathbb{C}^*)^n}(P)$  in  $\mathbb{C}\Delta$ .

Using Theorem 3.1 and a projection along a well-suited singular foliation of  $\mathbb{R}^n$ , G. Mikhalkin was able to construct a stratified  $T^n$ -fibration  $\lambda_t : V_{\mathbb{C}\Delta}(P_t) \rightarrow V_{\mathbb{T}\Delta}(\text{Trop}(P_t))$  for any small enough  $t > 0$  (see [27], section 4.3). This stratified fibration can be seen as a higher-dimensional pairs-of-pants decomposition, whose combinatorics for the gluing maps is encoded by the tropical hypersurface  $\text{Trop}(P_t)$ . Let us precise this last sentence with Theorem 3.2 below. The statement of this theorem is a reformulation of the statements of Theorems 4.1' and 4.2 in [27]. One of the main difference in the formulation is that we use some tropical vocabulary. Here, an (open) pair-of-pants of dimension  $n$  is the complementary of  $n+2$  hyperplanes, in generic position in  $\mathbb{C}P^n$ . We denote by  $T^n = \mathbb{R}^n / (2\pi\mathbb{Z}^n)$  the  $n$ -dimensional torus, and by  $S^n$  the  $n$ -dimensional sphere.

**Theorem 3.2.** [27] *For any small enough  $t > 0$ , there exists a  $T^n$ -stratified fibration  $\lambda_t : V_{\mathbb{C}\Delta}(P_t) \rightarrow V_{\mathbb{T}\Delta}(\text{Trop}(P_t))$  satisfying the following properties.*

- (1) *For any primitive piece  $U$  of  $V_{\mathbb{T}\Delta}(\text{Trop}(P_t))$ , the inverse image  $\lambda^{-1}(U)$  is diffeomorphic to an open pair-of-pants. More generally, for any non-negative integers  $k, s$ , the smooth manifold  $V_{k,s}$  is diffeomorphic to  $(\mathbb{C}^*)^k \times \mathcal{P}^{n-k-s} \times \mathbb{C}^s$ , where  $\mathcal{P}^{n-k-s}$  is a  $(n-k-s)$ -dimensional pair-of-pants.*

- (2) *The stratified fibration preserves the real structure, that is,  $\lambda \circ \text{conj} = \lambda$ , where  $\text{conj}$  is induced by the standard conjugation on  $(\mathbb{C}^*)^n \subset \mathbb{C}\Delta$ .*

*Remark 3.3.* Theorems 4.1' and 4.1 in [28] focus on a particular choice of real coefficients  $a_k$  for the tropical polynomials  $P_t$ , in order to be able to lift tropical  $(0, n)$ -cycles in  $V_{\mathbb{T}\Delta}(\text{Trop}(P_t))$  as Lagrangian spheres in  $V_{\mathbb{C}\Delta}(P_t)$ . The lifting of  $(n, 0)$ -cycles is also mentioned, but in that case it does not depend on a particular choice of real coefficients  $a_k$ . In Section 4.1, we lift  $(n, 0)$ - and  $(0, n)$ -cycles in the case  $n = 2$ , but also the  $(1, 1)$ -cycles, in order to obtain a filtration of the second homology group of a phase tropical surface. It is worth mentioning that G. Mikhalkin obtained the Lagrangian spheres as components of the real part of  $V_{\mathbb{C}\Delta}(P_t)$ , which is also the way that we lift tropical  $(0, 2)$ -cycles to a phase tropical surface in Section 4.1.3, except that we have to modify our original real structure.

### 3.1.2 Phase Tropical Manifolds

The goal of this section is to introduce the concept of phase tropical manifold, in order to generalize the stratified fibrations over non-singular tropical hypersurfaces of Section 3.1.1. The main inspiration for our setup is [7] by B. Bertrand, E. Brugallé and A. Renaudineau. A first difference with the previous section is that we consider only standard pairs-of-pants, as defined in [20].

*Definition 3.5.* The  $n$ -dimensional *standard pair-of-pants*, denoted by  $\mathcal{P}^n$ , is the zero set of  $\sum_i z_i$  in  $\mathbb{C}P^{n+1} \setminus \bigcup_i \{z_i = 0\}$ , where  $z_0, \dots, z_n$  are the homogeneous coordinates of  $\mathbb{C}P^n$ . We often drop the word "standard".

The pair-of-pants as defined above, is non-compact. It is more convenient to work with compact pairs-of-pants as in [7]. To compactify  $\mathcal{P}^n$ , we define a homeomorphism  $\mathbb{C}P^{n+1} \setminus \bigcup_i \{z_i = 0\} \rightarrow \overset{\circ}{\Delta}_{n+1} \times (T^{n+2}/T)$  as in [20], where  $\Delta_{n+1} = \{(x_i)_i \in (\mathbb{R}_{\geq 0})^{n+1} \mid \sum_i x_i = 1\}$  is the standard  $n$ -dimensional simplex, and  $T^n$  is the  $n$ -dimensional torus with  $T = \mathbb{R}/(2\pi\mathbb{Z})$ . The quotient by  $T$  is taken for the simultaneous additive action on  $T^{n+2}$ . This homeomorphism is given by the moment map

$$M : [z_0, \dots, z_{n+1}] \mapsto \left( \left( \frac{|z_0|}{|z_0| + \dots + |z_{n+1}|}, \dots, \frac{|z_{n+1}|}{|z_0| + \dots + |z_{n+1}|} \right), (\arg(z_0), \dots, \arg(z_{n+1})) \right).$$

*Definition 3.6.* The  $n$ -dimensional *compactified pair-of-pants*, denoted by  $\overline{\mathcal{P}}^n$ , is the closure in  $\Delta_{n+1} \times (T^{n+2}/T)$  of  $M(\mathcal{P}^n)$ .

*Example 3.1.* The 0-dimensional pair-of-pants is a point (compactified or not). The compactified pair-of-pants of dimension 1 is homeomorphic to a 2-sphere minus 3 open (non-intersecting) disks. The boundary of the one-dimensional pair-of-pants is composed of 3 disjoint circles. Each of them is the intersection of  $\overline{\mathcal{P}}^1$  with  $\{x_i = 0\} \times T^3/T$  where  $x_1, x_2, x_3$  are the coordinates of  $\mathbb{R}^3$ .

The following lemma generalizes the observation from the example above. Given a subset  $J$  of  $\{0, \dots, n+1\}$ , put  $B_J^n := \overline{\mathcal{P}}^n \cap \left( \bigcap_{j \in J} \{x_j = 0\} \times (T^{n+2}/T) \right)$ . In particular, one has  $B_\emptyset^n = \overline{\mathcal{P}}^n$  and  $B_J^n = \emptyset$  for any subset  $J \subset \{0, \dots, n+1\}$  of cardinal greater than or equal to  $n+1$ . Given a subset  $J \subset \{0, \dots, n+1\}$  of cardinal  $k$ , the projection  $\Delta_{n+1} \times (T^{n+2}/T) \rightarrow \Delta_{n+1-k} \times (T^{n+2-k}/T)$ ,

which forgets the coordinates indexed by  $J$ , is denoted by  $p_J$ . The coordinates of  $p_J(x, \theta)$  for  $(x, \theta) \in \Delta_{n+1} \times (T^{n+2}/T)$  are denoted by  $(x_J, \theta_J)$ .

**Lemma 3.1.** *Let  $n \in \mathbb{Z}_{\geq 0}$  and  $J \subset \{0, \dots, n+1\}$  of cardinal  $k$ . The projection  $p_J$  restricts to a trivial fibration  $B_J^n \rightarrow \overline{P}^{n-k}$ , with fiber homeomorphic to  $T^k$ . In particular,  $B_J^n$  is homeomorphic to  $\overline{P}^{n-k} \times T^k$ .*

*Proof.* The restriction of  $p_J$  to  $B_J^n \rightarrow \Delta_{n+1-k} \times (T^{n+2-k}/T)$  is still denoted by  $p_J$ . The image of  $p_J$  is then equal to  $p_J(B_J^n) = \overline{P}^{n-k}$ . In fact, any  $(x, \theta) \in B_J^n$ , is in the closure of  $M(\mathcal{P}^n)$ , so it satisfies  $\sum_{j \in \{0, \dots, n+1\}} x_j \exp(i\theta_j) = 0$ . Since it also satisfies  $x_j = 0$ , for all  $j \in J$ , we have

$\sum_{j \in \{0, \dots, n+1\} \setminus J} x_j \exp(i\theta_j) = 0$ . Thus, one has  $p_J(B_J^n) \subset \overline{P}^{n-k}$ . Let us consider  $(y, \vartheta) \in \overline{P}^{n-k}$  and

denote by  $(y^0, \vartheta^0) \in \Delta_{n+1} \times (T^{n+2}/T)$  the completion of  $(y, \vartheta)$  by 0's for the coordinates indexed by  $i \notin J$ . Then, one has  $p_J(y^0, \vartheta^0) = (y, \vartheta)$ . Finally, given  $(x, \theta) \in B_J^n$ , the fiber of  $p_J$  over  $p_J(x, \theta)$  is equal to  $\{x\} \times (\theta + T^J)/T$  where  $T^J$  is the subset of  $T^{n+2}$ , such that all coordinates  $\theta_j$  with  $j \notin J$ , are equal. Therefore, one has an homeomorphism  $B_J^n \rightarrow \overline{P}^{n-k} \times T^J/T$  given by  $(x, \theta) \mapsto (p_J(x, \theta), \theta - \theta^0)$ . Noticing that  $T^J/T$  is homeomorphic to  $T^k$  ends the proof.  $\square$

*Remark 3.4.* A compactified pair-of-pants is a differentiable manifold with corners, as mentioned in [20]. The stratification of the standard simplex  $\Delta_{n+1}$  by the relative interior of the subsets  $\Delta_{n+1}^J = \bigcap_{j \in J} \{x_j = 0\}$  induces a stratification of  $\overline{P}^n = \bigcup_J \overset{\circ}{B}_J^n$  (the superscript  $\circ$  corresponds to taking the relative interior). Then the topological boundary of  $\overline{P}^n$  is equal to  $\partial \overline{P}^n = \bigcup_{\text{Card}(J) \geq 1} \overset{\circ}{B}_J^n$ . The differentiable boundary is exactly  $\bigcup_{\text{Card}(J)=1} \overset{\circ}{B}_J^n$ . More precisely, the points whose differentiable charts are of the form  $U \rightarrow \mathbb{R}^{n-k} \times (\mathbb{R}_{\geq 0})^k$  are the points in  $\bigcup_{\text{Card}(J)=k} \overset{\circ}{B}_J^n$ .

The cohomology of a (non-central) hyperplane arrangement is well understood and is known to be equal to the Orlik-Solomon algebra of the matroid associated with the hyperplane arrangement, as exposed in [32]. Here, we focus only on the case of a generic arrangement of  $n+2$  hyperplanes in  $\mathbb{P}^n$ . The following proposition gives the value of the groups  $H^k(\mathcal{P}^n; \mathbb{Z})$  as a special case of the much more general Theorem 5.89 of [32].

**Proposition 3.1.** *For any  $k > n$ ,  $H^k(\mathcal{P}^n; \mathbb{Z}) = 0$  and for  $k \leq n-1$  there exists an isomorphism of graded algebra  $H^k(\mathcal{P}^n; \mathbb{Z}) \cong \Lambda^k \mathbb{Z}^{n+1}$ . In de Rham cohomology, a system of generators of the algebra  $H_{dR}^*(\mathcal{P}^n)$  is given by the  $\frac{dz_j}{2i\pi z_j}$ , for the homogeneous coordinates  $z_j$  of  $\mathbb{C}P^{n+1}$ .*

In the following, we are not directly interested with the cohomology of the standard pair-of-pants, but rather with its homology. Since  $\mathcal{P}^n$  and  $\overline{P}^n$  have the same homotopy type, they share the same cohomology groups. Moreover, since there is no torsion in these cohomology groups, the universal coefficients theorem (for cohomology) states that they are dual to the homology groups of  $\overline{P}^n$ . In particular, there is no torsion in the homology groups. Therefore, the universal coefficient theorem (for homology this time) also tells us that for any abelian group  $G$ , one has  $H_k(\overline{P}^n; \mathbb{Z}) \otimes G \cong H_k(\overline{P}^n; G)$ .

**Corollary 3.1.** *Let  $G$  be an abelian group. For any integer  $k > n$ , one has  $H_k(\overline{P}^n; G) = 0$  and for  $k \leq n-1$  there exists an isomorphism of group  $H_k(\overline{P}^n; G) \cong (\Lambda^k \mathbb{Z}^{n+1}) \otimes G$ .*

For any index  $j \in \{0, \dots, n+1\}$ , denote by  $p_j$  the projection  $p_{\{j\}} : B_{\{j\}}^n \rightarrow \overline{P}^{n-1}$  from Lemma 3.1. For any  $z \in \overline{P}^{n-1}$ , arbitrarily orienting the fiber  $(p_j)^{-1}(z)$  yields a 1-cycle in  $\overline{P}^n$  with  $\mathbb{Z}$  coefficients. One can then consider the homology class of this cycle in  $\overline{P}^n$  and send it into the 1<sup>st</sup> homology group of  $\mathcal{P}^n$  by the inverse of the morphism induced by the inclusion  $\mathcal{P}^n \subset \overline{P}^n$ . The evaluation of the de Rham cohomology class of  $\frac{dz_j}{2i\pi z_j}$  on this homology class (seen with coefficients in  $\mathbb{R}$ ) is either +1 or -1, depending on the orientation. We define  $\beta_j^n \in H_1(\overline{P}^n; \mathbb{Z})$  as the homology class of the fiber  $(p_j)^{-1}(z)$ , for any  $z \in \overline{P}^{n-1}$ , oriented such that the evaluation of  $\frac{dz_j}{2i\pi z_j}$  on the image of  $\beta_j^n$  in  $H_1(\overline{P}^n; \mathbb{R})$  is +1. For any subset  $J \subset \{0, \dots, n+1\}$  of cardinal  $k$ , we similarly define  $\beta_J^n \in H_k(\overline{P}^n; \mathbb{Z})$  as the homology class of the fiber  $(p_J)^{-1}(z)$  for any  $z \in \overline{P}^{n-k}$  and oriented so that the evaluation of the de Rham cohomology class of  $\bigwedge_{j \in J} \frac{dz_j}{2i\pi z_j}$  (where the order on  $J$  is induced by the order  $0 < \dots < n+1$ ), on the image of  $\beta_J^n$  in  $H_k(\overline{P}^n; \mathbb{R})$ , is +1. Therefore, one can interpret the homology classes  $\beta_j^n$  for  $j \in \{0, \dots, n+1\}$ , as a system of generators for the graded algebra structure on  $H_*(\overline{P}^n; \mathbb{Z})$ , dual to the one on  $H^*(\mathcal{P}^n; \mathbb{Z})$ . The product on  $H_*(\overline{P}^n; \mathbb{Z})$  is also denoted by  $\wedge$ , and given two subsets  $J, J' \subset \{0, \dots, n+1\}$  this product is defined as  $\beta_J^n \wedge \beta_{J'}^n = \varepsilon_{J, J'} \beta_{J \cup J'}^n$ , where  $\varepsilon_{J, J'} \in \{-1, 0, 1\}$  is defined by the equation  $\left( \bigwedge_{j \in J} \frac{dz_j}{2i\pi z_j} \right) \wedge \left( \bigwedge_{j \in J'} \frac{dz_j}{2i\pi z_j} \right) = \varepsilon_{J, J'} \bigwedge_{j \in J \cup J'} \frac{dz_j}{2i\pi z_j}$ . This discussion about the homology  $H_*(\overline{P}^k; \mathbb{Z})$  of the  $k$ -dimensional compactified pair-of-pants, yields the following lemma.

**Lemma 3.2.** *Let  $k \in \mathbb{Z}_{\geq 0}$  be a non-negative integer. For any subset  $J \subset \{0, \dots, k+1\}$ , one has*

$$\beta_J^k = \bigwedge_{j \in J} \beta_j^k \in H_p(\overline{P}^k; \mathbb{Z}).$$

For the rest of this section, we consider  $X$  to be a hypersmooth tropical variety of dimension  $n$ , with a polyhedral combinatorial stratification. Recall that  $\mathcal{C}(X)$  is the set of the closed cells of the combinatorial stratification  $\mathcal{C}$ . Let  $k$  and  $s$  be two non-negative integers. We denote by  $\mathcal{C}_{k,s}(X)$  the (closed) cells of  $X$  of dimension  $k$  and of order of sedentarity  $s$ . For each cell  $\sigma \in \mathcal{C}_{k,s}(X)$ , we denote by  $\mathcal{C}_{k+1,s}^\sigma(X)$ , the cells of  $\mathcal{C}_{k+1,s}(X)$  that contain  $\sigma$ . It turns out that the number of elements in  $\mathcal{C}_{k+1,s}^\sigma(X)$  depends only on the pair  $(k, s)$ , as stated by the lemma and the implied corollary below. Recall that for any non-negative integer  $k$ , the standard tropical hyperplane in  $\mathbb{R}^{k+1}$  is denoted by  $V_k$ .

**Lemma 3.3.** *A point  $x \in X$ , lying in the relative interior of a cell  $\sigma \in \mathcal{C}_{k,s}(X)$  has an open neighborhood  $U \subset X$ , homeomorphic to  $\mathbb{R}^k \times V_{n-k-s} \times [0, +\infty)^s$ .*

*Proof.* If  $X$  is a non-singular tropical hypersurface in a smooth tropical toric variety, this is the statement of Proposition 2.14 in [27]. Since the statement is local, it implies the result for any hypersmooth tropical variety.  $\square$

**Corollary 3.2.** *Let  $k$  and  $s$  be two non-negative integers, and let  $\tau \in \mathcal{C}_{k,s}(X)$ . One has two possibilities for the number of cells of  $\mathcal{C}_{k+1,s}^\tau(X)$ , depending on the value of  $n_\tau := n - \dim \tau - |\text{sed}(\tau)|$ .*

- If  $n_\tau = 0$ , then  $\mathcal{C}_{k+1,s}^\tau(X)$  is empty.
- If  $n_\tau > 0$ , then  $\mathcal{C}_{k+1,s}^\tau(X)$  has  $n_\tau + 2$  elements.

Moreover, there is exactly one face  $\sigma \in \mathcal{C}_{k+s,0}(X)$  containing  $\tau$ . It is the parent face of  $\tau$ .

*Proof.* By Lemma 3.3, the number of elements in  $\mathcal{C}_{k+1,s}^\tau(X)$  is the number of rays in the fan tropical linear space  $V_{n-k-s}$ .  $\square$

Since for any vertex  $v$  of sedentarity  $s$  of  $X$ , the building-block  $S_v$  is a  $(n-s)$ -dimensional compactified pair-of-pants, we obtain the following lemma.

**Lemma 3.4.** *Let  $G$  be an abelian group, and let  $v \in \mathcal{C}_{0,s}(X)$  be a vertex of sedentarity  $s \in \mathbb{Z}_{\geq 0}$ . Any one-to-one correspondence  $e \leftrightarrow j(e)$  between  $\mathcal{C}_{1,s}^v$  and the homogeneous coordinates of  $\mathbb{C}P^{n-s+1}$  yields an isomorphism of graded algebra*

$$L_\bullet^v : \mathcal{F}_\bullet^G(v) \rightarrow H_\bullet(S_v; G),$$

satisfying

$$L_p^v(\vec{e}_1 \wedge \dots \wedge \vec{e}_p) = \beta_{j(e_1)}^k \wedge \dots \wedge \beta_{j(e_p)}^k \in H_p(S_v; G),$$

for any non-negative integer  $p$ , where for all  $j \in J$ , the edge  $e_j$  is in  $\mathcal{C}_{1,s}^v(X)$  and the integer vector  $\vec{e}_j$  is primitive, parallel to the edge  $e_j$  and directed outwards  $v$ .

Given a cell  $\sigma \in \mathcal{C}(X)$ , recall the definition of the vector space  $W'(\sigma)$  from Section 2.2.1. We define a  $(\dim \sigma)$ -dimensional torus by  $T^\sigma := W'(\sigma)/(2\pi W'_\mathbb{Z}(\sigma))$ . If  $\tau \in \mathcal{C}_{k,s}(X)$ , and  $\sigma \in \mathcal{C}_{k+1,s}^\tau(X)$ , then there is an injection  $T^\tau \rightarrow T^\sigma$  induced by the inclusion  $W'(\tau) \subset W'(\sigma)$ .

*Definition 3.7.* The *building-block* associated with  $\sigma \in \mathcal{C}(X)$  is defined by

$$S_\sigma := \sigma \times T^\sigma \times \overline{P}^{n_\sigma}.$$

We denote by  $(x, \theta, z)$  the elements of  $S_\sigma$ . For any (closed) cell  $\tau \subset \sigma$  contained in  $\sigma$ , we define the restriction of  $S_\sigma$  to  $\tau$  by

$$S_\sigma^\tau := \tau \times T^\sigma \times \overline{P}^{n_\sigma} \subset S_\sigma.$$

The projection on the first coordinate in  $\sigma$  is denoted by  $\lambda : S_\sigma \rightarrow \sigma$  and the composition of the projections on the third coordinate  $S_\sigma \rightarrow \overline{P}^{n_\sigma}$  with the projection on the simplex  $\overline{P}^{n_\sigma} \rightarrow \Delta_{n_\sigma+1}$  is denoted by  $\text{pr}_{\Delta_{n_\sigma+1}}$ .

The (real) dimension of the building-block associated with a cell  $\sigma \in \mathcal{C}(X)$  is equal to  $2(\dim \sigma + n_\sigma) = 2(n - |\text{sed}(\sigma)|)$ . Let us give a brief description of the homology of  $S_\sigma$ . Recall that for any non-negative integers  $l$  and  $k$ , the  $l^{\text{th}}$ -homology group of a  $k$ -dimensional torus  $T^k$  is isomorphic to  $H_l(T^k; \mathbb{Z}) \cong \mathbb{Z}^{\binom{k}{l}}$ . Since for any cell  $\sigma \in \mathcal{C}(X)$ , there is no torsion in the homology groups with integer coefficients of  $S_\sigma$ ,  $T^\sigma$  or  $\overline{P}^{n_\sigma}$ , one obtains the following lemma by Künneth's formula.

**Lemma 3.5.** *Let  $p$  be a non-negative integer. The  $p^{\text{th}}$  homology group of the building block  $S_\sigma$ , associated with cell  $\sigma \in \mathcal{C}_{k,s}(X)$  is given by*

$$H_p(S_\sigma; \mathbb{Z}) \cong \bigoplus_{0 \leq l \leq p} H_l(T^\sigma; \mathbb{Z}) \otimes H_{p-l}(\overline{P}^{n_\sigma}; \mathbb{Z}).$$

Given a cell  $\sigma \in \mathcal{C}(X)$ , and an integer primitive vector  $v \in W'_\mathbb{Z}(\sigma)$ , we denote by  $L_1^\sigma(v)$  the homological class in  $H_1(S_\sigma; \mathbb{Z})$  of a cycle  $\{*\} \times \mathbb{R}v / \mathbb{Z}v \times \{*\}$ , oriented according to  $v$ . We extend  $L_1^\sigma$  linearly to a morphism of abelian group  $L_1^\sigma : W'_\mathbb{Z}(\sigma) \rightarrow H_1(S_\sigma; \mathbb{Z})$ . Using the fact that the homology of a  $k$ -dimensional torus  $T^k$  can be obtained via Künneth formula, one can show that the morphism  $L_1^\sigma$  is injective and has for image the subgroup  $H_1(T^\sigma; \mathbb{Z}) \otimes H_0(\overline{P}^{n_\sigma}; \mathbb{Z}) \cong H_1(T^\sigma; \mathbb{Z})$ . This morphism is called a *lifting morphism*. If  $e \in \mathcal{C}_{1,s}(X)$  is a cell of dimension 1 and order of sedentarity  $s \in \mathbb{Z}_{\geq 0}$ , the case  $p = 1$  of Lemma 3.5 can be written as

$$H_1(S_e; \mathbb{Z}) \cong \mathbb{Z} \cdot L_1^e(\vec{e}) \oplus H_1(\overline{P}^{n-1}; \mathbb{Z}),$$

where  $\vec{e}$  is a primitive integer vector in  $W'_\mathbb{Z}(e)$  as in Lemma 3.4. We also introduce the notation  ${}^v\vec{e}$  for the primitive integer vector, parallel to the edge  $e$ , and directed outwards  $v$ , for any vertex  $v$  adjacent to  $e$ .

*Definition 3.8.* A *phase tropical manifold* over  $X$  consists in the following data:

- (1) for all  $\tau \in \mathcal{C}_{k,s}(X)$ , there is a bijection  $\sigma \mapsto j(\sigma)$  between the cells of  $\mathcal{C}_{k+1,s}^\tau(X)$  and the indices of the  $n_\tau + 2$  homogeneous coordinates of  $\mathbb{C}P^{n_\tau+1}$ ; recalling the notation  $B_j^n$  from Lemma 3.1, we put  $S_\tau^\sigma := \tau \times T^\tau \times B_{\{j(\sigma)\}}^{n_\tau} \subset S_\tau$ ;
- (2) for all  $\tau \in \mathcal{C}_{k,s}(X)$  and  $\sigma \in \mathcal{C}_{k+1,s}^\tau(X)$ , there is a homeomorphism  $\phi_\tau^\sigma : S_\tau^\sigma \rightarrow S_\tau^\tau$  and a map  $\theta_\tau^\sigma : \tau \times B_{\{j(\sigma)\}}^{n_\tau} \rightarrow T^\sigma$ , satisfying for all  $(x, \theta, z) \in S_\tau^\sigma$

$$(\phi_\tau^\sigma)(x, \theta, z) = (x, \rho'(\theta) + \theta_\tau^\sigma(x, z), p_{j(\sigma)}(z)); \quad (3.2)$$

- (3) for any vertex  $v \in \mathcal{C}_{0,s}(X)$  of order of sedentarity  $s \in \mathbb{Z}_{\geq 0}$ , for any edge  $e \in \mathcal{C}_{1,s}^v(X)$ , the following homological equation is satisfied

$$(\phi_v^e)_*(\beta_{j(e)}^n) = L_1^e({}^v\vec{e}); \quad (3.3)$$

- (4) for all  $\tau \in \mathcal{C}_{k,s}(X)$ , denoting by  $\sigma \in \mathcal{C}_{k+s,0}(X)$  the unique  $(k+s)$ -cell of zero sedentarity containing  $\tau$  (which exists by Lemma 3.3), there is a continuous map  $\phi_\sigma^\tau : S_\sigma^\tau \rightarrow S_\tau^\tau$ , acting coordinates by coordinates, which restricts to the identity on the first and third coordinates and restricts to the projection  $T^\sigma \rightarrow T^\tau$ , induced by the quotient by the divisorial directions, on the second coordinate;
- (5) for any cells  $\sigma \subset \tau \subset \varrho$  and  $\sigma \subset \tau' \subset \varrho$  in  $\mathcal{C}(X)$ , one has  $\phi_\sigma^\tau \circ \phi_\tau^\varrho = \phi_\sigma^{\tau'} \circ \phi_{\tau'}^\varrho$ , and we denote both of the compositions by  $\phi_\sigma^\varrho$ .

One defines a topological  $2n$ -manifold (see Lemma 3.6 below) by

$$S_X = \left( \bigsqcup_{\sigma \in \mathcal{C}(X)} S_\sigma \right) / \sim,$$

where  $\sim$  identifies  $x$  and  $\phi_\sigma^\tau(x)$  whenever it is well defined. For short, we write that  $(S_X, X)$  is a *phase tropical manifold*. A phase tropical manifold  $(S_X, X)$  comes with a stratified fibration  $\lambda : S_X \rightarrow X$ , given on a building-block  $S_\sigma$  by the projection on the first coordinate  $S_\sigma \rightarrow \sigma$ , for every  $\sigma \in \mathcal{C}(X)$ .



*Remark 3.5.* The homological Equation 3.3 is always true when tensored by  $\mathbb{Z}_2$ , as long as we require for  $\phi_\tau^\sigma$  to be a homeomorphism. In fact, one can show that any homeomorphism of  $\overline{P}^{n-1} \times T^1$  preserves, up to the sign, the homological class of the cycle  $\{*\} \times T^1$ . Therefore, this condition could probably be replaced by some orientability condition. In [27] (section 5), in order to reconstruct the complex hypersurface from the non-singular tropical hypersurface, two pairs-of-pants associated with two vertices connected by an edge in the tropical surface, are glued by an identification of the form  $[z_0 : \dots : z_n : z_{n+1}] \mapsto [z_0 : \dots : z_n : \bar{z}_{n+1}]$  along  $z_{n+1} = -R_n$ , for some  $R_n \in \mathbb{R}_{>0}$ . This identification is consistent with Equation (3.3).

*Remark 3.6.* The condition (2) of the previous definition is quite restrictive and in particular, it implies the following equations

$$\begin{aligned} \text{pr}_{\Delta_{n\tau+1}} &= \text{pr}_{\Delta_{n\sigma+1}} \circ \phi_\tau^\sigma, \\ \lambda &= \lambda \circ \phi_\tau^\sigma. \end{aligned}$$

Since the map  $\theta_\tau^\sigma : \tau \times B_{j(\sigma)}^{n_\tau} \rightarrow T^\sigma$  does not depend on  $\theta \in T^\tau$ , one also gets the following homological equation

$$(\phi_\tau^\sigma)_* (L_1^\tau(v)) = L_1^\sigma(\rho'(v)). \quad (3.4)$$

*Remark 3.7.* We want to think of the building blocks  $S_\sigma$  for  $\sigma \in \mathcal{C}(X)$ , as subsets of  $S_X$ . When the cell  $\sigma$  is *bounded*, meaning  $\sigma$  does not intersect the boundary  $\partial X$  of the hypersmooth tropical surface, then the equivalence relation  $\sim$  from Definition 3.8, does not identify two distinct points in  $S_\sigma$ . Therefore, one has the inclusion  $S_\sigma \subset S_X$ . However, when  $\sigma$  is adjacent to a cell  $\tau$  of higher sedentarity, there is no inclusion  $S_\sigma \subset S_X$ , because the quotient by the equivalence relation  $\sim$  identifies distinct points in  $S_\sigma^\tau$ . That is why we denote by  $\tilde{S}_\sigma$  the image of  $S_\sigma$  by the projection  $\bigsqcup_{\sigma \in \mathcal{C}(X)} S_\sigma \rightarrow S_X$ . In the case where  $\sigma$  does not admit an adjacent cell of higher sedentarity (e.g  $\sigma$  is bounded or  $\sigma$  is a vertex), we can speak indifferently of the building block  $S_\sigma$  or its image  $\tilde{S}_\sigma$  in  $S_X$ .

**Lemma 3.6.** *Let  $(S_X, X)$  be a phase tropical manifold. Then  $S_X$  is a topological  $2n$ -manifold.*

*Proof.* First, let us show that the inverse image of the mobile points  $\lambda^{-1}(X^\circ)$ , is indeed a topological manifold. Let  $v$  be a vertex of zero sedentarity of  $X$ ,  $J \subset \{0, \dots, n+1\}$  be a subset of cardinality  $n$  and  $(v, z) \in \{v\} \times B_J^n$ . The point  $(v, z)$  is at the intersection of  $2^n$  building-blocks, more precisely, this point is contained in  $\binom{n}{k}$  building blocks of  $k$ -dimensional cells (of sedentarity zero). We want to prove that  $(v, z)$  admits an open neighborhood in  $S_X$  homeomorphic to a ball. This is enough to show that any point in the inverse image  $\lambda^{-1}(X^\circ)$  admits such a neighborhood, because all possible type of points in  $\lambda^{-1}(X^\circ)$  are contained in an open neighborhood of  $(v, z)$ , meaning the points in  $\lambda^{-1}(X^\circ)$ , which are contained in  $2^m$  building blocks, with  $0 \leq m \leq n$ . Let  $\sigma \in \mathcal{C}_{k,0}(X)$  be a cell such that the associated building-block  $S_\sigma$  contains  $(v, z)$ . Since the cell  $\sigma$  is of sedentarity zero, one has  $S_\sigma = \sigma \times T^\sigma \times \overline{P}^{n-\dim \sigma}$ , and we denote by  $(v, \theta_\sigma(z), z_\sigma(z))$  the coordinates of the point  $(v, z)$  in  $S_\sigma$ . Since the subset  $J$  is of cardinal  $n$ , the coordinate  $z_\sigma(z)$  of  $(v, z)$  in  $S_\sigma$ , is contained in a component  $B_{J_\sigma}^{n-\dim \sigma}$  of the boundary of  $\overline{P}^{n-\dim \sigma}$ , where  $J_\sigma$  is of cardinal  $n - \dim \sigma$ . Now, recall that  $S_\sigma \subset \sigma \times T^\sigma \times (\Delta_{n-\dim \sigma+1} \times (T^{n-\dim \sigma+2}/T))$  and denote by  $(v, \theta_\sigma(z), (x_\sigma(z), \vartheta_\sigma(z)))$  the coordinates of  $(v, z)$ . The coordinate  $x_\sigma(z)$  is located at the intersection of  $n - \dim \sigma$  facets of the simplex  $\Delta_{n-\dim \sigma+1}$ , thus  $x_\sigma(z)$  is the middle point of an edge of  $\Delta_{n-\dim \sigma+1}$ . As a consequence, all points  $(v, z') \in \{v\} \times B_J^n$  have the same coordinate

$x_\sigma(z') = x_\sigma$  in  $S_\sigma$ . This discussion shows that the  $n$ -dimensional torus  $(p_J)^{-1}(p_J(v, z))$  is contained in  $\{v\} \times T^\sigma \times (\{x_\sigma\} \times T^{n-\dim\sigma+2}/T)$ . We denote by  $T_v^J$  this  $n$ -dimensional torus, which is the intersection of all the building blocks containing the point  $(v, z) \in S_X$ . Consider an open ball  $U_v^J(z)$  in  $T_v^J$ , containing  $(v, z)$ . For any cell  $\sigma$  such that  $S_\sigma$  contains  $(v, z)$ , denote by  $\Delta_{n+1}^\sigma$  a copy of  $\Delta_{n-\dim\sigma+1}$ . By points (1) and (5) of Definition 3.8 and by Remark 3.6 concerning the point (2), there is a one-to-one correspondence between the copies  $\Delta_{n+1}^\sigma$ 's and the (closed) faces of  $\Delta_{n+1}^v$  containing  $x_v$ , sending  $x_\sigma$  to  $x_v$ . Consider an open neighborhood of the point  $x_v \in \Delta_{n+1}$ , denoted by  $U^v(x_v)$ , homeomorphic to  $(\mathbb{R}_{\geq 0})^{n+1}$ . One can then consider the intersection of this neighborhood with the face  $\Delta_{n+1}^\sigma$  of  $\Delta_{n+1}^v$ . We denote this intersection by  $U^\sigma(x_\sigma) := U^v(x_v) \cap \Delta_{n+1}^\sigma$ . Now consider  $F \in \mathcal{C}_{n,0}(X)$  the unique facet whose building-block  $S_F$  contains  $(v, z)$  and consider an open neighborhood  $U_F$  of the vertex  $v$  inside the facet  $F$ . For any cell  $\sigma$  containing  $v$ , denote by  $U_\sigma$  the intersection of  $U_F$  with  $\sigma$ . Note that this is an open neighborhood of  $v$  inside  $\sigma$  and it is homeomorphic to  $(\mathbb{R}_{\geq 0})^{\dim\sigma}$ . Finally, denote by  $U^\sigma(v, z)$  the intersection  $(U^\sigma(x_\sigma) \times U_v^J(z)) \cap \overline{P}^n$  and notice that that the intersection is homeomorphic to  $(\mathbb{R}_{\geq 0})^{n-\dim\sigma} \times \mathbb{R}^n$ . One has then that for any cell  $\sigma \in \mathcal{C}(X)$  such that  $(v, z) \in S_\sigma$ , the Cartesian product  $U_\sigma \times U^\sigma(v, z)$ , is an open neighborhood of  $(v, z)$  inside  $S_\sigma$  and is homeomorphic to  $(\mathbb{R}_{\geq 0})^n \times \mathbb{R}^n$ . Because of the commutativity with the projection on the simplex from point (3) of Definition 3.8, for another cell  $\tau \subset \sigma$ , the Cartesian products  $U_\sigma \times U^\sigma(v, z)$  and  $U_\tau \times U^\tau(v, z)$  intersect along  $U_\tau \times U^\sigma(v, z)$  which is homeomorphic to  $(\mathbb{R}_{\geq 0})^{n-\dim\sigma+\dim\tau} \times \mathbb{R}^n$ . Therefore, the union of these  $2^n$  sets forms an open neighborhood of  $(v, z)$  inside  $S_\sigma$  and is homeomorphic to  $\mathbb{R}^n$ .

When  $v$  is a vertex of sedentarity  $s \in \mathbb{Z}_{>0}$ , the description of an open neighborhood is similar. In fact, as in the previous case, it is enough to consider  $z \in B_J^n$ , where  $J$  has a maximal number of elements, that is to say  $n - 1 - s$  elements. The point  $(v, z)$  is then at the intersection of  $2^{n-s}$  building-blocks of sedentarity  $s$ . For each of the building-block  $S_\sigma$  containing  $(v, z)$  and such that  $|\text{sed}(\sigma)| = s$ , one can consider the parent face  $\sigma_{par}$  of dimension  $s + \dim\sigma$ . One can restrict the phase tropical surface  $(S_X, X)$  to  $(S_{X^v}, X^v)$ , where  $X^v$  is the union of all cells of sedentarity  $s$  of  $X$ , containing the vertex  $v$ . By noticing that  $(S_{X^v}, X^v)$  is a phase tropical manifold of dimension  $n - s$ , in which  $v$  is a vertex of sedentarity 0, one can construct the same products  $U_\sigma \times U^\sigma(v, z)$ , as in the sedentarity 0 case, for all cells  $\sigma$  of sedentarity  $s$  and such that  $S_\sigma$  contains  $(v, z)$ . Denote by  $F$  the unique cell of sedentarity  $s$  and of dimension  $n - s$  such that  $S_\sigma$  contains  $(v, z)$ . We then consider an open neighborhood  $U_{F_{par}}$  of  $v$  in the parent cell  $F_{par}$  of  $F$ , such that  $U_{F_{par}}$  is homeomorphic to  $(\mathbb{R}_{\geq 0})^n$  and intersects the cell  $F$  exactly along the neighborhood  $U_F$  of  $v$  inside  $F$ . We denote by  $T^{div}$  the  $s$ -dimensional torus inside  $T^{v_{par}}$ , generated by the divisorial directions of  $v$  inside  $v_{par}$ . For any cell  $\sigma$  of sedentarity  $s$ , such that  $S_\sigma$  contains  $(v, z)$ , the intersection of  $U_{F_{par}}$  with the parent face  $\sigma_{par}$  of  $\sigma$  is homeomorphic to  $(\mathbb{R}_{\geq 0})^{\dim(\sigma_{par})}$ . Then we consider the union of the product of the form  $U_{\sigma_{par}} \times T^{\cdot} \times U^\sigma(v, z)$  for all cells  $\sigma$  of sedentarity  $s$  such that  $S_\sigma$  contains  $(v, z)$ . Taking the image by the quotient map  $\bigcup_{\sigma \in \mathcal{C}(X)} S_\sigma \rightarrow S_X$  yields an open neighborhood of  $(x, v)$ , which is homeomorphic to a ball.  $\square$

*Remark 3.8.* One should be careful when reading about "phase tropical objects" in the literature. To the knowledge of the author, the first occurrence of the term "phase" associated with a tropical object is by G. Mikhalkin in [28]. It was introduced to answer the question of the realisability of a plane tropical curve as a limit of a family of plane algebraic curves in the sense of Theorem 3.1. A phase is described as a lift of the neighborhood of a vertex in  $(\mathbb{C}^*)^2$ , that is, a constant family of lines in  $(\mathbb{C}^*)^2$  which degenerates to the neighborhood of the vertex.

Then, the question of the realisability of the whole tropical curve depends on the possibility to glue the phases over vertices together. More recently, G. Kerr and I. Zharkov in [20] defined phase tropical hypersurfaces as gluing of *coamoebas*, which does not quite coincide with our point of view in Definition 3.8. However, they do show that a phase tropical hypersurface (with their definition) is homeomorphic to a topological manifold decomposed into pairs-of-pants like ours, so it seems acceptable that we call the objects of Definition 3.8 "phase tropical manifolds". Finally, as mentioned at the beginning of this section, in the case of curves the closest definition to ours is the one of [7], even if the authors do not call it "phase tropical curve".

Let us describe the building-blocks of a phase tropical surface, that is, the case  $n = 2$  of Definition 3.8.

- If  $v$  is a vertex of sedentarity 0, then  $S_v = \{v\} \times \overline{P}^2$  is of dimension 4.
- If  $v$  is a vertex of sedentarity 1, then  $S_v = \{v\} \times \overline{P}^1$  of dimension 2.
- If  $v$  is a vertex of sedentarity 2, then  $S_v = \{v\}$  is a point.
- If  $e$  is an edge of sedentarity 0, then  $S_e = e \times T^e \times \overline{P}^1$  and  $S_e$  is of dimension 4 and homeomorphic to  $e \times T^1 \times \overline{P}^1$ .
- If  $e$  is an edge of sedentarity 1, then  $S_e = e \times T^e$  is of dimension 2 homeomorphic to  $e \times T^1$ .
- If  $F$  is a face, then  $S_F = F \times T^F$  is of dimension 4 and homeomorphic to  $F \times T^2$ .

We are now going to see a crucial point of view for tropical homology in the case of phase tropical manifold, allowing us to use equivalently the  $p^{\text{th}}$ -homology of the building-blocks and the cosheaf  $\mathcal{F}_p$ , as a system of local coefficients for tropical homology. Let  $G$  be an abelian group. For all non-negative integers  $p$ , one can associate to any cell  $\sigma \in \mathcal{C}(X)$ , the group  $H_p(S_\sigma; G)$ . Moreover, to any pair of cells  $\tau \subset \sigma$  one can consider the composition of the morphism  $(\phi_\sigma^\tau)_* : H_p(S_\sigma^\tau; G) \rightarrow H_p(S_\sigma; G)$ , with the isomorphism  $H_p(S_\sigma; G) \cong H_p(S_\sigma^\tau; G)$ , given by the inverse of the morphism induced by the inclusion  $S_\sigma^\tau \subset S_\sigma$ . We also denote by  $(\phi_\sigma^\tau)_* : H_p(S_\sigma; G) \rightarrow H_p(S_\tau; G)$  this composition, despite the slight abuse of notation. One has then a cellular co-sheaf of abelian groups on  $X$ , denoted by  $H_p(S_\bullet; G)$ . For any facet  $F \in \mathcal{C}_{n,0}(X)$ , there is an isomorphism of abelian group  $L_p^F : \mathcal{F}_p^{\mathbb{Z}}(F) \rightarrow H_p(S_F; \mathbb{Z})$  constructed in the following way. For all primitive integer vectors  $v = v_1 \wedge \dots \wedge v_p \in \mathcal{F}_p^{\mathbb{Z}}(F)$ , we define  $L_p^F(v)$  by the homological class in  $H_p(S_F; \mathbb{Z})$  of the cycle  $\{*\} \times (\text{Vect}_{\mathbb{R}}\{v_1, \dots, v_p\} / (2\pi \text{Vect}_{\mathbb{Z}}\{v_1, \dots, v_p\}))$ , oriented according the basis  $(v_1, \dots, v_p)$  of  $\text{Vect}_{\mathbb{R}}(v_1, \dots, v_p)$ . We then extend  $L_p^F$  linearly to a morphism of abelian groups. The  $p^{\text{th}}$  homology group  $H_p(S_F; \mathbb{Z})$  is generated by the classes of cycles of the form  $\{*\} \times (V/2\pi(V \cap W'_Z(F)))$ , so the morphism  $L_p^F$  is surjective. Moreover, both the target and the source of  $L_p^F$  are free  $\mathbb{Z}$ -modules of rank  $\binom{n}{p}$ , thus the morphism  $L_p^F$  is an isomorphism.

**Lemma 3.7.** *Let  $(S_X, X)$  be a phase tropical manifold. Let  $\sigma \in \mathcal{C}(X)$  be a cell of  $X$ , adjacent to  $k \in \mathbb{Z}_{\geq 0}$  facets denoted by  $F_1, \dots, F_k$  and let  $p$  be a non-negative integer. For all  $j \in \{1, \dots, k\}$ , consider an integer vector  $v_j \in \mathcal{F}_p^{\mathbb{Z}}(F_j)$ . If  $\sum_j \iota(v_j) = 0 \in \mathcal{F}_p^{\mathbb{Z}}(\sigma)$ , then one has  $\sum_j \left( \phi_{F_j}^\sigma \right)_* L_p^{F_j}(v_j) = 0$ .*

*Proof.* Let  $v$  be a vertex adjacent to  $\sigma$  and of same sedentarity. The existence of such a cell is given by the fact that the tropical manifold  $X$  is hypersmooth. Applying the map  $\mathcal{F}_p^{\mathbb{Z}}(\sigma) \rightarrow \mathcal{F}_p^{\mathbb{Z}}(v)$  to the equality  $\sum_j \iota(v_j) = 0 \in \mathcal{F}_p^{\mathbb{Z}}(\sigma)$ , yields  $\sum_j \iota(v_j) = 0 \in \mathcal{F}_p^{\mathbb{Z}}(v)$ . Recalling the isomorphism from Lemma 3.4, one has then that  $\sum_j L_p^v(\iota(v_j)) = 0 \in H_p(S_v; \mathbb{Z})$ . Moreover, one can show that for all  $j \in \{1, \dots, k\}$ , one has  $(\phi_{F_j}^v)_* L_p^{F_j}(v_j) = L_p^v(\iota(v_j))$ . In fact, it is enough to prove it for  $v_j = {}^v\vec{e}_1 \wedge \dots \wedge {}^v\vec{e}_p$ , where the edges  $e_j$  are adjacent to both  $v$  and  $F_j$ , since these elements form a  $\mathbb{Z}$ -basis of  $\mathcal{F}_p^{\mathbb{Z}}(F_j)$ . Yet, one has  $L_p^{F_j}({}^v\vec{e}_1 \wedge \dots \wedge {}^v\vec{e}_p) = L_1^{F_j}({}^v\vec{e}_1) \wedge \dots \wedge L_1^{F_j}({}^v\vec{e}_p)$  and after applying  $(\phi_{F_j}^v)_*$ , one gets

$$\left(\phi_{F_j}^v\right)_* L_p^{F_j}({}^v\vec{e}_1 \wedge \dots \wedge {}^v\vec{e}_p) = \left(\phi_{F_j}^v\right)_* L_1^{F_j}({}^v\vec{e}_1) \wedge \dots \wedge \left(\phi_{F_j}^v\right)_* L_1^{F_j}({}^v\vec{e}_p).$$

By Equation (3.3), for any  $1 \leq l \leq p$ , one has  $(\phi_{F_j}^v)_* L_1^{F_j}({}^v\vec{e}_l) = (\phi_{e_l}^v)_* L_1^{e_l}({}^v\vec{e}_l)$  and then the equality  $(\phi_{F_j}^v)_* L_1^{F_j}({}^v\vec{e}_l) = \beta_1^{n_\sigma} = L_1^v({}^v\vec{e}_l)$  follows from Equation (3.4), where, for simplicity, we assume that for all  $l$ , the index  $l \in \{0, \dots, n_\sigma + 1\}$  of the coordinates of  $\mathbb{C}P^{n_\sigma+1}$ , corresponds to the edge  $e_l$ , by the bijection from the first point of Definition 3.8. One has then  $(\phi_{F_j}^v)_* L_p^{F_j}({}^v\vec{e}_1 \wedge \dots \wedge {}^v\vec{e}_p) = L_p^v({}^v\vec{e}_1 \wedge \dots \wedge {}^v\vec{e}_p)$ . We deduce from the relation  $(\phi_{F_j}^v)_* L_p^{F_j}(v_j) = L_p^v(\iota(v_j))$  that  $\sum_j (\phi_{F_j}^v)_* L_p^{F_j}(v_j) = 0 \in H_p(S_v; \mathbb{Z})$ . Applying the isomorphism  $(\phi_v^v)_*$  and using the last point of Definition 3.8, one gets the equation of the statement.  $\square$

Lemma 3.6 above makes the following definition possible.

*Definition 3.9.* Let  $(S_X, X)$  be a phase tropical manifold. Let  $p$  be a non-negative integer and  $\sigma \in \mathcal{C}(X)$  be a cell of  $X$ . The  $p$ -lifting isomorphism is the morphism of abelian group  $L_p^\sigma : \mathcal{F}_p^{\mathbb{Z}} \rightarrow H_p(S_\sigma; \mathbb{Z})$  defined on any element  $\iota(v)$ , for  $v \in \mathcal{F}_p^{\mathbb{Z}}(F)$ , and  $F$  an adjacent facet to  $\sigma$ , by

$$L_p^\sigma(\iota(v)) := (\phi_F^\sigma)_*(L_p^F(v)).$$

Note that, because of Equation (3.4), the definition of  $L_p^\sigma$  in the case  $p = 1$ , agrees with the previously defined lifting morphism  $L_1^\sigma$  on  $W_\mathbb{Z}'(\sigma)$ . The following lemma justifies the denomination "isomorphism" for  $L_p^\sigma$ . Recall the notation  $B_J^n \subset \overline{P}^n$  used in Lemma 3.1.

**Lemma 3.8.** *Let  $(S_X, X)$  be a phase tropical surface. Let  $p \in \mathbb{Z}_{\geq 0}$  be a non-negative integer and  $\sigma \in \mathcal{C}(X)$  be a cell of  $X$ . The  $p$ -lifting isomorphism  $L_p^\sigma$  is an isomorphism. Moreover, for any two non-negative integers  $k$  and  $l$  such that  $k+l = p$ , for any integer vectors  $v_\sigma \in \Lambda^k W_\mathbb{Z}'(\sigma)$  and  $v_F \in \mathcal{F}_p(F)$ , where  $F$  is an adjacent facet, the image  $L_p^\sigma(v_\sigma \wedge \iota(v_F))$  is in  $H_k(T^\sigma; \mathbb{Z}) \otimes H_l(B_{J(F)}^{n_\sigma}; \mathbb{Z})$ , from decomposition of Lemma 3.5, where  $J(F) \subset \{0, \dots, n_\sigma + 1\}$  is the subset of indices of coordinates of  $\mathbb{C}P^{n_\sigma+1}$  corresponding to the faces of dimension  $\dim \sigma + 1$ , which are adjacent to both  $\sigma$  and the facet  $F$ .*

*Proof.* The second part of the statement is a consequence of the fact that the image of  $\phi_F^\sigma$  is included in  $S_\sigma^F := \sigma \times T^\sigma \times B_{J(F)}^{n_\sigma}$ . One is left to show that, restricted to the sub-group generated by the vectors of the form  $v_\sigma \wedge v_F$  like in the statement, the morphism  $L_p^\sigma$  is an isomorphism onto  $H_k(T^\sigma; \mathbb{Z}) \otimes H_l(B_{J(F)}^{n_\sigma}; \mathbb{Z})$ . Yet, evaluated on a wedge product of this form, by definition,  $L_p^\sigma(v_\sigma \wedge \iota(v_F))$  is equal to  $(\phi_F^\sigma)_* L_p^F(v_\sigma \wedge \iota(v_F))$ . Consider the parent face  $\sigma_{par} \in \mathcal{C}_{0,s}^\sigma(X)$

the parent face of  $\sigma$ , where  $s = |\text{sed}(\sigma)|$ . Since the kernel of  $\iota : \mathcal{F}_1^{\mathbb{Z}}(\sigma_{par}) \rightarrow \mathcal{F}_1^{\mathbb{Z}}(\sigma)$  is composed of vectors sent to zero by the divisorial projection  $\sigma_{par} \rightarrow \sigma$ , it does not intersect the subspace  $W'_{\mathbb{Z}}(\sigma)$  outside  $\{0\}$ . Therefore, one can consider a  $(n - s)$ -dimensional supplementary subspace  $E_F^{\sigma} \subset W'_{\mathbb{Z}}(F) = \mathcal{F}_1^{\mathbb{Z}}(F)$  of the kernel  $\text{Ker}(\iota : \mathcal{F}_1^{\mathbb{Z}}(F) \rightarrow \mathcal{F}_1^{\mathbb{Z}}(\sigma))$ , such that  $W'_{\mathbb{Z}}(\sigma) \subset E_F^{\sigma}$ . Then one can consider a  $n_{\sigma}$ -dimensional supplementary subspace  $\tilde{E}_F^{\sigma}$  of  $W'_{\mathbb{Z}}(\sigma)$  inside  $E_F^{\sigma}$ . By adding some element of  $\text{Ker}(\iota : \mathcal{F}_1^{\mathbb{Z}}(F) \rightarrow \mathcal{F}_1^{\mathbb{Z}}(\sigma)) \wedge \mathcal{F}_{k-1}^{\mathbb{Z}}$  to the vector  $v_F$  and then adding an element of  $\Lambda^k W'_{\mathbb{Z}}(\sigma)$ , one can write  $v_{\sigma} \wedge \iota(v_F) = v_{\sigma} \wedge \iota(v'_F)$ , where  $v'_F \in \Lambda^k \tilde{E}_F^{\sigma}$ . Moreover, notice that since  $F$  is a facet, the boundary component  $B_{J(F)}^{n_{\sigma}}$  of  $\overline{P}^{n_{\sigma}}$  is a  $\dim \sigma$ -dimensional torus, so that both  $(\Lambda^k W'_{\mathbb{Z}}(\sigma)) \wedge \iota(\Lambda^l \tilde{E}_F^{\sigma})$  and  $H_k(T^{\sigma}; \mathbb{Z}) \otimes H_l(B_{J(F)}^{n_{\sigma}}; \mathbb{Z})$  are free  $\mathbb{Z}$ -modules of rank  $\binom{\dim \sigma}{k} \cdot \binom{n_{\sigma}}{l}$ . Finally, using the fourth point of Definition 3.8, one gets that the morphism  $(\phi_{\sigma_{par}}^{\sigma})_*$  is an isomorphism onto  $H_p(S_{\sigma}; \mathbb{Z})$ , when restricted to the subgroup  $H_p(\sigma \times T^{\sigma} \times \overline{P}^{n_{\sigma}}; \mathbb{Z}) \subset H_p(S_{\sigma_{par}}; \mathbb{Z})$ . In particular, this morphism is also an isomorphism onto  $H_k(T^{\sigma}; \mathbb{Z}) \otimes H_l(B_{J(F)}^{n_{\sigma}}; \mathbb{Z}) \subset H_p(S_{\sigma}; \mathbb{Z})$ , when restricted to  $H_k(T^{\sigma}; \mathbb{Z}) \otimes H_l(B_{J(F)}^{n_{\sigma}}; \mathbb{Z}) \subset H_p(S_{\sigma_{par}})$ . Yet,  $\phi_F^{\sigma_{par}} : S_F^{\sigma} \rightarrow S_{\sigma_{par}}^F$  is a homeomorphism because  $F$  and  $\sigma_{par}$  are both of sedentarity zero. Thus, the composition  $(\phi_F^{\sigma})_* = (\phi_{\sigma_{par}}^{\sigma})_* (\phi_F^{\sigma_{par}})_*$  is surjective onto  $H_k(T^{\sigma}; \mathbb{Z}) \otimes H_l(B_{J(F)}^{n_{\sigma}}; \mathbb{Z}) \subset H_p(S_{\sigma}; \mathbb{Z})$ . Since the lifting morphism  $L_p^F$  is an isomorphism (because  $F$  is a facet), it implies the surjectivity of  $(\phi_F^{\sigma})_* \circ L_p^F : (\Lambda^k W'_{\mathbb{Z}}(\sigma)) \wedge \iota(\Lambda^l \tilde{E}_F^{\sigma}) \rightarrow H_k(T^{\sigma}; \mathbb{Z}) \otimes H_l(B_{J(F)}^{n_{\sigma}}; \mathbb{Z})$ . It implies the desired bijectivity, since a surjective morphism between free abelian groups of same rank is an isomorphism.  $\square$

**Proposition 3.2.** *Let  $(S_X, X)$  be a phase tropical manifold and  $G$  an abelian group. There is an isomorphism of (cellular) co-sheaves  $L_p^{\bullet} : H_p(S_{\bullet}; G) \cong \mathcal{F}_p^G$ .*

*Proof.* The isomorphism  $H_p(S_{\sigma}; \mathbb{Z}) \cong \mathcal{F}_p^{\mathbb{Z}}(\sigma)$  for all cells  $\sigma \in \mathcal{C}(X)$  is the first part of the statement of Lemma 3.8. For another cell  $\tau \subset \sigma$ , the commutativity of the diagram

$$\begin{array}{ccc} \mathcal{F}_p^{\mathbb{Z}}(\sigma) & \xrightarrow{\iota} & \mathcal{F}_p^{\mathbb{Z}}(\tau) \\ \downarrow L_p^{\sigma} & & \downarrow L_p^{\tau} \\ H_p(S_{\sigma}; \mathbb{Z}) & \xrightarrow{(\phi_{\sigma}^{\tau})_*} & H_p(S_{\tau}; \mathbb{Z}) \end{array}$$

is true by definition of the  $p$ -lifting isomorphism. Tensoring the definition of the  $p$ -lifting morphism  $L_p$  by the abelian group  $G$  yields the result.  $\square$

Proposition 3.2 allows us to compute the cellular tropical homology groups  $H_q^{cell}(X; \mathcal{F}_p^G)$  as  $H_q^{cell}(X; H_p(S_{\bullet}; G))$ . This point of view was mentioned in the case of a limit of a 1-parameter family of the form of Equation (3.1) in [2]. In particular, one can use the Leray-Serre spectral sequence associated with the stratified fibration  $\lambda : S_X \rightarrow X$ , in order to obtain the following result.

**Proposition 3.3.** *Let  $(S_X, X)$  be a phase tropical manifold. For any  $k \in \mathbb{Z}_{\geq 0}$ , we have the inequality*

$$\dim H_k(S_X; \mathbb{Z}_2) \leq \sum_{p+q=k} \dim H_{p,q}(X; \mathbb{Z}_2).$$

*Proof.* The stratified fibration  $\lambda : S_X \rightarrow X$  induces a filtration of the singular chain complex  $C_*(S_X; \mathbb{Z}_2)$  by:

$$0 \subset C_*(\lambda^{-1}(X^0); \mathbb{Z}_2) \subset \dots \subset C_*(\lambda^{-1}(X^n); \mathbb{Z}_2) = C_*(X; \mathbb{Z}_2),$$

where  $X^k$  denote the  $k$ -skeleton of  $X$ . This filtration induces a Leray-Serre spectral sequence with  $\mathbb{Z}_2$ -coefficients associated with the stratified fibration  $S_X \rightarrow X$ . This spectral sequence has for second page  $E_{q,p}^2 = H_q^{cell}(X; H_p(\bullet; \mathbb{Z}_2))$ . Moreover, it degenerates ( $S_X$  is a finite CW-complex) and converges to the graded homology  $F_p H_*(S_X; \mathbb{Z}_2)$ , where  $F_p H_*(S_X; \mathbb{Z}_2)$  is the subset of all  $a \in H_*(S_X; \mathbb{Z}_2)$  such that there exists  $\alpha \in C_*(\lambda^{-1}(X^p); \mathbb{Z}_2)$  representing  $a$ . As a result, one has that  $\dim(\sum_{p+q=k} E_{q,p}^\infty) = \dim H_k(S_X; \mathbb{Z}_2)$ . The rank formula for  $\mathbb{Z}_2$ -vector spaces implies that for all  $p, q$ , one has  $\dim E_{q,p}^2 \geq \dim E_{q,p}^\infty$ . Summing over all  $p + q = k$  and applying Proposition 2.3 yields the result.  $\square$

This result is quite easy to obtain thanks to the efficiency of the spectral sequence. One may ask whether this inequality is an equality. This question is answered in the affirmative in Chapter 4.

### 3.1.3 Real Structure of a Phase Tropical Manifold

Let  $(S_X, X)$  be a phase tropical manifold of dimension  $n$ . We denote by  $\lambda : S_X \rightarrow X$  the associated stratified fibration.

*Definition 3.10.* Let  $\sigma \in \mathcal{C}(X)$  be a cell of  $X$ . The *standard conjugation* on the building block  $S_\sigma$ , denoted by  $\text{conj}_\sigma : S_\sigma \rightarrow S_\sigma$ , is defined on  $(x, \theta, (y, \vartheta)) \in S_\sigma \subset \sigma \times T^\sigma \times (\Delta_{n+1} \times (T^{n+2}/T))$  by

$$\text{conj}_\sigma((x, \theta, (y, \vartheta))) = (x, -\theta, (y, -\vartheta)).$$

*Definition 3.11.* A *real structure* of  $(S_X, X)$  is a continuous involution  $c : S_X \rightarrow S_X$ , which is fiber-preserving, i.e.  $\lambda \circ c = \lambda$ , and such that

- for any vertex  $v$  of sedentarity 0, the restriction of the involution  $c$  to the building-block  $S_v = \tilde{S}_v$  acts as the standard conjugation on  $S_v$ , that is,  $c|_{S_v} = \text{conj}_v$ ;
- for any cell  $\sigma \in \mathcal{C}(X)$ , the restriction of the involution  $c$  to the relative interior  $\overset{\circ}{S}_\sigma = \tilde{\overset{\circ}{S}}_\sigma$  of the building-block  $S_\sigma$  acts as the standard conjugation on  $\overset{\circ}{S}_\sigma$ , up to a homeomorphism of  $S_\sigma$ , which restricts to the identity of  $\{v\} \times T^\sigma \times \overline{P}^{n_\sigma}$ , for all vertices  $v$  of  $\sigma$  (whatever their sedentarity).

Consider a cell  $\sigma$  of  $X$  and a real structure  $c$  of  $(S_X, X)$ . By Definition 3.11 of a real structure, the restriction on the fiber  $\lambda^{-1}(\overset{\circ}{\sigma})$  over the relative interior of  $\sigma$ , acts as the standard conjugation up to a automorphism of  $S_\sigma$ , which fixes the components  $(\partial\sigma) \times T^\sigma \times \overline{P}^{n_\sigma}$ . This restriction can then be extended by continuity to an involution on  $S_\sigma$  and we denote by  $c_\sigma$  this involution. In particular, the involution  $c_\sigma$  is the identity when restricted to  $\{v\} \times T^\sigma \times \overline{P}^{n_\sigma}$ , for any vertex  $v$  of the cell  $\sigma$ .

*Definition 3.12.* Let  $\sigma$  be a cell of  $X$ . A *local real structure* of  $(S_\sigma, \sigma)$  is an involution  $c_\sigma$ , coming from the restriction of a real structure of  $(S_X, X)$  as above.

*Definition 3.13.* Two real structures  $c$  and  $c'$  of  $(S_X, X)$  are said to be *isomorphic* if there exists a homeomorphism  $\varphi : S_X \rightarrow S_X$  such that  $\varphi \circ c \circ \varphi^{-1} = c'$ . They are said to be *X-isomorphic* if this homeomorphism is fiber-preserving and restricts to the identity of the fibers  $S_v$  for all vertices  $v$  of sedentarity 0 of  $X$ .

*Remark 3.9.* J. Rau, A Renaudineau and K. Shaw recently introduced the notion of *real phase structure* on a matroid fan in [33]. As explained in Section 2.1.3, matroid fans are local models for tropical manifolds and the definition of real phase structure can be extended to a tropical manifold  $X$  in a smooth tropical toric variety of dimension  $N$ . Briefly, a real phase structure can be described as the assignment for any cell  $\sigma$  of  $X$  of a  $\dim \sigma$ -dimensional  $\mathbb{Z}_2$ -affine space in  $\mathbb{Z}_2^N$ , parallel to  $\sigma$ . Given a phase tropical manifold  $(S_X, X)$ , endowed with a real structure  $c$ , one could recover a real phase structure on  $X$  by considering only the fixed locus of  $c$  in  $S_X$ . This emphasizes one of the main differences between the two definitions: a real phase structure does not remember the data of an embedding of the fixed locus inside the complex locus, but only remembers the fixed locus.

### 3.2 Real Structures of Phase Tropical Curves

In this section, we present the approach and results of [7] by B. Bertrand, E. Brugallé and A. Renaudineau, translated into our setting, which is slightly different. Moreover, we rewrite the results so that their formulation generalizes to the case of phase tropical surfaces, in particular for the description of real structures. The approach of [7] develops a new point of view on Haas's Theorem (see [11]). Briefly, Haas's theorem is a description of the unimodular (a.k.a primitive) patchworking giving an M-curve.

Let  $\Gamma$  be a compact hypersmooth tropical curve and let  $(S_\Gamma, \Gamma)$  be a phase tropical curve (see Definition 3.8). As mentioned in Remark 2.5, the curve  $\Gamma$  has a polyhedral combinatorial stratification, denoted by  $\mathcal{C}$ . Note that the edges of  $\Gamma$  are all of sedentarity 0 and compact because  $\Gamma$  is compact. Since the vertices of a standard tropical line in  $\mathbb{T}^2$  are of sedentarity less than or equal to 1, the vertices of the hypersmooth tropical curve  $\Gamma$  are also of sedentarity less than or equal to 1. The vertices of sedentarity 0 are 3-valent, meaning they are adjacent to 3 edges, while the vertices of sedentarity 1 are 1-valent.

*Remark 3.10.* The authors of [7] work with an abstract topological graph  $\Gamma$  and require that the vertices are either 1-valent or 3-valent. This makes no difference with our setting, except that our formulation extends directly to higher dimensions. However, they work in a more general setting by endowing  $\Gamma$  with an involution, continuous for the usual graph topology and whose restriction to the relative interior of an edge has either no fixed point or is the identity. Here, we completely forget about this involution, that is, we focus on the case where this involution is the identity. Another difference is the building-blocks over cells with positive sedentarity. In [7], the building-block over a vertex of sedentarity 1 is a disk of dimension 2. We could use the same approach by taking the product of a disk of dimension  $2s$  for the building-block over a cell of sedentarity  $s$ . The nice aspects with this point of view is that one can view every building-block as a fiber inside the phase tropical surface  $S_X$  and all the building-blocks have the same dimension. The downside, However, is that an involution  $c_\sigma$  does not have to restrict to the identity of  $\{v\} \times T^\sigma \times \overline{P}^{n_\sigma}$  for vertices of positive sedentarity. This would make many

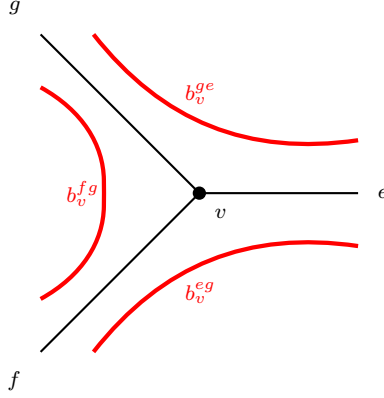

Figure 3.1: Labeling of the components of the real part of the fiber  $S_v$  over a trivalent vertex  $v$ .

definitions in Section 3.4 more difficult. Another disadvantage would also be that we would have to modify the real structures on the fibers over cells of positive sedentarity, while in Section 3.4, we only have to twist the real structures over cells of sedentarity 0.

### 3.2.1 Affine Space of Real Structures

In the case where  $(S_\Gamma, \Gamma)$  is obtained as a degeneration of a 1-parameter family of plane real algebraic curves  $(C_t)_{t>0}$ , one can describe the resulting real structure of  $(S_\Gamma, \Gamma)$  in terms of *twisted edges* (see [8], section 3). This description makes possible a nice formulation for Haas' Theorem. Moreover, the real curve  $S_\Gamma$  is of type  $I$  if and only if for every topological cycle  $\Sigma \subset \Gamma$ , there is an even number of twisted edges contained in  $\Sigma$  (see [8], Proposition 3.11). This notion of twisted edge has even a geometric visualization when looking at the boundary of the amoeba (see e.g [8]). However, it depends on the embedding inside the plane. That is why, for an edge  $e$  of  $\Gamma$  and a topological cycle  $\Sigma \subset \Gamma$  containing  $e$ , we introduce the notion of being *twisted along  $\Sigma$*  for the edge  $e$ .

Given a 3-valent vertex  $v$  of  $\Gamma$ , each of the 3 components of  $\mathbb{R}S_v$  intersects exactly 2 components of the boundary of  $S_v$ . Given two edges  $e$  and  $f$ , adjacent to  $v$ , we denote by  $b_v^{ef}$  the component of  $\mathbb{R}S_v$  which intersects  $S_v^e$  and  $S_v^f$ . This notation is illustrated by Figure 3.1.

*Definition 3.14.* Let  $e$  be a bounded edge of  $\Gamma$ . Denote by  $u$  and  $v$  the adjacent vertices to  $e$ , by  $f_u$  and  $g_u$  the two other adjacent edges to  $u$ , and similarly for  $f_v$  and  $g_v$ . The edge  $e$  is said to be *twisted along  $\mathbf{f} = (f_u, f_v)$*  if  $\mathbb{R}S_e$  connects  $b_u^{ef_u}$  and  $b_v^{ef_v}$ . Otherwise, the edge  $e$  is said to be *untwisted along  $\mathbf{f}$* .

*Remark 3.11.* The order in the above definition does not matter, that is, being twisted along  $(f_u, f_v)$  is equivalent to being twisted along  $(f_v, f_u)$ . Note also that being twisted along  $\mathbf{g} = (g_u, g_v)$  is equivalent to being twisted along  $\mathbf{f} = (f_u, f_v)$ , which is also equivalent to being untwisted along  $(f_u, g_v)$ .

*Definition 3.15.* Let  $\Sigma \subset \Gamma$  be a topological circle, and let  $e$  be an edge of  $\Gamma$  contained in  $\Sigma$ . The edge  $e$  is said to be *twisted along  $\Sigma$*  if  $e$  is twisted along  $(f, g)$ , where  $f$  and  $g$  are the edges



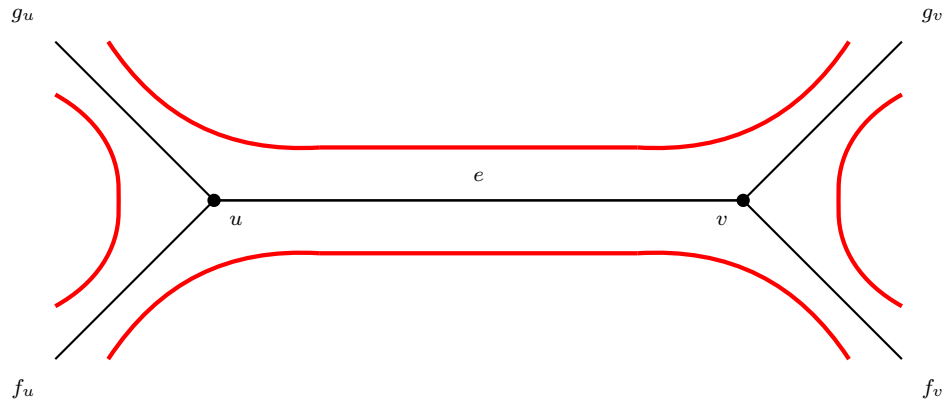

Figure 3.2: Edge  $e$  untwisted along  $\mathbf{f} = (f_u, f_v)$ . In red, the real part  $\mathbb{R}S_\Gamma$  of  $S_\Gamma$ .

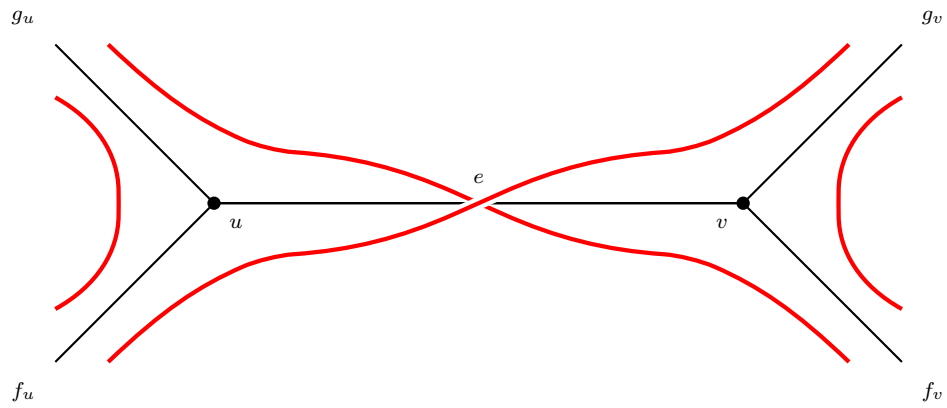

Figure 3.3: Edge  $e$  twisted along  $\mathbf{f} = (f_u, f_v)$ . In red, the real part  $\mathbb{R}S_\Gamma$  of  $S_\Gamma$ .

of  $\Sigma$  adjacent to  $e$ . Otherwise, the edge  $e$  is said to be *untwisted along*  $\Sigma$ . We denote by  $\mathcal{T}_c(\Sigma)$  the subset of the edges of  $\Sigma$ , which are twisted along  $\Sigma$ .

Now, let us notice that the real structures of  $(S_\Gamma, \Gamma)$  admit a description in terms of the (cellular) cohomology of the wave space  $W_{\mathbb{Z}_2}$ . Note that any 1-co-chain is a co-boundary because  $\Gamma$  is of dimension 1. Note also that the image of the cellular tropical co-boundary map  $d : C_{cell}^0(\Gamma; W_{\mathbb{Z}_2}) \rightarrow C_{cell}^1(\Gamma; W_{\mathbb{Z}_2})$  is the subspace of the 1-co-chains with support in the union of the unbounded edges of  $\Gamma$ . This is a consequence of the fact that for any 3-valent vertex  $v \in \mathcal{C}_0(\Gamma)$ , one has  $W_{\mathbb{Z}_2}(v) = 0$ . One obtains the following lemma.

**Lemma 3.9.** *One has*

$$H_{cell}^1(\Gamma; W_{\mathbb{Z}_2}) = \bigoplus_{e \in \mathcal{C}_1^0(\Gamma)} \mathbb{Z}_2 e,$$

where  $\mathcal{C}_1^0(\Gamma)$  is the subset of the bounded edges of  $\Gamma$ .

We denote by  $\Pi(S_\Gamma, \Gamma)$  the set of  $\Gamma$ -isomorphism classes of real structures. Given two real structures  $c$  and  $c'$  of  $(S_\Gamma, \Gamma)$  and a bounded edge  $e$  of  $\Gamma$ , the homeomorphism given by the composition of this restriction to the building-block  $S_e = \tilde{S}_e$ , is isotopic to a certain power of a Dehn twist on  $(S_e, e)$  (see Definition 3.23 for a precise definition). This power does not depend on the representative of the  $\Gamma$ -isomorphism classes of the real structures  $c$  and  $c'$  and the parity of this power is denoted by  $t_e(c', c) \in \mathbb{Z}_2$ . We call this parity *twist from  $c$  to  $c'$  at the edge  $e$* . Therefore, given a real structure  $c$  of  $(S_\Gamma, \Gamma)$ , we obtain a map from  $\Pi(S_\Gamma, \Gamma)$  to the  $\mathbb{Z}_2$ -vector space  $\bigoplus_{e \in \mathcal{C}_1^0(\Gamma)} \mathbb{Z}_2 e$  by associating to any  $\Gamma$ -isomorphism class of a real structure  $c'$ , the vector whose coordinate labeled by the bounded edge  $e$ , is the twist  $t_e(c', c)$ . One can then interpret  $\Pi(S_\Gamma, \Gamma)$  as a  $\mathbb{Z}_2$ -affine space.

**Proposition 3.4** (Proposition 2.11 [7]). *The set  $\Pi(S_\Gamma, \Gamma)$  is a  $\mathbb{Z}_2$ -affine space with direction*

$$\overrightarrow{\Pi}_\Gamma = \bigoplus_{e \in \mathcal{C}_1^0(\Gamma)} \mathbb{Z}_2 e = H_{cell}^1(\Gamma; W_{\mathbb{Z}_2}).$$

*Remark 3.12.* In [7], only the left equality of the above proposition is written. The identification between  $\bigoplus_{e \in \mathcal{C}_1^0(\Gamma)} \mathbb{Z}_2 e$  and  $H_{cell}^1(\Gamma; W_{\mathbb{Z}_2})$  is a better point of view in order to generalize the description of the affine space of real structures to phase tropical surfaces. This is the point of Section 3.4 and more precisely of Theorem 3.3. Finally, notice that we deliberately forget the dependence on the phase tropical curve  $(S_\Gamma, \Gamma)$  in the direction  $\overrightarrow{\Pi}_\Gamma$ , since this direction depends only on the tropical curve  $\Gamma$ .

### 3.2.2 Lifting Tropical Cycles

Let  $G$  be an abelian group. We are interested in lifting singular tropical  $(1, 0)$  and  $(0, 1)$ -cycles of  $\Gamma$  to 1-cycles of  $S_\Gamma$ . Let  $e \in \mathcal{C}(X)$  and  $x \otimes v \in \overset{\circ}{e} \otimes \mathcal{F}_1^\mathbb{Z}(e)$  be a framed point. We put  $L_{1,0}(x \otimes v) = x \times (\mathbb{R}v / (2\pi\mathbb{Z}v)) \in C_1(S_\Gamma; \mathbb{Z})$ . Extending  $L_{1,0}$  by linearity and tensoring by  $G$ , it defines a morphism  $C_{1,0}(\Gamma; G) \rightarrow C_1(S_\Gamma; G)$ . The induced morphism  $H_{1,0}(\Gamma; G) \rightarrow H_1(S_\Gamma; G)$  is also denoted by  $L_{1,0}$ . Notice that in the previous construction, there is no need to lift  $(1, 0)$ -cycles whose support intersect vertices of sedentarity 0, thanks to Lemma 2.3. We denote by

$H_{1,0}(S_\Gamma; G) := \text{Im } L_{1,0}$  the image of the morphism  $L_{1,0}$ . Now, let  $\Sigma \subset \Gamma$  be a topological circle embedded in the tropical curve  $\Gamma$ . As proved in [7], the homology class of a lift of  $\Gamma$  in  $S_\Gamma$  is well-defined, up to an element of  $H_{1,0}(S_\Gamma; G)$  (done only in the case  $G = \mathbb{Z}_2$  in [7], but there is no restriction to extend the proof for any abelian group  $G$ ). The image of the homology class of this lift in the quotient group  $H_1(S_\Gamma; G) / (H_{1,0}(S_\Gamma; G))$ , is denoted by  $L_{0,1}([\Sigma])$ , where  $[\Sigma] \in H_{0,1}(\Gamma; G)$  is the tropical homology class of  $\Sigma$ . We extend  $L_{0,1}$  by linearity to a morphism of abelian groups  $L_{0,1} : H_{0,1}(\Gamma; G) \rightarrow H_1(S_\Gamma; G) / H_{1,0}(S_\Gamma; G)$ . We denote by  $H_{0,1}(S_\Gamma; G)$  the subgroup of  $H_1(S_\Gamma; G)$  whose elements are sent to  $\text{Im } L_{0,1}$  by the projection to the quotient  $H_1(S_\Gamma; G) / H_{1,0}(S_\Gamma; G)$ . We now have two morphisms, called  $(1, 0)$ - and  $(0, 1)$ -*lifting morphisms*:

$$\begin{aligned} L_{1,0} &: H_{1,0}(\Gamma; G) \rightarrow H_1(S_\Gamma; G), \\ L_{0,1} &: H_{0,1}(\Gamma; G) \rightarrow H_1(S_\Gamma; G) / H_{1,0}(S_\Gamma; G). \end{aligned}$$

**Proposition 3.5.** [7] *The lifting morphisms  $L_{1,0}$  and  $L_{0,1}$  are injective.*

*Remark 3.13.* The proof proposed in [7] uses the intersection form on  $H_1(S_\Gamma; G)$ . Although it is not mentioned there, it relies on the fact that the lifting morphisms push forward the tropical pairing on  $H_{1,0}(\Gamma; G) \times H_{0,1}(\Gamma; G)$  to the intersection form on  $H_1(S_\Gamma; G)$ . More precisely, for  $[a], [b] \in H_{1,0}(\Gamma; G) \times H_{0,1}(\Gamma; G)$  one has  $L_{1,0}([a]) \circ L_{0,1}([b]) = [a] \circ [b]$ .

**Corollary 3.3.** *For  $G = \mathbb{Z}_2$ , one has the following filtration*

$$0 \subset H_{1,0}(S_\Gamma; \mathbb{Z}_2) \subset H_{0,1}(S_\Gamma; \mathbb{Z}_2) = H_1(S_\Gamma; \mathbb{Z}_2).$$

*Proof.* It is done in [7], but in our text, it is a consequence of Propositions 3.3 and 3.5.  $\square$

Now, let us see consider a way of lifting tropical  $(0, 1)$ -cycles, using the fixed locus of a real structure  $c$  of  $(S_X, X)$ . Let  $c$  be a real structure of  $(S_X, X)$ .

**Lemma 3.10.** *Let  $\Sigma \subset \Gamma$  be a topological circle embedded in  $\Gamma$ . This circle can be lifted as a component of  $\text{Fix}(c)$  if and only if all the edges of  $\Sigma$  are untwisted along  $\Sigma$ .*

*Proof.* A lift of  $\Sigma$  by a real component has to contain the component  $b_v^{fg}$  of  $\mathbb{R}S_v$ , for any vertex  $v$  of  $\Sigma$ , where  $f$  and  $g$  are the adjacent edges to  $v$  contained in  $\Sigma$ . By definition, these components  $b_v^{fg}$  are connected by the real part  $\mathbb{R}S_e$  of the building-block  $S_e$  associated with the edges  $e$  of  $\Sigma$  if and only if none of these edges is twisted along  $\Sigma$ .  $\square$

**Lemma 3.11.** *Let  $c$  and  $c'$  be two real structures of  $(S_\Gamma, \Gamma)$ . Let  $e$  be a bounded edge of  $\Gamma$ , adjacent to the vertices  $u$  and  $v$ . Denote by  $f_u, g_u$  the other edges adjacent to  $u$  and by  $f_v, g_v$  the other edges adjacent to  $v$ . The following statements are equivalent.*

- *The edge  $e$  is either untwisted along  $\mathbf{f} = (f_u, f_v)$  for both  $c$  and  $c'$ , or twisted along  $\mathbf{f}$  for both  $c$  and  $c'$ .*
- *The twist from  $c$  to  $c'$  at the edge  $e$  is  $t_e(c', c) = 0$ .*

*Proof.* By Proposition 3.4, one can assume that  $c' = D_e^t$ , where  $D_e$  is the Dehn twist on  $(S_e, e)$  and  $t$  is an integer congruent to  $t_e(c', c)$ . Let us work in the coordinates of  $S_e$  where the local real structure  $c_e$  acts as the standard conjugation  $\text{conj}_e$ . The edge  $e$  is then untwisted along  $\mathbf{f}$  for  $c$  if and only if  $\{u\} \times \{0\}$  intersects  $b_u^{efu}$  and  $\{v\} \times \{0\}$  intersects  $b_v^{efv}$ . The component of the fixed locus of the real local structure  $c'_e$  containing  $\{u\} \times \{0\}$  has the expression  $\{(x, t\pi x) \mid x \in [0, 1]\}$ . This component also contains the point  $\{v\} \times \{0\}$  if and only if  $t$  is even. The result follows.  $\square$

**Proposition 3.6.** *Let  $\Sigma \subset \Gamma$  be a topological circle embedded inside  $\Gamma$ . There exists a real structure  $c'$  of  $(S_X, X)$  such that  $\Sigma$  lifts as a component of  $\text{Fix}(c')$ . Moreover, for any edge  $e \in \mathcal{C}_1^0(\Gamma)$ , the twist from  $c$  to  $c'$  at the edge  $e$  is given by  $t_e(c, c') = 1 \in \mathbb{Z}_2$  if and only if  $e \in \mathcal{T}_c(\Sigma)$ .*

*Proof.* All the edges of  $\Sigma$  are bounded, because both of their vertices are at least 2-valent. By Proposition 3.4, there exists a real structure  $c'$  such that the twist from  $c$  to  $c'$  at  $e$  satisfies the second part of the statement. By Lemma 3.11, the edges of  $\Gamma$  are untwisted along  $\Sigma$  for the real structure  $c'$ , so by Lemma 3.10, the circle  $\Sigma$  lifts as a connected component of  $\text{Fix}(c')$ .  $\square$

### 3.2.3 Type and Maximality of a Phase Tropical Curve

Let  $c$  be a real structure of the phase tropical curve  $(S_\Gamma, \Gamma)$ . In order to obtain a criterion for the type with our point of view, there is one key observation, namely that there are always two fixed points by  $c$  in a toric fiber  $\lambda^{-1}(x)$  for a point  $x$  in the relative interior of an edge  $e$ . Therefore, one has the following lemma.

**Lemma 3.12.** *The fixed locus  $c$  is orthogonal to the group  $H_{1,0}(S_\Gamma; \mathbb{Z}_2)$  for the intersection product.*

Thanks to this lemma, the intersection product of the fixed locus  $\text{Fix}(c)$  with an element in  $\text{Im } L_{0,1}$  is well defined.

**Proposition 3.7.** *Let  $c$  be a real structure of  $(S_\Gamma, \Gamma)$  and let  $\Sigma \subset \Gamma$  be a topological cycle. One has*

$$L_{0,1}([\Sigma]) \circ [\text{Fix}(c)] = \text{Card}(\mathcal{T}_c(\Sigma)).$$

*Proof.* Denote by  $s_\Sigma$  the fixed component by the real structure  $c'$  of Proposition 3.6, such that  $s_\Sigma$  is a lift of  $\Sigma$ . In particular, one has  $L_{0,1}([\Sigma]) \circ \text{Fix}(c) = [s_\Sigma] \circ \text{Fix}(c)$ . By Lemma 1.2, one obtains  $L_{0,1}([s_\Sigma]) \circ \text{Fix}(c) = [s_\Sigma] \circ c_* [s_\Sigma]$ . By Lemma 1.1, one has  $[s_\Sigma] \circ [s_\Sigma] = \chi(\sigma) = 0$ . Hence the equality  $L_{0,1}([s_\Sigma]) \circ \text{Fix}(c) = [s_\Sigma] \circ (c_* [s_\Sigma] + [s_\Sigma]) = [s_\Sigma] \circ ([s_\Sigma] + c_* [s_\Sigma])$ . Yet  $s_\Sigma + c_* s_\Sigma$  is contained in the union of the building-blocks  $S_e$  for the edges  $e$ , twisted along  $\Sigma$ . In fact, elsewhere, the involutions  $c$  and  $c'$  coincide. More precisely, the cycle realized in  $S_e = e \times T^e$  by  $s_\Sigma + c_* s_\Sigma$  is equal, in the coordinates of  $S_e$  where  $c$  acts as the standard conjugation on  $S_e$ , to  $\{(x, \pi x) \mid x \in e\} + \{(x, -\pi x) \mid x \in e\}$ . Therefore, the cycle  $S_e \cap (s_\Sigma + c_* s_\Sigma)$  is homologous to  $L_{0,1}(x_e \otimes \vec{e})$ , where  $x_e$  is the barycenter of the edge  $e$  and  $\vec{e} \in W_{\mathbb{Z}_2}(e)$  is the non-zero element. Finally, it implies that  $L_{0,1}([s_\Sigma]) \circ \text{Fix}(c) = [s_\Sigma] \circ \left( \sum_{e \in \mathcal{T}_c(\Sigma)} L_{0,1}(x_e \otimes \vec{e}) \right) = \sum_{e \in \mathcal{T}_c(\Sigma)} 1 = \text{Card}(\mathcal{T}_c(\Sigma)) \pmod{2}$ .  $\square$

**Corollary 3.4.** *The phase tropical curve  $(S_\Gamma, \Gamma)$  endowed with a real structure  $c$  is of type I if and only if, for every embedded topological circle  $\Sigma \subset \Gamma$ , there is an even number of edges twisted along  $\Sigma$ .*

*Remark 3.14.* Although the statement seems similar to the one of [8], proposition 3.11 (attributed to B. Haas in his thesis [11]), the notion of twisted edges is not the same, so the two statements are different.

In order to obtain a criterion for the maximality, one has to understand the action of the real structure  $c_*$  on the lifts of tropical cycles. The action on  $H_{1,0}(\Gamma; \mathbb{Z}_2)$  is trivial because the elements of this subgroup can be represented by fibers  $\lambda^{-1}(x)$  for  $x$  in the relative interior of an edge, and  $c_*\lambda^{-1}(x) = \lambda^{-1}(x)$  by Definition 3.11. About the action on  $H_{0,1}(\Gamma; \mathbb{Z}_2)$ , one needs to understand  $[s_\Sigma] + c_*[s_\Sigma]$  for a lift  $s_\Sigma$  of a topological circle  $\Sigma$ . We already proved in the proof of Proposition 3.7, that

$$[s_\Sigma] + c_*[s_\Sigma] = \sum_{e \in \mathcal{T}_c(\Sigma)} L_{1,0}(x_e \otimes \vec{e}).$$

*Remark 3.15.* In particular, one can see that the morphism  $1 + c_*$  decreases the index by one in the filtration of Corollary 3.3.

One can then formulate, using the injectivity of the lifting morphism  $L_{1,0}$ , the following criterion for the maximality of  $(S_\Gamma, \Gamma)$  endowed with a real structure  $c$ . This criterion depends only on the data of the twisted edges along the cycles and of the combinatorics of the tropical curve  $\Gamma$ .

**Proposition 3.8.** *The phase tropical curve  $(S_\Gamma, \Gamma)$ , endowed with a real structure  $c$ , is maximal if and only if for all topological circle  $\Sigma$  contained in  $\Gamma$  one has*

$$\sum_{e \in \mathcal{T}_c(\Sigma)} [x_e \otimes \vec{e}] = 0 \in H_{1,0}(\Gamma; \mathbb{Z}_2).$$

*Proof.* As mentioned in [7], in the case of a phase tropical curve, there is an equivalence between being maximal and that the action of the conjugation on the  $\mathbb{Z}_2$ -homology is trivial. The conjugation acts trivially on  $H_0(S_\Gamma; \mathbb{Z}_2)$  and  $H_2(S_\Gamma; \mathbb{Z}_2)$  because  $S_\Gamma$  is connected. Therefore,  $S_\Gamma$  is maximal if and only if the conjugation acts trivially on  $H_1(S_\Gamma; \mathbb{Z}_2)$ . The statement is then a consequence of the formula

$$(1 + c_*)[s_\Sigma] = \sum_{e \in \mathcal{T}_c(\Sigma)} L_{1,0}(x_e \otimes \vec{e}),$$

and of the injectivity of the 1-lifting isomorphism. □

### 3.3 First properties of a Real Structure

#### 3.3.1 Real structure along an edge

Let us fix a hypersmooth tropical surface  $X$  with a polyhedral combinatorial stratification and a phase tropical surface  $(S_X, X)$ . Assume that  $(S_X, X)$  admits a real structure  $c$ . Since there is no other real structure than  $c$  in this section, we denote by  $\mathbb{R}S_\sigma$  the fixed locus of  $c$  on every building-block  $S_\sigma$ . The goal of this section is to study the different topological possibilities of the real part  $\mathbb{R}S_e$  of the building block of an edge  $e$  of  $X$ . The most interesting case is of course the one of non-sedentary edges, and more particularly, of bounded edges, that is, edges connecting two vertices of sedentarity 0.

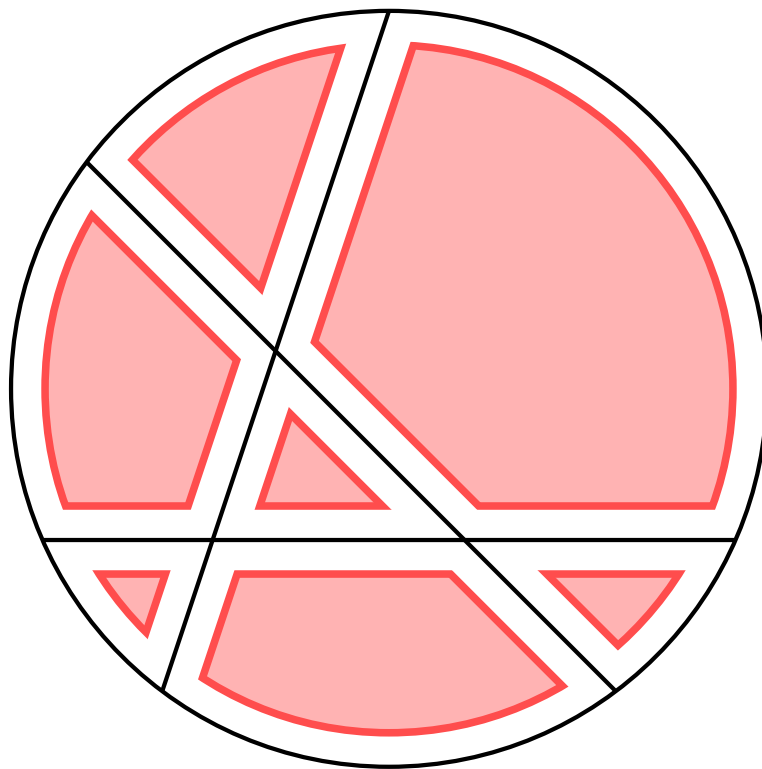

Figure 3.4: Real part of a compactified pair-of-pants.

Let  $v$  be a vertex of  $X$  of sedentarity 0. The real part of  $S_v$  has 7 connected components, each of them corresponding (via the moment map) to the intersection of the plane  $\left\{ \sum_{0 \leq i \leq 3} z_i = 0 \right\}$  with one of the 8 orthants of  $(\mathbb{R}^*)^3$  in the trivialisation  $z_0 = 1$ , except for the positive orthant  $(\mathbb{R}_{>0})^3$ . Let us introduce some vocabulary, borrowed to the one of the anatomy of a leaf.

*Definition 3.16.* We call these components of  $\mathbb{R}S_v$  *leaves*. All the leaves are homeomorphic to closed disks. The intersection of a leaf with  $\{x_j = 0\} \times T^4/T$  for any  $j \in \{0, \dots, 4\}$  is called a *margin*. The margins are homeomorphic to closed segments. The intersection of a leaf with  $(\{x_j = 0\} \cap \{x_k = 0\}) \times T^4/T$  for any  $j, k \in \{0, \dots, 4\}$ , with  $j \neq k$ , is called an *apex*. The apices (plural of apex) are points, whose projection on  $\Delta_3$  is the middle point of one of the 4 edges of  $\Delta_3$ .

A leaf can have either 3 or 4 margins. There are exactly 4 leaves with 3 margins and 3 leaves with 4 margins. More precisely, one can check that the leaves with 3 margins are the ones corresponding to an orthant of  $(\mathbb{R}^*)^3$  having an odd number of negative coordinates, in the trivialization  $z_0 = 1$  previously mentioned. There are exactly  $6 \cdot 4 = 24$  apices. In fact, if  $x$  is the middle point of one of the 6 edges of  $\Delta_3$ , there are 4 points in the inverse image of  $x$  by the projection  $\mathbb{R}\overline{P}^3 \rightarrow \Delta_3$ . There are  $4 \cdot 3 \cdot 2 = 24$  margins. In fact, the projection of a margin on  $\Delta_3$  is a segment joining the middle points of two edges of a same face of  $\Delta_3$  and for a point  $x$  in the relative interior of this segment, there are 2 points in the inverse image of  $x$  by the projection  $\mathbb{R}\overline{P}^3 \rightarrow \Delta_3$ .

*Definition 3.17.* Two leaves which both admit a margin projecting onto a same segment of  $\Delta_3$ , are said to be *adjacent leaves*.

Two adjacent leaves correspond, in the trivialization  $z_0 = 1$  to two orthants in  $(\mathbb{R}^*)^3$  which are images of one another by a symmetry  $x_i \mapsto -x_i$  for  $i \in \{1, 2, 3\}$ . In particular, the number of negative coordinates of these two orthants have distinct parity and therefore, two adjacent leaves have different number of margins. All of this discussion is illustrated by Figure 3.4, where the real part of the compactified pair-of-pants is represented, in red, as the complementary of open neighborhoods of 4 lines in generic position, which are drawn in black, one of the lines being represented at infinity.

*Remark 3.16.* The projection on the tetrahedron  $\Delta_3$  of a leaf is always convex, as one can notice from the definition of the moment map  $M$  in Section 3.1.2, and from the convexity of the real components of the pair-of-pants  $\mathcal{P}^2$ . A leaf  $l$ , with 3 margins also contains 3 apices and thus the projections of the leaf  $l$  on  $\Delta_3$  is the convex hull between 3 middle points of edges of  $\Delta_3$ , which are the projection of the apices contained in  $l$ . Since  $l$  has only 3 margins, the projection  $\text{pr}_{\Delta_3}(l)$  does not intersect one of the faces of  $\Delta_3$ , which has for equation  $x_i = 0$ , for some  $i \in \{0, \dots, 3\}$ . It is then an easy observation, that the projection of  $l$  has for equation  $\text{pr}_{\Delta_3}(l) = \{x_i = \frac{1}{2}\}$  and is contained in the boundary of  $\text{pr}_{\Delta_3}(\overline{P}^2)$ . To the contrary, a leaf  $l'$  with 4 margins is the convex hull of 4 middle points of edges of  $\Delta_3$ , which are the projections of the apices contained in  $l'$  and  $\text{pr}_{\Delta_3}(l')$  intersects all the faces of  $\Delta_3$ . This remark is illustrated by Figure 3.5, where the projection of two leaves are represented, one with 3 margins in light red and one with 4 margins in light orange. The projection of the leaves share a common segment, implying that the corresponding leaves are adjacent. This point of view illustrates well the fact that two adjacent leaves have a different number of margins.

Now, let us study how does the real structure vary along an edge  $e$  of  $X$ . Let us focus on the case where  $e$  is of sedentarity 0. Let us denote by  $F, G$  and  $H$  the adjacent faces to the

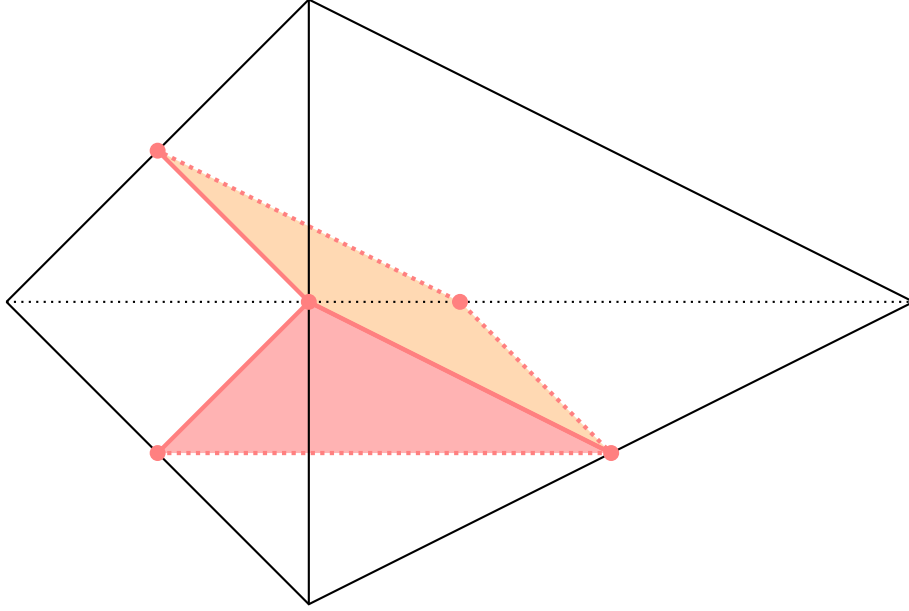

Figure 3.5: Projection on  $\Delta_3$  of a leaf with 3 margins and a leaf with 4 margins.

edge  $e$  and by  $u$  and  $v$  the adjacent vertices. Then the real part of the building-block  $S_e$  is homeomorphic to

$$\mathbb{R}S_e \simeq e \times \mathbb{R}T^e \times \mathbb{R}\bar{P}^1 = e \times \{0, \pi\bar{e}\} \times \mathbb{R}\bar{P}^1,$$

where  $\bar{e}$  is a primitive direction of the edge  $e$ . We do not need to specify the orientation of  $\bar{e}$ , since it does not change the value of  $\pi\bar{e} \in T^e$ . This surface  $\mathbb{R}S_e$  has 6 connected components. Each of these real components of  $\mathbb{R}S_e$  connects one of the components of  $\mathbb{R}S_u^e = \mathbb{R}S_u^u$  to one of the components of  $\mathbb{R}S_v^e = \mathbb{R}S_v^v$ . In the case where the vertex  $v$  is of sedentarity 0, the connected components of  $\mathbb{R}S_v^e$  are margins of  $\mathbb{R}S_v$ . We can distinguish between three pairs of margins, denoted by  $m_{FG}(v)$ ,  $m_{GH}(v)$  and  $m_{HF}(v)$ , where  $m_{FG}(v)$  corresponds to the margins of  $\mathbb{R}S_v^e$  which intersect both  $S_e^F$  and  $S_e^G$ . One can further distinguish between the two margins of the pair  $m_{FG}(v)$ . In fact, the projection  $\bar{P}^2 \rightarrow \Delta_3$  sends the margins of the pair  $m_{FG}(v)$  to the segment joining the points  $x_F$  and  $x_G$ , where  $x_F$  and  $x_G$  are the images of  $S_u^F$  and  $S_u^G$  by the projection on  $\Delta_3$ . Therefore, the leaves containing the margins of  $m_{FG}(v)$  are adjacent and thus, they are bordered by a different number of margins. We denote by  $m_{FG}^k(v)$  the margin of  $m_{FG}(v)$  which borders a leaf having  $k$  margins, for  $k \in \{3, 4\}$ . We denote by  $a_G^{v,k}(F)$  the only apex of intersection between  $m_{FG}^k(v)$  and  $S_v^F$ . Sometimes, we also denote by  $m_{FG}(v)$  the union of the two components of  $m_{FG}(v)$ , we hope it should be clear from context what sense is meant. Finally we introduce the homeomorphism  $\varphi_{u \rightarrow v} : S_e^u \rightarrow S_e^v$  defined by

$$\varphi_{u \rightarrow v} : \begin{array}{l} \{u\} \times T^e \times \bar{P}^1 \rightarrow \{v\} \times T^e \times \bar{P}^1 \\ (u, \theta, z) \mapsto (v, \theta, z) \end{array}.$$

Contrary to the case of curves, there are some restrictions on the bijection between the



components of  $\mathbb{R}S_e^v$  and  $\mathbb{R}S_e^v$ . The first one is given by Lemma 3.13 below. Before stating the lemma, we introduce more notations. Recall that the bijection from the first point of Definition 3.8, induces a one-to-one correspondence between the boundary components of  $\overline{P}^1$  and the 3 faces adjacent to the edge  $e$ . We denote by  $B_e^F$  the boundary component corresponding to  $F$ , for the bijection associated with the edge  $e$ . One has then  $S_e^F = e \times T^e \times B_e^F$ . Moreover, given an edge  $e$  of  $X$  we denote by  $\vec{e}$  the non-zero element of the  $\mathbb{Z}_2$ -line  $W'_{\mathbb{Z}_2}(e)$  and if  $F$  is a face adjacent to the edge  $e$ , then the image of  $\vec{e}$  in  $W_{\mathbb{Z}_2}(F)$  is also denoted by  $\vec{e}$ . Note that it makes sense to write  $\pi\vec{e} \in T^e$  because  $T^e$  is defined by  $W'_{\mathbb{Z}_2}(e)/(2\pi W'_{\mathbb{Z}_2}(e))$ .

**Lemma 3.13.** *Let  $e$  be a bounded edge of  $X$  connecting two vertices  $u$  and  $v$ , and  $F, G$  be two adjacent faces to  $e$ . Then one has  $\varphi_{u \rightarrow v}(m_{FG}(u)) = m_{FG}(v)$ .*

*Proof.* Only two of the components of  $\mathbb{R}S_e$  intersect simultaneously  $\mathbb{R}S_e^F$  and  $\mathbb{R}S_e^G$ . These are the two components of  $e \times \{0, \pi\vec{e}\} \times m$ , where  $m$  is the connected component of  $\mathbb{R}\overline{P}^1$  connecting  $B_e^F$  and  $B_e^G$ . The equality  $(\partial e) \times \{0, \pi\vec{e}\} \times m = m_{FG}(u) \sqcup m_{FG}(v)$  implies the result.  $\square$

**Definition 3.18.** Let  $e$  be a bounded edge of  $X$  and let  $F, G$  and  $H$  be the three adjacent faces. The edge  $e$  is said to be *twisted along  $FG$*  if  $\varphi_{u \rightarrow v}(m_{FG}^3(u)) = m_{FG}^4(v)$ . Otherwise, the edge  $e$  is said to be *untwisted along  $FG$*  and one has  $\varphi_{u \rightarrow v}(m_{FG}^k(u)) = m_{FG}^k(v)$  for  $k \in \{3, 4\}$ . The edge  $e$  is said to be *asymmetrical along  $F$*  if either the edge  $e$  is twisted along  $FG$  and untwisted along  $FH$ , or the edge  $e$  is untwisted along  $FG$  and twisted along  $FH$ . Otherwise, the edge  $e$  is said to be *symmetrical along  $F$* .

The following proposition gives a characterization of symmetrical edges along a face  $F$  of the hypersmooth tropical surface  $X$ . An interesting feature is that this characterization does not depend on the real structure  $c$ , but only on the directions, modulo 2, of the adjacent edges to  $e$  in the face  $F$ , compared in the wave space  $W_{\mathbb{Z}_2}(F)$ .

**Proposition 3.9.** *Let  $e$  be a bounded edge of  $X$ , adjacent to two vertices  $u$  and  $v$  (of sedentarity 0). Let  $F$  be a face adjacent to the edge  $e$ . Denote by  $e_u$  the edge of  $F$  intersecting the edge  $e$  at the vertex  $u$  and by  $e_v$  the edge of  $F$  intersecting the edge  $e$  at the vertex  $v$ . The edge  $e$  is symmetrical along  $F$  if and only if one has*

$$\vec{e}_u = \vec{e}_v \in W_{\mathbb{Z}_2}(F).$$

*Proof.* We work in the trivialization  $S_F = F \times T^F$ , in which the local real structure  $c_F$  acts as standard conjugation. One has two privileged cycles representing the lift  $L_1^e(u \otimes \vec{e}_u)$  of the tropical cycle  $u \otimes \vec{e}_u$ . These cycles are the two components of  $\{u\} \times T^{e_u} \times \mathbb{R}B_{e_u}^F \subset S_{e_u}^F$ . We denote by  $\gamma^+(e_u)$  and  $\gamma^-(e_u)$  these cycles. Both of them contain a pair of apices, and these pairs are of empty intersection since the cycles  $\gamma^+(e_u)$  and  $\gamma^-(e_u)$  do not intersect either. Moreover, a component of  $\{u\} \times T^e \times \mathbb{R}B_{e_u}^F \subset S_e^F$  connects the margins of the pair  $m_{FG}(u)$  if the corresponding point in  $\mathbb{R}B_{e_u}^F$  is connected to  $B_e^G$  by a component of  $\mathbb{R}\overline{P}^1$ . Since the directions  $\vec{e}$  and  $\gamma^\pm(e_u)$  form a  $\mathbb{Z}_2$ -basis of  $W_{\mathbb{Z}_2}(F)$ , they are not equal and thus the cycles  $\vec{e}_u$  cannot connect two margins of a same pair  $m_{FG}(u)$  or  $m_{FH}(u)$ . Therefore, one of the cycles  $\gamma^\pm(e_u)$  has the apices  $a_G^{u,3}(F)$  and  $a_H^{u,4}(F)$  as real points, while the other one connects the apices  $a_H^{u,3}(F)$  and  $a_G^{u,4}(F)$ . In the same way, we obtain two cycles  $\gamma^\pm(e_v)$  representing the lift  $L_1^e(v \otimes \vec{e}_v)$ , such that the cycle  $\gamma^+(e_v)$  connects the apices  $a_G^{v,3}(F)$  and  $a_H^{v,4}(F)$ , while the cycle  $\gamma^-(e_v)$  connects the apices  $a_H^{v,3}(F)$  and  $a_G^{v,4}(F)$ .

The core of our proof is the computation of an intersection number in the homology group  $H_1(S_F; \mathbb{Z}_2)$ , defined as the intersection number in  $H_1(T^F; \mathbb{Z}_2)$ , pulled-back by the retraction  $F \times T^F \rightarrow F$ . Notice, that a cycle in  $S_v^e$  and its image by  $(\phi_{u \rightarrow v})_*$  are homologous in  $S_e$  and thus, they are also homologous in  $S_F$ . In particular, the cycle  $(\phi_{u \rightarrow v})_* \gamma^\pm(e_u)$  is homologous to  $\gamma^\pm(e_v)$  and therefore, a perturbation of  $(\phi_{u \rightarrow v})_* \gamma^\pm(e_u)$  intersecting the cycle  $\gamma^+(e_v)$  transversally, intersects  $\gamma^+(e_v)$  in  $L_1^e(u \otimes \vec{e}_u) \circ L_1^e(v \otimes \vec{e}_v)$  points (modulo 2). Let us parametrize  $(\phi_{u \rightarrow v})_* \gamma^\pm(e_u)$  by  $\alpha^\pm : T^1 \rightarrow S_v^F$  so that the images of the real points 0 and  $\pi$  are in  $\mathbb{R}S_v^F$ . Now, we perturb  $\alpha^\pm$  on  $(0, \pi) \subset T^1$ , fixing the images of 0 and  $\pi$ , so that the the resulting perturbation intersect transversally the cycle  $\gamma^+(e_v)$ . Then we perturb  $\alpha^\pm$  on  $(\pi, 0) \subset T^1$  as the image by the involution  $c$  of the perturbation on  $(\pi, 0)$ . The final perturbation is denoted by  $\tilde{\alpha}^\pm$ . By construction, the cycles  $\tilde{\alpha}^\pm$  and  $\gamma^+(e_v)$  intersect transversally and the set of their intersection points is stable by the involution  $c$  so the number of real points of intersection between these cycles, is equal, modulo 2, to the total number of points of intersection. Hence, denoting by  $\mathbb{R}(\alpha^\pm \cap \gamma^+(e_v)) = \mathbb{R}((\phi_{u \rightarrow v})_* \gamma^\pm(e_u) \cap \gamma^+(e_v))$  their real points of intersection, one has

$$\text{Card}(\mathbb{R}((\phi_{u \rightarrow v})_* \gamma^\pm(e_u) \cap \gamma^+(e_v))) = L_1^e(u \otimes \vec{e}_u) \circ L_1^e(v \otimes \vec{e}_v). \quad (3.5)$$

Up to inverting  $\gamma^+(e_u)$  and  $\gamma^-(e_u)$ , one may assume that the cycles  $(\phi_{u \rightarrow v})_* \gamma^+(e_u)$  and  $\gamma^+(e_v)$  intersect (at least) at the apex  $a_G^{v,3}(F)$ . First, let us assume that the edge  $e$  is untwisted along  $FG$ , that is to say,  $\varphi_{u \rightarrow v}(a_G^{u,3}(F)) = a_G^{v,3}(F)$ . By the discussion at the beginning of the proof, we know that  $\gamma^+(e_u) \cap m_{FG}(u)$  contains only one apex, either  $a_G^{u,3}(F)$  or  $a_G^{u,4}(F)$ . Moreover, by Lemma 3.13, the image of this apex  $\varphi_{u \rightarrow v}(\gamma^+(e_u) \cap m_{FG}(u))$  is an apex contained in one of the margins of  $m_{FG}(v)$ , so this apex is either  $a_G^{v,3}(F)$  or  $a_G^{v,4}(F)$ . Yet, the cycle  $\varphi_{u \rightarrow v}(\gamma^+(e_u))$  cannot contained both of the apices  $a_G^{v,3}(F)$  and  $a_G^{v,4}(F)$ , because it would imply that the  $\mathbb{Z}_2$ -homology class of the cycle  $\varphi_{u \rightarrow v}(\gamma^+(e_u))$  is parallel to  $L_1^e(v \otimes \vec{e})$ , which would contradict the fact that  $L_1^e(u \otimes \vec{e}_u)$  and  $L_1^e(v \otimes \vec{e})$  form a  $\mathbb{Z}_2$ -basis of  $H_1(S_F; \mathbb{Z}_2)$ . Hence, one has  $\gamma^+(e_u) \cap m_{FG}(u) = a_G^{u,3}(F)$ . By the discussion at the beginning of the proof, it implies that  $\gamma^+(e_u) \cap m_{FH}(u) = a_H^{u,4}(F)$  and thus, the edge  $e$  is untwisted along  $FH$  if and only if  $\varphi_{u \rightarrow v}(\gamma^+(e_u) \cap m_{FH}(u)) = a_H^{v,4}(F) = \gamma^+(e_v) \cap m_{FH}(v)$ . As a consequence, the edge  $e$  is untwisted along  $FH$  if and only if  $\varphi_{u \rightarrow v}(\gamma^+(e_u))$  and  $\gamma^+(e_v)$  have both apices  $a_G^{v,3}(F)$  and  $a_H^{v,4}(F)$  as real point of intersection, which is equivalent by Equation (3.5) to  $L_1^e(u \otimes \vec{e}_u) \circ L_1^e(v \otimes \vec{e}_v) = 0 \pmod{2}$ , as illustrated in the twisted case by Figure 3.6. Since two elements of the group  $H_1(S_F; \mathbb{Z}_2)$  are equal if and only if their intersection number is 0, modulo 2, one deduces that the edge  $e$  is twisted along  $FH$  if and only if  $L_1^e(u \otimes \vec{e}_u) = L_1^e(v \otimes \vec{e}_v) \in H_1(S_F; \mathbb{Z}_2)$ . Recalling that  $L_1^e$  is an isomorphism by Lemma 3.8, one obtains the desired statement in the case where the edge  $e$  is untwisted along  $FG$ . Symmetrical arguments apply to the case where the edge  $e$  is twisted along  $FG$ .  $\square$

In light of Proposition 3.9, we introduce a new definition for symmetrical and asymmetrical edges along a face, extending Definition 3.18 to all the edges of  $X$ , including the unbounded edges and the edges of sedentarity 1.

*Definition 3.19.* Let  $F$  be an edge of  $X$  and let  $e$  be an edge of  $F$ . Denote by  $\underline{f}$  and  $\underline{g}$  the two edges of  $F$  which intersect  $e$ . The edge  $e$  is said to be *symmetrical* along  $F$  if  $\underline{f} = \underline{g} \in W_{\mathbb{Z}_2}(F)$ . Otherwise, the edge  $e$  is said to be *asymmetrical*.

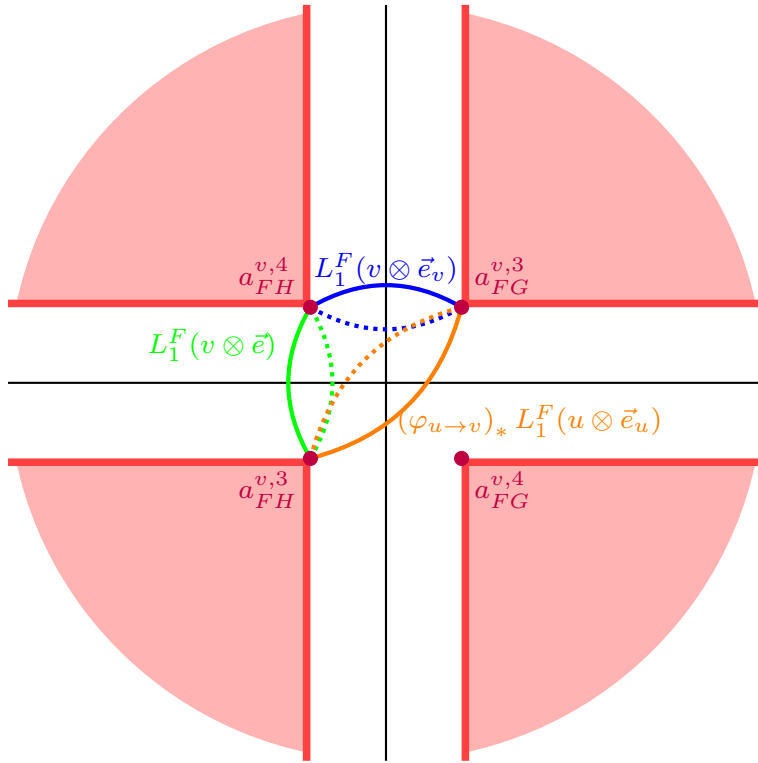

Figure 3.6: Illustration of the proof of Proposition 3.9 in the asymmetrical case.

### 3.3.2 Real Structure along a Face

As in the previous section, let us fix a hypersmooth tropical surface  $X$  and a phase tropical surface  $(S_X, X)$ . Assume that it admits a real structure  $c$ . In this section, we present some restrictions for the real structure along a face. The first restriction is a condition on the sum of the directions of the asymmetrical edges along a face. Let us denote by  $\mathcal{A}(F)$  the subset of the edges of  $F$  which are asymmetrical along  $F$ .

**Proposition 3.10.** *Let  $F$  be a face of  $X$ . One has*

$$\sum_{e \in \mathcal{A}(F)} \vec{e} = 0 \in W_{\mathbb{Z}_2}(F)$$

*Proof.* Let us index the edges of  $F$  by  $i \in \mathbb{Z}_n$ , where  $n$  is the number of edges of  $F$ , and denote the edges by  $e_0, \dots, e_{n-1}$ , so that  $e_i$  and  $e_{i+1}$  share one common vertex for all  $i \in \mathbb{Z}_n$ . Using Definition 3.19, one can show that for any  $i \in \mathbb{Z}_n$ , the edge  $e_i$  is asymmetrical along  $F$  if and only if  $\vec{e}_i = \vec{e}_{i-1} + \vec{e}_{i+1}$  and  $e_i$  is symmetrical along  $F$  if and only if  $\vec{e}_{i-1} + \vec{e}_{i+1} = 0$ . In fact, if the edge  $e_i$  is symmetrical along  $F$ , then  $\vec{e}_{i-1} = \vec{e}_{i+1}$ , so  $\vec{e}_{i-1} + \vec{e}_{i+1} = 0$ , while if the edge  $e_i$  is asymmetrical along  $F$ , the three vectors  $\vec{e}_{i-1}, \vec{e}_{i+1}$  and  $\vec{e}_i$  are all distinct and non-zero so their sum is zero in  $W_{\mathbb{Z}_2}(F) \cong (\mathbb{Z}_2)^2$ . Therefore, the sum of the statement  $\sum_{e \in \mathcal{A}(F)} \vec{e}$  can be rewritten as  $\sum_{i \in \mathbb{Z}_n} (\vec{e}_{i-1} + \vec{e}_{i+1})$ . Each term  $\vec{e}_i$ , for  $i \in \mathbb{Z}_n$ , appears twice in this sum and thus, the sum is equal to  $\sum_{i \in \mathbb{Z}_n} (\vec{e}_{i-1} + \vec{e}_{i+1}) = 2 \cdot \sum_i \vec{e}_i = 0 \pmod{2}$ .  $\square$

Note that the previous condition relies on a relatively simple algebraic proof, and holds for any face of  $X$ , bounded or not. Now, we fix a face  $F$  and we assume that  $F$  is bounded. In particular, all the edges of  $F$  are of sedentarity 0. As in the proof of Proposition 3.10, we index the edges of  $F$  by  $i \in \mathbb{Z}_n$  and denote them by  $e_0, \dots, e_{n-1}$ , so that  $e_i$  and  $e_{i+1}$  share one common vertex for all  $i \in \mathbb{Z}_n$ . Each of the edges of  $F$  is adjacent to two other faces than  $F$ . Let  $G_0$  and  $H_0$  be the faces adjacent to the edge  $e_0$ . Now, define by recursion the faces  $G_i$  and  $H_i$  for  $i \in \{1, \dots, n-1\}$ , such that  $G_{i-1}$  and  $G_i$  have one common edge, or equivalently,  $G_{i-1}$  and  $H_i$  have no common edge. Now, there are two possibilities. Either the faces  $G_{n-1}$  and  $G_0$  have a common edge and so the topological space  $\bigcup_{i \in \mathbb{Z}_n} (G_i \cup H_i)$  is homeomorphic to a cylinder, or the faces  $G_{n-1}$  and  $G_0$  do not have an edge in common and so the topological space  $\bigcup_{i \in \mathbb{Z}_n} (G_i \cup H_i)$  is homeomorphic to a Möbius band.

*Definition 3.20.* Let  $F$  be a bounded face of  $X$ . The *band of the face  $F$* , denoted by  $R(F)$  (the letter  $R$  stands for "ruban" in french), is  $\bigcup_{i \in \mathbb{Z}_n} (G_i \cup H_i)$ , using the notation from the discussion above.

If the band of  $F$  is orientable, then the topological space  $R(F) \setminus F$  consists of two connected components  $\bigcup_{i \in \mathbb{Z}_n} (G_i \setminus F)$  and  $\bigcup_{i \in \mathbb{Z}_n} (H_i \setminus F)$ , both of which are homeomorphic to a cylinder. Let us denote by  $\mathbf{G}$  the set of all faces  $G_i$ , for  $i \in \mathbb{Z}_n$ . We also denote by  $\mathcal{T}_{\mathbf{G}}(F)$  the set of all edges  $e_i$  for  $i \in \mathbb{Z}_n$ , which are twisted along  $FG_i$ . We say that an edge of  $\mathcal{T}_{\mathbf{G}}(F)$  is *twisted along  $F\mathbf{G}$* .

**Proposition 3.11.** *Let  $F$  be a bounded face with an orientable band. One has*

$$\sum_{e \in \mathcal{T}_{\mathbf{G}}(F)} \vec{e} = 0 \in W_{\mathbb{Z}_2}(F).$$

*Remark 3.17.* One could use Proposition 3.11 to find back the equality of Proposition 3.10 about the same sum over asymmetrical edges, by summing the equations  $\sum_{e \in \mathcal{T}_G(F)} \vec{e} = 0$  and  $\sum_{e \in \mathcal{T}_H(F)} \vec{e} = 0$ . The drawbacks are that it only works for bounded faces with an orientable band, but also that the proof of Proposition 3.11 is much more technical than the simple proof of Proposition 3.11.

Let fix a bounded face  $F$ , with an orientable band  $R(F)$ , so that for all  $i \in \mathbb{Z}_n$ , with the notations from Definition 3.20, the faces  $G_i$  and  $G_{i+1}$  share a common edge denoted by  $g_i$  and the faces  $H_i$  and  $H_{i+1}$  share a common edge denoted by  $h_i$ . In order to prove Proposition 3.11, we need to be able to follow the path of the apices associated with the face  $F$ , along the boundary of  $F$ . We make the last sentence precise by Lemmas 3.14 and 3.15. Denoting by  $v_i$  the common vertex to  $e_i$  and  $e_{i-1}$ , there are two ways to look at the apices of the real fiber  $\mathbb{R}S_{v_i}^F$ . One can write them as  $a_{G_i}^{v_i, k}(F)$  and  $a_{H_i}^{v_i, k}(F)$  for  $k = 3, 4$ , or as  $a_{G_{i-1}}^{v_i, k}(F)$  and  $a_{H_{i-1}}^{v_i, k}(F)$  for  $k = 3, 4$ . Lemma 3.14 connects these two points of view.

**Lemma 3.14.** *With the same notations as above and as Definition 3.20, for any  $i \in \mathbb{Z}_n$  one has,*

$$\begin{aligned} a_{G_i}^{v_i, 3}(F) &= a_{G_{i-1}}^{v_i, 3}(F), \\ a_{G_i}^{v_i, 4}(F) &= a_{H_{i-1}}^{v_i, 4}(F). \end{aligned}$$

*Proof.* For  $K$  a face adjacent to the vertex  $v_i$ , denote by  $x_K$  the projection on  $\Delta_3$  of  $S_{v_i}^K = S_{v_i} \cap S_K$ . With these notations, the apex  $a_{G_i}^{v_i, 3}(F)$  is contained in a leaf  $l$ , which is sent by the projection  $\text{pr}_{\Delta_3}$  to a triangle containing  $x_F$  and  $x_{G_i}$  for vertices. The point  $x_F$  is the intersection of the faces of  $\Delta_3$  corresponding to the edges  $e_i$  and  $e_{i-1}$  and the point  $x_{G_i}$  is the intersection of the faces of  $\Delta_3$  corresponding to the edges  $e_i$  and  $g_i$ . Since the triangle  $\text{pr}_{\Delta_3}(l)$  has only three vertices, the last vertex of the triangle is the intersection of the faces corresponding to the edges  $e_{i-1}$  and  $g_i$ , which is  $x_{G_{i-1}}$  (see Figure 3.7). Since the leaf  $l$  has 3 margins and the projection  $\text{pr}_{\Delta_3}(l)$  contains the segment  $[x_F, x_{G_{i-1}}] = \text{pr}_{\Delta_3}(m_{FG_{i-1}}(v_i))$ , the leaf  $l$  contains the margin  $m_{FG_{i-1}}^3$  and thus  $a_{G_i}^{v_i, 3}(F) = m_{FG_{i-1}}^3 \cap S_{v_i}^F$ , that is,  $a_{G_i}^{v_i, 3}(F) = a_{G_{i-1}}^{v_i, 3}(F)$ .

Similarly, the apex  $a_{G_i}^{v_i, 4}(F)$  is contained in a leaf  $l'$ , which is sent by the projection  $\text{pr}_{\Delta_3}$  to a quadrangle containing  $x_F$  and  $x_{G_i}$  for vertices. By the same reasoning as for the apex  $a_{G_i}^{v_i, 3}(F)$ , the two remaining vertices of the rectangle  $\text{pr}_{\Delta_3}(l')$  have to intersect the face of  $\Delta_3$  corresponding to the edge  $e_{i-1}$  for one of them and the face corresponding to the edge  $g_i$  for the other one. Thus, each of these vertices is given by the intersection of one of these faces of  $\Delta_3$  with the face corresponding to the edge  $h_i$  (the only remaining face). Therefore, the vertices of  $\text{pr}_{\Delta_3}(l')$  are  $x_F, x_{G_i}, x_I$  and  $x_{H_{i-1}}$  (see Figure 3.7), where  $I$  is the face spanned by the edges  $g_i$  and  $h_i$ . As in the first case of the proof, it implies that the leaf  $l'$  contains the margin  $m_{FH_{i-1}}^4(v_i)$  and that the apices  $a_{G_i}^{v_i, 4}(F)$  and  $a_{H_{i-1}}^{v_i, 4}(F)$  are equal.  $\square$

Now, recall the homeomorphism  $\varphi_{u \rightarrow v}$  from Section 3.3.1. For any  $i \in \mathbb{Z}_n$ , the homeomorphism  $\varphi_{v_i \rightarrow v_{i+1}}$  restricts to a bijection from the set of all four apices  $a_{K_i}^{v_i, k}(F)$  for  $k = 3, 4$  and  $K = G, H$  to the set of all apices  $a_{K_{i+1}}^{v_{i+1}, k}(F)$  for  $k = 3, 4$  and  $K = G, H$ . By identifying the apex  $a_{K_i}^{v_i, k}(F)$  with the apex  $a_{K_{i+1}}^{v_{i+1}, k}(F)$  and denoting both of them as  $a_K^k$ , the homeomorphism  $\varphi_{v_i \rightarrow v_{i+1}}$  induces a permutation of the set  $\{a_G^3, a_G^4, a_H^3, a_H^4\}$ , for all  $i \in \mathbb{Z}_n$ . This permutation is denoted by  $\varphi_i$ , for all  $i \in \mathbb{Z}_n$ . Our notations for permutations of a finite set are as follows.

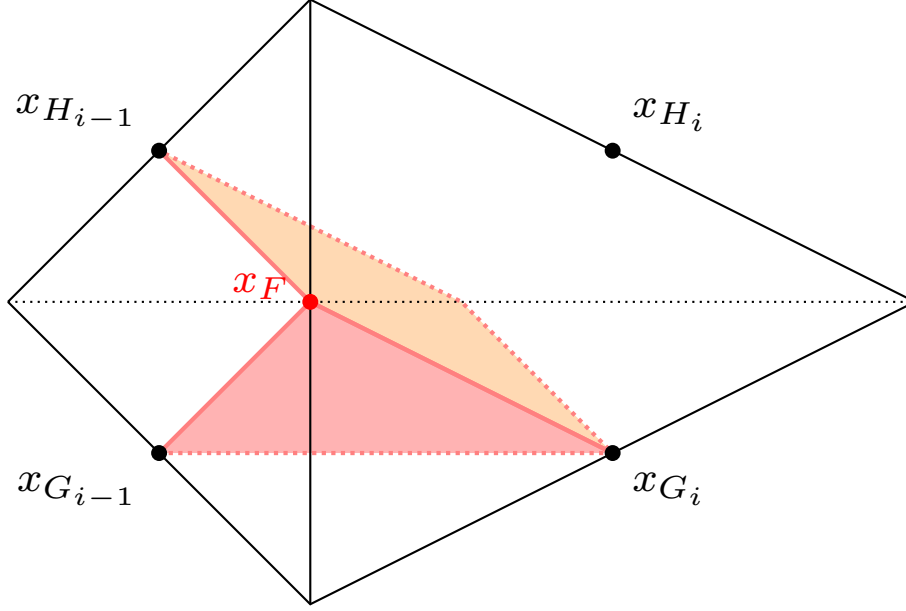

Figure 3.7: Illustration of Lemma 3.14.

Given a set of  $N$  elements  $a_1, \dots, a_N$ , for  $i_1, \dots, i_l \in \{1, \dots, N\}$ , we denote by  $(a_{i_1} \dots a_{i_l})$  the cycle of length  $1 \leq l \leq l$ , sending  $a_{i_j}$  to  $a_{i_{j+1}}$  for  $j \in \{1, \dots, l\}$  and sending  $a_{i_l}$  to  $a_{i_1}$ .

**Lemma 3.15.** *Let  $i \in \mathbb{Z}_n$ . The permutation  $\varphi_i$  depends only on the twisting of the edge  $e_i$  along  $FG_i$  and  $FH_i$ . More precisely, one has four distinct possibilities.*

- If  $e_i$  is untwisted along both  $FG_i$  and  $FH_i$ , then  $\varphi_i = (a_G^4 a_H^4)$ .
- If  $e_i$  is twisted along  $FG_i$  and untwisted along  $FH_i$ , then  $\varphi_i = (a_H^4 a_G^4 a_G^3)$ .
- If  $e_i$  is untwisted along  $FG_i$  and twisted along  $FH_i$ , then  $\varphi_i = (a_G^4 a_H^4 a_H^3)$ .
- If  $e_i$  is twisted along both  $FG_i$  and  $FH_i$ , then  $\varphi_i = (a_H^4 a_H^3 a_G^4 a_G^3)$ .

*Proof.* Let us deal with the first case. If the edge  $e_i$  is untwisted along both  $FG_i$  and  $FH_i$ , then for  $k = 3, 4$  and  $K = G, H$  we have  $a_{K_i}^{v_i, k}(F) = a_{K_i}^{v_{i+1}, k}(F)$ . Using Lemma 3.14, we get  $a_{K_{i+1}}^{v_i, 3}(F) = a_{K_{i+1}}^{v_{i+1}, 3}(F)$  for  $K = G, H$  (so  $a_G^3$  and  $a_H^3$  are fixed),  $a_{G_{i+1}}^{v_i, 4}(F) = a_{H_{i+1}}^{v_i, 4}(F)$  and  $a_{H_{i+1}}^{v_i, 4}(F) = a_{G_{i+1}}^{v_i, 4}(F)$  (so  $a_G^4$  and  $a_H^4$  are swapped by  $\varphi_i$ ). The induced permutation  $\varphi_i$  is indeed equal to  $(a_G^4 a_H^4)$ . Now, if the edge  $e_i$  is twisted along  $FG_i$  and untwisted along  $FH_i$ , then one has  $a_{G_i}^{v_i, 3}(F) = a_{G_i}^{v_{i+1}, 4}(F)$  and  $a_{G_i}^{v_i, 4}(F) = a_{G_i}^{v_{i+1}, 4}(F)$ , but also  $a_{H_i}^{v_i, k}(F) = a_{H_i}^{v_{i+1}, k}(F)$ , for  $k = 3, 4$ . Applying Lemma 3.15 yields  $a_{H_i}^{v_i, 3}(F) = a_{H_{i+1}}^{v_{i+1}, 3}(F)$  (so  $a_H^3$  is fixed by  $\varphi_i$ ),  $a_{G_i}^{v_i, 3}(F) = a_{H_{i+1}}^{v_{i+1}, 4}(F)$  (so  $\phi_i(a_G^3) = a_H^4$ ),  $a_{H_i}^{v_i, 4}(F) = a_{G_{i+1}}^{v_{i+1}, 4}(F)$  (so  $\phi_i(a_H^4) = a_G^4$ ) and  $a_{G_i}^{v_i, 4}(F) = a_{G_{i+1}}^{v_{i+1}, 3}(F)$  (so  $\phi_i(a_G^4) = a_G^4$ ). The third case is obtained from the second one by inverting  $G_i$  and  $H_i$ . The remaining case can be treated exactly in the same way as the first two.  $\square$

The composition  $\varphi_{n-1} \dots \varphi_0$  is equal to the identity. It is a consequence of the triviality of the fibration  $\lambda : \mathbb{R}S_F \rightarrow F$ , restricted, to the boundary of  $F$ . One then gets the following corollary (but it is in no way necessary for the proof of Proposition 3.11).

**Corollary 3.5.** *Let  $F$  be a bounded edge. The number of symmetrical edges along  $F$  is even.*

*Proof.* We use the notations from Lemma 3.15. One can notice that the edge  $e_i$  is asymmetrical along the face  $F$  if and only if the signature of  $\varphi_i$  is  $-1$ , for all  $i \in \mathbb{Z}_n$ . Since the composition of all  $\varphi_i$ , for  $i \in \mathbb{Z}_n$ , is equal to the identity, it has signature 1. Since the signature of a permutation is a morphism of group, there can only be an even number of asymmetrical edges for the product of the signatures to be equal to 1.  $\square$

*Proof of Proposition 3.11.* We work in the trivialization  $S_F = F \times T^F$ , where the involution  $c$  acts as the standard conjugation on  $S_F$ . We denote by  $r : T^F \times F \rightarrow T^F$  the natural retraction. We parametrize  $T^F$  by  $\alpha : T^2 \rightarrow T^F$  so that the real points  $(0, 0)$ ,  $(0, \pi)$ ,  $(\pi, 0)$  and  $(\pi, \pi)$  are sent to the fixed points by  $c$  in  $T^F$ . We denote by  $T_+^F$  the image of the square  $[0, \pi]^2$  by  $\alpha$ , inside  $T^F$ . For any  $i \in \mathbb{Z}_n$ , there exists a unique segment in  $T_+^F$ , denoted by  $g(e_i)$ , connecting the real points  $r(a_{G_i}^{v_i, 3}(F))$  and  $r(a_{G_i}^{v_i, 4}(F))$ . Since, the boundary of  $g(e_i)$  is invariant by the conjugation  $c$ , the 1-chain  $g(e_i) + c_*g(e_i)$  is a  $\mathbb{Z}_2$ -cycle in  $T^F$ . By the same technique as in the proof of Proposition 3.9, one can compute the intersection number of  $r_*(L_1^F(v_i \otimes \vec{e}_i))$  and  $[g(e_i) + c_*g(e_i)]$  in  $H_1(T^F; \mathbb{Z}_2)$ . The result is equal to 0, which implies the equality

$$r_*(L_1^F(v_i \otimes \vec{e}_i)) = [g(e_i) + c_*g(e_i)].$$

Let us now denote by  $\tau_0, \dots, \tau_{k-1}$  the edges of  $F$ , twisted along  $F\mathbf{G}$ , indexed by  $\mathbb{Z}_k$ , so that the cyclic order on the edges  $\tau_1, \dots, \tau_k$  is induced by the cyclic order on the edges  $e_1, \dots, e_n$ . Also denote by  $u(e_i)$  the vertex  $v_i$ , by  $v(e_i)$  the vertex  $v_{i+1}$  and by  $G_{e_i}$  the face  $G_i$ , for all  $i \in \mathbb{Z}_n$ . With these new notations, for any  $j \in \mathbb{Z}_k$ , the edge  $\tau_j$  is twisted along  $FG_{\tau_j}$  so one has

$$r(a_{G_{\tau_j}}^{u(\tau_j), 4}(F)) = r(a_{G_{\tau_j}}^{v(\tau_j), 3}(F)). \quad (3.6)$$

Moreover, for  $i \in \mathbb{Z}_n$ , if  $e_i$  is an edge untwisted along  $FG_{e_i}$ , then by Lemma 3.15, one obtains  $r(a_{G_{e_i}}^{v(e_{i-1}), 3}(F)) = r(a_{G_{e_{i+1}}}^{u(e_{i+1}), 3}(F))$ . For any  $j \in \mathbb{Z}_k$ , since there are only untwisted edges along  $F\mathbf{G}$  between  $\tau_j$  and  $\tau_{j+1}$ , the previous equality yields

$$r(a_{G_{\tau_j}}^{v(\tau_j), 3}(F)) = r(a_{G_{\tau_{j+1}}}^{u(\tau_{j+1}), 3}(F)). \quad (3.7)$$

Hence, by combining Equations 3.6 and 3.7 one obtains

$$\begin{aligned} \partial(g(\tau_j) + c_*g(\tau_{j+1})) &= r(a_{G_{\tau_j}}^{u(\tau_j), 3}(F)) + r(a_{G_{\tau_j}}^{u(\tau_j), 4}(F)) + r(a_{G_{\tau_{j+1}}}^{u(\tau_{j+1}), 3}(F)) \\ &\quad + r(a_{G_{\tau_{j+1}}}^{u(\tau_{j+1}), 4}(F)), \\ \partial(g(\tau_j) + c_*g(\tau_{j+1})) &= r(a_{G_{\tau_j}}^{u(\tau_j), 3}(F)) + r(a_{G_{\tau_{j+1}}}^{u(\tau_{j+1}), 4}(F)). \end{aligned}$$

By summing over all  $j \in \mathbb{Z}_k$ , it follows that  $\partial\left(\sum_{j \in \mathbb{Z}_k} g(\tau_j)\right) = 0$ . We now have a 1-cycle  $\sum_{e \in \mathcal{T}_{F\mathbf{G}}(F)} g(e)$ , contained in  $T_+^F$ . Since  $T_+^F$  is contractile, the homology class of the cycle

$\sum_{e \in \mathcal{T}_{\mathbf{FG}}(F)} g(e)$  is equal to zero in  $H_1(T^F; \mathbb{Z}_2)$ . Finally, the following computation gives us the value of the sum  $\sum_{e \in \mathcal{T}_{\mathbf{FG}}(F)} L_1^F(u(e) \otimes \vec{e})$ .

$$\begin{aligned} r_* \left( \sum_{e \in \mathcal{T}_{\mathbf{FG}}(F)} L_1^F(u(e) \otimes \vec{e}) \right) &= \sum_{e \in \mathcal{T}_{\mathbf{FG}}(F)} (g(e) + c_* g(e)) \\ &= \left[ \sum_{e \in \mathcal{T}_{\mathbf{FG}}(F)} g(e) \right] + c_* \left[ \sum_{e \in \mathcal{T}_{\mathbf{FG}}(F)} g(e) \right] \\ r_* \left( \sum_{e \in \mathcal{T}_{\mathbf{FG}}(F)} L_1^F(u(e) \otimes \vec{e}) \right) &= 0 \end{aligned}$$

Yet, the map  $r_*$  induced by the retraction  $r$  is an isomorphism so  $\sum_{e \in \mathcal{T}_{\mathbf{FG}}(F)} L_1^F(u(e) \otimes \vec{e}) = 0$  and by Lemma 3.8,  $L_1^F$  is also an isomorphism, so one obtains the equation of the statement of the proposition.  $\square$

### 3.4 Affine Space of Real Structures

Let us fix a compact hypersmooth tropical surface  $X$  with a polyhedral combinatorial stratification and a phase tropical surface  $(S_X, X)$ . In Section 3.3, we fixed a real structure of the phase tropical surface and we obtained some inherent properties of the real structure, such as Propositions 3.9 and 3.10. In this section, we study the properties of real structures of the phase tropical surface  $(S_X, X)$  relatively to one another. We start by considering the local real structure of a building block  $(S_e, e)$  associated with an edge  $e$  of  $X$ .

Given an edge  $e$  of sedentarity 0 of  $X$ , we introduce the quotient of the building-block  $S_e = e \times T^e \times \overline{P}^1$  by identifying the two points of  $(\partial e) \times \{\theta\} \times \{z\}$  for all  $\theta \in T^e$  and  $z \in \overline{P}^1$ . The quotient space is denoted by  $\overline{S}_e$  and the quotient map  $S_e \rightarrow \overline{S}_e$  is denoted by  $p$ . The topological space  $\overline{S}_e$  is homeomorphic to  $T^1 \times T^e \times \overline{P}^1$ , so a basis of its first homology group can be described as follows. Fix two oriented 1-cycles  $b_1$  and  $b_2$  in  $\overline{P}^1$ , such that their homology classes form a  $\mathbb{Z}$ -basis of  $H_1(\overline{P}^1; \mathbb{Z})$ . We denote by  $\beta_i$  the homology class of the cycle  $\{*\} \times \{*\} \times b_i$ , for  $i = 1, 2$ . Let us fix an arbitrary orientation on the edge  $e$  and denote the oriented edge by  $r_{\vec{e}}$ . In particular,  $r_{\vec{e}} \times \{*\} \times \{*\}$  is a 1-chain in  $S_e$  whose endpoints have the same image by the quotient map  $p$ , so one can consider the homology class of the 1-cycle  $p_*(r_{\vec{e}} \times \{*\} \times \{*\})$  in  $H_1(\overline{S}_e; \mathbb{Z})$ . We denote by  $\alpha_e$  this homology class. We also consider  $\vec{e} \in W_{\mathbb{Z}}(e)$  to be the primitive element of  $W_{\mathbb{Z}}(e)$ , directed according to the chosen orientation of the edge  $e$ . One can then consider the lift  $\gamma_e := L_1^e(\vec{e}) \in H_1(S_e; \mathbb{Z})$ . We now have a basis of  $H_1(\overline{S}_e; \mathbb{Z})$  formed by  $p_*\gamma_e, \alpha_e, p_*\beta_1, p_*\beta_2$ . We denote this basis by  $\mathcal{B}_e$ . Given two local real structures  $c_e$  and  $c'_e$  of  $(S_e, e)$ , one can consider their composition  $c'_e \circ c_e$ . Since two real structures coincide on the fibers  $S_v$  over any vertex  $v$  of  $X$ , the composition  $c'_e \circ c_e$  acts as the identity on  $(\partial e) \times T^e \times \overline{P}^1$ , so one can consider the induced map  $\overline{c'_e \circ c_e}$  on the quotient  $\overline{S}_e$ .

**Lemma 3.16.** *Let  $e$  be an edge of sedentarity 0 of  $X$ . Let  $c_e$  and  $c'_e$  be two local real structures of  $(S_e, e)$ . There exists an integer  $t \in \mathbb{Z}$  such that, in the basis  $\mathcal{B}_e$  defined above, the matrix of*



the morphism  $(\overline{c'_e \circ c_e})_*$  is equal to

$$\begin{pmatrix} 1 & t & 0 & 0 \\ 0 & 1 & 0 & 0 \\ 0 & 0 & 1 & 0 \\ 0 & 0 & 0 & 1 \end{pmatrix}.$$

*Proof.* On the image  $p\left((\partial e) \times T^e \times \overline{P^1}\right)$ , the map  $\overline{c'_e \circ c_e}$  acts as the identity. Since the classes  $p_*\gamma_e, p_*\beta_1$  and  $p_*\beta_2$  can be represented by cycles living inside  $p\left((\partial e) \times T^e \times \overline{P^1}\right)$ , the induced map  $(\overline{c'_e \circ c_e})_*$  acts as the identity on these classes. We can then assume that  $b_i$  is taken to be a cycle contained in the boundary component  $B_{\{i\}}^2$ . Now, as a representative of  $\alpha$ , one can then consider the cycle  $p_*(r_{\vec{e}} \times \{*\} \times \{z_i\})$ , with  $z_i \in B_{\{i\}}^2$  for  $i = 1, 2$ . Since, the map  $c'_e \circ c_e$  preserves  $e \times T^e \times B_{\{i\}}^2$ , it shows that the image  $(\overline{c'_e \circ c_e})_* \alpha_e$  is contained in the sub-group generated by  $p_*\gamma_e, \alpha_e$  and  $p_*\beta_i$ , for  $i = 1, 2$ . Thus,  $(\overline{c'_e \circ c_e})_* \alpha_e$  is contained in the intersection of these sub-groups, that is, in the sub-group generated only by  $\alpha_e$  and  $p_*\gamma_e$ . Using the fact that  $\overline{c'_e \circ c_e}$  is an orientation preserving homeomorphism, one obtains that the determinant of the matrix in the base  $\mathcal{B}_e$  is 1. The result follows.  $\square$

The previous lemma allows us to make the following definition.

**Definition 3.21.** Let  $e$  be an edge of sedentarity 0 of  $X$ . Let  $c$  and  $c'$  be two real structures of  $(S_X, X)$ . The *twist from  $c$  to  $c'$  at the edge  $e$*  is defined as the only integer  $t_e(c', c)$  such that, using the notations of Lemma 3.16, one has

$$(\overline{c'_e \circ c_e})_* \alpha_e = \alpha_e + t_e(c', c) \cdot p_*\gamma_e.$$

**Remark 3.18.** The sign of the twist from  $c$  to  $c'$  at the edge  $e$  does not depend on the chosen orientation of  $e$ . In fact, changing this orientation would change the signs of both  $\alpha_e$  and  $\gamma_e$ . Note also that the homology class  $t_e(c', c)\gamma_e \in H_1(S_e; \mathbb{Z})$  is equal to the lift  $L_1^e(t_e(c', c)\vec{e})$ , where  $\vec{e}$  is a primitive vector in  $W_{\mathbb{Z}}(e) \subset \mathcal{F}_1^{\mathbb{Z}}(e)$  directed according to the orientation of the edge  $e$ .

There is another way to obtain the twist from one real structure to another at an edge  $e$  of sedentarity 0 of  $X$ , without passing to the quotient  $\overline{S}_e$ .

**Lemma 3.17.** *Let  $e$  be an edge of sedentarity 0 of  $X$ . Let  $c_e$  and  $c'_e$  be two local real structures of  $(S_e, e)$ . For any oriented lift  $r$  of the edge  $e$  in the fixed locus  $\text{Fix}(c_e)$ , the 1-chain  $(c'_e)_*r - r$  is a cycle whose homology class satisfies*

$$[(c'_e)_*r - r] = t_e(c', c)\gamma_e.$$

*Proof.* The chain  $(c'_e)_*r - r$  is a cycle because the local real structures  $c_e$  and  $c'_e$  coincide on  $(\partial e) \times T^e \times \overline{P^1}$ . Now, taking the image of this cycle by the map  $p_*$  yields  $p_*[(c'_e)_*r - r] = [p_*(c'_e)_*r] - [p_*r]$ . Yet, by definition, one has  $[p_*r] = \alpha_e$  and since  $r$  is invariant by  $c_e$ , one gets  $[p_*(c'_e)_*r] = [p_*(c'_e \circ c_e)_*r] = (\overline{c'_e \circ c_e})_* [p_*r] = \alpha_e + t_e(c', c)p_*\gamma_e$ . The only element of  $H_1(S_e, \mathbb{Z})$  that maps to  $p_*\gamma_e$ , is  $\gamma_e$ , so the desired result follows.  $\square$

Given an edge  $e$  of sedentarity 0 of a face  $F$  of  $X$ , Lemma 3.17, shows that the twist from a real structure  $c$  to another real structure  $c'$ , can be computed in  $S_F^e \subset S_F$ , by taking for the

component  $r$ , one of the four connected components of  $S_F^e = e \times T^F$  fixed by the real local structure  $c_F$  on  $(S_F, F)$ . From this point of view there seems to be no difference between edges of sedentarity 0 and of sedentarity 1, since for any edge  $e$  of  $F$ , one has  $S_F^e = e \times T^F$  and one can compute the homology class  $[(c'_e)_*r - r] \in H_1(S_F; \mathbb{Z})$ . There is one difference though. We have no guarantee that the homology class computed at an edge of sedentarity 1, is a lift of an element of  $W_{\mathbb{Z}}'(e)$ . In fact, it could be a lift of any element in the wave space  $W_{\mathbb{Z}}(e) = W_{\mathbb{Z}}(F)$ . Therefore, we adopt a new point of view for the twist from  $c$  to  $c'$  at an edge  $e$ , of any sedentarity, by viewing it as an element of the wave space  $W_{\mathbb{Z}}(e)$ , instead of an integer.

*Definition 3.22.* The *twist wave* from  $c$  to  $c'$  is the cellular tropical 1-co-chain with coefficients in the sheaf  $W_{\mathbb{Z}}$  defined on any oriented edge  $e$  of  $X$  by

$$w(c', c) \cdot e = (L_1^F)^{-1} [(c'_F)_*r - r] \in W_{\mathbb{Z}}(e),$$

where  $F$  is any face adjacent to  $e$  and  $r$  is any fixed component by  $c_F$  in  $S_F^e$ .

*Remark 3.19.* Let us consider an edge  $e$  of sedentarity 0. By Lemma 3.17, the value  $w(c', c) \cdot e$  does not depend on the chosen adjacent face  $F$ , nor on the choice of the fixed component  $r$ . The previous definition also claims that the value  $w(c', c) \cdot e$  is in  $W_{\mathbb{Z}}(e)$ . It is a consequence of Lemmas 3.16 and 3.17. Moreover, the definition also claims that for an edge  $e$  of sedentarity 1, the value  $w(c', c) \cdot e$  does not depend on the fixed component  $r$  chosen. This assertion is justified by Lemma 3.18.

Let  $e$  be an edge of sedentarity 1, let  $u$  and  $v$  be the adjacent vertices, and let  $F$  be the parent face of  $e$ . As for an edge of sedentarity 0, one can consider the quotient space  $\overline{S}_F^e := S_F^e / \sim$ , where  $\sim$  identifies the points  $\{u\} \times \{\theta\}$  and  $\{v\} \times \{\theta\}$  for all  $\theta \in T^F$ . We denote by  $p : S_F^e \rightarrow \overline{S}_F^e$  the quotient map and by  $\alpha_e$  the homology class of the cycle  $p_*(e \times \{*\})$ . Fix a  $\mathbb{Z}$ -basis  $w_1, w_2$  of  $W_{\mathbb{Z}}(F)$ . One can view the lifts  $L_1^F(w_1)$  and  $L_1^F(w_2)$  to be in  $H_1(S_F^e; \mathbb{Z})$  under the isomorphism induced by the injection  $S_F^e \subset S_F$ . By setting  $\mu_i = p_*L_1^F(w_i)$ , one has then a basis  $\mathcal{B}_e = (\alpha_e, \mu_1, \mu_2)$ , of the first homology group  $H_1(\overline{S}_F^e; \mathbb{Z})$  of the quotient space  $\overline{S}_F^e$ . Given two local real structures  $c_F$  and  $c'_F$  on  $(S_F, F)$ , we also denote by  $c_F$  and  $c'_F$  their restriction on  $S_F^e$  and by  $\overline{c'_F} \circ c_F$  the involution on  $\overline{S}_F^e$  induced by  $c'_F \circ c_F$ .

**Lemma 3.18.** *Let  $e$  be an edge of sedentarity 1 of a face  $F$  of  $X$ . Let  $c_F$  and  $c'_F$  be two local real structures of  $(S_F, F)$ . In the basis  $\mathcal{B}_e$  as above, the matrix of the isomorphism  $(\overline{c'_F} \circ c_F)_*$ , is equal to*

$$\begin{pmatrix} 1 & 0 & t_1 \\ 0 & 1 & t_2 \\ 0 & 0 & 1 \end{pmatrix},$$

where  $t_1, t_2$  are the integers such that  $w(c', c) \cdot e = t_1w_1 + t_2w_2$ .

*Proof.* As in the proof of Lemma 3.16, the automorphism  $\overline{c'_F} \circ c_F$  acts as identity on the image  $p((\partial e) \times T^F)$ . Therefore, the induced map in homology acts as the identity on  $\mu_1$  and  $\mu_2$ . By assumption, and by applying successively the lifting morphism  $L_1^F$  and the induced map  $p_*$ , one has  $p_*L_1^F(w(c', c) \cdot e) = t_1\mu_1 + t_2\mu_2$ . Yet, by Definition 3.22, one also has  $p_*L_1^F(w(c', c) \cdot e) = p_*[(c'_e)_*r - r]$ , where  $r$  is a fixed component by  $c_F$  of  $S_F^e$ . In a similar manner to the proof of

Lemma 3.17, one gets  $p_* [(c'_F)_* r - r] = [p_*(c'_F \circ c_F)_* r] - [p_* r] = \overline{(c'_F \circ c_F)}_* \alpha_e - \alpha_e$ . Combining the two preceding equations, one obtains  $\overline{(c'_F \circ c_F)}_* \alpha_e = \alpha_e + t_1 \mu_1 + t_2 \mu_2$ .  $\square$

There are now two points of view on the twist wave from a real structure  $c$  to another real structure  $c'$  of  $(S_X, X)$ . The first point of view is the one of Definition 3.21 and Lemma 3.18, where one looks at the action of the composition of the local real structures on the homology of  $\overline{S}_e$  or  $\overline{S}_F^e$ . The second one is the point of view of Lemma 3.17 and Definition 3.22, where one looks at the action of the local real structures of  $c'$  on fixed components by  $c$ . The first point of view shows that the second one does not depend on the chosen real component, but also makes it easier to prove Proposition 3.12 below. The second point of view, makes the proof of Proposition 3.13 quite easy.

**Proposition 3.12.** *Let  $c, c'$  and  $c''$  be three real structures of the phase tropical surface  $(S_X, X)$ . One has*

$$w(c'', c) = w(c'', c') + w(c', c).$$

*Proof.* Let  $e$  be an edge of  $X$ . Let us first assume that  $e$  is of sedentarity 0. We write  $c''_e \circ c_e$  as the composition  $(c''_e \circ c'_e) \circ (c'_e \circ c_e)$ . Passing to the quotient in  $\overline{S}_e$  yields  $c''_e \circ c_e = \overline{(c''_e \circ c'_e)} \circ \overline{(c'_e \circ c_e)}$ . One only has to consider the induced maps on the first homology group of  $\overline{S}_e$  in the basis of Lemma 3.16 and then, obtaining the equation of the statement boils down to a multiplication of two upper triangular matrices (the ones obtained in Lemma 3.16). Now, let us assume that the edge  $e$  is of order of sedentarity 1. The proof works in the same way as for the non-sedentary case. Write  $c''_F \circ c_F$  as the composition  $(c''_F \circ c'_F) \circ (c'_F \circ c_F)$  and the result also boils down to the multiplication of two upper triangular matrices (this time, the ones obtained in Lemma 3.18).  $\square$

**Proposition 3.13.** *Let  $c$  and  $c'$  be two real structure of the phase tropical surface  $(S_X, X)$ . The twist wave from  $c$  to  $c'$  is a (cellular) co-cycle in  $Z_{cell}^1(X; W_{\mathbb{Z}})$ .*

*Proof.* Let  $F$  be an oriented face of  $X$ . To prove the statement, we need to show that  $dw(c', c) \cdot F = 0$ , that is,  $\sum_{e \in \mathcal{C}_1(F)} w(c', c) \cdot e = 0$ , where the edges  $e$  are oriented according to the boundary orientation of  $\partial F$ , induced by  $F$ . The fixed locus of the local real structure  $c_F$  in  $S_F$  is made of four distinct components, all contractile in  $S_F$ . As lifts of the oriented face  $F$  to the corresponding building-block  $S_F$ , one can orient these components according to  $F$ . Denote by  $r$  the oriented boundary of one of these components, and for any edge  $e$  of  $F$  denote by  $r_e$  the intersection  $r \cap S_e$ . In particular, the homology class  $[r]$  is equal to zero in  $H_1(S_F; \mathbb{Z})$ . By Lemma 3.17 and Definition 3.22, one has for any edge  $e$  of  $F$

$$L_1^F(w(c', c) \cdot e) = [(c'_F)_* r_e - r_e].$$

By summing over all edges of  $F$  one obtains

$$\sum_{e \in \mathcal{C}_1(F)} L_1^F(w(c', c) \cdot e) = (c'_F)_* [r] - [r] = 0.$$

From the injectivity of the lifting isomorphism  $L_1^F$  one deduces the co-cycle condition

$$dw(c', c) \cdot F = 0 \in W_{\mathbb{Z}}(F).$$

$\square$

Given a real structure  $c$  of the phase tropical surface  $(S_X, X)$ , one has then a map from the real structures of  $(S_X, X)$  to the (cellular) co-cycles group  $Z_{cell}^1(X; W_{\mathbb{Z}})$  defined by  $w(\bullet, c)$ . In light of this new perspective on the real structures of a phase tropical surface, there are three main questions that can be asked.

- (1) Is the map  $w(\bullet, c)$  surjective onto  $Z_{cell}^1(X; W_{\mathbb{Z}})$  ?
- (2) What are the equivalence classes of the real structures of the phase tropical surface  $(S_X, X)$  defined by the inverse images of the elements of  $Z_{cell}^1(X; W_{\mathbb{Z}})$  ?
- (3) What are the images of the isomorphism classes of the real structures of the phase tropical surface  $(S_X, X)$  ?

We are able answer the first question in an affirmative way. Given any tropical wave  $w \in Z_{cell}^1(X; W_{\mathbb{Z}})$ , we provide, using composition by Dehn twist, an explicit real structure  $c'$  such that  $w = w(c', c)$ . This is the statement of Proposition 3.14. The second and third questions however, are more difficult to tackle. In the case of curves, the authors of [7] consider real structures, up to composition by a homeomorphism fixing the fibers  $S_v$  over the vertices of sedentarity 0 (see Section 2.2.1). There is a nice and simple result used in this article, which is the fact that an orientation preserving automorphism of a cylinder, restricting to the identity on the boundary, is isotopic to a certain power of a Dehn twist. In other words, the mapping class group of the 2-dimensional torus  $T^2$ , in the topological category, is isomorphic to the group  $GL_2(\mathbb{Z})$ . Thanks to this result, in the case of a phase tropical curve  $(S_{\Gamma}, \Gamma)$ , it is possible to describe the real structures of  $(S_{\Gamma}, \Gamma)$ , up to isomorphism, as a  $\mathbb{Z}_2$ -affine space with direction  $H_{cell}^1(\Gamma; W_{\mathbb{Z}_2})$  (see Proposition 3.4). The author is not able to provide such a nice description in the case of phase tropical surfaces for several reasons. First, it is not even clear that there always exist a real structure of the phase tropical surface  $(S_X, X)$ , so we decide to restrict to the case where a real structure is already given. Second, the author does not know of a similar result to the orientation preserving automorphisms on a cylinder being isotopic to powers of Dehn twist, on manifolds of the form  $[0, 1] \times T^1 \times \overline{P}^1$ . It should actually boils down to knowing the mapping class group, in the topological category, of the space  $T^2 \times \overline{P}^1$ . The author is not familiar with mapping class group of tori in higher dimensions, but it seems that they can get more complicated than just looking at the action on the homology. For  $n \geq 5$ , the mapping class group of the  $n$ -dimensional torus  $T^n$  is not isomorphic to  $GL_n(\mathbb{Z})$  (see Theorem 4.1 in [13]). Finally, even with a description of the isotopy classes of the automorphisms of the building-block  $S_e$ , fixing  $(\partial a) \times T^e \times \overline{P}^1$ , one would still have to understand how these automorphisms can be glued together along the building-block  $S_F$  of faces  $F$  of  $X$ .

The discussion above leads us to focus on a simpler class of real structures, namely the *real structures obtained by Dehn twists* (see Definition 3.25), from a real structure  $c$ , already existing on  $(S_X, X)$ . Of course, this is not completely satisfactory, but it is enough to lift tropical  $(0, 2)$ -cycles as fixed components of another real structure  $c'$  (see Chapter 4).

*Definition 3.23.* Let  $e$  be an edge of  $X$ , and let us denote by  $u$  and  $v$  the two adjacent vertices. Orient the edge from  $u$  to  $v$  and parametrize  $e$  by  $x \in [0, 1]$ , so that every element of  $e$  is written as  $(1 - x)u + xv$ . We define the *Dehn twist* on  $S_e = e \times T^e \times \overline{P}^{1-|sed(e)|}$  by

$$D_e(x, \theta, z) := (x, \theta + 2\pi x \vec{e}, z),$$

where  $\vec{e}$  is the primitive integer vector in  $W_{\mathbb{Z}}'(e)$ , directed according to the orientation of the edge  $e$ .

*Remark 3.20.* Notice that the above definition does not depend on the chosen orientation of the edge  $e$ , since reversing the orientation changes the vector  $\vec{e}$  to  $-\vec{e}$ , but also  $x$  to  $(1-x)$  and one has  $2\pi x\vec{e} = 2\pi(1-x)(-\vec{e}) \in T^e$ .

This definition of a Dehn twist is classical. Up to the product by the pair-of-pants  $\overline{P}^{n_e}$ , this definition is exactly the same one as in [7]. Given a real structure  $c$  of  $(S_X, X)$ , the idea to prove the surjectivity of  $w(\bullet, c')$  is to compose the local real structure  $c_e$  of  $(S_e, e)$ , by a certain power of the Dehn twist on  $S_e$ , for every edge  $e$  of sedentarity 0. If we look for a real structure  $c'$  such that  $w(c', c) = w$ , where  $w$  is a given 1-co-cycle in  $Z_{cell}^1(X; \mathbb{Z})$ , the Dehn twist on  $S_e$  should be raised to the power  $w(c', c) \cdot e$ . This assertion is justified by the following lemma.

**Lemma 3.19.** *Let  $e$  be an edge of sedentarity 0 of  $X$ . Let  $c_e$  be a local real structure of  $(S_e, e)$ . For any  $t \in \mathbb{Z}$ , the homeomorphism  $(D_e)^t \circ c_e$  acts as the standard conjugation  $\text{conj}_e$ , up to conjugation by a homeomorphism of  $S_e$ . Moreover, for any local real structure  $c'_e$  such that  $c'_e = (D_e)^t \circ c_e$ , one has*

$$t_e(c', c) = t.$$

*Proof.* Let us work in the coordinates of  $S_e = e \times T^e \times \overline{P}^1$ , where the local real structure  $c_e$  acts as the standard conjugation  $\text{conj}_e$ . The first part of the statement is then a consequence of the fact that for any  $t' \in \mathbb{R}$ , one has  $D_e^{t'} \circ \text{conj}_e = \text{conj}_e \circ D_e^{-t'}$ , where  $D_e^{t'}(x, \theta, z) = (x, \theta + 2\pi t'x, z)$ . In particular, for any  $t' \in \mathbb{Z}$ , one has  $D_e^{t'} = (D_e)^{t'}$ , so one can deduce  $(D_e)^t \circ \text{conj}_e = \left(D_e^{\frac{-t}{2}}\right) \circ \left((D_e)^t \circ \text{conj}_e\right) \circ \left(D_e^{\frac{t}{2}}\right)$ , which implies the first part of the statement. Regarding the second part of the statement, let us consider the component  $r = e \times \{0\} \times \{z\}$  of  $S_e$  fixed by the local real structure  $c_e$ , where  $z \in \mathbb{R}\overline{P}^1$ . The image of  $r$  by  $c'_e = (D_e)^t \circ c_e$  is given by  $\{(x, 2\pi tx, z) | x \in e\}$ . Therefore, the 1-cycle  $(c'_e)_* r - r$  is homologous to  $t$  times the homology class  $\gamma_e \in H_1(S_e; \mathbb{Z})$ , which implies the result by Lemma 3.17.  $\square$

In the case of phase tropical curves, we would have already found our real structure  $c'$  thanks to the lemma above. In the case of surfaces, however, we also need to modify our real structures on the building-blocks associated with the faces of  $X$ . In fact, consider a face  $F$  of  $X$  and an edge  $e$ , of sedentarity 0 of  $F$ . Let us post-compose the local real structure  $c_e$  by a Dehn twist to the appropriate power  $t_e$  and denote the result by  $c'_e$ . If we want  $c'_e$  to be the local real structure of  $(S_e, e)$  coming from a real structure  $c'$  of  $(S_X, X)$ , then the local real structure  $c'_F$ , defined on  $S_F$  has to coincide with  $c'_e$  on  $S_F^e = S_e^F$ . More precisely, restricted to  $S_F^e$ , the real local structure  $c_F$  must satisfy

$$\phi_F^e \circ c'_F \circ (\phi_F^e)^{-1}(x, \theta, z) = (x, -\theta + 2\pi x\vec{e}, z),$$

where  $\phi_F^e$  is the gluing homeomorphism of Definition 3.8. Yet, by Equation (3.2), the above equation is equivalent to

$$c'_F(x, \theta, z) = (x, -\theta + 2\pi x\vec{e}, z). \quad (3.8)$$

Recall that  $F$  admits a barycenter  $x_F$  (the combinatorial stratification of  $X$  is polyhedral). Given an edge  $e$  of  $F$ , define the triangle  $\Gamma_F^e = \text{conv}(e, x_F)$ . One can then write  $F$  as the union  $F = \bigcup_{e \in \mathcal{C}_1(F)} \Gamma_F^e$ . We parametrize the triangle  $\Gamma_F^e$  by the map  $(\xi, x) \mapsto (\xi x + (1-\xi)x_F) \in \Gamma_F^e$ , for  $(\xi, x) \in ([0, 1] \times e) / \sim$ , where  $\sim$  identifies all the points in  $\{0\} \times e$ .

*Definition 3.24.* Let  $F$  be an oriented face of  $X$  and let  $e$  be an edge of  $F$ . Let  $w$  be a 1-co-cycle in  $Z_{cell}^1(F; W_{\mathbb{Z}})$ . Let us label the edges of  $F$  by  $e_0, \dots, e_{n-1}$ , such that the  $e_0 = e$  and the cyclic order is induced by the boundary orientation of  $\partial F$ . For any  $i \in \mathbb{Z}_n$ , we work in the parametrization of the triangle  $\Gamma_F^{e_i}$ , mentioned in the discussion above, where  $e_i$  is oriented according to the boundary orientation of  $\partial F$ . We define the  $w$ -twist on  $S_F$  starting at the edge  $e$ , denoted by  $D_w^e$ , by defining it on any product  $\Gamma_F^{e_i} \times T^F$ , for  $i \in \mathbb{Z}_n$ , by

$$D_w^e(\xi, x, \theta) := \left( \xi, x, \theta + 2\pi\xi \left( x(w \cdot e_i) + \sum_{0 \leq j \leq i-1} (w \cdot e_j) \right) \right). \quad (3.9)$$

**Lemma 3.20.** *Let  $F$  be an oriented face of  $X$ . The  $w$ -twist  $D_w^e$ , starting at the edge  $e$  on  $S_F$ , is well defined. Moreover,  $D_w^e$  is a homeomorphism whose restriction on  $S_F^f$ , for any edge  $f$  of the face  $F$  of sedentarity 0, coincides with the restriction of the Dehn twist on  $S_f$ , raised to the power  $t_f \in \mathbb{Z}$ , where the integer  $t_f$  is such that  $w \cdot f = t_f \vec{f}$ .*

*Proof.* First of all, let us notice that, since  $dw \cdot F = 0$ , one has  $\sum_{j \in \mathbb{Z}_n} w \cdot e_j = 0$ , so that for any  $i \in \mathbb{Z}_n$ , the sum  $\sum_{0 \leq j \leq i-1} w \cdot e_j$  is well defined. By substituting  $\xi = 0$  into Equation (3.9), one immediately gets that the maps  $D_w^e$  are well defined on the product  $\Gamma_F^e \times T^F$  and that they all coincide at the fiber  $\{x_F\} \times T^F$ . Now, for any  $i \in \mathbb{Z}_n$ , denoting by  $v_i$  the vertex common to  $e_i$  and  $e_{i+1}$ , the  $w$ -twist  $D_w^{e_i}$  coincides with  $D_w^{e_{i+1}}$  at all  $(\xi, v_i, \theta)$ , simply by substituting  $x = 1$  on the right hand side of Equation (3.9) for  $D_w^{e_i}$  and  $x = 0$ , for  $D_w^{e_{i+1}}$ . The map  $D_w$  is obviously continuous and it has a continuous inverse given by the  $(-w)$ -twist starting at the edge  $e$ . Therefore, the map  $D_w^e$  is a homeomorphism. Now, denote by  $e_0, \dots, e_{n-1}$  the edges of  $F$  as in Definition 3.24. Substituting  $\xi = 1$  into Equation (3.9), one obtains for every  $x \in [0, 1]$  and  $\theta \in T^F$ ,

$$D_w^e(1, x, \theta) := (1, x, \theta + 2\pi(x(w \cdot e_i))),$$

because the sum  $\sum_{0 \leq j \leq i-1} (w \cdot e_j)$  is an integer. By Equation (3.2) of Definition 3.8, this expression coincides with the one of the Dehn twist on  $S_{e_i}$ , in restriction to  $S_{e_i}^F = S_{e_i} \cap S_F$ .  $\square$

Lemma 3.20 above shows that given a cellular 1-co-cycle  $w \in Z_{cell}^1(X; W_{\mathbb{Z}})$ , using the  $w$ -twist on  $S_F$  for all faces  $F$ , we can glue together all Dehn twists to the power  $t_e$  one  $S_e$ , where  $w \cdot e = t_e \vec{e} \in W_{\mathbb{Z}}(e)$  for all edges of sedentarity 0. In fact, let us choose an arbitrary edge  $e_F \in \mathcal{C}_1(F)$  and an arbitrary orientation of  $F$  for each face  $F$  of  $X$ , and let us denote by  $t_e \in \mathbb{Z}$  the integer such that  $w \cdot e = t_e \vec{e} \in W_{\mathbb{Z}}(e)$ , for any oriented edge  $e$  of sedentarity 0. Then we define a *global  $w$ -twist*  $D_w$  by the homeomorphism of  $S_X$ , which acts as the identity on  $S_v$  for any vertex  $v$  of  $X$ , acts as  $(D_e)^{t_e}$  on  $S_e$  for any edge of sedentarity 0 and acts as the  $w$ -twist on  $S_F$  starting at the edge  $e_F$  for any face  $F$  of  $X$ . Note that a different choice of edge  $e_F$  yields a different global  $w$ -twist  $D_w$ , even if our notation does not emphasize this dependence.

**Proposition 3.14.** *Let  $c$  be a real structure of  $(S_X, X)$  and let  $w \in Z_{cell}^1(X; W_{\mathbb{Z}})$ . Let also  $D_w$  be a global  $w$ -twist on  $S_X$ . The involution  $c' = D_w \circ c$  is a real structure of  $(S_X, X)$ , satisfying*

$$w(D_w \circ c, c) = w.$$

*Proof.* Let  $e$  be an edge of sedentarity 0 of  $X$ . Let us denote by  $c'_e$  the restriction of  $c'$  to the fiber  $S_e$ . By definition of  $c'$ , one has  $c'_e = (D_e)^{t_e} \circ c_e$ , where  $t_e$  is the integer such that  $w \cdot e = t_e \vec{e}$ . By

Lemma 3.19, the restriction  $c'_e$  acts like the standard conjugation on  $S_e$ , up to the conjugation by a homeomorphism of  $S_e$ . Let  $F$  be an edge of  $X$  and  $e_F$  be the edge of  $F$  at which the  $w$ -twist  $D_w$  starts. Denoting by  $c'_F$  the restriction of  $c'$  to  $S_F$ , one has  $c'_F = D_w \circ c_F$ . Working in the coordinates of  $S_F$ , where the real local structure  $c_F$  acts as the standard conjugation  $\text{conj}_F$  on  $S_F$ , one obtains that  $c'_F = D_w^{\frac{1}{2}} \circ c_F \circ \left(D_w^{\frac{1}{2}}\right)^{-1}$ , where  $D_w^{\frac{1}{2}}$  is a homeomorphism of  $S_F$  defined by

$$D_w^{\frac{1}{2}}(\xi, x, \theta) = \left( \xi, x, \theta + \pi\xi \left( x(w \cdot e_i) + \sum_{0 \leq j \leq i-1} w \cdot e_j \right) \right),$$

using the notations of Definition 3.24.  $\square$

*Definition 3.25.* Let us fix an arbitrary orientation of every face  $F$  of  $X$  together with an arbitrary choice of an edge  $e_F$  of sedentarity 0 of the face  $F$ . The *real structures obtained by Dehn twists* from  $c$  are real structures of the form  $D_w \circ c$ , where  $w \in Z_{cell}^1(X; W_{\mathbb{Z}})$  and  $D_w$  is a global  $w$ -twist on  $(S_X, X)$  such that, for any face  $F$  of  $X$ , the restriction of  $D_w$  on  $S_F$  starts at the edge  $e_F$ . The set of all real structures obtained by Dehn twist from  $c$ , up to  $X$ -isomorphism, is denoted by  $\Pi_c(S_X, X)$ . Although the notation does not underline it, this set depends on the orientation of  $F$  and on the arbitrary choice of the edge  $e_F$ , for each face  $F$  of  $X$ .

*Remark 3.21.* The author was not able to get rid of the dependency on the choice of the edge  $e_F$  for each face  $F$ . A statement that would enable us to get rid of this dependency would be that, given a face  $F$  of  $X$  and a 1-co-cycle  $w \in Z_{cell}^1(F; W_{\mathbb{Z}})$ , if  $D_w^{(1)}$  and  $D_w^{(2)}$  are  $w$ -twists on  $S_F$ , starting at different edges, then there exists a homeomorphism  $D$  of  $S_F$ , restricting to the identity on the boundary  $(\partial F) \times T^F$ , such that  $D_w^{(1)} \circ \text{conj}_F = D \circ D_w^{(2)} \circ \text{conj}_F \circ D^{-1}$ .

Let us now state and prove three lemmas before stating the main result of this section, Theorem 3.3.

**Lemma 3.21.** *Let  $c$  be a real structure of  $(S_X, X)$  and  $c' \in \Pi_c(S_X, X)$  be a real structure obtained by Dehn twist from  $c$ . If the twist wave  $w(c', c)$  is a co-boundary, then  $c$  and  $c'$  are  $X$ -isomorphic.*

*Proof.* The image of the co-boundary operator  $d : C_{cell}^0(X; W_{\mathbb{Z}}) \rightarrow C_{cell}^1(X; W_{\mathbb{Z}})$  is, by definition, generated by the elements of the form  $d(v \otimes w)$ , where  $v$  is a vertex of  $X$  and  $w \in W_{\mathbb{Z}}(v)$ . Therefore, one can assume that  $w(c', c) = d(v \otimes w)$ . If  $v$  is a vertex of sedentarity 0, then  $W_{\mathbb{Z}}(v) = 0$  so there is nothing to show. We are left with the case where the vertex  $v$  is of order of sedentarity 1 and the case where  $v$  is of order of sedentarity 2.

If  $v$  is of order of sedentarity 1 then the parent face of the vertex  $v$  is an edge  $e$  and the wave space  $W_{\mathbb{Z}}(v) = W_{\mathbb{Z}}(e)$  is generated by  $\vec{e}$ , a primitive integer vector parallel to the edge  $e$ . We denote by  $u$  the other vertex adjacent to  $e$ . Thus, there exists  $t \in \mathbb{Z}$ , such that  $w \cdot e = t\vec{e}$ . Let us orient  $e$  from  $u$  to  $v$  and parametrize the edge  $e$  by a map  $[0, 1] \rightarrow e$  sending  $x$  to  $xv + (1-x)u$  (as in Definition 3.23). The Dehn twist  $D_e$  on  $S_e$  can then be written  $D_e = \left(D_{\vec{e}}^{\frac{1}{2}}\right)^2$ , where  $D_{\vec{e}}^{\frac{1}{2}}(x, \theta, z) = (x, \theta + \pi x \vec{e}, z)$ . In particular, the homeomorphism  $D_{\vec{e}}^{\frac{1}{2}}$  is the identity on  $S_e^u$ . Now, for each of the three faces  $F$  of  $X$ , adjacent to the edge  $e$ , we orient the boundary of  $F$ , such that the restricted orientation to  $e$  is the orientation from the vertex  $u$  to  $v$ . We also denote by  $e_0, \dots, e_{n-1}$  the edges of  $F$  in cyclic order, such that one has  $D_w^{e_0} \circ c_F = c'_F$ . Let  $i \in \mathbb{Z}_n$  be

the index such that  $e_i = e$ , so that  $e_{i+1}$  is the other edge of  $F$  adjacent to  $v$ . In particular, the edge  $e_{i+1}$  is of sedentarity 1. Thus, by Definition 3.25, one has  $e_0 \neq e_{i+1}$ . It implies that for any  $j \in \mathbb{Z}_n \setminus \{i, i+1\}$ , the sum  $\sum_{0 \leq k \leq j-1} w \cdot e_k$  is zero. As a consequence, one can consider the same homeomorphism  $D_w^{\frac{1}{2}}$  as in the proof of Proposition 3.14, which here, restricts to the identity on all products  $\Gamma_F^{e_j} \times T^F$ , for  $j \notin \{i, i+1\}$ . Moreover, it coincides with  $(D_e)^{t_e(c',c)}$  on  $S_F^{e_i} = S_F^e$ . Finally, we have constructed a fiber-preserving homeomorphism  $D : S_X \rightarrow S_X$ , which restricts to the identity on the fibers  $S_v$  for all vertices  $v$  of sedentarity 0 and satisfying  $c' = D \circ c \circ D^{-1}$ , which implies by definition that  $c$  and  $c'$  are  $X$ -isomorphic. More precisely, this homeomorphism is given by the identity outside  $\lambda^{-1}(F \cup G \cup H)$ , where  $F, G$  and  $H$  are the faces adjacent to the edge  $e$ , it restricts to the power of the Dehn twist  $\left(D_e^{\frac{1}{2}}\right)^{t_e(c',c)}$  to the relative interior of  $S_e$  and it restricts to  $D_w^{\frac{1}{2}}$  on the relative interior of the building blocks  $S_F, S_G$  and  $S_H$ .

If  $v$  is a vertex of order of sedentarity 2, then, denoting by  $F$  the parent face of  $v$ , and by  $e$  and  $f$  the adjacent edges to  $v$ , which are of order of sedentarity 1, one can construct a fiber-preserving homeomorphism  $D : S_X \rightarrow S_X$ , in a similar way. This time this homeomorphism restricts to the identity to  $\lambda^{-1}(X \setminus F)$  and it restricts to  $D_w^{\frac{1}{2}}$  to the relative interior of the building-block  $S_F$ . As for the case of a vertex of sedentarity 1, one can check that the homeomorphism  $D_w^{\frac{1}{2}}$  restricts to the identity outside  $\lambda^{-1}(\Gamma_F^e \cup \Gamma_F^f)$ , using the fact that the edge  $e_F$  where the  $w$ -twist starts, is of sedentarity 0, combined with the fact that the combinatorial stratification is polyhedral.  $\square$

**Lemma 3.22.** *Let  $c$  be a real structure of  $(S_X, X)$  and  $c' \in \Pi_c(S_X, X)$  be a real structure obtained by Dehn twist. If the twist wave  $w(c', c)$  is even, then  $c$  and  $c'$  are  $X$ -isomorphic.*

*Proof.* Since  $w$  is even, for any edge  $e$  of sedentarity 0 of  $X$ , the twist  $t_e(c', c)$  from  $c$  to  $c'$  is even and thus the homeomorphism  $\left(D_e^{\frac{1}{2}}\right)^{t_e(c',c)} = (D_e)^{\frac{t_e(c',c)}{2}}$  restricts to the identity to  $S_e^v$  for all vertices  $v$  adjacent to the edge  $e$ . Similarly, for any face  $F$  of  $X$ , the homeomorphism  $D_w^{\frac{1}{2}} = D_{\frac{w}{2}}$  also restricts to the identity to  $S_F^v$  for all adjacent vertices  $v$ . Therefore, one obtains a fiber-preserving homeomorphism  $D : S_X \rightarrow S_X$ , which restricts to the identity on any fiber  $S_v$ , with  $v$  a vertex of sedentarity 0 and satisfying  $c' = D \circ c \circ D^{-1}$ . More precisely, the restriction of  $D$  to the relative interior of a building block  $S_F$  is equal to  $D_{\frac{w}{2}}$  and the restriction to the relative interior of an edge of sedentarity 0 is equal to  $(D_e)^{\frac{t_e(c',c)}{2}}$ .  $\square$

The next and third lemma is not only useful in order to prove Theorem 3.3, but also gives a connection between the twist from a real structure to another one and the twist along a pair of faces of Definition 3.18. One can see this lemma as a generalisation to the case  $n = 2$  of Lemma 3.11.

**Lemma 3.23.** *Let  $e$  be an edge of  $X$  of sedentarity 0. Let  $F$  and  $G$  be two faces adjacent to  $e$ . Let  $c_e$  and  $c'_e$  be two local real structures of  $(S_e, e)$ . The following statements are equivalent to each other.*

- *The edge  $e$  is untwisted along  $FG$  for both real structures  $c$  and  $c'$ , or the edge  $e$  is twisted along  $FG$  for both real structures  $c$  and  $c'$ .*



- *The twist from  $c$  to  $c'$  at the edge  $e$  is even.*

*Proof.* Let us set  $t := t_e(c', c)$  and let us work in the coordinates of  $S_e$ , where the local real structure  $c_e$  acts as the standard conjugation  $\text{conj}_e$  on  $S_e$ . We denote by  $u$  and  $v$  the adjacent vertices (of sedentarity 0) to the edge  $e$ . By assumption, one has  $c'_e = D_e^t \circ c$ . Let us denote by  $B_F$  and by  $B_G$  the boundary components of  $\overline{P}^1$  corresponding to the faces  $F$  and  $G$  for the bijection of point (1) of Definition 3.8, associated with the edge  $e$ . There is only one component  $b$  of  $\mathbb{R}\overline{P}^1$ , which connects the boundary components  $B_F$  and  $B_G$ . Let us denote by  $z$  the intersection point of the real component  $b$  with the boundary component  $B_F$ . Since the real structures coincide with the standard conjugation on the fibers  $S_u$  and  $S_v$ , they define the same leaves. Therefore, the fact that the edge  $e$  is untwisted along  $FG$  is equivalent to saying that the fixed component of  $c'_e$  containing the point  $(u, 0, z)$  also contains the point  $(v, 0, z)$ . Yet, this component is given by  $\{(xu + (1-x)v, \pi tx, z) \mid x \in [0, 1]\}$  and so this component contains the point  $(v, 0, z)$  if and only if the twist  $t$  is even.  $\square$

**Theorem 3.3.** *Let  $c$  be a real structure of  $(S_X, X)$ . The set  $\Pi_c(S_X, X)$  of real structures of  $(S_X, X)$ , obtained by Dehn twists from  $c$  and up to  $X$ -isomorphism, is a  $\mathbb{Z}_2$ -affine space of direction*

$$\overrightarrow{\Pi}_X = H_{\text{cell}}^1(X; W_{\mathbb{Z}}) / 2 \cdot H_{\text{cell}}^1(X; W_{\mathbb{Z}}).$$

*Proof.* Let  $c'$  be a real structure  $X$ -isomorphic to the real structure  $c$ . Let us show that the cohomology class of  $w(c', c)$  is even. Since  $c$  and  $c'$  are  $X$ -isomorphic, they have the same twisted and untwisted edges of sedentarity 0 along pair of faces. Therefore, by Lemma 3.23, one has  $w(c', c) \cdot e \in 2W_{\mathbb{Z}}(e)$ . Since the wave space of an edge of sedentarity 1 is equal to the wave space of the parent face, one can check that any co-chain satisfying the co-cycle relation for all bounded faces, can be transformed into a co-cycle by setting the appropriate values on the edge of sedentarity 1. Thus, one can add an even co-cycle  $2w'$  to  $w(c', c)$  such that  $w(c', c) + 2w'$  has support contained in the edges of sedentarity 1. Denoting by  $\tilde{w}$  the co-cycle  $w(c', c) + 2w'$ , we are left with proving that  $\tilde{w}$  is in the image of the tropical co-boundary operator (up to an even co-cycle). Recall that  $X$  admits a polyhedral combinatorial stratification. Therefore, every unbounded face of  $X$  is contained in a single chart with values in  $\mathbb{T}^N$  for some integer  $N > 1$ . Using the fact that the vertices of  $F$  are of order of sedentarity at most 2 (because  $X$  is hypersmooth), one can show that the face  $F$  has either only one edge of sedentarity 1 or two edges of sedentarity 1 intersecting at a vertex of sedentarity 2. Consider an edge  $e$  of sedentarity 1. If  $e$  is the only edge of sedentarity 1 in its parent face  $F$ , then the co-cycle condition at the face  $F$  yields  $\tilde{w} \cdot e = 0$ . If  $e$  intersects another edge  $f$  of sedentarity 1 at a vertex  $v$  of sedentarity 2, then the co-cycle condition yields  $\tilde{w} \cdot e + \tilde{w} \cdot f = 0$ , where  $e$  is oriented towards the vertex  $v$  and the edge  $f$  is oriented outwards the vertex  $v$ . Hence, one has  $(\tilde{w} + d(v \otimes (\tilde{w} \cdot e))) \cdot e = 2\tilde{w} \cdot e$  and  $(\tilde{w} + d(v \otimes (\tilde{w} \cdot e))) \cdot f = 0$ . It follows that the cohomology class of  $w(c', c)$  is even. We have shown that the map  $w(\bullet, c)$  induces on the quotient  $\Pi_c(S_X, X)$  the map

$$[w(\bullet, c')]_2 : \Pi_c(S_X, X) \rightarrow H_{\text{cell}}^1(X; W_{\mathbb{Z}}) / 2 \cdot H_{\text{cell}}^1(X; W_{\mathbb{Z}}).$$

By Proposition 3.14, this map is surjective, and by Lemmas 3.21 and 3.22, the map  $[w(\bullet, c')]_2$  is injective.  $\square$

## 4 Filtration of the Homology of a Phase Tropical Surface

### 4.1 Lifting Tropical Cycles

Let  $X$  be a hypersmooth tropical surface with a polyhedral combinatorial stratification, and let  $(S_X, X)$  be a phase tropical surface. Let  $G$  be an abelian group. The goal of this section is to define the following three lifting morphisms:

$$\begin{aligned} L_{2,0} &: H_{2,0}(X; G) \rightarrow H_2(S_X; G); \\ L_{1,1} &: H_{1,1}(X; G) \rightarrow H_2(S_X; G) / H_{2,0}(S_X; G); \\ L_{0,2} &: H_{0,2}(X; G) \rightarrow H_2(S_X; G) / H_{1,1}(S_X; G). \end{aligned}$$

The group  $H_{2,0}(S_X; G)$  is defined as the image of the lifting morphism  $L_{2,0}$  and the group  $H_{1,1}(S_X; G)$  is defined by the homology classes which are sent to the image of  $L_{1,1}$  by the quotient map  $H_2(S_X; G) \rightarrow H_2(S_X; G) / H_{2,0}(S_X; G)$ . The idea is to generalize the approach of [7] to phase tropical surfaces. Concerning tropical  $(2, 0)$ - and  $(1, 1)$ -cycles, there is a "natural" way to define their liftings, as was done in [7] and summarized in Section 3.2.2 for tropical  $(1, 0)$ - and  $(0, 1)$ -cycles in a hypersmooth tropical curve (see Sections 4.1.1 and 4.1.2). The main difficulty is to lift tropical  $(0, 2)$ -cycles, which boils down to lift topological surfaces embedded in  $X$ . Under the assumption that the phase tropical surface  $(S_X, X)$  admits a real structure, we present a way to explicitly lift orientable topological surfaces embedded in  $X$  to the 4-dimensional manifold  $S_X$  in Section 4.1.3. The key property of these lifting morphisms, in order to obtain a filtration of the second homology group  $H_2(S_X; \mathbb{Z}_2)$ , is that they commute with the intersection product in a sense that is precised in Section 4.2. This property is briefly referred to in Remark 3.13 in the case of curves.

#### 4.1.1 Lifting $(2, 0)$ -cycles

The aim of this section is to define the lifting morphism

$$L_{2,0} : H_{2,0}(X; G) \rightarrow H_2(S_X; G).$$

Consider a framed point  $x \otimes v$ , where  $x$  is a point in the relative interior of a cell  $\sigma$  of  $X$  and  $v \in \mathcal{F}_2^G(\sigma)$ . Recall the definition of the lifting isomorphism  $L_2^\sigma$  (Definition 3.9). Under the map induced by the inclusion of the relative interior of the building block  $S_\sigma$  inside  $S_X$ , one can view the image of  $L_2^\sigma$  inside the homology group  $H_2(S_X; G)$ . We then define the lift of the framed point  $x \otimes v$  by

$$L_{2,0}(x \otimes v) := L_2^\sigma(v) \in H_2(S_X; G).$$

We extend the morphism  $L_{2,0}$  linearly to any sum of  $\mathcal{F}_2^G$ -framed points, in other words, we extend  $L_{2,0}$  to any tropical singular  $(2, 0)$ -cycle of  $X$ .

**Lemma 4.1.** *Let  $a$  be a tropical singular  $(1, 2)$ -chain of  $X$ . The lift of the tropical boundary  $\partial a$  is zero, that is,*

$$L_{2,0}(\partial a) = 0 \in H_2(S_X; G).$$

*Proof.* Recalling Definitions 2.16, 2.17 and 2.18, one can write the tropical singular chain  $a$  as a sum  $a = \sum_\alpha \alpha \otimes v_\alpha$ , where every singular simplex  $\alpha$  indexing the sum is  $\mathcal{C}$ -stratified. In particular, for any (singular) simplex  $\alpha$ , the image  $\alpha([0, 1])$  is contained in a single cell  $\sigma_\alpha$  and

the framing  $v_\alpha$  is an element of the 2-multi-tangent space  $\mathcal{F}_2^G(\sigma_\alpha)$ . Thus, the lift  $L_2^{\sigma_\alpha}(v_\alpha)$  of the framing  $v_\alpha$  is equal to a homology class  $\mu_\alpha[\{*\} \times \nu_\alpha]$ , where  $\mu_\alpha \in G$  and  $\nu_\alpha$  is an oriented cycle in  $T^{\sigma_\alpha} \times \overline{P}^{n_{\sigma_\alpha}}$  (so that  $\{*\} \times \nu_\alpha$  is an oriented cycle in the building-block  $S_{\sigma_\alpha}$ ). We then lift the framed simplex  $\alpha \otimes v_\alpha$  by defining the singular 3-chain  $l_\alpha := \mu_\alpha \alpha([0, 1]) \times \nu_\alpha$ , with coefficients in the abelian group  $G$  and with the product orientation coming from the orientation of  $\nu_\alpha$  and the orientation from 0 to 1 on the segment  $[0, 1]$ . For  $j = 0, 1$ , we denote by  $\sigma_\alpha^j$  the cell of  $X$ , such that  $\alpha(j)$  lies in the relative interior of  $\sigma_\alpha^j$ . The boundary of the lift  $l_\alpha$  is then equal to  $\mu_\alpha \left( \left( \phi_{\sigma_\alpha^1}^{\sigma_\alpha^1} \right)_* (\alpha(1) \times \nu_\alpha) - \left( \phi_{\sigma_\alpha^0}^{\sigma_\alpha^0} \right)_* (\alpha(0) \times \nu_\alpha) \right)$ . Yet, by definition of the lifting isomorphism  $L_2^{\sigma_\alpha^j}$ , one has for  $j = 0, 1$  that,

$$L_2^{\sigma_\alpha^j}(\iota(v_\alpha)) = \mu_\alpha \left( \phi_{\sigma_\alpha^j}^{\sigma_\alpha^j} \right)_* (\alpha(j) \otimes \nu_\alpha).$$

Hence, by summing over all singular 1-simplices  $\alpha$ , one obtains that a representative of the lift  $L_{2,0}(\partial\alpha)$  is given by the boundary  $\partial(\sum_\alpha l_\alpha)$ , whose homology class is by definition 0  $\in H_2(S_X; G)$ .  $\square$

The above lemma allows us to consider the map  $H_{2,0}(X; G) \rightarrow H_2(S_X; G)$  induced by  $L_{2,0}$ .

*Definition 4.1.* The resulting map from Lemma 4.1 above is still denoted by  $L_{2,0}$ . We call this map the *(2,0)-lifting morphism*

$$L_{2,0} : H_{2,0}(X; G) \rightarrow H_2(S_X; G).$$

The image of the (2,0)-lifting morphism is denoted by  $H_{2,0}(S_X; G)$ .

We conclude this section with an easy observation about the intersection form on  $H_2(S_X; \mathbb{Z}_2)$ . Recall that we denote by  $l \circ l'$  the intersection product between two homology classes  $l$  and  $l'$  in  $H_2(S_X; \mathbb{Z}_2)$ . Two elements in the sub-group  $H_{2,0}(S_X; \mathbb{Z}_2)$  always have a trivial intersection number. In fact, they can always be represented as 2-cycles, whose projections on the hyper-smooth tropical surface  $X$  do not intersect each other. This observation is summarized in the following lemma.

**Lemma 4.2.** *The intersection form on  $H_2(S_X; \mathbb{Z}_2)$  vanishes when restricted to the subspace  $H_{2,0}(S_X; \mathbb{Z}_2)$ .*

*Proof.* Let  $a$  and  $b$  be two non-singular tropical (2,0)-cycles. We want to show that their lifts  $L_{2,0}([a])$  and  $L_{2,0}([b])$  do not intersect. By Lemma 2.3, the tropical (2,0)-cycle  $a$  is homologous to a tropical (2,0)-cycle  $a' = \sum_x x \otimes v_x$ , whose support is contained in the relative interiors of the faces of  $X$ , that is, for every point  $x$  appearing in the sum defining  $a'$ , the point  $x$  is contained in the relative interior of a face  $F_x$  of  $X$  and  $v_x$  is the only non-zero element of the multi-tangent space  $\mathcal{F}_2^{\mathbb{Z}_2}(F_x) \cong (\mathbb{Z}_2)^2$ . Since the support of the tropical (2,0)-cycle  $b$  is a finite set of points, if a point  $x$  lies in the intersection of the support of  $a'$  and  $b$ , there exists a point  $x'$  in  $F_x$  such that  $x'$  does not lie in the support of  $b$ . Thus, one can add the boundary of the tropical (2,1)-chain  $[x, x'] \otimes v_x$  to  $a'$  and the result is homologous to  $a'$ . We denote by  $a''$  the (2,0)-cycle homologous to  $a'$  obtained by adding all the boundaries of the (2,1)-chains  $[x, x'] \otimes v_x$  for every point  $x$  in the intersection of the supports of  $a'$  and  $b$ . The support of  $a''$  does not intersect the support of  $b$ , so the lifts  $L_{2,0}(a'')$  and  $L_{2,0}(b)$  are represented by 2-cycles whose supports do not intersect, since their images by  $\lambda$  do not intersect. Hence the equality  $L_{2,0}(a'') \circ L_{2,0}(b) = 0$  and by Lemma 4.1, one obtains  $L_{2,0}([a]) \circ L_{2,0}([b]) = 0$ .  $\square$

### 4.1.2 Lifting (1,1)-cycles

The aim of this section is to define the lifting morphism

$$L_{1,1} : H_{1,1}(X; G) \rightarrow H_2(S_X; G) / H_{2,0}(S_X; G).$$

The following construction defines the lift of a tropical singular (1,1)-cycle with coefficients in the abelian group  $G$ .

*Construction 4.1.* Consider a singular tropical (1,1)-cycle  $a$  of  $X$  with coefficients in  $G$ . As in the proof of Lemma 4.1, we write  $a$  as the finite sum  $a = \sum_{\alpha} \alpha \otimes v_{\alpha}$ , where the relative interior of the image  $\alpha([0, 1])$  is contained in the relative interior of a cell  $\sigma_{\alpha}$  of  $X$  and  $v_{\alpha} \in \mathcal{F}_1^{\mathbb{Z}}(\sigma_{\alpha})$  for every  $\mathcal{C}$ -stratified 1-simplex  $\alpha$  indexing the sum. Similarly to the proof of Lemma 4.1, the lift of the framing  $v_{\alpha}$  can be written  $L_1^{\sigma_{\alpha}}(v_{\alpha}) = \mu_{\alpha} [\{*\} \times \nu_{\alpha}]$ , where  $\mu_{\alpha} \in G$  and  $\nu_{\alpha}$  is an oriented cycle in  $T^{\sigma_{\alpha}} \times \overline{P}^{\sigma_{\alpha}}$ . Still in a similar way to the proof of Lemma 4.1, one can lift the  $\mathcal{F}_1^G(\sigma_{\alpha})$ -framed 1-simplex  $\alpha \otimes v_{\alpha}$  by defining  $l_{\alpha} = \mu_{\alpha} \alpha([0, 1]) \times \nu_{\alpha}$ , with the orientation given by the product of the orientation from 0 to 1 and the orientation of  $\nu_{\alpha}$ . Notice that the boundary of the 2-chain  $\sum_{\alpha} l_{\alpha}$  is contained in the inverse image, by the stratified fibration  $\lambda$ , of the finite set of points  $Y(a) := \bigcup_{\alpha} (\alpha(1) \cup \alpha(0))$ . Consider a point  $y \in Y(a)$  and denote by  $\alpha_1, \dots, \alpha_k$  the  $\mathcal{C}$ -stratified simplices among the  $\alpha$ 's appearing in the sum defining the tropical (1,1)-cycle  $a$ , such that  $y$  is either  $\alpha_j(1)$  or  $\alpha_j(0)$  for all  $j \in \{1, \dots, k\}$  and  $k$  is a positive integer. Also denote by  $\sigma_y$  the cell such that  $y$  lies in the relative interior of  $\sigma_y$ . For any  $j \in \{1, \dots, k\}$ , up to the multiplication of the framing  $v_{\alpha_j}$  by  $-1$ , one can assume that  $y = \alpha_j(1)$ . Since  $a$  is a cycle, one has  $\sum_{1 \leq j \leq k} \iota(v_{\alpha_j}) = 0$ , where for every integer  $j$  between 1 and  $k$ , the morphism  $\iota$  goes from  $\mathcal{F}_1^G(\sigma_{\alpha_j})$  to  $\mathcal{F}_1^G(\sigma_y)$ . Thus, one has  $L_1^{\sigma_y} \left( \sum_{1 \leq j \leq k} \iota(v_{\alpha_j}) \right) = 0$ . Yet, the homology class of the lift  $L_1^{\sigma_y} \left( \sum_{1 \leq j \leq k} \iota(v_{\alpha_j}) \right) = 0$  is represented by the cycle  $\sum_{1 \leq j \leq k} \mu_{\alpha_j} \left( \phi_{\sigma_{\alpha_j}}^{\sigma_y} \right)_* (\{y\} \times \nu_{\alpha_j})$ . Hence the existence of a 2-chain  $\beta_y$  in  $S_{\sigma_y}$  such that

$$\partial \beta_y = \sum_{1 \leq j \leq k} \mu_{\alpha_j} \left( \phi_{\sigma_{\alpha_j}}^{\sigma_y} \right)_* (\{y\} \times \nu_{\alpha_j}). \quad (4.1)$$

By construction, the singular 2-chain  $l_a = (\sum_{\alpha} l_{\alpha}) + \sum_{y \in Y(a)} \beta_y$  is a cycle. We define the lift of the tropical singular (1,1)-cycle  $a$  as the homology class of  $l_a$ , modulo the subgroup  $H_{2,0}(S_X; G)$ , and we denote it by

$$L_{1,1}(a) := [l_a] \in H_2(S_X; G) / H_{2,0}(S_X; G).$$

This construction seems quite natural, but it depends *a priori* on the choices of the cycles  $\nu_{\alpha}$  but also on the choices of the two 3-chains  $\beta_y$  for the tropical singular (1,1)-cycle  $a$  and  $y \in Y(a)$ . Lemma 4.3 shows that the lift of a singular tropical (1,1)-cycle does not depend on the choices of the cycles  $\nu_{\alpha}$ , even without passing to the quotient by the subgroup  $H_{2,0}(S_X; G)$ . However, still in the proof of Lemma 4.3, we see that the reason why the lift  $L_{1,1}(a)$  does not depend on the choices of the 2-chains  $\beta_y$  for  $y \in Y(a)$  is precisely because we consider the class of the lift  $L_{1,1}(a)$  in the quotient by the subgroup  $H_{2,0}(S_X; G)$ .

**Lemma 4.3.** *Let  $a$  be a tropical singular (1,1)-cycle. The lift  $L_{1,1}(a) \in H_2(S_X; G) / H_{2,0}(S_X; G)$  does not depend on the choices of the of the cycles  $\nu_{\alpha}$ , nor on the choices of the 2-chains  $\beta_y$  for  $y \in Y(a)$ .*

*Proof.* First, let us show that the lift  $L_{1,1}(a)$  does not depend on the choices of the 1-cycles  $\nu_\alpha$ . As in Construction 4.1 we write  $a = \sum_\alpha \alpha \otimes v_\alpha$  and we fix one of the  $\mathcal{C}$ -stratified simplices  $\alpha$  indexing the sum, which we denote by  $\alpha_0$ . Consider two 1-cycles  $\nu_{\alpha_0}$  and  $\nu'_{\alpha_0}$  in  $T^{\sigma_{\alpha_0}} \times \overline{P}^{n\sigma_{\alpha_0}}$  such that the homology classes  $[\{*\} \times \nu_{\alpha_0}]$  and  $[\{*\} \times \nu'_{\alpha_0}]$  are both equal to the lift  $L_1^{\sigma_{\alpha_0}}(v_{\alpha_0})$ . Denote by  $L_{1,1}(a)$  the lift of  $a$  obtained with the choice of the 1-cycle  $\nu_{\alpha_0}$  and  $L'_{1,1}(a)$  the lift obtained with the choice of  $\nu'_{\alpha_0}$ . We assume that all other choices of 1-cycles  $\nu_\alpha$  for  $\alpha \neq \alpha_0$ , as well as the choices of the 2-chains  $\beta_y$  for  $y \in Y(a)$ , are identical. The difference of the lifts  $L_{1,1}(a) - L'_{1,1}(a)$  is thus represented by the cycle  $\alpha_0([0, 1]) \times \nu_{\alpha_0} - \alpha_0([0, 1]) \times \nu'_{\alpha_0}$ . Yet, the cycles  $\nu_{\alpha_0}$  and  $\nu'_{\alpha_0}$  being homologous, there exists a 2-chain  $\xi_{\alpha_0}$  in  $T^{\sigma_{\alpha_0}} \times \overline{P}^{n\sigma_{\alpha_0}}$  whose boundary is equal to  $\partial\xi_{\alpha_0} = \nu_{\alpha_0} - \nu'_{\alpha_0}$ . The boundary of the 3-chain  $\alpha_0([0, 1]) \times \xi_{\alpha_0}$  is thus equal to the cycle  $\alpha_0([0, 1]) \times \nu_{\alpha_0} - \alpha_0([0, 1]) \times \nu'_{\alpha_0}$ , which represents the difference of the lifts. The homology classes of these cycles are then equal, by definition, and so are their classes in the quotient by the sub-group  $H_{2,0}(S_X; G)$ . To summarize, one has  $L_{1,1}(a) = L'_{1,1}(a)$  and as a consequence the lift  $L_{1,1}(a)$  does not depend on the choices of the 1-cycles  $\nu_\alpha$ .

Now, let us show that the lift  $L_{1,1}(a)$  does not depend on the choices of the 2-chains  $\beta_y$ . Let  $y \in Y(a)$ . Using the notations from Construction 4.1, we assume that  $\beta_y$  and  $\beta'_y$  are two 2-chains in  $S_{\sigma_y}$  whose boundaries are both equal to  $\sum_{1 \leq j \leq k} \mu_{\alpha_j} \left( \phi_{F_{\alpha_j}}^{\sigma_y} \right)_* (\{y\} \times \nu_{\alpha_j})$  as in Equation (4.1). Denote by  $L_{1,1}(a)$  the lift of  $a$  obtained with the choice of the 2-chain  $\beta_y$  and by  $L'_{1,1}(a)$  the lift of  $a$  obtained with the choice of the 2-chain  $\beta'_y$ . We assume that for any other point  $x \in Y(a)$ , the choices of the 2-chain  $\beta_x$  are identical for the lifts  $L_{1,1}(a)$  and  $L'_{1,1}(a)$  and we also assume that the choices of the 1-cycles  $\nu_\alpha$  are identical for every  $\mathcal{C}$ -stratified simplex  $\alpha$  indexing the sum  $\sum_\alpha \alpha \otimes v_\alpha$ . The difference  $L_{1,1}(a) - L'_{1,1}(a)$  is then represented by the cycle  $\beta_y - \beta'_y$ . Yet, the homology class of the cycle  $\beta_y - \beta'_y$  admits an inverse by the 2-lifting isomorphism  $L_2^{\sigma_y}$ , denoted by  $v_y$ . Therefore, the difference  $L_{1,1}(a) - L'_{1,1}(a)$  is represented by the lift of the tropical singular (2,0)-cycle  $y \otimes v_y$ , and by definition this lift  $L_{2,0}(y \otimes v_y)$  lies in the subgroup  $H_{2,0}(S_X; G)$ .  $\square$

**Lemma 4.4.** *Let  $b$  be a tropical singular (1,2)-cycle of  $X$ . The lift of the tropical boundary of  $b$  is zero, that is,*

$$L_{1,1}(\partial b) = 0 \in H_2(S_X; G)/H_{2,0}(S_X; G).$$

*Proof.* As in the proof of Lemma 4.1, we can decompose the tropical singular (1,2)-cycle  $b$  as the sum  $b = \sum_\beta \beta \otimes v_\beta$ , where every  $\mathcal{C}$ -stratified 2-simplex  $\beta$  indexing the sum has its image contained in a cell  $\sigma_\beta$  and the framing  $v_\beta$  is a vector of the 1-multi-tangent space  $\mathcal{F}_1^G(\sigma_\beta)$ . One can write the homology class of the lift of  $v_\beta$  as  $L_1^{\sigma_\beta}(v_\beta) = \mu_\beta [\{*\} \times \nu_\beta] \in H_1(S_{\sigma_\beta}; G)$ , where  $\mu_\beta \in G$  and  $\nu_\beta$  is an oriented 1-cycle in  $T^{\sigma_\beta} \times \overline{P}^{n\sigma_\beta}$ . We can then define a lift of the framed simplex  $\beta \otimes v_\beta$  by defining  $l_\beta := \beta(\Delta_2) \times \nu_\beta$ . The boundary  $\partial(l_\beta)$  of this lift is of course a cycle representing the lift  $L_{1,1}(\partial(\beta \otimes v_\beta))$ . Hence, one has  $L_{1,1}(\partial(\beta \otimes v_\beta)) = 0$  and by summing over all  $\beta$ , one obtains  $L_{1,1}(\partial(b)) = 0$ .  $\square$

The above Lemma 4.4 allows us to consider the map  $H_{1,1}(X; G) \rightarrow H_2(S_X; G)/H_{2,0}(S_X; G)$  induced by  $L_{1,1}$ .

*Definition 4.2.* The resulting map from Lemma 4.4 is still denoted by  $L_{1,1}$  and we name this map the (1,1)-*lifting morphism*

$$L_{1,1} : H_{1,1}(X; G) \rightarrow H_2(S_X; G)/H_{2,0}(S_X; G).$$

We define the subgroup  $H_{1,1}(S_X; G) \subset H_2(S_X; G)$  as the subgroup of the elements sent to the image  $\text{Im}(L_{1,1})$  of the (1,1)-lifting morphism, by the quotient map  $H_2(S_X; G) \rightarrow H_2(S_X; G)/H_{2,0}(S_X; G)$ .

As in Section 4.1.1, we end this section with some considerations on the intersection form of  $H_2(S_X; \mathbb{Z}_2)$  evaluated at a pair of lifts of singular tropical (1,1)-cycles. But first, let us show that the intersection product between any element of the  $\mathbb{Z}_2$ -space  $H_{1,1}(S_X; \mathbb{Z}_2)$  and any element of  $H_{2,0}(S_X; \mathbb{Z}_2)$  is always zero.

**Lemma 4.5.** *Let  $a$  be a tropical (1,1)-cycle and  $b$  be a tropical (2,0)-cycle, both with  $\mathbb{Z}_2$ -coefficients. For any representative  $\tilde{L}_{1,1}(a) \in H_{1,1}(S_X; \mathbb{Z}_2)$  of the lift  $L_{1,1}(a)$ , one has*

$$\tilde{L}_{1,1}(a) \circ L_{2,0}(b) = 0.$$

*Proof.* By Lemma 4.2, the intersection product  $\tilde{L}_{1,1}(a) \circ L_{2,0}(b) = 0$  does not depend on the representative  $\tilde{L}_{1,1}(a)$  of the lift  $L_{1,1}(a)$ . Thus, we can take  $\tilde{L}_{1,1}(a)$  to be the homology class obtained by Construction 4.1. By Lemma 2.3, the tropical (2,0)-cycle  $b$  is homologous to a tropical (2,0)-cycle  $b' = \sum_x x \otimes v_x$ , whose support is contained in the relative interiors of the faces of  $X$ , that is, for every point  $x$  appearing in the sum defining  $b'$ , the point  $x$  is contained in the relative interior of a face  $F_x$  of  $X$  and  $v_x$  is the only non-zero element of the multi-tangent space  $\mathcal{F}_2^{\mathbb{Z}_2}(F_x)$ . Since the intersection of the support of the tropical (1,1)-cycle  $a$  with a face  $F$  of  $X$  is a union of submanifolds of codimension 1, if a point  $x$  lies in the intersection of the support of  $a$  and  $b'$ , there exists a point  $x'$  in  $F_x$ , such that the segment  $[x, x']$  intersects the support of  $a$  only at the point  $x$ . One can add the boundary of the tropical (2,1)-chain  $[x, x'] \otimes v_x$  to  $b'$  and the result is homologous to  $b'$ . We denote by  $b''$  the tropical (2,0)-cycle homologous to  $b'$  obtained by adding all the boundaries of the (2,1)-chains  $[x, x'] \otimes v_x$  for all points  $x$  in the intersection of the supports of  $a$  and  $b'$ . The support of  $b''$  does not intersect the support of  $a$ , so the lift  $L_{2,0}(b'')$  and the homology class  $\tilde{L}_{1,1}(a)$  are represented by 2-cycles whose supports do not intersect since their images by  $\lambda$  do not intersect. Hence the equality  $L_{1,1}(a) \circ L_{2,0}(b'') = 0$  and by Lemma 4.3, one obtains  $L_{1,1}([a]) \circ L_{2,0}([b]) = 0$ .  $\square$

**Proposition 4.1.** *Let  $a^{(1)}$  and  $a^{(2)}$  be a transversal pair of singular tropical (1,1)-cycles in  $X$  with coefficients in  $\mathbb{Z}_2$ . For any homology classes  $\tilde{L}_{1,1}(a^{(1)})$  and  $\tilde{L}_{1,1}(a^{(2)})$  representing the lifts  $L_{1,1}(a^{(1)})$  and  $L_{1,1}(a^{(2)})$  respectively, the intersection product of the homology classes  $\tilde{L}_{1,1}(a^{(1)})$  and  $\tilde{L}_{1,1}(a^{(2)})$  in  $H_2(S_X; \mathbb{Z}_2)$  is equal to the tropical intersection product of the corresponding tropical (1,1)-cycles, that is,*

$$\tilde{L}_{1,1}(a^{(1)}) \circ \tilde{L}_{1,1}(a^{(2)}) = a^{(1)} \circ a^{(2)}.$$

*Proof.* Since the (1,1)-cycles  $a^{(1)}$  and  $a^{(2)}$  form a transversal pair, the points of intersection between their supports  $\text{supp}(a^{(1)})$  and  $\text{supp}(a^{(2)})$  only occur in the relative interior of the faces of  $X$ . Moreover decomposing  $a^{(1)}$  and  $a^{(2)}$  as the sums  $a^{(1)} = \sum_{\alpha^{(1)}} \alpha^{(1)} \otimes v_{\alpha^{(1)}}$  and  $a^{(2)} = \sum_{\alpha^{(2)}} \alpha^{(2)} \otimes v_{\alpha^{(2)}}$ , a point  $x$  in the intersection  $\text{supp}(a^{(1)}) \cap \text{supp}(a^{(2)})$  is at the intersection of only one  $\mathcal{C}$ -stratified simplex  $\alpha_x^{(1)}$  and one  $\mathcal{C}$ -stratified simplex  $\alpha_x^{(2)}$ . Up to the subdivision of the simplices  $\alpha_x^{(1)}$  and  $\alpha_x^{(2)}$ , one can always assume that  $x$  is the only point of intersection of  $\alpha_x^{(1)}$  with  $\text{supp}(a^{(2)})$  and the only point of intersection of  $\text{supp}(a^{(1)})$  with  $\alpha_x^{(2)}$ . Since the point  $x$  lies in the relative interior of a face  $F_x$ , the framings  $v_{\alpha_x^{(1)}}$  can be written as  $v_{\alpha_x^{(1)}} = \mu_{\alpha_x^{(1)}} \cdot \tilde{v}_{\alpha_x^{(1)}}$ , where  $\mu_{\alpha_x^{(1)}} \in \mathbb{Z}_2$  and  $\tilde{v}_{\alpha_x^{(1)}}$  is a primitive vector of  $W_{\mathbb{Z}}'(F_x) = \mathcal{F}_1^{\mathbb{Z}_2}(F_x)$ , so that the lift of the

framing  $v_{\alpha_x^{(1)}}$  is equal to  $L_1^{F_x}(v_{\alpha_x^{(1)}}) = \mu_{\alpha_x^{(1)}} \left[ \{*\} \times \left( \mathbb{R}\tilde{v}_{\alpha_x^{(1)}}/2\pi\mathbb{Z}\tilde{v}_{\alpha_x^{(1)}} \right) \right] \in H_1(S_{F_x}; \mathbb{Z}_2)$ . Similarly, the lift of the framing  $v_{\alpha_x^{(2)}}$  is equal to  $L_1^{F_x}(v_{\alpha_x^{(2)}}) = \mu_{\alpha_x^{(2)}} \left[ \{*\} \times \left( \mathbb{R}\tilde{v}_{\alpha_x^{(2)}}/2\pi\mathbb{Z}\tilde{v}_{\alpha_x^{(2)}} \right) \right] \in H_1(S_{F_x}; \mathbb{Z}_2)$ , where  $\mu_{\alpha_x^{(2)}} \in G$  and the vector  $\tilde{v}_{\alpha_x^{(2)}} \in W'_{\mathbb{Z}}(F_x)$  is primitive. Since the vector space  $W'(F_x)$  is of dimension 2, there exists a vector  $w_{\alpha_x^{(1)}}$  in  $W'(F_x) \setminus \left( \mathbb{R}\tilde{v}_{\alpha_x^{(1)}} \right)$  and such that this vector  $w_{\alpha_x^{(1)}}$  is not an integer multiple of  $2\pi\tilde{w}$  for  $w \in W'_{\mathbb{Z}}(F_x)$ . We then denote by  $\nu_{\alpha_x^{(1)}} = \mathbb{R}\tilde{v}_{\alpha_x^{(1)}}/2\pi\mathbb{Z}\tilde{v}_{\alpha_x^{(1)}}$  and by  $\nu_{\alpha_x^{(2)}} = w_{\alpha_x^{(1)}} + \left( \mathbb{R}\tilde{v}_{\alpha_x^{(2)}}/2\pi\mathbb{Z}\tilde{v}_{\alpha_x^{(2)}} \right)$  the cycles in  $T^{F_x}$  used to lift  $\alpha_x^{(1)}$  and  $\alpha_x^{(2)}$  as in Construction 4.1. Thus, we have a lift  $l_{\alpha_x^{(1)}x} := \mu_{\alpha_x^{(1)}}\alpha_x^{(1)}([0,1]) \times \nu_{\alpha_x^{(1)}}$  of the framed simplex  $\alpha_x^{(1)} \otimes v_{\alpha_x^{(1)}}$  and a lift  $l_{\alpha_x^{(2)}x} := \mu_{\alpha_x^{(2)}}\alpha_x^{(2)}([0,1]) \times \nu_{\alpha_x^{(2)}}$  of the framed simplex  $\alpha_x^{(2)} \otimes v_{\alpha_x^{(2)}}$ . Since we added the vector  $w_{\alpha_x^{(1)}}$  to the cycle  $\mathbb{R}\tilde{v}_{\alpha_x^{(2)}}/2\pi\mathbb{Z}\tilde{v}_{\alpha_x^{(2)}}$ , the singular 2-chains  $l_{\alpha_x^{(1)}}$  and  $l_{\alpha_x^{(2)}}$  intersect if and only if the framings  $v_{\alpha_x^{(1)}}$  and  $v_{\alpha_x^{(2)}}$  are non-colinear vectors. Moreover, if these vectors are non-colinear, then the chains  $l_{\alpha_x^{(1)}}$  and  $l_{\alpha_x^{(2)}}$  intersect transversally at a single point  $(x, \theta) \in S_{F_x}$  and their intersection product at  $x$  is equal to  $\mu_{\alpha_x^{(1)}} \cdot \mu_{\alpha_x^{(2)}} \cdot \left( \alpha_x^{(1)} \circ \alpha_x^{(2)} \right)_x \det \left( \tilde{v}_{\alpha_x^{(1)}}, \tilde{v}_{\alpha_x^{(2)}} \right)$ , where  $\left( \alpha_x^{(1)} \circ \alpha_x^{(2)} \right)_x$  is the intersection number of the singular simplices  $\alpha_x^{(1)}$  and  $\alpha_x^{(2)}$  at  $x$  (see Definition 2.23). We recognize the tropical intersection number at  $x$  of the framed simplices  $\alpha_x^{(1)} \otimes v_{\alpha_x^{(1)}}$  and  $\alpha_x^{(2)} \otimes v_{\alpha_x^{(2)}}$  with coefficients in  $\mathbb{Z}_2$ . By summing over all points  $x \in \text{supp}(a^{(1)}) \cap \text{supp}(a^{(2)})$ , using the facts that the image of the singular simplex  $\alpha_x^{(1)}$  intersects  $\text{supp}(a^{(2)})$  only at  $x$  and that the image of  $\alpha_x^{(2)}$  intersects  $\text{supp}(a^{(1)})$  only at  $x$ , one obtains the equality of the intersection numbers

$$\left( \sum_{x \in \text{supp}(a^{(1)}) \cap \text{supp}(a^{(2)})} l_{\alpha_x^{(1)}} \right) \circ \left( \sum_{x \in \text{supp}(a^{(1)}) \cap \text{supp}(a^{(2)})} l_{\alpha_x^{(2)}} \right) = a^{(1)} \circ a^{(2)}.$$

One can then add all the remaining lifts  $l_{\alpha}^{(1)}$  to the 2-chain  $\left( \sum_{x \in \text{supp}(a^{(1)}) \cap \text{supp}(a^{(2)})} l_{\alpha_x^{(1)}} \right)$  without changing the intersection product with  $\left( \sum_{x \in \text{supp}(a^{(1)}) \cap \text{supp}(a^{(2)})} l_{\alpha_x^{(2)}} \right)$ , because the remaining singular simplices  $\alpha^{(1)}$  do not intersect the support  $\text{supp}(a^{(2)})$  of  $a^{(1)}$ . For the same reason, one can also add the 2-chains  $\beta_y^{(1)}$  (i.e the 2-chains  $\beta_y$  of Construction 4.1 associated with the  $(1, 1)$ -cycle  $a^{(1)}$ ) to the 2-chain  $\sum_{\alpha^{(1)}} l_{\alpha^{(1)}}$  without modifying the intersection product with the 2-chain  $\left( \sum_{x \in \text{supp}(a^{(1)}) \cap \text{supp}(a^{(2)})} l_{\alpha_x^{(2)}} \right)$ . For the same reason, one can also add the remaining lifts  $l_{\alpha}^{(2)}$  as well as the 2-chains  $\beta_y^{(2)}$  to the 2-chain  $\sum_{x \in \text{supp}(a^{(1)}) \cap \text{supp}(a^{(2)})} l_{\alpha_x^{(2)}}$  without modifying the intersection product. In conclusion, we have constructed two representatives of the homology classes  $\tilde{L}_{1,1}(a^{(1)})$  and  $\tilde{L}_{1,1}(a^{(2)})$  which have an intersection number equal to  $a^{(1)} \circ a^{(2)}$  points, which implies the result by passing to the homology classes.  $\square$

*Remark 4.1.* As for Lemma 4.2, we are only concerned with the intersection form on  $H_2(S_X; \mathbb{Z}_2)$  but not on  $H_2(S_X; G)$  for  $G \neq \mathbb{Z}_2$ . If we had fixed an orientation on  $S_X$ , the above result should hold up to the sign with  $G = \mathbb{Z}$ , and the same proof should work, although it would require some care to obtain the right sign.

### 4.1.3 Lifting (0-2)-cycles

The aim of this section is to define the lifting morphism

$$L_{0,2} : H_{0,2}(X; G) \rightarrow H_2(S_X; G) / H_{1,1}(S_X; G).$$

Let  $\Sigma$  be an orientable topological surface embedded (topologically) inside  $X$ . The surface  $\Sigma$  then defines a tropical singular (0,2)-cycle in  $X$ . Let us notice that  $\Sigma$  induces a sub-complex of the (polyhedral) combinatorial stratification  $\mathcal{C}$ . Therefore, as explained at the end of Definition 2.21, one can consider the cellular tropical cohomology group  $H_{cell}^1(\Sigma; \mathcal{F})$  of  $\Sigma$ , for any cellular sheaf  $\mathcal{F}$  on  $X$ . In particular, we use it for the sheaves  $W_{\mathbb{Z}_2}$  and  $W_{\mathbb{Z}}$ . Let us also notice that every edge of  $\Sigma$  is adjacent to two faces in  $\Sigma$ , so it cannot be of sedentarity 1, and thus it is of sedentarity 0. The vertices of  $\Sigma$  are then adjacent to three edges of sedentarity 0 and thus they are also of sedentarity 0. In particular, the faces of  $\Sigma$  are all bounded.

In order to lift this tropical singular (0,2)-cycle we want to find a lift  $s_\Sigma$  of  $\Sigma$  in  $S_X$ , in the sense that  $s_\Sigma$  is a 2-cycle in  $S_X$  and  $\lambda_*(s_\Sigma) = \Sigma$ . As explained at the beginning of this chapter, we assume that the phase tropical surface  $(S_X, X)$  admits a real structure  $c$ . The method we want to use is similar to the one at the end of Section 3.2.2, where we lift topological circles in the hypersmooth tropical curve  $\Gamma$  as a component of the fixed locus of a new real structure obtained from  $c$  by twisting along some appropriate edges. Recall Definition 3.18 about edges of sedentarity 0 twisted along a pair of faces. The following definition is the counterpart of Definition 3.15, in the case of phase tropical surfaces with a real structure.

*Definition 4.3.* Let  $e$  be an edge of  $\Sigma$ . The edge  $e$  is said to be *twisted along  $\Sigma$*  if  $e$  is twisted along  $FG$ , where  $F$  and  $G$  are the faces of  $\Sigma$  adjacent to  $e$ . Otherwise, we say that the edge  $e$  is *untwisted along  $\Sigma$* . The set of edges of  $\Sigma$  twisted along  $\Sigma$  for the real structure  $c$  is denoted by  $\mathcal{T}_c(\Sigma)$ .

The next lemma is the counterpart of Lemma 3.10 in the case of phase tropical surfaces and the proof works in a similar way.

**Lemma 4.6.** *The topological surface  $\Sigma$  lifts to  $S_X$  as a fixed component of  $c$  if and only if all the edges of  $\Sigma$  are untwisted along  $\Sigma$ .*

*Proof.* For any vertex  $v$  of  $\Sigma$ , adjacent to the three edges  $e, f$  and  $g$  of  $\Sigma$ , a fixed component  $s_\Sigma$  lifting  $\Sigma$  has to intersect the fiber  $S_v$  exactly at the leaf in  $\mathbb{R}S_v$  with three margins, each of them lying in one of the intersection  $S_v^e, S_v^f$  or  $S_v^g$ . Let us denote by  $l_v$  this leaf in the fiber  $S_v$ . Now, if the topological surface  $\Sigma$  lifts as a component fixed by  $c$ , then the fixed locus of  $c$  in the fiber  $S_e$ , of an edge  $e$  connecting two vertices  $u$  and  $v$ , has to connect the leaves  $l_u$  and  $l_v$ . Since both  $l_u$  and  $l_v$  have three margins, it means that the edge  $e$  is untwisted along  $\Sigma$ . Therefore it is a necessary condition that the edges of  $\Sigma$  are untwisted along  $\Sigma$ . This condition is in fact sufficient. If we assume that all edges are indeed untwisted along  $\Sigma$ , then by the previous discussion, one obtains a fixed component  $\tilde{s}$  in the inverse image  $\lambda^{-1}\left(\Sigma \setminus \left(\bigsqcup_{F \in \mathcal{C}_2(\Sigma)} \overset{\circ}{F}\right)\right)$ ,

which is sent to  $\Sigma \setminus \left(\bigsqcup_{F \in \mathcal{C}_2(\Sigma)} \overset{\circ}{F}\right)$ . Yet for any face  $F$  of  $\Sigma$ , the intersection of  $\tilde{s}$  with the fiber  $S_F$  is a cycle  $s_F$ , fixed by  $c$  in  $S_F$ . Since the fixed locus of the real structure  $c$  in the fiber  $S_F$  is homeomorphic to 4 disjoint disks, one of the fixed components has as boundary the cycle  $s_F$  and we denote this fixed component by  $d_F$ . By taking the sum of  $\tilde{s}$  with  $\sum_{F \in \mathcal{C}_2(\Sigma)} d_F$ , we obtain a



2-cycle lifting  $\Sigma$ . By fixing an orientation of  $\Sigma$  and orienting each of the disks  $d_F$  accordingly to the orientation of the face  $F$ , obtained by restricting the orientation of  $\Sigma$ , we obtain an oriented 2-cycle  $s_\Sigma$  in  $\Sigma$  such that  $\lambda_* s_\Sigma = \Sigma$ , taking into account the orientations of the 2-chains  $s_\Sigma$  and  $\Sigma$ .  $\square$

*Definition 4.4.* We define the *twist wave along  $\Sigma$*  of the real structure  $c$  as the cellular tropical 1-co-chain  $w_\Sigma(c) \in C_{cell}^1(\Sigma; W_{\mathbb{Z}_2})$  such that

$$w_\Sigma(c) : e \mapsto \begin{cases} \vec{e} \in W_{\mathbb{Z}_2}(e), & \text{if } e \text{ is twisted along } \Sigma; \\ 0 \in W_{\mathbb{Z}_2}(e), & \text{if } e \text{ is untwisted along } \Sigma. \end{cases}$$

*Remark 4.2.* Let us insist on the fact that the twist wave along  $\Sigma$  is defined only on the edges of  $\Sigma$ , so it does not define a co-chain on  $X$ . Moreover, this point of view might seem confusing because we are talking about a co-chain defined only on edges of  $\Sigma$ , while the wave-space sheaf  $W_{\mathbb{Z}_2}$  is defined on the whole of  $X$ . In this text, we consider only hypersmooth tropical surfaces, but one could also consider tropical surfaces which also happen to be topological surface. In particular, the topological surface  $\Sigma$  could be endowed with an atlas of tropical manifold of dimension 2. We should be careful to the fact that the restriction of the wave space sheaf on  $X$  to the cells of  $\Sigma$  does not coincide at all with the wave space sheaf that could be defined by endowing the topological surface  $\Sigma$  with an atlas of topological manifold, especially at the edges and at the vertices of  $\Sigma$ .

**Lemma 4.7.** *The twist wave  $w_\Sigma(c)$  of the real structure  $c$  along  $\Sigma$  is a co-cycle in  $Z_{cell}^1(\Sigma; W_{\mathbb{Z}_2})$ , that is,*

$$dw_\Sigma(c) = 0.$$

*Proof.* Let  $F$  be a face of  $\Sigma$ . As mentioned at the beginning of this section, the face  $F$  is bounded. Moreover the band  $R(F)$  of  $F$  is orientable, because the union of all the faces adjacent to  $\Sigma$  is a cylinder, and thus must be one of the two orientable halves of the orientable band of  $F$ . Hence, one can apply Proposition 3.11, so that we obtain the co-cycle condition  $dw_\Sigma(c) \cdot F = 0$ .  $\square$

We now have a co-cycle  $w_\Sigma(c)$  defining a cohomology class in  $H_{cell}^1(\Sigma; W_{\mathbb{Z}_2})$ . We would like to be able to extend this co-cycle to a co-cycle in  $Z_{cell}^1(X; W_{\mathbb{Z}_2})$ , because then we would be able to find an inverse image  $w$  in the cohomology group  $H_{cell}^1(X; W_{\mathbb{Z}})$  by the reduction modulo 2 map (assuming that there is no 2-torsion in the cohomology group  $H_{cell}^1(X; W_{\mathbb{Z}})$ ). The point would be to use Theorem 3.3 to obtain a real structure  $c'$  such that  $w(c', c) = w$ , so that the topological surface  $\Sigma$  has only untwisted edges along  $\Sigma$  for the real structure  $c'$ . Then we could take the fixed component of  $c'$  lifting  $\Sigma$  to define the image of our  $(0, 2)$ -lifting morphism  $L_{0,2}(\Sigma)$ . The author was not able to extend any twist wave to a co-cycle in  $Z_{cell}^1(X; W_{\mathbb{Z}})$ . However, we can still use our results from Section 3.4, in order to lift the orientable topological surface  $\Sigma$  as a fixed component of an involution that is locally a real structure, but does not necessarily extend to a real structure on the phase tropical surface  $(S_X, X)$ . Let us define  $S_\Sigma = \lambda^{-1}(\Sigma) \subset S_X$ . Note that we cannot consider  $(S_\Sigma, \Sigma)$  as a phase tropical surface because  $\Sigma$  is not a hypersmooth tropical surface. We say that  $c'_\Sigma$  is a real structure of  $(S_\Sigma, \Sigma)$  if it satisfies the axioms of Definition 3.11 of a real structure, in restriction to  $S_\Sigma$ . In particular, the restriction of  $c$  to  $S_\Sigma$ , denoted by  $c_\Sigma$ , is a real structure of  $(S_\Sigma, \Sigma)$ . If  $c'_\Sigma$  is a real structure of  $(S_\Sigma, \Sigma)$ , one can define the twist wave from  $c_\Sigma$  to  $c'_\Sigma$  along  $\Sigma$  as a co-chain  $w_\Sigma(c'_\Sigma, c_\Sigma) \in C_{cell}^1(\Sigma; W_{\mathbb{Z}})$ , with the same definition for  $w_\Sigma(c'_\Sigma, c_\Sigma) \cdot e$  as Definition 3.21. Proposition 4.2 allows us to lift the orientable topological surface  $\Sigma$ , in the case where  $\Sigma$  can be embedded in a tropical toric variety, of any dimension.

*Definition 4.5.* Let  $A \subset X$ , where  $X$  is a tropical manifold. A *tropical embedding* of  $A$  inside a tropical toric variety  $Y$  is a map  $j : A \rightarrow Y$  such that  $j$  is integer affine (that is to say an integer affine map in any chart) and is a homoeomorphism onto its image.

**Proposition 4.2.** *If there exists a tropical embedding  $\Sigma \xrightarrow{j} \mathbb{R}^N$ , for  $N \geq 3$ , then there exists a real structure  $c'_\Sigma$  of  $(S_\Sigma, \Sigma)$  such that  $\Sigma$  lifts as a fixed component of  $c'_\Sigma$  in  $S_\Sigma$ .*

In order to prove this proposition, we first need Lemma 4.8 below.

**Lemma 4.8.** *Assume that there exists a tropical embedding  $\Sigma \xrightarrow{j} \mathbb{R}^N$ , for  $N \geq 3$ . Then the group  $H_{\text{cell}}^2(\Sigma; W_{\mathbb{Z}})$  is isomorphic to  $\mathbb{Z}^3$  as an abelian group. As a consequence, the group  $H_{\text{cell}}^2(\Sigma; W_{\mathbb{Z}})$  is torsion-free.*

*Proof.* Choose an arbitrary orientation of  $\Sigma$ . For any face  $F \in \mathcal{C}_2(\Sigma)$ , we orient  $F$  according to the orientation induced by  $\Sigma$ . Since  $j(\Sigma) \subset \mathbb{R}^N$ , for any face  $F \in \mathcal{C}_2(\Sigma)$ , the integer lattice  $T_{\mathbb{Z}}F$  is naturally a sublattice of  $\mathbb{Z}^N$  (all points are of empty sedentarity) and therefore we have an inclusion of the wave space  $W_{\mathbb{Z}}(F) \subset \mathbb{Z}^N$ . Let  $f : C_{\text{cell}}^2(\Sigma; W_{\mathbb{Z}}) \rightarrow \mathbb{Z}^N$  be a morphism of abelian groups defined by

$$f \left( \sum_{F \in \mathcal{C}_2(\Sigma)} F \otimes v_F \right) = \sum_F j_*(v_F).$$

The key remark is that  $f$  descends to cohomology, yielding an injective morphism  $H_{\text{cell}}^2(\Sigma; W_{\mathbb{Z}}) \rightarrow \mathbb{Z}^N$ . Since  $\mathbb{Z}^N$  is free, it implies that  $H_{\text{cell}}^2(\Sigma; W_{\mathbb{Z}})$  has no torsion. So all that remains is to check, that any 2-co-chain in the image of the tropical co-boundary operator is in the kernel of  $f$ , and then that the induced morphism is injective. Let  $e$  be an oriented cell of  $\Sigma$  and let  $v \in W_{\mathbb{Z}}(e)$ . The edge  $e$  is adjacent to two faces  $F$  and  $G$  of  $\Sigma$ . Only one of them is endowed with an orientation that induces the orientation of  $e$ . Therefore, we have  $d(e \otimes v) = \pm(F \otimes v - G \otimes v)$ , and we deduce  $f(d(e \otimes v)) = 0 \in \mathbb{Z}^N$ . Thus,  $f$  descends to co-homology and we still denote by  $f$  the induced morphism  $f : H_{\text{cell}}^2(\Sigma; W_{\mathbb{Z}}) \rightarrow \mathbb{Z}^N$ . Now, let us prove that  $f$  is injective. Fix a vertex  $v$  of  $\Sigma$ . There are three edges adjacent to  $v$  in  $\Sigma$  and we denote them by  $e_1, e_2$  and  $e_3$ , where the indices are in  $\mathbb{Z}_3$ . The edges  $e_i$  are oriented outwards  $v$  for  $i \in \mathbb{Z}_3$ . For any  $i \in \mathbb{Z}_3$ , we denote by  $F_i$  the face of  $\Sigma$  spanned by  $e_i$  and  $e_{i+1}$ , oriented such that the boundary orientation on  $e_{i+1}$  coincides with the previously chosen orientation of  $e_{i+1}$  (recall that the orientation of  $F_i$  was fixed at the beginning of the proof). For every  $i \in \mathbb{Z}_3$  denote by  $w_i = F_i \otimes v_{i+1}$ , where  $v_{i+1}$  is the primitive vector in  $W_{\mathbb{Z}}(e_{i+1})$  oriented according to the orientation of the edge  $e_{i+1}$ . The cohomology classes of the cocycles  $w_1, w_2$  and  $w_3$  form a generating family of the group  $H_{\text{cell}}^2(\Sigma; W_{\mathbb{Z}})$ . Indeed, for any  $i \in \mathbb{Z}_3$ , if  $w = F_i \otimes v$ , where  $v \in W_{\mathbb{Z}}(F_i)$ , by decomposing the vector  $v$  as  $v = k_i e_i + k_{i+1} e_{i+1}$ , where  $k_i$  and  $k_{i+1}$  are integers, one can express the cohomology class of  $w$  as an integer linear combination of the cohomology classes of  $w_{i-1}$  and  $w_i$ . By induction, one can then show that any cohomology class of a cocycle of the form  $w = F \otimes v$  is an integer linear combination of the cohomology classes of  $w_1, w_2$  and  $w_3$ . Yet, for any  $i \in \mathbb{Z}_3$  one has  $f(w_i) = j_* v_{i+1}$  and since  $j$  is an injective affine integer map, the family of vectors  $(j_* v_1, j_* v_2, j_* v_3)$  is free, so that  $f : H_{\text{cell}}^2(\Sigma; W_{\mathbb{Z}}) \rightarrow \mathbb{Z}^N$  is injective.  $\square$

*Remark 4.3.* In the hypothesis of the previous statement,  $N$  is required to be at least 3 only because otherwise there cannot be such an embedding of  $\Sigma$  into  $\mathbb{R}^N$ . We ask that the embedding be in  $\mathbb{R}^N$ , but since a tropical embedding preserves the order of sedentarity,  $\Sigma$  is actually a subset

of  $X^\circ$ . Thus, any embedding of  $\Sigma$  in a tropical variety  $Y$  of dimension  $N$  yields an embedding in  $Y^\theta = \mathbb{R}^N$ .

*Proof of Proposition 4.2.* By Lemma 4.8, the cohomology group  $H_{cell}^2(\Sigma; W_{\mathbb{Z}})$  has no torsion. Thus, the reduction modulo 2 morphism  $H_{cell}^1(\Sigma; W_{\mathbb{Z}}) \rightarrow H_{cell}^1(\Sigma; W_{\mathbb{Z}_2})$  is surjective, and so there exists a cohomology class  $[w] \in H_{cell}^1(\Sigma; W_{\mathbb{Z}})$  such that  $[w] = [w_\Sigma(c)] \pmod{2}$ . Yet, by restricting the statement of Proposition 3.14 to  $S_\Sigma$ , one can find a real structure  $c'_\Sigma$  of  $(S_\Sigma, \Sigma)$ , obtained by Dehn twist from  $c_\Sigma$  such that the twist wave  $w_\Sigma(c', c)$  along  $\Sigma$  has for cohomology class  $[w_\Sigma(c', c)] = [w]$ , so that the reduction modulo 2 of  $[w_\Sigma(c', c)]$  is also equal to  $[w_\Sigma(c)]$ . Recalling that all edges of  $\Sigma$  are of sedentarity 0, one can apply Lemma 3.23 in order to obtain that all edges of  $\Sigma$  are untwisted, or equivalently that the twist wave  $w_\Sigma(c')$  of  $c'$  along  $\Sigma$  is zero. By Lemma 4.6, the orientable topological surface  $\Sigma$  lifts a fixed component of  $c'_\Sigma$  in  $S_\Sigma$ .  $\square$

Let us assume that for every topological surface  $\Sigma' \subset X$ , the surface  $\Sigma'$  is orientable and the cohomology group  $H^2(\Sigma'; W_{\mathbb{Z}})$  has no 2-torsion. In particular, if  $X$  is a tropical subvariety of a tropical toric variety of dimension 3, then this assumption is satisfied by Lemma 4.8 and because a topological surface embedded in  $\mathbb{R}^3$  is orientable. In particular, there is no torsion in  $H_1(X; \mathbb{Z})$  and thus one has  $H_2(X; G) \cong G^{b_2(X)}$ , where  $b_2(X) = \text{rank}(H_2(X; \mathbb{Z}_2))$ . We are now ready to define the lifting morphism for  $(0, 2)$ -cycles in  $X$ . To that end, we fix  $b_2(X) = \dim_{\mathbb{Z}_2}(H_2(X; \mathbb{Z}_2))$  orientable topological surfaces in  $X$ , denoted by  $\Sigma_1, \dots, \Sigma_{b_2(X)}$ , such that their homology classes form a base of the homology group  $H_2(X; G) \cong H_{0,2}(X; G)$ .

*Definition 4.6.* Let  $G$  be an abelian group. With the above assumption, any homology class in  $H_2(X; G)$  is of the form  $\sum_j \mu_j [\Sigma_j]$ , where  $\mu_1, \dots, \mu_{b_2(X)}$  are in  $G$ . We define the  $(0, 2)$ -lifting morphism  $L_{0,2} : H_2(X; G) \rightarrow H_2(S_X; G) / H_{1,1}(S_X; G)$  by

$$L_{0,2} \left( \sum_{1 \leq j \leq b_2(X)} \mu_j [\Sigma_j] \right) = \sum_{1 \leq j \leq b_2(X)} \mu_j [\Sigma_j] \pmod{H_{1,1}(S_X; G)},$$

where  $s_{\Sigma_j}$  is the lift of  $\Sigma_j$  obtained by Proposition 4.2 for all  $j$  in  $\{1, \dots, b_2(X)\}$ . The elements of  $H_2(S_X; G)$  which are projected onto the image  $\text{Im}(L_{0,2})$  of the lifting morphism  $L_{0,2}$ , by the projection  $H_2(S_X; G) \rightarrow H_2(S_X; G) / H_{1,1}(S_X; G)$ , form a sub-group denoted by  $H_{0,2}(S_X; G) \subset H_2(S_X; G)$ .

For now, note that the  $(0, 2)$ -lifting morphism evaluated on  $\mu \cdot \Sigma$  depends on the choice of the real structure  $c'_\Sigma$ , obtained by Dehn twist from  $c_\Sigma$ , used in order to lift the orientable topological surface  $\Sigma$ . In fact, this real structure depends first on the co-cycle  $w$  we choose in the proof of Proposition 4.2, which is well defined up to an even co-cycle in  $Z_{cell}^1(\Sigma; W_{\mathbb{Z}})$ , but also depends on the choice, for each face  $F$  of  $\Sigma$ , of the edge  $e_F$  at which the  $w$ -twist on  $S_F$  starts. The lifting morphism  $L_{0,2}$  also depends on the choices of the orientation of the faces  $F$  of  $\Sigma$ , but it seems quite natural to orient the faces for the orientation induced by the orientation of  $\Sigma$ . In the rest of this section, we assume that for any orientable topological surface in  $X$ , the co-cycles  $w$  and the edges  $e_F$  are fixed. More importantly, this lifting morphism depends on the choice of a basis  $[\Sigma_1], \dots, [\Sigma_{b_2(X)}]$  of  $H_2(X; G)$ . We show in Section 4.2 that the lift  $L_{0,2}(\mu \Sigma)$  does not depend on these choices, but only in the case where  $G = \mathbb{Z}_2$ .

*Remark 4.4.* Notice that in the case where  $G = \mathbb{Z}_2$ , although there is no need for an orientation on the topological surface  $\Sigma$  in order to make it a  $(0, 2)$ -cycle with coefficients in  $\mathbb{Z}_2$ , we still need to require that the topological surface  $\Sigma$  be orientable, in order to be able to lift it.

As in Sections 4.1.1 and 4.1.2, we end this section with a comparison between the tropical intersection product and the intersection product in  $S_X$ .

**Proposition 4.3.** *Let  $a$  and  $b$  be tropical singular respectively  $(2, 0)$ - and  $(0, 2)$ -cycles with  $\mathbb{Z}_2$ -coefficients, forming a transversal pair. The tropical intersection product of  $a$  and  $b$  is equal to the intersection product between the lift  $L_{2,0}(a)$  and  $\tilde{L}_{0,2}(b)$  in  $H_2(S_X, \mathbb{Z}_2)$ , where  $\tilde{L}_{0,2}(b)$  is any representative of the lift  $L_{0,2}(b)$ , that is to say*

$$L_{2,0}(a) \circ \tilde{L}_{0,2}(b) = a \circ b.$$

*Proof.* It is enough to prove the result for  $a = x \otimes v$  (where  $x$  lies in the relative interior of a face  $F$ , because  $a$  intersects transversally the combinatorial stratification and  $v \in \mathcal{F}_2^{\mathbb{Z}_2}(F)$ ) and for  $b = \mu \cdot \Sigma_j$ , where  $\mu = 1 \in \mathbb{Z}_2$  and  $j \in \{1, \dots, b_2(X)\}$  (see Definition 4.6). By Lemma 4.5, the result of the intersection product  $L_{2,0}(a) \circ \tilde{L}_{0,2}(b)$  does not depend on the representative  $\tilde{L}_{0,2}(b)$  of the lift  $L_{0,2}(b)$ , so let us take  $\tilde{L}_{0,2}(b) = \mu [s_{\Sigma_j}] \in H_2(S_X; \mathbb{Z}_2)$ , where  $s_{\Sigma_j}$  is a fixed component of a real structure  $c'_{\Sigma_j}$  of  $(S_{\Sigma_j}, \Sigma_j)$ , obtained by Dehn twist from  $c_{\Sigma_j}$  (see Proposition 4.2). In the fiber  $\lambda^{-1}(x)$  there are four fixed points by  $c'_{\Sigma_j}$  and only one of them lies in the lift  $s_{\Sigma_j}$  (it is the point corresponding to the disk  $d_F$  in the proof of Lemma 4.6). Therefore, the intersection product  $L_{2,0}(a) \circ \tilde{L}_{0,2}(b)$  is equal to  $1 = \mu = a \circ b$ .  $\square$

## 4.2 Obtaining a Filtration

In this section,  $(S_X, X)$  is a phase tropical surface, endowed with a real structure  $c$  and such that for any topological surface  $\Sigma$  in  $X$ , the cohomology group  $H^2(\Sigma; W_{\mathbb{Z}}^1)$  has no 2-torsion and the surface  $\Sigma$  is orientable. The goal of this section is to show that we have a filtration

$$0 \subset H_{2,0}(S_X; \mathbb{Z}_2) \subset H_{1,1}(S_X; \mathbb{Z}_2) \subset H_{0,2}(S_X; \mathbb{Z}_2) = H_2(S_X; \mathbb{Z}_2). \quad (4.2)$$

*Remark 4.5.* This filtration is a generalization of the filtration obtained in [7] (see Section 3.2.1). In a different context, namely torus fibrations over integral affine manifolds, the lifting of tropical cycles also leads to a very similar filtration (see for example [35]).

Note that in this section we only work with  $\mathbb{Z}_2$ -coefficients. Also note that for now, the sub-group  $H_{0,2}(S_X; \mathbb{Z}_2) \subset H_2(S_X; \mathbb{Z}_2)$  depends on some choices we have to make in the proof of Proposition 4.2 and on the choice of a basis  $[\Sigma_1], \dots, [\Sigma_{b_2(X)}]$  of  $H_2(X; \mathbb{Z}_2)$ .

**Proposition 4.4.** *The  $(p, q)$ -lifting morphisms  $L_{p,q}$  (with coefficients in  $\mathbb{Z}_2$ ) are injective for all non-negative integers  $p$  and  $q$  such that  $p + q = 2$ .*

*Proof.* Let us begin with  $p = 2$  and  $q = 0$ . Let  $[a] \in H_{2,0}(X; \mathbb{Z}_2)$  such that  $L_{2,0}([a]) = 0$ . In particular, it implies that the intersection product of  $L_{2,0}([a])$  with any element  $\tilde{L}_{0,2}(b)$ , representing a lift  $L_{0,2}(b)$  of a tropical singular  $(0, 2)$ -cycle  $b$ , is zero. By Proposition 4.3, it implies that the tropical intersection product of  $[a]$  with any element of  $H_{0,2}(X; \mathbb{Z}_2)$  is also 0. By the non-degeneracy of the tropical intersection form with  $\mathbb{Z}_2$  coefficients (see Theorem 2.3), we obtain  $[a] = 0$ , so the  $(2, 0)$ -lifting morphism is injective. With very similar arguments, the injectivity of the  $(0, 2)$ -lifting morphism  $L_{0,2}$  is also as consequence of Proposition 4.3 and Theorem 2.3, while the injectivity of the  $(1, 1)$ -lifting morphism is a consequence of Proposition 4.1 and Theorem 2.3.  $\square$

**Proposition 4.5.** *The  $(0, 2)$ -lifting morphism is surjective onto  $H_2(S_X; \mathbb{Z}_2) / H_{1,1}(S_X; \mathbb{Z}_2)$ , that is,  $H_{0,2}(S_X; \mathbb{Z}_2) = H_2(S_X; \mathbb{Z}_2)$ .*

*Proof.* By Proposition 4.4 above, one has  $\dim H_{p,q}(X; \mathbb{Z}_2) = \dim(\text{Im } L_{p,q})$ , for all non-negative integers  $p$  and  $q$  such that  $p + q = 2$ . Thus by summing over  $p + q = 2$  one obtains

$$\sum_{p+q=2} \dim H_{p,q}(X; \mathbb{Z}_2) = \dim H_{0,2}(S_X; \mathbb{Z}_2).$$

Yet, by Proposition 3.3 one has

$$\sum_{p+q=2} \dim H_{p,q}(X; \mathbb{Z}_2) \geq \dim H_2(S_X; \mathbb{Z}_2).$$

Therefore, the dimension of the  $\mathbb{Z}_2$  vector sub-space  $H_{0,2}(S_X; \mathbb{Z}_2) \subset H_2(S_X; \mathbb{Z}_2)$  is equal to the dimension of the ambient vector space  $H_2(S_X; \mathbb{Z}_2)$ , hence the equality  $H_{0,2}(S_X; \mathbb{Z}_2) = H_2(S_X; \mathbb{Z}_2)$ .  $\square$

**Corollary 4.1.** *The lifting morphism  $L_{0,2}$  does not depend on the choice of the real structure  $c'_\Sigma$  of  $(S_\Sigma, \Sigma)$  made in the proof of Proposition 4.2 nor on the choice of the basis  $[\Sigma_1], \dots, [\Sigma_{b_2(X)}]$  of  $H_2(X; \mathbb{Z}_2)$ .*

*Proof.* Since  $L_{0,2}$  is surjective, an element in  $H_2(S_X; \mathbb{Z}_2) / H_{1,1}(S_X; \mathbb{Z}_2) = \text{Im } L_{0,2}$  is uniquely determined by its intersection products with the elements of  $H_{2,0}(S_X; \mathbb{Z}_2)$ , by the non-degeneracy of the tropical intersection form. Yet, these intersection products depend only on the homology class of the  $(0, 2)$ -tropical cycle  $\Sigma$ , hence the statement of the corollary.  $\square$

## 5 Type and Maximality of a Real Structure of a Phase Tropical Surface

In this chapter,  $(S_X, X)$  is a phase tropical surface, endowed with a real structure  $c$  and such that for any topological surface in  $X$ , the cohomology group  $H^2(\Sigma; W_{\mathbb{Z}})$  has no 2-torsion and the surface  $\Sigma$  is orientable. In particular, we may apply the result of the previous chapter about the lifting of tropical  $(0, 2)$ -cycles and we have the filtration (4.2) of the second  $\mathbb{Z}_2$ -homology group  $H_2(S_X; \mathbb{Z}_2)$ .

### 5.1 Action of the Conjugation on the filtered Homology

In this section we compute the action of the conjugation on the sub-groups  $H_{p,q}(S_X; \mathbb{Z}_2)$  of the filtration (4.2). The action on the sub-group  $H_{2,0}(S_X; \mathbb{Z}_2)$  is trivial (Proposition 5.1). We also manage to compute the action of  $1 + c_*$  on the lifts of (orientable) topological surfaces  $\Sigma \subset X$  as some tropical  $(1, 1)$ -cycle dual to the twist wave  $w_{\Sigma}(c)$  of  $c$  along  $\Sigma$  (see Proposition 5.3). The author did not manage to find an expression for the action of  $1 + c_*$  on the lift of tropical  $(1, 1)$ -cycles. However, we show that  $(1 + c_*)(H_{1,1}(S_X; \mathbb{Z}_2)) \subset H_{2,0}(S_X; \mathbb{Z}_2)$  (Proposition 5.2).

**Proposition 5.1.** *The involution acts trivially on the lifts of singular tropical  $(2, 0)$ -cycles, that is,*

$$(1 + c_*)(H_{2,0}(S_X; \mathbb{Z}_2)) = 0.$$

*Proof.* By Lemma 2.3, a tropical  $(2, 0)$ -cycle is homologous to a tropical  $(2, 0)$ -cycle whose support is contained in the relative interior of the faces of  $X$  (i.e it intersects transversally the combinatorial stratification). The lift of such a  $(2, 0)$ -cycle  $x \otimes v$ , where  $x$  is in the relative interior of a face  $F$  of  $X$ , is given by the homology class  $L_{2,0}(x \otimes v) [\lambda^{-1}(\{x\})]$  (if  $v \neq 0$ ). Yet, the real structure  $c$  acts fiber-wise on  $S_F$  and is a homeomorphism so  $c_* L_{2,0}(x \otimes v) = L_{2,0}(x \otimes v)$ .  $\square$

**Proposition 5.2.** *One has*

$$(1 + c_*)(H_{1,1}(S_X; \mathbb{Z}_2)) \subset H_{2,0}(S_X; \mathbb{Z}_2).$$

*Proof.* Let us consider  $[a] \in H_{1,1}(S_X; \mathbb{Z}_2)$ . By Lemma 2.3, we can take the tropical  $(1, 1)$ -cycle  $a$  to be intersecting transversally the combinatorial stratification of  $X$ . So one can decompose  $a$  as the sum  $a = \sum_{\alpha} \alpha \otimes v_{\alpha}$ , where for any singular 1-chain  $\alpha$ , the relative interior of the image  $\alpha([0, 1])$  is contained in the relative interior of a face  $F_{\alpha}$  of  $X$ . Recalling the notations of Construction 4.1, one can then choose  $\nu_{\alpha} := \mathbb{R}\tilde{v}_{\alpha}/2\pi\mathbb{Z}\tilde{v}_{\alpha} \subset T^{F_{\alpha}}$  for the cycle  $\nu_{\alpha}$ , where  $\tilde{v}_{\alpha}$  is a primitive integer vector in  $W'_{\mathbb{Z}}(F_{\alpha}) = W_{\mathbb{Z}}(F_{\alpha})$ , whose reduction modulo 2 coincides with  $v_{\alpha} \in W'_{\mathbb{Z}_2}(F_{\alpha})$ . The lift  $l_{\alpha} = \alpha([0, 1]) \times \nu_{\alpha}$  of the framed simplex  $\alpha \otimes v_{\alpha}$ , is then invariant by  $c_*$ . Therefore, one has

$$(1 + c_*) \left( \left( \sum_{\alpha} l_{\alpha} \right) + \sum_{y \in Y(a)} \beta_y \right) = \sum_{y \in Y(a)} (1 + c_*)(\beta_y), \quad (5.1)$$

where  $Y(a)$  and  $\beta_y$  are the notations from Construction 4.1. Since the  $\beta_y$  represent lifts of tropical  $(2, 0)$ -cycles for every  $y \in Y(a)$ , the homology class of the left hand-side term of Equation (5.1), which represents the lift  $L_{1,1}(a)$ , is in the sub-group  $H_{2,0}(S_X; \mathbb{Z}_2)$ .  $\square$

*Definition 5.1.* Let  $\Sigma \subset X$  be an orientable topological surface and  $w \in Z_{cell}^1(\Sigma; W_{\mathbb{Z}_2})$ . We define the dual (1,1)-cycle to  $w$  by

$$w^* = \sum_{F \in \mathcal{C}_2(\Sigma)} \sum_{e \in \mathcal{C}_1(F)} [x_F, x_e] \otimes (w \cdot e).$$

**Lemma 5.1.** *Let  $\Sigma \subset X$  be an orientable topological surface and  $w \in Z_{cell}^1(\Sigma; W_{\mathbb{Z}_2})$ . The dual (1,1)-cycle  $w^*$  is indeed a tropical cycle.*

*Proof.* There are two types of points where we have to check that the image  $\partial w^*$  of  $w^*$  by the tropical boundary operator  $\partial$  is zero: the middle points of the edges and the barycenters of the faces. Let  $e$  be an edge of  $\Sigma$ . There are two singular 1-chains of  $w^*$  having  $x_e$  in their boundary:  $[x_G, x_e] \otimes (w \cdot e)$  and  $[x_H, x_e] \otimes (w \cdot e)$ , where  $G$  and  $H$  are the faces of  $\Sigma$  adjacent to the edge  $e$ . The tropical (1,0)-chain  $\partial w^*$  restricts to  $w \cdot e + w \cdot e = 0$  at the point  $x_e$  (implying  $x_e$  is not in the support of  $\partial w^*$ ). Now, let  $F$  be a face of  $X$ . There are  $\text{Card}(\mathcal{C}_1(F))$  singular 1-chains of  $w^*$  having the barycenter  $x_F$  in their boundary: all the  $[x_F, x_e] \otimes (w \cdot e)$  for  $e$  an edge of  $F$ . The vanishing of the tropical (1,0)-chain  $\partial w^*$  at the point  $x_F$  is exactly given by the co-cycle condition  $dw \cdot F = 0$ .  $\square$

**Proposition 5.3.** *Let  $\Sigma \subset X$  be an orientable topological surface. Let  $\tilde{L}_{0,2}(\Sigma) \in H_2(S_X; \mathbb{Z}_2)$  be a homology class representing the lift  $L_{0,2}(\Sigma)$ . One has*

$$(1 + c_*) \tilde{L}_{0,2}(\Sigma) = L_{1,1}(w_\Sigma^*(c)) \pmod{(H_{2,0}(S_X; \mathbb{Z}_2))},$$

where  $w_\Sigma^*(c)$  is the dual cycle to  $w_\Sigma(c)$ .

*Proof.* Let us choose a real structure  $c'_\Sigma$  of  $(S_\Sigma, \Sigma)$  obtained by Dehn twists from  $c$ , such that  $\Sigma$  lifts as a fixed component  $s_\Sigma$  of  $\text{Fix}(c'_\Sigma)$ . First of all, recall that  $c$  and  $c'_\Sigma$  coincide on the fibers  $S_v$  for all vertices  $v$  of  $\Sigma$ . Therefore, the 2-chain  $(1 + c_*)s_\Sigma$  is contained in  $S_\Sigma \setminus \left( \bigcup_{v \in \mathcal{C}_0(\Sigma)} \overset{\circ}{S}_v \right)$ .

Denote by  $w \in Z_{cell}^1(\Sigma; W_{\mathbb{Z}})$  the co-cycle used to construct the  $w$ -twists in order to obtain the real structure  $c'_\Sigma$ . Let  $F$  be a face of  $\Sigma$ . Denote by  $e_F$  the edge of  $F$ , at which the chosen  $w$ -twist  $D_w$  on  $S_F$  starts. As in Definition 3.23, denote by  $e_0, \dots, e_{n-1}$  the edges of  $F$ , such that  $e_F = e_0$ . Recall the notation  $\Gamma_F^{e_i} = \text{conv}(e_i, x_F)$  introduced in Definition 3.24. In the coordinates of  $S_F$  where the local real structure  $c_F$  acts as the standard conjugation, the intersection  $(\Gamma_F^{e_i} \times T^F) \cap s_\Sigma$ , for  $i \in \mathbb{Z}_n$ , is given by

$$s_\Sigma \cap (\Gamma_F^{e_i} \times T^F) = \left\{ \left( \xi, x, \theta_F + \pi \xi \left( x(w \cdot e_i) + \sum_{0 \leq j \leq i-1} (w \cdot e_j) \right) \right) \mid \xi \in [0, 1], x \in [0, 1] \right\},$$

where  $\theta_F \in T^F$  is a fixed point by the conjugation  $\theta \mapsto -\theta$ . Now, consider the 3-chain  $\eta_F^{e_i}$  defined by

$$\eta_F^{e_i} := \left\{ \left( \xi, x, \theta_F + \pi((1-t) + t\xi) \left( x(w \cdot e_i) + \sum_{0 \leq j \leq i-1} w \cdot e_j \right) \right) \mid (\xi, x, t) \in [0, 1]^3 \right\}.$$

When adding the boundary of  $\eta_F^{e_i}$  to the 2-chain  $s_\Sigma \cap \Gamma_F^{e_i} \times T^F$ , one obtains

$$\begin{aligned} s_\Sigma \cap (\Gamma_F^{e_i} \times T^F) + \partial(\eta_F^{e_i}) = & \left\{ \left( \xi, x, \theta_F + \pi x(w \cdot e_i) + \pi \sum_{0 \leq j \leq i-1} (w \cdot e_j) \right) \mid (\xi, x_i) \in [0, 1]^2 \right\} \\ & + \left\{ \left( \xi, 0, \theta_F + \pi((1-t) + t\xi) \sum_{0 \leq j \leq i-1} w \cdot e_j \right) \mid (\xi, t) \in [0, 1]^2 \right\} \\ & + \left\{ \left( \xi, 1, \theta_F + \pi((1-t) + t\xi) \sum_{0 \leq j \leq i} w \cdot e_j \right) \mid (\xi, t) \in [0, 1]^2 \right\} \\ & + \left\{ \left( 0, x, \theta_F + \pi(1-t) \left( x(w \cdot e_i) + \sum_{0 \leq j \leq i-1} w \cdot e_j \right) \right) \mid (x, t) \in [0, 1]^2 \right\}, \end{aligned}$$

Note that on the right hand-side of the above equation, we have 4 terms of the boundary of the 3-chain  $\eta_F^{e_i}$ : the one with  $t = 0$ , followed by the ones with  $x = 0$  and with  $x = 1$ , and finally the one with  $\xi = 0$ . The boundary term with  $t = 1$  is equal to the 2-chain  $s_\Sigma \cap (\Gamma_F^{e_i} \times T^F)$  and the one with  $\xi = 1$  has a 1-dimensional image so it does not appear (more precisely it is contained in the terms with  $t = 0$  and  $t = 1$ ). We put  $\theta_F^{e_i} := \theta_F + \pi \sum_{0 \leq j \leq i-1} (w \cdot e_j)$ , which is also invariant by  $\theta \mapsto -\theta$ , because the sum  $\sum_{0 \leq j \leq i-1} (w \cdot e_j)$  is in the integer lattice  $W'_\mathbb{Z}(F)$ . We also put

$$\beta_F^{e_i} := \left\{ \left( 0, x, \theta_F + \pi(1-t) \left( x(w \cdot e_i) + \sum_{0 \leq j \leq i-1} w \cdot e_j \right) \right) \mid (x, t) \in [0, 1]^2 \right\}. \quad (5.2)$$

By summing over all  $i \in \mathbb{Z}_n$ , one gets

$$s_\Sigma \cap S_F + \partial\eta_F = \sum_{i \in \mathbb{Z}_n} \left\{ (\xi, x_i, \theta_F^{e_i} + \pi x_i(w \cdot e_i)) \mid (\xi, x_i) \in [0, 1]^2 \right\} + \beta_F,$$

where we put  $\eta_F := \sum_{i \in \mathbb{Z}_n} \eta_F^{e_i}$  and  $\beta_F := \sum_{i \in \mathbb{Z}_n} \beta_F^{e_i}$ . Now, for all  $i \in \mathbb{Z}_n$ , define the 3-chain  $\nu_F^{e_i}$  in  $\Gamma_F^{e_i} \times T^F$  by

$$\nu_F^{e_i} := \left\{ \left( \xi, tx_i + \frac{1-t}{2}, \theta_F^{e_i} + \pi x_i(w \cdot e_i) \right) \mid (\xi, x_i, t) \in [0, 1]^3 \right\}.$$

For all edges  $e$  of the topological surface  $\Sigma$ , one can write, in the coordinates of  $S_e$  where the local real structure  $c_e$  acts as the standard conjugation, the intersection of the lift  $s_\Sigma$  with the building-block  $S_e$  as

$$s_\Sigma \cap S_e = \{(x, \theta_e + \pi x(w \cdot e)) \mid x \in [0, 1]\} \times b_e,$$

where  $b_e \subset \overline{P}^1$  is one of the three fixed components by the standard conjugation of the compactified pair-of-pants  $\overline{P}^1$  and  $\theta_e \in T^e$  is a fixed element by the involution  $\theta \mapsto -\theta$ . Similarly



to the definition of the 3-chains  $\nu_F^{e_i}$ , for all edges  $e$  of  $\Sigma$ , let us consider the 3-chain  $\nu_e$  in  $S_e$  defined by

$$\nu_e := \left\{ \left( tx + \frac{1-t}{2}, \theta_e + \pi x(w \cdot e) \right) \mid (x, t) \in [0, 1]^2 \right\} \times b_e.$$

We now add the boundary  $(1 + c_*) \partial \left( \sum_{e \in \mathcal{C}_1(\Sigma)} \nu_e + \sum_{F \in \mathcal{C}_2(\Sigma)} \sum_{e \in \mathcal{C}_1(F)} \nu_F^e \right)$  to the 2-cycle  $(1 + c_*) \left( s_\Sigma + \sum_{F \in \mathcal{C}_2(\Sigma)} \partial \eta_F \right)$  (which is homologous to  $(1 + c_*) s_\Sigma$ ). The resulting 2-cycle, denoted by  $s_\Sigma^*$  is a 2-chain whose projection by  $\lambda$  is contained in the support of  $(1, 1)$ -cycle  $w_\Sigma^*(c)$ . More precisely, the 2-cycle  $s_\Sigma^*$  can be written as a sum

$$s_\Sigma^* = \sum_{F \in \mathcal{C}_2(\Sigma)} \sum_{e \in \mathcal{C}_1(F)} t_e[x_F, x_e] \times (\theta_F^e + \mathbb{R}v_e/2\pi\mathbb{Z}v_e) + \sum_{F \in \mathcal{C}_2(\Sigma)} (1 + c_*) \beta_F + \sum_{e \in \mathcal{C}_1(\Sigma)} \beta_e,$$

where  $v_e$  is a primitive vector in  $W_{\mathbb{Z}}^1(e)$ ,  $t_e$  is the reduction modulo 2 of the twist  $t_e(c'_\Sigma, c)$  (in particular one has  $w \cdot e = t_e v_e \pmod{2}$ ) and the 2-chains  $(1 + c_*) \beta_F$  and  $\beta_e$  are contained respectively in the fibers over the barycenters  $\lambda^{-1}(x_F)$  and  $\lambda^{-1}(x_e)$  for every face  $F$  and for every edge  $e$  of  $\Sigma$ . Indeed, by Equation (5.2), the 2-chain  $(1 + c_*) \beta_F$  is sent on the barycenter  $x_F$  by  $\lambda$  and the 2-chain  $\beta_e$  is equal to

$$\beta_e = t_e \{x_e\} \times (\theta_e + \mathbb{R}v_e/2\pi\mathbb{Z}v_e) \times b_e. \quad (5.3)$$

Therefore, the homology class of  $s_\Sigma^*$  in  $H_2(S_X; \mathbb{Z}_2)$  represents the lift  $L_{1,1}(w_\Sigma^*(c))$  of the singular tropical  $(1, 1)$ -cycle  $w_\Sigma^*(c)$  in the quotient group  $H_2(S_X; \mathbb{Z}_2)/H_{2,0}(S_X; \mathbb{Z}_2)$ .  $\square$

**Corollary 5.1.** *One has*

$$(1 + c_*) (H_{0,2}(S_X; \mathbb{Z}_2)) \subset H_{1,1}(S_X; \mathbb{Z}_2).$$

Another interesting corollary, is a tropical necessary criterion for the maximality of  $(S_X, c)$ . Let us recall that the statement below is proved only under the assumptions made at the beginning of the chapter.

**Corollary 5.2.** *If  $(S_X, c)$  is maximal, then for all topological surfaces  $\Sigma \subset X$  the dual  $(1, 1)$ -cycle to the twist wave  $w_\Sigma^*(c)$  of the real structure  $c$ , is homologous to zero, that is,*

$$[w_\Sigma^*(c)] = 0 \in H_{1,1}(X; \mathbb{Z}_2).$$

*Proof.* It is a direct consequence of Proposition 5.3 and the fact that in the maximal case, the conjugation acts trivially on the homology of  $S_X$  with coefficients in  $\mathbb{Z}_2$  (see Theorem 1.2).  $\square$

*Example 5.1.* The situation depicted in Figure 5.1 is a local obstruction to being maximal. We represent the topological sphere  $\Sigma$  as embedded in  $\mathbb{R}^3$  where the 6 vertices have coordinates  $(0, 0, 0), (1, 0, 0), (0, 1, 0), (0, 0, 1), (1, 0, 1)$  and  $(0, 1, 1)$ . The twisted edges are the vertical ones (in red). The dual  $(1, 1)$ -cycle to the twist wave of the real structure  $c$  along  $\Sigma$  is non-zero, as one can see by finding another tropical  $(1, 1)$ -cycle having an odd tropical intersection number with  $w_\Sigma^*(c)$ . We do not give a precise expression, but this tropical  $(1, 1)$ -cycle is depicted in green in Figure 5.2, where only the framings on the vertical edges are represented. Moreover, such a

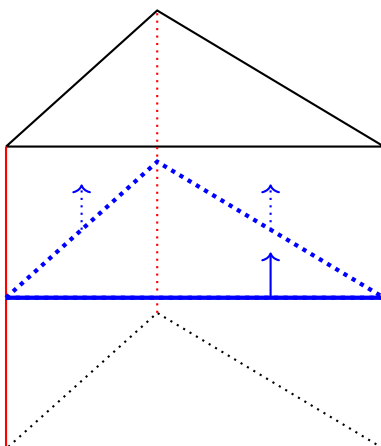

Figure 5.1: Topological sphere  $\Sigma$  in a hypersmooth tropical surface, with edges twisted along  $\Sigma$  in red, and the dual  $(1, 1)$ -cycle  $w_\Sigma^*(c)$  in blue.

situation can arise in the case of primitive combinatorial patchworking. For instance, consider any integer point  $(x, y, z) \in \mathbb{Z}^3$  in the relative interior of a lattice polytope  $\Delta \subset \mathbb{R}^3$ . Assume that there are 6 (primitive) tetrahedrons of the triangulation of  $\Delta$  containing  $(x, y, z)$  as a vertex and having the following form. Each of the tetrahedra has for base one of the three horizontal triangles  $\text{conv}((x, y, z), (x - 1, y, z), (x, y - 1, z))$ ,  $\text{conv}((x, y, z), (x - 1, y, z), (x + 1, y + 1, z))$  and  $\text{conv}((x, y, z), (x, y - 1, z), (x + 1, y + 1, z))$ , while the fourth vertex is either  $(x, y, z - 1)$  or  $(x, y, z + 1)$ . Then the topological sphere  $\Sigma$  arises as the boundary of the dual cell to the vertex  $(x, y, z)$ . In order to have the appropriate twisting of the edges along the topological sphere  $\Sigma$ , one can, for example, take all the three vertices in the horizontal plane having height equal to  $z$  and different from  $(x, y, z)$ , to have a sign opposite to the sign of the vertex  $(x, y, z)$ . Regarding the signs of the vertices  $(x, y, z \pm 1)$  we take them to be opposite to one another.

## 5.2 A Combinatorial criterion for Type I

In this section, we compute the intersection number of the real part  $\mathbb{R}S_X$  with homology classes of the different sub-groups of the filtration 4.2, where by  $\mathbb{R}S_X$  we mean the fixed locus of the real structure  $c$ . The intersection with any element of the sub-group  $H_{2,0}(S_X; \mathbb{Z}_2)$  is always zero (Proposition 5.4). As a consequence, the intersection number of the real part with a representative of the lift of a  $(1, 1)$ -cycle does not depend on the representative and we give a formula for this intersection number, which has the property of not depending on the real structure  $c$  (Proposition 5.5).

**Proposition 5.4.** *The real part intersects the lifts of tropical  $(2, 0)$ -cycles in an even number of points, that is,*

$$[\mathbb{R}S_X] \in (H_{2,0}(S_X; \mathbb{Z}_2))^\perp.$$

*Proof.* By Lemma 2.3, one can assume that the support of the  $(2, 0)$ -cycle is contained in the relative interior of faces of  $X$ . The result then follows from the fact that there are always 4

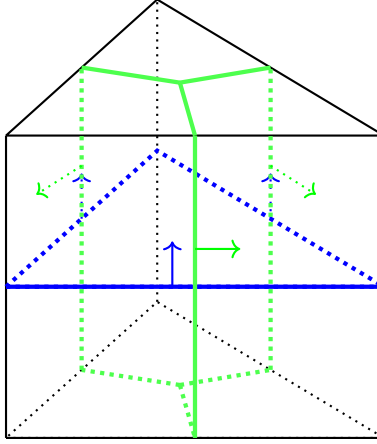

Figure 5.2: Topological sphere  $\Sigma$  in a hypersmooth tropical surface, with two  $(1,1)$ -cycles having an odd tropical number of intersection.

points in a toric fiber  $\lambda^{-1}(x)$  for any point  $x$  in the relative interior of a face. So the intersection number  $[\mathbb{R}S_X] \circ [\lambda^{-1}(x)]$  in  $\mathbb{Z}_2$  is zero.  $\square$

**Proposition 5.5.** *Let  $a$  be a singular tropical  $(1,1)$ -cycle of  $X$ . The intersection of the real part  $\mathbb{R}S_X$  of  $S_X$  with a homology class  $\tilde{L}_{1,1}(a)$ , which represents the lift  $L_{1,1}(a)$ , is equal to the tropical self-intersection number of  $a$ , that is*

$$[\mathbb{R}S_X] \circ \tilde{L}_{1,1}(a) = a \circ a.$$

*Proof.* By Lemma 1.2, one has  $[\mathbb{R}S_X] \circ \tilde{L}_{1,1}(a) = \tilde{L}_{1,1}(a) \circ c_* \tilde{L}_{1,1}(a)$ . By Proposition 5.2, one has  $c_* \tilde{L}_{1,1}(a) = \tilde{L}_{1,1}(a) + \beta$ , where  $\beta \in H_{2,0}(S_X; \mathbb{Z}_2)$ , hence the fact that  $c_* \tilde{L}_{1,1}(a) \in H_2(S_X; \mathbb{Z}_2)$  is also a representative of the lift  $L_{1,1}(a)$ . By Proposition 4.1, one deduces the result.  $\square$

**Corollary 5.3.** *If the phase tropical surface  $(S_X, X)$  endowed with the real structure  $c$  is of type I, then the  $\mathbb{Z}_2$ -tropical intersection form on  $H_{1,1}(X; \mathbb{Z}_2)$  is even.*

*Remark 5.1.* As mentioned at the beginning of this section, the intersection product  $[\mathbb{R}S_X] \circ \tilde{L}_{1,1}(a)$  does not depend on the real structure  $c$ , but only on the tropical  $(1,1)$ -cycle  $a$ .

In order to compute the self-intersection number of the lift of an orientable topological surface  $\Sigma$ , we need an additional assumption: an almost complex structure on  $S_X$ , such that  $c$  is a conjugation (in the sense of Definition 1.2). Note that an almost complex structure comes with a structure of (orientable) differentiable manifold. We have not yet fixed a differentiable structure on  $S_X$ . However, each building-block  $S_\sigma = \sigma \times T^\sigma \times \overline{P}^{n_\sigma}$ , for every cell  $\sigma$  of sedentarity zero, is a differentiable manifold with corners as a product of differentiable manifolds with corners and at a point  $(x, \theta, z)$  in the relative interior of  $S_\sigma$ , the tangent space to  $S_\sigma$  is equal to  $T_x \sigma \oplus T_\theta T^\sigma \oplus T_z M(\mathcal{P}^{n_\sigma})$  and thus can be identified with  $W'(\sigma) \oplus W'(\sigma) \oplus M_* P$ , where  $P$  is the plane in  $\mathbb{C}^3$  of equation  $1 + z_1 + z_2 + z_3 = 0$ , and the differential  $M_*$  of the moment map  $M$  (see Section 3.1.2) are taken in the trivialization  $z_0 = 1$  of  $\mathbb{C}P^3$ . Thus the tangent space of the relative interior of  $S_\sigma$  can be written as the trivial vector bundle  $S_\sigma \times (W'(\sigma) \oplus W'(\sigma) \oplus M_*(P))$ . We

call this differentiable structure on the relative interior of the building-block  $S_\sigma$ , the *standard differentiable structure* on  $S_\sigma$ . Given a differentiable structure on  $S_X$ , which restricts to the standard differentiable structure on the relative interior of the building-block  $S_\sigma$  for any cell  $\sigma$  of sedentarity 0, we say that an almost complex structure  $J \in \text{End}(S_X)$  on  $S_X$  is an *X-almost complex structure* on  $S_X$ , if for any cell  $\sigma$  and any point  $x$  in the relative interior of  $\sigma$ , the restriction of  $J$  to the tangent space  $\lambda^{-1}(x) \times (W'(\sigma) \oplus W'(\sigma) \oplus M_*(P))$  is constant to an endomorphism  $j_x$  of  $W'(\sigma) \oplus W'(\sigma) \oplus P$ .

**Lemma 5.2.** *Assume that there exists an X-almost complex structure on  $S_X$  such that  $c$  is a conjugation. Then, for any real structure  $c'$  of  $(S_X, X)$  obtained by Dehn twist from  $c$ , there exists an almost complex structure  $J'$  on the inverse image  $\lambda^{-1}(X^o)$  of the interior  $X^o = X \setminus \partial X$ , such that  $c'$  is a conjugation for  $J'$ .*

*Proof.* Denote by  $J$  an X-almost complex structure for which the involution  $c$  is a conjugation. By assumption, there exists a homeomorphism  $D : S_X \rightarrow S_X$  such that  $c' = D \circ c$ . The homeomorphism  $D$  acts fiberwise and we denote by  $D_\sigma$  the restriction of  $D$  to the building-block  $S_\sigma$ , for any cell  $\sigma$  of sedentarity 0. If  $v$  is a vertex of sedentarity 0, then  $D_v = \text{id}$ . If  $\sigma$  is an edge or a face, there exists a homeomorphism  $D_\sigma^{\frac{1}{2}}$  of  $S_\sigma$  such that  $(D_\sigma^{\frac{1}{2}})^2 = D_\sigma$  and  $D_\sigma^{\frac{1}{2}} \circ c \circ D_\sigma^{\frac{1}{2}} = c$  (see the proof of Lemma 3.19 if  $\sigma$  is an edge and the proof of Proposition 3.14 if  $\sigma$  is a face). For any cell  $\sigma$  of sedentarity 0 of  $X$ , we define a new almost complex structure  $J'_\sigma$  on the relative interior of  $S_\sigma$  by  $J'_\sigma := (D_\sigma^{\frac{1}{2}})_* J (D_\sigma^{\frac{1}{2}})^{-1}$ . Since the local real structure  $c'_\sigma$  is equal to  $c'_\sigma = D_\sigma c_\sigma = D_\sigma^{\frac{1}{2}} \circ c \circ (D_\sigma^{\frac{1}{2}})^{-1}$ , the local real structure  $c'_\sigma$  is a conjugation for  $J'_\sigma$ . Now it remains to show that the  $J'_\sigma$  extend to an almost complex structure on  $\lambda^{-1}(X^o)$ . Therefore, we first need to precise the differentiable structure at a point  $(x, \theta, z)$  in the intersection  $S_\sigma \cap S_\tau$ , where  $\sigma \subset \tau$  are two adjacent cells of sedentarity 0. The key observation is that one can check, from the expression of  $D_\sigma^{\frac{1}{2}}$  and  $D_\tau^{\frac{1}{2}}$  from the proofs of Lemma 3.19 and Proposition 3.14, that both homeomorphisms, in restriction to the intersection  $S_\sigma \cap S_\tau$ , differ by a homeomorphism of the form  $D_{\sigma, \tau}^w : (x, \theta, z) \mapsto (x, \theta + \pi w, z)$ , where  $w \in W'_Z(\tau)$ . Now let us describe the charts of our new differentiable structure in the case where  $\sigma = e$  is an edge,  $\tau = F$  is a face (both of sedentarity 0) and  $D_e^{\frac{1}{2}}(x, \theta, z) \in e \times T^e \times \overline{P}^1$  is a point lying in the relative interior of the intersection  $S_e \cap S_F$  (written in the coordinates of  $S_e$ ). Denote by  $w$  the vector such that  $D_e^{\frac{1}{2}} = D_{e, F}^w \circ D_F^{\frac{1}{2}}$  in restriction to the intersection  $S_e \cap S_F$ . We denote by  $D_{e, F}^{\frac{1}{2}}$  the homeomorphism  $S_F \cup S_e \rightarrow S_F \cup S_e$  given by  $D_e^{\frac{1}{2}}$  on  $S_e$  and by  $D_F^w \circ D_F^{\frac{1}{2}}$  on  $S_F$ , where  $D_F^w$  is a homeomorphism of  $S_F = F \times T^F$  defined as  $D_F^w(x, \theta) = (x, \theta + \pi w)$ . Consider a chart  $\phi_U : U \rightarrow V_U$  for the original differentiable structure of  $S_X$  such that the point  $(x, \theta, z)$  lies in the open set  $U \subset S_X$ , then we define a chart of our new differentiable structure in a neighborhood of  $D_e^{\frac{1}{2}}(x, \theta, z)$  by

$$\phi_U \circ (D_{e, F}^{\frac{1}{2}})^{-1} : (D_{e, F}^{\frac{1}{2}})(U) \rightarrow V_U.$$

The transition maps with the charts of the original differentiable structure contained in the relative interiors of  $S_e$  and  $S_F$  are differentiable because  $D_e^{\frac{1}{2}}$  and  $D_e^{\frac{1}{2}}$  are differentiable in the relative interiors of  $S_e$  and  $S_F$ , respectively. This new differentiable structure makes of  $D_{e, F}^{\frac{1}{2}}$  a

diffeomorphism of the relative interior of the union  $S_F \cup S_e$  and the differential of  $D_{e,F}^{\frac{1}{2}}$  in the relative interior of  $S_e$  coincide with the one of  $D_e^{\frac{1}{2}}$  because they are equal and thus, in restriction to the tangent space of the relative interior of  $S_e$ , one has  $\left(D_{e,F}^{\frac{1}{2}}\right)_* J \left(D_{e,F}^{\frac{1}{2}}\right)^{-1} = J'_e$ . In restriction to the tangent space of the relative interior of  $S_F$ , one also obtains  $\left(D_{e,F}^{\frac{1}{2}}\right)_* J \left(D_{e,F}^{\frac{1}{2}}\right)^{-1} = J'_F$ , using the fact  $J$  is constant to  $j_x$  on  $\lambda^{-1}(x) \times (W'(\sigma) \oplus W'_\sigma \oplus M_*(P))$  for any point  $x$  in the relative interior of  $F$  and that the differential  $\left(D_F^{\frac{1}{2}}\right)_*$  acts on the second component of  $\lambda^{-1}(x) \times (W'(\sigma) \oplus W'_\sigma \oplus M_*(P))$  independently on the point  $(x, \theta)$  in the fiber  $\lambda^{-1}(x)$ . Therefore, we can extend  $J'_e$  and  $J'_F$  to an almost complex structure (for the new structure of differentiable manifold on  $S_X$ ) on the relative interior of the union  $S_F \cup S_e$  by  $\left(D_{e,F}^{\frac{1}{2}}\right)_* J \left(D_{e,F}^{\frac{1}{2}}\right)^{-1}$ . The same arguments work as well when we consider the intersection between a building block  $S_v$  of a vertex of sedentarity 0 and a building block  $S_e$  of an edge  $e$  of sedentarity 0 or the intersection between 4 building blocks, that is, one building block  $S_v$  of a vertex of sedentarity zero, two building-blocks  $S_e$  and  $S_f$  of edges of sedentarity 0 and one building block  $S_F$  of a face. The new almost complex structure  $J'$ , together with the new differentiable structure we defined, satisfies the statement of the lemma.  $\square$

**Proposition 5.6** (Criterion for Type  $I_{wu}$ ). *Let  $(S_X, X)$  be a phase tropical surface endowed with a real structure  $c$  which is a conjugation for an  $X$ -almost complex structure on  $S_X$ . The surface  $(S_X, c)$  is of type  $I_{wu}$  if and only if for every orientable topological surfaces  $\Sigma \subset X$ , the intersection between the homology class  $[s_\Sigma]$  of a lift of  $\Sigma$  and  $[\mathbb{R}S_X]$  is even.*

*Proof.* We have to show that the fixed locus of  $\mathbb{R}S_X$  realizes the characteristic element  $wu(S_X)$  (see Definition 1.9) of the intersection form on  $H_2(S_X; \mathbb{Z}_2)$  if and only if for all topological surfaces  $\Sigma$ , the intersection product  $[s_\Sigma] \circ [\mathbb{R}S_X]$  is even. By Lemma 4.2, the self intersection of an element  $[a]$  in  $H_{2,0}(S_X; \mathbb{Z}_2)$  is zero and thus is equal to  $[a] \circ c_*[a] = 0$ . By Propositions 4.1 and 5.5 the self intersection  $[a]^2$  of an element  $[a]$  in  $H_{1,1}(S_X; \mathbb{Z}_2)$  is equal to the intersection  $[a] \circ c_*[a]$ . Therefore, we see that the  $\mathbb{Z}_2$ -intersection form and the  $\mathbb{Z}_2$ -form of the involution (see Definition 1.8) yield the same self-intersections for the elements of the sub-group  $H_{1,1}(S_X; \mathbb{Z}_2)$ . Fix a basis  $\mathcal{B}$  of the tropical homology group  $H_{0,2}(X; \mathbb{Z}_2)$ , where the elements of  $\mathcal{B}$  are homology classes of orientable topological surfaces in  $X$ . The homology classes of the lifts  $[s_\Sigma] \in H_2(S_X; \mathbb{Z}_2)$  span a  $\mathbb{Z}_2$ -subspace of  $H_2(S_X; \mathbb{Z}_2)$ , complementary to  $H_{1,1}(S_X; \mathbb{Z}_2)$ . Thus, the characteristic elements of the  $\mathbb{Z}_2$ -intersection form and the  $\mathbb{Z}_2$ -form of the involution  $c$  are equal if and only if the self-intersection  $[s_\Sigma] \circ [s_\Sigma]$  are equal to  $[s_\Sigma] \circ c_*[s_\Sigma] = [s_\Sigma] \circ [\mathbb{R}S_X] \pmod{2}$  (note that we only need to compare the squares because the coefficients are  $\mathbb{Z}_2$  so one has  $(a+b)^2 = a^2 + b^2$ ). Yet, for every topological surface  $\Sigma \subset X$ , the self-intersection of the lift  $[s_\Sigma]$  is equal to  $\chi(s_\Sigma) = 0 \pmod{2}$  by Lemma 1.2 and because the real structure  $c'_\Sigma$  of  $(S_\Sigma, \Sigma)$  used to lift  $\Sigma$  is a conjugation by Lemma 5.2. The equivalence of the statement follows.  $\square$

We can specialize Proposition 5.6 to the case where the Wu-class  $wu(S_X)$  vanishes and obtain a criterion specific to type  $I$ .

**Corollary 5.4.** *Let  $(S_X, X)$  be a phase tropical surface endowed with a real structure  $c$  which is a conjugation for an  $X$ -almost complex structure on  $S_X$ . The surface  $(S_X, c)$  is of type  $I$  if and only if*

- (1) the  $\mathbb{Z}_2$ -tropical intersection form on  $H_{1,1}(X; \mathbb{Z}_2)$  is even and,
- (2) for all topological surfaces  $\Sigma \subset X$ , the intersection number  $[s_\Sigma] \circ [\mathbb{R}S_X]$  is even.

In order to obtain a useful criterion for type  $I_{wu}$  we need to compute the intersection number  $[s_\Sigma] \circ [\mathbb{R}S_X]$ , where  $\Sigma$  is an orientable topological surface. Let  $e_0, \dots, e_{n-1}$  be the cyclically ordered edges of a face  $F$  of  $\Sigma$  and let  $w \in H_{cell}^1(\Sigma; W_{\mathbb{Z}})$  (note that the co-homology group  $H_{cell}^1(\Sigma; W_{\mathbb{Z}})$  is equal to the group of cellular co-cycles because all the vertices of  $\Sigma$  are of sedentarity 0, so  $C_{cell}^0(\Sigma; W_{\mathbb{Z}}) = 0$ ). The vectors  $w \cdot e_0, \dots, w \cdot e_{n-1}$  form a polygonal chain in  $W(F)$  with  $\mathbb{Z}_2$  coefficients defined as

$$P_w(F) := \sum_{i \in \mathbb{Z}_n} \left[ \sum_{0 \leq j \leq i-1} w \cdot e_j, \sum_{0 \leq j \leq i} w \cdot e_j \right], \quad (5.4)$$

where the edges  $e_0, \dots, e_{n-1}$  are oriented according to the boundary orientation of  $F$ . This chain is closed because of the co-cycle condition  $dw \cdot F = 0$ . We denote by  $B_w(F)$  the 2-chain in  $C_2(W(F); \mathbb{Z}_2)$  which has for boundary  $\partial B_w(F) = P_w(F)$ . Note that the 2-chain  $\beta_F$  from the proof of Proposition 5.3 is equal to  $\theta_F + (p_\pi)_*(B_w(F))$ , where we denote by  $p_\pi$  the composition of the multiplication by  $\pi$  in  $W(F)$  with the projection  $W(F) \rightarrow T^F$ .

*Definition 5.2.* Let  $\Sigma \subset X$  be an orientable topological surface, let  $w \in H_{cell}^1(\Sigma; W_{\mathbb{Z}})$ , and let  $F$  be a face of  $\Sigma$ . As in the discussion above, the face  $F$  is oriented and the edges of  $F$  are labeled by  $i \in \mathbb{Z}_n$ . We denote by  $\kappa(w)$  the number of integer vectors lying in the polygonal cycle  $P_w(F)$  with even coordinates in  $W_{\mathbb{Z}}(F)$ . For every  $i \in \mathbb{Z}_n$  such that the edge  $e_i$  is twisted along  $\Sigma$ , we denote by  $\tilde{\theta}_F^{e_i} \in W(F)$  an arbitrarily small vector such that the base  $(\tilde{\theta}_F^{e_i}, w \cdot e_i)$  is a positively oriented basis of  $W(F)$  (for the orientation of  $F$ ). We denote by  $q_w(e_i)$  the number of points of intersection between the segment  $\left[0, \pi \left(\frac{1}{2}w \cdot e_i + \sum_{0 \leq j \leq i-1} w \cdot e_j\right)\right]$  and the cycle  $\mathbb{R}\tilde{e}_i / (2\pi\mathbb{Z}\tilde{e}_i) + \pi \sum_{0 \leq j \leq i-1} w \cdot e_j$ , where  $\tilde{e}_i \in W_{\mathbb{Z}}(e_i)$  is a primitive integer vector. We say that  $F$  is *w-twisted along  $\Sigma$*  if the sum

$$\kappa(w) + \sum_{e \in \mathcal{T}_c(\Sigma)} q_w(e)$$

is odd. We denote by  $\mathcal{T}_w(\Sigma)$  the set of  $w$ -twisted faces along  $\Sigma$ .

*Remark 5.2.* The above definition depends *a priori* on the order of the edges of the face  $F$ . However, the quantity  $\kappa(w) + \sum_{e \in \mathcal{T}_c(\Sigma)} q(e)$  appears in the proof of Proposition 5.7 as the number of points of intersection between a lift  $s_\Sigma$  and a 2-cycle  $\tilde{s}_\Sigma^*$  homologous to  $s_\Sigma^*$  in the relative interior of  $T^F \times F \subset S_\Sigma$ . The order of the edges of  $F$  corresponds to the choice of a starting edge for the  $w$ -twist  $D_w$  used to lift the topological surface  $\Sigma$  above the face  $F$ . It can be shown that the parity of the number of intersection points in  $F \times T^F$  does not depend on the choice of the starting edge for  $D_w$ , so that the definition 5.2 does not depend on the order of the edges of  $F$  either. However, there is surely a less complicated and more convincing argument to show this independence, and maybe even a simpler definition.

*Example 5.2.* Consider a triangle  $F$  in the plane  $\mathbb{R}^2$  with vertices  $(0, 0)$ ,  $(1, 0)$  and  $(0, 1)$ . We orient  $F$  so that  $((1, 0), (0, 1))$  is a positively oriented basis of  $W(F)$ . If  $F$  is contained in a topological surface  $\Sigma$  with all three edges twisted along  $\Sigma$  and the cellular co-cycle  $w \in$

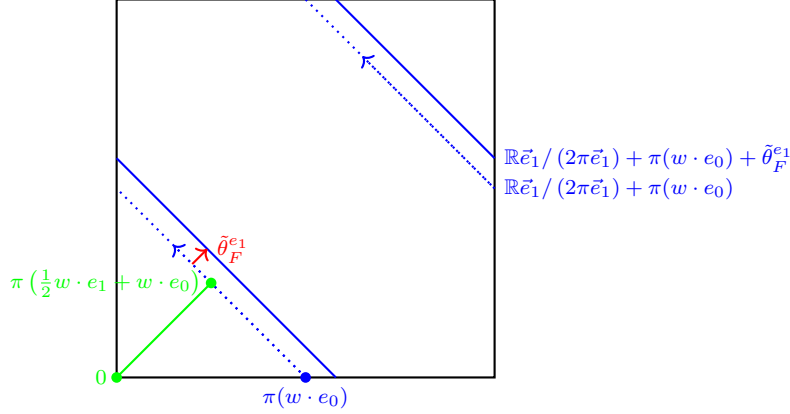

Figure 5.3: Illustration of the computation of  $q_w(e_1)$  in Example 5.2. The opposite edges of the black square are identified in the usual way to obtain a torus.

$H_{cell}^1(\Sigma; W_{\mathbb{Z}})$  is such that for any oriented edge  $e$  of  $F$ , one has  $w \cdot e = \vec{e}$ , where  $\vec{e} \in W_{\mathbb{Z}}(e)$  is the primitive integer vector whose sign is induced by the orientation of the edge  $e$ , then the face  $F$  is  $w$ -twisted along  $\Sigma$ . In fact, denoting by  $e_0$ ,  $e_1$  and  $e_2$  the edges  $[(0, 0), (1, 0)]$ ,  $[(1, 0), (0, 1)]$  and  $[(0, 1), (0, 0)]$ , respectively, there here is only one vector in the polygonal cycle  $P_w(F)$  with even coordinates so  $\kappa(w) = 1$ . Moreover, one has  $q_w(e_0) = q_w(e_2) = 0$  because for  $i = 0$  or  $2$  the segment  $\left[0, \pi \left(\frac{1}{2} w \cdot e_i + \sum_{0 \leq j \leq i-1} w \cdot e_j\right)\right]$  is parallel to the cycle  $\mathbb{R}\vec{e}_i / (2\pi\mathbb{Z}\vec{e}_i) + \pi \sum_{0 \leq j \leq i-1} w \cdot e_j$ , so after adding  $\tilde{\theta}_F^{e_i}$  to the cycle they do not intersect. We also have  $q_w(e_1) = 0$  because adding the vector  $\tilde{\theta}_F^{e_1}$  to the cycle  $\mathbb{R}\vec{e}_1 / (2\pi\mathbb{Z}\vec{e}_1)$  translates it outwards the 2-chain  $B_w(F)$  (see Figure 5.4). Therefore we have  $\kappa(w) + q_w(e_0) + q_w(e_1) + q_w(e_2) = 1$ .

*Example 5.3.* Let  $F$  be a square in  $\mathbb{R}^2$  with vertices  $(0, 0)$ ,  $(1, 0)$ ,  $(1, 1)$  and  $(0, 1)$ . We orient  $F$  so that  $((1, 0), (0, 1))$  is a positively oriented basis of  $W(F)$ . Denote by  $e_0$ ,  $e_1$ ,  $e_2$  and  $e_3$  the edges  $[(0, 0), (1, 0)]$ ,  $[(1, 0), (1, 1)]$ ,  $[(1, 1), (0, 1)]$  and  $[(0, 1), (0, 0)]$ , respectively. Assume that  $F$  is contained in a topological surface  $\Sigma$  with the two edges  $e_0$  and  $e_2$  twisted along  $\Sigma$  and the two other edges  $e_1$  and  $e_3$  untwisted along  $\Sigma$ . If  $w \in H_{cell}^1(\Sigma; W_{\mathbb{Z}})$  is a cellular co-cycle such that  $w \cdot e_0 = \vec{e}_0$ ,  $w \cdot e_2 = \vec{e}_2$  and  $w \cdot e_1 = w \cdot e_3 = 0$ , then the face  $F$  is  $w$ -twisted along  $\Sigma$ . In fact the polygonal cycle has two edges, namely  $[0, w \cdot e_0]$  and  $[w \cdot e_0, 0]$ . There is only one integer point in  $P_w(F)$  with even coordinates, that is the point  $(0, 0)$ , so one has  $\kappa(w) = 1$ . Moreover one has  $q_w(e_0) = q_w(e_2) = 0$  because the edges  $[(0, 0), (\frac{\pi}{2}, 0)]$  and  $[(\frac{\pi}{2}, 0), (0, 0)]$  are both parallel to the cycle  $\mathbb{R}\vec{e}_0 / (2\pi\mathbb{Z}\vec{e}_0)$ . If  $w \in H_{cell}^1(\Sigma; W_{\mathbb{Z}})$  is a cellular co-cycle such that  $w \cdot e_0 = \vec{e}_0$ ,  $w \cdot e_2 = \vec{e}_2$ ,  $w \cdot e_1 = 2\vec{e}_1$  and  $w \cdot e_3 = 2\vec{e}_3$ , then the face  $F$  is also  $w$ -twisted along  $\Sigma$ . In this case, the polygonal cycle  $P_w(F)$  consists of 4 edges  $[(0, 0), (1, 0)]$ ,  $[(1, 0), (1, 2)]$ ,  $[(1, 2), (0, 2)]$  and  $[(0, 2), (0, 0)]$ , so one has  $\kappa(w) = 2$ . One also has  $q_w(e_0) = 0$ , because the segment  $[(0, 0), (\frac{\pi}{2}, 0)]$  is parallel to the cycle  $\mathbb{R}\vec{e}_0 / (2\pi\mathbb{Z}\vec{e}_0)$ , but  $q_w(e_2) = 1$ , as one can see in Figure 5.4.

Given a face  $F$  of the hypersmooth tropical surface  $X$ , the associated building-block  $S_F = F \times T^F$  is canonically oriented as for a complex manifold. In fact the tangent space at a point  $(x, \theta) \in F \times T^F$ , where the point  $x$  is in the relative interior of the face  $F$ , can be identified

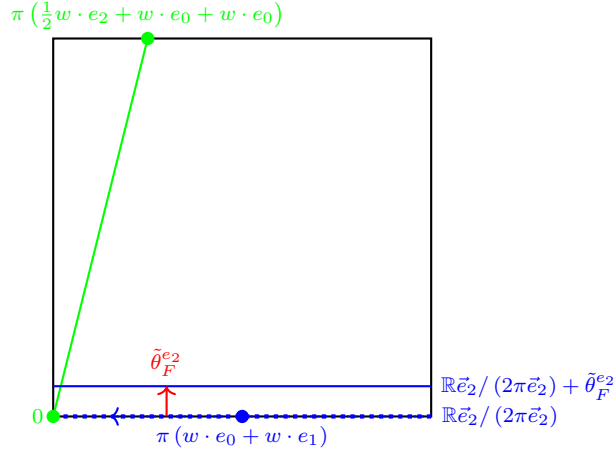

Figure 5.4: Illustration of the computation of  $q_w(e_2)$  in Example 5.3 in the torus  $T^F$ . The opposite edges of the black square are identified in the usual way to obtain a torus.

with  $W(F) \oplus W(F)$  (recall that the wave space  $W(F)$  is the tangent space at  $x$  of the face  $F$ ). The tangent space  $T_{(x,\theta)}S_F$  is thus canonically oriented by bases of the form  $(\vec{u}, l_{\vec{u}}, \vec{v}, l_{\vec{v}})$ , for any basis  $(\vec{u}, \vec{v})$  of  $W(F)$ , where we denote by  $l_{\vec{u}}$  a copy of the vector  $\vec{u} \in W(F) \oplus 0$  in  $0 \oplus W(F)$ .

*Definition 5.3.* If the phase tropical surface  $(S_X, X)$  is such that  $S_X$  is orientable and the canonical orientations of the building-blocks  $S_F$  associated with the faces  $F$  of  $X$  are coherent, we say that  $S_X$  is *X-oriented*.

*Remark 5.3.* The above definition is *ad hoc* for the proof of Proposition 5.7. The author hopes that the corresponding assumption in the statement of Proposition 5.7 can be removed with a little more work.

**Proposition 5.7.** *Let  $(S_X, X)$  be a phase tropical surface endowed with a real structure  $c$  which is a conjugation for an X-almost complex structure on  $S_X$  and such that  $S_X$  is X-oriented. Let  $\Sigma \subset X$  be an orientable topological surface and let  $s_\Sigma$  be a lift of  $\Sigma$  as obtained by Proposition 4.2 with a 1-co-cycle  $w \in H_{cell}^1(\Sigma; W_{\mathbb{Z}})$ . The intersection number of the real part  $\mathbb{R}S_X$  with  $s_\Sigma$  is equal to the (parity of) the sum of the number of twisted edges along  $\Sigma$  with the number of  $w$ -twisted faces along  $\Sigma$ , that is,*

$$[\mathbb{R}S_X] \circ [s_\Sigma] = \text{Card}(\mathcal{T}_c(\Sigma)) + \text{Card}(\mathcal{T}_w(\Sigma)) \pmod{2}.$$

*Proof.* The lift  $s_\Sigma$  of  $\Sigma$  is obtained using for every face  $F$  of  $\Sigma$ , the  $D_w$  twist starting at an arbitrary edge, denoted by  $e_F$  and defined with the orientation of  $F$  induced by a fixed choice of an orientation of  $\Sigma$  (see Definition 3.24). By Lemma 1.2, one has  $[\mathbb{R}S_X] \circ [s_\Sigma] = [s_\Sigma] \circ c_* [s_\Sigma]$ . By Lemma 5.2 the real structure  $c'_\Sigma$  of  $(S_\Sigma, \Sigma)$  used to lift  $\Sigma$  is a conjugation, and so by Lemma 1.1 the self-intersection number  $[s_\Sigma] \circ [s_\Sigma]$  is congruent modulo 2 to the Euler characteristic  $\chi(\Sigma)$ . Yet  $\Sigma$  is orientable, so one deduces  $[s_\Sigma] \circ [s_\Sigma] = 0$  and thus

$$[\mathbb{R}S_X] \circ [s_\Sigma] = [s_\Sigma] \circ ([s_\Sigma] + c_* [s_\Sigma]). \tag{5.5}$$



Recall the notations of the proof of Proposition 5.3 and the expression found for the 2-cycle  $s_\Sigma^*$  homologous to  $(1 + c_*)s_\Sigma$ . In particular, by Equation (5.5) above, one has

$$[\mathbb{R}S_X] \circ [s_\Sigma] = [s_\Sigma] \circ [s_\Sigma^*].$$

Recall that the intersection of  $s_\Sigma^*$  with the building-block  $S_e$  associated with an edge  $e$  of  $\Sigma$  is equal to the 2-chain  $\beta_e$  with  $\mathbb{Z}_2$  coefficients whose expression is given by Equation (5.3). We perturb the 2-chain  $\beta_e$  so that it intersects transversally  $s_\Sigma$  in  $t_e$  points modulo 2 (where  $t_e \in \mathbb{Z}_2$  is introduced in Equation (5.3)). This perturbation  $\tilde{\beta}_e$  is equal to

$$\tilde{\beta}_e = t_e (\theta_e + \mathbb{R}v_e/2\pi\mathbb{Z}v_e) \times \tilde{b}_e,$$

where  $\tilde{b}_e$  is a perturbation of  $b_e$  in  $\overline{P}^1$  defined in the following way. Denote by  $F$  and  $G$  the faces adjacent to the edge  $e$  in  $\Sigma$  and denote by  $B_F$  and  $B_G$  the respective corresponding boundary components of  $\overline{P}^1$ . The component  $b_e$  connects the boundary components  $B_F$  and  $B_G$ . All the points of the boundary component  $B_F$  are sent to a same point  $y_F$  of  $\Delta_2$  and similarly for  $B_G$  which is mapped to a point  $y_G$  by the projection  $\text{pr}_{\Delta_2}$ . With these notations, the fixed component  $b_e$  is equal to  $[y_F, y_G] \times \{\vartheta_e\}$ , where  $\vartheta_e \in T^3/T$  is a fixed point by the involution  $\vartheta \mapsto -\vartheta$ . Now, parametrize the segment  $[y_F, y_G]$  by  $y(s) = sy_F + (1-s)y_G$  for  $s \in [0, 1]$  and define the vector field  $((y(s), \vartheta_e), \tau(s))$  on  $b$ , where

$$\tau(s) = \left( y(s) - \frac{1}{2}(y_F + y_G), 0 \right) \in T_{y(s)}\Delta_2 \oplus T_{\vartheta_e}(T^3/T). \quad (5.6)$$

Multiplying the vector field  $((y(s), \vartheta_e), \tau(s))$  by the almost complex structure  $(y, \vartheta) \mapsto (y, -\vartheta)$  yields a normal vector field  $\vec{n}_e : b_e \rightarrow N_{\overline{P}^1}b_e$  to  $b_e$  in  $\overline{P}^1$  which has only one zero. This zero is the middle point  $(\frac{1}{2}(y_F + y_G), \vartheta_e)$ . By identifying a tubular neighborhood of  $b_e$  in  $\overline{P}^1$  and the normal bundle  $N_{\overline{P}^1}b_e$  of  $b_e$  in  $\overline{P}^1$ , the normal vector field  $\vec{n}_e$  induces a perturbation  $\tilde{b}_e$  of  $b_e$  in  $\overline{P}^1$ , which is also parametrized by  $s \in [0, 1]$  and such that  $\tilde{b}_e$  and  $b_e$  intersect only at the middle point  $(\frac{1}{2}(y_F + y_G), \vartheta_e)$ . Furthermore, the perturbation  $\tilde{b}_e$  intersects the boundary of the building-block  $S_e$  at the points  $(y_F, \vartheta_F)$  and  $(y_G, \vartheta_G)$  for  $\vartheta_F \in (\text{pr}_{\Delta_2})^{-1}(y_F)$  and  $\vartheta_G \in (\text{pr}_{\Delta_2})^{-1}(y_G)$ . Note that if  $\vec{o}_1$  and  $\vec{o}_0$  are tangent vectors to  $\overline{P}^1$  pointing outwards  $\overline{P}^1$  at the points  $(y(1), \vartheta_e)$  and  $(y(0), \vartheta_e)$  respectively, the bases  $(\vec{o}_1, \vec{n}_e(y(1), \vartheta_e))$  and  $(\vec{o}_0, \vec{n}_e(y(0), \vartheta_e))$  define the same orientation of the 1-dimensional compactified pair-of-pants.

Now, we parametrize the cycle  $(\mathbb{R}v_e/2\pi\mathbb{Z}v_e) \subset T^e$  by the continuous map  $u_e : [0, 1] \rightarrow T^e$ . In the coordinates of  $S_F$ , the intersection of the 2-chain  $\tilde{\beta}_e$  with  $S_F^e$  is equal to

$$\tilde{\beta}_e \cap S_F^e = t_e \{x_e\} \times \left\{ \theta_F^e + u_e(t) + \tilde{\theta}_F^e(t) \mid t \in [0, 1] \right\},$$

where  $\theta_F^e \in T^F$  is as in the proof of Proposition 5.3 and the map  $\tilde{\theta}_F^e : [0, 1] \rightarrow T^F$  is continuous and its image is contained in  $V \setminus (\mathbb{R}v_e/2\pi\mathbb{Z}v_e)$ , where  $V$  is an arbitrarily small neighborhood of  $0 \in T^F$  (we can take the normal vector field  $n_e$  to be arbitrarily small). For any  $t \in [0, 1]$ , one can consider the lift of the vector  $\tilde{\theta}_F^e(t)$  in  $W(F)$  lying in a neighborhood of  $0 \in W(F)$ . We still denote this lift by  $\tilde{\theta}_F^e(t)$ . Denote by  $\vec{e}$  a non-zero vector of  $W(e)$  and by  $l_{\vec{e}}$  a copy of this vector as, in the discussion above Definition 5.3. Denote also by  $\vec{o}_F \in W(F)$  and  $\vec{o}_G \in W(G)$  vectors pointing inwards  $F$  and  $G$ , respectively, from the barycenter  $x_e$  of the edge  $e$ , and denote by  $l_{\vec{o}_F}$

and  $l_{\vec{o}_G}$  copies of these vectors as previously. Since  $S_X$  is  $X$ -oriented, the bases  $(\vec{e}, l_{\vec{e}}, \vec{o}_F, l_{\vec{o}_F})$  and  $(\vec{e}, l_{\vec{e}}, \vec{o}_G, l_{\vec{o}_G})$  define the same orientation of the 4-dimensional manifold  $S_X$  (see Definition 5.3). Yet for any  $t, t' \in [0, 1]$ , the bases  $(\vec{e}, l_{\vec{e}}, \vec{o}_F, \tilde{\theta}_F^e(t))$  and  $(\vec{e}, l_{\vec{e}}, \vec{o}_G, \tilde{\theta}_G^e(t'))$  define the same orientation of the building-block  $S_e$  (because of the remark above about the tangent vectors  $\vec{o}_1$  and  $\vec{o}_0$  of  $\overline{P^1}$ ) so they define the same orientation of  $S_X$ . Thus, the base  $(\tilde{\theta}_F^e(t), l_{\vec{e}})$  induces the same orientation of the copy of  $W(F)$  as the base  $(l_{\vec{o}_F}, l_{\vec{e}})$  and the base  $(\tilde{\theta}_G^e(t), l_{\vec{e}})$  induces the same orientation of the copy of  $W(G)$  as the base  $(l_{\vec{o}_G}, l_{\vec{e}})$ . Up to the multiplication by  $-1$  of the normal vector field used in the construction of the perturbation  $\tilde{b}_e$ , we can assume that the bases  $(\tilde{\theta}_F^e(t), l_{w \cdot e})$  and  $(\tilde{\theta}_G^e(t), l_{w \cdot e})$  are positively oriented bases for the orientations of  $W(F)$  and  $W(G)$  induced by the surface  $\Sigma$ . As a consequence, we have a 2-cycle  $\tilde{s}_\Sigma^*$  homologous to  $s_\Sigma^*$  given by

$$\sum_{e \in \mathcal{C}_1(\Sigma)} \tilde{\beta}_e + \sum_{F \in \mathcal{C}_2(\Sigma)} \tilde{\beta}_F + \sum_{F \in \mathcal{C}_2(\Sigma)} \sum_{e \in \mathcal{C}_1(F)} \left( [x_F, x_e] \times \left\{ \theta_F^e + u_e(t) + \tilde{\theta}_F^e(t) \mid t \in [0, 1] \right\} \right),$$

where for every face  $F$  of  $\Sigma$ , in the torus  $T^F$ , one has

$$\tilde{\beta}_F = (1 + c_*)\beta_F + \sum_{e \in \mathcal{T}_c(\Sigma) \cap \mathcal{C}_1(F)} \left\{ \theta_F + u_e(t) + s\tilde{\theta}_F^e(t) \mid (t, s) \in [0, 1]^2 \right\}.$$

In the relative interior of a face  $F$  there can be points of intersection between  $s_\Sigma$  and  $\tilde{s}_\Sigma^*$  either in the fiber  $\{x_F\} \times T^F$  or in the inverse image of the relative interior of the segment  $[x_F, x_e]$  for every edge  $e$  of  $F$ . We denote by  $e_0, \dots, e_{n-1}$  the edges of  $F$  labeled in the cyclic order induced by the orientation of  $F$ , where  $e_0 = e_F$  is the starting edge of the  $w$ -twist  $D_w$  used to lift the topological surface  $\Sigma$ . We begin with the intersection in the fiber  $\{x_F\} \times T^F$ . The intersection of the lift  $s_\Sigma$  with this fiber consists in a single point  $\{x_F\} \times \{\theta_F\}$ , while the intersection of the 2-chain  $\tilde{s}_\Sigma^*$  with this fiber is equal to the perturbation  $\tilde{\beta}_F$  of  $(1 + c_*)\beta_F$ .

Let us show that for any face  $F$  of  $\Sigma$ , the 2-chain  $\tilde{\beta}_F$  intersects  $\{x_F\} \times T^F$  transversally and the intersection number is the number  $\kappa(w)$  of Definition 5.2. Recall that one has  $\beta_F = \theta_F + (p_\pi)_*(B_w(F))$  (see the discussion above Definition 5.2 for the definition of the projection  $p_\pi : W(F) \rightarrow T^F$ ). For every edge  $e$  of  $F$  twisted along  $\Sigma$ , we denote by  $m(e)$  the 2-chain  $\left\{ \theta_F + u_e(t) + s\tilde{\theta}_F^e(t) \mid (t, s) \in [0, 1]^2 \right\}$ . For every edge  $e$  of  $F$ , untwisted along  $\Sigma$  and such that  $w \cdot e \neq 0$ , we denote by  $\tilde{\theta}_F^e$  an arbitrary small vector in  $W(F)$  such that  $(w \cdot e, \tilde{\theta}_F^e)$  is a positively oriented basis of  $W(F)$  (for the orientation induced by  $F$ ). We denote by  $m(e)$  the 2-chain  $\left\{ \theta_F + t(w \cdot e) + s\tilde{\theta}_F^e \mid (t, s) \in [0, 1]^2 \right\}$  in  $C_2(T^F; \mathbb{Z}_2)$ . We also denote by  $\tilde{\theta}_F^e : [0, 1] \rightarrow W(F)$  the constant map equal to  $\tilde{\theta}_F^e$ .

Let  $u \in W_{\mathbb{Z}}(F)$  be an integer vector with even coordinates lying in the the polygonal cycle  $P_w(F)$ . In particular, one has  $p_\pi(u) = 0 \in T^F$ . If the vector  $u$  is in the relative interior of an edge  $\left[ \sum_{0 \leq j \leq i-1} w \cdot e_j, \sum_{0 \leq j \leq i} w \cdot e_j \right]$  for  $i \in \mathbb{Z}_n$ , then the intersection of  $B_w(F)$  with a sufficiently small neighborhood  $U$  of the point  $u$  in  $W(F)$  is equal to the intersection of  $U$  with a half-plane whose boundary is the affine line  $\mathbb{R}(w \cdot e_i) + u$ . As a consequence, the 2-chain  $\theta_F + (1 + c_*)(p_\pi)_*(B_w(F) \cap U) = \theta_F + (p_\pi)_*((B_w(F) + 2u - B_w(F)) \cap U)$ , contains a

neighborhood of  $\theta_F$  in the torus  $T^F$ , so the intersection is transverse and contributes 1 to the total intersection number  $s_\Sigma \circ \tilde{s}_\Sigma^* \in \mathbb{Z}_2$ . If  $u$  is not in the relative interior of an edge of the polygonal cycle  $P_w(F)$ , then the vector  $u$  is equal to the sum  $u = \sum_{0 \leq j \leq i-1} w \cdot e_j$  for  $i \in \mathbb{Z}_n$ . It can happen that  $w \cdot e_{i-1}$  or  $w \cdot e_i$  are equal to 0. If for any edge  $e$  of  $F$ , one has  $w \cdot e = 0$ , then the 2-chain  $\tilde{s}_\Sigma^*$  does not intersect the building block  $S_F$ , so there is trivially no points of intersection with the lift  $s_\Sigma$  in this building-block. As a consequence we restrict to the case where there exists at least one edge such that  $w \cdot e = 0$ , so we can always assume that the edge  $e_{i-1}$  is such that  $w \cdot e_{i-1} \neq 0$ . We denote by  $k \in \mathbb{Z}_n$  the index such that  $w \cdot e_k \neq 0$  and for any  $i \leq j \leq k-1$  (for the cyclic order of  $\mathbb{Z}_n$  induced by the orientation of the boundary  $\partial F$ ) one has  $w \cdot e_j = 0$ .

If the vectors  $w \cdot e_k$  and  $w \cdot e_{i-1}$  are colinear of same sign, then the 2-chains  $m(e_{i-1})$  and  $m(e_k)$  are equal in restriction to a sufficiently enough neighborhood of  $\theta_F$  because for any  $t \in [0, 1]$ , the bases  $(w \cdot e_{i-1}, \tilde{\theta}_F^{e_{i-1}}(t))$  and  $(w \cdot e_k, \tilde{\theta}_F^{e_k}(t))$  define the same orientation of  $W(F)$ . Moreover, the intersection of the 2-chain  $B_w(F)$  with a sufficiently small neighborhood  $U$  of the point  $u$  in  $W(F)$  is either equal to the intersection of  $U$  with a half-plane whose boundary is the affine line  $\mathbb{R}(w \cdot e_{i-1}) + u$  or is equal to the intersection with the affine line  $\mathbb{R}w \cdot e_{i-1} + u$ . The second possibility cannot happen because  $B_w(F)$  has the polygonal cycle  $P_w(w)$  as a boundary so it would imply the existence of an edge  $e$  of  $F$  such that  $w \cdot e$  is non-zero and colinear with  $w \cdot e_{i-1}$  and  $w \cdot e_k$ , which would contradict the convexity of the face  $F$  ( $F$  would have 3 parallel edges). Thus the intersection of the 2-chain  $B_w(F)$  with  $U$  is equal to the intersection of  $U$  with a half-plane whose boundary is the affine line  $\mathbb{R}(w \cdot e_{i-1}) + u$  and by arguments similar to the case where the vector  $u$  lies in the relative interior of an edge, one can show that the 2-chain

$$(1 + c_*) (p_\pi)_* (B_w(F) \cap U) + (m(e_{i-1}) + m(e_k)) \cap p_\pi(U)$$

intersects transversally  $\{\theta_F\}$  and contributes 1 to the total intersection number  $s_\Sigma \circ \tilde{s}_\Sigma^* \in \mathbb{Z}_2$ .

Now we have to deal with the case where the vectors  $w \cdot e_k$  and  $w \cdot e_{i-1}$  are not colinear of the same sign. In that case, the intersection of the 2-chain  $B_w(F)$  with a sufficiently small neighborhood  $U$  of the point  $u$  in  $W(F)$  is equal to  $B_w(F) \cap U = (C_i + u) \cap U$ , where  $C_i$  is the rational cone generated by the family  $(w \cdot e_k, -w \cdot e_{i-1})$ . Since for any  $t \in [0, 1]$ , the bases  $(\tilde{\theta}_F^{e_{i-1}}(t), w \cdot e_{i-1})$  and  $(\tilde{\theta}_F^{e_k}(t), w \cdot e_k)$  form positively oriented bases of  $W(F)$ , if the neighborhood  $U$  is small enough, the 2-chain  $(p_\pi)_* (B_w(F) \cap U) + (m_{i-1} + m_k) \cap p_\pi(U)$  is equal to  $p_\pi(U \setminus (-C_i + v))$ . Thus by adding the 2-chain  $c_* (p_\pi)_* (B_w(F) \cap U) = (p_\pi)_* ((-B_w(F) + 2\pi u) \cap U)$ , one gets that the 2-chain

$$(1 + c_*) (p_\pi)_* (B_w(F) \cap U) + (m_{i-1} + m_k) \cap p_\pi(U)$$

intersects transversally  $\{\theta_F\}$  and contributes 1 to the total intersection number  $s_\Sigma \circ \tilde{s}_\Sigma^* \in \mathbb{Z}_2$ .

We sum over all the vectors  $u$  with even coordinates lying in the the polygonal cycle  $P_w(F)$  and we obtain that the intersection number  $\tilde{\beta}_F \circ \{\theta_F\}$  is equal to  $\kappa(w)$  (see Definition 5.2). Note that for every edge  $e$  untwisted along  $\Sigma$  such that  $w \cdot e \neq 0$ , the 2-chain  $m(e)$  appears twice in the sum because the vertices  $u_0$  and  $u_1$  of the edge  $e$  have coordinates of the same parity so  $p_\pi(u_0) = p_\pi(u_1)$ . The only other contributions can come from vectors  $u \in W_\mathbb{Z}(F)$  which have even coordinates and are inside the 2-chain  $B_w(F)$ . These terms cancel out because for every vector  $u$  in the interior of  $B_w(F)$ , the opposite vector  $-u \in W(F)$  lies in the interior of the 2-chain  $B_w(F)$ , so after projecting on  $T^F$  one gets two 2-chains that are images of one

another by  $c_*$  and intersecting transversally  $\{\theta_F\}$ . These 2-chains both contribute 1 to the total intersection number, so their sum contributes 0 to the total intersection number.

Now, let us prove that for any face  $F$  of  $\Sigma$  and for any edge  $e$  of  $F$  twisted along  $\Sigma$ , the intersection number between the lift  $s_\Sigma$  and  $[x_F, x_e] \times \left(\theta_F^e + u_e(t) + \tilde{\theta}_F^e(t)\right)$  is equal to the number  $q_w(e)$  of Definition 5.3. Denoting by  $i \in \mathbb{Z}_n$  the index such that  $e_i = e$ , the intersection of the lift  $s_\Sigma$  with  $[x_F, x_{e_i}] \times T^F$  is equal to

$$s_\Sigma \cap \left([x_F, x_{e_i}] \times T^F\right) = \left\{ \left( \xi, \frac{1}{2}, \theta_F + \pi \xi \left( \frac{1}{2} w \cdot e_i + \sum_{0 \leq j \leq i-1} w \cdot e_j \right) \right) \mid \xi \in [0, 1] \right\}.$$

So the points of intersection of the 2-cycle  $\tilde{s}_\Sigma^*$  with  $s_\Sigma \cap \left([x_F, x_{e_i}] \times T^F\right)$  correspond to the points of intersection of the 1-cycle  $\left\{ \theta_F^e + u_e(t) + \tilde{\theta}_F^e(t) \mid t \in [0, 1] \right\}$  with the interval

$$\left\{ \theta_F + \pi \xi \left( \frac{1}{2} w \cdot e_i + \sum_{0 \leq j \leq i-1} w \cdot e_j \right) \mid \xi \in [0, 1] \right\}$$

in  $T^F$ . Yet, one has  $\theta_F^{e_{i-1}} = \theta_F + \pi \sum_{0 \leq j \leq i-1} w \cdot e_j$  and one can assume that the map  $t \mapsto \tilde{\theta}_F^{e_i}(t)$  is constant to an arbitrary small vector  $\tilde{\theta}_F^{e_i}$  forming a positively oriented basis  $(\tilde{\theta}_F^{e_i}, w \cdot e_i)$  of  $W(F)$  without modifying the number of points of intersection. So this number of points of intersection is equal to the number of points of intersection of the 1-cycle  $\left\{ \theta_F^e + u_e(t) + \tilde{\theta}_F^e(t) \mid t \in [0, 1] \right\}$  with the interval

$$\left[ 0, \pi \left( \frac{1}{2} w \cdot e_i + \sum_{0 \leq j \leq i-1} w \cdot e_j \right) \right]$$

in  $T^F$ , that is,  $q_w(e_i)$  by Definition 5.3.

As a conclusion, for any face  $F$  of  $\Sigma$ , the number of points of intersection between the lift  $s_\Sigma$  and the 2-chain  $\tilde{s}_\Sigma^*$  in the building-block  $S_F$  is equal to

$$\kappa(w) + \sum_{e \in \mathcal{T}_c(\Sigma) \cap \mathcal{C}_1(F)} q_w(e).$$

Thus, this number of points of intersection is equal to  $1 \in \mathbb{Z}_2$  if and only if the face  $F$  is  $w$ -twisted along  $\Sigma$ . Since for any edge  $e$  of  $\Sigma$ , there is a point of intersection in the building-block  $S_e$  if and only if the edge  $e$  is twisted along  $\Sigma$ , by summing over all faces  $F$  and all edges  $e$  of  $\Sigma$  one obtains the equation of the statement.  $\square$

*Example 5.4.* Coming back to Example 5.1, under the hypotheses of Proposition 5.7, the situation represented in Figure 5.1 is not local obstruction to type  $I$ , since there are an odd number of twisted edges along the topological sphere  $\Sigma$ , but also an odd number of  $w$ -twisted faces for the following choice of co-cycle  $w \in H_{cell}^1(\Sigma; W_{\mathbb{Z}})$ . For any oriented edge untwisted along  $\Sigma$ , we set  $w \cdot e = 0$  and for any oriented edge twisted along  $\Sigma$ , we set  $w \cdot e = \vec{e}$ , where  $\vec{e}$  is the primitive vector in  $W_{\mathbb{Z}}(e)$  whose sign coincides with the orientation of the edge  $e$ . In fact, the two horizontal triangles are trivially not  $w$ -twisted along  $\Sigma$ , because they do not have any twisted

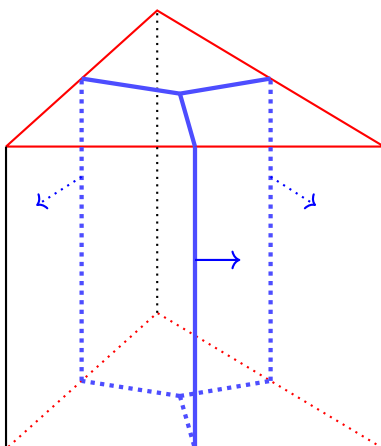

Figure 5.5: Local obstruction to type  $I_{wu}$  is true. The twisted edges are in red and the dual  $(1, 1)$ -cycle is in blue.

edge along  $\Sigma$ , and the three vertical edge are  $w$ -twisted along  $\Sigma$  by the first case of Example 5.3. In particular, this example shows that non-maximal surfaces of degree 4 in  $\mathbb{P}^3$  of type  $I$  can be realized by primitive combinatorial patchworking. In fact, one only needs to insert the dual triangulation described in Example 5.1, as the star of the vertex  $(x, y, z) = (1, 1, 1)$ , complete it to a primitive triangulation of the tetrahedron  $\Delta = \text{conv}(\{(0, 0, 0), (4, 0, 0), (0, 4, 0), (0, 0, 4)\})$  and then choose arbitrary signs on the remaining vertices of  $\Delta \cap \mathbb{Z}^3$ .

*Example 5.5.* Let us describe an example of a surface of degree 4 in  $\mathbb{P}^3$  constructed by primitive patchworking, neither of type  $I$  nor maximal. We consider the same topological sphere as in Examples 5.1 and 5.3, but with a different set of twisted edges, the complementary set to be precise. The sphere  $\Sigma$  is depicted in Figure 5.5 with the twisted edges in red and the dual  $(1, 1)$ -cycle in blue. There are 6 twisted edges and 5  $w$ -twisted faces along  $\Sigma$  for the following choice of co-cycle  $w \in H_{cell}^1(\Sigma; W_{\mathbb{Z}})$ . For any oriented edge untwisted along  $\Sigma$ , we set  $w \cdot e = 0$ , and for any oriented edge twisted along  $\Sigma$ , we set  $w \cdot e = \vec{e}$ , where  $\vec{e}$  is the primitive vector in  $W_{\mathbb{Z}}(e)$  whose sign coincides with the orientation of the edge  $e$ . In fact, the two horizontal triangles are  $w$ -twisted along  $\Sigma$  by Example 5.2, and the three vertical squares are also  $w$ -twisted by the first case of Example 5.3. Thus, by Proposition 5.7, the intersection number  $[s_{\Sigma}] \circ [\mathbb{R}S_X]$  is odd and by Proposition 5.6, a phase tropical surface containing  $\Sigma$  with a real structure yielding this set of twisted edges cannot be of type  $I_{wu}$ . This situation may also arise in the primitive combinatorial patchwork. We consider the same triangulation as in Example 5.1 but the signs of the vertices are different in order to get the appropriate set of twisted edges. Take the points  $(x, y, z \pm 1)$  to have the same sign and take all the signs of the vertices in the horizontal plane of height  $z$  to be equal.

To conclude this chapter, let us discuss some of the directions in which this work could be carried further. First, we should write a complete proof that our results actually apply to the case of primitive combinatorial patchworking (as claimed in Examples 5.4 and 5.5). Second, we could try to obtain a better formulation for Proposition 5.7, so that the criterion for type  $I_{wu}$  would be easier to apply. In particular, we should try to get rid of some hypotheses in Propositions 5.6 and

5.7. The next step would be to determine exactly which orientable topological surfaces (seen as embedded in a hypersmooth tropical surface with polyhedral combinatorial stratification) with a set of twisted edges (satisfying the co-cycle condition of Proposition 3.11) are local obstruction to type  $I_{wu}$ . Another interesting question is whether any set of twisted edges satisfying the co-cycle condition is realizable or not. An interesting case is when the tropical surface  $X$  is embedded in a smooth tropical toric variety of dimension 3. In this case there are surely some additional restrictions, similar to the notion of *twist admissible set* in the case of curves in the plane (see [8]). Another direction would be to try to find a criterion for maximality, similar to the proof of Haas's theorem in [7]. A promising approach is to study the connections between Chapter 3 with Kalinin spectral sequence (see for example [19]) and A. Renaudineau and K. Shaw's spectral sequence (see [34]). An intermediate step in this process is to better understand the action of the conjugation on the lifts of tropical  $(1, 1)$ -cycles. Finally, it would be interesting to know which results can be carried over to higher dimensions.



## References

- [1] Lars V. Ahlfors. Open riemann surfaces and extremal problems on compact subregions. *Comment. Math. Helv.*, 24:100–134, 1950.
- [2] Charles Arnal. *Patchworking, tropical homology, and Betti numbers of real algebraic hypersurfaces*. Phd thesis, Sorbonne Université, 2020.
- [3] Charles Arnal, Arthur Renaudineau, and Kristin Shaw. Lefschetz section theorems for tropical hypersurfaces, 2019. [arXiv:1907.06420](https://arxiv.org/abs/1907.06420).
- [4] Vladimir I. Arnold. On the location of ovals of real algebraic plane curves, involutions on 4-dimensional smooth manifolds, and the arithmetic of integral quadratic forms, functional analysis and its applications. *Functional Analysis and its Applications*, pages 1–9, 1971.
- [5] Michel Atiyah and Isadore Singer. Index of elliptic operators : III. *Annals of Mathematics*, 87(3):546–604, 1968.
- [6] Benoit Bertrand. Euler characteristic of primitive T-hypersurfaces and maximal surfaces. *Journal of the Institute of Mathematics of Jussieu*, 9(1):1–27, 2010. doi:10.1017/S1474748009000152.
- [7] Benoit Bertrand, Erwan Brugallé, and Arthur Renaudineau. Haas' theorem revisited. *Épjournal de Géométrie Algébrique*, Volume 1, sep 2017. URL: <https://doi.org/10.46298/2Fepiga.2017.volume1.2030>, doi:10.46298/epiga.2017.volume1.2030.
- [8] Erwan Brugallé, Ilia Itenberg, Grigory Mikhalkin, and Shaw Kris. Brief introduction to tropical geometry. *Proceedings of Gökova Geometry-Topology Conference*, pages 1–75, 2014.
- [9] Alex Degtyarev. Stiefel orientations on a real algebraic variety. *Proc. of the Rennes Conf. on Real Alg. Geom. Lect. Notes in Math.*, 1524:205–220, 1992. doi:10.1007/BFb0084621.
- [10] Alexandre Gabard. Sur la représentation conforme des surfaces de riemann à bord et une caractérisation des courbes séparantes. *Commentarii Mathematici Helvetici*, 81:945–964, 01 2006. doi:10.4171/CMH/82.
- [11] Bertrand Haas. *Real algebraic curves and combinatorial constructions*. thèse doctorale, Université de Strasbourg, 1997.
- [12] Axel Harnack. Über die vieltheiligkeit der ebenen algebraischen curven. *Mathematische Annalen*, 10:189–198, 1876.
- [13] Allen Edward Hatcher. Concordance spaces, higher simple-homotopy theory, and application. In *Proceedings of Symposia in Pure Mathematics*, volume 32. American Mathematical Society, 1978.
- [14] Ilia Itenberg. Topology of real algebraic t-surfaces. *Revista Matemática de la Universidad Complutense de Madrid*, 10(Supl.):131–152, 1997. URL: <http://eudml.org/doc/44256>.
- [15] Ilia Itenberg, Ludmil Katzarkov, Grigory Mikhalkin, and Ilia Zharkov. Tropical homology. *Mathematische Annalen*, 374:963–1006, 2019. doi:10.1007/s00208-018-1685-9.



- [16] Philipp Jell, Johannes Rau, and Kristin Shaw. Lefschetz (1,1)-theorem in tropical geometry. *Epijournal de géométrie algébrique*, 2(11), 2018.
- [17] Philipp Jell, Kristin Shaw, and Jascha Smacka. Superforms, tropical cohomology, and poincaré duality. *Advances in Geometry*, 19(1):101–130, 2018. URL: <https://doi.org/10.1515/advgeom-2018-0006>, doi:doi:10.1515/advgeom-2018-0006.
- [18] Klaus Jänich and Erich Ossa. On the signature of an involution. *Topology*, 8(1):27–30, 1969. doi:10.1016/0040-9383(69)90027-5.
- [19] I. O. Kalinin. Cohomology of real algebraic varieties. *Journal of Mathematical Sciences*, 131:5323–5344, 2005.
- [20] Gabriel Kerr and Ilia Zharkov. Phase tropical hypersurfaces. *Geometry & Topology*, 22(6):3287 – 3320, 2018. doi:10.2140/gt.2018.22.3287.
- [21] Viatcheslav Kharlamov and Alex Degtyarev. Topological properties of real algebraic varieties : du côté de chez Rokhlin. *Uspekhi matematicheskikh nauk*, (2):546–604, 2000. Engl. transl. in Russian mathematical surveys.
- [22] Felix Klein. Über eine neue art von riemann’schen fläschen. *Mathematische Annalen*, 10:398–416, 1876.
- [23] Mario Kummer and Kristin Shaw. The separating semigroup of a real curve. *Annales de la Faculté des sciences de Toulouse : Mathématiques*, Ser. 6, 29(1):79–96, 2020. URL: <https://afst.centre-mersenne.org/articles/10.5802/afst.1624/>, doi:10.5802/afst.1624.
- [24] Diane Maclagan. Introduction to tropical algebraic geometry, 2012. arXiv:1207.1925.
- [25] Diane Maclagan and Bernd Sturmfels. *Introduction to Tropical Geometry*, volume 161 of *Graduate Studies in Mathematics*. American Mathematical Society, Providence, RI, 2015.
- [26] G. Mikhalkin and I. Zharkov. *Tropical Eigenwave and Intermediate Jacobians*. Preprints of the Max-Planck-Institut für Mathematik: Max-Planck-Institut für Mathematik. Max-Planck-Inst. für Mathematik, 2013. URL: <https://books.google.fr/books?id=JVzuvgEACAAJ>.
- [27] Grigory Mikhalkin. Decomposition into pairs-of-pants for complex algebraic hypersurfaces. *Topology*, 43(5):1035–1065, 2004.
- [28] Grigory Mikhalkin. Enumerative tropical algebraic geometry in  $\mathbb{R}^2$ . *Journal of the American Mathematical Society*, 19(2):313–377, 2005.
- [29] Grigory Mikhalkin. Tropical geometry and its applications. *International Congress of Mathematicians*, 2, 02 2006.
- [30] Grigory Mikhalkin and Johannes Rau. *Tropical Geometry*.
- [31] Stepan Yu. Orevkov. Algebraically unrealizable complex orientations of plane real pseudo-holomorphic curves, 2021. arXiv:2010.09130.

- [32] Orlik Peter and Hiroaki Terao. *Arrangements of hyperplanes*. Springer Verlag, 1992.
- [33] Johannes Rau, Arthur Renaudineau, and Kris Shaw. Real phase structures on matroid fans and matroid orientations. *Journal of the London Mathematical Society*, 106(4):3687–3710, 2022. doi:10.1112/jlms.12671.
- [34] Arthur Renaudineau and Kristin Shaw. Bounding the betti numbers of real hypersurfaces near the tropical limit, 2019. arXiv:1805.02030.
- [35] Helge Ruddat. A homology theory for tropical cycles on integral affine manifolds and a perfect pairing. *Geometry & Topology*, 25(6):3079–3132, 2021. doi:10.2140/gt.2021.25.3079.
- [36] Kristin Shaw. *Tropical intersection theory and surfaces*. Phd thesis, Université de Genève, 2011.
- [37] Oleg Viro. Introduction to topology of real algebraic varieties. URL: <http://www.math.stonybrook.edu/~oleg/easymath/es/es.html>.
- [38] Oleg Viro. Patchworking real algebraic varieties, 2006. arXiv:math/0611382.
- [39] Oleg Ya. Viro. Complex orientations of real algebraic surfaces. *Uspekhi Mat. Nauk*, 37(4), 1982. Russian.
- [40] George Wilson. Hilbert’s sixteenth problem. *Topology*, 17:53–73, 1977.