



HAL
open science

Développement de techniques de planification multi-agent basées sur la modélisation des processus et l'analyse des risques : le cas des dispositifs d'intervention face aux crises environnementales et humanitaires

Cendrella Chahine

► **To cite this version:**

Cendrella Chahine. Développement de techniques de planification multi-agent basées sur la modélisation des processus et l'analyse des risques : le cas des dispositifs d'intervention face aux crises environnementales et humanitaires. Autre. Institut National Polytechnique de Toulouse - INPT, 2022. Français. NNT : 2022INPT0073 . tel-04248110

HAL Id: tel-04248110

<https://theses.hal.science/tel-04248110v1>

Submitted on 18 Oct 2023

HAL is a multi-disciplinary open access archive for the deposit and dissemination of scientific research documents, whether they are published or not. The documents may come from teaching and research institutions in France or abroad, or from public or private research centers.

L'archive ouverte pluridisciplinaire **HAL**, est destinée au dépôt et à la diffusion de documents scientifiques de niveau recherche, publiés ou non, émanant des établissements d'enseignement et de recherche français ou étrangers, des laboratoires publics ou privés.



Université
de Toulouse

THÈSE

En vue de l'obtention du

DOCTORAT DE L'UNIVERSITÉ DE TOULOUSE

Délivré par :

Institut National Polytechnique de Toulouse (Toulouse INP)

Discipline ou spécialité :

Génie Industriel

Présentée et soutenue par :

Mme CENDRELLA CHAHINE

le vendredi 18 novembre 2022

Titre :

Développement de techniques de planification multi-agent basées sur la modélisation des processus et l'analyse des risques : le cas des dispositifs d'intervention face aux crises environnementales et humanitaires

Ecole doctorale :

Systemes (EDSYS)

Unité de recherche :

Laboratoire Génie de Production de l'ENIT (E.N.I.T-L.G.P.)

Directeurs de Thèse :

M. FRANÇOIS PERES

M. MOHAMAD EL FALOU

Rapporteurs :

MME ZINEB SIMEU-ABAZI, UNIVERSITE GRENOBLE ALPES

M. M'HAMMED SAHNOUN, CESI ROUEN

Membres du jury :

M. PIERRE DEHOMBREUX, UNIVERSITE DE MONS, Président

M. FRANÇOIS PERES, ECOLE NATIONALE D'INGENIEURS DE TARBES, Membre

M. MOHAMAD EL FALOU, CESI ROUEN, Membre

MI. THIERRY VIDAL, ECOLE NATIONALE D'INGENIEURS DE TARBES, Membre

Abstract — Today’s society is increasingly seeking to ensure the constant safety of its inhabitants, for their lives, their health, their material goods and for the maintenance of common infrastructures. The objective of crisis management is to limit the impact of an event and to restore the conditions corresponding to a nominal situation. In this context, we will focus on the management of emergency services in crises such as terrorist attacks, earthquakes, etc. Response plans are available in a textual format defining the actors involved and their roles. In order to provide a global view of the collaboration between emergency services, we have established models distinguishing between decisional, operational and informational task sets. These models were built using the BPMN (Business Process Model and Notation) standard. On the basis of this representation, a dysfunctional analysis was carried out from a FMEA (Failure Mode, Effects and Criticality Analysis) in order to identify and better anticipate the events likely to disrupt the intervention plan. The rest of the work is in the field of planning and scheduling under temporal uncertainties. The existing intervention plans are intended to guarantee the mobilization of resources and the operational organization of the rescue. In this field, it is also important to distinguish the preparation phase upstream of the intervention plans, which will try to anticipate most of the possible situations, from the plans execution which will have to be able to adapt to the unforeseen events of the real situation, and thus envisage degraded modes. We focus our efforts on proactive, reactive and progressive approaches that seem to fit well in this context. The first one takes into account the uncertainties from the offline construction phase. In the second approach, a predictive plan, built off-line without accounting for uncertainties, will be completed by different reactive algorithms executed online to correct inconsistencies in the initial plan inducing a re-planning. In the third approach, the plan is generated in the short term, which allows the plan to be planned and executed online.

Generally, in planning the number of actions needed to reach the goal is unknown. In scheduling, we know exactly how many tasks to execute. In our project, we are between the two because we can have a global idea of the plan size and we don’t know at the beginning what we will execute. Each actor in an emergency plan has a library of standard plans. We use a plan insertion algorithm to select from the standard plans the ones that can be used to achieve the objective. The multi-agent system is a decision support tool that allows us to simulate our scenario in both semi-centralized and decentralized aspects in order to compare the behavior of the agents by giving them a level of autonomy.

In this thesis, we aim to test distributed strategies to generate and execute emergency plans in a terrorist attack scenario. In this context, we propose a dynamic multi-agent planning system that focuses on the response phase in a rescue plan where the reaction must be fast and efficient as much as possible in order to minimize human losses.

Résumé — Notre société actuelle cherche de plus en plus à assurer une sécurité constante à ses habitants, tant pour leur vie, leur santé, leurs biens matériels que pour le maintien des infrastructures communes. La gestion de crise a pour objectif de limiter l'impact d'un évènement redouté avéré et de rétablir les conditions correspondant à une situation nominale. Dans cette thèse, nous nous intéressons à la gestion des secours dans les crises telles que les attentats terroristes, les séismes, etc. Les plans d'intervention sont disponibles dans un format textuel définissant les acteurs impliqués et leurs rôles. Afin de fournir une vue globale de la collaboration entre les services de secours, nous avons établi des modèles distinguant les ensembles des tâches : décisionnel, opérationnel et informationnel. Ces modèles ont été construits à partir du standard BPMN (Business Process Model and Notation). Sur la base de cette représentation, une analyse dysfonctionnelle a été effectuée à partir d'une analyse AMDEC (Analyse les Modes de Défaillance, leurs Effets et leur Criticité) dans l'optique d'identifier pour mieux anticiper les événements susceptibles de perturber le plan d'intervention. La suite du travail s'inscrit dans le domaine de planification sous incertitudes. Les plans d'intervention qui existent sont destinés à garantir la mobilisation des ressources et l'organisation opérationnelle des secours. Dans ce domaine, il est également important de distinguer la phase de préparation en amont des plans d'interventions, qui va tâcher d'anticiper la plupart des situations possibles, de l'exécution des plans qui devront pouvoir s'adapter aux imprévus de la situation réelle, et envisager donc des modes dégradés. Nous concentrons nos efforts sur des approches de type proactive, réactive et progressive qui semblent pouvoir bien s'adapter à ce contexte. La première prend en compte les incertitudes dès la phase de construction hors ligne. Dans la seconde approche, un plan prédictif, construit hors ligne sans tenir compte des incertitudes, sera complété par différents algorithmes réactifs exécutés en ligne pour corriger des incohérences dans le plan initial induisant une re planification. Dans la troisième approche le plan est généré à court terme, ce qui permet de planifier et d'exécuter le plan en ligne.

Généralement, en planification le nombre des actions nécessaires afin d'atteindre l'objectif est inconnu. Ainsi qu'en ordonnancement, nous savons exactement le nombre de tâche à exécuter. Dans notre projet, nous sommes entre les deux car nous pouvons avoir une idée globale de la taille du plan et nous ne savons pas au départ qu'est-ce que nous allons exécuter. Chaque acteur de plan d'intervention a une bibliothèque des plans types. Nous utilisons un algorithme d'insertion de plans afin de choisir parmi les plans types ceux qui peuvent servir à atteindre l'objectif. Le système multi-agents est un outil d'aide à la décision qui nous permet de simuler notre scénario dans les deux aspects semi-centralisé et décentralisé afin de comparer les comportements des agents en leur donnant un niveau d'autonomie.

Dans cette thèse, nous visons à tester des stratégies distribuées pour générer et exécuter des plans d'urgence dans un scénario d'attaque terroriste. Dans ce contexte, nous proposons un système de planification multi-agent dynamique qui se concentre sur la phase de réponse

dans un plan de sauvetage où la réaction doit être rapide et efficace autant que possible afin de minimiser les pertes humaines.

Dedicated to my family and to the memory of my grandfather Antoine.

Aknowledgments

Completing this research work has been one of the most challenging academic endeavors I have ever had, with ups and downs and twists and turns along the way, but one that has given me a remarkable experience. At the end of my thesis journey, it is essential to express my thanks to all those who contributed in various ways to the success of this study and who made this adventure an unforgettable moment.

First of all, I would like to warmly thank my co-directors, François Pérès and Mohamad El Falou, and my co-supervisor Thierry Vidal, for their help, their availability, their kindness, their moral and technical support, and the trust they have given me. Their wise advice and constructive remarks allowed me to develop my scientific skills. I was delighted to realize this work with you.

I would like to thank Mrs. Zineb Simeu-Abazi and Mr. M'hammed Sahnoun for the honor they have given me by accepting to be the reviewers of this thesis. I would also like to express my gratitude to Mr. Pierre Dehombreux and Mr. Thierry Vidal who accepted to participate in my thesis jury. A special thanks to Mr. Thierry Vidal for sharing his ideas and helpful suggestions for my work, for the fruitful discussions, and his willingness to help and meet me whenever I need some clarification.

I am extremely grateful to all the members of the Lebanese Red Cross, especially to Mr. Roger Bafitos, the head of the Northern Governorate, who helped me find answers to my questions about the Lebanese emergency plans that are not available in text format.

This research is a collaboration between the Production Engineering Laboratory in France and the laboratory of the Lebanese-French University in Lebanon. My thanks go to the staff members of the two laboratories for their welcome and their help.

I am also deeply thankful to all my colleagues and friends for their support during my thesis through very fruitful discussions and continuous moral support, especially Maroua, Matthieu, Meriem, Pierre, Sylvain, Amina, Nesrine and Rami.

I do not forget, of course, my family who supported me in the good and bad moments of the thesis and who always knew how to be there for me. I take this opportunity to thank my father Sami, my mother Roula and my brothers Roy and Rudy.

Finally, I would like to thank all the people who have contributed, from near or far, to the realization of this work.

Thank you!

Contents

Introduction	1
1 Domain analysis and State-of-the-Art	7
1.1 Introduction	8
1.2 Crisis management: motivation and State-of-the-Art	8
1.2.1 Crisis	8
1.2.2 Victims	9
1.2.3 Hazard and stake	10
1.2.4 Vulnerability	10
1.2.5 Risk	11
1.2.6 Crisis management	12
1.2.7 Emergency plan	14
1.3 Crisis typology	15
1.4 Crisis response level	17
1.4.1 Strategic level	17
1.4.2 Tactical level	17
1.4.3 Operational level	17
1.5 Decision	18
1.5.1 Decision Support System (DSS)	20
1.6 Dedicated work and scientific challenges	21
1.7 Terrorist attack scenario	25
1.7.1 Description	25

1.7.2	Challenges and thesis objectives	28
1.8	Conclusion	28
2	Process modelling and vulnerability assessment	31
2.1	Introduction	32
2.2	Emergency response plan: state-of-the-art	32
2.2.1	The chain care for victims in Lebanon and France	34
2.3	Functional modelling	37
2.3.1	BPMN	37
2.3.2	UML-AD	40
2.3.3	SADT	41
2.3.4	Comparison Between BPMN, UML-AD and SADT	41
2.4	Emergency response plan modelling	43
2.4.1	Notion of business process	43
2.4.2	Introduction to decisional, operational and informational levels	44
2.4.3	ORSEC plan services	45
2.4.4	ORSEC plan modelling	46
2.5	Dysfunctional modelling	53
2.5.1	FMECA	53
2.5.2	Fault tree	54
2.6	FMECA of the ORSEC plan	56
2.6.1	Failure modes	56
2.6.2	Causes	57
2.6.3	Effects	61
2.6.4	Criticality	64

2.7	Vulnerability assessment of an emergency response plan	66
2.7.1	Codification of a function	66
2.8	Application of terrorist attack scenario	68
2.8.1	Functional modelling	69
2.8.2	Dysfunctional modelling	75
2.8.3	Vulnerability indicators	75
2.8.4	Causes and failure modes	76
2.8.5	Failure modes and effects	78
2.9	Conclusion	80
3	State-of-the-Art: MAS and planning and scheduling	83
3.1	Introduction	83
3.2	State-of-the-art: multi-agent systems	84
3.2.1	Definition of agents	84
3.2.2	Environment properties	85
3.2.3	Definition of Multi-agent system	86
3.2.4	Mechanisms of interactions	86
3.2.5	JADE framework	87
3.3	Path planning	90
3.3.1	Dijkstra algorithm	91
3.3.2	A star algorithm	92
3.4	State-of-the-art: planning and scheduling	95
3.4.1	Planning vs scheduling	95
3.4.2	Classical planning	95
3.4.3	Temporal planning	98

3.4.4	Planning under uncertainty	100
3.4.5	Classification of techniques for dynamic planning	101
3.4.6	Multi-agent planning	106
3.5	Conclusion	110
4	Terrorist attack scenario: Planning and scheduling and MAS	111
4.1	Introduction	111
4.2	What do we consider as an agent?	112
4.2.1	Homogeneous agents vs heterogeneous agents	113
4.3	Planning and scheduling: where are we?	114
4.4	Formal framework	114
4.4.1	Definitions	115
4.4.2	Model description	120
4.5	Link between design level and simulation level	132
4.5.1	FMECA	134
4.5.2	Library of standard plan	135
4.6	Algorithms	136
4.6.1	Assignment algorithm	137
4.6.2	Insertion of plans	138
4.6.3	FastIDC algorithm	138
4.7	Conclusion	141
5	Experimental environment	145
5.1	Introduction	145
5.2	The distribution of decisions between agents	146

5.3	Decisions type	147
5.4	The representation of the semi-centralized architecture and the decentralized architecture	148
5.4.1	Dynamic multi-agent planning and scheduling techniques	149
5.5	Simulation level: general architecture	150
5.6	Simulation level: our scenario's implementation	151
5.6.1	Scenario's information	151
5.6.2	Assignment results	153
5.7	Communication	159
5.8	Uncertainty	159
5.9	Comparison between the two architectures	163
5.10	Conclusion	167
6	Conclusions and perspectives	169
	Bibliography	172
	Bibliography	173
A	Appendix	187
A.1	Security centre	187
A.2	Firefighter department	187
A.3	Ambulance centre	190
A.4	Security officers	191
A.5	Ambulances	194
A.6	Hospitals	195
A.7	Firefighters	196

A.8	Central agent	197
A.9	PMA	199
B	Appendix	205
B.1	Security centre agent	205
B.2	Fire department agent	207
B.3	Ambulance centre agent	207
B.4	Security agent	207
B.5	Ambulance agent	209
B.6	Hospital agent	211
B.7	Firefighter agent	212
B.8	Central agent	213
B.9	PMA agent	213

List of Figures

1.1 Risk representation	12
1.2 crisis management cycle.	14
1.3 crisis response level.	18
1.4 The city of our scenario	26
1.5 Graphical representation of distance in our scenario	27
2.1 Crisis response levels commanders	35
2.2 Care of victims in France and Lebanon	36
2.3 Examples of process diagrams (Von Rosing et al., 2014)	37
2.4 An example of a collaboration diagram (Von Rosing et al., 2014)	38
2.5 An example of a conversation diagram (Von Rosing et al., 2014)	38
2.6 BPMN conversation description (Von Rosing et al., 2014)	38
2.7 An example of a choreography diagram (Von Rosing et al., 2014)	39
2.8 BPMN core elements of process diagram. (Kluza et al., 2017)	39
2.9 UML-AD elements. (Amici et al., 2022)	41
2.10 SADT activity’s concept (Congram and Epelman, 1995)	42
2.11 Activity color legend	44
2.12 Generic model: the interaction between the three levels	45
2.13 The ORSEC plan services at the three levels	46
2.14 Alert centre’s process	47
2.15 Emergency services’ process	47
2.16 COD’s process	48
2.17 PCO’s process	49

2.18 Pickup sector's process	50
2.19 PMA's process	51
2.20 LRI's process	52
2.21 Mortuary's process	52
2.22 The process of evacuation sector and health care centre	53
2.23 FMECA table example ¹	54
2.24 the three fundamental gates in a fault tree	55
2.25 The events in a fault tree	55
2.26 Examples of fault tree structures	56
2.27 Structure of the identification of causes	57
2.28 Level I causes	58
2.29 An example of the level I causes for an operational activity	58
2.30 Level II causes	59
2.31 An example of the level II causes for an operational activity	59
2.32 Level III causes	60
2.33 An example of the level III causes for an operational activity	60
2.34 Level of causes	61
2.35 Level I consequences	62
2.36 An example of the level I consequences for an operational activity	62
2.37 Level II consequences	63
2.38 An example of the level II consequences for an operational activity	63
2.39 Level III consequences	64
2.40 An example of the level III consequences for an operational activity	64
2.41 Level of consequences	65

2.42	Codification of a function	67
2.43	An example of the vulnerability indicators for three different activities	67
2.44	Operational actors in France, Lebanon and our scenario	70
2.45	Centres representation in both semi-centralized and decentralized architectures	71
2.46	Security officers' missions in the two architectures	72
2.47	Firefighters' missions in the two architectures	72
2.48	Ambulances' missions in both architectures	73
2.49	Hospitals' missions in both architectures	73
2.50	PMA missions in both architectures	74
2.51	Central agent missions	75
2.52	PMA's FMECA table in the decentralized architecture	76
2.53	Causes-Failure modes table	77
2.54	Bar graph of the causes-failure modes relationship	77
2.55	Pie chart of the duration of causes	78
2.56	Pie chart of the origin of the causes	78
2.57	A histogram of the percentage of causes for each failure mode	79
2.58	Failure modes-Effects table	79
2.59	Bar graph of the failure modes-effects relationship	79
2.60	Pie chart of the duration of effects	80
2.61	Pie chart of the origin of the effects	80
2.62	A histogram of the percentage of effects for each failure mode	81
3.1	FIPA Agent Management Reference model	88
3.2	ACL message elements	89
3.3	An example of the Dijkstra algorithm	92

3.4	Dijkstra algorithm diagram	93
3.5	A* algorithm diagram	94
3.6	An example of the A* algorithm	94
3.7	Graphplan example	97
3.8	Resource allocation example	101
3.9	Proactive example of M2 plan	102
3.10	Reactive example of M2 plan	103
3.11	Progressive example	104
3.12	Proactive-reactive approach example	105
3.13	Proactive-progressive approach example	105
3.14	Reactive-progressive technique example	106
3.15	Proactive-reactive-progressive technique example	106
3.16	Centralized planning for distributed plans	107
3.17	Distributed planning for centralized plans	107
3.18	Distributed planning for distributed plans	108
3.19	Decoupling a 2 agent MaSTN (Mogali et al., 2016)	109
4.1	Agents in semi-centralized and decentralized architectures	113
4.2	Action's representation	116
4.3	Action in PDDL 2.1	116
4.4	The action loadVictim in PDDL 2.1 (Soubaras et al., 2013)	116
4.5	Bob's standard plan: to get ready	118
4.6	Bob's local plan	119
4.7	SC actions in BPMN	122
4.8	S action in BPMN	124

4.9	Ambulance's actions in BPMN	126
4.10	Hospital's actions in BPMN	128
4.11	F action in BPMN	129
4.12	PMA's actions in BPMN	131
4.13	Central agent's action in BPMN	132
4.14	Design level vs Simulation level	134
4.15	E: Library of standard plans in a decentralized architecture	136
4.16	Assign centres to site algorithm	137
4.17	Assignment of hospitals by distance	139
4.18	Assignment of hospitals by experience and distance	139
4.19	InsertionPlan algorithm	140
4.20	The derivedStandardPlan(L,s) method	141
4.21	FastIDC rules (Nilsson et al., 2016)	142
4.22	FastIDC algorithm	143
5.1	Decisions distribution	146
5.2	Example of centralized, semi-centralized and decentralized architectures	147
5.3	Semi-centralized architecture	149
5.4	Decentralized architecture	150
5.5	Global simulation architecture	151
5.6	Admin agent's GUI	152
5.7	Admin agent's GUI: Enter manually the information	152
5.8	Agents information in our scenario	153
5.9	Injured of the terrorist attack scenario	154
5.10	Agents assignment to the site	155

5.11	List of injured from the PMA agent	156
5.12	Assignment method of figure 4.17	157
5.13	Assignment method of figure 4.18	157
5.14	An example of the arrival of the ambulance agents at the site	159
5.15	An example of the assignment of the casualties to ambulance agents according to figures 5.12 and 5.14	160
5.16	Example of the new assignment of casualties to ambulance agents	161
5.17	Communication between the centres and the central agent	162
5.18	Communication between <i>m14</i> and <i>H1</i>	163
5.19	Find a road by an ambulance agent	164
5.20	Assignment of the new injured	165
5.21	A representation of the decentralized architecture STNU	165
5.22	SC agent shares its dates with S agent	166
A.1	Security centre's FMECA table in semi-centralized architecture	188
A.2	Security centre's FMECA table in decentralized architecture	189
A.3	Firefighter department's FMECA table in semi-centralized architecture	190
A.4	Firefighter department's FMECA table in decentralized architecture	191
A.5	Ambulance centre's FMECA table in semi-centralized architecture	192
A.6	Ambulance centre's FMECA table in decentralized architecture	193
A.7	Security officers' FMECA table in both architectures	194
A.8	Ambulance's FMECA table in semi-centralized architecture	195
A.9	Ambulance's FMECA table in decentralized architecture	196
A.10	Hospital's FMECA table in semi-centralized architecture	198
A.11	Hospital's FMECA table in decentralized architecture	199

A.12 Firefighters FMECA table in both architectures	201
A.13 Central agent FMECA table	202
A.14 PMA's FMECA table in the semi-centralized architecture	203
B.1 Security centre agent's library	205
B.2 Security agent's library	208
B.3 Ambulance agent's library	209
B.4 Hospital agent's library	211
B.5 Firefighter agent's library	213
B.6 central agent's library	215
B.7 PMA's library of standard plans	217

List of Tables

1.1	Definitions of DSS	21
2.1	Information on some existing emergency plans in France	34
2.2	Code of Physical Entities	47
2.3	Problems code's category	57
2.4	Probability of occurrence level associated with the failure mode	65
2.5	Severity level associated with the failure mode	66
2.6	Criticality matrix	66
2.7	Criticality levels	66
2.8	PMA's vulnerability indicators for figure 2.52	77
3.1	Comparative table of MAS development tools (Atohoum, 2013)	90
4.1	SC actions.	123
4.2	S actions.	125
4.3	Ambulance agent's actions	127
4.4	Hospital agent's actions	128
4.5	F_j actions.	130
4.6	PMA actions.	131
4.7	central agent's actions.	133
4.8	The nomenclature of BPMN, MAS and planning and scheduling.	133
4.9	The sources of uncertainty	135
4.10	PMA: Failure modes criticality levels according to figure 2.52	135
4.11	the preconditions and effects of PMA agent's standard plans in figure 4.15	136

5.1	The main phases in different architectures	148
5.2	Comparison between the two architectures	164
A.1	Security centre’s vulnerability indicators for figure A.1	187
A.2	Security centre’s vulnerability indicators for figure A.2	188
A.3	Firefighter department’s vulnerability indicators for figure A.3	189
A.4	Firefighter department’s vulnerability indicators for figure A.4	190
A.5	Ambulance centre’s vulnerability indicators for figure A.5	191
A.6	Ambulance centre’s vulnerability indicators for figure A.6	192
A.7	Security officers vulnerability indicators for figure A.7	193
A.8	Ambulance’s vulnerability indicators for figure A.8	197
A.9	Ambulance’s vulnerability indicators for figure A.9	197
A.10	Hospital’s vulnerability indicators for figure A.10	198
A.11	Hospital’s vulnerability indicators for figure A.11	199
A.12	Firefighters vulnerability indicators for figure A.12	200
A.13	Central agent vulnerability indicators for figure A.13	200
A.14	PMA’s vulnerability indicators for figure A.14	204
B.1	SC: Failure modes criticality levels of figure A.1	206
B.2	SC: Failure modes criticality levels of figure A.2	206
B.3	the preconditions, effects and goals of security centre agent’s standard plans	206
B.4	S: Failure modes criticality levels of figure A.7	207
B.5	the preconditions, effects and goals of security agent’s standard plans	208
B.6	m: Failure modes criticality levels of figure A.8	209
B.7	m: Failure modes criticality levels of figure A.9	209

B.8	the preconditions and effects of ambulance agent's standard plans	210
B.9	H: Failure modes criticality levels of figure A.11	211
B.10	H: Failure modes criticality levels of figure A.11	211
B.11	the preconditions, effects and goals of hospital agent's standard plans	212
B.12	F: Failure modes criticality levels of figure A.12	212
B.13	the preconditions and effects of firefighter agent's standard plans	214
B.14	c: Failure modes criticality levels of figure A.13	215
B.15	the preconditions and effects of central agent's standard plans	216
B.16	E: Failure modes criticality levels according to figure A.14	216
B.17	the preconditions and effects of PMA agent's standard plans	217

List of acronyms

ACL	Agent Communication Languages
AI	Artificial Intelligence
BPMN	Business Process Model and Notation
COD	« Centre Opérationnel Départemental » (Departmental operational centre)
COS	« Commandant des opérations de secours » (commander of rescue operations)
DOS	« Directeur des opérations de secours » (Director of rescue operations)
DSM	« Directeur des secours médicaux » (Director of medical rescue)
DSIS	« directeur des secours incendie et sauvetage » (director of fire and rescue services)
DSS	Decision Support System
FIPA	Foundation for Intelligent Physical Agents
FMECA	Failure mode, effects, and criticality analysis
JADE	Java Agent DEvelopment framework
IDE	Integrated Development Environment
LRC	Lebanese Red Cross
LRI	« Lieu de regroupement des indemnes » (Meeting place for unharmed people)
MAS	Multi-agent systems
MDP	Markov Decision Problem
MHPSS	Mental health and psychosocial support services
OMG	Object Management Group
ORSEC	« Organisation de la Réponse de Sécurité Civile »
PCO	« Poste de commandement opérationnel » (Operational command centre)
PCS	« Plan Communal de Sauvegarde » (Communal safeguard plan)
PDDL	Planning Domain Definition Language
PMA	« Poste médical avancé » (Advanced Medical Post)
POI	« Plan d'Opération Interne » (Internal Operation Plan)
PPI	« Plans particuliers d'intervention » (Specific intervention plans)
PPR	« Plans de prévention des risques » (Risk prevention plans)
PRM	:"point de rassemblement des moyens" (vehicle assembly point)
PRV	« Point de Regroupement des Victimes » (Victims' Gathering Point)

RPN	Risk Priority Number
SADT	Structured analysis and design technique
SAMU	«Service d'Aide Médicale Urgente» (Urgent medical aid service)
SDIS	« service départemental d'incendie et de secours » (Departmental fire and rescue services)
SMUR	« Service Mobile d'Urgence et de Réanimation » (Mobile Emergency and Resuscitation Service)
SSSM	« service de santé et de secours médical» (health and emergency medical service)
UML-AD	Unified Modeling Language - Activity diagram
XMI	XML Metadata Interchange
XML	Extensible Markup Language

Introduction

For a long time, we have been hearing about environmental and humanitarian disasters around the world and their impact on the property, the environment and the population. The effects of human-made disasters are as significant as natural disasters. Wars, pollution, terrorist attacks, technological accidents, etc. are the effects of humans on themselves, the environment and goods. Unfortunately, whatever the nature of the disaster, and whether it is predictable or not, we often may not know its intensity. Sometimes the impact of a disaster can be limited or more global, in terms of the number of people affected, the economic cost, the geographical extent or the persistence of the hazard over a long period. Indeed, to be prepared for natural and humanitarian disasters, each community should define a rescue plan that aims to organize the actions between the actors to minimize the human loss. This plan faces uncertainties generated by dynamic disaster environment.

This thesis is a collaboration work between France and Lebanon. Both have experienced anthropic and natural disasters with very strong human and material impacts.

For example, during the evening rush hour of August 4 2020, the ammonium nitrate stored at the port of Beirut exploded, sending shockwaves throughout the city causing 204 deaths, 7,000 injured and up to 300,000 affected citizens. It was the most powerful ammonium nitrate explosion for almost one century (Yu et al., 2021). Victims at the port were hurled out to sea, trapped underground or disappeared... In addition, the infrastructures in the blast radius area and most of Beirut's health care centres were blown up. The destroyed hospitals were forced to discharge their patients and send some to other facilities. Furthermore, the occurrence of explosion in the context of covid-19, made the nearest hospitals capacity, outside the blast radius, overwhelmed by casualties transferred by volunteers and epidemic patients. In addition, due to the panic of friends and families searching for their relatives in hospitals and on site, it was difficult for responders to reach their destinations. Unfortunately, the explosion was initially reported as an incident. Thus, the first responders were a team of 10 firefighters prepared to deal with an incident. Due to misinformation, they were all dead at the time of the explosion. Finally, the response was not easy for the actors, especially because they knew some of the victims.

In France, on the night of Friday 13 November 2015, Paris was hit by six coordinated attacks that killed 130 people and injured more than 300 (Nossiter, 2015). It was a multi-site terrorist attack with mass casualties. During the intervention, stakeholders faced many challenges. According to (Franchin et al., 2016), it includes the identification of the sites concerned because of the diversity of the addresses given, the high number of victims in

several areas, the unsecured area due to the escape of some terrorists, the rapid consumption of bleeding control, and the lack of communication.

Further information on the attack and the challenges that faced the responders can be found in (Elmhadhbi, 2020). We notice that both disasters were sudden, but Beirut blast could have been avoided if ammonium nitrate had been stored in a safe place away from people, and an intervention could have taken place before the terrorist attack if the French intelligence services had been more efficient.

Although emergency response plans exist, they are intended to ensure the mobilization of resources and the operational organization of relief efforts. These plans explain how the different actors coordinate and what their missions are. In addition, each actor has a private or local plan, which is a set of actions to be performed in order to help victims and achieve a specific goal. For example, the paramedics aim to transfer victims to an appropriate hospital. To achieve this goal, they go to the disaster area, get the injured on board the ambulance and transport them to the appropriate hospitals. For a better performance, it is important to anticipate as much as possible the situations of which actors can face during their response so they can be capable of adapting to unforeseen events in the real situation. In this context, in our work, we distinguish between the preparation phase upstream of the intervention plans (plan generation) and the execution of the plans. Therefore, planning and scheduling paradigm is the perfect way to take into consideration the two phases: plan generation and plan execution. In this thesis, we seek to test distributed generation and execution strategies of emergency plans in a terrorist attack scenario. We use the multi-agent system to model the actors and their actions to test the strategies. In this context, we aim to propose a dynamic multi-agent planning system.

Our work focuses on the response phase and more specifically on the response level in a rescue plan where the reaction must be quick and efficient as much as possible in order to minimize the human loss by providing help and rescue to the injured. We are concerned with securing the area to prevent further events and, with helping and transporting the injured as fast as possible to the appropriate healthcare centre that can treat their wounds. Although a crisis has several impacts, we are interested only in human cost impact, which is a common effect regardless of the disaster's nature. In addition and, even if we consider the three hierarchical levels of a rescue plan (strategic, tactical and operational), we will focus only on the operational level. France and Lebanon have emergency plans according to the crisis type. Unlike France, there is no textual format for such a plan in Lebanon. Thus, we contacted the Lebanese Red Cross (LRC) to obtain more information on Lebanese emergency plans and studied the French generic emergency plan, ORSEC ("Organisation de la Réponse de Sécurité Civile") plan. Although they have a different way of managing a crisis, they mobilize the same actors and pursue the same objectives but with different labels and strategies specific to each

country. Yet, how can the actors' behaviour be represented in a comprehensible and global way? In order to provide a global view of the collaboration between the emergency services, we will establish a functional model (graphical representation) using BPMN (Business Process Model and Notation) standard. This representation makes it possible to clearly see the emergency services involved in a rescue plan and their missions. We chose to model the ORSEC plan because it is easily accessible to everyone. The analysis of this latter shows that the decisions are not made by the operational level's actors. They transmit information to the actors at higher levels in order to make decisions, then, the latter are performed by the actors on site (operational level). However, the ORSEC plan lists the actions to be carried out by an actor at the operational level, assuming that they are on the ground and no unforeseen event will disrupt their missions. For example, the role of an ambulance is to transfer a victim from the site to a hospital selected by the Advanced Medical Post (PMA) exit secretariat. What happens if an ambulance has had an accident before arriving at the site or at the hospital?... or if there is too much traffic and the ambulance has not arrived in time? We notice that actors at the operational level may face potential risks that can disrupt their plans. In this context, we aim to model the process dysfunctions. The dysfunctional modelling is carried out using the FMECA (Failure mode, effects, and criticality analysis) in order to identify the sources of uncertainty that can occur on each activity of the BPMN process. The functional and dysfunctional modelling constitute the design level of this work.

Based on the dramatic experiences of Beirut explosion and Paris attack, we identify some of the challenges that the emergency plan actors may face during a crisis:

- Lack of information or incorrect information (Beirut explosion's first firefighters' responders).
- Hospitals and primary care centres can be damaged or completely destroyed.
- Nearest and available health care centres can be overburdened due to:
 - the transfer of injured by inexperienced actors or volunteers on site (no distribution of casualties between hospitals).
 - another event such as COVID-19
- Hospitals may run out of beds and equipment to treat injured.
- Difficulties to reach hospitals due to crowds (victims' families)
- A disaster may occur during the existence of another crisis (Beirut explosion and COVID-19)
- A crisis may occur at a rush hour in a densely urbanised area. It may also be a multi-site crisis.
- Victims can be located in many places.
- Many of responders' families and friends can be directly affected by the disaster
- Some authorities may have a limited knowledge and experience of crisis response

- Difficulties in communication among actors
- etc.

Therefore, the response phase challenges are related to information, communication, resources and coordination. At the operational level of a crisis emergency plan, many actors intervene in order to reduce human losses such as the firefighters, the medical teams, the Police, etc. In this context, we use the multi-agent system to represent the different actors involved at this level and to simulate our scenario. Each agent (actor) executes a set of actions that form a plan in order to achieve its goal. Choosing the appropriate action, knowing when to execute it and by whom in a dynamic environment full of uncertainty require the planning and scheduling part. The combination of planning and scheduling, and multi-agent system form the simulation level of our work.

In this work, we will propose a multi-agent dynamic planning approach that will be tested in two different architectures in order to see how much autonomy we can give to an agent and how they coordinate to save the victims. This model is based on the functional and dysfunctional modelling of the response plan's operational level.

Thesis structure

The thesis structure will be organized as follows:

In chapter 1: First, we first present an analysis of the domain by defining some main terms in the field of crisis. Moreover, we give an overview about crisis characteristics, its management's phases and the three levels of organizations in rescue plan. Second, we present the different criteria that allow us to differentiate the crises. Then, we explain what is a decision and how we can define a decision support systems. Next, we expose some dedicated works and scientific challenges in the domain of crisis. Finally, we describe our terrorist attack scenario, explaining the difficulties that emergency services may face in their response and how they can confront them by defining the goals of our work.

Chapter 2 is devoted first to existing implemented emergency response plans in France and in Lebanon. We also give an overview about modelling techniques that exist in literature for functional and dysfunctional modelling. We outline a functional modelling of the ORSEC plan, using BPMN and we distinguish between three processes (Informational process, Decision-making process and Operational process). Then, we develop our dysfunctional model by identifying the failure modes, causes and effects of the ORSEC plan. We subsequently define the criticality of a failure mode. Next, we represent the indicators that are used to assess the vulnerability of an emergency response plan. Finally, we model our scenario in

functional and dysfunctional ways. For each emergency service, we analyse its vulnerability. We present the relationship between causes and failure modes to show to which failure mode most causes in a process belong and their origins. In addition, we present the relationship between failure modes and effects to show the effects associated with each failure mode in a process and their origins and type, respectively.

Chapter 3 is dedicated to the technology we will need for the simulation and decision support system, through a bibliographical analysis relating to planning, scheduling and multi-agent system. This chapter starts with the definition of an agent, the presentation of the different types of agents and the properties of an environment. In addition, we define a multi-agent system, represent the interaction mechanisms in such a system and the platform chosen to develop the simulation level i.e the JADE framework. Next, we present a state-of-the-art on planning and scheduling.

Chapter 4 develops our scenario in a formal way. We determine our scenario's agents and their roles. Then, we explain the fact that we are between planning and scheduling and we develop a formal framework which contains all the definitions required in this chapter and the algorithms that will be used to implement our scenario. Furthermore, it shows the link between our design level and our simulation level.

Chapter 5 presents the results of our scenario in both centralized and decentralized architectures and the difference between the two. Finally, we conclude this work with a synthesis of the lessons learned from the study, the limitations of our approach and the perspectives for continuing the developments undertaken.

Domain analysis and State-of-the-Art

Sommaire

1.1 Introduction	8
1.2 Crisis management: motivation and State-of-the-Art	8
1.2.1 Crisis	8
1.2.2 Victims	9
1.2.3 Hazard and stake	10
1.2.4 Vulnerability	10
1.2.5 Risk	11
1.2.6 Crisis management	12
1.2.7 Emergency plan	14
1.3 Crisis typology	15
1.4 Crisis response level	17
1.4.1 Strategic level	17
1.4.2 Tactical level	17
1.4.3 Operational level	17
1.5 Decision	18
1.5.1 Decision Support System (DSS)	20
1.6 Dedicated work and scientific challenges	21
1.7 Terrorist attack scenario	25
1.7.1 Description	25
1.7.2 Challenges and thesis objectives	28
1.8 Conclusion	28

1.1 Introduction

When a natural or human-made event occurs in a territory, the authorities responsible for crisis management intervene to ensure the safety of the population and the environment. We hear the words "crisis" and "crisis management" more and more often, especially with the increasing number of terrorist attacks around the world or the climate change effects. Their sudden nature makes them difficult to anticipate. This is why countries have taken measures to cope with the crisis and reduce its impact, such as increased security, especially at particularly exposed events or locations, administrative controls and individual surveillance measures, etc. Terrorism is a threat to vulnerable target populations. As we can see, many words are related to the crisis such as risk, vulnerability, threat, stake, prevention, decisions, etc.

In this chapter, we present the domain analysis by defining the key terms. Furthermore, we present the crisis characteristics and explain the crisis management cycle and response levels. In addition, we outline existing criteria in the literature for differentiating crises. Then, we expose decision support systems. Next, we provide an overview of the topics related to this thesis. At the end, we describe the terrorist attack scenario we will consider later on, formulating the initial problems faced by emergency services in crisis management and to highlight their needs.

1.2 Crisis management: motivation and State-of-the-Art

1.2.1 Crisis

History is like a gigantic record of archiving disasters such as droughts, earthquakes, volcanic eruptions, etc. In the ancient world, natural disasters were considered the wrath of the gods. It was believed that the sacrifices were supposed to reduce God's irritation. Thus, sacrifice has long been associated with disasters. In addition, epidemics, famines and wars were common at that time. Some authors make a distinction between the term "disaster" and the term "crisis". ([Mukhopadhyay, 2005](#), as cited in [Rongier, 2012](#)) explained the difference between crisis that is a result of human activity and disaster that is considered as a natural phenomenon. For the sake of simplicity, we will use the term crisis for both.

Crisis is a complex phenomenon whatever the field concerned (health, economic, environmental...). Indeed, no definition of crisis is universally accepted because its definition depends on the discipline that uses the term. Crisis derives from the Greek *krisis* which means decision. It has been used in many disciplines and each has developed its own spe-

cific definition. For example, it was used in medicine to refer to the sudden change in the patient's condition (Dautun, 2007). According to (Heiderich, 2010), it is the disruption of an environment by a triggering event that generates several classes of behaviour that can impact entities as varied as an organization, a structure or a territory. (Dautun, 2007) states several characteristics of large-scale crises:

- A triggering event with significant potential impact;
- Dramatic consequences;
- An organization impacted by its own vulnerabilities and destabilized due to the situation that may prevent it from acting effectively and in a timely manner.

In this context, we define a crisis as the result of an event that can be sudden and requires the coordination of disciplines to limit the consequences of the threat on human, material and economic levels.

1.2.2 Victims

Originally, the word victim comes from the Latin "victima" which means "one who was offered to God", so there is a linguistic approach with the term "sacrifice" (Damiani et al., 2003; Dahin, 2013). The term will also include, by extension, any person suffering from the acts of others (ROSOLATO, 1987; Girard, 2000). Its use remains rare before the end of the 15th century (Marzano, 2006). It was used progressively from the 18th century onwards to refer to any person killed or injured as a result of a cataclysm, an accident or any type of violence. Nowadays, this meaning is dominant but the old value remains active when the term is applied to a voluntary human decision (ROSOLATO, 1987; Girard, 2000). In present times, this term is used by most encyclopaedias and dictionaries to describe people who have suffered serious physical injuries (Marzano, 2006). The latter define a victim as someone who suffers violence or injustice at the hands of someone else, or suffers as a result of adverse events, or dies as a result of an accident or illness, etc.

The use of the word victim to define anyone who suffers harm or damage has trivialized the concept. In this work, we use the term victim to refer to people who have suffered moral, health and material losses, as well as those who have been killed. There are three types of victims: direct, indirect and deferred victims. Direct victims are those present on site at the time of the event. Deferred victims are those who came to the site after the event such as the responders (the Police, the medical team, etc.) and are likely to be psychologically affected afterwards. Indirect victims are those who know a direct victim. Note that a victim can be deferred and indirect at the same time. For example, a responder may know a direct victim

(a member of his/her family or friend, etc.).

1.2.3 Hazard and stake

An event modifies the system's state. Hazard relates to the probability of occurrence and the intensity of an event. (Wells, 1997) defines hazard as "something that can cause harm". (Chicken and Posner, 1998) consider it as the way in which something or a situation can cause harm. The notion of hazard can refer either to the characteristics of a phenomenon, or to the probability of occurrence and intensity of a phenomenon in a given area during a certain period of time (Dauphiné and Provitolo, 2013). In our work, hazard is considered as the danger's source characterized by its dangerousness. The latter is defined by the probability of intensity and the probability of occurrence of an event. Hazard intensity is the source's state and it can be high, medium or low.

$$\text{Hazard} = P(\text{occurrence}) \times P(\text{intensity}).$$

According to (Gleyze, 2005), stakes are the entities values exposed on the territory. We define stake as the danger's target characterized by its vulnerability. A target is vulnerable only if it is exposed to a hazard. Exposure is defined as the extent to which the person likely to suffer the harm can be influenced (Chicken and Posner, 1998). In fact, not only humans are exposed to a threat, but also material goods and natural world such as natural resources. In this thesis, we adapt the definition of (Pachauri et al., 2014) that consider the exposure as "the presence of people, livelihoods, . . . , cultural assets in places and settings that could be adversely affected."

1.2.4 Vulnerability

Despite the fact that the vulnerability is a widely used concept in many fields, its definition varies depending on the authors. According to (Godeau, 2002) the word vulnerable comes from the Latin "vulnus, eris"; the wound. (Gallopín, 2006) defines vulnerability as the potential for transformation of a system under the influence of a hazard, such as climate change. The vulnerability of a system results from its sensitivity and its exposure. It can be characterized by the potential of damage, the exposition function and sensitivity of a system (Cutter, 1996; Adger, 2006). According to (Haines, 2006), vulnerability is the way of the degradation of a system, an organization or human performance when certain hazards or threats are exploited. For (Johansson et al., 2007), it is the system's degree of loss or damage when it is susceptible to a perturbation of a given type and magnitude. Vulnerability focuses

on the system capacity to resist a hazard or threat (Johansson, 2010). He explicates the vulnerability as the consequences that arise when a system is exposed to a strain for a given type and magnitude. The system moves from a planned state into an unplanned state. In this work, we define vulnerability as the stake's sensitivity to a threat (a hazard). In other words, it is the potential damage level (probability of sensitivity/damage) in relation to the danger's intensity.

After explaining vulnerability and exposure, we want to give an example to avoid confusion between the two. People (stake) around the world are highly exposed to corona virus (hazard) every day. As we have been living with this virus since 2019, we are starting to get used to it. We adopt a new lifestyle to protect ourselves such as no shaking hands, social distance, wearing a face mask, etc. Thus, we have a low vulnerability to the virus. Although we are decreasing our vulnerability to corona virus, it is not a desirable situation because we are highly exposed. Ideally, both should be low.

1.2.5 Risk

Risk has several definitions because of the proliferation of its fields of study. (Hopkin, 2018) defines a risk as an event that has the potential to impact mission, strategy, projects, current operations, goals, core processes, key dependencies, and/or the achievement of stakeholder expectations. As cited in (MIALED and DADSI, 2020), the ISO 31000 standard defines risk as "the effect of uncertainty on the achievement of objectives". (Ayril, 2001, as cited in Dautun, 2007) considered a risk as the combination of a hazard and a stake (distributed on a territory). The first one is characterized by its probability of occurrence and its intensity. While stake is characterized by its vulnerability. The risk brings to light the notion of territory and this varies according to the actors' representations. (Girard, 2014) mentions that the human, economic and environmental stakes characterize the major risk. The latter can be ignored when a scenario has an important intensity (can generate dramatic consequences) but the probability of its occurrence is low. We define risk as the combination between the hazard, the spatial and temporal exposure to it and the damage level. There is a risk if there is an exposure between the hazard and the stake. Figure 1.1 shows the risk representation **risk= Hazard x Exposure x Vulnerability**. As shown in figure 1.1d, if one set is eliminated, there is no risk. Compared to figure 1.1a, figure 1.1b and figure 1.1c show an increase and decrease in risk when one of the sets increases or decreases, respectively.

After having defined crisis, risk, vulnerability, danger and stake, let us take the example of the Beirut explosion in order to better clarify the different notions. Ammonium nitrate is the hazard that threatens the stakes that are the population, the infrastructures, the environment, the economy, etc. The storage of the ammonium nitrate in the port of Beirut has generated

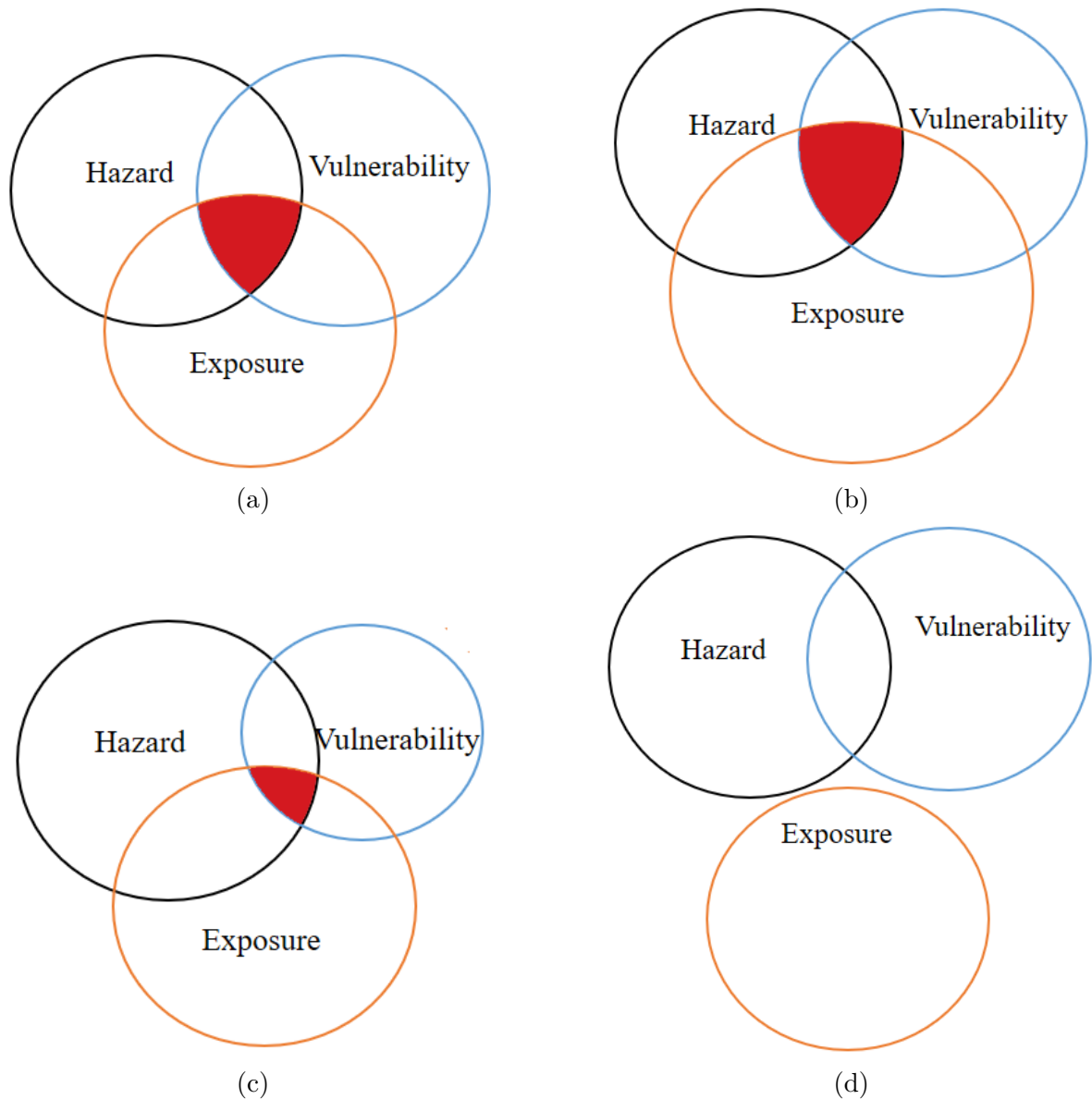

Figure 1.1: Risk representation

a risk of explosion and exposes the stakes to this risk. Indeed, a risk is not certain, it may or may not occur. After the explosion, the risk leads to a crisis.

1.2.6 Crisis management

Although it appeared at the beginning of the 20th century, the term crisis management has really been used since the 1960s (Rongier, 2012). Crisis management relies on the implementation of varied plans, which structures the organization of the emergency services and whose

existence makes it possible to resolve crises and reduce their impact.

A crisis has three stages: pre-crisis, during the crisis and post-crisis. (Zogning et al., 2007) called the first stage as the risk management phase consisting of risk assessment operations (risk identification, specification of risk zones, etc.), prevention actions (training, construction norms, etc.) and prediction and warning alerts (alert system). In addition, the authors indicate that the second phase is the crisis management phase where the emergency plan is implemented. Furthermore, a post-crisis is dedicated to the reconstruction and/or rehabilitation of the victims. According to (Lemieux, 2007), the three phases are: pre-impact, impact and post-impact. In the first one, efforts are made to identify the risks of a crisis and to plan a response to reduce their negative effects on the organization or society. The second one is a time interval that the most significant damage occurs. This duration depends on the crisis type. Moreover, during this phase, emergency management identify the most urgent needs and determine priorities for operations. Finally, the post-impact is the confrontation of the affected population with a new reality. It is the period of recovery and reconstruction.

1.2.6.1 Crisis management cycle

Crisis management is a cyclic process covering the three crisis stages. It can be divided into three phases (Ahmad, 2003; Grange, 2008), four (Coombs, 2007; Paulheim et al., 2009; Franke, 2011) or more (La Rosa and Mendling, 2009; Halpern and Vermeulen, 2017). Regardless of the cycle division and its phase order, it aims at reducing or preventing the risk of a crisis. Furthermore, in general, the pre-impact actions are aimed at preventing a crisis and preparing for it in advance. The response actions provide assistance during a crisis. Post-crisis actions consist of recovery and reconstruction after an event. According to (Carter, 2008) and as indicated in figure 1.2, the phase order that we will consider is:

- **Prevention:** it is a pre-crisis phase when the upstream measures taken to minimize the impact of a crisis such as vulnerability analysis, zoning and land-use management, etc. According to (Prudhomme, 2020), to avoid a crisis or reduce its impact, this phase aims mainly to reduce the vulnerability of the population and the infrastructure by preventing and creating norms. In addition, (Sun et al., 2020) refer to it as “management activities to prevent or minimize future emergencies and consequences with long-term benefits.”
- **Preparedness** This phase also takes place before a crisis. The plans are designed to reduce damage and save lives when a crisis occurs. Therefore, we should know what we have as available resources and how to mobilize actors. Actors’ training, resources maintenance and design of predefined rescue plans such as ORSEC plan are a part of the measures taken in this phase.

- **Response** The response phase takes place during the crisis. The activities of the different actors are coordinated in order to fight against serious situations in case of emergency. The most important tasks in this phase are: minimizing the impact and damage, and saving lives. Other tasks include warning, evacuation of populations, sheltering, feeding, search and rescue, etc.
- **Recovery** This is the phase when actions are taken to return the community to a similar or better state than before the crisis. It is the slowest phase. It is a post-crisis phase that includes restoration, reconstruction, donation, etc. The affected community learns from dramatic experiences and improves its ability to cope with such an event. Recovery includes the concept of resilience, which is about managing change by improving well-being in the face of risk.

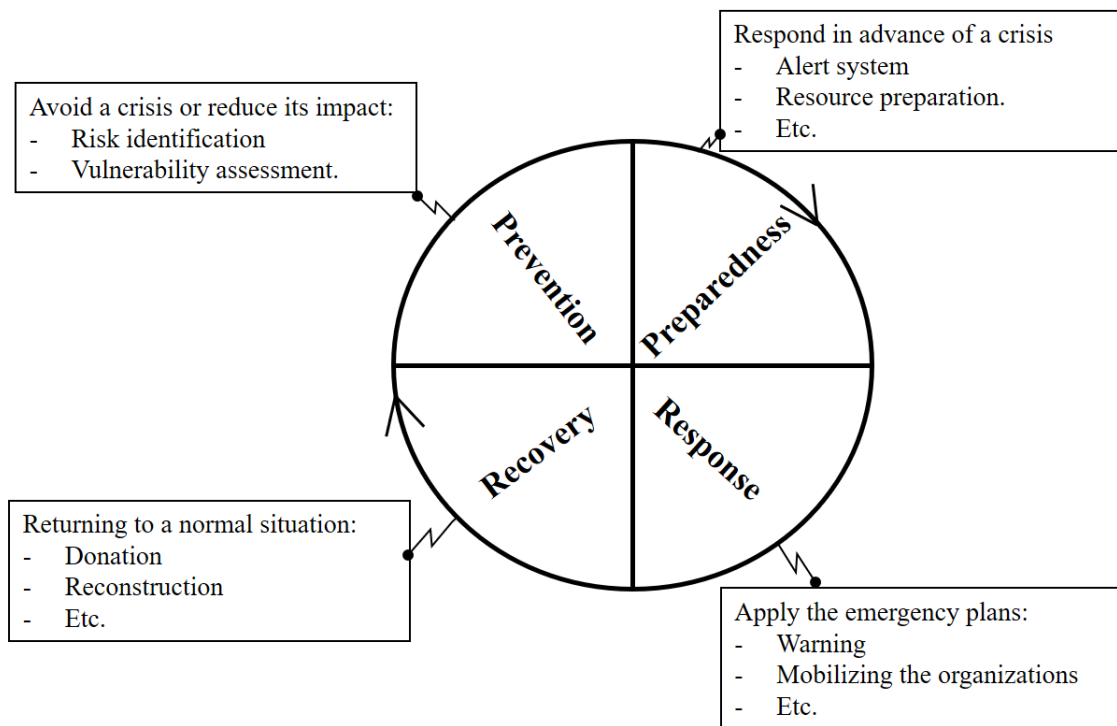

Figure 1.2: crisis management cycle.

1.2.7 Emergency plan

An emergency plan is a set of activities to be taken in order to achieve a remediation or mitigation objective for a problem that has occurred. It is a formal, written plan in response to potential accidents and their consequences. Its main objective is to limit the negative effects of the event by being prepared and to facilitate an immediate response ([Ramabrahmam et al.](#),

1996). According to (Calixto and Larouvere, 2010), an emergency plan specifies procedures to be implemented in case of sudden events. It must involve whatever is necessary to reduce the impact of unexpected situations such as communication, planning, action, risk analysis, operational and logistical support, etc.

1.3 Crisis typology

The characteristics of a crisis as cited in (Halpern and Vermeulen, 2017) are as follows:

- **Crisis size:** it depends on the scope, intensity and the duration of an event. The first one describes the extent of the impact on the entire community, including the relief and support infrastructure, which helps predict the extent of assistance available and the speed of recovery. The second one refers to the living being cost. Finally, the duration may be the length of crisis itself or the period during which people are affected.
- **Crisis cause:** it refers to the crisis type as if the source of the danger is human or natural. Sometimes a natural crisis triggers a human-made crisis. For example, the Fukushima nuclear explosion was triggered by an earthquake and tsunami in Tokyo on March 11, 2011.
- **Expected vs unexpected:** Unlike expected events, unexpected events give people no opportunity to be prepared, both psychologically and physically. On the other hand, some crises are predictable because they offer a warning period that can be short like tornadoes or long like storms. It is a double-edged sword that can have a positive or negative impact on human mental health. Knowing in advance that a threat is imminent helps people evacuate, prepare and take other protective measures. In contrast, it can cause panic, guilt and shame because of the difficult situation that makes it not easy to make a decision that can sometimes be wrong.
- **Timing:** it is a really important factor because it affects the event's gravity and the response of the emergency services. Intervening at night is more difficult than during the day, especially if there is no electricity. In addition, the day on which the crisis occurs has an important influence on the response phase; for example, rush hour traffic during vacations, weather in winter, etc.

(Berren et al., 1980) develop five factors that are not limited to natural crises and allow us to distinguish one crisis from another: crisis type, crisis duration, degree of personal impact, potential occurrence (recurrence) and control over future impact.

- **Crisis type:** although there are several types of crises such as financial, economic,

health, etc., in this thesis, we focus on natural and anthropogenic crises. Unfortunately, natural crises are becoming more and more frequent. Although often caused by nature (earthquakes, earthquakes, floods, etc.), they can also have a human origin (wars, famines, epidemics, etc.).

- **Crisis duration:** duration can be considered in several ways. In addition to (Berren et al., 1980), (Halpern and Vermeulen, 2017) refer to crisis duration as either the crisis duration itself as its name indicates, or the time elapsed between the beginning of the crisis and its end, including the recovery period. For example, for an explosion, the duration of the crisis corresponds to the duration of the explosion itself, which is a few seconds, whereas the duration of a hurricane is several hours or days. Furthermore, large-scale crises are good examples of how much time the recovery period can take. For example, the nuclear accident at the Chernobyl plant preceded years of impending doom.
- **Degree of personal impact:** even though human has created different scales that are used to measure crises, the degree of personal impact must be taken into account. It is the ability of people to react differently to the same events they face. Some people are more resilient than others. For the same event, victims can be affected in different ways. For example, people with para-seismic houses will not be affected by earthquakes like people with normal houses. In addition, some victims may have lost a family member while others may only have poor phone service. Furthermore, the perception of life for severely affected victims will change after the crisis.
- **Potential occurrence (recurrence):** taking into account the existing amount of records and information that have been collected for each crisis that has occurred, we find that some crises have a higher probability of occurring than others. For example, spring tornadoes in Texas and Oklahoma have a high potential for occurrence to occur regularly. Conversely, the probability of being a victim of an airplane crash is extremely low. Furthermore, certain crises types regularly occur within a specific area. Indeed, their consequences are unpredictable but their appearance is not surprising.
- **Control over future impact:** there are certain crises that people have the ability to prevent from happening again or at least to reduce their potential devastating consequences. The authors give the example of a citizens' group that successfully lobbied a local Air Force base in Arizona to stop flying over populated communities. This example shows how the community's movement reduced the potential future impact of another air crisis. On the other hand, the likelihood of significant damage cannot be significantly reduced even if certain precautions are taken by the community, such as the fires that regularly occur due to the dry Southern California summer.

1.4 Crisis response level

In management, three types of decisions are defined: strategic, tactical and operational decisions (Ansoff and McDonnell, 1988). In supply chain planning decisions, the three levels are distinguished according to the time horizon (Thierry, 2003; Kaddoussi, 2012). According to (Schmidt and Wilhelm, 2000), in logistics network, strategic level designs the network while tactical level deals with material flow management policy. Furthermore, the operational level schedules actions to ensure timely delivery of products to customers. According to (Kaddoussi, 2012), the strategic decision level concerns long-term decisions (at least 6 months). The tactical level consists of making decisions in medium-term (a few weeks to a few months). Moreover, the operational decision level are limited to a day or week decisions. In this work, we are interested in decisions in natural and human-made crises situations, so we adopt the three hierarchical levels of a crisis rescue plan explained by (Elmhadhbi, 2020) as below (see figure 1.3):

1.4.1 Strategic level

The highest level of decision-making is the strategic level and it is managed by public authorities. The latter provide the media with valuable information about events to alert citizens and play an essential role in inter-agency communication. In addition, they define strategies and guide the organizations concerned to engage in crisis response. The command of the crisis response process is determined based on three factors: the event type, its impact and the administrative division of the country.

1.4.2 Tactical level

Despite the fact that goals are determined at the strategic level, these objectives are translated into actions at the tactical level. In order to implement a strategy, stakeholders at this level define the steps to be implemented by other actors on the site to end a potential threat. Note that for each emergency response organization (ERO), there is a command centre managed by a commander. Thus, stakeholder commanders compose the tactical level.

1.4.3 Operational level

Finally, at the operational level, the tactical plan is executed by the emergency responders on the site of the crisis like firefighters and healthcare services. These actors work together



Figure 1.3: crisis response level.

under a unified command in a dynamic environment where uncertainty is high.

We talked about decisions and decision makers, but what is a decision?

1.5 Decision

Decision-making is an omnipresent act in everyone’s daily life, like choosing what clothes to wear today or what kind of coffee to drink... Decisions can also be made for others and not only for the decision maker him/herself. For example, parents decide which school their children will attend. The decision is based on many criteria such as the school’s reputation, its distance from home, its tuition, safety, etc. The selection criteria depend mainly on the decision objective (choose an appropriate school). This decision has positive or negative results on both children and parents. Unlike choosing the wrong school, the right decision allows the child to grow both personally and academically which will make the parents proud and happy. In this context, a decision can be individual or collaborative to solve a problem facing the organization or individual. In the dictionary “Le petit Robert” (Rey, 2018), the definition of the action of deciding is the fact of “making a judgment, adopting a final conclusion on a disputed point” or “deciding, determining what to do”. According to (Kast, 1993), a decision is a “choice between several existing solutions, each with different consequences, the choice will be made according to precise selection criteria”. In the opinion of (Longueville, 2003), “the decision is information transformation’s process. It leads an actor or a group of actors in an organization to answer a question leading to an action (through the answer)”. As defined by (Mintzberg, 1982), “a decision, whether it is individual or the result of group work, can be defined as a commitment to act, that is, an explicit intention to act.”

([Herbert, 1980](#)) proposed a formalization of the decision as a succession of intermediate steps forming a four-step process:

- intelligence: search for information, intelligence on the problem to be solved, its constraints and its environment,
- design: conception, development and analysis of possible solutions to the problem,
- choice: the evaluation and choice of the solution, by applying evaluation criteria, then the implementation of the chosen decision, of the actions to be taken to solve the initial problem,
- evaluation of previous choices because the decision's history does not end at when it is made.

When there is only one actor, his/her decisions are necessarily sequential. In the case of several actors, decisions can be made in series when the decision of one actor depends on the choices of the others or in parallel when the decisions are independent. For example, in a crisis situation, although all the actors on the ground make decisions in parallel, such as evacuating victims to the center corresponding to their situation (dead, unharmed, injured), serial decisions remain dominant. The decision as to which hospital a victim will be transferred to can only be made if the victim is sorted and prioritized.

([Trentesaux, 1996](#), as cited in [Adla, 2010](#)) distinguishes between:

1. Structured decision: is a decision for which the necessary information is available, the possible alternatives can be listed and the mechanisms for evaluating them are known;
2. Ill-structured decision: The problem may not be clearly stated and requires a major effort to formalize, the data are often qualitative, unreliable, highly unstable, difficult to access, etc.
3. Unstructured decision: The problem is not clear. It has specific characteristics

According to ([Adla, 2010](#)), “collaborative or multi-stakeholder decision-making refers to processes in which several decision-makers are involved, with divergent or even conflicting interests, and participate more or less directly in the final decision”. ([Seguy, 2008](#)) describes collaborative decision making, in the field of e-maintenance, as a process composed of several steps leading a group of people to a decision. The author summarizes the collaboration decision as follows:

- an actor can contribute to a stage of the decision-making process without being involved in it.
- the level of responsibility or competence of the actors plays an important role in

decision making

- it is associated with the whole process and its stakeholders leading to a decision
- a human-machine collaboration is also possible

Furthermore, (Cadier et al., 2006) explain the three dimensions of a collective decision or also called distributed decision. The spatial distribution which allows to obtain different points of view. The functional distribution which supposes that the different agents perceive data relevant to their needs. The temporal distribution indicates that the environment is dynamic and the process must manage these evolutions.

Decisions may be distributed among different actors who coordinate to achieve a goal or they may be made by a single actor. For example, when a person wants to buy a phone, the advisor offers several models with many features from different brands. The person chooses the phone that suits him or her according to their criteria (price, features, etc.). In a cooperative game like soccer, players make decisions (changing the direction of play, keeping the ball, etc.) directly during the game. Their common goal is to score points.

1.5.1 Decision Support System (DSS)

Decision Support Systems are very useful to improve and facilitate management at different levels of decision-making in the industry: strategic, tactical and operational (Klement et al., 2017). (Lachtar, 2012) considered crisis management as a complex system. In this context, she studied DSS to model it. What is a DSS? Research into the development of technological solutions capable of supporting decision-making to solve problems began in the 1970s (Gorry and Scott Morton, 1971). There are many definitions in the literature, we cite:

(Kebair, 2009) considers the DSS objectives to be:

- supplement decision makers: complete one or more of the decision maker's capabilities;
- allow better information, design or choice: facilitate the decision phases;
- facilitate problem solving: make problem solving smooth and fast;
- provide unstructured decisions support;
- manage knowledge: by improving knowledge processing and representation.

DSSs are present in many fields and their objective is to assist the human decision in his task by facilitating the exploration of the different alternatives of the problem. The hierarchical levels of decision-making in the emergency plan limit the autonomy of the actors on site, especially when some decisions should be made by tactical level actors after passing the information from the operational level. The diversity of actors at the operational level makes

Definition	Reference
The implementation of a DSS consists of developing and implementing systems using information and communication technologies for decision making and problem solving.	(Shim et al., 2002)
A flexible, adaptive, responsive and interactive computer-based system to provide decision makers with relevant information that will help them make the best decisions.	(Milot and Lemoine, 1998)
"The person's activity who, on the basis of clearly explained but not necessarily completely formalized models, seeks to obtain answers to questions posed by a decision-maker in a decision-making process, elements that contribute to enlightening the decision and normally prescribing, recommending, or simply encouraging a behaviour likely to increase the coherence between the process evolution, and the objectives and the system of values at the service of which this decision-maker is placed".	(Roy and Bouyssou, 1993)

Table 1.1: Definitions of DSS

it necessary to have different command centres at tactical level. Thus, the commanders of each command centre make decisions and coordinate the operational level actors at the same time. In this thesis, we intend to distribute decisions at the operational level due to the dynamic environment of the crisis. Multi-agent systems that come from Artificial Intelligence research are one of the ways to implement decision making tools (Lachtar, 2012). It is a tool that allows the coordination between a set of agents interacting in a certain environment and the distributed resolution of the problem.

1.6 Dedicated work and scientific challenges

Several studies exist in the field of crisis management that are especially relevant with respect to our objectives. These studies define the notions of risk, vulnerability, typology of a crisis as well as the crisis management cycle. They allow the consideration of a non-automated decision-making support, based on simulations.

According to (Lachtar, 2012), crisis management relies on the crisis cell which implements anticipation, intervention and safeguard measures and involves multiple actors who interact. The author addresses the communication problems between actors in a crisis. Actors must make decisions based on the information they have gathered and their personal knowledge. Based on experience feedback and interviews conducted in the field, it is noticed that sudden events can occur and disrupt this communication. For example, each community in France has a PCS ("Plan Communal de Sauvegarde"). It is communal crisis management plan under the authority of the mayor which details the management steps and the crisis cell. Although the municipalities have a PCS, this does not guarantee the optimal performance of the crisis cells, because sometimes and depending on the event, it cannot accomplish their safeguard and protection missions. Therefore, in order to study the organizational vulnerability of the crisis cell and to evaluate its performance at the communal level, a global approach for decision-making is proposed, based on systemic thinking and multi-agent systems using the Java Agent DEvelopment framework (JADE). Organizational performance indicators were grouped together in a dashboard so that they can be analyzed. In addition, the communal crisis cell using UML (Unified Modeling Language) is modeled. The multi-agent system is used as the decision-making system in order to simulate the organization. In short, Lachtar worked on the response phase of a crisis management, and specifically on the strategic level of a crisis cell. Moreover, the centralized aspect (central agent) has been used to tackle the situations where the crisis environment is dynamic and fully observable.

Lachtar did not represent the system's behaviour by describing the sequence of actions of actor's process. In other words, although the crisis cells, their missions, and the interactions between the actors are represented, the order of the missions (actions) and the actions on which the interactions occur are missing. In addition, only the strategic level is modelled. In this thesis, we represent the process of each actor in the ORSEC plan at the three levels: strategic, tactical and operational. Then, we focus on the operational level and develop strategies based on multi-agent system (MAS) using the Java Agent DEvelopment framework (JADE) to compare the behaviour of agents not only in a centralized architecture but also in decentralized architecture.

It is necessary that the various actors, in natural and humanitarian crises, act simultaneously and quickly to control and reduce the impacts of the crisis on the real world. This problem has been addressed by (Thanh, 2016), who aimed to contribute to the engineering of coordination in crisis areas by providing a comprehensive approach that considers: the task level (workflow between the actors) and the organizational level (actors, missions and relationships). The author used Petri nets to transform the textual emergency plan into a graphical view understandable by decision makers. The Petri nets are then mapped to BPMN. Next, Thanh combined the BPMN with the multi-agent paradigm to present the two aspects

and simulate them. The model was limited to the city of Vietnam and the tsunami scenario. Unanticipated information is not considered.

In this thesis, the MAS model we propose takes uncertainty into account and is not limited to the terrorist suicide attack scenario. It can also be used in other crises with mass casualties requiring the same actors at the operational level, such as avalanches, earthquakes, non-nuclear explosions for instance. In addition, it is not country-specific and can be applied in France as well as in Lebanon.

([Aligne et al., 2011](#)) have developed a decision-making tool to improve crisis management at the strategic level. A rescue plan is executed in given situations whose evolution is not anticipated, such as traffic. In this context, they translated a rescue plan into an automated temporal planning system where actions are linked to each other by constraints. They showed that this tool can optimize the coordination of rescue operations. An optimal scheduling of emergency response operations is established taking into account the forecasted evolution of the crisis situation. It is applied in a very dense road environment where the coordination of rescue operations in the face of a terrorist attack depends on the road traffic forecast, which are an evolving situation. This work was extended in ([Soubaras et al., 2013](#)). They added the deployment phase of the rescue operations, which allowed the monitoring of the emergency operations progress. They included the triggering of the alert. In addition, they proposed corrective actions when a deviation from the initial plan is detected. In other words, they proposed a plan repair method. Their work took into account the evacuation of victims to hospitals by choosing the closest and most appropriate one for the injured person's situation, taking into account the number of available beds and the medical specialty.

These works transform the textual format of the emergency plan into temporal planning using PDDL language. It is understandable by the people familiar with this domain whereas in our work, we model the emergency plan in BPMN which is comprehensible by everyone. In addition, they assign the victims to the nearest hospitals that have medical services adapted to their conditions. While in our proposed assignment algorithms, the hospital's experience is also taken into account, indicating whether the hospital has the ability to handle the crisis situation through its experience for a similar event.

In some crises, such as earthquakes, it is difficult to find victims because they may be in places that rescuers cannot reach or are difficult to access. In this case, in order to search and bring victims to rescuers, the latter send Unmanned Autonomous Vehicle (UAV). In this context, ([Soubaras van den Broek and Labreuche, 2014](#)) addressed a sequential planning decision problem under uncertainty for a search and rescue UAV. Although they assumed that the location of all victims and their number were known in advance, injured situation and exact location were not known. The problem is deciding whether UAV should immediately

recue the first injured found or look up more critical casualties. The action to be performed is chosen according to the wounded injury level and the total trajectory length (duration). They proposed two multi-criteria MDP (Markov Decision Problem) approaches in finite-horizon: Choquet integral and priority criterion. Contrary to their assumption, in this work, the number of casualties and their location are uncertain (not known in advance).

(Dautun, 2007) has improved the knowledge of crisis situations in order to develop a strategic monitoring system of the territory for the Civil Security actors to anticipate and manage a large-scale crisis. Unlike our work, the pre-crisis phase and the strategic level of rescue plan are studied. On the other hand, (Elmhadhbi, 2020) focused on the crisis response's operational level. The communication problem between heterogeneous stakeholders involved in a crisis and the assignment problem (casualties-hospitals) are considered. In this context, an ontology formalizing operational actors' vocabularies is introduced and an ontology-based multi-criteria decision support is developed to help transferring injured to the suitable hospital.

Infrastructure can obviously be a stake. (Kamissoko et al., 2013) address the vulnerability of infrastructure networks to natural crises. Vulnerability models are proposed to represent in natural hazard situations for effective decisions. (Kaddoussi, 2012) developed a model of Crisis Management Supply Chain (CMSC) based on the multi-agent system for military purposes, providing goods. The model aimed to optimize the transport by minimizing the delivery duration between the crisis areas and the supplier areas and maximizing the use of available resources, etc. Similarly, (Othman et al., 2014) developed the former model presented by (Kaddoussi, 2012) and added the notion of priority to the requested goods in order to transport them first to the crisis areas.

(Ndiaye et al., 2014) worked on pedestrian evacuation during natural disasters taking into account two criteria: time and safety. They aimed to minimize the evacuation time while maximizing the evacuation safety. The problem was represented as a bounded Time-Expanded-Network on which they applied the ant colony algorithm by initializing its pheromones using two proposed heuristics.

The field of crisis has been studied for a long time. Several studies have been carried out to help the various actors involved in a natural or human-made crisis to make decisions. The works cited above show us that the response to a crisis is confronted with several problems such as communication, collaboration between agents, resource allocation, etc. Some authors have worked on the strategic level and others on the operational level. In addition, some have proposed a decision support tool to help actors at the strategic level to make decisions, others have developed a system to help them understand the variety of vocabulary, etc. Although we notice that crisis problems can be translated into planning and scheduling, as

well as multi-agent systems, we have not seen any work aimed at giving operational actors some autonomy to make decisions without top-level intervention such as deciding which road to take to transfer a casualty, to which hospital an injured should be transferred, which ambulance to use, which injured should be transferred first, what action to take when an unexpected event occurs, etc. Furthermore, there is no study about the source of uncertainty that may arise on each action executed by an actor that may prevent him/her from reaching his goal. In this context, we will propose a multi-agent planning and scheduling model based on functional and dysfunctional analysis of an emergency plan in order to help operational level actors achieve their objectives in a stochastic environment.

1.7 Terrorist attack scenario

1.7.1 Description

Several scenarios can be envisaged. The response differs according to the context but the objective is common. The most lethal form of terrorism is suicide, where the attackers' objective is to kill by committing suicide. In this work, we chose to work on a suicide bombing attack. An attack is characterised by its location, time and damage. For example, an attack in a church on Sunday morning during mass has a much greater impact than an attack in the same place on Wednesday evening. As an assumption, we consider in our scenario that a double suicide bombing hits a shopping street of a city during rush hour (6 p.m.), and killed 40 people and injured 100. Five minutes after the first explosion, the second was triggered by a suicide bomber in the middle of the crowd.

City

As shown in figure 1.4, we assume that the city in our scenario has three hospitals, one police station, one gendarmerie office, two fire departments, two ambulance centres, three churches, five universities, five schools, one movie theatre, two malls, three newspapers buildings, one train station, three gardens, two museums, seven hotels, five nightclubs, and twenty restaurants.

Resources

We have human and material resources (vehicles, centres, equipment, etc.). Before describing the resources in our scenario, Let us note that neither volunteers (associations and individual) nor emotional and psychological trauma are taken into account in this thesis. Furthermore, as we are working on the operational level of an emergency plan, only actors at this level are considered. In this work, we consider that our scenario's actors are: firefighters,

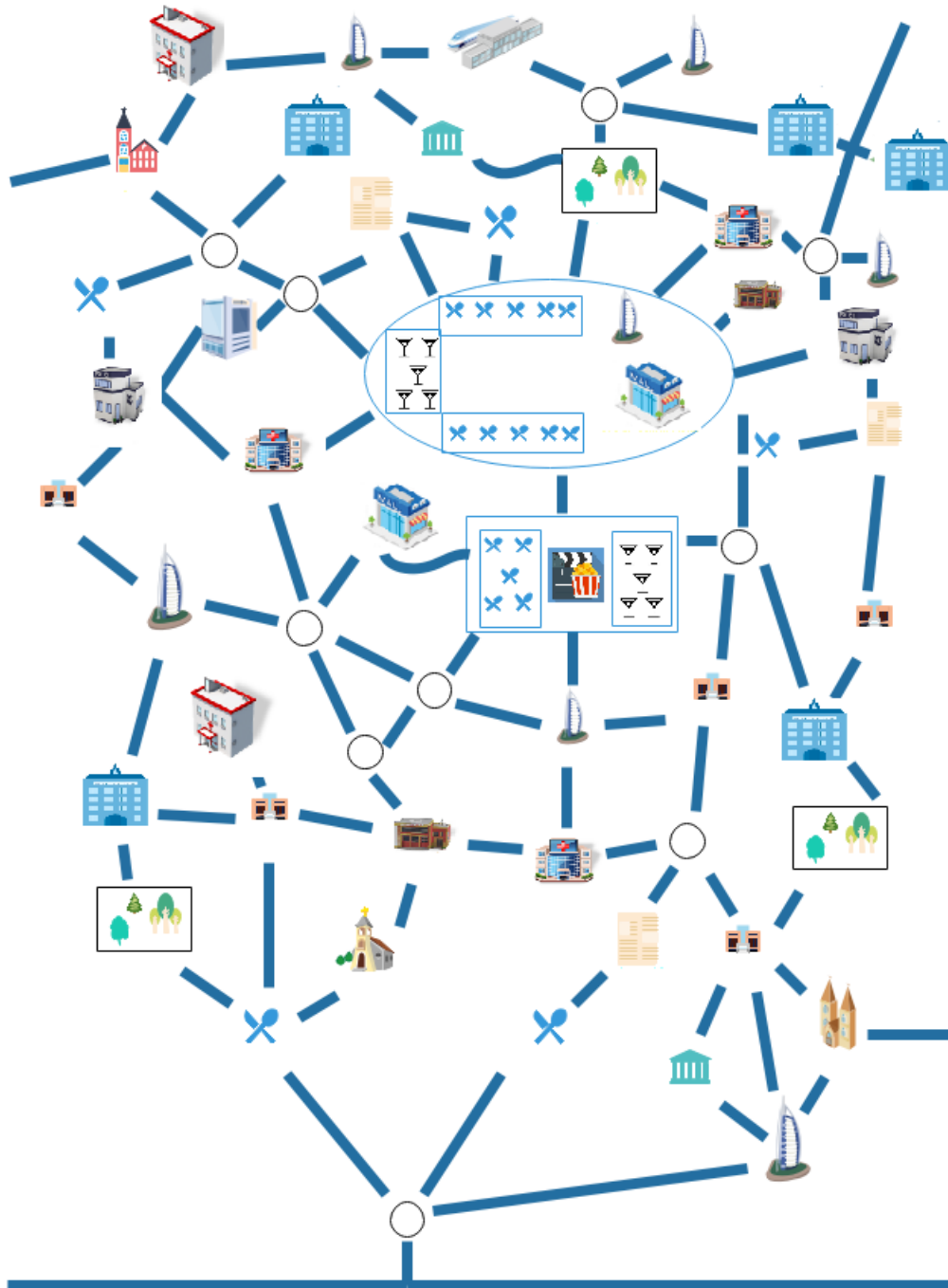

Figure 1.4: The city of our scenario

police, gendarmerie, ambulance crew, medical teams of hospitals and PMA. Ambulance is the only vehicle used to transfer victims to hospitals. Moreover, we are only interested in transferring victims to an appropriate hospital that is capable of treating their injuries and has available place. Thus, we do not take into account how this hospital manages the queue

of injured people during a crisis.

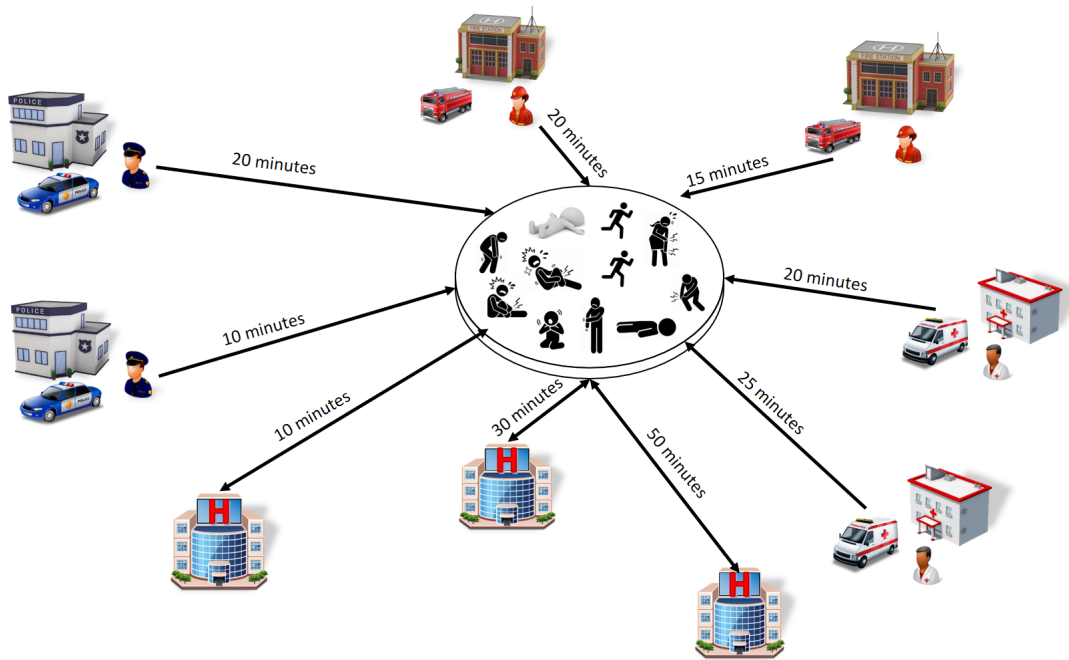

Figure 1.5: Graphical representation of distance in our scenario

Figure 1.5 shows the distance between scenario centres and site and between hospitals. The police station and the gendarmerie office are grouped in this work under the name of security officers. They are located 20 minutes and 10 minutes respectively from the crisis zone, referred here after as the site. Each one has 40 actors. In addition, the two fire departments, fc_1 and fc_2 , have 40 and 15 firefighters and are located 20 minutes and 15 minutes from the site, respectively. Furthermore, the ambulance centre mc_1 has 30 ambulances, of which 20 have capacity 1 and 10 have capacity 2. On the other hand, mc_2 has 35 ambulances, of which 20 are capacity 1 and 15 are capacity 2. mc_1 and mc_2 are 20 minutes and 25 minutes away from the site, respectively. The three hospitals h_1 , h_2 and h_3 provide the same services and are located 10, 30 and 50 minutes from the site, respectively. Finally, 10, 20 and 10 are the capacities of h_1 , h_2 and h_3 , respectively. We also assume that h_1 has experience in treating injuries from this type of event and always conducts training for its emergency teams. h_3 has never experienced this type of event but does occasionally organize training for its emergency teams. While h_2 has not experienced a similar event or organised training.

Victims

The victims can be any individual. According to (Prieur, 2012), assistance measures are implemented in a spirit of humanity, solidarity, hope and impartiality. In addition, the author indicates that priority in the provision of first aid and evacuation of victims is given to the

most vulnerable people such as pregnant women without prejudice to the priority assistance to be provided to all people who have a chance of survival.

In this thesis, we distinguish victims based on their injuries. During a crisis, injured people can be affected physically and psychologically. In this work, we take into account physical injuries and especially, critical and severe (serious) injuries.

1.7.2 Challenges and thesis objectives

The operational management of crisis situations requires the mobilization and rapid coordination of the various emergency services. Unfortunately, this interdepartmental coordination is a very delicate exercise due to the diversity of actors intervening on the ground and the heterogeneity of the different organizations. In addition, actors can work in a specific and aggressive environment, so certain factors can affect or restrict their work. Although material damage and human losses are common points between natural and human-made disasters, we will focus on human losses. Today, most countries have their own emergency plans to minimize human casualties. Starting with the ORSEC plan in France (see chapter 2, we find that decisions are not made by actors directly on the site. Decisions are distributed to the different levels of the plan (mentioned in 1.4).

In this context, the aim of this thesis is to improve the response at the operational level by giving some autonomy to the operational actors in order to make decisions and reduce casualties. What decisions can be made directly at the operational level? By which actors? To answer these questions, we will improve our knowledge of crisis situations by carrying out a study to analyse the types of risks and especially attacks. In addition, we will model the actors' plans using BPMN in order to have an easy-to-understand visual representation. Next, what can affect the missions of the operational actors? By analysing the FMECA, we will foresee the events that can disrupt the overall plan. More precisely, for each task (mission), we will define the cause and effect of the failure. From a computational point of view, the problem will be modelled and solved as a multi-agent distributed planning and scheduling problem in order to give some autonomy to agents and to compare their behaviour.

1.8 Conclusion

In this chapter, after deepening the domain analysis and developing our terrorist attack scenario, we have provided an overview of the literature and what this work will bring to emergency planning at the operational level. Our scenario is explained in a non-formal way but will be modelled later in a formal way in both process modelling and multi-agent planning

and scheduling. The multi-agent system is a decision support system that helps us represent our actors as agents and see the coordination between them as well as the ability of the agents to make decisions. In addition, the planning and scheduling part will help each agent to create its local plan at the operational level and to reach its goal with some autonomy.

Process modelling and vulnerability assessment

Sommaire

2.1	Introduction	32
2.2	Emergency response plan: state-of-the-art	32
2.2.1	The chain care for victims in Lebanon and France	34
2.3	Functional modelling	37
2.3.1	BPMN	37
2.3.2	UML-AD	40
2.3.3	SADT	41
2.3.4	Comparison Between BPMN, UML-AD and SADT	41
2.4	Emergency response plan modelling	43
2.4.1	Notion of business process	43
2.4.2	Introduction to decisional, operational and informational levels	44
2.4.3	ORSEC plan services	45
2.4.4	ORSEC plan modelling	46
2.5	Dysfunctional modelling	53
2.5.1	FMECA	53
2.5.2	Fault tree	54
2.6	FMECA of the ORSEC plan	56
2.6.1	Failure modes	56
2.6.2	Causes	57
2.6.3	Effects	61
2.6.4	Criticality	64
2.7	Vulnerability assessment of an emergency response plan	66
2.7.1	Codification of a function	66
2.8	Application of terrorist attack scenario	68
2.8.1	Functional modelling	69

2.8.2	Dysfunctional modelling	75
2.8.3	Vulnerability indicators	75
2.8.4	Causes and failure modes	76
2.8.5	Failure modes and effects	78
2.9	Conclusion	80

2.1 Introduction

The objective of crisis management is to limit the impact of a feared event that has occurred and to restore the conditions corresponding to a nominal situation. In this context, we focus on emergency response plans in crises such as terrorist attacks. First of all, we define an emergency response plan and provide an overview of some existing emergency response plan in the literature. Then, we present the modelling techniques that exist in literature for functional and dysfunctional modelling. In addition, we distinguish the three levels: decisional level, operational level and informational level in an emergency plan. Moreover, we propose a functional modelling of the French generic emergency plan, departmental ORSEC plan, using the Business Process Model and Notation (BPMN). On the basis of this representation, a dysfunctional analysis will be performed from a new approach identifying failure mode, effects and criticality analysis (FMECA), in order to better anticipate, the events likely to interrupt the intervention plan. Then, we represent the indicators that can be used to assess the vulnerability of an emergency response plan. Finally, we model our scenario according to functional and dysfunctional views. In the dysfunctional model, due to the large size of FMECA table, we illustrate the methodology through an example of the PMA service for which we detail the failure modes and characterize its vulnerability indicators. We present the relationship between causes and failure modes as well between failure modes and effects to show to which failure mode most causes in a process belong and their origins, and the effects associated with each failure mode in a process and their origins and type, respectively. The purpose of the design level is to ensure that everything has been taking into account for a realistic simulation model.

2.2 Emergency response plan: state-of-the-art

As mentioned in (Dautun, 2007), emergency planning, in France, is currently based on law n°2004-811 of 13 August 2004¹ on modernization of civil security and more particularly on

¹Code des général des collectivités territoriales, articles L. 1424-7 et L. 3551-11

implementing decree n ° 2005-1156 of the Communal Safety Plan² (PCS) and decree n ° 2005-1157 of the ORSEC³ plan which, according to it, ORSEC has become the only plan for the organization of emergency assistance either in each department or in each zone. It revolves around a common and simplified crisis management organization accompanied by an inventory of risks. In addition, according to (Rongier, 2012), in France, there are two types of crisis response plans that are triggered when a natural or technological crisis occurs, depending on the needs. On the one hand, the ORSEC plan that is set up when the local means are not sufficient. There are three types of ORSEC plans: zonal, departmental and maritime. On the other hand, special emergency plans exist, such as the white plan and the red plan. The first one is activated when dealing with the arrival of numerous casualties while the second one is triggered if an emergency has a large number of injured in a limited area.

Depending on the event criticality, an emergency plan can be divided into three levels (Girard, 2014; Calixto and Larouvere, 2010): individual, regional and national. The individual plan is associated with industries posing a serious risk to the environment and their employees, such as the chemical, oil, gas and nuclear industries. It is applied at the public authorities' level. For example, in France, there is the PCS. It is defined under the mayor's authority. This document allows the management of a crisis by detailing the management steps and the crisis unit. It must be used by municipalities subject to a Risk Prevention Plan (PPR) or a Particular Intervention Plan (PPI) in order to set up the municipal crisis unit and crisis management and relief organizations. In contrast, the Internal Operation Plan (POI) aims to define the organizational measures, the intervention methods and the means implemented by the industry to protect the personnel, the population and the environment. Moreover, it is under the prefect's responsibility (Baert, 2005). Both PPI and POI are more developed in (Baert, 2005). When the event exceeds the capacity of the individual plan, a regional emergency plan (like PPI) is involved. It defines the conditions for the management of the accident and its consequences by the public authorities when it exceeds the enclosure of the industrial site (Viger, 2004). The preparation of this plan is also the prefect's responsibility. The national plan requires multi-organizational coordination and imposes a large number of different resources.

Table 2.1 shows some of the existing emergency plans in France. It presents who triggers them, their application level and their purpose.

²Article 13 de la loi de modernisation de la loi n°2004-811 du 13 août 2004 de modernisation de la sécurité civile

³Pris pour application de l'article 14 de la loi n°2004-811 du 13 août 2004 de modernisation de la sécurité civile

Plan	Authority	Application level	What for?
PPI	Prefect	Communal	To deal with the particular risks associated with the existence of one or more industrial facilities.
POI	Prefect	Communal	To manage crisis situations for specific establishments.
Red plan	Prefect	Departmental	It is intended to assist many victims for a limited event.
White plan	Director of the health care facility	The health care facility	It is adapted to the reception in hospitals.
ORSEC	Prefect	Zonal, departmental and maritime	To cope with a major crisis (terrorist attack, natural disaster, technological disaster, etc.).
PCS	Mayor	Communal	To deal with a wide range of situations: major disasters, disruption of community life and frequent accidents.
PPR	Prefect	Communal	To define the geographical areas exposed to natural or technological risks.

Table 2.1: Information on some existing emergency plans in France

2.2.1 The chain care for victims in Lebanon and France

The objective of this research is to work on the operational level of an emergency response plan, taking into account only the seriously and critically injured. In this case, in order to better understand the coordination of the actors on site in both countries, a comparison of the care of victims' chain in France and in Lebanon took place. Before explaining this chain, in an emergency plan, whether in Lebanon or in France, there are three levels of response and at

each level there are one or several decision makers. As shown in Figure 2.1, the commanders of crisis response level in France and Lebanon have different nomenclatures but identical roles.

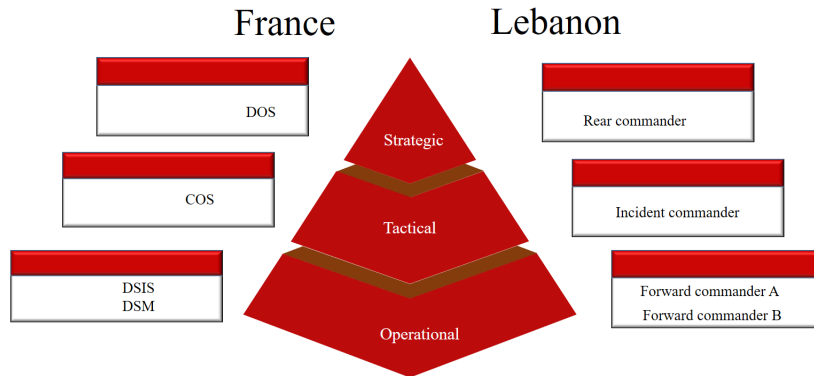
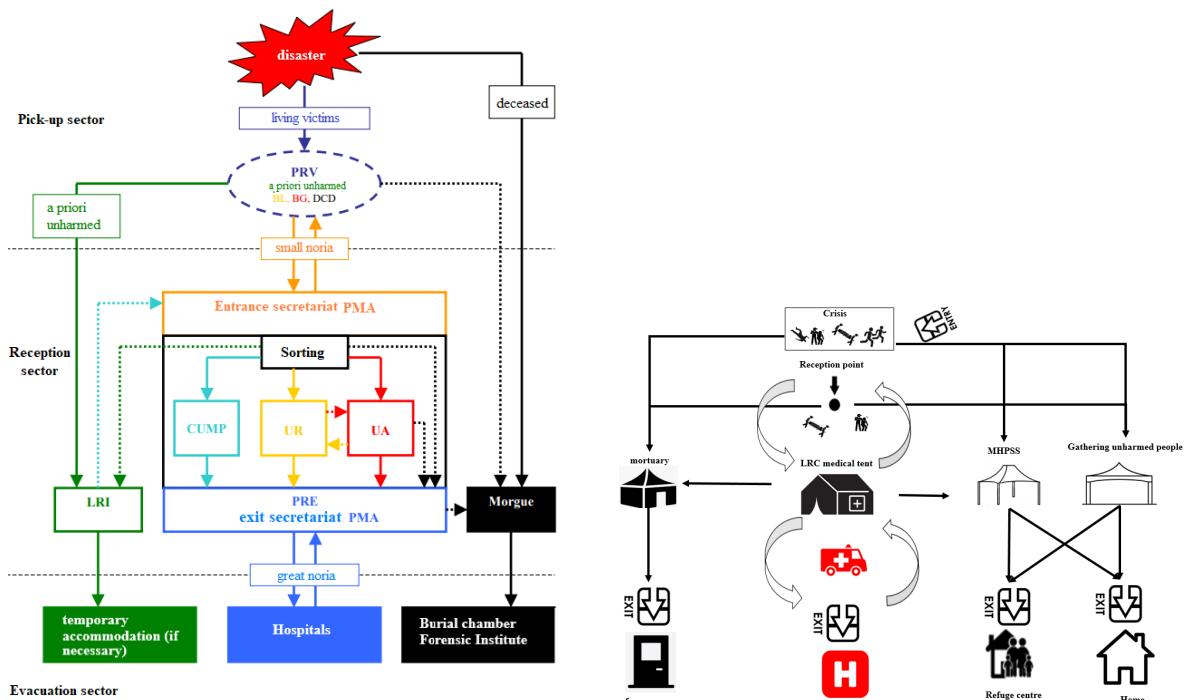

Figure 2.1: Crisis response levels commanders

When the alert is received, the first operation to be performed is the reconnaissance. It is common for both countries. Its purpose is to evaluate the type and number of victims, in order to adapt the means to be requested from the different services. In France, it is a collaboration action between the first teams of the fire brigades and the SMUR ("Service Mobile d'Urgence et de Réanimation") arriving on the site. They search for the most appropriate zone to install PMA and transmit the necessary information to SAMU («Service d'Aide Médicale Urgente») and SDIS («service départemental d'incendie et de secours»). While in Lebanon, two ambulance crews of Lebanese Red Cross (LRC) perform this operation and inform their centre. In addition, the LRC relies on public relations (PR) to verify the veracity of information. Each city in Lebanon has at least two PR determined by the LRC to gather more information about the crisis and to identify from where to enter (Enter point) the city to reach the site and where to leave (Exit point) the city from the crisis site. The PR has information about the safest route in or out of the city.

Figure 2.2 shows the chain of care for victims in France 2.2a and Lebanon 2.2b. As in France, the victims are grouped in reception point where the first triage took place. The corpses are taken to the morgue and then to the funeral chambers. The unharmed people are evacuated to gathering unharmed people point, then they go to the place adapted to their situation (e.g., refuge for those who have lost their home). The psychologically injured persons are assisted by Mental Health and Psychosocial Support Services (MHPSS). Next, they are evacuated to the appropriate place for their situation. Furthermore, a second triage takes place in LRC medical tent. Afterwards, injured people receive first aid and will be transferred by ambulances to the appropriate hospital for their situation. In France, the DSM («Directeur des Secours Médicaux») is responsible for the medical decisions and coordinates



(a) Care of victims in France

(b) Care of victims in Lebanon

Figure 2.2: Care of victims in France and Lebanon

medical resources on site. While DSIS («Directeur des Secours Incendie et Sauvetage») organizes the pick-up sector. In Lebanon, pick-up sector and LRC medical tent are under the responsibility of forward commanders (or also called bronze commanders) A and B.

After explaining the medical chain in Lebanon, we would like to add the strategy applied by the LRC to transfer injured to hospitals based on their experience on the site. Volunteers play a role in rescue operations in Lebanon. Many people transport the injured with their own cars or motorcycles, with or without coordination with the LRC. Due to panic, they transfer them to the nearest hospitals. It is difficult to respect the order of transfer of the wounded to hospitals, which means that the slightly injured may be transferred before the seriously injured. In addition, the nearest hospitals may be overwhelmed and difficult to reach due to crowds of friends, family, media, etc. In this context, LRC applies the following strategies:

1. Contact volunteers through the media to let them know where to transfer the injured.
2. Inform the media about overwhelmed hospitals.
3. Transfer victims to the appropriate hospitals to their situations, trying as much as possible to avoid the closest hospitals.

2.3 Functional modelling

A functional model is a graphical representation of functions within a system. It transfers a concept to a comprehensive representation. In order to proceed with the development of the emergency plan modeling, several process modeling methods exist. Taking into account the objectives and constraints of this work, a modeling method will be chosen.

2.3.1 BPMN

BPMN is a graphical notation language developed by Business Process Management Initiative (BPMI). In 2005, BPMI and the Object Management Group (OMG) merged together and since then, OMG is in charge of the evolution of the tool (Geambaşu, 2012). BPMN version 2.0 was released in 2011 to extend the adequacy of BPMN 1.2 (OMG, 2010). The main objective of BPMN is to provide a notation that is easily understood by all business users, from the business analysts to the business people passing by the technical developers. The business analysts create the initial drafts of the processes, while the technical developers implement the technology that will execute these processes and finally the business users manage and monitor these processes. BPMN 2.0 can be serialized to BPMN 2.0 XML. This file contains the model semantics and the diagram-interchange information.

Four different types of diagrams are provided in the current BPMN version (Kluza et al., 2017):

1. Process diagram: describes the ways in which the activities are executed to achieve the objectives of an organization. It is usually sufficient in most cases. As shown in figure 2.3, process diagram can be public (the activities and the events that are used to communicate to the other participants are included) or private.

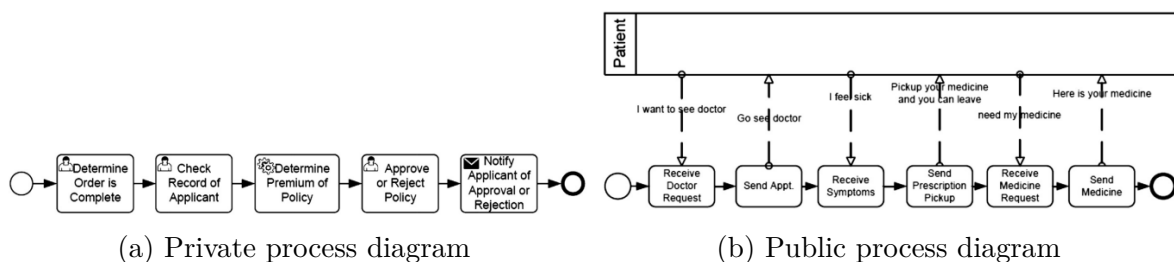

Figure 2.3: Examples of process diagrams (Von Rosing et al., 2014)

2. Collaboration diagram: presents the interactions between two or more business entities (see figure 2.4).
3. Conversation diagram: shows the relation of message exchanges in a process (see

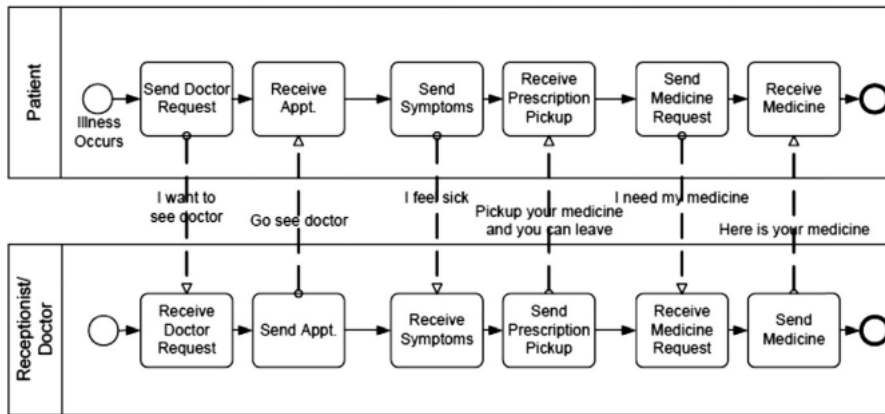

Figure 2.4: An example of a collaboration diagram (Von Rosing et al., 2014)

figure 2.5). According to (Von Rosing et al., 2014), a conversation diagram has specific symbols as shown in figure 2.6.

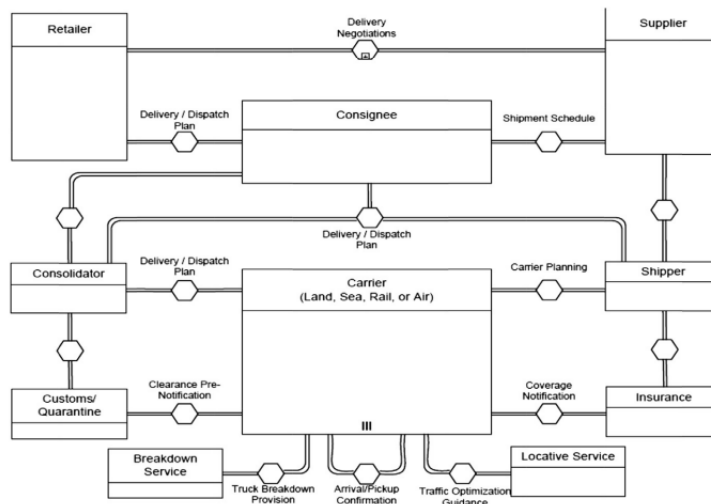

Figure 2.5: An example of a conversation diagram (Von Rosing et al., 2014)



BPMN 2.0.2	Conversations Description
 Conversation	A Conversation defines a set of logically related Message Flows. When marked with a (+) symbol it indicates a Sub-Conversation, a compound conversation element.
 Call Conversation	A Call Conversation is a wrapper for a globally defined, re-usable Conversation or Collaboration. A call to a Collaboration is marked with a (+) symbol.
 Conversation Link	Connects Conversations and Participants.

Figure 2.6: BPMN conversation description (Von Rosing et al., 2014)

4. Choreography diagram: despite the fact that it has no pool, it defines interactions between two or more individual processes

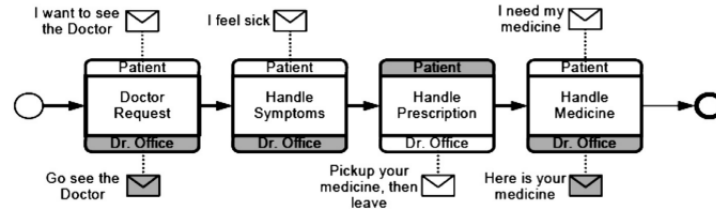

Figure 2.7: An example of a choreography diagram (Von Rosing et al., 2014)

The process model depicts four element types to model business process diagrams as shown in Figure 2.8: Flow objects (events, gateways and activities), Connecting objects (sequence flows, message flows and associations), Swimlanes (lane or pool), and artifacts (data object, group and annotation). Swimlanes can group the primary modeling elements. An event, in the flow object elements, represents something that happens during the lifetime of the process. An Activity can be elementary (task) or decomposable (Sub-Process). It is a task that has to be performed by a person or a system. The path is adjusted by a decision point (gateway) based on conditions or events. In the case of connecting objects, sequence flows are used to represent the order of activities to be performed. A message flow shows messages flowing across pools while an association links information and Artifacts with BPMN graphical elements. The arrowhead indicates the flow's direction. Finally, artifacts provide additional data about process without affecting the flow (Kluza et al., 2017; Chinosi and Trombetta, 2012).

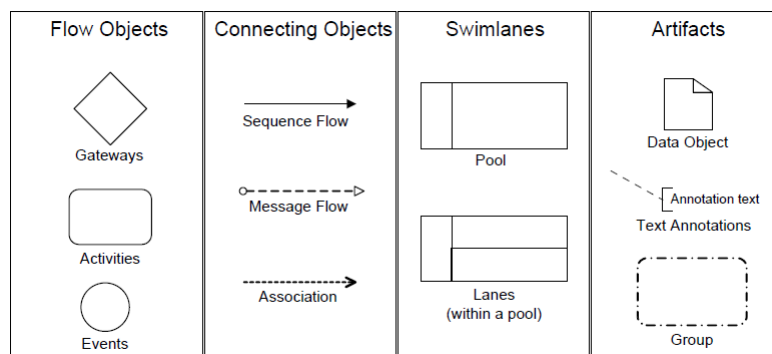

Figure 2.8: BPMN core elements of process diagram. (Kluza et al., 2017)

In order to model a BPMN process, we present three tools that can be used. No matter which modeler we use, they all support the modelling notation of BPMN. Although each company mentioned below has several products that allow a user to model, simulate and improve their process, we are only interested in the modeling of the process and not in

its execution. Further information about Camunda, Bizagi and BPMN 2 can be found, respectively, in (Ayad, 2013; Caione et al., 2015; Heguy, 2018):

- Camunda modeler: It is a user-friendly desktop application that allows users to design workflows and decisions. Besides the visual diagram, using Camunda modeler makes it easier for developers to combine their models with an IDE (Integrated Development Environment), like Eclipse, since it works directly on BPMN XML file. In addition, the diagram can be exported as images (png, svg and jpeg format).
- Bizagi modeler: It enables organizations to model and document business processes in BPMN. Users can export the Business Process diagrams into: Microsoft Visio, Image files (png, bpm, svg. or jpg format) and to XPD (XML Process Definition Language).
- BPMN 2 modeler: It is an open source tool supported by Red Hat for authoring and editing files meetings with BPMN 2.0 standard. It is a plug-in of the Eclipse development platform.

2.3.2 UML-AD

UML has evolved through numerous modifications and revisions, the current version being 2.5.1, according to the OMG. OMG developed and maintained UML. In 1995, the first version of UML was released. The primary goal of UML is “providing system architects, software engineers and developers with tools for analysis, design, and implementation of software-based systems as well as for modeling business and similar processes”(OMG, 2017). There are many modelling tools to model UML-AD such as StarUML⁴ and Visual Paradigm Online⁵. Most UML tools export XMI (XML Metadata Interchange) code. The goal of XMI which contains modeling data, is to exchange these data between different modeling tools (Daum and Merten, 2002).

There are two major kinds of UML diagram: structure diagrams that show the static structure of the system and behavior diagrams that represents the dynamic behavior of the objects in a system. UML Activity Diagram (UML-AD) is used for business process modeling (Geambaşu, 2012). It describes system activities and their causal relationships. It is redesigned in UML 2.0 both in terms of syntax changes and in terms of semantics, going from State Machine-based semantics to token flow semantics. These modifications make UML-AD able to represent business processes. Figure 2.9 shows the basic elements of an activity diagram. The activity designates an atomic activity of the system. Its execution is triggered when the system reaches it. The initial and final states of the workflow are represented by

⁴<https://staruml.io/>

⁵<https://www.visual-paradigm.com>

the start and stop elements. With the fork element, different activities from the same entry are split. While the join node combines different incoming flows into one outgoing flow. They can be used together for synchronization. A decision node represents the choice between several execution edges. The merge node gathers different execution branches. It is used to accept one of several alternative flows. Finally, the sequence element is used to represent the execution sequence of the activities.

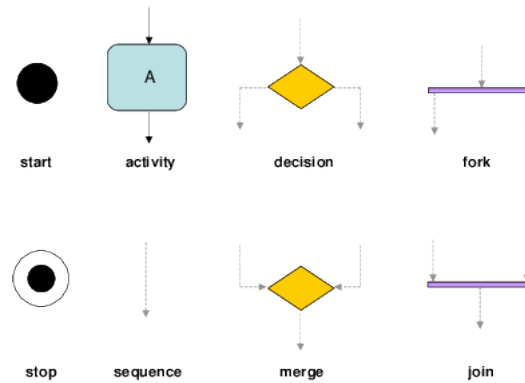

Figure 2.9: UML-AD elements. (Amici et al., 2022)

2.3.3 SADT

According to (Ahmed et al., 2014), SADT is a method developed by Douglas.T. Ross in the United States in 1977 to model a complex system by decomposing it into subsystems in a physical and structural way. It is a top-down model that focuses on either system activities or system data. The first is "activity models" while the second is "data models". SADT can be used in order to functionally model an organization, as it describes functions and their relationships (Karagiannis, 2010). Systems, entities and/or activities are represented by boxes which are connected by arrows (see figure 2.10). Control arrow means what guides or limits the activity while the mechanism arrow describes who or what performs the activity (Congram and Epelman, 1995). The input data are transformed into output data by the function represented by the box. The SADT modeling technique is a methodology based on a graphical language which generates activity models describing, in a successively detailed manner, the process activities and their relationships with each other (Demri et al., 2008).

2.3.4 Comparison Between BPMN, UML-AD and SADT

(Geambaşu, 2012) compares BPMN 2.0 and UML AD (version 2.4.1) based on three criteria: how much can be readily understandable, capability of their graphical elements to represent the real business processes of an organization and mapping to Business Process Execution

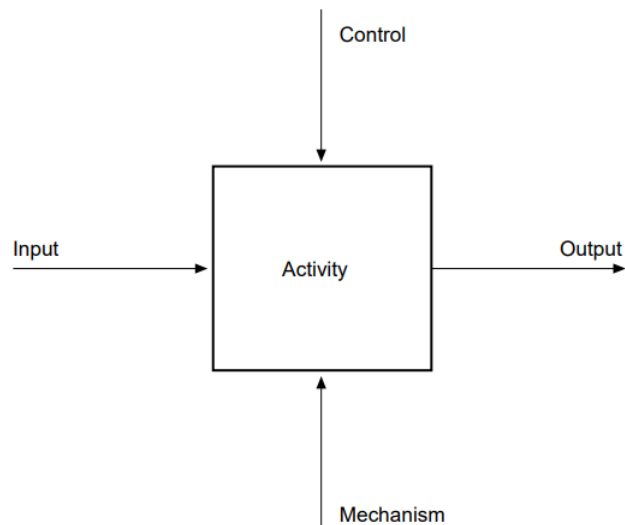

Figure 2.10: SADT activity's concept (Congram and Epelman, 1995)

Languages. The complexity of the graphical elements used by both languages is considered. Modelling some aspects using UML-AD requires a group of symbols (e.g., a loop) because of the use of a single symbol for each business process component. Likewise, BPMN can model some aspects by using only one symbol but, also, it uses complex symbols to describe a series of information as a whole. We note that both languages use, in many cases, similar symbols to describe business processes. The ability of mapping to a business process execution language (BPEL) to compare the two modeling languages is also investigated. A model can be executed by mapping from BPMN and UML models to a BPEL. This part is beyond the scope of this thesis, however, many information can be found in (Geambaşu, 2012; Ayad, 2013).

(Peixoto et al., 2008) demonstrate that both UML AD and BPMN are equally readily understandable by doing some experiments with computer science students that do not know the languages and the modeled domain, and have to read and understand the processes diagrams.

SADT provides a graphical representation of functions, without assembling functions with common attributes, nor assigning a resource to several functions (Karagiannis, 2010).

In order to choose a method of modeling organizational systems adapted to the analysis of the emergency plans, it is necessary to take into account the objectives and constraints of this thesis with respect to the characteristics of these methods. In our work, we are interested in creating an easy-to-understand visual representation of an emergency response plan. All the methods can be used in order to create our model, hence, we decided to choose BPMN 2.0 to represent our processes. It is event-oriented modeling (time sequencing). According to (Rongier, 2012), BPMN modeling highlights the phenomena of coordination, synchronization,

collaboration and other interactions between the different actors participating in the process, which is very important in the case of crisis management. In addition, we use the structure of SADT later in our dysfunctional model to specify the source of the cause (input, control or mechanism).

2.4 Emergency response plan modelling

In order to better understand the interactions between the actors of an emergency plan, we analysed the existing plans in Lebanon and France. Unlike France, there is no textual format for an emergency plan in Lebanon. Therefore, the French generic emergency plan, ORSEC⁶ plan, is studied in this section. In order to obtain more information on Lebanese emergency plans, and particularly on the operational level, meetings with the Lebanese Red Cross⁷ (LRC) were organized. These meetings and the study of ORSEC plan help us later on in our dysfunctional model to specify the failure modes, their causes and effects.

2.4.1 Notion of business process

Processes are everywhere finance, law, business and management, science and technology, nature, insofar they govern the dynamic of any system. According to (Borne and Richard, 1992), a process is an evolutionary (dynamic) system for which time plays an essential role. As mentioned in (Srdic, 2020), in the dictionary definitions, it is defined as “a set of activities that interact to produce a result; it can occur once or be recurring or periodic”. Depending on the field in which it is applied, some words can be used in combination with process, like business process, chemical process, etc. However, this combination generates a domain-specific definition. This research project uses BPMN in order to model the emergency response plan. Therefore, business process is used. (Davenport, 1993) define business processes as “structured and controlled set of activities designed to produce a specific output”. (Eriksson and Penker, 2000) also consider a business process as focusing on doing the work, not on describing a service that is the result of the process. Others propose variations, but the common thread is considering a business process as a set of diverse tasks that produce an outcome.

In a crisis rescue plan, each service has a set of actors where each has a sequence of tasks to accomplish to achieve an objective. In this context, an actor can perform one task at a

⁶<https://www.interieur.gouv.fr/Le-ministere/Securite-civile/Documentation-technique/Planification-et-exercices-de-Securite-civile>

⁷<https://www.redcross.org.lb/>

time while a service can perform several actions at once (parallel tasks). Unlike our scenario, the ORSEC plan is modeled by services. The tasks are represented as activities in BPMN.

2.4.2 Introduction to decisional, operational and informational levels

Analysis of the ORSEC plan in France shows that decisions are not taken by agents directly in the field. The decisions are distributed to the different levels of the plan (strategic, tactical and operational level). In this case, we distinguish between three sets:

- Decisional level: represents the decisions made by decision-makers.
- Informational level: contains the tasks performed by actors to communicate with other agents in order to inform them of a situation or a decision. Actors may receive information directly from actors on the site or from external actors, In addition, communication can be visual. For example, the tag's color on the victim informs an actor of his/her state.
- Operational level: is composed of tasks to be carried out by the actors on the site.

In order to differ in the next figures between the actions of each level, we color an activity belonging namely to the decisional level, informational level, and/or operational level, in blue, green and pink colors, respectively. In addition, an action can belong to one or more levels (see figure 2.11). We modeled a generic model (see figure 2.12) that shows the process when

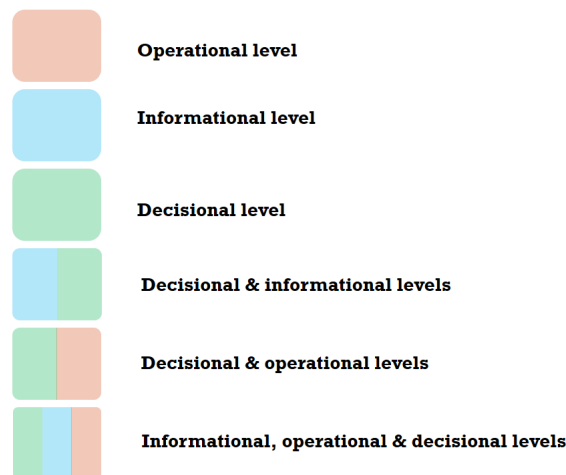

Figure 2.11: Activity color legend

there are decisions, information exchange and execution of an action (act). This model makes it possible to represent in a general way the interaction between the three levels. When an actor receives information, s/he analyzes it in order to make a decision. This latter is taken if the actor has enough information, otherwise, s/he asks to be better informed. The decision

made by an actor is either executed by the actor him/herself or by other actors, so s/he must first transfer the decision to them. While executing a task, an event can interrupt it at any time, in this case, the actors inform the other actors of the situation. Furthermore, if the task is performed by the decision maker him/herself, s/he will change his/her decision depending on the situation.

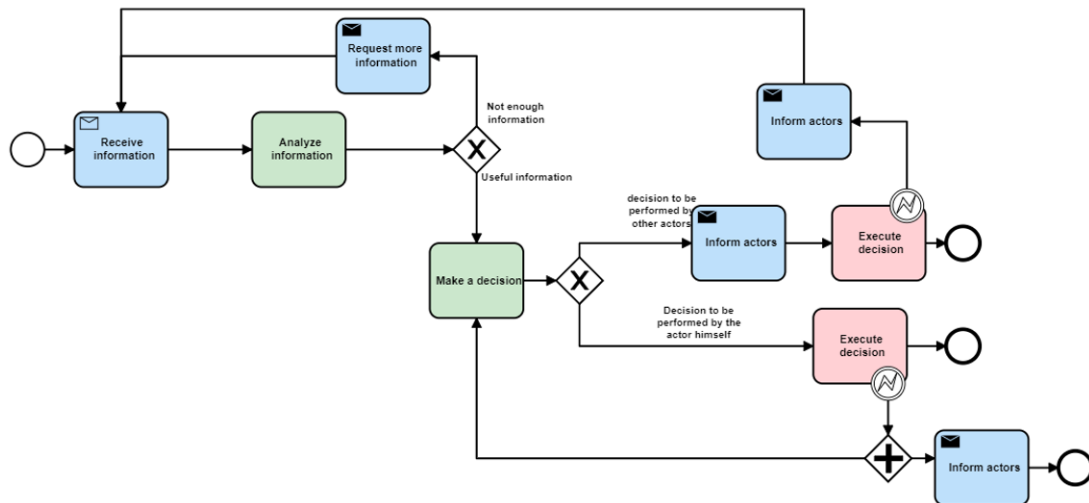

Figure 2.12: Generic model: the interaction between the three levels

2.4.3 ORSEC plan services

ORSEC plan defines actors at three levels: strategic level, tactical level and operational level. The figure 2.13 presents the actors belonging to each level.

The departmental operational centre (COD) is located at the prefecture and is headed by the director of rescue operations (DOS). It is at the strategic level and gathers the representatives of the services involved in the ORSEC plan. Each unit provides services that enable the COD to be in charge of decision-making, coordinating actions, centralizing information and passing it on to the various parties involved. At the tactical level, the operational command centre (PCO) is the outpost of the COD in the field. It is under the responsibility of the commander of rescue operations (COS). It is located as close as possible to the field and responsible for the coordination of actions in the field. Within it, it groups together all the command structures as well as the various structures internal to each service and necessary for the organization of the command. Both the director of fire and rescue services (DSIS) and the director of medical rescue (DSM) are responsible of the sectors at the operational level. The DSIS manages the pickup sector where the firefighters and the doctors and nurses of the health and emergency medical service (SSSM) intervened. While the DSM manages

the PMA (SMUR teams, SSSM doctors, the personnel of the SDIS and the approved civil security associations) and the evacuation sector (the means of the SAMU, the SDIS, the other public services and the approved private companies of medical transport).

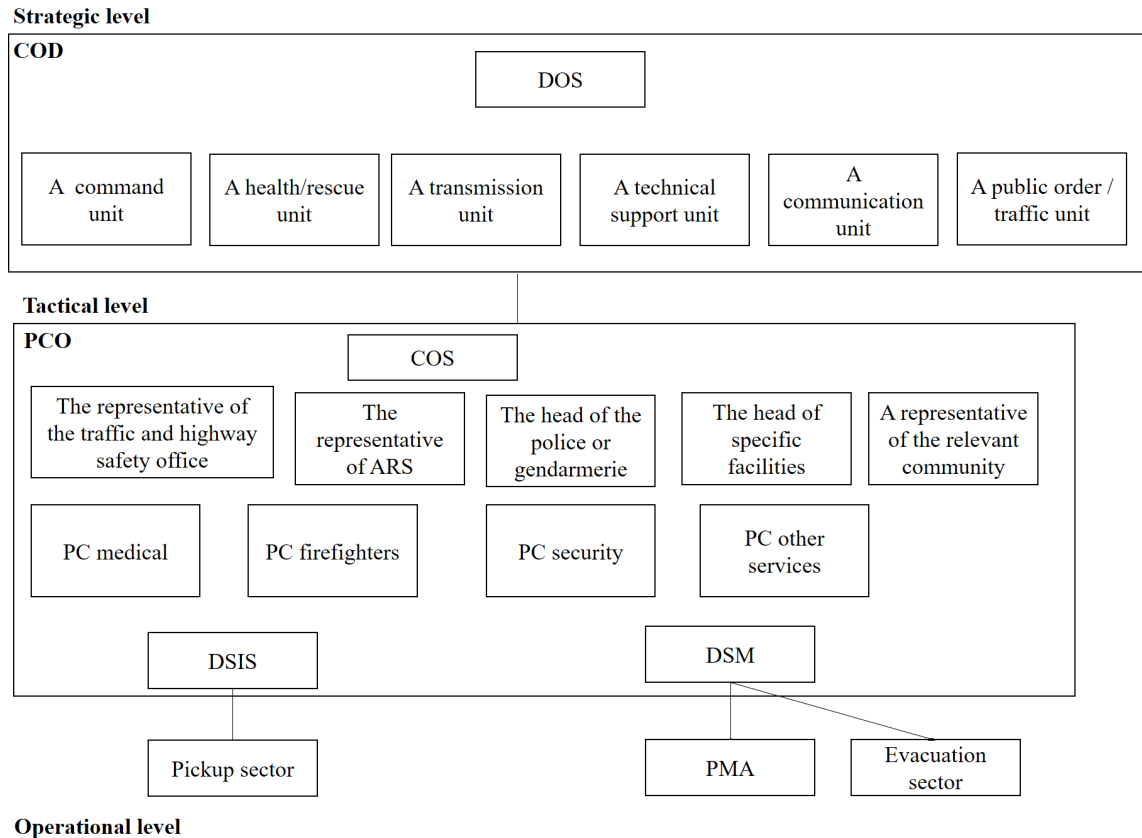

Figure 2.13: The ORSEC plan services at the three levels

2.4.4 ORSEC plan modelling

In France, intervention plans are available in a textual format defining the actors involved and their roles. In order to provide a global view of the collaboration between the emergency services, we have established models distinguishing between the three levels mentioned above. These models were built from the BPMN standard. We give for each service a number from A to L (see table 2.2) and for each activity a number. For clarity reasons, each part of the BPMN process is shown separately in order to explain each part of the emergency plan.

Alert Centre

The process begins when receiving the information by the alert centre which analyzes it and alerts the concerned emergency services and authorities. In order to send the alert

Number	Service
A	Alert centre
B	Departmental operational centre (COD)
C	Operational command centre (PCO)
D	Pick up sector
E	Advanced Medical Post (PMA)
F	Mortuary
G	Meeting place for unharmed people (LRI)
H	Health care centre
I	Evacuation sector
J	Police centre
K	Departmental fire and rescue services (SDIS) centre
L	Urgent medical aid service (SAMU) centre

Table 2.2: Code of Physical Entities

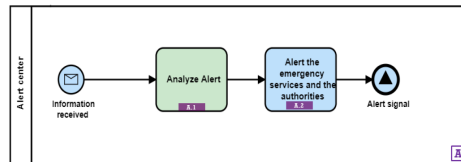

Figure 2.14: Alert centre's process

message to the prefectural authority, it must contain the nature of the event, its exact location and a description of its environment. Likewise, it contains the presumed number of victims and the first estimate of the means to be engaged and of future needs, if possible the evaluation of a potential secondary danger.

Emergency Services Centres

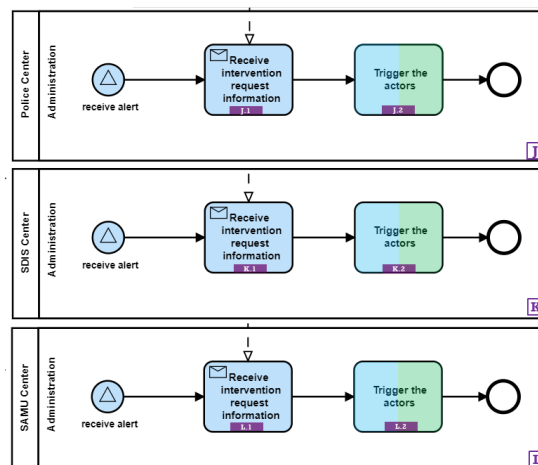

Figure 2.15: Emergency services' process

The alert is received by the three centres: police centre, SAMU centre and SDIS centre. Each center receives the necessary information from COD to trigger the actors.

COD

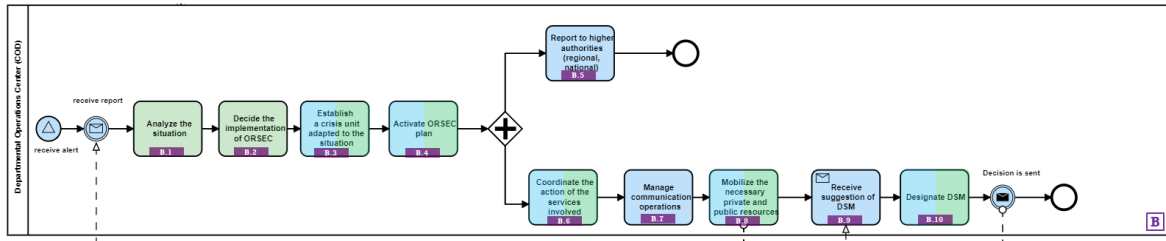

Figure 2.16: COD's process

It is the strategic level of the plan. After receiving the alert, the first report is also received from the commander of rescue operations (COS). The director of rescue operations (DOS) analyzes the situation and according to this latter, it decides the establishment of a crisis unit adapted to the situation and whether or not to activate the ORSEC plan. The COD's missions are to report to higher authorities, coordinate the action of the services involved, manage the communication operations, mobilize the necessary private and public resources; It is the DOS who decides who is the director of medical rescue (DSM) on site after receiving the suggestion from the COS.

PCO

It belongs to the tactical level. It is responsible for coordinating all operations carried out in the field. Activated by decision of the prefect or his representative, it is supervised by a member of the prefectural body appointed by the DOS and who coordinates the actions carried out on the scene of the crisis. COS suggests the DSM to DOS and s/he designates the director of fire and rescue services (DSIS) who organizes the pickup sector. Placed under the authority of the COS, the DSM coordinates medical resources in the field and is responsible for making medical decisions. PCO's missions:

- Carry out a first analysis of the situation and its probable evolution.
- Send information to COD.
- Communicate the press.
- Request more resources.
- Receive medical report from DSM.
- Manage the intervention.

The SAMU command centre receives information about critically injured people who were transferred to the hospital before the activation of the PMA. As soon as the PMA is

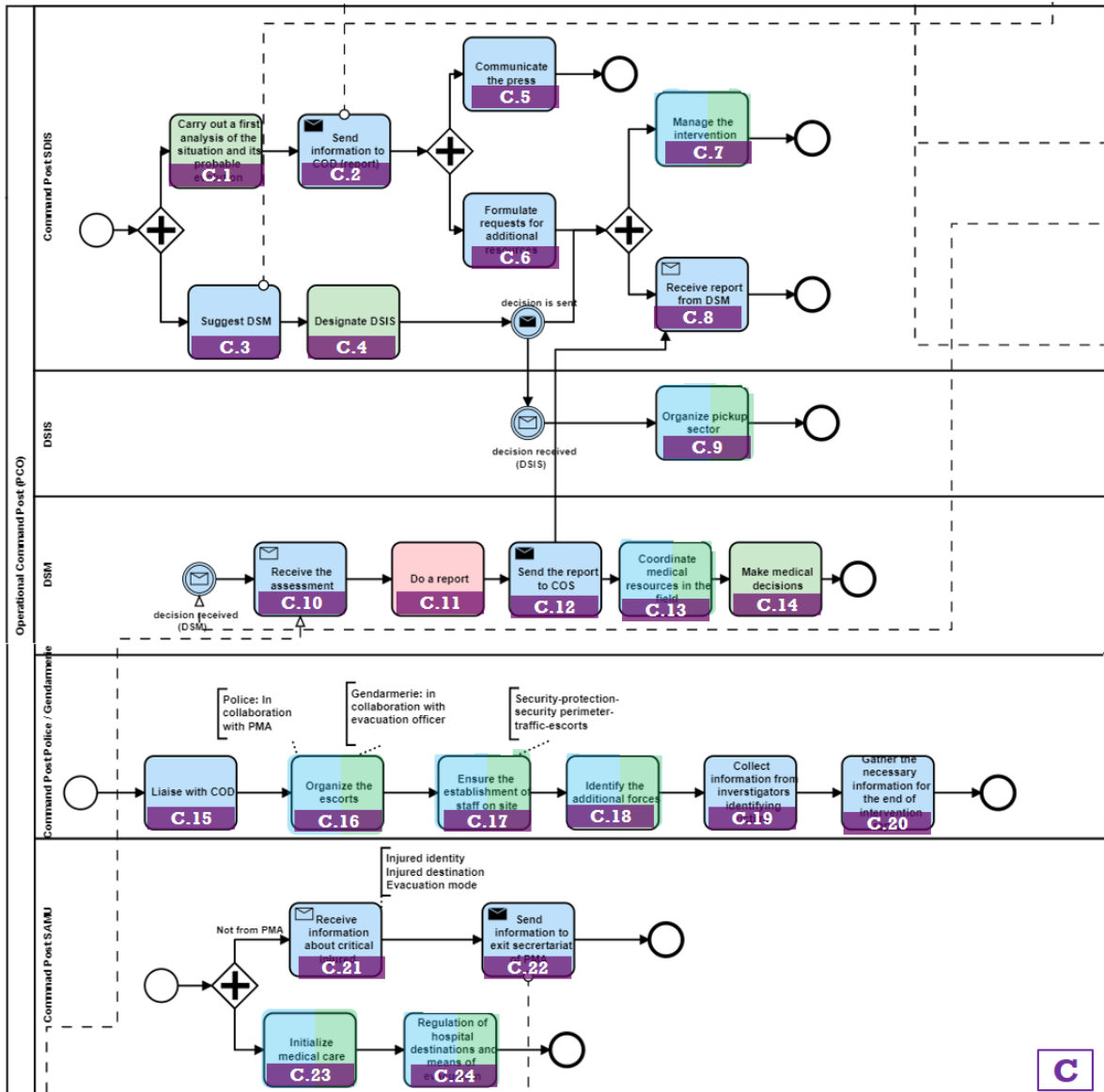

Figure 2.17: PCO's process

active, these elements are transmitted to the PMA exit secretariat. In addition, it initializes the medical care by confirming to the departmental SAMU the mass casualties, organizing medical care and transmitting the first medical report. Regulation of hospital destinations and means of evacuation is done according to the regional health agencies scheme.

The security command centre liaises with the COD, collects information from investigators identifying the victims and gathers the necessary information for the end-of-intervention report. It identifies the auxiliary forces to be called upon and ensures the establishment of staff on the site. In addition, the Police collaborate with the PMA while the gendarmerie collaborate with the evacuation officer to organize the escorts.

Pick up sector

It is provided mainly by the doctors and nurses of the health service and medical rescue (SSSM) and the firefighters, possibly assisted by other stakeholders, in order to provide first aid. These operations are placed under the authority of the DSIS assisted by an officer from the SSSM identified by a yellow "health officer" chasuble. Those involved and victims are grouped together at the PRV.

When victims are located, the rescuers provide them with first aid. After these operations, the victims are evacuated to the PRV where first triage is carried out. Unharmful people are evacuated to the LRI, corpses are removed to the mortuary and finally the injured are transported to the PMA. In parallel, an emergency report is established and is sent to the DSM at regular intervals.

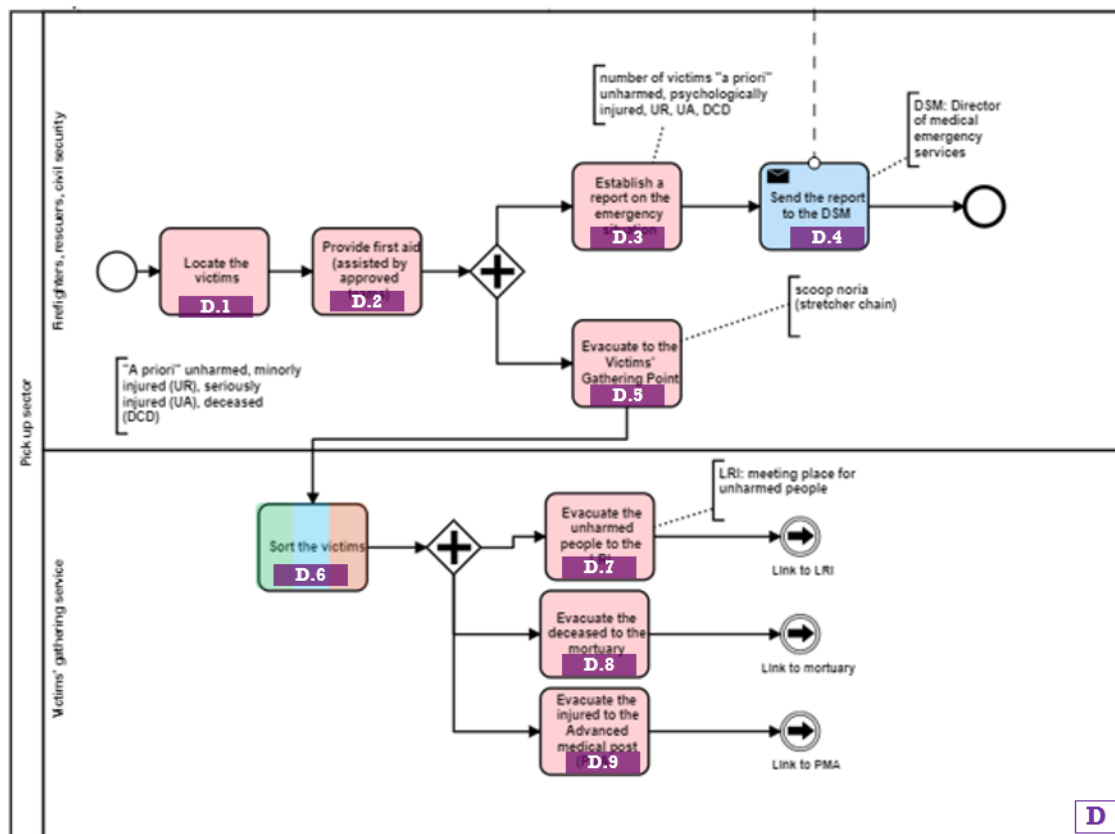

Figure 2.18: Pickup sector's process

PMA sector

As shown in figure 2.19, a second triage occurs in PMA and each type of victims is evacuated to the zone corresponding to their situation. In each zone, a medical team takes

care of the injured under the responsibility of a doctor. The unharmed people and dead bodies are transferred to LRI and the mortuary, respectively.

The DSM appoints the doctor who will head the PMA and the triage and evacuation doctors for the PMA. S/he keeps the DOS informed of the situation from the medical point of view. In the evacuation distribution zone (PRE), the injured are prioritized and assigned to hospitals and ambulances.

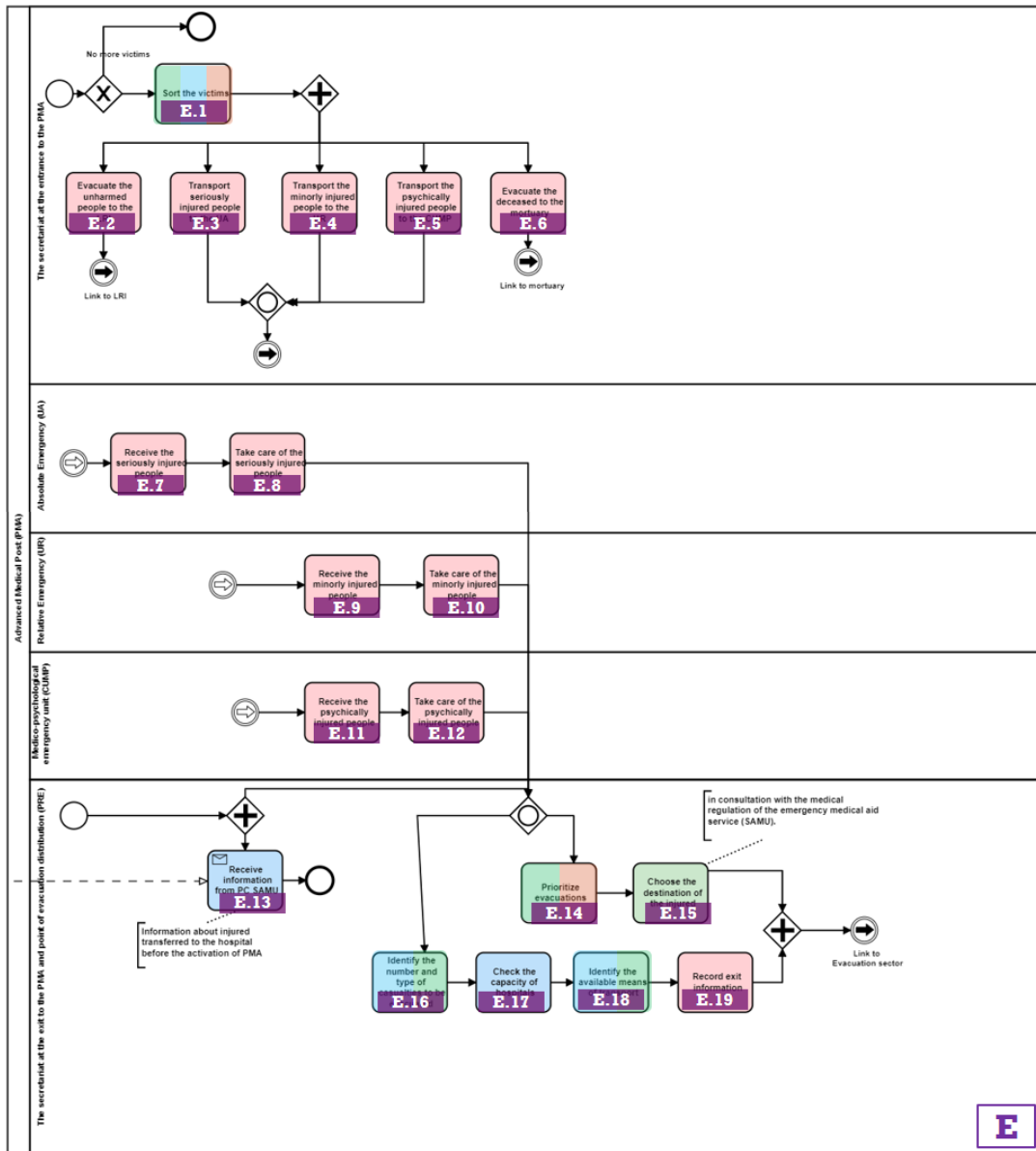

Figure 2.19: PMA's process

LRI and mortuary

LRI (see figure 2.20) groups the a priori unharmed people, takes care of them and identifies them. It is under the authority of security forces. The location of LRI is determined by the COS.

Mortuary (see figure 2.21) groups the dead bodies and it is under the authority of security forces. One or more forensic pathologists, first-aid personnel and agents of specialized companies are associated with the mortuary.

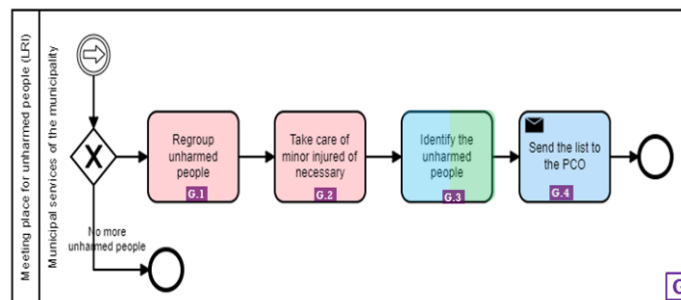

Figure 2.20: LRI's process

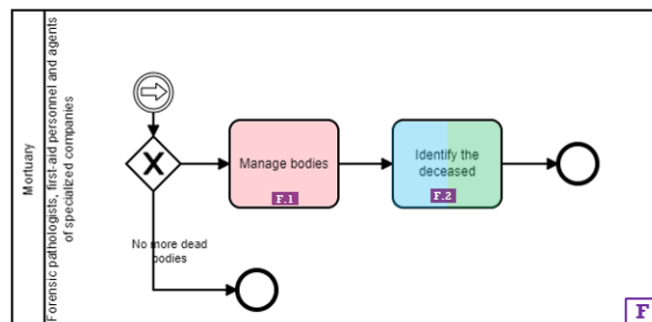

Figure 2.21: Mortuary's process

Evacuation sector and health care centre

This corresponds to the evacuation of the injured from the PMA to the hospitals (see figure 2.22). It is under the authority of DSM. A vehicle assembly point (PRM) may be set up near the PMA for regulation. A health care centre communicates its capacity with the SAMU in the evacuation distribution zone and triggers the white plan, if necessary, to organize the reception and management of a massive influx of victims. It receives the injured, diagnoses and sorts them in order to take care of them. It is necessary that the injured be registered in order to take care of them. Finally, either the injured is cured and s/he will go out of the hospital or is dead and s/he is transferred to the mortuary.

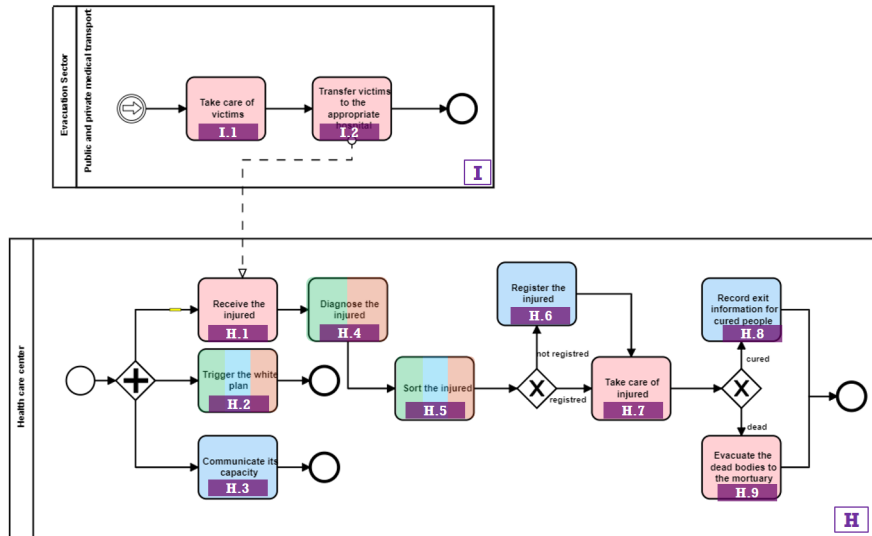

Figure 2.22: The process of evacuation sector and health care centre

2.5 Dysfunctional modelling

Dysfunctional modelling adds to functional modelling information about potential failures that a system may encounter. This allows the decision maker to determine the causes of failure as well as to specify the effects of these causes on the system. In what follows, we describe two tools classically used for this dysfunctional modelling: FMECA and event trees.

2.5.1 FMECA

Failure Mode and Effects Analysis (FMEA) is a qualitative technique which defines main causes and effects of failures. The quantitative FMECA is an extension of FMEA which allows the assessment of the criticality level of failures by combining different sources of knowledge related to the causes and consequences of the different failure modes of a component, a product, a task or an activity. It is a predictive approach that also allows to identify the causes and therefore to explain the past. A failure cause is the reason for a problem while failure mode is the way a problem is observed (a process can fail). It describes how the failure occurs and its effect on the equipment operations. Failure effect is the consequence of a failure mode (Brahim et al., 2019).

In addition, FMECA is a decision-making tool. It reduces the critical failures' probability and analyzes potential failures to prioritize the improvement of actions in order to enhance the performance of the system (Brahim et al., 2019). Moreover, the failure factors to determine the risk priority number (RPN), which is an integrated measure of risk, (García and Gilabert,

2011; Deng et al., 2020; Chang and Sun, 2009) are:

- Severity (S): representing the seriousness of the failure effect.
- Occurrence (O): indicating the likelihood of this failure to happen.
- Detection (D): referring to the probability of detecting a failure.

Each input factor takes a discrete value in the range [0, 10]. This is an example of a possible scale, but others can be considered. The RPN is obtained by multiplying these three ranks. The higher the RPN, the higher the chances of failure of the mode. Figure 2.23 shows an example of a FMECA table.

Functions	Requirement	Failure Mode	Effects	Severity Class	Causes	Control Methods				RPN
						Prevention Control	Occurrence	Detection Control	Detection	
Automatically paint the door of the car	Fully cover the required area of the door with required color	Foreign body in painting layer of the door	Bad appearance	5	Contamination of the room	Check room cleanliness every day	6	Appearance check after painting 100%	4	120
		Door surface is not covered	Bad appearance of the door; Car surface is not protected.	6	Door is not set correctly in the painting machine	Door setting working instruction	8	Appearance check after painting 100%	4	192
	Paint thickness meet the required specification	Pain layer is too thin	Color is not good Durability of painting layer is shorter than specification	8	Spraying machine parameter is incorrect	Painting parameter setting instruction	8	Check the thickness of the first piece sample	6	384
					Painting machine with travel	Painting		Appearance	4	192

RPN = Severity x Occurrence x Detection
= 5 x 6 x 4 = 120

Figure 2.23: FMECA table example ⁸

2.5.2 Fault tree

A tree is a way to synthetically present the results of studies showing the relationships between causes and consequences both qualitatively and quantitatively. A fault tree is a top-down (deductive) method proposed by (Watson, 1961). It is a major tool for technology risk analysis that has the advantage of being simple to implement and easily understood. Originally, the fault tree approach completely eliminates the temporal aspects of scenarios. Then, additional gates are added to the fault tree that represent the temporal aspect and make it dynamic such as the priority AND gate proposed by (Vesely et al., 1981 as cited in Imakhlaf, 2021). According to (Baklouti, 2020), the fault tree analysis allows both the quantitative and the qualitative analysis. The qualitative analysis is used to identify weaknesses in the system. It identifies the necessary and sufficient combination(s) of basic events leading to the undesirable event. While the quantitative analysis is performed to calculate the probability of

⁸<https://www.iqasystem.com/news/risk-priority-number/>

occurrence of the undesirable event. According to (Kanazy, 2020), logic gates represent the combination(s) that can produce the event in the top level to which they are attached. The figure 2.24 presents the three fundamental gates in a fault tree according to (Imakhlaf, 2021). In reality, there are other types of gates such as the "k/n" combination, exclusive OR, inhibit, ... that are represented in (Kanazy, 2020; Baklouti, 2020; Imakhlaf, 2021). Furthermore, the figure 2.25 shows the events in a fault tree as cited in (Baklouti, 2020; Čatić et al., 2014).



Graphic representation	Symbol name	Significance
	AND	The output event occurs if all input events occur
	OR	The output event occurs if at least one of the input events occurs
	Not	The output event occurs if the input event does not occur

Figure 2.24: the three fundamental gates in a fault tree





Graphic representation	Symbol name	Significance
	Basic	It requires no additional development
	Undeveloped	It has an insufficient consequence or it has an unavailable information.
	House	An event which is expected to occur or not occur
	Conditional	An event that applies a specific condition or a specific restriction on the logic gates.
	Intermediate	An event resulting from one or more preceding events acting through logic gates

Figure 2.25: The events in a fault tree

The figure 2.26a represents an example of a fault tree, where its construction is based on events linked together by logic gates. The first line contains the event to be described. It is decomposed into two causal failures (Cause 1 and Cause 2). Likewise, Cause 1 is also decomposed into two subcauses. It continues to decompose events until a non-decomposable causal failure is found. On the other hand, the figure 2.26b shows that different types of events can be used in a fault tree and having a specific geometric shape.



(a) (Kanazy, 2020)

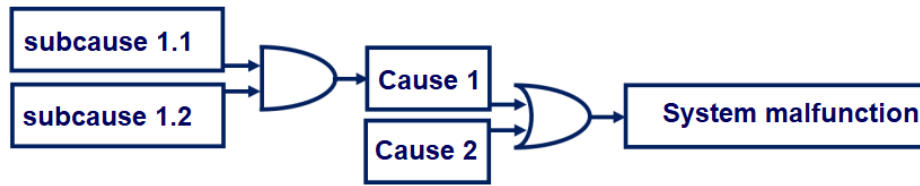
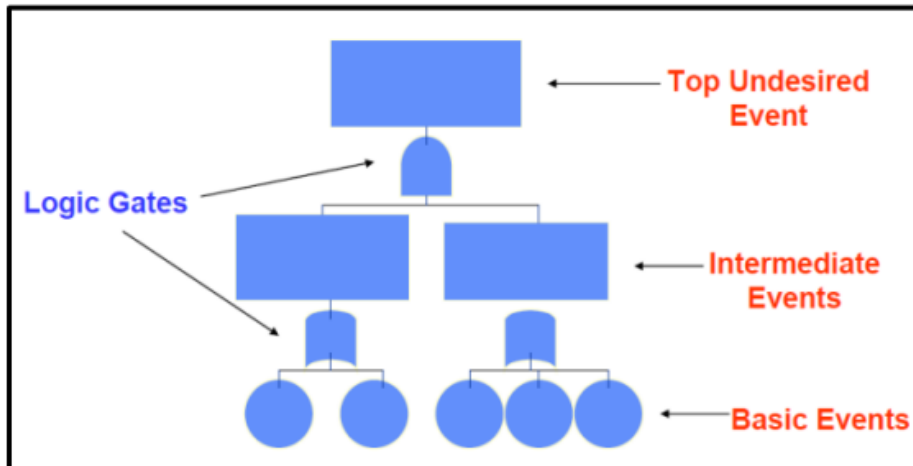

(b) (Baklouti, 2020)

Figure 2.26: Examples of fault tree structures

2.6 FMECA of the ORSEC plan

Modelling the ORSEC plan with BPMN gives a static view of the emergency plan. The crisis has a dynamic environment, which means that many uncertainties can arise and disrupt the response plan. In order to anticipate the sources of uncertainty that may occur, we propose a new approach relying on the Failure mode, effects and criticality analysis (FMECA) methodology. It is based on our analysis of the ORSEC plan and our meetings with the LRC, which means that it is not only dependent on theoretical information but also on the observations of actors having some experience on different types of crises.

2.6.1 Failure modes

Whatever process a function belongs to, we identified seven types of problems numbered from 0 to 6 (see table 2.3). We note that FM_i denotes the failure mode i where it belongs to $i = \{0, \dots, 6\}$. Each activity (function) in BPMN has one or more failure modes that correspond to a category of a problem.

Category	Description
0	It is not activated
1	It is not carried out
2	It gives no results
3	It lasts longer than expected
4	It gives incomplete results
5	It gives incorrect results
6	It is carried out intermittently

Table 2.3: Problems code's category

2.6.2 Causes

Problems can be explained by direct or indirect, internal or external reasons. They can also be dynamic or static. Unlike external causes, an internal cause means that the origin of the cause comes from within the process. Moreover, unlike static, dynamic means that the cause may change over time but cannot be controlled at the moment. In addition, a cause could happen before the process is executed or during its performance. In order to specify the cause's source, we use the SADT briefly introduced in section 2.3.3.

As indicated in figure 2.34, we identify three causes' levels in a bottom-up fault tree. A cause is represented by a square called an event in the fault tree. The two colors blue and green represent internal causes and external causes, respectively. Static and dynamic are designated by light and dark colors, respectively. The symbols " \leftarrow " and " \odot " designate when a cause is generated (before or during the execution of a process). In our work, the source of a cause can be from the input (I) which is the entry to of an activity, control (C) which is the external constraints and/or the internal organization that limits the activity or mechanism (S) which is the service that performs the activity (see figure 2.27). For example, if the cause belongs to level one (denoted N1) and comes from the input (I), the category of the cause is IN1.

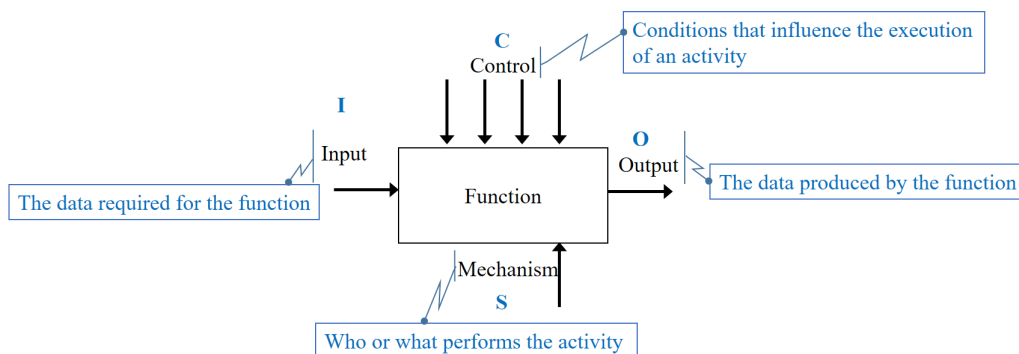

Figure 2.27: Structure of the identification of causes

Level one causes or direct causes are three (see figure 2.28):

- Non-compliance of inputs which means that the input is incorrect, incomplete, etc.
- Inability of the support to support the task which means that the system is not compliant (state, capacity, availability of resources, willingness).
- Non-standard disturbances (intensity, specificity) represent external constraints that are too strong and internal organization that is insufficient.

The figure 2.29 presents an example of level I causes for the "Evacuate to the Advanced Medical Post" activity.

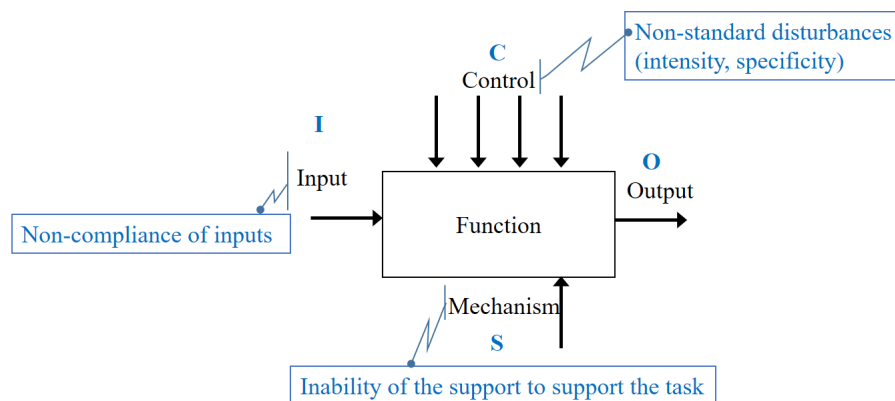

Figure 2.28: Level I causes

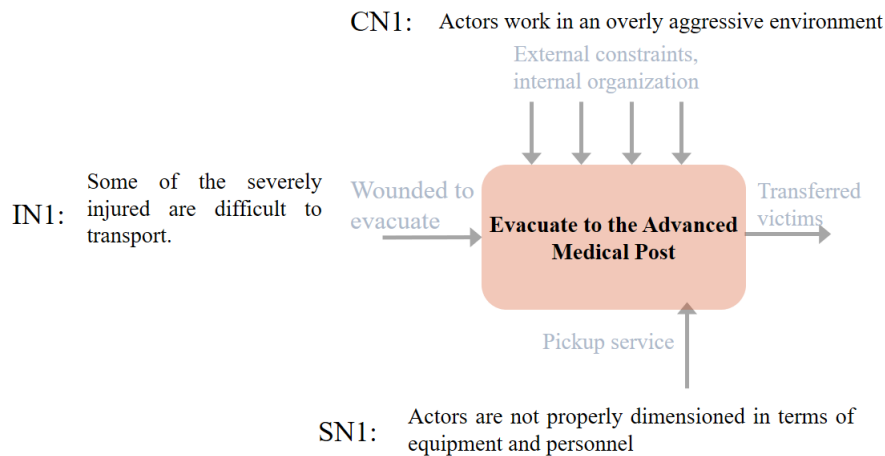

Figure 2.29: An example of the level I causes for an operational activity

We find the level two causes by going up in the fault tree (see figure 2.30):

- The non-compliance of inputs resulting from an upstream function malfunction, an unreliable source of the input or non-standard disturbances.
- Inability of the mechanism to support the task resulting either from the poor physical

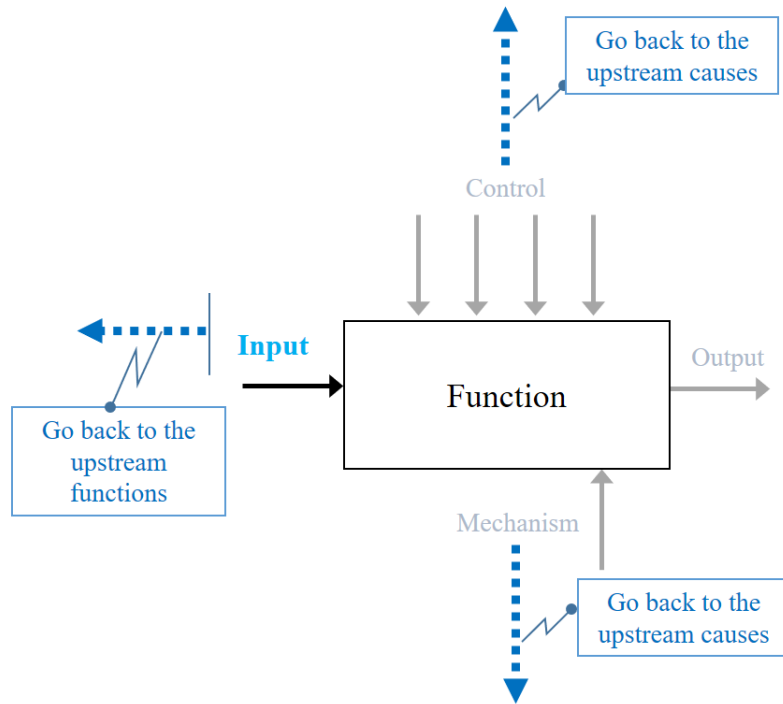

Figure 2.30: Level II causes

and psychological condition of the mechanism or from the default in design, system’s realization and maintenance.

- Non-standard disturbances resulting either from an event occurring simultaneously with another event or from a non-conforming system response.

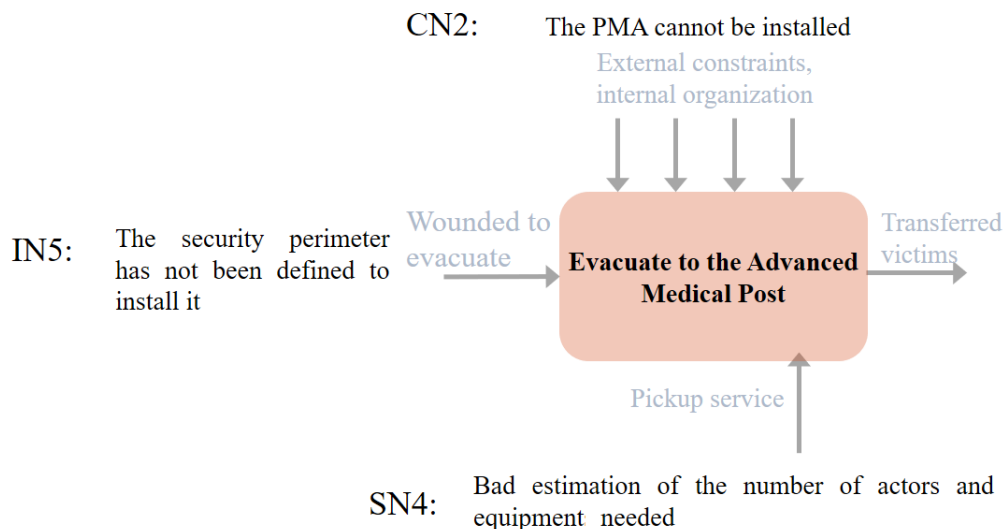

Figure 2.31: An example of the level II causes for an operational activity

The figure 2.31 presents an example of level II causes for the "Evacuate to the Advanced

Medical Post" activity.

In level three (see figure 2.32), we identify two causes for the default in design, system's realization and maintenance cause. It results from either the bad anticipation of the scenario or from the insufficient budget of the state or the centre.

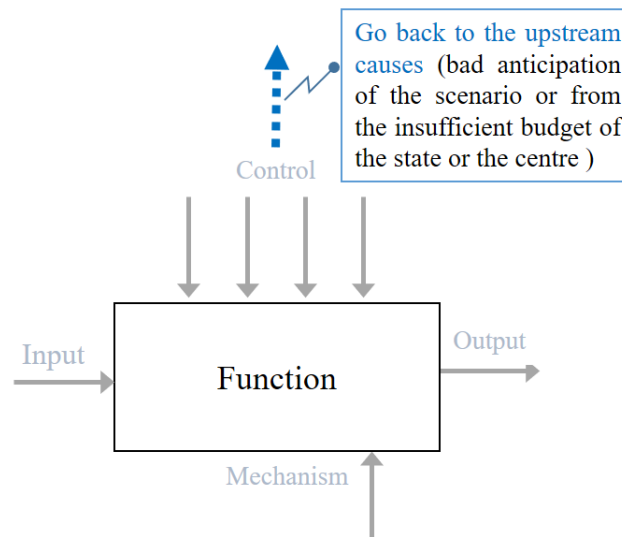
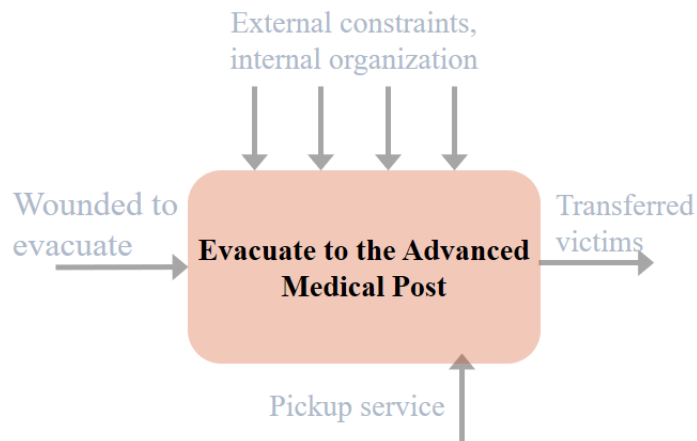

Figure 2.32: Level III causes



SN5: Bad estimation of victims' number

Figure 2.33: An example of the level III causes for an operational activity

The figure 2.33 presents an example of level II causes for the "Evacuate to the Advanced Medical Post" activity.

followed by the level of the consequence. Effects are generated either during the execution of the process or after the end of the process. Events' colors and the symbol “🕒” have the same meaning as for the causes. We added symbol “→” to indicate that the effect occurs after the process is completed.

Direct consequences are three (see figure 2.35):

- Non-compliance of outputs which means that the output is incorrect, incomplete, etc.
- Bad effect on the mechanism itself which means that the service is physically or/and psychologically affected.
- No outputs; i.e. there are no results.

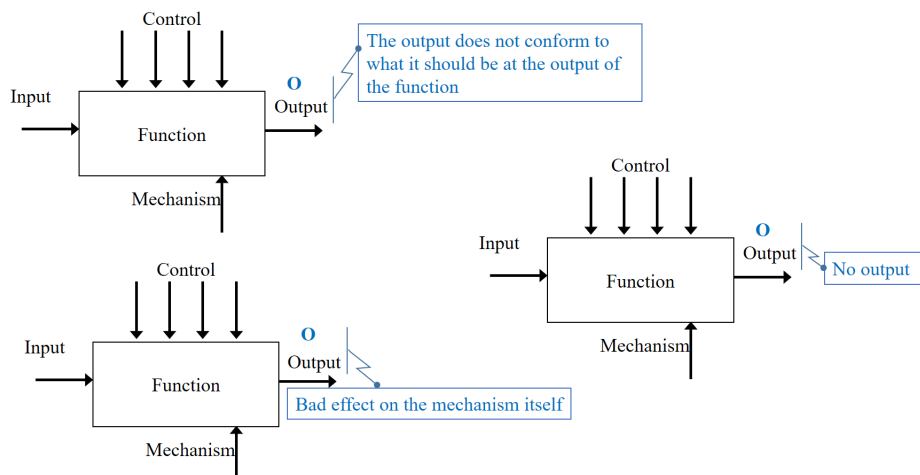

Figure 2.35: Level I consequences

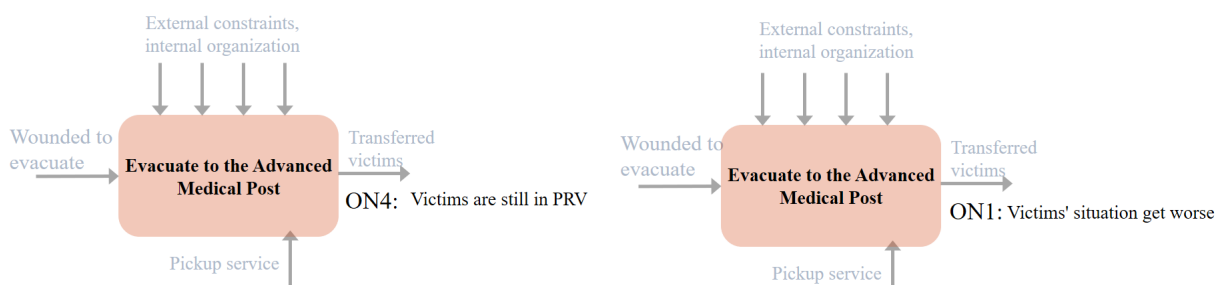

Figure 2.36: An example of the level I consequences for an operational activity

The figure 2.36 presents an example of level I consequences for the "Evacuate to the Advanced Medical Post" activity.

We find the level two consequences by going down in the fault tree. We identified two effects (see figure 2.37):

- Non-compliance of outputs affects a downstream function malfunction.
- The consequences can also affect other services involved in saving victims.

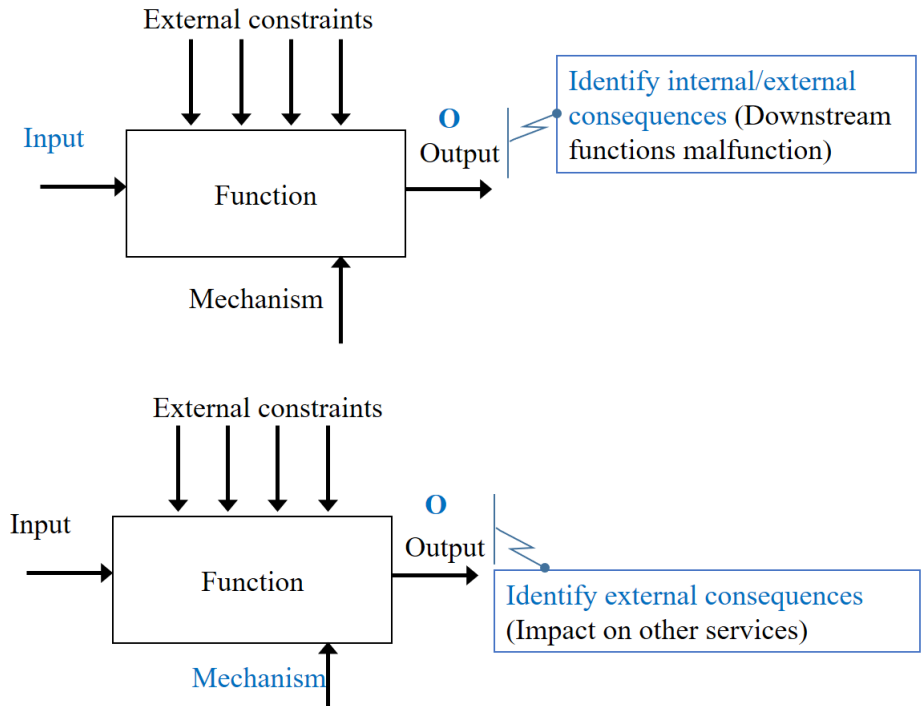

Figure 2.37: Level II consequences

The figure 2.38 presents an example of level II consequences for the "Evacuate to the Advanced Medical Post" activity.

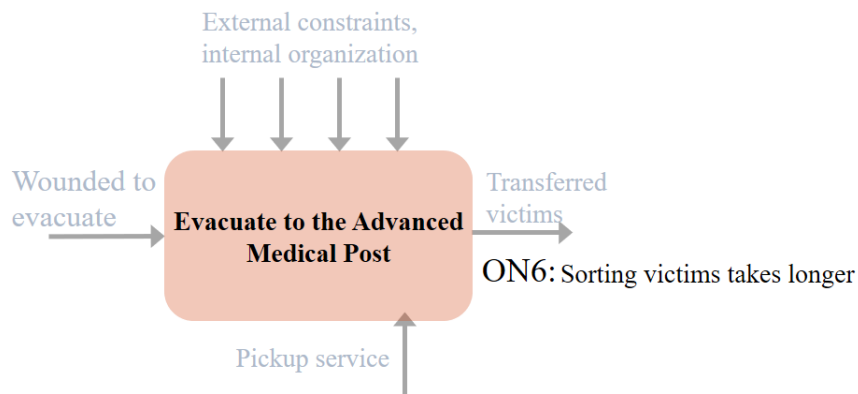

Figure 2.38: An example of the level II consequences for an operational activity

In level three consequences (see figure 2.39), we find that the results may not be optimal or that we can observe non-standard consequences (climate change, state's image, problems with neighboring countries, economic and social problems, death, etc.)

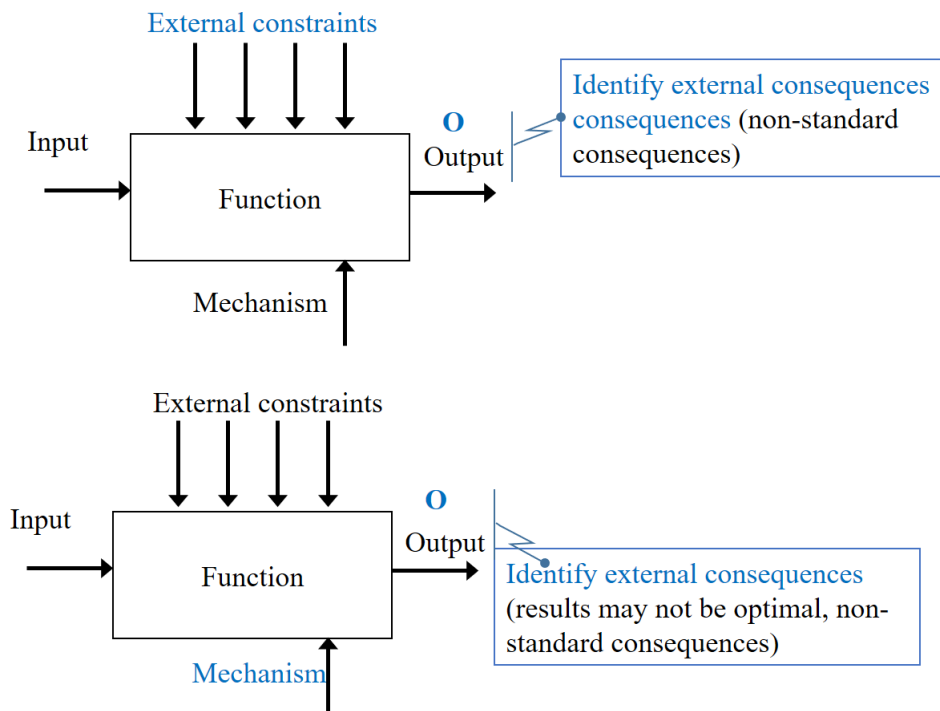

Figure 2.39: Level III consequences

The figure 2.40 presents an example of level III consequences for the "Evacuate to the Advanced Medical Post" activity.

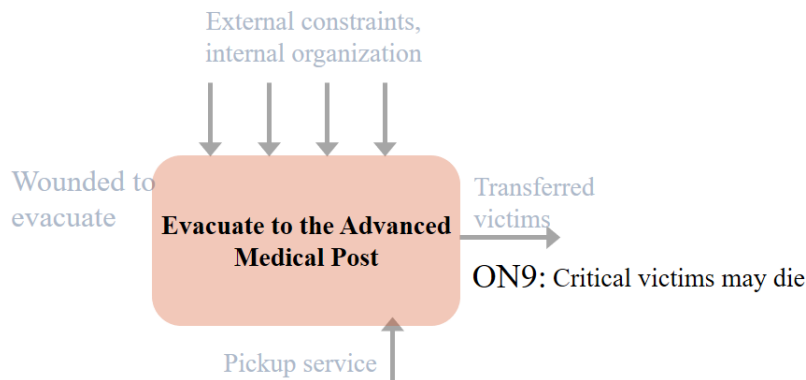

Figure 2.40: An example of the level III consequences for an operational activity

2.6.4 Criticality

In FMECA, the criticality is measured by multiplying the failure's severity, its probability of occurrence and the probability of its detection. In this work, failure mode criticality is defined as the combination between the damage and the exposure. In this context, we only consider

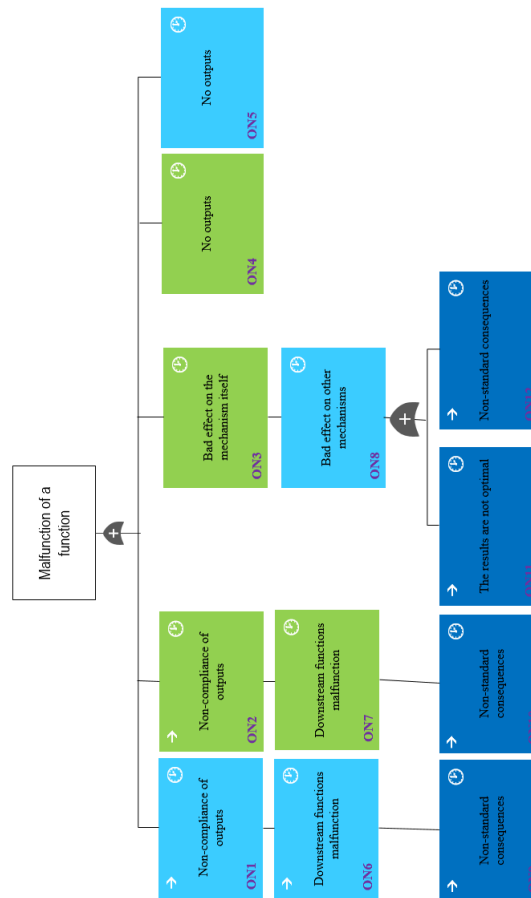

Figure 2.41: Level of consequences

the probability of occurrence (see table 2.4) and the severity (see table 2.5) to calculate the failure mode criticality (see table 2.6). Severity is related to the care of an injured person based on the type of injury and time. As shown in table 2.7, three levels are distinguished: not very significant, moderately significant and very significant. Each failure mode belongs to one of them.

Level	Description
1 Very low	Very low probability of occurrence
2 Low	Low probability of occurrence
3 Moderate	Moderate probability of occurrence
4 High	High probability of occurrence
5 Very high	Very high probability of occurrence

Table 2.4: Probability of occurrence level associated with the failure mode

	Level	Description
1	Low	Seriously or critically injured with a low possibility of delayed care
2	Significant	Seriously injured with a moderate possibility of delayed care
3	Serious	Seriously injured with a high possibility of delayed care
4	Critical	Critically injured with a moderate possibility of delayed care
5	Catastrophic	Critically injured with a high possibility of delayed care

Table 2.5: Severity level associated with the failure mode

		Severity index				
		1	2	3	4	5
Probability of occurrence index	1	1	2	3	4	5
	2	2	4	6	8	10
	3	3	6	9	12	15
	4	4	8	12	16	20
	5	5	10	15	20	25

Table 2.6: Criticality matrix

Criticality level	Description	Value
C_1	Not significant	Between 1 and 4
C_2	Moderately significant	Between 5 and 10
C_3	Very significant	Between 12 and 25

Table 2.7: Criticality levels

2.7 Vulnerability assessment of an emergency response plan

Vulnerability is defined in 1.2.4 as the stake's sensitivity to a threat (a hazard). The process must allow attending as quickly and efficiently as possible the potential victims of a crisis. It is temporally bounded on the left by the instant of occurrence of the catastrophic event and on the right by the instant of resolution of the crisis situation. The system moves from a planned state into an unplanned state. In this section, the vulnerability of an activity is represented by observing 11 indicators identified after gathering information from the LRC and analyzing the ORSEC plan which is well detailed in textual format and accessible by everyone. An activity is vulnerable if it can potentially be unable to be performed (no output) or if it is performed but potentially gives non-compliant results.

2.7.1 Codification of a function

The codification of a function is represented in figure 2.42. The vulnerability indicators are built on the global observation of the functional signature (and thus dysfunctional of

- Function number (Code)
 - A1 → L2
 - ex : L₂=Trigger the actors
- Nature
 - D-I-O
 - Decisional, Informational, Operational
- Interactions
 - I-E
 - Internal or External to the process
- Cost (Economic impact)
 - Direct, Indirect, Absent
 - Ex : A (the economic value of this function is not significant)
- Human impact
 - Direct, Indirect, Absent
 - Ex : D (function that induces immediate risk of death)
- Recurrence
 - R-I-U
 - Periodic, intermittent or unique function
- Technicality
 - High, Medium, Elementary
 - Ex : H : high level of qualification (difficult to replace)
- Heavy or specific equipment
 - Y (Yes) N (No)
 - (Machines, Consumables, Tools)
- Fluids
 - Y (Yes) N (No)
 - (Electricity, Water, Gas,...)
- Network
 - Y (Yes) N (No)
 - (hertzian, internet, satellite,...)
- Dedicated infrastructure
 - Y (Yes) N (No)
 - Rooms, Spaces,...
- Failure mode
 - 0,1,2,3,4,5,6

Figure 2.42: Codification of a function

each function). Each point is a column in the vulnerability indicators table as shown in the example in figure 2.43. This table is filled once we have finished our functional (BPMN) and dysfunctional modelling (FMECA). How can these indicators contribute to the assessment of the vulnerability of an activity?

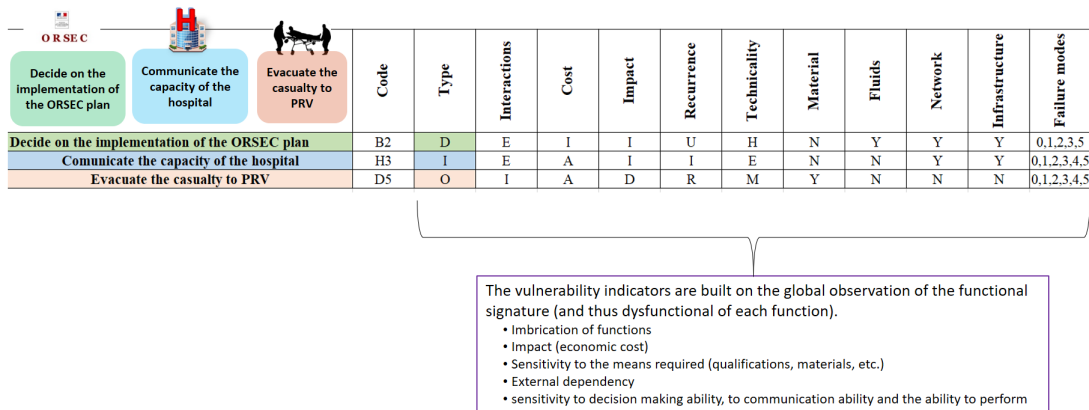

Figure 2.43: An example of the vulnerability indicators for three different activities

The three levels Decisional (D), Informational (I) and Operational (O) are represented in the column “Type” which indicates the problem nature’s type ; a problem in making a decision, or/and in communication or/and in performing the activity. It indicates the sensitivity to decision making ability (inability to decide), to communication ability (inability to inform or receive) and the ability to perform (inability to act or execute an action correctly). The “interactions” column indicates whether the function has an internal (I) or external (E) interaction with the process. It aims to determine if the activity has directly affected other services or only the service itself. The vulnerability is reflected in a decrease in decision-making autonomy or ability to continue the process. The “Cost” column allows us to know

if the function has a direct (D), indirect (I) or not significant (A) economic cost. At the operational level, economic cost is directly related to the care of victims (medical supplies and services, images, etc.). While it is indirect for electricity, water, food, etc. In addition, economic cost means that an activity can have an economic impact related to the human and material resources used to perform an activity (function) such as the number of actors involved, number of ambulances, etc. It is also associated to other indicators that represent the activity's sensitivity to necessary resources such as materials, fluids, infrastructure and network. In contrast to symbol (I) in the column "Impact", D indicates whether the function induces an immediate risk of death. If it is neither (I) nor (D), it means there is no risk (A). This indicator can be linked to the technicality indicator, which determines the need for competent actors. It determines the sensitivity of victims to the performance of actors. In the "Recurrence" column, a function can be performed only once (U), or intermittently (I) or periodically (R). Furthermore, it may need a high (H), average (M) or elementary (E) technicality in order to be performed. It may also require heavy or specific materials (vehicles, stretchers, etc.), fluids (oxygen, liquid, medicines, etc.), networks or infrastructures (power supplies, communication network, transportation systems, etc.). It is either yes (Y) or no (N). These indicators present the sensitivity to the required means (qualifications, materials, humans, etc.)

Finally, the last column indicates which failure modes may have a function. It shows the sensitivity of a function to the criticality level of the failure mode (not very significant, significant, very significant).

2.8 Application of terrorist attack scenario

The scenario presented in Chapter 1 is modeled in both functional and dysfunctional way in this section. As explained in chapter 1, the scenario's actors are: fire fighters, police, gendarmerie, medical teams of ambulances and hospitals. In section 2.2.1, the chain of care for victims in Lebanon and France is explained. Although the strategy in the two countries is different and the operational actors have different nomenclature and roles, helping the maximum number of victims is a common goal. In this context, the actors in our scenario are chosen and their roles are assigned in the functional model. On this basis, a dysfunctional analysis followed by a vulnerability assessment, is performed on each activity of the studied process. Finally, the relationships between the failure modes, their causes and effects can be identified and formalized in order, later on, to prevent or mitigate the risks.

As explained in section 1.5, decisions can be made by a single actor or can be distributed among actors. In this work, a centralized architecture is considered when there is a single

decision-maker whose decision is based on one or more criteria. In the semi-centralized architecture, certain decisions are taken by a single actor after the proposal of solutions by the other actors, and other decisions are made directly by the actors themselves. When decisions are distributed among the actors, we speak of a decentralized architecture.

We want our architectures to be close to reality. In fact, there are some decisions that are taken directly by the operational level's actors during a crisis such as choosing the appropriate trajectory to a destination or prioritizing the injured. In addition, the fact that one decision-maker makes all the decisions without negotiating with other actors in a crisis is neither logical nor real. In this context, the functional modelling applied to this scenario is carried out in the two architectures: semi-centralized and decentralized.

2.8.1 Functional modelling

Figure 2.44 shows the different actors in France, Lebanon and our unified scenario. Based on the ORSEC plan, in France, the main actors at the operational level are: the French fire brigades, the national police, the national gendarmerie and the Urgent Medical Aid Service (SAMU). While in Lebanon, respecting the order mentioned before, there are: The Lebanese civil defense, the Lebanese armed forces, the Lebanese internal security forces and the LRC. In this scenario, the actors are: security officers, firefighters, ambulance crew (ambulance) and medical teams in a hospital (hospital). Apart of hospital, each actor is attached to his/her centre. In this case, we have the fire brigade (or fire department), the security centre and the ambulance centre. In this context, we divide the actors into two types: mobile actors and fixed actors. Unlike fixed actors, mobile actors move from one place to another during a crisis such as firefighters. Furthermore, a number is given for each actor and for each activity. Common actors have the same number as indicated in table 2.2.

In general, whether in Lebanon or in France, the organization of the medical chain includes three intervention phases:

- lifting and transport of victims to the advanced Medical Post (PMA) which is located near the site.
- categorization and prioritization of victims.
- transfer of victims to a hospital

The only difference between the modelling of the scenario in decentralized and semi-centralized architectures is that the latter has a central agent responsible for making some important decisions.

In this work, we seek to avoid any risk of replication on the site. In other words, to

avoid any new attack that could cause more damage. Thus, security officers are the first to intervene. In the pick-up sector, the firefighters are the only actors involved. In the evacuation sector, ambulances are the only vehicle used to transfer injured to hospitals.



Figure 2.44: Operational actors in France, Lebanon and our scenario

2.8.1.1 Security centre, ambulance centre and fire department

In a semi-centralized architecture (see figure 2.45a), a centre receives an alert, checks its capacity and proposes assignment solutions to the central agent. A solution contains the number of operational actors needed on site according to each centre's capacity. When a centre receives the decision from the central agent, it triggers its actors and continues to communicate with them if necessary. Whereas in a decentralized architecture (see figure 2.45b), a centre is responsible for making its own decisions.

2.8.1.2 Security officers

The missions of security officers do not change in either architecture (see figure 2.46). They clear the road for the transfer of wounded, seal off the crisis area and secure the zone by killing and arresting the attackers. When the area is safe, they allow other actors to enter the site. Security officers choose the appropriate route to the site after receiving the request from its centre. When they find a route, they go to the site. In addition, they communicate with their centre.

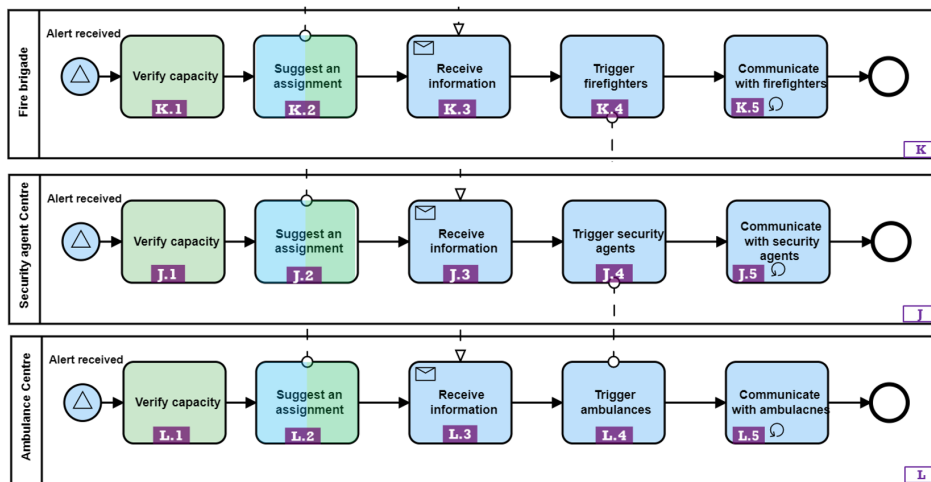

(a) Semi-centralized architecture

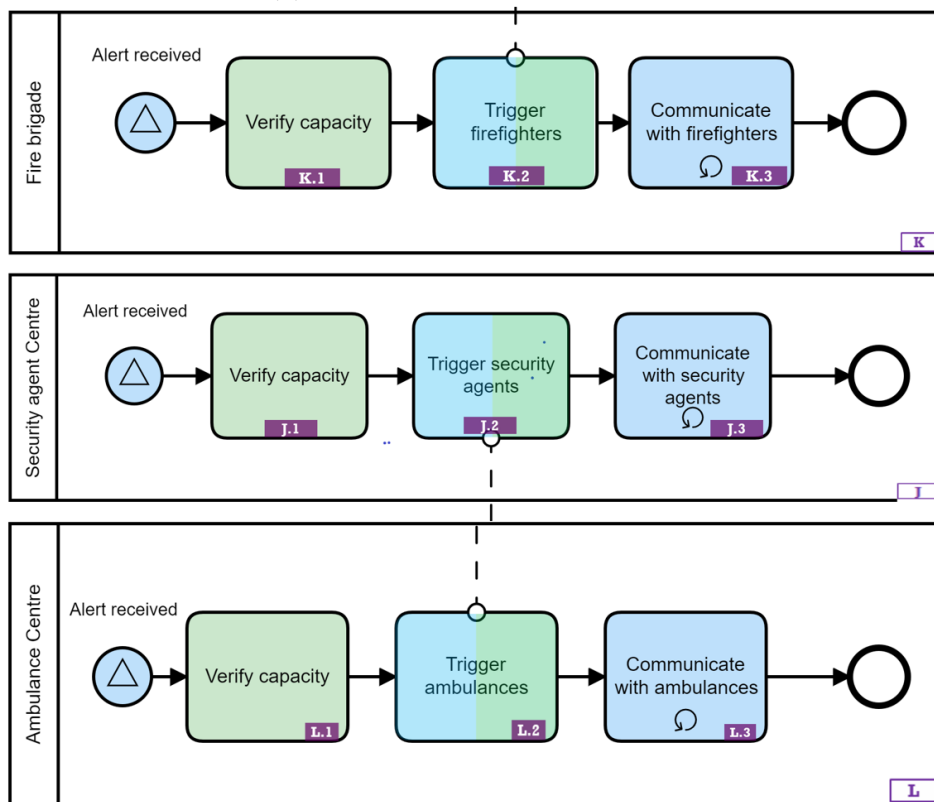

(b) Decentralized architecture

Figure 2.45: Centres representation in both semi-centralized and decentralized architectures

2.8.1.3 Firefighters

Figure 2.47 shows the firefighters' missions in both architectures. In order to reach the site, they look for a route and head towards the site. After receiving the authorization from

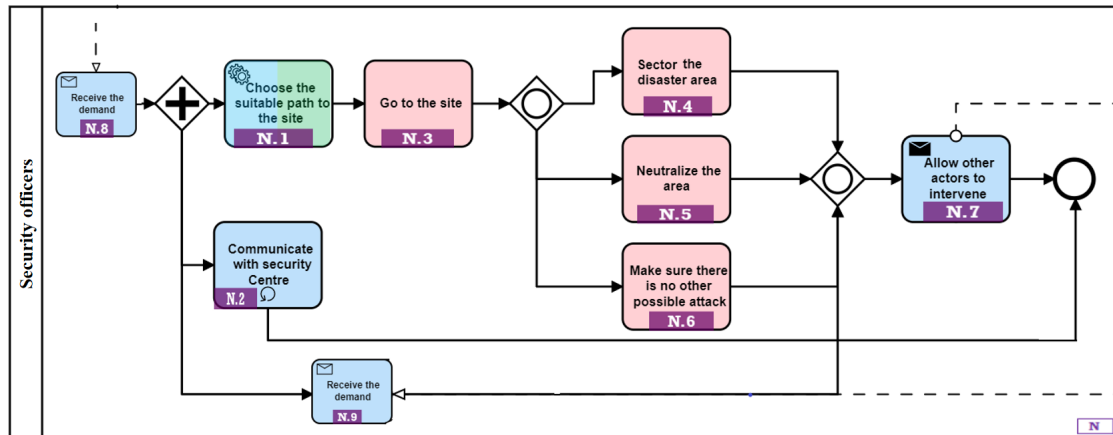

Figure 2.46: Security officers' missions in the two architectures

security officers, they access the site. They locate, pick-up and transfer victims to the PRV. In addition, they provide first aid to the injured and sort them before transporting them to the PMA. Furthermore, they communicate with their centre when needed.

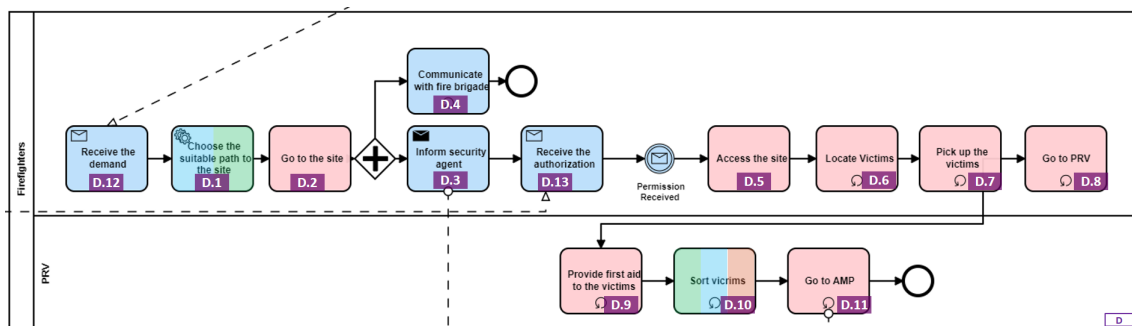
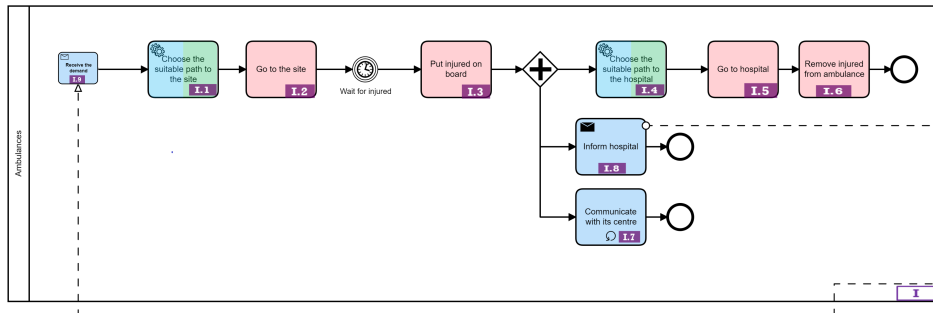

Figure 2.47: Firefighters' missions in the two architectures

2.8.1.4 Ambulances

For an ambulance, the only difference between the two architectures is that in a decentralized architecture, when it arrives at the site, it puts the first casualty that need to be transferred to a hospital and communicates the available hospitals in order to choose the appropriate one for the injured person to transfer him/her. In a semi-centralized architecture, ambulances transfer the injured to the hospital chosen by the central agent. They only inform the hospital of the condition of the injured and their expected time of arrival. An ambulance moves between its centre and the site, then the site and a hospital. In this context, as shown in figure 2.48, it chooses the suitable path to its destination (I.1 and I.4) and moves (I.2 and I.5) towards it.



(a) Semi-centralized architecture

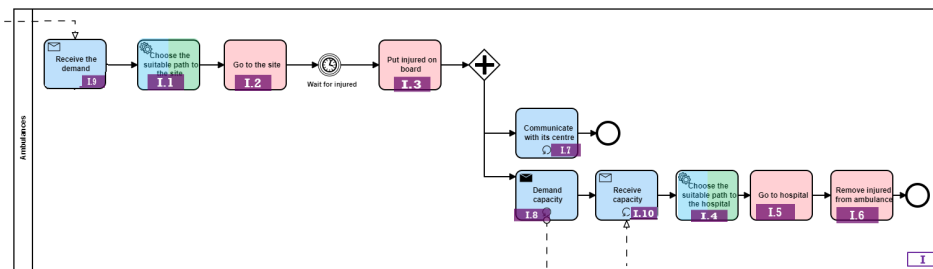

(b) Decentralized architecture

Figure 2.48: Ambulances' missions in both architectures

2.8.1.5 Hospitals

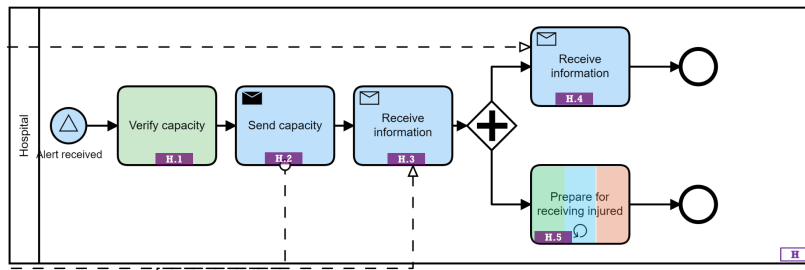

(a) Semi-centralized architecture

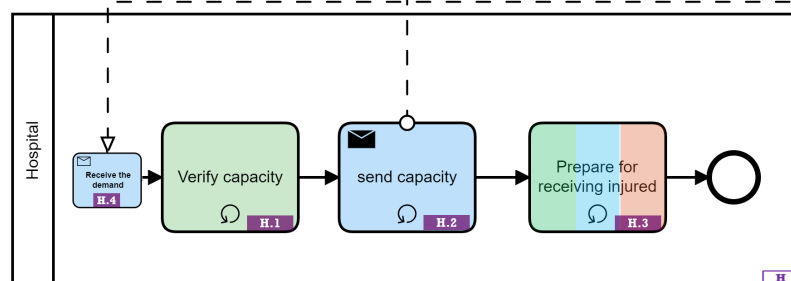

(b) Decentralized architecture

Figure 2.49: Hospitals' missions in both architectures

In a semi-centralized architecture, after receiving the alert, a hospital verifies its capacity, sends it to the central agent and prepares to admit victims after receiving the decision from the central agent. It also receives the information about the injured from the ambulances. In a decentralized architecture, each hospital shares its capacity with the ambulances to transfer the injured.

2.8.1.6 PMA

The PMA is not presented in figure 2.44 because it is a place to assist victims. It is composed of the main actors represented in figure 2.44. Therefore, by the PMA, and more specifically by the medical team of the PMA. In this work, only critical and serious injuries are considered. In this context, there is no difference in the primary missions of the PMA medical team. They sort the injured after receiving them from the firefighters. Each casualty is transported to the appropriate location for treatment and prioritization. In a semi-centralized architecture, the decision to install the PMA is made by the central agent.

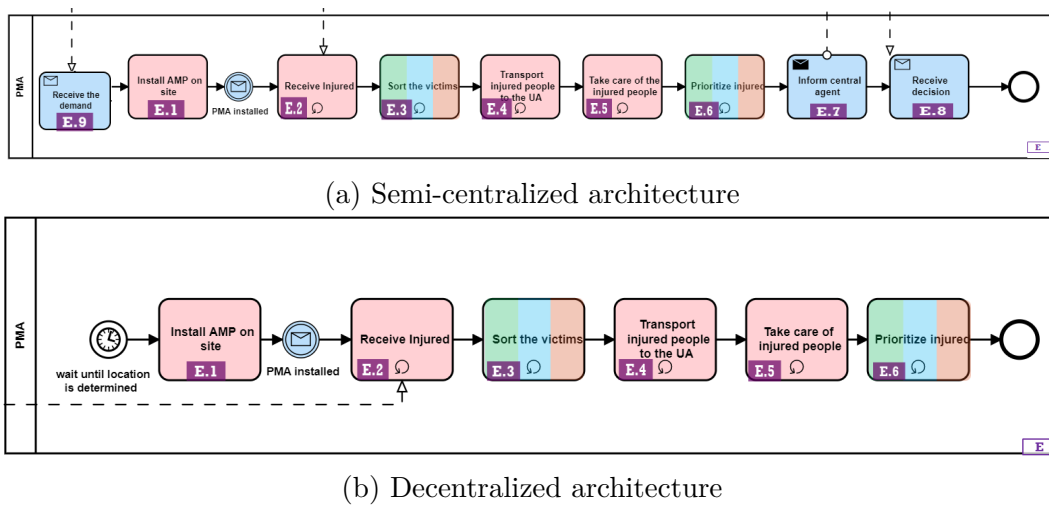

Figure 2.50: PMA missions in both architectures

2.8.1.7 Central agent

It is present in the semi-centralized architecture. The central agent chooses the appropriate solutions among the solutions proposed by other actors. Next, it informs each centre of its decision. In addition, it assigns casualties to hospitals after receiving their situations from the PMA and informs the latter of its decision.

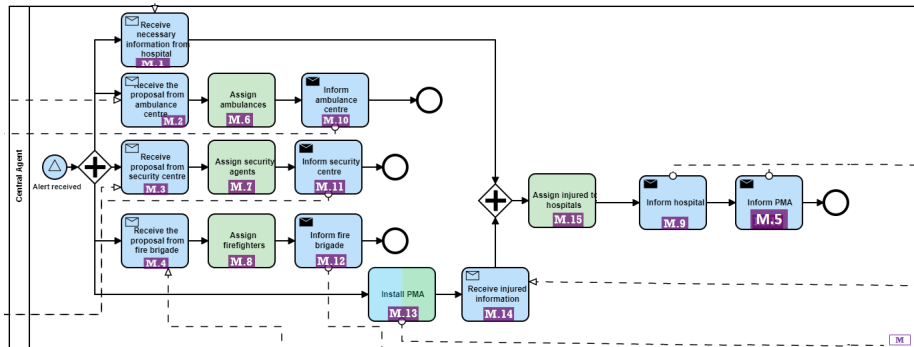

Figure 2.51: Central agent missions

2.8.2 Dysfunctional modelling

In our work, FMECA table consists of the following columns: activity's name, activity's number in BPMN (code), failure mode and its category, causes and consequences levels as well as their categories, the service executing the activity (Source) and on which services it has an effect (Target). At the end of the table, we added the severity and the occurrence in order to calculate the criticality of the failure mode. Due to the large size of the FMECA table, only the PMA's FMECA table is shown in figure 2.52. The FMECA tables for the other services are presented in the Appendix A.

2.8.3 Vulnerability indicators

Based on the FMECA table of the PMA service, table 2.8 is filled. All the activities have internal interactions, needs infrastructure and do not require any network. In addition, they all requires the use of materials except for E.2. Unlike E.5, the activities does not need fluids. E.1 is the only activity that is not repetitive, has an indirect economic cost and requires no infrastructure. All other functions are repetitive. E.3 and E.6 belong to the following three sets: decisional, informational and operational, which means that actors may have a problem in deciding, informing and operating the task. The rest of the activities are part of the operational set which means that stakeholders may have problems in operating these tasks. E.2 has no economic cost while the functions from E.3 to E.6 have a direct cost. Unlike E.1 and E.2, E.5 has a direct human impact, and E.3, E.4 and E.6 have an indirect human impact. In addition, only E.3, E.5 and E.6 requires a high technicality to be performed. Finally, E.2 and E.3 have the same failure modes from 0 to 5. Similarly, E.5 and E.6 have also identical failure modes (0,2,3,5). Four and three failure modes occur on E.1 and E.4, respectively.

Activity	Code	Mode	Category	Cause I		Cause II		Cause III	
				Before	During	Before	During	Before	During
Install PMA	E.1	-	0	Decision is not made	-	-	-	-	-
			1	No available actors	-	SN2	Actors are not enough	SN4	-
			2	No actor knows how to install it	-	SN2	Actors are not trained	SN4	-
			3	Environment is so aggressive	-	CN1	-	-	-
Receive Injured	E.2	-	0	PMA is not installed	-	IN1	-	-	
			1	No injured is evacuated to PMA	-	IN1	-	-	
			2	No available actors in PMA	-	SN2	No more available actors in the centre	SN4	-
			3	Number of victims is high in PMA	-	CN1	Actors are not enough	-	CN2
			4	The capacity of PMA is not enough	-	SN2	Actors and equipment are not enough	SN4	-
Sort the Victims	E.3	-	5	Poor organization	-	CN1	Capacity of PMA is not enough	-	CN2
			6	No victim is received	-	IN1	-	-	
			1	No available actors	-	SN2	No more available actors in the centre	SN4	-
			2	Actors do not have tags	-	SN2	The center did not buy the tags	SN4	-
			2	Skateholders don't know how to evaluate victims (not trained)	-	SN2	Center has never organized any training	SN4	-
			3	Some actors cannot sort victims	-	SN1	Some actors are injured during the response	-	SN3
			3	The number of victims is increasing very rapidly	-	CN1	Stress and poor organization on site	-	CN2
			3	Actors are not enough in the PMA	-	SN2	Bad estimation of the number of actors needed	SN4	-
Transport the injured to UA	E.4	-	4	No more available tags	-	SN2	Not enough tags in the center	SN4	-
			5	Injured's situation is poorly evaluated by stakeholders	-	SN1	Fatigue and stress	-	SN3
			0	No victim to transport	-	IN1	No victim is sorted	-	IN4
			1	No available actors	-	SN2	No more available actors in the centre	SN4	-
			3	The number of victims is increasing very rapidly	-	CN1	-	-	-
Take care of injured	E.5	-	0	No injured is received	-	IN1	No injured is received	-	IN4
			2	They do not know how to aid them	-	SN2	They are not trained	SN4	-
			3	All injured have critical injuries	-	IN3	Aggressive environment	-	CN7
			5	Limited experience for actors	-	SN2	Not trained for a long time	SN4	-
Prioritize Injured	E.6	-	4	No injured is aided	-	IN1	No injured is received	-	IN4
			2	They do not know how to prioritize them	-	SN2	They are not trained	SN4	-
			3	The decision-makers have difficulties processing information	-	SN2	Decision-makers do not have enough experience	SN4	-
			5	Poor organization	-	CN1	-	-	-

Cause III	Category of cause III	Source	Effect I		Category of effect I		Effect II		Category of effect II		Effect III		Category of effect III		Target	S	O	C
			Before	After	During	After	During	After	During	After								
-	-	-	E	ON4	-	-	-	-	-	-	-	-	-	-	E	1	1	1
Situation is poorly analyzed	SN6	E	E	ON4	-	-	-	-	-	-	-	-	-	-	E	2	1	2
No budget for trainings	SN6	E	E	ON4	-	-	-	-	-	-	-	-	-	-	E	3	1	3
No budget to buy means	SN6	E	E	ON2	-	Injured are received late	ON7	-	Possibility of death	-	ON10	-	-	E	4	3	10	
-	-	-	E	ON4	-	No injured is received	-	-	-	-	-	-	-	E	1	1	1	
-	-	-	E	ON4	-	No injured is received	-	-	-	-	-	-	-	E	1	1	1	
Situation is poorly analyzed	SN6	E	E	ON4	-	Injured are sorted late	ON7	-	Possibility of death	-	ON10	-	-	E	5	1	5	
Situation is poorly analyzed	SN6	E	E	ON2	-	Injured are not received	ON7	-	Possibility of death	-	ON10	-	-	E	5	4	20	
-	-	-	E	ON2	-	Part of injured are not helped	ON7	-	Possibility of death	-	ON10	-	-	E	5	4	20	
-	-	-	E	ON3	-	Actors are stressed	ON8	-	Injured are poorly sorted	-	ON11	-	-	E	1	3	15	
-	-	-	E	ON3	-	Actors are not well received	ON8	-	Ambulances transfer more critical injured	-	ON11	-	-	E	1	3	15	
-	-	-	E	ON4	-	Victims are stressed	-	-	Injured are not helped in optimal conditions	-	ON11	-	-	E	1	1	1	
-	-	-	E	ON4	-	No victim is sorted	-	-	-	-	-	-	-	E	2	1	2	
No budget to purchase tags	SN6	E	E	ON4	-	No victim is sorted	-	-	-	-	-	-	-	E	3	1	3	
No budget for trainings	SN6	E	E	ON4	-	No victim is sorted	-	-	-	-	-	-	-	E	3	1	3	
-	-	-	E	ON3	-	Actors are tired	ON8	-	Ambulances may deal with more critical injured	-	ON11	-	-	E	1	1	1	
Bad estimation of victims' number	SN5	E	E	ON3	-	Actors are tired	ON8	-	Victims are not helped in optimal conditions	-	ON11	-	-	E	1	1	1	
No budget for tags	SN6	E	E	ON2	-	There are still unsorted injured	ON7	-	Possibility of death	-	ON10	-	-	E	4	2	8	
Never though they would use this amount of tags	SN5	E	E	ON2	-	There are still unsorted injured	ON7	-	Possibility of death	-	ON10	-	-	E	4	2	8	
-	-	-	E	ON2	-	Injured are not properly labelled	ON7	-	Possibility of death	-	ON10	-	-	E	5	1	5	
-	-	-	E	ON4	-	Victim are still in triage area	-	-	-	-	-	-	-	E	1	1	1	
-	-	-	E	ON4	-	Victim are still in triage area	-	-	-	-	-	-	-	E	1	1	1	
-	-	-	E	ON4	-	Victim are still in triage area	-	-	-	-	-	-	-	E	2	1	2	
-	-	-	E	ON2	-	Victims are transported late	ON7	-	Possibility of death	-	ON10	-	-	E	2	2	4	
-	-	-	E	ON4	-	No injured is helped	-	-	-	-	-	-	-	E	1	1	1	
No budget for trainings	-	-	E	ON4	-	No injured is helped	-	-	-	-	-	-	-	E	1	1	1	
-	-	-	E	ON4	-	No injured is helped	-	-	-	-	-	-	-	E	4	1	4	
-	-	-	E	ON2	-	Injured are aided late	ON7	-	Possibility of death	-	ON10	-	-	E	1	5	2	
No budget for trainings	SN6	E	E	ON2	-	Injured are wrongly helped	ON7	-	Possibility of death	-	ON10	-	-	E	5	2	10	
-	-	-	E	ON4	-	They are not prioritized	-	-	-	-	-	-	-	E	1	1	1	
-	-	-	E	ON4	-	They are not prioritized	-	-	-	-	-	-	-	E	3	1	3	
No budget for trainings	-	-	E	ON4	-	They are not prioritized yet	-	-	-	-	-	-	-	E	3	1	3	
No budget to organize enough trainings	SN6	E	E	ON3	-	The decision-makers are stressed	ON8	-	Possibility of death	-	ON10	-	-	E	1	4	2	
-	-	-	E	ON3	-	The decision-makers are stressed	ON8	-	Possibility of death	-	ON10	-	-	E	1	4	2	
-	-	-	E	ON2	-	Order of injured is not respected	-	-	-	-	-	-	-	E	1	2	2	

Figure 2.52: PMA's FMECA table in the decentralized architecture

2.8.4 Causes and failure modes

Figure 2.53 shows the relationship between causes and failure modes based on the FMECA table of the PMA service (see figure 2.52). The figure 2.54 represents the data of the table in figure 2.52 in a bar graph. It indicates that all direct causes occur during process execution, with 21.82% related to the inability of the mechanism to support the activity (SN2), 12.73% deriving from input problems (IN1), and 9.9% being uncontrolled (CN1). In addition, most of the level II causes are the consequences are related to the mechanism before the execution of the process where 14.55% of them are caused by level III causes (SN6). As shown in figure 2.55, 64% of causes occur during process execution, while only 36% of the causes occur before process execution. In addition, 69% of the causes are external to the process while 31% are internal to the process.

Furthermore, the figure 2.57 shows the percentage of causes for each failure mode. Ac-

Code	Nature	Interactions	Cost	Impact	Recurrence	Technicality	Material	Fluids	Network	Infrastructure	Failure modes
E.1	O	I	I	A	U	M	Y	N	N	Y	0,1,2,3
E.2	O	I	A	A	R	E	N	N	N	Y	0,1,2,3,4,5
E.3	D,I,O	I	D	I	R	H	Y	N	N	Y	0,1,2,3,4,5
E.4	O	I	D	I	R	M	Y	N	N	Y	0,1,3
E.5	O	I	D	D	R	H	Y	Y	N	Y	0,2,3,5
E.6	D,I,O	I	D	I	R	H	Y	N	N	Y	0,2,3,5

Table 2.8: PMA’s vulnerability indicators for figure 2.52

Failure mode	Cause I																		Cause II						Cause III		Total	Percentage						
	IN1		IN2		IN3		SN1		SN2		CN2		IN4		IN5		IN6		SN3		SN4		CN2		CN3				CN4		SN5		SN6	
	During	Before	During	Before	During	Before	During	Before	During	Before	During	Before	During	Before	During	Before	During	Before	During	Before	During	Before	During	Before	During	Before			During	Before	During	Before	During	Before
1	1	0	0	0	0	0	0	3	0	0	0	0	0	0	0	0	0	0	0	0	0	3	0	0	0	0	0	0	0	0	1	8	14,55	
2	0	0	0	0	0	0	0	5	0	0	0	0	0	0	0	0	0	0	0	0	5	0	0	0	0	0	0	0	0	3	15	23,64		
3	0	0	0	1	1	0	0	1	3	0	0	0	0	0	0	0	0	1	1	1	1	1	1	0	0	0	0	0	0	1	11	20		
4	0	0	0	0	0	0	0	2	0	0	0	0	0	0	0	0	0	0	0	0	2	0	0	0	0	0	0	0	2	6	10,91			
5	0	0	0	0	1	0	0	1	2	0	0	0	0	0	0	0	0	0	0	0	1	1	1	0	0	0	0	0	1	8	14,55			
6	0	0	0	0	0	0	0	0	0	0	0	0	0	0	0	0	0	0	0	0	0	0	0	0	0	0	0	0	0	0	0	0		
Total	7	0	0	1	2	0	0	12	5	3	0	0	0	0	0	0	0	1	2	12	2	0	0	0	0	0	0	0	8	55	100			
Percentage	12,73	0	0	1,82	3,64	0	0	21,82	9,09	5,45	0	0	0	0	0	0	0	1,82	3,64	21,82	3,64	0	0	0	0	0	0	0	14,55	100				

Figure 2.53: Causes-Failure modes table

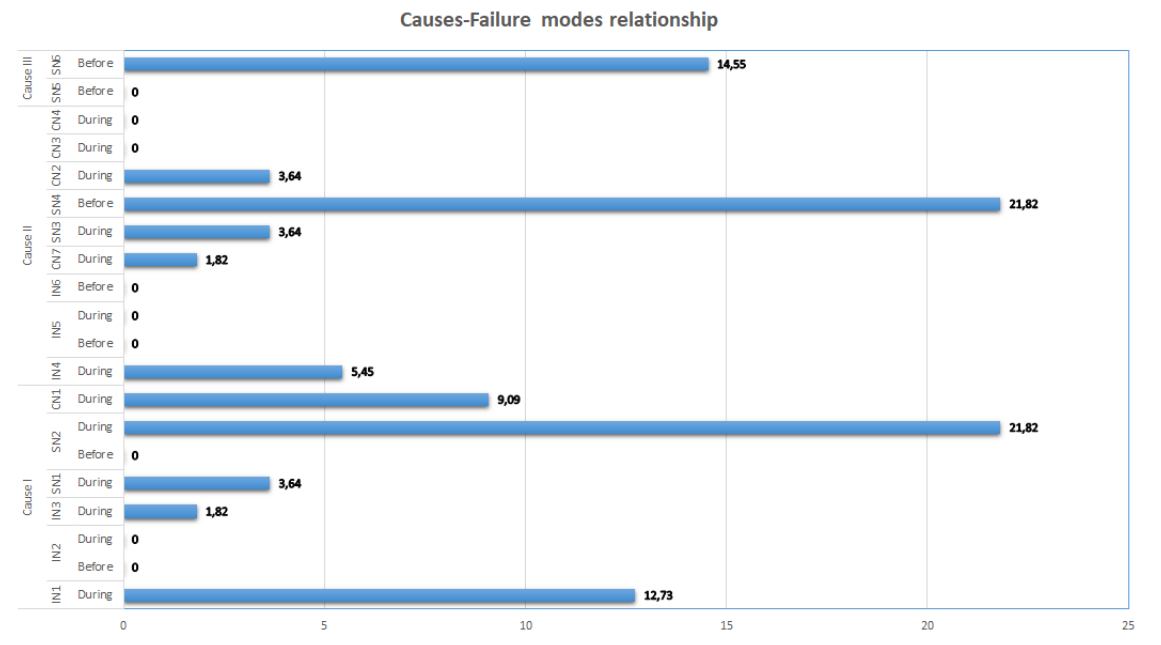

Figure 2.54: Bar graph of the causes-failure modes relationship

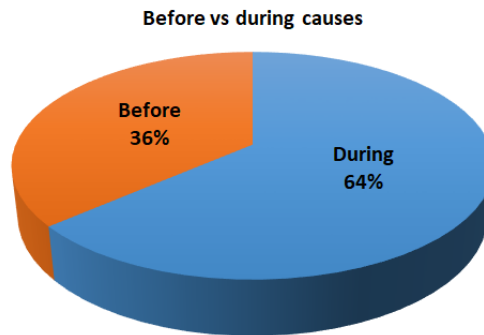

Figure 2.55: Pie chart of the duration of causes

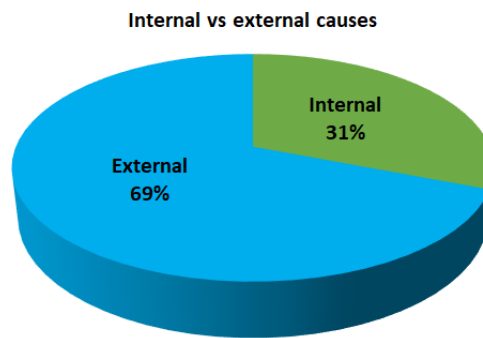

Figure 2.56: Pie chart of the origin of the causes

According to the histogram, failure mode 6 (FM_6) does not occur on this service, which means that only five failure modes occur on PMA service activities. Moreover, failure mode 2 (FM_2) is the most frequent in the service process, with a percentage of 23,63%, while failure mode 3 (FM_3) is the second most frequent failure mode (20%). Note that the failure modes 0, 1 and 2 has no results as effects whereas the others indicate the non-conforming of outputs.

2.8.5 Failure modes and effects

Figure 2.58 shows the relationship between causes and failure modes based on the FMECA table of the PMA service (see figure 2.52). The relationship between failure modes and effects shows the effects associated with each failure mode in a process and their origins and type. The figure 2.59 represents the data of the table in figure 2.52 in a bar graph. It indicates that 34.04% of direct effects has no results while 21.28% of them are not what they should be at the output of the function. Furthermore, most of the level II effects are a downstream function malfunction belonging to the category ON7 (19.15%) which lead to non-standard consequences (ON10) at level III with the same percentage.

As shown in figure 2.60, all the effects of the PMA service functions occur during the

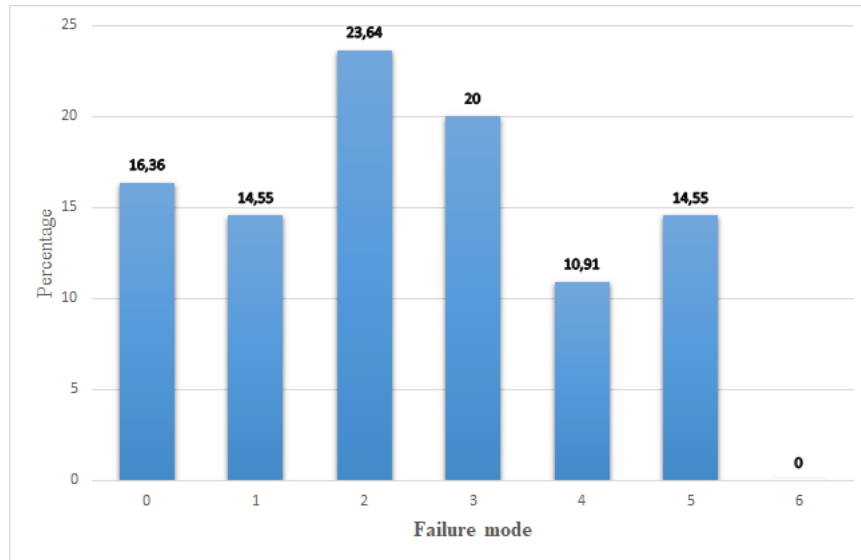

Figure 2.57: A histogram of the percentage of causes for each failure mode

Failure mode	Effect I				Effect II				Effect III				Total	Percentage						
	ON1	ON2	ON3	ON4	ON5	ON6	ON7	ON8	ON9	ON10	ON11	ON12								
0	0	0	0	0	6	0	0	0	0	0	0	0	0	0	0	0	0	0	6	12,77
1	0	0	0	0	4	0	0	0	0	0	0	0	0	0	0	0	0	0	4	8,51
2	0	0	0	0	5	0	0	0	0	0	0	0	0	0	0	0	0	0	5	10,64
3	0	0	4	0	1	0	0	0	4	1	0	0	4	1	0	0	0	0	16	34,04
4	0	0	2	0	0	0	0	0	2	0	0	0	2	0	0	0	0	0	6	12,77
5	0	0	4	0	0	0	0	0	3	0	0	0	3	0	0	0	0	0	10	21,28
6	0	0	0	0	0	0	0	0	0	0	0	0	0	0	1	0	0	0	0	0
Total	0	0	10	0	1	16	0	0	9	1	0	0	9	0	1	0	0	0	47	100
Percentage	0	0	21,28	0	2,13	34,04	0	0	19,15	2,13	0	0	19,15	2,13	2,13	0	0	0	100	

Figure 2.58: Failure modes-Effects table

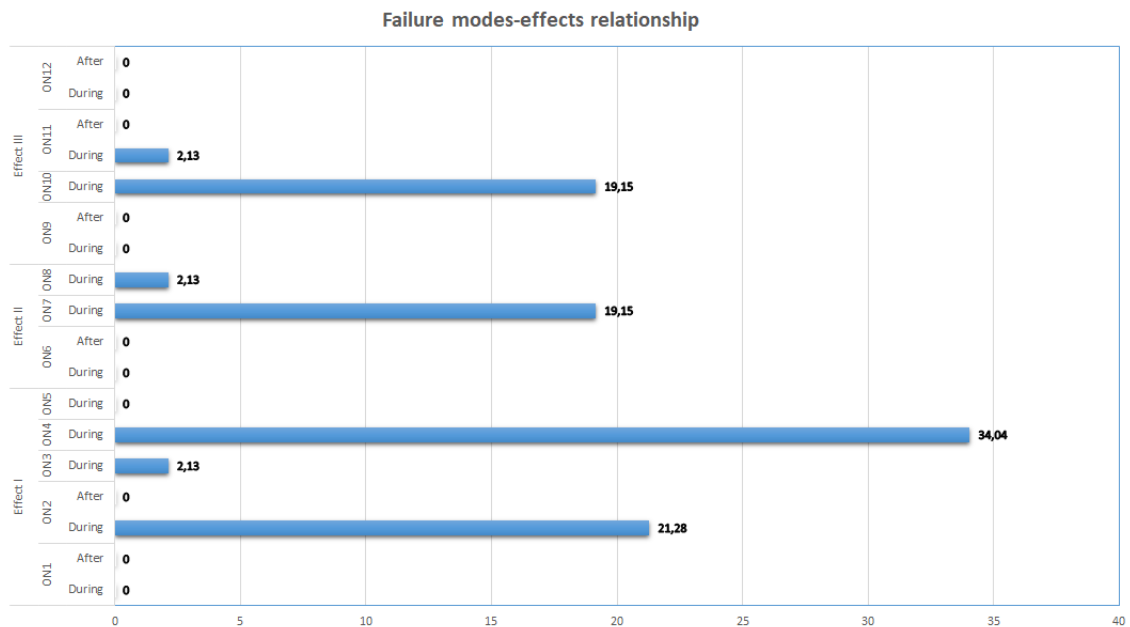

Figure 2.59: Bar graph of the failure modes-effects relationship

process execution , 77% of which are internal to the process and 33% of which are external (see figure 2.61).

Furthermore, the figure 2.62 shows the percentage of effects for each failure mode. As FM_6 is not present in PMA service, it has no outputs. Most of the effects happens on failure mode 3 (34.04%). Next, 21.28% of the consequences belong to failure mode 5, while 12.77% belong to each of failure mode 0 and 4. Finally, failure modes 2 and 1 have 10.64% and 8.51% of the effects, respectively.

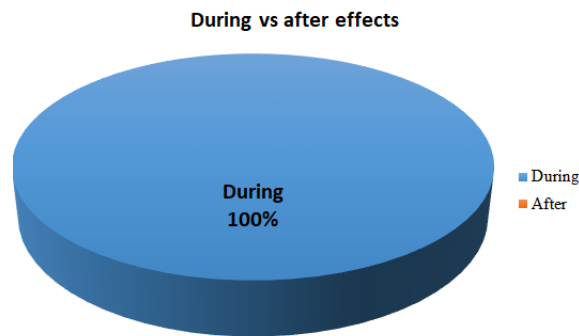

Figure 2.60: Pie chart of the duration of effects

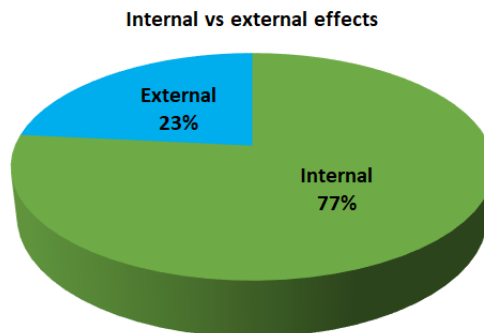

Figure 2.61: Pie chart of the origin of the effects

2.9 Conclusion

In this chapter, we have represented our design level composed of the functional and dys-functional models. First, we explained the different techniques that exist in the literature in order to use them in the modeling of the emergency plan. In functional modelling, we have used BPMN to give an understandable global view of the ORSEC Plan. This representation allows us to determine the different actors involved, their roles and the interactions between them. Based on this representation, we proposed a new FMECA approach by adding levels and durations to causes and effects. For each failure mode of an activity, we calculated its

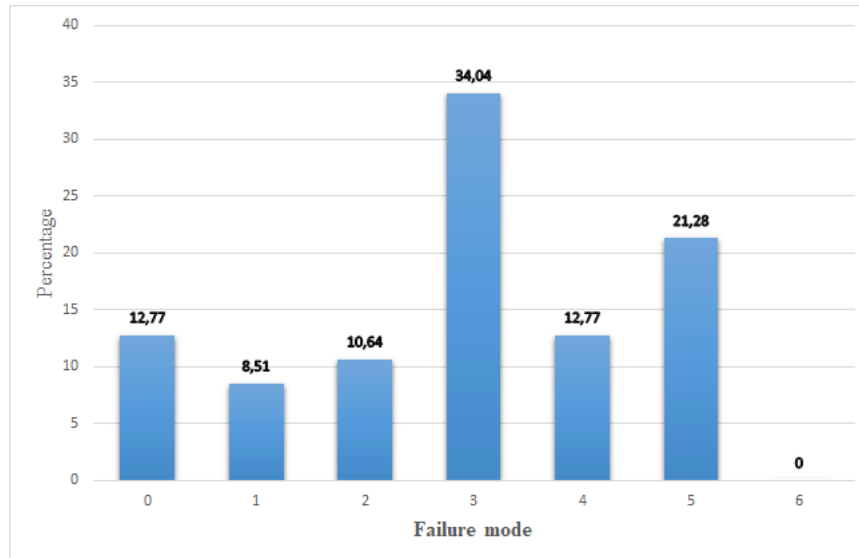

Figure 2.62: A histogram of the percentage of effects for each failure mode

criticality. The functional and dysfunctional modeling enabled identification and vulnerability analysis of indicators of each activity. Furthermore, we applied the design level on our terrorist attack explained in section 1.7. Since we are only interested in the operational level, we have modeled each service at this level by taking into account the activities needed to achieve their objectives from their starting points. The FMECA is applied to each activity of a service process. On the basis of the FMECA table, we filled in the vulnerability indicators table. At the end, the relationship between causes and failure modes, failure modes and effects are established.

State-of-the-Art: MAS and planning and scheduling

Sommaire

3.1 Introduction	83
3.2 State-of-the-art: multi-agent systems	84
3.2.1 Definition of agents	84
3.2.2 Environment properties	85
3.2.3 Definition of Multi-agent system	86
3.2.4 Mechanisms of interactions	86
3.2.5 JADE framework	87
3.3 Path planning	90
3.3.1 Dijkstra algorithm	91
3.3.2 A star algorithm	92
3.4 State-of-the-art: planning and scheduling	95
3.4.1 Planning vs scheduling	95
3.4.2 Classical planning	95
3.4.3 Temporal planning	98
3.4.4 Planning under uncertainty	100
3.4.5 Classification of techniques for dynamic planning	101
3.4.6 Multi-agent planning	106
3.5 Conclusion	110

3.1 Introduction

In the field of Artificial Intelligence (AI), planning and scheduling is considered as one of the most complex problems. During a crisis, different actors coordinate to minimize the

human loss by providing aid and relief to the victims. Actors exchange information and make decisions in a chaotic and sometimes aggressive environment. Indeed, coordination, communication, time, uncertainty and resources are the main challenges of an emergency response. In this context, different dynamic planning and scheduling techniques are studied in this chapter in order to propose strategies for the distributed generation and execution of a rescue plan, and to test them in a multi-agent system. This chapter is devoted to the state-of-the art of multi-agent systems and planning and scheduling. They constitute the simulation level of this thesis.

3.2 State-of-the-art: multi-agent systems

The purpose of this section is to define the notion of agent and to present the properties of its environment. In addition, we define a MAS and represent interaction between agents which is one of the most important characteristics of a MAS. Lastly, we explain the chosen framework to model our terrorist attack scenario.

3.2.1 Definition of agents

Agents are the basic elements of MAS, so it is necessary to define them. Several definitions have described the agent because of the variety of contexts and applications for which the agent is designed. Although there are many definitions, it is commonly accepted that an agent must analyze its environment and choose the best actions by applying a cognitive process (Baki, 2006). The agent is “simply something that acts”, according to (Russell and Norvig, 2010). The latter add to their definition “that a computational agent must meet a number of criteria¹” because their first definition is not sufficient for agents in computer science (Canu, 2011). A computational agent makes decisions autonomously, perceives its environment, and adapts to changes to achieve a given goal. Similarly, an agent is “a computer system located in an environment where it has the ability to act through autonomous actions in that environment to achieve its design goals” (Wooldridge and Jennings, 1995; Weiss, 1999). (Ferber, 1995) defined an agent as a physical or virtual entity that can reproduce itself, has its own resources and skills to achieve its goal and tendencies. It can act, communicate and perceive its environment. Its environment’s representation is either partial or null. From a computational perspective, an agent describes a computational abstraction similar to the object in object-oriented programming, except that instead of being defined

¹“But computer agents are expected to have other attributes that distinguish them from mere programs, such as operating under autonomous control, perceiving environment, persisting over a prolonged period, adapting to change and being capable of taking on another’s goals.”

in terms of methods and attributes, an agent is defined in terms of behaviors (Huhns and Singh, 1998). An agent is an entity characterized by the fact that it is, at least partially, autonomous, which excludes a centralized control of the global system.

An agent has a life cycle in order to act in its environment. This cycle is the fact that each agent will successively repeat the following three elements: observe, reason and act. This is the behavior of an autonomous agent. However, the agent can be semi-autonomous, i.e. human-controlled during a critical phase, or even completely piloted (Goodrich et al., 2001). Conversely, an agent progressively improves its behavior by learning from its experiences. Indeed, in the reasoning phase, an agent must consider its actions to accomplish its mission. At a given moment, there are certain actions that are better to execute than others. The agent will therefore identify and choose these actions. This agent is a rational agent, meaning that it makes the best possible decision (Canu, 2011; El Falou, 2010). Similarly, a performance metric indicates whether the agent's behavior is optimal or not. Two types of reasoning can be employed by the agent: reactive and proactive. The reactive agent is a special type of agent with a simple structure with "reflexive" behavior, so it makes decisions quickly but it is difficult for it to reach an optimal behavior. In other words, it has not a complete representation of its environment and it reacts without taking into consideration its history. On the other hand, a proactive agent, sometimes requires a lot of time to think but has a good long-term reasoning. It anticipates events in order to act according to future observations. In other words, it has an explicit representation of its environment and other agents' environment so it acts by referencing to them to accomplish his explicit goals. Moreover, a mixed (hybrid) agent is a compromise between the two agents. It adopts a proactive behavior if it is possible like searching for the best route and reactive if it is necessary to avoid vehicles on the way. According to (Malas, 2017), it has three layers. The lowest is a reactive layer which decisions are based on the data processing from sensors. An intermediate layer is a reasoning on the agent's knowledge of its environment. Finally, an upper layer that reasons by taking interactions into account.

3.2.2 Environment properties

According to (Tranier, 2007), the environment is the world in which an agent evolves. It provides a common support for the agents' actions, allowing interaction in the system, it constitutes a source of information to which the agents can access by their perception. The properties of the environment influence the decision-making process of agents. According to (El Falou, 2010; Canu, 2011), an agent's environment can be fully observable when the agent is able to collect all the information or partially observable when the agent perceives only a part of its environment. Similarly, it can be static, which means that it evolves only when

the agent applies an action, or dynamic, in the opposite case. In addition, it can be either deterministic when the actions of the agent on this environment have a unique and certain effect, or it is qualified as stochastic when the agent's actions have a non-deterministic effect. Furthermore, the agent can perceive the environment as discrete if the set of perceptions and the set of possible actions on this environment are finite, or continuous otherwise.

3.2.3 Definition of Multi-agent system

MAS are a fascinating field of research. They were born in the late seventies and early eighties, from the idea of distributing knowledge and control in AI systems (Hassas, 2003). There have been many studies based on the multi-agent system. The latter is a technology that allows modeling and simulating entities that will interact to produce a collective behavior to solve a problem. (Hassas, 2003) describes a multi-agent system as a set of entities, sharing a common environment, which they are able to perceive and on which they can act. Perceptions allow agents to acquire information about the environment evolution, and their actions allow them to modify it. The agents interact with each other, directly or indirectly, and present correlated behaviors, thus creating a synergy that allows all the agents to form an organized collective. MAS is an organized corpus of agents in which a certain number of phenomena comes out as the result of interaction between these aforesaid agents. (Briot and Demazeau, 2001) define a MAS as a set of interacting agents that can organize in a dynamic and adaptive way. One of the interesting features is the distribution of the complexity over several agents. (Ferber, 1995) defines a MAS as “a system composed of a set of agents in an environment that manipulate a set of related passive objects by applying operations. In addition, it has a set of operators that represents the application of these operations and the reaction of the world to this attempted manipulation. As stated in (Wooldridge, 2009), MAS are distributed systems engaging a set of agents which are intelligent and autonomous. According to (Cardon and Itmi, 2016), a system is agentic when all its active entities are agents. Agentification consists in transforming all the knowledge and the relations between knowledge into agents.

3.2.4 Mechanisms of interactions

Interactions is defined by (Doniec, 2006) as being a dynamic relation established between several agents due to their combined and reciprocal actions. Interaction can take several forms: coordination, negotiation, collaboration, etc. Among the characteristics of MAS, we can mention (El Falou, 2010):

- **Collaboration:** it refers to a situation where all agents work on the same project to solve a common goal by allowing them to share tasks, data and resources. The

main objective of MAS is to make a number of agents collaborate to solve a problem (HAFRI and NAJID, 2001).

- **Coordination:** this term should not be confused with collaboration. The coordination refers to the organization of the agents' work in order to avoid conflicts in accessing the resources.
- **Communication:** it allows agents to share their knowledge and benefit from the knowledge of others. As for humans, communication is the basis of interactions between agents. There are many forms of information exchange between agents (Malas, 2017): direct communication, indirect communication and communication by observation. The first is the direct sending of a message to one or more agents (broadcast). Several researches have focused on this type of communication and have developed agent communication languages such as FIPA-ACL². The second is achieved by modifying the environment or manipulating common knowledge. The last one is realized by observing the characteristics of the environment on which the agents have no influence.
- **Negotiation** is the exchange and evolution of agents' proposals to achieve a goal. It is used when an agent coordinates with others to consider the distribution of resources and tasks. Moreover, no rule is acceptable if it does not respect the rule of the negotiation protocol.
- **Observability** by which an agent perceives its environment. For an agent, the environment can be fully or partially observable. This observability is considered as the observation of the agent local state. Another type of observability concerns the global state of the system (agent and environment). It can be individual, which corresponds to the observations of a single agent, or collective, which results from the combination of all the agents' observations, whether partial or total. Collective observability is partial when all the information needed to an agent to make a decision is not accessible.
- **Uncertainty:** it is when the environment of the agents is considered stochastic and the uncertainties are represented using probability distributions, intervals of values or fuzzy intervals.

3.2.5 JADE framework

There are several tools to create intelligent software agents such as JADE (Bellifemine et al., 2005), MadKit (Gutknecht and Ferber, 2000), MASON (Luke, 2011), etc. JADE is detailed in this document because it will be used later on in this thesis. In addition to its compatibility with FIPA standards, JADE is implemented in JAVA, one of the most widely used languages

²<http://www.fipa.org>

in the world. It is a multi-agent simulation environment developed by the TILAB laboratory and described in (Bellifemine et al., 2001). It can support a large number of agents and has several advanced features: it is fast, easily extensible, portable, highly modular, flexible and its basic model is easy to understand. Figure 3.1 represents the components of the JADE platform. A platform is composed of one or more containers representing JADE environments.

The platform requires a so-called main container. It contains Directory Facilitator (DF) agent and Agent Management System (AMS). DF provides "yellow pages" service to the platform. It allows the user to search for an agent by name or services. The AMS oversees agent registration, authentication, access and use of the system. Only one AMS should exist in a platform. It authenticates each agent, through an AID (Agent Identifier Directory) and a status. In addition, Agent Communication Channel (ACC) or also called Message Transport Service (MTS) manages interactions between agents inside and outside the platform. Furthermore, ACC, AMS and DF agents are automatically created and activated when the platform is launched.

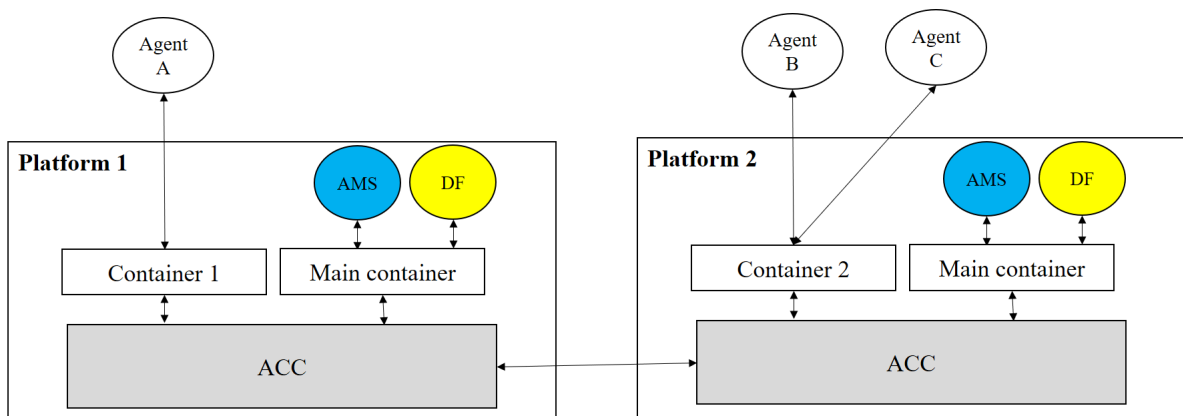

Figure 3.1: FIPA Agent Management Reference model

An ACL message is composed of several elements (Lachtar, 2012):

- sender: contains the identifier of the agent that is the source of the message.
- receiver: contains the list of identifiers of the agents that are the target of the message.
- reply-to: indicates the agent who should be answered.
- communication act: is the type of communication (INFORM, ACCEPT-PROPOSAL, REQUEST, CONFIRM, etc.).
- content: is the message content which can be a string or an object.
- language: the language in which the message content should be encoded.
- encoding: is used for transforming the message's content into another format as the agents serialize the messages on the network.

The screenshot shows a dialog box titled "ACL Message" with a close button (X) in the top right corner. The dialog is divided into two tabs: "ACLMessage" (selected) and "Envelope". The "ACLMessage" tab contains the following fields:

- Sender:** A text input field with a "View" button to its right.
- Receivers:** A text input field.
- Reply-to:** A text input field.
- Communicative act:** A dropdown menu.
- Content:** A large text area with a scrollbar.
- Language:** A text input field.
- Encoding:** A text input field.
- Ontology:** A text input field.
- Protocol:** A dropdown menu.
- Conversation-id:** A text input field.
- In-reply-to:** A text input field.
- Reply-with:** A text input field.
- Reply-by:** A text input field with a "View" button to its right.
- User Properties:** A text input field.

An "OK" button is located at the bottom center of the dialog.

Figure 3.2: ACL message elements

- ontology: can be used for the layout of the contained message.
- protocol: informs on FIPA protocol the message belongs to
- conversation-id: stands for the identifier of the conversation.
- reply-with: is the expression with which the receiver must respond to identify the original message.
- in-reply-to: specifies to which earlier action is this reply
- reply-by: is the deadline for the response

In JADE, each agent is recognized by a unique identifier and behaves in an environment. A behavior represents a task that the agent can perform. In addition, an agent has a life cycle consisting of six execution states, according to FIPA (as cited in [Bellifemine et al., 2010](#)):

- **Initiated:** the agent is built but cannot communicate with other agents because it has not yet been registered with the AMSs;
- **Active:** the agent has access to the functionalities of JADE because it is registered with the AMS;
- **Suspended:** the agent is stopped which means that none of its behaviours are in execution;
- **Waiting:** the agent is blocked until the validation of certain conditions;

- **Transit:** the mobile agent remains in this state as long as it migrates to a new location;
- **Delete:** the agent is dead which means it is removed from the AMS and its execution is terminated.

JADE is an open-source software implemented in JAVA and uses FIPA-ACL communication. Each agent is capable to control its actions, to decide and to manage its life cycle. In other words, the agents are autonomous. In addition, they are reactive, which means that they perceive their environment and react according to perceived events. Furthermore, several platforms are developed for modeling a distributed multi-agent system.

Table 3.1 represents part of a study conducted by (Atohou, 2013) that compares several MAS platforms, we chose: JADE, Jack, Madkit, Zeus and AgentTool. The author compares some multi-agent tools and environments based on 12 criteria, we chose 7 that interests us which are the communication between the agents, the system management (adding, deleting, modifying agents), the deployment of the system, the debugging tools, the documentation availability, and the system flexibility in the use of its components and methodology. The author rated each criterion from 0 to 4, representing its level of satisfaction, where 4 means fully satisfied. According to this study and to the selected criteria in this thesis, JADE has the highest score. For these reasons, it is chosen in our work in order to develop different strategies in MAS to simulate our scenario and compare the agents behaviours.

Platform	JADE	Jack	Madkit	Zeus	AgentTool
Inter-agent communication	4	3	3	4	2
Easy to manage MAS	4	0	4	3	1
Documentation availability	3	3	3	4	1
Easy to deploy	4	2	3	2	1
Code extensibility	4	4	3	2	0
Availability of debugging tools	3	0	4	4	2
The tool's flexibility	3	3	3	1	0
Total	25	15	23	20	7

Table 3.1: Comparative table of MAS development tools (Atohou, 2013)

3.3 Path planning

In this work, path planning is used by operational actors (firefighters, security officers and ambulance crew) in order to find a path between two given places. A path planning enables the selection and the identification of a suitable path between two given points without collision with obstacles. It is different from task planning which aims to determine each action to be

carried out to achieve a goal and integrate them into a plan. Path planning is complementary to task planning, which uses it as a subroutine to choose the resources to be assigned. The main algorithms that are the basis on which the vast majority of current planning algorithms are built are:

3.3.1 Dijkstra algorithm

As stated in (Weiteng et al., 2013), the Dijkstra algorithm is an algorithm created in 1959 by Edsger Dijkstra and dedicated to solving the shortest path problem. This algorithm objective is to find the shortest path from a source vertex to another given vertex by traversing all possible paths and computing their costs until the goal is reached. When all paths are visited, the algorithm compares the costs and finds the minimal path to the goal state from the initial state or the possible paths if there are several. The flowchart in figure 3.4 explains the algorithm. According to (Schmidt, 2012), it presents the basis for forward planning. Throughout the computation, two sets are maintained: the processed set and unprocessed vertices set also called open and closed sets. At the beginning, the open set contains the initial state while the closed set is empty. Unlike the second, the first contains all nodes reached but not yet developed. At each step, the algorithm selects a node from open set having the minimum cost to reach it. After having applied the different allowed actions, three possibilities exist to process the results. First, nothing is done if it belongs to the closed set because the cost from initial state to the current node via the node which its development is in process, is greater than the one already found. If it belongs to the open set, it means that the obtained cost is lower than the cost already found. Only in this case, it is updated. Finally, if the obtained state has not yet been reached, the best cost to this state is assigned to it and is equal to the sum of the cost to reach the current node and the cost of the last action. Then, this state is added to the open set. In the end, the newest developed node is deleted from the open set and added to the closed set. This operation is repeated until the goal is reached when a solution exists or when the open set is empty (no solution).

Figure 3.3 shows an example of the Dijkstra algorithm. "A" is the source node and "E" is the goal node. At the beginning, the start node is added to the processed set and the others to the unprocessed set with the infinity symbol because the distance between the source node and all other nodes is not yet determined. Each time, the distance is calculated and updated between the source node and the adjacent nodes. The node with the minimum distance is added to the path and marked as visited.

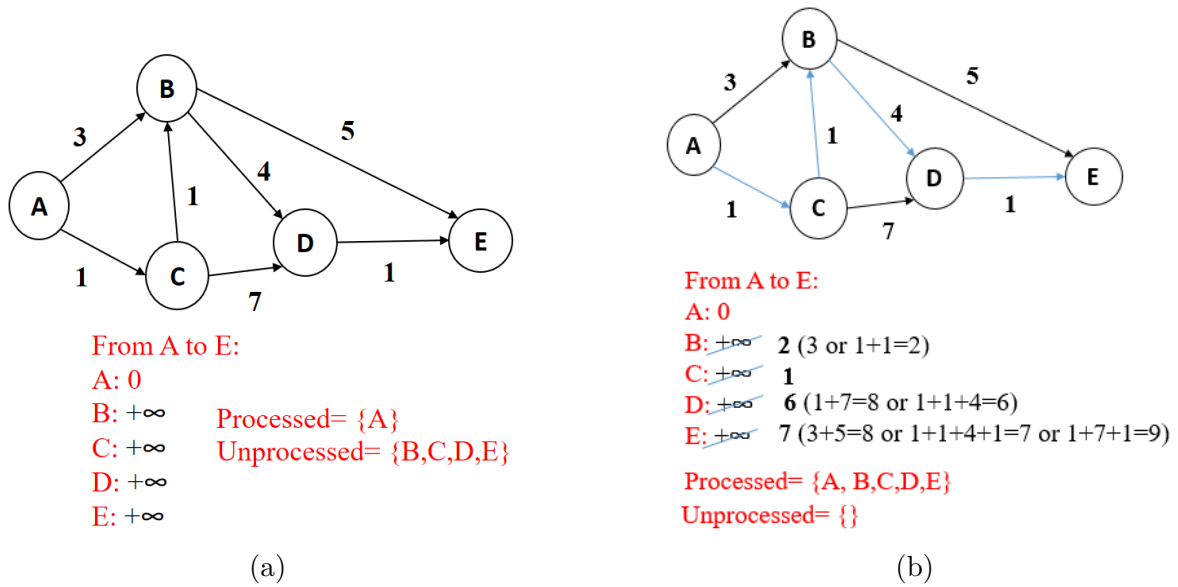

Figure 3.3: An example of the Dijkstra algorithm

3.3.2 A star algorithm

The A* algorithm (see figure 3.5) is commonly used to solve problems related to finding the optimal path between a start node and an end node. However, it is one of the best known classical algorithms. It is robust because it always finds a path if there is one (Weiteng et al., 2013). This algorithm uses a combination of heuristic search and shortest path search. It uses two lists: the "open" list and the "closed" list. The first is the list of cells or nodes to be checked and the second is the list of cells or nodes that have been checked. The main idea can be defined as follows (Shakour, 2012): the first step is to calculate and compare the distance, especially in the grid, from the starting node to the current node and from the current point to the target node, with the existing evaluation function. Then, the node with the minimum evaluation is selected as the current node and continues with the first step until the target node is the current node. Finally, the optimal path is obtained using the retrospective method. The evaluation function is usually defined as follows:

$$f(x) = h(x) + g(x) \quad (3.1)$$

where:

- $h(x)$ is the estimated distance between node x and the destination node. It may decrease at each step as it gets closer to the target than the previous step.
- $g(x)$ is the path cost. It increases as the number of steps increases.
- $f(x)$ is the sum of the two variables g and h . All variables f are then compared to

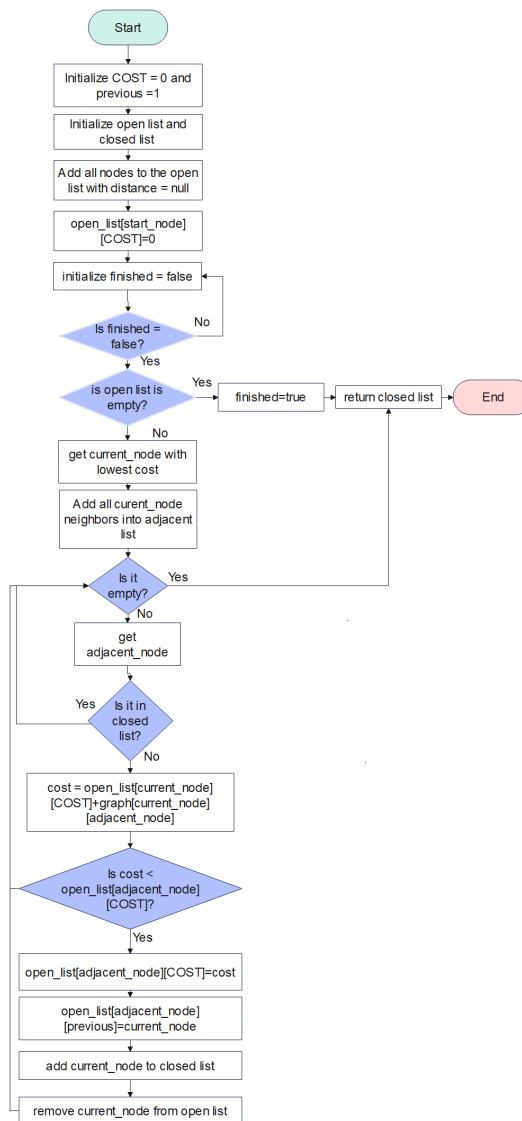

Figure 3.4: Dijkstra algorithm diagram

find the shortest path.

Figure 3.6 shows an example of the A* algorithm. First, the open set contains only the source node "A". Then, at each step, the node with the lowest f value is selected to reach the target state "E".

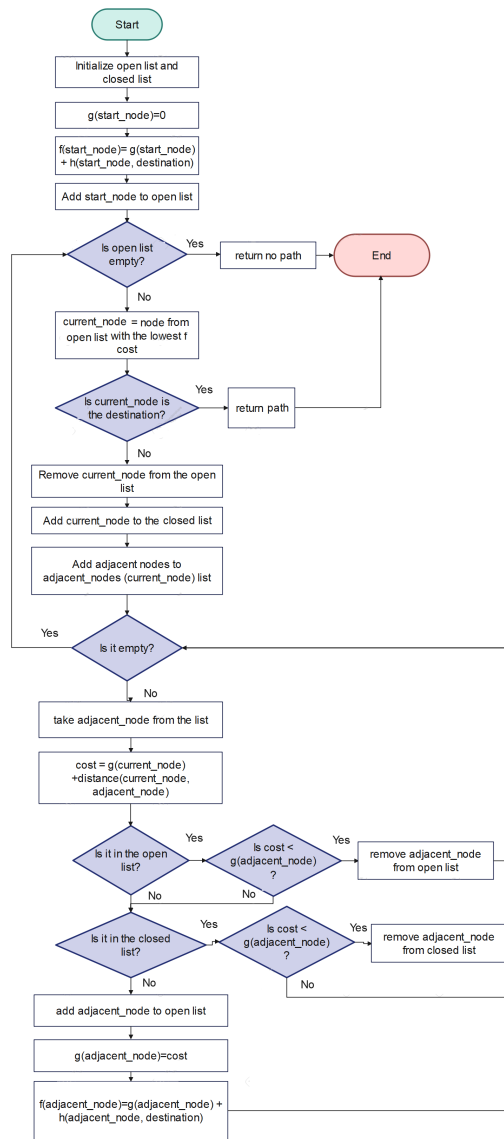

Figure 3.5: A* algorithm diagram

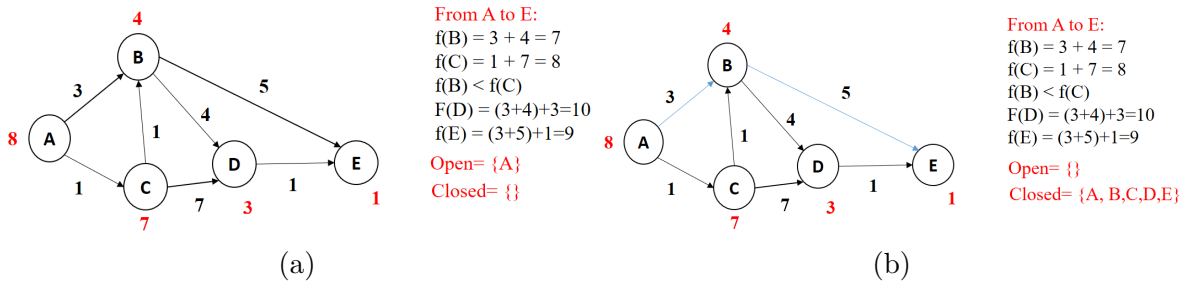

Figure 3.6: An example of the A* algorithm

3.4 State-of-the-art: planning and scheduling

An overview of the classical planning, temporal planning, planning under uncertainty, different dynamic approaches and multi-agent planning is given. Since time is really important in an emergency response and it is not clear how long it takes to accomplish an action, different temporal networks that can manage time are presented.

3.4.1 Planning vs scheduling

In accordance with (Baki, 2006), planning and scheduling are applied in several fields such as project management where planning aims to determine the various operations to be carried out and the material and the human resources to be allocated to them, while scheduling aims to determine the different dates corresponding to the activities. According to (Ghallab et al., 2004), planning in AI is concerned with achieving a goal by taking a series of actions from an initial state. This solution is called a plan. It is found by a planner. AI renews the techniques used in the domain of operational research by representing the knowledge of the field in a richer way (Baki, 2006). Solving a scheduling problem consists in placing actions in time, taking into account temporal constraints (deadlines, precedence constraints, etc.) and constraints relating to the use and availability of the required resources by the actions (Lopez and Roubellat, 2001). In the opinion of (Canu, 2011), planning is the action of one or more agents calculating a plan or policy of behavior to accomplish a given mission in an environment.

3.4.2 Classical planning

In order to specify the set of actions allowing the passage from the initial state to the desired goal state, two main families of planning algorithms are distinguished: those in a space of states (Fikes and Nilsson, 1971; Zhang, 1999; Farreny, 1996) and the others in a space of plans (Sacerdoti, 1975; Weld, 1994; Kambhampati, 1997). In state-space search algorithms, a state of the world is represented by a node, a transition is denoted by an arc, and finally a path in the state space corresponds to a plan. In these algorithms, the search space is considered as a subset of the state space. Indeed, the main search algorithms of this family are: forward search, backward search, mixed search and the STRIPS algorithm (Fikes and Nilsson, 1971). While in plan-space planning algorithms, a node corresponds to a partial plan (Barrett and Weld, 1994) and an arc represents a reconciliation operation of a partial plan. The refinement rule is the act of adding actions to the partial plan in order to complete a proposal or to add constraints between actions. The Partial Order Planning (POP) algorithm is an example of

a search algorithm in the space of partial plans (El Falou, 2010).

An action has preconditions that must be true in order to start its execution. They represent the properties of the environment. In addition, it has effects which are the results of its execution. The modeling of a planning problem can be done using a planning language such as Planning Domain Definition Language (PDDL). PDDL is a standard language used in artificial intelligence planning. It was proposed in 1998 and although it is not the only existing language to describe planning problems, it is widely used (Ghallab et al., 1998). PDDL modeling consists of two files relating to the domain and the problem definition. In the domain, the system behaviors are described and the variables that constitute it are declared. In the problem file, the initial state of the system and its goal state are given (Soubaras et al., 2013). Different versions of PDDL exist and each of them adds new features to the language. The version 1.2 is the first version and it determines how to compose the two files domain and problem. The following versions are used in other forms of planning. According to (Fox and Long, 2003), version 2.1 is one of the most important PDDL versions. It is quite complete for time planning and scheduling. In this version, “durative actions” facilitate temporal constraints and, numerical constraints are accepted (e.g. evaluating distance). According to (Edelkamp and Hoffmann, 2004), version 2.2 extends version 2.1 by introducing derived predicates and temporal initial literals. Derived predicates are used to model the dependency of given predicates on other facts. For example, if the ambulance is on crisis site (predicate 1) and has an injured on board (predicate 2) then the ambulance can take off (derived predicate). Temporal initial literals are used to model exogenous events occurring at a given time independently of the plan execution. For example, let us consider the fact that the bus runs from Monday to Saturday from 8 am to midnight. If the plan execution starts at 7 am, the bus will not be available until later in the plan. PDDL 3.0 adds the preferences and constraints representation on the occurrence or ordering of some situations (Gerevini and Long, 2005). The latest version is PDDL 3.1. It allows to consider functions that can return any kind of object, not only Booleans or numbers (Kovacs, 2011).

The problem with classical planning is that it creates plans in a static and completely known environment by applying deterministic actions without resource management (Baki, 2006); this is very different from reality where the crisis environment is dynamic and partially observable universe. Consequently, classical planners cannot manage actions with durations, nor can they add probabilistic effects. Moreover, the execution of actions is not simultaneous. The evaluation of plans is limited to the success or failure of the plan, whereas some situations require other criteria such as cost, time, resources, etc.

3.4.2.1 GraphPlan

The structure of the planning graph allows to efficiently estimate which set of propositions is accessible from the initial state of the problem and with which actions. According to (Baki, 2006), the planning graph is composed of the propositions that constitute the proposal levels and the actions that constitute the action levels. A state is composed of all true propositions at a given time. The GraphPlan planner is able to efficiently build a global plan in the form of a flow of actions responding to a subset of desires (objectives), which could be executed in competition (Meneguzzi et al., 2007). It is a procedure close to iterative deepening, which discovers a new part of the search space at each iteration.

According to (Sprauel, 2016), to build the graph from an initial state, at each step, it takes the set of true predicates and adds the predicates made true by the actions applicable with this set of predicates, without removing the predicates imposed by these actions. Figure 3.7 presents an example of a graphplan. P0 is the initial level and P1 is the goal level. A1 consists of actions that may be applicable at this level. Their preconditions are in P0 and their effects in P1.

A mutex set is added to signal two predicates that cannot be true at the same time in this step, or two actions that cannot be applied at the same time in this step, due to incompatible preconditions, for example. Graphplan allows to define an incomplete reachability condition through a planning graph of polynomial size and which can be built in a time polynomial to the size of the input problem.

This approach consists in building a planning graph, on which a search algorithm is applied to extract a solution. However, GraphPlan does not allow to represent explicit time and duration.

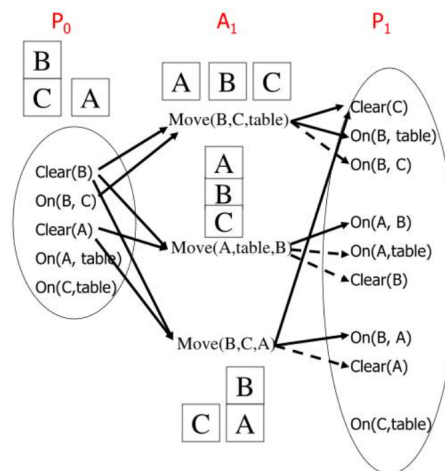

Figure 3.7: Graphplan example

3.4.3 Temporal planning

Temporal planning takes time into account for evaluating the plan. According to (Schmidt, 2012), with temporal planning, it is possible to know which actions can be executed in parallel and the constraints between them. All this is due to the possibility of defining action durations, preconditions, overall conditions and post-conditions (effects). Unlike preconditions, post-conditions must be verified at the end of the action. Overall condition must be verified during the whole action duration. In addition to the classical final effects (that become true at the end of the action), it allows to express initial effects that are applied at the beginning of the action.

The development of planners that take time as a criterion (such as DEVISER, IxTeT, CPT, etc.) began in the early 1980s with the development of temporal logics of McDermott and Allen (McDermott, 1982; Allen, 1983). There are planners that focus on precedence constraints (qualitative temporal constraints), others focus on quantitative constraints (start dates, end dates and durations) and a limited number of planners consider both at the same time. However, like classic planning, these planners are applicable in a static and totally observable universe.

3.4.3.1 Temporal Constraint Satisfaction Problem

Several classes of Temporal Constraint Satisfaction problem (TCSP) are developed in the article of (Schwalb and Vila, 1998). (Dechter et al., 1991) define TCSP as a set of variables where each one represents a time point and has a domain $D_n = [low_n, high_n]$ (Unary constraint). Domains and constraints are continuous (an interval of possible values). They express the duration between the two instants i and j by an inequality: $low_{ij} \leq V_j - V_i \leq high_{ij}$ where V_i and V_j are time points.

A binary TCSP can be represented by a directed constraint graph, where vertexes are variables and edges are constraints. Each unary constraint C_i is treated as a binary constraint C_{0i} because all times are relative to the variable V_0 which is a special time point introducing the beginning of the world ($V_0 = 0$) (Dechter et al., 1991). A solution satisfies all the constraints. If $V_i = x$, the value x is considered as feasible for variable V_i . A minimal domain is a set of all feasible values of V_i . If there is at least one solution, the network is called consistent. Furthermore, (Dechter et al., 1991) distinguish between TCSP and STP (Simple temporal problem). A constraint is a disjunction of intervals of possible durations in the first one, while it is a simple interval in the second one. Unlike TCSP, STP is decomposable which means that binary operations on constraints (union, intersection and composition) are represented as following (Dechter et al., 1991; Vidal, 1995): Let $C_{ij} = [low_{ij}, high_{ij}]$,

$C_{zk} = [low_{zk}, high_{zk}]$, $C_{ky} = [low_{ky}, high_{ky}]$ and the new constraint between the two time points i and j , $C'_{ij} = [low'_{ij}, high'_{ij}]$.

- **Union:** $C_{ij} \cup C_{zk} = [low_{ij} \cup low_{zk}, high_{ij} \cup high_{zk}]$ only values allowed by either C_{ij} or C_{zk} are admitted.
- **Intersection:** $C_{ij} \cap C'_{ij} = [max(low_{ij}, low'_{ij}), min(high_{ij}, high'_{ij})]$ only values allowed by both C_{ij} and C'_{ij} are admitted.
- **Composition:** $C_{zk} \otimes C_{ky} = [low_{zk} + low_{ky} + high_{zk} + high_{ky}]$

To verify the consistency of a network, a simple filtering algorithm is sufficient ([Mackworth, 1977](#)).

3.4.3.2 Simple Temporal Problem

With Simple Temporal Problem (STP), the quantitative temporal networks with simple interval duration are managed. According to ([Dechter et al., 1991](#)), Simple Temporal Network (STN) is a set of time points and a single interval constraint between each pair of these time points. Each edge is labeled by an interval $[a_{ij}, b_{ij}]$ representing the time interval between a_{ij} and b_{ij} . It represents a constraint $a_{ij} \leq V_j - V_i \leq b_{ij}$ that can be expressed as a pair of inequalities: $V_j - V_i \leq b_{ij}$ and $V_i - V_j \leq a_{ij}$. Each constraint $C_{ij} = [low_{ij}, high_{ij}]$ designates durations between instants (binary constraints). In addition, V_0 is a reference point in STN. A solution to a STN is a complete set of assignments to variables such that all temporal constraints are satisfied. Having at least one solution means that a STN is consistent. The simplest solution to solve a STN is to convert the directed constraint graph into a directed edge-weighted graph $G_d = (N_d, E_d)$ called a distance graph where time-points are nodes in N_d and constraints are edges in E_d ; each edge represents a linear inequality $N_j - N_i \leq a_{ij}$ which is labeled by a weight a_{ij} . By applying Floyd-Warshall's all-pairs-shortest-paths algorithm ([Papadimitriou and Steiglitz, 1998](#)) or also Johnson's algorithm ([Cormen et al., 2022](#)) to the distance graph, a d-graph is constructed. This latter is a tighter equivalent network of the original STN where each edge $i \rightarrow j$ is labeled by the shortest path length, d_{ij} , in G_d . When G_d has no negative cycles, the STN is considered consistent. Floyd-Warshall's algorithm detects negative cycles by examining the sign of the diagonal elements. Johnson's algorithm uses Bellman-Ford and Dijkstra as subroutines. It makes all edges positive by reweighting them in order to apply Dijkstra's algorithm for every node. For an STN with n time-points and m edges, it runs in $O(n^2 \log n + m)$ while Floyd-Warshall runs in $O(n^3)$.

3.4.4 Planning under uncertainty

Uncertainty is another feature for planning. During the execution of a plan, it is possible that unforeseen events occur and disrupt it. In the literature, several approaches are proposed such as conditional planning, probabilistic planning, probabilistic conditional planning, etc.

Conditional planning consists in defining alternatives where the sequence actions of the plan adapts to the observations made by the agent during the execution phase. It takes into account the uncertainty on the state of the environment and on the effects of some actions. The generated plan takes into account all possibilities whereas probabilistic planning generates a plan that has a high probability of success, even if the effects of the actions are not guaranteed and the data on the states of the world are neither complete nor deterministic. In an environment full of uncertainty, the combination of these two approaches allows generating a plan with a high probability of success when the world's state is not observed. Otherwise, an agent chooses the appropriate branch of the tree based on its observation during execution (conditional planning). Finally, there is probabilistic temporal planning, which is the combination of temporal planning and probabilistic planning. It is the most recent in the field of AI planning. It consists on adding probabilities to the temporal constraints and effects of actions. Some planners combine the two criteria of time and uncertainty as probabilities in a single system, but they are limited to well-defined problems such as travel companies and military operations (Baki, 2006).

3.4.4.1 Simple Temporal Network with Uncertainty

STN does not take uncertainty into account. (Vidal and Ghallab, 1996) were the first to address STNU formally, Thus, by adding uncertainty to STN, a new extension is created called the Simple Temporal Network under Uncertainty (STNU). It is defined by a triplet where V and C have the same definitions as in STN, and L is a set of contingent links (Morris et al., 2001; Hunsberger, 2013; Cairo et al., 2018). A contingent link represents actions with uncertain durations which means they are uncontrollable but bounded (Morris et al., 2001). It has the form $\langle V_i, low, high, V_j \rangle$ where $0 < low < high < \infty$, V_i is an activation time point assigned by an agent and V_j is a contingent time point controlled by Nature. For example, ambulance crews do not know how long the loading action of an injured will take, but according to their experience, they know that it will take anywhere from 1 to 5 minutes. In this case, the duration of the action “load” will be observed in real time after it is finished and it is not controllable by the ambulance agent. The All-Pairs, Shortest Semi-Reducible Paths (APSSRP) in STNU has the same role as all-pairs-shortest-paths algorithm in STN. Furthermore, when STNU has a strategy to execute online the executable (non-contingent)

time points by satisfying every constraint in the network no matter what is the duration of the contingent link, it is called dynamically controllable. This strategy depends only on the past observations. The most accepted formalization of STNU is dynamic controllability (DC) is developed in (Hunsberger, 2013). According to (Nilsson et al., 2016), dynamic controllability can be either fully verified or incrementally verified. Unlike incremental DC verification, full DC verification is when the DC for a STNU is verified in one step and it can be obtained by applying Morris' algorithm (Morris, 2014). FastIDC, EfficientIDC and E2IDC are the algorithms that incrementally check the DC of STNU from oldest to newest.

3.4.5 Classification of techniques for dynamic planning

(Bidot et al., 2009) presented three pure different approaches for planning and scheduling under uncertainty with regard to the balance between the generation and the execution. The first one is creating a plan, while the second one is the step at the moment this plan is executed online. In addition, when combining two or more pure techniques, a mixed approach is created. Furthermore, we distinguish between synchronous event and asynchronous event. Unlike the latter, a synchronous event occurs at a specific stage of the plan (Vidal et al., 2003).

To clarify the idea of each technique, an example of resource allocation is given in Figure 3.8. In this case study, we have three casualties who have to be transferred to two hospitals with two ambulances. They are prioritized in a queue. M1 and M2 are two ambulances capable of transferring 1 and 2 casualties at a time, respectively. H1 and H2 are two hospitals with equal capacities to receive wounded. H2 is closer to the site than H1, but unlike H2, the H1's medical team has experienced a similar event. The three pure approaches: proactive, reactive and progressive, and some of the mixed approaches are explained below:



		M1	M2		H1	H2
	Capacity	1	2	Capacity	3	3
				Distance	30	20
		H1	H1	Experience	Yes	No
Queue	I3	I2	I1			
	60	40	20			

Figure 3.8: Resource allocation example

I1, I2 and I3 are casualties that should be transferred to the hospital before 20,40 and 60 minutes, respectively.

3.4.5.1 Proactive approach

Proactive approach has a knowledge base about uncertainty in order to have the power to decide offline. Since the solution is insensitive to perturbations, it is not revised during execution. Knowledge about uncertainty is included to create more robust and reliable schedules.

According to figure 3.8, we deduce that the optimal solution is to transfer I1 to H2 by M1 and, I2 and I3 to H1 by M2. With this approach, the assignment of casualties to hospitals and ambulances is performed offline before the ambulances arrive at the site. Since the solution is not revised online, this approach takes uncertainty into account.

Figure 3.9 shows an example of M2 proactive plan. The plan has two alternatives a1 and a2. If M2 arrives before M1 on site (synchronous event), I1 and I2 are transferred to H2 by M2 whereas M1 transfers I3 to H2.

Although this technique takes uncertainty into account when generating a plan, in the crisis domain it is not possible to anticipate all uncertainties because unforeseen events can always occur at any time due to the dynamic and aggressive crisis environment.

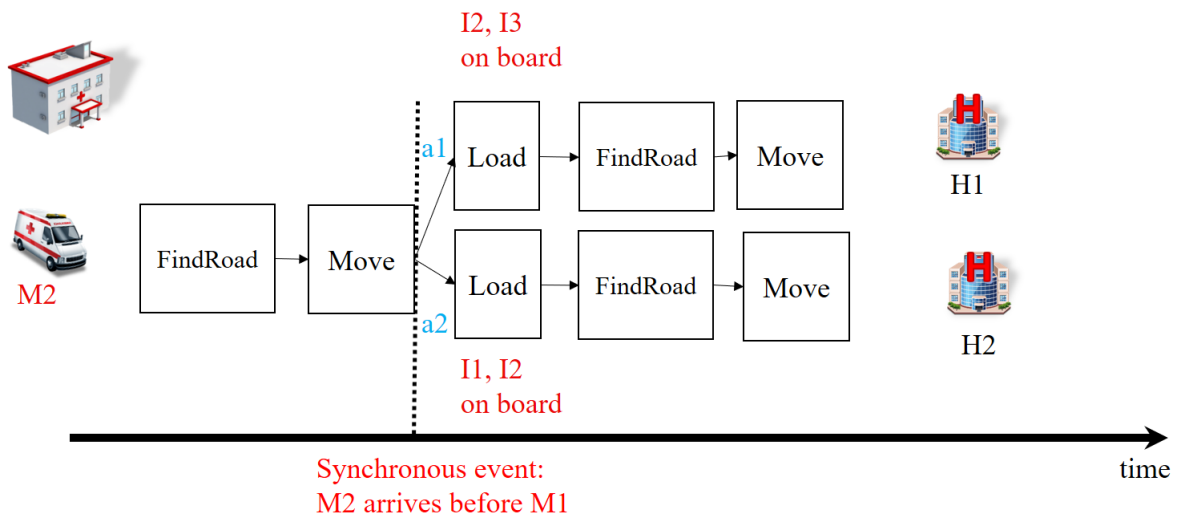

Figure 3.9: Proactive example of M2 plan

3.4.5.2 Reactive approach

This approach generates a complete schedule online and if during execution the solution differs from the observed situation, then the plan can be changed through online schedule regeneration. Unlike proactive approach, the decisions are made online in this technique and no uncertainty is taken into account. In this context, using the same example, since uncertainties

are not taken into account in predictive planning, one of the previous alternatives has been chosen (e.g. considering M1 arrives first), and then when executing online, if eventually M2 arrives first, a re-planning must be done and I1 and I2 are transferred to H2. This is not an optimal solution because I1 and I2 are transferred to an inexperienced hospital, but they will get the necessary services for their injuries. On the other hand, if the road is suddenly blocked before the arrival of M2 at the site, a new solution is generated online as shown in figure 3.10 (in red), e.g. by taking another road. Note that only the actions in red are executed after the event occurs. The others are removed. Each time a solution is revised, the resources, precedence constraints and duration are also revised.

Reactive approach is a good technique to manage uncertainty during a crisis because decisions could be taken online. Although it is unavoidable, making all decisions online is not effective in an emergency plan, because with a large number of agents, frequent re-planning makes the plan non-robust. In addition, it requires a high online computational effort.

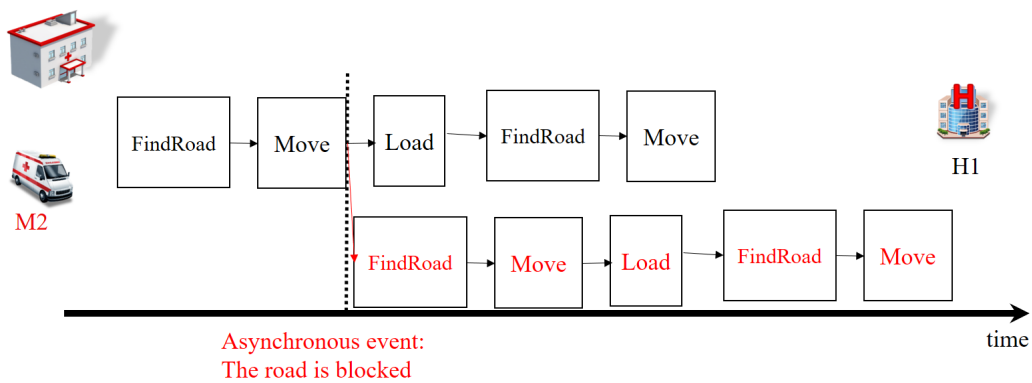

Figure 3.10: Reactive example of M2 plan

3.4.5.3 Progressive approach

With this approach, we are able to both plan and execute incrementally online. The plan is only generated in the short term. New steps are generated online either on a specific timestamp or whenever a condition expressing that some uncertainties are resolved is satisfied. In addition, it requires a high online computational effort. For example, the ambulances are assigned to the site according to the injured number and not injured situations. To arrive to the site, an ambulance executes a set of actions considered as the first sub-solution. Due to the absence of re-planning in this technique and to the uncertainty of when each hospital is overwhelmed, the assignment of injured to hospitals is not included in the first horizon. In figure 3.11, When M2 arrives on site, it receives an information about the H2 capacity. In this example, H2 has no more places to accept injured. In this case, M2 transfers I2 and I3 to H1.

Note that the actions in red are inserted into the plan after receiving the information. On the other hand, although the plan is generated piece by piece, the results are not guaranteed, which means that uncertainty cannot be totally avoided. For example, if the road is blocked while transferring the casualties, the move action is stopped and further actions are inserted into the plan.

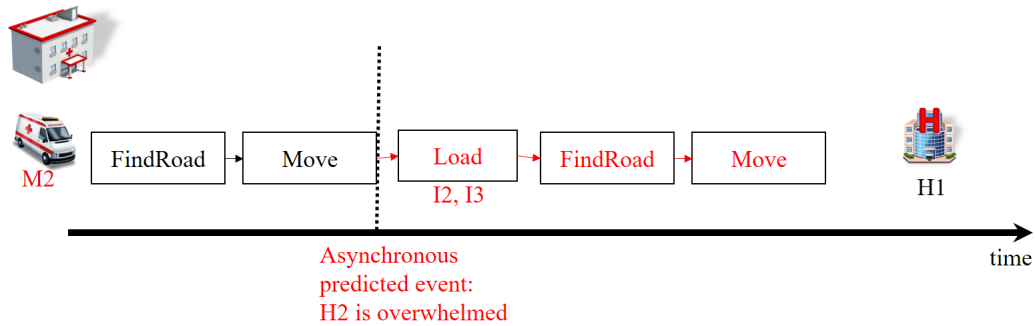

Figure 3.11: Progressive example

3.4.5.4 Mixed approaches

It combines at least two pure-generation techniques. Mixed approaches address the inevitable risks by limiting the memory blow-up. Let us use the example above for the proactive-reactive technique (see figure 3.12). In a proactive-reactive technique, hospitals and ambulances assignments are carried out offline. The optimal solutions (inserted actions, selected resources and constraints) is generated offline. In this case, I1 must be transferred to H2 by M1 and the others by M2 to H1. If M2 arrives first, a new solution is given by assigning I2 and I1 to H2 according to the capacity of M2 (reactive approach). In addition, if the road is blocked during the transfer of the injured, a new one can be chosen (revision). In this technique, decisions are made offline taking into account the uncertainty and, if necessary, some decisions can be modified online.

In a proactive-progressive approach, the plan is generated piece by piece by taking into account uncertainty. No revision is considered in this technique. For example, the proactive technique ensures that the duration of the solution is respected. In addition, the blocked road is taken into account in advance. We consider that when M2 arrives at the site, it receives information about the new casualty found. New actions are added to the plan taking into account all possibilities of this transfer to a hospital whereas in a reactive-progressive technique, the plan is generated piece by piece by modifying certain decisions if necessary. Although uncertainty is not taken into account when generating a sub-solution, the next sub-solution depends on the results of the first one and each of them can be revised. For example,

figure 3.14 shows an example of this technique. When the road is blocked, the action move is removed and new actions are added to the plan (reactive approach). When M2 is on site, two injured are assigned to it then to a hospital. M2 is informed that H2 is overwhelmed, in this case, it transfers the injured people to H1 (progressive approach). Finally, by combining the three approaches, uncertainties are taken into consideration in the plan construction phase, step by step, with the possibility of reconsidering certain decisions online. For example, in figure 3.15, M2 chooses the alternative a1. During the execution of action move, the road is suddenly blocked. In this case, the current action is removed and further actions are taken to transfer the injured people to H1.

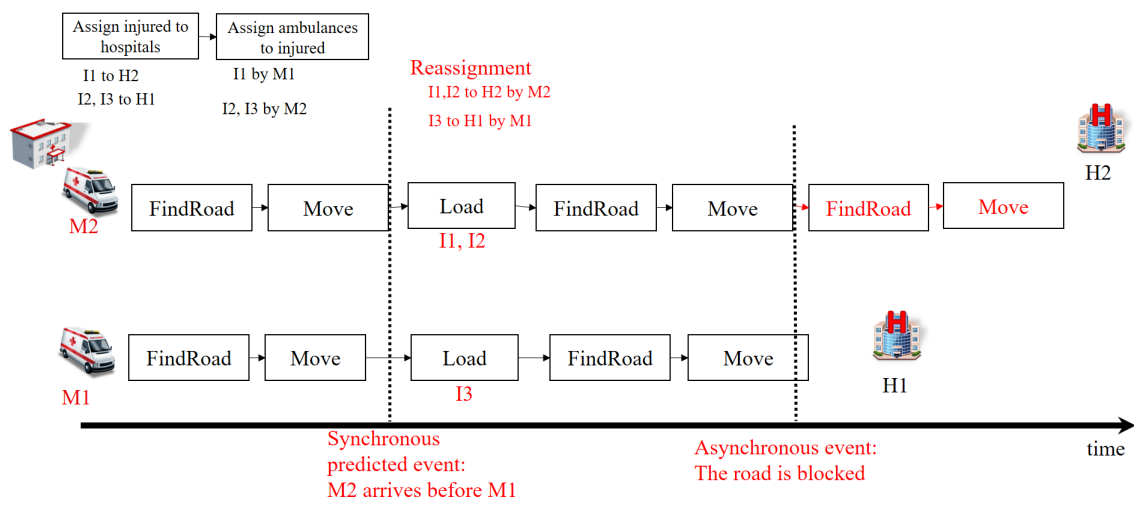

Figure 3.12: Proactive-reactive approach example

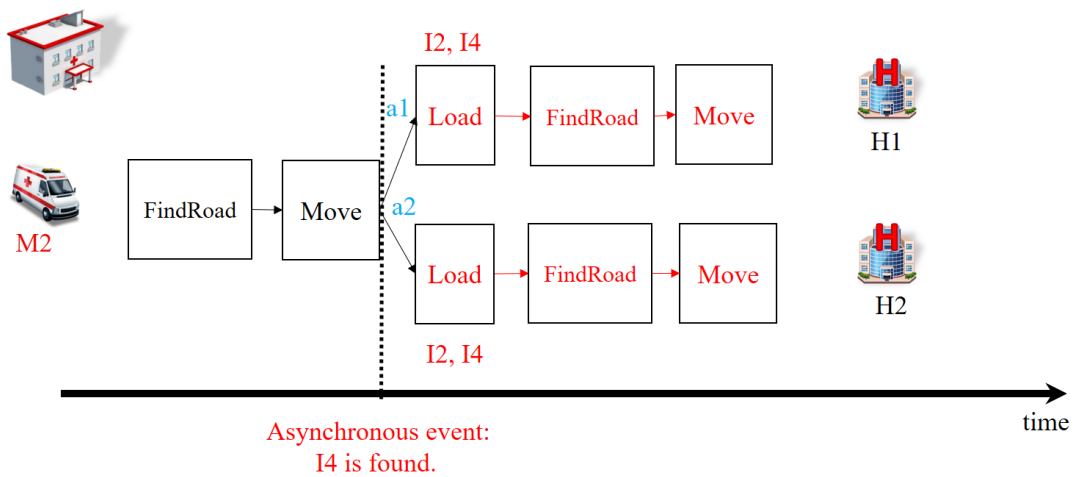

Figure 3.13: Proactive-progressive approach example

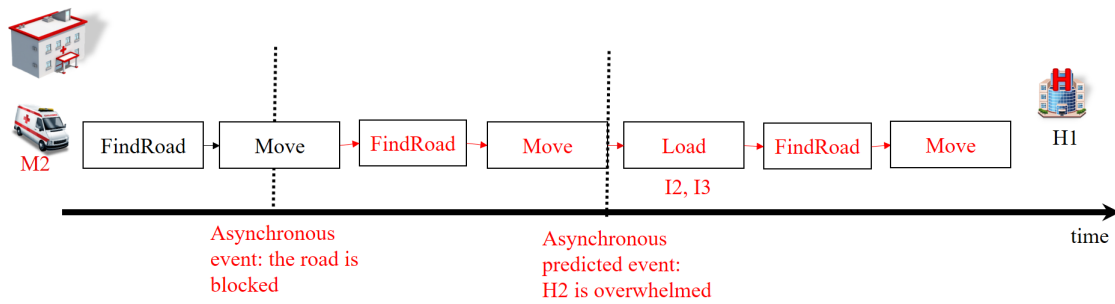

Figure 3.14: Reactive-progressive technique example

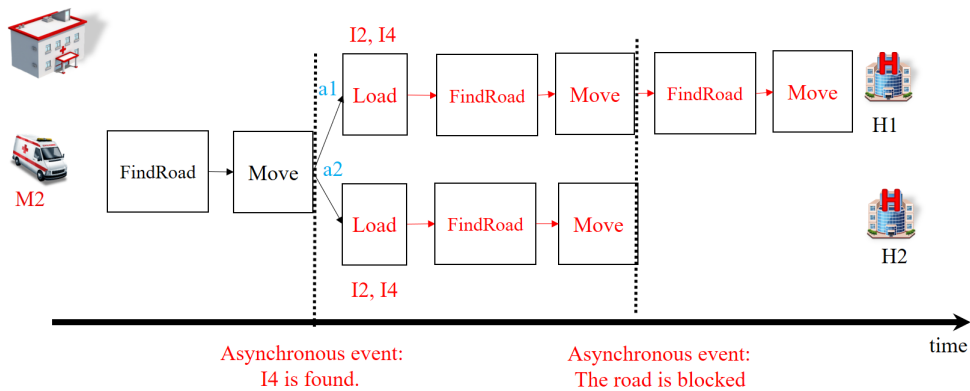

Figure 3.15: Proactive-reactive-progressive technique example

3.4.6 Multi-agent planning

Multi-agent planning consists, as its name suggests, in having many agents planning and interacting. The world around us is full of examples of interactions between individual entities to achieve a private or common goal in a shared environment. (Wood, 1983) sets an example that a driver must obey the road rules, consider other vehicles and avoid colliding with them while choosing a route. In addition, crisis rescue plans, transportation systems, games such as soccer, cards, chess, etc. are concrete examples of a set of agents that plan and interact in an environment.

3.4.6.1 Distributed planning

Distributed planning (also called multi-agent planning) is an ambiguous term because it is not clear what is distributed. Multi-agent planning is based on the plan planning phase and the plan execution phase. According to (Weiss, 1999), distributed planning is divided into three types when the agents' goal is common. It can be centralized planning for distributed plans, which means that plans are built centrally and then distributed to agents. Only the

plan execution is distributed. As shown in figure 3.16, “agent planner” generates three plans and distributes of them to the corresponding agent (e.g. plan 1 to “agent executor 1”).

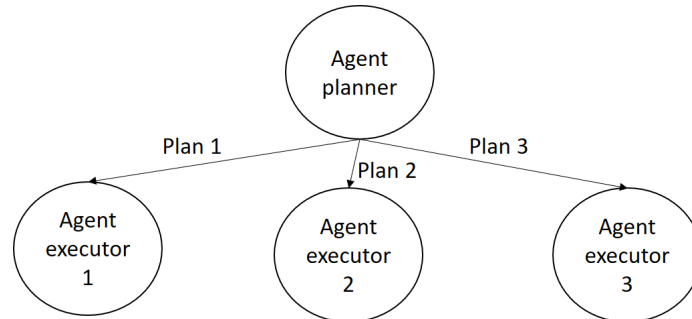

Figure 3.16: Centralized planning for distributed plans

Alternatively, it can be a distributed planning for centralized plans (see figure 3.17), which means that agents build locally their private plan and then a single agent (e.g. agent central) coordinate them into one coherent plan. In this case, only the coordination is carried out in a centralized way. The last one consists of distributed planning for distributed plans (see figure 3.18). In this case, when the planning process and plans are distributed, agents need to communicate with each other in order to achieve their plans without being in conflict during plan execution. There are several options or alternatives to ensure the coordination between agents in a distributed manner.

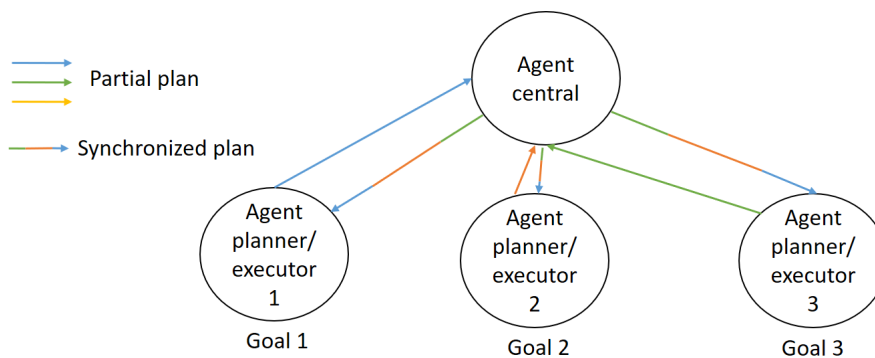

Figure 3.17: Distributed planning for centralized plans

In chapter 2, we explained the difference between centralized, semi-centralized and decentralized architectures by taking into account decisions. On the other hand, the plan generation can also be centralized or decentralized. Whatever the architecture type is, the execution of plans is always distributed. In this context, we present what exists in literature for each architecture. First, in planning, centralized architecture can be considered when one central agent plans for all the agents at the same time and resolves potential conflicts between their

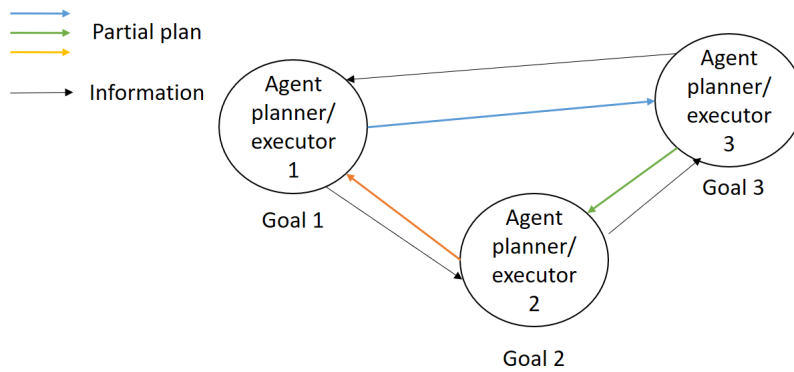

Figure 3.18: Distributed planning for distributed plans

activities by introducing synchronization actions. Alternatively, it is called centralized when coordinator agent decomposes the generated global plan into synchronized sub-plans or when it synchronizes the plans generated by the agents themselves (Ben Larbi, 2009). For decentralized architecture, there are several research axes to ensure coordination between agents in a distributed manner. We cite:

- **Merging the plans:** The problem of conflict between local plans generated directly by the agents is solved by this method. In the literature, many methods were proposed to merge the plans such as using a conditional simple temporal network (Tsamardinos et al., 2000), A* algorithm (Ephrati and Rosenschein, 1993) or incrementally generate the global plan (Ephrati et al., 1995).
- **Distributed synchronization of plans:** Each agent generates its local plan and shares it with other agents. In other words, it is responsible for synchronizing its plan with the other agents (Melliti et al., 2005).
- **Negotiation:** It is used to indicate the agent who should change plans. This choice must re-evaluate the local plans taking into account the possibilities offered to the agent (Von Martial, 1992).

3.4.6.2 Multi-agent Simple Temporal Network

According to (Casanova et al., 2015), another extension of STN is MaSTN where time-points are controlled by a set of agents and each variable is assigned an owner. Despite the fact that an agent maintains its private STN, it shares constraints with other agents. (Mogali et al., 2016) differ between inter-agent constraints where some time-points that belong to different agents are coupled and intra-agent constraints belonging to the agent itself. Figure 3.19 shows clearly the two constraints. There are many algorithms developed to solve a MaSTN such as incremental partial path consistency using the distributed incremental Δ STP. However, they

are not robust to intermittent communications. In this context, four incremental algorithms were proposed by (Casanova et al., 2015) to manage dynamic MaSTNs such as centralized incremental propagation.

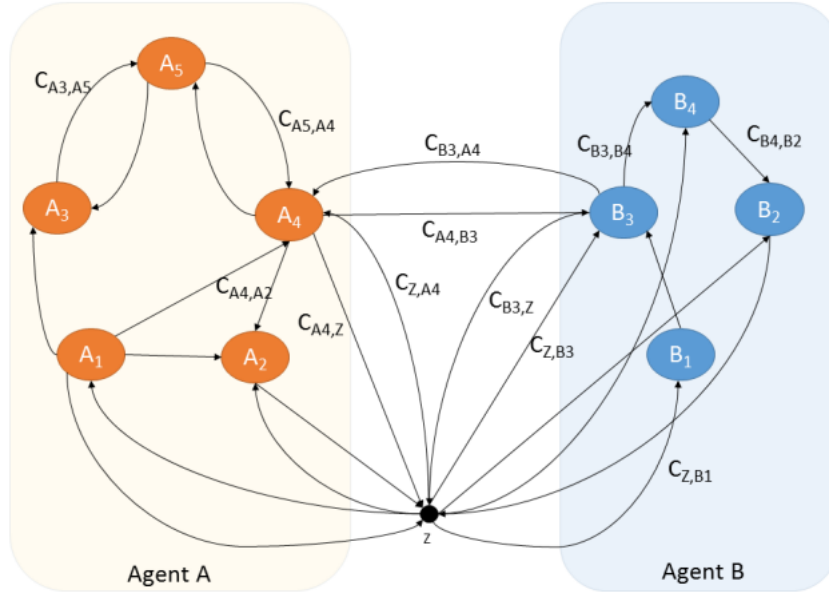

Figure 3.19: Decoupling a 2 agent MaSTN (Mogali et al., 2016)

3.4.6.3 Multi-agent Simple Temporal Network with Uncertainty

Although STNU takes uncertainty into account, it is not designed for a multi-agent system. None of the above temporal networks take into account both the multi-agent system and the uncertainty. According to (Casanova et al., 2015), in STNU, when the communication is intermittent, agents view a part of the problem and react based on their local observations. In this context, they proposed a Multi-agent STNU (A, V, L, C) where (V, L, C) is a STNU and A is a set of agents. The reference-point is shared by all agents. As in MaSTN, a variable is owned by a unique agent. A MaSTNU is dynamically controllable when it has an execution strategy that is valid, dynamic and distributed. An execution strategy is a mapping from projections (replacing contingent links by deterministic links) to schedules (all variables have a value). It is valid when all requirement links are satisfied in all the schedules. It is dynamic when in schedule 1, executable time-points before the current one, are the same as in schedule 2.

Finally, it is distributed when agents react according to their observations. Formally, when scheduling each contingent link duration assignment possibility assigns the same values to all contingent links and executable variables for each agent. (Casanova et al., 2016) worked

on a centralized offline procedure where one agent builds a global STNU for all agents and then decomposes it into synchronized set of STNUs and distributes them among the agents.

3.5 Conclusion

In this chapter, we gave an overview about planning and scheduling, and MAS. In this thesis, we work on an emergency response where the environment of agents is uncertain. Time, uncertainty, resource allocation and the interactions between different agents in a stochastic environment are the main challenges in our multi-agent dynamic planning model. In this thesis, we use the MAS to model our scenario in different architectures and specially in distributed way. During a crisis, information is distributed and each actor, in addition to its limited capabilities, does not have complete data on its environment and is therefore not able to solve its problem alone. The MAS provide a solution by offering the possibility to represent individuals, their behaviours and their interactions. They are well suited to model and simulate complex systems. In addition, ([Casanova et al., 2016](#)) assumes that the communication is intermittent and in this case, STNU cannot be used directly in a MAS. In this context, in case of lack of communication in a crisis response plan, the MaSTNU can be used. Otherwise, as the case in this thesis, STNU can be used to deal with duration uncertainty. In addition, mixed techniques are used in order to generate automatically plans for agents to achieve their goal. These techniques are used in the simulation level to test strategies for rescue plan distributed generation and execution. Finally, a fine analysis of the application must allow us to correctly set the levels of prediction, reaction and progression.

Terrorist attack scenario: Planning and scheduling and MAS

Sommaire

4.1 Introduction	111
4.2 What do we consider as an agent?	112
4.2.1 Homogeneous agents vs heterogeneous agents	113
4.3 Planning and scheduling: where are we?	114
4.4 Formal framework	114
4.4.1 Definitions	115
4.4.2 Model description	120
4.5 Link between design level and simulation level	132
4.5.1 FMECA	134
4.5.2 Library of standard plan	135
4.6 Algorithms	136
4.6.1 Assignment algorithm	137
4.6.2 Insertion of plans	138
4.6.3 FastIDC algorithm	138
4.7 Conclusion	141

4.1 Introduction

In this chapter, we determine our scenario's agents and their roles. Then, we explain the place of our work in planning and scheduling. Next, we define an action and its preconditions and effects. Moreover, we define uncertainty and the different plans in our work. Furthermore, we model our terrorist attack scenario in a formal framework and explain our proposed algorithms

to allow agents to generate their plans and assign the required agents to the site and casualties to the hospitals.

In addition, we intend to reveal the link between the design level (see chapter 2) and simulation level defined in this chapter. We explain the role of the design level in modelling our simulation level and what does it bring to it.

4.2 What do we consider as an agent?

The definition of agents is done in chapter 3, section 3.2.1. In this thesis, an agent is a system that is autonomous, capable to perceive its environment and to decide the best actions to execute in its plan to achieve its goal.

As described in chapter 2, section 2.2.1, at the operational level of an emergency plan, although France and Lebanon have a different way of managing a crisis, they have the same actors and the same objectives but with different labels and strategies specific to each country. In order to identify the actors in our scenario, we use terms that are understandable to both countries. Firstly, the French fire brigades and the Lebanese Civil Defence are represented as fire brigades' agents. On the other hand, the national police, the national gendarmerie, the Lebanese Armed Forces and the Lebanese Internal Security Forces are designated by the security agents. In addition, the SAMU is a call centre that coordinates with the hospital to transfer victims. The medical team that goes to help victims and transfer them to the hospital uses a vehicle called mobile emergency and resuscitation structure (SMUR). While, in Lebanon, the paramedics use the red cross ambulance and keeps in touch with its centre which coordinates with hospitals. In our architectures, we refer to the medical team and the vehicle by the ambulance agent, that is in contact with its centre if necessary. The three agents: security agent, fire brigade agent and ambulance agent are triggered by security centre agent, fire department agent and ambulance centre agent, respectively. A centre represents the administration and the call centre. Furthermore, the hospital agent represents a health care centre in our scenario. As mentioned before, the scenario will be tested in a semi-centralized architecture and decentralized architecture. Regardless of the architecture type, the agents have the same roles (objectives). The semi-centralized architecture differs from the decentralized architecture by adding the central agent who is the only decision-maker (see figure 4.1). Finally, the PMA agent is common to both countries.

In this context, the roles of the agents in our scenario are as follows:

- **Security centre agent, ambulance centre agent and fire department agent** that coordinate with corresponding agents.

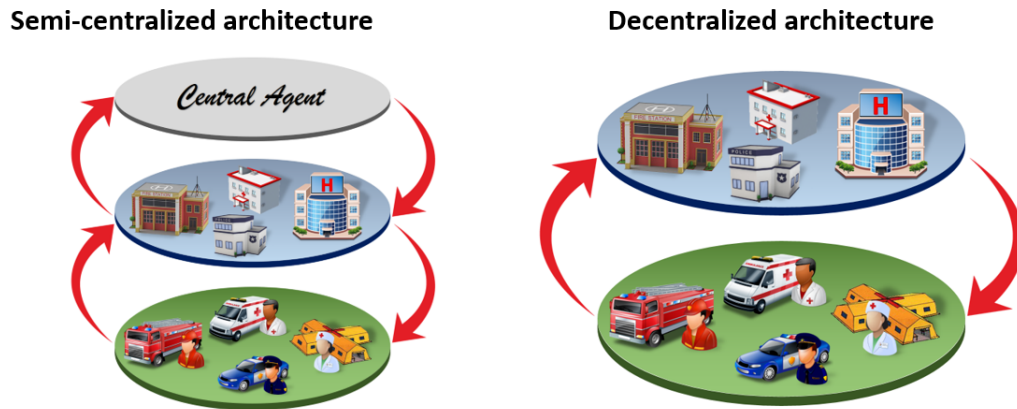

Figure 4.1: Agents in semi-centralized and decentralized architectures

- **Security agent:** it aims to avoid any further unexpected events and to protect victims.
- **Ambulance agent:** it seeks to transfer wounded to hospitals.
- **Hospital agent:** usually, it takes care of injured people. In our scenario, we are only interested in transferring casualties to an appropriate hospital that is capable of treating their injuries and has an available place. In this context, hospital agent aims to communicate its capacity with the corresponding agent in real time.
- **Firefighter agent:** it assists injured people on site and transfers them to the PMA.
- **Central agent:** it is only present in the semi-centralized architecture. It aims to assign casualties to hospitals and agents to the site.
- **PMA agent:** it represents the medical team who helps the casualties before their transfer to a hospital.

4.2.1 Homogeneous agents vs heterogeneous agents

As BPMN clearly represents, different stakeholders coordinate in an emergency rescue plan to help victims. These actors can work with actors of the same or/and different types. For example, the firefighters work together in the pick-up sector to locate and assist the victims. In addition, they transfer them to the PMA for further assistance. In this case, the firefighters and the medical teams in PMA collaborate to help victims. In this context, we define:

Definition 4.2.1 (Homogeneous agents). They are identical agents or agents of the same given type. In this work, we consider that homogeneous agents share the same actions in planning and scheduling.

Definition 4.2.2 (Heterogeneous agents). They are agents of a different type that share different actions.

4.3 Planning and scheduling: where are we?

The objective of planning and scheduling is to provide a system with the ability to interact with its environment autonomously, in order to achieve the objectives assigned to it. Generally, in planning, the number of actions required to achieve the goal is usually unknown. On the contrary, scheduling starts from a set of actions known in advance, which must be positioned in time with respect to each other. In this thesis, we are between planning and scheduling because we can obtain an overall idea of the size of the plan and we don't know in the beginning what we are going to execute.

Knowing the exact number of casualties means knowing the exact number of sub-plans (predefined set of actions) needed to save them. For example, for 10 casualties, 10 ambulances with capacity of transferring one injured at a time are assigned, which means 10 sub-plans to execute. In a crisis, victims number is not certain which means that we do not know at the beginning what we will execute. In this case, it is not considered as a pure scheduling problem. In addition, the objectives for each actor is known and h/she has certain missions to accomplish. In other words, the number of actions from which the actor chooses to generate its plan is known. Although the needed actions to achieve the goal may differ from an agent to another, we can have an overall idea of the size of the plan. For example, to go from the centre to the site, an ambulance has to look for the best road and move. The number to actions needed to achieve this goal is known. In this case, it is not a pure planning problem.

In this work, each actor in the emergency plan has a library of standard plans. We develop an assignment method in order to assign for each injured a hospital and an ambulance by taking into account the number of available ambulances as well as their capacity, the number of available hospitals and the capacity of each hospital. Likewise, we take in consideration the number of injured people and the situation of each injured and finally the estimated distance from the crisis area (site) to the hospital. We use a plans insertion algorithm to allow an agent to choose among the standard plans those that can be used to achieve its goal. In semi-centralized model, the central agent will merge all the plans of the actors in order to have a global plan.

4.4 Formal framework

This section is dedicated to the formal representation of our scenario. In this section, we indicate on each activity of an actor's process (see section 2.8.1), its equivalent at the simulation level in the form of actions. In addition, we represent how the design level has identified what we call simulation level uncertainties and how they are handled.

4.4.1 Definitions

Adam wants to call his friend Jonathan in order to ask him a favor. To make a phone call, he holds his phone, opens it, enters the contacts application, searches for Jonathan's number, chooses it then presses the call button (calls him). All these steps are considered as actions in planning. In this example, we notice that all the actions are sequential which means that by respecting the order of the actions, an action cannot be started before the end of the execution of the previous action (Adam cannot enter the application if the mobile is closed). All these actions and the precedence constraints between them form a plan that has a goal which is, in our case, reaching Jonathan to ask him a favor. In addition, a plan starts its execution by starting the execution of the first action in it. We intend by an executed plan, a plan that finishes the execution of all its actions. Some actions can be performed in parallel. For example, Adam drinks his coffee while he is calling Jonathan. He may finish his coffee before, after or at the same time as ending the call with his friend.

In a formal way, $A = \{a_1^z, \dots, a_n^z\}$ is a set of possible (not instantiated) actions for an agent z where $|A| = n$ and $i \in \{1, \dots, n\}$. It needs to choose among them, those that serve it in order to achieve its goals.

Definition 4.4.1 (Instantiated action). Instantiated actions are the actions chosen and inserted in a plan.

Definition 4.4.2 (Executed plan). An executed plan is a plan where all its actions are executed (performed).

Definition 4.4.3 (Generated plan). A generated plan is a plan where its actions are instantiated but not executed yet.

Definition 4.4.4 (Action). An action is the task performed by an agent z over a period of time. To an action a_i^z is associated the list $\langle t_{(a_i^z)}^-, t_{(a_i^z)}^+, pcond(a_i^z), eff(a_i^z) \rangle$ (see figure 4.2) such that:

- $t_{(a_i^z)}^-$: is the date on which the agent starts the execution of a_i^z ;
- $t_{(a_i^z)}^+$: is the date on which the agent finishes the execution of a_i^z ;
- $pcond(a_i^z)$: are the preconditions of an action a_i^z . They are the properties of the world required for an action. An action cannot be performed if its preconditions are not satisfied. Thus, preconditions let an agent know when to execute the action;
- $eff(a_i^z)$: are the results of executing an action a_i^z .

Actions Agents actions are later represented in PDDL 2.1 language. As shown in Figure 4.3, an action's preconditions are can be defined at the beginning of the action, at its end, or

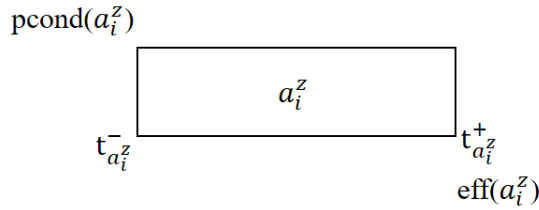

Figure 4.2: Action's representation

over the period between them. In addition, effects can be activated either at the beginning or at the end of the action (Fox and Long, 2003). In PDDL, objects are real-world entities (such

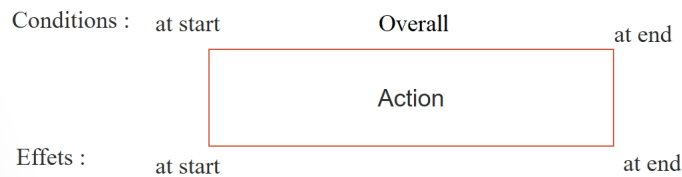

Figure 4.3: Action in PDDL 2.1

as vehicles, humans, etc.) that have properties, that is, predicates in PDDL. Figure 4.4 shows an example of loading a victim on board of an ambulance in PDDL 2.1 language. This action has three objects: victim ($?p$), vehicle ($?v$) and place ($?s$). In addition, action duration is the time required for getting the victim on board. In this example, the predicates presented in *:condition* must be true in order to start the execution of *loadVictim* action. While the predicates in *:effect*, represents the results of the action. They are of Boolean type (true or false).

```
(:durative-action loadVictim
:parameters (?p - Victim ?v - Vehicle ?s - Place )
:duration (= ?duration (tempsLoadVictim))
:condition (and (free ?p)
                (free ?v)
                (loc ?p ?s)
                (loc ?v ?s)
                (available ?v))

:effect (and (not (available ?v))
             (onBoard ?p ?v)
             (not (notOnBoard ?p))))
```

Figure 4.4: The action loadVictim in PDDL 2.1 (Soubaras et al., 2013)

The explanation of the predicates in figure 4.4 is as follows:

- (free ?p-victim): the victim ?p is currently free

- (free ?v-vehicle): the vehicle ?v is currently available
- (loc ?p-victim ?s-place): the victim ?p is currently at the place ?s
- (loc ?v-vehicle ?s-place): the vehicle ?v is currently at the place ?s
- (available ?v-vehicle): the vehicle ?v is currently available
- (onBoard ?p-victim ?v-vehicle): the victim ?p is currently in vehicle ?v
- (notOnBoard ?p-victim): the victim ?p is not on board

In this thesis, we have four different objects: location(? l), vehicle (? v), agent(? z) and person(? p). The locations in our scenario are three: the centre of each agent, the site and the hospitals. In this case, we have ? l_1 , ? l_2 and ? l_3 as locations. ? t and ? o represent truck and police car, respectively. They are the only vehicle in our scenario. An ambulance is considered as an agent in our work. It represents the vehicle and the ambulance crew. In addition, ? F , ? S , ? SC , ? MC , ? FC , ? h , ? m , ? c and ? E represent firefighter agent, security agent, security centre agent, ambulance centre agent, fire department agent, hospital agent, ambulance agent, central agent and PMA agent, respectively. Furthermore, injured people and attackers are not agents. In this case, ? x designates an injured and ? r represent an attacker.

Definition 4.4.5 (Standard plan). A standard plan is a set of non-instantiated actions that have the same order in the local plan (set of sequential instantiated standard plans; defined in section 4.4.6) of each homogeneous agent and the same constraints. Moreover, it has a goal.

For example, every morning, Bob dresses up, prepares his breakfast and eats it while reading the newspaper before leaving the house. These actions are repeated every day in the same order and for the same goal which is to get ready for something. When Bob wants to go to work or to the store or to any other destination, he repeats these steps in order to get ready. In this thesis, these actions form a standard plan that has a goal. In our example, the standard plan includes four actions (see figure 4.5). In our work, an agent will choose from its library of standard plans, the ones that allow it to achieve its goal instead of choosing among a set of possible actions in order to create a local plan (composed of several standard plans; see definition 4.4.6). The chosen standard plans are called instantiated standard plans which means the standard plans that are inserted in a local plan. An executed local plan is an instantiated plan where all its actions are executed.

In addition, we came up with the idea of standard plans when modeling the terrorist attack scenario in chapter 2 because of the repetitiveness of certain activities (actions) in a service process. Furthermore, although the centres trigger a different type of agents, they have the same actions for this objective. Moreover, whether we have a single centre or several centres of the same agent type (homogeneous), they have the same actions. These actions are used for any type of crisis that requires the response of these actors. For these reasons,

we propose the idea of standard plans, where homogeneous agents have a common library of standard plans and choose among them those that allow them to reach their private goals.

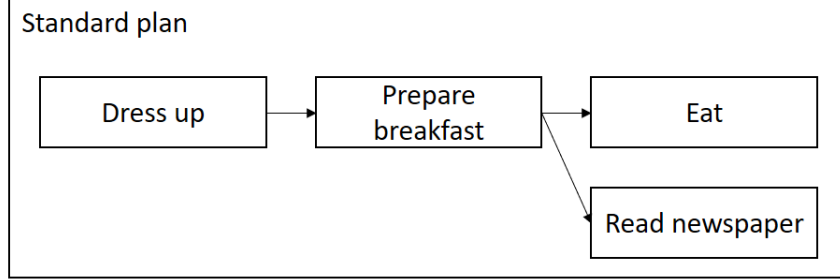

Figure 4.5: Bob's standard plan: to get ready

We consider a standard plan \mathcal{J}_i^z as a Septuplets $\langle pcond(\mathcal{J}_i^z), eff(\mathcal{J}_i^z), B_k, \prec, g, t_{\mathcal{J}_i^z}^-, t_{\mathcal{J}_i^z}^+ \rangle$ where:

- **pcond**(\mathcal{J}_i^z): They are the properties of the world required for a \mathcal{J}_i^z ;
- **eff**(\mathcal{J}_i^z): are the results of executing a \mathcal{J}_i^z ;
- **B_k**: is a nonempty (or nonvoid) set of actions; $|B_k| = y$; $B_k \subset A$. Nonempty set is a set that contains at least one element. A set is called singleton set if and only if it contains only one element;
- **≺**: represents precedence constraints; $\prec = \emptyset$ if and only if B_k is a singleton set;
- **g**: is the goal of \mathcal{J}_i^z ;
- **t_{ℳ_i^z}**⁻: is the non-instantiated time-point on which the agent starts the execution of \mathcal{J}_i^z ;
- **t_{ℳ_i^z}**⁺: is the non-instantiated time-point on which the agent finishes the execution of \mathcal{J}_i^z .

Despite the fact that we have a heterogeneous multi-agent system, in a homogeneous set of agents, all the agents share the same library but each agent may have a local plan different from the others. For example, all the ambulances share the same library, but two ambulances may have two different local plans. This depends on the environment of the ambulance. In addition, each type of agent has a library of standard plans that is different from the others. Furthermore, each standard plan has preconditions and effects. If a precondition of an action is not established as an effect of a previous action, it is a precondition of the standard plan. If an effect of an action is not canceled by a subsequent action, it is an effect of the standard plan.

Definition 4.4.6 (Local plan). It is a set of instantiated actions executed by an agent in order to reach its goals. Local plan is the set of actions of the standard plans with the instance variables and the precedence constraints. It is represented as a STNU. r^z is the local plan r

associated to agent z . In order to choose among the standard plans those that will allow an agent z to achieve its goals, we develop the “insertionPlans” algorithm (see 4.6.2).

Let’s take Bob’s example. He wants to go to the supermarket. In this case, Bob’s private (local) plan is composed of two instantiated standard plans as shown in figure 4.6. The first standard plan has a goal to prepare Bob, while the second’s goal is to move by car between two locations. Each standard plan has preconditions and effects. In addition, they have precedence constraints between them. For example, Bob cannot go to the supermarket if he is not prepared. In order to start the execution of the standard plan 2, first of all, the standard plan 1 must be executed. Then, BOB needs to be in the car, the two locations are different and he is at home for example as first location (preconditions). When he finishes the execution of standard plan 2, he is at the supermarket (location 2) and not at home (the effects of standard plan 2). Figure 4.6 shows Bob’s local plan which is a STNU. In order to clarify our idea, we represent it also as standard plans.

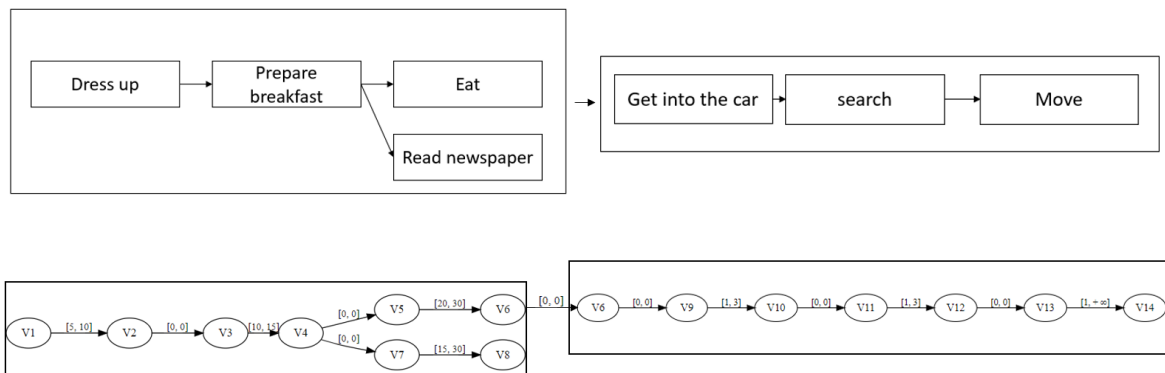

Figure 4.6: Bob’s local plan

Definition 4.4.7 (Uncertainty). An uncertainty is an uncertain event that may or may not occur during the agent’s plan execution. Its presence disrupts the agent’s plan. Sometimes it can be anticipated by studying the field or based on previous experience. Although it could be anticipated, the exact moment of its appearance is unknown. In planning and scheduling, we may have uncertainty about the duration of an action or a plan, the effects of an action or a plan and the availability of resources.

If we take the example of the meeting of Bob and Alice, many uncertainties may arise that affect their plan. For example, Bob may get stuck in traffic and be late or he may have an accident and not be able to come at all. On the other hand, Alice may be unavailable on the meeting day due to unexpected event.

4.4.2 Model description

We seek to formally model the terrorist attack scenario. In addition, for each agent, we present its set of actions and its library of standard plans. We want our architectures to be close to reality in order to know how agents can coordinate with each other by executing their private plans to achieve the main goal. Furthermore, we want to know how an agent can make a decision without affecting the local plan of other agents.

In reality, apart from ambulance agents, not all homogeneous agents on the site have the same local plan. For example, the missions are distributed among the firefighters, which means that they are divided into groups. There is a group to locate victims, another to provide first aid, etc. In our architectures, unlike ambulance agents, the firefighters are divided into four groups:

- F_1 : to locate and pick-up victims
- F_2 : to take them to the PRV
- F_3 : to take them to the PMA
- F_4 : to aid, sort and prioritize them

In addition, all the homogeneous centre agents involved in the response to a crisis coordinate together. Since this work focus more on the actors acting at the site, the homogeneous centre agents are grouped together, meaning that there is a centre agent for each agent type representing all the centres. For example, for the two security centre agents sc_1 and sc_2 , 40 security agents are available in each of them. sc_1 and sc_2 are 20 minutes and 10 minutes away from the site, respectively. This information is used to allocate agents to the site (resource allocation). In planning and execution, the homogeneous agents sc_1 and sc_2 are represented by SC agent.

Moreover, in real life, communication between homogeneous agents and their centre is in broadcast mode, which means that the information is shared between all agents. For example, if a security agent communicates with its centre, all other security agents hear the conversation. In this work, although security agents on site have different missions, their overall objective is to secure the area so that the other agents can intervene. In this context, all the security agents are also grouped into one agent.

4.4.2.1 Site

When a terrorist attack occurs, in order to intervene, the agents must know the exact location of the crisis, when it happened, the type of the attack and the expected number of injured

(it is uncertain). In this context, a crisis is characterized by:

- Physical location, longitude and latitude coordinate $r(x_r, y_r)$;
- Expected number of injured people: d ;
- Event time: t ;
- Event type: v .

4.4.2.2 Injured people

$X = \{x_1, x_2, \dots, x_n\}$ is a set of injured people where $n \in \mathbb{N}$. Each injured is characterised by a medical diagnosis and triage tag that represents his/her situation. Therefore, there are four colours to describe the injured situation:

- Black colour means the victim is dead.
- Red colour identified injured people with critical or serious injuries.
- Yellow colour means that the injured person has a minor injury.
- Green colour represents unharmed victims; they have no physical injuries but may have psychological injuries.

Only injured with red colour tags are considered in this thesis. They should be transferred to a hospital immediately or before a delay which is maximum six hours (360 minutes), depending on the injury situation (Foucher et al., 2018). In this context, we model the life expectancy of injured people with severe and critical conditions (E_{x_i}) as follows:

$$E_{x_i} \in [30, 360] \quad \forall x_i = \{1, \dots, n\} \quad (4.1)$$

$$x_i = \begin{cases} [30, 45], & \text{if } x_i \text{ critical.} \\ [45, 360], & \text{if } x_i \text{ is severe.} \end{cases}$$

4.4.2.3 Security centre agent

$SC = \{sc_1, \dots, sc_n\}$ is a set of security centre agents where $|SC| = n$, $n \in \mathbb{N}^*$ and $i = \{1, \dots, n\}$. It has a library of standard plans $\mathbb{I}^{SC} = \{\mathbb{I}_1^{SC}, \dots, \mathbb{I}_p^{SC}\}$; $|\mathbb{I}^{SC}| = p$; $p \in \mathbb{N}^*$; $j = \{1, \dots, p\}$. In this context, sc_i is characterized by:

- Physical location, longitude and latitude coordinates $sc_i(x_{sc_i}, y_{sc_i})$;
- Set of available security agents: $S^{sc_i} = \{S_1^{sc_i}, \dots, S_m^{sc_i}\}$; $|S^{sc_i}| = m$; $m \in \mathbb{N}$ (it can be empty); $j = \{1, \dots, m\}$.

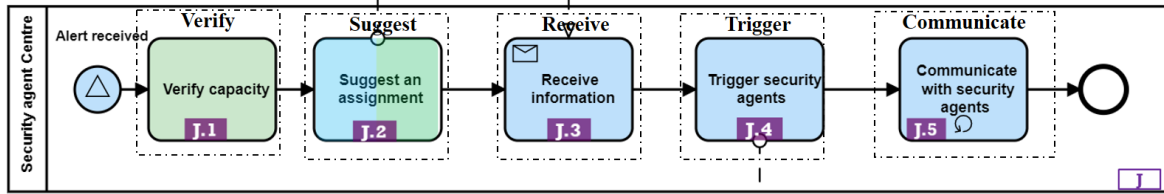

(a) semi-centralized architecture

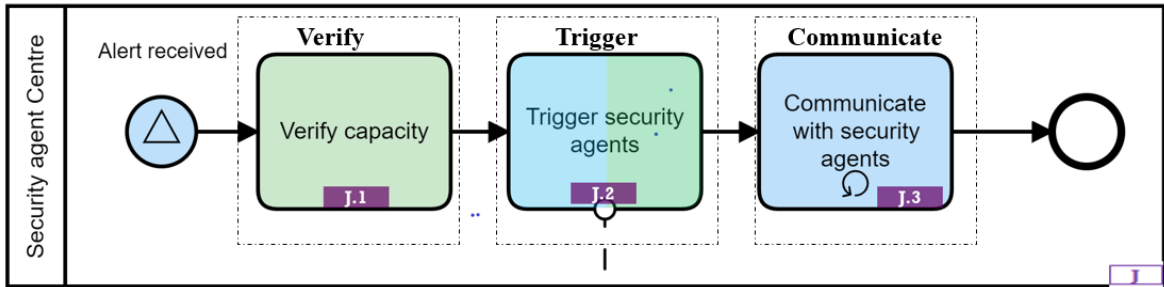

(b) decentralized architecture

Figure 4.7: SC actions in BPMN

Actions Figure 4.7 shows the SC activities in the functional model and their equivalent in planning and scheduling. For example, the activity "verify capacity" of the SC centre is called "verify" in planning and scheduling. In a semi-centralized architecture, SC agent executes five actions:

- verify: to check its capacity in term of the number of available security agents that it has.
- suggest: to propose to the central agent the assignment of security agents to the site.
- receive: to receive the decision of the central agent.
- trigger: to inform the security agent about central agent’s decision.
- communicate: to communicate with the security agent on site.

While in a decentralized architecture, it executes three actions where verify and communicate have the same role as in a semi-centralized architecture. In addition, the action "trigger" assigns the number of security officers required for the response and inform them. The security officers are grouped into one agent called security agent (designated by S).

The actions of security centre agent and their preconditions and effects are shown in table 4.1. SC agent has 6 actions. To launch the execution of an action, its preconditions must be true. In this context, the predicates used by SC agent are:

- (available ?z-agent): the agent ?z is currently available.
- (sent ?z-agent): information is sent to the agent ?z
- (received ?z-agent): the information is received from the agent ?z

- (agent-at ?l-location ?z-agent): the agent ?z is currently at the location ?l

Some of the predicates can also be used by other agents. Furthermore, there are functions that represent numerical fluent in PDDL 2.1, such as *cap* that represents the capacity of a centre.

a_1^{SC} requires the SC agent to be available to check the capacity of the centres (number of available security officers). When SC completes the execution of a_1^{SC} , it obtains its total capacity. Moreover, to suggest solutions (a_2^{SC}) to the central agent(?c), the SC agent must be available and know the capacity of the centres. At the end of the action, the proposal is sent to the central agent. (a_3^{SC}) allows SC agent to receive information. It is used to receive the decision of the central agent. In this case, SC agent must be available and the results is knowing the destination (the site) and the decision of central agent (*received ?c*). In addition, in order to communicate with the security agent, both agents must be available. Communicating means exchanging information (informing and receiving). At the end of this action, the results are the information sent to S or SC, and the information received by S or SC. Furthermore, the difference between a_4^{SC} and a_6^{SC} , is that unlike a_6^{SC} , a_4^{SC} is used in a semi-centralized architecture which means that it needs the decision of the central agent. It is only considered as an information task. Action's result is that the agent S is triggered. Note that we consider that SC agent is always available unless it is making a decision. For example, overall the actions a_1^{SC} and a_6^{SC} , SC agent is not available and at the end of the action, it is available again. For simplicity, we represent it is availability only in preconditions.

pcond(a_i^{SC})	Action name	Action code	eff(a_i^{SC})
(available ?SC)	verify(?SC)	a_1^{SC}	(cap > 0)
(available ?SC) (cap > 0)	suggest(?SC, ?c)	a_2^{SC}	(sent ?c)
(available ?SC)	receive(?SC, ?c)	a_3^{SC}	(received ?c)
(agent – at ?l ₁ ?S) (received ?c)	trigger(?l ₁ , ?S, ?c)	a_4^{SC}	(sent ?S)
(available ?SC) (available ?S)	communicate(?SC, ?S)	a_5^{SC}	(sent ?S) (received ?S) (sent ?SC) (received ?SC)
(available ?SC) (agent – at ?l ₁ ?S) (cap > 0)	trigger(?l ₁ , ?S, ?SC)	a_6^{SC}	(sent ?S)

Table 4.1: SC actions.

4.4.2.4 Security agent

Each security officer is an actor which means that s/he is an agent. In real life, the Police work in groups. For example, there is a group to cordon off the area, another one to follow the attackers, etc. For simplicity, we have considered all the security agents involved as a single agent.

$s_z^{sc_i}$ is the security agent s_z that belongs to the security centre sc_i . $S = \{S^{sc_1}, \dots, S^{sc_n}\}$ is an agent representing all the available security agents involved in the actual rescue plan where $|S| = n$; $n \in \mathbb{N}^*$. It has a library of standard plans $\mathcal{I}^S = \{\mathcal{I}_1^S, \dots, \mathcal{I}_p^S\}$; $|\mathcal{I}^S| = p$; $p \in \mathbb{N}^*$; $j = \{1, \dots, p\}$.

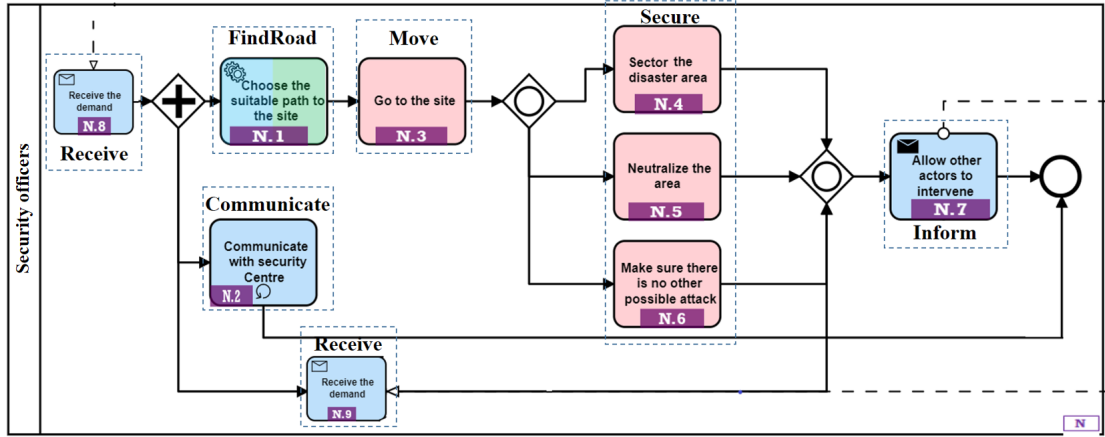

Figure 4.8: S action in BPMN

Actions Figure 4.8 shows the equivalent of the security agent’s activities in planning and scheduling. First, security agent receives the demand from its centre. Then, S searches for an appropriate road to the site and heads there (move). In addition, security agent secures the area by killing or arresting the attackers and cordoning off the area. Once the area is secured, S agent authorizes the firefighters to access the area after receiving their demand. Finally, S communicates with its centre.

The actions of S are represented in table 4.2. It has seven actions to perform from a_1^S to a_7^S that require, in addition to some predicates defined in 4.4.2.3, the following predicates:

- (equal $?l_1$ -location $?l_2$ -location): the two locations $?l_1$ and $?l_2$ are the same.
- (linked $?l_1$ -location $?l_2$ -location): there is an available road between the two locations $?l_1$ and $?l_2$
- (vehicle-at $?l$ -location $?v$ -vehicle): the vehicle $?v$ is currently at the location $?l$
- (agent-in $?v$ -vehicle $?z$ -agent): the agent $?z$ is currently in the vehicle $?v$

- (free ?v-vehicle) : the vehicle ?v is currently available
- (person-at ?l-location ?p-person): the person ?p is currently at the location ?l
- (free2 ?p-person): the person ?p is currently free.
- (cordoned-off ?l-location): location ?l is currently cordoned off.

$\text{pcond}(a_i^S)$	Action name	Action code	$\text{eff}(a_i^S)$
$\text{not}(\text{equal } ?l_1 ?l_2)$	$\text{findRoad}(?l_1, ?l_2)$	a_1^S	$(\text{linked } ?l_1 ?l_2)$
$(\text{linked } ?l_1 ?l_2)$ $(\text{vehicle} - \text{at } ?l_1 ?o)$ $(\text{agent} - \text{at } ?l_1 ?S)$ $(\text{agent} - \text{in } ?o ?S)$ $\text{not}(\text{equal } ?l_1 ?l_2)$ $(\text{free } ?o)$	$\text{move}(?S, ?l_1, ?l_2, ?o)$	a_2^S	$\text{not}(\text{vehicle} - \text{at } ?l_1 ?o)$ $(\text{vehicle} - \text{at } ?l_2 ?o)$ $\text{not}(\text{agent} - \text{at } ?l_1 ?S)$ $(\text{agent} - \text{at } ?l_2 ?S)$ $\text{not}(\text{free } ?o)$
$(\text{available } ?S)$ $(\text{agent} - \text{at } ?l_2 ?S)$ $(\text{person} - \text{at } ?l_2 ?r)$ $(\text{free2 } ?r)$	$\text{secure}(?S, ?l_2, ?r)$	a_3^S	$(\text{cordoned} - \text{off } ?l_2)$ $\text{not}(\text{free2 } ?r)$
$(\text{available } ?S)$	$\text{inform}(?F, ?S)$	a_4^S	$(\text{sent } ?F)$
$(\text{available } ?SC)$ $(\text{available } ?S)$	$\text{communicate}(?S, ?SC)$	a_5^S	$(\text{received } ?S)$ $(\text{sent } ?S)$ $(\text{received } ?SC)$ $(\text{sent } ?SC)$
$(\text{available } ?S)$	$\text{receive}(?S, SC)$	a_6^S	$(\text{received } ?SC)$
$(\text{available } ?S)$	$\text{receive}(?S, ?F)$	a_7^S	$(\text{received } ?F)$

Table 4.2: S actions.

4.4.2.5 Ambulance centre agent

$MC = \{mc_1, \dots, mc_n\}$ is a set of ambulance centre agents where $|MC| = n$, $n \in \mathbb{N}^*$ and $i = \{1, \dots, n\}$. It has a library of standard plans $\mathbb{I}^{MC} = \{\mathbb{I}_1^{MC}, \dots, \mathbb{I}_p^{MC}\}$; $|\mathbb{I}^{MC}| = p$; $p \in \mathbb{N}^*$; $j = \{1, \dots, p\}$. In this context, mc_i is characterized by:

- Physical location, longitude and latitude coordinates $mc_i(x_{mc_i}, y_{mc_i})$;
- Set of available ambulance agents: $M^{mc_i} = \{m_1^{mc_i}, \dots, m_k^{mc_i}\}$; $|M^{mc_i}| = k$; $k \in \mathbb{N}$ (it can be empty); $j = \{1, \dots, K\}$.

The actions of ambulance centre agent are identical to the actions shown in table 4.1 by replacing SC with MC and S with m.

4.4.2.6 Ambulance agent

$m_z^{mc_i}$ is the ambulance agent m_z that belongs to the ambulance centre mc_i . It has a library of standard plans $\mathcal{J}^{m_z^{mc_i}} = \{\mathcal{J}_1^{m_z^{mc_i}}, \dots, \mathcal{J}_p^{m_z^{mc_i}}\}$; $|\mathcal{J}^{m_z^{mc_i}}| = p$; $p \in \mathbb{N}^*$; $j = \{1, \dots, p\}$. Each ambulance agent has a capacity cap which can be $cap = 1$ or $cap = 2$, which means an ambulance can transfer either one or two casualties at a time.

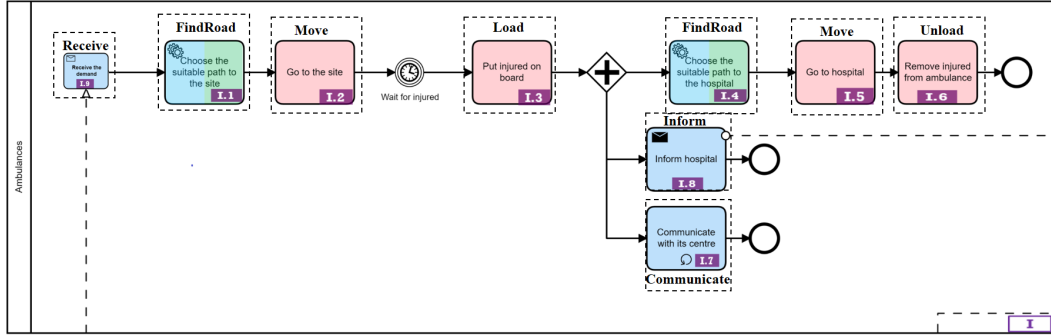

(a) semi-centralized architecture

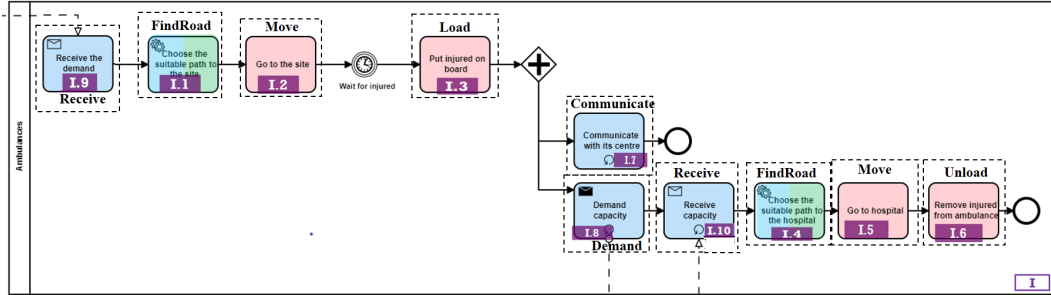

(b) decentralized architecture

Figure 4.9: Ambulance’s actions in BPMN

Actions The actions of ambulance agent are presented in table 4.3 according to their representation in figure 4.9. The four actions a_1^m , a_2^m , a_5^m and a_6^m are identical to a_1^S , a_2^S , a_5^S and a_6^S in table 4.2 by replacing S with m and SC with MC. a_4^m and a_8^m aim to put injured on board of an ambulance and remove them from it. An ambulance gives (a_7^m) a hospital information about the injured on board. When an ambulance has some autonomy, it demands (a_3^m) the capacity of a hospital in order to transfer an injured person. a_9^m seeks to receive the hospital’s capacity. In addition to the predicates defined in 4.4.2.3 and 4.4.2.4, it uses ($person - in ?z - agent ?p - person$) which means that the person ?p is currently in the agent ?z. This predicate is dedicated only for ambulance agent. Furthermore, for an ambulance, we have its maximum capacity (MaxCap) and the number of loaded injured (loadedInjured) as numerical fluent.

$\text{pcond}(a_i^m)$	Action name	Action code	$\text{eff}(a_i^m)$
$\text{not}(\text{equal } ?l_1 ?l_2)$	$\text{findRoad}(?l_1, ?l_2)$	a_1^m	$(\text{linked } ?l_1 ?l_2)$
$(\text{linked } ?l_1 ?l_2)$ $(\text{agent} - \text{at } ?l_1 ?m)$ $\text{not}(\text{equal } ?l_1 ?l_2)$	$\text{move}(?m, ?l_1, ?l_2)$	a_2^m	$\text{not}(\text{agent} - \text{at } ?l_1 ?m)$ $(\text{agent} - \text{at } ?l_2 ?m)$
$(\text{person} - \text{in } ?m ?x)$	$\text{demand}(?m, ?h, ?x)$	a_3^m	$(\text{sent } ?h)$
$(\text{available } ?m)$ $(\text{agent} - \text{at } ?l_2 ?m)$ $(\text{person} - \text{at } ?l_2 ?x)$ $(\leq (\text{MaxCap}))$ $(-\text{loadedInjured})$	$\text{load}(?l_2, ?m, ?x)$	a_4^m	$(\text{person} - \text{in } ?m ?x)$ $\text{not}(\text{available } ?m)$
$(\text{available } ?MC)$ $(\text{available } ?m)$	$\text{communicate}(?MC, ?m)$	a_5^m	$(\text{received } ?m)$ $(\text{sent } ?m)$ $(\text{received } ?MC)$ $(\text{sent } ?MC)$
$(\text{available } ?m)$	$\text{receive}(?m, ?MC)$	a_6^m	$(\text{received } ?MC)$
$(\text{person} - \text{in } ?m ?x)$	$\text{inform}(?m, ?h, ?x)$	a_7^m	$(\text{sent } ?h)$
$\text{not}(\text{available } ?m)$ $(\text{agent} - \text{at } ?l_3 ?m)$ $(\text{person} - \text{in } ?m ?x)$	$\text{unload}(?l_3, ?m, ?x)$	a_8^m	$(\text{available } ?m)$ $(\text{person} - \text{at } ?l_3 ?x)$ $\text{not}(\text{person} - \text{in } ?m ?x)$
$(\text{available } ?m)$	$\text{receive}(?m, ?h)$	a_9^m	$(\text{received } ?h)$

Table 4.3: Ambulance agent's actions

4.4.2.7 Hospital agent

h_i is the hospital agent i where $i \in \mathbb{N}^*$. It has a library of standard plans $\mathbb{I}^{h_i} = \{\mathbb{I}^{h_1}, \dots, \mathbb{I}^{h_p}\}$; $|\mathbb{I}^{h_i}| = p$; $p \in \mathbb{N}^*$; $j = \{1, \dots, p\}$. A hospital has a maximum injured capacity. This latter corresponds to the hospital's services, medical team, available operating rooms, emergency rooms and beds, etc. In addition, a hospital may or may not have experience in treating injuries from this type of event, and/or it may organize training for its emergency teams. h_i is characterised by:

- Physical location, longitude and latitude coordinates $h_i(x_{h_i}, y_{h_i})$;
- Capacity: $cap \in \mathbb{N}$;
- Experience: $exp = [0, 0.5, 1]$; unlike 1, 0 means it has no experience. 0.5 means that the hospital has not experienced a similar event but does organize training.

Actions Hospital agent's actions are represented in figure 4.10 and in table 4.4. In addition to the predicates defined previously, it uses $(\text{ready } ?z - \text{agent})$ which means that the agent $?z$ is currently ready. In addition, cap represents the capacity of the hospital.

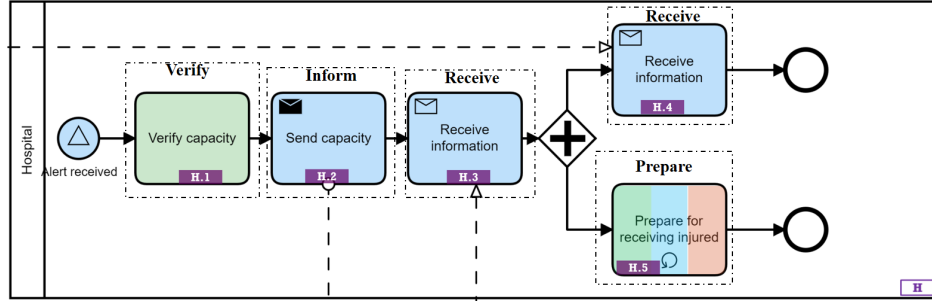

(a) semi-centralized architecture

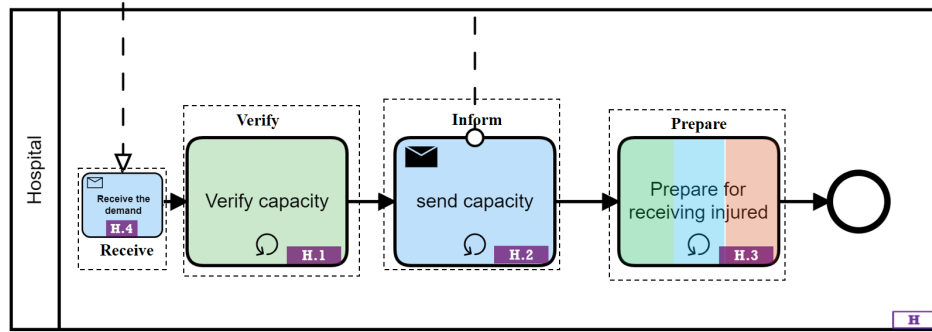

(b) decentralized architecture

Figure 4.10: Hospital's actions in BPMN

Hospital agent verifies (a_1^h) its capacity and send it to either the central agent (a_3^h) or an ambulance agent (a_2^h). a_5^h and a_4^h allow hospital agent to receive information from central agent and ambulance agent, respectively. Finally, a hospital prepares (a_6^h) to accept casualties.

$\text{pcond}(a_i^h)$	Action name	Action code	$\text{eff}(a_i^h)$
$(\text{available } ?h)$	verify(?h)	a_1^h	$(\text{cap} \geq 0)$
$(\text{available } ?h)$	inform(?h, ?m)	a_2^h	$(\text{sent } ?m)$
$(\text{available } ?h)$	inform(?h, ?c)	a_3^h	$(\text{sent } ?c)$
$(\text{available } ?h)$	receive(?h, ?m)	a_4^h	$(\text{received } ?m)$
$(\text{available } ?h)$	receive(?h, ?c)	a_5^h	$(\text{received } ?c)$
$(\text{available } ?h)$	prepare(?h)	a_6^h	$(\text{ready } ?h)$

Table 4.4: Hospital agent's actions

4.4.2.8 Fire department agent

$FC = \{fc_1, \dots, fc_n\}$ is a set of fire department agents where $|FC| = n$, $n \in \mathbb{N}^*$ and $i = \{1, \dots, n\}$. It has a library of standard plans $\mathcal{P}^{FC} = \{\mathcal{P}_1^{FC}, \dots, \mathcal{P}_p^{FC}\}$; $|\mathcal{P}^{FC}| = p$; $p \in \mathbb{N}^*$;

$j = \{1, \dots, p\}$. In this context, f_{c_i} is characterized by:

- Physical location, longitude and latitude coordinates $f_{c_i}(x_{f_{c_i}}, y_{f_{c_i}})$;
- Set of available firefighters agents: $F^{f_{c_i}} = \{F_1^{f_{c_i}}, \dots, F_m^{f_{c_i}}\}$; $|F^{f_{c_i}}| = m$; $m \in \mathbb{N}$;
 $j = \{1, \dots, m\}$.

The actions of firefighter department agent are identical to the actions shown in table 4.1 by replacing SC with FC and S with F.

4.4.2.9 Firefighter agent

$f_z^{f_{c_i}}$ is the firefighter officer f_z that belongs to the fire department f_{c_i} . There are four groups of firefighters on site where each group is considered as an agent. $f_z^{f_{c_i}}$ belongs to only one group; $f_z^{f_{c_i}} \in F_j$; $j = \{1, 2, 3, 4\}$. All the firefighters agents (F_j) share the same library of standard plans $\mathbb{I}^{F_j} = \{\mathbb{I}_1^{F_j}, \dots, \mathbb{I}_p^{F_j}\}$; $|\mathbb{I}^{F_j}| = p$; $p \in \mathbb{N}^*$; $d = \{1, \dots, p\}$.

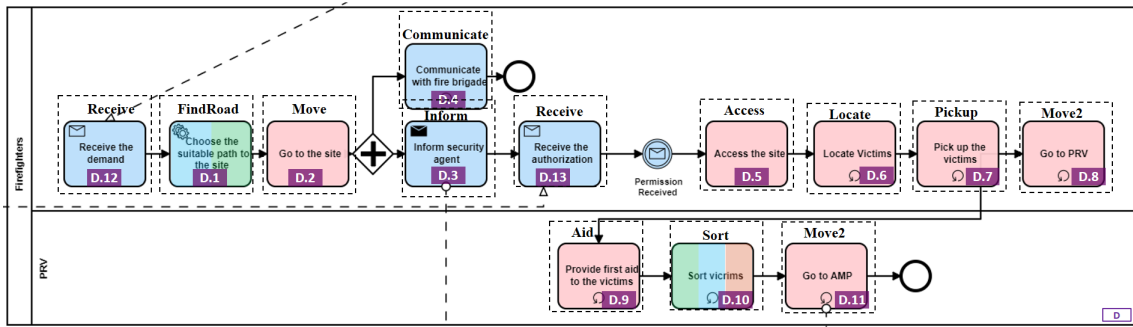

Figure 4.11: F action in BPMN

Actions Table 4.5 shows the firefighter agent's actions according to figure 4.11. Actions $a_1^{F_j}$, $a_2^{F_j}$, $a_5^{F_j}$, $a_6^{F_j}$ are similar to the same actions in table 4.2 by replacing S by F_j . F_j agent informs ($a_3^{F_j}$) S agent of its arrival at the site. F_j agent accesses ($a_4^{F_j}$) the site when it receives ($a_7^{F_j}$) authorization from the security agent. $a_8^{F_j}$ and $a_9^{F_j}$ allow F agent to locate and pickup the victims, respectively. $a_{10}^{F_j}$ is used to move between two locations by walking. In addition, $a_{11}^{F_j}$ and $a_{12}^{F_j}$ are used to aid and sort victims, respectively. In this context, new predicates are defined:

- (accessed ?l-location ?z-agent): the agent ?z has currently accessed the location ?l
- (aided ?p-person): the person ?p is currently aided
- (labelled ?p-person): the person ?p is currently labelled

$\text{pcond}(a_i^{F_j})$	Action name	Action code	$\text{eff}(a_i^{F_j})$
$\text{not}(\text{equal } ?l_1 ?l_2)$	$\text{findRoad}(?l_1, ?l_2)$	$a_1^{F_j}$	$(\text{linked } ?l_1 ?l_2)$
$(\text{linked } ?l_1 ?l_2)$ $(\text{vehicle} - \text{at } ?l_1 ?t)$ $(\text{agent} - \text{at } ?l_1 ?F)$ $(\text{agent} - \text{in } ?t ?F)$ $\text{not}(\text{equal } ?l_1 ?l_2)$ $(\text{free } ?t)$	$\text{move}(?F, ?l_1, ?l_2, ?t)$	$a_2^{F_j}$	$\text{not}(\text{vehicle} - \text{at } ?l_1 ?t)$ $(\text{vehicle} - \text{at } ?l_2 ?t)$ $\text{not}(\text{agent} - \text{at } ?l_1 ?F)$ $(\text{agent} - \text{at } ?l_2 ?F)$ $\text{not}(\text{free } ?t)$
$(\text{available } ?F)$	$\text{inform}(?F, ?S)$	$a_3^{F_j}$	$(\text{sent } ?S)$
$(\text{agent} - \text{at } ?l_2 ?F)$	$\text{access}(?F, ?l_2)$	$a_4^{F_j}$	$(\text{accessed } ?l_2 ?F)$
$(\text{available } ?FC)$ $(\text{available } ?F)$	$\text{communicate}(?FC, ?F)$	$a_5^{F_j}$	$(\text{received } ?F)$ $(\text{sent } ?F)$ $(\text{received } ?FC)$ $(\text{sent } ?FC)$
$(\text{available } ?F)$	$\text{receive}(?F, ?FC)$	$a_6^{F_j}$	$(\text{received } ?FC)$
$(\text{available } ?F)$	$\text{receive}(?F, ?S)$	$a_7^{F_j}$	$(\text{received } ?S)$
$(\text{accessed } ?l_2 ?F)$	$\text{locate}(?F, ?l_2, ?x)$	$a_8^{F_j}$	$(\text{person} - \text{at } ?l_2 ?x)$
$(\text{person} - \text{at } ?l_2 ?x)$	$\text{pickup}(?F, ?x, ?l_2)$	$a_9^{F_j}$	$(\text{ready } ?x)$
$(\text{linked } ?l_2 ?l_3)$ $\text{not}(\text{equal } ?l_2 ?l_3)$ $(\text{agent} - \text{at } ?l_2 ?F)$ $(\text{person} - \text{at } ?l_2 ?x)$	$\text{move2}(?F, ?l_2, ?l_3, ?x)$	$a_{10}^{F_j}$	$(\text{agent} - \text{at } ?l_3 ?F)$ $(\text{person} - \text{at } ?l_3 ?x)$
$(\text{person} - \text{at } ?l_3 ?x)$	$\text{aid}(?x, ?l_3, ?F)$	$a_{11}^{F_j}$	$(\text{aided } ?x)$
$(\text{person} - \text{at } ?l_3 ?x)$ $(\text{aided } ?x)$	$\text{sort}(?F, ?x, ?l_3)$	$a_{12}^{F_j}$	$(\text{labelled } ?x)$

Table 4.5: F_j actions.

4.4.2.10 PMA agent

The PMA agent represents the actors who take care of the injured before transferring them to the hospital. In our scenario, we consider the PMA to be essential and assume that it is installed directly on site after the area is secured. It has a library of standard plans $\mathcal{PI}^E = \{\mathcal{PI}_1^E, \dots, \mathcal{PI}_p^E\}$; $|\mathcal{PI}^E| = p$; $p \in \mathbb{N}^*$; $j = \{1, \dots, p\}$.

Actions Table 4.6 shows the PMA agent's actions represented in figure 4.12. First of all, we suppose that the PMA is always needed in our scenario. It needs to be installed (a_1^E) in order to receive injured (a_2^E), sort them (a_3^E), transport them to the absolute urgency place in PMA (a_5^E), aid them (a_7^E) and prioritize them (a_8^E). In addition, new predicates are used by PMA agent:

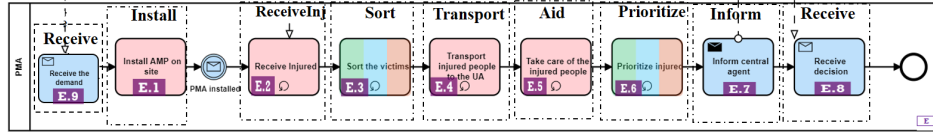

(a) semi-centralized architecture

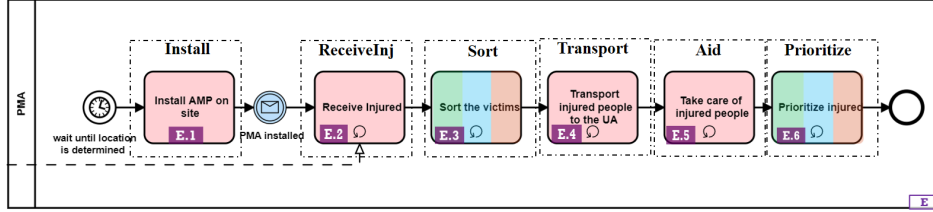

(b) decentralized architecture

Figure 4.12: PMA's actions in BPMN

- (installed $?z$ -agent): the agent $?z$ is currently installed
- (transported $?p$ -person): the person $?p$ is currently transported
- (prioritized $?p$ -person): the person $?p$ is currently prioritized

$\text{pcond}(a_1^E)$	Action name	Action code	$\text{eff}(a_1^E)$
$(\text{agent} - \text{at } ?l_2 \ ?E)$	install($?E, ?l_2$)	a_1^E	$(\text{installed } ?E \ ?l_2)$
$(\text{installed } ?E \ ?l_2)$	receiveInj($?E, ?x, ?l_2$)	a_2^E	$(\text{person} - \text{in } ?l_2 \ ?x)$
$(\text{person} - \text{in } ?l_2 \ ?x)$	sort($?l_2, ?x$)	a_3^E	$(\text{labelled } ?x)$
$(\text{available } ?E)$	inform($?c, ?E$)	a_4^E	$(\text{sent } ?c)$
$(\text{labelled } ?x)$	transport($?x$)	a_5^E	$(\text{transported } ?x)$
$(\text{available } ?E)$	receive($?c, E$)	a_6^E	$(\text{received } ?c)$
$(\text{transported } ?x)$	aid($?x$)	a_7^E	$(\text{aided } ?x)$
$(\text{aided } ?x)$	prioritize($?x$)	a_8^E	$(\text{prioritized } ?x)$

Table 4.6: PMA actions.

4.4.2.11 Central agent

c is the decision-maker of the semi-centralized architecture in term of the assignment of agents. It has a library of standard plans $\mathcal{PI}^c = \{\mathcal{PI}_1^c, \dots, \mathcal{PI}_p^c\}$; $|\mathcal{PI}^c| = p$; $p \in \mathbb{N}^*$; $j = \{1, \dots, p\}$.

Actions Figure 4.13 shows the activities of the central agent in BPMN. M.13 is not considered an action at the simulation level, because in our scenario, PMA is a must, so the decision is already made. In addition, although some activities are represented in parallel in BPMN, a single agent can make only one decision at a time. Parallel activities mean that the order of receipt is not important. In this context, when a suggestion is received, the central agent

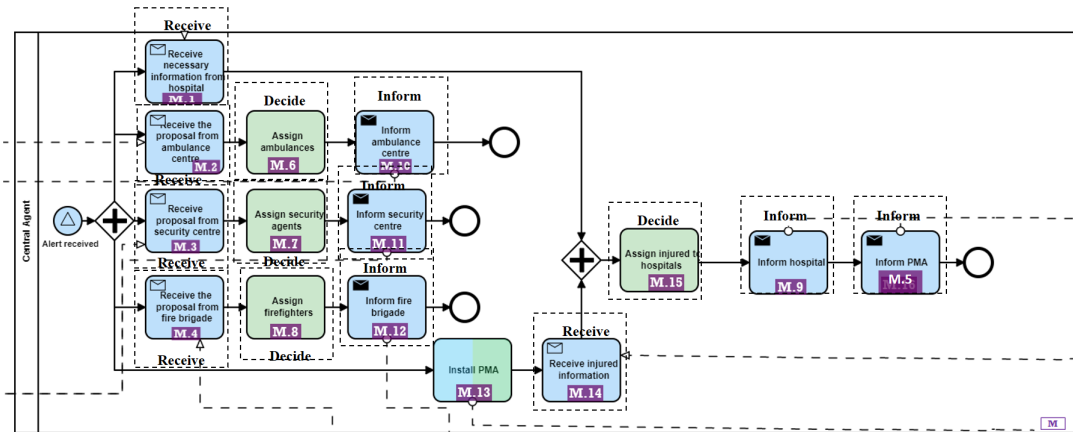

Figure 4.13: Central agent’s action in BPMN

makes a decision. Furthermore, assigning injured to hospitals requires information about the hospitals and the injured.

Table 4.7 represents the central agent’s actions. Central agent receives information from other agents ($a_1^c, a_2^c, a_3^c, a_4^c, a_{14}^c$), affects agents ($a_9^c, a_{10}^c, a_{11}^c, a_{12}^c$) and sends its decision to the appropriate agents ($a_5^c, a_6^c, a_7^c, a_8^c, a_{13}^c$).

In addition to the predicates defined above, it has:

- ($assigned ?z - agent ?z_2 - agent$): the agent $?z_2$ is needed from the agent $?z$
- ($assigned2 ?p - person ?z - agent$): the person $?p$ is assigned to agent $?z$

4.5 Link between design level and simulation level

Figure 4.14 explores our two levels while table 4.8 illustrates the nomenclature which differs between them. The design level is composed of the BPMN models and the FMECA tables. On the other hand, the simulation level is composed of the MAS and dynamic approaches to planning and scheduling.

As we can see, each actor in an emergency plan has missions that should be executed in a specific order. For example, the firefighters cannot provide first aid to victims without first locating them. In addition, different actors coordinate to help victims. For example, firefighters provide first aid, medical teams sort and prioritize the victims and the latter are transferred to hospitals by ambulances. The nomenclature varies between the design level and the simulation level. The term “actors” is represented by “swimlanes” designating the emergency services in BPMN and is called “agents” in MAS. The missions and their order are

pcond(a_i^c)	Action name	Action code	eff(a_i^c)
(available ?c)	receive(?c, ?SC)	a ₁ ^c	(received ?SC)
(available ?c)	receive(?c, ?FC)	a ₂ ^c	(received ?FC)
(available ?c)	receive(?c, ?MC)	a ₃ ^c	(received ?MC)
(available ?c)	receive(?c, ?h)	a ₄ ^c	(received ?h)
(available ?c)	inform(?c, ?SC)	a ₅ ^c	(sent ?SC)
(available ?c)	inform(?c, ?FC)	a ₆ ^c	(sent ?FC)
(available ?c)	inform(?c, ?MC)	a ₇ ^c	(sent ?MC)
(available ?c)	inform(?c, ?h)	a ₈ ^c	(sent ?h)
(available ?c) (received ?SC)	decide(?c, ?SC, ?S)	a ₉ ^c	(assigned ?S ?SC)
(available ?c) (received ?FC)	decide(?c, ?FC, ?F)	a ₁₀ ^c	(assigned ?F ?FC)
(available ?c) (received ?MC)	decide(?c, ?MC, ?m)	a ₁₁ ^c	(assigned ?m ?MC)
(available ?c) (received ?E)	decide(?c, ?h, ?x, ?E)	a ₁₂ ^c	(assigned2 ?x ?h)
(available ?c)	inform(?c, ?E)	a ₁₃ ^c	(sent ?E)
(available ?c)	receive(?c, ?E)	a ₁₄ ^c	(received ?E)

Table 4.7: central agent's actions.

Emergency Plan	BPMN	Planning and scheduling	Multi-agent system
Actors	Swimlanes	Actors	Agents
Missions	Activities	Actions/time-points	Behaviours
Order of missions	Connecting objects	Precedence constraints/constraints	Sequential or parallel behaviours
Coordination between actors	Connecting objects	Precedence constraints/constraints	Communication/interaction

Table 4.8: The nomenclature of BPMN, MAS and planning and scheduling.

symbolized by activities and connection objects in BPMN. Thus, the coordination between agents is represented by connection objects. Whereas in planning and scheduling, missions are actions and time points (in temporal networks) linked by precedence constraints. Actions are then transformed into behaviours in MAS that can be sequential or parallel. Moreover, agents interact and communicate in order to coordinate. After we explained the nomenclature, we can affirm that FMECA in design level is a method used on each activity in BPMN to identify the sources of uncertainty that may disrupt the execution of the agent's plan.

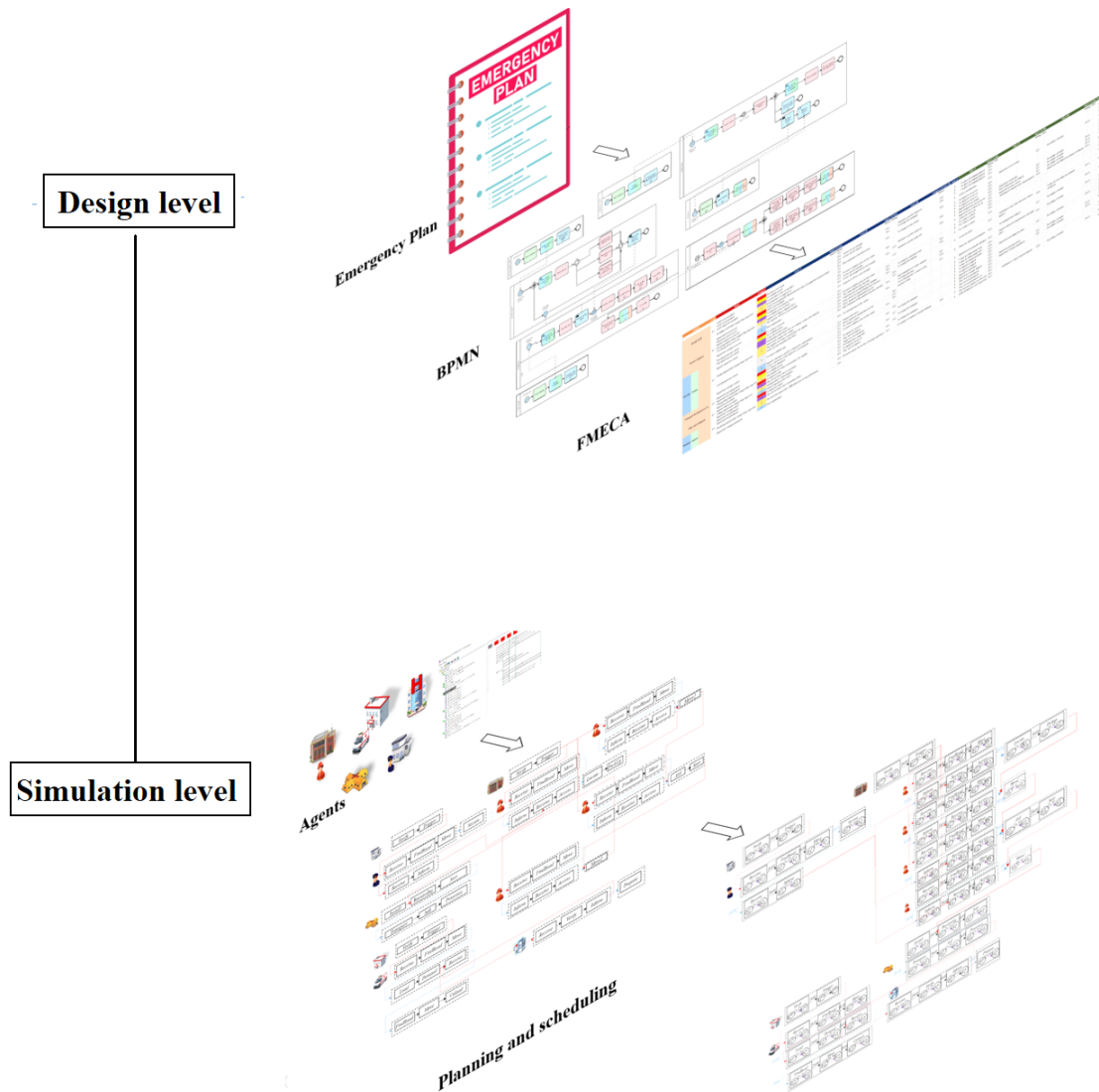

Figure 4.14: Design level vs Simulation level

4.5.1 FMECA

The criticality of a failure mode is actually the risk priority number of how an activity can fail. For example, failure mode 3 describes the risk of an activity being delayed and thus, that is how it fails. In planning and scheduling, a failure mode is considered as the source of uncertainty of an action (see table 4.9). In this work, the criticality is used to determine to which level a failure mode (source of uncertainty) belongs to in order to create a standard plan. The generation of standard plans facilitates the choice of the dynamic planning and scheduling technique. In this context, the activities that belong to C_3 have a high risk to fail. Hence, no action is added after an action belonging to C_3 in a standard plan in order to avoid the risk of re-planning and re-scheduling for a large number of actions.

Failure mode	Description	Sources of uncertainty
0	It is not activated	The action can have no results
1	It is not carried out	The action can have no results
2	It gives no results	The action can have no results
3	It lasts longer than expected	The action can be delayed (Duration)
4	It gives incomplete results	The action can have unexpected results
5	It gives incorrect results	The action can have unexpected results
6	It is carried out intermittently	The action can be delayed (Duration)

Table 4.9: The sources of uncertainty

4.5.2 Library of standard plan

In the previous sections, we demonstrated the extraction of the actions of each agent from BPMN. In addition, we defined a standard plan and explained where this idea comes from. Furthermore, we represented the role of criticality in our work.

In this subsection, we take the same example in chapter 2 of the PMA in a decentralized architecture (see section 2.8.2) in order to explain how we define a standard plan. Table 4.10 represents the criticality level of each failure mode for each activity of the PMA service process, according to its FMECA table in figure 2.52 (see Appendix B for more details on other services).

Activity code	Action code	C3	C2	C1
E_1	a_1^E		3	0,1,2
E_2	a_2^E	3,4,5	2	0,1
E_3	a_3^E	3	4,5	0,1,2
E_4	a_5^E			0,1,3
E_5	a_7^E		3,5	0,2
E_6	a_8^E		3	0,2,5

Table 4.10: PMA: Failure modes criticality levels according to figure 2.52

To create a standard plan, we take into account the criticality of each failure mode of an activity in a process. In this case, we consider that no action can be added after the action that belongs to a failure mode of level C_3 because the risk of failure is high. In addition, one or more standard plans can be derived from a standard plan consisting of more than two actions because an error can occur on any action. In this case, if an error occurs on an action in a standard plan, the agent looks for an appropriate standard plan to insert it into its local plan. The inserted standard plan can start by the action that was failed in the previous standard plan. To better clarify the idea, figure 4.15 shows the library of standard plans for the PMA agent in a decentralized architecture.

Table 4.10 demonstrates that only a_2^E and a_3^E have failure modes belonging to level C_3 . In this case, no action can be added after either one. In this context, \mathcal{J}_1^E , \mathcal{J}_2^E and \mathcal{J}_3^E are the first standard plans created from the BPMN. Then, \mathcal{J}_4^E is derived from \mathcal{J}_1^E because it is required when an error occurs on a_2^E after the execution of a_1^E . In addition, \mathcal{J}_5^E and \mathcal{J}_6^E are obtained from \mathcal{J}_3^E .

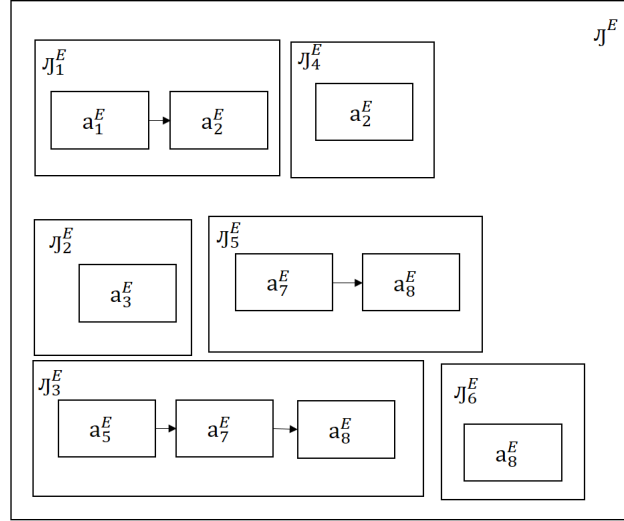

Figure 4.15: E: Library of standard plans in a decentralized architecture

$\text{pcond}(\mathcal{J}_j^E)$	Standard plan	$\text{eff}(\mathcal{J}_j^E)$	Goal
$(agent - at ?l_2 ?E)$	$\mathcal{J}_1^E(?E, ?l_2, ?x)$	$(person - in ?l_2 ?x)$	Install and accept injured
$(person - in ?l_2 ?x)$	$\mathcal{J}_2^E(?l_2, ?x)$	$(labelled ?x)$	To sort injured
$(labelled ?x)$	$\mathcal{J}_3^E(?x)$	$(prioritized ?x)$	To transport and prioritize
$(installed ?E ?l_2)$	$\mathcal{J}_4^E(?x, ?l_2, ?E)$	$(person - in ?l_2 ?x)$	To receive injured
$(transported ?x)$	$\mathcal{J}_5^E(?x)$	$(prioritized ?x)$	Aid and prioritize
$(aided ?x)$	$\mathcal{J}_6^E(?x)$	$(prioritized ?x)$	To prioritize injured

Table 4.11: the preconditions and effects of PMA agent's standard plans in figure 4.15

4.6 Algorithms

In order to affect agents to the site and injured to hospitals, we develop an assignment method. In addition, for an agent, it modifies its local plan using the “insertionPlan” method when an event occurs. Furthermore, an agent uses an incremental dynamic controllability algorithm in order to verify its local STNU (execution).

4.6.1 Assignment algorithm

First, we need to assign the closest centre to the site in order to respond as quickly as possible. Then, if the selected centre has agents available, we compare its capacity with the number of agents needed. If its capacity is not sufficient, in this case, another centre needs also to be assigned. At the end of the algorithm, it returns the centre assigned list. Figure 4.16 shows the algorithm used in order to assign ambulance centres, security centres and fire departments.

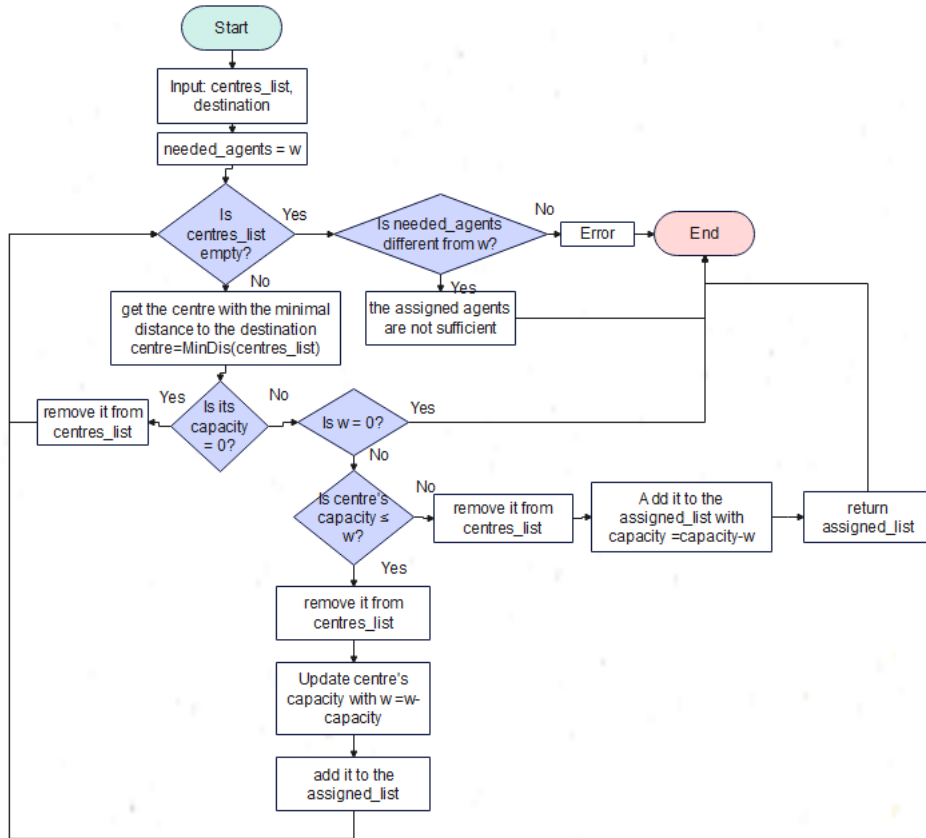

Figure 4.16: Assign centres to site algorithm

For example, in our terrorist attack scenario, the two security centres sc_1 and sc_2 are 20 minutes and 10 minutes away from the site, respectively. In this case, $d(x_{sc_2}, y_{sc_2}) < d(x_{sc_1}, y_{sc_1})$ which means that sc_2 is closer than sc_1 to the site. We assume that the number of security agents needed is 30 ($w = 30$). In this case, $w < |S^{sc_2}|$, which means that the security agents available in sc_2 are sufficient.

$$sc_1 = \begin{cases} d(x_{sc_1}, y_{sc_1}) = 20 \\ |S^{sc_1}| = 40. \end{cases} \quad sc_2 = \begin{cases} d(x_{sc_2}, y_{sc_2}) = 10 \\ |S^{sc_2}| = 40. \end{cases}$$

Next, we assign casualties to hospitals. We propose two methods, the first one depends on the distance between the hospital and the site (see figure 4.17). The injured persons are assigned to the nearest hospital until there are no more injured or no more place available in the hospital ($cap = 0$). The second method also takes into account the experience of the hospital (see figure 4.18). In this method, injured are assigned to the most experienced hospital available until it is overloaded or no more injured to assign or the injured cannot make it to the selected hospital ($situation \leq h(distance)$). If the injured cannot make it to the most experienced hospital, s/he is transferred to the nearest hospital if possible.

Finally, assignment algorithms has a complexity of $O(n)$.

4.6.2 Insertion of plans

Agents must find the standard plan that allows them to reach their objectives and insert it into their local plans. In this context, we have developed "insertionPlan" method shown in figure 4.19 that uses the "derivedStandardPlan" method in figure 4.20. Each agent has a set of goals to achieve and each standard plan has a goal. Although two standard plans may have the same goal, they have different starting actions. In this case, several standard plans can have the same objective, but they are not identical.

This method takes the agent's library of standard plans and its instantiated local plan in order to return the standard plan needed for its goal. Our algorithm has a complexity of $O(n^2)$.

4.6.3 FastIDC algorithm

The FastIDC algorithm was first published by (Stedl and Williams, 2005) and corrected by (Nilsson et al., 2013). It verifies incrementally the dynamic controllability (DC) of a STNU based on a set of derivation rules (see figure 4.21). Based on this algorithm, other incrementally DC verification algorithms are generated such as EfficientIDC in (Nilsson et al., 2016). In this thesis, we are interested in checking incrementally the DC of each agent's STNU. We modelled the FastIDC shown in figure 4.22 as a flow diagram as represented in (Nilsson et al., 2016). The FastIDC starts by adding the requirement links to a sorted Q and add the negative links to a graph C that contains the same nodes as the STNU (G). If C has a negative loop, G is not DC. For each requirement link "i", if a node to itself has a negative weight, G is not DC because it means that the node must be performed before itself. While it is skipped when it has a positive weight because the constraint is satisfied. Next, for each derived rule, if the link "i" is modified or a new link "j" is added, C is updated. If it has a

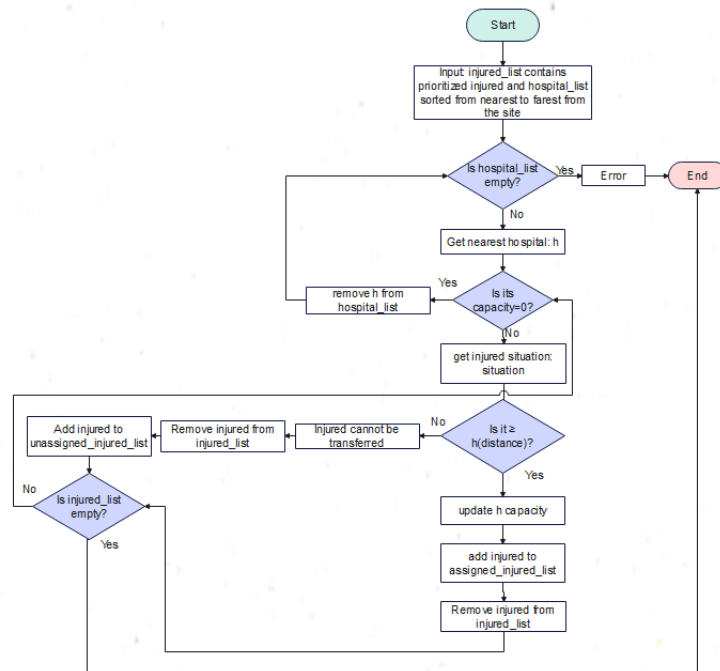

Figure 4.17: Assignment of hospitals by distance

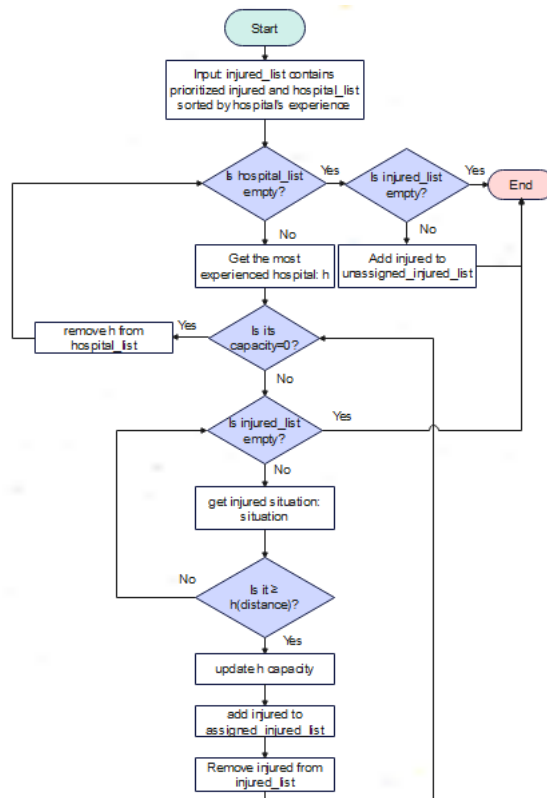

Figure 4.18: Assignment of hospitals by experience and distance

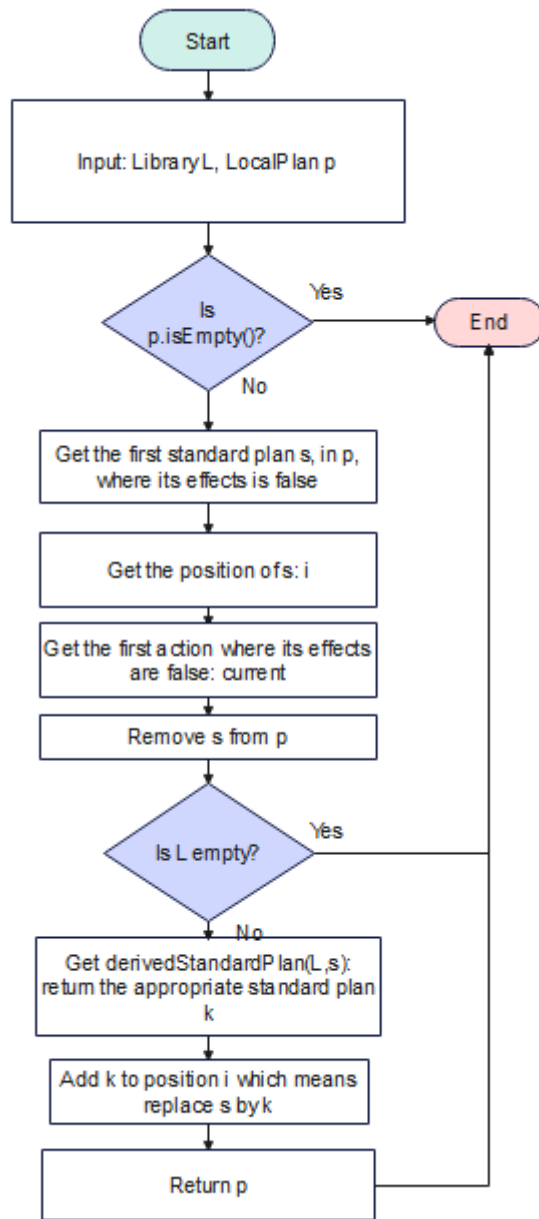

Figure 4.19: InsertionPlan algorithm

negative cycle or G has a squeezed contingent link, then, G is not DC. Finally, FastIDC is called recursively to handle all derivations caused by "j".

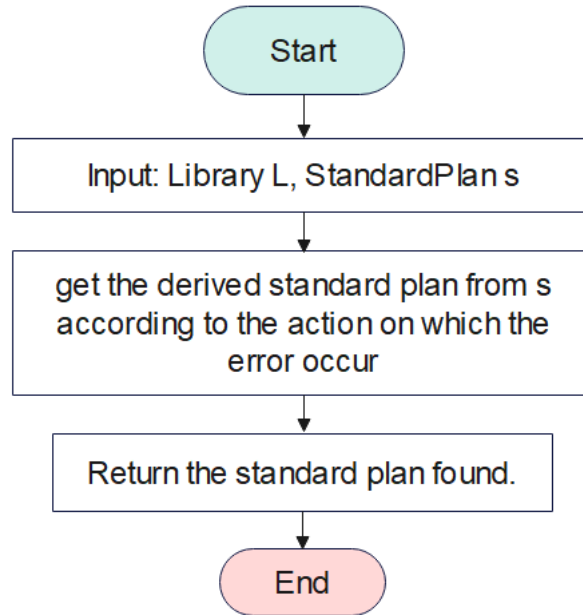

Figure 4.20: The derivedStandardPlan(L,s) method

4.7 Conclusion

In this chapter, we have presented each algorithm required for our scenario in a flowchart and explained them. We have formally represented the latter by determining the scenario's agents and their roles. In addition, we explained the planning and scheduling part of this work and how the standard plan idea is created. Furthermore, this chapter is applied in the last chapter of our work.

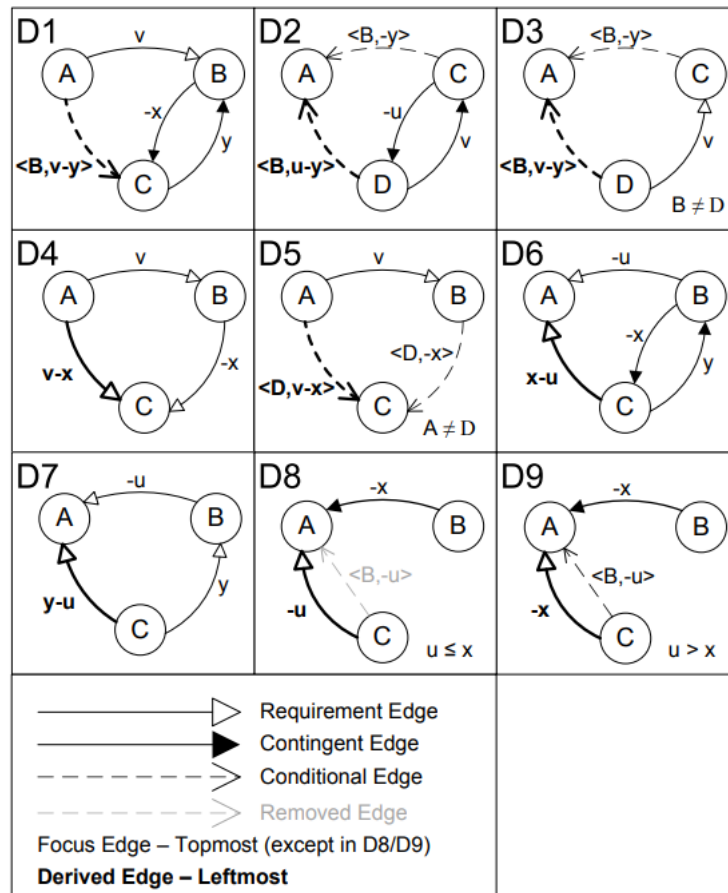

Figure 4.21: FastIDC rules (Nilsson et al., 2016)

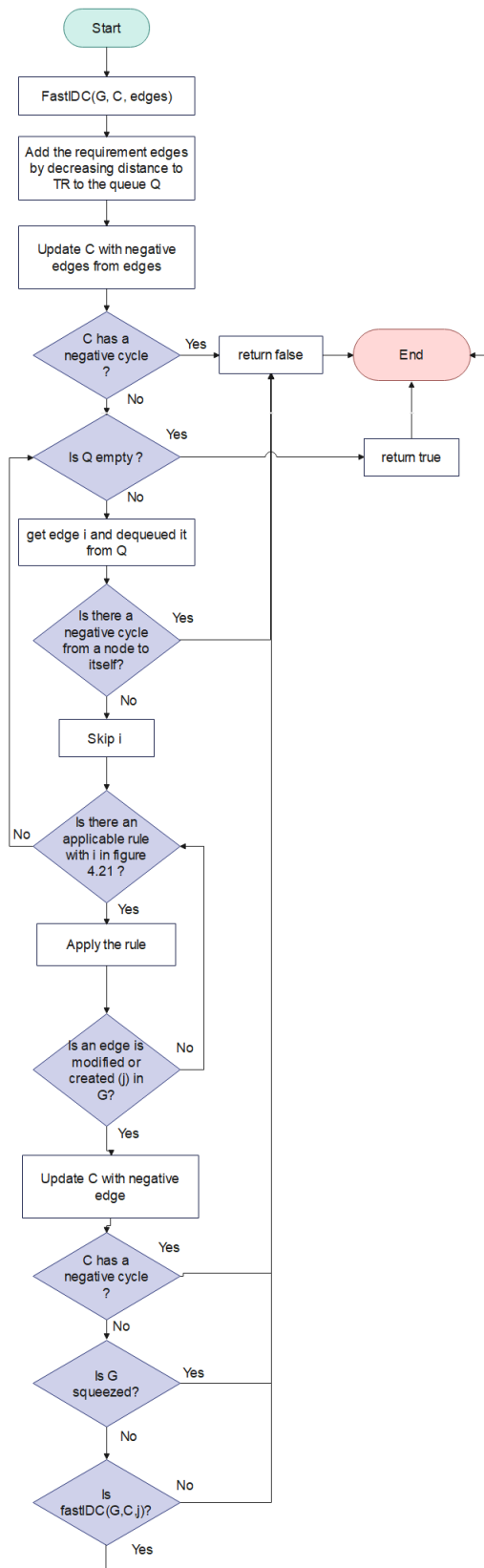

Figure 4.22: FastIDC algorithm

Experimental environment

Sommaire

5.1	Introduction	145
5.2	The distribution of decisions between agents	146
5.3	Decisions type	147
5.4	The representation of the semi-centralized architecture and the decentralized architecture	148
5.4.1	Dynamic multi-agent planning and scheduling techniques	149
5.5	Simulation level: general architecture	150
5.6	Simulation level: our scenario's implementation	151
5.6.1	Scenario's information	151
5.6.2	Assignment results	153
5.7	Communication	159
5.8	Uncertainty	159
5.9	Comparison between the two architectures	163
5.10	Conclusion	167

5.1 Introduction

In the previous chapters, we define a semi-centralised architecture and a decentralised architecture. In this chapter, for each architecture, we identify the decisions for each agent and what should be made by each one of them. We implement our scenario in each architecture and we compare them.

The scenario is developed using JADE for MAS and implemented in Java. The support used is the Eclipse development software which is a free integrated development environment.

5.2 The distribution of decisions between agents

In order to better explain the degree of autonomy we aim to give to each agent in our scenario, we represent in this section by whom the decisions made by each agent are made in the ORSEC plan.

Figure 5.1 shows the decisions made by each agent in the semi-centralized architecture (Figure 5.1a) and the decentralized architecture (Figure 5.1b). In the ORSEC plan, decisions 2, 3 and 4 are taken by the COD after suggestions from the corresponding actors and, applied by each centre (decision 6). Decision 1 is under the responsibility of the exit secretariat at PMA where the SAMU coordinates with the hospitals for the transfer of the injured. In addition, when the ORSEC plan is activated, the PMA will be installed by default. The DSM proposes the location of the PMA to the DSM who makes the final decision. Moreover, the triage of the injured (decision 7) is carried out once at the PRV by the firefighters and a second time at the PMA entrance secretariat by the medical teams. Furthermore, the hospitals prepared (decision 11) to receive the injured after triggering the white plan in case of massive causality. Finally, the ORSEC plan develops the missions of actors directly on site which means that decisions 9 and 10 are not described in it. Our meetings with the LRC have confirmed that each centre checks its capacity and that each vehicle contains a Global Positioning System (GPS). In our scenario, decisions from 7 to 11 are assigned to the same agents in both architectures. All the other decisions are made by the central agent in the semi-centralized architecture. In our decentralized architecture, we assign decision 1 to the ambulances agents and decisions 2, 3 and 4 to the centres. Unlike the semi-centralized architecture, in the decentralized architecture, triggering agents belongs to the decision-making set and is made by each centre. In this context, in our decentralized architecture, we give some autonomy to the centres to assign and trigger agents and, more importantly, to the ambulances to choose the appropriate hospital for the injured.

	SC	MC	FC	E	m	H	F	S	c
1- Assign injured									✓
2- Assign SC and S									✓
3- Assign FC and F									✓
4- Assign MC and m									✓
5- Install E									✓
6- Trigger Agents									✓
7- Sort injured				✓			✓		
8- Prioritize injured				✓					
9- Verify capacity	✓	✓	✓			✓			
10- Find road					✓			✓	✓
11- Prepare H						✓			

(a) Semi-centralized architecture

	SC	MC	FC	E	m	H	F	S
1- Assign injured					✓			
2- Assign SC and S	✓							
3- Assign FC and F			✓					
4- Assign MC and m		✓						
5- Install E								
6- Trigger Agents	✓	✓	✓					
7- Sort injured				✓			✓	
8- Prioritize injured				✓				
9- Verify capacity	✓	✓	✓			✓		
10- Find road					✓		✓	✓
11- Prepare H						✓		

(b) Decentralized architecture

Figure 5.1: Decisions distribution

5.3 Decisions type

In planning and scheduling, in the case of a multi-actor scenario, we have two types of problems: resource allocation and plan synchronization. In MAS and planning and scheduling, we have five main points: resource assignment, plan generation, plan synchronization, plan distribution and plan execution. Figure 5.2 shows different examples of multi-agent architectures to better explain the difference between them. Table 5.1 demonstrates what is performed by each agent in each architecture.

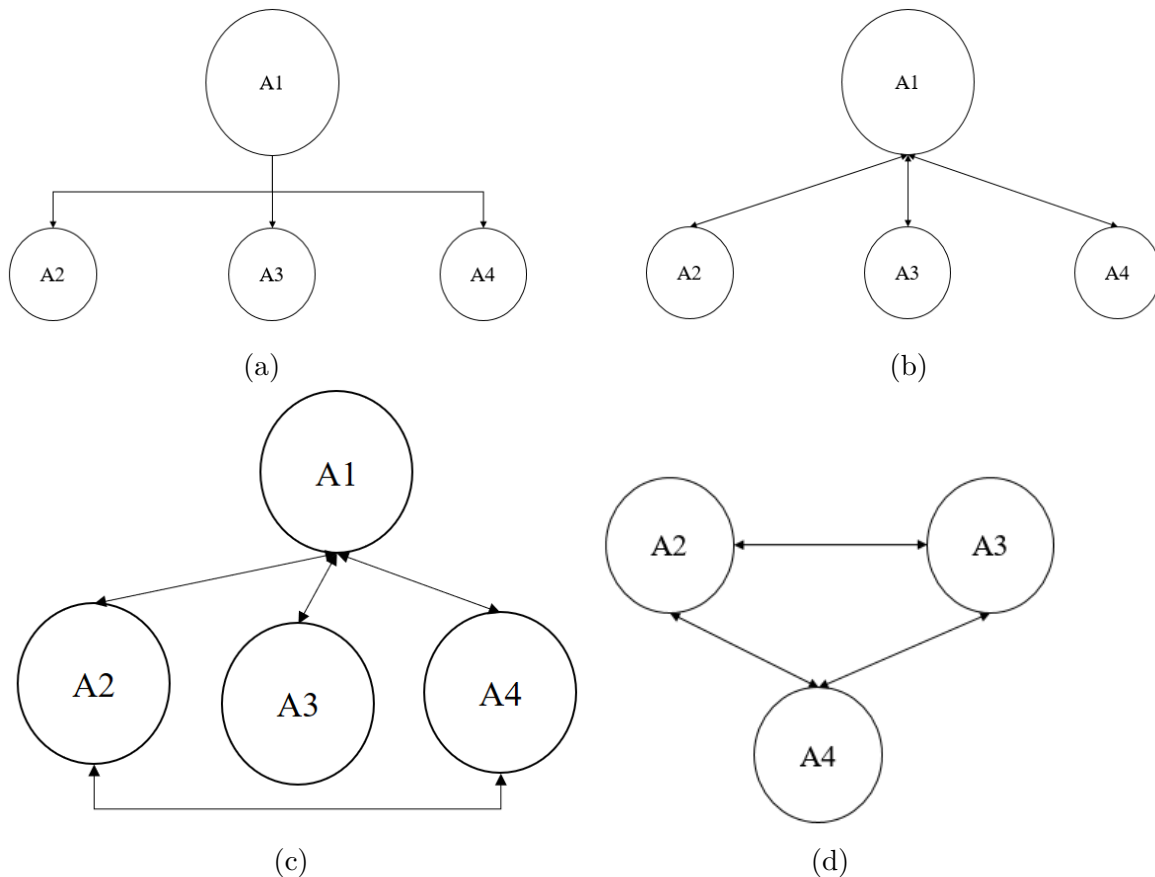

Figure 5.2: Example of centralized, semi-centralized and decentralized architectures

First of all, assignment is the allocation of agents to tasks. Moreover, as their names imply, plan generation and plan execution represent respectively the creation of the plan and its execution by an agent. In addition, plan distribution indicates that an agent receives its local plan from another agent. Finally, plan synchronization is used when an agent has multiple plans for multiple agents and coordination between them is required.

According to the table 5.1, the execution of plans is always distributed regardless of the

	Centralized architecture		Semi-centralized architecture	Decentralized architecture
	a	b	c	d
Assignment	A1		A1	A2, A3, A4
Plan generation	A1	A2, A3, A4	A1, A2, A3, A4	A2, A3, A4
Plan synchronization	A1		(A1, A2), (A1, A3), (A1, A4), (A2, A4)	A2, A3, A4
Plan distribution	A1		-	-
Plan execution	A1, A2, A3, A4		A1, A2, A3, A4	A2, A3, A4

Table 5.1: The main phases in different architectures

architecture type. Figures 5.22b and 5.22c represent two different centralized architectures in terms of plan generation. In the first one, the plans are generated by A1, while in the second one, they are created by agents themselves. Whether this phase is generated by the central agent or by the agents themselves, the synchronization of plans and their distribution among the agents is performed by the central agent; A1 in our case. In contrast to a centralized architecture, in the other two architectures, the agents themselves create and synchronize plans by communicating. In this context, the distribution of plans is only necessary in the centralized architecture. Furthermore, in semi-centralized and decentralized architecture, the agents synchronize their plans by communicating (sharing) a part of their plans with the appropriate agents. Finally, the assignment of resources in a centralized architecture and a semi-centralized architecture is made by a single agent. While, in the decentralized architecture, it is distributed among the agents because they communicate in order to assign resources.

5.4 The representation of the semi-centralized architecture and the decentralized architecture

In this section, we represent the communication between the agents in the two architectures: semi-centralized (see figure 5.3) and decentralized (see figure 5.4). Note that not all the hospital agents and the ambulance agents are represented in order to keep it simple. In addition, for each architecture, we present the agents that make each type of decision (see section 5.3).

There are two differences in the communication between the two architectures. The first one is that in a semi-centralized architecture, there is a communication between the centres

agents and the central agent. The second one is that unlike the decentralized architecture, the communication between an ambulance agent and a hospital agent is unidirectional (the ambulance agent informs the hospital agent of its arrival time and the injured situation). Furthermore, certain agents interact together in order to achieve their goals. For example, when F1 agent locates and lifts the injured, F2 agent moves him/her to the PRV.

As explained in section 5.2, unlike the semi-centralized architecture, the assignment of each mobile agent is made by the centre agent to which it is attached in the decentralized architecture. Moreover, as explained in section 5.3, in both architectures, each agent generates its local plan and executes it. In addition, for synchronization of plans, the agents that communicate and interact share together their dates (in STNU), which means a part of their plans is shared with other agents. In this context, the only difference between the two architectures is related to the agent who will make the assignment decision.

Finally, it is now more transparent why we chose to model temporal uncertainty with STNU and not MaSTNU. The MaSTNU requires a single agent for the synchronization of the agents local plans. While in our architectures, the synchronization is done by the communication between the agents.

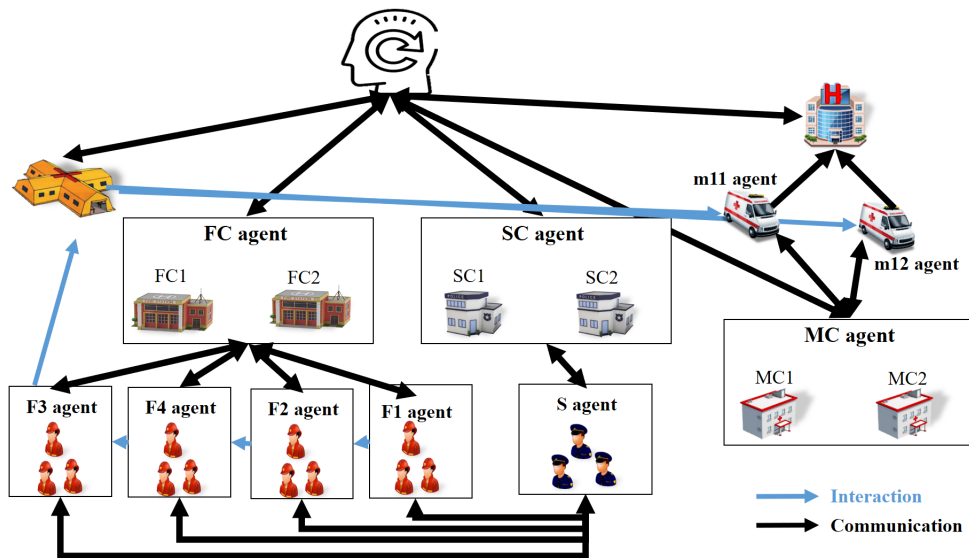

Figure 5.3: Semi-centralized architecture

5.4.1 Dynamic multi-agent planning and scheduling techniques

After representing the two architectures, the type of decisions in planning and scheduling and the distribution of decisions between the agents in an emergency rescue plan, we explain the approaches used by each agent in each architecture to manage uncertainty.

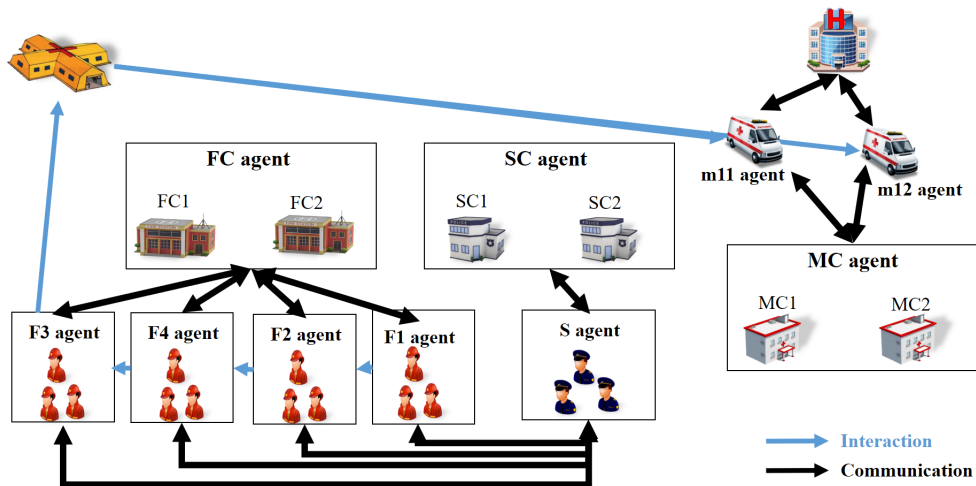

Figure 5.4: Decentralized architecture

First, STNU is a proactive duration propagation approach to find out if STNU has a dynamic execution strategy that assigns for each time-point a value by respecting all requirement links regardless of the value of the contingent time-points. Furthermore, the reactive approach is unavoidable in our architectures because when an asynchronous event occurs, an agent removes a standard plan and inserts another one in order to continue the execution of its local plan (STNU). Furthermore, in the case of when an agent cannot continue the execution of its local plan without receiving an information from another agent, the approach is progressive. For example, the security centre agent, in the semi-centralized architecture, cannot continue the execution of its local plan without receiving the decision of the central agent.

In this context, we develop different strategies in MAS to simulate our scenario and compare the agents behaviours.

5.5 Simulation level: general architecture

In this section, we explain the simulation level model as shown in figure 5.5. It is implemented in JAVA and developed by JADE. In order to test the generation and execution strategies of the operational level actors in a terrorist attack scenario, we need first to define our scenario. In this context, we create an administrator agent (admin agent) that has a graphical interface called "Admin GUI". The agents are created via this interface. While their standard plan libraries are generated in each "agent class", which means that each agent only has access to its library. When the scenario is created, Admin GUI displays the agents in our scenario and the injured people on site. Based on the agents' environment, each agent generates its

local plan (STNU) using dynamic planning and scheduling techniques that take into account uncertainty over time.

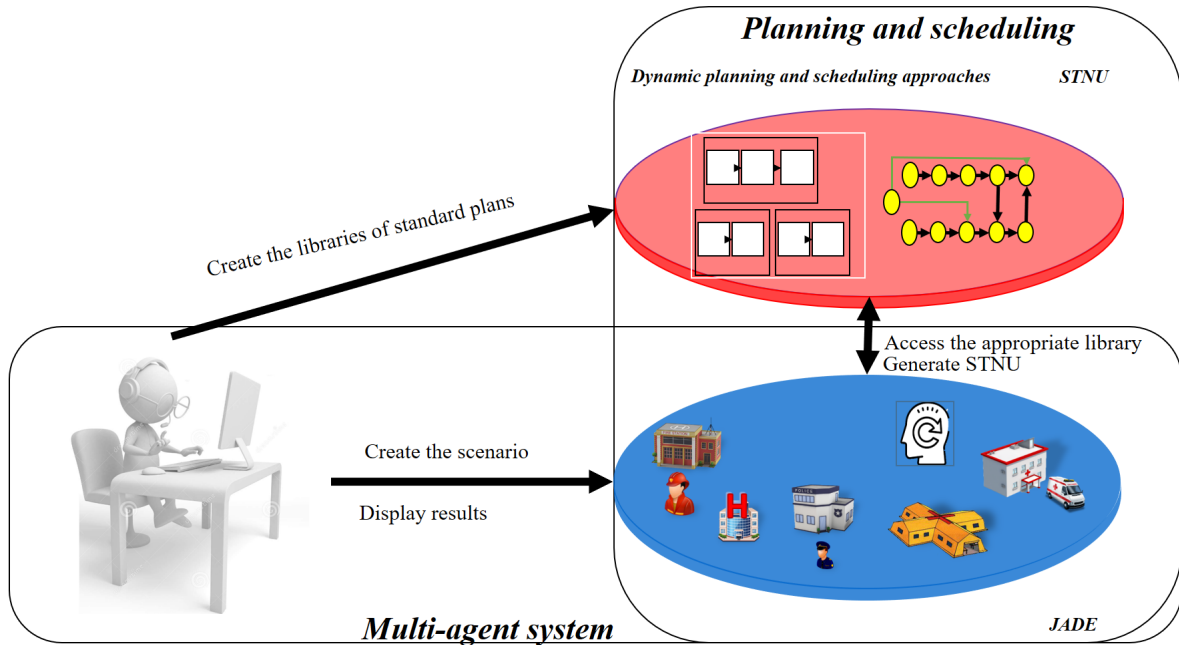

Figure 5.5: Global simulation architecture

5.6 Simulation level: our scenario's implementation

In this section, we aim to represent our scenario's implementation in two different architectures: the semi-centralized architecture and the decentralized architecture. In addition, we represent the different algorithms explained in chapters 4 for the STNU and the assignment methods.

5.6.1 Scenario's information

Figure 5.6 shows the admin GUI where the admin can specify the number of security centres, ambulance centres, fire departments, hospitals and the assumed injured on site. The information can be generated randomly or manually (see figure 5.7). In addition, the admin enters the number of agents needed for the triggering at the site.

The figure 5.8 shows the agents information in our scenario. For example, figure 5.8a shows the capacity and the distance from the site in minutes for the two centres *SC1* and

SC2. While figure 5.9 shows each casualty in our scenario and their life expectancy. As mentioned in chapter 1, the terrorist attack injured 100 people but we only take into account the critical and serious cases. In our scenario, we consider that we have 20 casualties with serious and critical cases.

In addition, the admin agent GUI does not create the PMA agent and the central agent because we consider them essential in the corresponding architectures.

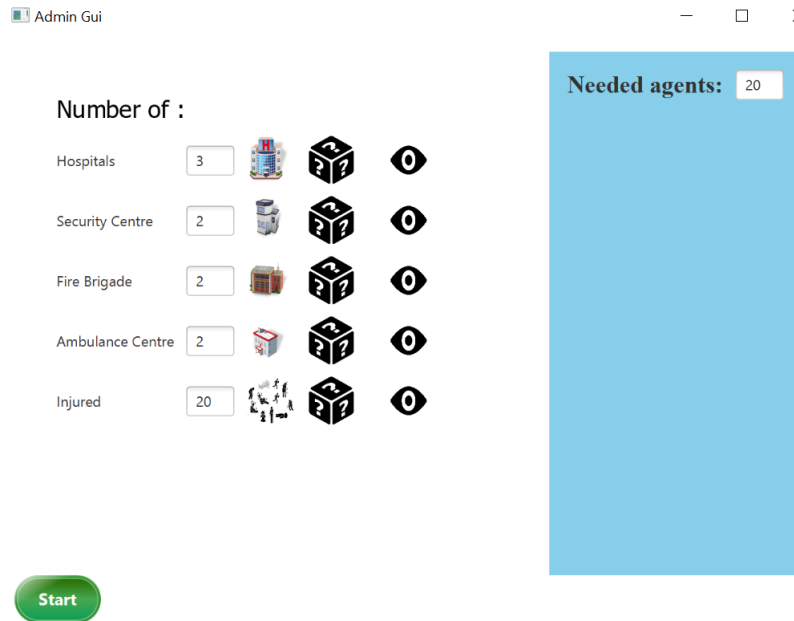

Figure 5.6: Admin agent's GUI

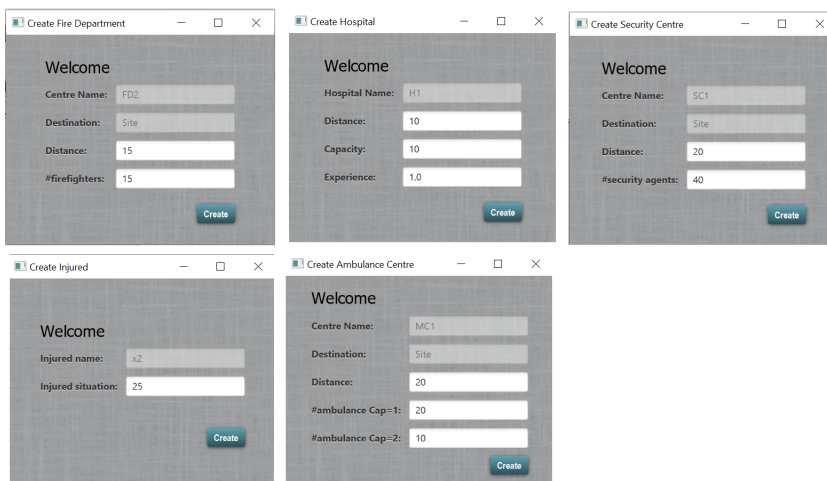
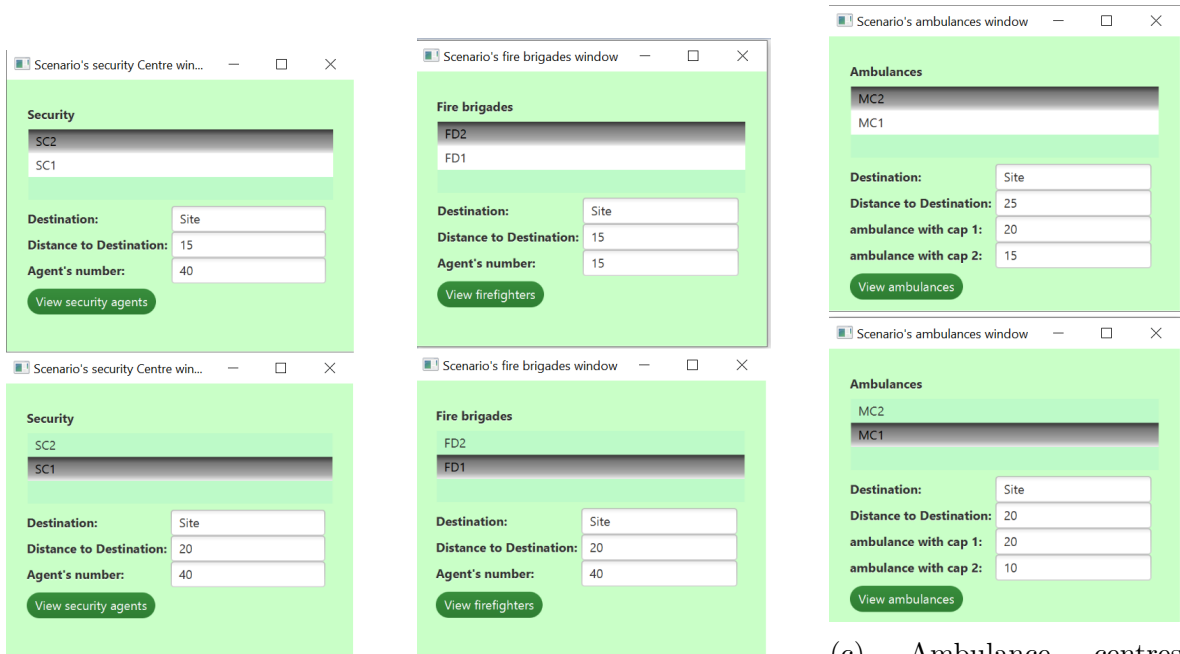

Figure 5.7: Admin agent's GUI: Enter manually the information



(a) Security centres agents

(b) Fire departments agents

(c) Ambulance centres agents

Scenario's hospitals window

Hospitals

Name	Capacity	Distance	Experience
H1	10	10	1.0
H3	10	50	0.5
H2	20	30	0.0

(d) Hospitals agents

Figure 5.8: Agents information in our scenario

5.6.2 Assignment results

The results of the assignment algorithms explained in chapter 4 are represented in this subsection.

Name	Situation
x1	20
x2	25
x3	30
x4	20
x5	35
x6	15
x7	18
x8	10
x9	32
x10	34
x11	100
x12	50
x13	60
x14	70
x15	80
x16	90
x17	45
x18	48
x19	200
x20	200

Figure 5.9: Injured of the terrorist attack scenario

5.6.2.1 Assign agents to the site

Regardless the type of the architecture, the assignment of agents to the site is a must. The difference between the two architectures is that in a semi-centralized architecture, the assignment is decided by the central agent after the proposition of the centres agents. While in a decentralized architecture, each centre agent assigns the mobile agents (security agents, ambulance agents and firefighters agents) to the site. At the beginning, we assume that the number of needed agents is w ($w=20$ in figure 5.6). For the security centre agent (SC) and the fire department agent (FD or FC), w is considered as the number of security officers and firefighters needed at the site, respectively. While the ambulance centre agent (MC) requires the number of casualties and not the needed agents. In our example, the number of casualties is also 20 ($w = 20$). w is the capacity of ambulance agents needed to be assigned for the injured because the triggered ambulances can be mixed between those with capacity of transferring one injured at a time or two injured at a time. They are chosen randomly. The important thing is that their total capacity is equal to w . Figure 5.10 shows some of the results of agents assignment to the site. For example, The ambulance agents $m121$ and $m14$ are triggered to the site from $MC1$ agent. Unlike $m14$, $m121$ can transfer two injured at a time. In our architecture, ambulances agents are not grouped into a single agent. In this context, the first digit represents the number of the centre to which the ambulance is attached and the others are the number of the agent. For example, the first digit in $m14$ is 1 which means that the ambulance agent $m4$ is attached to the ambulance centre agent $MC1$.

The assignment of agents to the site is performed by each centre in the two architectures.

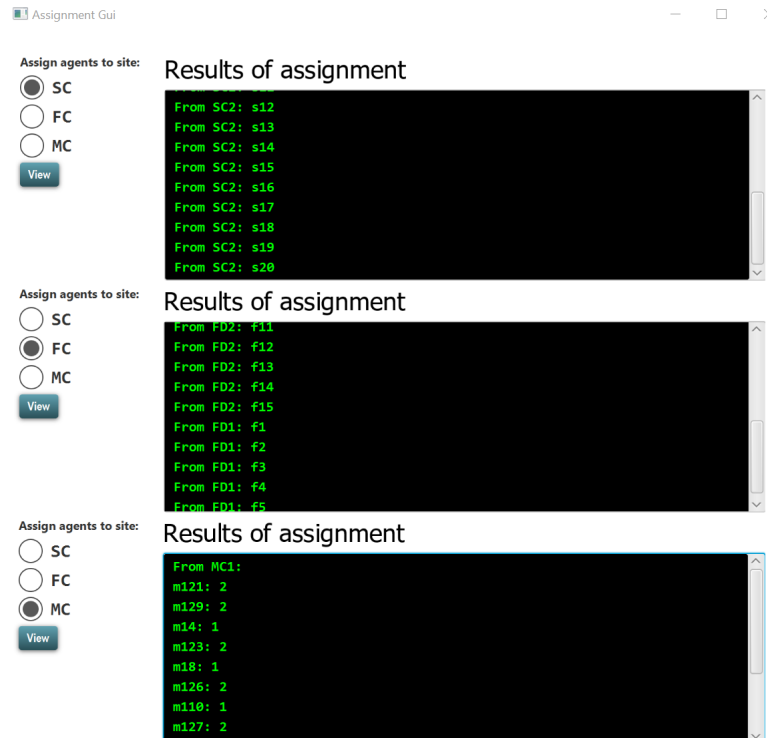

Figure 5.10: Agents assignment to the site

The central agent approves or does not approve the assignment.

5.6.2.2 Assignment of injured to hospitals

In a semi-centralized architecture, we have implemented the two algorithms presented in 4.6.1. The central agent assigns the injured when it receives from the PMA agent the list of injured prioritized (as shown in figure 5.11). They are sorted in ascending order according to their situation (in minutes as explained in 4.4.2.2) to determine their priority. For example, x_8 is a critical injured who must be transferred to a hospital in 10 minutes. While x_{19} is an injured person who needs to be transferred to the hospital within 200 minutes.

Furthermore, the results of the assignment of injured are shown in figures 5.12 and 5.13, respectively. The first one takes into account the capacity of the hospital, the distance to the hospital and the situation of the injured. In addition to these factors, the second algorithm of assignment takes also the experience of the hospital into account.

In a decentralized architecture, the assignment of an injured to a hospital is performed directly by the ambulance agent. The latter contacts the hospitals until it finds an available one for the casualty. Section 5.7 shows an example of the communication between an ambulance

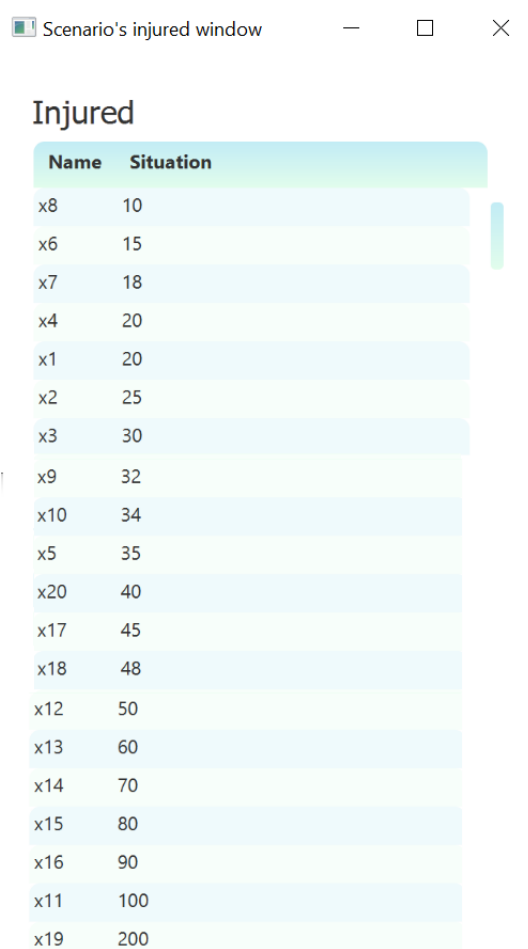

The image shows a window titled "Scenario's injured window" with a standard window control bar (minimize, maximize, close). Below the title bar, the word "Injured" is displayed. Underneath, there is a table with two columns: "Name" and "Situation". The table contains 20 rows of data, each representing an individual with a unique name and a numerical situation value.

Name	Situation
x8	10
x6	15
x7	18
x4	20
x1	20
x2	25
x3	30
x9	32
x10	34
x5	35
x20	40
x17	45
x18	48
x12	50
x13	60
x14	70
x15	80
x16	90
x11	100
x19	200

Figure 5.11: List of injured from the PMA agent

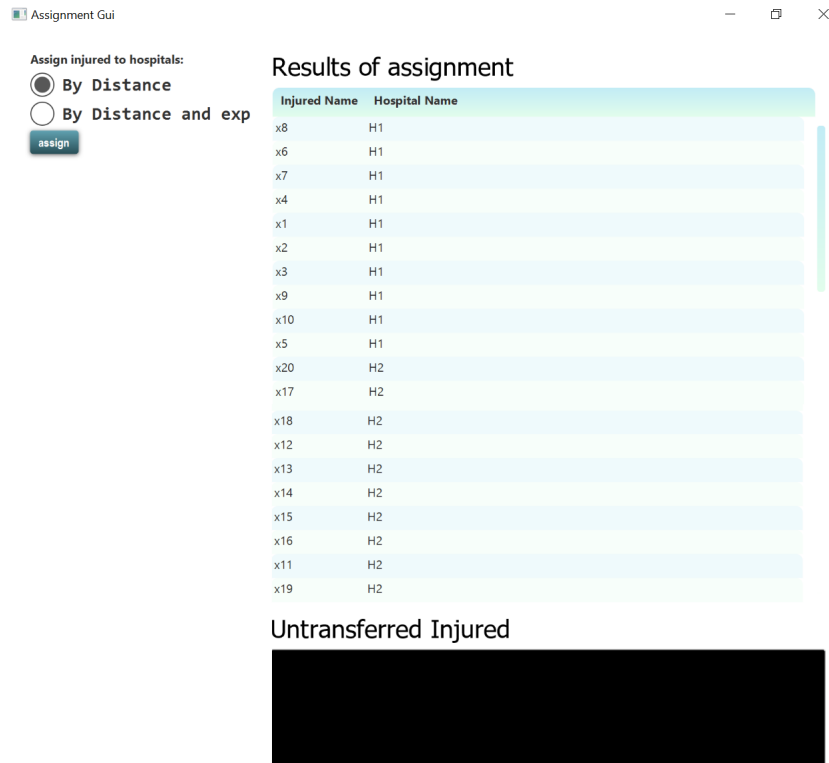

Figure 5.12: Assignment method of figure 4.17

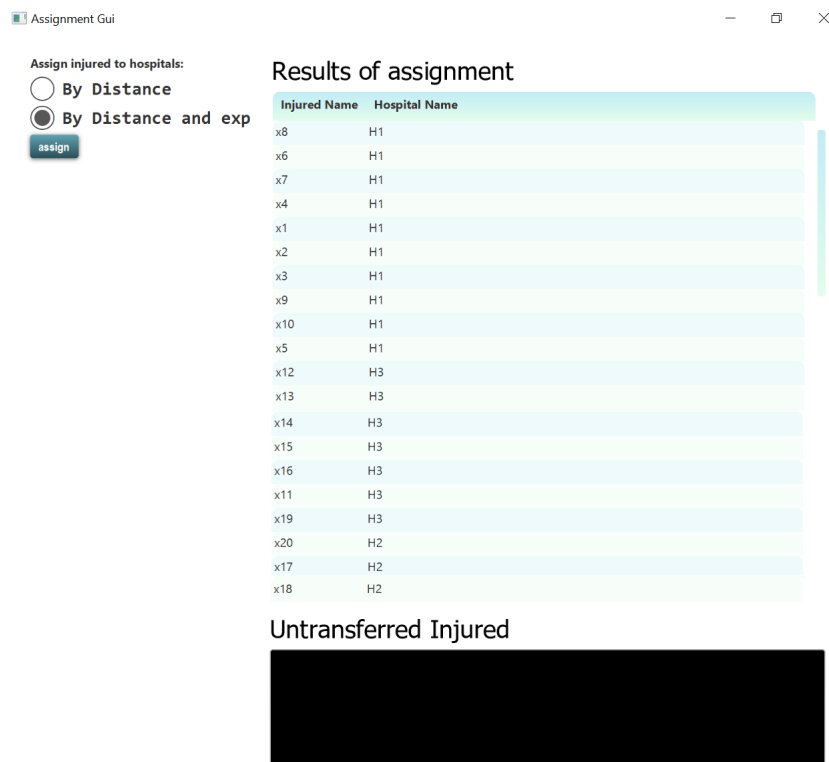

Figure 5.13: Assignment method of figure 4.18

agent and a hospital agent in a decentralized architecture.

Finally, unlike the decentralized architecture, in the semi-centralized architecture, the assignment of an injured to a hospital agent is performed before its assignment to an ambulance agent.

5.6.2.3 Assignment of ambulances to injured

Ambulances shall be dispatched according to their ability to reach the site as quickly as possible, with the understanding that the total capacity of all ambulances shall be greater than or equal to the number of injured, but never less. After assigning the ambulances to the site, the question that arises here is: which ambulance transfers which injured?

When all triggered ambulance agents are at capacity 1, the first ambulance arrives at the site will transfer the most critical casualty. On the other hand, when the triggered ambulance agents are at capacity 2 or mixed, there is a risk of assigning a single ambulance to two casualties that should be transferred to two different hospitals. Figure 5.14 shows an example of the arrival of the ambulance agents at the site. In this case, when $m126$ arrives at the site, $x5$ and $x20$ are assigned to it (see figure 5.15), but $x5$ and $x20$ should be transferred to $H1$ and $H2$, respectively (see figure 5.12). This problem can only occur in the semi-centralized architecture if the injured are assigned to hospitals before the arrival of ambulances at the site. In order to avoid this problem, we assume that the ambulance agents must be at the site before the assignment of casualties by the central agent. In this case, the new assignment is shown in figure 5.16). In this context, the order of arrival of ambulance agents is important in the decentralized architecture. Although an ambulance agent may arrive before another ambulance agent, the order in which the demands of ambulance agents are processed may be different. For example, $m12$ arrives before $m127$ but it doesn't mean that $m12$ will have a respond from the hospital before $m127$. In this work, the communication between the agents does not exceed 2 minutes. All the duration uncertainty are handled with STNU. In this context, although the transfer of casualties may differ, we are certain that a critical casualty is always transferred before a serious one. Furthermore, in this thesis, we focus on the behaviours of the agents when we give them some degree of autonomy. We are interested in the transfer of the casualty to an appropriate hospital. Although the assignment of the operating rooms to the casualties is out of the of scope of this thesis, We should mention that a hospital agent has the information about the injured and his/her expected arrival time before s/he is actually at the hospital. In this context, the most important thing in our work is that the casualties are assigned to the appropriate hospital. In this context, although the assignment is performed by different agents in the two architectures, the assignment results for the same example in the decentralized architecture, has identical results as in the semi-



Name	Capacity	Arrival order
m14	1	1
m127	2	2
m121	2	3
m16	1	4
m116	1	5
m124	2	6
m126	2	7
m110	1	8
m123	2	9
m18	1	10
m129	2	11
m125	2	12
m112	1	13

Figure 5.14: An example of the arrival of the ambulance agents at the site

centralized architecture.

5.7 Communication

Since we model our architectures with JADE, the communication follows FIPA standards. Figure 5.17 shows part of the communication in a semi-centralized architecture. For example, SC agent proposes to central agent (c) the assignment of security agent to the site and c accepts the proposal. While figure 5.18 shows an example of the communication between the ambulance $m14$ and the hospital $H1$. $m14$ requests (a) the capacity of $H1$ and the latter responds (b). How does an ambulance know which hospital to contact? Since JADE has a DF agent, when a hospital agent is created, it registers its service in the DF. In this case, an ambulance agent searches for the hospital agent service in the DF.

5.8 Uncertainty

In this section, we give an example of the uncertainties that are taking into account in our work. Moreover, we present the behaviour of an the agent in order to manage them.

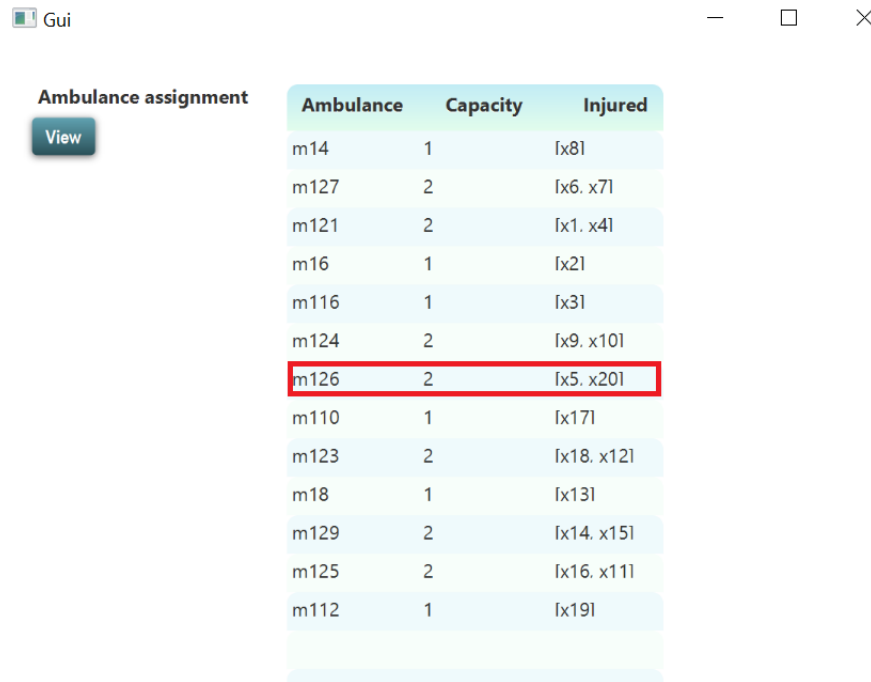

Ambulance assignment

View

Ambulance	Capacity	Injured
m14	1	{x8}
m127	2	{x6, x7}
m121	2	{x1, x4}
m16	1	{x2}
m116	1	{x3}
m124	2	{x9, x10}
m126	2	{x5, x20}
m110	1	{x17}
m123	2	{x18, x12}
m18	1	{x13}
m129	2	{x14, x15}
m125	2	{x16, x11}
m112	1	{x19}

Figure 5.15: An example of the assignment of the casualties to ambulance agents according to figures 5.12 and 5.14

Let us consider the example of the transfer of the injured $x8$ by the ambulance agent $m14$ to the hospital agent $H1$. Figure 5.19a shows an example of the road found by $m14$. Figure 5.19b shows the alternative road found by $m14$ when the first one is blocked. The approach used by the ambulance agent is reactive because it re-searches for a road during the execution of its local plan. Note that the algorithm used by an ambulance agent in order to find the best road to a hospital agent is the A* algorithm (see 3.3.2). The calculation performed by the algorithm are shown in the figures and the best road is colored in blue.

Let us assume that $x8$ and $x13$ are transferred to $H1$ and $H3$, respectively (see figure 5.13). In this case, $m14$ and $m18$ are available. A new injured $x21$ is found on site and s/he has a serious condition (66 minutes). This information is sent to all the ambulance agents and to the MC agent. In a semi-centralized architecture, PMA agent sends the information to the central agent and the latter assigns the injured. In a decentralized architecture, the assignment is done by an ambulance agent on site. $m14$ and $m18$ are now 10 minutes and 50 minutes away from the site. In addition, there are still available ambulance agents at the MC agent. Which ambulance to assign to the new injured?

Each ambulance agent calculates the travel cost from its location to an appropriate hospital agent. If the cost does not exceed the life expectation of the casualty, that ambulance agent is assigned to the casualty. In this context, the appropriate hospital agent is $H3$ and

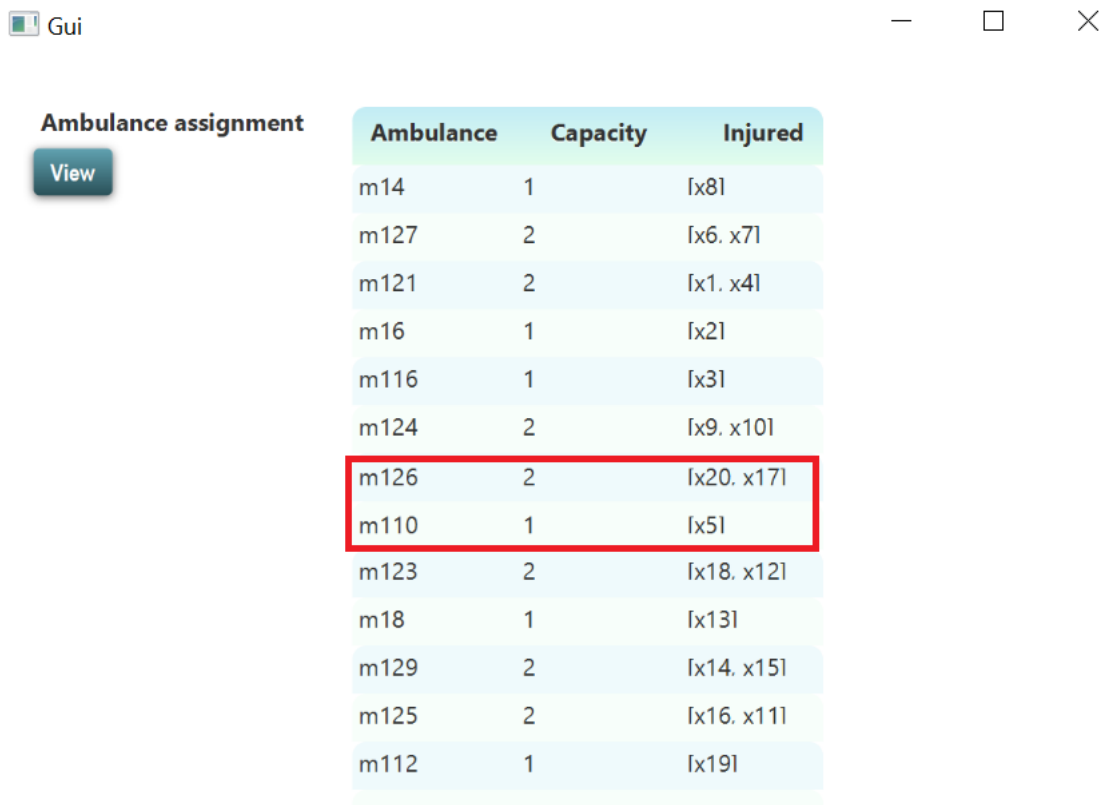

Gui

Ambulance assignment

View

Ambulance	Capacity	Injured
m14	1	[x8]
m127	2	[x6. x7]
m121	2	[x1. x4]
m16	1	[x2]
m116	1	[x3]
m124	2	[x9. x10]
m126	2	[x20. x17]
m110	1	[x5]
m123	2	[x18. x12]
m18	1	[x13]
m129	2	[x14. x15]
m125	2	[x16. x11]
m112	1	[x19]

Figure 5.16: Example of the new assignment of casualties to ambulance agents

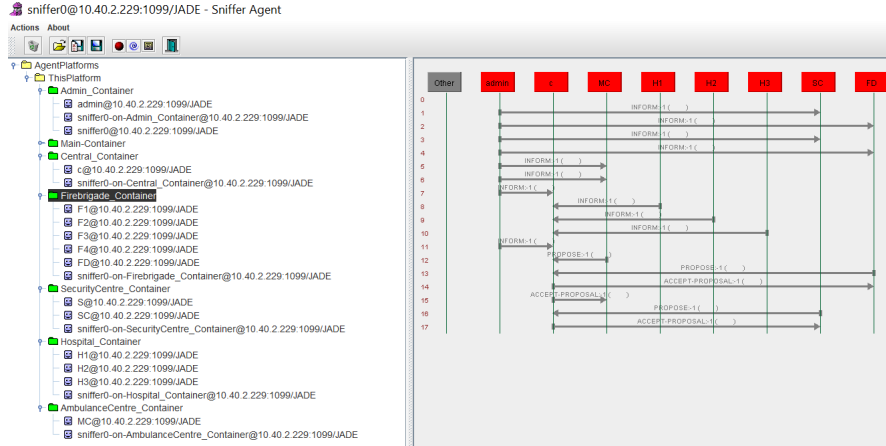

Figure 5.17: Communication between the centres and the central agent

the travel cost of $m14$ and $m18$ is 60 ($10+50$) and 100 ($50+50$), respectively. As shown in figure 5.20, $x21$ is assigned to $m14$.

Note that in order to know from the triggered ambulance agents, the ones that are currently available, each ambulance agent registers its service in DF agent. When a new injured is received by the PMA agent, the latter searches the DF by service and share the information with the currently available ambulance agents. Furthermore, the ambulance agents sends their travel cost to the PMA agent to compare them and accept the service of an ambulance agent with the lowest cost.

Finally, duration uncertainty is addressed by STNU. Figure 5.21 gives an overview of the interaction of agents local plans in a decentralized architecture. The synchronization links are represented in red and they are requirement links. In addition, the contingent links and the requirement links are colored in purple and black, respectively. This example is given in order to understand how each action in a standard plan is represented in a local plan and the synchronization between the agents. In fact, in our architectures, each agent shares the required dates with the corresponded agent. Figure 5.22 gives an example of sharing dates between the security agent centre and the security agent. Figure 5.22a shows the time propagation from the temporal reference time-point V_0 to V_3^{SC} that is a contingent link with an interval $[1,4]$. This contingent link is a requirement link in the STNU of S agent. At the beginning, it is between $[-\infty, +\infty]$ as shown in figure 5.22b, then, when SC agent propagates its STNU, the interval becomes $[1,4]$ (see figure 5.22c). Finally, figure 5.22a shows that S agent needs minimum 12 minutes (sum of lower bounds) and maximum 36 minutes (sum of upper bounds) from V_0 to V_3^S . In this case, the requirement link is squeezed to $[12,36]$ and it is satisfied because it belongs to $[10,40]$.

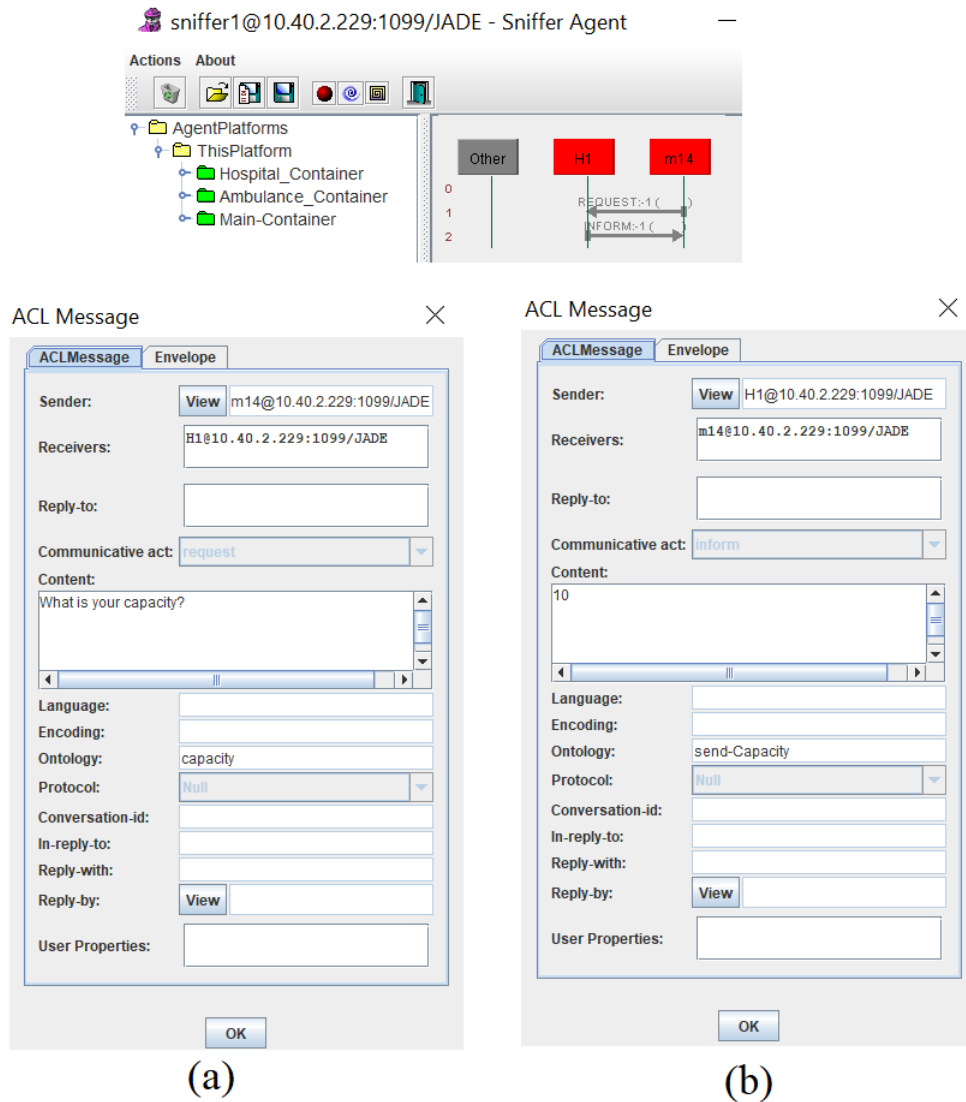
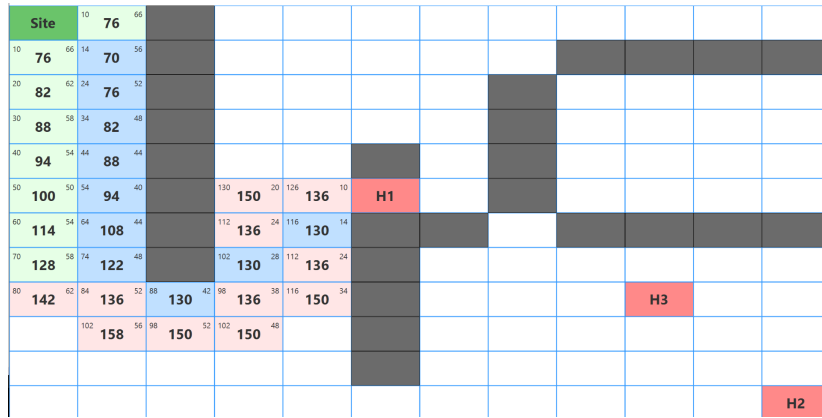

Figure 5.18: Communication between *m14* and *H1*

5.9 Comparison between the two architectures

Section 5.2 shows the difference in decision making between the two architectures. In this section, we present the difference between the two architectures in term of number of agents, exchanging messages with and without an uncertainty and the execution time of each one. In addition, we present the complexity of algorithm used in both architectures to assign injured to hospital agents, injured to ambulance agents, centre agents to site and the insertionPlan algorithm.

Table 5.2 shows the difference between the two architectures for our terrorist attack sce-



(a)



(b)

Figure 5.19: Find a road by an ambulance agent

Architecture	Number of agents	Number of messages	Number of messages with uncertainty	Execution time (in ms)
Semi-centralized	27	61	71	8762
Decentralized	26	71	81	7504

Table 5.2: Comparison between the two architectures

nario where twenty casualties have critical and serious cases. In the two architectures, we have: admin agent, SC agent, S agent, FC agent, F1 agent, F2 agent, F3 agent, F4 agent, E agent, 3 hospital agents and 13 assigned ambulance agents. In addition, the centralized architecture has one more agent which is the central agent (c agent). The maximum number of messages exchanged in a centralized architecture, when no uncertainty has occurred, is 61, while it is 71 in a decentralized architecture. Furthermore, in the case where a new casualty appears and we have 2 ambulances available, the number of messages is 71 and 81 in the

Ambulance	Capacity	Injured	Total time of transfer: 60 minutes
m14	1	x21	

Figure 5.20: Assignment of the new injured

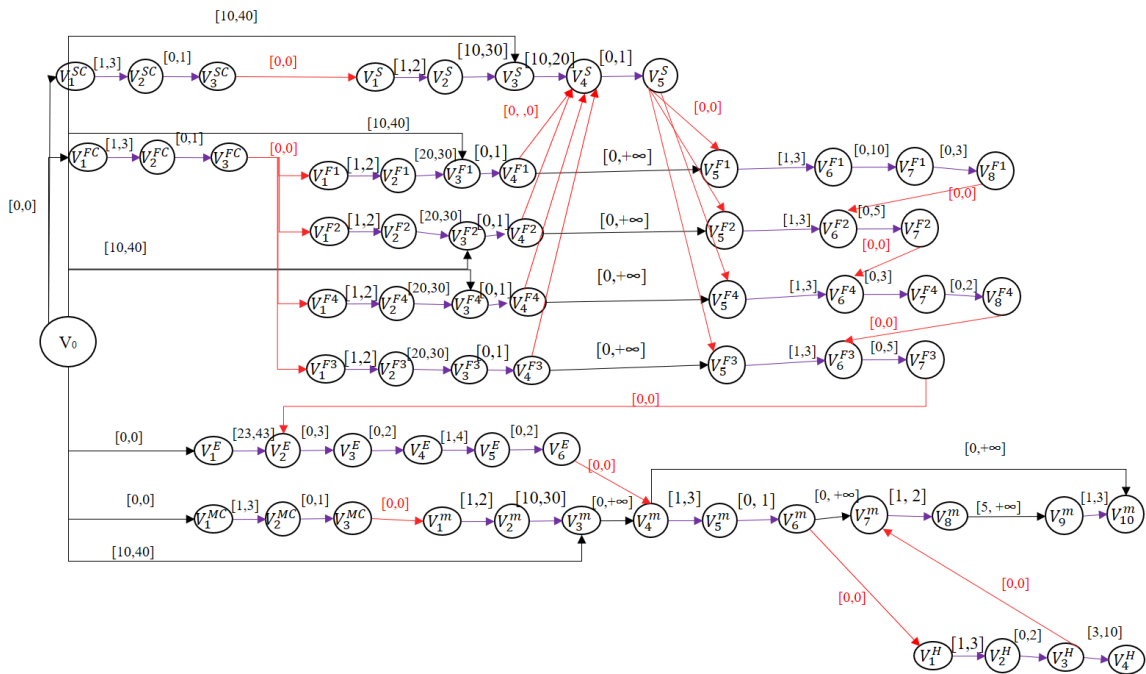

Figure 5.21: A representation of the decentralized architecture STNU

semi-centralized and decentralized architecture, respectively. According to the table 5.2, there are 10 messages of difference between the two architectures with or without uncertainty. The decentralized architecture has an execution time lesser than the semi-centralized architecture.

In this context, although giving some autonomy to the operational actors increases the number of communication among the agents, the execution time is better than the semi-centralized architecture. In addition, in a decentralized architecture, the number of messages increases according to the number of assigned ambulance agents.

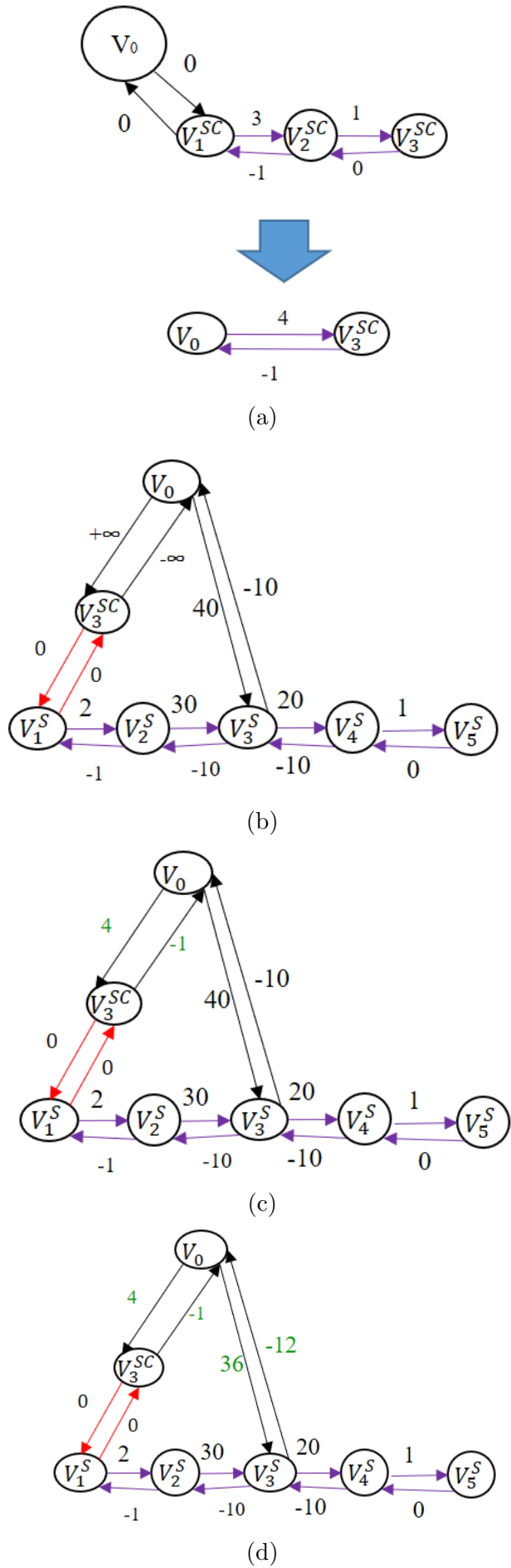

Figure 5.22: SC agent shares its dates with S agent

5.10 Conclusion

In this chapter, we explain the distribution of decisions among the agents in the semi-centralized and decentralized architectures. Moreover, we explain what type of decisions we are interested in in our multi-agent dynamic planning and scheduling model. In addition, we represent the general simulation architecture and the results of our algorithms for the two proposed architectures applied to our terrorist attack scenario. Furthermore, we gave some examples of the communication between the agents in both architectures and their behaviours under uncertainty. Finally, a comparison of the two architectures is represented. The three dynamic planning and scheduling approaches are used in our models in order to manage the uncertainty.

Conclusions and perspectives

Introduction

Based on the dramatic experiences that have faced France and Lebanon such as the Beirut explosion in 2020 and Paris attack in 2015, the response phase challenges are related to information, communication, resources and coordination. The operational management of crisis situations requires the mobilization and rapid coordination of the various emergency services. Unfortunately, this interdepartmental coordination is a very delicate exercise due to the diversity of actors intervening on the ground and the heterogeneity of the different organizations. In addition, actors can work in a specific and aggressive environment, hence, certain factors can affect or restrict their work. Our work is divided into two levels: the design level (chapter 2) and the simulation level (chapter 4).

The design level is essential to analyze the emergency plan to improve the response. We applied the BPMN in combination with a novel a new approach FMECA. The existing emergency plans are available in text form defining the actors involved and their roles. Hence, our first contribution is to have a simple and straightforward model of the emergency plan. In this context, we use BPMN standard in our functional modeling which represents the relationship between the different activities as interactions between them. This relationship can be external and then represents the relationship between the emergency services (resources). Resource allocation is also present where each process represents the activities to be performed by a specific service. Functional modeling allows us to represent each service separately.

Based on previous experiences, unforeseen events can disrupt the actors tasks on site. Thus, our second contribution is to anticipate events likely to interrupt the intervention plan. In this context, we propose a new FMECA approach by adding levels and durations to causes and effects. This dysfunctional modelling allows us to identify the sources of uncertainty that can occur on each activity of the BPMN process. Each activity is represented as a box in SADT that transforms input elements into output elements by taking some limits into account. In addition, it represents which service performs it. In this context, we represented three levels of causes and three levels of consequences in an event tree by adding to each event

a duration. For each failure mode of an activity, we calculate its criticality. The functional and dysfunctional modelling allowed us to see the vulnerability indicators of each activity.

The simulation level represents our architectures to test the distributed generation and execution strategies of emergency plans in a terrorist attack scenario. It is defined based on the design level which makes the link between the two levels our third contribution. The functional model gives an overall view of the actors in the response plan, their missions, the coordination between them and the decisions made by each actor. Each actor has missions that must be carried out in a specific order. In addition, the different actors coordinate to help the victims. In this context, MAS is used as a decision support system to simulate our scenario and observe the coordination between the agents (services). In addition, we distribute the decisions among the agents. An agent executes a set of actions that form a plan in order to achieve its objective. The set of actions is determined from BPMN where each activity represents an action. Furthermore, due to the repetitiveness of certain activities (actions) in a service process, we propose the library of standard plans where an agent chooses the appropriate standard plan and inserts it in its local plan to achieve its goal. The fact of choosing a standard plan in a stochastic environment requires a dynamic planning and scheduling strategy. In this context, we defined a semi-centralized architecture and a decentralized architecture in order to test the generation and execution strategies by the agents when they have a certain degree of autonomy to make decisions and face uncertainties.

In this thesis, our model is applicable in other crises with mass casualties requiring the same actors at the operational level in France and Lebanon.

Perspectives

In the design level, we have identified seven failure modes that serve us in the simulation level. In addition, we have determined the vulnerability indicators for each function in a process and analyze them. Another point, which adds value to the analysis is the calculation of the function vulnerability. Knowing the vulnerability of the functions of a process allows us to know the vulnerability of the process itself. In other words, since a process in BPMN shows the function of a service in an ORSEC plan, the vulnerability of the service itself.

In the simulation level, we assign casualties to hospitals based on their life expectation, distance to the hospital from their location, the hospital capacity, and hospital experience to manage this type of situation. The management of casualties in hospitals is not considered in our work. The reception and treatment of an influx of injured people in a hospital is an interesting topic that could be added to this work. Furthermore, we modelled our scenario in

two different architectures that aim to give a certain degree of autonomy to the operational actors in a fully observable environment. In our decentralized architecture, an ambulance agent assigns a casualty to a hospital agent by communicating with the latter. The casualties are already prioritized by the PMA agent. In our future work, we want to give more autonomy to the ambulance agents by letting them communicate in order to transfer the injured to the appropriate hospital agents in a partially observable environment where each agent only perceives its environment.

Our architectures work in an environment where there are no communication problem. Otherwise, the STNU is not applicable because each agent observes and control a subset of the contingent and executable time-points, respectively. In this context, the MaSTNU proposed by (Casanova et al., 2016) replaces the STNU.

In addition, an influence diagram can be incorporated into our model to see how decisions, variables and outcomes are related, so that we can easily determine the impact of each factor on the others. For example, it can be used to show the assignment quality (e.g. the appropriate hospital) after making the decision of a suitable hospital for example, related to the following variables: hospitals capacity, hospitals distance, the distance to the hospitals from the casualty's position, casualty's life expectation and the traffic.

Let us take the example of having two ambulance agents m_1 and m_2 with capacity 1 and 2, respectively. In addition, we have three injuries, one of which is in critical condition and assigned to m_1 . If m_1 arrives before m_2 , the critical injured is transferred before the others to the hospital. What happens if m_2 arrives first? Should m_2 be sacrificed in order to transfer the critically injured and, therefore, need more ambulances? Finally, multi-criteria optimisation can complete our work by taking into account the cost of triggering the ambulances and intervention duration.

Bibliography

- Adger, W. N. (2006), ‘Vulnerability’, *Global environmental change* **16**(3), 268–281.
- Adla, A. (2010), Aide à la Facilitation pour une prise de Décision Collective: Proposition d’un Modèle et d’un Outil, PhD thesis, Université Paul Sabatier-Toulouse III.
- Ahmad, A. (2003), *Disaster Management Through The New Millennium*, Anmol Publications Pvt. Limited.
- Ahmed, F., Robinson, S. and Tako, A. A. (2014), Using the structured analysis and design technique (sadt) in simulation conceptual modeling, *in* ‘Proceedings of the Winter Simulation Conference 2014’, IEEE, pp. 1038–1049.
- Aligne, F., Savéant, P. and Vidal, V. (2011), Prise en compte d’un contexte évolutif dans la coordination des opérations de secours, *in* ‘In Cinquième Workshop Interdisciplinaire sur la Sécurité Globale (WISG 2011)’.
- Allen, J. F. (1983), ‘Maintaining knowledge about temporal intervals’, *Communications of the ACM* **26**(11), 832–843.
- Amici, R., Cacciagrano, D., Corradini, F. and Merelli, E. (2022), ‘A process algebra view of coordination models with a case study in computational system biology’.
- Ansoff, H. I. and McDonnell, E. J. (1988), *The new corporate strategy*, New York: J. Wiley.
- Atohou, B. C. A. (2013), Architecture logique d’un système multi agents de suivi multi caméra distribué: exploitation du modèle de croyance transférable, Université du Littoral Côte d’Opale.
- Ayad, S. (2013), Business Process Models Quality: evaluation and improvement, PhD thesis, Paris, CNAM.
- Ayral, P. (2001), ‘Contribution à l’élaboration d’une méthodologie d’évaluation de la vulnérabilité face à quatre risques «naturels» particuliers liés à la ressource en eaux’, *Mémoire de DEA de Géographie, Mention Environnement et Paysage, Université Toulouse-Le-Mirail*.
- Baert, A. (2005), ‘Les risques industriels: dispositifs pour éviter les catastrophes et réduire les conséquences des accidents’, *Archives des Maladies Professionnelles et de l’Environnement* **66**(5), 488–493.
- Baki, B. (2006), Planification et ordonnancement probabilistes sous contraintes temporelles, PhD thesis, Université de Caen.

- Baklouti, A. (2020), Prise en compte de la sûreté de fonctionnement lors du choix d'architectures des systèmes complexes, PhD thesis, Université Paris-Saclay; Ecole Nationale d'Ingénieurs de Sousse (Tunisie).
- Barrett, A. and Weld, D. S. (1994), 'Partial-order planning: Evaluating possible efficiency gains', *Artificial Intelligence* **67**(1), 71–112.
- Bellifemine, F., Bergenti, F., Caire, G. and Poggi, A. (2005), Jade—a java agent development framework, in 'Multi-agent programming', Springer, pp. 125–147.
- Bellifemine, F., Poggi, A. and Rimassa, G. (2001), 'Developing multi-agent systems with a fipa-compliant agent framework', *Software: Practice and Experience* **31**(2), 103–128.
- Bellifemine, F. et al. (2010), 'Jade programmer's guide, online: <http://jade.tilab.com/doc/programmersguide.pdf> (accessed january 17, 2012) telecom italia spa', *Milan, Italy*.
- Ben Larbi, R. (2009), Un modèle pour la prise de décision multi-agent sous incertitude stricte, PhD thesis, Artois.
- Berren, M. R., Beigel, A. and Ghertner, S. (1980), 'A typology for the classification of disasters', *Community mental health journal* **16**(2), 103–111.
- Bidot, J., Vidal, T., Laborie, P. and Beck, J. C. (2009), 'A theoretic and practical framework for scheduling in a stochastic environment', *Journal of Scheduling* **12**(3), 315–344.
- Borne, P. and Richard, J. (1992), *Modélisation et identification des processus*, number v. 2 in 'Modélisation et identification des processus', Technip.
URL: <https://books.google.fr/books?id=wN68ryUQn58C>
- Brahim, I. B., Addouche, S.-A., El Mhamedi, A. and Boujelbene, Y. (2019), 'Build a bayesian network from fmeca in the production of automotive parts: diagnosis and prediction', *IFAC-PapersOnLine* **52**(13), 2572–2577.
- Briot, J.-P. and Demazeau, Y. (2001), *Principes et architecture des systèmes multi-agents*, Hermès-Lavoisier.
- Cadier, F., Coppin, G., Lenca, P. and Marchalot, G. (2006), Approche cognitive des systèmes d'aide à la décision distribuée, in 'MOSIM'06: 6ème conférence francophone de modélisation et simulation'.
- Caione, A., Guido, A. L., Paiano, R. and Pandurino, A. (2015), 'A survey of open source workflow management system', *International Journal OF Emerging Trends & Technology IN Computer Science*, ISSN pp. 2278–6856.

- Cairo, M., Hunsberger, L. and Rizzi, R. (2018), Faster dynamic controllability checking for simple temporal networks with uncertainty, *in* ‘25th International Symposium on Temporal Representation and Reasoning (TIME 2018)’, Schloss Dagstuhl-Leibniz-Zentrum fuer Informatik.
- Calixto, E. and Larouvere, E. L. (2010), ‘The regional emergency plan requirement: Application of the best practices to the brazilian case’, *Safety science* **48**(8), 991–999.
- Canu, A. (2011), Planification multiagent sous incertitude orientée interactions: modèle et algorithmes, PhD thesis, Université de Caen.
- Cardon, A. and Itmi, M. (2016), *Les nouveaux systèmes autonomes*, Vol. 1, ISTE Group.
- Carter, W. N. (2008), ‘Disaster management: A disaster manager’s handbook’.
- Casanova, G., Pralet, C. and Lesire, C. (2015), Managing dynamic multi-agent simple temporal network, *in* ‘Proceedings of the 2015 International Conference on Autonomous Agents and Multiagent Systems’, pp. 1171–1179.
- Casanova, G., Pralet, C., Lesire, C. and Vidal, T. (2016), ‘Solving dynamic controllability problem of multi-agent plans with uncertainty using mixed integer linear programming.’.
- Chang, D.-S. and Sun, K.-L. P. (2009), ‘Applying dea to enhance assessment capability of finea’, *International Journal of Quality & Reliability Management* .
- Chicken, J. C. and Posner, T. (1998), *The philosophy of risk*, Thomas Telford.
- Chinosi, M. and Trombetta, A. (2012), ‘Bpmn: An introduction to the standard’, *Computer Standards & Interfaces* **34**(1), 124–134.
- Congram, C. and Epelman, M. (1995), ‘How to describe your service: An invitation to the structured analysis and design technique’, *International Journal of Service Industry Management* .
- Coombs, W. T. (2007), ‘Protecting organization reputations during a crisis: The development and application of situational crisis communication theory’, *Corporate reputation review* **10**(3), 163–176.
- Cormen, T. H., Leiserson, C. E., Rivest, R. L. and Stein, C. (2022), *Introduction to algorithms*, MIT press.
- Cutter, S. L. (1996), ‘Vulnerability to environmental hazards’, *Progress in human geography* **20**(4), 529–539.
- Dahin, A.-F. (2013), *La victime dans tous ses états*, Ed. Fabert.

- Damiani, C., Vaillant, C. and Cario, R. (2003), *Être victime, aides et recours: agression, cambriolage, violence conjugale, terrorisme...: choisir la psychothérapie adaptée: connaître ses droits*, Vuibert.
- Daum, B. and Merten, U. (2002), *System architecture with XML*, Elsevier.
- Dauphiné, A. and Provitolo, D. (2013), *Risques et catastrophes: observer, spatialiser, comprendre, gérer*, Armand Colin.
- Dautun, C. (2007), Contribution à l'étude des crises de grande ampleur: connaissance et aide à la décision pour la sécurité civile, PhD thesis, Ecole Nationale Supérieure des Mines de Saint-Etienne.
- Davenport, T. H. (1993), *Process innovation: reengineering work through information technology*, Harvard Business Press.
- Dechter, R., Meiri, I. and Pearl, J. (1991), 'Temporal constraint networks', *Artificial intelligence* **49**(1-3), 61–95.
- Demri, A., Charki, A., Guerin, F. and Christofol, H. (2008), Functional and dysfunctional analysis of a mechatronic system, in '2008 Annual Reliability and Maintainability Symposium', IEEE, pp. 114–119.
- Deng, Y., Song, L., Zhou, J., Xu, N., Ni, G. and Wang, L. (2020), 'Analysis of failures and influence factors of critical infrastructures: a case of metro', *Advances in Civil Engineering* **2020**.
- Doniec, A. (2006), Prise en compte des comportements anticipatifs dans la coordination multi-agent: application à la simulation de trafic en carrefour, PhD thesis, Université de Valenciennes.
- Edelkamp, S. and Hoffmann, J. (2004), Pddl2. 2: The language for the classical part of the 4th internal planning competition, Technical report, Technical Report 195, University of Dortmund, German.
- El Falou, M. (2010), Contributions à la composition dynamique de services fondée sur des techniques de planification et diagnostic multi-agents, PhD thesis, Université de Caen.
- Elmhadhbi, L. (2020), Ontology-driven services for interoperable multi-stakeholders operational disaster response, PhD thesis, Toulouse, INPT.
- Ephrati, E., Pollack, M. E. and Rosenschein, J. S. (1995), A tractable heuristic that maximizes global utility through local plan combination., in 'ICMAS', pp. 94–101.

- Ephrati, E. and Rosenschein, J. S. (1993), Distributed consensus mechanisms for self-interested heterogeneous agents, *in* '[1993] Proceedings International Conference on Intelligent and Cooperative Information Systems', IEEE, pp. 71–79.
- Eriksson, H.-E. and Penker, M. (2000), 'Business modeling with uml', *New York* **12**.
- Farreny, H. (1996), Une généralisation pour la recherche heuristiquement ordonnée: les algorithmes[®] et la propriété d'arrêt avec découverte de solution, *in* 'Proc. of RFIA', Vol. 96, pp. 225–234.
- Ferber, J. (1995), Les systèmes multi-agents: vers une intelligence collective.
- Fikes, R. E. and Nilsson, N. J. (1971), 'Strips: A new approach to the application of theorem proving to problem solving', *Artificial intelligence* **2**(3-4), 189–208.
- Foucher, S., Le Loch, J., Desbrest, A., Lefort, H. and Tazarourte, K. (2018), 'Catastrophe avec nombreuses victimes en milieu urbain: plan blanc et difficultés de gestion des places hospitalières', *Med Armees* **46**(3), 213–224.
- Fox, M. and Long, D. (2003), 'Pddl2. 1: An extension to pddl for expressing temporal planning domains', *Journal of artificial intelligence research* **20**, 61–124.
- Franchin, M., Frattini, B., Briche, F., Travers, S., Bignand, M. and Tourtier, J.-P. (2016), 'Retour d'expérience des attentats du 13 novembre 2015. prise en charge secouriste et interactions avec les équipes médicales', *Annales françaises de médecine d'urgence* **6**(1), 9–12.
- Franke, J. (2011), Coordination of distributed activities in dynamic situations. The case of inter-organizational crisis management, PhD thesis, Université Henri Poincaré-Nancy I.
- Gallopín, G. C. (2006), 'Linkages between vulnerability, resilience, and adaptive capacity', *Global environmental change* **16**(3), 293–303.
- García, A. and Gilabert, E. (2011), 'Mapping fmea into bayesian networks', *International Journal of Performability Engineering* **7**(6), 525–537.
- Geambaşu, C. V. (2012), 'Bpmn vs uml activity diagram for business process modeling', *Accounting and Management Information Systems* **11**(4), 637–651.
- Gerevini, A. and Long, D. (2005), 'Plan constraints and preferences in pddl3-the language of the fifth international planning competition'.
- Ghallab, M., Howe, A., Knoblock, C., McDermott, D., Ram, A., Veloso, M., Weld, D. and Wilkins, D. (1998), 'Pddl—the planning domain definition language'.

- Ghallab, M., Nau, D. and Traverso, P. (2004), *Automated Planning: theory and practice*, Elsevier.
- Girard, C. (2014), Diagnostic des Dysfonctionnements des Plans de Secours pour la Gestion des Risques majeurs, PhD thesis, Saint-Etienne, EMSE.
- Girard, R. (2000), ‘Violence et religion’, *Revista portuguesa de Filosofia* pp. 11–23.
- Gleyze, J.-F. (2005), La vulnérabilité structurelle des réseaux de transport dans un contexte de risques, PhD thesis, Université Paris-Diderot-Paris VII.
- Godeau, P. (2002), ‘Vulnérabilité: un concept d’avenir?’, *Vulnérabilité et vieillissement: comment les prévenir, les retarder ou les maîtriser*.
- Goodrich, M. A., Olsen, D. R., Crandall, J. W. and Palmer, T. J. (2001), Experiments in adjustable autonomy, in ‘Proceedings of IJCAI Workshop on autonomy, delegation and control: interacting with intelligent agents’, Seattle, WA, pp. 1624–1629.
- Gorry, G. A. and Scott Morton, M. S. (1971), ‘A framework for management information systems’.
- Grange, D. (2008), ‘Risques et catastrophes : une approche en trois phases et trois plans’, *Revue électronique suisse de science de l’information (RESSI)* (7).
URL: <http://www.ressi.ch/num07/article047>
- Gutknecht, O. and Ferber, J. (2000), Madkit: A generic multi-agent platform, in ‘Proceedings of the fourth international conference on Autonomous agents’, pp. 78–79.
- HAFRI, Y. and NAJID, N. M. (2001), Utilisation de l’approche multi-agents pour le pilotage en temps réel des systèmes de production, in ‘3e Conférence Francophone de Modélisation et Simulation: Conception, Analyse et Gestion des Systèmes Industriels, MOSIM’, Vol. 1, p. 25.
- Haimès, Y. Y. (2006), ‘On the definition of vulnerabilities in measuring risks to infrastructures’, *Risk Analysis: An International Journal* **26**(2), 293–296.
- Halpern, J. and Vermeulen, K. (2017), *Disaster mental health interventions: Core principles and practices*, Routledge.
- Hassas, S. (2003), ‘Systèmes complexes à base de multi-agents situés’, *University Claude Bernard Lyon*.
- Heguy, X. (2018), Extensions de BPMN 2.0 et méthode de gestion de la qualité pour l’interopérabilité des données, PhD thesis, Bordeaux.

- Heiderich, D. (2010), *Plan de gestion de crise : organiser, gérer et communiquer en situation de crise*, Fonctions de l'entreprise Direction, conseil.
- Herbert, S. (1980), 'Le nouveau management: la décision par les ordinateurs', *Economica* .
- Hopkin, P. (2018), *Fundamentals of risk management: understanding, evaluating and implementing effective risk management*, Kogan Page Publishers.
- Huhns, M. N. and Singh, M. P. (1998), *Readings in agents*, Morgan Kaufmann.
- Hunsberger, L. (2013), Magic loops in simple temporal networks with uncertainty, in 'Proceedings of the Fifth International Conference on Agents and Artificial Intelligence (ICAART-2013)'.
- Imakhlaf, A. (2021), Application des diagrammes de décision binaires pour l'analyse des arbres de défaillance cohérents et non-cohérents en présence d'incertitudes, PhD thesis, Université de Technologie de Compiègne.
- Johansson, J. (2010), 'Risk and vulnerability analysis of interdependent technical infrastructures', *Lund University, Dept. of Measurement Technology and Industrial Electrical Engineering* .
- Johansson, J., Jonsson, H. and Johansson, H. (2007), 'Analysing the vulnerability of electric distribution systems: a step towards incorporating the societal consequences of disruptions', *International Journal of Emergency Management* **4**(1), 4–17.
- Kaddoussi, A. (2012), Optimisation des flux logistiques: vers une gestion avancée de la situation de crise, PhD thesis, Ecole centrale de Lille.
- Kambhampati, S. (1997), 'Refinement planning as a unifying framework for plan synthesis', *AI magazine* **18**(2), 67–67.
- Kamissoko, D., Zaraté, P. and Pérès, F. (2013), A decision support framework for crisis management, in 'Decision Support Systems III-Impact of Decision Support Systems for Global Environments', Springer, pp. 1–10.
- Kanazy, R. (2020), Pronostic des événements de défaillance basé sur les réseaux de Petri Temporels labellisés, PhD thesis, Université de Lyon.
- Karagiannis, G. M. (2010), Méthodologie pour l'analyse de la robustesse des plans de secours industriels, PhD thesis, Saint-Etienne, EMSE.
- Kast, R. (1993), *La théorie de la décision*, La Découverte Paris.

- Kebair, F. (2009), Modélisation multiagent de postes de commande coordonnateurs de prise de décisions stratégiques: application au système de simulation de RoboCupRescue, PhD thesis, Le Havre.
- Klement, N., Silva, C. and Gibaru, O. (2017), ‘A generic decision support tool to planning and assignment problems: Industrial application & industry 4.0’, *Procedia Manufacturing* **11**, 1684–1691.
- Kluza, K., Wiśniewski, P., Jobczyk, K., Ligęza, A. and Mroczek, A. S. (2017), Comparison of selected modeling notations for process, decision and system modeling, in ‘2017 Federated Conference on Computer Science and Information Systems (FedCSIS)’, IEEE, pp. 1095–1098.
- Kovacs, D. L. (2011), ‘Complete bnf description of pddl 3.1’, *Dept. Meas. Inf. Syst., Budapest Univ. Technol. Econ., Budapest, Hungary* .
- La Rosa, M. and Mendling, J. (2009), Domain-driven process adaptation in emergency scenarios, in ‘Business Process Management Workshops: BPM 2008 International Workshops, Milano, Italy, September 1-4, 2008, Revised Papers’, Vol. 17, Springer Science & Business Media, p. 290.
- Lachtar, D. (2012), Contribution des systèmes multi-agent à l’analyse de la performance organisationnelle d’une cellule de crise communale, PhD thesis, Ecole Nationale Supérieure des Mines de Paris.
- Lemieux, F. (2007), *DÉSASTRES ET CRISES MAJEURES : LE DYSFONCTIONNEMENT DU SYSTÈME*, pp. 585–599.
- Longueville, B. (2003), Capitalisation des processus de décision dans les projets d’innovation: Application à l’automobile, PhD thesis, Ecole Centrale Paris.
- Lopez, P. and Roubellat, F. (2001), ‘éditeurs’, *Ordonnancement de la production. Hermes Science Publications, Paris* .
- Luke, S. (2011), ‘Multiagent simulation and the mason library’, *George Mason University* **1**.
- Mackworth, A. K. (1977), ‘Consistency in networks of relations’, *Artificial intelligence* **8**(1), 99–118.
- Malas, A. (2017), Contributions à la résolution du transport à la demande fondées sur les systèmes multi-agents, PhD thesis, Normandie Université.
- Marzano, M. (2006), ‘Qu’est-ce qu’une victime?’, *Archives de politique criminelle* (1), 11–20.

- McDermott, D. (1982), ‘A temporal logic for reasoning about processes and plans’, *Cognitive science* **6**(2), 101–155.
- Melliti, T., Haddad, S. and Suna, A. (2005), Web-masi: Multi-agent systems interoperability using a web services based approach, in ‘IEEE/WIC/ACM International Conference on Intelligent Agent Technology’, IEEE, pp. 739–742.
- Meneguzzi, F. R., Zorzo, A. F., da Costa Móra, M. and Luck, M. (2007), ‘Incorporating planning into bdi systems’, *Scalable Computing: Practice and Experience* **8**(1).
- MIALED, K. and DADSI, I. (2020), ‘Culture de management des risques dans les entreprises: Revue de littérature’, *Revue du contrôle, de la comptabilité et de l’audit* **4**(1).
- Millot, P. and Lemoine, M. (1998), An attempt for generic concepts toward human-machine cooperation, in ‘SMC’98 Conference Proceedings. 1998 IEEE International Conference on Systems, Man, and Cybernetics (Cat. No. 98CH36218)’, Vol. 1, IEEE, pp. 1044–1049.
- Minitzerg, H. (1982), ‘Structure et dynamique des organisations’.
- Mogali, J. K., Smith, S. F. and Rubinstein, Z. B. (2016), Distributed decoupling of multiagent simple temporal problems, in ‘Proceedings of the 25th International Joint Conference on Artificial Intelligence (IJCAI). AAAI Press’.
- Morris, P. (2014), Dynamic controllability and dispatchability relationships, in ‘International Conference on Integration of Constraint Programming, Artificial Intelligence, and Operations Research’, Springer, pp. 464–479.
- Morris, P., Muscettola, N. and Vidal, T. (2001), ‘Dynamic control of plans with temporal uncertainty’.
- Mukhopadhyay, A. K. (2005), *Crisis and disaster management turbulence and aftermath*, New Age International.
- Ndiaye, I. A., Neron, E., Linot, A., Monmarche, N. and Goerigk, M. (2014), ‘A new model for macroscopic pedestrian evacuation planning with safety and duration criteria’, *Transportation Research Procedia* **2**, 486–494.
- Nilsson, M., Kvarnström, J. and Doherty, P. (2013), Incremental dynamic controllability revisited, in ‘Proceedings of the International Conference on Automated Planning and Scheduling’, Vol. 23, pp. 337–341.
- Nilsson, M., Kvarnström, J. and Doherty, P. (2016), ‘Efficient processing of simple temporal networks with uncertainty: algorithms for dynamic controllability verification’, *Acta Informatica* **53**(6), 723–752.

- Nossiter, A. (2015), ‘Response to paris attacks points to weaknesses in french police structure’, *the New York Times* .
- OMG (2010), ‘Omg: Business process model and notation (bpmn) version 2.0’.
- OMG, O. (2017), ‘Unified modeling language (omg uml) version 2.5. 1’, *Object Management Group* .
- Othman, S. B., Zoghalmi, N., Hammadi, S. and Zgaya, H. (2014), Adaptive collaborative agent-based system for crisis management, *in* ‘2014 IEEE/WIC/ACM International Joint Conferences on Web Intelligence (WI) and Intelligent Agent Technologies (IAT)’, Vol. 3, IEEE, pp. 151–158.
- Pachauri, R. K., Allen, M. R., Barros, V. R., Broome, J., Cramer, W., Christ, R., Church, J. A., Clarke, L., Dahe, Q., Dasgupta, P. et al. (2014), *Climate change 2014: synthesis report. Contribution of Working Groups I, II and III to the fifth assessment report of the Intergovernmental Panel on Climate Change*, Ipcc.
- Papadimitriou, C. H. and Steiglitz, K. (1998), *Combinatorial optimization: algorithms and complexity*, Courier Corporation.
- Paulheim, H., Döweling, S., Tso-Sutter, K., Probst, F. and Ziegert, T. (2009), ‘Improving usability of integrated emergency response systems: the soknos approach’, *Informatik 2009–Im Focus das Leben* .
- Peixoto, D. C., Batista, V. A., Atayde, A. P., Borges, E. P., Resende, R. F. and Pádua, C. I. P. (2008), A comparison of bpmn and uml 2.0 activity diagrams, *in* ‘Anais do VII Simpósio Brasileiro de Qualidade de Software’, SBC, pp. 1–12.
- Prieur, M. (2012), ‘Principes éthiques pour la réduction des risques de catastrophe et la résilience des personnes (2012)’.
- Prudhomme, C. (2020), Ingénierie de simulation multi-agents conduite par la connaissance pour évaluer l’efficacité des plans de gestion de catastrophes, PhD thesis.
- Ramabrahmam, B. V., Sreenivasulu, B. and Mallikarjunan, M. M. (1996), ‘Model on-site emergency plan. case study: toxic gas release from an ammonia storage terminal’, *Journal of loss prevention in the process industries* **9**(4), 259–265.
- Rey, A. (2018), *Le Petit Robert: dictionnaire alphabétique et analogique de la langue française/sous la direction de Alain Rey et Josette Rey-Debove*, Le Robert.
- Rongier, C. (2012), Gestion de la réponse à une crise par la performance: vers un outil d’aide à la décision. Application à l’humanitaire, PhD thesis.

- ROSOLATO, G. (1987), 'Le sacrifice: Repères psychanalytiques, sous la dir. de Jean Laplanche', *Coll. «Bibliothèque de psychanalyse»*. Paris: Presses Universitaires de France .
- Roy, B. and Bouyssou, D. (1993), *Aide multicritère à la décision: méthodes et cas*, Economica Paris.
- Russell, S. and Norvig, P. (2010), 'Artificial intelligence: A modern approach. third edit', *Upper Saddle River, New Jersey* **7458**.
- Sacerdoti, E. D. (1975), The nonlinear nature of plans, *in* 'IJCAI'.
- Schmidt, G. and Wilhelm, W. E. (2000), 'Strategic, tactical and operational decisions in multi-national logistics networks: a review and discussion of modelling issues', *International Journal of Production Research* **38**(7), 1501–1523.
- Schmidt, P. (2012), Planification multi-niveaux avec expertise humaine, PhD thesis, Toulouse, ISAE.
- Schwalb, E. and Vila, L. (1998), 'Temporal constraints: A survey', *Constraints* **3**(2), 129–149.
- Seguy, A. (2008), Décision collaborative dans les systèmes distribués-Application à la E-Maintenance, PhD thesis, Institut National Polytechnique de Toulouse-INPT.
- Shakour, M. (2012), Conception et implementation d'un algorithme de planification de chemin dans un jeu vidéo comportant un environnement triangularisé, PhD thesis, Université du Québec à Montréal.
- Shim, J. P., Warkentin, M., Courtney, J. F., Power, D. J., Sharda, R. and Carlsson, C. (2002), 'Past, present, and future of decision support technology', *Decision support systems* **33**(2), 111–126.
- Soubaras, H., Aligne, F. and SAV EANT, P. (2013), 'Omar: un outil d'aide à la décision pour optimiser, suivre, alerter et réparer en gestion de crise', *Proc. of JFPDA, Lille* .
- Soubaras van den Broek, H. and Labreuche, C. (2014), Multi-criteria finite horizon mdp for search-and-rescue.
- Sprauel, J. (2016), Conception sûre et optimale de systèmes dynamiques critiques auto-adaptatifs soumis à des évènements redoutés probabilistes, PhD thesis, UNIVERSITE DE TOULOUSE.
- Srdic, I. (2020), 'Innovation management and international standards – how they relate to research institutes', *Annals of Social Sciences Management Studies* **5**.
- Stedl, J. and Williams, B. C. (2005), A fast incremental dynamic controllability algorithm, *in* 'Proceedings of the ICAPS Workshop on Plan Execution: A Reality Check', pp. 69–75.

- Sun, W., Bocchini, P. and Davison, B. D. (2020), ‘Applications of artificial intelligence for disaster management’, *Natural Hazards* **103**(3), 2631–2689.
- Thanh, N. T. (2016), *Coordination Models for Crisis Resolution: Discovery, Analysis and Assessment*, PhD thesis, Université Toulouse 3 Paul Sabatier.
- Thierry, C. (2003), ‘Gestion des chaînes logistiques: modèles et mise en oeuvre pour l’aide à la décision moyen terme, mémoire d’habilitation à diriger des recherches de l’université de toulouse ii le mirail’, *Université Toulouse II Le Mirail*.
- Tranier, J. (2007), *Vers une vision intégrale des systèmes multi-agents: Contribution à l’intégration des concepts d’agent, d’environnement, d’organisation et d’institution.*, PhD thesis, Université Montpellier II-Sciences et Techniques du Languedoc.
- Trentesaux, D. (1996), *Conception d’un système de pilotage distribué, supervisé et multi-critère pour les systèmes automatisés de production*, PhD thesis, Institut National Polytechnique de Grenoble-INPG.
- Tsamardinos, I., Pollack, M. E. and Horty, J. F. (2000), Merging plans with quantitative temporal constraints, temporally extended actions, and conditional branches., *in* ‘AIPS’, pp. 264–272.
- Vesely, W. E., Goldberg, F. F., Roberts, N. H. and Haasl, D. F. (1981), *Fault tree handbook*, Technical report, Nuclear Regulatory Commission Washington DC.
- Vidal, T. (1995), *Le temps en planification et en ordonnancement*, PhD thesis, Toulouse.
- Vidal, T., Bidot, J., Beck, J. and Laborie, P. (2003), ‘Gestion de projets sous incertitudes: un modèle de génération de plans flexibles en horizon glissant’.
- Vidal, T. and Ghallab, M. (1996), Dealing with uncertain durations in temporal constraint networks dedicated to planning’, *in* ‘ECAI’, PITMAN, pp. 48–54.
- Viger, R. (2004), *Prevoir et faire face : guide des risques naturels, technologiques et terroristes*, Les Territoires du risque, Edisud, Aix-en-Provence.
- Von Martial, F. (1992), *Coordinating plans of autonomous agents*, Vol. 2, Springer.
- Von Rosing, M., Von Scheel, H. and Scheer, A.-W. (2014), *The Complete Business Process Handbook: Body of Knowledge from Process Modeling to BPM, Volume 1*, Vol. 1, Morgan Kaufmann.
- Watson, H. A. (1961), ‘Launch control safety study’, *Bell labs*.
- Weiss, G. (1999), *Multiagent systems: a modern approach to distributed artificial intelligence*, MIT press.

- Weiteng, Z., Baoming, H., Dewei, L. and Bin, Z. (2013), Improved reversely a star path search algorithm based on the comparison in valuation of shared neighbor nodes, *in* '2013 Fourth International Conference on Intelligent Control and Information Processing (ICI-CIP)', IEEE, pp. 161–164.
- Weld, D. S. (1994), 'An introduction to least commitment planning', *AI magazine* **15**(4), 27–27.
- Wells, G. (1997), *Hazard identification and risk assessment*, IChemE.
- Wood, S. (1983), Dynamic world simulation for planning with multiple agents., *in* 'IJCAI', Vol. 8, Citeseer, pp. 69–71.
- Wooldridge, M. (2009), *An introduction to multiagent systems*, John wiley & sons.
- Wooldridge, M. and Jennings, N. R. (1995), 'Intelligent agents: Theory and practice', *The knowledge engineering review* **10**(2), 115–152.
- Yu, G., Wang, Y., Zheng, L., Huang, J., Li, J., Gong, L., Chen, R., Li, W., Huang, J. and Duh, Y.-S. (2021), 'Comprehensive study on the catastrophic explosion of ammonium nitrate stored in the warehouse of beirut port', *Process Safety and Environmental Protection* **152**, 201–219.
- Zhang, W. (1999), *State-space search: Algorithms, complexity, extensions, and applications*, Springer Science & Business Media.
- Zogning, A., Ngouanet, C. and Nghonda, J.-P. (2007), 'Recherche scientifique et technique: gestion des risques et catastrophes naturels au cameroun'.
- Ćatić, D., Milomir, G., Mile, S. and Glisovic, J. (2014), 'Fault tree analysis of hydraulic power-steering system', *International Journal of Vehicle Design* **64**.

Appendix

This appendix contains the actors FMECA tables for our terrorist attack scenario explained in chapter 2.

A.1 Security centre

The FMECA tables of the security centre are shown in figure A.1 for the semi-centralized architecture and in figure A.2 for the decentralized architecture.

Based on the FMECA tables, the tables A.1 and A.2 show the vulnerability indicators of the security centre in the two architectures: semi-centralized and decentralized.

Code	Nature	Interactions	Cost	Impact	Recurrence	Technicality	Material	Fluids	Network	Infrastructure	Failure modes
J.1	D	I	A	A	U	M	Y	N	N	Y	0,1,2,3,5
J.2	D,I	I,E	I	A	U	E	Y	N	Y	Y	0,1,2,3,4,5,6
J.3	I	I	I	A	U	E	Y	N	Y	Y	0,1,3,5
J.4	I	I,E	I	A	U	E	Y	N	Y	Y	0,1,2,3,4,5
J.5	I	E	I	A	R	E	Y	N	Y	Y	1,2,3,4,5,6

Table A.1: Security centre's vulnerability indicators for figure A.1

A.2 Firefighter department

Figure A.3 and A.4 show the FMECA tables of the firefighter department for the semi-centralized architecture and the decentralized architecture, respectively.

Activity	Code	Mode	Category	Cause I	Category of cause I		Cause II	Category of cause II	
					Before	During		Before	During
Verify capacity	J.1		0	Alert in not received	-	IN1	-	-	-
			1	No actors capable of making a decision at the centre	-	SN2	The actors' schedules are poorly organized	SN4	-
			2	Decision makers are reluctant to make the decision	-	SN1	Decision-makers are stressed and tired	-	SN3
			3	The alert is received late	-	IN1	-	-	-
			5	The decision-makers have difficulties processing information	-	SN2	Decision-makers do not have enough experience	SN4	-
Suggest an assignment	J.2		5	Decision makers did not properly analyze the information	-	SN2	Decision-makers have no experience	SN4	-
			6	Capacity is not received	-	IN1	Decision is not made	-	IN4
			1	There is no connection	-	CN1	-	-	-
			2	They forgot to send them	-	CN1	-	-	-
			2	They are not reachable	-	CN1	-	-	-
			3	Decisions are received late	-	IN1	They took time to decide	-	IN4
			3	Actors do not know how to send them	-	SN2	They have no experience	SN4	-
			4	There is a bad connection	-	CN1	-	-	-
			4	Part of suggestions are missing	-	CN1	-	-	-
			4	No available actors in the centre	-	SN2	The actors are tired. They did not pay attention.	-	SN3
Receive information	J.3		5	Decisions are wrongly received	-	IN1	The decisions are incorrect	-	IN4
			6	There is a bad connection	-	CN1	-	-	-
			6	Shutdown of the system every few minutes	-	SN2	No maintenance of equipment and systems	SN4	-
			0	Suggestions are not sent	-	IN2	Decisions are not made	-	IN5
			1	There is no connection	-	CN1	-	-	-
Trigger the security agents	J.4		3	They did not read the message	-	CN1	-	-	-
			3	There is a bad connection	-	CN1	-	-	-
			5	The information sent is incorrect	-	IN2	The decision made is incorrect	-	IN5
			0	Information is not received	-	IN1	-	-	-
			1	The line is down or out of service	-	CN1	-	-	-
			2	No available actors in the centre	-	SN2	The actors' schedules are poorly organized	SN4	-
			2	They are not reachable	-	CN1	-	-	-
			3	There is a bad connection	-	CN1	-	-	-
			3	Actors do not know how to trigger (send it)	-	SN2	They are not trained	SN4	-
			4	Some information is not filled in	-	SN1	The actors are tired. They did not pay attention.	-	SN3
Communicate with security agents	J.5		5	The decision received is incorrect	-	IN2	The decision made is incorrect	-	IN5
			1	The line is down or out of service	-	CN1	-	-	-
			2	They are not reachable	-	CN1	-	-	-
			3	There is a bad connection	-	CN1	-	-	-
			4	Part of information is not received	-	IN2	-	-	-
			4	Not enough actors at the centre	-	SN2	Centre does not have a lot of actors	SN4	-
			5	They confuse the senders and their requests	-	SN1	They did not pay attention	-	SN3
			6	Lots of communication to do	-	IN1	-	-	-
			6	Not enough actors at the centre	-	SN2	Centre does not have a lot of actors	SN4	-

Cause III	Category of cause III	Source	Effect I	Category of effect I		Effect II	Category of effect II		Effect III	Category of effect III		Target	S	O	C
				During	After		During	After		During	After				
-	-	J	They do not make a decision	ON4	-	-	-	-	-	-	-	J	4	1	4
Not enough budget to train actors in decision making	SN6	J	They do not make a decision	ON4	-	-	-	-	-	-	-	J	4	1	4
-	-	J	The available actors are stressed and panicked	ON3	-	-	-	-	-	-	-	J	4	1	4
-	-	J	They do not make a decision	ON4	-	-	-	-	-	-	-	J	4	1	4
-	-	J	The capacity is not determined yet	ON4	-	-	-	-	-	-	-	J	3	3	9
No budget to organize enough trainings	SN6	J	The capacity is not determined yet	ON4	-	-	-	-	-	-	-	J	3	3	9
-	-	J	The decision-makers are stressed	ON3	-	-	-	-	-	-	-	J	3	2	6
No budget to organize a training	SN6	J	The capacity is not correct	ON2	-	The suggestions are incorrect	ON7	-	The centre's image is distorted	-	ON10	J	3	2	6
-	-	J	They did not send any suggestions	ON5	-	-	-	-	-	-	-	J	1	1	1
-	-	J	No suggestions are received	ON5	-	-	-	-	-	-	-	J	1	1	1
-	-	J	No suggestions are received	ON5	-	-	-	-	-	-	-	J	1	1	1
-	-	J	No suggestions are received	ON5	-	-	-	-	-	-	-	J	3	1	3
No budget to organize trainings	SN6	J	Suggestions are sent late	ON1	-	Late receipt of the proposal	ON6	-	-	-	-	J	3	2	6
-	-	J	Part of the suggestions are not sent	ON1	-	Not all suggestions are received	ON6	-	-	-	-	J	4	1	4
-	-	J	Suggestions sent are incorrect	ON1	-	Suggestions received are incorrect	ON6	-	The centre's image is distorted	-	ON9	J	4	1	4
-	-	J	Suggestions are not received immediately	ON1	-	Decisions are made late	ON6	-	-	-	-	J	2	1	2
No budget for new equipment or system maintenance	SN6	J	They received no information	ON4	-	-	-	-	-	-	-	J	2	1	2
-	-	J	They received no information	ON4	-	-	-	-	-	-	-	J	2	1	2
-	-	J	Information received late	ON4	-	Actors are not triggered on time	ON7	-	-	-	-	J	3	1	3
-	-	J	The information received is incorrect	ON2	-	The actors are wrongly triggered	ON7	-	-	-	-	J	4	1	4
-	-	J	No actor is triggered	ON5	-	-	-	-	-	-	-	J	1	1	1
-	-	J	No actor is triggered	ON5	-	-	-	-	-	-	-	J	1	1	1
-	-	J	No actor is triggered	ON5	-	-	-	-	-	-	-	J	1	1	1
-	-	J	No actor is triggered	ON5	-	-	-	-	-	-	-	J	2	1	2
-	-	J	Security agents are triggered late	ON1	-	Late receipt of the information	ON6	-	-	-	-	J	3	1	3
No budget for trainings	SN6	J	Security agents are triggered late	ON1	-	Late receipt of the information	ON6	-	-	-	-	J	3	1	3
-	-	J	Part of security agents are not triggered	ON1	-	-	-	-	-	-	-	J	3	1	3
-	-	J	The number of actors triggered is incorrect	ON1	-	-	-	-	-	-	-	J	4	1	4
-	-	J	No information is provided	ON5	-	-	-	-	-	-	-	J	1	1	1
-	-	J	No information is provided	ON5	-	-	-	-	-	-	-	J	1	1	1
-	-	J	Information is poorly provided	ON1	-	-	-	-	-	-	-	J	3	1	3
-	-	J	Part of information is not processed	ON1	-	-	-	-	-	-	-	J	3	1	3
-	-	J	Communication is with the wrong senders	ON1	-	-	-	-	-	-	-	J	1	1	1
-	-	J	Communication is late	ON1	-	-	-	-	-	-	-	J	2	2	4

Figure A.1: Security centre's FMECA table in semi-centralized architecture

Code	Nature	Interactions	Cost	Impact	Recurrence	Technicality	Material	Fluids	Network	Infrastructure	Failure modes
J.1	D	I	A	A	U	M	Y	N	N	Y	0,1,2,3,5
J.2	D,I	I,E	I	A	U	E	Y	N	Y	Y	0,1,2,3,4,5
J.3	I	E	I	A	R	E	Y	N	Y	Y	1,2,3,4,5,6

Table A.2: Security centre's vulnerability indicators for figure A.2

Activity	Code	Mode	Category	Cause I	Category of cause		Cause II	Memory of cause	
					Before	During		Before	During
Verify capacity	J.1		0	Alert in not received	-	IN1	-	-	-
			1	No actors capable of making a decision at the centre	-	SN2	The actors' schedules are poorly organized	SN4	-
			2	Decision makers are reluctant to make the decision	-	SN1	Decision-makers are stressed and tired	-	SN3
			3	The alert is received late	-	IN1	-	-	-
			4	The decision-makers have difficulties processing information	-	SN2	Decision-makers do not have enough experience	SN4	-
Trigger the security agents	J.2		5	Decision makers did not properly analyze the information	-	SN2	Decision-makers have no experience	SN4	-
			0	Capacity is not received	-	IN1	Decision is not made	-	IN4
			1	No available actors at the centre	-	SN2	All the actors are assigned to another event	SN4	-
			1	No actors capable of making a decision at the centre	-	SN2	The centre's schedules are poorly organized	SN4	-
			1	They forgot to trigger the actors	-	CN1	-	-	-
			1	There is no connection	-	CN1	-	-	-
			1	They are not reachable	-	CN1	-	-	-
			2	No available trucks on site	-	SN2	The centre did not order new trucks	SN4	-
			2	The trucks are out of order	-	SN2	The centre did not maintain the trucks	SN4	-
			3	The decision-makers have difficulties processing information	-	SN2	Decision-makers do not have enough experience	SN4	-
Communicate with security agents	J.3		3	There is a bad connection	-	CN1	-	-	-
			3	Actors do not know how to trigger (send it)	-	SN2	They are not trained	-	SN4
			4	Some information is not filled in	-	SN1	Actors are tired. They did not pay attention	-	SN3
			5	Decision makers did not properly analyze the information	-	SN2	Decision-makers have no experience	SN4	-
			5	The capacity is wrong	-	IN1	Poor analysis of the centre's capacity	-	IN4
			1	The line is down or out of service	-	CN1	-	-	-
			2	They are not reachable	-	CN1	-	-	-
			3	There is a bad connection	-	CN1	-	-	-
			4	Part of information is not received	-	IN2	-	-	-
			4	Not enough actors at the centre	-	SN2	Centre does not have a lot of actors	SN4	-
5	They confuse the senders and their requests	-	SN1	They did not pay attention	-	SN3			
6	Lots of communication to do	-	IN1	-	-	-			
6	Not enough actors at the centre	-	SN2	Centre does not have a lot of actors	SN4	-			

Cause III	Category of cause III	Source	Effect I	Legacy of effect		Effect II	Legacy of effect		Effect III	Legacy of effect		Target	S	O	C
				During	After		During	After		During	After				
-	-	J	They do not make a decision	ON4	-	-	-	-	-	-	J	4	1	4	
Not enough budget to train actors in decision making	SN6	J	They do not make a decision	ON4	-	-	-	-	-	-	J	4	1	4	
-	-	J	The available actors are stressed and panicked	ON3	-	-	-	-	-	-	J	4	1	4	
-	-	J	They do not make a decision	ON4	-	-	-	-	-	-	J	4	1	4	
-	-	J	The capacity is not determined yet	ON4	-	-	-	-	-	-	J	3	3	9	
No budget to organize enough trainings	SN6	J	The capacity is not determined yet	ON4	-	-	-	-	-	-	J	3	3	9	
-	-	J	The decision-makers are stressed	ON3	-	-	-	-	-	-	J	3	3	9	
No budget to organize a training	SN6	J	The capacity is not correct	ON3	-	Actors are not triggered correctly	ON7	-	The centre's image is distorted	ON10	J,M	3	2	6	
-	-	J	No actor is triggered	ON5	-	-	-	-	-	-	J	2	1	2	
The center never thought that another event would happen	SN5	J	No actor is triggered	ON5	-	-	-	-	-	-	J	3	1	3	
Not enough budget to train actors in decision making	SN6	J	The available actors are stressed and panicked	ON3	-	-	-	-	-	-	J	3	1	3	
-	-	J	No actor is triggered	ON5	-	-	-	-	-	-	J	3	1	3	
-	-	J	No actor is triggered	ON5	-	-	-	-	-	-	J,M	3	1	3	
No budget to buy new trucks	SN6	J	No actor is triggered	ON5	-	-	-	-	-	-	J,M	3	1	3	
No budget to maintain trucks	SN6	J	No actor is triggered	ON5	-	-	-	-	-	-	J,M	3	1	3	
No budget to organize enough trainings	SN6	J	Assignment is under discussion	ON5	-	-	-	-	-	-	J,M	3	3	9	
-	-	J	Security agents are triggered late	ON1	-	Late receipt of the information	ON6	-	-	-	J,M	3	3	9	
No budget for trainings	SN6	J	Some of the security agents are triggered	ON1	-	-	-	-	-	-	J,M	2	1	2	
-	-	J	The number of actors triggered is wrong	ON1	-	-	-	-	-	-	J,M	3	1	3	
-	-	J	No information is provided	ON5	-	-	-	-	-	-	J,M	1	1	1	
-	-	J	No information is provided	ON5	-	-	-	-	-	-	J,M	2	1	2	
-	-	J	Information is poorly provided	ON1	-	-	-	-	-	-	J,M	3	1	3	
-	-	J	Part of information is not processed	ON1	-	-	-	-	-	-	J,M	3	1	3	
-	-	J	Communication is with the wrong senders	ON1	-	-	-	-	-	-	J,M	1	1	1	
-	-	J	Communication is late	ON1	-	-	-	-	-	-	J,M	2	2	4	

Figure A.2: Security centre's FMECA table in decentralized architecture

Based on the FMECA tables, the tables A.3 and A.4 show the vulnerability indicators of the firefighter department in the two architectures: semi-centralized and decentralized.

Code	Nature	Interactions	Cost	Impact	Recurrence	Technicality	Material	Fluids	Network	Infrastructure	Failure modes
k.1	D	I	A	A	U	M	Y	N	N	Y	0,1,2,3,5
k.2	D,I	I,E	I	A	U	E	Y	N	Y	Y	0,1,2,3,4,5,6
k.3	I	I	I	A	U	E	Y	N	Y	Y	0,1,3,5
k.4	I	I,E	I	A	U	E	Y	N	Y	Y	0,1,2,3,4,5
k.5	I	E	I	A	R	E	Y	N	Y	Y	1,2,3,4,5,6

Table A.3: Firefighter department's vulnerability indicators for figure A.3

Activity	Code	Mode	Category	Cause I	Category of cause I	Cause II	Category of cause II	
Verify capacity	K.1	The capacity is not verified	1	Alert is not received	-	BN1	-	
		The capacity is not verified	1	No actors capable of making a decision at the centre	-	SN2	The actors' schedules are poorly organized	SN4
		The capacity cannot be verified	2	Decision makers are reluctant to make the decision	-	SN1	Decision-makers are stressed and tired	SN3
		Verifying the capacity takes longer than expected	3	The alert is received late	-	BN1	-	-
		The capacity is wrongly verified	5	Decision makers did not properly analyze the information	-	SN2	Decision-makers have no experience	SN4
Suggest an assignment	K.2	The suggestions are not sent	1	Capacity is not received	-	BN1	Decision is not made	BN4
		The suggestions cannot be sent	2	There is no connection	-	CN1	-	-
		Sending suggestions takes longer than expected	3	They are not reachable	-	BN1	-	-
		Not all suggestions are sent	4	Decisions are received late	-	BN1	They took time to decide	BN4
		Suggestions are wrongly sent	5	Part of suggestions are missing	-	CN1	-	-
Receive information	K.3	Suggestions are wrongly sent	5	Decisions are wrongly received	-	BN1	The decisions are incorrect	BN4
		Suggestions are sent at an irregular pace	6	There is a bad connection	-	CN1	-	-
		The information is not received	1	Suggestions are not sent	-	BN2	Decisions are not made	BN5
		The information is not received	1	There is no connection	-	CN1	-	-
		Receiving information takes longer than expected	3	There is a bad connection	-	CN1	-	-
Trigger the firefighters	K.4	Information is wrongly received	5	The information sent is incorrect	-	BN2	The decision made is incorrect	BN5
		The firefighters are not triggered	1	Information is not received	-	BN1	-	-
		The firefighters cannot be triggered	2	The line is down or out of service	-	CN1	-	-
		Triggering firefighters takes longer than expected	3	They are not reachable	-	BN1	-	-
		Not all firefighters are triggered	4	Some information is not filled in	-	SN1	The actors are tired. They did not pay attention.	SN3
Communicate with firefighters	K.5	Firefighters are wrongly triggered	5	The decision received is incorrect	-	BN2	The decision made is incorrect	BN5
		The communication is not done	1	The line is down or out of service	-	CN1	-	-
		The communication cannot be done	2	They are not reachable	-	CN1	-	-
		The communication takes longer than expected	3	There is a bad connection	-	CN1	-	-
		Not all communication is done	4	Part of information is not received	-	BN2	-	-

Cause III	Category of cause III	Source	Effect I	Category of Effect I	Effect II	Category of Effect II	Effect III	Category of Effect III	Target	S	O	C
Not enough budget to train actors in decision making	SN6	R	They do not make a decision	ON4	-	-	-	-	R	4	1	4
-	-	R	They do not make a decision	ON4	-	-	-	-	R	4	1	4
-	-	R	The capacity is not determined yet	ON4	-	-	-	-	R	3	1	3
No budget to organize a training	SN6	R	The capacity is not correct	ON2	-	The suggestions are incorrect	ON7	-	ON10	R	3	2
-	-	R	They did not send any suggestions	ON5	-	-	-	-	R,M	3	1	3
-	-	R	No suggestions are received	ON5	-	-	-	-	R,M	3	1	3
-	-	R	Suggestions are sent late	ON1	-	Late receipt of the proposal	ON6	-	R,M	3	1	3
-	-	R	Part of the suggestions are not sent	ON1	-	Not all suggestions are received	ON6	-	R,M	4	1	4
-	-	R	Suggestions are not received immediately	ON1	-	Suggestions received are incorrect	ON6	-	R,M	4	1	4
-	-	R	They received no information	ON4	-	Decisions are made late	ON6	-	R,M	3	1	3
-	-	R	They received no information	ON4	-	-	-	-	R	2	1	2
-	-	R	Information received late	ON2	-	Actors are not triggered on time	ON7	-	R	3	1	3
-	-	R	The information received is incorrect	ON2	-	The actors are wrongly triggered	ON7	-	R	4	1	4
-	-	R	No actor is triggered	ON5	-	-	-	-	R,D	1	1	1
-	-	R	No actor is triggered	ON5	-	-	-	-	R,D	1	1	1
-	-	R	Firefighters are triggered late	ON1	-	Late receipt of the information	ON6	-	R,D	3	1	3
-	-	R	Part of firefighters are not triggered	ON1	-	-	-	-	R,D	3	1	3
-	-	R	The number of actors triggered is incorrect	ON1	-	-	-	-	R,D	4	1	4
-	-	R	No information is provided	ON5	-	-	-	-	R,D	2	1	2
-	-	R	No information is provided	ON5	-	-	-	-	R,D	2	1	2
-	-	R	Information is poorly processed	ON1	-	-	-	-	R,D	3	1	3
-	-	R	Part of information is not processed	ON1	-	-	-	-	R,D	3	1	3
-	-	R	Communication is with the wrong senders	ON1	-	-	-	-	R,D	3	1	3
-	-	R	Communication is late	ON1	-	-	-	-	R,D	2	1	2

Figure A.3: Firefighter department's FMECA table in semi-centralized architecture

Code	Nature	Interactions	Cost	Impact	Recurrence	Technicality	Material	Fluids	Network	Infrastructure	Failure modes
k.1	D	I	A	A	U	M	Y	N	N	Y	0,1,2,3,5
k.2	D,I	I,E	I	A	U	E	Y	N	Y	Y	0,1,2,3,4,5
k.3	I	E	I	A	R	E	Y	N	Y	Y	1,2,3,4,5,6

Table A.4: Firefighter department's vulnerability indicators for figure A.4

A.3 Ambulance centre

The FMECA tables of the ambulance centre are shown in figure A.5 for the semi-centralized architecture and in figure A.6 for the decentralized architecture.

Based on the FMECA tables, the tables A.5 and A.6 show the vulnerability indicators of the ambulance centre in the two architectures: semi-centralized and decentralized.

Activity	Code	Mode	Category	Cause I	Category of cause		Cause II	Category of cause	
					Before	During		Before	During
Verify capacity	K.1		0	Alert in not received	-	BN1	-	-	-
			1	No actors capable of making a decision at the centre	-	SN2	The actors' schedules are poorly organized	SN4	-
			2	Decision makers are reluctant to make the decision	-	SN1	Decision-makers are stressed and tired	-	SN3
			3	The alert is received late	-	BN1	-	-	-
			5	The decision-makers have difficulties processing information	-	SN2	Decision-makers do not have enough experience	SN4	-
Trigger the firefighters	K.2		6	Decision makers did not properly analyze the information	-	SN2	Decision-makers have no experience	SN4	-
			0	Capacity is not received	-	BN1	Decision is not made	-	BN4
			1	No available actors at the centre	-	SN2	All the actors are assigned to another event	SN4	-
			1	No actors capable of making a decision at the centre	-	SN2	The actors' schedules are poorly organized	SN4	-
			1	They forgot to trigger the actors	-	CN1	-	-	-
			2	There is no connection	-	CN1	-	-	-
			2	They are not reachable	-	SN2	The centre did not order new trucks	SN4	-
Communicate with firefighters	K.3		2	No available trucks on site	-	SN2	The centre did not maintain the trucks	SN4	-
			3	The trucks are out of order	-	SN2	Decision-makers do not have enough experience	SN4	-
			3	The decision-makers have difficulties processing information	-	CN1	-	-	-
			3	There is a bad connection	-	SN2	They are not trained	SN4	-
			4	Actors do not know how to trigger (send it)	-	SN1	Actors are tired. They did not pay attention	SN4	-
			4	Some information is not filled in	-	SN2	Decision-makers have no experience	SN4	-
			5	Decision makers did not properly analyze the information	-	BN1	Poor analysis of the centre's capacity	-	DN4
1	The line is down or out of service	-	CN1	-	-	-			
2	They are not reachable	-	CN1	-	-	-			
3	There is a bad connection	-	BN2	-	-	-			
4	Part of information is not received	-	SN2	Centre does not have a lot of actors	SN4	-			
5	They confuse the senders and their requests	-	SN1	They did not pay attention	-	SN3			
6	Lots of communication to do	-	BN1	-	-	-			
6	Not enough actors at the centre	-	SN2	Centre does not have a lot of actors	SN4	-			

Cause III	Category of cause III	Source	Effect I	Category of effect		Effect II	Category of effect		Effect III	Category of effect		Target	S	O	C
				During	After		During	After		During	After				
-	-	K	They do not make a decision	ON4	-	-	-	-	-	-	-	K	4	1	4
Not enough budget to train actors in decision making	SN6	K	The available actors are stressed and panicked	ON3	-	-	-	-	-	-	-	K	4	1	4
-	-	K	They do not make a decision	ON4	-	-	-	-	-	-	-	K	4	1	4
-	-	K	The capacity is not determined yet	ON4	-	-	-	-	-	-	-	K	3	3	9
No budget to organize enough trainings	SN6	K	The decision-makers are stressed	ON3	-	-	-	-	-	-	-	K	3	3	9
No budget to organize a training	SN6	K	The capacity is not correct	ON2	-	Actors are not triggered correctly	ON7	-	The centre's image is distorted	-	ON10	K	3	2	6
-	-	K	No actor is triggered	ON5	-	-	-	-	-	-	-	K	2	1	2
The center never thought that another event would happen	SN5	K	No actor is triggered	ON5	-	-	-	-	-	-	-	K	3	1	3
Not enough budget to train actors in decision making	SN6	K	The available actors are stressed and panicked	ON3	-	-	-	-	-	-	-	K	3	1	3
-	-	K	No actor is triggered	ON5	-	-	-	-	-	-	-	K	3	1	3
No budget to buy new trucks	SN6	K	No actor is triggered	ON5	-	-	-	-	-	-	-	K	3	1	3
No budget to maintain trucks	SN6	-	-	-	-	-	-	-	-	-	-	-	-	-	-
No budget to organize enough trainings	SN6	K	Assignment is under discussion	ON5	-	-	-	-	-	-	-	K	3	3	9
No budget for trainings	SN6	K	Firefighters are triggered late	ON1	-	Late receipt of the information	ON6	-	-	-	-	K	3	3	9
-	-	K	Some of the firefighters are triggered	ON1	-	-	-	-	-	-	-	K	2	1	2
No budget for trainings	SN6	K	The number of actors triggered is wrong	ON1	-	-	-	-	-	-	-	K	3	1	3
-	-	K	No information is provided	ON5	-	-	-	-	-	-	-	K	1	1	1
-	-	K	No information is provided	ON5	-	-	-	-	-	-	-	K	2	1	2
-	-	K	Information is poorly provided	ON1	-	-	-	-	-	-	-	K	3	1	3
-	-	K	Part of information is not processed	ON1	-	-	-	-	-	-	-	K	3	1	3
-	-	K	Communication is with the wrong senders	ON1	-	-	-	-	-	-	-	K	1	1	1
-	-	K	Communication is late	ON1	-	-	-	-	-	-	-	K	2	2	4

Figure A.4: Firefighter department's FMECA table in decentralized architecture

Code	Nature	Interactions	Cost	Impact	Recurrence	Technicality	Material	Fluids	Network	Infrastructure	Failure modes
I.1	D	I	A	A	U	M	Y	N	N	Y	0,1,2,3,5
I.2	D,I	I,E	I	A	U	E	Y	N	Y	Y	0,1,2,3,4,5,6
I.3	I	I	I	A	U	E	Y	N	Y	Y	0,1,3,5
I.4	I	I,E	I	A	U	E	Y	N	Y	Y	0,1,2,3,4,5
I.5	I	E	I	A	R	E	Y	N	Y	Y	1,2,3,4,5,6

Table A.5: Ambulance centre's vulnerability indicators for figure A.5

A.4 Security officers

The FMECA table of the security officers is shown in figure A.7 for both architectures. Table A.7 is filled according to this FMECA table.

Activity	Code	Mode	Category	Cause I		Category of cause I		Cause II		Category of cause II	
				Before	During	Before	During	Before	During		
Verify capacity	L.1		0	Alert in not received	-	-	IN1	-	-	-	-
			1	No actors capable of making a decision at the centre	-	-	SN2	The actors' schedules are poorly organized	SN4	-	-
			2	Decision makers are reluctant to make the decision	-	-	SN1	Decision-makers are stressed and tired	-	SN3	-
			3	The decision-makers have difficulties processing information	-	-	IN1	-	-	-	-
			5	Decisions are wrongly received	-	-	SN2	Decision-makers do not have enough experience	SN4	-	-
Suggest an assignment	L.2		0	Capacity is not received	-	-	IN1	Decision is not made	-	IN4	-
			1	There is no connection	-	-	CN1	-	-	-	-
			2	They forgot to send them	-	-	CN1	-	-	-	-
			3	Decisions are received late	-	-	IN1	They took time to decide	-	IN4	-
			4	Actors do not know how to send them	-	-	SN2	They have no experience	SN4	-	-
			5	There is a bad connection	-	-	CN1	-	-	-	-
			6	Part of suggestions are missing	-	-	CN1	-	-	-	-
			7	Some of the suggestions are not filled in	-	-	SN1	The actors are tired. They did not pay attention.	-	SN3	-
			8	Decisions are wrongly received	-	-	IN1	The decisions are incorrect	-	IN4	-
			9	There is a bad connection	-	-	CN1	-	-	-	-
Receive information	L.3		0	Suggestions are not sent	-	-	IN2	Decisions are not made	-	IN5	-
			1	There is no connection	-	-	CN1	-	-	-	-
			2	They did not read the message	-	-	CN1	-	-	-	-
			3	There is a bad connection	-	-	CN1	-	-	-	-
			4	The information sent is incorrect	-	-	IN2	The decision made is incorrect	-	IN5	-
Trigger the security agents	L.4		0	Information is not received	-	-	IN1	-	-	-	-
			1	The line is down or out of service	-	-	SN2	-	-	-	-
			2	No available actors in the centre	-	-	SN1	The actors' schedules are poorly organized	SN4	-	-
			3	They are not reachable	-	-	CN1	-	-	-	-
			4	There is a bad connection	-	-	CN1	-	-	-	-
Communicate with security agents	L.5		5	Some information is not filled in	-	-	SN1	The actors are tired. They did not pay attention.	-	SN3	-
			6	The decision received is incorrect	-	-	IN2	The decision made is incorrect	-	IN5	-
			7	The line is down or out of service	-	-	CN1	-	-	-	-
			8	They are not reachable	-	-	CN1	-	-	-	-
			9	There is a bad connection	-	-	CN1	-	-	-	-
			0	Part of information is not received	-	-	IN2	-	-	-	-
			1	Not enough actors at the centre	-	-	SN2	Centre does not have a lot of actors	SN4	-	-
			2	They confuse the senders and their requests	-	-	SN1	They did not pay attention	-	SN3	-
			3	Lots of communication to do	-	-	IN1	-	-	-	-
			4	Not enough actors at the centre	-	-	SN2	Centre does not have a lot of actors	SN4	-	-

Cause III	Category of cause III	Source	Effect I	Category of effect I		Effect II	Category of effect II		Effect III	Category of effect III		Target	S	O	C
				Before	After		Before	After		Before	After				
-	-	-	L They do not make a decision	ON4	-	-	-	-	-	-	-	L	4	1	4
Not enough budget to train actors in decision making	SN6	L	L They do not make a decision	ON4	-	-	-	-	-	-	-	L	4	1	4
-	-	L	L The available actors are stressed and panicked	ON5	-	-	-	-	-	-	-	L	4	1	4
-	-	L	L They do not make a decision	ON4	-	-	-	-	-	-	-	L	4	1	4
-	-	L	L The capacity is not determined yet	ON4	-	-	-	-	-	-	-	L	3	3	9
No budget to organize enough trainings	SN6	L	L The capacity is not determined yet	ON4	-	-	-	-	-	-	-	L	3	3	9
-	-	L	L The decision-makers are stressed	ON3	-	-	-	-	-	-	-	L	3	2	6
No budget to organize a training	SN6	L	L The capacity is not correct	ON2	-	The suggestions are incorrect	ON7	-	The centre's image is distorted	-	ON10	L	3	2	6
-	-	L	L They did not send any suggestions	ON5	-	-	-	-	-	-	-	L	M	1	1
-	-	L	L No suggestions are received	ON5	-	-	-	-	-	-	-	L	M	2	1
-	-	L	L No suggestions are received	ON5	-	-	-	-	-	-	-	L	M	3	1
No budget to organize trainings	SN6	L	L Suggestions are sent late	ON1	-	Late receipt of the proposal	ON6	-	-	-	-	L	M	3	2
-	-	L	L Part of the suggestions are not sent	ON1	-	Not all suggestions are received	ON6	-	-	-	-	L	M	4	1
-	-	L	L Suggestions sent are incorrect	ON1	-	Suggestions received are incorrect	ON6	-	The centre's image is distorted	-	ON9	L	M	4	1
-	-	L	L Suggestions are not received immediately	ON1	-	Decisions are made late	ON6	-	-	-	-	L	M	2	1
No budget for new equipment or system maintenance	SN6	L	L They received no information	ON4	-	-	-	-	-	-	-	L	2	1	2
-	-	L	L They received no information	ON4	-	-	-	-	-	-	-	L	2	1	2
-	-	L	L Information received late	ON2	-	Actors are not triggered on time	ON7	-	-	-	-	L	3	1	3
-	-	L	L The information received is incorrect	ON2	-	The actors are wrongly triggered	ON7	-	-	-	-	L	4	1	4
-	-	L	L No actor is triggered	ON5	-	-	-	-	-	-	-	L	1	1	1
-	-	L	L No actor is triggered	ON5	-	-	-	-	-	-	-	L	1	1	1
-	-	L	L No actor is triggered	ON5	-	-	-	-	-	-	-	L	1	1	1
-	-	L	L No actor is triggered	ON5	-	-	-	-	-	-	-	L	2	1	2
No budget for trainings	SN6	L	L Ambulances are triggered late	ON1	-	Late receipt of the information	ON6	-	-	-	-	L	1	9	3
-	-	L	L Part of ambulances are not triggered	ON1	-	-	-	-	-	-	-	L	3	1	3
-	-	L	L The number of actors triggered is incorrect	ON1	-	-	-	-	-	-	-	L	4	1	4
-	-	L	L No information is provided	ON5	-	-	-	-	-	-	-	L	1	1	1
-	-	L	L No information is provided	ON5	-	-	-	-	-	-	-	L	1	2	1
-	-	L	L Information is poorly provided	ON1	-	-	-	-	-	-	-	L	1	3	1
-	-	L	L Part of information is not processed	ON1	-	-	-	-	-	-	-	L	1	3	1
-	-	L	L Communication is with the wrong senders	ON1	-	-	-	-	-	-	-	L	1	1	1
-	-	L	L Communication is late	ON1	-	-	-	-	-	-	-	L	1	2	2

Figure A.5: Ambulance centre's FMECA table in semi-centralized architecture

Code	Nature	Interactions	Cost	Impact	Recurrence	Technicality	Material	Fluids	Network	Infrastructure	Failure modes
I.1	D	I	A	A	U	M	Y	N	N	Y	0,1,2,3,5
I.2	D,I	I,E	I	A	U	E	Y	N	Y	Y	0,1,2,3,4,5
I.3	I	E	I	A	R	E	Y	N	Y	Y	1,2,3,4,5,6

Table A.6: Ambulance centre's vulnerability indicators for figure A.6

Activity	Code	Mode	Category	Cause I		Cause II		Effect of cause	
				Before	During	Before	During	Before	During
Verify capacity	L.1	The capacity is not verified		Alert in not received	-	IN1	-	-	-
		The capacity is not verified	1	No actors capable of making a decision at the centre	-	SN2	The actors' schedules are poorly organized	-	SN4
		The capacity cannot be verified	2	Decision makers are reluctant to make the decision	-	SN1	Decision-makers are stressed and tired	-	SN3
		The capacity takes longer than expected	3	The alert is received late	-	IN1	-	-	-
		Verifying the capacity takes longer than expected	3	The decision-makers have difficulties processing information	-	SN2	Decision-makers do not have enough experience	-	SN4
Trigger the ambulances	L.2	The capacity is wrongly verified	5	Decision makers did not properly analyze the information	-	SN2	Decision-makers have no experience	-	SN4
		The ambulances are not triggered	0	Capacity is not received	-	IN1	Decision is not made	-	IN4
		The ambulances are not triggered	1	No available actors at the centre	-	SN2	All the actors are assigned to another event	-	SN4
		The ambulances are not triggered	1	No actors capable of making a decision at the centre	-	SN2	The actors' schedules are poorly organized	-	SN4
		The ambulances are not triggered	1	They forgot to trigger the actors	-	CN1	-	-	-
		The ambulances are not triggered	1	There is no connection	-	CN1	-	-	-
		The ambulances cannot be triggered	2	They are not reachable	-	CN1	-	-	-
		The ambulances cannot be triggered	2	No available trucks on site	-	SN2	The centre did not order new trucks	-	SN4
		The ambulances cannot be triggered	2	The trucks are out of order	-	SN2	The centre did not maintain the trucks	-	SN4
		Triggering ambulances takes longer than expected	3	The decision-makers have difficulties processing information	-	SN2	Decision-makers do not have enough experience	-	SN4
Communicate with ambulances	L.3	Not all ambulances are triggered	4	There is a bad connection	-	CN1	-	-	
		Not all ambulances are triggered	4	Actors do not know how to trigger (send it)	-	SN2	They are not trained	-	SN4
		Ambulances are wrongly triggered	5	Some information is not filled in	-	SN1	Actors are tired. They did not pay attention	-	SN3
		Ambulances are wrongly triggered	5	Decision makers did not properly analyze the information	-	SN2	Decision-makers have no experience	-	SN4
		The communication is not done	1	The capacity is wrong	-	IN1	Poor analysis of the centre's capacity	-	IN4
		The communication cannot be done	2	The line is down or out of service	-	CN1	-	-	-
		The communication takes longer than expected	3	They are not reachable	-	CN1	-	-	-
		The communication takes longer than expected	3	There is a bad connection	-	CN1	-	-	-
		Not all communication is done	4	Part of information is not received	-	IN2	-	-	-
		Communication is wrongly done	5	Not enough actors at the centre	-	SN2	Centre does not have a lot of actors	-	SN4
Communication is done at an irregular pace	6	They confuse the senders and their requests	-	SN1	They did not pay attention	-	SN3		
				Lots of communication to do	-	IN1	-	-	
				Not enough actors at the centre	-	SN2	Centre does not have a lot of actors	-	SN4

Cause III	Category of cause III	Source	Effect I		Effect II		Effect III		Target	S	O	C	
			Before	During	After	Before	During	After					
-	-	L	They do not make a decision	ON4	-	-	-	-	L	4	1	4	
Not enough budget to train actors in decision making	SN6	L	They do not make a decision	ON4	-	-	-	-	L	4	1	4	
		L	The available actors are stressed and panicked	ON3	-	-	-	-	L	4	1	4	
-	-	L	They do not make a decision	ON4	-	-	-	-	L	4	1	4	
-	-	L	The capacity is not determined yet	ON4	-	-	-	-	L	3	3	9	
No budget to organize enough trainings	SN6	L	The capacity is not determined yet	ON4	-	-	-	-	L	3	3	9	
No budget to organize a training	SN6	L	The decision-makers are stressed	ON3	-	-	-	-	L	3	2	6	
		L	The capacity is not correct	ON2	-	Actors are not triggered correctly	ON7	-	ON10	L	3	2	6
		L	No actor is triggered	ON5	-	-	-	-	L	2	1	2	
The center never thought that another event would happen	SN5	L	No actor is triggered	ON5	-	-	-	-	L	2	1	2	
Not enough budget to train actors in decision making	SN6	L	The available actors are stressed and panicked	ON3	-	-	-	-	L	3	1	3	
		L	No actor is triggered	ON5	-	-	-	-	L	3	1	3	
No budget to buy new trucks	SN6	L	No actor is triggered	ON5	-	-	-	-	L, M	3	1	3	
No budget to maintain trucks	SN6	L	Assignment is under discussion	ON5	-	-	-	-	L, M	3	3	9	
No budget to organize enough trainings	SN6	L	Ambulances are triggered late	ON1	-	Late receipt of the information	ON6	-	L, M	3	3	9	
No budget for trainings	SN6	L	Some of the ambulances are triggered	ON1	-	-	-	-	L, M	2	1	2	
No budget for trainings	SN6	L	The number of actors triggered is wrong	ON1	-	-	-	-	L, M	3	1	3	
		L	No information is provided	ON5	-	-	-	-	L, M	1	1	1	
		L	No information is provided	ON5	-	-	-	-	L, M	2	1	2	
		L	Information is poorly provided	ON1	-	-	-	-	L, M	3	1	3	
		L	Part of information is not processed	ON1	-	-	-	-	L, M	3	1	3	
		L	Communication is with the wrong senders	ON1	-	-	-	-	L, M	1	1	1	
		L	Communication is late	ON1	-	-	-	-	L, M	2	2	4	

Figure A.6: Ambulance centre's FMECA table in decentralized architecture

Code	Nature	Interactions	Cost	Impact	Recurrence	Technicality	Material	Fluids	Network	Infrastructure	Failure modes
N.1	D,I	I	I	I	U	E	Y	N	Y	N	0,1,2,3,5,6
N.2	I	E	I	A	R	E	Y	N	Y	Y	1,2,3,4,6
N.3	O	I	I	I	U	M	Y	Y	N	Y	0,1,3,4,6
N.4	O	I	I	I	U	M	Y	N	N	N	0,1,2,3,4
N.5	O	I	I	I	U	H	Y	N	N	N	0,1,2,3,4,5,6
N.6	O	I	I	I	U	H	Y	N	N	N	0,1,3,5
N.7	I	E	I	I	U	E	Y	N	Y	Y	0,1,2
N.8	I	I	I	A	U	E	Y	N	Y	Y	0,1,3,5
N.9	I	I	I	A	U	E	Y	N	Y	Y	0,1,3

Table A.7: Security officers vulnerability indicators for figure A.7

Activity	Code	Mode	Category	Cause I	Category of cause I		Cause II	Category
					Before	During		
Choose the suitable path to the site	N1	No road to the site is found	1	Actors are not triggered	-	BN1	Destination is not received	-
		No road to the site is found	1	They don't know the destination	-	BN1	Destination is not received	-
		A road to the site cannot be found	2	All roads leading to the site are closed	-	CN1	There is another big event in the city	-
Communicate with security centre	N2	Choosing a road is taking longer than expected	3	The GPS is out of service	-	SN2	No maintenance for GPS is performed	SN4
		Road is wrongly chosen	5	There is a bad connection	-	CN1	-	-
		The road is chosen at an irregular pace	2	Actors hesitate to choose a route	-	SN1	They are stressed	-
		The communication is not done	1	Actors enter the wrong destination	-	SN1	They did not pay attention	-
		The communication cannot be done	2	There are a lot of interruptions on the road (an accident may occur in front of the actors)	-	SN1	-	-
Go to the site	N3	The communication takes longer than expected	3	There is no connection	-	CN1	-	-
		Not all communication is done	4	There are not reachable	-	CN1	-	-
		Communication is done at an irregular pace	6	Standstill of the wrong every few minutes	-	SN2	Centre does not have a lot of actors	SN4
Seal off the area	N4	The actors are not going to the site	6	They don't know which road to take	-	BN1	No maintenance of equipment and systems	SN4
		The actors are not going to the site	1	No available cars at the centre	-	SN2	Centre does not have a lot of cars	SN4
		The actors cannot go to the site	2	All the cars are out of order	-	SN2	Centre did not maintain the cars	SN4
Neutralize the area	N5	Going to the site takes longer than expected	3	There is traffic	-	CN1	Not enough cars for all actors	SN4
		Not all actors are going to the site	2	There are no places available for everyone to go	-	SN2	Lack of resource management	SN4
		The area is not closed	1	No actor on the site	-	BN1	The actors have not yet arrived	SN4
Make sure there is no other possible attack	N6	The area cannot be closed	2	First communication between actors	-	CN1	Lack of resource management	SN4
		The sealing of the area is taking longer than expected	3	The actors do not have a tape	-	SN2	Poor resource estimation	SN4
		Not all the area is closed	4	No actor on the site	-	BN1	Bad estimation of required tapes	SN4
Allow other actors to intervene	N7	The area is not neutralized	4	No actor on the site	-	BN1	The actors have not yet arrived	-
		The area is not neutralized	1	This is the first intervention of actors	-	SN1	Actors are injured	-
		The area cannot be neutralized	2	The actors have no weapons	-	SN1	Lack of resource management	SN4
Receive the demand	N8	The neutralization of the area is taking longer than expected	3	Actors are not properly dimensioned in terms of equipment and personnel	-	SN2	Poor resource estimation	SN4
		Not all the area is neutralized	4	Aggressive environment (dangerousness)	-	CN1	Actors are injured	-
		The neutralization of the area is done wrongly	5	Some attackers fled to another site	-	CN1	No anticipation of the attacker's existence	BN2
Receive the demand (from firefighters)	N9	The neutralization of the area is done at an irregular pace	6	Aggressive environment (dangerousness)	-	CN1	Lack of resource management	SN4
		The assurance of not having another event is not made	1	This is the first intervention of actors	-	SN1	Poor resource estimation	SN4
		The assurance of not having another event is wrongly made	5	Actors are not properly dimensioned in terms of equipment and personnel	-	SN2	Poor resource estimation	SN4

Cause II	Cause III	Category of cause III	Source	Effect I	Category of effect I		Effect II	Category of effect II		Effect III	Category of effect III		Target	S	O	C
					Before	During		After	Before		During	After				
-	-	-	-	They did not search for a road	ON4	-	-	-	-	-	-	-	N	1	1	1
-	-	-	-	They did not search for a road	ON4	-	-	-	-	-	-	-	N	4	1	4
-	-	-	-	No available road is found	ON4	-	-	-	-	-	-	-	N	4	1	4
-	-	-	-	Actors belatedly find a road to the site	ON2	-	The actors go to the site late	ON7	-	Possibility of death	ON10	-	N	5	1	5
-	-	-	-	Choosing a road is under discussion	ON4	-	-	-	-	-	-	-	N	5	1	5
-	-	-	-	The chosen road does not lead to the site	ON4	-	Actors go to the wrong place	ON7	-	Victims' death	ON10	-	N	5	1	5
-	-	-	-	Actors may take the long road	ON4	-	Actors arrive late at the site	ON7	-	Possibility of death	ON10	-	N	5	1	5
-	-	-	-	No information is provided	ON5	-	-	-	-	-	-	-	N, J	3	1	3
-	-	-	-	Information is poorly provided	ON5	-	-	-	-	-	-	-	N, J	3	1	3
-	-	-	-	Part of information is not processed	ON5	-	-	-	-	-	-	-	N, J	4	1	4
-	-	-	-	Communication is poor	ON1	-	-	-	-	-	-	-	N, J	3	1	3
-	-	-	-	Actors did not leave the centre	ON4	-	-	-	-	-	-	-	N	5	1	5
-	-	-	-	Actors did not leave the centre	ON4	-	-	-	-	-	-	-	N	5	1	5
-	-	-	-	Actors arrive late at the site	ON2	-	Securing the area starts late	ON7	-	More victims could die	ON10	-	N	5	3	10
-	-	-	-	Actors are not enough	ON2	-	Securing the area takes longer	ON7	-	Victims can increase	ON10	-	N	5	1	5
-	-	-	-	Not all the needed actors are on site at the same time	ON2	-	Securing the area takes longer	ON7	-	Increasing number of victims	ON10	-	N	3	2	6
-	-	-	-	The area is not secured	ON4	-	-	-	-	-	-	-	N	4	1	4
-	-	-	-	The area is not secured	ON4	-	-	-	-	-	-	-	N	4	1	4
-	-	-	-	The area is not secured	ON4	-	-	-	-	-	-	-	N	4	1	4
-	-	-	-	The area is not secured	ON4	-	-	-	-	-	-	-	N	4	1	4
-	-	-	-	The area is not secured	ON4	-	-	-	-	-	-	-	N	5	1	5
-	-	-	-	Securing the area is overdue	ON2	-	-	-	-	-	-	-	N, D	5	3	10
-	-	-	-	Part of the area is secured	ON2	-	-	-	-	-	-	-	N	5	1	5
-	-	-	-	Another area is also at risk	ON2	-	No authorization is given	ON7	-	Increase in the number of victims	ON10	-	N, D	5	1	5
-	-	-	-	Securing the area takes longer	ON2	-	-	-	-	-	-	-	N, D	5	1	5
-	-	-	-	The area is not secured	ON4	-	-	-	-	-	-	-	N	4	1	4
-	-	-	-	The area is not secured	ON4	-	-	-	-	-	-	-	N	4	1	4
-	-	-	-	The area is not secured	ON4	-	-	-	-	-	-	-	N	4	1	4
-	-	-	-	Securing the area is overdue	ON2	-	-	-	-	-	-	-	N, D	5	2	10
-	-	-	-	The area is not secured	ON4	-	-	-	-	-	-	-	N, D	5	1	5
-	-	-	-	No authorization is given	ON5	-	-	-	-	-	-	-	N, D	4	1	4
-	-	-	-	No authorization is given	ON5	-	-	-	-	-	-	-	N, D	4	1	4
-	-	-	-	They received no information	ON4	-	-	-	-	-	-	-	N	2	1	2
-	-	-	-	They received no information	ON4	-	-	-	-	-	-	-	N	3	1	3
-	-	-	-	Information received late	ON2	-	Choosing the road starts late	ON7	-	Getting stuck in traffic	ON10	-	N	4	1	4
-	-	-	-	The information received is incorrect	ON2	-	Choosing the wrong road	ON7	-	Not acted on site	ON10	-	N	4	1	4
-	-	-	-	The information received is incorrect	ON2	-	-	-	-	-	-	-	N	2	1	2
-	-	-	-	They received no information	ON4	-	-	-	-	-	-	-	N	3	1	3
-	-	-	-	Information received late	ON2	-	Authorization is given late	ON7	-	Victims can increase	ON10	-	N	4	1	4

Figure A.7: Security officers' FMECA table in both architectures

A.5 Ambulances

The FMECA tables of the ambulances are shown in figure A.8 for the semi-centralized architecture and in figure A.9 for the decentralized architecture.

Based on the FMECA tables, the tables A.8 and A.9 show the vulnerability indicators of an ambulance in the two architectures: semi-centralized and decentralized.

Activity	Code	Mode	Category	Cause I		Cause II		Cause III	
				Severity or cause	Before	Severity or cause	Before	Severity or cause	Before
Choose the suitable path to the site	11	No road to the site is found	1	Actors are not triggered	-	-	-	-	-
		No road to the site is found	1	They don't know the destination	-	-	-	-	-
		A road to the site cannot be found	2	All roads leading to the site are closed	-	-	-	-	-
		Choosing/finding a road takes longer than expected	3	The GPS is out of service	-	-	-	-	-
		Choosing/finding a road takes longer than expected	3	There is a bad connection	-	-	-	-	-
Go to the site	12	Road is wrongly chosen	3	Actors enter the wrong destination	-	-	-	-	-
		The road is chosen at an irregular pace	6	There are a lot of uncertainties on the road (an accident may occur in front of the actors)	-	-	-	-	-
		The ambulances are not going to the site	1	They don't know which road to take	-	-	-	-	-
		The ambulances are not going to the site	1	No available ambulances at the centre	-	-	-	-	-
		The ambulances cannot go to the site	2	All the ambulances are out of order	-	-	-	-	-
Put the injured on board	13	The injured is not on board	1	Ambulance is not on site	-	-	-	-	-
		The injured is not on board	1	Injured is not in PMA or not ready	-	-	-	-	-
		Putting the injured on board takes longer than expected	3	Injured has a critical situation	-	-	-	-	-
		Putting injured on board is wrongly done	5	Actors move for the first time	-	-	-	-	-
		Putting injured on board is wrongly done	5	Injured is not critical	-	-	-	-	-
Choose the suitable path to the site	14	No road to the hospital is found	1	Actors enter the wrong destination	-	-	-	-	-
		No road to the hospital is found	1	They don't know the destination	-	-	-	-	-
		A road to the hospital cannot be found	2	All roads leading to the hospital are closed	-	-	-	-	-
		Choosing/finding a road takes longer than expected	3	The GPS is out of service	-	-	-	-	-
		Choosing/finding a road takes longer than expected	3	There is a bad connection	-	-	-	-	-
Go to hospital	15	Road is wrongly chosen	3	Actors hesitate to choose a route	-	-	-	-	-
		The road is chosen at an irregular pace	6	There are a lot of uncertainties on the road (an accident may occur in front of the actors)	-	-	-	-	-
		The ambulances are not going to the hospital	1	They don't know which road to take	-	-	-	-	-
		The ambulances cannot go to the hospital	2	Ambulance doesn't know the destination	-	-	-	-	-
		The ambulances cannot go to the hospital	2	All roads leading to the site are closed	-	-	-	-	-
Remove injured from ambulance	16	The injured is not removed	2	Ambulance cannot leave the site	-	-	-	-	-
		The injured is not removed	2	There is traffic	-	-	-	-	-
		Removing injured takes longer than expected	3	Not all ambulances have injured on board	-	-	-	-	-
		Removing injured takes longer than expected	3	Not all ambulances are equipped	-	-	-	-	-
		Removing injured takes longer than expected	3	They are in too dangerous	-	-	-	-	-
Communicate with ambulance centre	17	The communication is not done	1	They are not arrived	-	-	-	-	-
		The communication cannot be done	2	They do not know how to remove it	-	-	-	-	-
		The communication takes longer than expected	3	There is no connection	-	-	-	-	-
		Communication is done at an irregular pace	6	There is a bad connection	-	-	-	-	-
		Communication is done at an irregular pace	6	Shutdown of the system every few minutes	-	-	-	-	-
Inform hospital	18	The hospital is not informed	1	Actors are not reachable	-	-	-	-	-
		The hospital is not informed	1	They are not reachable	-	-	-	-	-
		The hospital cannot be informed	2	They forget to inform the hospital	-	-	-	-	-
		Informing the hospital takes longer than expected	3	There is a bad connection	-	-	-	-	-
		Hospital is wrongly informed	3	Poor analysis of the situation	-	-	-	-	-
Receive the demand	19	The demand is not received	1	The information is not sent	-	-	-	-	-
		The demand is not received	1	There is no connection	-	-	-	-	-
		Receiving the demand takes longer than expected	3	There is a bad connection	-	-	-	-	-
		The demand is wrongly received	5	The information sent is incorrect	-	-	-	-	-
		The demand is wrongly received	5	The information sent is incorrect	-	-	-	-	-

Cause III	Category of cause III	Source	Effect I	Effect II		Effect III		Effect IV		S	O	C
				Severity or effect	Before	Severity or effect	Before	Severity or effect	Before			
-	-	-	I They did not search for a road	ON4	-	-	-	-	-	I	1	1
-	-	-	I They did not search for a road	ON4	-	-	-	-	-	I	4	1
-	-	-	I No available road is found	ON4	-	-	-	-	-	I	4	1
No budget for maintenance	-	SN6	I Actors belatedly find a road to the site	ON2	-	-	ON7	-	-	-	-	-
-	-	-	I Choosing a road is under discussion	ON4	-	-	ON7	-	-	-	-	-
-	-	-	I The chosen road does not lead to the site	ON2	-	-	ON7	-	-	-	-	-
-	-	-	I Ambulances may take the long road	ON2	-	-	ON7	-	-	-	-	-
-	-	-	I Ambulances did not leave the centre	ON4	-	-	ON7	-	-	-	-	-
Centre does not have the budget to buy more ambulances	-	SN6	I Ambulances did not leave the centre	ON4	-	-	ON7	-	-	-	-	-
Centre does not have the budget to maintain them	-	SN6	I Ambulances did not leave the centre	ON4	-	-	ON7	-	-	-	-	-
-	-	-	I Ambulances arrive late at the site	ON2	-	-	ON7	-	-	-	-	-
No budget to buy enough ambulances	-	SN6	I Ambulances are not enough	ON2	-	-	ON7	-	-	-	-	-
Newer expect all parameters to be necessary	-	-	I Not all the needed ambulances are on site at the same time	ON2	-	-	ON7	-	-	-	-	-
-	-	-	I Injured is not in the ambulance	ON4	-	-	-	-	-	-	-	-
-	-	-	I Injured is not in the ambulance	ON5	-	-	-	-	-	-	-	-
No budget for training	-	SN6	I Injured is on board late	ON2	-	-	ON7	-	-	-	-	-
-	-	-	I An injured with no critical situation is on board	ON2	-	-	-	-	-	-	-	-
-	-	-	I They did not search for a road	ON4	-	-	-	-	-	-	-	-
-	-	-	I They did not search for a road	ON4	-	-	-	-	-	-	-	-
-	-	-	I No available road is found	ON4	-	-	-	-	-	-	-	-
No budget for maintenance	-	SN6	I No road is found	ON4	-	-	ON7	-	-	-	-	-
-	-	-	I Ambulances belatedly find a road to the hospital	ON2	-	-	ON7	-	-	-	-	-
-	-	-	I Choosing a road is under discussion	ON4	-	-	-	-	-	-	-	-
-	-	-	I The chosen road is not the best one	ON2	-	-	ON7	-	-	-	-	-
-	-	-	I Ambulances may take the long road	ON2	-	-	ON7	-	-	-	-	-
-	-	-	I Ambulances did not leave the site	ON4	-	-	-	-	-	-	-	-
-	-	-	I They did not search for a road	ON4	-	-	-	-	-	-	-	-
-	-	-	I Ambulances did not leave the site	ON4	-	-	-	-	-	-	-	-
-	-	-	I Ambulance arrive late at the hospital	ON2	-	-	ON7	-	-	-	-	-
-	-	-	I Not all the injured are transferred	ON4	-	-	-	-	-	-	-	-
-	-	-	I Not all the injured are transferred on time	ON2	-	-	-	-	-	-	-	-
-	-	-	I Injured is not removed	ON4	-	-	-	-	-	-	-	-
No budget for training	-	SN6	I Injured is removed late	ON4	-	-	-	-	-	-	-	-
-	-	-	I No information is provided	ON3	-	-	-	-	-	-	-	-
-	-	-	I No information is provided	ON3	-	-	-	-	-	-	-	-
-	-	-	I Information is poorly provided	ON1	-	-	-	-	-	-	-	-
-	-	-	I Part of information is not processed	ON1	-	-	-	-	-	-	-	-
No budget for new equipment or system maintenance	-	SN6	I Communication is poor	ON1	-	-	-	-	-	-	-	-
-	-	-	I No information is sent	ON3	-	-	-	-	-	-	-	-
-	-	-	I No information is provided	ON3	-	-	-	-	-	-	-	-
-	-	-	I Information is poorly provided	ON1	-	-	-	-	-	-	-	-
-	-	-	I Information is wrong	ON1	-	-	-	-	-	-	-	-
-	-	-	I They received no information	ON4	-	-	-	-	-	-	-	-
-	-	-	I They received no information	ON4	-	-	-	-	-	-	-	-
-	-	-	I Information received late	ON2	-	-	ON7	-	-	-	-	-
-	-	-	I The information received is incorrect	ON2	-	-	ON7	-	-	-	-	-

Figure A.8: Ambulance's FMECA table in semi-centralized architecture

A.6 Hospitals

The FMECA tables of the hospitals are shown in figure A.10 for the semi-centralized architecture and in figure A.11 for the decentralized architecture.

Based on the FMECA tables, the tables A.10 and A.11 show the vulnerability indicators of a hospital in the two architectures: semi-centralized and decentralized.

Activity	Code	Mode	Category	Cause I	Category of cause		Cause II	Category of cause	
					Before	During		Before	During
Choose the suitable path to the site	1.1	No road to the site is found	0	Actors are not triggered	-	IN1	-	-	-
		No road to the site is found	1	They don't know the destination	-	IN1	Destination is not received	-	IN4
		A road to the site cannot be found	2	All roads leading to the site are closed	-	SN1	There is another big event in the city	-	CN4
		Choosing/finding a road takes longer than expected	3	The GPS is out of service	-	SN2	No maintenance for GPS is performed	-	SN4
		Road is wrongly chosen	5	Actors hesitate to choose a route	-	SN1	They are stressed	-	SN3
		The road is chosen at an irregular pace	6	Actors enter the wrong destination	-	SN1	They did not pay attention	-	SN3
Go to the site	1.2	The ambulances are not going to the site	0	There are a lot of uncertainties on the road (an accident may occur in front of the actors)	-	CN1	No available roads were found	-	IN4
		The ambulances cannot go to the site	1	No available ambulances at the centre	-	SN2	Centre does not have a lot of ambulances	-	SN4
		The ambulances are out of order	2	All the ambulances are out of order	-	CN1	Centre did not maintain the ambulances	-	SN4
		Going to the site takes longer than expected	3	There is traffic	-	CN1	-	-	-
		Not all ambulances are going to the site	4	Not all ambulances are equipped	-	SN2	Not enough equipment for all ambulances	-	SN4
		Ambulances are going to the site at an irregular pace	6	Wait for the paramedics to come to the centre	-	SN2	Lack of resource management (they were on vacation)	-	SN4
Put the injured on board	1.3	The injured is not on board	1	Ambulance is not on site	-	IN1	Going to site starts late	-	IN4
		The injured is not on board	1	Injured is not in PMA or not ready	-	IN2	Injured is not helped yet	-	IN5
		Putting the injured on board takes longer than expected	3	Injured has a critical situation	-	IN3	Dangerous event	-	CN7
		Putting injured on board is wrongly done	3	Actors intervene for the first time	-	SN2	They are not trained	-	SN4
		The communication is not done	5	Injured is not critical	-	IN1	Injuries are poorly prioritized	-	IN4
		The communication cannot be done	2	There is no connection	-	CN1	-	-	-
Communicate with ambulance centre	1.7	The communication takes longer than expected	3	There is a bad connection	-	CN1	-	-	-
		Not all communication is done	4	Not enough actors at the centre	-	SN2	Centre does not have a lot of actors	-	SN4
		The communication is done at an irregular pace	6	Standdown of the system every few minutes	-	SN1	No maintenance of equipment and systems	-	SN4
		The request is not sent	2	Injured is not on board	-	IN1	Difficulties in putting injured on board	-	IN4
		The request cannot be sent	2	They are not reachable	-	CN1	-	-	-
		Sending request takes longer than expected	3	There is a bad connection	-	CN1	-	-	-
Demand capacity	1.8	The capacity is not received	0	Prior analysis of the situation	-	CN1	-	-	-
		The capacity is not received	1	The information is not sent	-	IN2	Decisions are not made	-	IN5
		The capacity is not received	1	There is no connection	-	CN1	-	-	-
		Receiving capacity takes longer than expected	3	They did not read the message	-	CN1	-	-	-
		Capacity is wrongly received	5	There is a bad connection	-	CN1	-	-	-
		The decision made is incorrect	2	The request is incorrect	-	IN2	The decision made is incorrect	-	IN5
Choose the suitable path to the hospital	1.4	No road to the hospital is found	0	Capacity is not received	-	IN2	Hospital did not send it	-	IN5
		No road to the hospital is found	1	They don't know the destination	-	IN1	Destination is not received	-	IN4
		A road to the hospital cannot be found	2	All roads leading to the hospital are closed	-	CN1	There is another big event in the city	-	CN4
		Choosing/finding a road takes longer than expected	3	The GPS is out of service	-	SN2	No maintenance for GPS is performed	-	SN4
		Road is wrongly chosen	5	Actors hesitate to choose a route	-	SN1	They are stressed	-	SN3
		The road is chosen at an irregular pace	6	Actors enter the wrong destination	-	SN1	They did not pay attention	-	SN3
Go to hospital	1.5	The ambulances are not going to the hospital	0	There are a lot of uncertainties on the road (an accident may occur in front of the actors)	-	CN1	No available roads were found	-	IN4
		The ambulances cannot go to the hospital	1	Ambulance doesn't know the destination	-	IN1	Destination is not received	-	IN4
		The ambulances are out of order	2	All roads leading to the site are closed	-	CN1	There is another big event in the city	-	CN4
		Going to the hospital takes longer than expected	3	Ambulance cannot leave the site	-	CN1	Ambulance is out of order	-	SN3
		Not all ambulances are going to the hospital	4	Not all ambulances have injured on board	-	IN3	Some injured died because of their conditions	-	CN7
		Ambulances are going to the hospital at an irregular pace	6	The site is too dangerous	-	CN1	-	-	-
Remove injured from ambulance	1.6	The injured is not removed	1	They are not arrived	-	IN3	They had an accident	-	CN7
		Removing injured takes longer than expected	3	They do not know how to remove it	-	SN2	No experience	-	SN4
		The demand is not received	0	The information is not sent	-	IN2	Triggering actors is not done	-	IN5
		The demand is not received	1	There is no connection	-	CN1	-	-	-
		Receiving the demand takes longer than expected	3	There is a bad connection	-	CN1	-	-	-
		The demand is wrongly received	5	The information sent is incorrect	-	IN2	Triggering actors is not done right	-	IN5

Cause III	Category of cause III	Source	Effect I	Degree of Eff.		Effect II	Degree of Eff.		Effect III	Degree of Eff.		S	O	C	
				Before	After		Before	After		Before	After				
-	-	1	They did not search for a road	ON4	-	-	-	-	-	-	1	1	1	4	
-	-	1	They did not search for a road	ON4	-	-	-	-	-	-	1	4	1	4	
No budget for maintenance	SN6	1	No road is found	ON4	-	-	-	-	-	-	1	4	1	4	
-	-	1	Actors belatedly find a road to the site	ON2	-	The ambulances go to the site late	ON7	-	Possibility of death	ON10	-	1	5	1	5
-	-	1	Choosing a road is under discussion	ON4	-	-	-	-	-	-	-	-	-	-	
-	-	1	The chosen road does not lead to the site	ON2	-	Actors go to the wrong place	ON7	-	Victims death	ON10	-	1	5	1	5
-	-	1	Ambulances may take the long road	ON2	-	Ambulances arrive late at the site	ON7	-	Possibility of death	ON10	-	1	5	1	5
Centre does not have the budget to buy new ambulances	SN6	1	Ambulances did not leave the centre	ON4	-	-	-	-	-	-	-	-	-	-	
Centre does not have the budget to maintain them	SN6	1	Ambulances did not leave the centre	ON4	-	-	-	-	-	-	-	-	-	-	
-	-	1	Ambulances arrive late at the site	ON2	-	Victims are not transferred in time	ON7	-	Possibility of death	ON10	-	1	5	3	13
No budget to buy enough ambulances	SN6	1	Ambulances did not leave the centre	ON4	-	Not all victims are transferred or maybe transferring victims takes longer	ON7	-	Possibility of death	ON10	-	1	5	1	5
Never expect all parameters to be necessary	SN5	1	Not all the needed ambulances are on site at the same time	ON2	-	Transferring victims takes longer	ON7	-	Possibility of death	ON10	-	1	3	2	9
-	-	1	Injured is not in the ambulance	ON4	-	-	-	-	-	-	-	1	4	1	4
-	-	1	Injured is not in the ambulance	ON5	-	-	-	-	-	-	-	1	4	1	4
No budget for training	SN6	1	Injured is on board late	ON2	-	Injured is transferred late	ON7	-	Possibility of death	ON10	-	1	3	2	6
-	-	1	An injured with no critical situation is on board	ON2	-	-	-	-	-	-	-	1	4	1	4
-	-	1	No information is provided	ON5	-	-	-	-	-	-	-	1	3	1	3
-	-	1	No information is provided	ON5	-	-	-	-	-	-	-	1	3	1	3
-	-	1	Information is poorly provided	ON1	-	-	-	-	-	-	-	1	3	1	3
-	-	1	Part of information is not processed	ON1	-	-	-	-	-	-	-	1	4	1	4
No budget for new equipment or system maintenance	SN6	1	Communication is poor	ON1	-	-	-	-	-	-	-	1	3	1	3
-	-	1	No request is sent	ON5	-	-	-	-	-	-	-	1	3	1	3
-	-	1	No request is sent	ON5	-	-	-	-	-	-	-	1	3	1	3
-	-	1	Request is sent late	ON1	-	Information is received late	ON7	-	Possibility of death	ON10	-	1	3	1	3
-	-	1	Wrong request is sent	ON1	-	Wrong information is received	ON7	-	Possibility of death	ON10	-	1	4	1	4
-	-	1	They do not receive the information	ON4	-	-	-	-	-	-	-	1	4	1	4
-	-	1	They do not receive the information	ON4	-	-	-	-	-	-	-	1	4	1	4
-	-	1	Information received late	ON2	-	Choosing a road starts late	ON7	-	Possibility of death	ON10	-	1	5	1	5
-	-	1	The information received is incorrect	ON2	-	To wrong hospital may be transferred	ON7	-	Possibility of death	ON10	-	1	4	1	4
-	-	1	They did not search for a road	ON4	-	-	-	-	-	-	-	1	1	1	1
-	-	1	They did not search for a road	ON4	-	-	-	-	-	-	-	1	4	1	4
-	-	1	No available road is found	ON4	-	-	-	-	-	-	-	1	4	1	4
No budget for maintenance	SN6	1	No road is found	ON4	-	The actors go to the site late	ON7	-	Possibility of death	ON10	-	1	4	1	4
-	-	1	Ambulances belatedly find a road to the hospital	ON2	-	-	-	-	-	-	-	1	5	1	5
-	-	1	Choosing a road is under discussion	ON4	-	-	-	-	-	-	-	1	5	1	5
-	-	1	The chosen road is not the best one	ON2	-	Getting to hospital site may take longer	ON7	-	Possibility of death	ON10	-	1	5	1	5
-	-	1	Ambulances may take the long road	ON2	-	Actors arrive late at the site	ON7	-	Possibility of death	ON10	-	1	5	1	5
-	-	1	Ambulances did not leave the site	ON4	-	-	-	-	-	-	-	1	5	1	5
-	-	1	They did not search for a road	ON4	-	-	-	-	-	-	-	1	5	1	5
-	-	1	Ambulances did not leave the site	ON4	-	-	-	-	-	-	-	1	5	1	5
-	-	1	Ambulance arrive late at the hospital	ON2	-	Removing injured starts late	ON7	-	Possibility of death	ON10	-	1	5	3	13
-	-	1	Not all the injured are transferred	ON4	-	-	-	-	-	-	-	1	5	2	10
-	-	1	Not all the injured are transferred on time	ON2	-	-	-	-	-	-	-	1	3	2	9
-	-	1	Injured is not removed	ON4	-	-	-	-	-	-	-	1	5	1	5
No budget for training	SN6	1	Injured is removed late	ON4	-	-	-	-	-	-	-	1	3	1	3
-	-	1	They received no information	ON4	-	-	-	-	-	-	-	1	3	1	3
-	-	1	They received no information	ON4	-	-	-	-	-	-	-	1	3	1	3
-	-	1	Information received late	ON2	-	Choosing the road starts late	ON7	-	Getting stuck in road	ON10	-	1	4	1	4
-	-	1	The information received is incorrect	ON2	-	Choosing the wrong road	ON7	-	Not arrived on site	ON10	-	1	4	1	4

Figure A.9: Ambulance's FMECA table in decentralized architecture

A.7 Firefighters

The FMECA table of the firefighters is shown in figure A.12 for both architectures. Table A.12 is filled according to this FMECA table.

Code	Nature	Interactions	Cost	Impact	Recurrence	Technicality	Material	Fluids	Network	Infrastructure	Failure modes
I.1	D,I	I	I	I	U	E	Y	N	Y	N	0,1,2,3,5,6
I.2	O	I	I	I	U	M	Y	Y	N	Y	0,1,2,3,4,6
I.3	O	I	D	D	U	E	Y	N	N	N	0,1,3,5
I.4	D,I	I	I	I	U	E	Y	N	Y	N	0,1,2,3,5,6
I.5	O	I	I	I	U	M	Y	Y	N	Y	0,1,2,3,4,6
I.6	O	I	A	D	U	E	Y	N	N	N	0,3
I.7	I	E	I	A	R	E	Y	N	Y	Y	1,2,3,4,6
I.8	I	E	I	A	I	E	Y	N	Y	Y	0,1,2,3,5
I.9	I	I	I	A	U	E	Y	N	Y	Y	0,1,3,5

Table A.8: Ambulance's vulnerability indicators for figure A.8

Code	Nature	Interactions	Cost	Impact	Recurrence	Technicality	Material	Fluids	Network	Infrastructure	Failure modes
I.1	D,I	I	I	I	U	E	Y	N	Y	N	0,1,2,3,5,6
I.2	O	I	I	I	U	M	Y	Y	N	Y	0,1,2,3,4,6
I.3	O	I	D	D	U	E	Y	N	N	N	0,1,3,5
I.4	D,I	I	I	I	U	E	Y	N	Y	Y	0,1,2,3,5,6
I.5	O	I	I	I	U	M	Y	Y	N	Y	0,1,2,3,4,6
I.6	O	I	D	D	U	E	Y	N	N	N	0,3
I.7	I	E	I	A	R	E	Y	N	Y	N	1,2,3,4,6
I.8	I	I,E	I	A	U	E	Y	N	Y	Y	0,2,3,5
I.9	I	I,E	I	A	U	E	Y	N	Y	Y	0,1,3,5
I.10	I	I	I	A	U	E	Y	N	Y	Y	0,1,3,5

Table A.9: Ambulance's vulnerability indicators for figure A.9

A.8 Central agent

The FMECA table of the central agent is shown in figure A.13. Table A.13 is filled according to this FMECA table.

Activity	Code	Mode	Category	Cause I	Category of cause	Cause II	Category of cause	
					Before/ During		Before/ During	
Verify capacity	H.1	The capacity is not verified	0	Alert in not received	-	-	-	
		The capacity is not verified	1	No actors capable of making a decision at the centre	-	SN2	The actors' schedules are poorly organized	SN4
		The capacity cannot be verified	2	Decision makers are reluctant to make the decision	-	SN1	Decision-makers are stressed and tired	SN3
		Verifying the capacity takes longer than expected	3	The decision-makers have difficulties processing information	-	SN2	Decision-makers do not have enough experience	SN4
		The capacity is wrongly verified	5	Decision makers did not properly analyze the information	-	SN2	Decision-makers have no experience	SN4
Send capacity	H.2	The capacity is not sent	0	Decision is not received	-	IN1	Decision is not made	IN4
		The capacity is not sent	1	There is no connection	-	CN1	-	-
		The capacity cannot be sent	2	They forgot to send it	-	CN1	-	-
		The capacity cannot be sent	2	They are not reachable	-	CN1	-	-
		Sending capacity takes longer than expected	3	Decision is received late	-	IN1	They took time to decide	IN4
Receive information (from central agent)	H.3	Capacity is wrongly sent	5	Decision is wrongly received	-	IN1	The decisions are incorrect	IN4
		The information is not received	0	Decision is not sent from hospital	-	IN1	Decision is not made	IN4
		The information is not received	1	Decision is not sent from central agent	-	IN2	Decision is not made	IN5
		The information is not received	1	There is no connection	-	CN1	-	-
		Receiving information takes longer than expected	3	Actors do not know how to send them	-	SN2	They have no experience	SN4
Receive information (from ambulance)	H.4	Information is wrongly received	5	There is a bad connection	-	CN1	-	-
		Information is wrongly received	5	The information sent is incorrect	-	IN2	The decision made is incorrect	IN5
		Information is wrongly received	5	The information sent is incorrect	-	IN1	The decision made is incorrect	IN4
		The information is not received	0	The information sent is incorrect	-	IN1	The decision made is incorrect	IN5
		The information is not received	1	The information is not sent	-	IN2	The decision made is incorrect	IN5
Prepare for receiving injured	H.5	Receiving information takes longer than expected	3	There is a bad connection	-	CN1	-	-
		Information is wrongly received	5	There is a bad connection	-	CN1	-	-
		Preparation is not done	0	The information sent is incorrect	-	IN2	Analyzing injured information is incorrect	IN5
		Preparation takes longer than expected	3	The actors have not received a decision	-	IN1	-	-
		Preparation is wrongly done	5	Actors have no experience	-	SN2	No training is organized	SN4
				Actors are not properly dimensioned in terms of equipment and personnel	-	SN2	Floor resource estimation	SN4
				Actors have no experience	-	SN2	No training is organized	SN4

Cause III	Category of cause III	Source	Effect I	Category of effect	Effect II	Category of effect	Effect III	Category of effect	Target	S	O	C
				During/ After		During/ After		During/ After				
-	-	-	H They do not make a decision	ON4	-	-	-	-	H	4	1	4
Not enough budget to train actors in decision making	SN6	H	They do not make a decision	ON4	-	-	-	-	H	4	1	4
-	-	H	The available actors are stressed and panicked	ON3	-	-	-	-	H	4	1	4
-	-	H	They do not make a decision	ON4	-	-	-	-	H	4	1	4
-	-	H	The capacity is not determined yet	ON4	-	-	-	-	H	3	3	9
No budget to organize enough trainings	SN6	H	The capacity is not determined yet	ON4	-	-	-	-	H	3	3	9
No budget to organize a training	SN6	H	The decision-makers are stressed	ON3	-	-	-	-	H	3	3	9
-	-	H	The capacity is not correct	ON2	The information sent is incorrect	ON7	The centre's image is distorted	ON10	H	3	2	6
-	-	H	They did not send the capacity	ON5	-	-	-	-	H.M	2	1	2
-	-	H	No capacity is received	ON5	-	-	-	-	H.M	4	1	4
-	-	H	No capacity is received	ON5	-	-	-	-	H.M	4	1	4
No budget to organize trainings	SN6	H	Capacity is sent late	ON1	Late receipt of the capacity	ON6	-	-	H.M	3	2	6
-	-	H	Capacity sent is incorrect	ON1	Capacity received is incorrect	ON6	The centre's image is distorted	ON9	H.M	3	1	3
-	-	H	They received no information	ON4	-	-	-	-	H	2	1	2
-	-	H	They received no information	ON4	-	-	-	-	H	2	1	2
-	-	H	Information received late	ON2	Preparation is late	ON7	-	-	H	3	1	3
-	-	H	The information received is incorrect	ON2	Preparation is poorly done	ON7	Injured may not be well helped	ON10	H	4	1	4
-	-	H	They received no information	ON4	-	-	-	-	H	2	1	2
-	-	H	They received no information	ON4	-	-	-	-	H	2	1	2
-	-	H	Information received late	ON2	-	-	-	-	H	3	1	3
-	-	H	The information received is incorrect	ON2	-	-	-	-	H	4	1	4
-	-	H	Hospital is not prepared	ON4	-	-	-	-	H	4	1	4
No budget for trainings	-	H	The hospital is not fully prepared	ON4	-	-	-	-	H	3	5	15
No budget to buy equipment	-	H	Hospital is poorly prepared	ON4	-	-	-	-	H	5	1	5
No budget for trainings	-	H	Hospital is poorly prepared	ON4	-	-	-	-	H	5	1	5

Figure A.10: Hospital's FMECA table in semi-centralized architecture

Code	Nature	Interactions	Cost	Impact	Recurrence	Technicality	Material	Fluids	Network	Infrastructure	Failure modes
H.1	D,I	I	A	A	U	M	Y	N	N	Y	0,1,2,3,5
H.2	I	I,E	I	A	U	E	Y	N	Y	Y	0,1,2,3,5
H.3	I	I	I	A	U	E	Y	N	Y	Y	0,1,3,5
H.4	I	I	I	A	U	E	Y	N	Y	Y	0,1,3,5
H.5	D,I,O	I	D	D	R	H	Y	Y	N	Y	0,3,5

Table A.10: Hospital's vulnerability indicators for figure A.10

Activity	Code	Mode	Category	Cause I	Category of cause		Cause II	Category of cause	
					Before	During		Before	During
Verify capacity	H.1		0	Request in not received	-	IN1	-	-	-
			1	No actors capable of making a decision at the centre	-	SN2	The actors' schedules are poorly organized	SN4	-
			2	Decision makers are reluctant to make the decision	-	SN1	Decision-makers are stressed and tired	-	SN3
			3	The alert is not received	-	IN1	-	-	-
			5	The decision-makers have difficulties processing information	-	SN2	Decision-makers do not have enough experience	SN4	-
Send capacity	H.2		5	Decision makers did not properly analyze the information	-	SN2	Decision-makers have no experience	SN4	-
			0	Decision is not received	-	IN1	Decision is not made	-	IN4
			1	There is no connection	-	CN1	-	-	-
			2	They forgot to send it	-	CN1	-	-	-
			3	They are not reachable	-	CN1	-	-	-
Prepare for receiving injured	H.3		5	Decision is received late	-	IN1	They took time to decide	-	IN4
			3	Actors do not know how to send them	-	SN2	They have no experience	SN4	-
			3	There is a bad connection	-	CN1	-	-	-
			5	Decision is wrongly received	-	IN1	The decisions are incorrect	-	IN4
			0	The actors have not received a decision	-	IN1	-	-	-
Prepare information (from ambulance)	H.4		3	Actors have no experience	-	SN2	No training is organized	SN4	-
			3	Actors are not properly dimensioned in terms of equipment and personnel	-	SN2	Poor resource estimation	SN4	-
			5	Actors have no experience	-	SN2	No training is organized	SN4	-
			0	The information is not sent	-	IN2	Injured is not on board	-	IN5
			1	There is no connection	-	CN1	-	-	-
			3	There is a bad connection	-	CN1	-	-	-
			5	The information sent is incorrect	-	IN2	Analyzing injured information is incorrect	-	IN5

Cause III	Category of cause III	Source	Effect I	Category of effect		Effect II	Category of effect		Effect III	Category of effect		Target	S	O	C
				Before	During		After	During		After	During				
-	-	H	They do not make a decision	ON4	-	-	-	-	-	-	H	4	1	4	
-	-	H	They do not make a decision	ON4	-	-	-	-	-	-	H	4	1	4	
-	-	H	The available actors are stressed and panicked	ON3	-	-	-	-	-	-	H	4	1	4	
-	-	H	They do not make a decision	ON4	-	-	-	-	-	-	H	4	1	4	
-	-	H	The capacity is not determined yet	ON4	-	-	-	-	-	-	H	3	3	9	
-	-	H	The decision-makers are stressed	ON3	-	-	-	-	-	-	H	4	1	4	
No budget to organize enough trainings	SN6	H	The capacity is not correct	ON2	-	The information sent is incorrect	ON7	-	The centre's image is distorted	ON10	H	3	2	6	
No budget to organize a training	SN6	H	They did not send the capacity	ON5	-	-	-	-	-	-	H, I	2	1	2	
-	-	H	No capacity is received	ON5	-	-	-	-	-	-	H, I	4	1	4	
-	-	H	No capacity is received	ON5	-	-	-	-	-	-	H, I	4	1	4	
No budget to organize trainings	SN6	H	Capacity is sent late	ON1	-	Late receipt of the capacity	ON6	-	-	-	H, I	4	1	4	
-	-	H	Capacity sent is incorrect	ON1	-	Capacity received is incorrect	ON6	-	The centre's image is distorted	ON9	H	4	1	4	
-	-	H	Hospital is not prepared	ON4	-	-	-	-	-	-	H	3	1	3	
No budget for trainings	-	H	The hospital is not fully prepared	ON4	-	-	-	-	-	-	H	3	5	15	
No budget to buy equipment	-	H	Hospital is poorly prepared	ON4	-	-	-	-	-	-	H	5	1	5	
No budget for trainings	-	H	They received no information	ON4	-	-	-	-	-	-	H	2	1	2	
-	-	H	They received no information	ON4	-	-	-	-	-	-	H	2	1	2	
-	-	H	Information received late	ON2	-	Verifying capacity is done late	ON7	-	-	-	H	3	1	3	
-	-	H	The information received is incorrect	ON2	-	Verifying capacity is not fault	ON7	-	-	-	H	4	1	4	

Figure A.11: Hospital's FMECA table in decentralized architecture

Code	Nature	Interactions	Cost	Impact	Recurrence	Technicality	Material	Fluids	Network	Infrastructure	Failure modes
H.1	D	I	A	A	U	M	Y	N	N	Y	0,1,2,3,5
H.2	I	I,E	I	A	U	E	Y	N	Y	Y	0,1,2,3,5
H.3	D,I,O	I	D	D	R	H	Y	Y	N	Y	0,3,5
H.4	I	I	I	A	U	E	Y	N	Y	Y	0,1,3,5

Table A.11: Hospital's vulnerability indicators for figure A.11

A.9 PMA

The FMECA table of the PMA in semi-centralized architecture is shown in figure A.14. Table A.14 is filled according to this FMECA table.

Code	Nature	Interactions	Cost	Impact	Recurrence	Technicality	Material	Fluids	Network	Infrastructure	Failure modes
D.1	D,I	I	I	I	U	E	Y	N	Y	N	0,1,2,3,5,6
D.2	O	I	I	I	U	M	Y	Y	N	Y	0,1,2,3,4,6
D.3	I	I,E	I	A	U	E	Y	N	Y	Y	0,1,2,3
D.4	I	E	I	A	R	E	Y	N	Y	Y	1,2,3,4,6
D.5	O	I	A	A	U	E	N	N	N	N	0,3,6
D.6	O	I	I	D	U	E	Y	N	Y	N	0,1,2,3,4,5,6
D.7	O	I	D	D	R	M	Y	N	N	N	0,1,3,4,5,6
D.8	O	I	D	D	R	M	Y	N	N	N	0,1,2,3,4,5
D.9	O	I	D	D	R	H	Y	Y	N	Y	0,1,2,3,4,5,6
D.10	D,I,O	I	D	D	R	H	Y	N	N	Y	0,1,2,3,4,5
D.11	O	I,E	D	D	R	M	Y	N	N	N	0,1,2,3,4,5
D.12	I	I	I	A	U	E	Y	N	Y	Y	0,1,3,5
D.13	I	I	I	A	U	E	Y	N	Y	Y	0,1,3

Table A.12: Firefighters vulnerability indicators for figure A.12

Code	Nature	Interactions	Cost	Impact	Recurrence	Technicality	Material	Fluids	Network	Infrastructure	Failure modes
M.1	I	I	I	A	U	E	Y	N	Y	Y	0,1,3,5
M.2	I	I	I	A	U	E	Y	N	Y	Y	0,1,2,3,4,5,6
M.3	I	I	I	A	U	E	Y	N	Y	Y	0,1,2,3,4,5,6
M.4	I	I	I	A	U	E	Y	N	Y	Y	0,1,2,3,4,5,6
M.6	D	I	I	I	U	H	Y	N	Y	Y	0,1,2,3,5
M.7	D	I	I	I	U	H	Y	N	Y	Y	0,1,2,3,5
M.8	D	I	I	I	U	H	Y	N	Y	Y	0,1,2,3,5
M.9	I	I,E	I	A	U	E	Y	N	Y	Y	0,1,2,3
M.10	I	I	I	A	U	E	Y	N	Y	Y	0,1,2,3
M.11	I	I	I	A	U	E	Y	N	Y	Y	0,1,2,3
M.12	I	I	I	A	U	E	Y	N	Y	Y	0,1,2,3
M.13	D,I	I,E	I	I	U	E	Y	N	Y	Y	0,1,2,3,5
M.14	I	I	I	A	U	E	Y	N	Y	Y	0,1,2,3,5
M.15	D	I	I	I	U	H	Y	N	N	Y	0,1,2,3,4,5
M.5	I	E	I	A	U	E	Y	N	Y	Y	0,1,2,3

Table A.13: Central agent vulnerability indicators for figure A.13

Activity	Code	Mode	Category	Cause I		Cause II		Category of cause I	
				Before	During	Before	During	Before	During
Install AMP	E.1	AMP is not installed	0	Decision is not received	-	BN2	Decision is not sent	BN5	-
		AMP is not installed	1	No available actors	-	SN2	Actors are not enough	SN4	-
		AMP cannot be installed	2	No actor knows how to install it	-	SN2	Actors are not trained	SN4	-
Receive injured	E.2	Installing AMP takes longer than expected	3	Environment is so aggressive	-	SN1	Bad estimation of needed actors	SN4	-
		Injured are not received	4	AMP is not installed	-	BN1	-	-	-
		Injured are not received	1	No injured is estimated in PMA	-	BN1	-	-	-
		Injured cannot be received	2	No available actors in PMA	-	SN2	No more available actors in the centre	SN4	-
		Receiving injured takes longer than expected	3	Number of victims is high in PMA	-	SN1	Actors are not enough	SN4	CN2
Sort the Victims	E.3	Not all injured are received	4	The capacity of PMA is not enough	-	SN2	Actors and equipment are not enough	SN4	-
		Injured are wrongly received	5	Poor organization	-	CN1	Capacity of PMA is not enough	-	CN2
		The injured are not sorted	0	No victim is received	-	BN1	-	-	-
		The injured are not sorted	1	No available actors	-	SN2	No more available actors in the centre	SN4	-
		Injured cannot be sorted	2	Actors do not have tags	-	SN2	The center did not buy the tags	SN4	-
		Injured cannot be sorted	2	Stakeholders don't know how to evaluate victims (not trained)	-	SN2	Center has never organized any training	SN4	-
		Sorting injured takes longer than expected	3	Some actors cannot sort victims	-	SN1	Some actors are injured during the response	-	SN3
		Sorting injured takes longer than expected	3	The number of victims is increasing very rapidly	-	CN1	Stress and poor organization on site	-	CN2
		Sorting injured takes longer than expected	3	Actors are not enough in the PMA	-	SN2	Bad estimation of the number of actors needed	SN4	-
		Not all injured are sorted	4	No more available tags	-	SN2	Not enough tags in the center	SN4	-
Transport the injured to UA	E.4	Injured are not transported	0	Injured's situation is poorly evaluated by stakeholders	-	SN1	Fatigue and stress	-	SN3
		Injured are not transported	1	Actors work in an overly aggressive environment	-	CN1	Stress and poor organization on site	-	CN2
Take care of injured	E.5	Injured are not transported	1	No victim to transport	-	BN1	No victim is sorted	-	BN4
		Transporting injured takes longer than expected	3	No available actors	-	SN2	No more available actors in the centre	SN4	-
		Transporting injured takes longer than expected	3	The number of victims is increasing very rapidly	-	CN1	-	-	-
Prioritize Injured	E.6	Injured are not sorted	0	No injured to aid	-	BN1	No injured is received	-	BN4
		Injured are not sorted	1	They do not know how to aid them	-	CN1	They are not trained	SN4	-
		Aiding injured takes longer than expected	3	All injured have critical injuries	-	BN3	Aggressive environment	CN7	-
		Injured are wrongly aided	5	Limited experience for actors	-	SN2	Not trained for a long time	SN4	-
		Injured are not prioritized	0	No injured is aided	-	BN1	No injured is received	-	BN4
Inform central agent	E.7	Injured are not prioritized	2	They do not know how to prioritize them	-	SN2	They are not trained	SN4	-
		Prioritizing injured takes longer than expected	3	The decision-makers have difficulties processing information	-	SN2	Decision-makers do not have enough experience	SN4	-
		Injured are wrongly prioritized	5	Poor organization	-	CN1	-	-	-
Receive decision	E.8	The agent is not informed	0	No decision is made	-	BN1	Injured are not prioritized	-	BN4
		The agent is not informed	1	They forget to inform them	-	SN1	They are stressed and tired	-	SN3
		The agent cannot be informed	2	There are not reachable	-	CN1	-	-	-
Receive the demand	E.9	Informing the agent takes longer than expected	3	There is a bad connection	-	CN1	-	-	-
		Agent is wrongly informed	5	Poor prioritization of injured	-	SN1	Stress and fatigue	-	SN3
		The decision is not received	0	Decision is not sent	-	BN2	Decisions are not made	-	BN5
Receive the demand	E.9	The decision is not received	1	There is no connection	-	CN1	-	-	-
		Receiving decision takes longer than expected	3	There is a bad connection	-	CN1	-	-	-
		Decision is wrongly received	5	The information sent is incorrect	-	BN2	The decision made is incorrect	-	BN5
Receive the demand	E.9	The demand is not received	1	The information is not sent	-	BN2	Sending information is not done	-	BN5
		Receiving the demand takes longer than expected	3	There is a bad connection	-	CN1	-	-	-
		The demand is wrongly received	5	The information sent is incorrect	-	BN2	Sending information is not done	-	BN5

Cause III	Category of cause III	Source	Effect I	Category of effect I		Effect II	Category of effect II		Effect III	Category of effect III		Target	S	O	C
				Before	After		Before	After		Before	After				
Situation is poorly analyzed	SN6	E	No place for helping injured	ON4	-	-	-	-	-	-	-	E	1	1	1
No budget for training	SN6	E	No place for helping injured	ON4	-	-	-	-	-	-	-	E	2	1	2
No budget to buy means	SN6	E	AMP is installed late	ON2	-	Injured are received late	ON7	-	Possibility of death	ON10	-	E	4	2	8
-	-	E	No injured is received	ON4	-	-	-	-	-	-	-	E	1	1	1
-	-	E	No injured is received	ON4	-	-	-	-	-	-	-	E	1	1	1
Situation is poorly analyzed	SN6	E	No injured is received	ON4	-	-	-	-	-	-	-	E	5	1	5
-	-	E	Injured are received late	ON2	-	Injured are sorted late	ON7	-	Possibility of death	ON10	-	E	5	4	20
Situation is poorly analyzed	SN6	E	Part of injured are not received	ON3	-	Part of injured are not helped	ON7	-	Possibility of death	ON10	-	E	5	4	20
-	-	E	Injured are not well received	ON2	-	Injured are poorly sorted	ON7	-	Possibility of death	ON10	-	E	1	5	3
-	-	E	Actors are stressed	ON3	-	Ambulances transfer more critical injured	ON8	-	Injured are not helped in optimal conditions	ON11	-	E	1	1	1
-	-	E	No victim is sorted	ON4	-	-	-	-	-	-	-	E	2	1	2
No budget to purchase tags	SN6	E	No victim is sorted	ON4	-	-	-	-	-	-	-	E	3	1	3
No budget for training	SN6	E	No victim is sorted	ON4	-	-	-	-	-	-	-	E	3	1	3
-	-	E	Actors are tired	ON3	-	Ambulances may deal with more critical injured	ON8	-	Victims are not helped in optimal conditions	ON11	-	E	1	3	12
Bad estimation of victims' number	SN5	E	There are still unsorted injured	ON2	-	Not all injured are helped	ON7	-	Possibility of death	ON10	-	E	4	2	8
No budget for tags	SN6	E	There are still unsorted injured	ON2	-	Not all injured are helped	ON7	-	Possibility of death	ON10	-	E	4	2	8
Never though they would use this amount of tags	SN5	E	There are still unsorted injured	ON2	-	Injured will not be transferred to the right place	ON7	-	Possibility of death	ON10	-	E	5	1	5
-	-	E	Injured are not properly labelled	ON2	-	Injured will not be transferred to the right place	ON7	-	Possibility of death	ON10	-	E	5	1	5
-	-	E	Victims are still in triage area	ON4	-	-	-	-	-	-	-	E	1	1	1
-	-	E	Victims are still in triage area	ON4	-	-	-	-	-	-	-	E	2	1	2
-	-	E	Victims are transported late	ON2	-	Injured are not helped on time	ON7	-	Possibility of death	ON10	-	E	2	2	4
-	-	E	No injured is helped	ON4	-	-	-	-	-	-	-	E	1	1	1
-	-	E	No injured is helped	ON4	-	-	-	-	-	-	-	E	4	1	4
No budget for training	-	E	Injured are aided late	ON2	-	Injured are unsorted late	ON7	-	Possibility of death	ON10	-	E	1	5	2
No budget for training	-	E	Injured are wrongly helped	ON2	-	Injured are wrongly unsorted	ON7	-	Possibility of death	ON10	-	E	5	2	10
-	-	E	They are not prioritized	ON4	-	-	-	-	-	-	-	E	1	1	1
-	-	E	They are not prioritized	ON4	-	-	-	-	-	-	-	E	3	1	3
No budget for training	-	E	They are not prioritized yet	ON4	-	-	-	-	-	-	-	E	3	1	3
-	-	E	The decision-makers are stressed	ON3	-	Ambulances cannot transfer injured	ON8	-	Possibility of death	ON10	-	E	1	4	2
-	-	E	Order of injured is not respected	ON2	-	-	-	-	-	-	-	E	1	2	2
-	-	E	No information is sent	ON5	-	-	-	-	-	-	-	E	4	1	4
-	-	E	No information is sent	ON5	-	-	-	-	-	-	-	E	4	1	4
-	-	E	No information is provided	ON5	-	-	-	-	-	-	-	E	4	1	4
-	-	E	Information is poorly provided	ON1	-	-	-	-	-	-	-	E	2	1	2
-	-	E	Information is wrong	ON1	-	-	-	-	-	-	-	E	4	1	4
-	-	E	No information is received	ON4	-	-	-	-	-	-	-	E	4	1	4
-	-	E	No information is received	ON4	-	-	-	-	-	-	-	E	4	1	4
-	-	E	Information received late	ON2	-	Injured are transferred late	ON7	-	Possibility of death	ON10	-	E	4	1	4
-	-	E	The information received is incorrect	ON2	-	Injured are wrongly transferred	ON7	-	Possibility of death	ON10	-	E	4	1	4
-	-	E	They received no information	ON4	-	-	-	-	-	-	-	E	2	1	2
-	-	E	They received no information	ON4	-	-	-	-	-	-	-	E	3	1	3
-	-	E	Information received late	ON2	-	Installation starts late	ON7	-	Possibility of death	ON10	-	E	4	1	4
-	-	E	The information received is incorrect	ON2	-	Installation is not done	ON7	-	Possibility of death	ON10	-	E	4	1	4

Figure A.14: PMA's FMECA table in the semi-centralized architecture

Code	Nature	Interactions	Cost	Impact	Recurrence	Technicality	Material	Fluids	Network	Infrastructure	Failure modes
E.1	O	I	I	A	U	M	Y	N	N	Y	0,1,2,3
E.2	O	I	A	A	R	E	Y	N	N	Y	0,1,2,3,4,5
E.3	D,I,O	I	D	D	R	H	Y	N	N	Y	0,1,2,3,4,5
E.4	O	I	I	D	R	E	Y	N	N	Y	0,1,3
E.5	O	I	D	D	R	H	Y	Y	N	Y	0,2,3,5
E.6	D,I,O	I	D	D	R	H	Y	N	N	Y	0,2,3,5
E.7	I	I,E	I	A	I	E	Y	N	Y	Y	0,1,2,3,5
E.8	I	I	I	A	I	E	Y	N	Y	Y	0,1,3,5
E.9	I	I	I	A	U	E	Y	N	Y	Y	0,1,3,5

Table A.14: PMA's vulnerability indicators for figure A.14

Appendix

B.1 Security centre agent

Figure B.1 shows the library of standard plans of the security centre agent. As shown in tables B.1 and B.2, the actions of the security centre agent belong to either C_1 or C_2 . The action a_5^{SC} is used for the communication with the security agents. In this case, we consider it to be a standard plan (\mathcal{J}_3^{SC}) because every time the centre wants to contact its agents, it looks for this standard plan; no other actions are needed. In addition, a_1^{SC} is either followed by a_2^{SC} or a_6^{SC} depending on the architecture used. In this case, two standard plans are determined \mathcal{J}_1^{SC} and \mathcal{J}_4^{SC} and two other are derived from them (\mathcal{J}_5^{SC} and \mathcal{J}_6^{SC}). Furthermore, \mathcal{J}_7^{SC} is obtained from \mathcal{J}_2^{SC} .

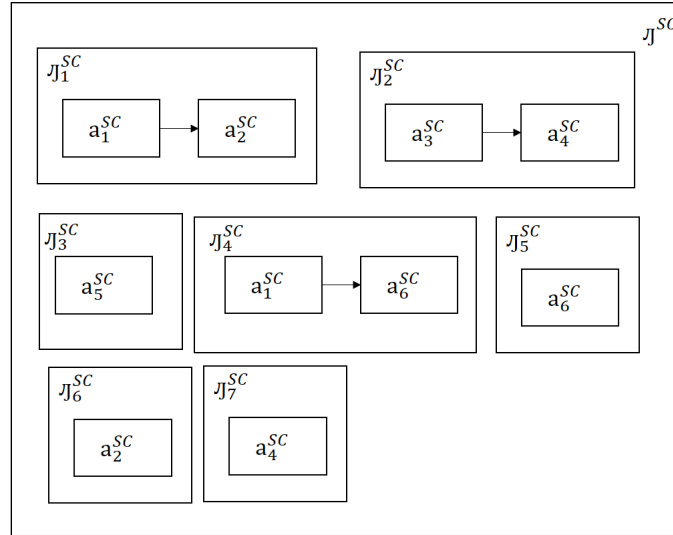

Figure B.1: Security centre agent's library

Library of standard plans Table B.3 exhibit the preconditions and effects of each standard plan. \mathcal{J}_3^{SC} , \mathcal{J}_5^{SC} , \mathcal{J}_6^{SC} and \mathcal{J}_7^{SC} are composed of a single action, which means that their preconditions and effects are the same as those of their actions. \mathcal{J}_1^{SC} contains the two

Activity code	Action code	C3	C2	C1
J_1	a_1^E		3,5	0,1,2
J_2	a_2^E		3	0,1,2,4,5,6
J_3	a_3^E			0,1,3,5
J_4	a_4^E			0,1,2,3,4,5
J_5	a_5^E			1,2,3,4,5,6

Table B.1: SC: Failure modes criticality levels of figure A.1

Activity code	Action code	C3	C2	C1
J_1	a_1^E		3,5	0,1,2
J_2	a_6^E		3	0,1,2,4,5
J_3	a_5^E			1,2,3,4,5,6

Table B.2: SC: Failure modes criticality levels of figure A.2

$\text{pcond}(\Pi_j^{\text{SC}})$	Standard plan	$\text{eff}(\Pi_j^{\text{SC}})$	Goal
$(\text{available } ?SC)$	$\Pi_1^{\text{SC}}(?SC, ?c)$	$(\text{cap}) > 0$ $(\text{sent } ?c)$	Propose solutions
$(\text{available } ?SC)$ $(\text{agent} - \text{at } ?l_1 ?S)$	$\Pi_2^{\text{SC}}(?l_1, ?SC, ?S)$	$(\text{sent } ?S)$	Inform S
$(\text{available } ?SC)$ $(\text{available } ?S)$	$\Pi_3^{\text{SC}}(?S, ?SC)$	$(\text{sent } ?S)$ $(\text{sent } ?SC)$ $(\text{received } ?SC)$ $(\text{received } ?S)$	To communicate
$(\text{available } ?SC)$ $(\text{agent} - \text{at } ?l_1 ?S)$	$\Pi_4^{\text{SC}}(?l_1, ?SC, ?S)$	$(\text{sent } ?S)$	Trigger S
$(\text{available } ?SC)$ $(\text{agent} - \text{at } ?l_1 ?S)$ $(\text{cap} > 0)$	$\Pi_5^{\text{SC}}(?l_1, ?SC, ?S)$	$(\text{sent } ?S)$	Trigger S
$(\text{available } ?SC)$ $(\text{cap} > 0)$	$\Pi_6^{\text{SC}}(?l_1, ?SC, ?S)$	$(\text{sent } ?c)$	Propose Solution
$(\text{received } ?c)$ $(\text{agent} - \text{at } ?l_1 ?S)$	$\Pi_7^{\text{SC}}(?l_1, ?SC, ?S)$	$(\text{sent } ?S)$	Trigger S

Table B.3: the preconditions, effects and goals of security centre agent's standard plans

actions a_1^{SC} and a_2^{SC} . We eliminate all the redundancy in the preconditions of the actions. For example, $(\text{available } ?SC)$ is a precondition that is repeated in both actions. In addition, the precondition $(\text{cap} > 0)$ of a_2^{SC} is removed from the standard plan's effects because it is the effect of a_1^{SC} . Likewise, the preconditions $(\text{received } ?c)$ of a_4^{SC} and $(\text{cap} > 0)$ of a_6^{SC} are removed from Π_2^{SC} and Π_4^{SC} , respectively. On the other hand, the effects $(\text{received } ?c)$ of a_3^{SC} in Π_2^{SC} is cancelled by the subsequent actions' effects a_4^{SC} .

B.2 Fire department agent

The FC library of standard plans is identical to SC library. We replace SC by FC and S by F.

B.3 Ambulance centre agent

The MC library of standard plans is identical to SC library. We replace SC by MC and S by m.

B.4 Security agent

Table B.4 shows the criticality level of each failure mode for each activity in the security officers process. Note that for N_4 , N_5 and N_6 , we take the maximum criticality of each failure mode because the three actions are combined into one action in planning and scheduling. Moreover, no action can be added after a_2^S and a_3^S while creating the standard plans.

Activity code	Action code	C3	C2	C1
N_1	a_1^S		3,5,6	0,1,2
N_2	a_5^S			1,2,3,4,6
N_3	a_2^S	3	0,1,2,4,6	
N_4, N_5, N_6	a_3^S	3	2,4,5,6	0,1
N_7	a_4^S			0,1,2
N_8	a_6^S			0,1,3,5
N_9	a_7^S			0,1,3

Table B.4: S: Failure modes criticality levels of figure A.7

Library of standard plans As shown in Figure B.2, the security agent has 6 standard plans. Table B.5 represents preconditions, effects and goals of these standard plans. The standard plans Π_2^S , Π_3^S and Π_6^S contain only one action, which means that they have the same preconditions and effects of this action. In addition, Π_4^S is derived from Π_1^S .

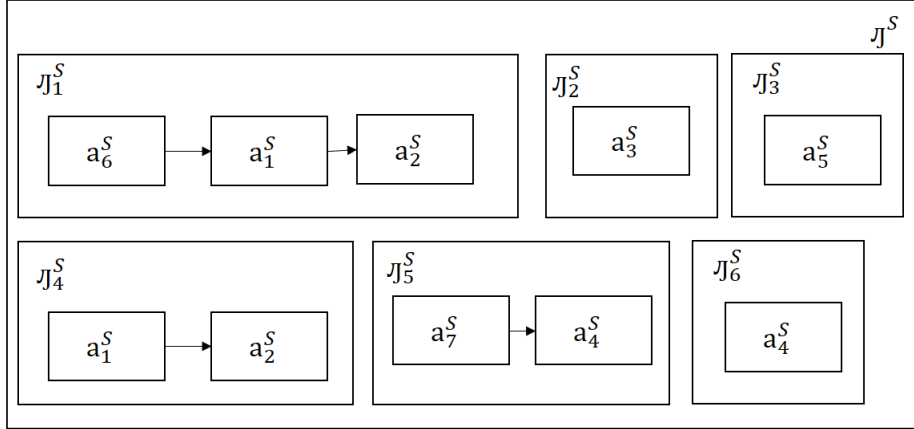

Figure B.2: Security agent's library

$\text{pcond}(\Pi_j^S)$	Standard plan	$\text{eff}(\Pi_j^S)$	Goal
$(\text{available } ?S)$ $\text{not}(\text{equal } ?l_1 ?l_2)$ $(\text{vehicle} - \text{at } ?l_1 ?o)$ $(\text{agent} - \text{at } ?l_1 ?S)$ $(\text{agent} - \text{in } ?o ?S)$ $(\text{free } ?o)$	$\Pi_1^S(?S, ?l_1, ?l_2, ?o)$	$\text{not}(\text{vehicle} - \text{at } ?l_1 ?o)$ $(\text{vehicle} - \text{at } ?l_2 ?o)$ $\text{not}(\text{agent} - \text{at } ?l_1 ?S)$ $(\text{agent} - \text{at } ?l_2 ?S)$ $\text{not}(\text{free } ?o)$	Receive and move
$(\text{available } ?S)$ $(\text{agent} - \text{at } ?l_2 ?S)$ $(\text{person} - \text{at } ?l_2 ?r)$ $(\text{free2 } ?r)$	$\Pi_2^S(?F, ?l_2, ?r, ?S)$	$(\text{cordoned} - \text{off } ?l_2)$ $\text{not}(\text{free2 } ?r)$	Secure
$(\text{available } ?S)$ $(\text{available } ?SC)$	$\Pi_3^S(?SC, ?S)$	$(\text{sent } ?S)$ $(\text{sent } ?SC)$ $(\text{received } ?S)$ $(\text{received } ?SC)$	To communicate
$\text{not}(\text{equal } ?l_1 ?l_2)$ $(\text{vehicle} - \text{at } ?l_1 ?o)$ $(\text{agent} - \text{at } ?l_1 ?S)$ $(\text{agent} - \text{in } ?o ?S)$ $(\text{free } ?o)$	$\Pi_4^S(?S, ?l_1, ?l_2, ?o)$	$\text{not}(\text{vehicle} - \text{at } ?l_1 ?o)$ $(\text{vehicle} - \text{at } ?l_2 ?o)$ $\text{not}(\text{agent} - \text{at } ?l_1 ?S)$ $(\text{agent} - \text{at } ?l_2 ?S)$ $\text{not}(\text{free } ?o)$	Move between two locations
$(\text{available } ?S)$	$\Pi_5^S(?F, ?S)$	$(\text{received } ?F)$ $(\text{sent } ?F)$	Give authorization
$(\text{available } ?S)$	$\Pi_6^S(?S, ?F)$	$(\text{sent } ?F)$	Give authorization

Table B.5: the preconditions, effects and goals of security agent's standard plans

B.5 Ambulance agent

Tables B.6 and B.7 show the criticality level of each failure mode for each activity in the ambulance process in both architectures. Action a_2^m has a failure mode that belongs to level C_3 . In this case, no action is added after it.

Activity code	Action code	C3	C2	C1
I_1, I_4	a_1^m		3,5,6	0,1,2
I_2, I_5	a_2^m	3	0,1,2,4,6	
I_3	a_4^m		3	0,1,5
I_6	a_8^m		0	3
I_7	a_5^m			1,2,3,4,6
I_8	a_7^m			0,1,2,3,5
I_9	a_6^m			0,1,3,5

Table B.6: m: Failure modes criticality levels of figure A.8

Activity code	Action code	C3	C2	C1
I_1, I_4	a_1^m		3,5,6	0,1,2
I_2, I_5	a_2^m	3	0,1,2,4,6	
I_3	a_4^m		3	0,1,5
I_6	a_8^m		0	3
I_7	a_5^m			1,2,3,4,6
I_8	a_3^m		3	0,2,5
I_9	a_6^m			0,1,3,5
I_{10}	a_9^m		3	0,1,5

Table B.7: m: Failure modes criticality levels of figure A.9

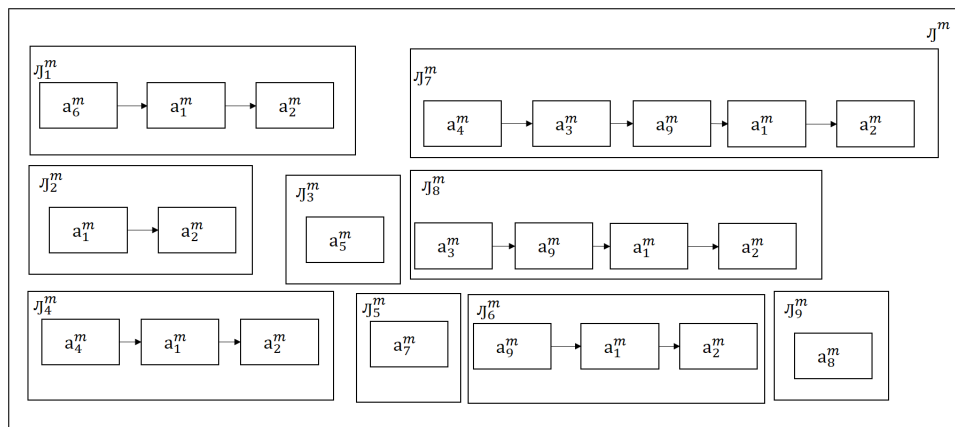

Figure B.3: Ambulance agent's library

$\text{pcond}(\mathbb{J}_j^m)$	Standard plan	$\text{eff}(\mathbb{J}_j^m)$	Goal
not(<i>equal</i> ? l_1 ? l_2) (<i>available</i> ? m) (<i>agent</i> – <i>at</i> ? l_1 ? m)	$\mathbb{J}_1^m(?m, ?l_1, ?l_2)$	not(<i>agent</i> – <i>at</i> ? l_1 ? m) (<i>agent</i> – <i>at</i> ? l_2 ? m) (<i>received</i> ? MC)	Receive and move
not(<i>equal</i> ? l_1 ? l_2) (<i>agent</i> – <i>at</i> ? l_1 ? m)	$\mathbb{J}_2^m(?l_1, ?l_2, ?m)$	not(<i>agent</i> – <i>at</i> ? l_1 ? m) (<i>agent</i> – <i>at</i> ? l_2 ? m)	Move between two places
(<i>available</i> ? MC) (<i>available</i> ? m)	$\mathbb{J}_3^m(?MC, ?m)$	(<i>received</i> ? m) (<i>sent</i> ? m) (<i>received</i> ? MC) (<i>sent</i> ? MC)	To communicate
(<i>available</i> ? m) (<i>agent</i> – <i>at</i> ? l_2 ? m) (<i>person</i> – <i>at</i> ? l_2 ? x) (\leq (MaxCap) (-loadedInjured)) not(<i>equal</i> ? l_2 ? l_3)	$\mathbb{J}_4^m(?m, ?l_2, ?l_3, ?x)$	not(<i>agent</i> – <i>at</i> ? l_2 ? m) (<i>agent</i> – <i>at</i> ? l_3 ? m) not(<i>available</i> ? m)	Transfer injured
(<i>person</i> – <i>in</i> ? m ? x)	$\mathbb{J}_5^m(?m, ?h, ?x)$	(<i>sent</i> ? h)	Inform hospital
not(<i>equal</i> ? l_2 ? l_3) (<i>available</i> ? m) (<i>agent</i> – <i>at</i> ? l_2 ? m)	$\mathbb{J}_6^m(?m, ?l_3, ?l_2)$	not(<i>agent</i> – <i>at</i> ? l_2 ? m) (<i>agent</i> – <i>at</i> ? l_3 ? m)	Receive and move
(<i>available</i> ? m) (<i>agent</i> – <i>at</i> ? l_2 ? m) (<i>person</i> – <i>at</i> ? l_2 ? x) (\leq (MaxCap) (-loadedInjured)) not(<i>equal</i> ? l_2 ? l_3)	$\mathbb{J}_7^m(?m, ?l_2, ?l_3, ?x, ?h)$	not(<i>agent</i> – <i>at</i> ? l_2 ? m) (<i>agent</i> – <i>at</i> ? l_3 ? m) not(<i>available</i> ? m) (<i>received</i> ? h) (<i>person</i> – <i>in</i> ? m ? x)	Load and transfer injured
(<i>person</i> – <i>in</i> ? m ? x) not(<i>equal</i> ? l_2 ? l_3) (<i>agent</i> – <i>at</i> ? l_2 ? m) (<i>available</i> ? m)	$\mathbb{J}_8^m(?m, ?l_2, ?l_3, ?x)$	not(<i>agent</i> – <i>at</i> ? l_2 ? m) (<i>agent</i> – <i>at</i> ? l_3 ? m)	Demand and move
not(<i>available</i> ? m) (<i>agent</i> – <i>at</i> ? l_3 ? m) (<i>person</i> – <i>in</i> ? m ? x)	$\mathbb{J}_9^m(?l_3, ?m, ?x)$	(<i>available</i> ? m) (<i>person</i> – <i>at</i> ? l_3 ? x) not(<i>person</i> – <i>in</i> ? m ? x)	Remove injured

Table B.8: the preconditions and effects of ambulance agent's standard plans

Library of standard plans Ambulance agent has 9 standard plans. Table B.8 represents the effects and preconditions of ambulance agent's standard plans in figure B.3. \mathbb{J}_3^m , \mathbb{J}_5^m and \mathbb{J}_9^m have the same preconditions and effects of their actions. Note that a_1^m and a_2^m in \mathbb{J}_7^m are

also used to move between l_2 and l_3 which means that l_1 is replaced by l_2 and l_2 by l_3 .

B.6 Hospital agent

Tables B.9 and B.10 show the failure modes' criticality level for a hospital agent in both architectures.

Activity code	Action code	C3	C2	C1
H_1	a_1^h		3,5	0,1,2
H_2	a_3^h		3	0,1,2,5
H_3	a_5^h			0,1,3,5
H_4	a_4^h			0,1,3,5
H_5	a_6^h	3	5	0

Table B.9: H: Failure modes criticality levels of figure A.11

Activity code	Action code	C3	C2	C1
H_1	a_1^h		3,5	0,1,2
H_2	a_2^h			0,1,2,3,5
H_3	a_6^h	3	5	0
H_4	a_4^h			0,1,3,5

Table B.10: H: Failure modes criticality levels of figure A.11

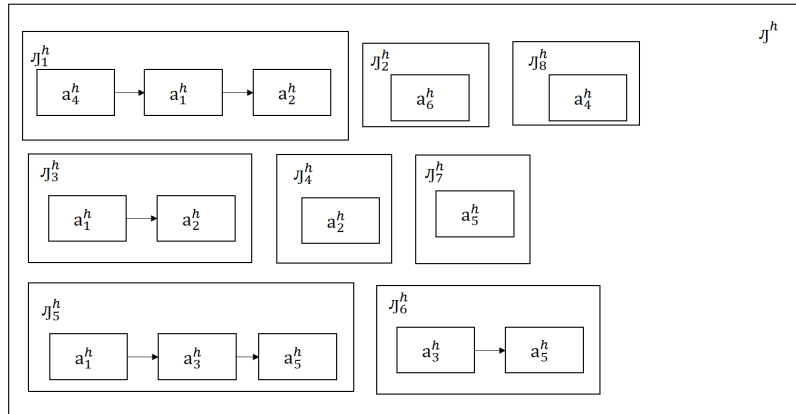

Figure B.4: Hospital agent's library

Library of standard plans Table B.4 represents the library of standard plans shown in figure B.4. Hospital agent has 8 standard plans where \mathcal{J}_2^h , \mathcal{J}_4^h , \mathcal{J}_7^h and \mathcal{J}_8^h have the same preconditions and effects of their actions.

$\text{pcond}(\Pi_j^h)$	Standard plan	$\text{eff}(\Pi_j^h)$	Goal
$(\text{available } ?h)$	$\Pi_1^h(?h, ?m)$	$(\text{cap} \geq 0)$ $(\text{sent } ?m)$	To receive and check the capacity for ambulance agent
$(\text{available } ?h)$	$\Pi_2^h(?h)$	$(\text{ready } ?h)$	To prepare for injured
$(\text{available } ?h)$	$\Pi_3^h(?h, ?m)$	$(\text{cap} \geq 0)$ $(\text{sent } ?m)$	to check the capacity for an ambulance agent
$(\text{available } ?h)$	$\Pi_4^h(?h, ?m)$	$(\text{sent } ?m)$	To inform an ambulance
$(\text{available } ?h)$	$\Pi_5^h(?h, ?c)$	$(\text{cap} \geq 0)$ $(\text{sent } ?c)$	To check the capacity for central agent
$(\text{available } ?h)$	$\Pi_6^h(?h, ?c)$	$(\text{cap} \geq 0)$ $(\text{sent } ?c)$	To receive central agent's decision
$(\text{available } ?h)$	$\Pi_7^h(?h, ?c)$	$(\text{sent } ?c)$	To receive information from central agent
$(\text{available } ?h)$	$\Pi_8^h(?h)$	$(\text{received } ?m)$	To receive from ambulance agent

Table B.11: the preconditions, effects and goals of hospital agent's standard plans

B.7 Firefighter agent

Table B.12 shows the failure modes' criticality level for a firefighter agent in both architectures.

Activity code	Action code	C3	C2	C1
D_1	a_1^F		3,5,6	0,1,2
D_2	a_2^F	3	0,1,2,4,6	
D_3	a_3^F			0,1,2,3
D_4	a_5^F			1,2,3,4,6
D_5	a_4^F	6	3	0
D_6	a_8^F	3,4,6	0,1,2,5	
D_7	a_9^F		1,3,4,5	0,6
D_8, D_{11}	a_{10}^F		0,1,2,3,4,5	
D_9	a_{11}^F		0,1,2,3,4,5,6	
D_{10}	a_{12}^F	3	5	0,1,2,4
D_{12}	a_6^F			0,1,3,5
D_{13}	a_7^F			0,1,3

Table B.12: F: Failure modes criticality levels of figure A.12

Library of standard plans Firefighter agent has 11 standard plans as shown in figure B.5. Their preconditions, effects and goals are represented in table B.13.

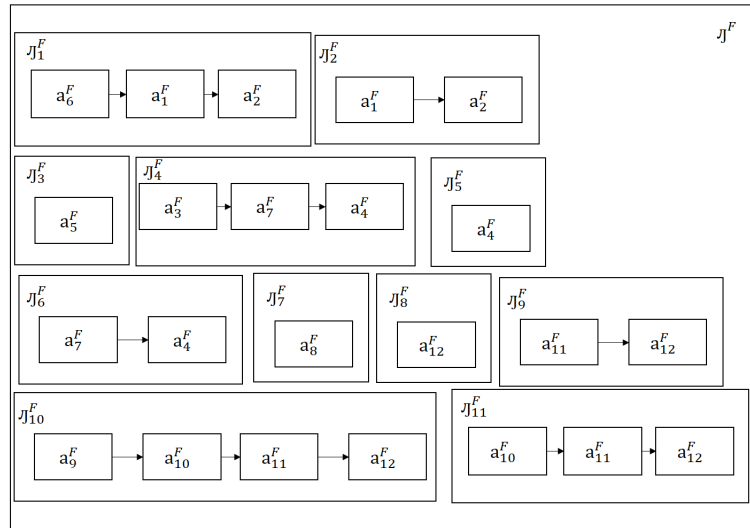

Figure B.5: Firefighter agent's library

B.8 Central agent

Table B.14 shows the failure modes' criticality level for a central agent.

Library of standard plans Table B.15 shows the central agent's library of standard plans shown in figure B.6.

B.9 PMA agent

Table B.16 shows the failure modes' criticality level for a PMA agent in a semi-centralized architecture. this is a continuation of the work done in chapter 4 for the decentralized architecture.

Library of Standard plans Figure B.7 shows the PMA agent's library of standard plans. Table B.17 represents the preconditions and effects for each standard plan.

pcond (Π_j^F)	Standard plan	eff (Π_j^F)	Goal
(<i>available</i> ? <i>F</i>) (<i>vehicle</i> – at ? <i>l</i> ₁ ? <i>t</i>) (<i>agent</i> – at ? <i>l</i> ₁ ? <i>F</i>) (<i>agent</i> – in ? <i>t</i> ? <i>F</i>) not(<i>equal</i> ? <i>l</i> ₁ ? <i>l</i> ₂) (<i>free</i> ? <i>t</i>)	$\Pi_1^F(?F, ?FC, ?t, ?l_1, ?l_2)$	not(<i>vehicle</i> – at ? <i>l</i> ₁ ? <i>t</i>) (<i>vehicle</i> – at ? <i>l</i> ₂ ? <i>t</i>) not(<i>agent</i> – at ? <i>l</i> ₁ ? <i>F</i>) (<i>agent</i> – at ? <i>l</i> ₂ ? <i>F</i>) not(<i>free</i> ? <i>t</i>) (<i>received</i> ? <i>FC</i>)	Receive and move
(<i>vehicle</i> – at ? <i>l</i> ₁ ? <i>t</i>) (<i>agent</i> – at ? <i>l</i> ₁ ? <i>F</i>) (<i>agent</i> – in ? <i>t</i> ? <i>F</i>) not(<i>equal</i> ? <i>l</i> ₁ ? <i>l</i> ₂) (<i>free</i> ? <i>t</i>)	$\Pi_2^F(?F, ?l_1, ?l_2, ?t)$	not(<i>vehicle</i> – at ? <i>l</i> ₁ ? <i>t</i>) (<i>vehicle</i> – at ? <i>l</i> ₂ ? <i>t</i>) not(<i>agent</i> – at ? <i>l</i> ₁ ? <i>F</i>) (<i>agent</i> – at ? <i>l</i> ₂ ? <i>F</i>) not(<i>free</i> ? <i>t</i>)	Move between two places
(<i>available</i> ? <i>FC</i>) (<i>available</i> ? <i>F</i>)	$\Pi_3^F(?FC, ?F)$	(<i>received</i> ? <i>F</i>) (<i>sent</i> ? <i>F</i>) (<i>received</i> ? <i>FC</i>) (<i>sent</i> ? <i>FC</i>)	To communicate
(<i>available</i> ? <i>F</i>) (<i>agent</i> – at ? <i>l</i> ₂ ? <i>F</i>)	$\Pi_4^F(?F, ?l_2, ?S)$	(<i>accessed</i> ? <i>l</i> ₂ ? <i>F</i>) (<i>received</i> ? <i>S</i>)	Demand authorization for access
(<i>agent</i> – at ? <i>l</i> ₂ ? <i>F</i>)	$\Pi_5^F(?F, ?l_2)$	(<i>accessed</i> ? <i>l</i> ₂ ? <i>F</i>)	To access the site
(<i>available</i> ? <i>F</i>) (<i>agent</i> – at ? <i>l</i> ₂ ? <i>F</i>)	$\Pi_6^F(?F, ?l_2)$	(<i>accessed</i> ? <i>l</i> ₂ ? <i>F</i>)	Receive authorization and access the site
(<i>accessed</i> ? <i>l</i> ₂ ? <i>F</i>)	$\Pi_7^F(?F, ?l_2)$	(<i>person</i> – at ? <i>l</i> ₂ ? <i>x</i>)	Locate victims
(<i>aided</i> ? <i>x</i>) (<i>peron</i> – at ? <i>l</i> ₃ ? <i>x</i>)	$\Pi_8^F(?F, ?l_3, ?x)$	(<i>labelled</i> ? <i>x</i>)	Sort victims
(<i>person</i> – at ? <i>l</i> ₃ ? <i>x</i>)	$\Pi_9^F(?F, ?l_3, ?x)$	(<i>aided</i> ? <i>x</i>) (<i>labelled</i> ? <i>x</i>)	Help and sort
not(<i>equal</i> ? <i>l</i> ₂ ? <i>l</i> ₃) (<i>linked</i> ? <i>l</i> ₂ ? <i>l</i> ₃) (<i>agent</i> – at ? <i>l</i> ₂ ? <i>F</i>) (<i>person</i> – at ? <i>l</i> ₂ ? <i>x</i>)	$\Pi_{10}^F(?F, ?l_3, ?x)$	(<i>agent</i> – at ? <i>l</i> ₃ ? <i>F</i>) (<i>person</i> – at ? <i>l</i> ₃ ? <i>x</i>) (<i>labelled</i> ? <i>x</i>)	Pickup, Help and sort
not(<i>equal</i> ? <i>l</i> ₂ ? <i>l</i> ₃) (<i>linked</i> ? <i>l</i> ₂ ? <i>l</i> ₃) (<i>agent</i> – at ? <i>l</i> ₂ ? <i>F</i>) (<i>person</i> – at ? <i>l</i> ₂ ? <i>x</i>)	$\Pi_{11}^F(?F, ?l_3, ?x)$	(<i>agent</i> – at ? <i>l</i> ₃ ? <i>F</i>) (<i>person</i> – at ? <i>l</i> ₃ ? <i>x</i>) (<i>labelled</i> ? <i>x</i>)	Help and sort

Table B.13: the preconditions and effects of firefighter agent's standard plans

Activity code	Action code	C3	C2	C1
M_1	a_4^c			0,1,3,5
M_2	a_3^c			0,1,2,3,4,5,6
M_3	a_1^c			0,1,2,3,4,5,6
M_4	a_2^c			0,1,2,3,4,5,6
M_5	a_{13}^c			0,1,2,3
M_6	a_{11}^c			0,1,2,3,5
M_7	a_9^c			0,1,2,3,5
M_8	a_{10}^c			0,1,2,3,5
M_9	a_8^c			0,1,2,3
M_{10}	a_7^c			0,1,2,3
M_{11}	a_5^c			0,1,2,3
M_{12}	a_6^c			0,1,2,3
M_{13}	—		3	0,1,2,5
M_{14}	a_{14}^c			0,1,2,3,5
M_{15}	a_{12}^c			0,1,2,3,4,5

Table B.14: c: Failure modes criticality levels of figure A.13

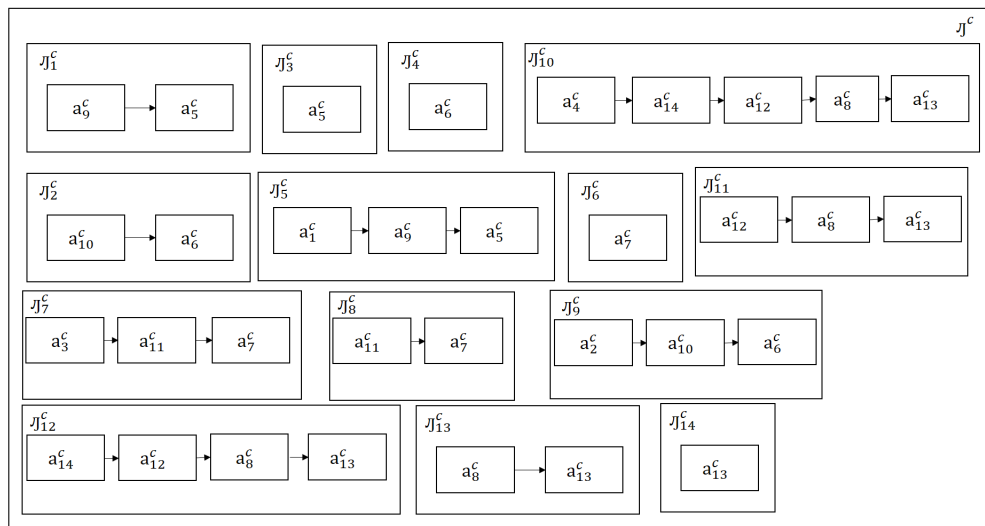

Figure B.6: central agent's library

$\text{pcond}(\Pi_j^c)$	Standard plan	$\text{eff}(\Pi_j^c)$	Goal
(available ?c) (received ?SC)	$\Pi_1^c(?c, ?SC)$	(assigned ?S ?SC) (sent ?SC)	Assign SC and S
(available ?c) (received ?FC)	$\Pi_2^c(?c, ?FC)$	(assigned ?F ?FC) (sent ?FC)	Assign FC and F
(available ?c)	$\Pi_3^c(?c, ?SC)$	(sent ?SC)	Inform SC
(available ?c)	$\Pi_4^c(?c, ?FC)$	(sent ?FC)	Inform FC
(available ?c)	$\Pi_5^c(?c, ?SC, ?S)$	(assigned ?S ?SC) (sent ?SC)	Receive and assign SC and S
(available ?c)	$\Pi_6^c(?c, ?MC)$	(sent ?MC)	To inform MC
(available ?c)	$\Pi_7^c(?c, ?m, ?MC)$	(assigned ?m ?MC) (sent ?MC)	Receive and assign MC and m
(available ?c) (received ?MC)	$\Pi_8^c(?c, ?MC)$	(assigned ?m ?MC) (sent ?MC)	Assign MC and m
(available ?c)	$\Pi_9^c(?F, ?FC, ?c)$	(assigned ?F ?FC) (sent ?FC)	Receive and assign FC and F
(available ?c)	$\Pi_{10}^c(?c, ?l_3, ?x)$	(assigned2 ?x ?h) (sent ?E) (sent ?h)	Assign injured to hospitals
(available ?c) (received ?E)	$\Pi_{11}^c(?c, ?x, ?E, ?h)$	(assigned2 ?x ?h) (sent ?E) (sent ?h)	Decide and inform H and E
(available ?c)	$\Pi_{12}^c(?c, ?x, ?E, ?h)$	(assigned2 ?x ?h) (sent ?E) (sent ?h)	Receive, decide and inform H and E
(available ?c)	$\Pi_{13}^c(?c, ?E, ?h)$	(sent ?E) (sent ?h)	Inform H and E
(available ?c)	$\Pi_{14}^c(?c, ?h)$	(sent ?E)	To inform E

Table B.15: the preconditions and effects of central agent's standard plans

Activity code	Action code	C3	C2	C1
E_1	a_1^E		3	0,1,2
E_2	a_2^E	3,4,5	2	0,1
E_3	a_3^E	3	4,5	0,1,2
E_4	a_5^E			0,1,3
E_5	a_7^E		3,5	0,2
E_6	a_8^E		3	0,2,5
E_7	a_4^E		3	0,1,2,3,5
E_8, E_9	a_6^E		3	0,1,3,5

Table B.16: E: Failure modes criticality levels according to figure A.14

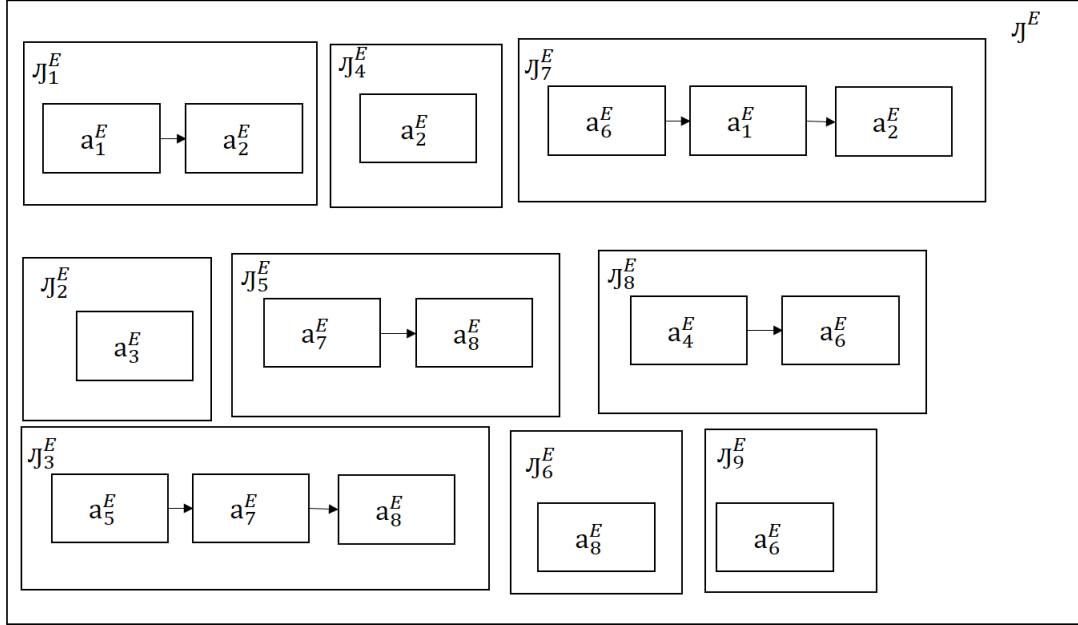

Figure B.7: PMA's library of standard plans

$\text{pcond}(\Pi_j^E)$	Standard plan	$\text{eff}(\Pi_j^E)$	Goal
$(\text{agent} - \text{at } ?l_2 \ ?E)$	$\Pi_1^E(?E, ?l_2, ?x)$	$(\text{person} - \text{in } ?l_2 \ ?x)$	Install and accept injured
$(\text{person} - \text{in } ?l_2 \ ?x)$	$\Pi_2^E(?l_2, ?x)$	$(\text{labelled } ?x)$	To sort injured
$(\text{labelled } ?x)$	$\Pi_3^E(?x)$	$(\text{prioritized } ?x)$	To transport and prioritize
$(\text{installed } ?E \ ?l_2)$	$\Pi_4^E(?x, ?l_2, ?E)$	$(\text{person} - \text{in } ?l_2 \ ?x)$	To receive injured
$(\text{transported } ?x)$	$\Pi_5^E(?x)$	$(\text{prioritized } ?x)$	Aid and prioritize
$(\text{aided } ?x)$	$\Pi_6^E(?x)$	$(\text{prioritized } ?x)$	To prioritize injured
$(\text{available } ?E)$ $(\text{agent} - \text{at } ?l_2 \ ?E)$	$\Pi_7^E(?x)$	$(\text{person} - \text{in } ?l_2 \ ?x)$	Receive, install and accept injured
$(\text{transported } ?x)$	$\Pi_8^E(?x)$	$(\text{prioritized } ?x)$	Aid and prioritize
$(\text{available } ?E)$	$\Pi_9^E(?c, E)$	$(\text{received } ?c)$	Receive assignment

Table B.17: the preconditions and effects of PMA agent's standard plans