



HAL
open science

Etude des procédés de transformation du curcuma (*Curcuma longa* L.) au Cambodge - impact sur la qualité sensorielle et fonctionnelle

Molika Yin

► **To cite this version:**

Molika Yin. Etude des procédés de transformation du curcuma (*Curcuma longa* L.) au Cambodge - impact sur la qualité sensorielle et fonctionnelle. Ingénierie des aliments. Montpellier SupAgro; Institut de technologie du Cambodge (Phnom Penh ; 1964-..), 2022. Français. NNT : 2022NSAM0006 . tel-04250475

HAL Id: tel-04250475

<https://theses.hal.science/tel-04250475v1>

Submitted on 19 Oct 2023

HAL is a multi-disciplinary open access archive for the deposit and dissemination of scientific research documents, whether they are published or not. The documents may come from teaching and research institutions in France or abroad, or from public or private research centers.

L'archive ouverte pluridisciplinaire **HAL**, est destinée au dépôt et à la diffusion de documents scientifiques de niveau recherche, publiés ou non, émanant des établissements d'enseignement et de recherche français ou étrangers, des laboratoires publics ou privés.

**THÈSE POUR OBTENIR LE GRADE DE DOCTEUR
DE L'INSTITUT AGRO MONTPELLIER
DE L'UNIVERSITÉ DE MONTPELLIER
ET DE L'INSTITUT DE TECHNOLOGIE DU CAMBODGE**

En Sciences des Aliments et Nutrition

**École doctorale GAIA – Biodiversité, Agriculture, Alimentation, Environnement, Terre, Eau
Portée par
Unité de recherche UMR QualiSud**

**Étude des procédés de transformation du
curcuma (*Curcuma longa* L.) au Cambodge -
impact sur la qualité sensorielle et fonctionnelle**

**Présentée par Molika YIN
Le 29 novembre 2022**

**Sous la direction de Philippe BOHUON Directeur de thèse
et Sokneang IN co-Directeur de thèse**

Devant le jury composé de

Yves WACHÉ, Professeur, Institut Agro Dijon

Joël SCHER, Professeur, ENSAIA - Université de Lorraine

Hasika MITH, Maître de Conférences, Institut de Technologie du Cambodge

Sokneang IN, Maître de Conférences, Institut de Technologie du Cambodge

Philippe BOHUON, Professeur, Institut Agro Montpellier

Mathieu WEIL, Chercheur, CIRAD Montpellier

Rapporteur (Président)

Rapporteur

Examineur

co-Directeur de thèse

Directeur de thèse

Invité



**UNIVERSITÉ
DE MONTPELLIER**

**L'INSTITUT
agro Montpellier**



Acknowledgements

I would like to extend my gratitude to institutions and people that have supported me since the beginning until my completion of this PhD project as follows:

French Government Scholarships Cofounded by the Ministry of Education, Youth and Sports of Cambodia and Erasmus Camfoodtech Project for providing financial support for living allowance during the period of research in Montpellier, France and CIRAD – UMR Qualisud for providing the place for conducting the research and laboratory costs as well as for financial support for attending the international conference. Cambodia Higher Education Improvement Project (Credit No. 6221-KH), grants from the Institut de Technologie du Cambodge (ITC) and Agence Universitaire de la Francophonie (AUF) for providing financial support during the period of research in Cambodia.

A special acknowledgement goes to my thesis director, Prof. Philippe BOHUON, who gave me an opportunity to do this research in QualiSud and I appreciate for his advice, guidance and valuable suggestions for the complete writing of the thesis.

My unforgettable thank goes to my thesis supervisor, Dr. Mathieu WEIL, for his suggestion, advice, and help with the research aspect and the daily survival in France. He supports me in both administrative work and technical work. I am grateful for his available time to guide, discuss and advise during my research with patience and kindness. Without him, I could not complete my thesis successfully.

I would like to gratefully thank Prof. Sylvie AVALLONE, for her kind guidance and discussion both in laboratory work and in writing articles. I appreciate her available time to share scientific knowledge and solve problems during my research.

I would like to sincerely thank my thesis co-director, Dr. Sokneang IN, at ITC for her assistance in the completion of administration work and review of the articles to conform to all requirements of ITC.

Thanks to Prof. Marie Paule GONTHIER, Dr. Renaud BOULANGER and Prof. Pascale CHALIER for their contributions and suggestions to the annual PhD evaluation to improve my research work.

I also would like to sincerely thank Marc LEBRUN, Geneviève CONEJERO, Adrien SERVENT, Isabelle MARAVAL, Nelly FORESTIER-CHIRON, Charlotte DELPECH, Zoé DEUSCHER, Léa OLLIER, Jean-Michel MEOT and Jocelyne MERIENNE for helping and facilitating my experimental works and administration throughout the project.

I would like to show my sincere appreciation to Lisa CASAMAJOU, Simona DURAND and Ivan RAKOCEVIC, administrative coordinators of the French Government Scholarship Cofounded by the Ministry of Education, Youth and Sports of Cambodia and Cécile DURAND coordinator of the international project Erasmus+, for their facilitation, comprehension, support

and assistance within this whole three-year PhD program. Unforgettable thanks to the coordinating staffs at CIRAD, L'Institut Agro Montpellier and ITC who helped me to deal with administrative procedures.

Unforgettable thanks to the directors and staffs of the three companies in Cambodia where we conducted our field study for allowing us to study their processes and thanks to my Cambodia team: Soukim HENG, Seanghai HOEUN and Rithy KAN for their help and facilitation in this fieldwork.

I would like to thank my Cambodian team: Davin SANG, Sophoan PHAL and Daroth VANTHA for participation in the focus group discussion and help with the consumer test and all ITC staff and students who participated in my consumer test at ITC.

Thanks to Keovathana RUN and Lyda CHIN for their kind help to bring turmeric samples from Cambodia to France. Without their support, I may face difficulties getting the samples during the pandemic of Covid-19.

Thanks to Sengly SROY for encouraging and sharing her experiences both in administrative and also in research works, moreover, I would like to thank Kimhan SENG and Vuthy MEN for their help in figures and map design.

I have deeply appreciated my father Yunteang HONG, my mother Simhor LY for their love and for raising us to be good cells in our society, and my six siblings (Gueksim TEANG, Guekseang HONG, Guekseng TEANG, Gueksay TEANG, Engseam YIN and Sokunthea TEANG), my brothers in law and my husband Phearith SENG for their continuing encouragement, love and unconditional support throughout my life and my studies. They have always been behind me every moment giving me motivation and encouragement in my studies and in all missions of my life. Although now you could not see my achievement in study's life, father, but all your advices are still in my mind. You always reminded me to study hard every time I were with you. Thank you for your unconditional love, you are our super father.

Last but not least, I appreciate all the love, encouragement, motivation and support from beloved people who are always with me along the journey.

Glossary

Term	Definition
5M	Material (turmeric), machines (equipment tools), mother nature (environment, conditions), methods and men (persons, staff)
a*	Redness
ANOVA	Analysis of variance: A statistical tool used to analyse the difference among means
b*	Yellowness
BDMC	Bisdemethoxycurcumin
BP	British Pharmacopoeia
c*	Chroma value
C	Curcumin
CI	Confidence Interval: The mean of an estimate +/- the variation in the estimate
CIRAD	Centre de Coopération Internationale en Recherche Agronomique pour le Développement
D3,2	Surface mean diameter
db	Dry basis
DMC	Demethoxycurcumin
DSC	Differential scanning calorimetry
dX/dt	Drying rate ($\text{kg} \cdot \text{kg}^{-1} \cdot \text{h}^{-1}$)
FDA	Food and Drug Administration
GA/MD	Gum Arabic and Maltodextrins
GRAS	Generally Recognized As Safe
HACCP	Hazard Analysis Critical Control Point
HPLC	High Performance Liquid Chromatography
IS	Indian Standard
ISO	International Organization for Standardization
ITC	Institut de Technologie du Cambodge
L*	Lightness
ppm	Part Per Million
PTFE	Polytetrafluoroethylene
RH	Relative humidity
SMEs	Small and Medium-sized Enterprises
<i>t</i>	Time (hour)
US	United States Federal Specifications
UV	Ultra violet
wb	Wet basis
WHO	World Health Organization
w/w	Weight/weight
X	Water content of turmeric ($\text{kg} \cdot \text{kg}^{-1}$ dry basis)

Table of Contents

Acknowledgements	i
Glossary	iii
Table of Contents	iv
List of Figures	vi
List of Tables	viii
List of Supplementary Figures and Tables.....	ix
General Introduction	1
1. Chapter 1 – State of the art.....	4
1.1 Turmeric general presentation.....	4
1.1.1 Origin, classification and production	4
1.1.2 Turmeric in Cambodia	6
1.1.3 Anatomy and structure of turmeric rhizome	7
1.2 Characteristics of turmeric.....	9
1.2.1 General composition	9
1.2.2 Biochemical and functional properties	9
1.3 Transformation processes and unit operations.....	14
1.3.1 Sorting, separating and washing.....	14
1.3.2 Curing.....	14
1.3.3 Drying.....	15
1.3.4 Polishing.....	16
1.3.5 Sorting and re-polishing (at industrial level)	17
1.3.6 Grinding and milling.....	17
1.3.7 Packing and storage.....	17
1.4 Quality of turmeric–specifications.....	18
1.5 Conclusion of state of art and scientific investigation.....	19
2. Chapter 2 – Postharvest treatments of turmeric (<i>Curcuma longa</i> L.) in Cambodia – impact on quality.....	23
2.1 Introduction to Chapter.....	23
2.2 Postharvest treatments of turmeric (<i>Curcuma longa</i> L.) in Cambodia – impact on quality (paper 1).....	23
2.2.1 Introduction.....	24
2.2.2 Material and methods	25
2.2.3 Results and discussion	28
2.2.4 Conclusion	43
2.3 Chapter 2 summary and outlook	43
3. Chapter 3 – Impact of processes on the quality of turmeric (physicochemical quality) .	46
3.1 Introduction to Chapter.....	46

3.2	Impact of cooking and drying operations on colour, curcuminoids and aroma of <i>Curcuma longa</i> L. (paper 2)	46
3.2.1	Introduction	47
3.2.2	Material and methods	47
3.2.3	Results and discussion	52
3.2.4	Conclusion	61
3.3	Chapter 3 summary and outlook	62
4.	Chapter 4 – Impact of processes on the quality of turmeric (sensorial and functional quality)	64
4.1	Introduction to Chapter	64
4.2	Impact of cooking, drying and grinding operations on sensorial and functional quality of <i>Curcuma longa</i> L. (paper 3)	64
4.2.1	Introduction	65
4.2.2	Material and methods	66
4.2.3	Results and discussion	71
4.2.4	Conclusion	80
4.3	Chapter 4 summary and outlook	80
5.	General Discussion	83
5.1	Processes implemented in Cambodia	83
5.2	Impact of sourcing (origin and part of rhizomes) on sensorial quality	85
5.3	Impact of process on sensorial quality	86
5.4	Impact of sourcing (origin and part of rhizomes) on functional quality	89
5.5	Impact of process on functional quality	90
5.6	Proposal of sustainable processing itineraries for turmeric in Cambodia	90
	Conclusion and Prospects	93
	References	96
	Summary in French	104
	Summary in Khmer	115
	Annex 1: Supplementary materials	126
	Annex 2: Questionnaire for process description thanks to 5M approach	132
	Annex 3: Description of turmeric processing in Cambodia	136
	Annex 4: Guide for focus group discussion – consumer test	147
	Annex 5: Questionnaire for consumer preference of turmeric powders	150
	Annex 6: Questionnaire for quantitative descriptive analysis	154
	Annex 7: List of scientific articles	156

List of Figures

Figure 1-1 Leading turmeric exporting countries worldwide in 2021 (Tridge 2022b).....	5
Figure 1-2 Export of turmeric from Cambodia between 2014 – 2021 (Tridge 2022a)	6
Figure 1-3 Turmeric varieties in Cambodia (A) whole rhizomes and (B) sliced rhizomes (Internal report of HEIP-ITC-SGA#08 2022)	8
Figure 1-4 The <i>Curcuma longa</i> plant, rhizomes and powder.....	8
Figure 1-5 Structure of curcumin, demethoxycurcumin, and bisdemethoxycurcumin (Sasikumar 2012).....	10
Figure 1-6 Monoterpenes from turmeric essential oil (Jacob 2016).....	12
Figure 1-7 Bisabolane-type compounds (Jacob 2016).....	12
Figure 1-8 Germacane-type compounds (Jacob 2016).....	13
Figure 1-9 Guaiane-type compounds (Jacob 2016).....	13
Figure 1-10 Scientific approach	20
Figure 2-1 Location of case study selected for studying postharvest treatments of turmeric (<i>Curcuma longa</i> L.) in Cambodia: Case study 1 (Siem Reap); Case study 2 (Phnom Penh); Case study 3 (Kampot).....	28
Figure 2-2 Diagram of processes of three distinct turmeric production case studies in Cambodia (Siem Reap, SR; Phnom Penh, PP/O1, PP/O2; Kampot, KP/O1, KP/O2) and an indication of sampling. See also Supplementary Figure 1	32
Figure 2-3 Fresh turmeric finger and mother rhizomes from three distinct case studies: Case study 1 (Siem Reap); Case study 2 (Phnom Penh); Case study 3 (Kampot).....	33
Figure 2-4 Particle size distribution of turmeric powders from distinct case studies, origins and processes	38
Figure 3-1 Processes applied to turmeric. F: fresh turmeric; C: cooking (C1: 95 °C/3 min; C2: 95 °C/60 min); D: drying (60 °C, 40 % RH).....	48
Figure 3-2 Visualization of essential oil, starch and curcuminoids distribution in turmeric rhizome by wide-field microscopy. (I) essential oil distribution (blue Nadi colouration) in a cross-section of turmeric rhizome, (II) essential oil distribution in the epidermis of fresh (F) turmeric, curcuminoid distribution (natural orange colour) in the epidermis of fresh (F) turmeric, (III) essential oil distribution in the epidermis of cooked (FC1) turmeric, curcuminoid distribution in epidermis cooked (FC1) turmeric, (IV) starch distribution (black Lugol colouration) in a cross-section of turmeric rhizome, (V) starch distribution in the cortex of fresh (F) turmeric, curcuminoid distribution in the cortex of fresh (F) turmeric and (VI) starch distribution in the cortex of cooked (FC1) turmeric. am, amyloplast; c, cortex; cur, curcuminoids cell; en, endodermis; ep, epidermis; gel, gelatinized starch; st, stele; bar = 500 µm (I and IV) or 50 µm (II, III, V and VI).....	52

Figure 3-3 Visualization of curcuminoids distribution by multiphotonic microscopy. (I) curcuminoids distribution in the cortex of fresh turmeric, (II) curcuminoids distribution in the cortex of cooked and dried (FC2D) turmeric and (III) Emission spectra of curcuminoids between 400 and 700 nm, excitation 720 nm, bar = 50 μm53

Figure 3-4 Impact of processes on (A) colour values (L^* , a^* , b^* and C^*) and (B) curcuminoid content (g/100g initial dry weight basis). FR: frozen rhizome; F: fresh turmeric; C: cooking (C1: 95 $^{\circ}\text{C}$ /3 min; C2: 95 $^{\circ}\text{C}$ /60 min); D: drying (60 $^{\circ}\text{C}$, 40 % RH). The error bars represent the standard error ($n = 6$). Within the same parameters, the values followed by the same superscript letters are not significantly different ($p < 0.05$)55

Figure 3-5 Impact of processes on essential oil content (mL/100g initial dry weight basis). F: fresh turmeric, C: cooking (C1: 95 $^{\circ}\text{C}$ /3 min; C2: 95 $^{\circ}\text{C}$ /60 min); D: drying (60 $^{\circ}\text{C}$, 40 % RH). The error bars represent the standard error ($n = 4$). Within the same parameters, the values followed by the same superscript letters are not significantly different ($p < 0.05$)55

Figure 3-6 Drying curves of fresh and cooked turmeric. (A) water content (X) on a dry basis as a function of time (t) and (B) drying rate (dX/dt) as a function of X . Drying curves recorded by an air dryer (60 $^{\circ}\text{C}$, RH 40 %, air velocity at $2.1 \pm 0.1 \text{ m s}^{-1}$). The different dash types on curves correspond to different trials.56

Figure 3-7 Composition of essential oil of fresh and processed turmeric. F: fresh turmeric; C: cooking (C1: 95 $^{\circ}\text{C}$ /3 min; C2: 95 $^{\circ}\text{C}$ /60 min); D: drying (60 $^{\circ}\text{C}$, 40 % RH). The error bars represent the standard error ($n = 8$). Within the same parameters, the values followed by the same superscript letters are not significantly different ($p < 0.05$).....61

Figure 4-1 Processes applied to turmeric. F: fresh; C: cooking (95 $^{\circ}\text{C}$ /3 min); D: drying (D1: 60 $^{\circ}\text{C}$, 40 % RH; D2: 50 $^{\circ}\text{C}$, 40 % RH; D3: 80 $^{\circ}\text{C}$ /1h + 50 $^{\circ}\text{C}$, 40 % RH); Grinding leading to different particle size (P1: <500 μm ; P2: <750 μm)67

Figure 4-2 Drying curves of fresh and cooked turmeric. (A) water content (X) on a dry basis as a function of time (t) and (B) drying rate (dX/dt) as a function of X . Drying curves recorded by an air dryer at different temperatures with an air velocity at $2.1 \pm 0.1 \text{ m s}^{-1}$. The different dash types on curves correspond to different trials76

Figure 4-3 The appreciation of consumers on turmeric powder. (A) general appreciation, (B) reasons of dislike and (C) purposes of buy/use, ways of consuming and occasion of consumption. F: fresh; C: cooking (95 $^{\circ}\text{C}$ /3 min); D: drying (D1: 60 $^{\circ}\text{C}$, 40 % RH; D2: 50 $^{\circ}\text{C}$, 40 % RH; D3: 80 $^{\circ}\text{C}$ /1h + 50 $^{\circ}\text{C}$, 40 % RH); P: particle size (P1: <500 μm ; P2: <750 μm) ...78

List of Tables

Table 1-1 Classification of Turmeric (<i>Curcuma longa</i>) (USDA Plants Database 2022)	4
Table 1-2 Distribution of the <i>Curcuma</i> Species (Ravindran et al. 2007).....	5
Table 1-3 Composition of fresh <i>Curcuma longa</i> L. from different scientific sources	9
Table 1-4 Composition of dried <i>Curcuma longa</i> L. from different scientific sources	9
Table 1-5 Major aroma compounds in <i>Curcuma longa</i> from different scientific sources.....	13
Table 1-6 Chemical specifications	18
Table 2-1 Impact of sourcing (origins and part of rhizomes) on the contents of essential oil, curcuminoids and their bioaccessibility (%) of turmeric obtained from different origins.....	39
Table 2-2 Impact of the full processes on the contents of essential oil, curcuminoids and their bioaccessibility (%) of turmeric obtained from different origins	40
Table 2-3 Impact of peeling and cooking at different time (i.e., 30 min and 40 min) on the contents of essential oil, curcuminoids and their bioaccessibility (%) of turmeric.....	41
Table 2-4 Impact of the origins (case study 3) and the part of the rhizomes (case studies 1 and 2) on colour values and particle sizes of turmeric powders	42
Table 3-1 Major aroma compounds in <i>Curcuma longa</i> L. fresh turmeric (F) essential oil.....	60
Table 4-1 Definition of sensory attributes used to describe turmeric powders	72
Table 4-2 Particle size (Sauter mean diameter $D_{3,2}$) of turmeric powder; curcumin (C), demethoxycurcumin (DMC), bisdemethoxycurcumin (BDMC), total curcuminoids content; total and relative bioaccessible curcuminoids of fresh (F) and processed turmeric samples obtained by cooking (C: 95 °C/3 min) or not, drying (D) and grinding with fine (P1) or coarse (P2) particle sizes	74
Table 4-3 Impact of processes on consumer preference and descriptive attributes of processed turmeric samples obtained by cooking (C: 95 °C/3 min) or not, drying (D) and grinding with fine (P1) or coarse (P2) particle sizes	79

List of Supplementary Figures and Tables

Supplementary Figure 1 Drying temperature profile of turmeric from three distinct case studies: Case study 1 (Siem Reap); Case study 2 (Phnom Penh); Case study 3 (Kampot)	126
Supplementary Figure 2 The hot air drier developed by CIRAD	128
Supplementary Figure 3 Temperature kinetic inside turmeric.....	129
Supplementary Figure 4 DSC thermogram of turmeric powder at 80 %	129
Supplementary Figure 5 Chromatogram of curcuminoids of fresh turmeric before and after digestion	130
Supplementary Figure 6 Standard curve of curcuminoids (A) used in chapter 2 and (B) used in chapter 3 and 4	131
Supplementary Table 1 Influence of different types of processing on mass, yield, dehydration time and water content of ground turmeric	127

General Introduction

General Introduction

Turmeric (*Curcuma longa* L.) belongs to the *Zingiberaceae* family and is widely distributed throughout the tropical and subtropical regions of the world (Kutti Gounder and Lingamallu 2012). Turmeric powder used in food formulation has colouring properties (yellow), aromatic function and health effects (El-Sayed and Youssef 2019; Kutti Gounder and Lingamallu 2012). Its price depends on many quality-related factors, including moisture content, appearance (colour) and curcuminoid content (Hirun, Utama-ang, and Roach 2014). In Cambodia, turmeric is mainly consumed fresh as it is available throughout the year. It is mixed with other spices or herbs to make *Kroeung* for traditional Cambodian foods (*Machu Kroeung*, *Korko*, *Kari*, *Amok* and so on) to enhance their aroma and colour and to boost the flavour (marinate) of meat by mixing it with other seasonings or spices. Turmeric powder is also used in cosmetic products (body lotion and scrap to whiten the skin) and medicine; it is produced mainly for export to the international market.

After harvest, fresh turmeric rhizomes undergo continuous physical, chemical and microbiological changes. These changes are particularly influenced by the moisture content of the material, relative humidity of ambient air and storage conditions (Bambirra *et al.* 2002). To preserve its quality and reduce its weight during transportation, it must be subjected to specific technological treatment such as drying to reduce the moisture content from 2.3 – 4.0 kg·kg⁻¹ db at the time of harvest to a safe value of 0.11 kg·kg⁻¹ db (International Organization for Standardization 1983). The processing of fresh turmeric rhizomes, prior to grinding and prior to extraction of curcuminoids or oleoresin or essential oil, involves two main steps: curing and drying. Curing turmeric is a significant postharvest processing operation that involves cooking fresh turmeric in boiling water. The goals of curing are to reduce microbial load, inactivate enzymes, avoid unpleasant odours, gelatinize the starch, and change the cell walls of the turmeric facilitating its permeability and reducing resistance to mass transfer which leads to an increase in the drying rate (Jayashree *et al.* 2018). However, curing is an optional unit operation sometimes practised before drying. Sun-drying has traditionally been the dehydration method used for turmeric rhizomes. It has been practised extensively in hot climates and tropical countries (including Cambodia) due to its low cost and simple technology. However, it is extremely weather-dependent and may, therefore, requires long processing time and affects the quality of the product, especially curcuminoid content (Hirun *et al.* 2014). Air drying is an alternative to sun drying, not only to increase the drying rate and reduce drying time but also to better preserve the quality of the product (Prathapan *et al.* 2009). Processing does affect the quality of turmeric; it is a real challenge for food small and medium-sized enterprises (SMEs) in Cambodia. Traditionally, the turmeric rhizomes are dried directly or cooked and then dried. In traditional process, whole rhizomes are cooked for a long

time (up to 1 hour) at high temperature (up to 100 °C). As cooking transfers water inside the product and drying purpose is to remove the water from the cooked rhizomes, we question the value of using these operations in a combined way. Moreover, numerous studies have demonstrated the impact of processes on the quality of turmeric powder, by comparing the initial and final products. They did not focus on the impact of each unit operation (cooking, drying and grinding) on sensorial and functional quality of turmeric. In addition, to our knowledge, turmeric processing practices in Cambodia have never been precisely described in scientific literature.

Objectives and research questions

The objective of this thesis was to describe postharvest treatments of turmeric (*Curcuma longa* L.) in Cambodia and their impact on turmeric's quality and to study, under controlled conditions, the impact of the combination of unit operations (cooking, drying and grinding) on the quality of turmeric. A better comprehension is indeed necessary to adapt processes in order to improve the sensorial and functional quality of turmeric and to propose acceptable technological innovation paths for Southern countries, Cambodia in particular.

This work aimed to answer the following main research questions:

- Q1. What are the turmeric transformation processes implemented in Cambodia?
- Q2. What quality characteristics of turmeric are affected by the processes, how and in which proportion?

Chapter 1 – STATE OF THE ART

1. Chapter 1 – State of the art

This first chapter focuses on an overview of turmeric general presentation, characteristics of turmeric, transformation processes and unit operations applied to turmeric and quality of turmeric (specification). Based on this literature review, we identified the gaps to study. Then, we described our scientific investigation.

1.1 Turmeric general presentation

1.1.1 Origin, classification and production

Turmeric has at least 6000 years of documented history of its use as medicine and in many socioreligious practices. Turmeric is probably a native of Southeast Asia, where many related species of *Curcuma* occur wildly, though turmeric itself is not known to occur in the wild (Ravindran, Nirmal Babu, and Sivaraman 2007). The classification of *Curcuma longa* is shown in **Table 1-1** (USDA Plants Database 2022). The genus *Curcuma* belongs to the family *Zingiberaceae* and contains 49 genera and 1400 species (Sasikumar 2012).

Table 1-1 Classification of Turmeric (*Curcuma longa*) (USDA Plants Database 2022)

Rank	Scientific Name and Common Name
Kingdom	Plantae – Plants
Subkingdom	Tracheobionta – Vascular plants
Superdivision	Spermatophyta – Seed plants
Division	Magnoliophyta – Flowering plants
Class	Liliopsida – Monocotyledons
Subclass	Zingiberidae
Order	Zingiberales
Family	Zingiberaceae – Ginger family
Genus	<i>Curcuma</i> L. – curcuma
Species	<i>Curcuma longa</i> L. – common turmeric

About 110 species (**Table 1-2**) are distributed predominantly in South and Southeast Asia of which around 40 to 45 species including *C. longa* are native to India (Ravindran *et al.* 2007). Recent studies have shown that the taxonomy of *C. longa* is problematic, with only the specimens from South India being identifiable as *C. longa* (Leong-Škorničková *et al.* 2008). The six taxonomic varieties within *C. longa* based on numerical taxonomic analysis are *C. longa* var. *typica*, *C. longa* var. *atypica*, *C. longa* var. *camphora*, *C. longa* var. *spiralifolia*, *C. longa* var. *musacifolia* and *C. longa* var. *platifolia* (Sasikumar 2012).

Table 1-2 Distribution of the *Curcuma* Species (Ravindran *et al.* 2007)

Geographic Area	<i>Curcuma</i> Species (Approximate)
Bangladesh	16 – 20
China	20 – 25
India	40 – 45
Cambodia, Vietnam and Laos	20 – 25
Malaysia	20 – 30
Nepal	10 – 15
The Philippines	12 – 15
Thailand	30 – 40
Total	100 – 110

Turmeric is exported as fresh, dry, powder, turmeric oleoresin and turmeric oil. Largely consumed in powdered form because of its yellow colouring property, it imparts characteristic flavour and preserves the freshness of the product prepared (Kutti Gounder and Lingamallu 2012). India is the leading producer and exporter of turmeric in the world. In 2021, India exported about 226 million U.S. dollars of turmeric (**Figure 1-1**) (Tridge 2022b). The entire 2021 production of turmeric was worth more than 350 million U.S. dollars (Tridge 2022b). The top export flow in 2021 was from India to the United States, with an export value of 45.83 million U.S. dollar according to Tridge (2022b) and 47 million U.S. dollars according to Statista (2022). The second and third largest importers of turmeric were the United Kingdom and Germany, which imported approximately 17 and 15 million U.S. dollars worth of turmeric, respectively (Statista 2022).

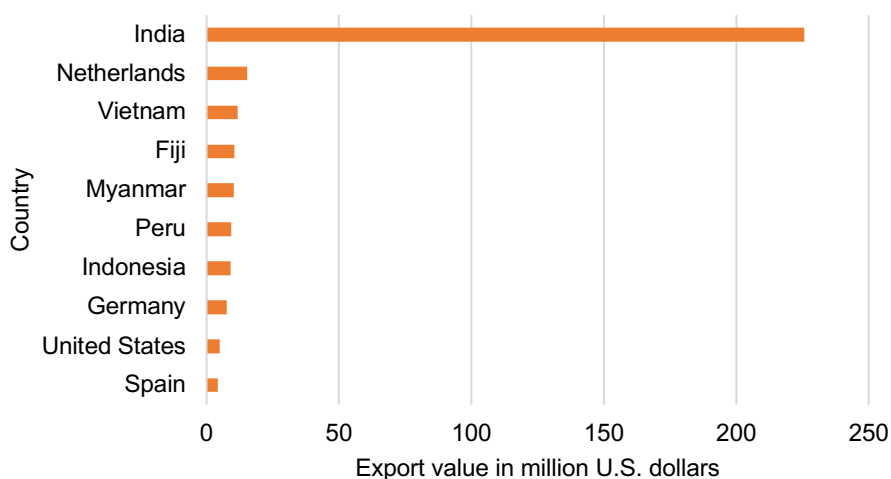
**Figure 1-1** Leading turmeric exporting countries worldwide in 2021 (Tridge 2022b)

According to data published by Tridge (2022a), the export value of turmeric from Cambodia has been increased every year from just only 9290 U.S. dollars in 2014 to 1.55 million U.S. dollars in 2021 with an export volume of 1.34 tons in 2014 and 512.64 tons in 2021 (**Figure 1-2**). This allowed Cambodia to have a share in export of 0.44 % (globally). In 2021, the top export destination of turmeric from Cambodia was India representing 94.16 % of share in export (equal to 1.46 million U.S. dollars of export value). The second and third ones were Czechia (2.59 %) and Belgium (1.63 %) (Tridge 2022a). Right after the Covid-19 outbreak, turmeric sales have been continuously increasing in 2020-2021 because it values the health benefits in the form of an immunity booster (Nithyashree 2022).

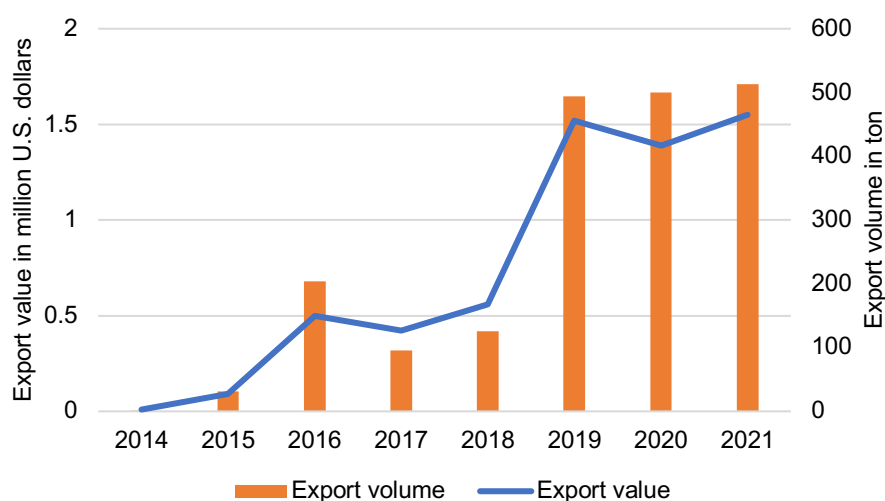

Figure 1-2 Export of turmeric from Cambodia between 2014 – 2021 (Tridge 2022a)

1.1.2 Turmeric in Cambodia

In Khmer cuisine, turmeric (local name: *Lamiet* or *Romiet*, scientific name: *Curcuma longa*) is a key ingredient in the preparation of *Kroeung* (mixture of herbs and spices) which is used in many recipes (*Machu Kroeung*, *Korko*, *Kari*, *Amok* and so on). In 2004, Indian investors were interested in Cambodian turmeric for its high-quality (smell and taste). Indian delegates came to Cambodia to visit Chamkar Leu district following the invitation of the director of Green Box Company, one of the main turmeric local actors. Turmeric was sent to India to check if the quality of Cambodian turmeric could challenge that of Vietnam and Myanmar. Then, in late 2004, the Green Box Company bought 50 tons of fresh turmeric from the farmers who lived in Chamkar Leu district to process into dried turmeric. The 10 tons of dry turmeric obtained were packed in a container and sent to India in 2005. After that, farmers mainly in Chamkar Leu (Kampong Cham province) and Samlot districts (Battambang province) started to collect seeds for plantations. However, in 2008, the price dropped continuously from 0.15 to 0.075 U.S. dollars per kilogram as the export of turmeric to India was postponed. Since then, most of the turmeric farmers were eventually forced to give up growing turmeric (The Phnom

Penh Post 2011). A few years later, in 2015, the farmers in O'Som commune, Veal Veng district started to collect the seeds for plantations again for supplying to an Indian company located in Samlot district, Battambang province of Cambodia. Just only in O'Som commune, the farmers can supply turmeric from 300 to 400 tons per year to the Indian company. According to farmer Nhem Dip, a kilogram of turmeric can be sold for 0.375 U.S. dollars for the first year (2017) and then it decreased to 0.35 and 0.325 U.S. dollars for the second (2018) and the third year (2019), respectively. Growing turmeric is not difficult, just look after the weeds, but they need to rotate the land for cultivation every year. Turmeric can be harvested once a year and the yield of turmeric is between 18 to 20 tons per hectare. The growing season for turmeric is the dry season, best from January to April, and the harvesting season is also between January and April (ThmeyThmey 2020).

The appearance of whole and sliced rhizomes is illustrated in **Figure 1-3** (Internal report of HEIP-ITC-SGA#08 2022). At least 13 turmeric varieties (most of them are wild varieties) have been discovered in Kulen mountain located in Siem Reap province of Cambodia. We believe that there are many more turmeric varieties in Cambodia and our team are presently trying to identify them. According to Ravindran *et al.* (2007), approximately 20 to 25 *Curcuma* species are native to Cambodia, Vietnam and Laos (**Table 1-2**). Currently, we found only local names *i.e.*, Neang Kong, Neang Kraoub, Broteal Banton Plok, Reus Doung, White Turmeric in Siem Reap, Broteal Neang Sab, Broteal Starng, Broteal Tom Pouk, Broteal Neang Svay, Preash Chheas Nhi, Broteal Neang S'boun, Preash Chheas Chhmol and yellow turmeric. They are different in shape, size, colour and smell. Among these turmeric, yellow turmeric which refers to *Curcuma longa* L. is the most mainly used.

1.1.3 Anatomy and structure of turmeric rhizome

The turmeric plant is about 60 – 90 cm in height with a short stem tufted oblong leaf. The flowers are white to light yellow and they are between 10 and 15 cm in length and they group together in dense spikes, which appear from the end of spring until the middle session (Das 2016). The rhizome is yellowish-brown with a dull orange interior that looks bright yellow when powdered. The rhizome is the underground stem of turmeric, which can be divided into two parts, the central pear-shaped "mother rhizome" and its lateral axillary branches known as "fingers" (Nair 2013). The whole turmeric rhizome has a rough, segmented skin. The fingers' length ranged from 2.5 to 7.0 cm in length and 2.5 cm in diameter with small tubers branching off (Das 2016). The *Curcuma longa* plant, rhizomes and powder are shown in **Figure 1-4**.

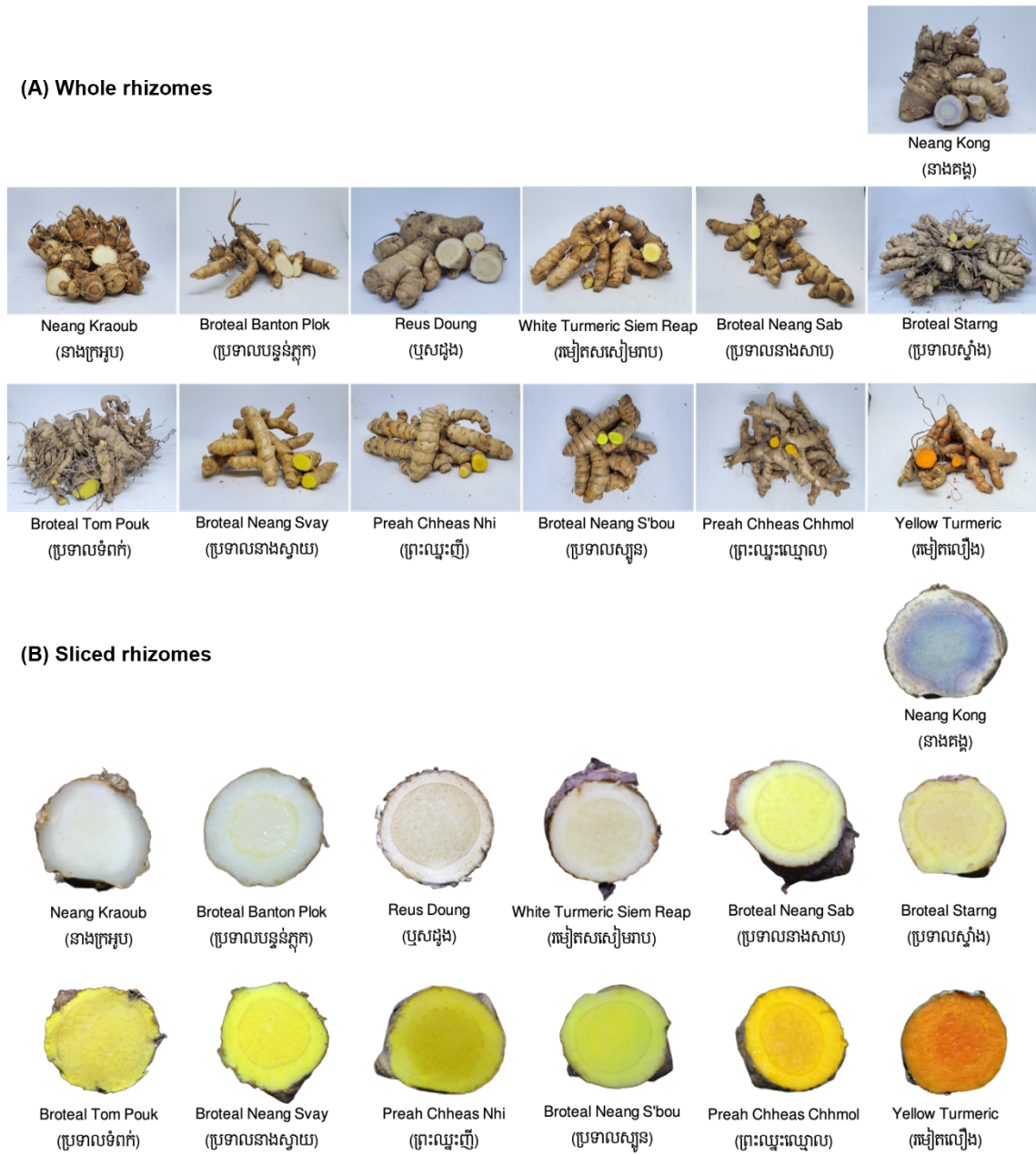

Figure 1-3 Turmeric varieties in Cambodia (A) whole rhizomes and (B) sliced rhizomes (Internal report of HEIP-ITC-SGA#08 2022)

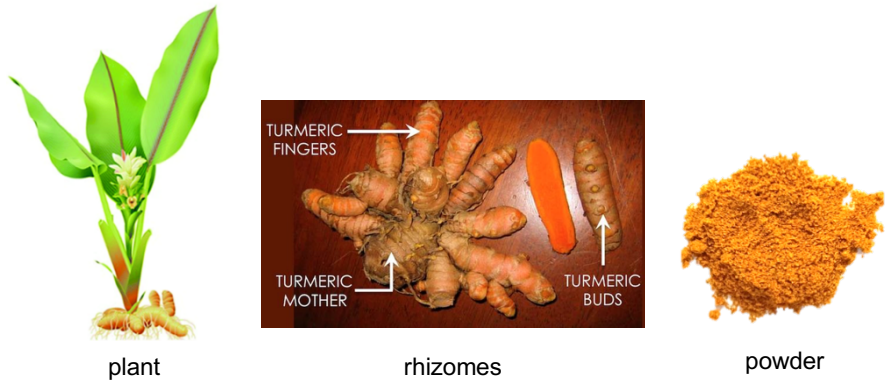

Figure 1-4 The *Curcuma longa* plant, rhizomes and powder

1.2 Characteristics of turmeric

1.2.1 General composition

Composition of fresh turmeric rhizomes (*Curcuma longa* L.) are presented in **Table 1-3** and composition of dried turmeric are shown in **Table 1-4**. Different turmeric variety, planting period, environmental conditions, plant development stage and harvesting season provide different compositions (Hirun *et al.* 2014).

Table 1-3 Composition of fresh *Curcuma longa* L. from different scientific sources

Composition	Concentration (% wb)		
	Garg <i>et al.</i> (1999)	Hirun <i>et al.</i> (2014)	Mane <i>et al.</i> (2018)
Moisture (%)	–	91.5 ± 0.65	84.25 ± 0.23
Fat (%)	–	–	1.08 ± 0.13
Carbohydrates (%)	–	–	9.10 ± 0.10
Protein (%)	–	–	1.20 ± 0.07
Ash (%)	–	6.9 ± 0.06	0.66 ± 0.01
Crude fibre (%)	–	–	0.72 ± 0.03
Essential oil (%)	0.16 – 1.94	–	–
Curcuminoids (%)	–	9.4 ± 3.38	5.1 ± 0.17

Table 1-4 Composition of dried *Curcuma longa* L. from different scientific sources

Composition	Concentration (% db)			
	Ravindran <i>et al.</i> (2007)	Sasikumar (2012)	Lokhande <i>et al.</i> (2013)	Monton <i>et al.</i> (2019a)
Moisture (%)	6 – 13	7.9 – 9.9	8.6 – 9.1	–
Fat (%)	5 – 10	–	7.2 – 8.4	–
Carbohydrates (%)	60 – 70	43.1 – 57.5	67.9 – 70.0	–
Protein (%)	6 – 8	1.1 – 2.1	7.6 – 8.7	–
Minerals (%)	3 – 7	5.7 – 6.9	6.5 – 6.8	–
Crude fibre (%)	2 – 7	2.8 – 4.0	7.2 – 8.1	–
Essential oil (%)	3 – 7	3.0 – 5.6	3.6 – 4.8	5.2 – 8.5
Curcuminoids (%)	2 – 6	–	2.6 – 5.2	3.9 – 6.6

1.2.2 Biochemical and functional properties

Turmeric contains variety of phytochemicals. Roughly 235, primarily phenolic compounds and terpenoids have been identified from various species of turmeric. Plant phenolics provide a functional quality, colour and flavour and have vital roles as singlet oxygen quenchers and free radical scavengers, aiding to decrease molecular damage. Turmeric is a good source of natural flavonoids, that have been revealed to have many health benefits (Tanvir *et al.* 2017).

1.2.2.1 Curcuminoids and their bioaccessibility

Curcumin is a yellowish powder that is insoluble in water but soluble in methanol, ethanol, acetone and dimethylsulfoxide (Goel *et al.* 2008). Curcumin is the principal constituent that imparts the yellow colour to turmeric; it is the phytochemical that is perceived as being accountable for most of therapeutic effects (Jain *et al.* 2011). Besides curcumin, there are a few related pigments (*i.e.*, demethoxycurcumin and bisdemethoxycurcumin) which impart the yellow colour, which together are named curcuminoids (**Figure 1-5**) (Sasikumar 2012). Curcuminoids consists of 52 – 63 % curcumin (C), 19 – 27 % demethoxycurcumin (DMC) and 18 – 28 % bisdemethoxycurcumin (BDMC) (Ravindran *et al.* 2007).

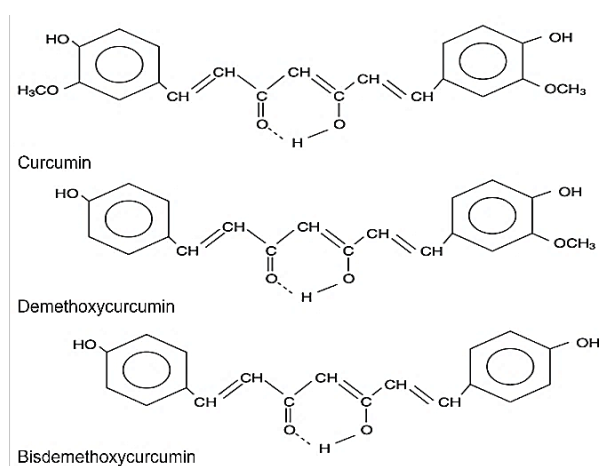

Figure 1-5 Structure of curcumin, demethoxycurcumin, and bisdemethoxycurcumin (Sasikumar 2012)

Many scientific researchers are interested in the health effects of curcuminoids. Curcumin has been proved to have many pharmacological properties including antioxidant, anti-hypertensive, neuroprotective, anti-ischemic, anti-cancer, antiplasmodial, antimalarial and nematocidal activities and is trendily in human clinical trials for an array of conditions, including cancer, myelodysplastic syndromes, colon cancer, psoriasis and Alzheimers disease. It is also used in folk medicine to treat a variety of diseases in animals and humans (Sasikumar 2012). Curcuminoids have been approved by the US Food and Drug Administration (FDA) as “Generally Recognized As Safe” (GRAS) (Fadus *et al.* 2017), and good tolerability and safety profiles have been shown by clinical trials, even at dose up to 12 g/day of 95 % concentration of curcuminoids (Hewlings and Kalman 2017).

We did not find any article(s) that mentioned about the impact of processes and unit operations on the content of bioaccessible curcuminoids and their bioaccessibility in turmeric (*Curcuma longa* L.) powder. Curcuminoids are lipophilic and poorly soluble in water, acid and neutral solutions, these characteristics give them a low bioaccessibility during digestion. They are

poorly absorbed from the intestine by enterocyte cells, metabolised rapidly and intensively, and eliminated systemically (Wang *et al.* 2008). The bioaccessibility of curcuminoids in turmeric powder (17 ± 4.1 %) can be increased by a factor of four if they are nanostructured with a lipid carrier (75 ± 1.2 %). The use of nanoparticles increases the contact surface between the biological fluids of the human body and the powder particles, and promotes the solubilisation of bioactive compounds (Park *et al.* 2018). The microencapsulation of curcuminoids (using gum arabic and maltodextrins, GA/MD) improved their digestive stability (by protecting them from degradation reactions) while promoting their bioaccessibility up to 25-fold higher than that of turmeric powder. The C, DMC and BDMC in turmeric powder and their relative percentage were 14.4 ± 0.3 mg/g (71 %), 3.26 ± 0.05 mg/g (16 %) and 2.49 ± 0.05 mg/g (12 %), respectively. The bioaccessible curcuminoids in turmeric powder was 16.8 ± 1.2 mg/g. Added to rice and yoghurt, the curcuminoid bioaccessibility of GA/MD was about 2-fold higher than for the ingredient alone; the addition of microencapsulated food ingredients in carbohydrate-rich meal (like rice) improved bioaccessibility more than in protein-rich meal (yoghurt) (Papillo *et al.* 2019). The absorption of curcuminoids from turmeric depends on coating and structuring which modulate their stability, solubility in the digestive tract and absorption into the systemic circulation. The presence of coating agents and food matrices may enhance the intestinal absorption of bioactive compounds. It helps to consume turmeric with black pepper, which contains piperine, a natural substance that enhances the absorption of curcumin by 2000 % (Hewlings and Kalman 2017).

1.2.2.2 Essential oil and aromatic composition

Essential oils are the volatile and fragrant substances of plants. They are aromatic stimulants and carminatives which give turmeric, its aroma. The essential oil from rhizomes of *Curcuma longa* manifests a broad variety of biological activities in terms of antibacterial, antifungal, anticancer, insect repellent and anti-snake venom activity (Singh *et al.* 2011). Turmeric essential oil acts as a carminative stomachic appetizer and tonic in small doses, however, it appears to act as an antioxidant in large doses (Raina *et al.* 2005). Turmeric essential oil contains terpenoids such as mono- and sesquiterpenes. Monoterpenes (**Figure 1-6**) contain two isoprene units with the molecular formula, $C_{10}H_{16}$, and they may be acyclic or cyclic compounds. *Curcuma* essential oils contain about 30 different monoterpenes. Sesquiterpenes are compounds with molecular formula $C_{15}H_{24}$ and their derivatives containing three isoprenoid units, and as in monoterpenes, they can be acyclic or cyclic compounds. Over 140 different sesquiterpenes have been isolated from the genus *Curcuma*. These compounds fall into one of the three major categories, bisabolanes (**Figure 1-7**), germacranes (**Figure 1-8**) and guaianes (**Figure 1-9**) (Jacob 2016).

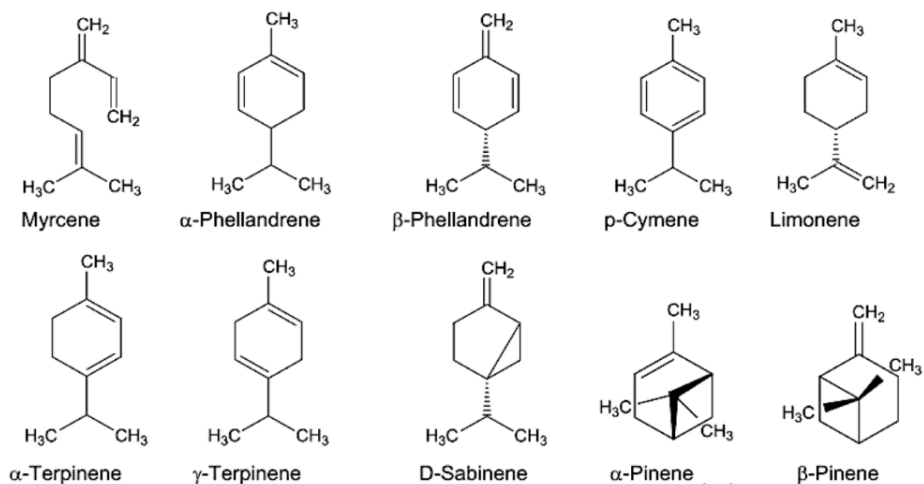

Figure 1-6 Monoterpenes from turmeric essential oil (Jacob 2016)

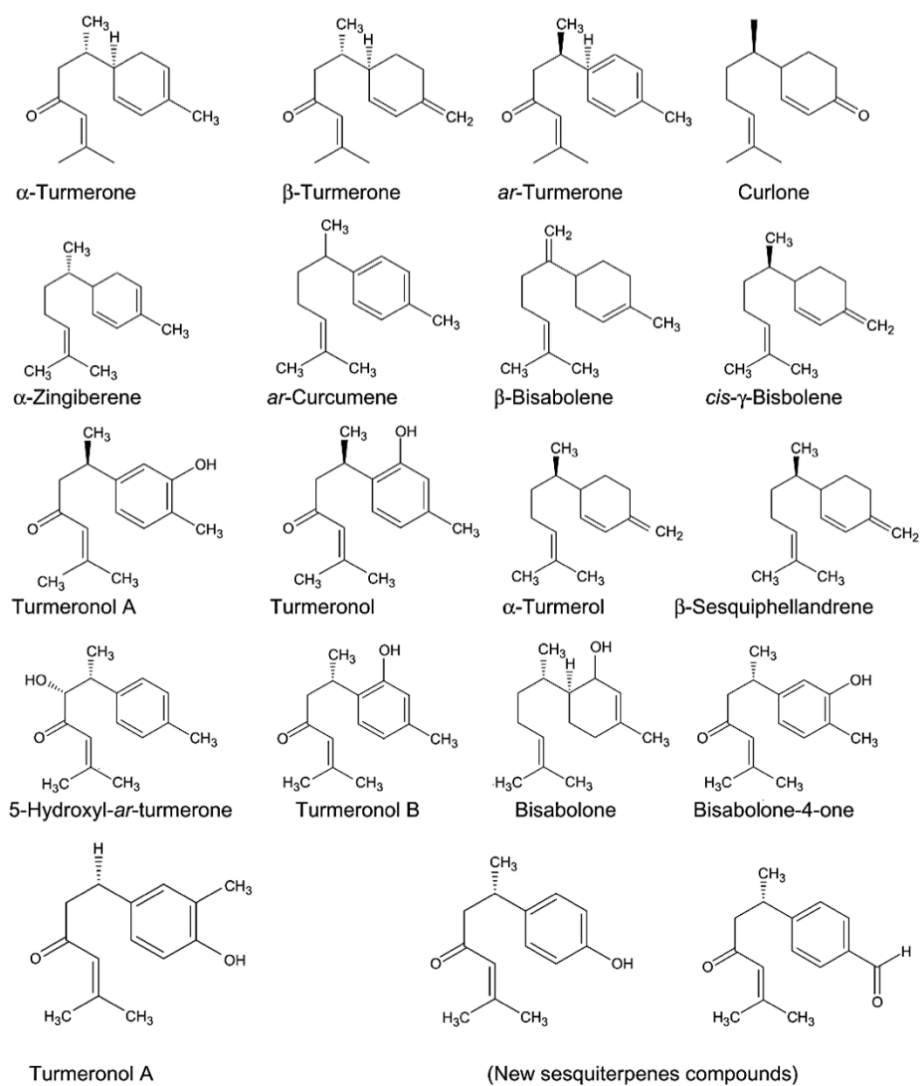

Figure 1-7 Bisabolane-type compounds (Jacob 2016)

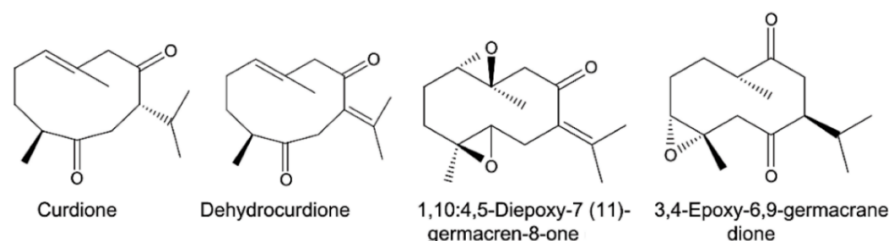

Figure 1-8 Germacane-type compounds (Jacob 2016)

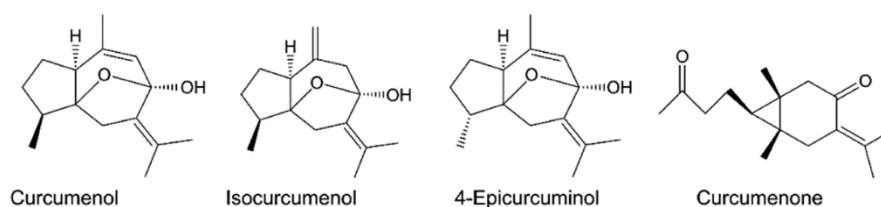

Figure 1-9 Guaiane-type compounds (Jacob 2016)

The composition of the essential oil of turmeric has been reported to differ in quantity and quality from various geographical regions concerning varietal and environmental differences (Singh *et al.* 2011). The major aroma compounds in *Curcuma longa* from different origins (*i.e.*, Iran, Pakistan, India and Brazil) are presented in **Table 1-5**.

Table 1-5 Major aroma compounds in *Curcuma longa* from different scientific sources

Aroma compounds	Concentration (%)			
	Iran (Asghari <i>et al.</i> 2009a)	Pakistan (Naz <i>et al.</i> 2010)	India (Singh <i>et al.</i> 2011)	Brazil (Avanço <i>et al.</i> 2017)
α -Phellanderene	2.2	0.4	5.3	6.5
Carene	–	–	0.3	–
Eucalyptol	0.4	1.6	2.6	3.2
α -Terpinene	–	–	–	–
p-Cymene	0.4	–	–	–
Terpinolene	1.5	–	–	1.4
β -Farnesene	–	–	0.6	–
Ar-Curcumene	–	–	3.5	–
Caryophyllene	0.6	2.3	0.8	–
α -Zingiberene	1.5	–	–	1.9
β -Bisabolene	0.4	–	0.6	–
β -Sesquiphellandrene	1.3	–	1.7	1.4
aR-Turmerol	–	–	–	1.1
Curzerenone	–	–	–	1.1
aR-Turmerone	68.9	25.3	49.1	12.9
α -Turmerone	20.9	18.4	–	42.6
β -Turmerone	–	12.5	16.8	16.0
Total	98.1	60.5	81.3	88.1

1.3 Transformation processes and unit operations

Species, environmental conditions including climate, cultivation practices, maturity when harvesting, transformation processes and storage do all influence the quality of turmeric. However, we focused our three years' work on the impact of the unit operations constituting the transformation processes. Various transformation processes can be applied to turmeric depending on the traditions, practices and need of each region or country. As India is the main production country, most of the process described below is practised in India.

1.3.1 Sorting, separating and washing

The whole raw turmeric is dug out from the underground. Tilled-out turmeric contains the whole raw mother rhizomes and finger rhizomes that are separated from each other. The large-sized rhizomes, subsidiary rhizomes, fingers and damaged rhizomes are categorized and heaped separately according to farmers' convenience. Then, the rhizomes are washed thoroughly, thanks to soaking or water spray washers, to remove adhering soil, mud, residues and other foreign materials. Turmeric is often soaked in still water before being washed with water sprays the next day (Sasikumar 2012).

1.3.2 Curing

Curing, also known as blanching, essentially involves boiling fresh rhizomes in water until soft. Curing is a process that reduces the microbial load on the rhizomes, removes the raw odour, reduces the drying time, gelatinizes the starch and provides uniform distribution of pigments inside the rhizome and a more attractive product (not wrinkled) that lends itself to easier polishing. After the rhizomes are removed from the ground, curing must be completed within 10 days to secure maximum usable product. Normally, mother and finger rhizomes are boiled separately for about 40 – 60 min under slightly alkaline conditions (1 gram of sodium bicarbonate or sodium carbonate in 1 litre of water) in copper, galvanized iron or earthen vessels. It is important to boil batches of rhizomes that are equal in size since different size materials would require different cooking times. Boiling is stopped when froth comes out, with the release of white fumes having the typical turmeric aroma. Rhizomes are tested by pressing with fingers (Gagare *et al.* 2015). Optimum cooking is attained when the rhizome yields to finger pressure and can be perforated by a blunt piece of wood (Sasikumar 2012).

Bambirra *et al.* (2002) showed that yields ranged from 9.84 to 14.51 % with moisture ranging from 8.84 to 9.86 %. Peel removal caused 30 % mass loss but the powder obtained had higher intensity of yellow and red. Cooking caused a reduction in dehydration time and provided a powder with lower moisture content, higher levels of curcuminoid pigments and higher Hunter CIE L*(lightness), a* (redness) and b* (yellowness) values. Cooking by immersion provided higher quality powder as compared to autoclave as it resulted in a loss of soluble sugars in

the cooking water, thereby limiting the number of sugars available for the Maillard reaction. Several studies reported that high temperatures, such as those experienced in blanching, cause thermal degradation of the curcumin (Chen *et al.* 2014), while other studies found that blanching protects the bioactive ingredients from the effects of the drying (Blasco *et al.* 2006). The loss of curcumin and oleoresin contents in turmeric steam blanching are less (Blasco *et al.* 2006; Shinde *et al.* 2011), moreover, steam blanching could save more energy, labour and time as compared to boiling (Blasco *et al.* 2006). Suresh *et al.* (2007) studied the heat treatments of turmeric by: (i) boiling for 10 min, (ii) boiling for 20 min and (iii) pressure cooking for 10 min. The results showed that the significant loss of curcumin due to heat processing was between 27 – 53 %, with maximum loss in pressure cooking for 10 min. An increase in the curing time of turmeric rhizomes resulted in a significant reduction in curcumin, starch, essential oil and oleoresin contents (Jayashree and Zachariah 2016).

1.3.3 Drying

Sun drying: the cooked rhizomes are allowed to cool gradually and spread out to dry in the open air in 5 to 7 cm thick layers on uncoated plain bamboo mats or concrete drying floor. A thinner layer is not desirable as this may result in surface discoloration. During night time, the rhizomes are heaped or covered with a material that allows adequate aeration. The spread rhizomes can be displaced twice a day. After 4 to 5 days of drying, it can be placed in gunny bags. Purely dried and undried turmeric cannot be mixed. When displacing the turmeric, wet turmeric that may be dried for another 3 to 4 days is separated. It may take 10 to 15 days for rhizomes to get completely dried. Moisture or rain should not come in contact with the drying rhizomes at any cost, so as to prevent loss of colour and lustre. Completely dried turmeric produces a cracking sound when turned into hands. Generally, turmeric is dried from an initial moisture content of 80 – 83 % (w.b) to a moisture content of 8 – 10 % (w.b), for paramount storage, quality and value of produce. In open yard sun drying, sudden rain and inclement weather reduce turmeric quality; drying can then last up to 25 days when this too slow rate of drying allows the development of moulds (Sasikumar 2012).

Mechanical drying: mechanical drying refers to drums, trays or continuous parallel or cross-flow hot air tunnel. Drying using cross-flow hot air at a maximum temperature of 60 °C is found to give a satisfactory product. Solar dryers can also be energy efficient used for drying turmeric; however, it has limitations *i.e.*, the maximum temperature achieved by the dryer depends on the outside climatic conditions. Since the sun is serving as an energy source, satisfying outputs cannot be achieved in regions where cloudiness and humidity are high. Solar dryers are far more rapid, providing uniformity and hygiene to the products being dried and are suitable for industrial food drying processes. A solar tunnel dryer is essentially a poly house having a tunnel-like framed structure covered with ultra violet (UV)-stabilized polythene

sheet, where agricultural and industrial products could be dried under at least a partially controlled environment, in which loading and unloading are quite easy (Sasikumar 2012). Sun drying has been practiced extensively in hot climates and in tropical countries where the outdoor temperature is high enough (usually 30 °C or higher), due to its low cost and simple technology. However, it is extremely weather-dependent and requires long processing times and the rhizomes are still prone to infestation, decrease quality, which is not acceptable for industry. Due to the longer duration of drying and non-uniformity of heating effect, the occurrence of chemical changes like browning is more prevalent in sun drying method compared to mechanical drying. As a result, the sun-dried turmeric powder appears darker in colour in comparison to the mechanically dried ones (Bambirra *et al.* 2002). Air drying is an alternative to sun drying, not only to increase the drying rate and reduce drying time but also to better preserve the quality of the product (Prathapan *et al.* 2009). The finger rhizomes took less time to dry than mother rhizomes and the optimum drying conditions for best product quality were found to be air temperature of 55 – 60 °C and air velocity of 2 m s⁻¹ (Singh *et al.* 2010). High air temperature (> 60 °C) caused degradation of volatile compounds and curcuminoids; it also provided flesh darkening and discolouration. The traditional drying method could result in the loss of volatile oil (up to 25 %) by evaporation, and in the destruction of some light sensitive oil constituents (Ararsa 2018). Drying temperature, vacuum level and the thickness of turmeric slices had significant effects on the drying kinetics and qualities of the turmeric slice for colour change, it is found that L* and a* increased with an increase in drying temperature while b* was quite constant. The curcumin content of dried turmeric decreased with an increase in temperature, absolute pressure and turmeric slice thickness (Saetan *et al.* 2013). Solar drying is better than direct sun drying as it achieved the desired moisture content and essential quality in 42 hours (6 days) compared to 56 hours (8 days) in sun drying, thus saving considerable time (14 hours). All the fingers were orange-yellow in colour on breaking. Uncooked slices had a yellow surface on sun drying while the hot air-dried slices had an orange-yellow surface (Sasikumar 2012). Pradeep *et al.* (2016) revealed that curcumin content is higher in turmeric dried under mechanical drying followed by black surface coupled with sun drying. Drying in the sun on a black surface gave better results than normal sun drying. The dried product yield of 17.1 – 20.6 % is comparable between different dryers.

1.3.4 Polishing

Sometimes, the outer layer of the rhizomes turns black in colour after cooking. That layer must be removed with the help of polish, otherwise, it looks unattractive and should not get a good market price. Turmeric polishing (either manually or mechanically in power-operated drums) is another important process after boiling and drying. Turmeric is polished by producers by a simple method before it is taken to the market. In the village, turmeric is polished by rubbing

hard substances or gunny bags against it. Sometimes it is spread on hard ground and trampled by persons after tying gunny bags to their feet. Polishing the turmeric in drums also have been practised in some areas. When the drum is filled with turmeric is rotated, polishing is affected by abrasion of the surface against the mesh as well as by mutual rubbing against each other as they roll inside the drum. However, polishing is sometimes done by rocking it in suspended bamboo baskets containing small granite stones (Gagare *et al.* 2015).

1.3.5 Sorting and re-polishing (at industrial level)

After curing and polishing in the villages, turmeric is sorted out by some producers by separating fingers and bulbs before it is taken to the market. Many producers are not careful and take the produce to the markets without proper sorting. Since sorting is not properly done, some bulbs are left over among the fingers and vice-versa. Polishing by machine- or power-driven drums is not undertaken by the producers. It is normally done by the merchants or turmeric processing and powder making units, when turmeric is to be dispatched to outside states, either after taking out from storage or after purchasing from the market. Normally, the fine dust obtained during the polishing is used as manure for paddy rice. A weight loss of about 5 – 8 % is expected due to full polishing (Sasikumar 2012).

1.3.6 Grinding and milling

Grinding is a simple process involving cutting and crushing the rhizomes into small particles. Small quantities can occasionally be grinded in a household stone grinder. For the large-scale, the whole turmeric pieces have to be grinded by machines. The turmeric powder shall be ground to such a fineness that all the material shall pass through 300 µm sieve (Bureau of Indian Standards 2010). The turmeric may be heated up and volatiles are lost depending on the type of mill and speed of crushing. Heat and oxygen during the process may contribute to curcumin degradation. Ground spices are size sorted through screens, and the larger particles can be further ground to meet the standards (Sasikumar 2012). In the ambient grinding process, the temperature of the powder raises to as high as 90 – 95 °C resulting in losses of essential oils, aroma, and colour leading to the deterioration of its quality. Cryogenic milling under liquid nitrogen prevents oxidation and volatile loss, but it is expensive and wider spread in the industry (Ararsa 2018; Sasikumar 2012).

1.3.7 Packing and storage

Turmeric powder should be packed in UV protective packaging and stored appropriately (cool and dry environment) to prevent moisture absorption and loss of flavour and colour. Turmeric powder is packed in bulk in containers such as fibre hard drums, multiwall bags and tin containers suitably lined or coated. However, for the retail trade, the unit packages are in

flexible packaging such as aluminium foil laminate, low- and high-density polyethylene, polyvinyl chloride, glassine or in glass packages (Sasikumar 2012).

1.4 Quality of turmeric–specifications

Several organizations *i.e.*, International Standard Organization (ISO), World Health Organisation/Food and Drug Administration (WHO/FDA), United States (US) Federal Specifications, British Pharmacopoeia (BP) and Indian Standard (IS) Specifications have established standards for *Curcuma longa*. These standards provide sanitary, sensory and chemical specifications. Whole turmeric refers to the primary (bulbs, rounds) and secondary (fingers) rhizomes, harvested at full maturity, cured, dried and polished (optional in ISO and IS standards). Turmeric powder is obtained by grinding whole turmeric. The limits for chemical characteristics specified for whole and powdered turmeric from different scientific sources are shown in **Table 1-6**.

Table 1-6 Chemical specifications

Characteristic	BP	US	ISO 5562:1983		IS 3576:2010		WHO/FAO
	Whole	Whole	Whole	Powder	Whole	Powder	Powder
Water (% wb), max.	8–9	9	12	10	11	11	10
Total ash (% db), max.	6–9	7	–	9	8	8	7
Ash insoluble in acid (% db), max.	–	0.5	–	1.5	–	1.5	1.5
Starch (% db), max.	–	–	–	–	–	60	60
Crude fibre (% db), max.	4–6	6	–	–	–	–	–
Volatile oil (% db), max.	2–5	4	–	–	–	–	–
Colouring power as curcuminoids (% db), min.	–	5	–	2	2	2	–
Present of chromate	–	–	–	–	Absent	Absent	Absent
Lead (ppm), max.	–	–	–	–	10	10	1.5
Copper (ppm), max.	–	–	–	–	5	5	–
Arsenic (ppm), max	–	–	–	–	0.1	0.1	–
Zinc (ppm), max	–	–	–	–	25	25	–
Cadmium (ppm), max	–	–	–	–	0.1	0.1	–
Tin (ppm), max.	–	–	–	–	Absent	Absent	–
<i>Salmonella</i> (in 25 g)	–	–	–	–	Absent	Absent	–

BP: British Pharmacopoeia; US: United States Federal Specifications; WHO/FDA: World Health Organisation/Food and Drug Administration cited by Govindarajan and Stahl (1980)

ISO: International Standard Organization (International Organization for Standardization 1983)

IS: Indian Standard Specifications (Bureau of Indian Standards 2010)

Whole turmeric must have the characteristic shape and colour of the variety (no artificial colouring matter or dyes). Whole or powdered turmeric should have the characteristic odour and flavour of the spice and be free from foreign flavours. Whole turmeric must be free from living insects and moulds and practically free from dead insects, insect fragments and rodent contamination (Bureau of Indian Standards 2010; International Organization for Standardization 1983). Turmeric fingers should not be less than 15 mm in length with only admissible levels of small pieces (7 %) and bulbs (5 %) (International Organization for Standardization 1983). Whole turmeric should not contain more than 2 % of foreign matter and 5 % of defectives. Whole turmeric is classified according to its presentation (rhizomes *i.e.* fingers or bulbs), its origin, and its foreign matter content (Bureau of Indian Standards 2010; International Organization for Standardization 1983). Turmeric powder is classified based on its grain size: (i) coarse powder: 98 % of the product must pass through a sieve with a mesh size of 500 µm; (ii) fine powder: 98 % of the product must pass through a sieve with a mesh size of 300 µm (International Organization for Standardization 1983). However, as mentioned in Bureau of Indian Standards (2010), turmeric powder shall be ground to such a fineness that all the material shall pass through 300 µm sieve.

1.5 Conclusion of state of art and scientific investigation

After conducting bibliographic study, we observed that the description of turmeric transformation processes practiced in Cambodia and the assessment of the impact of those processes on quality have never been precisely described and published in the scientific literature. In addition, we noticed that the rhizomes are normally dried directly or cooked and then dried. We question the value of using these operations in a combined way, as cooking transfers water inside the product and drying will have to remove the water from the cooked rhizome. Moreover, in traditional process, whole rhizomes are cooked long time (up to 1 hour) at high temperature (up to 100 °C). The objective of this thesis work was to describe postharvest treatments of turmeric (*Curcuma longa* L.) in Cambodia and their impact on turmeric's quality and to study, under controlled conditions, the impact of the combination of unit operations (cooking, drying and grinding) on functional and sensorial quality of turmeric (*Curcuma longa* L.). Our study will contribute to a better understanding of the postharvest treatments of turmeric (*Curcuma longa* L.) in Cambodia and their impact on quality and finally to propose acceptable technological innovation paths for Southern countries, Cambodia in particular. To achieve our objective and ultimately answer our research questions, the following scientific approach (**Figure 1-10**) was implemented.

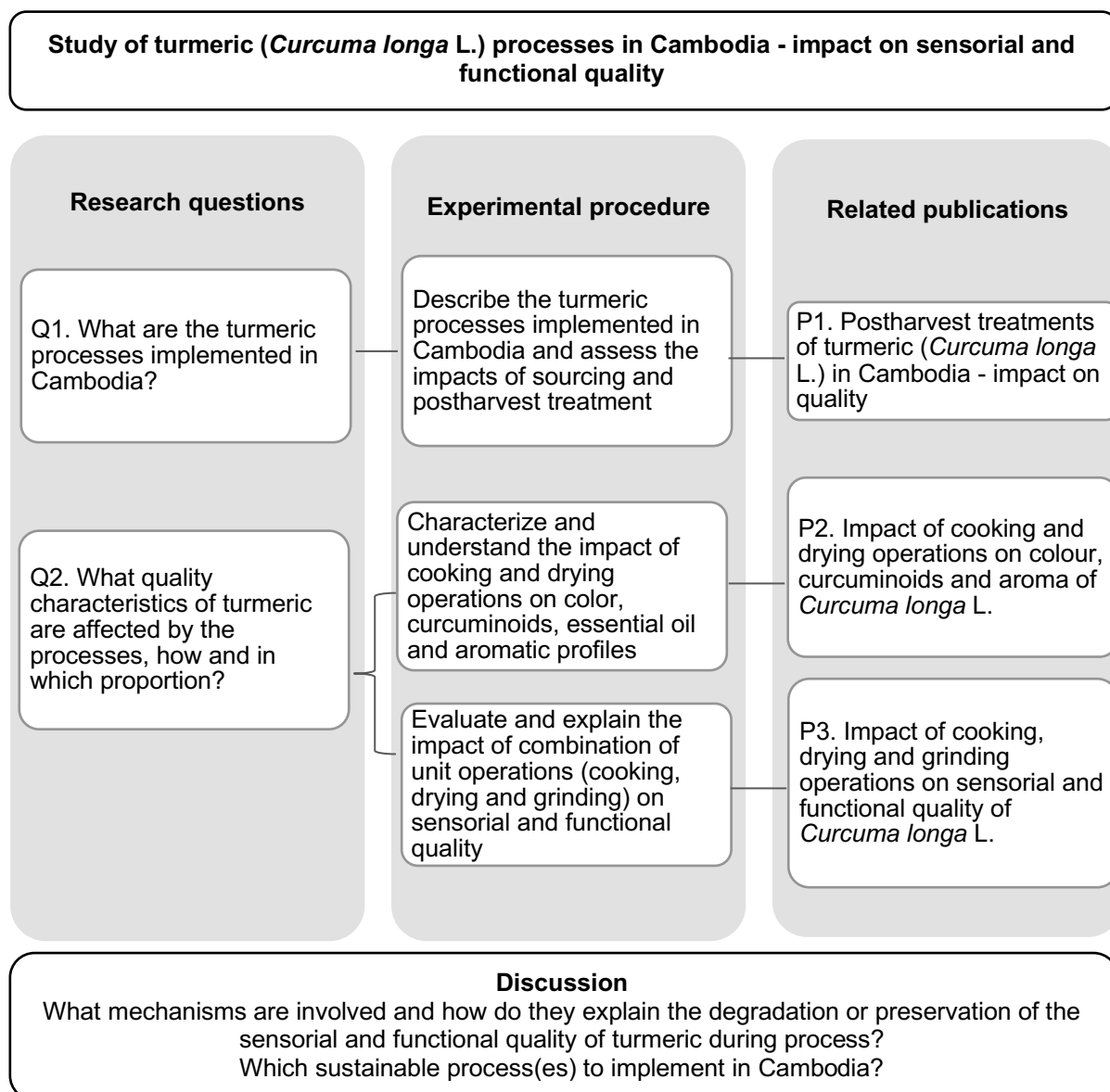

Figure 1-10 Scientific approach

First, we conducted a field survey on turmeric postharvest treatments implemented in Cambodia and measured their impact on quality (paper 1, Chapter 2). In this chapter, we aimed to describe the main local postharvest treatments of turmeric (*Curcuma longa* L.) in Cambodia and assess the impacts of sourcing (including the origins of the raw material and the parts of the rhizomes *i.e.*, finger and mother rhizomes) and postharvest treatments on turmeric quality (including the full processes and the unit operations of peeling and cooking). The quality characteristics considered in this study were particle sizes and distribution, colour values (L^* , a^* and b^*), essential oil and curcuminoid contents (C, DMC and BDMC) and bioaccessibility of curcuminoids. Next, we studied (paper 2, Chapter 3) under controlled conditions the impact of cooking and drying and their combinations on the colour values (L^* , a^* and b^*), curcuminoid contents (C, DMC and BDMC), essential oil content and aromatic profiles of *Curcuma longa* L. The impact of cooking on drying kinetics was assessed and mass

balances of dry matter, water and curcuminoids were calculated. Microscopic analysis of turmeric was realized to localize starch, essential oil and curcuminoids and to assess process effects on their distribution in the cells. Then, we studied (paper 3, Chapter 4) the impact of cooking, drying and grinding unit operations and their combinations on essential oil and curcuminoid contents (C, DMC and BDMC), bioaccessibility of curcuminoids and sensorial quality of *Curcuma longa* L. In order to determine optimum transformation conditions, the impact of cooking, drying and grinding was studied through different process conditions on sliced rhizomes. The impact of cooking and drying on drying kinetics was also studied in this chapter.

The results obtained from these studies are presented in the form of three scientific articles and published in three international journals:

- Publication #1. Postharvest treatments of turmeric (*Curcuma longa* L.) in Cambodia – impact on quality
- Publication #2. Impact of cooking and drying operations on colour, curcuminoids and aroma of *Curcuma longa* L.
- Publication #3. Impact of cooking, drying and grinding operations on functional and sensorial quality of *Curcuma longa* L.

Chapter 2 – Postharvest
treatments of turmeric (*Curcuma
longa* L.) in Cambodia – impact on
quality

2. Chapter 2 – Postharvest treatments of turmeric (*Curcuma longa* L.) in Cambodia – impact on quality

2.1 Introduction to Chapter

This chapter corresponds to an audit (3 companies) and analysis on turmeric postharvest treatments in Cambodia. The data allowed us to summarise the processing techniques used to produce the turmeric powders and their impact on quality. It was published as a research article in the Journal of Fruits - the International Journal of Tropical and Subtropical Horticulture.

2.2 Postharvest treatments of turmeric (*Curcuma longa* L.) in Cambodia – impact on quality (paper 1)

Molika Yin ^{1,2}, Philippe Bohuon ¹, Sylvie Avallone ¹, Sokneang In ², Mathieu Weil ^{1,3*}

Fruits - the International Journal of Tropical and Subtropical Horticulture

Volume 77, Issue 6, page 1 – 12

¹Qualisud, Univ Montpellier, CIRAD, Institut Agro, Avignon Université, Univ de La Réunion, Montpellier, France

²Institut de Technologie du Cambodge, Food Technology and Nutrition Research Unit, Phnom Penh, Cambodia

³CIRAD, UMR Qualisud, F-34398 Montpellier, France

Abstract: Introduction. A study on postharvest treatments of turmeric (*Curcuma longa* L.) was carried out in Cambodia with the aim of describing the local practices and measuring their impacts on the quality of the products. **Materials and methods.** Three case studies were observed, described and compared by using the 5M methodology. The impacts of sourcing and postharvest treatments on turmeric quality were assessed in samples collected in the case studies. **Results and discussion.** The local processing practices of turmeric were described in detail through the study of three turmeric production systems located in three areas (Siem Reap, Phnom Penh and Kampot), and known as the main turmeric processors in Cambodia. The essential oil, bioaccessible curcuminoids (both finger and mother) and total curcuminoids contents (mother only) of the rhizomes from different origins were different. The essential oil content of fingers was lower than that of mothers. The contents of total and bioaccessible curcuminoids also varied according to the rhizome parts analysed. After processing, no general rule was observed for essential oil and curcuminoid contents but the bioaccessible curcuminoids significantly decreased. **Conclusion.** Our findings clearly indicate

that fresh turmeric from Siem Reap should be a good choice as it contains higher essential oil and equal curcuminoid contents compared to the turmeric from case study 2 (Phnom Penh). The postharvest treatment in Kampot had the shortest drying time and got the highest yield (16.2 %), with the water content (about 6 %) conforming with the specifications of the ISO standard 5562:1983.

Keywords: Bioaccessibility; Curcuminoids; Essential oil; Field study; Particle size

2.2.1 Introduction

Turmeric (*Curcuma longa* L.) belongs to the Zingiberaceae family and is widely distributed throughout the tropical and subtropical regions of the world (Kutti Gounder and Lingamallu 2012). In Cambodia, turmeric (local name: lamiet) is mainly consumed fresh as it is available throughout the year. Moreover, it is mixed with other spices or herbs to make *Kroeung* for traditional Cambodian foods (*Machu Kroeung*, *Korko*, *Kari*, *Amok* and so on) to enhance their aroma and colour and to marinate meat by mixing it with other seasonings or spices to boost the flavour of the meat. Turmeric powder has been used in cosmetic products (body lotion and scrap to whiten the skin) and medicine; it has been produced mainly for export to international market. The export value of turmeric from Cambodia was 1.55 million U.S. dollars with an export volume of 512.64 tons in 2021. This allowed Cambodia to rank at 21th with a share in export of 0.44 %. The top export destination of turmeric from Cambodia in 2021 was India (94.16 % of share in export equal to 1.46 million U.S. dollars of export value) (Tridge 2022a). After harvest, fresh turmeric rhizome undergoes continuous physical, chemical and microbiological degradation. These changes are particularly influenced by the moisture content of the material, relative humidity of ambient air and the drying and storage conditions (Bambirra *et al.* 2002). To preserve its quality and reduce its weight during transportation, it must be subjected to specific technological treatment such as drying. Sun-drying has traditionally been the dehydration method used for turmeric rhizome. It has been practised extensively in hot climates and tropical countries due to its low cost and simple technology. However, it is extremely weather-dependent and may, therefore, requires long processing times and it affects the quality of the product, especially in the curcuminoid content (Hirun *et al.* 2014). Hence, each company does its best to find an acceptable process, *i.e.*, a set of operations to obtain good quality turmeric at a reasonable price. Parameters such as complexity and duration of the process or even sustainability can also be taken into account. Currently, there is no study combining the description of turmeric processes and the assessment of the impact of those processes on quality. Thus, in this study, we aimed to describe the main local postharvest treatments of turmeric (*Curcuma longa* L.) in Cambodia and assess the impacts of raw material sourcing (origin and part of the rhizome) and

postharvest treatments (full processes and unit operations of peeling and cooking) on turmeric quality. The main quality characteristics considered in this study were essential oil content, curcuminoid contents (curcumin: C, demethoxycurcumin: DMC and bisdemethoxycurcumin: BDMC) and their bioaccessibility. Moreover, the impact of origin and part of the rhizomes on colour values (L^* , a^* and b^*) and particle characterisation (sizes and distribution) of turmeric powders were also assessed.

2.2.2 Material and methods

2.2.2.1 Description of turmeric production systems

The harvest season of turmeric in Cambodia is from January to April. Our study (sampling included) was carried out from January to February 2022 in three different areas *i.e.*, Siem Reap (point: 13.325749382221119, 103.91928620819341), Phnom Penh (point: 11.538663924648885, 104.8845437152102) and Kampot (point: 10.6126459894834, 104.31763155656039) (**Figure 2-1**). These areas were selected because they are known as the main production areas in Cambodia. In all three cases, the surveys were carried out in medium-sized companies with a number of employees of approximately 30. These actors produce annually about 10 tons of dried turmeric powders. The target market of case study 1 (Siem Reap), case study 2 (Phnom Penh) and case study 3 (Kampot) are tourism, local market and export, respectively. A checklist was used for interviewing 33 actors in order to describe the turmeric process. We used the 5M methodology – a widely utilized tool in developing hazard analysis critical control point (HACCP) systems – to describe each step of the three turmeric production systems accurately and exhaustively through five dimensions: material (turmeric), machines (equipment tools), mother nature (environment, conditions), methods and men (persons, staff).

2.2.2.2 Determination of turmeric quality

Sampling procedure

About 200 g of fresh turmeric and turmeric powders were sampled for quality analysis. Samples were packed in a zip-lock aluminium bag (primarily packaging) and put in secondary packaging *i.e.*, zip-lock plastic bag. The samples were stored in an icebox containing refrigerant gel and transported to Institut de Technologies du Cambodge (ITC) by car and frozen at $-20\text{ }^{\circ}\text{C}$ in ITC's laboratory (Cambodia) for further transportation to CIRAD's laboratory (France). The samples were transported by airplane from Phnom Penh (Cambodia) to Montpellier (France) within 48 h and refrozen at $-20\text{ }^{\circ}\text{C}$ on arrival for further analysis.

Sample preparation

About 100 g of fresh turmeric were cleaned and cut into small pieces. Next, they were frozen by using liquid nitrogen and ground for 10 s at 10 000 rpm in a mill (Retsch Grindomix GM200,

Retsch GmbH, Germany) for immediate analyses of water content, essential oil content, curcuminoids and their bioaccessibility whereas the turmeric powder sampled from each case study were analysed directly.

Analytical methods

Dry matter and water contents

The dry matter content (means “dry matter free of essential oil”) was obtained by drying 1 g of ground turmeric in an aluminium cup in an oven (Gefran 800, Italy) at 105 °C for 30 h (*i.e.*, until constant weight). The mean relative deviation of repeatability was $\pm 1.5\%$ ($n = 3$). Water content, expressed on a dry basis, was deduced from essential oil and dry matter contents.

Colour measurements

Colour values *i.e.*, lightness (L^*), redness (a^*) and yellowness (b^*) of ground turmeric samples were determined using a Colorimeter (CM-5; Konica-Minolta, Tokyo, Japan). The mean relative deviation of repeatability was 0.7 %, 0.4 % and 0.3 %, respectively for L^* , a^* and b^* ($n = 3$).

Particle characterisation

A laser granulometry instrument (Mastersizer 3000, Malvern Instruments Ltd., Malvern, Worcestershire, UK) was used to measure the turmeric powders' particle diameter and particle size distribution. The particle size was reported as the surface mean diameter ($D [3;2]$), the volume-weighted mean diameter ($D [4;3]$), and median $D_x (50)$. The mean relative deviation of repeatability was 1.8 %, 10.0 % and 1.6 %, respectively for $D [3;2]$, $D [4;3]$ and $D_x (50)$ ($n = 5$).

Essential oil content

The essential oil content, expressed in mL/100g on a dry weight basis (mL/100g db), was determined using a method adapted from the international official standard method ISO 6571:2008 (International Organization for Standardization 2008). The only modification in the method we applied was the elimination of xylene. The mean relative deviation of repeatability was $\pm 1.2\%$ ($n = 3$).

Curcuminoid contents

Approximately 0.3 g of turmeric sample was mixed with 30 mL of 60 °C ethanol (99.8 %) and homogenized for 2 min at 30 000 rpm (IKA T10 basic Ultra-Turrax, ProLabo, France). The samples were heated for 30 min at 60 °C (Sogi *et al.* 2010). After cooling, the extracts were diluted 1/10 with ethanol and filtered on 0.45 μm PTFE Minisart SRP4 membrane (Sartorius, Palaiseau, France). Curcuminoids were analysed by high-performance liquid chromatography

(Agilent System 1200 series, Massy, France). The column was a polymeric ACE C₁₈ (250 × 4.6 mm, 5 µm particle size, Inc Wilmington NC) and the injection volume was 5 µL. The quantification of curcuminoids was carried out according to the method of Sepahpour *et al.* (2018) with small modifications. The elution was done isocratically with a mixture of acetonitrile and 0.1 % acetic acid (40:60) at a flow rate of 1.0 mL/min. The temperature of the column was set at 25 °C. Chromatograms were recorded over 30 min period with a UV-visible photodiode array detector (Agilent Technologies 1200 series) at 425 nm, the wavelength of maximum absorption of the curcuminoids in the mobile phase. The curcuminoids were identified by their retention time and spectrum. External calibration was realized weekly with standard solutions of the pure chemicals in ethanol in the range of 1 to 200 mg/L. The curcuminoid contents were expressed in g/100g on a dry weight basis (g/100g db). The mean relative deviation of repeatability was 2.8 %, 2.2 %, 2.4 % and 2.5 %, respectively for C, DMC, BDMC and total curcuminoid contents ($n = 3$).

Assessment of bioaccessible curcuminoids

A static *in vitro* gastrointestinal tract model was used to study the potential gastrointestinal fate and bioaccessibility of curcuminoids in turmeric powders. The simulated gastrointestinal tract used in our study was based on one described previously (Minekus *et al.* 2014; Yerramilli *et al.* 2018) with some slight modifications. The stock solutions were prepared before the experiments while the enzymatic solutions were prepared at the last moment. About 1.0 g of fresh turmeric or 0.3 g of dried turmeric was weighed and distilled water was added into the sample to get the total weight about 5.0 g that was left at room temperature for 15 min. Then, 5 mL of salivary solution was added and the sample was incubated for 2 min at 37 °C with gentle stirring (Oral phase). Next, 10 mL of gastric phase was added and incubated for 2 h at 37 °C with gentle stirring (Gastric phase). The solution was adjusted to pH 5.0 with sodium hydroxide at 2 M and then 20 mL of intestinal phase was added. The sample was incubated for 2 h at 37 °C with gentle stirring (Intestinal phase). After that, the digest phases were separated from the solid residue by centrifugation at 10 000 g for 30 min at 15 °C (Avanti™ J-E, Beckman Coulter®). The liquid phase was weighed accurately. To extract the bioaccessible curcuminoids, 10 mL of the digesta was mixed with 10 mL of chloroform (≥ 99.8 %) and vortexed for 10 s (Fisherbrand™ Classic Vortex Mixer). Next, the samples were centrifuged at 10 000 g for 10 min at 15 °C. After that, 5 mL of yellow phase was evaporated at 50 °C for 3 min using a rotary evaporator (Heidolph Laborota 4000, Schwabach, Germany). Then, the residue was solubilized in 10 mL ethanol (≥ 99.8 %) and filtered on 0.45 µm PTFE Minisart SRP4 membrane. Finally, the bioaccessible curcuminoids were analysed by HPLC following the same method as the curcuminoid analysis. The content of bioaccessible curcuminoids was expressed in g/100g on a dry weight basis (g/100g db) by using the total content in the

sample. The mean relative deviation of repeatability was 6.0 %, 4.4 %, 4.1 % and 4.8 %, respectively for C, DMC, BDMC and total curcuminoids ($n = 3$). The bioaccessibility (in %) corresponds to the amount of compounds transferred to the micellar phase compared to the initial contents in the products.

2.2.2.3 Statistical analysis

The results were expressed as means \pm standard deviations. To study the impact of the origin of the raw material, the significant differences were treated by analysis of variance (ANOVA) and Duncan's Multiple Range Test. To study the impact of the part of the rhizome, the impact of full processes and the impact of peeling and cooking, the significant differences were determined by the Independent-Samples t-test. The SPSS version 26.0 (SPSS Inc., Chicago, IL, USA) was used for the statistical analysis and the level of significance was set at $p < 0.05$.

2.2.3 Results and discussion

2.2.3.1 Description of turmeric postharvest treatments

The case studies took place in three areas of Cambodia where turmeric processing was observed, described and sampled (**Figure 2-1**). The observed processes were precisely detailed hereafter (**Figure 2-2**). Some process steps were common to all processes, whereas others were specific.

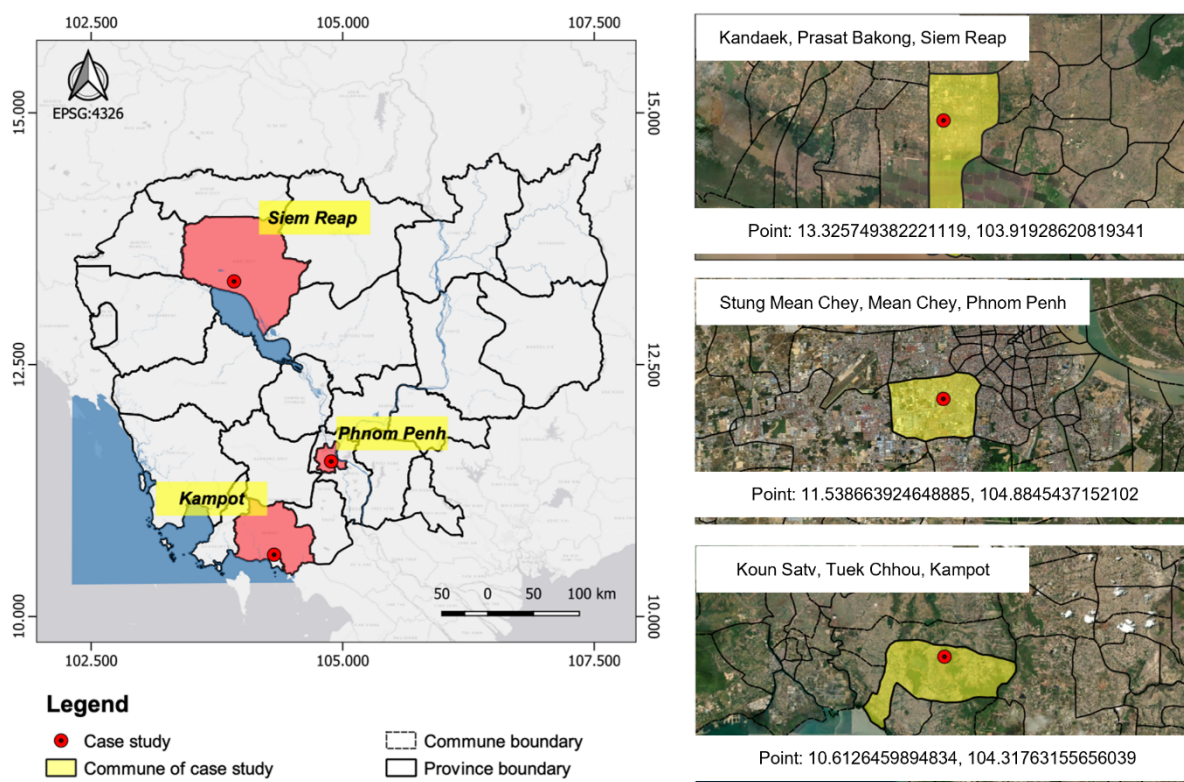

Figure 2-1 Location of case study selected for studying postharvest treatments of turmeric (*Curcuma longa* L.) in Cambodia: Case study 1 (Siem Reap); Case study 2 (Phnom Penh); Case study 3 (Kampot)

Reception of fresh turmeric

The turmeric roots were harvested a day before transporting them to processors. When there was a large purchase order from a processor, sometimes a farmer would act as a collector who collected the fresh turmeric from other farmers who lived in their village and then sold them to the processor. Transport could take from a couple of hours to a day depending on the distances and means used: trailer or truck. There was one origin of turmeric for case study 1 (SR: purchased from farmers in Siem Reap province) and two origins for case study 2 (PP/O1: grown in their own farm and PP/O2: purchased from Kampong Speu province) and for case study 3 (KP/O1: grown in their own farm in Kampot province and KP/O2: purchased from Pursat provinces). According to their origins, the turmeric rhizomes were very different in size, shape and colour. This can be explained by the fact that species, age/maturity of the rhizome, soil, climate and growing technics that are different according to origins, affect the phenotype (**Figure 2-3**, fresh turmeric at t_0). Great differences on rhizomes dimensions were observed according to their origins; SR being the smallest rhizomes and PPO1 the biggest. The length of the fingers ranged from 3.0 to 10.5 cm while their diameters ranged from 1.1 to 2.4 cm. Mothers, ovate in shape, are of shorter length (from 2.5 to 9.5 cm) and have a larger diameter (from 2.5 to 4.7 cm) than the fingers.

Sorting and separating

Sorting and separating were usually done manually. The processors separated the finger and mother rhizomes to process them separately (case studies 1 and 2 only). At the same time, foreign matter, small rootlets and adherent soil were removed. In case study 3, foreign matter, small rootlets and adherent soil were also removed during sorting but the turmeric rhizomes (finger and mother) were processed together. The quantity of turmeric processed varied from 100 to 200 kg per day and required 4 (case study 2) to 13 (case studies 1 and 3) persons (mainly women).

Washing, peeling and cleaning

Washing and peeling were usually done at the same time by using a peeling machine that requires water for its functioning. In case study 1, the turmeric rhizomes were hand-washed twice with underground water to remove adhering soil and other foreign materials and then they were peeled (SY-PP8, Guangzhou Sunrry Kitchen Equipment Co., Ltd., China) (2 kg of finger rhizome/batch for 2 min and 2.5 kg of mother rhizome/batch for 5 min). Next, the peeled rhizomes were re-peeled manually using knives by 10 people to make sure that all the peel was completely removed. It is not only a time-consuming and low-yield process, but it also has an impact on quality as we could observe browning (enzymatic or non-enzymatic oxidation) on the peeled rhizomes. Mother rhizomes were cut into 4 pieces before subjecting

to the next step. In case study 2, after separating finger and mother rhizomes, the rhizomes were peeled (CY-WP08, Zhengzhou Chenyue Machinery Equipment Co., Ltd., China) (10 kg of rhizome/batch for 15 min and 30 min for finger and mother rhizomes, respectively). Then, the peeled rhizomes were cleaned in brine (75 g salt/300 l of water), tap water and treated water (UV and O₃) and then drained on a sieve tray. In case study 3, after sorting, the turmeric rhizomes were washed and slightly peeled (MSTP-80, Zhaoqing Fengxiang Food Machinery Co., Ltd., China) (20 kg/batch) which took about 30 min to process 100 kg of turmeric.

Cooking (case studies 1 and 3 only)

In case study 1, the peeled turmeric rhizomes were cooked in hot water (between 70 to 100 °C) with a ratio of 1:1 w/v (10 kg of turmeric: 10 l of water) for 30 min and 35 min for finger and mother rhizomes, respectively. In case study 3, the cleaned turmeric rhizomes were cooked in hot water (between 88 to 101 °C) for 30 min or 40 min for turmeric roots from their own farm and only for 40 min for the turmeric roots purchased from the farmers with a ratio of 1:2 w/v (30 – 33 kg of turmeric: 60 L of water). The cooked turmeric rhizomes were then drained. Cooking was used not only to remove impurities (dust and foreign matter) but also to decrease the microbial load.

Slicing (case studies 2 and 3 only)

In case study 2, after cleaning, the rhizomes were hand-cut into small pieces before being sliced to a thickness of 1 – 2 mm by using a slicing machine. In case study 3, slicing was done after the turmeric rhizomes were cooked. The cooked rhizomes were sliced to a thickness of 3 mm by a slicing machine; it took about 20 min for 100 kg of turmeric.

Drying

The drying time of all samples in the three case studies is shown in **Supplementary Figure 1**. In case study 1, the cooked turmeric rhizomes were spread on trays (2.5 kg/tray) and dried in a solar dryer at 22 – 70 °C for 93 – 95 h. The large difference in drying temperatures was due to day and night periods. The dried turmeric rhizomes (finger and mother) were put separately in plastic bags (10 – 15 kg/pack), kept in a big plastic box and stored at ambient temperature. In case study 2, the sliced turmeric rhizomes (2 – 3 kg/tray) were put on tray and dried in a room (with iron roof) at 26 – 47 °C for 18 – 41 h by using fans to speed up the drying process. The semi-dried turmeric chips were sieved manually to separate between small and big turmeric chips. The small turmeric chips were collected but the big ones were dried in an oven dryer at 35 – 49 °C for 24 – 25 h. After drying, the turmeric chips were put in plastic bags (20 – 25 kg/pack) and stored at 25 °C. In case study 3, the sliced-cooked turmeric rhizomes were spread on trays (2.5 – 3 kg/tray) and dried in a solar dryer at 31 – 65 °C for 24 – 45 h. The drying time depends on the temperatures reached during the day and night. As there was heavy rain during drying, the drying time was increased up to 45 h for turmeric from their own farm (KP/O1_Ground).

The turmeric chips were put in plastic bags (about 10 kg/pack) and stored at 25 °C. The processors checked if the turmeric were completely dried by visual observation and by evaluating with their hands if they were crispy or easy to crack. The drying process would be stopped according to these empiric criteria. The dried turmeric in the three case studies were then stored for a few days to a few months and the grinding operation was carried out just before sale or expedition, depending on market demand.

Grinding and packing

In case study 1, the dried finger and mother turmeric were ground separately by a grinder until “fine” particles were obtained. However, in case studies 2 and 3, the dried turmeric were normally ground by a big-scale grinder (10 kg/batch) and then reground by using a small-scale grinder (2 – 3 times) until “fine” particles were obtained. Then, the ground turmeric were sieved and the particles remaining on the sieve would be reground to complete the process. Finally, the finger and mother turmeric powders were mixed together before being vacuum-packed in plastic bags and repacked in various packaging with various net contents of different prices (case study 1). In case study 2, the finger and mother turmeric powders were mixed together and then it was made as a capsule for selling to the market. In case study 3, the turmeric powders were vacuum-packed in plastic bags and repacked in various packaging with various net contents of different prices and they were also used as an ingredient to make other products (*e.g.*, *Kari paste*, *Kroeung* to marinate meat and so on). The highest yield of final products was found in case study 3 (16.2 %), followed by case study 2 (between 10.8 – 14.2 %) and case study 1 (10.0 %), respectively (**Supplementary Table 1**). The water content of fresh turmeric ranged from 77.1 ± 0.1 to 84.3 ± 0.1 % (w/w); that of turmeric (dried) powders ranged from 3.3 ± 0.1 to 8.2 ± 0.1 % (w/w) (**Supplementary Table 1**). These values were in accordance with the specifications of the ISO standard ISO 5562: 1983 (International Organization for Standardization 1983), indicating that the maximum water content in turmeric powder is 10 % (w/w). Hence, there is a potential saving to be made by the companies on drying: they could dry less and obtain a better yield.

Selling price

The average selling prices (in US dollars per kg) by each supply chain actor were as follows: farmer 0.45, collector 0.55, company (the prices varied according to net contents and packaging types) or shops on local market 20, and shops on European market 63. If we reason in equivalent water content, means if we consider the loss of water during the process, we can consider that the selling price was multiplied by 3 from farmer to company or local shops and by 10 from farmer to European shops.

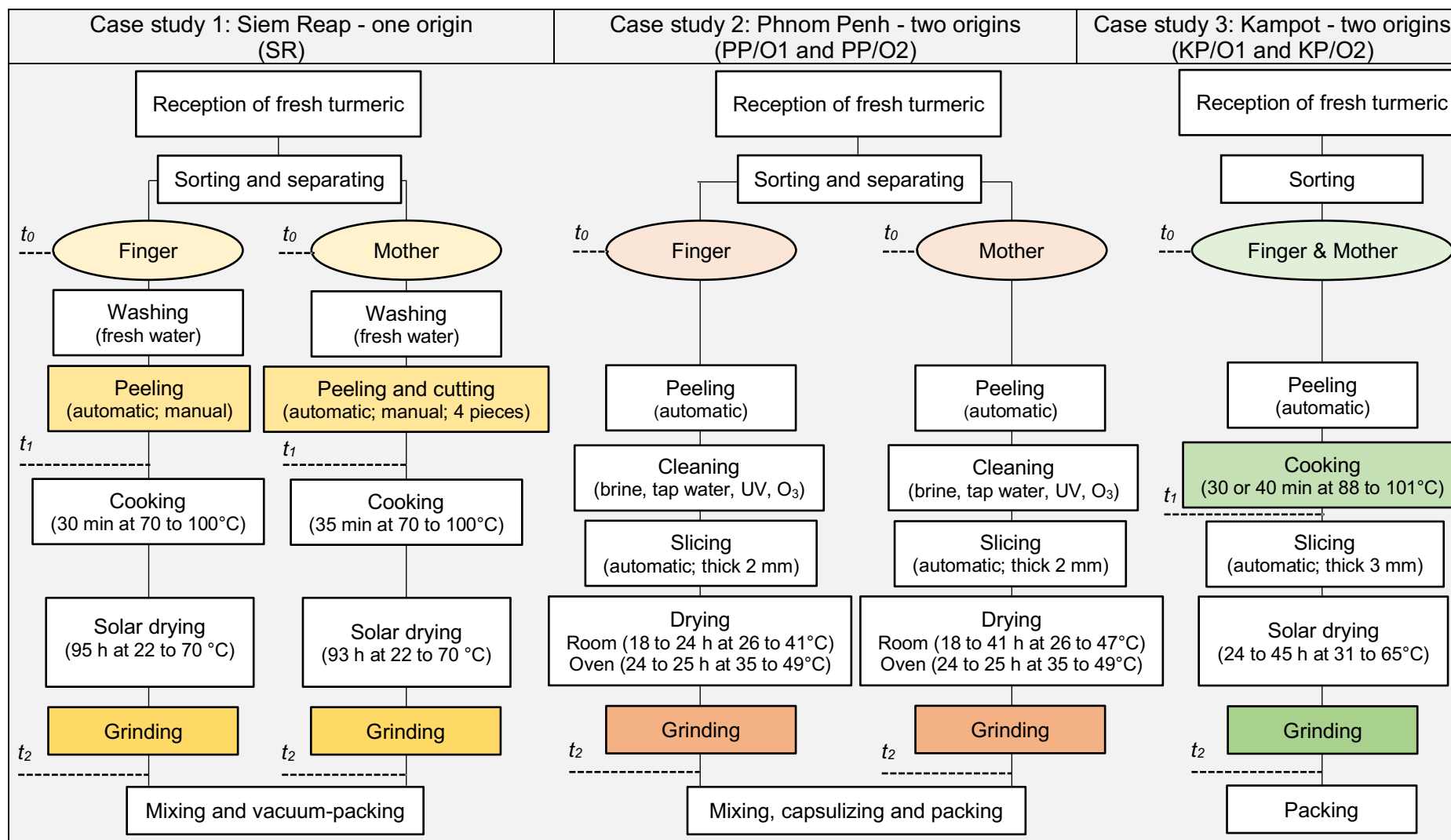

Figure 2-2 Diagram of processes of three distinct turmeric production case studies in Cambodia (Siem Reap, SR; Phnom Penh, PP/O1, PP/O2; Kampot, KP/O1, KP/O2) and an indication of sampling. See also **Supplementary Figure 1**.



Figure 2-3 Fresh turmeric finger and mother rhizomes from three distinct case studies: Case study 1 (Siem Reap); Case study 2 (Phnom Penh); Case study 3 (Kampot)

2.2.3.2 Impact of sourcing and postharvest treatments on turmeric quality

Impact of sourcing

Impact of the origins on the essential oil, curcuminoid contents and their bioaccessibility of raw material

Different “Origins” could mean different terroir/climate (for sure), and also different species/varieties, different cultural practices and different maturities. The essential oil content of the turmeric rhizomes (both finger and mother) from different origins was significantly

different (**Table 2-1**). The highest essential oil content of fresh finger rhizome was observed in the turmeric from case study 1 (SR_Fresh finger: 9.76 mL/100 g db) followed by PP/O1_Fresh finger (8.21 mL/100 g db) and PP/O2_Fresh finger (6.68 mL/100 g db), respectively. These values were lower than the value of 10.72 mL/100 g db (equal to 1.32 mL/100 g wb) found by Yin *et al.* (2022), on fresh turmeric from Thailand. However, the values were in agreement with Garg *et al.* (1999) who found that the essential oil content of turmeric collected from the sub-Himalayan Tarai region of India ranged from 0.16 to 1.94 mL/100g wb. Fresh mother rhizome from case study 1 (Siem Reap) had the highest essential oil content (17.84 mL/100g db), followed by PP/O2_Fresh finger (10.85 mL/100g db) and PP/O1_Fresh finger (7.90 mL/100g db) and respectively.

The total curcuminoid content of the fresh finger rhizomes from different origins was not significantly different (**Table 2-1**), an average of 8.49 g/100g db (equal to 1.36 g/100g wb). This value was lower than the values found by Yin *et al.* (2022) (14.86 g/100 g db) and Hirun *et al.* (2014) (9.39 g/100g db), but in accordance with the data of Govindarajan and Stahl (1980) (2 – 9 g/100g db). In contrast, the total curcuminoid content of the fresh mother rhizomes from different origins was significantly different (**Table 2-1**). The highest total curcuminoid content of fresh mother rhizome was found in the turmeric from case study 1 (SR_Fresh mother: 9.54 g/100g) followed by PP/O1_Fresh mother (8.99 g/100g db) and PP/O2_Fresh mother (8.08 g/100g db), respectively.

Different origins of the turmeric rhizomes (both finger and mother) provided different bioaccessible curcuminoid contents (**Table 2-1**). The bioaccessibility of curcuminoids of fresh finger rhizomes ranged from 7.0 % to 13.6 % while that of fresh mother rhizomes ranged from 9.5 % to 16.8 %.

Impact of part of the rhizomes on the essential oil, curcuminoid contents and their bioaccessibility of raw material

The mass ratio of finger and mother in rhizomes (data not shown) in Siem Reap and Phnom Penh was the same and ranged from 89 to 92 % (w/w) for the finger and 8 to 11 % (w/w) for the mother rhizomes. The mass ratio of mother rhizome was even lower (between 2 % to 3 %) in Kampot. The essential oil content in mothers was 59 % higher than in fingers for the sample in Siem Reap but these differences were not so high for the other origins (samples in case study 2).

Within the same rhizome, fingers and mothers can have different levels of total and bioaccessible curcuminoids (**Table 2-1**). In case study 1, the curcuminoid content of fresh mother rhizome from case study 1 (Siem Reap) was 15 % higher than the fresh finger rhizome. This value was in agreement with Choudhury *et al.* (2017) who found that the phytochemical constituents are not evenly distributed in all plant parts and curcumin content

(average) of fresh mother rhizomes was 15 – 38 % higher than the fresh finger rhizomes. In case study 2, the curcuminoid content in finger and mother rhizomes was not different for samples from the farm (PP/O1) but the curcuminoid content of PP/O2_Fresh finger was 2.9 % higher than that of PP/O2_Fresh mother. Moreover, overall, regardless of the sourcing, C, DMC and BDMC represented 46 ± 6 %, 23 ± 1 % and 31 ± 6 % of the total curcuminoids respectively.

Overall, regardless of the sourcing, the bioaccessibility of C, DMC and BDMC reached 50 ± 9 %, 29 ± 2 % and 21 ± 1 % of total curcuminoids, respectively. No general rule was observed for the contents of bioaccessible curcuminoids and their bioaccessibility in different parts of fresh rhizomes (*i.e.*, finger and mother). In case study 1, the bioaccessible curcuminoid contents of SR_Fresh finger were significantly lower than those of SR_Fresh mother; however, there was no significant difference in the bioaccessibility of curcuminoid between SR_Fresh finger and SR_Fresh mother (**Table 2-1**). In case study 2, the bioaccessible curcuminoid contents and their bioaccessibility of PP/O1_Fresh finger were significantly higher than those of PP/O1_Fresh mother. In contrast, the bioaccessible curcuminoid contents and their bioaccessibility of PP/O2_Fresh finger were significantly lower than those of PP/O2_Fresh mother.

Impact of the process on quality

Impact of the full processes on the essential oil, curcuminoid contents and their bioaccessibility

The impact of the full processes on the essential oil, curcuminoid contents and their bioaccessibility was assessed (**Table 2-2**). Compared to fresh rhizomes, the essential oil content of turmeric powders in case study 1 decreased significantly by 6.6 % for fingers and 23.8 % for mother rhizomes. The drying condition of these samples was the same but the relative loss of essential oil content was different. This may be due to the different particle sizes of fresh and ground turmeric. In case study 2, the essential oil content of PP/O1_Ground finger significantly decreased (relative loss of 14.6 %). However, in two cases the essential oil content increased during the process with a relative gain of 11.1 % (PP/O1_Ground mother) and 35.0 % (PP/O2_Ground finger), respectively. This is probably a bias due to the unhomogenized dried samples (not well represent the whole rhizome). Before drying in an oven, the semi-dried turmeric chips were sieved manually to separate between small and big turmeric chips. Then, the small turmeric chips (semi-dried) were collected and put in one bag and the dried turmeric were sampled after completing the oven drying. In case study 3 at Kampot, the essential oil content of KP/O1_Ground significantly decreased (relative loss of 9.4 %) while that of KP/O2_Ground was stable. This may be due to the large difference in drying time applied to these turmeric. KP/O1_Ground was dried up to 45 h because there

was heavy rain during its drying process, while KP/O2_Ground was dried just for 24 h. The essential oil content of turmeric powders from the three case studies ranged from 7.01 ± 0.13 mL/100g db to 13.60 ± 0.01 mL/100g db. The drying decreases the essential oil content more or less depending on the drying technique (Kutti Gounder and Lingamallu 2012). The relative loss of essential oil content in our case studies were lower than the value of 25 % found by Ararsa (2018).

The behaviour of curcuminoids was variable depending on the case study (**Table 2-2**). No general rule was observed; in some cases, the curcuminoid content decreased (up to 17.3 %) and in other cases increased (up to 18.8 %). The total curcuminoid content of turmeric powders from the three case studies ranged from 7.72 ± 0.40 g/100g db to 11.53 ± 0.06 g/100g db. These values were in accordance with the specifications of the ISO standard 5562:1983 (International Organization for Standardization 1983), indicating that the minimum curcuminoids in turmeric powder is 2 % (w/w) db. Suresh *et al.* (2007) found the curcumin loss from heat processing of turmeric was in the range of 27 – 53 %, with maximum loss in pressure cooking (at high temperature) for 10 min. However, Choudhury *et al.* (2017) reported that the processing of fresh rhizomes (mother and finger) to yield dry powder resulted in a significant reduction of curcumin just only between 2.0 to 8.0 %.

It was also in agreement with the literature (Monton *et al.* 2019b; Yin *et al.* 2022) which indicated that the texture of turmeric is hard after drying. The hypothesis is that the biological fluids from *in vitro* digestion did not diffuse well into the powder particles. As a result, their constituents were less well solubilised in the digestive tract than the ones of fresh turmeric. The bioaccessibility of curcuminoids of turmeric powders from three distinct case studies ranged from 8.3 ± 0.6 % to 11.4 ± 0.1 % (**Table 2-2**). Globally, in powders, the bioaccessibility of curcuminoids significantly decreased (case study 1: 29.0 % for finger and 22.3 % for mother; case study 2: 22.2 % for finger and 32.3 % for mother; case study 3: between 18.1 % to 27.9 % for mixture of finger and mother). The bioaccessibility of curcuminoids of turmeric powders from three distinct case studies ranged from 8.3 ± 0.6 % to 11.4 ± 0.1 % (**Table 2-2**). These values were lower than the value of 17 ± 4.1 % found by Park *et al.* (2018).

Impact of peeling and cooking on the essential oil, curcuminoid contents and their bioaccessibility

The impact of peeling and cooking time (*i.e.*, 30 min and 40 min) on the essential oil, curcuminoid contents and their bioaccessibility were studied on the samples from case study 1 (Siem Reap) and case study 3 (Kampot) (**Table 2-3**). Peeling significantly increased the contents of essential oil up to 5.1 % and bioaccessible curcuminoids up to 18.2 % (finger only). However, it had no impact on curcuminoid contents and their bioaccessibility. Cooking (for 30 or 40 min at 88 to 101 °C) had no impact on essential oil content. However, the curcuminoid

contents decreased as the cooking time increased to 40 min. This may be due to the fact that their drying time was different (4 h 20 min): the KP/O1_Ground (30 min) was dried for a shorter time than the KP/O1_Ground (40 min). However, cooking time had no impact on bioaccessible curcuminoid contents and their bioaccessibility even though the whole rhizomes were cooked in water for 30 to 40 min at boiling temperature.

Impact of origins and part of the rhizomes on colour and particle characterisation of turmeric powders

The impact of origins (case study 3) and part of the rhizomes (case studies 1 and 2) on colour values and particle sizes of turmeric powders were illustrated in **Table 2-4**. Different origins of turmeric (KP/O1_Ground and KP/O2_Ground) presented different a^* and b^* values (case study 3) and particle sizes *i.e.*, D [3;2], D [4;3] and Dx (50). Different parts of the rhizomes (finger and mother) also had different colour values. L^* , a^* and b^* values of finger rhizome were significantly higher than those of mother rhizome as there were significant differences between SR_Ground finger and SR_Ground mother (case study 1). However, the results of case study 2 showed that L^* , a^* and b^* values of finger rhizomes were significantly lower than those of mother rhizomes. Different parts of the rhizomes (finger and mother) had an impact on the particle size of turmeric powders. The particle sizes of mother rhizomes were significantly larger than those of finger rhizomes even though they were ground under same conditions (same time and same grinder). This may be due to the fact that the texture and the size of dried mother rhizomes were harder and larger than those of finger rhizomes (based on observation). The particle sizes *i.e.*, D [3;2], D [4;3] and Dx (50) of turmeric powders from the three case studies ranged from $53.8 \pm 0.9 \mu\text{m}$ to $135.7 \pm 1.9 \mu\text{m}$, from $227.1 \pm 21.2 \mu\text{m}$ to $310.8 \pm 26.8 \mu\text{m}$ and from $68.5 \pm 1.7 \mu\text{m}$ to $163.9 \pm 3.0 \mu\text{m}$, respectively. These values were in accordance with the ISO Standard 5562:1983 (International Organization for Standardization 1983). This standard indicates that the turmeric powder is classified into two groups according to its granulometry *i.e.*, coarse powder (98 % of the product must pass through a sieve of 500 μm mesh opening) and fine powder (98 % of the product must pass through a sieve of 300 μm mesh opening). The turmeric powders from all case studies are considered as fine powder. Moreover, the turmeric powders from case study 1 (Siem Reap) and case study 2 (Phnom Penh) had bimodal distribution while those from case study 3 (Kampot) had monomodal distribution (**Figure 2-4**).

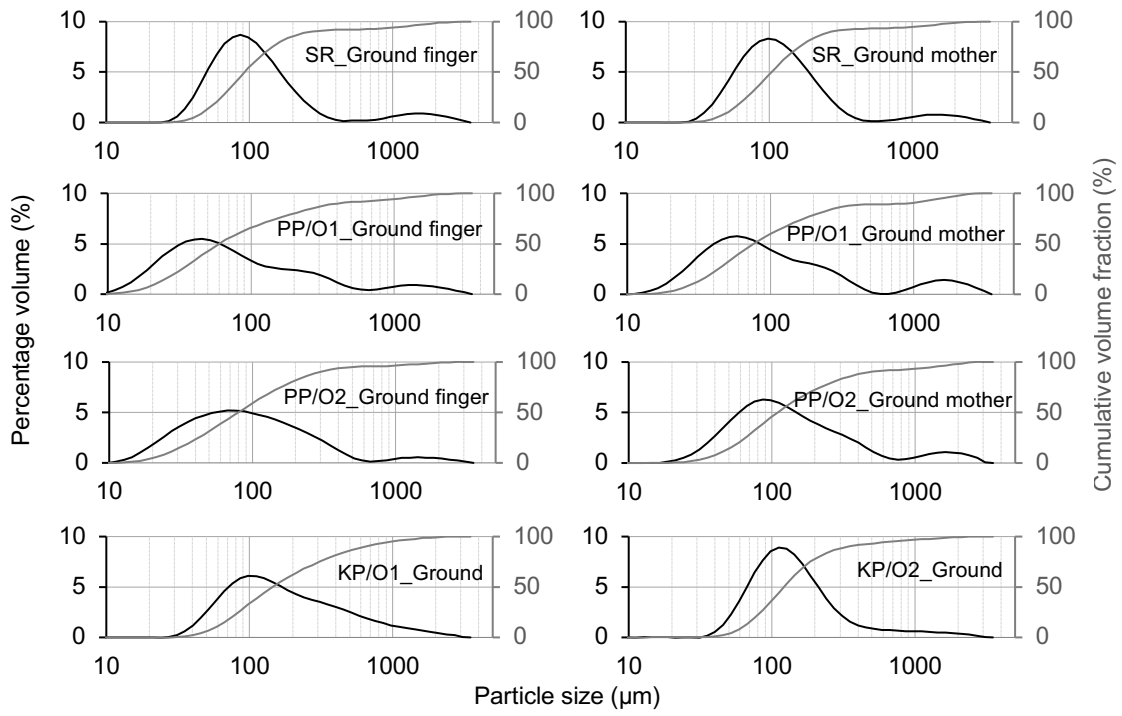

Figure 2-4 Particle size distribution of turmeric powders from distinct case studies, origins and processes

Table 2-1 Impact of sourcing (origins and part of rhizomes) on the contents of essential oil, curcuminoids and their bioaccessibility (%) of turmeric obtained from different origins

Sample	Essential oil (mL/100 g db)	Curcuminoids (g/100 g db)				Bioaccessible curcuminoids (g/100 g db)				Bioaccessibility (%)
		C	DMC	BDMC	Total	C	DMC	BDCM	Total	
SR_Fresh finger	9.76±0.16 ^{aB}	3.94±0.11 ^{bA}	1.87±0.07 ^{bB}	2.60±0.10 ^{aB}	8.42±0.27 ^{aB}	0.41±0.00 ^{bB}	0.29±0.01 ^{bB}	0.28±0.01 ^{aB}	0.99±0.01 ^{bB}	12.3±0.2 ^{bA}
PP/O1_Fresh finger	8.21±0.12 ^{bA}	4.04±0.18 ^{bB}	2.03±0.09 ^{aA}	2.66±0.10 ^{aA}	8.73±0.37 ^{aA}	0.64±0.03 ^{aA}	0.34±0.02 ^{aA}	0.22±0.02 ^{bA}	1.20±0.06 ^{aA}	13.6±0.8 ^{aA}
PP/O2_Fresh finger	6.68±0.16 ^{cB}	4.62±0.05 ^{aA}	1.98±0.01 ^{abA}	1.72±0.04 ^{bB}	8.32±0.08 ^{aA}	0.42±0.02 ^{bB}	0.16±0.01 ^{cB}	0.07±0.00 ^{cB}	0.64±0.02 ^{cB}	7.0±0.2 ^{cB}
SR_Fresh mother	17.84±0.03 ^{aA}	3.75±0.19 ^{bA}	2.09±0.06 ^{aA}	3.71±0.15 ^{aA}	9.54±0.40 ^{aA}	0.46±0.01 ^{bA}	0.36±0.01 ^{bA}	0.34±0.02 ^{aA}	1.16±0.04 ^{bA}	12.9±0.6 ^{bA}
PP/O1_Fresh mother	7.90±0.18 ^{cA}	4.48±0.02 ^{aA}	2.10±0.05 ^{aA}	2.41±0.02 ^{cB}	8.99±0.09 ^{bA}	0.46±0.02 ^{bB}	0.26±0.01 ^{cB}	0.14±0.02 ^{bB}	0.86±0.05 ^{cB}	9.5±0.7 ^{cB}
PP/O2_Fresh mother	10.85±0.35 ^{bA}	3.33±0.02 ^{cB}	1.87±0.01 ^{bB}	2.89±0.01 ^{bA}	8.08±0.01 ^{cB}	0.58±0.04 ^{aA}	0.40±0.03 ^{aA}	0.33±0.03 ^{aA}	1.31±0.10 ^{aA}	16.8±1.3 ^{aA}

Means with the same superscript (a–c) within the same column do not differ significantly (Duncan’s test, *p*-value < 0.05).

Means with the same superscript (A–B) at each column of each pair of the part of the rhizome (finger and mother) do not differ significantly (Independent-Samples t-test, *p*-value < 0.05). Curcumin (C), demethoxycurcumin (DMC), bisdemethoxycurcumin (BDMC). Siem Reap (SR), Phnom Penh (PP) and origin (O)

Table 2-2 Impact of the full processes on the contents of essential oil, curcuminoids and their bioaccessibility (%) of turmeric obtained from different origins

Sample	Essential oil (mL/100 g db)	Curcuminoids (g/100 g db)				Bioaccessible curcuminoids (g/100 g db)				Bioaccessibility (%)
		C	DMC	BDMC	Total	C	DMC	BDCM	Total	
Case study 1										
SR_Fresh finger	9.76±0.16 ^A	3.94±0.11 ^B	1.87±0.07 ^A	2.60±0.10 ^B	8.42±0.27 ^B	0.41±0.00 ^A	0.29±0.01 ^A	0.28±0.01 ^A	0.99±0.01 ^A	12.3±0.2 ^A
SR_Gound finger	9.12±0.06 ^B	4.59±0.14 ^A	1.93±0.06 ^A	2.86±0.09 ^A	9.38±0.29 ^A	0.25±0.05 ^B	0.24±0.01 ^B	0.24±0.01 ^B	0.73±0.06 ^B	8.7±0.5 ^B
SR_Fresh mother	17.84±0.03 ^A	3.75±0.19 ^A	2.09±0.06 ^A	3.71±0.15 ^A	9.54±0.40 ^A	0.46±0.01 ^A	0.36±0.01 ^A	0.34±0.02 ^A	1.16±0.04 ^A	12.9±0.6 ^A
SR_Ground mother	13.60±0.00 ^B	3.88±0.04 ^A	1.89±0.01 ^B	2.92±0.02 ^B	8.69±0.06 ^A	0.29±0.03 ^B	0.26±0.01 ^B	0.25±0.01 ^B	0.80±0.06 ^B	10.0±0.6 ^B
Case study 2										
PP/O1_Fresh finger	8.21±0.12 ^A	4.04±0.18 ^A	2.03±0.09 ^A	2.66±0.10 ^A	8.73±0.37 ^A	0.64±0.03 ^A	0.34±0.02 ^A	0.22±0.02 ^A	1.20±0.06 ^A	13.6±0.8 ^A
PP/O1_Ground finger	7.01±0.13 ^B	3.76±0.20 ^A	1.67±0.08 ^B	2.29±0.11 ^B	7.72±0.40 ^B	0.30±0.03 ^B	0.23±0.01 ^B	0.24±0.01 ^A	0.76±0.05 ^B	10.6±0.6 ^B
PP/O2_Fresh finger	6.68±0.16 ^B	4.62±0.05 ^B	1.98±0.01 ^A	1.72±0.04 ^B	8.32±0.08 ^B	0.42±0.02 ^A	0.16±0.01 ^B	0.07±0.00 ^B	0.64±0.02 ^B	7.0±0.2 ^B
PP/O2_Ground finger	9.02±0.06 ^A	4.86±0.07 ^A	1.92±0.03 ^B	3.09±0.05 ^A	9.88±0.14 ^A	0.33±0.04 ^B	0.21±0.01 ^A	0.22±0.01 ^A	0.76±0.06 ^A	8.3±0.6 ^A
PP/O1_Fresh mother	7.90±0.18 ^B	4.48±0.02 ^B	2.10±0.05 ^B	2.41±0.02 ^B	8.99±0.09 ^B	0.46±0.02 ^A	0.26±0.01 ^B	0.14±0.02 ^B	0.86±0.05 ^A	9.5±0.7 ^A
PP/O1_Ground mother	8.78±0.02 ^A	4.65±0.09 ^A	2.26±0.04 ^A	3.03±0.06 ^A	9.94±0.19 ^A	0.39±0.01 ^B	0.29±0.01 ^A	0.24±0.01 ^A	0.92±0.01 ^A	9.8±0.2 ^A
PP/O2_Fresh mother	10.85±0.35 ^A	3.33±0.02 ^B	1.87±0.01 ^B	2.89±0.01 ^B	8.08±0.01 ^B	0.58±0.04 ^A	0.40±0.03 ^A	0.33±0.03 ^A	1.31±0.10 ^A	16.8±1.3 ^A
PP/O2_Ground mother	10.87±0.06 ^A	4.11±0.07 ^A	2.18±0.03 ^A	3.26±0.05 ^A	9.55±0.15 ^A	0.39±0.01 ^B	0.33±0.01 ^B	0.30±0.00 ^A	1.03±0.01 ^B	11.4±0.1 ^B
Case study 3										
KP/O1_Fresh	10.29±0.05 ^A	4.22±0.25 ^A	2.37±0.10 ^A	3.84±0.11 ^A	10.42±0.45 ^A	0.64±0.02 ^A	0.40±0.01 ^A	0.32±0.01 ^A	1.36±0.03 ^A	13.5±0.2 ^A
KP/O1_Ground	9.32±0.16 ^B	4.04±0.05 ^A	2.20±0.02 ^B	2.85±0.04 ^B	9.10±0.10 ^B	0.36±0.03 ^B	0.33±0.02 ^B	0.26±0.00 ^B	0.95±0.05 ^B	11.0±0.6 ^B
KP/O2_Fresh	12.08±0.04 ^A	6.16±0.31 ^A	2.59±0.03 ^A	5.20±0.20 ^A	13.95±0.52 ^A	0.93±0.05 ^A	0.45±0.03 ^A	0.46±0.02 ^A	1.84±0.10 ^A	13.8±0.8 ^A
KP/O2_Ground	12.65±0.25 ^A	5.38±0.03 ^B	2.02±0.01 ^B	4.13±0.03 ^B	11.53±0.06 ^B	0.40±0.01 ^B	0.27±0.00 ^B	0.37±0.01 ^B	1.04±0.01 ^B	9.9±0.1 ^B

Means with the same superscript (A-B) at each column of each pair of the fresh and ground turmeric do not differ significantly (Independent-Samples t-test, *p*-value < 0.05). Curcumin (C), demethoxycurcumin (DMC), bisdemethoxycurcumin (BDMC). Siem Reap (SR), Phnom Penh (PP), Kampot (KP) and origin (O)

Table 2-3 Impact of peeling and cooking at different time (*i.e.*, 30 min and 40 min) on the contents of essential oil, curcuminoids and their bioaccessibility (%) of turmeric

Sample	Essential oil (mL/100 g db)	Curcuminoids (g/100 g db)				Bioaccessible curcuminoids (g/100 g db)				Bioaccessibility (%)
		C	DMC	BDMC	Total	C	DMC	BDCM	Total	
Case study 1										
SR_Fresh finger	9.76±0.16 ^B	3.94±0.11 ^A	1.87±0.07 ^A	2.60±0.10 ^B	8.42±0.27 ^A	0.41±0.00 ^A	0.29±0.01 ^A	0.28±0.01 ^B	0.99±0.01 ^B	12.3±0.2 ^A
SR_Peeled finger	10.26±0.17 ^A	4.02±0.19 ^A	1.89±0.05 ^A	2.87±0.08 ^A	8.77±0.31 ^A	0.49±0.04 ^A	0.34±0.03 ^B	0.34±0.02 ^A	1.17±0.07 ^A	14.1±0.9 ^A
SR_Fresh mother	17.84±0.03 ^A	3.75±0.19 ^A	2.09±0.06 ^A	3.71±0.15 ^A	9.54±0.40 ^A	0.46±0.01 ^A	0.36±0.01 ^A	0.34±0.02 ^A	1.16±0.04 ^A	12.9±0.5 ^A
SR_Peeled mother	16.91±0.03 ^A	3.56±0.18 ^A	1.98±0.06 ^A	3.51±0.14 ^A	9.05±0.38 ^A	0.43±0.02 ^A	0.34±0.01 ^A	0.33±0.01 ^A	1.10±0.04 ^A	12.9±0.5 ^A
Case study 3										
KP/O1_Ground (40 min)	9.32±0.16 ^A	4.04±0.05 ^B	2.20±0.02 ^B	2.85±0.04 ^B	9.10±0.10 ^B	0.36±0.03 ^A	0.33±0.02 ^A	0.26±0.00 ^A	0.95±0.05 ^A	11.0±0.6 ^A
KP/O1_Ground (30 min)	9.35±0.13 ^A	4.27±0.11 ^A	2.32±0.05 ^A	3.06±0.07 ^A	9.65±0.22 ^A	0.36±0.05 ^A	0.34±0.03 ^A	0.27±0.02 ^A	0.96±0.09 ^A	10.6±1.0 ^A

Case study 1, means with the same superscript (A–B) at each column of each pair of the fresh and peeled turmeric do not differ significantly (Independent-Samples t-test, p-value < 0.05). Case study 3, means with the same superscript (A–B) within the same column do not differ significantly (Independent-Samples t-test, p-value < 0.05). Siem Reap (SR), Kampot (KP) and origin (O)

Table 2-4 Impact of the origins (case study 3) and the part of the rhizomes (case studies 1 and 2) on colour values and particle sizes of turmeric powders

Samples	Colour values			Particle size (µm)		
	L*	a*	b*	D [3;2]	D [4;3]	Dx (50)
Case study 1						
SR_Ground finger	55.69±0.02 ^A	28.42±0.01 ^A	66.25±0.06 ^A	97.0±0.8 ^B	238.1±10.8 ^A	105.1±0.7 ^B
SR_Ground mother	53.31±0.17 ^B	25.44±0.11 ^B	64.62±0.20 ^B	105.6±3.2 ^A	236.0±32.9 ^A	118.4±2.1 ^A
Case study 2						
PP/O1_Ground finger	51.10±0.74 ^B	24.61±0.10 ^B	59.30±0.24 ^B	53.8±0.9 ^B	227.1±21.1 ^B	68.5±1.7 ^B
PP/O1_Ground mother	55.02±0.43 ^A	32.18±0.18 ^A	67.09±0.17 ^A	69.5±0.5 ^A	292.7±0.2 ^A	86.7±0.5 ^A
PP/O2_Ground finger	48.09±0.18 ^B	25.12±0.08 ^B	56.26±0.51 ^B	65.6±1.1 ^B	191.3±40.3 ^B	89.9±1.5 ^B
PP/O2_Ground mother	50.14±0.58 ^A	27.71±0.16 ^A	59.61±0.26 ^A	102.0±0.8 ^A	290.0±8.3 ^A	124.6±1.2 ^A
Case study 3						
KP/O1_Ground	53.49±0.36 ^A	28.82±0.15 ^B	62.71±0.08 ^B	135.7±1.9 ^A	310.8±26.8 ^A	163.9±3.0 ^A
KP/O2_Ground	54.33±0.65 ^A	33.45±0.23 ^A	64.95±0.10 ^A	125.1±4.9 ^B	232.1±49.0 ^B	137.3±3.1 ^B

Case study 1 and 2, means with the same superscript (A-B) at each column of each pair of the part of the rhizome (finger and mother) do not differ significantly (Independent-Samples t-test, *p*-value < 0.05).

Case study 3, means with the same superscript (A-B) within the same column do not differ significantly (Independent-Samples t-test, *p*-value < 0.05).

2.2.4 Conclusion

The local processing practices of turmeric were described in through the study of three turmeric production systems located in three areas (Siem Reap, Phnom Penh and Kampot), known as the main turmeric processors in Cambodia. The turmeric rhizomes from Siem Reap had higher essential oil content than those from Phnom Penh. The essential oil content in mother was quite higher than in finger for the sample in Siem Reap but these differences were not so high for the other origins. The total curcuminoid contents of the fresh finger rhizome from Siem Reap and Phnom Penh were not different while that of the fresh mother rhizome from Siem Reap was higher than those from Phnom Penh. Different origins of turmeric rhizomes provided different bioaccessible curcuminoids and their bioaccessibility. In most cases, after processing, the essential oil content, total curcuminoid content, bioaccessible curcuminoids and their bioaccessibility of the turmeric powders decreased (in powders compared to raw material). Peeling had no impact on curcuminoid contents and their bioaccessibility but it increased the essential oil content (finger only). Cooking had no impact on essential oil content, bioaccessible curcuminoids and their bioaccessibility. We recommend fresh turmeric from Siem Reap as it contains higher essential oil and equal curcuminoid contents compared to the turmeric from case study 2 (Phnom Penh). There is a potential saving to be made by all the companies on drying. Indeed, they could dry less, obtain better yield and still comply with ISO standards 5562:1983 (water content <10 % w/w). The postharvest treatment in Kampot appeared to be the easiest to implement, had the shortest drying time and got the highest yield (16.2 %), with the water content (about 6 %) conforming with the specification of the ISO standards 5562:1983 (International Organization for Standardization 1983).

2.3 Chapter 2 summary and outlook

We could not find any scientific literatures which described the turmeric transformation processes in Cambodia and their impact on the quality. Turmeric is not only used for aroma and colour but also for nutritional values. Turmeric sales have been increasing right after the Covid-19 outbreak as it values the health benefits in the form of an immunity booster. Three different turmeric transformation processes at three different areas in Cambodia were observed, described and compared by using the 5M methodology. The main specificities of the processes in the different areas were: (i) cooking before drying (case study 1: Siem Reap); (ii) slicing before drying (case study 2: Phnom Penh); (iii) cooking and slicing before drying (case study 3: Kampot). Among these, the process in Kampot (thanks to cooking and slicing operations) had the shortest drying time (*i.e.*, between 24 to 45 h dependent on weather) and got the highest yield (16.2 %), with a final water content of about 6 %, conforming with the specification of the ISO standards 5562:1983 (International Organization for Standardization

1983). Peeling had no impact on curcuminoid contents and their bioaccessibility (both finger and mother rhizomes) but it increased the essential oil content (finger only), just only 5.1 %. However, it is not only a time-consuming (required 5 h and 10 people to complete 100 kg of turmeric) and low-yield process (relative loss of 4.5 %), but it also impacts on quality as we observed browning (enzymatic or non-enzymatic oxidation) on the surface of the peeled rhizomes. Cooking had no impact on essential oil content, bioaccessible curcuminoid contents and their bioaccessibility even though the whole rhizomes were cooked for a long time (between 30 to 40 min) at high temperatures (up to 100 °C). After processing, no general rule was observed for essential oil and curcuminoid contents but the bioaccessible curcuminoids decreased. This is probably a bias due to the different particle sizes of fresh and ground turmeric (case study 1), unhomogenized dried samples (not well represent the whole rhizome as shown in case study 2), the large difference in drying time (case study 3) and uncontrollable drying conditions (as solar dryer depends on the weather). However, the results obtained from observation and quality analysis of samples from field survey in Cambodia allowed us to preliminarily conclude that cooking and slicing are essential unit operations to be applied in turmeric process because they reduce the drying time, save energy consumption, and preserve turmeric quality. Fresh turmeric from Siem Reap should be a good choice as it contains higher essential oil and equal curcuminoid contents compared to the turmeric from case study 2 (Phnom Penh).

We studied here the turmeric processes implemented in Cambodia, little known and never described. The main limit of our approach lies in the fact that the processes are poorly controlled in Cambodia due to a lack of equipment and/or knowledge as well as requirements of customer. Indeed, the drying conditions depend on the weather, moreover, the processors checked if the turmeric are completely dried by visual observation and by evaluating with their hands if they are crispy or easy to crack. The drying process would be stopped according to these empiric criteria. These can lead to vary the quality of final product (turmeric powder). In the next chapter (chapter 3), our study was focused on the impact of cooking and drying operations on colour (L^* , a^* , b^* and C^* values), curcuminoids (C, DMC and BDMC), essential oil and aroma composition of *Curcuma longa* L. under controlled conditions- using hot air dryer (**Supplementary Figure 2**). After cooking at 95 °C/3 min all the starch could be gelatinized (**Supplementary Figure 3** and **Supplementary Figure 4**). We applied this short cooking time (95 °C/3 min) to sliced rhizomes (thickness of 5 mm) before subjected to air-drying at 60 °C and 40 % RH (the standard drying temperature). Direct drying and drastic cooking (95 °C/60 min) prior to drying were also assessed. Due to the pandemic of Covid-19, we could not bring the samples from Cambodia for our study, so the raw material used in chapter 3 was bought from Asian grocery store in Montpellier (Wei Sin), France. We focused only on finger rhizome for next chapters as its percentage represents about 90 % (w/w) of whole rhizomes.

Chapter 3 – Impact of processes on the quality of turmeric (physicochemical quality)

3. Chapter 3 – Impact of processes on the quality of turmeric (physicochemical quality)

3.1 Introduction to Chapter

The chapter 3 was published as a research article in the Journal of Food Processing and Preservative which described the impact of cooking and drying operations on colour, curcuminoids and aroma of *Curcuma longa* L. under controlled conditions.

3.2 Impact of cooking and drying operations on colour, curcuminoids and aroma of *Curcuma longa* L. (paper 2)

Molika Yin ^{1,2}, Mathieu Weil ^{1,3*}, Sylvie Avallone ¹, Marc Lebrun ^{1,3}, Geneviève Conejero ⁴,
Sokneang In ², Philippe Bohuon ¹

Journal of Food Processing and Preservation (2022)

Volume 46, Issue 5, page e16643

¹Qualisud, Univ Montpellier, CIRAD, Institut Agro, Avignon Université, Univ de La Réunion, Montpellier, France

²Institut de Technologie du Cambodge, Food Technology and Nutrition Research Unit, Phnom Penh, Cambodia

³CIRAD, UMR Qualisud, F-34398 Montpellier, France

⁴BPMP, CNRS, INRAE, Institut Agro, University of Montpellier, Montpellier, France

Abstract: Effects of cooking and drying on colour, curcuminoids, essential oil and aroma compounds of *Curcuma longa* L. were assessed. Sliced fresh turmeric rhizomes were air-dried at 60 °C directly or after cooking at 95 °C for 3 or 60 min. Microscopic observations showed that curcuminoids and essential oil are located in different dedicated cells. Curcuminoids and essential oil of dried turmeric were both around 10 % db. After processing, curcuminoids were dispersed throughout the matrix. Drastic cooking and drying operations decreased chromatic values more than smooth cooking. Cooking had no impact on curcuminoid and essential oil contents and slightly modified aromatic profile of essential oils. Drying decreased the curcuminoid (< 38 %) and essential oil (< 13 %) contents. Turmeric starchy matrix preserves the curcuminoids and essential oil during the process. We recommend a preliminary smooth cooking step to reduce the drying time, save energy consumption and preserve turmeric quality.

Keywords: Turmeric; Blanching; Curcuminoids; Essential oil; Microscopy

3.2.1 Introduction

Turmeric (*Curcuma longa* L.) belongs to the Zingiberaceae family and is widely distributed throughout tropical and subtropical regions of the world (Kutti Gounder and Lingamallu 2012). Curing turmeric is a significant postharvest processing operation that involves cooking fresh turmeric in boiling water. The goals of curing are to reduce microbial load, inactivate enzymes, avoid unpleasant odours, gelatinize the starch, and change the cell walls of the turmeric facilitating its permeability and reducing resistance to mass transfer which leads to an increase in the drying rate (Jayashree *et al.* 2018). The main aim of drying is to reduce the moisture present in turmeric, from 2.3 to 4.0 kg·kg⁻¹ db at the time of harvest to a safe value of 0.11 kg·kg⁻¹ db (International Organization for Standardization 1983).

Air drying is an alternative to sun drying, not only to increase drying rate and reduce drying time but also to better preserve the quality of the product (Prathapan *et al.* 2009). The optimum drying conditions for best product quality were found to be air temperature of 55 – 60 °C and air velocity of 2 m s⁻¹ (Singh *et al.*, 2010). High air temperature (> 60 °C) caused degradation of volatile compounds and curcuminoids.

Traditionally, the rhizomes are dried directly or cooked and then dried. We question the value of using these operations in a combined way, as cooking transfers water inside the product and drying will have to remove the water from the cooked rhizome. In the traditional process, whole rhizomes are cooked for a long time at high temperatures. Moreover, numerous studies have demonstrated the impact of processes on the quality of turmeric powder. However, they did not focus on the impact of each unit operation (cooking and drying) on turmeric's quality. In our study, we applied, as an alternative, short cooking time to sliced rhizomes and microscopic observation and biochemical contents evolution during the process were studied. Our objective was to assess the impact of cooking and drying in controlled conditions on the quality of *Curcuma longa* L. The quality characteristics considered in this study were colour, curcuminoids and aromatic profiles. The impact of cooking on drying kinetics was studied. Mass balances of dry matter, water and curcuminoids were assessed. Microscopic analysis was realized to localize essential oil, starch and curcuminoids and to assess process effects.

3.2.2 Material and methods

3.2.2.1 Materials

Solvents (ethanol and dichloromethane), sodium sulfate, homologous series of C8 – C20 n-alkanes standards, and HPLC standards (curcumin, demethoxycurcumin and bisdemethoxycurcumin) were obtained from Sigma-Aldrich (Saint Quentin Fallavier, France). The polytetrafluoroethylene (PTFE) membranes were obtained from Sartorius (Palaiseau, France). The water used in all the experiments was purified water (milli-Q reference water purification). Turmeric, *Curcuma longa* L., used in this study was a product of Thailand which

was purchased (4 kg) from an Asian grocery store (Wei Sin) in Montpellier, France, on the 20th of February 2020. Fresh turmeric rhizomes were stored at 4 °C until being processed. Before processing, the fresh turmeric rhizomes were cleaned and washed thoroughly under running water to remove adhering soil and mud, spray residues, roots and other foreign materials. Then, the excess water was drained and the cleaned turmeric rhizomes were sliced manually to a thickness of 5 mm. The sliced turmeric is called “fresh” turmeric.

3.2.2.2 Processing experiments

Cooking

Two-unit operations were applied to obtain different samples (**Figure 3-1**). The sliced fresh turmeric (F) was divided into two lots of 420 g for cooking experiments and one lot of 360 g for direct drying assessment. Cooking treatment consisted of soaking sliced turmeric in a nylon net in hot water at a ratio of 1:10 w/w material to water at two different conditions: FC1: 95 °C/3 min and FC2: 95 °C/60 min. The starch could be completely gelatinized in these cooking conditions. After cooking, the cooked turmeric was immediately soaked in an ice water bath for 1 min to stop the cooking process, before being drained. About 60 g of each sample was collected for further analysis.

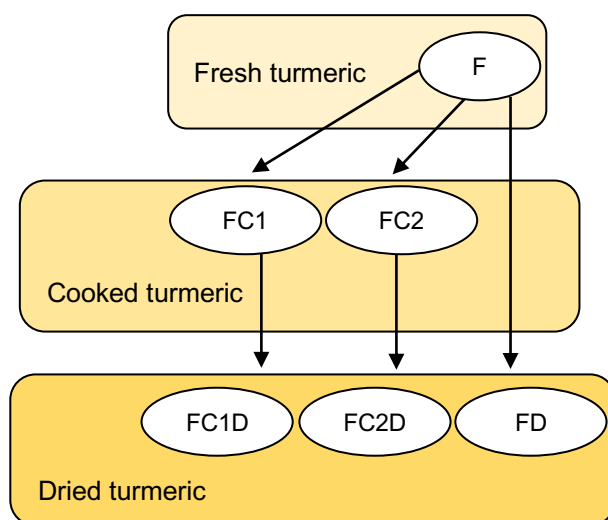

Figure 3-1 Processes applied to turmeric. F: fresh turmeric; C: cooking (C1: 95 °C/3 min; C2: 95 °C/60 min); D: drying (60 °C, 40 % RH)

Drying and drying kinetics

A hot air dryer, developed in our laboratory, was used for drying the sliced turmeric. In the vertical drying chamber, 360 g of sliced turmeric were spread on-grid rack (0.25 m long × 0.25 m wide × 0.06 m high). Hot air (60 ± 1 °C, RH 40 ± 2 %) was circulated downwards through the layer of sliced turmeric by a high-capacity fan. The drying times are different for each treatment *i.e.*, 7 h 14 min, 4 h 29 min and 3 h 38 min for fresh turmeric (F), FC1 (cooking at 95 °C/3 min) and FC2 (cooking at 95 °C/60 min), respectively. Airspeed was

measured thanks to an anemometer (ALMEMO® 2690-8A, Ahlborn Mess, Germany). The air velocity was just high enough ($2.1 \pm 0.1 \text{ m s}^{-1}$) to have no significant effect on temperature when passing through the layer of sliced turmeric. Monitoring by weighing was carried out continuously during the drying process, every 10 min for the first hour and then every 15 min. The water content, which was measured on a dry basis (noted X) as a function of time, was estimated in line, using the mass reading of the sieve. Water content kinetics $X^{(t)}$ were fitted with a cubic smoothing spline (Matlab® Version 5.2, The Mathworks Inc., USA). The drying rate (dX/dt) was calculated as the direct analytical derivative of the cubic smoothing spline function on $X^{(t)}$.

3.2.2.3 Microscopic analysis

Thick cross-sections (100 – 135 μm) were obtained from fresh (F), cooked (FC), cooked and dried (FCD) and dried (FD) turmeric rhizomes using a microtome with a vibrating blade (Thermo Scientific, Microm HM650V, Walldorf, Germany) and then dipped in 10 mM phosphate buffer saline (7 mM Na_2HPO_4 , 3 mM NaH_2PO_4 , 120 mM NaCl, 2.7 mM KCl). Starch and terpenes were respectively stained dipping cross-sections in Lugol solution (2 g KI and 1 g I_2 dissolved in 100 mL distilled water) for 5 min or NADI solution (0.001 % 1-naphthol, 0.001 % *N,N*-dimethyl-*p*-phenylenediamine dihydrochloride and 0.4 % ethanol in 100 mM sodium cacodylate-HCl buffer (pH 7.2) for 45 min (David and Carde 1964). Rhizomes tissues were observed with a wide-field microscope Eclipse Ni-E (Nikon Instruments Inc., NY, USA). The pictures were obtained with 4x 0.2 NA, 10x 0.45 NA or 20x 0.75 NA Plan-APO objectives under transmitted light. The autofluorescence of curcuminoids was visualized with a multiphoton microscope (Zeiss 880, Jena, Germany, infra-red laser Chameleon Ultra II, Coherent, CA, USA) and an objective 20X Plan APO 1.0 NA. The spectral detector of this microscope was used at 720 nm (UV-like excitation) to obtain emission spectra of pure curcuminoids (curcumin, demethoxycurcumin and bisdemethoxycurcumin) between 400 and 690 nm, and to visualize the fluorescence of these molecules in the rhizome tissues (Talamond *et al.* 2015).

3.2.2.4 Sample preparation for colour, curcuminoids and essential oil measurements

The samples resulting from the different processing operations (approximately 50 g of each treatment) were frozen by using liquid nitrogen and then ground for 10 s at 10 000 rpm in a mill (Retsch Grindomix GM200, Retsch GmbH, Germany) for immediate analyses of dry matter and colour. The samples for further essential oil and curcuminoids analyses were put in glass bottles and frozen at $-80 \text{ }^\circ\text{C}$. The samples dedicated to curcuminoids analysis were made on the sliced rhizome.

3.2.2.5 Analytical methods

Dry matter and water contents

The dry matter content (means “dry matter free of essential oil”) was obtained by drying 1 g of ground turmeric in an aluminium cup in the oven (Gefran 800, Italy) at 105 °C for 30 h (*i.e.*, until constant weight). The mean relative deviation of repeatability was $\pm 4.4\%$ ($n = 4$). Water content expressed on a dry basis was deduced from essential oil and dry matter contents.

Colour measurements

Colour values *i.e.*, lightness (L^*), redness (a^*) and yellowness (b^*) of ground turmeric samples were determined using a chromameter (Minolta CR-400, Minolta, Osaka, Japan). The illuminant was D65, and an incidence angle of 0° was used. Each data point was the mean of three replications measured on the surface of the samples at randomly selected positions. Chroma value (C^*) was calculated following this equation: $C^* = \sqrt{a^{*2} + b^{*2}}$. The mean relative deviation of repeatability was 3.5 %, 4.2 %, 5.8 % and 5.4 %, respectively for L^* , a^* , b^* and C^* ($n = 6$).

Curcuminoid contents

Approximately 0.3 g of sliced turmeric was mixed with 30 mL of 60 °C ethanol (99.8 %) and homogenized for 2 min at 30 000 rpm (IKA T10 basic Ultra-Turrax, ProLabo, France). The samples were heated for 30 min at 60 °C (Sogi *et al.* 2010). After cooling, the extracts were diluted 1/10 with ethanol and filtered on 0.45 μm PTFE Minisart SRP4 membrane (Sartorius, Palaiseau, France). Curcuminoids were analysed by high-performance liquid chromatography (Agilent System 1200 series, Massy, France). The column was a polymeric ACE C₁₈ (250 \times 4.6 mm, 5 μm particle size, Inc Wilmington NC) and the injection volume was 5 μL . The quantification of curcuminoids was carried out according to the method of Sepahpour *et al.* (2018) with small modifications. The elution was done isocratically with a mixture of acetonitrile and 0.1 % acetic acid (40:60) at a flow rate of 1.0 mL/min and the temperature of the column was set at 25 °C. Chromatograms were recorded over 30 min period with a UV-visible photodiode array detector (Agilent Technologies 1200 series) at the wavelength of maximum absorption of the curcuminoids in the mobile phase (*i.e.*, 425 nm). The curcuminoids were identified by their retention time and spectrum. External calibration was realized weekly with standard solutions of the pure chemicals in ethanol in the range of 1 to 50 mg/L. The curcuminoid contents were expressed in g/100g of initial dry weight basis (g/100g db). The mean relative deviation of repeatability was 12.5 %, 11.2 %, 16.8 % and 13.5 %, respectively for curcumin, demethoxycurcumin, bisdemethoxycurcumin and total curcuminoids ($n = 4$).

Essential oil content

The essential oil content was determined using a method adapted from the international official standard method ISO 6571:2008 (International Organization for Standardization 2008). The modification in the applied method was the elimination of xylene. Approximately 20 g of ground turmeric samples were weighed and transferred to 1 L of a round bottom flask, then 250 mL of distilled water was added and about 10 pieces of pumice stones were added to homogenize boiling. It was heated at medium heat for 4 h and the condensed vapour was separated. The essential oil present at the uppermost layers was collected and put in a vial containing sodium sulfate and then stored at $-20\text{ }^{\circ}\text{C}$ for later essential oil compounds analysis by gas chromatography-mass spectrometry (GC-MS). The essential oil content was expressed in mL/100g of initial dry weight basis (mL/100g db). The mean relative deviation of repeatability was $\pm 4.7\%$ ($n = 4$).

Identification of essential oil compounds

Separation on a polar column: An Agilent 6890 series GC (Agilent Technologies, Palo Alto, CA, USA) equipped with a DB-WAX UI column (60 m \times 250 μm , 0.25 μm phase film thickness, Agilent J&W GC column) coupled to an Agilent 5973 mass spectrometer detector (Agilent Technologies) was used. Hydrogen was used as carrier gas at 1.5 mL/min at a constant flow. Column temperature program was 100 $^{\circ}\text{C}$ to 200 $^{\circ}\text{C}$ at the rate of 2 $^{\circ}\text{C}/\text{min}$, then to 250 $^{\circ}\text{C}$ at the rate of 10 $^{\circ}\text{C}/\text{min}$. The sample injection volume was 1.0 μL with a split ratio of 100:1. The samples (essential oils) were diluted 1/10 with dichloromethane before injecting. The retention indices were calculated using a homologous series of n-alkanes C8 – C20.

Separation on a non-polar column: On the same GC-MS with the same column program temperature, a DB-5MS column (60 m \times 250 μm , 0.25 μm phase film thickness, Agilent J&W GC column) was used. The retention indices were calculated using a homologous series of n-alkanes C8 – C20.

Identification: The aroma compounds separated on both polar and apolar columns were identified by comparing their mass spectrum to those available in commercial libraries (NIST 14 and PubChem). The mean relative deviation of repeatability was $\pm 13.2\%$ ($n = 8$).

Statistical analysis

Differences in the mean values of colour (L^* , a^* , b^* and C^* values), curcuminoid contents, essential oil content and its composition were tested by analysis of variance (ANOVA); the significance of differences between samples was determined using Duncan's test. The level of significance was $p < 0.05$.

3.2.3 Results and discussion

3.2.3.1 Characterization of fresh turmeric

Localization of essential oil, starch and curcuminoids

The distribution of essential oil, starch and curcuminoids was represented in **Figure 3-2** and **Figure 3-3**. The essential oils (**Figure 3-2.I**) were particularly abundant in the cortex. They were more concentrated under the epidermis and in the endoderm than in other parts. Starch was present in amyloplasts throughout the whole rhizome and was most abundant in the cortex (**Figure 3-2.IV**).

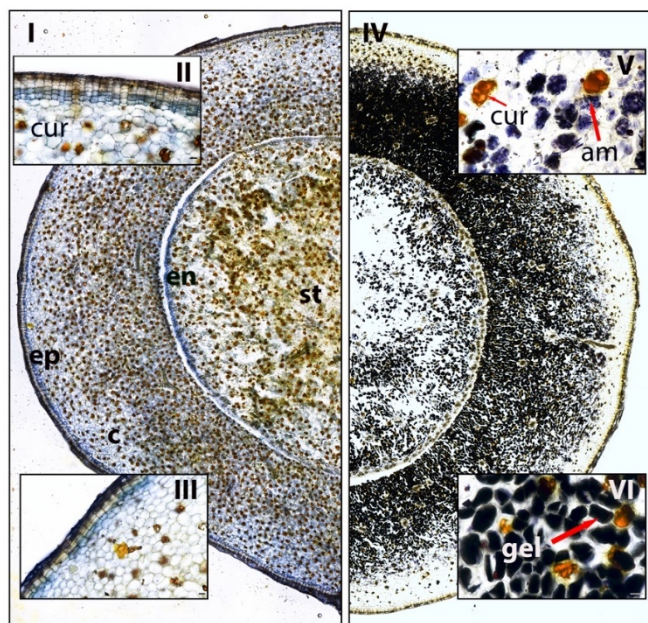

Figure 3-2 Visualization of essential oil, starch and curcuminoids distribution in turmeric rhizome by wide-field microscopy. (I) essential oil distribution (blue Nadi colouration) in a cross-section of turmeric rhizome, (II) essential oil distribution in the epidermis of fresh (F) turmeric, curcuminoid distribution (natural orange colour) in the epidermis of fresh (F) turmeric, (III) essential oil distribution in the epidermis of cooked (FC1) turmeric, curcuminoid distribution in epidermis cooked (FC1) turmeric, (IV) starch distribution (black Lugol colouration) in a cross-section of turmeric rhizome, (V) starch distribution in the cortex of fresh (F) turmeric, curcuminoid distribution in the cortex of fresh (F) turmeric and (VI) starch distribution in the cortex of cooked (FC1) turmeric. am, amyloplast; c, cortex; cur, curcuminoids cell; en, endodermis; ep, epidermis; gel, gelatinized starch; st, stele; bar = 500 μm (I and IV) or 50 μm (II, III, V and VI)

The curcuminoids were distributed throughout the whole rhizome; two cells containing curcuminoids were never adjacent (**Figure 3-3.I**). Curcuminoids occupied the entire cell volume in fresh turmeric (**Figure 3-3.I**). They were recognizable by their orange colour, but as they had the property of fluorescing in UV, they could be identified more specifically. Curcuminoids had the property of being fluorescent under UV light; they emitted in yellow (**Figure 3-3**). The observed fluorescence was obtained between 500 and 650 nm. The maximum fluorescence emission of the three curcuminoids (curcumin, demethoxycurcumin and bisdemethoxycurcumin) was observed between 500 and 600 nm (**Figure 3-3.III**).

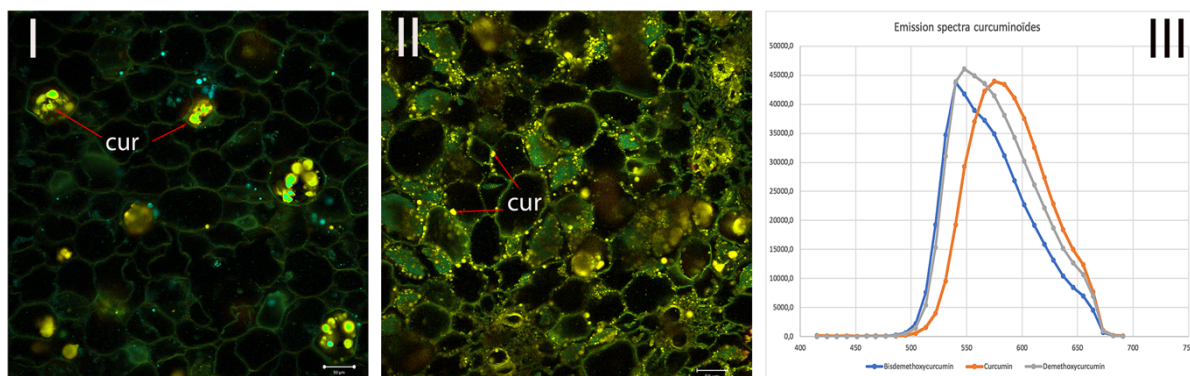

Figure 3-3 Visualization of curcuminoids distribution by multiphotonic microscopy. (I) curcuminoids distribution in the cortex of fresh turmeric, (II) curcuminoids distribution in the cortex of cooked and dried (FC2D) turmeric and (III) Emission spectra of curcuminoids between 400 and 700 nm, excitation 720 nm, bar = 50 μ m

Curcuminoid and essential oil contents

The major curcuminoid compound found in our fresh turmeric was curcumin (6.24 g/100g db) followed by bisdemethoxycurcumin (5.70 g/100g db) and demethoxycurcumin (2.92 g/100g db). Moreover, the total curcuminoid contents (the sum of the three curcuminoids) in the turmeric was 14.86 g/100g db (equal to 1.95 g/100g wb). This value was higher than the values found by Hirun *et al.* (2014) (9.39 g/100g db), (Govindarajan and Stahl 1980) (2 – 9 g/100g db) and Garg *et al.* (1999) (0.61 – 1.45 g/100g wb). The essential oil content of our fresh turmeric was 10.72 mL/100g db (equal to 1.32 mL/100g wb). This value was higher than that reported by (Govindarajan and Stahl 1980) who found the content of essential oil up to 6.3 % db. However, the value was in agreement with Garg *et al.* (1999) who stated that the essential oil contents of *Curcuma longa* rhizomes collected from the sub-Himalayan Tarai region of India were in the range of 0.16 – 1.94 mL/100g wb. The disparity of the content of active phytochemicals could be due to environmental factors of each growing location, plant development stage, planting period, harvesting season and turmeric varieties (Hirun *et al.* 2014; Monton *et al.* 2019a)

3.2.3.2 Impacts of the unit processing operations

Impact of cooking on colour values, curcuminoid content, essential oil content and drying curve

By mass balances (data not shown), we measured low water gain (whether for short or long cooking time); the water gain was lower than 3.0 % (kg water per 100 kg initial product). Moreover, very little dry matter and curcuminoids were transferred from the turmeric to the cooking water (not significantly different from zero). Thus, the cooking process only slightly increased the water amount, which must be removed during drying. Cooking had a slight impact on colour values (**Figure 3-4**). Our results showed that both cooking conditions had no impact on L*; however, smooth cooking significantly decreased a* value (8.3 %), while drastic

cooking significantly decreased a^* (6.1 %), b^* (9.3 %) and C^* (8.6 %) values. Heat treatment of the rhizome before dehydration can inactivate oxidative enzymes and limit the browning of the products. The browning of the turmeric during drying could be due to the Maillard reaction. However, rhizomes subjected to immersion cooking should have limited Maillard reactions because some of the reducing sugars could have diffused into the cooking water. Overall, drastic cooking impacted b^* and C^* colour values more than smooth cooking.

Cooking had no impact on curcuminoid content (**Figure 3-4**). This may be because curcuminoid is an oil-soluble pigment, practically insoluble in water at acidic and neutral pH, soluble in alkali. Moreover, it is stable at high temperatures and in acids, but unstable in alkaline conditions and the presence of light (Lee *et al.* 2013). Curcumin, demethoxycurcumin, bisdemethoxycurcumin and total curcuminoid contents of fresh and cooked turmeric (F, FC1 and FC2) ranged from 6.00 – 6.24, 2.92 – 3.31, 5.35 – 5.71 and 14.71 – 15.02 g/100g db, respectively.

Cooking had no impact on essential oil content (**Figure 3-5**) as evidenced by the absence of a significant difference ($p < 0.05$) in the results obtained for essential oil in samples F, FC1 and FC2. The essential oil contents of fresh and cooked turmeric (F, FC1 and FC2) ranged from 10.70 – 11.06 mL/100g db). The results of microscopic analysis (**Figure 3-2.II and III**) also confirmed that the essential oils were not affected by cooking.

The impact of cooking on the drying curves was shown in **Figure 3-6**. Cooking saved 38.1 % and 49.8 % of drying time for FC1 (cooking at 95 °C/3 min) and FC2 (cooking at 95 °C/60 min), respectively. About 59 min, 48 min and 45 min were required to obtain a 50 % reduction in the initial water content of fresh turmeric (F) and cooked turmeric *i.e.*, FC1 and FC2, respectively. Drying kinetics presented a classical behaviour: an intense water loss during the initial stage and slowly at a later stage. This can be attributed to the fact that the moisture from the surface is easily evaporated while it takes time for the moisture to be removed from the interior. The comparison of the drying curves showed a much higher initial drying rate ($5.05 \pm 0.25 \text{ kg.kg}^{-1}.\text{h}^{-1}$ for FC2 and $5.01 \pm 0.23 \text{ kg.kg}^{-1}.\text{h}^{-1}$ for FC1) in cooked turmeric than in fresh ones (F: $4.83 \pm 0.33 \text{ kg.kg}^{-1}.\text{h}^{-1}$). Govindarajan and Stahl (1980) observed that when turmeric rhizomes are cooked, the starch granules gelatinize as a result of the heat treatment, which facilitates drying and increases the rate of dehydration; as a result, the total drying time is reduced.

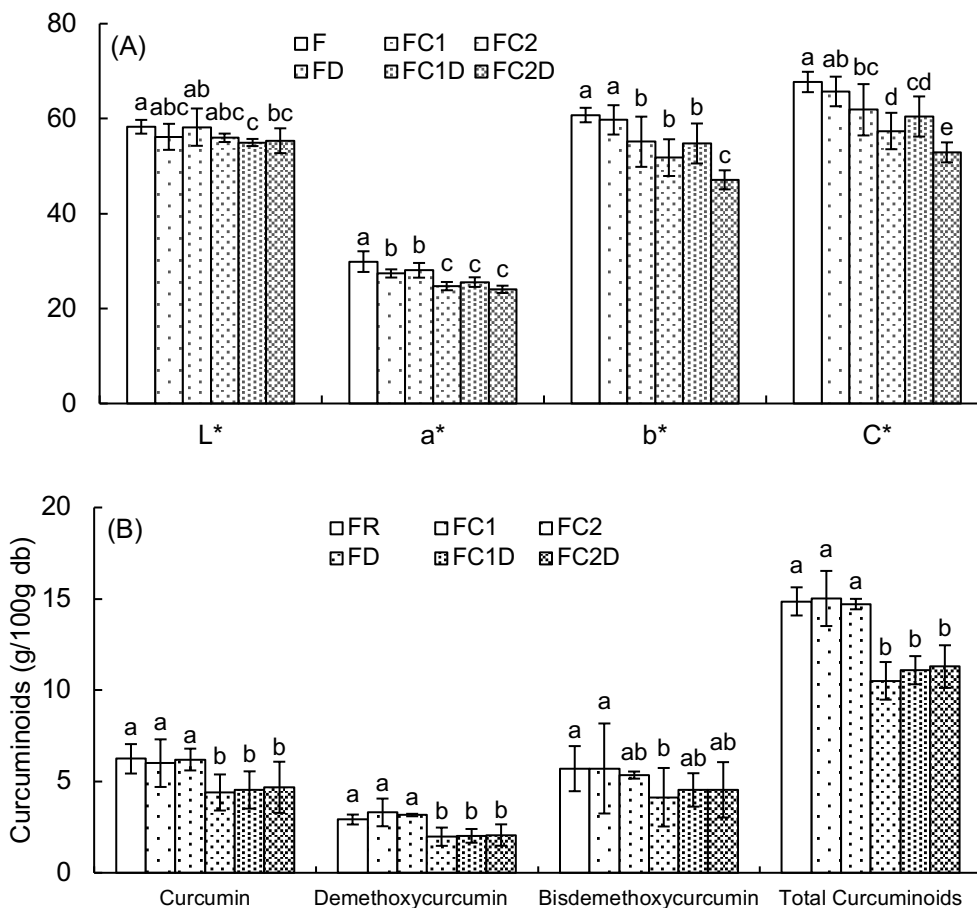

Figure 3-4 Impact of processes on (A) colour values (L*, a*, b* and C*) and (B) curcuminoid content (g/100g initial dry weight basis). FR: frozen rhizome; F: fresh turmeric; C: cooking (C1: 95 °C/3 min; C2: 95 °C/60 min); D: drying (60 °C, 40 % RH). The error bars represent the standard error (n = 6). Within the same parameters, the values followed by the same superscript letters are not significantly different ($p < 0.05$)

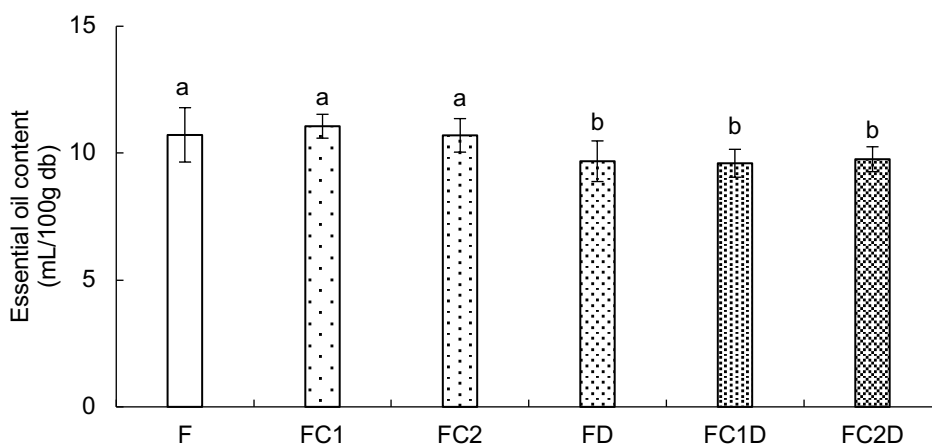

Figure 3-5 Impact of processes on essential oil content (mL/100g initial dry weight basis). F: fresh turmeric, C: cooking (C1: 95 °C/3 min; C2: 95 °C/60 min); D: drying (60 °C, 40 % RH). The error bars represent the standard error (n = 4). Within the same parameters, the values followed by the same superscript letters are not significantly different ($p < 0.05$)

The results of the microscopic analysis confirmed that cooking for 3 min at 95 °C was enough to completely gelatinize the starch (**Figure 3-2.VI**). The amyloplasts were clearly visible in fresh (F) turmeric (**Figure 3-2.V**) while they were no longer visible in cooked (FC1) turmeric (**Figure 3-2.VI**). Moreover, cooking combined with drying caused the partial exit (dispersion) of the curcuminoids from their dedicated cells; curcuminoids were then found throughout the whole rhizome and seem to be partly adsorbed on the starch cells (**Figure 3-3.II**). The degradation of the cell walls allowing curcuminoid exited could also explain the easier water removal when turmeric was cooked prior to drying. Cooking at 95 °C/3 min is the optimum cooking condition for turmeric sliced rhizome (5 mm thick) because it is a good compromise between drying time and the quality of turmeric in terms of b^* and C^* colour chromatic values and it is also less energy-consuming than cooking at 95 °C/60 min.

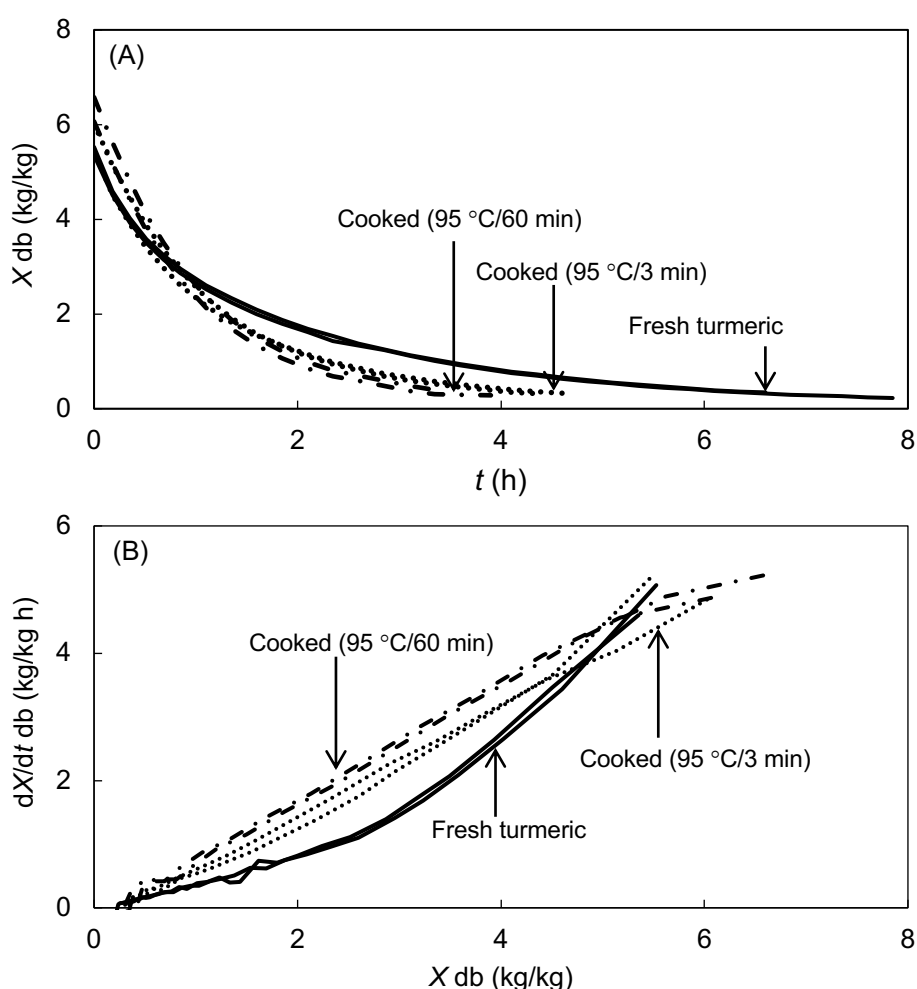

Figure 3-6 Drying curves of fresh and cooked turmeric. (A) water content (X) on a dry basis as a function of time (t) and (B) drying rate (dX/dt) as a function of X . Drying curves recorded by an air dryer (60 °C, RH 40 %, air velocity at $2.1 \pm 0.1 \text{ m s}^{-1}$). The different dash types on curves correspond to different trials.

Impact of drying on colour values, curcuminoid content, and essential oil content

Drying did have a marked impact on colour and curcuminoid contents (**Figure 3-4**). There were significant differences between samples F/FD, FC1/FC1D and FC2/FC2D considered in pairs for all values (a^* , b^* and C^*) except for L^* . The greatest differences were observed between sample F and FD with reductions of 17.3 %, 14.8 % and 15.3 % for a^* , b^* and C^* values, respectively. Similar results were described by (Bambirra *et al.* 2002). In the absence of heat treatment, a product with lower intensity of a^* and b^* was obtained. These results indicated that cooking the turmeric prior to dehydration is essential to obtain a product with higher intensity of a^* and b^* .

There were significant differences ($p \geq 0.05$) between the F/FD, FC1/FC1D and FC2/FC2D samples considered in pairs for all curcuminoids and total curcuminoids with the exception of FC1/FC1D and FC2/FC2D for bisdemethoxycurcumin content. Direct drying significantly decreased curcumin, demethoxycurcumin and bisdemethoxycurcumin contents 29.5 %, 32.3 % and 27.4 %, respectively while drying with previous cooking significantly decreased curcumin and demethoxycurcumin contents 24.5 % and 34.6 – 38.8 %, respectively. These results were in agreement with Madhusankha *et al.* (2018) who indicated that there was an evident and clear relationship between the curcuminoid content and the colour values. When the curcuminoid content decreased, a^* , b^* and C^* values also decreased. Curcumin, demethoxycurcumin, bisdemethoxycurcumin and total curcuminoid contents of our dried turmeric (FD, FC1D and FC2D) ranged from 4.40 – 4.68, 1.98 – 2.07, 4.14 – 4.54 and 10.51 – 11.29 g/100g db, respectively. These values were comparable to those found by (Monton *et al.* 2016). These authors found that: the contents of curcumin, demethoxycurcumin, bisdemethoxycurcumin and total curcuminoids were 6.61 – 7.67, 2.76 – 3.33, 2.64 – 3.47 and 12.02 – 14.36 % w/w, respectively. However, our turmeric contained a higher amount of curcuminoids than those found by Monton *et al.* (2019b) who reported that their turmeric powders contained 2.3 – 3.6 % curcumin, 1.0 – 1.6 % demethoxycurcumin, 1.5 – 2.3 % bisdemethoxycurcumin and 4.8 – 7.3 % (w/w) total curcuminoids.

Drying did have an impact on essential oil content (**Figure 3-5**) as significant visible differences ($p \geq 0.05$) were observed between samples F/FD, FC1/FC1D and FC2/FC2D considered in pairs (relative loss of 8.8 – 13.2 %). The method of drying usually has a significant effect on the contents of the essential oil (Kutti Gounder and Lingamallu 2012). The essential oil is present in the specific cells and ducts present in the meristematic region of the rhizome. These oleaginous cells are damaged during the cooking of the rhizome and the exposure of the essential oil to the atmosphere induces a loss by volatilization during drying (Díaz-Maroto *et al.* 2002). The essential oil content of our dried turmeric (FD, FC1D and FC2D) ranged from 9.60 – 9.76 mL/100g db. These values were higher than that found by (Monton *et al.* 2016) (7.00 – 8.00 % v/w) and (Monton *et al.* 2019a) (5.20 – 8.50 % v/w). The

factors that might affect the content of curcuminoids and essential oil were seasonal variation, environmental condition, post-harvest handling, storage, manufacturing and microbial contamination (Monton *et al.* 2016).

3.2.3.3 Impacts of “full” processes

In this study, a “full” process referred either to a single drying or to a process including cooking before drying (**Figure 3-1**). The impacts of the “full” processes on colour and curcuminoid content (**Figure 3-4**), essential oil content (**Figure 3-5**) and aroma profile (**Table 3-1** and **Figure 3-7**) were described.

Impact of the “full” processes on colour, and curcuminoids content

The impact of the “full” processes on colour and curcuminoid content were illustrated in **Figure 3-4**. There were significant differences ($p \geq 0.05$) between samples F/FD, F/FC1D and F/FC2D considered in pairs for all colour values (L^* , a^* , b^* and C^*). When turmeric was cooked for short time (95 °C/3 min; FC1D) prior to the drying, the colour values decreased less than during drying alone. However, when drying was preceded by drastic cooking (95 °C/60 min; FC2D), the colour values decreased more than during drying alone (FC1D>FD>FC2D). By comparing the three finished products (FD, FC1D and FC2D), the results showed that there were no significant differences ($p < 0.05$) between FD and FC1D for all colour values, while FC2D had more impact on b^* and C^* values as compared to FD and FC1D. The “full” processes did have a marked impact on curcuminoid content (**Figure 3-4**). There were significant differences ($p \geq 0.05$) between samples F/FD, F/FC1D and F/FC2D considered in pairs for all curcuminoid contents and total curcuminoids except that there were no significant differences ($p < 0.05$) between samples F/FC1D and F/FC2D considered in pairs for bisdemethoxycurcumin content. The greatest differences were observed between sample F and FD with reductions of 29.5 %, 32.3 %, 27.4 % and 29.3 % for curcumin, demethoxycurcumin, bisdemethoxycurcumin and total curcuminoids, respectively. These results were in agreement with Suresh *et al.* (2007) who stated that curcumin loss from heat processing of turmeric was in the range of 27 – 53 %, with maximum loss in pressure cooking (at high temperature) for 10 min. However, Bambirra *et al.* (2002) indicated that heat treatment (up to 100 °C) had no effect on curcuminoids in turmeric. Therefore, an appropriate treatment (not too high nor not too low) to dry the turmeric may play a vital role in preserving curcuminoids in the turmeric (Hirun *et al.* 2014). The ground turmeric obtained without heat treatment was the one of worst quality respect to curcuminoid pigments and good quality of ground turmeric can be obtained by cooking in plain water as cooking favours diffusion of pigments from cells to adjacent tissue, contributing to a better pigment homogenization (Bambirra *et al.* 2002). There were no significant differences ($p < 0.05$) between the three

finished products (FD, FC1D and FC2D) for curcuminoid content as compared between them. These results were in accordance with Prathapan *et al.* (2009) who found no significant differences in curcuminoid contents between turmeric samples submitted to different cooking and drying conditions.

Impact of the “full” processes on essential oil content

The “full” processes did have a marked impact on essential oil content (**Figure 3-5**). There were significant differences ($p \geq 0.05$) between samples F/FD, F/FC1D and F/FC2D considered in pairs for essential oil content (relative loss of 9.0 – 10.0 %). This relative loss was lower than that of the traditional drying method which could result in the loss of volatile oil up to 25 % by evaporation and in the destruction of some light-sensitive oil constituents (Ararsa 2018). Though, there were no significant differences ($p < 0.05$) between the three finished products (FD, FC1D and FC2D) for essential oil content as compared between them. These results were in agreement with those found by Jayashree and Zachariah (2016) who reported that there were no significant differences for essential oil content once the duration of cooking in boiling water increased up to 60 min.

Impact of the “full” processes on aroma composition

Fresh sample (F) was used as a reference and 15 aroma compounds representing 95.0 % of the total essential oil were identified. Among these, 10 major compounds, all of which present at a rate greater than 7.0 %, represented 92.1 % (**Table 3-1**) of the total essential oil. The major compounds in fresh turmeric were sesquiterpenes *i.e.*, turmerone (37.9 %), aR-turmerone (16.8 %) and β -turmerone (16.1 %). These turmerones have similar chemical structures, physical properties and molecule weights, although they have different tastes (Kao *et al.* 2007) and they are believed to be an intermediate for the formation of zingiberene and sesquiphellandrene (Asghari *et al.* 2009). α -terpinolene (8.1 %), β -sesquiphellandrene (4.0 %), α -zingiberene (3.7 %), α -phellandrene (1.9 %), caryophyllene (1.6 %), α -curcumene (1.3 %) and eucalyptol (0.7 %) were also identified. Raina *et al.* (2005) reported that the major components of essential oils from turmeric were α -turmerone (44.1 %), β -turmerone (18.5 %) and aR-turmerone (5.4 %), while (Naz *et al.* 2010) reported that the most abundant components of the oils were aR-turmerone (25.3 %), α -turmerone (18.3 %) and β -turmerone (12.5 %). The aroma composition of the fresh turmeric rhizome oils varies with species, origin, agricultural system, climate or maturity.

Table 3-1 Major aroma compounds in *Curcuma longa* L. fresh turmeric (F) essential oil.

Aroma compounds	DB-Wax UI column		DB-5MS column		Area (%)
	RI ^a	RI ^b	RI ^a	RI ^b	
Turmerone	2198	2245	1682	1650	37.8 ± 3.4
aR-Turmerone	2274	–	1678	1637	16.8 ± 1.9
β-Turmerone	2261	–	1711	1680	16.1 ± 0.8
α-Terpinolene	1307	1283	1096	1079	8.1 ± 1.4
β-Sesquiphellandrene	1771	1772	1527	1515	4.0 ± 0.6
α-Zingiberene	1724	1724	1497	1488	3.7 ± 0.7
α-Phellandrene	1197	1167	1016	998	1.9 ± 0.3
Caryophyllene	1610	1595	1425	1419	1.6 ± 0.4
α-Curcumene	1773	1777	1482	1473	1.3 ± 0.3
Eucalyptol	1240	1213	1041	1022	0.7 ± 0.1
<i>Total</i>					92.1 ± 1.0

Mean values ($n = 8$) ± 95 % confidence interval. RI^a is retention indices relative to C8–C20 n-alkanes (Experimental value) and RI^b is retention indices from NIST and PubChem (literatures).

The impact of the “full” processes on the aroma profile was shown in **Figure 3-7**. There were significant differences ($p \geq 0.05$) between samples F/FD, F/FC1D and F/FC2D considered in pairs for all molecules, except for turmerone and α-phellandrene. For aR-turmerone and β-turmerone, the greatest differences were observed between sample F and FD with relative loss of 21.6 % and 9.8 %, respectively. For α-curcumene, the greatest difference (30.8 %) was observed between sample F and FC1D. For α-terpinolene, β-sesquiphellandrene, α-zingiberene, caryophyllene and eucalyptol, the greatest differences were observed between sample F and FC2D with a reduction in the range of 19.7 – 46.3 %. Cooking slightly impacted the concentration of aroma compounds (**Figure 3-7**). Smooth cooking significantly decreased 14.9 %, 21.7 % and 19.7 % of aR-turmerone, α-curcumene and eucalyptol, respectively. Drastic cooking significantly decreased aR-turmerone, α-terpinolene, caryophyllene and eucalyptol with a reduction of 6.5 %, 43.4 %, 37.2 % and 19.7 %, respectively. Conversely, cooking (smooth and drastic) significantly increased turmerone up to 19.0 %. The major aroma compounds in our fresh and cooked turmeric (F, FC1 and FC2) were turmerone (37.9 – 44.6 %), aR-turmerone (14.0 – 16.8 %) and β-turmerone (16.1 – 16.8 %) (data not shown). Drying also had a slight impact on the concentration of aroma compounds (**Figure 3-7**) as there were significant differences ($p \geq 0.05$) between samples F/FD, FC1/FC1D and FC2/FC2D considered in pairs. Direct drying significantly decreased aR-turmerone, β-turmerone and α-curcumene with relative loss of 21.6 %, 9.8 % and 14.5 %, respectively. Drying with previous smooth cooking significantly decreased turmerone, β-turmerone, β-sesquiphellandrene and α-zingiberene with relative loss of 13.9 %, 14.2 %, 23.3 % and

24.4 %, respectively. Drying with previous drastic cooking significantly decreased aR-turmerone (8.3 %), β -turmerone (8.2 %) and β -sesquiphellandrene (15.4 %). The changes in the percentage of each aroma compound may be due to the complete release of these compounds during cooking and drying processes and another reason may be due to oxidation or rearrangement of less stable compounds to the more stable compounds (Kutti Gounder and Lingamallu 2012). The major aroma compounds in our dried turmeric (FD, FC1D and FC2D) were turmerone (40.9 – 44.4 %), aR-turmerone (14.6 – 15.8 %) and β -turmerone (16.1 – 17.1 %) (data not shown). The major aroma compounds of dried turmeric from Thailand found by Monton *et al.* (2019b) were aR-turmerone (43 – 49 %), turmerone (13 – 16 %) and β -turmerone (17 – 18 %) and by Thongphasuk and Thongphasuk (2013) were aR-turmerone (32 %), α -turmerone (16 %), and β -turmerone (13 %).

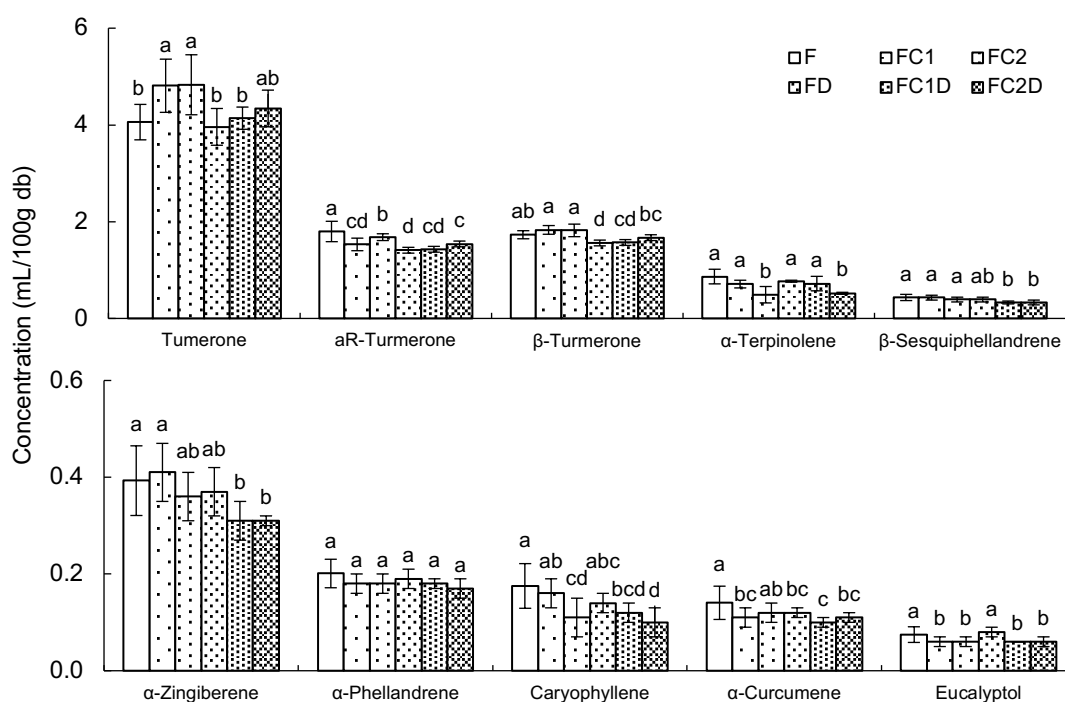

Figure 3-7 Composition of essential oil of fresh and processed turmeric. F: fresh turmeric; C: cooking (C1: 95 °C/3 min; C2: 95 °C/60 min); D: drying (60 °C, 40 % RH). The error bars represent the standard error ($n = 8$). Within the same parameters, the values followed by the same superscript letters are not significantly different ($p < 0.05$)

3.2.4 Conclusion

Our original approach combining microscopy and biochemistry brought interesting results. Curcuminoid and essential oil were found in different dedicated cells. After processing, curcuminoids were dispersed throughout the matrix. This starchy matrix seems to protect essential oil and curcuminoid to a certain extent. Drastic cooking (95 °C/60 min) and drying operations impacted b^* and C^* colour values more than smooth cooking (95 °C/3 min). Cooking (either smooth or drastic) had no impact on curcuminoid and essential oil contents

and only a slight impact on essential oil composition. Drying significantly decreased curcuminoid (between 24.5 – 38.8 %) and essential oil (between 8.8 – 13.2 %) contents. There is a real interest in combining cooking and drying unit operations. Indeed, cooking turmeric before drying saved 38.1 to 49.8 % of the drying time. Cooking at 95 °C/3 min is the optimum cooking condition for turmeric sliced rhizome (5 mm thick) because it is a good compromise between drying time and the quality of turmeric considering colour and aroma. It is also less energy-consuming than cooking at 95 °C/60 min. For further studies, we should focus on the impact of unit operations (cooking, drying and grinding) on the functional and sensorial qualities of turmeric.

3.3 Chapter 3 summary and outlook

The results of our field study (chapter 2) indicated that cooking (between 30 to 40 min in boiling water) and slicing should be applied in turmeric processing as they reduce drying time and maintain the contents of essential oil and bioaccessible curcuminoids. Many researches revealed that sun-drying has been practised broadly in hot climates and tropical countries due to its low cost and simple technology. However, it is extremely weather-dependent and may, therefore, requires long processing time and affects the quality of the product. Air drying is an alternative to sun drying, not only to reduce drying time but also to better preserve the quality of the product. Hence, the impact of cooking and drying on colour, curcuminoids, essential oil and aroma compounds of *Curcuma longa* L. were assessed (chapter 3). Sliced fresh turmeric rhizomes (thickness of 5 mm) were air-dried at 60 °C with 40 % RH directly or after cooking at 95 °C for 3 or 60 min. Our study revealed that drastic cooking (95 °C/60 min) and drying operations decreased colour values more than smooth cooking (95 °C/3 min). Cooking (either smooth or drastic) had no impact on curcuminoid and essential oil contents and just slightly modified aromatic profile of essential oils. Microscopic observations made it possible to locate the starch granules, the curcuminoids and the essential oil. The overall analysis suggests the protective effect of the starch matrix on curcuminoids. Drying decreased the curcuminoid (< 38 %) and essential oil (< 13 %) contents. Cooking at 95 °C for 3 min which is enough to gelatinise starch is the optimum cooking condition. However, we did not know if cooking could have any impact on the bioaccessibility of curcuminoids and sensorial quality of turmeric. As drying highly impacted on turmeric's quality, an in-depth study on the drying process should be conducted. The bioaccessibility of compound of interests are linked to particle size (based on literature review) so we expect particle size to have an impact on sensorial quality. The following work (chapter 4) aimed to study on the impact of the combination of unit operations: cooking (95 °C/3 min), drying (50, 60 or 80 °C; 40 % RH) and grinding (to obtain two powders of different particle sizes: fine <500 µm and coarse <750 µm) on sensorial and functional quality of *Curcuma longa* L. under controlled conditions.

Chapter 4 – Impact of processes on the quality of turmeric (sensorial and functional quality)

4. Chapter 4 – Impact of processes on the quality of turmeric (sensorial and functional quality)

4.1 Introduction to Chapter

This chapter was published as a research article in the Journal of Food Measurement and Characterization which described the impact of cooking, drying and grinding operations and their combinations on sensorial and functional quality of *Curcuma longa* L. under controlled conditions.

4.2 Impact of cooking, drying and grinding operations on sensorial and functional quality of *Curcuma longa* L. (paper 3)

Molika Yin^{1,2}, Mathieu Weil^{1,3*}, Sylvie Avallone¹, Isabelle Maraval^{1,3}, Nelly Forestier-Chiron^{1,3}, Adrien Servent^{1,3}, Sokneang In², Philippe Bohuon¹

Journal of Food Measurement and Characterization

¹Qualisud, Univ Montpellier, CIRAD, Institut Agro, Avignon Université, Univ de La Réunion, Montpellier, France

²Institut de Technologie du Cambodge, Food Technology and Nutrition Research Unit, Phnom Penh, Cambodia

³CIRAD, UMR Qualisud, F-34398 Montpellier, France

Abstract: The impact of cooking, drying and grinding on the essential oil, curcuminoids and their bioaccessibility and sensorial quality of turmeric was assessed. Sliced fresh turmeric rhizomes were air-dried at 60 °C, 40 % RH directly or pre-cooked (95 °C/3 min) before drying at different conditions (50, 60 or 80 °C; 40 % RH). Dried slices were ground to obtain two powders of different particle sizes (*i.e.*, fine <500 µm and coarse <750 µm). Cooking had no impact on essential oil content, curcuminoid contents and their bioaccessibility but reduced drying time. Drying decreased essential oil content (– 22.5 %), curcuminoid contents (– 11.0 %) and their bioaccessibility (– 28.6 %). Surprisingly, grinding had no impact on curcuminoid contents and their bioaccessibility. The combination of the tested unit operations produced final products with the same quality in terms of total curcuminoid contents (12.1 g/100 g db) and bioaccessible curcuminoids (1.0 g/100 g db). However, consumers detected differences in colour, texture and overall liking between processed turmeric powders (dried and cooked-dried). Our results demonstrate that smooth cooking (95 °C/3 min) followed by drying (60 °C, 40 % RH) is the most appropriate process to produce a curcuminoid-rich powder and improve consumer acceptance.

Keywords: Curcuminoids; Bioaccessibility; Particle size; Essential oil; Consumer acceptance; Descriptive attributes

4.2.1 Introduction

Turmeric (*Curcuma longa* L.) has been used for years all over the world to prepare a large number of recipes and improve their aroma and colour. Consumers are also increasingly attracted to its anti-inflammatory potential and health properties. As a spice, turmeric is used fresh or processed in the formulation of sauces, soups, seasonings and marinades to enhance the sensory profile of many foods, particularly meat products. Rhizomes of dried *Curcuma longa* L. contain carbohydrates (60 – 70 %), protein (6 – 8 %), fibre (2 – 7 %), minerals (3 – 7 %), fat (5 – 10 %), essential oil (3 – 7 %) and curcuminoid pigments (2 – 6 %). The essential oil and the curcuminoid pigments are active components of turmeric. The essential oil is composed mainly of sesquiterpenes *i.e.*, α - (30 – 32 %), β - (15 – 18 %) and ar-turmerone (17 – 26 %). Curcuminoids are a mixture of curcumin (52 – 63 %) and its two derivatives demethoxycurcumin (19 – 27 %) and bisdemethoxycurcumin (18 – 28 %) (Ravindran *et al.* 2007). These are considered bioactive polyphenols with beneficial health properties and are responsible for the yellow-orange colouration of turmeric powder (Jiang *et al.* 2020). Although turmeric has been used as a food colourant and functional ingredient, these uses have remained challenging due to its low solubility in water, which limits its dispersion in food matrices and its bioaccessibility (Calligaris *et al.* 2020; Gómez-Estaca *et al.* 2015).

After harvest, fresh turmeric rhizome undergoes continuous physical, chemical and microbiological changes. These changes are particularly influenced by the moisture content of the material, relative humidity of ambient air and storage conditions (Bambirra *et al.* 2002). To preserve its quality and make it available throughout the year, it must be subjected to specific technological treatment such as drying. Depending on the geographical area of production, turmeric is either dried directly or bleached and then dried; depending on local consumer preferences, it may also be ground more or less finely. Air drying is an alternative to sun drying, not only to increase the drying rate and reduce drying time but also to better preserve the quality of the product (Bambirra *et al.* 2002; Prathapan *et al.* 2009). However, it is recognised that it is time- and energy-consuming when whole rhizomes are dried directly or pre-cooked for a long time at a high temperature (≥ 100 °C) and then dried (Pethkar *et al.* 2017; Suresh *et al.* 2007). Heat applied to turmeric may inactivate enzymes and soften the tissue to prevent phytochemical degradation and improve their release from plant matrix and therefore, turmeric powder functionality (*i.e.*, curcuminoids bioaccessibility).

This study aimed to assess the impact of unit operations and their combinations on the essential oil content, curcuminoid contents and their bioaccessibility and sensorial quality of *Curcuma longa* L. In order to determine optimum transformation conditions, the impact of

cooking, drying and grinding was studied through different process conditions on sliced rhizomes. The impact of cooking and drying on drying kinetics was also studied.

4.2.2 Material and methods

4.2.2.1 Materials

Fresh turmeric rhizome (*Curcuma longa* L.) was purchased from a farmer in Kampong Cham (Cambodia) in November 2020. It was packed and transported to Montpellier (France) by airplane in the next two days. Turmeric rhizomes were stored at 4 °C before processing. About 60 g of fresh turmeric rhizome was cleaned and sliced to a thickness of 5 mm. Next, it was frozen by using liquid nitrogen and ground for 10 s at 10 000 rpm in a mill (Retsch Grindomix GM200, Retsch GmbH, Germany) prior to immediate analyses of water content, essential oil content, curcuminoids and their bioaccessibility. About 360 g of fresh turmeric rhizome was cleaned and sliced then frozen at – 80 °C overnight before being freeze-dried in a vacuum freeze-dryer (Cryonext, France) for 48 h. It was ground following the same method as for the fresh turmeric. The commercial turmeric powder (Ducros) was purchased from a supermarket in Montpellier (France) in February 2021. It was packed in glass bottle with a net content of 45 g. HPLC standards curcumin (C), demethoxycurcumin (DMC), bisdemethoxycurcumin (BDMC), α -amylase from human saliva (5 units/mg protein), pepsin from porcine gastric mucosa (3200 – 4500 units/mg protein) and pancreatin from porcine pancreas (8 x USP specifications) were purchased from Sigma-Aldrich (Saint Quentin Fallavier, France).

4.2.2.2 Processing experiments

The fresh turmeric rhizomes were cleaned and washed thoroughly under running water to remove adhering soil and mud and other foreign materials. Then, the excess water was drained and the cleaned turmeric rhizomes were sliced manually to a thickness of 5 mm. The sliced turmeric (420 g) were cooked at 95 °C/3 min by immersion in a nylon net in hot water at a ratio of 1:10 w/w material to water. The cooked turmeric was immediately soaked in an ice water bath for 1 min to stop the heat exposure, before being drained. Then, the cooked turmeric was dried in a hot air dryer, developed in our laboratory at three conditions (D1: 60 °C, 40 % RH; D2: 50 °C, 40 % RH; D3: 80 °C/1h + 50 °C, 40 % RH) until reaching a water content of 0.11 kg·kg⁻¹ db (International Organization for Standardization 2015). In the vertical drying chamber, the sliced turmeric was spread on a grid sieve (0.25 m × 0.25 m × 0.06 m). Hot air was circulated downwards through the layer of sliced turmeric by a high-capacity fan. Airspeed was measured thanks to an anemometer (ALMEMO® 2690-8A, Ahlborn Mess, Germany). The air velocity was set to 2.1 ± 0.1 m s⁻¹ to have no significant effect on temperature when passing through the layer of sliced turmeric. Monitoring by weighing was carried out continuously during the drying process, every 10 min for the first hour and then

every 15 min. The water content, which was expressed on a dry basis (noted X) as a function of time, was estimated in line, using the mass reading of the sieve. Water content kinetics $X^{(t)}$ were fitted with a cubic smoothing spline (Matlab® Version 5.2, The Mathworks Inc., USA). The drying rate (dX/dt) was calculated as the direct analytical derivative of the cubic smoothing spline function on $X^{(t)}$. Next, the dried turmeric was ground at 10 000 rpm for 10 s by using an ultra-centrifugal mill (Retsch ZM 200, Retsch GmbH, Germany) with two different sieves (500 μm and 750 μm) in order to produce two different particle size powders (P1: <500 μm ; P2: <750 μm) (**Figure 4-1**). For essential oil content determination, the dried turmeric was ground following the same method as for the fresh turmeric. The samples were put in glass bottles and frozen at $-80\text{ }^{\circ}\text{C}$ for further analysis.

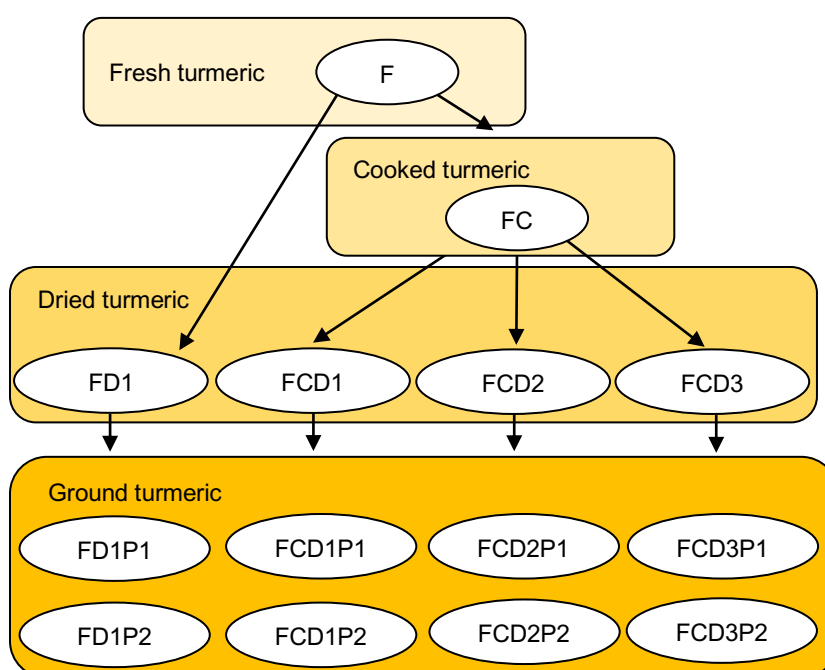

Figure 4-1 Processes applied to turmeric. F: fresh; C: cooking (95 °C/3 min); D: drying (D1: 60 °C, 40 % RH; D2: 50 °C, 40 % RH; D3: 80 °C/1h + 50 °C, 40 % RH); Grinding leading to different particle size (P1: <500 μm ; P2: <750 μm)

4.2.2.3 Analytical methods

Dry matter and water contents

The dry matter content (means “dry matter free of essential oil”) was obtained by drying 1 g of ground turmeric in an aluminium cup in an oven (Gefran 800, Italy) at 105 °C for 30 h (*i.e.*, until constant weight). The mean relative deviation of repeatability was $\pm 1.9\%$ ($n = 4$). Water content, expressed on a dry basis, was deduced from essential oil and dry matter contents.

Essential oil content

The essential oil content, expressed in mL/100g on a dry weight basis (mL/100g db), was determined using a method adapted from the international official standard method ISO

6571:2008 (International Organization for Standardization 2008). The only modification in the method we applied was the elimination of xylene. About 20 g of fresh turmeric or 5 g of dried turmeric was weighed and transferred to 1 L round bottom flask, then 250 mL of distilled water was added with 10 pieces of pumice stones to homogenize boiling. It was heated at medium heat for 4 h and the condensed vapour was separated. The essential oil present in the uppermost layers was measured. The mean relative deviation of repeatability was $\pm 3.8\%$ ($n = 4$).

Particle characterisation

A laser granulometry instrument (Mastersizer 3000, Malvern Instruments Ltd., Malvern, Worcestershire, UK) was used to measure the particle diameter and particle size distribution of the turmeric powders. The particle size was reported as the surface mean diameter ($D_{3,2}$). The mean relative deviation of repeatability was $\pm 15.9\%$ ($n = 6$).

Curcuminoid contents

Approximately 0.3 g of turmeric sample was mixed with 30 mL of 60 °C ethanol (99.8 %) and homogenized for 2 min at 30 000 rpm (IKA T10 basic Ultra-Turrax, Prolabo, France). The samples were heated for 30 min at 60 °C (Sogi *et al.* 2010). After cooling, the extracts were diluted 1/10 with ethanol and filtered on 0.45 μm PTFE Minisart SRP4 membrane (Sartorius, Palaiseau, France). Curcuminoids were analysed by high-performance liquid chromatography (Agilent System 1200 series, Massy, France). The column was a polymeric ACE C₁₈ (250 \times 4.6 mm, 5 μm particle size, Inc Wilmington NC) and the injection volume was 5 μL . The quantification of curcuminoids was carried out according to the method of Sepahpour *et al.* (2018) with small modifications. The elution was done isocratically with a mixture of acetonitrile and 0.1 % acetic acid (40:60) at a flow rate of 1.0 mL/min. The temperature of the column was set at 25 °C. Chromatograms were recorded over 30 min period with a UV-visible photodiode array detector (Agilent Technologies 1200 series) at 425 nm, the wavelength of maximum absorption of the curcuminoids in the mobile phase. The curcuminoids were identified by their retention time and spectrum. External calibration was realized weekly with standard solutions of the pure chemicals in ethanol in the range of 1 to 50 mg/L. The curcuminoid contents were expressed in g/100g on a dry weight basis (g/100g db). The mean relative deviation of repeatability was 2.5 %, 3.6 %, 4.2 % and 3.5 %, respectively for C, DMC, BDMC and total curcuminoid contents ($n = 4$).

Assessment of bioaccessible curcuminoids

A static *in vitro* gastrointestinal tract model was used to study the potential gastrointestinal fate and bioaccessibility of curcuminoids in turmeric powders. The simulated gastrointestinal tract used in our study was based on one described previously (Minekus *et al.* 2014; Yerramilli

et al. 2018) with some slight modifications. The stock solutions were prepared before the experiments while the enzymatic solutions were prepared at the last moment. About 1.0 g of fresh turmeric or 0.3 g of dried turmeric was weighed and distilled water was added into the sample to get the total weight about 5.0 g that was left at room temperature for 15 min. Then, 5 mL of salivary solution was added and the sample was incubated for 2 min at 37 °C with gentle stirring (Oral phase). Next, 10 mL of gastric phase was added and incubated for 2 h at 37 °C with gentle stirring (Gastric phase). The solution was adjusted to pH 5.0 with sodium hydroxide at 2 M and then 20 mL of intestinal phase was added. The sample was incubated for 2 h at 37 °C with gentle stirring (Intestinal phase). After that, the digest phases were separated from the solid residue by centrifugation at 10 000 g for 30 min at 15 °C (Avanti™ J-E, Beckman Coulter®). The liquid phase was weighed accurately. To extract the bioaccessible curcuminoids, 10 mL of the digesta was mixed with 10 mL of chloroform ($\geq 99.8\%$) and vortexed for 10 s (Fisherbrand™ Classic Vortex Mixer). Next, the samples were centrifuged at 10 000 g for 10 min at 15 °C. After that, 5 mL of yellow phase was evaporated at 50 °C for 3 min using a rotary evaporator (Heidolph Laborota 4000, Schwabach, Germany). Then, the residue was solubilized in 10 mL ethanol ($\geq 99.8\%$) and filtered on a 0.45 μm PTFE Minisart SRP4 membrane. Finally, the bioaccessible curcuminoids were analysed by HPLC following the same method as the curcuminoids analysis. The chromatogram figure of curcuminoids separated in the total extract and after digestion was shown in the supplementary material. The bioaccessible curcuminoids were expressed in g/100g on a dry weight basis (g/100g db) by using the total content in the sample. The mean relative deviation of repeatability was 10.4 %, 6.4 %, 5.6 % and 7.5 %, respectively for C, DMC, BDMC and total curcuminoids ($n = 4$). The bioaccessibility (in %) corresponds to the amount of compounds transferred to the micellar phase compared to the initial contents in the products.

Sample preparation for the focus group, consumer acceptance and quantitative descriptive analysis

As turmeric is not consumed alone, the consumer evaluation was carried out by mixing the powders with cooked rice. For this purpose, plain rice was cooked in a pressure cooker with a ratio of rice/water equal to 1/1.5 (w/w). Then, it was mixed (in bowls) with the processed turmeric in a w/w ratio of 1.5 % (kept warm by covering). About 20 g of sample per tasting glass was prepared for each panellist. The “turmeric rice samples” were kept warm (between 60 and 70 °C) in a heated cabinet and tested by using a teaspoon. The panellists were recommended to rinse their mouths with white rice and/or water between the samples, to minimise any residual effect.

Focus group and consumer acceptance

The focus group and consumer acceptance tests were conducted at the Institut de Technologie du Cambodge (Phnom Penh, Cambodia). The consumers were informed prior to the study that their participation was entirely voluntary, that they could stop the interview at any point/time and that their responses would remain anonymous. A focus group discussion was performed to collect the perceptions and attitudes of consumers towards turmeric powders. Six volunteers (three females and three males) of different ages (20 to 60-year-old) were invited to evaluate two turmeric powders and to taste two turmeric rice samples. We asked them to give their impressions about the samples, main product attributes and their motivations to buy and to consume turmeric powders. The results from the focus group discussion were used to develop a survey for the consumer acceptance test. The consumer acceptance test was carried out with 120 non-trained consumers. Since there were eight samples, two sessions were held on four consecutive days. The samples were presented in random order and labelled with three-digit numbers. We asked the participants to provide information on their gender, age, occupation, marital status, turmeric consumption pattern and frequency. For each sample, the consumers were asked to score their appreciation of each attribute (colour, texture, odour, taste and overall liking) on a structured nine-point hedonic scale (1: dislike extremely, 5: neither like nor dislike, 9: like extremely). After tasting, we asked them to provide their appreciation of turmeric powder: general appreciation, purposes of buy/use, ways of consuming and occasion of consumption.

Quantitative descriptive analysis

A quantitative descriptive analysis was carried out to characterize four turmeric rice samples. The panellists were recruited and selected in compliance with ISO Standard 8586:2012 (International Organization for Standardization 2012a) and panel performance was evaluated in compliance with ISO Standard 11132:2012 (International Organization for Standardization 2012b). Twelve trained panellists (seven females and five males) were selected from researchers and staff in the UMR – Qualisud of CIRAD (Montpellier, France). We provided two training sessions to the panellists in order to determine the consensus list of quality attributes. In the first session, the panellists were specifically asked to identify and describe the quality attributes perceived and to memorize the perception and trained how to use the scale. After the individual assessment, an open discussion was held to assess the evaluation results. From this discussion, the terms were selected and the mean of each attribute was calculated for the second training session. The list of descriptors, their definitions and the assessment protocols were developed (**Table 4-1**). In the second session, the panellists were trained to assess warm-up samples using the same sensory sheets to be used in the main sensory evaluation. All panellists were asked to compare their results with the previous ones

and the mean scale. We made sure that all the panellists were able to identify each attribute and score them in accordance with the entire panel. Sensory evaluation was performed in random order and the samples were coded with three-alphabets. We asked the panellists to evaluate the samples in monadic service and to participate in two sessions with a 15 min break after the 1st session. The intensity of each attribute was scaled from 0 to 10 on which 0 corresponded to “low intensity” and 10 to “high intensity”. The laboratory met the requirements of the international norm ISO 8589 (International Organization for Standardization 2007) *i.e.* it was air-conditioned with a controlled temperature ($22\text{ }^{\circ}\text{C} \pm 1\text{ }^{\circ}\text{C}$) and humidity ($75\% \pm 10\%$). The panellists tasted in individual tasting booths.

Statistical analysis

The results were expressed as means \pm standard deviations. The significance of differences was determined by analysis of variance (ANOVA) and Duncan’s test using SPSS version 26.0 (SPSS Inc., Chicago, IL, USA). The level of significance was set at $p < 0.05$.

4.2.3 Results and discussion

4.2.3.1 Essential oil content

The essential oil content of our fresh turmeric was 13.25 mL/100g db (equal to 1.51 mL/100g wb). This value was higher than the value of 10.72 mL/100 g db (equal to 1.32 mL/100 g wb) found in our previous study (Yin *et al.* 2022), on fresh turmeric from Thailand. However, the value was in agreement with Garg *et al.* (1999) who found that the essential oil content of turmeric collected from the sub-Himalayan Tarai region of India ranged from 0.16 to 1.94 mL/100g wb. The difference may be due to turmeric variety, planting period, environmental conditions, plant development stage, and harvesting season (Hirun *et al.* 2014; Monton *et al.* 2019a). Cooking had no impact on essential oil content but drying significantly decreased it with a relative loss of 22.5 %. This result was in agreement with Ararsa (2018) who found a loss of essential oil up to 25 % by evaporation and destruction of some light-sensitive oil constituents. The essential oil contents of freeze-dried and hot air-dried turmeric were not significantly different ($p < 0.05$) and the average value (10.30 mL/100g db) was much higher than that of commercial turmeric powder (2.44 mL/100g db). The essential oil content was quite stable during the tested unit operations.

Table 4-1 Definition of sensory attributes used to describe turmeric powders

Attribute family	Attribute	Definition	Assessment protocol	Rating scale
Appearance	Yellow	Yellow colour intensity	Observe the colour of the sample and note its intensity ranging from yellow to yellow-orange	0: Yellow 10: Yellow orange
	Dull	Opposite to the brightness of rice colour	Observe the colour brightness of the sample and note its intensity ranging from bright to dull colour	0: Bright; 10: Dull
	Particle size	Size and shape of particles in the sample	Take a spoon of sample and observe the size and shape of the particles in the sample. Note the finesse of the sample	0: Fine; 10: Coarse
Odour	Turmeric	Odour of turmeric produced by the essential oil and the compounds called "turmerones"	Smell the sample and note the intensity of the turmeric odour	0: Weak; 10: Strong
	Earthy	Odour of earth, cultivated soil	Smell the sample and note the intensity of the earthy odour	0: Weak; 10: Strong
Taste	Bitter	Basic taste of quinine or caffeine	Put a spoon of sample in your mouth, chew it and swirl it around your tongue to detect the bitter taste	0: Weak; 10: Strong
Aroma	Turmeric	Aroma of turmeric produced by the essential oil and the compounds called "turmerones"	Put a spoon of sample in your mouth, chew and note the intensity of the aromas	0: Weak; 10: Strong
	Earthy	Aroma of earth corresponding to an organic compound present in the soil		0: Weak; 10: Strong
	Woody	Aroma reminiscent of wood, ...		0: Weak; 10: Strong
	Green	Aroma reminiscent of grass, vegetables, ...		0: Weak; 10: Strong
	Minty	Aroma of mint		0: Weak; 10: Strong
	Floral	Aroma reminiscent of flowers: rose, jasmine, ...		0: Weak; 10: Strong
Mouthfeel	Piquant	Feeling of piquant	Evaluate the feeling of piquant in the mouth after swallowing	0: Weak; 10: Strong
	Fresh	Feeling of freshness in the mouth, like menthol, liquorice, camphor, eucalyptus, ...	Evaluate the feeling of freshness in the mouth after swallowing	0: Weak; 10: Strong
Comments		Specify the other odours-aromas felt and note their intensity		0: Weak; 10: Strong

4.2.3.2 Particle characterization

Different drying conditions had no impact on the particle size of turmeric powders obtained by grinding (**Table 4-2**). Our turmeric powders (both fine and coarse particle size groups) had bimodal distribution (data not shown). The average of $D_{3,2}$ of fine and coarse particle size groups was $425 \pm 49 \mu\text{m}$ and $711 \pm 54 \mu\text{m}$, respectively. The particle size distribution is dependent on the mill used for the grinding (de la Hera *et al.* 2013). Here, the results were relevant with the use of two different sieves ($<500 \mu\text{m}$ for fine and $<750 \mu\text{m}$ for coarse). Different drying conditions, but with the same final water content ($0.11 \pm 0.01 \text{ kg}\cdot\text{kg}^{-1} \text{ db}$), had no impact on the particle size distribution and surface mean diameter of turmeric powders. We can notice that the freeze-dried powder with low water content ($0.06 \text{ kg}\cdot\text{kg}^{-1} \text{ db}$) have a very low $D_{3,2}$ ($63 \mu\text{m}$).

4.2.3.3 Impact of cooking and drying on drying curves

The water content of our fresh turmeric was $86.9 \pm 0.5 \text{ g}/100\text{g wb}$ (equal to $6.7 \pm 0.3 \text{ kg}\cdot\text{kg}^{-1} \text{ db}$). The drying time required to reach a water content of $0.11 \text{ kg}\cdot\text{kg}^{-1} \text{ db}$ for FD1, FCD1, FCD2 and FCD3 was 8 h 19 min, 5 h 37 min, 7 h 48 min and 6 h 17 min, respectively. The use of a pre-cooking step saved 32.4 % of drying time; increasing drying temperature reduced drying time (**Figure 4-2**). Drying the cooked turmeric at $60 \text{ }^\circ\text{C}$ (FCD1) saved 11.8 % and 38.7 % as compared to drying at $80 \text{ }^\circ\text{C}/1\text{h} + 50 \text{ }^\circ\text{C}$ (FCD3) and $50 \text{ }^\circ\text{C}$ (FCD2), respectively. The initial drying rate of FCD3 ($9.0 \pm 0.3 \text{ kg}\cdot\text{kg}^{-1}\cdot\text{h}^{-1}$) was much higher than FCD2 ($5.7 \pm 0.1 \text{ kg}\cdot\text{kg}^{-1}\cdot\text{h}^{-1}$), FCD1 ($5.2 \pm 0.2 \text{ kg}\cdot\text{kg}^{-1}\cdot\text{h}^{-1}$) and FD1 ($5.8 \pm 0.7 \text{ kg}\cdot\text{kg}^{-1}\cdot\text{h}^{-1}$). The drying rate increased with the drying temperature. This behaviour is due to higher temperature increasing the system's enthalpy, which increases the transfer of mass and energy, accelerating the migration of water (Osorio-Arias *et al.* 2020). Llano *et al.* (2022) evaluated different temperatures (between 50 to $80 \text{ }^\circ\text{C}$) in a fluidized bed dryer on turmeric, finding that the efficiency of dehydration was better at a higher temperature ($80 \text{ }^\circ\text{C}$) which can reduce drying time up to 37.5 % as compared to drying at $50 \text{ }^\circ\text{C}$. Drying kinetics presented a classical behaviour with an intense water loss during the initial stage and a lower one at a later stage. This can be attributed to the fact that water on the surface of the food evaporates easily at the beginning of the drying process, whereas it takes longer to remove the water inside the product.

Table 4-2 Particle size (Sauter mean diameter $D_{3,2}$) of turmeric powder; curcumin (C), demethoxycurcumin (DMC), bisdemethoxycurcumin (BDMC), total curcuminoids content; total and relative bioaccessible curcuminoids of fresh (F) and processed turmeric samples obtained by cooking (C: 95 °C/3 min) or not, drying (D) and grinding with fine (P1) or coarse (P2) particle sizes

Samples	$D_{3,2}$ (μm)	Curcuminoids (g/100 g db)				Bioaccessible curcuminoids (g/100 g db)				Relative (%)
		C	DMC	BDMC	Total	C	DMC	BDMC	Total	
F	–	5.29±0.21 ^b	3.50±0.12 ^a	4.77±0.20 ^b	13.56±0.52 ^b	0.87±0.01 ^a	0.51±0.02 ^a	0.35±0.02 ^{ab}	1.72±0.04 ^a	12.7 ^a
Freeze-dried	63±5 ^c	5.80±0.34 ^a	3.31±0.25 ^a	5.33±0.36 ^a	14.44±0.95 ^a	0.50±0.06 ^b	0.41±0.04 ^b	0.36±0.03 ^a	1.27±0.13 ^b	9.2 ^b
FD1P1	444±149 ^b	5.38±0.23 ^b	2.53±0.14 ^b	4.38±0.21 ^c	12.30±0.58 ^c	0.37±0.04 ^{cd}	0.32±0.01 ^c	0.31±0.02 ^d	1.00±0.06 ^c	8.9 ^b
FCD1P1	335±37 ^b	5.35±0.04 ^b	2.48±0.01 ^b	4.18±0.10 ^c	12.01±0.14 ^c	0.34±0.04 ^{cd}	0.32±0.01 ^c	0.33±0.00 ^{abcd}	0.99±0.05 ^c	9.0 ^b
FCD2P1	467±80 ^b	5.30±0.11 ^b	2.41±0.08 ^b	4.11±0.26 ^c	11.81±0.43 ^c	0.35±0.03 ^{cd}	0.31±0.02 ^c	0.33±0.03 ^{abcd}	0.98±0.08 ^c	9.1 ^b
FCD3P1	454±56 ^b	5.46±0.01 ^b	2.43±0.03 ^b	4.12±0.08 ^c	12.01±0.11 ^c	0.33±0.05 ^d	0.30±0.02 ^c	0.33±0.02 ^{abcd}	0.97±0.07 ^c	8.9 ^b
FD1P2	645±72 ^a	5.35±0.12 ^b	2.49±0.08 ^b	4.31±0.09 ^c	12.14±0.30 ^c	0.41±0.05 ^c	0.32±0.02 ^c	0.31±0.02 ^{cd}	1.04±0.08 ^c	9.2 ^b
FCD1P2	738±159 ^a	5.40±0.03 ^b	2.46±0.03 ^b	4.17±0.03 ^c	12.03±0.08 ^c	0.36±0.03 ^{cd}	0.30±0.02 ^c	0.32±0.01 ^{bcd}	0.98±0.06 ^c	8.9 ^b
FCD2P2	740±115 ^a	5.44±0.22 ^b	2.46±0.10 ^b	4.22±0.35 ^c	12.12±0.67 ^c	0.40±0.05 ^{cd}	0.32±0.03 ^c	0.35±0.03 ^{abc}	1.06±0.11 ^c	9.5 ^b
FCD3P2	723±34 ^a	5.49±0.10 ^b	2.45±0.14 ^b	4.19±0.20 ^c	12.12±0.42 ^c	0.37±0.05 ^{cd}	0.31±0.03 ^c	0.34±0.02 ^{abcd}	1.01±0.08 ^c	9.1 ^b

Values are the mean ± standard deviation ($n = 6$ for $D_{3,2}$; $n = 4$ for curcuminoids analysis).

Means with the same superscript (a–d) within the same column do not differ significantly different (Duncan's test, p -value < 0.05).

Drying conditions: D1: 60 °C, 40 % RH; D2: 50 °C, 40 % RH; D3: 80 °C/1h + 50 °C, 40 % RH.

4.2.3.4 Impacts of unit operations on curcuminoid contents and their bioaccessibility

The C, DMC, BDMC and total curcuminoid contents of fresh turmeric were 5.29, 3.50, 4.77 and 13.56 g/100g, respectively on a dry weight basis (**Table 4-2**). Cooking had no significant impact on curcuminoid contents; the average contents of C, DMC, BDMC and total curcuminoid contents of final products were 5.40, 2.46, 4.21 and 12.07 g/100g db respectively. Among all the samples, the freeze-dried had the highest curcuminoid contents. Air drying (≥ 50 °C) decreased DMC, BDMC and total curcuminoid contents while grinding had no impact. At the end, the combination of the distinct unit operations produced final products with the same quality in terms of curcuminoid profiles. The curcuminoids were rather stable during the tested unit operations. Indeed, they are known to resist at high temperatures (above 100 °C) and in acidic conditions; however, they can be degraded by reactions in alkaline conditions and by light (Lee *et al.* 2013). Our previous study (Yin *et al.* 2022) showed that the turmeric starchy matrix could preserve the curcuminoids and essential oil during cooking. Prathapan *et al.* (2009) found no significant differences in curcuminoid content when comparing fresh and heat-treated material (between 50 to 100 °C for 30 min). Heat treatment of turmeric immersed in water produced good-quality turmeric with respect to curcuminoid; cooked turmeric showed higher uniformity or better pigment distribution (Bambirra *et al.* 2002). Llano *et al.* (2022) found no significant differences in the C, DMC and BDMC concentrations between the dried turmeric obtained under different drying conditions (between 50 to 80 °C). The total curcuminoid content of a commercial turmeric powder was assessed and it reached 1.94 g/100g db, a value greatly lower than ours. The differences may be due to different turmeric crop origin, seasonal variation, environmental conditions and the post-harvest process operations (Monton *et al.* 2016).

The bioaccessible C, DMC, BDMC and total curcuminoids of fresh turmeric were 0.87, 0.51, 0.35 and 1.72 g/100g db, respectively which correspond to an average bioaccessibility equal to 12.7 % (**Table 4-2**). Regardless of the treatment applied, cooking had no impact on the average contents of bioaccessible curcuminoids. Only fresh turmeric differs from other products with a higher bioaccessibility of curcuminoids. Drying decreased the contents of C, DMC and total bioaccessible curcuminoids while grinding had no impact. The bioaccessible curcuminoids of the commercial turmeric powder was 0.42 g/100g db, a value greatly lower than ours. The average relative bioaccessibility of curcuminoids in the final products (9.1 %) and in the freeze-dried turmeric (9.2 %) was identical although their particle sizes were very different (ranging from 63 to 711 μm). Our previous results (Yin *et al.* 2022) showed that starch could be completely gelatinized when the sliced turmeric (thickness of 5 mm) was cooked at 95 °C for 3 min. Here, even though starch was gelatinised or not, we observed that the bioaccessibility of the curcuminoids was not significantly different. We also observed that after

drying, the texture of turmeric was hard. Our hypothesis is that the biological fluids from *in vitro* digestion did not diffuse well into the powder particles. As a result, their constituents were less well solubilised in the digestive tract than the ones of fresh turmeric.

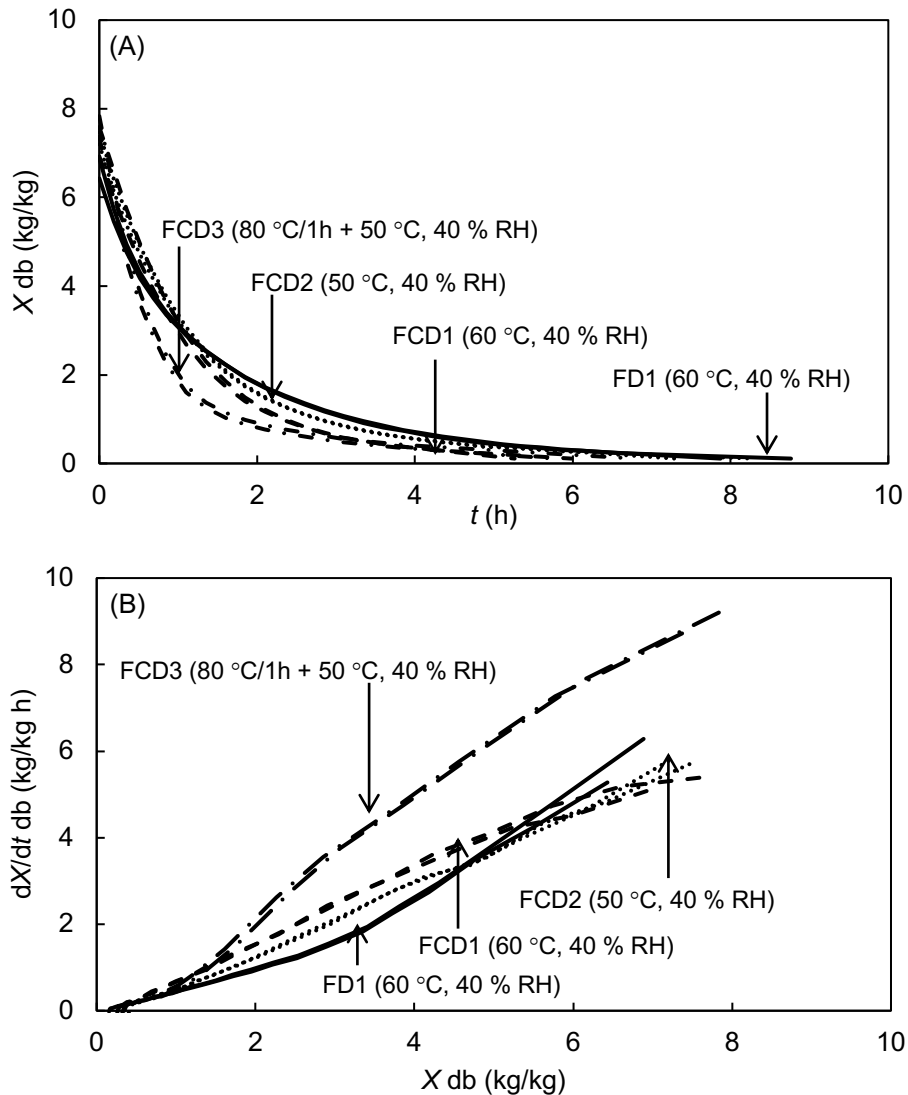

Figure 4-2 Drying curves of fresh and cooked turmeric. (A) water content (X) on a dry basis as a function of time (t) and (B) drying rate (dX/dt) as a function of X . Drying curves recorded by an air dryer at different temperatures with an air velocity at $2.1 \pm 0.1 \text{ m s}^{-1}$. The different dash types on curves correspond to different trials

4.2.3.5 Impacts of unit operations on sensorial quality

Focus group

The participants observed both turmeric powders and turmeric rice samples and made some considerations and reactions as follows:

- Local consumers use turmeric in a fresh form as it is easy to grow and available throughout the year.

- Turmeric is mixed with other spices or herbs to make *Kroeung* for traditional Cambodian foods (*Machu Kroeung, Koriko, Kari...*) to enhance their aroma and colour and to marinate meat by mixing it with other seasonings or spices to boost the flavour of the meat.
- Turmeric is also used in cosmetic products (body lotion and scrap to whiten the skin) and medicine.

Consumer study

The consumer panel was constituted by 73.3 % women, 91.7 % young adults aged between 18 – 35 years old, 65.0 % university students and 91.7 % single. Almost all of them (96.7 %) ate turmeric and mainly in fresh form (76.1 %). About 25.9 % ate turmeric once a week, 24.1 % ate several times a month, 22.4 % ate several times a week and 13.8 % ate once a month and rarely. The results of the consumer acceptance showed that cooking improved colour, texture and overall liking while drying and grinding had no impact. The score of the sensory attributes was 6.2 on a 1 – 9 scale (**Table 4-3**). The samples that looked more like the ones they usually consumed were direct-dried samples (FD1P1: 16.3 % and FD1P2: 14.0 %). Surprisingly, both of them were also the most disliked (FD1P1: 27.1 % and FD1P2: 23.7 %). In contrast, they liked the most the samples that were cooked-dried at 60 °C and 40 % RH (FCD1P2: 19.0 % and FCD1P1: 14.9 %) (**Figure 4-3A**). The reasons for disliking direct-dried samples (FD1P1 and FD1P2) that appear most frequently are the perception of a strong bitterness (25.9 – 33.3 %), strong odour (33.3 – 34.6 %) and dark/brown colour (12.5 – 29.6 %) (**Figure 4-3B**). Approximately 47.5 % of consumers would use this type of dried turmeric for cooking purposes (to enhance colour and odour), followed by 30.3 % for health and 22.2 % for cosmetics. Moreover, about 28.9 % of them preferred to use this dried turmeric in soup or Khmer foods and 24.3 % and 22.5 % preferred to use it to prepare marinade and paste, respectively and 34.7 % of them preferred to eat the turmeric at lunch and dinner (**Figure 4-3C**). Madhusankha *et al.* (2018) reported that once the curcuminoid contents decreased, yellowness and redness also decreased. The curcuminoid contents of our final products were not significantly different, however, the consumers detected a significant difference in colour, texture and overall liking between dried and cooked-dried samples. Heat treatment of the rhizome before dehydration can inactivate oxidative enzymes, avoid unpleasant odours and limit enzymatic browning reactions (Jayashree *et al.* 2018). Boiling comprises the removal of boiled water after cooking so as to reduce the bitterness of some species (Faber *et al.* 2010). These might be reasons why the consumers could detect higher intensity of bitter taste, odour and colour in direct-dried samples. Cooking the turmeric followed by drying at 60 °C and 40 % RH (FCD1) improved the consumer's perception of taste by reducing bitterness, odour and dark colour. Based on these data, four samples (*i.e.*, FD1P1,

FD1P2, FCD1P1 and FCD1P2) were selected for quantitative descriptive analysis to see if trained panellists detected differences in sensory profile.

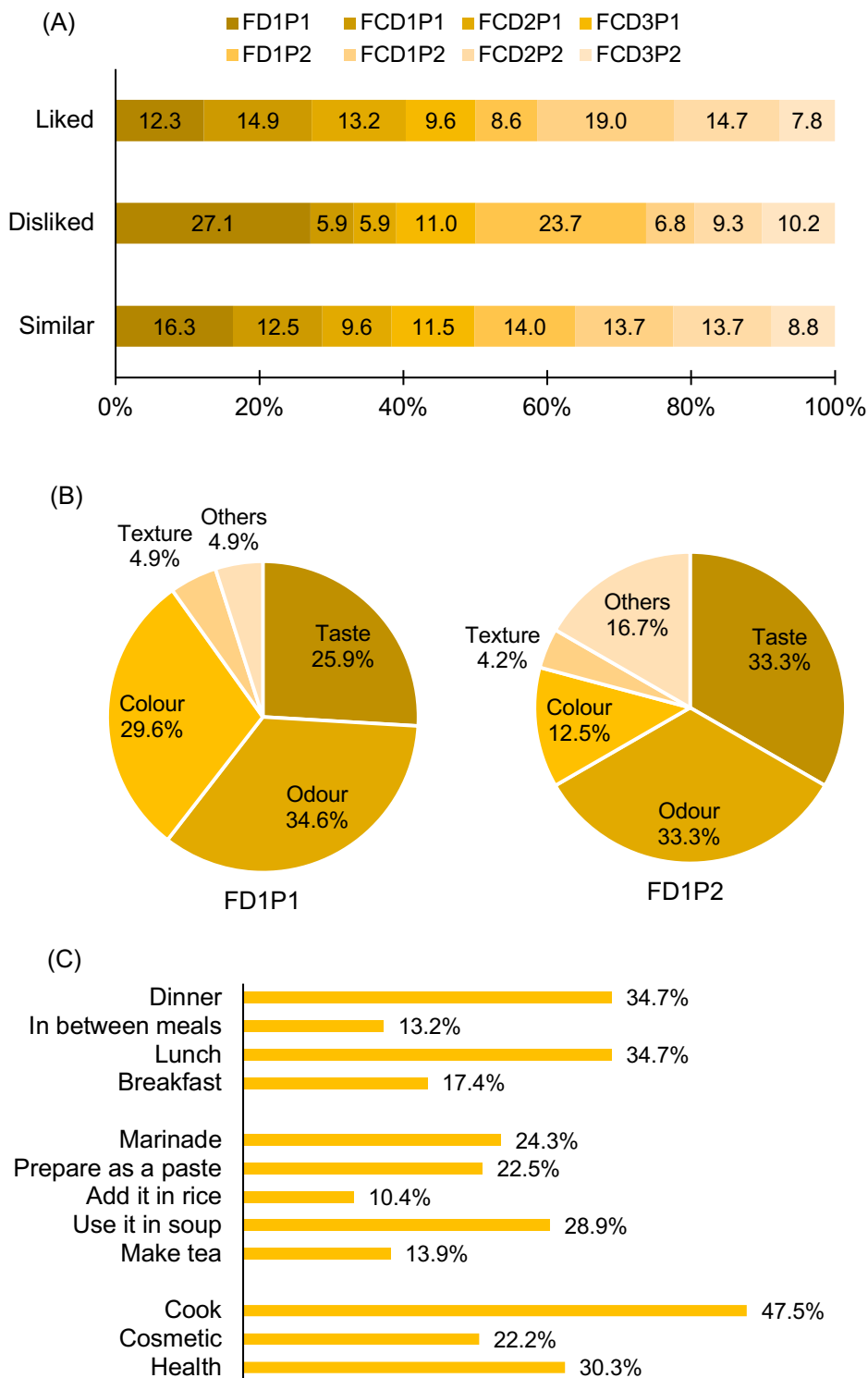

Figure 4-3 The appreciation of consumers on turmeric powder. (A) general appreciation, (B) reasons of dislike and (C) purposes of buy/use, ways of consuming and occasion of consumption. F: fresh; C: cooking (95 °C/3 min); D: drying (D1: 60 °C, 40 % RH; D2: 50 °C, 40 % RH; D3: 80 °C/1h + 50 °C, 40 % RH); P: particle size (P1: <500 µm; P2: <750 µm)

Table 4-3 Impact of processes on consumer preference and descriptive attributes of processed turmeric samples obtained by cooking (C: 95 °C/3 min) or not, drying (D) and grinding with fine (P1) or coarse (P2) particle sizes

Samples	Consumer test 9-point hedonic (<i>n</i> = 120)					Descriptive test (1-10 scales) (<i>n</i> = 12)					
	Colour	Texture	Odour ^{*ns}	Taste ^{*ns}	Overall	Yellow	Dull	Size	Turmeric odour	Bitter	Pungency mouthfeel
FD1P1	5.9±1.6 ^b	5.7±1.8 ^{bc}	6.3±1.7	5.5±1.8	5.8±1.6 ^{ab}	8.0±1.0 ^a	6.2±1.1 ^a	5.8±1.1 ^b	7.4±1.0 ^a	6.0±1.4 ^a	3.0±1.7 ^b
FCD1P1	6.8±1.1 ^a	6.4±1.3 ^a	6.4±1.3	6.0±1.8	6.3±1.4 ^a	6.9±0.8 ^{bc}	4.6±1.2 ^b	5.5±0.6 ^b	6.2±1.1 ^b	4.9±1.1 ^b	4.4±1.2 ^a
FCD2P1	6.9±1.1 ^a	6.6±1.3 ^a	6.6±1.0	6.0±1.8	6.3±1.3 ^a	–	–	–	–	–	–
FCD3P1	6.5±1.2 ^a	6.4±1.3 ^a	6.5±1.3	5.9±1.5	6.2±1.4 ^a	–	–	–	–	–	–
FD1P2	6.0±1.7 ^b	5.4±1.7 ^c	6.1±1.6	5.7±1.9	5.6±1.6 ^b	7.3±1.0 ^b	6.0±1.0 ^a	7.0±1.3 ^a	7.2±1.0 ^a	5.9±1.1 ^a	2.8±1.8 ^b
FCD1P2	6.7±1.3 ^a	6.2±1.5 ^{ab}	6.4±1.3	6.0±1.5	6.3±1.3 ^a	6.7±0.9 ^c	4.7±0.9 ^b	6.9±0.8 ^a	6.4±0.8 ^b	4.8±1.1 ^b	4.3±1.5 ^a
FCD2P2	6.7±1.2 ^a	6.1±1.3 ^{ab}	6.3±1.3	5.8±1.6	6.2±1.3 ^a	–	–	–	–	–	–
FCD3P2	6.6±1.3 ^a	6.0±1.6 ^{ab}	6.3±1.5	5.9±1.5	6.2±1.3 ^a	–	–	–	–	–	–

Means with the same superscript (a–c) within the same column do not differ significantly different (Duncan's test, *p*-value < 0.05). *ns: no significance. Drying conditions: D1: 60 °C, 40 % RH; D2: 50 °C, 40 % RH; D3: 80 °C/1h + 50 °C, 40 % RH.

Descriptive attributes

The results of the descriptive test indicated that cooking decreased yellowness, turmeric odour and bitterness while it increased brightness and pungency mouthfeel; grinding had no impact on all descriptive attributes (**Table 4-3**). However, all the tested unit operations had no impact on earthy odour, aroma (turmeric, earthy, woody, green, minty and floral) and fresh mouthfeel. From consumer acceptance and quantitative descriptive analysis, the overall quality of turmeric powder is linked to low yellowness, turmeric odour, bitterness and high brightness and pungency mouthfeel.

4.2.4 Conclusion

Our findings clearly indicate that cooking saved drying time and improved overall liking with no impact on the essential oil, curcuminoid contents and their bioaccessibility. Drying decreased essential oil, curcuminoid contents and their bioaccessibility while grinding had no impact at all. Although starch was gelatinised or not, the bioaccessibility of the curcuminoids was not significantly different. The combination of the tested unit operations produced identical final products in terms of curcuminoid contents and their bioaccessibility. However, the consumers detected significant differences in colour, texture and overall liking between dried and cooked-dried samples. The overall quality of turmeric powder is correlated to low yellowness, turmeric odour, bitterness and high brightness and pungency mouthfeel. Therefore, it is necessary to process turmeric with a smooth cooking (95 °C/3 min) followed by drying at 60 °C and 40 % RH (FCD1) to reduce drying time and improve consumer liking. This study shows that it is possible to master turmeric processing to preserve bioactive compounds and improve consumer acceptability. The technological conditions identified in this work allow the production of interesting turmeric powders in terms of sensorial and functional qualities for consumers. As Cambodian consumers prefer fresh turmeric, this processing would be more interesting to use for export to the international market, and thus contribute to the improvement of the income of local producers and processors. However, based on the results of our consumer study, it is also worthwhile to introduce turmeric powder in Cambodia as it is interesting for health benefits and cosmetic products (body lotion and scrap to whiten the skin).

4.3 Chapter 4 summary and outlook

Cooking either smooth or drastic had no impact on curcuminoid and essential oil contents and just slightly modified aromatic profile of essential oils (chapter 3). However, we did not know if cooking had any impact on the bioaccessibility of curcuminoids and sensorial quality of turmeric. Moreover, drying significantly impacted on the curcuminoids and essential oil contents.

According to literature, the bioaccessibility of compound of interests are linked to particle size, therefore, we expect particle size to have an impact on sensorial quality.

The impact of cooking (95 °C/3 min), drying (50, 60 or 80 °C; 40 % RH) and grinding (to obtain two powders *i.e.*, fine <500 µm and coarse <750 µm) unit operations and their combinations on essential oil, total and bioaccessible curcuminoid contents (C, DMC, BDMC and total), bioaccessibility of curcuminoids and sensorial quality of *Curcuma longa* L. under controlled conditions were studied. The results revealed that cooking maintained essential oil content, curcuminoid contents and their bioaccessibility. Drying decreased essential oil content (– 22.5 %), curcuminoid contents (– 11.0 %) and their bioaccessibility (– 28.6 %). Contrast to literature concerning micronutrient bioaccessibility, particle sizes (between 63 and 711 µm) had no impact on curcuminoid contents and their bioaccessibility. Curcuminoid bioaccessibility ranged from 9.1 to 12.7 %; the state of starch had no impact on bioaccessibility. The combination of the tested unit operations produced final products with the same quality in terms of total curcuminoid contents (12.1 g/100 g db) and bioaccessible curcuminoids (1.0 g/100 g db). However, the results of the consumer acceptance showed that cooking improved colour, texture and overall liking while drying and grinding had no impact. Furthermore, the consumers disliked the samples that looked more like the ones they usually consumed (direct-dried). In contrast, they liked the most the samples that were cooked-dried. Moreover, the consumers preferred turmeric with low yellowness, turmeric odour, bitterness and high brightness and pungency mouthfeel. Our results proved that smooth cooking (95 °C/3 min) followed by drying (60 °C, 40 % RH) is the most suitable process to produce a curcuminoid-rich powder and improve consumer acceptance.

The main differences of postharvest treatments of turmeric implemented in three different areas in Cambodia were briefly described and discussed. Then, the impact of sourcing (origins and parts of rhizomes *i.e.*, finger and mother) and processes on functional and sensorial quality of turmeric were discussed in detail in the next section. Finally, sustainable processing itineraries for turmeric in Cambodia were proposed (General discussion).

General Discussion

5. General Discussion

The objective of this thesis work was to describe postharvest treatments of turmeric (*Curcuma longa* L.) in Cambodia by using 5M methodology and their impact on turmeric's quality and to study, under controlled conditions, the impact of the combination of unit operations: cooking, drying and grinding on sensorial and functional quality of *Curcuma longa* L.

The research questions of this study were:

- Q1. What are the turmeric transformation processes implemented in Cambodia?
- Q2. What quality characteristics of turmeric are affected by the processes, how and in which proportion?

Thanks to the outputs of this work and the results obtained, we are able to propose optimized processes to enhance the quality of turmeric powder in Cambodia. In the following paragraphs, the main results that attempt to answer the research questions and explain the mechanisms involved in degradation or preservation of the sensorial and functional quality of turmeric during process were discussed.

5.1 Processes implemented in Cambodia

A field study was conducted in Cambodia aiming to study postharvest treatments of turmeric (*Curcuma longa* L.) in Cambodia and the impacts of sourcing (*i.e.*, origins of the raw material and parts of rhizomes: finger and mother) and processes (*i.e.*, the full processes and the unit operations of peeling and cooking) on turmeric's quality. The three different turmeric processes implemented in three different areas in Cambodia (Siem Reap, Phnom Penh and Kampot) were observed, described and compared in order to answer to our first research question. The 5M methodology – a wisely utilized tool in developing hazard analysis critical control point (HACCP) systems – was used to describe each step of the three turmeric production systems accurately and profoundly through five dimensions: material (turmeric), machines (equipment tools), mother nature (environment, conditions), methods and men (persons, staff). The results indicate that the main difference(s) among the three different processes, corresponding to three different areas in Cambodia, were: (i) cooking before drying (case study 1: Siem Reap); (ii) slicing before drying (case study 2: Phnom Penh); (iii) cooking and slicing before drying (case study 3: Kampot). The requirement of man-powers to process turmeric in the three companies were: 10 person/100 kg/day, 4 person/200 kg/day and 13 person/200 kg/day for case studies 1, 2 and 3, respectively. After automatic peeling, the peeled rhizomes were re-peeled manually using knives to make sure that all the peel was completely removed (case study 1). It is not worthwhile to include this step in the process as it is not only a time-consuming (required 5 h and 10 people to completely peeling) and low-yield process (relative loss of 4.5 %), but it also impacts on quality as browning on the peeled rhizomes was observed. The results contradict the claims of Bambirra *et al.* (2002) that

removal of the peel caused yield loss up to 30 %. The colour deteriorates as a result of overcooking, but that the rhizome became hard when undercooked. The Indian Institute of Spice Research and the Agricultural Technology Information Centre recommend boiling whole turmeric in water for 45 min to 1 hour, until froth appears at the surface and the typical turmeric aroma is released, cited by Ararsa (2018). Though, in Cambodia, the peeled turmeric rhizomes were cleaned (with brine, tap water and treated waters *i.e.*, UV and Ozone) or cooked in boiling water for 30 to 40 min to remove impurities (dust and foreign matter) and to reduce the microbial load. Prior to drying, the cleaned or cooked turmeric (direct drying for case study 1) were sliced by using a slicing machine to a thickness of 1 – 2 mm (case study 2) and 3 mm (case study 3), respectively. By using the solar dryer, the drying time decreases (about 50 %) when the slicing is included in the process (case study 3). Furthermore, drying the sliced turmeric in a room (with iron roof and fans to speed up the drying process) and then drying in oven (case study 2) also reduce the drying time but it is more energy consuming as comparing to the solar-drying. Additionally, this technique is a bit complicated as the semi-dried turmeric chips were sieved manually to separate between small and big turmeric chips. The small turmeric chips were collected but the big ones were transferred to oven dryer to continue the drying process.

We observed that in all case studies, there were no specific temperatures and times for the drying process that was dependent on the weather *i.e.*, the temperatures reached during the day and night time. In addition, the processors checked if the turmeric were completely dried and would be stopped the drying process by visual observation and by evaluating with their hands if they were crispy or easy to crack. This leads the quality of final products (turmeric powders) varies from one batch to another.

The data suggests that the process in Kampot (thanks to cooking and slicing operations) had the shortest drying time (*i.e.*, between 24 to 45 h dependent on weather) and got the highest yield (16.2 %), with the water content (about 6 %) conforming with the specifications of the ISO standard 5562:1983 (International Organization for Standardization 1983). The results of this “ideal” process was in agreement with Pradeep *et al.* (2016) who found that the dried product yield of 17.1 – 20.6 % was comparable between different dryers (*i.e.*, mechanical drying, black surface coupled with sun drying and normal sun drying). However, Bambirra *et al.* (2002) found the yield of turmeric powders were just between 9.8 to 14.5 % with moisture varying from 8.8 to 9.9 %. Sasikumar (2012) reported that the solar drying is better than direct sun drying as it achieves the desired moisture content and essential quality in 42 hours (6 days) compared to 56 hours (8 days) in sun drying, thus saving considerable time (14 hours). The main difference between Cambodian and Indian turmeric processes are slicing, peeling, and polishing unit operations. In India, the turmeric processing is not included peeling before cooking and drying but polishing is applied after drying (Sasikumar 2012). In

Cambodia, the turmeric rhizomes are sliced after cleaning (case study 2) or cooking (case study 1) but slicing is not included in turmeric processing in India (Sasikumar 2012).

5.2 Impact of sourcing (origin and part of rhizomes) on sensorial quality

About 20 to 25 *Curcuma* species are native from Cambodia, Vietnam and Laos (Ravindran *et al.* 2007). Currently, at least 13 turmeric varieties (most of them are wild varieties) have been discovered in Kulen mountain located in Siem Reap province of Cambodia, in which, yellow turmeric (*Curcuma longa* L.) is the most used. Our quality analysis of the samples from the field study revealed that the turmeric rhizomes from different sourcing (origins and parts of rhizomes *i.e.*, finger and mother) were different in colour, shape and size. The length of the fingers is between 3.0 to 10.5 cm and their diameters ranged from 1.1 to 2.4 cm. Mothers, ovate in shape, were of shorter length (from 2.5 to 9.5 cm) and had a larger diameter (from 2.5 to 4.7 cm) than the fingers. This can be explained by the fact that species, age/maturity of the rhizome, soil, climate, and growing technics affect the phenotype.

The major compounds of essential oil in our fresh turmeric were sesquiterpenes *i.e.*, turmerone (37.9 %), α R-turmerone (16.8 %) and β -turmerone (16.1 %). These turmerones have similar chemical structures, physical properties and molecule weights, although they have different tastes (Kao *et al.* 2007) and they are believed to be an intermediate for the formation of zingiberene and sesquiphellandrene (Asghari *et al.* 2009). α -terpinolene (8.1 %), β -sesquiphellandrene (4.0 %), α -zingiberene (3.7 %), α -phellandrene (1.9 %), caryophyllene (1.6 %), α -curcumene (1.3 %) and eucalyptol (0.7 %) are also identified. These ten major compounds represent 92.1 % of the total compounds in essential oil. The essential oil (aroma) is more affected by sourcing (origins and parts of rhizomes *i.e.*, finger and mother) than the curcuminoids (colour). The essential oil content of the turmeric rhizomes (both finger and mother) and curcuminoid content (mother only) from different origins were different. Moreover, these compounds also differ according to the rhizome parts (*i.e.*, finger and mother). The essential oil content of fresh mother rhizomes was 48 – 59 % higher than the fresh finger rhizomes while the curcuminoid content of fresh mother rhizomes was 15 % higher than the fresh finger rhizome. Choudhury *et al.* (2017) also found that the curcumin content of fresh mother rhizomes was 15 – 38 % higher than the fresh finger rhizomes as the phytochemical constituents are not evenly distributed in all plant parts.

Sensorial quality is the main reason for people (not only in Cambodia but also everywhere in fact) to consume turmeric (*i.e.*, mainly to enhance aroma and colour). Pharmacologists have been trying to find the better way to consume turmeric in order to get high and positive impact on its functional quality. Thus, when people want functional effect, they consume turmeric in other forms: functional foods, supplements and concentrated forms. The consumer survey of 120-people in Cambodia showed that almost all of them (96.7 %) consume turmeric and

mainly in fresh form (76.1 %). However, it is also advisable to introduce turmeric powder in Cambodia as it is interesting for health benefits and cosmetic products (body lotion and scrap to whiten the skin). Cambodian consumers prefer fresh turmeric because it is easy to grow and available throughout the year. About 47.5 % of them would use turmeric powder for cooking purposes (to enhance colour and odour), followed by 30.3 % for health and 22.2 % for cosmetic purposes.

5.3 Impact of process on sensorial quality

Due to the different particle sizes of fresh and ground turmeric, unhomogenized dried samples (not well represent the whole rhizome), the large difference in drying time and uncontrollable drying conditions (as solar dryer depends on the weather), we could not find general rule for the impact of processes on essential oil and curcuminoids. However, the results obtained from observation and quality analysis of samples from field survey in Cambodia allowed us to preliminary conclude that cooking and slicing are essential unit operations to be applied in turmeric process because they reduce the drying time, save energy consumption and preserve turmeric quality. Therefore, two studies, under controlled conditions, were carried out to answer to our second research question. The impacts of combination of unit operations: cooking (95 °C for 3 or 60 min), drying (50, 60 or 80 °C; 40 % RH) and grinding (to obtain two powders of different particle sizes: fine <500 µm and coarse <750 µm) on sensorial and functional quality of *Curcuma longa* L. were studied. The sensorial quality parameters considered in these studies were particle sizes, colour values (L*, a* and b*), curcuminoid contents (C, DMC and BDMC), essential oil content and its aroma compounds. In overall, the results of physicochemical analysis revealed that cooking, drying and grinding unit operations and their combinations had little impact (no impact at all in some cases) on these parameters. Hence, consumer acceptance and descriptive attribute tests were conducted by 120 untrained panellists at ITC (Cambodia) and 12 trained panellists at CIRAD (France), respectively for better understanding. This thesis took place during the period of the Covid-19 crisis, which disrupted the planned mobility between France and Cambodia and also limited access to the laboratory during confinements – consumer acceptance test was conducted prior to descriptive test.

The data demonstrates that different unit operations, especially drying and drastic cooking (95 °C/60 min), decreased colour values (yellowness, b*) more than smooth cooking (95 °C/3 min). Moreover, among the tested unit operations (*i.e.*, cooking, drying and grinding), drying unit operation significantly impacted on essential oil and curcuminoid contents as well as the consumer acceptability. **Cooking** (either smooth or drastic) preserved the contents of essential oil and curcuminoids, reduced drying time and just slightly modified aromatic profile of essential oils. It is well known that curcuminoids are oil-soluble pigments, practically insoluble in water at acidic and neutral pH and they are known to resist at high temperatures

(above 100 °C) (Lee *et al.* 2013). Furthermore, microscopic observations confirmed that cooking for 3 min at 95 °C was enough to completely gelatinize the starch. The amyloplasts were visible in fresh turmeric but they were no longer visible in cooked turmeric. In addition, cooking combined with drying caused the partial exit (dispersion) of the curcuminoids from their dedicated cells; curcuminoids were then found through the whole rhizome and seem to be partly absorbed on the starch cells. It seems this starchy matrix could protect curcuminoids. The degradation of the cell walls allowing curcuminoids exited could also explain the easier water removal when turmeric was cooked prior to drying. Cooking at 95 °C for 3 min and for 60 min saved drying time up to 38.1 % and 49.8 %, respectively. These results were in agreement with Govindarajan and Stahl (1980) who found that when turmeric rhizomes are cooked, the starch granules gelatinize which facilitates drying and increases the rate of dehydration; as a result, the total drying time is reduced. Here, we recommend cooking sliced turmeric (thickness of 5 mm) at 95 °C for 3 min (smooth cooking) before drying (60 °C, 40 % RH) although the drying time was saved less than cooking at 95 °C for 60 min (drastic cooking) because it impacts the colour values less than drastic cooking.

Drying decreased essential oil up to 22.5 % and curcuminoid contents up to 11.0 %. The method of drying usually has a significant effect on essential oil content (Kutti Gounder and Lingamallu 2012). Ararsa (2018) also found a loss of essential oil up to 25 % by evaporation and destruction of some light-sensitive oil constituents. The essential oil is present in the specific cells and ducts present in the meristematic region of the rhizome. These oleaginous cells are damaged during the cooking of the rhizome and the exposure of the essential oil to the atmosphere induces a loss by volatilization during drying (Díaz-Maroto *et al.* 2002). The essential oil and curcuminoid contents are quite stable during the tested unit operations. The essential oil contents of freeze-dried and hot air-dried (between 50 to 80 °C, 40 % RH) turmeric were not significantly different ($p < 0.05$), the average value was 10.30 mL/100g db, although their particle sizes (between 63 and 711 µm) were much different. The freeze-dried turmeric (14.44 g/100 g db) had 19.6 % higher in curcuminoid contents than hot air-dried turmeric (in average of 12.07 g/100 g db).

Particle sizes of turmeric powders (between 425 and 711 µm) obtaining by different drying conditions, but with same final water content ($0.11 \pm 0.01 \text{ kg} \cdot \text{kg}^{-1} \text{ db}$) had no impact on curcuminoid contents. This may be due the fact that our sliced-dried turmeric were ground under the fixed temperature (10 °C) and same conditions (at 10 000 rpm for 10 s) by using an ultra-centrifugal mill attached with two different sieves (500 µm and 750 µm) in order to produce two different particle size powders (P1: <500 µm; P2: <750 µm). The same trend was observed for the essential oil content, there was no significant difference between freeze-dried and hot air-dried (between 50 to 80 °C, 40 % RH) turmeric. In our study, the hot-air dried turmeric were frozen by using liquid nitrogen and then ground for 10 s at 10 000 rpm in a mill

for analyses of essential oil content. Here, it means an increase of temperature during grinding was not occurred in our case. It may be a reason why we got identical products even though the turmeric were dried at different temperatures (between 50 to 80 °C, 40 % RH) and had different particle sizes. Cryogenic milling under liquid nitrogen prevents oxidation and volatile loss; it widely spreads in the industry but it is an expensive unit operation (Ararsa 2018; Sasikumar 2012). Sasikumar (2012) stated that in the ambient grinding process, the temperature of the powder raises to as high as 90 – 95 °C resulting in losses of essential oils, aroma, and colour leading to the deterioration of its quality. The quality analysis of the samples from our field study illustrates that the particle sizes of mother rhizomes were significantly larger than those of finger rhizomes even though they were ground under same conditions (same time and same grinder). This may be due to the fact that the texture and the size of dried mother rhizomes were harder and larger than those of finger rhizomes (based on observation). This clearly showed in case of our freeze-dried sample, it was ground by the same conditions (same sieve, same time and same grinder) as our air-dried samples, but it obtained smaller particle size (63 µm) (due to the difference in texture).

Combination of the tested unit operations (direct dried at 60 °C or pre-cooked at 95 °C for 3 or 60 min prior to drying at temperatures between 50 to 80 °C with 40 % RH) produced final products with the same quality in terms of essential oil and curcuminoid contents. Curcuminoids were stable during cooking (no impact) and drying (no important loss) may due to the interaction between starch and curcuminoids – starchy matrix protects curcuminoids. These results were in agreement with Llano *et al.* (2022) who found no significant differences in curcuminoids between the turmeric powders obtained under different drying conditions (between 50 to 80 °C). Jayashree and Zachariah (2016) reported that there were no significant differences for essential oil content once the duration of cooking in boiling water increased up to 60 min. Prathapan *et al.* (2009) found no significant differences in curcuminoid content when comparing fresh and heat-treated material (between 50 to 100 °C for 30 min). However, if we calculated the percentage changes (from fresh to ground turmeric), the greatest differences in curcuminoid content were observed between samples “fresh” and “direct-dried” with a reduction of 30 % (approximately). These results were in agreement with Suresh *et al.* (2007) who stated that curcumin loss from heat processing of turmeric was in the range of 27 – 53 %, with maximum loss in pressure cooking (at high temperature) for 10 min. However, Choudhury *et al.* (2017) reported that processing of fresh rhizomes (mother and finger) to yield dry powders resulted in a significant reduction of curcumin just only between 2.0 to 8.0 %. An appropriate treatment (not too high nor not too low) to dry the turmeric plays an essential role in preserving curcuminoids in the turmeric (Hirun *et al.* 2014). Bambirra *et al.* (2002) found that the ground turmeric obtained without heat treatment had worst quality respect to

curcuminoid pigments and good quality of ground turmeric was obtained by cooking in plain water as cooking favours diffusion of pigments from cells to adjacent tissue, contributing to a better pigment homogenization.

The results of the **consumer acceptance** test revealed that cooking improved the consumer's perception of taste by reducing bitterness, odour and dark colour leading to increase the overall liking while drying and grinding had no impact. Additionally, the consumers disliked the samples that looked more like the ones they usually consumed (direct-dried at 60 °C). They disliked the direct-dried samples because of their strong bitterness (25.9 – 33.3 %), strong odour (33.3 – 34.6 %) and dark/brown colour (12.5 – 29.6 %). In contrast, they liked the most the samples that were cooked at 95 °C/3 min and then dried at 60 °C. Although the curcuminoid contents of our final products were not significantly different, the consumers detected a significant difference in colour, texture and overall liking between direct-dried and cooked-dried samples. Heat treatment of the rhizome before dehydration can inactivate oxidative enzymes, avoid unpleasant odours and limit enzymatic browning reactions (Jayashree *et al.* 2018). Boiling comprises the removal of boiled water after cooking so as to reduce the bitterness of some species (Faber *et al.* 2010). These might be reasons why the consumers could detect higher intensity of bitter taste, odour and colour in direct-dried samples. According to these finding, the direct-dried and cooked (95 °C/3 min) before dried at 60 °C and 40 % RH were selected for quantitative descriptive analysis to see if trained panellists detected differences in sensory profile. The results of **consumer acceptance** and **descriptive tests** revealed that consumers preferred turmeric with low yellowness, turmeric odour, bitterness and high brightness and pungency mouthfeel. Our results proved that smooth cooking (95 °C/3 min) followed by drying (60 °C, 40 % RH) is the optimum process to produce a curcuminoid-rich powder and improve consumer acceptance.

5.4 Impact of sourcing (origin and part of rhizomes) on functional quality

The results obtained from quality analysis of samples from field survey in Cambodia revealed that different origins of the turmeric rhizomes (both finger and mother) provided different bioaccessible curcuminoid contents. The bioaccessibility of curcuminoids of fresh finger rhizomes ranged from 7.0 % to 13.6 % while that of fresh mother rhizomes ranged from 9.5 % to 16.8 %. Furthermore, no general rule was observed for the contents of bioaccessible curcuminoids and their bioaccessibility in different parts of fresh rhizomes (*i.e.*, finger and mother). While curcuminoid contents of fresh turmeric from Siem Reap were higher than those of turmeric from case study 2 (Phnom Penh), the bioaccessible curcuminoid contents and their bioaccessibility were not that high.

5.5 Impact of process on functional quality

Globally, in powders, the bioaccessibility of curcuminoids significantly decreased (22.2 - 29.0 % for finger, 22.3 - 32.3 % for mother and 18.1 - 27.9 % for mixture of finger and mother). The bioaccessibility of curcuminoids in turmeric powders from three distinct case studies ranged from 8.3 ± 0.6 % to 11.4 ± 0.1 %. The result of quality analysis of the samples collected from field study in Cambodia showed that **cooking** also had no impact on bioaccessible curcuminoids and their bioaccessibility even though the whole rhizomes were cooked in boiling water for 30 to 40 min. This result was confirmed in our study under controlled conditions. **Drying** decreased the contents of bioaccessible curcuminoids and their bioaccessibility (27 % for freeze-dried and 29 % for hot air-dried powders) while **grinding** (different particle sizes) had no impact. The average bioaccessibility of curcuminoids in the final products (average value: 9.1 %) and in the freeze-dried turmeric (9.2 %) was identical although their particle sizes were very different (between 63 to 711 μm). The bioaccessible curcuminoids of turmeric powder and their bioaccessibility found by Papillo *et al.* (2019) (1.68 ± 0.12 g/100g db) and Park *et al.* (2018) (17 ± 4.1 %) were much higher than those found in our samples. Although starch was gelatinised or not, the bioaccessibility of the curcuminoids was not significantly different. Moreover, after drying, the texture of turmeric was hard. Our hypothesis is that the biological fluids from *in vitro* digestion did not diffuse well into the powder particles. As a result, their constituents were less well solubilised in the digestive tract than the ones of fresh turmeric. As curcuminoids are lipophilic and poorly soluble in water, acid and neutral solutions, these characteristics give them a low bioaccessibility during digestion. Furthermore, they are poorly absorbed from the intestine by enterocyte cells, metabolised rapidly and intensively, and eliminated systemically (Wang *et al.* 2008). The absorption of curcuminoids from turmeric depends on coating (Papillo *et al.* 2019) and structuring (Park *et al.* 2018) which modulate their stability, solubility in the digestive tract and absorption into the systemic circulation.

5.6 Proposal of sustainable processing itineraries for turmeric in Cambodia

The results of our studies, under controlled conditions, revealed that the optimum operating conditions to be implemented are cooking the sliced rhizome (thickness of 5 mm) at 95 °C for 3 min (enough for starch gelatinisation) and drying (in a hot air dryer) at 60 °C, 40 % RH under non-limiting conditions until obtaining 10 % of dry matter. However, the results of quality analysis of the samples from our field study in Cambodia indicated that the process implemented in Kampot (thanks to cooking and slicing operations) had the shortest drying time (*i.e.*, between 24 to 45 h dependent on weather) and got the highest yield (16.2 %), with the water content about 6 % – compared to other two processes (*i.e.*, Siem Reap and Phnom Penh). The relative loss of essential oil content in our process (22.5 %) was higher than that

in Kampot (9.4 %). However, the relative loss of curcuminoid contents in our process (11.0 %) was lower than that in Kampot (between 12.7 to 17.3 %) while a decrease in bioaccessibility of curcuminoids in turmeric powders from our process (- 28.6 %) and from Kampot (between 18.1 to 27.9 %) were not different. Our process (hot air dryer) is better than the process implemented in Kampot as it achieves the desired water content (about 10 %) in 6 hours compared to 24 – 45 hours in Kampot (solar dryer, the water content about 6 %), thus saving considerable time (between 18 – 39 hours). There is a potential saving to be made by all the companies on drying. Indeed, they could dry less, obtain better yield, and still comply with the specifications of the ISO standard 5562:1983 (International Organization for Standardization 1983) (water content <10 % w/w). Moreover, the cooking time in our process (3 min) was also shorter than in Kampot (between 30 to 40 min).

The scientific and technical knowledge acquired from this study is a basis to improve the turmeric processes (concerning Cambodia). Cooking has many advantages: it reduces the microbial load of the rhizomes, removes the raw odour (unfavourable odour), gelatinizes the starch, provides uniform distribution of pigments, improves drying efficiency and limits browning, particularly enzymatic (Sasikumar 2012). Drying, although it negatively impacts the essential oil content, curcuminoid contents and their bioaccessibility, is essential to stabilize the turmeric from microorganisms. The relative loss of curcuminoids in turmeric powders by freeze-drying process was about 20 % lower than that by hot air-drying processes (between 50 °C to 80 °C with 40 % RH) but both processes produced products with the same quality in term of essential oil contents and bioaccessibility of curcuminoids of turmeric powders. Freeze-drying process produces better products compared to hot air-drying process but it is an expensive process. Apart from cooking, another unit operation – slicing – is important and useful to accelerate the drying time, save energy consumption and preserve turmeric quality. Regarding drying, a hot air dryer has allowed us to obtain good results and has the advantage of being able to be controlled automatically and finely. Solar drying in a ventilated space would probably give good results. This remains to be validated and has the disadvantage of being dependent on the climate.

Conclusion and Prospects

Conclusion and Prospects

This research aimed to describe postharvest treatments of turmeric (*Curcuma longa* L.) in Cambodia and their impact on turmeric's quality and to study, under controlled conditions, the impact of processes and unit operations on turmeric's quality. The bibliographic analysis demonstrated that turmeric and its transformation are well described in the literature. Nevertheless, most of the existing works come from Indian research teams and mainly focus on the impact of the full process, not on the combination of unit operations on sensorial and functional quality. To our knowledge, before the start of this thesis, no work had been published on the turmeric processing practices in Cambodia. Our ambition was to provide suggestions on the choice of raw material (considering notably curcuminoids and essential oil contents) and the unit operations (cooking, drying and grinding) to implement, in order to obtain the best turmeric quality. Based on the results obtained, we are able to propose revisited transformation processes to enhance the quality of turmeric.

The central questions for this research were as follow:

1. What are the turmeric transformation processes implemented in Cambodia?
2. What quality characteristics of turmeric are affected by the processes, how and in which proportion?

This research clearly demonstrates that the fresh turmeric from Siem Reap contained higher essential oil and equalled curcuminoid contents compared to the turmeric from case study 2 (Phnom Penh). The postharvest treatments in Kampot had the shortest drying time (*i.e.*, between 24 to 45 h depending on weather) and resulted in the highest yield (16.2 %), with a water content (about 6 %) conforming with the specifications of the ISO standard 5562:1983 (International Organization for Standardization 1983). Cooking not only had no negative impact on essential oil content, curcuminoid contents and their bioaccessibility (just slightly modified aromatic profile of essential oil) but also saved drying time. Drying decreased essential oil content (– 22.5 %), curcuminoid contents (– 11.0 %) and their bioaccessibility (– 28.6 %). In contradiction with literature concerning micronutrient bioaccessibility, particle sizes (between 63 and 711 μm) after grinding had no impact on curcuminoid contents and their bioaccessibility. The combination of the tested unit operations produced final products with the same quality in terms of total curcuminoid contents (mean value: 12.1 g/100 g db) and bioaccessible curcuminoids (mean value: 1.0 g/100 g db). However, consumers detected differences in colour, texture and overall liking between processed turmeric powders (dried and cooked-dried). The best thermal processing was to air-dry the sliced-cooked turmeric (5 mm; 95 °C for 3 min) at a standard temperature (60 °C, 40 % RH) to produce a curcuminoid-rich powder and improve consumer acceptance.

Although most of Cambodian users consume fresh turmeric as it is easy to grow and available throughout the year, it is still useful to introduce turmeric powder in Cambodia because at least 47.5 % of them (based on the consumer survey of 120-people in Cambodia) would use turmeric powder for cooking purposes (to enhance colour and odour), followed by 30.3 % for health and 22.2 % for cosmetic purposes. This study contributes to better understand the turmeric transformation processes and assist to determine which origin of turmeric and postharvest treatment should be privileged to save drying time and get the highest essential oil and curcuminoid contents. Furthermore, the technological conditions identified in this work allow the production of interesting turmeric powders in terms of sensorial and functional quality for consumers. However, this work needs to be complemented by storage (impact of duration, temperature, humidity and light) and packaging studies to find the best conditions to be used by local operators. Future studies should also consider the impact of unit operations and their combinations on sanitary quality of turmeric. Moreover, a study using a liquid model (with various starch concentrations) to understand the role of the starchy matrix in curcuminoids protection during process would also be interesting to implement.

References

References

- Ararsa, Biruk Hirko. 2018. "Effect of Processing Methods on Quality of Turmeric (*Curcuma Longa* L.) Finger Rhizome Grown in Teppi, Sheka Zone, Ethiopia." Haramaya University, Haramaya.
- Asghari, G., A. Mostajeran, and M. Shebli. 2009. "Curcuminoid and Essential Oil Components of Turmeric at Different Stages of Growth Cultivated in Iran." *Research in Pharmaceutical Sciences* 4(1):55–61.
- Avanço, Geleys Brado, Flavio Dias Ferreira, Natália Silva Bomfim, Paula Andréia de Souza Rodrigues dos Santos, Rosane Marina Peralta, Tatiane Brugnari, Carlos Augusto Mallmann, Benício Alves de Abreu Filho, Jane Martha Graton Mikcha, and Miguel Machinski Jr. 2017. "Curcuma Longa L. Essential Oil Composition, Antioxidant Effect, and Effect on *Fusarium Verticillioides* and Fumonisin Production." *Food Control* 73:806–13. doi: 10.1016/j.foodcont.2016.09.032.
- Bambirra, Maria Lúcia A., Roberto G. Junqueira, and Maria Beatriz A. Glória. 2002. "Influence of Post Harvest Processing Conditions on Yield and Quality of Ground Turmeric (*Curcuma Longa* L.)." *Brazilian Archives Biology and Technology* 45(4):423–29. doi: <https://doi.org/10.1590/S1516-89132002000600004>.
- Blasco, M., J. V. García-Pérez, J. Bon, J. E. Carreres, and A. Mulet. 2006. "Effect of Blanching and Air Flow Rate on Turmeric Drying." *Food Science and Technology International* 12(4):315–23. doi: 10.1177/1082013206067352.
- Bureau of Indian Standards. 2010. *Indian Standard IS 3576 (2010): Spices and Condiments - Turmeric, Whole and Ground*. India: Bureau of Indian Standards.
- Calligaris, Sonia, Marilisa Alongi, Paolo Lucci, and Monica Anese. 2020. "Effect of Different Oleogelators on Lipolysis and Curcuminoid Bioaccessibility upon in Vitro Digestion of Sunflower Oil Oleogels." *Food Chemistry* 314:126146. doi: 10.1016/j.foodchem.2019.126146.
- Chen, Lingli, Guangling Bai, Senpei Yang, Rui Yang, Guanghua Zhao, Chuanshan Xu, and Wingnang Leung. 2014. "Encapsulation of Curcumin in Recombinant Human H-Chain Ferritin Increases Its Water-Solubility and Stability." *Food Research International*. doi: 10.1016/j.foodres.2014.05.054.
- Choudhury, B. U., A. Nath, S. Hazarika, M. A. Ansari, J. Buragohain, and D. Mishra. 2017. "Effects of Pre-Harvest Soil Management Practices and Post-Harvest Processing on Phytochemical Qualities of Turmeric (*Curcuma Longa*)." *Indian Journal of Agricultural Sciences* 87(8):1002–7.
- Das, Kuntal. 2016. "Turmeric (*Curcuma Longa*) Oils." Pp. 835–41 in *Essential Oils in Food Preservation, Flavor and Safety*. Elsevier.
- David, R., and J. P. Carde. 1964. "Coloration Différentielle Dès Inclusions Lipidique et Terpeniques Dès Pseudophylles Du Pin Maritime Au Moyen Du Reactif Nadi." *Comptes Rendus de l'Academie Des Sciences Paris* 258:1338–40.
- Díaz-Maroto, M. Consuelo, M. Soledad Pérez-Coello, and M. Dolores Cabezudo. 2002. "Effect of Drying Method on the Volatiles in Bay Leaf (*Laurus Nobilis* L.)." *Journal of Agricultural and Food Chemistry* 50(16):4520–24. doi: 10.1021/jf011573d.

- El-Sayed, Samah M., and Ahmed M. Youssef. 2019. "Potential Application of Herbs and Spices and Their Effects in Functional Dairy Products." *Heliyon* 5(6):e01989.
- Faber, M., A. Oelofse, Pj Van Jaarsveld, Fam Wenhold, and Ws Jansen van Rensburg. 2010. "African Leafy Vegetables Consumed by Households in the Limpopo and KwaZulu-Natal Provinces in South Africa." *South African Journal of Clinical Nutrition* 23(1):30–38. doi: 10.1080/16070658.2010.11734255.
- Fadus, Matthew C., Cecilia Lau, Jai Bikhchandani, and Henry T. Lynch. 2017. "Curcumin: An Age-Old Anti-Inflammatory and Anti-Neoplastic Agent." *Journal of Traditional and Complementary Medicine* 7(3):339–46. doi: 10.1016/j.jtcme.2016.08.002.
- Gagare, Santosh, V. D. Mudgal, P. S. Champawat, and Amit Pisal. 2015. "Standardization of Curing and Microwave Drying of Turmeric (*Curcuma Longa*) Rhizomes." *International Journal of Food Engineering* 11(2):295–300. doi: 10.1515/ijfe-2014-0155.
- Garg, S. N., R. P. Bansal, M. M. Gupta, and Sushil Kumar. 1999. "Variation in the Rhizome Essential Oil and Curcumin Contents and Oil Quality in the Land Races of Turmeric *Curcuma Longa* of North Indian Plains." *Flavour and Fragrance Journal* 14:315–18.
- Goel, Ajay, Ajaikumar B. Kunnumakkara, and Bharat B. Aggarwal. 2008. "Curcumin as 'Curecumin': From Kitchen to Clinic." *Biochemical Pharmacology* 75(4):787–809. doi: 10.1016/j.bcp.2007.08.016.
- Gómez-Estaca, Joaquín, Rafael Gavara, and Pilar Hernández-Muñoz. 2015. "Encapsulation of Curcumin in Electrospayed Gelatin Microspheres Enhances Its Bioaccessibility and Widens Its Uses in Food Applications." *Innovative Food Science & Emerging Technologies* 29:302–7. doi: 10.1016/j.ifset.2015.03.004.
- Govindarajan, V. S., and William H. Stahl. 1980. "Turmeric — Chemistry, Technology, and Quality." *C R C Critical Reviews in Food Science and Nutrition* 12(3):199–301. doi: 10.1080/10408398009527278.
- de la Hera, Esther, Manuel Gomez, and Cristina M. Rosell. 2013. "Particle Size Distribution of Rice Flour Affecting the Starch Enzymatic Hydrolysis and Hydration Properties." *Carbohydrate Polymers* 98(1):421–27. doi: 10.1016/j.carbpol.2013.06.002.
- Hewlings, Susan, and Douglas Kalman. 2017. "Curcumin: A Review of Its Effects on Human Health." *Foods* 6(10):92. doi: 10.3390/foods6100092.
- Hirun, Sathira, Niramom Utama-ang, and Paul D. Roach. 2014. "Turmeric (*Curcuma Longa* L.) Drying: An Optimization Approach Using Microwave-Vacuum Drying." *Journal of Food Science and Technology* 51(9):2127–33. doi: 10.1007/s13197-012-0709-9.
- Internal report of HEIP-ITC-SGA#08. 2022. *13 Types of Turmeric Varieties in Cambodia. Internal report of HEIP-ITC-SGA#08*. Phnom Penh, Cambodia: Institut de Technologie du Cambodge.
- International Organization for Standardization. 1983. *Turmeric, Whole or Ground (Powdered) - Specification (ISO Standard No. 5562:1983)*.
- International Organization for Standardization. 2007. *Sensory Analysis. General Guidance for the Design of Test Rooms (ISO Standard No. 8589:2007)*.

- International Organization for Standardization. 2008. "Spices, Condiments and Herbs — Determination of Volatile Oil Content (Hydrodistillation Method) (ISO Standard No. 6571:2008)."
- International Organization for Standardization. 2012a. *Sensory Analysis. General Guidelines for the Selection, Training and Monitoring of Selected Assessors and Expert Sensory Assessors (ISO Standard No. 8586:2012)*.
- International Organization for Standardization. 2012b. *Sensory Analysis. Methodology. Guidelines for Monitoring the Performance of a Quantitative Sensory Panel (ISO Standard No. ISO 11132:2012)*.
- International Organization for Standardization. 2015. "Turmeric, Whole or Ground (Powdered) — Specification (ISO Standard No. 5562:1983)."
- Jacob, J. N. 2016. "Comparative Studies in Relation to the Structure and Biochemical Properties of the Active Compounds in the Volatile and Nonvolatile Fractions of Turmeric (*C. Longa*) and Ginger (*Z. Officinale*)." Pp. 101–35 in *Studies in Natural Products Chemistry*. Vol. 48. Elsevier.
- Jain, Pritam S., Amar J. Chaudhari, Stuti A. Patel, Zarana N. Patel, and Dhvani T. Patel. 2011. "Development and Validation of the UV-Spectrophotometric Method for Determination of Terbinafine Hydrochloride in Bulk and in Formulation." *Pharmaceutical Methods* 2(3):198–202. doi: 10.4103/2229-4708.90364.
- Jayashree, E., T. J. Zachariah, and R. Rakhi. 2018. "Comparison of Quality of Dry Turmeric (*Curcuma Longa*) Produced by Slicing and Other Curing Methods." *Journal of Spices and Aromatic Crops* 27(2):138–44. doi: 10.25081/josac.2018.v27.i2.1102.
- Jayashree, E., and T. John Zachariah. 2016. "Processing of Turmeric (*Curcuma Longa*) by Different Curing Methods and Its Effect on Quality." *Indian Journal of Agricultural Sciences* 86(5):696–98.
- Jiang, Tian, Wei Liao, and Catherine Charcosset. 2020. "Recent Advances in Encapsulation of Curcumin in Nanoemulsions: A Review of Encapsulation Technologies, Bioaccessibility and Applications." *Food Research International* 132:109035. doi: 10.1016/j.foodres.2020.109035.
- Kao, Lounge, Chao-Rui Chen, and Chieh-Ming J. Chang. 2007. "Supercritical CO₂ Extraction of Turmerones from Turmeric and High-Pressure Phase Equilibrium of CO₂+turmerones." *The Journal of Supercritical Fluids* 43(2):276–82. doi: 10.1016/j.supflu.2007.06.007.
- Kutti Gounder, Dhanalakshmi, and Jaganmohanrao Lingamallu. 2012. "Comparison of Chemical Composition and Antioxidant Potential of Volatile Oil from Fresh, Dried and Cured Turmeric (*Curcuma Longa*) Rhizomes." *Industrial Crops and Products* 38:124–31. doi: 10.1016/j.indcrop.2012.01.014.
- Lee, Wing-Hin, Ching-Yee Loo, Mary Bebawy, Frederick Luk, Rebecca Mason, and Ramin Rohanzadeh. 2013. "Curcumin and Its Derivatives: Their Application in Neuropharmacology and Neuroscience in the 21st Century." *Current Neuropharmacology* 11(4):338–78. doi: 10.2174/1570159X11311040002.
- Leong-Škorničková, Jana, Otakar Šída, Siril Wijesundara, and Karol Marhold. 2008. "On the Identity of Turmeric: The Typification of *Curcuma Longa* L. (Zingiberaceae)."

Botanical Journal of the Linnean Society 157(1):37–46. doi: 10.1111/j.1095-8339.2008.00788.x.

- Llano, Sandra M., Ana María Gómez, and Yudy Duarte-Correa. 2022. "Effect of Drying Methods and Processing Conditions on the Quality of Curcuma Longa Powder." *Processes* 10(4):702. doi: 10.3390/pr10040702.
- Lokhande, S. M., R. V. Kale, A. K. Sahoo, and R. C. Ranveer. 2013. "Effect of Curing and Drying Methods on Recovery, Curcumin and Essential Oil Content of Different Cultivars of Turmeric (*Curcuma Longa* L.)." *International Food Research Journal* 20(2):745–49.
- Madhusankha, GDMP, RCN Thilakarathna, T. Liyanage, and SB Navaratne. 2018. "Analysis of Curcumin Content in Sri Lankan and Indian Turmeric Rhizomes and Investigating Its Impact on the Colour." *International Journal of Food Science and Nutrition* 3(4):3–5.
- Mane, RP, RB Kshirsagar, AR Sawate, and RG Kale. 2018. "Studies on Evaluation of Physicochemical and Nutritional Properties of Fresh Turmeric Rhizome." *Journal of Pharmacognosy and Phytochemistry* 7(2):2895–97.
- Minekus, M., M. Alminger, P. Alvito, S. Ballance, T. Bohn, C. Bourlieu, F. Carrière, R. Boutrou, M. Corredig, D. Dupont, C. Dufour, L. Egger, M. Golding, S. Karakaya, B. Kirkhus, S. Le Feunteun, U. Lesmes, A. Macierzanka, A. Mackie, S. Marze, D. J. McClements, O. Ménard, I. Recio, C. N. Santos, R. P. Singh, G. E. Vegarud, M. S. J. Wickham, W. Weitschies, and A. Brodkorb. 2014. "A Standardised Static *in Vitro* Digestion Method Suitable for Food – an International Consensus." *Food Funct.* 5(6):1113–24. doi: 10.1039/C3FO60702J.
- Monton, Chaowalit, Laksana Charoenchai, Jirapornchai Suksaeree, and Lukman Sueree. 2016. "Quantitation of Curcuminoid Contents, Dissolution Profile, and Volatile Oil Content of Turmeric Capsules Produced at Some Secondary Government Hospitals." *Journal of Food and Drug Analysis* 24(3):493–99. doi: 10.1016/j.jfda.2016.01.007.
- Monton, Chaowalit, Chitradee Luprasong, and Laksana Charoenchai. 2019a. "Acceleration of Turmeric Drying Using Convection and Microwave-assisted Drying Technique: An Optimization Approach." *Journal of Food Processing and Preservation* 43(9):1–10. doi: 10.1111/jfpp.14096.
- Monton, Chaowalit, Chitradee Luprasong, and Laksana Charoenchai. 2019b. "Convection Combined Microwave Drying Affect Quality of Volatile Oil Compositions and Quantity of Curcuminoids of Turmeric Raw Material." *Revista Brasileira de Farmacognosia* 29(4):434–40. doi: 10.1016/j.bjp.2019.04.006.
- Nair, K. P. Prabhakaran. 2013. "Genetics of Turmeric." *The Agronomy and Economy of Turmeric and Ginger* 33–46. doi: 10.1016/b978-0-12-394801-4.00003-x.
- Naz, Shagufta, Saiqa Ilyas, Zahida Parveen, and Sumera Javed. 2010. "Chemical Analysis of Essential Oils from Turmeric (*Curcuma Longa*) Rhizome Through GC-MS." *Asian J. Chem.* 22(4):3153–58.
- Nithyashree, M. L. 2022. "Market Trends Turmeric Processing." *Ministry of Food Processing Industries*. Retrieved August 23, 2022 (<https://www.mofpi.gov.in/pmfme/enewsaugust9/markettrends1.html>).

- Osorio-Arias, J., S. Delgado-Arias, L. Cano, S. Zapata, M. Quintero, H. Nuñez, C. Ramírez, R. Simpson, and O. Vega-Castro. 2020. "Sustainable Management and Valorization of Spent Coffee Grounds Through the Optimization of Thin Layer Hot Air-Drying Process." *Waste and Biomass Valorization* 11(9):5015–26. doi: 10.1007/s12649-019-00793-9.
- Papillo, Valentina Azzurra, Marco Arlorio, Monica Locatelli, Laura Fuso, Nicoletta Pellegrini, and Vincenzo Fogliano. 2019. "In Vitro Evaluation of Gastro-Intestinal Digestion and Colonic Biotransformation of Curcuminoids Considering Different Formulations and Food Matrices." *Journal of Functional Foods* 59:156–63. doi: 10.1016/j.jff.2019.05.031.
- Park, Sung Jin, Coralia V. Garcia, Gye Hwa Shin, and Jun Tae Kim. 2018. "Improvement of Curcuminoid Bioaccessibility from Turmeric by a Nanostructured Lipid Carrier System." *Food Chemistry* 251:51–57. doi: 10.1016/j.foodchem.2018.01.071.
- Pethkar, Rajendra, Admuthu Ujwal, Kabure Siddhesh, Kadam Avadhoot, and Kadam Shrikant. 2017. "Study of Design and Development of Turmeric Processing Unit: A Review." *International Journal of Innovations in Engineering Research and Technology* 4(3):128–34.
- Pradeep, K., R. Ravi, and M. Madhava Naidu. 2016. "Influence of Blanching and Drying Methods on the Quality Characteristics of Fresh Turmeric (*Curcuma Longa* L.) Rhizomes." *International Journal of Applied and Pure Science and Agriculture* 02(03):32–44.
- Prathapan, A., M. Lukhman, C. Arumughan, A. Sundaresan, and K. G. Raghu. 2009. "Effect of Heat Treatment on Curcuminoid, Colour Value and Total Polyphenols of Fresh Turmeric Rhizome." *International Journal of Food Science & Technology* 44(7):1438–44. doi: 10.1111/j.1365-2621.2009.01976.x.
- Raina, V. K., S. K. Srivastava, and K. V. Syamsundar. 2005. "Rhizome and Leaf Oil Composition of *Curcuma Longa* from the Lower Himalayan Region of Northern India." *Journal of Essential Oil Research* 17(5):556–59. doi: 10.1080/10412905.2005.9698993.
- Ravindran, P. N., K. Nirmal Babu, and K. Sivaraman. 2007. *Turmeric: The Genus Curcuma*. Vol. Medicinal and Aromatic Plants-Industrial Profiles. 1st ed. New York: CRC Press Taylor & Francis Group.
- Saetan, Pisit, Naris Pratinthong, and Thanit Swasdisevi. 2013. "Turmeric Drying Using a Combined Vacuum and Far-Infrared." *The 14th TSAE National Conference and the 6th TSAE International Conference: TSAE 2013* 123–26.
- Sasikumar, B. 2012. "Turmeric." Pp. 526–46 in *Handbook of Herbs and Spices*. Elsevier.
- Sepahpour, Shabnam, Jinap Selamat, Mohd Yazid Abdul Manap, Alfi Khatib, and Ahmad Faizal Abdull Razis. 2018. "Comparative Analysis of Chemical Composition, Antioxidant Activity and Quantitative Characterization of Some Phenolic Compounds in Selected Herbs and Spices in Different Solvent Extraction Systems." *Molecules* 23(2):1–17. doi: 10.3390/molecules23020402.
- Shinde, Gopal U., Kailas J. Kamble, and Mahesh G. Harkari. 2011. "Process Optimization in Turmeric Heat Treatment by Design and Fabrication of Blancher." Pp. 1–5 in Chengadu, China.

- Singh, Gursewak, Sadhna Arora, and Satish Kumar. 2010. "Effect of Mechanical Drying Air Conditions on Quality of Turmeric Powder." *Journal of Food Science and Technology* 47(3):347–50. doi: 10.1007/s13197-010-0057-6.
- Singh, Shikha, Bhawani Sankar, Sathpathy Rajesh, Kumar Sahoo, Enketeswara Subudhi, and Sanghamitra Nayak. 2011. "Chemical Composition of Turmeric Oil (*Curcuma Longa* L. Cv. Roma) and Its Antimicrobial Activity against Eye Infecting Pathogens." *Journal of Essential Oil Research* 23(6):11–18. doi: 10.1080/10412905.2011.9712275.
- Sogi, D. S., S. Sharma, D. P. S. Oberoi, and I. A. Wani. 2010. "Effect of Extraction Parameters on Curcumin Yield from Turmeric." *Journal of Food Science and Technology* 47(3):300–304. doi: 10.1007/s13197-010-0047-8.
- Statista. 2022. "Leading Turmeric Exporting Countries Worldwide in 2021." *Statista.Com*. Retrieved August 22, 2022 (<https://www.statista.com/statistics/798287/main-turmeric-export-countries-worldwide/>).
- Suresh, D., H. Manjunatha, and Krishnapura Srinivasan. 2007. "Effect of Heat Processing of Spices on the Concentrations of Their Bioactive Principles: Turmeric (*Curcuma Longa*), Red Pepper (*Capsicum Annuum*) and Black Pepper (*Piper Nigrum*)." *Journal of Food Composition and Analysis* 20(3–4):346–51. doi: 10.1016/j.jfca.2006.10.002.
- Talamond, Pascale, Jean-Luc Verdeil, and Geneviève Conéjéro. 2015. "Secondary Metabolite Localization by Autofluorescence in Living Plant Cells." *Molecules* 20:5024–37. doi: 10.3390/molecules20035024.
- Tanvir, E. M., Md. Sakib Hossen, Md. Fuad Hossain, Rizwana Afroz, Siew Hua Gan, Md. Ibrahim Khalil, and Nurul Karim. 2017. "Antioxidant Properties of Popular Turmeric (*Curcuma Longa*) Varieties from Bangladesh." *Journal of Food Quality* 2017:1–8. doi: 10.1155/2017/8471785.
- The Phnom Penh Post. 2011. "Farmers will increase turmeric cultivation if there is a market." *The Phnom Penh Post*, September 6.
- ThmeyThmey. 2020. "Mr. Nhem Dip grows many hectares of turmeric in Osom to export to India." *ThmeyThmey*, August 30.
- Thongphasuk, Piyanuch, and Jarunee Thongphasuk. 2013. "Effects of Gamma-Irradiation on Free Radicals, Active Components and Toxicity of Turmeric Rhizomes." *Rangsit Journal of Arts and Sciences* 3(2):169–77. doi: 10.14456/RJAS.2013.4.
- Tridge. 2022a. "Overview of Turmeric Market in Cambodia." *Tridge.Com*. Retrieved September 1, 2022 (<https://www.tridge.com/intelligences/turmeric1/KH>).
- Tridge. 2022b. "Turmeric Global Exports and Top Exporters 2022." *Tridge.Com*. Retrieved August 23, 2022 (<https://www.tridge.com/intelligences/turmeric1/export>).
- USDA Plants Database. 2022. "Classification for Kingdom Plantae Down to Genus *Curcuma* L." *United States Department of Agriculture*. Retrieved August 23, 2022 (<https://plants.usda.gov/home/classification/31105>).
- Wang, Xiaoyong, Yan Jiang, Yu-Wen Wang, Mou-Tuan Huang, Chi-Tang Ho, and Qingrong Huang. 2008. "Enhancing Anti-Inflammation Activity of Curcumin through O/W

Nanoemulsions.” *Food Chemistry* 108(2):419–24. doi: 10.1016/j.foodchem.2007.10.086.

Yerramilli, Manispuritha, Natalie Longmore, and Supratim Ghosh. 2018. “Stability and Bioavailability of Curcumin in Mixed Sodium Caseinate and Pea Protein Isolate Nanoemulsions.” *Journal of the American Oil Chemists’ Society* 95(8):1013–26. doi: 10.1002/aocs.12084.

Yin, Molika, Mathieu Weil, Sylvie Avallone, Marc Lebrun, Geneviève Conejero, Sokneang In, and Philippe Bohuon. 2022. “Impact of Cooking and Drying Operations on Color, Curcuminoids, and Aroma of *Curcuma Longa* L.” *Journal of Food Processing and Preservation*. doi: 10.1111/jfpp.16643.

Summary in French

Summary in French

Contexte : Le curcuma (*Curcuma longa* L.) appartient à la famille des Zingibéracées et est largement distribué dans les régions tropicales et subtropicales du monde (Kutti Gounder et Lingamallu, 2012). Après la récolte, les rhizomes de curcuma frais subissent des changements physiques, chimiques et microbiologiques. Ces altérations sont notamment influencées par la teneur en eau de la matière première, l'humidité relative de l'air ambiant et les conditions de stockage (Bambirra *et al.* 2002). Pour préserver sa qualité et réduire sa masse pendant le transport, le curcuma est séché. Le séchage a pour but de réduire sa teneur en eau élevée (de 2,3 à 4,0 kg·kg⁻¹ db), à une teneur en eau faible (0,11 kg·kg⁻¹ db) afin de garantir sa stabilité (International Organization for Standardization 1983).

Le procédé affecte la qualité du curcuma ; c'est un défi pour les petites et moyennes entreprises alimentaires au Cambodge. Les rhizomes peuvent être soit séchés directement ou préalablement cuits et ensuite séchés. L'intérêt d'utiliser l'opération de cuisson interpelle : en effet, la cuisson transfère de l'eau à l'intérieur du rhizome alors que le séchage ultérieur devra ensuite retirer l'eau du rhizome cuit. De nombreuses études ont démontré l'impact des procédés de transformation sur la qualité de la poudre de curcuma, en comparant la matière première et les poudres obtenues. Cependant ces études ne se sont pas intéressées à l'impact de chaque opération unitaire (cuisson, séchage et broyage) sur la qualité du curcuma et notamment sur l'effet de ces opérations (unitaires et combinées) sur la qualité sensorielle et fonctionnelle. De plus, à notre connaissance, les pratiques de transformation du curcuma au Cambodge n'ont jamais été précisément décrites dans la littérature scientifique.

Les objectifs : L'objectif de cette thèse était de décrire les traitements post-récolte du curcuma (*Curcuma longa* L.) mis en œuvre au Cambodge et leurs impacts sur la qualité. À la suite d'un état des lieux au Cambodge, il s'agissait d'étudier, en conditions maîtrisées, l'impact des opérations unitaires (cuisson, séchage et broyage) et de leurs combinaisons sur la qualité finale du curcuma. Une meilleure compréhension est en effet nécessaire pour adapter les procédés de transformation afin d'améliorer la qualité sensorielle et fonctionnelle du curcuma et proposer des voies d'innovation technologique acceptables pour les pays du Sud, le Cambodge en particulier.

Ce travail visait à répondre aux questions de recherche suivantes :

- Q1. Quels sont les procédés de transformation du curcuma mis en œuvre au Cambodge ?
- Q2. Quelles caractéristiques qualitatives du curcuma sont affectées par les procédés de transformation, comment et dans quelle proportion ?

Pour répondre à ces questions de recherche, une étude bibliographique a été réalisée sur les caractéristiques du curcuma, ainsi que sur les procédés de transformation et opérations

unitaires appliquées au curcuma et leur impact sur la qualité du curcuma (Chapitre 1). Ensuite, un audit de terrain a été mené sur les traitements post-récolte du curcuma mis en œuvre au Cambodge et leurs impacts sur la qualité du curcuma (article 1, chapitre 2). Dans ce chapitre, les principaux traitements post-récolte du curcuma (*Curcuma longa* L.) mis en œuvre au Cambodge ont été analysés dans trois régions différentes (Siem Reap, Phnom Penh et Kampot) et trois entreprises de transformations. Les impacts de l'approvisionnement (y compris l'origine de la matière première et les parties du rhizome utilisées) et les traitements post-récolte sur la qualité du curcuma ont été mesurés (procédés de transformation complets et opérations unitaires d'épluchage et de cuisson). En situation réelle sur le terrain Cambodgien, les conditions opératoires ont été relevées et étaient variables. Les caractéristiques de qualité considérées dans cette étude étaient la distribution des tailles des particules de la poudre, la couleur (valeurs chromatiques L*, a* et b*), les teneurs en huiles essentielles et en curcuminoïdes (la curcumine noté « C », la demethoxycurcumine noté « DMC » et la bisdemethoxycurcumine, noté « BDMC ») et la bioaccessibilité des curcuminoïdes. Ensuite, un travail a été conduit (article 2, chapitre 3) en conditions contrôlées à l'échelle du laboratoire, sur les mêmes attributs de qualité. L'impact de la cuisson sur la cinétique de séchage a également été étudié. Les bilans massiques de la matière sèche, de l'eau et des curcuminoïdes ont été évalués. L'analyse microscopique du curcuma a été réalisée pour localiser l'amidon, l'huile essentielle et les curcuminoïdes et ainsi évaluer les effets du procédé sur leur distribution dans les cellules. Enfin (article 3, chapitre 4) l'impact des opérations unitaires de cuisson, de séchage et de broyage et leurs combinaisons a été analysé sur les teneurs en huiles essentielles et en curcuminoïdes (C, DMC et BDMC), la bioaccessibilité des curcuminoïdes et la qualité sensorielle de *Curcuma longa* L.

Les résultats obtenus dans ces études sont présentés sous la forme de trois articles scientifiques et publié dans des revues internationales :

- Publication #1. Traitements post-récolte de *Curcuma longa* L. au Cambodge – impact de la qualité
- Publication #2. Impact des opérations de cuisson et de séchage sur la couleur, les curcuminoïdes et l'arôme de *Curcuma longa* L.
- Publication #3. Impact des opérations de cuisson, de séchage et de broyage sur la qualité sensorielle et fonctionnelle de *Curcuma longa* L.

Principaux résultats : Les trois procédés de transformation différents du curcuma mis en œuvre dans trois régions différentes du Cambodge (Siem Reap, Phnom Penh et Kampot) ont été observés, décrits et comparés afin de répondre à notre première question de recherche. La méthode dite des « 5M » - un outil utilisé dans le développement de systèmes d'analyse des risques et de maîtrise des points critiques (HACCP) - a été utilisée pour décrire chaque étape des trois systèmes de production de curcuma de manière précise et exhaustive à

travers cinq dimensions : matière (curcuma), matériel (les équipements, machines), milieu (environnement, conditions), méthodes et main d'œuvre (personnes) (article 1, chapitre 2). Les résultats indiquent que les principales différences entre les trois procédés de transformation différents, correspondant aux trois régions différentes du Cambodge, sont : (i) la cuisson avant le séchage (étude de cas 1 : Siem Reap) ; (ii) le tranchage avant le séchage (étude de cas 2 : Phnom Penh) ; (iii) la cuisson et le tranchage avant le séchage (étude de cas 3 : Kampot). Les besoins en main-d'œuvre pour traiter le curcuma dans les trois entreprises sont : 10 personnes/100 kg/jour, 4 personnes/200 kg/jour et 13 personnes/200 kg/jour pour les études des cas régions 1, 2 et 3, respectivement. Après un épluchage automatique de ces rhizomes, un second épluchage manuel de finition réalisé à l'aide de couteaux permet d'éliminer toute la peau (étude de cas 1). Cette étape manuelle d'épluchage de finition dans le procédé questionne ; bien que le rendement massique soit très bon (faible perte de matière 4,5 %), l'opération d'épluchage de finition est longue et pénible (nécessité 5 h et 10 personnes pour un pelage complet de 100 kg), et expose longtemps les produits à l'air, ce qui provoque un brunissement sur les rhizomes épluchés. Les résultats contredisent les affirmations de Bambirra *et al.* (2002) que l'enlèvement de la peau entraînait une perte de rendement allant jusqu'à 30 %. La couleur se détériore à la suite d'une cuisson excessive, mais le rhizome devient trop « dur » lorsqu'il n'est pas assez cuit. L'Institut indien de recherche sur les épices et le Centre d'information sur les technologies agricoles recommandent de faire bouillir le curcuma entier dans l'eau pendant 45 min à 1 heure, jusqu'à ce que de la mousse apparaisse à la surface de l'eau de cuisson et que l'arôme typique du curcuma se libère, cité par Ararsa (2018). Au Cambodge, les rhizomes de curcuma pelés sont nettoyés (avec de la saumure, de l'eau de consommation courante ou de l'eau assainie par UV et ozone) ou cuits dans de l'eau bouillante pendant 30 à 40 min pour éliminer les impuretés (poussières et corps étrangers) et réduire la charge microbienne. Avant le séchage, les curcumas nettoyés ou cuits (séchage direct pour l'étude de cas 1) sont tranchés à l'aide d'une trancheuse pour obtenir des tranches de 1 à 2 mm d'épaisseur (étude de cas 2) et 3 mm (étude de cas 3), respectivement. En utilisant le séchoir solaire, le temps de séchage diminue de moitié lorsque le tranchage est inclus dans le procédé (étude de cas 3). Le séchage des curcumas tranchés dans un local dédié (avec une toiture en tôle métallique et des ventilateurs pour renouveler l'air) puis le séchage dit « au four » (étude de cas 2) réduisent également le temps de séchage, mais consomment plus d'énergie que le séchage solaire. De plus, cette technique est compliquée car les copeaux de curcuma semi-séchés sont séparés manuellement pour sélectionner les petits et les gros copeaux de curcuma. Les petits copeaux de curcuma sont collectés mais les plus gros sont transférés dans un séchoir à four pour continuer le séchage. Dans toutes les études de cas observées, il n'y a pas de températures et de temps spécifiques pour l'opération de séchage. Ces séchages dépendaient du temps,

c'est-à-dire des variations diurnes des températures pendant la journée et la nuit. De plus, les transformateurs vérifiaient si les curcumas étaient suffisamment séchés et arrêtaient le séchage juste par des observations visuelles et évaluaient avec leurs mains s'ils étaient croustillants ou faciles à casser. Cela conduit à une variabilité de la qualité des produits finaux (poudres de curcuma) d'un lot à l'autre. Les données montrent que le procédé à Kampot (avec les opérations de cuisson et de tranchage) a le temps de séchage le plus court (c'est-à-dire entre 24 et 45 h selon la météo) et obtient le rendement le plus élevé (16,2 %), avec une teneur en eau finale (environ 6 %) conforme aux spécifications de la norme ISO 5562:1983 (International Organization for Standardization 1983). Les résultats de ce procédé étaient en accord avec Pradeep *et al.* (2016) qui constatent que le rendement massique de produit séché de 17,1 à 20,6 % est comparable entre les différents séchoirs (c'est-à-dire le séchage convectif, le séchage solaire et le séchage classique au soleil). Cependant, Bambirra *et al.* (2002) ont trouvé que le rendement massique des poudres de curcuma était compris entre 9,8 et 14,5 % avec une teneur en eau variant de 8,8 à 9,9 %. Sasikumar (2012) rapporte que le séchage dans un séchoir solaire est meilleur que le séchage direct au soleil car il permet d'atteindre la teneur en eau souhaitée et la qualité en 42 heures (6 jours) contre 56 heures (8 jours) pour le séchage au soleil, ce qui permet de gagner un temps considérable (14 heures). La principale différence entre les procédés de transformation cambodgiens et indiens de curcuma réside dans les opérations unitaires de tranchage, de pelage et de polissage. En Inde, la transformation du curcuma n'inclut pas l'opération unitaire d'épluchage avant cuisson et séchage mais un polissage du curcuma est appliqué après séchage (Sasikumar 2012). Au Cambodge, les rhizomes de curcuma sont tranchés après nettoyage (étude de cas 2) ou cuisson (étude de cas 1) mais l'opération de tranchage n'est pas incluse dans la transformation du curcuma en Inde (Sasikumar 2012).

Environ 20 à 25 espèces de *Curcuma* sont originaires du Cambodge, du Vietnam et du Laos (Ravindran *et al.* 2007). Actuellement, au moins 13 espèces de curcuma (la plupart sont des espèces sauvages) ont été découvertes dans la montagne Kulen située dans la province de Siem Reap au Cambodge, dans laquelle le curcuma jaune (*Curcuma longa* L.) est le plus utilisé. Les rhizomes de curcuma de différentes origines (origines et partie des rhizomes, c'est-à-dire doigt et mère) sont de couleur, de forme et de taille différentes. La longueur des doigts est comprise entre 3,0 et 10,5 cm et leur diamètre varie de 1,1 à 2,4 cm. Les mères, de forme ovale, sont de longueur plus courte (de 2,5 à 9,5 cm) et ont un diamètre plus grand (de 2,5 à 4,7 cm) que les doigts. Cela peut s'expliquer par le fait que l'espèce, l'âge/maturité du rhizome, le sol, le climat et les techniques de culture affectent le phénotype. L'huile essentielle (arôme) est plus affectée par la source (origines et parties de rhizomes, c'est-à-dire doigt et mère) que les curcuminoïdes (couleur). Les teneurs en huile essentielle des rhizomes (doigt et mère) et les curcuminoïdes totaux (mère uniquement) de Siem Reap étaient plus élevés que ceux de

l'étude de cas 2 (Phnom Penh). De plus, ces composés diffèrent également selon les parties du rhizome. La teneur en huile essentielle des rhizomes mères frais des études de cas 1 (Siem Reap) et 2 (Phnom Penh) était de 48 à 59 % supérieure à celle des rhizomes frais des doigts. Le contenu en curcuminoïdes du rhizome mère frais de l'étude de cas 1 (Siem Reap) était supérieur de 15 % à celui du rhizome doigt frais. Choudhury *et al.* (2017) ont également constaté que la teneur en curcumine des rhizomes mères frais était de 15 à 38 % supérieure à celle des rhizomes frais des doigts, car les constituants phytochimiques ne sont pas uniformément répartis dans toutes les parties de la plante. Cependant, dans l'étude de cas 2, la teneur en curcuminoïdes des rhizomes du doigt et de la mère n'était pas différente pour les échantillons de la ferme (PP/O1), mais la teneur en curcuminoïdes de PP/O2_Fresh finger était supérieure de 2,9 % à celle de PP/O2_Fresh mother. Les différentes origines des rhizomes de curcuma (doigt et mère) ont fourni différents teneurs en curcuminoïdes bioaccessibles. La bioaccessibilité des curcuminoïdes des rhizomes frais des doigts variait de 7,0 % à 13,6 % tandis que celle des rhizomes mères frais variait de 9,5 % à 16,8 %. Aussi, aucune règle générale n'a été observée pour le contenu des curcuminoïdes bioaccessibles et leur bioaccessibilité dans différentes parties des rhizomes frais (c'est-à-dire le doigt et la mère). Alors que la teneur en curcuminoïdes du curcuma frais de Siem Reap était plus élevée que celle des curcumas de l'étude de cas 2 (Phnom Penh), la teneur en curcuminoïdes bioaccessibles et leur bioaccessibilité n'étaient pas si élevées.

Le pelage n'a eu aucun impact sur la teneur en curcuminoïdes et leur bioaccessibilité (doigt et rhizomes mères) mais la teneur en huile essentielle était légèrement supérieure (doigt uniquement), de seulement 5,1 %. La cuisson n'a eu aucun impact sur la teneur en huile essentielle, la teneur en curcuminoïdes bioaccessibles et leur bioaccessibilité bien que les rhizomes entiers aient été cuits longtemps (entre 30 à 40 min) à des températures élevées (jusqu'à 100 °C). Après traitement, aucune règle générale n'a été observée pour les teneurs en huiles essentielles et en curcuminoïdes, mais les curcuminoïdes bioaccessibles ont diminué. Il s'agit probablement d'un biais dû aux différentes granulométries des curcumas frais et moulus (étude de cas 1), des échantillons séchés non homogénéisés (non représentatifs de l'ensemble du rhizome, étude de cas 2), de la grande différence de temps de séchage (étude de cas 3) et des conditions de séchage incontrôlées (car le temps de séchage nécessaire avec le séchoir solaire dépendait de la météorologie). Cependant, les résultats obtenus à partir de l'observation et de l'analyse de la qualité des échantillons de l'enquête sur le terrain au Cambodge ont permis de conclure de manière préliminaire que la cuisson et le tranchage sont des opérations unitaires essentielles à appliquer dans le procédé du curcuma car elles réduisent le temps de séchage, économisent l'énergie et préservent la qualité du curcuma. Le curcuma frais de Siem Reap devrait être un bon choix car il contient plus d'huile essentielle et une teneur égale en curcuminoïdes par rapport au curcuma de

l'étude de cas 2 (Phnom Penh). En raison de la pandémie du Covid-19, aucun échantillon du Cambodge n'a pu être acheminé en France pour notre étude. La matière première utilisée dans le chapitre 3 a été achetée dans une épicerie asiatique de Montpellier (Wei Sin). L'étude s'est concentrée uniquement sur le rhizome des doigts (les mères étant non disponibles) pour les prochains chapitres. Les doigts représentent environ 90 % (p/p) de la masse des rhizomes entiers. De nombreuses recherches ont révélé que le séchage au soleil était largement pratiqué dans les climats chauds et les pays tropicaux en raison de son faible coût et de sa technologie simple. Cependant, il est fort dépendant des conditions météorologiques et peut par conséquent, nécessiter un long temps de séchage et affecter la qualité du produit. Le séchage convectif à l'air chaud est une alternative au séchage au soleil, non seulement pour réduire le temps de séchage mais aussi pour mieux préserver la qualité du produit.

Deux travaux expérimentaux ont été menés pour caractériser et comprendre l'impact des opérations unitaires (cuisson, séchage et broyage) et du procédé sur la qualité sensoriel et fonctionnel de *Curcuma longa* L. L'impact de la cuisson et du séchage sur les valeurs de couleur (L^* , a^* et b^*), les teneurs en curcuminoïdes (C, DMC et BDMC), la teneur en huile essentielle et les profils aromatiques de *Curcuma longa* L. ont été évalués dans des conditions contrôlées (article 2, chapitre 3). Des curcumas frais tranchés (épaisseur de 5 mm) ont été séchés par convection à l'air à 60 °C avec une humidité relative (RH) de 40 % soit directement, soit après une cuisson à 95 °C pendant 3 ou 60 min. L'étude a révélé que les cuissons drastiques (95 °C/60 min) et les opérations de séchage diminuaient davantage les valeurs de couleur (jaunissement, b^*) que les cuissons modérées (95 °C/3 min). La cuisson (modérée ou drastique) préservait le contenu en huile essentielle et en curcuminoïdes, réduisait le temps de séchage et modifiait à peine le profil aromatique des huiles essentielles. Il est bien connu que les curcuminoïdes sont des pigments solubles dans l'huile, et pratiquement insolubles dans l'eau à pH acide ou neutre. Ils sont connus pour résister à des températures élevées (supérieures à 100 °C) (Lee *et al.* 2013). De plus, des observations microscopiques ont confirmé qu'une cuisson de 3 min à 95 °C était suffisante pour gélatiniser complètement l'amidon. Les amyloplastés étaient visibles dans le curcuma frais mais ils n'étaient plus visibles dans le curcuma cuit. De plus, la cuisson combinée au séchage a provoqué la sortie partielle (dispersion) des curcuminoïdes de leurs alvéoles dédiées ; les curcuminoïdes se retrouvent alors dans tout le rhizome et semblent être en partie « absorbés » sur les cellules de l'amidon. Il semble que cette matrice d'amidon protège les curcuminoïdes. La dégradation des parois cellulaires permettant aux curcuminoïdes de sortir pourrait également expliquer l'élimination plus facile dans l'eau lorsque le curcuma était cuit avant le séchage. La cuisson à 95 °C pendant 3 min et pendant 60 min a permis de réduire le temps de séchage jusqu'à 38 % et 50 %, respectivement. Ces résultats sont en accord avec Govindarajan and Stahl (1980) qui ont observé que lorsque les rhizomes de curcuma sont

cuits, les granules d'amidon gélatinisés facilite le séchage et augmente la vitesse de séchage ; en conséquence, le temps de séchage total est réduit. Le séchage a diminué les teneurs en curcuminoïdes (- 38 %) et en huiles essentielles (- 13 %). La méthode de séchage a généralement un effet significatif sur la teneur en huile essentielle (Kutti Gounder and Lingamallu 2012). Ararsa (2018) a également constaté une perte d'huile essentielle jusqu'à 25 % par évaporation et destruction de certains constituants de l'huile sensible à la lumière. L'huile essentielle est présente dans les cellules et canaux spécifiques présents dans la région méristématique du rhizome. Ces cellules oléagineuses sont endommagées lors de la cuisson du rhizome et l'exposition de l'huile essentielle à l'atmosphère induit une perte par volatilisation lors du séchage (Díaz-Maroto *et al.* 2002). Une cuisson de curcuma en tranches (épaisseur de 5 mm) à 95 °C pendant 3 min (cuisson douce) est préconisée avant séchage (60 °C, 40 % RH) bien que le temps de séchage soit moins réduit après une cuisson à 95 °C pendant 60 min (cuisson drastique). Cependant, nous ne savons pas si la cuisson avait un impact sur la bioaccessibilité des curcuminoïdes et la qualité sensorielle du curcuma. De plus, le séchage ayant un impact important sur la teneur en huiles essentielles et en curcuminoïdes, une étude approfondie sur le processus de séchage a été menée. Selon la littérature, la bioaccessibilité des composés d'intérêt est liée à la taille des particules, nous nous attendons aussi à ce que la taille des particules ait un impact sur la qualité sensorielle.

L'impact des opérations unitaires de cuisson, de séchage et de broyage et de leurs combinaisons sur les teneurs en huiles essentielles, en curcuminoïdes totaux et bioaccessibles (C, DMC et BDMC), la bioaccessibilité des curcuminoïdes et la qualité sensorielle de *Curcuma longa* L. a été évalué dans des conditions contrôlées (article 3, chapitre 4). Les tranches fraîches (épaisseur de 5 mm) ont été séchées à l'air à 60 °C, 40 % HR directement ou précuites (95 °C/3 min) avant d'être séchées dans différentes conditions (50, 60 ou 80 °C ; 40 % RH). Les tranches séchées ont été broyées pour obtenir deux poudres de tailles de particules différentes : fines <500 µm et grossières <750 µm. La cuisson a maintenu la teneur en huiles essentielles, la teneur en curcuminoïdes et leur bioaccessibilité. Le séchage a diminué la teneur en huiles essentielles (- 22,5 %), la teneur en curcuminoïdes (- 11,0 %) et leurs bioaccessibilités (- 28,6 %). Contrairement à la littérature concernant la bioaccessibilité des micronutriments, la taille des particules (entre 63 et 711 µm) n'a eu aucun impact sur la teneur en curcuminoïdes et leur bioaccessibilité. Cela peut être dû au fait que nos curcumas séchés en tranches ont été broyés à température fixe (10 °C) et dans les mêmes conditions (à 10 000 tr/min pendant 10 s) en utilisant un broyeur ultra-centrifuge relié à deux tamis différents (500 µm et 750 µm) afin de produire deux poudres de granulométrie différente (P1 : <500 µm ; P2 : <750 µm). Le broyage cryogénique sous azote liquide empêche l'oxydation et la perte de composés volatiles ; il se répand largement dans l'industrie, mais il s'agit d'une opération unitaire coûteuse (Ararsa 2018; Sasikumar

2012). Sasikumar (2012) mentionne que dans le processus de broyage ambiant, la température de la poudre s'élevait jusqu'à 90 – 95 °C, entraînant des pertes d'huiles essentielles, d'arôme et de couleur, provoquant une détérioration de la qualité. La bioaccessibilité des curcuminoïdes des poudres de curcuma (en moyenne 9,1 %) était bien inférieure à la valeur de $17 \pm 4,1$ % trouvée par Park *et al.* (2018). Même si l'amidon était gélatinisé ou non, la bioaccessibilité des curcuminoïdes n'était pas significativement différente. Après séchage, la texture du curcuma était dure. Notre hypothèse est que les fluides biologiques issus de la digestion *in vitro* ne se sont pas bien diffusés dans les particules de poudre. De ce fait, leurs constituants étaient moins bien solubilisés dans le tube digestif que ceux du curcuma frais. Comme les curcuminoïdes sont lipophiles et peu solubles dans l'eau, les solutions acides et neutres, ces caractéristiques leur confèrent une faible bioaccessibilité lors de la digestion. De plus, ils sont mal absorbés à partir de l'intestin par les cellules des entérocytes, métabolisés rapidement et intensivement et éliminés par voie systémique (Wang *et al.* 2008). L'absorption des curcuminoïdes du curcuma dépend de l'enrobage (Papillo *et al.* 2019) et de la structuration (Park *et al.* 2018) qui modulent leur stabilité, leur solubilité dans le tube digestif et leur absorption dans la circulation systémique. La combinaison des opérations unitaires testées a généré des produits finaux de même qualité en termes de teneur totale en curcuminoïdes (12,1 g/100 g db) et en curcuminoïdes bioaccessibles (1,0 g/100 g db). Ces résultats étaient en accord avec Llano *et al.* (2022) qui n'ont trouvé aucune différence significative en curcuminoïdes entre les poudres de curcuma obtenues dans différentes conditions de séchage (entre 50 et 80 °C). Jayashree and Zachariah (2016) ont rapporté qu'il n'y avait pas de différences significatives pour la teneur en huile essentielle une fois que la durée de cuisson dans l'eau bouillante augmentait jusqu'à 60 min. Prathapan *et al.* (2009) n'ont trouvé aucune différence significative dans la teneur en curcuminoïdes lors de la comparaison de matériel frais et traité thermiquement (entre 50 et 100 °C pendant 30 min). Cependant, les plus grandes différences relatives de teneur en curcuminoïdes ont été observées entre les échantillons « frais » et « séchés directement » avec une réduction de 30 % (environ). Ces résultats sont en accord avec Suresh *et al.* (2007) qui déclarent que la perte de curcumine due au traitement thermique du curcuma est de l'ordre de 27 à 53 %, avec une perte maximale lors de la cuisson sous pression (à haute température) pendant 10 min. Cependant, Choudhury *et al.* (2017) ont rapporté que le traitement des rhizomes frais (mère et doigt) pour produire des poudres sèches entraînait une réduction significative de la curcumine de seulement 2,0 à 8,0 %. Un traitement approprié (ni trop élevé, ni trop faible) pour sécher le curcuma joue un rôle essentiel dans la préservation des curcuminoïdes dans le curcuma (Hirun *et al.* 2014). Bambirra *et al.* (2002) ont constaté que le curcuma moulu obtenu sans traitement thermique avait la pire qualité par rapport aux pigments curcuminoïdes et que la bonne qualité du curcuma moulu était obtenue par cuisson

dans de l'eau car la cuisson favorise la diffusion des pigments des cellules vers les tissus adjacents, contribuant à une meilleure homogénéisation des pigments. Les résultats du test d'acceptation par le consommateur ont révélé que la cuisson améliorait la perception du goût du consommateur en réduisant l'amertume, l'odeur et la couleur foncée, ce qui augmentait le goût général tandis que le séchage et le broyage n'avaient aucun impact. De plus, les consommateurs n'aimaient pas les échantillons qui ressemblaient le plus à ceux qu'ils consommaient habituellement (séchage direct à 60 °C). Ils n'aimaient pas les échantillons séchés directement car ils leur trouvaient une forte amertume (25,9 – 33,3 %), une forte odeur (33,3 – 34,6 %) et une couleur foncée/marron (12,5 – 29,6 %). En revanche, ils ont préféré les échantillons cuits (95 °C/3 min) -séchés à 60 °C. Bien que les teneurs en curcuminoïdes de nos produits finaux ne soient pas significativement différentes, les consommateurs ont détecté une différence significative de couleur, de texture et de goût général entre les échantillons séchés directement et cuits-séchés. Le traitement thermique du rhizome avant la déshydratation peut inactiver les enzymes oxydatives, éviter les odeurs désagréables et limiter les réactions de brunissement enzymatique (Jayashree *et al.* 2018). La cuisson pourrait réduire la teneur en composés amers de certaines espèces (Faber *et al.* 2010). Cela pourrait être la raison pour laquelle les consommateurs pourraient détecter une intensité plus élevée de goût, d'odeur et de couleur amer dans les échantillons séchés directement. Selon ces résultats, les échantillons séchés directement et cuits (95 °C/3 min) avant d'être séchés à 60 °C et 40 % RH ont été sélectionnés pour une analyse descriptive quantitative afin de voir si les panélistes formés détectaient des différences dans le profil sensoriel. Les résultats des tests d'acceptation par les consommateurs et des tests descriptifs ont révélé que les consommateurs ont préféré le curcuma avec un faible jaunissement, une odeur de curcuma, une amertume et une sensation en bouche intense et piquante. Nos résultats ont prouvé qu'une cuisson douce (95 °C/3 min) suivie d'un séchage (60 °C, 40 % HR) est le processus le plus approprié pour produire une poudre riche en curcuminoïdes et améliorer l'acceptation par le consommateur.

Conclusion et perspectives : En conclusion, sur la base des résultats obtenus, nous sommes en mesure de proposer des procédés de transformation révisés pour améliorer la qualité du curcuma. Le traitement post-récolte de Kampot présente le temps de séchage le plus court (entre 24 à 45 h selon la météo) et a donné le rendement massique le plus élevé (16,2 %), avec une teneur en eau (environ 6 %) conforme aux normes ISO 5562 :1983 (International Organization for Standardization 1983). Il y a un potentiel d'économie transposable à toutes les entreprises sur le séchage. En effet, ils pourraient moins sécher, obtenir un meilleur rendement tout en étant conforme aux normes ISO 5562 :1983 (teneur en eau < 10 % p/p). La cuisson n'a non seulement eu aucun impact négatif sur la teneur en huile essentielle, la teneur en curcuminoïdes et leur bioaccessibilité (profil aromatique légèrement

modifié de l'huile essentielle), mais a également permis de diminuer la durée de séchage. Le séchage a diminué la teneur en huiles essentielles (- 22,5 %), la teneur en curcuminoïdes (- 1,0 %) et leur bioaccessibilité (- 28,6 %). Contrairement à la littérature concernant la bioaccessibilité des micronutriments, la taille des particules (entre 63 et 711 µm) n'a eu aucun impact sur les teneurs en curcuminoïdes et leur bioaccessibilité. La combinaison des opérations unitaires testées a produit de la poudre de curcuma de même qualité en termes de teneur totale en curcuminoïdes (12,1 g/100 g db) et en curcuminoïdes bioaccessibles (1,0 g/100 g db). Cependant, les consommateurs ont détecté des différences de couleur, de texture et de goût général entre les poudres de curcuma transformées (séchées et cuites-séchées). Le meilleur traitement thermique consistait à sécher à l'air le curcuma cuit en tranches (5 mm ; 95 °C pendant 3 min) à une température standard (60 °C, 40 % RH) pour produire une poudre riche en curcuminoïdes et améliorer l'acceptation par le consommateur. Bien que la plupart des consommateurs cambodgiens consomment du curcuma frais, car il est facile à cultiver et disponible toute l'année. Il est toujours utile d'introduire la poudre de curcuma au Cambodge car au moins 47,5 % d'entre eux (sur la base de l'enquête auprès des consommateurs de 120 personnes au Cambodge) utiliseraient la poudre de curcuma à des fins culinaires (pour rehausser la couleur et l'odeur), suivis de 30,3 % pour santé et 22,2 % à des fins cosmétiques. Cette étude contribue à mieux comprendre le processus du curcuma et aide à déterminer quelle origine du curcuma et le traitement post-récolte doivent être privilégiés pour réduire la durée de séchage et obtenir les teneurs les plus élevées en huiles essentielles et en curcuminoïdes. De plus, les conditions technologiques identifiées dans ce travail permettent la production de poudres de curcuma intéressantes en termes de qualité sensorielle et fonctionnelle pour les consommateurs. Cependant, ce travail pourrait être complété par des études de stockage (température, humidité et lumière) et de conditionnement afin de trouver les meilleures conditions à utiliser par les opérateurs locaux. Les études futures devraient également prendre en compte l'impact des opérations unitaires et de leurs combinaisons sur la qualité sanitaire du curcuma.

Summary in Khmer

Summary in Khmer

បរិបទ៖ រមៀត (*Curcuma Longa* L.) ដែលស្ថិតនៅក្នុងគ្រួសារ Zingiberaceae ត្រូវបានដាំដុះ និងប្រើប្រាស់យ៉ាងទូលំទូលាយនៅតំបន់ត្រូពិក (Kutti Gounder and Lingamallu 2012)។ រមៀតស្រស់ងាយរងការខូចគុណភាពបន្ទាប់ពីការប្រមូលផល ដោយសារតែការផ្លាស់ប្តូរលក្ខណៈរូប គីមី និងមីក្រូជីវសាស្ត្រ។ បម្រែបម្រួលទាំងនេះអាចកើតឡើងដោយសារតែបរិមាណសំណើមរបស់រមៀត សំណើមនៅក្នុងបរិយាកាស និងការរក្សាទុករមៀត (Bambirra *et al.* 2002)។ រមៀតស្រស់ត្រូវបានសម្ងួតដើម្បីកាត់បន្ថយបរិមាណសំណើមដើម (ចន្លោះពី ២,៣ ដល់ ៤,០ kg·kg⁻¹ db) ទៅដល់បរិមាណសំណើមសុវត្ថិភាព (0,១១ kg·kg⁻¹ db) (International Organization for Standardization 1983)។

វិធីសាស្ត្រក្នុងការកែច្នៃអាចធ្វើឲ្យប៉ះពាល់ដល់គុណភាពរបស់រមៀតស្រស់ ហើយវាគឺជាបញ្ហាប្រឈមរបស់សហគ្រាសធុនតូច និងមធ្យមនៅក្នុងប្រទេសកម្ពុជា។ ជាទូទៅ រមៀតត្រូវបានសម្ងួតដោយផ្ទាល់ ឬចម្អិនមុនសម្ងួត។ យើងមានចម្ងល់អំពីការប្រើប្រាស់វិធីសាស្ត្រទាំងនេះតាមរបៀបរួមបញ្ចូលគ្នា ដោយសារតែនៅពេលចម្អិន បរិមាណទឹកត្រូវបានស្រូបចូលក្នុងរមៀត ហើយវានឹងត្រូវបានដកចេញមកវិញនៅពេលសម្ងួត។ ការសិក្សាជាច្រើនបានបង្ហាញពីផលប៉ះពាល់នៃដំណើរការកែច្នៃ ទៅលើគុណភាពនៃរមៀត ដោយធ្វើការប្រៀបធៀបវត្ថុធាតុដើម និងផលិតផលសម្រេច។ ប៉ុន្តែការសិក្សាទាំងនោះមិនបានផ្តោតលើផលប៉ះពាល់នៃប្រតិបត្តិការ (ចម្អិន សម្ងួត និងកិន) និងដំណើរការផលិតទៅលើគុណភាពវិភាគដោយញាណ និងគុណភាពមុខងាររបស់រមៀតនោះឡើយ។ លើសពីនេះទៅទៀត តាមអ្វីដែលយើងបានដឹងកន្លងមក ការកែច្នៃរមៀតនៅប្រទេសកម្ពុជាមិនដែលត្រូវបានពិពណ៌នាយ៉ាងជាក់លាក់នៅក្នុងឯកសារបែបវិទ្យាសាស្ត្រនោះទេ។

គោលបំណង៖ គោលបំណងនៃនិក្ខេបបទនេះគឺដើម្បី ពិពណ៌នាអំពីការកែច្នៃរមៀត (*Curcuma Longa* L.) ក្រោយការប្រមូលផល នៅក្នុងប្រទេសកម្ពុជា និងផលប៉ះពាល់របស់វាទៅលើគុណភាពរមៀត។ បន្ទាប់ពីទទួលបានលទ្ធផលពីការសិក្សានៅប្រទេសកម្ពុជា ការសិក្សាពីផលប៉ះពាល់ (ក្រោមលក្ខខណ្ឌត្រួតពិនិត្យ) ដល់គុណភាពរបស់រមៀតដោយសារតែប្រតិបត្តិការ (ចម្អិន សម្ងួត និងកិន) និងដំណើរការនៃការកែច្នៃ ត្រូវបានសិក្សា។ ការសិក្សានេះគឺពិតជាចាំបាច់ណាស់ដើម្បីកែសម្រួលដំណើរការផលិតរមៀត ក្នុងគោលបំណងធ្វើឱ្យប្រសើរឡើងនូវគុណភាពវិភាគដោយញាណ និងគុណភាពមុខងារ របស់រមៀត និងដើម្បីផ្តល់យោបល់ពីវិធីសាស្ត្រក្នុងការកែច្នៃរមៀតដែលអាចទទួលយកបាន សម្រាប់ប្រទេសនៅភាគខាងត្បូង និងជាពិសេសសម្រាប់ប្រទេសកម្ពុជា។

ការងារនេះមានគោលបំណងឆ្លើយសំណួរស្រាវជ្រាវសំខាន់ៗដូចខាងក្រោម៖

1. តើវិធីសាស្ត្រនៃការកែច្នៃរមៀតអ្វីខ្លះដែលត្រូវបានអនុវត្តនៅក្នុងប្រទេសកម្ពុជា?
2. តើលក្ខណៈគុណភាពរបស់រមៀតអ្វីខ្លះដែលត្រូវបានប៉ះពាល់ដោយសារដំណើរការនៃការកែច្នៃ តើវាប៉ះពាល់យ៉ាងដូចម្តេចខ្លះ និងមានសមាមាត្រប៉ុន្មាន?

ដើម្បីឆ្លើយសំណួរស្រាវជ្រាវទាំងនេះ ដំបូងយើងបានធ្វើការសិក្សាគន្ថនិទ្ទេសអំពីទិដ្ឋភាពទូទៅ និងលក្ខណៈរបស់រមៀត ដំណើរការនៃការកែច្នៃរមៀត និងគុណភាពរមៀត (ជំពូក១)។ បន្ទាប់មក យើងបានធ្វើការសម្ភាសប្រតិបត្តិការកែច្នៃរមៀត នៅក្នុងប្រទេសកម្ពុជា អំពីវិធីសាស្ត្រនៃការកែច្នៃរមៀត ដែលត្រូវបានអនុវត្តនៅក្នុងក្រុមហ៊ុន ឬក៏សហគ្រាសរបស់ពួកគេ និងវាស់វែងវិភាគផលប៉ះពាល់របស់វាទៅលើគុណភាពរបស់រមៀត (អត្ថបទ១)

ជំពូក២)។ ក្នុងជំពូកនេះ យើងមានគោលបំណងពិពណ៌នាអំពីការកែច្នៃរមៀត (*Curcuma longa* L.) ក្រោយ ការប្រមូលផល នៅក្នុងប្រទេសកម្ពុជា ដោយកំណត់យកតំបន់ចំនួនបីផ្សេងគ្នា (ខេត្តសៀមរាប រាជធានីភ្នំពេញ និងខេត្តកំពត) និងក្រុមហ៊ុនកែច្នៃចំនួនបី។ ផលប៉ះពាល់នៃប្រភព (ប្រភពដើមនៃវត្ថុធាតុដើម និងផ្នែកនៃមើម រមៀត៖ ដៃរមៀត និងក្បាលរមៀត) និងផលប៉ះពាល់នៃដំណើរការនៃការកែច្នៃ ទៅលើគុណភាពរបស់រមៀត (ដំណើរការនៃការកែច្នៃ ការចិតសំបក និងការចម្អិន) ត្រូវបានវាយតម្លៃ។ នៅក្នុងស្ថានភាពជាក់ស្តែងនៅប្រទេស កម្ពុជា វិធីសាស្ត្រនៃការកែច្នៃរមៀតត្រូវបានកត់សម្គាល់ និងមានលក្ខណៈប្រែប្រួល។ លក្ខណៈគុណភាពដែល ត្រូវបានសិក្សាមាន៖ ទំហំ និងបំណែងចែកភាគល្អិត ពណ៌ (L^* a^* និង b^*) បរិមាណប្រេងប្រហើរ បរិមាណ Total និង Bioaccessible Curcuminoids (Curcumine "C" Demethoxycurcumine "DMC" និង Bisdemethoxycurcumine "BDMC") និង Bioaccessibility របស់ Curcuminoids។ បន្ទាប់មក (អត្ថបទ២ ជំពូក៣) ផលប៉ះពាល់នៃការចម្អិន និងការសម្ងួត (ក្រោមលក្ខខណ្ឌត្រួតពិនិត្យ) ទៅលើ ពណ៌ (L^* a^* និង b^*) បរិមាណ Curcuminoids (C DMC និង BDMC) បរិមាណប្រេងប្រហើរ និងសមាសធាតុក្លិន របស់ *Curcuma Longa* L. ត្រូវបានសិក្សា។ ផលប៉ះពាល់នៃការចម្អិន ទៅលើស៊ីនេទិចនៃការសម្ងួតក៏ត្រូវបានសិក្សាផងដែរ។ សមតុល្យនៃបរិមាណសារធាតុស្អុត បរិមាណទឹក និងបរិមាណ Curcuminoids ត្រូវបានគណនា។ ការវិភាគ ផ្នែកមីក្រូទស្សន៍នៃរមៀតត្រូវបានសិក្សា ដើម្បីកំណត់ទីតាំងរបស់ អាមីដុង ប្រេងប្រហើរ និង Curcuminoids និងដើម្បីវាយតម្លៃពីផលប៉ះពាល់នៃដំណើរការកែច្នៃ លើការចែកចាយរបស់វានៅក្នុងកោសិកា។ បន្ទាប់មកទៀត (អត្ថបទ៣ ជំពូក៤) ផលប៉ះពាល់នៃការចម្អិន ការសម្ងួត និងការកិន និងដំណើរការកែច្នៃ ទៅលើបរិមាណប្រេង ប្រហើរ បរិមាណ Total និង Bioaccessible Curcuminoids (C DMC និង BDMC) និង Bioaccessibility របស់ Curcuminoids និងគុណភាពវិភាគដោយញ្ញាណរបស់ *Curcuma Longa* L. ត្រូវបានសិក្សា។ លទ្ធផលទទួលបានពីការសិក្សានេះត្រូវបានបោះពុម្ពផ្សាយជាទម្រង់អត្ថបទវិទ្យាសាស្ត្រប៊ី នៅក្នុងទស្សនាវដ្តី អន្តរជាតិ៖

- ការបោះពុម្ពផ្សាយអត្ថបទ១៖ ការកែច្នៃរមៀត *Curcuma Longa* L. ក្រោយការប្រមូលផល នៅក្នុង ប្រទេសកម្ពុជា - ផលប៉ះពាល់ទៅលើគុណភាព
- ការបោះពុម្ពផ្សាយអត្ថបទ២៖ ផលប៉ះពាល់នៃការចម្អិន និងការសម្ងួត លើពណ៌ បរិមាណ Curcuminoids និងសមាសធាតុក្លិន របស់ *Curcuma Longa* L.
- ការបោះពុម្ពផ្សាយអត្ថបទ៣៖ ផលប៉ះពាល់នៃការចម្អិន ការសម្ងួត និងការកិន លើគុណភាពវិភាគ ដោយញ្ញាណ និងគុណភាពមុខងារ របស់ *Curcuma Longa* L.

លទ្ធផល៖ ដំណើរការកែច្នៃរមៀតបីផ្សេងគ្នាដែលបានអនុវត្តនៅក្នុងតំបន់ចំនួនបីផ្សេងគ្នានៃប្រទេសកម្ពុជា (ខេត្ត សៀមរាប រាជធានីភ្នំពេញ និងខេត្តកំពត) ត្រូវបានអង្កេត ពិពណ៌នា និងប្រៀបធៀប ដើម្បីឆ្លើយសំណួរស្រាវជ្រាវ ដំបូងរបស់យើង។ វិធីសាស្ត្រដែលគេហៅថា "5M" ដែលត្រូវបានប្រើប្រាស់ក្នុងការអភិវឌ្ឍន៍ប្រព័ន្ធការវិភាគគ្រោះ ថ្នាក់ និងចំណុចត្រួតពិនិត្យសំខាន់ (HACCP) ត្រូវបានប្រើដើម្បីពិពណ៌នាជំហាននីមួយៗនៃការផលិតរមៀត ទាំងបី ក្នុងលក្ខណៈច្បាស់លាស់ និងពេញលេញ ដោយប្រើវិមាត្រប្រាំ៖ សម្ភារៈ (រមៀត) ម៉ាស៊ីន (ឧបករណ៍ បរិក្ខារ) មជ្ឈដ្ឋាន (បរិស្ថាន លក្ខខណ្ឌ) វិធីសាស្ត្រ និងកម្លាំងពលកម្ម (មនុស្ស) (អត្ថបទ១ ជំពូក ២)។ លទ្ធផល បង្ហាញថា ភាពខុសគ្នាចម្បងនៃការកែច្នៃរមៀតនៅតំបន់ផ្សេងៗគ្នាមានដូចជា៖ (i) ចម្អិនមុនសម្ងួត (ករណី

សិក្សា១៖សៀមរាប) (ii) កាត់មុនសម្អាត (ករណីសិក្សា២៖ភ្នំពេញ) (iii) ចម្អិន និងកាត់មុន សម្អាត (ករណីសិក្សា ៣៖កំពត)។ តម្រូវការកម្លាំងពលកម្មសម្រាប់ការកែច្នៃរមៀតនៅក្នុងសហគ្រាសទាំងបីគឺ៖ ១០នាក់/១០០ គីឡូក្រាម/ថ្ងៃ ៤នាក់/២០០គីឡូក្រាម/ថ្ងៃ និង១៣នាក់/២០០គីឡូក្រាម/ថ្ងៃ សម្រាប់ករណីសិក្សាតំបន់ទី១ ២ និងទី៣ រៀងគ្នា។ បន្ទាប់ពីការចិតសម្បករមៀតដោយស្វ័យប្រវត្តិ រមៀតត្រូវចិតម្តងទៀត ដោយប្រើកាំបិត ដើម្បី ធានាថាសម្បករទាំងអស់ត្រូវបានដកចេញទាំងស្រុង (ករណីសិក្សា១)។ ការចិតសម្បករដោយប្រើកាំបិតនេះ មិន គួរ រួមបញ្ចូលទៅក្នុងដំណើរការកែច្នៃរមៀតនោះទេ ពីព្រោះវាមិនត្រឹមតែចំណាយពេលយូរ (ត្រូវការមនុស្ស ១០ នាក់ និងរយៈពេល ៥ម៉ោង ដើម្បីចិតសំបករមៀត១០០គីឡូក្រាម) និងទិន្នផលទាប (បាត់បង់ទិន្នផល ៤,៥ ភាគរយ) ប៉ុន្តែវាក៏មានផលប៉ះពាល់ដល់គុណភាពផងដែរ ដោយសារតែរមៀតប្តូរពណ៌ទៅជាពណ៌ត្នោត។ លទ្ធផលនេះផ្ទុយនឹងការអះអាងរបស់ Bambirra *et al.* (2002) ដែលបានបង្ហាញថាការចិតសម្បករចេញ អាចបណ្តាលឱ្យបាត់បង់ទិន្នផលរហូតដល់ ៣០ ភាគរយ។ ការចម្អិនអាហារហ្វូសប្រមាណធ្វើឱ្យពណ៌របស់ រមៀតខូច ប៉ុន្តែរមៀតនឹងក្លាយជា "រឹង" ពេក នៅពេលចម្អិនមិនគ្រប់គ្រាន់។ វិទ្យាស្ថានស្រាវជ្រាវគ្រឿងទេស ឥណ្ឌា និងមជ្ឈមណ្ឌលព័ត៌មានបច្ចេកវិទ្យាកសិកម្ម ណែនាំឱ្យចម្អិនរមៀតទាំងមូលក្នុងទឹកពុះរយៈពេល ៤៥ នាទី ទៅ ១ ម៉ោង រហូតទាល់តែមានពុះលេចឡើងនៅលើផ្ទៃរមៀត ដកស្រង់ដោយ Ararsa (2018)។ នៅ ប្រទេសកម្ពុជា មើមរមៀតដែលចិតសម្បករចេញរមៀតលាងសម្អាត (ជាមួយទឹកអំបិល ទឹកប្រៃ និងទឹកដែលឆ្លង កាត់ការសម្អាតដោយប្រព័ន្ធកាំស្មីយូរី និងអូប្រូន) ឬចម្អិនក្នុងទឹកដាំពុះ រយៈពេល ៣០ ទៅ ៤០នាទី ដើម្បី កម្ទាត់ភាពខ្វក់ (ធូលី) និងកាត់បន្ថយមីក្រូសារពាង្គកាយ។ មុនយកទៅសម្អាត រមៀតដែលបានសម្អាត ឬ ចម្អិនរួច (សម្អាតដោយផ្ទាល់សម្រាប់ករណីសិក្សា១) គឺត្រូវហាន់ជាចំណិតស្តើងៗមានកម្រាស់ ចាប់ពី ១ ទៅ ២ មីលីម៉ែត្រ (ករណីសិក្សា២) និង ៣ មីលីម៉ែត្រ (ករណីសិក្សា៣) រៀងគ្នា។ ការប្រើទូរសម្អាតដើរដោយពន្លឺព្រះ អាទិត្យ (Solar dryer) ធ្វើឱ្យរយៈពេលសម្អាតថយចុះ (ប្រហែល ៥០ ភាគរយ) នៅពេលដែលការកាត់ត្រូវបាន បញ្ចូលនៅក្នុងដំណើរការកែច្នៃរមៀត (ករណីសិក្សា៣)។ ការសម្អាតរមៀតក្នុងបន្ទប់ (មានដំបូលដែក និងកង្ហារដើម្បី ពន្លឺនដំណើរការសម្អាត) រួចយកទៅសម្អាតក្នុងឡ (ករណីសិក្សា២) ក៏ជួយកាត់បន្ថយរយៈពេលសម្អាតផងដែរ ប៉ុន្តែវាប្រើប្រាស់ថាមពលច្រើនជាងបច្ចេកទេសសម្អាតក្នុងឡដើរដោយពន្លឺព្រះអាទិត្យ (Solar drying)។ ម្យ៉ាង វិញទៀត បច្ចេកទេសនេះគឺមានភាពស្មុគស្មាញ ដោយសារតែរមៀតពាក់កណ្តាលស្អាតត្រូវបានផងដោយដៃ ដើម្បីបំបែករមៀតតូចៗ ចេញពីរមៀតធំៗ កំណាត់រមៀតតូចៗត្រូវបានប្រមូលទុក ប៉ុន្តែកំណាត់រមៀតធំៗត្រូវ បានផ្ទេរទៅឡសម្អាត ដើម្បីបន្តការសម្អាត។ នៅក្នុងករណីសិក្សាទាំងអស់ ការសម្អាតគឺមិនមានសីតុណ្ហភាព និង រយៈពេលជាក់លាក់នោះឡើយ វាអាស្រ័យទៅលើអាកាសធាតុ (សីតុណ្ហភាពពេលថ្ងៃ និងពេលយប់)។ លើស ពីនេះ ប្រតិបត្តិការពិនិត្យមើលថាតើរមៀតស្អាតទាំងស្រុងហើយឬនៅ ដើម្បីបញ្ឈប់ដំណើរការសម្អាត ដោយការ សង្កេតមើលដោយភ្នែក និងវិនិច្ឆ័យដោយដៃរបស់ពួកគេថាតើវាក្រៀម ឬស្រួយ ហើយឬនៅ។ ការអនុវត្តបែបនេះ នាំឱ្យគុណភាពរបស់ផលិតផលសម្រេច (ម្សៅរមៀត) ប្រែប្រួល។ វិធីសាស្ត្រដែលគេអនុវត្តនៅខេត្តកំពត ចំណាយពេលវេលាសម្អាតខ្លីជាងគេ (ចន្លោះពី២៤ ដល់៤៥ម៉ោង ដោយសារតែគេធ្វើការចម្អិន និងកាត់រមៀតមុន នឹងយកទៅសម្អាត) និងទទួលបាន ទិន្នផលខ្ពស់ជាងគេ (១៦,២ ភាគរយ) ហើយមានបរិមាណទឹកចុង ក្រោយប្រហែល ៦ ភាគរយ អនុលោមតាមស្តង់ដារ ISO ៥៥៦២:១៩៨៣ (International Organization for Standardization 1983)។ លទ្ធផលនៃដំណើរការកែច្នៃនេះគឺមានការព្រមព្រៀងជាមួយ Pradeep *et al.*

(2016) ដែលបានរកឃើញថាទិន្នផលនៃរមៀតស្ងួតគឺចាប់ពី ១៧,១ ទៅ ២០,៦ ភាគរយ គឺអាចប្រៀបធៀបបាន រវាងវិធីសាស្ត្រសម្ងួតផ្សេងៗ (ការសម្ងួតមេកានិច Black surface coupled with sun drying និង Normal sun drying)។ ទោះយ៉ាងណាក៏ដោយ Sasikumar (2012) បានរកឃើញថាទិន្នផលរមៀតគឺស្ថិតនៅ ចន្លោះពី ៩,៨ ទៅ ១៤,៥ ភាគរយ ជាមួយនឹងបរិមាណទឹកចាប់ពី ៨,៨ ទៅ ៩,៩ ភាគរយ។ Sasikumar (2012) បានរាយការណ៍ថាការសម្ងួតក្នុងទូរដើរដោយពន្លឺព្រះអាទិត្យ (Solar drying) គឺប្រសើរជាងការសម្ងួត ដោយហាលថ្ងៃផ្ទាល់ (Sun drying) ព្រោះវាសម្រេចបាននូវបរិមាណទឹកដែលចង់បាន និងគុណភាពសំខាន់ៗ ក្នុងរយៈពេល ៤២ ម៉ោង (៦ ថ្ងៃ) បើប្រៀបធៀបទៅនឹង ៥៦ ម៉ោង (៨ ថ្ងៃ) សម្រាប់ការសម្ងួតដោយហាលថ្ងៃ ផ្ទាល់ (Sun drying) ដែលអាចសន្សំសំចៃពេលវេលាបានច្រើនរហូតដល់ ១៤ ម៉ោង។ ភាពខុសគ្នារវាងការកែ ច្នៃរមៀតនៅក្នុងប្រទេសកម្ពុជា និងប្រទេសឥណ្ឌា គឺការកាត់ ការចិតសម្បក និងការខាត។ នៅក្នុងប្រទេស ឥណ្ឌា ការកែច្នៃរមៀតមិនមានការចិតសម្បកមុនពេលចម្អិន និងមុនពេលសម្ងួតទេ ប៉ុន្តែការខាតត្រូវបានអនុវត្ត បន្ទាប់ពីការសម្ងួត។ នៅក្នុងប្រទេសកម្ពុជា រមៀតត្រូវបានកាត់ជាចំណិតៗបន្ទាប់ពីសម្អាតរួច (ករណីសិក្សា២) ឬចម្អិន (ករណីសិក្សា៣) ប៉ុន្តែការកាត់រមៀតជាចំណិតៗនេះគឺមិនត្រូវបានអនុវត្តនៅក្នុងការកែច្នៃរមៀតនៅ ក្នុងប្រទេសឥណ្ឌានោះទេ (Sasikumar 2012)។

Curcuma ប្រហែល ២០ ទៅ ២៥ ប្រភេទ មានដើមកំណើតនៅប្រទេសកម្ពុជា វៀតណាម និងឡាវ (Ravindran *et al.* 2007)។ បច្ចុប្បន្ននេះ រមៀតយ៉ាងហោចណាស់ ១៣ ប្រភេទ (ភាគច្រើនជាពូជព្រៃ) ត្រូវបាន គេរកឃើញនៅលើភ្នំគូលែន ខេត្តសៀមរាប នៃប្រទេសកម្ពុជា ក្នុងនោះរមៀតពណ៌លឿង (*Curcuma longa* L.) ត្រូវបានប្រើប្រាស់យ៉ាងទូលំទូលាយបំផុត។ រមៀតដែលមានប្រភពខុសៗគ្នា (ប្រភពដើម និងផ្នែកនៃមើមរមៀត ៖ ដៃរមៀត និងក្បាលរមៀត) មានពណ៌ រូបរាង និងទំហំខុសៗគ្នា។ ប្រវែងដៃរមៀតគឺមានប្រវែងចន្លោះពី ៣,០ ទៅ ១០,៥ សង់ទីម៉ែត្រ ហើយអង្កត់ផ្ចិតរបស់វាប្រែប្រួលពី ១,១ ទៅ ២,៤ សង់ទីម៉ែត្រ។ ក្បាលរមៀតដែលមាន រាងពងក្រពើមានប្រវែងខ្លីជាងដៃរមៀត (ពី ២,៥ ទៅ ៩,៥ សង់ទីម៉ែត្រ) និងមានអង្កត់ផ្ចិតធំជាងដៃរមៀត (ពី ២,៥ ទៅ ៤,៧ សង់ទីម៉ែត្រ)។ យើងអាចធ្វើការសន្និដ្ឋានបានថា ពូជ កម្រិតភាពចាស់ ដី អាកាសធាតុ និង បច្ចេកទេសដាំដុះអាចប៉ះពាល់ដល់រូបរាងរបស់រមៀត។ ប្រភព (ប្រភពដើម និងផ្នែកនៃមើមរមៀត៖ ដៃរមៀត និង ក្បាលរមៀត) ធ្វើឱ្យប៉ះពាល់ដល់បរិមាណប្រេងប្រហើរ (ក្លិន) ច្រើនជាងបរិមាណ Curcuminoids (ពណ៌)។ បរិមាណប្រេងប្រហើររបស់មើមរមៀត (ដៃរមៀត និងក្បាលរមៀត) និងបរិមាណ Curcuminoids (ក្បាលរមៀត) ពីខេត្តសៀមរាបគឺខ្ពស់ជាងរមៀតដែលយកមកពីករណីសិក្សា២ (ភ្នំពេញ)។ ជាងនេះទៅទៀត សមាសធាតុទាំង នេះក៏ខុសគ្នាទៅតាមផ្នែករបស់នៃមើមរមៀតផងដែរ។ បរិមាណប្រេងប្រហើររបស់ក្បាលរមៀតដែលយកមកពី ករណីសិក្សា១ (សៀមរាប) និង២ (ភ្នំពេញ) គឺមានបរិមាណខ្ពស់ជាងដៃរមៀត ចាប់ពី៤៨ ទៅ៥៩ ភាគរយ។ បរិមាណ Curcuminoids ក៏មានការប្រែប្រួលទៅតាមផ្នែកនៃរមៀតផងដែរ។ បរិមាណ Curcuminoids របស់ ក្បាលរមៀតដែលមានប្រភពពីខេត្តសៀមរាប មានបរិមាណខ្ពស់ជាងដៃរមៀត ១៥ ភាគរយ។ Choudhury *et al.* (2017) ក៏បានរកឃើញថាបរិមាណ Curcumin នៅក្នុងក្បាលរមៀតស្រស់គឺ ១៥ ទៅ ៣៨ ភាគរយ ខ្ពស់ ជាងដៃរមៀតស្រស់ ពីព្រោះ Phytochemical constituents មិនត្រូវបានចែកចាយស្មើៗគ្នានៅទូទាំងផ្នែកទាំង អស់នៃមើមរមៀតនោះទេ។ ទោះជាយ៉ាងណាក៏ដោយ ក្នុងករណីសិក្សា២ បរិមាណ Curcuminoids របស់ដៃ រមៀត និងក្បាលរមៀតមិនខុសគ្នានោះទេ សម្រាប់រមៀតដែលមានប្រភពមកពីចម្ការ (PP/O1) ប៉ុន្តែបរិមាណ

Curcuminoids របស់ PP/O2_Fresh finger គឺ ខ្ពស់ជាង PP/O2_Fresh mother ២,៩ ភាគរយ។ ប្រភព ដើមផ្សេងៗគ្នានៃមីមរមៀត (ដៃ និងក្បាលរមៀត) មានបរិមាណ Bioaccessible curcuminoids ខុសគ្នា។ Bioaccessibility របស់ curcuminoids របស់ដៃរមៀតស្រស់មានចាប់ពី ៧,០ ភាគរយ ដល់ ១៣,៦ ភាគរយ ខណៈដែលក្បាលរមៀតស្រស់មានចាប់ពី ៩,៥ ភាគរយ ទៅ ១៦,៨ ភាគរយ។ គ្មានលក្ខណៈទូទៅណាមួយត្រូវ បានគេសង្កេតឃើញសម្រាប់ បរិមាណ Bioaccessible curcuminoids និង Bioaccessibility របស់ curcuminoids របស់ដៃរមៀត និងក្បាលរមៀតស្រស់នោះទេ។ ទោះបីជាបរិមាណ Curcuminoids របស់រមៀត ស្រស់យកមកពីខេត្តសៀមរាបមានបរិមាណច្រើនជាងរមៀតដែលយកមកពីករណីសិក្សា២ (ភ្នំពេញ) ប៉ុន្តែ បរិមាណ Bioaccessible curcuminoids និង Bioaccessibility របស់ curcuminoids របស់វាមិនខ្ពស់នោះ ទេ។

ការចិតសម្បករមៀតមិនមានផលប៉ះពាល់ដល់បរិមាណ Curcuminoids និង Bioaccessibility របស់ Curcuminoids របស់ក្បាលរមៀត និងដៃរមៀតនោះទេ ប៉ុន្តែបរិមាណប្រេងប្រហើររបស់ដៃរមៀតបានកើនឡើង បន្តិច (៥,១ ភាគរយ)។ ការចម្អិនរមៀតគ្មានឥទ្ធិពលទៅលើបរិមាណប្រេងប្រហើរ Bioaccessible Curcuminoids និង Bioaccessibility របស់ Curcuminoids នោះទេ ទោះបីជារមៀតត្រូវបានចម្អិននៅ រយៈ ពេលយូរ ចន្លោះចាប់ពី ៣០ ទៅ ៤០ នាទី នៅសីតុណ្ហភាពខ្ពស់ រហូតដល់ ១០០ អង្សាសេ ក៏ដោយ។ បន្ទាប់ពី ការកែច្នៃ គ្មានលក្ខណៈទូទៅណាមួយត្រូវបានកត់សម្គាល់ឃើញសម្រាប់ បរិមាណប្រេងប្រហើរ និងបរិមាណ Curcuminoids នោះទេ ប៉ុន្តែបរិមាណ Bioaccessible Curcuminoids ថយចុះ ។ នេះអាចប្រហែល ដោយសារតែ ភាពខុសគ្នានៃទំហំរមៀតស្រស់ និងទំហំរមៀត (ករណីសិក្សា១) សំណាកស្នូតមិនមានភាព ស្មើសាច់ (សំណាកមិនតំណាងឱ្យរមៀតទាំងមូល ដូចដែលបានបង្ហាញនៅក្នុងករណីសិក្សា២) ភាពខុសគ្នា ខ្លាំងនៃរយៈពេលសម្ងួត (ករណីសិក្សា៣) និងលក្ខខណ្ឌសម្ងួតដែលមិនអាចគ្រប់គ្រងបាន (ដោយសារតែការស ង្កតក្នុងទូរដើរដោយពន្លឺព្រះអាទិត្យ Solar drying វាអាស្រ័យទៅលើអាកាសធាតុ)។ ទោះយ៉ាងណាក៏ដោយ លទ្ធផលដែលទទួលបានពីការសង្កេត និងការវិភាគលើគុណភាពរបស់សំណាកដែលយកមកពីការចុះអង្កេត នៅក្នុងប្រទេសកម្ពុជា បានអនុញ្ញាតឱ្យយើងអាចសន្និដ្ឋានជាបឋមថា ការចម្អិន និងការកាត់ជាចំណិត គឺជា ប្រតិបត្តិការចាំបាច់ដែលត្រូវអនុវត្តក្នុងដំណើរការនៃការកែច្នៃរមៀត ពីព្រោះវាអាចកាត់បន្ថយរយៈពេលសម្ងួត សន្សំសំចៃថាមពល និងថែរក្សាគុណភាពរមៀត។ រមៀតស្រស់យកមកពីខេត្តសៀមរាប គួរតែជាជម្រើសដ៏ល្អ ព្រោះវាមានបរិមាណប្រេងប្រហើរច្រើនជាង និងបរិមាណ Curcuminoids ស្មើគ្នា បើប្រៀបធៀបនឹងរមៀតយក មកពីករណីសិក្សា២ (ភ្នំពេញ)។ ដោយសារតែការរាតត្បាតនៃជម្ងឺ Covid-19 យើងមិនអាចយករមៀតពីប្រទេស កម្ពុជាសម្រាប់ការសិក្សារបស់យើងនៅប្រទេសបារាំងបាននោះទេ ដូច្នេះវត្ថុធាតុដើមដែលប្រើក្នុងជំពូកទី៣ ត្រូវ បានទិញពីហាងលក់គ្រឿងទេសអាស៊ីនៅទីក្រុង Montpellier (Wei Sin) ប្រទេសបារាំង។ ការសិក្សាបានផ្តោត តែលើ ដៃរមៀតសម្រាប់ជំពូកបន្ទាប់ (៣ និង៤) ពីព្រោះភាគរយរបស់វាតំណាងឱ្យប្រហែល ៩០ ភាគរយ នៃមីម រមៀតទាំងមូល។ ការស្រាវជ្រាវជាច្រើនបានបង្ហាញថា ការសម្ងួតដោយពន្លឺព្រះអាទិត្យ (Sun drying) ត្រូវបាន អនុវត្តយ៉ាងទូលំទូលាយនៅក្នុងប្រទេសដែលមានអាកាសធាតុក្តៅ និងប្រទេសនៅតំបន់ត្រូពិច ដោយសារតែ ការចំណាយទាប និងបច្ចេកវិទ្យាសាមញ្ញរបស់វា។ ទោះជាយ៉ាងណាក៏ដោយ វាពឹងផ្អែកខ្លាំងទៅលើលក្ខខណ្ឌ អាកាសធាតុ ដែលវាអាចត្រូវការរយៈពេលសម្ងួតយូរដែលធ្វើឱ្យប៉ះពាល់ដល់គុណភាពផលិតផល។ ការសម្ងួត

ដោយខ្យល់ក្តៅ (Air drying) គឺជាជម្រើសមួយជំនួសឱ្យការសម្ងួតដោយពន្លឺព្រះអាទិត្យ (Sun drying) ដោយសារតែវាមិនត្រឹមតែជួយកាត់បន្ថយរយៈពេលសម្ងួតប៉ុណ្ណោះទេ ប៉ុន្តែថែមទាំងជួយរក្សាគុណភាពផលិតផលឱ្យកាន់តែប្រសើរឡើងផងដែរ។

ការងារពិសោធន៍ពីរត្រូវបានអនុវត្តដើម្បីកំណត់លក្ខណៈ និងស្វែងយល់ពីផលប៉ះពាល់នៃការចម្អិន ការសម្ងួត និងការកិន និងដំណើរការនៃការកែច្នៃរមៀតទៅលើគុណភាពវាយតម្លៃដោយញាណ និងគុណភាពមុខងាររបស់រមៀត។ ផលប៉ះពាល់នៃការចម្អិន និងការសម្ងួត ទៅលើពណ៌ (L^* a^* និង b^*) បរិមាណ Curcuminoids (CDMC និង BDMC) បរិមាណប្រេងប្រហើរ និងសមាសធាតុគីមី របស់ *Curcuma Longa* L. ត្រូវបានសិក្សា (អត្ថបទ២ ជំពូក៣)។ រមៀតស្រស់ដែលមានកម្រាស់៥មីលីម៉ែត្រ ត្រូវបានសម្ងួតដោយប្រើទូរសម្ងួតនៅសីតុណ្ហភាព ៦០អង្សាសេ និងRH៤០ភាគរយ ដោយផ្ទាល់ ឬក្រោយពេលចម្អិននៅសីតុណ្ហភាព៩៥ អង្សាសេ រយៈពេល ៣ ឬ៦០ នាទី។ ការសិក្សាបានបង្ហាញថាការចម្អិននៅសីតុណ្ហភាព ៩៥ អង្សាសេ រយៈពេល ៦០ នាទី និងការសម្ងួត បានធ្វើឱ្យពណ៌របស់រមៀតថយចុះ ច្រើនជាងការចម្អិននៅសីតុណ្ហភាព ៩៥ អង្សាសេ រយៈពេល ៣ នាទី។ ការចម្អិន (សីតុណ្ហភាព ៩៥ អង្សាសេ រយៈពេល ៣ ឬ ៦០នាទី) អាចរក្សាបរិមាណ Curcuminoids និងបរិមាណប្រេងប្រហើរ កាត់បន្ថយរយៈពេលសម្ងួត និងធ្វើឱ្យបម្រែបម្រួលសារធាតុគីមីរបស់ប្រេងប្រហើរបន្តិចបន្តួចតែប៉ុណ្ណោះ។ Curcuminoids គឺជាសារធាតុពណ៌ដែលរលាយក្នុងប្រេង មិនរលាយក្នុងទឹកក្នុងមជ្ឈដ្ឋានអាស៊ីត និងណឺត ហើយត្រូវបានគេស្គាល់ថាជានឹងសីតុណ្ហភាពខ្ពស់ (លើសពី១០០អង្សាសេ) (Lee *et al.* 2013)។ លើសពីនេះទៀតការសង្កេតមីក្រូទស្សន៍បានបញ្ជាក់ថាការចម្អិនរមៀតរយៈពេល ៣ នាទី នៅសីតុណ្ហភាព ៩៥ អង្សាសេ គឺគ្រប់គ្រាន់ដើម្បីឱ្យអាមីដុងរលាយ (Gelatinise) ទាំងស្រុង។ Amyloplasts អាចមើលឃើញនៅក្នុងរមៀតស្រស់ ប៉ុន្តែពួកវាលែងឃើញនៅក្នុងរមៀតឆ្អិនទៀតហើយ។ លើសពីនេះទៅទៀត ការចម្អិនរួមជាមួយនឹងការសម្ងួតនាំឱ្យមានការចាកចេញដោយផ្នែក (ការបែកខ្ចាត់ខ្ចាយ) នៃសារធាតុ Curcuminoids ពីកោសិការបស់វា។ បន្ទាប់មក សារធាតុ Curcuminoids ត្រូវបានរកឃើញនៅពេញមើមរមៀត ហើយហាក់ដូចជាត្រូវបាន "ស្រូបយក" មួយផ្នែកនៅលើកោសិកាអាមីដុង។ ម៉ាទ្រីសអាមីដុងនេះអាចការពារ Curcuminoids។ ការវិវិលនៃជញ្ជាំងកោសិកាដែលអនុញ្ញាតឱ្យសារធាតុ Curcuminoids ចេញក៏អាចពន្យល់ពីការដកទឹកចេញបានកាន់តែងាយស្រួលនៅពេលដែលរមៀតត្រូវបានចម្អិនមុនពេលស្ងួត។ ការចម្អិននៅសីតុណ្ហភាព ៩៥ អង្សាសេ រយៈពេល ៣នាទី និងរយៈពេល ៦០នាទី អាចចំណេញពេលសម្ងួតរហូតដល់ ៣៨ ភាគរយ និង ៥០ ភាគរយ រៀងគ្នា។

លទ្ធផលទាំងនេះគឺស្របជាមួយ Govindarajan and Stahl (1980) ដែលបានរកឃើញថានៅពេលមើមរមៀតត្រូវបានចម្អិន អាមីដុងរលាយ វាសម្រួលដល់ការសម្ងួត និងបង្កើនអត្រានៃការដកជាតិទឹក ជាលទ្ធផលពេលវេលាសម្ងួតសរុបត្រូវបានកាត់បន្ថយ។ ការសម្ងួតបានបន្ថយបរិមាណ Curcuminoid (៣៨ ភាគរយ) និងបរិមាណប្រេងប្រហើរ (១៣ ភាគរយ)។ វិធីសាស្ត្រសម្ងួតជាទូទៅមានឥទ្ធិពលអវិជ្ជមានទៅលើបរិមាណប្រេងប្រហើរ (Kutti Gounder and Lingamallu 2012)។ Ararsa (2018) ក៏បានរកឃើញការបាត់បង់បរិមាណប្រេងប្រហើរ រហូតដល់ ២៥ ភាគរយ តាមរយៈការសម្ងួត និងការបម្លែងនៃសមាសធាតុប្រេងប្រហើរមួយចំនួនដែលងាយប្រតិកម្មនឹងពន្លឺ។ ប្រេងប្រហើរ មានវត្តមាននៅក្នុងកោសិកា ដែលមានវត្តមាននៅក្នុងតំបន់ Meristematic នៃមើមរមៀត។ កោសិកាប្រេងទាំងនេះត្រូវបានខូចខាតកំឡុងពេលចម្អិនរមៀត និងការហើរនៃ

ប្រេងប្រហើរទៅក្នុងបរិយាកាស ដែលបណ្តាលឱ្យមានការបាត់បង់ក្នុងអំឡុងពេលសម្ងាត់ (Díaz-Maroto *et al.* 2002)។ ការចម្អិនរៀត (កម្រាស់ ៥ មីលីម៉ែត្រ) នៅសីតុណ្ហភាព ៩៥ អង្សាសេ រយៈពេល ៣ នាទី ត្រូវបាន ណែនាំមុនពេលមុនសម្ងាត់ (សីតុណ្ហភាព ៦០ អង្សាសេ RH ៤០ ភាគរយ) ទោះបីជាពេលវេលាសម្ងាត់ត្រូវបាន កាត់បន្ថយតិចជាងបន្ទាប់ពីចម្អិននៅសីតុណ្ហភាព ៩៥ អង្សាសេ រយៈពេល ៦០ នាទី ក៏ដោយ។ ទោះជាយ៉ាង ណាក៏ដោយ យើងមិនដឹងថាតើការចម្អិនមានផលប៉ះពាល់ដល់ Bioaccessible curcuminoids និងគុណភាព វាយតម្លៃដោយញ្ញាណ របស់រៀតដែរឬទេ។ បន្ថែមពីលើនេះ ដោយសារតែការសម្ងាត់មានផលប៉ះពាល់ខ្លាំងទៅ លើបរិមាណប្រេងប្រហើរ និងបរិមាណ Curcuminoids ការសិក្សាស៊ីជម្រៅទៅលើការសម្ងាត់ត្រូវបានធ្វើឡើង។ Bioaccessibility នៃសមាសធាតុ (Compound of interests) គឺទាក់ទងទៅនឹងទំហំភាគល្អិត (Particle size) ដូច្នេះយើងរំពឹងផងដែរថាទំហំភាគល្អិត អាចមានឥទ្ធិពលលើគុណភាពវាយតម្លៃដោយញ្ញាណ។ ផលប៉ះពាល់នៃការចម្អិន ការសម្ងាត់ និងការកិន និងដំណើរការនៃការកែច្នៃរៀត លើបរិមាណប្រេងប្រហើរ បរិមាណ Total និង Bioaccessible Curcuminoids (C DMC និង BDMC) និង Bioaccessibility របស់ Curcuminoids និងគុណភាពវិភាគដោយញ្ញាណ របស់រៀត *Curcuma Longa* L. ក្រោមលក្ខខណ្ឌដែល បានគ្រប់គ្រង ត្រូវបានសិក្សា និងវាយតម្លៃ (អត្ថបទ៣ ជំពូក៤)។ ចំណិតរៀតស្រស់កម្រាស់ ៥ មីលីម៉ែត្រ ត្រូវ បានសម្ងាត់ដោយទូរសម្ងាត់ (Air dryer) នៅសីតុណ្ហភាព ៦០ អង្សាសេ ឬបានចម្អិនមុននៅសីតុណ្ហភាព ៩៥ អង្សាសេ រយៈពេល ៣ នាទី មុននឹងយកទៅសម្ងាត់នៅលក្ខខណ្ឌផ្សេងៗគ្នា (៥០ ៦០ ឬ៨០ អង្សាសេ និង RH ៤០ ភាគរយ)។ ចំណិតរៀតស្ងួតត្រូវបានកិនជាម្សៅដែលមានទំហំពីរប្រភេទ៖ ម៉ត់ ទំហំតូចជាង៥០០ មីក្រូ ម៉ែត្រ និងគ្រើម តូចជាង៧៥០ មីក្រូម៉ែត្រ។ ការចម្អិនបានរក្សា បរិមាណប្រេងប្រហើរ បរិមាណ Curcuminoids និង Bioaccessibility របស់ Curcuminoids។ ប៉ុន្តែការសម្ងាត់បណ្តាលឱ្យ បរិមាណប្រេងប្រហើរ (២២,៥ ភាគ រយ) បរិមាណ Curcuminoids (១១,០ ភាគរយ) និង Bioaccessibility របស់ Curcuminoids (២៨,៦ ភាគ រយ) ថយចុះ។ ផ្ទុយពីការសិក្សាទាក់ទងនឹង Micronutrient bioaccessibility ទំហំភាគល្អិត (ចន្លោះពី ៦៣ ទៅ ៧១១មីក្រូម៉ែត្រ) មិនមានឥទ្ធិពលដល់បរិមាណ Curcuminoids និង Bioaccessibility របស់ Curcuminoids នោះឡើយ។ នេះប្រហែលជាដោយសារតែរៀតស្ងួតរបស់យើងត្រូវបានកិននៅសីតុណ្ហភាព ថេរ (១០ អង្សាសេ) និងនៅក្រោមលក្ខខណ្ឌដូចគ្នា (១០០០០ ជុំក្នុង១នាទី រយៈពេល ១០ វិនាទី) ដោយ ប្រើម៉ាស៊ីនកិន Ultra-centrifuge ភ្ជាប់ទៅនឹង Sieves ពីរ (៥០០ មីក្រូម៉ែត្រ និង៧៥០ មីក្រូម៉ែត្រ) ដើម្បីផលិត ម្សៅពីរដែលមានទំហំខុសៗគ្នា (P1: <500 μm; P2: <750 μm)។ ការកិននៅសីតុណ្ហភាពទាប (Cryogenic milling) ដោយប្រើអាសូតរាវ ដើម្បីការពារអុកស៊ីតកម្ម និងការបាត់បង់សមាសធាតុងាយហើរ ត្រូវបានរីករាល ដាលយ៉ាងទូលំទូលាយនៅក្នុងឧស្សាហកម្ម ប៉ុន្តែវាជាប្រតិបត្តិការដែលមានតម្លៃថ្លៃ (Ararsa 2018; Sasikumar 2012)។ Sasikumar (2012) លើកឡើងថា ការកិននៅក្នុងមជ្ឈដ្ឋានបរិយាកាសអាចធ្វើឱ្យ សីតុណ្ហភាពរបស់ម្សៅកើនឡើងដល់ ៩០ ទៅ ៩៥ អង្សាសេ ដែលបណ្តាលឱ្យបាត់បង់ប្រេងប្រហើរ សមាស ធាតុក្លិន និងពណ៌ ដែលធ្វើឱ្យគុណភាពរបស់វាខូច។ Bioaccessibility របស់ Curcuminoids របស់រៀត (ជា មធ្យម ៩,១ ភាគរយ) គឺទាបជាងតម្លៃ ១៧ ± ៤,១ ភាគរយ ដែលបានរកឃើញដោយ Park *et al.* (2018)។ ទោះបីជាអាមីដុងឆ្អិន ឬអត់ក៏ដោយ Bioaccessibility របស់ Curcuminoids របស់រៀតមិនមានភាពខុសគ្នា នោះទេ។ បន្ទាប់ពីសម្ងាត់ វាយនភាពនៃរៀតគឺរឹង។ យើងសន្និដ្ឋានថា Biological fluids របស់ in-vitro

digestion សាយភាយចូលទៅក្នុងភាគល្អិតម្សៅ (Powder particles) មិនបានល្អនោះទេ។ ជាលទ្ធផល សមាសធាតុរបស់វាវិលាយមិនបានល្អក្នុងបំពង់វិលាយអាហារដូចរមៀតស្រស់នោះទេ។ លក្ខណៈមួយចំនួន របស់ Curcuminoids រួមមានភាពរលាយក្នុងខ្លាញ់ និងមិនងាយរលាយនៅក្នុងទឹក សូលុយស្យុងអាស៊ីត និង សូលុយស្យុងលីតធ្វើឱ្យ Bioaccessibility របស់សារធាតុនេះមានកម្រិតទាបក្នុងអំឡុងពេលវិលាយអាហារ។ ម្យ៉ាងវិញទៀត សារធាតុនេះត្រូវបានស្រូបពីពោះវៀនតូចតាមរយៈកោសិកា Enterocyte ក្នុងបរិមាណតិចតួច ហើយមេតាបូលីដាប់រហ័ស (Wang *et al.* 2008)។ ភាពសម្រួបនៃសារធាតុ Curcuminoids របស់រមៀតគឺ អាស្រ័យលើលក្ខណៈបន្លំ (Coating) (Papillo *et al.* 2019) និងបង្កើនរូបរាង (Structuring) (Park *et al.* 2018) ដែលកែប្រែស្ថេរភាព កម្រិតភាពរលាយក្នុងប្រព័ន្ធវិលាយអាហារ និងការស្រូបចូលក្នុងប្រព័ន្ធសរសៃ ឈាម (Systemic circulation) ។ ដំណើរការទាំងអស់ ផលិតបានផលិតផលសម្រេចដែលមានបរិមាណ Curcuminoids (ជាមធ្យម ១២,១ ក្រាម ក្នុង ១០០ក្រាម ម៉ាស់ស្លុត) និង Bioaccessible curcuminoids (ជា មធ្យម ១,០ ក្រាម ក្នុង ១០០ក្រាម ម៉ាស់ស្លុត) ដូចគ្នា។ លទ្ធផលទាំងនេះគឺមានការព្រមព្រៀងជាមួយ Llano *et al.* (2022) ដែលបានរកឃើញថាបរិមាណ Curcuminoids នៅក្នុងម្សៅរមៀតដែលទទួលបានក្រោម លក្ខខណ្ឌសម្ងាត់ខុសៗគ្នា (ចន្លោះពី ៥០ ទៅ ៨០ អង្សាសេ) មិនមានភាពខុសប្លែកគ្នាគួរឱ្យកត់សម្គាល់ឡើយ។ Jayashree and Zachariah (2016) បានរាយការណ៍ថាបរិមាណប្រេងប្រហើរមិនខុសគ្នាខ្លាំងនោះទេ នៅ ពេលដែលរយៈពេលចម្អិនក្នុងទឹកកំពុះកើនឡើងដល់ ៦០ នាទី។ Prathapan *et al.* (2009) បានរកឃើញថា បរិមាណ Curcuminoids មិនមានភាពខុសគ្នាខ្លាំងទេ នៅពេលប្រៀបធៀបរមៀតស្រស់ និងរមៀតចម្អិន (ចន្លោះពី ៥០ ទៅ ១០០ អង្សាសេ រយៈពេល ៣០ នាទី) ។ ទោះយ៉ាងណាក៏ដោយ ភាពខុសគ្នាធំបំផុតនៃ បរិមាណ Curcuminoids ត្រូវបានគេសង្កេតឃើញរវាងរមៀត "ស្រស់" និង "សម្ងាត់" ជាមួយនឹងការថយ ចុះ ប្រហែល ៣០ ភាគរយ។ លទ្ធផលទាំងនេះគឺស្របជាមួយ Suresh *et al.* (2007) ដែលបានបង្ហាញថាការ បាត់បង់ Curcumin នៅក្នុងរមៀតដោយសារតែការប្រើកំដៅគឺស្ថិតនៅក្នុងចន្លោះចាប់ពី ២៧ ទៅ ៥៣ ភាគរយ ជាមួយនឹងការបាត់បង់អតិបរមាក្នុងអំឡុងពេលចម្អិនក្រោមសម្ពាធន (នៅសីតុណ្ហភាពខ្ពស់) រយៈពេល ១០ នាទី។ ទោះយ៉ាងណាក៏ដោយ Choudhury *et al.* (2017) បានរាយការណ៍ថាការកែច្នៃរមៀតស្រស់ (ក្បាល រមៀត និងដៃរមៀត) ដើម្បី ផលិតបានជាម្សៅរមៀតស្ងួតបណ្តាលឱ្យមានការថយចុះបរិមាណ Curcumin ត្រឹមតែ ២ ទៅ ៨ ភាគរយប៉ុណ្ណោះ។ ដំណើរការត្រឹមត្រូវ (មិនខ្ពស់ពេក ឬទាបពេក) ដើម្បីសម្ងាត់រមៀតដើរតួនាទី យ៉ាងសំខាន់ក្នុងការរក្សាទុកសារធាតុ Curcuminoids នៅក្នុងរមៀត (Hirun *et al.* 2014)។ Bambirra *et al.* (2002) បានរកឃើញថា ម្សៅរមៀតដែលទទួលបានដោយមិនបានឆ្លងកាត់ការចម្អិន មានសារធាតុពណ៌ Curcuminoids អន់បំផុតបើប្រៀបធៀបទៅនឹងម្សៅរមៀតដែលត្រូវបានចម្អិនក្នុងទឹក មុនយកទៅសម្ងាត់ ពីព្រោះ ការចម្អិនជំរុញឱ្យមានការសាយភាយសារធាតុពណ៌ពីកោសិកាទៅកាន់ជាលិកាដែលនៅជាប់គ្នា ដែលរួម ចំណែកធ្វើឱ្យ ពណ៌របស់រមៀតកាន់តែប្រសើរឡើង។ លទ្ធផលនៃការធ្វើតេស្តការទទួលយករបស់អ្នកប្រើប្រាស់ បានបង្ហាញថាការចម្អិនបានធ្វើឱ្យសជាតិល្អិត ក្លិន និងពណ៌ថយចុះ ដែលវាបង្កើនការចូលចិត្ត ខណៈដែលការ សម្ងាត់ និងការកិន មិនមានផលប៉ះពាល់ដល់គុណភាពរបស់ម្សៅរមៀតនោះទេ។ បន្ថែមពីលើនេះ អតិថិជនមិន ចូលចិត្តម្សៅរមៀតណាដែលមើលទៅដូចនឹងម្សៅរមៀតដែលពួកគេធ្លាប់បានប្រើប្រាស់ និងទទួលទានកន្លងមក នោះទេ (រមៀតសម្ងាត់ដោយផ្ទាល់នៅ ៦០ អង្សាសេ) ពីព្រោះវាមានរសជាតិល្អិតខ្លាំង (ចាប់ពី ២៥,៩ ដល់

៣៣,៣ ភាគរយ) ក្លិនខ្លាំង (ចាប់ពី ៣៣,៣ ដល់ ៣៤,៦ ភាគរយ) និងពណ៌ស្រអាប់ ឬត្នោត (ចាប់ពី ១២,៥ ដល់ ២៩,៦ភាគរយ)។ ផ្ទុយទៅវិញ ពួកគេចូលចិត្តម្សៅរមៀតដែលត្រូវបានចម្អិននៅសីតុណ្ហភាព ៩៥ អង្សាសេ រយៈពេល ៣នាទី មុនយកទៅសម្អិតនៅសីតុណ្ហភាព៦០អង្សាសេ។ ទោះបីជាបរិមាណ Curcuminoids នៅ ក្នុងផលិតផលសម្រេចរបស់យើងមិនមានភាពខុសប្លែកគ្នាខ្លាំងក៏ដោយ អ្នកប្រើប្រាស់បានរកឃើញភាពខុសគ្នា គួរឱ្យកត់សម្គាល់នៃពណ៌ វាយនភាព និងការចូលចិត្តជាមួយ រវាងម្សៅសម្អិតផ្ទាល់ និងចម្អិនមុនសម្អិត។ ការ ចម្អិនដោយកំដៅមុនការដកជាតិទឹកអាចបង្កាក់សកម្មភាពអង់ស៊ីម ជៀសវាងក្លិនមិនល្អ និងមិនធ្វើឱ្យរមៀត ឡើងពណ៌ត្នោត (Jayashree *et al.* 2018)។ ការចម្អិនអាចកាត់បន្ថយរសជាតិល្ងឹងរបស់រមៀត (Faber *et al.* 2010)។ នេះអាចជាហេតុផលដែលអ្នកប្រើប្រាស់អាចរកឃើញអាំងតង់ស៊ីតេខ្ពស់នៃរសជាតិផូចត់ ក្លិន និង ពណ៌នៅក្នុងសំណាកសម្អិតដោយផ្ទាល់។ ដោយផ្អែកលើលទ្ធផលទាំងនេះ សំណាកសម្អិតដោយផ្ទាល់ និង ចម្អិន (៩៥ អង្សាសេ រយៈពេល ៣ នាទី) មុនពេលសម្អិតនៅសីតុណ្ហភាព ៦០អង្សាសេ និង RH ៤០ ភាគរយ ត្រូវបានជ្រើសរើសសម្រាប់ការវិភាគពិពណ៌នា (Descriptive test) ដើម្បីដឹងថាតើអ្នកវាយតម្លៃដែលបានបណ្តុះ បណ្តាលថាអាចរកឃើញភាពខុសគ្នាឬអត់ទេ។ លទ្ធផលនៃការធ្វើតេស្តពីកម្រិតនៃការទទួលយករបស់ អតិថិជន (Consumer acceptance) និងការពិពណ៌នា (Descriptive test) បានបង្ហាញថាអតិថិជនភាគ ច្រើនចូលចិត្តរមៀតដែលមានពណ៌លឿងថ្លា មិនមានក្លិនឆ្ងល់ខ្លាំង និងមិនមានរសជាតិល្ងឹងខ្លាំង ហើយមាន ពណ៌ក្លឹរលោង និង Pungency mouthfeel ខ្ពស់។ លទ្ធផលបានបង្ហាញថា ការចម្អិននៅ ៩៥ អង្សាសេ រយៈ ពេល ៣នាទី អមដោយការសម្អិត នៅ ៦០អង្សាសេ និង RH ៤០ ភាគរយ គឺជាវិធីសាស្ត្រសមស្របបំផុតក្នុង ការផលិតម្សៅរមៀតដែលសម្បូរទៅដោយសារធាតុ Curcuminoids និងធ្វើអោយកម្រិតនៃការទទួលយករបស់ អ្នកប្រើប្រាស់ និងទទួលទានរមៀតកាន់តែខ្ពស់។

ការសន្និដ្ឋាន និងទស្សនវិស័យ៖ សរុបសេចក្តីមក ដោយផ្អែកលើលទ្ធផលដែលទទួលបាន យើងអាចមាន លទ្ធភាពណែនាំអំពីវិធីសាស្ត្រថ្មី ដើម្បីបង្កើនគុណភាពរបស់ម្សៅរមៀត។ វិធីសាស្ត្រដែលអនុវត្តនៅខេត្តកំពត មានរយៈពេលសម្អិតខ្លី (ចន្លោះពី ២៤ ទៅ ៤៥ ម៉ោង អាស្រ័យលើអាកាសធាតុ) ហើយទទួលបានទិន្នផលខ្ពស់ (១៦,២ ភាគរយ) ដោយមានបរិមាណទឹក (ប្រហែល ៦ភាគរយ) អនុលោមតាមស្តង់ដារ ISO ៥៥៦២:១៩៨៣ (International Organization for Standardization 1983) បើប្រៀបធៀបទៅនឹងវិធីសាស្ត្រពីរផ្សេងទៀត។ ក្រុមហ៊ុនទាំងអស់អាចបង្កើនការចំណេញដោយកុំសម្អិតរមៀតឱ្យស្ងួតពេក។ ជាការពិតណាស់ គេអាចសម្អិតតិច ទទួលបានទិន្នផលល្អ ហើយនៅតែគោរពតាមស្តង់ដារ ISO ៥៥៦២:១៩៨៣ (បរិមាណទឹក តូចជាង ១០ ភាគ រយ) ការចម្អិនអាហារមិនត្រឹមតែមិនមានផលប៉ះពាល់អវិជ្ជមានលើបរិមាណប្រេងប្រហើរ បរិមាណ Curcuminoids និង Bioaccessibility របស់វា (សមាសធាតុក្លិននៃប្រេងប្រហើរផ្លាស់ប្តូរបន្តិចបន្តួច) ប៉ុន្តែវា ថែមទាំងអាចកាត់បន្ថយរយៈពេលសម្អិតផងដែរ។ ការសម្អិតបានបន្ថយបរិមាណប្រេងប្រហើរ (២២,៥ ភាគ រយ) បរិមាណ Curcuminoids (១១,០ ភាគរយ) និង Bioaccessibility របស់ Curcuminoids (២៨,៦ ភាគ រយ)។ ផ្ទុយពីការសិក្សាទាក់ទងនឹង Micronutrient bioaccessibility ពីមុនមកម្សៅរមៀតដែលមានទំហំនៃ ភាគល្អិត (ចន្លោះពី ៦៣ ទៅ ៧១១ មីក្រូម៉ែត្រ) មិនមានផលប៉ះពាល់លើ បរិមាណ Curcuminoids និង Bioaccessibility របស់វានោះទេ។ ការរួមបញ្ចូលគ្នានៃប្រតិបត្តិការបានផលិតផលិតផលសម្រេចដែលមាន គុណភាពដូចគ្នា ដោយមានបរិមាណ Curcuminoids (ជាមធ្យម ១២,១ ក្រាម ក្នុង១០០ក្រាម ម៉ាស់ស្អិត) និង

Bioaccessible Curcuminoids (ជាមធ្យម ១,០ក្រាម ក្នុង១០០ក្រាម ម៉ាស់ស្ងួត)។ ទោះជាយ៉ាងណាក៏ដោយ អ្នកប្រើប្រាស់រកឃើញភាពខុសគ្នានៃពណ៌ វាយនភាព និងការចូលចិត្តជាមួយ រវាងម្សៅរមៀតសម្ងាត់ និង ចម្អិនមុនសម្ងាត់។ លទ្ធផលនៃការសិក្សាបានបង្ហាញថា ការចម្អិននៅ ៩៥ អង្សាសេ រយៈពេល ៣នាទី អមដោយ ការសម្ងាត់ នៅ ៦០ អង្សាសេ និង RH ៤០ ភាគរយ គឺជាវិធីសាស្ត្រសមស្របបំផុតក្នុងការផលិតម្សៅរមៀតដែល សម្រួលទៅដោយសារធាតុ Curcuminoids និងធ្វើអោយកម្រិតនៃការទទួលយករបស់អ្នកប្រើប្រាស់ និងអ្នក ទទួលបានរមៀតកាន់តែខ្ពស់។ ថ្វីត្បិតតែប្រជាជនកម្ពុជាភាគច្រើនប្រើប្រាស់រមៀតស្រស់ ព្រោះវាងាយស្រួលដាំ ដុះ និងអាចរកបានពេញមួយឆ្នាំ ប៉ុន្តែការផលិតម្សៅរមៀតនៅក្នុងប្រទេសកម្ពុជាពិតជាសំខាន់ ពីព្រោះយ៉ាង ហោចណាស់ ៤៧,៥ ភាគរយ នៃអ្នកផ្តល់មតិទាំងអស់ (ផ្អែកលើការស្ទង់មតិអ្នកប្រើប្រាស់ ១២០ នាក់នៅ កម្ពុជា) នឹងប្រើប្រាស់ម្សៅរមៀតសម្រាប់គោលបំណងធ្វើម្ហូប (ដើម្បីបង្កើនពណ៌ និងក្លិន) ៣០,៣ ភាគរយ សម្រាប់សុខភាព និង ២២,២ ភាគរយ សម្រាប់គ្រឿងសំអាង។ ការសិក្សានេះអាចជួយប្រតិបត្តិករកែច្នៃរមៀត កំណត់ថាតើប្រភពរមៀត និងវិធីសាស្ត្រកែច្នៃរមៀតណាមួយគួរតែជ្រើសរើសយកមកប្រើប្រាស់ ដើម្បីកាត់បន្ថយ រយៈពេលសម្ងាត់ និងទទួលបានបរិមាណប្រេងប្រហើរ និងបរិមាណ Curcuminoids ខ្ពស់បំផុត។ លើសពីនេះ លក្ខខណ្ឌបច្ចេកទេសដែលបានបញ្ជាក់នៅក្នុងការងារនេះអនុញ្ញាតឱ្យមានការផលិតម្សៅរមៀតដែលមានគុណ ភាពវិភាគដោយញ្ញាណ និងគុណភាពមុខងារខ្ពស់សម្រាប់អ្នកប្រើប្រាស់។ ទោះយ៉ាងណា ការងារនេះចាំបាច់ ត្រូវបំពេញបន្ថែមដោយការសិក្សាលើការរក្សាទុក (សីតុណ្ហភាព សំណើម ពន្លឺ) និងការវេចខ្ចប់ ដើម្បីដឹងថាតើ លក្ខខណ្ឌណាដែលល្អបំផុតសម្រាប់ប្រតិបត្តិករក្នុងស្រុកជ្រើសរើសយកមកប្រើប្រាស់។ ការសិក្សានាពេល អនាគតក៏គួរពិចារណាផងដែរអំពីផលប៉ះពាល់នៃប្រតិបត្តិការ និងដំណើរការផលិតទៅលើគុណភាពអនាម័យ (Sanitary quality) របស់រមៀត។

Annex

Annex 1: Supplementary materials

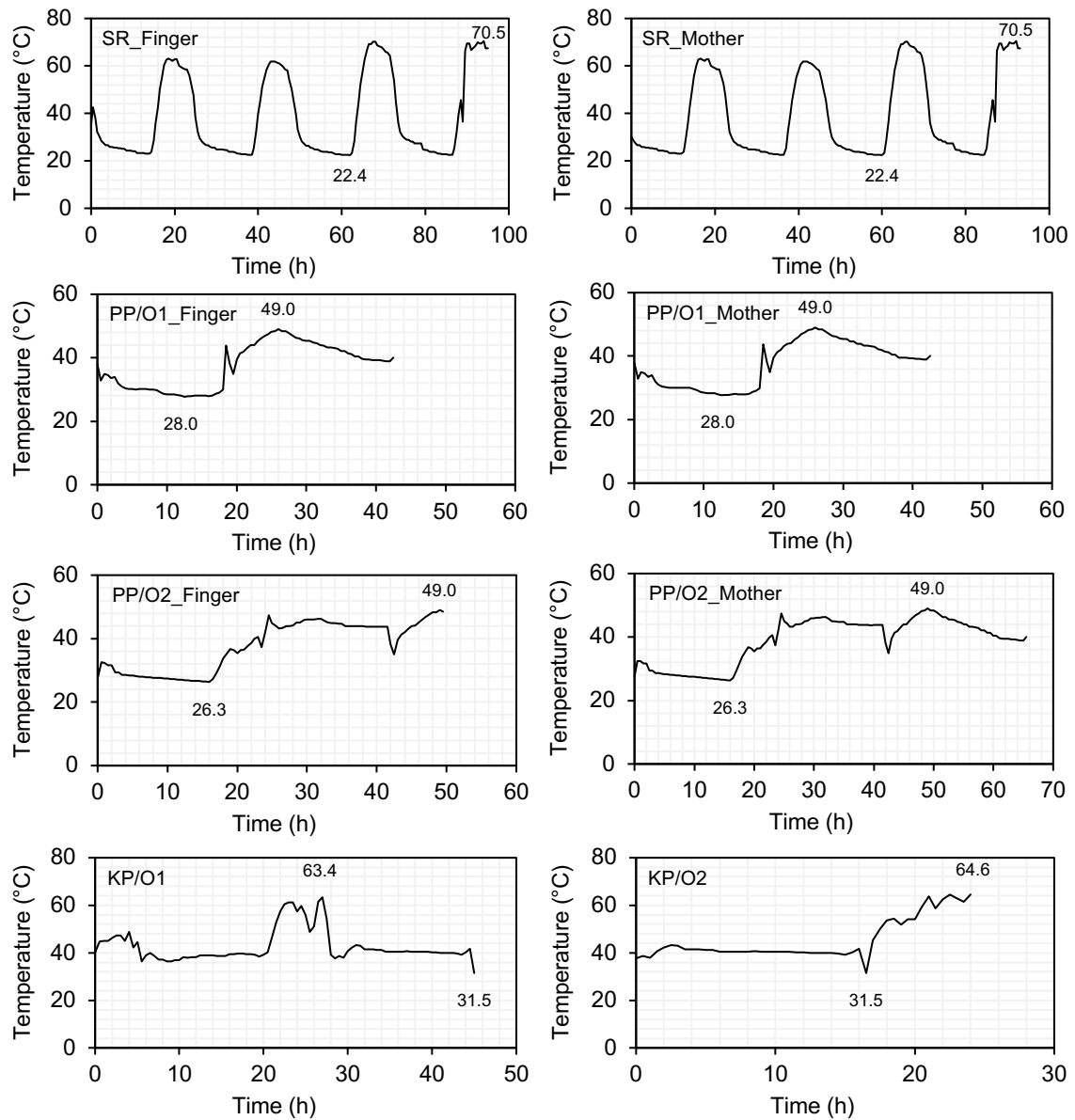

Supplementary Figure 1 Drying temperature profile of turmeric from three distinct case studies: Case study 1 (Siem Reap); Case study 2 (Phnom Penh); Case study 3 (Kampot)

Supplementary Table 1 Influence of different types of processing on mass, yield, dehydration time and water content of ground turmeric

Samples	Yield after cooking (g/100 g)	Yield after grinding (g/100 g)	Drying time (hours)	Yield (g/100 g)	Water content (g/100 g)	
					Fresh	Final
Case study 1						
SR_Ground finger	96.4	83.1	95	10.0	79.9±0.0	4.4±0.0
SR_Ground mother	96.8	86.0	93		77.5±0.0	3.3±0.1
Case study 2						
PP/O1_Ground finger	–	87.1	42.5	10.8	84.3±0.1	7.9±0.1
PP/O1_Ground mother	–	87.0	42.5		79.4±0.1	7.9±0.0
PP/O2_Ground finger	–	87.2	49.5	14.2	83.8±0.0	8.2±0.1
PP/O2_Ground mother	–	87.1	65.5		77.1±0.1	8.1±0.1
Case study 3						
KP/O1_Ground	96.3	87.0	45	–	78.9±0.0	6.3±0.1
KP/O2_Ground	91.4	87.3	24	16.2	83.5±0.0	5.0±0.2

Drying equipment: The electrically heated dryer developed by CIRAD is illustrated in **Supplementary Figure 2**. It is temperature-regulated by an electric heating coil and a cooling device by an exchanger with a large exchange surface. Humidity control is provided by an atmospheric steam generator and two air exchange butterfly valves. A driving computer ensures the regulation as well as the sequential starting, stopping and weighing phases. The air temperature, relative humidity and air speed are adjustable between 45 – 120 °C, 25 – 90 % and 0.8 and 4 m/s, respectively. Air temperature and humidity are measured by a Rotronic capacitive hygrometer (HTS11X converter and HYGROCLIP IC-3 probe) certified annually. The measured values are saved in an Excel compatible file at a period of 30 s. The dryer has three drying grid racks (0.25 m long × 0.25 m wide × 0.06 m high) and the air passes through the product layer from top to bottom. Monitoring by weighing is carried out semi-continuously. During weighing, the drying air is diverted into a secondary air stream. After stabilization of the air on the product, weighing is done by placing the mobile on a scale, without significantly modifying the environment to which the product is subjected. The duration of a weighing cycle is 15 s. The air speed in the dryer depends on the rotational speed of the fan and the pressure drops present in the circuit, including those created by the product. The adjustment is manual, by a potentiometer located at the right end of the electrical chute which is under the electrical power cabinet. An indication of the frequency of the current sent to the fan can be read through the window on the front of the electrical power cabinet. Air speed can be measured by inserting an anemometer into the dryer, the wire of which exits through one of the holes provided on instrument.

$$v_{air} = 0.102414 \text{ Freq} - 0.217 \quad (\text{where } v_{air} \text{ in m/s and Freq in Hz.})$$

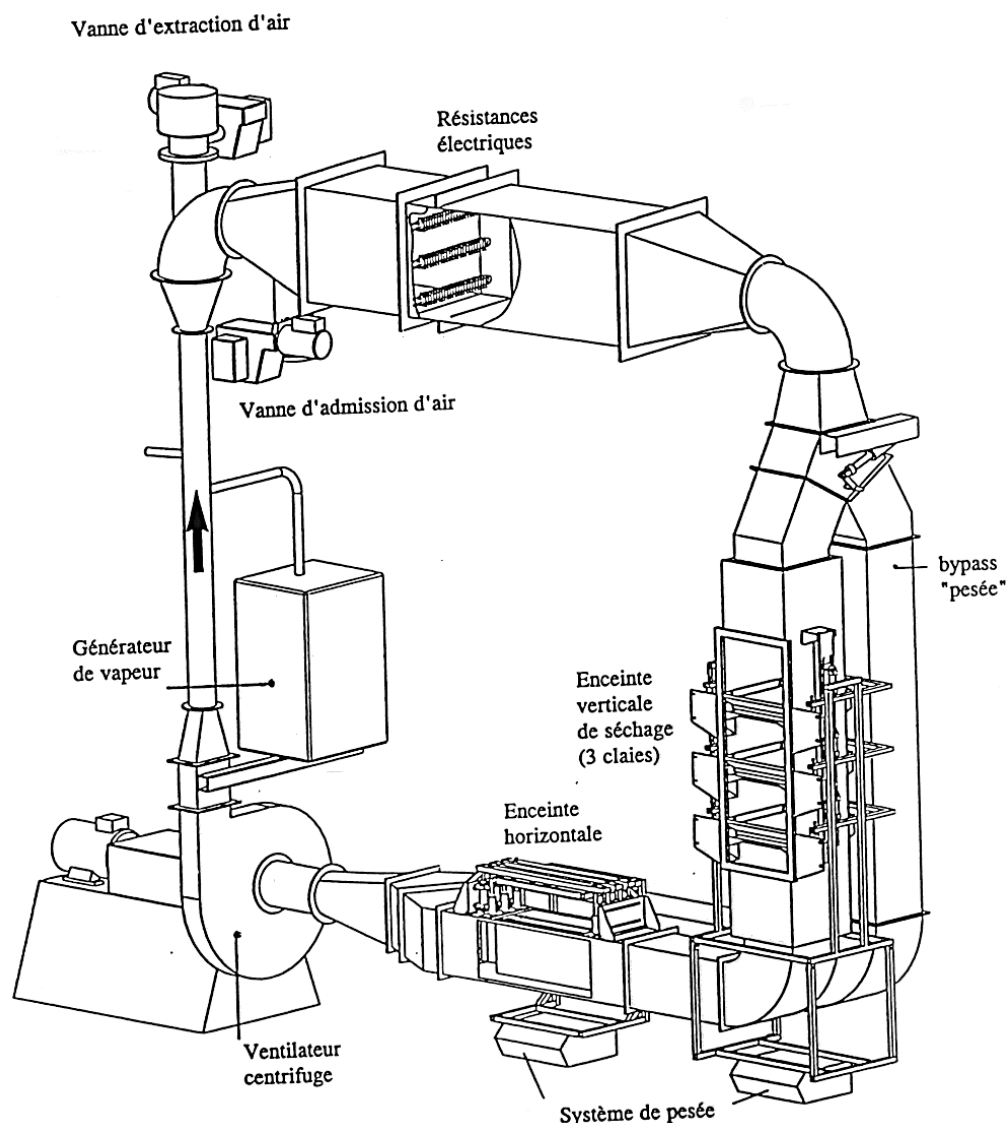

Supplementary Figure 2 The hot air drier developed by CIRAD

Thermal properties by differential scanning calorimetry (DSC): About 20 g of fresh turmeric rhizome was peeled and sliced. Then, the sliced turmeric was freeze-dried (Alpha I-6, Martin Christ, Germany) for 42 h. The freeze-dried sample was ground for 10 s at 28 000 rpm in analytical mill (IKA® A11 basic, Germany). After freeze-drying, the percentage of dry matter of the turmeric was 20.82 % which meant the moisture lose was 79.18 %. The thermal property of the sample was determined by using a Perkin Elmer Differential Scanning Calorimeter (Perkin Elmer DSC 8500, United States) under nitrogen atmosphere. The turmeric powder was submitted to the condition of 80 % water. Appropriately 8.2 mg of sample and 31.8 mg of mQ water (HPLC grade) were weighed putting in aluminium pan, using a micro analytical balance (Precisa EP 2255M-DR, Switzerland). The aluminium pan containing the sample and mQ water was sealed and allowed to stand for 1 h at room temperature (25 °C) before heating. The sample pan was heated from 25 to 160 °C at a scanning rate of 10 °C/min,

held for 2 min at 160 °C and cooled from 160 °C to 40 °C at 10 °C/min. Onset or gelatinization temperature (T_o), peak temperature (T_{peak}) and enthalpy of gelatinization (ΔH_{gel}) were obtained. The results are shown in the following figure (**Supplementary Figure 3**).

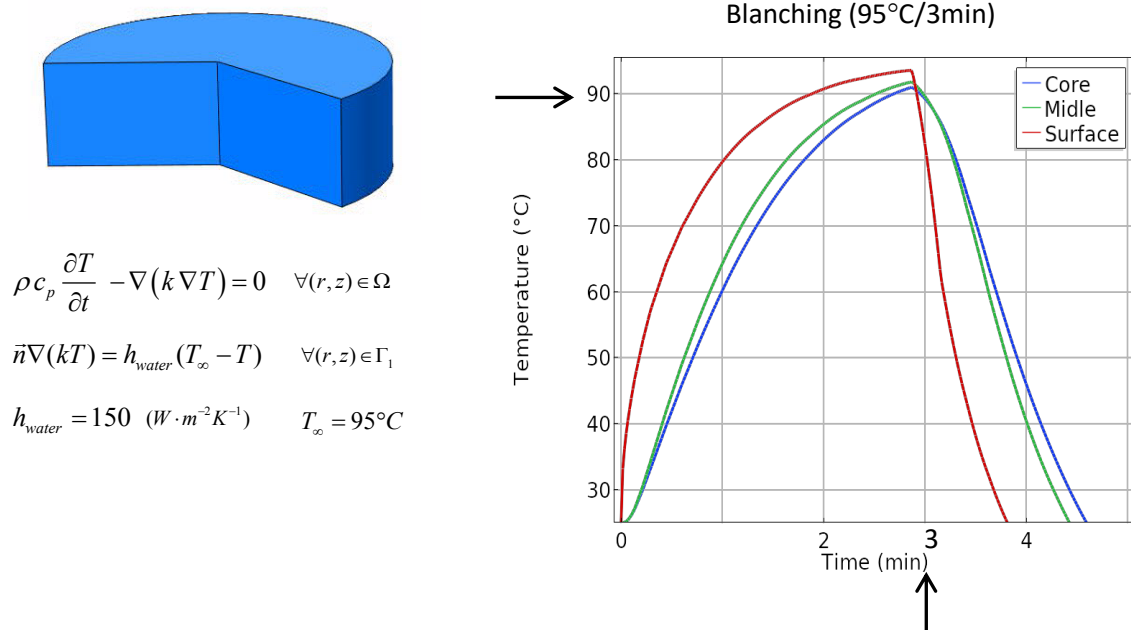

Supplementary Figure 3 Temperature kinetic inside turmeric

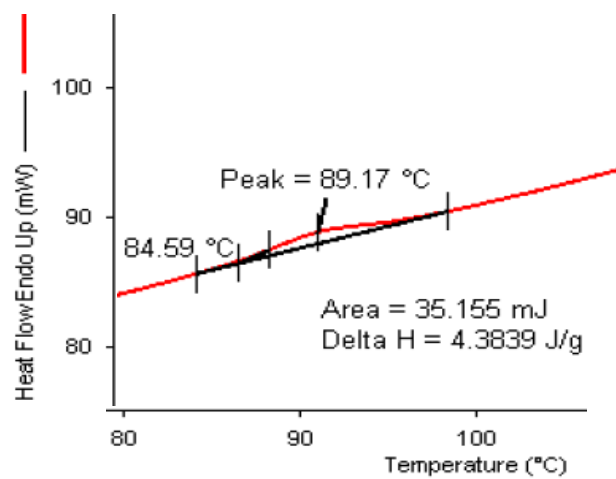

Supplementary Figure 4 DSC thermogram of turmeric powder at 80 %

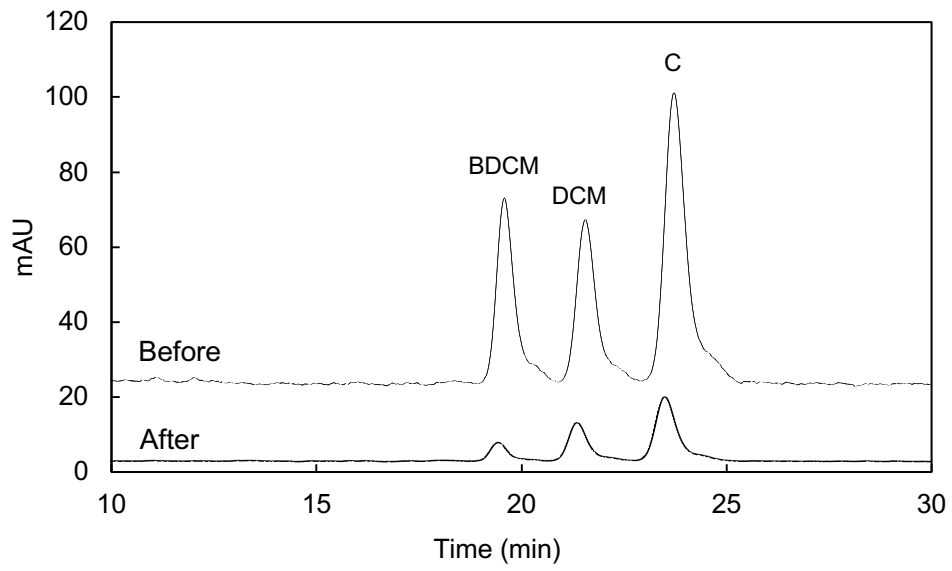

Supplementary Figure 5 Chromatogram of curcuminoids of fresh turmeric before and after digestion

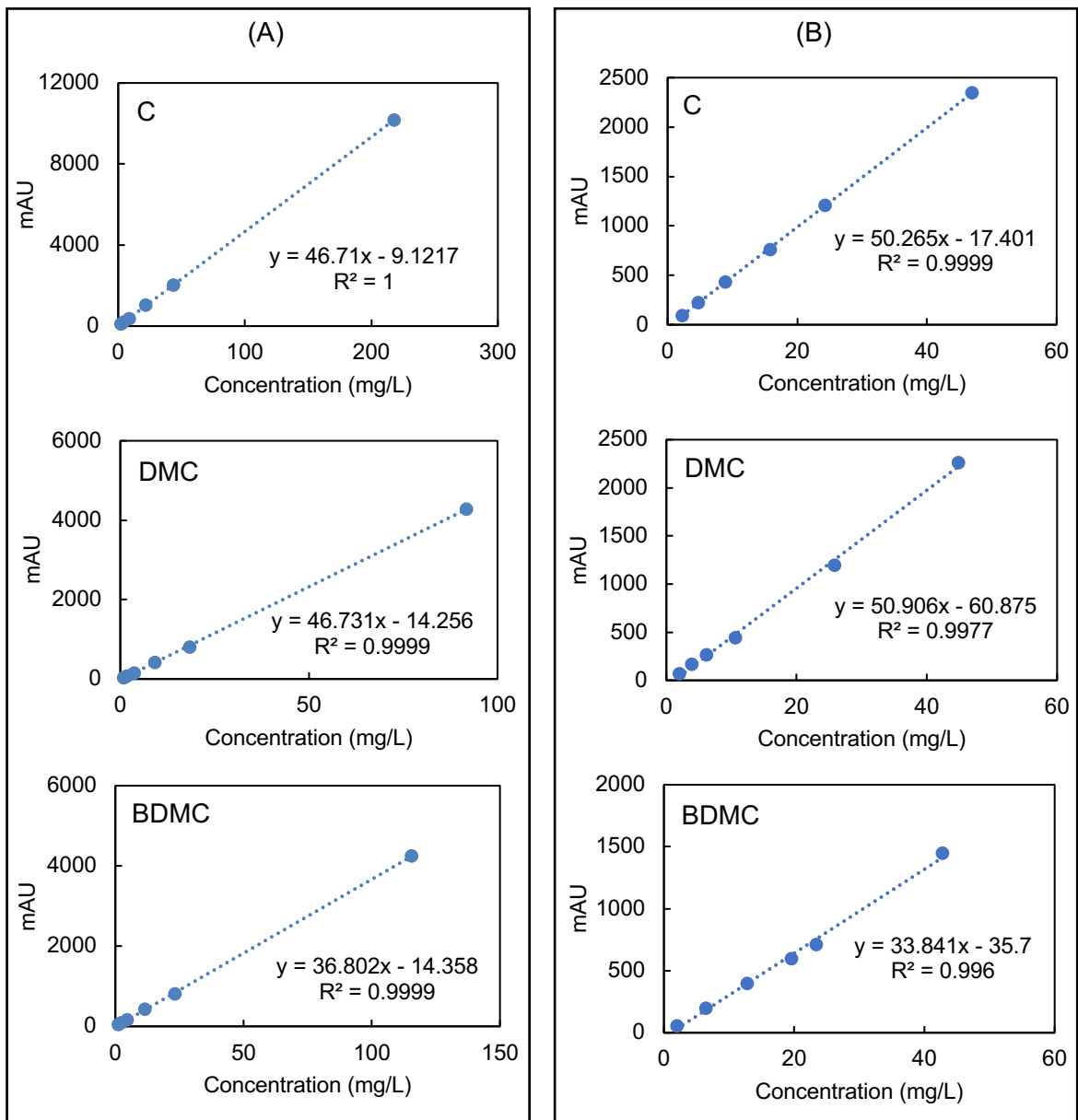

Supplementary Figure 6 Standard curve of curcuminoids (A) used in chapter 2 and (B) used in chapter 3 and 4

Annex 2: Questionnaire for process description thanks to 5M approach

Step	Time (days after harvesting)	Material (raw material sate/shape, consumables)	Method (practices and duration)	Machines (tools, equipment...)	Man power (who and how many)	Medium (Environment)
0 General information	<ol style="list-style-type: none"> 1. Which turmeric species do you grow (<i>yellow turmeric, black turmeric, ...</i>)? 2. How long have you grown turmeric (<5 years, 6 – 10 years, > 10 years, ...)? 3. How big is the land for growing turmeric? 4. What do you spend that money for (<i>land preparation, seed, fertiliser, harvesting, ...</i>)? 5. What is the yield of the turmeric (how many tons per hectare...)? 6. Do you mix other crops with your turmeric (<i>chillies, taro, onion, eggplant, maize, ...</i>)? 7. Do you grow the turmeric as an intercrop (in coconut and areca nut...) plantation? 8. How do you store the rhizomes for seed purposes (<i>in pits with sawdust</i>)? 9. What are the difficulties in growing turmeric do you face (<i>no market, too low price, spoilage, low quality, ...</i>)? 10. When do you plant (<i>rainfall begins during April – May</i>)? 11. When do you harvest your turmeric (<i>January – March or in 7 or 9 months</i>)? 12. Who do you sell turmeric to (<i>local market, collectors, intermediaries, local company/industry, ...</i>)? 13. Usually how many days do you store the fresh turmeric before selling them? 14. How do you store the fresh turmeric before processing it? 15. Do you grow turmeric rhizomes or buy them from others? 16. To whom do you sell your product (<i>local market, supermarket, export, ...</i>)? Please provide more information 17. What are the difficulties in processing turmeric that you face (<i>no market, too low price, spoilage, low quality, ...</i>)? 18. How long have you proceeded with turmeric (<5 years, 6 – 10 years, > 10 years, ...)? 					
1 Reception of fresh turmeric	1.1. When do you purchase the turmeric (within 3 or 4 days after harvest)?	1.2. How many kilograms of turmeric do you buy per time?	1.3. Where do you buy the fresh turmeric from?	1.4. Truck, ...?	1.5. How many worker (s) do you need for a batch / truck?	1.6. Where do you receive the turmeric?
2 Sorting	2.1. When do you sorting?	2.2. The fingers and bulbs (or mother rhizomes) are separated and cured separately?	2.3. Do you sort manually or machinery?	2.4. Sorting machine, bucket, ...?	2.5. Who and how many man-powers do you need for one batch (<i>i.e., 2 operators (women) for one batch</i>)?	2.6. Where do you sorting?
3 Washing / cleaning	3.1. When do you clean / wash the turmeric?	3.2. What are the materials do you use to clean / wash the turmeric (<i>i.e., turmeric rhizomes, water</i>)? 3.3. How many kilograms / litters of turmeric and water per each batch?	3.4. How do you clean / wash the fresh turmeric before processing?	3.5. What are the tools and equipment do you use to clean turmeric (<i>bucket, water jet, brushes, ...</i>)?	3.6. Who and how many man-powers do you need for one batch (<i>i.e., 2 operators (women) for one batch</i>)?	3.7. Where do you clean the turmeric (<i>i.e., outside, under a roof, on a concrete floor, ...</i>)?



4 Slicing / peeling	4.1. When do you slice the turmeric? 4.2. When do you peel the turmeric?	4.3. How many % of yield loss after slicing? 4.4. How many % of yield loss after peeling?	4.5. How do you slice fresh turmeric before processing (<i>manually or mechanically</i>)? 4.6. How do you peel the skin of fresh turmeric before processing (<i>manually or mechanically</i>)?	4.7. Knife, slicing machine, peeling machine, ...?	4.8. Who and how many man-powers do you need for one batch (<i>i.e., 2 operators (women) for one batch</i>)?	4.9. Where do you slice / clean the turmeric (<i>i.e., inside the building, ...</i>)?
5 Cooking / boiling / blanching / steaming	5.1. When do you cook / boil / blanching / steaming the turmeric?	5.2. What material do you use (<i>a vessel made of galvanized iron sheet</i>)? 5.3. How many liters of water added?	5.4. What pre-treatment technique do you use (<i>cooking / boiling / blanching / steaming</i>)? 5.5. How long of pre-treatment time for fingers and mother rhizome (<i>45 to 60 min for fingers and 90 min for mother rhizome</i>)?	5.6. What is the heating source (any available agricultural waste materials <i>i.e.</i> , the turmeric leaves or gas stove or electricity)?	5.7. How many kilograms of turmeric for each batch (50, 100, 150, ... kg)?	5.8. Surrounding environment?
6 Drying	18.1. Do you dry the pre-treated rhizome immediately or when do you dry it?	18.2. How many % of dry recovery of turmeric (<i>between 19 – 23 %</i>)? 18.3. One kilogram of fresh turmeric gives approximately how many grams of dried one?	18.4. What technique do you use to dry the turmeric (<i>sun drying in open space, solar drying, oven drying</i>)? 18.5. At what temperature and relative humidity do you use to dry the turmeric? 18.6. How many hours require to dry turmeric?	18.7. If sun drying, what is the thick layer on the drying floor (5-7 cm)? 18.8. During night time, the material is heaped or covered? 18.9. How long it takes (10-15 days)? 18.10. How do you determine if the rhizomes become completely dry? 18.11. Does the bulbs and fingers are dried separately? 18.12. How often do you clean the drying surface? And how? 18.13. Rhizomes are turned intermittently to ensure uniformity in drying?	18.14. How many kilograms of turmeric for each batch (50, 100, 150, ... kg)?	18.15. Surrounding environment?





7 Polishing / colouring	7.1. When do you polish the dried rhizome (<i>immediately or within a few days or week</i>)?	7.2. Do you use colouring material(s)? 7.3. If yes, what do you use? 7.4. How many % of colour material(s) do you use?	7.5. What technique do you use to polish the turmeric (<i>manual or mechanical rubbing</i>)? 7.6. Do you do full polishing or haft polishing? 7.7. How many % of polishing wastage (<i>5-8% for full and 2-3% for haft polishing</i>)? 7.8. How long does it take to polish the turmeric for each batch (<i>45-60 min</i>)?	7.9. What machine do you use?	7.10. What is the capacity to polish the turmeric for each batch (200, 500, 1000 kg)?	7.11. Surrounding environment?
8 Cleaning / grading	8.1. When do you clean / grade the dried rhizome (<i>immediately or within a few days or week</i>)?	8.2. Polished turmeric / uncleaned turmeric, ...?	8.3. How do you clean your turmeric (<i>using sifter, destoner, and an air screen separator</i>)? 8.4. How do you grade your turmeric (<i>fingers, bulbs, and splits</i>)?	8.5. Sifter, destoner, air screen separator, ...?	8.6. Who and how many man-powers do you need for one batch (<i>i.e., 2 operators (women) for one batch</i>)? 8.7. What is the capacity of the machine (<i>sifter, destoner, and an air screen separator</i>)?	8.8. Surrounding environment?
9 Grinding	9.1. When do you grind the turmeric?	9.2. What type of grinder to you use?	9.3. How long / speed to you use to grind the turmeric? 9.4. How is the size of the ground turmeric (<i>i.e., < 300 µm, < 500 µm</i>)?	9.5. Grinder, bucket, ...?	9.6. Who and how many man-powers do you need for one batch (<i>i.e., 2 operators (women) for one batch</i>)? 9.7. What is the capacity of the grinder?	9.8. Surrounding environment?
10 Packing	10.1. When do you pack the turmeric?	10.2. Ground turmeric, packaging, ...?	10.3. How do you pack your turmeric (<i>packing in new double burlap gunny bags</i>)?	10.5. Packing machine, packaging, ...?	10.6. Who and how many man-powers do you need for one batch (<i>i.e., 2 operators</i>)?	10.8. Surrounding environment?



			10.4. Do you pack manually or machinery?		(women) for one batch)? 10.7. What is the capacity of the packing machine?	
11 Storage	11.1. Usually how many days / months do you store before selling them?	11.2. Does it have any problem(s) when you store your dried turmeric (<i>fungi / mould growth, insect, spoilage</i>)?	11.3. How do you store the turmeric (<i>over wooden pallets in a cool, dry place protected from light</i>)?	11.4. Warehouse, storage room, ...?	11.5. How much do you spend for storing your turmeric (man-power)? 11.6. What is the capacity of the warehouse / storage room?	11.7. Surrounding environment?
Step 1 – 11 Quality control	1. Do you control the quality of turmeric along the processes? 2. At which step / process do you control the quality of turmeric? 3. What are the target values?	4. What material do you use for control?	5. How do you make the control? 6. What parameters (quality criteria) do you control? 7. How do you control them?	8. What equipment do you use?	9. Who/how many persons?	10. Where is it done?



Annex 3: Description of turmeric processing in Cambodia

Describe turmeric processing thanks to 5M approach (Case study #1 Siem Reap Province-Agrisud International Cambodia)

Step	Picture	Time (harvesting day=D0)	Material (raw material sate/shape, consumable)	Method (practices and duration)	Machines (tools and equipment)	Man power (who and how many)	Medium (Environment)	Product balance (+ product cost)	Comments (type of hazard: <u>sanitary</u> , <u>sensorial</u> , <u>nutritional</u> ; cause of occurrence of the hazard)
Reception of fresh turmeric		D1	Fresh turmeric (<i>i.e.</i> , a mixture of mother and finger rhizomes)	100 kg/per day of fresh turmeric is bought from Green Farmer with a contract of 0.4 USD/kg including the transportation fee. The turmeric roots are packed in a 10 kg/plastic bag and transported by using a truck or motorbike truck.	Truck or motorbike-truck, plastic bag	Transporter and 1 woman	The turmeric is received at processing place	100 kg	
Sorting		D1	Fresh turmeric (<i>i.e.</i> , a mixture of mother and finger rhizomes)	The turmeric roots are spread on the concrete floor and the workers sit on the floor and separate the finger and mother rhizomes. Small rootlets and adherent soil are also removed. The separation time is 80 min for 100 kg of turmeric root. The finger and mother rhizomes are processed separately in the next steps.	Bucket, knife	10 women; 80 min for 100 kg of turmeric root	Open-space on the concrete floor	99.5 kg (0.5 kg of rootlets, soil, foreign materials) The yield loss in this step is 0.5%.	



Washing		D1	Finger rhizome and mother rhizome	<p>The rhizomes are washed twice using underground water.</p> <p>It is soaked in the water and the small rootlets and adherent soil are removed.</p> <p>Then, it is put in the plastic bucket to drain the water.</p>	Bucket, underground water, washing tank	2 women	Open-space on the concrete floor	NA	
Peeling (automatic)		D1	Washed turmeric (finger and mother rhizomes)	<p>The washed turmeric are peeled by using a peeling machine.</p> <p>It requires 2 min for 2 kg of finger/batch and 5 min for 2.5 kg of mother/batch.</p>	Peeling machine, bucket, underground water	1 woman	Inside the building on concrete floor	NA	
Peeling (manual)		D1	Peeled turmeric (finger and mother rhizomes)	<p>The peeled rhizomes are re-peeled manually to make sure that all the peels are completely removed.</p> <p>For the mother rhizome, it is cut into 4 pieces before cooking to make sure that the its size is not much different to the finger rhizome.</p>	Knife, bucket, plastic film, washing tank	10 women, spending 5 h for 100 kg of turmeric	Inside the building and put a plastic film on the concrete floor	The yield loss in this step is 4.5 %.	The turmeric is oxidised and browning reaction occurred due to too long exposure to the air.
Cooking		D1	Completely peeled turmeric (finger and mother rhizomes)	<p>The peeled turmeric are cooked in hot water with a ratio of 1:1 w/v (10 kg of turmeric/10 L of water).</p> <ul style="list-style-type: none"> Finger: from 70 – 100 °C for 30 min. Mother: from 70 – 100 °C for 35 min. 	Cooking pot, gas stove, underground water, bucket, strainer, washing tank	1 woman 10 kg/batch	Inside the building	The yield loss in this step is 3.6% for finger and 3.2% for mother.	No temperature controller



Drying		D1	Cooked turmeric (finger and mother rhizomes)	<p>The cooked turmeric is spread on the tray and then dried in a solar dryer at different duration (depending on the weather)</p> <ul style="list-style-type: none"> • Finger: from 22 – 70 °C for 95 h. • Mother: from 22 – 70 °C for 93 h. <p>Just crack it to determine the dryness (just do base on their experience)</p>	Solar dryer	2 women 2.5 kg of turmeric/tray (capacity of dryer is 200 kg turmeric)	Open-space on the concrete floor	<p>The yield of dry recovery is 23.1% for finger and 24.1% for mother (before and after drying).</p> <p>The yield of dry recovery is 10% (compared to fresh turmeric)</p>	No material or equipment to measure the moisture of turmeric.
Storage		D (unknown)	Dried turmeric (finger and mother rhizomes)	<p>The dried turmeric is put in a plastic bag and kept in a big plastic box and stored at ambient temperature.</p> <p>It is stored for a few days to a few months until there is purchase order from Green Farmer.</p>	Plastic bag, plastic box	1 woman, packing 10 – 15 kg/pack	Inside the building	NA	No temperature control
Grinding		D (unknown)	Dried turmeric (finger and mother rhizomes)	<p>The dried turmeric is ground twice by a grinder (1420 rpm).</p> <p>The ground turmeric is sieved in order to get the fine particle while the big particle is reground. This process is repeated until the fine particle is obtained.</p>	Grinder, sieve, tray, ...	1 woman	Inside the building on the table	The yield loss is 16.9% for finger and 14.0% for mother.	Unknown particle size

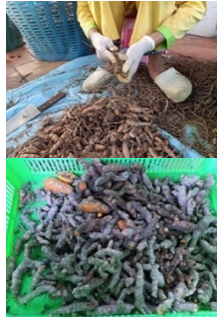

Packing	 	D (unknown)	Ground turmeric	<p>The finger and mother powders are mixed together and are vacuum-packed in a plastic bag with various net contents and prices:</p> <ul style="list-style-type: none"> • 40 g = 2.5 USD • 250 g = 5.0 USD • 500 g = 10.0 USD • 1 kg = 20.0 USD 	Vacuum pack machine, packaging	1 lady	Inside the building on the table	NA	The real proportion of finger and mother rhizomes to be mixed is unknown.
---------	---	----------------	--------------------	---	--------------------------------------	--------	--	----	--

Describe turmeric processing thanks to 5M approach (Case study #2 Phnom Penh-WoT-Khmer Natural Moringa)



Step	Picture	Time (harvesting day=D0)	Material (raw material sate/shape, consumables)	Method (practices and duration)	Machines (tools and equipment)	Man power (who and how many)	Medium (Environment)	Product balance (+ product cost)	Comments (type of hazard: <u>sanitary, sensorial, nutritional</u> ; cause of occurrence of the hazard)
Reception of fresh turmeric		D1 or D2	Fresh turmeric (i.e., a mixture of mother and finger rhizomes)	200 kg/per time of fresh turmeric is bought from local farmers in Kompong Speu province at a price of 0.5 – 0.6 USD/kg. The turmeric roots are packed in a 10 kg/plastic bag and transported by a truck or motorbike truck.	Truck or motorbike-truck and plastic bag	Transporter and 1 man	The turmeric is received at the processing place	100 kg	
Sorting		D1 or D2	Fresh turmeric (i.e., a mixture of mother and finger rhizomes)	The turmeric roots are spread on the concrete floor and the workers sit on the floor and separate the finger and mother rhizomes. Small rootlets and adherent soil are also removed. The separation time is 3 – 4 h for 200 kg of turmeric root. The finger and mother rhizomes are processed separately in the next steps.	Bucket, knife	2 women	Open-space and put a plastic film on the floor	99.5 kg (0.5 kg of rootlets, soil, foreign materials) The yield loss in this step is 0.5%.	



<p style="text-align: center;">Peeling</p>		<p>D1 or D2</p>	<p>Fresh turmeric (finger and mother rhizomes)</p>	<p>The fresh turmeric is washed and peeled by using a peeling machine. It requires 15 min for 10 kg of finger/batch and 30 min for 10 kg of mother/batch.</p>	<p>Peeling machine, bucket, tap water, washing tank</p>	<p>1 man</p>	<p>Outside the building with the plastic roof</p>	<p>99.2 kg (0.3 kg of peel) The yield loss in this step is 0.3%.</p>	
<p style="text-align: center;">Cleaning #1 (with brine and tap water)</p>		<p>D1 or D2</p>	<p>Peeled turmeric (finger and mother rhizomes)</p>	<p>The peeled turmeric is cleaned in brine (75 g salt/300 L of water) and then cleaned with 300 L of tap water.</p>	<p>Water, salt, bucket, basin</p>	<p>1 man</p>	<p>Inside the building (ground floor)</p>	<p>NA</p>	
<p style="text-align: center;">Cleaning #2 (with treated water)</p>		<p>D1 or D2</p>	<p>Cleaned turmeric (finger and mother rhizomes)</p>	<p>The cleaned turmeric is cleaned with treated water (UV and O₃) and then drained on the sieve tray.</p>	<p>Treated water, basin, sieve tray</p>	<p>1 woman</p>	<p>Inside the building (on 2nd floor)</p>	<p>NA</p>	



Slicing		D2 or D3	Cleaned turmeric (finger and mother rhizomes)	The big rhizome is cut into 2 – 3 pieces before slicing to the thickness between 1 – 2 mm by using a slicing machine.	Slicing machine, sieving tray, tank	3 – 4 people	Inside the building (on 2nd floor)	NA	The turmeric is oxidised and browning reaction occurred due to too long exposure to the air.
Room drying		D2 or D3	Sliced turmeric (finger and mother rhizomes)	<p>The sliced turmeric (2 – 3 kg/tray) are put on the tray and then dried in a drying room by using electronic fans to speed up the drying process.</p> <p>At 26 – 41 °C for 18 – 24 h.</p> <p>Crack it to determine the dryness (just do base on their experience)</p> <p>Only the big turmeric chips are dried in the oven dryer while the small ones are collected.</p>	Washing basin, fan, rack, sieving tray	3 – 4 people	Inside the building (on 2nd floor)	NA	No temperature control
Oven drying		D3 or D4	Semi-dried turmeric (finger and mother rhizomes)	<p>The semi-dried turmeric is put on the tray and then dried in an oven dryer until it is completely dried.</p> <p>At 35 – 49°C for 24 – 25 h.</p> <p>Just crack it to determine the dryness (just do base on their experience)</p>	Oven dryer, tank, fan, rack, sieve tray	3 – 4 people	Inside the building (on 2nd floor)	<p>10.8 kg of finger and mother (origin 1) and 14.2 kg of finger and mother (origin 2)</p> <p>The yield of dry recovery is 10.8% for origin 1 and 14.2% for origin 2 (compared to fresh turmeric)</p>	No temperature control

Storage		D (unknown)	Dried turmeric (finger and mother rhizomes)	The turmeric chips are put in a plastic bag (20 – 25 kg/pack) and stored in cool dry place at 25°C for a few days to a few months until there is market demand.	Plastic bag, balance	1 woman	Inside the building (1 st floor in storage room with the temperature control)	NA	
Grinding		D (unknown)	Dried turmeric (finger and mother rhizomes)	<p>The dried turmeric are ground by using a big-scale grinder (10 kg/batch) and then ground twice more by using a small-scale grinder.</p> <p>The ground turmeric are sieved in order to get the fine particle while the big particle is reground by small-scale grinder. This process is repeated until the fine particle obtained.</p> <p>The finger and mother powders are mixed together and it is made as a capsule for selling to the market.</p>	Big scale grinder, small scale grinder, sieve, basin, spoon, tray	1 man	Inside the building (1 st floor grinding room)	NA	Unknown particle size

Describe turmeric processing thanks to 5M approach (Case study #3 Kampot Province-La Plantation)

Step	Picture	Time (harvesting day=D0)	Material (raw material sate/shape, consumable)	Method (practices and duration)	Machines (tools and equipment)	Man power (who and how many)	Medium (Environment)	Product balance (+ product cost)	Comments (type of hazard: <u>sanitary, sensorial,</u> <u>nutritional</u> ; cause of occurrence of the hazard)
Reception of fresh turmeric		D1	Fresh turmeric (<i>i.e.</i> , a mixture of mother and finger rhizomes)	Two origins of turmeric are produced in this company (<i>i.e.</i> , origin 1 is from their own farm in Kampot province and origin 2 is bought from local farmers in Osom, Pursat province. Two tons of fresh turmeric roots (origin 2) are bought per time and it is packed in a 52 –53 kg/plastic bag and transported by a truck	Truck, plastic bag, bucket	Transporter and 2 men	The turmeric is received at processing place	100 kg	
Sorting		D1	Fresh turmeric (<i>i.e.</i> , a mixture of mother and finger rhizomes)	The turmeric roots are spread on the table and the workers sit on the chair to sort the turmeric. The small rootlets and adherent soil are removed from the turmeric rhizomes. The sorting time is 3 h/100 kg of turmeric root. The finger and mother rhizomes are processed together.	Table, bucket and knife	9 women	Inside building with fresh air circulation (this building is reserved for raw material storage and sorting) The sorting is done on the table.	NA	

Washing		D1	Fresh turmeric (<i>i.e.</i> , a mixture of mother and finger rhizomes)	<p>The turmeric rhizomes are washed and slightly peeled by a washing-peeling machine</p> <p>This machine can wash and peel the turmeric rhizome about 20 kg/batch (for 2.5 –3 min).</p> <p>It takes 30 min to process 100 kg of turmeric.</p>	Peeling machine, bucket, water, pallet	3 men	Inside a building reserved for peeling and slicing	NA	
Cooking		D1	Washed turmeric (<i>i.e.</i> , a mixture of mother and finger rhizomes)	<p>The washed turmeric rhizomes are cooked in hot water with a ratio of 1:2 w/v (30 – 33 kg of turmeric: 60 L of water) at 88 – 101 °C for 40 min.</p>	Gas stove, cooking pot with sieve, pot	3 men	Outside the building with the root	The weight loss in this step is 3.7% for origin 1 and 14.2% for origin 2.	No temperature controller
Slicing		D1	Cooked turmeric (<i>i.e.</i> , a mixture of mother and finger rhizomes)	<p>The cooked rhizomes are sliced to the thickness of 3 mm by a slicing machine.</p> <p>It takes 5.5 – 6.5 min/30 – 33 kg of turmeric). Thus, it takes 18 – 20 min to process 100 kg of turmeric.</p>	Slicing machine, bucket, pallet, plastic box	2 men	Inside building reserved for peeling and slicing	NA	

Drying		D1	Sliced turmeric (<i>i.e.</i> , a mixture of mother and finger rhizomes)	<p>The sliced turmeric are spread on the tray and then dried in a solar dryer.</p> <p>At 31 – 65 °C for 24 – 45 hours.</p> <p>Crack it to determine the dryness (just do base on their experience)</p>	Solar dryer, sieving tray, plastic box	3 men 2.5 – 3 kg of turmeric/tray (100 kg turmeric/solar dryer)	Open-space on the concrete floor	<p>The yield of dry recovery is 17.6% (before and after drying)</p> <p>According to responsible of production, the yield of dry recovery is 18 – 20% for mature turmeric and between 12 – 15% for young turmeric (compared to fresh)</p>	No material or equipment to measure the moisture of turmeric.
Storage		D (unknow)	Dried turmeric (<i>i.e.</i> , a mixture of mother and finger rhizomes)	<p>The turmeric chips are put in a plastic bag (about 10 kg/pack) and stored at 25°C for a few days to a few months until there is market demand.</p> <p>It is stored for a few days to a few months until there is market demand.</p>	Plastic bag, balance	1 man	Inside the building (storage room with the temperature control)	NA	
Grinding and packing		D (unknow)	Dried turmeric (<i>i.e.</i> , a mixture of mother and finger rhizomes)	<p>The turmeric are ground by using a big-scale grinder (10 kg/batch) and then ground twice with a small-scale grinder to get fine particle.</p> <p>The ground turmeric is sieved in order to get the target particle.</p> <p>The powder is packed in various packaging:</p> <ul style="list-style-type: none"> • 50 g tube = 9 USD • 100 g kraft = 12 USD • 500 g bag =35.4 USD • 1 kg bag = 62.9 USD 	Big scale grinder, small scale grinder, sieving machine, spoon, tray, plastic tank, plastic film, plastic net	2 men	Inside building (close system)	The yield loss in this step is 13.0% for origin 1 and 12.7% for origin 2.	Unknown particle size

Annex 4: Guide for focus group discussion – consumer test

Guide for focus group discussion – consumer test: perceptions and attitudes of consumer towards turmeric powder

General information	
Host's name	Molika Yin
Number of participants (age)	6 (aged 20 to 60)
Date (Duration)	Thursday 8 July 2021 (2 h)
City and Country	Phnom Penh, Cambodia
Language	Khmer and English

Phase 1: Introduction (10 min)

- Introduce the host.
- Thank the participants for attending and explain to them why they were chosen.
- Present the products (turmeric powders) and the objectives of the test.
- Present some rules for the proper conduct of the focus group (only one person speaks at a time, there is no wrong answer, all assessments are permitted, you must be comfortable giving your opinion ...).
- Explain how the meeting will go.
- Ask each participant to introduce themselves and what they think about this kind of study.

Phase 2: General discussion on turmeric powder: habits and modes of consumption (20 min)

- What word or phrase comes to your mind when you think of turmeric?
- Do you consume it? And if so, when?
- How do you consume it? In what form (fresh, make tea, use it in soup, add it in rice, prepare as a paste ...)? What is the most frequent form of consumption (fresh, dried)?
- Why do you consume it (for its health benefit, sensory...)?
- What are your problems or concerns when using turmeric powder?
- What companies or brands do you associate with this product?
- What trends do you see happening in this industry?

Phase 3: Evaluation test: the characteristic, the consumption and the purchase of turmeric powders (40 min)

Participants are invited to observe four products presented in their entirety (two turmeric powders and two turmeric rice). We use two commercial products available in Cambodia markets and we add these two products into plain rice.

- Are you familiar with these products? Why?

- Are these products different from the ones you are used to consume? Why?

Participants are invited to observe the products (appearance, colour), smell and taste them.

- Can you give us the characteristics of the turmeric powder you like to purchase / consume?
 - o Appearance / Colour: light yellow, yellow, orange; fine or coarse particle; dry or wet appearance
 - o Smell / Odour
 - strong or weak odour
 - pleasant or unpleasant odour
 - turmeric odour
 - o Taste / Flavour: ...
- Can you give us the characteristics of the turmeric powder that you don't like to purchase / consume?
 - o Appearance / Colour
 - o Smell / Odour
 - o Taste / Flavour
- Should the turmeric powders have different characteristics depending on the way of consumption?
- Would you be ready to use the turmeric powder? If yes or no, why?
- Do you know the nutritional quality of this type of turmeric powder and why it is good to consume it?
- Can you imagine yourself purchasing these products and which one (s) do you prefer (List on the board)? Why would you purchase them?
- Which one (s) wouldn't you purchase (list on the board)? Why don't you purchase them?

Sample	Source	Code	Purchase	Not purchase
Turmeric powder 1	Cambodia	832		
Turmeric powder 2	USA	573		
Turmeric rice 1	Cambodia	795		
Turmeric rice 2	USA	632		

- Where do you purchase the turmeric powder that you consume? Market? Transformer? Are you loyal to a seller? to a processor? Why are you purchasing it there?
- Who in your household purchases turmeric powder?

- When purchasing: to know if it is "a good turmeric powder", what do you pay attention to (brand name, price, packaging type....)?
- How do you perceive the quality criteria for purchasing (look, touch, smell, taste)?
- What is the average amount of turmeric powder you purchase in your household per week or per month?
- At what price do you usually purchase turmeric powder (specify the sales unit, if possible, i.e., 50 g in tube costs €7 or 50 g in kraft costs €6...)?
- Does the price influence your choice when buying turmeric powder?
- When you buy turmeric powder, what is priority for you: quality or price?
- When you buy turmeric powder, do you know where the turmeric comes from?
- Is it important for you to know where it comes from?
- After purchasing, do you keep the turmeric powder or consume it immediately? If you happen to keep it, for how long?
- Do you know any species of yellow turmeric (*Curcuma longa*) in Cambodia? What are they?

Phase 4: Summary and Synthesis (10 min)

- Summary
- Is there anything else you want to add to the conversation about this product?
- Thank the participants again and give them a gift.

Note:

- Moderator (Molika Yin): record the discussion / meeting, make an introduction, observe the participants for seating arrangements, take careful notes, summarize and make a conclusion.
- Assistant moderator (s) (Researcher / Research assistant): help with equipment and refreshments (sandwiches and coffee), arrange the room and take notes throughout the discussion.
- The test should be done at 8:30AM – 10:30AM and the refreshments are provided after Phase 2.

Annex 5: Questionnaire for consumer preference of turmeric powders



កាលបរិច្ឆេទ Date:

ឈ្មោះអ្នកធ្វើតេស្ត Name:

លេខកម្រងសំណួរ Questionnaire number:

ចំណាច់ចំណូលចិត្តរបស់អ្នកប្រើប្រាស់ម្សៅរមៀត
Consumer preference of turmeric powders

ភេទ Gender : ស F ប M

សញ្ជាតិ Nationality : ខ្មែរ Cambodian ផ្សេងៗ Other : _____

ទីលំនៅបច្ចុប្បន្ន Country of residence : កម្ពុជា Cambodia ផ្សេងៗ Other: _____

អាយុ (ឆ្នាំ) Age (years) : _____ មុខរបរ Occupation: _____

ស្ថានភាពគ្រួសារ Marital status :

- នៅលីវ Single
- រៀបការ Married
- មេម៉ាយ ឬ ពោះម៉ាយ Widow (er)

តើអ្នកធ្លាប់ទទួលបានរមៀតដែរឬទេ? Have you ever consumed turmeric?

- ធ្លាប់ Yes
- មិនធ្លាប់ No

បើធ្លាប់ តើអ្នកទទួលបានវា If yes, do you consume it:

- ស្រស់ Fresh?
- ស្ងួត Dried?
- ទាំងពីរ Both?

ប្រសិនបើទទួលបានទាំងពីរ តើអ្នកទទួលបានញឹកញាប់កម្រិតណា (គិតជា %)

If both, at which frequency (in %) do you consume each one:

ស្រស់ Fresh:ស្ងួត Dried:

តើអ្នកទទួលបានរមៀតញឹកញាប់កម្រិតណា? (ចូរជ្រើសរើសចម្លើយតែមួយ)

How often do you consume turmeric? (Tick one exclusively)

- រៀងរាល់ថ្ងៃ Every day
- ២ ទៅ ៣ ដងក្នុងមួយសប្តាហ៍ Several times a week
- ម្តងក្នុងមួយសប្តាហ៍ Once a week
- ២ ទៅ ៣ ដងក្នុងមួយខែ Several times a month
- ម្តងក្នុងមួយខែ Once a month
- កម្រ Rarely

ការត្រួតពិនិត្យរមៀត Turmeric tasting (session 1):

អ្នកត្រូវបានអញ្ជើញឱ្យត្រួតពិនិត្យសំណាករមៀតបួនដែលសំណាកនីមួយៗដាក់ស្លាកលេខកូដ ៣ ខ្ទង់។ សូមវាយតម្លៃសំណាកតាម លំដាប់ដែលបានផ្តល់ ហើយចង្អុលបង្ហាញថា តើអ្នកចូលចិត្តវាកម្រិតណា។ You are invited to taste four turmeric samples, each labelled with a three-digit code. Please assess the samples in the order provided and indicate how well you like it.

- 1. មិនចូលចិត្តខ្លាំងបំផុត Dislike extremely
- 2. មិនចូលចិត្តខ្លាំង Dislike very much
- 3. មិនចូលចិត្តល្មម Dislike moderately
- 4. មិនចូលចិត្តតិចតួច Dislike slightly
- 5. មិនប្រាកដថាចូលចិត្ត ឬមិនចូលចិត្ត Neither like nor dislike
- 6. ចូលចិត្តតិចតួច Like slightly
- 7. ចូលចិត្តល្មម Like moderately
- 8. ចូលចិត្តខ្លាំង Like very much
- 9. ចូលចិត្តខ្លាំងបំផុត Like extremely

សូមសម្អាតក្រអូបមាត់របស់អ្នកជាមួយនឹងទឹក និង / ឬ បាយធម្មតា បន្ទាប់ពីត្រួតពិនិត្យសំណាកនីមួយៗ។

Please clean your palate with water and/or plain rice after each sample.

លេខកូដសំណាក Sample code	រូបរាង / ពណ៌ Appearance / Colour	វាយនភាពនៃការកិនរមៀត Texture of the grind of the turmeric powder	ក្លិន Smell / Odour	រសជាតិ Taste / Flavour	ចំណូលចិត្តទូទៅ Overall preference

យោបល់ផ្ទាល់ខ្លួន Give your own opinion

បើចាំបាច់អ្នកអាចត្រួតពិនិត្យរមៀតទាំងបួនម្តងទៀត If necessary, you can taste all the four turmeric samples again

- 1. តើសំណាកមួយណាដែលមើលទៅដូចអ្វីដែលអ្នកតែងតែទទួលទាន? Which sample looks more like the one you usually consume?
 - 2. តើសំណាកមួយណាដែលអ្នកមិនចូលចិត្តជាងគេ? Which sample do you **dislike** the most?
ហេតុអ្វី? Why?
 - 3. តើសំណាកណាមួយដែលអ្នកចូលចិត្តជាងគេ? Which sample do you **like** the most?
ហេតុអ្វី? Why?.....
 - 4. តើអ្នកចូលចិត្តកិនរមៀតដាក់ក្នុងបាយដៃឬទេ? Do you like the grind of turmeric powder in the rice sample?
 ចូលចិត្ត Yes
 មិនចូលចិត្ត No
 ហេតុអ្វី? Why?.....
- យោបល់ / ការកត់សម្គាល់ Comments / remarks:

ការត្រួតពិនិត្យរមៀត Turmeric tasting (session 2):

អ្នកត្រូវបានអញ្ជើញឱ្យត្រួតពិនិត្យសំណាករមៀតបួនដែលសំណាកនីមួយៗដាក់ស្លាកលេខកូដ ៣ ខ្ទង់។ សូមវាយតម្លៃសំណាកតាម លំដាប់ដែលបានផ្តល់ ហើយចង្អុលបង្ហាញថា តើអ្នកចូលចិត្តវាកម្រិតណា។ You are invited to taste four turmeric samples, each labelled with a three-digit code. Please assess the samples in the order provided and indicate how well you like it.

- 1. មិនចូលចិត្តខ្លាំងបំផុត Dislike extremely
- 2. មិនចូលចិត្តខ្លាំង Dislike very much
- 3. មិនចូលចិត្តល្មម Dislike moderately
- 4. មិនចូលចិត្តតិចតួច Dislike slightly
- 5. មិនប្រាកដថា ចូលចិត្ត ឬមិនចូលចិត្ត Neither like nor dislike
- 6. ចូលចិត្តតិចតួច Like slightly
- 7. ចូលចិត្តល្មម Like moderately
- 8. ចូលចិត្តខ្លាំង Like very much
- 9. ចូលចិត្តខ្លាំងបំផុត Like extremely

សូមសម្អាតក្រអូបមាត់របស់អ្នកជាមួយនឹងទឹក និង / ឬ បាយធម្មតា បន្ទាប់ពីត្រួតពិនិត្យសំណាកនីមួយៗ។

Please clean your palate with water and/or plain rice after each sample.

លេខកូដសំណាក Sample code	រូបរាង / ពណ៌ Appearance / Colour	វាយនភាពនៃការកិនរមៀត Texture of the grind of the turmeric powder	ក្លិន Smell / Odour	រសជាតិ Taste / Flavour	ចំណូលចិត្តទូទៅ Overall preference

យោបល់ផ្ទាល់ខ្លួន Give your own opinion

បើចាំបាច់អ្នកអាចត្រួតពិនិត្យរមៀតទាំងបួនម្តងទៀត If necessary, you can taste all the four turmeric samples again

5. តើសំណាកមួយណាដែលមើលទៅដូចអ្វីដែលអ្នកតែងតែទទួលទាន? Which sample looks more like the one you usually consume?

6. តើសំណាកមួយណាដែលអ្នកមិនចូលចិត្តជាងគេ? Which sample do you **dislike** the most?
ហេតុអ្វី? Why?

7. តើសំណាកណាមួយដែលអ្នកចូលចិត្តជាងគេ? Which sample do you **like** the most?
ហេតុអ្វី? Why?.....

8. តើអ្នកចូលចិត្តកិនរមៀតដាក់ក្នុងបាយដៃឬទេ? Do you like the grind of turmeric powder in the rice sample?

- ចូលចិត្ត Yes
- មិនចូលចិត្ត No

ហេតុអ្វី? Why?.....

យោបល់ / ការកត់សម្គាល់ Comments / remarks:

តើអ្នកនឹងទិញ ឬអាចទិញ ឬប្រើរមៀតស្លុតប្រភេទនេះក្នុងគោលបំណងអ្វី? For what purpose would/could you buy/use this type of dried turmeric?

- សុខភាព Health
- គ្រឿងសំអាង Cosmetic
- ចម្អិន Cook:
 - ក្លិន smell
 - រសជាតិ taste
 - ពណ៌ colour
- ផ្សេងៗ Others:

ប្រសិនបើអ្នកអាចទិញរមៀតស្លុតនេះ តើអ្នកនឹងចម្អិនវាយ៉ាងដូចម្តេច? If you could buy this dried turmeric, how would you cook it?

(ចូរជ្រើសរើសចម្លើយមួយ ឬច្រើនបើចាំបាច់។ បញ្ជាក់លំដាប់លំដោយនៃភាពញឹកញាប់៖ ១ ២ ៣ ...: ១ តំណាងអោយញឹកញាប់បំផុត) (Tick one or more if necessary. Precise the order of frequency: 1, 2, 3, ...: 1 represents the most frequent)

- ឆុងជាតែ Make tea
- ដាក់ក្នុងសម្ល Use it in soup
- បន្ថែមក្នុងបាយ Add it in rice
- ធ្វើជាគ្រឿង Prepare as a paste
- ប្រឡាក់គ្រឿង Marinade

Frequency

ប្រសិនបើអ្នកអាចទិញរមៀតស្លុត តើអ្នកនឹងទទួលបានវានៅពេលណា? If you could buy dried turmeric, at what occasion would you consume it?

(ចូរជ្រើសរើសចម្លើយមួយ ឬច្រើនបើចាំបាច់។ បញ្ជាក់លំដាប់លំដោយនៃភាពញឹកញាប់៖ ១ ២ ៣ ...: ១ តំណាងអោយញឹកញាប់បំផុត) (Tick one or more if necessary. Precise the order of frequency: 1, 2, 3, ...: 1 represents the most frequent)

- អាហារពេលព្រឹក Breakfast
- អាហារថ្ងៃត្រង់ Lunch
- នៅចន្លោះពេលទទួលបានអាហារ In between meals
- អាហារពេលល្ងាច Dinner

Frequency

Annex 6: Questionnaire for quantitative descriptive analysis

Tasting order for the two training sessions

Sample name		Replicate	Code sensory
Curcuma Cambodgien Kam Angkor	Sample 1	1	A
Curcuma Cambodgien Kam Angkor	Sample 1	2	E
Curcuma Moulu Ducros	Sample 2	1	B
Curcuma Moulu Ducros	Sample 2	2	F
Test de Molika FCD1.I	Sample 3	1	C
Test de Molika FCD1.I	Sample 3	2	D

Panellist	Session 1			Session 2		
Nelly Forestier-Chiron	A	B	C	D	F	E
Zoé Deuscher	B	A	C	E	D	F
Adrien Servent	C	B	A	D	F	E
Marie-Christine Durand	A	C	B	F	D	E
Mathieu Weil	B	C	A	E	D	F
Magali	C	A	B	F	E	D
Jean-Christophe Meile	A	B	C	F	E	D
Philippe Gallet	A	C	B	F	D	E
Isabelle Maraval	B	C	A	D	F	E
Karima Meghar	C	A	B	D	E	F
Molika Yin	B	A	C	F	E	D
Santiago Guzman Penella	C	A	B	D	F	E

Tasting order for real samples-tasting

Sample name		Replicate	Code sensory
FD1P1.I	Sample 1	1	BYR
FD1P1.II	Sample 1	2	VVT
FD1P2.I	Sample 2	1	RDM
FD1P2.II	Sample 2	2	TDE
FCD1P1.I	Sample 3	1	PZX
FCD1P1.II	Sample 3	2	IAL
FCD1P2.I	Sample 4	1	ITV
FCD1P2.II	Sample 4	2	SKG

Panellist	Session 1				Session 2			
Nelly Forestier-Chiron	RDM	ITV	PZX	BYR	TDE	IAL	VVT	SKG
Zoé Deuscher	RDM	PZX	BYR	ITV	IAL	SKG	TDE	VVT
Adrien Servent	BYR	PZX	ITV	RDM	SKG	VVT	IAL	TDE
Marie-Christine Durand	ITV	RDM	PZX	BYR	VVT	TDE	SKG	IAL
Mathieu Weil	ITV	BYR	PZX	RDM	TDE	IAL	VVT	SKG
Magali	RDM	BYR	ITV	PZX	IAL	SKG	TDE	VVT
Jean-Christophe Meile	PZX	ITV	BYR	RDM	SKG	VVT	IAL	TDE
Philippe Gallet	BYR	PZX	RDM	ITV	VVT	TDE	SKG	IAL
Isabelle Maraval	ITV	BYR	RDM	PZX	TDE	IAL	VVT	SKG
Karima Meghar	BYR	RDM	ITV	PZX	IAL	SKG	TDE	VVT
Molika Yin	PZX	RDM	BYR	ITV	SKG	VVT	IAL	TDE
Santiago Guzman Penella	PZX	ITV	RDM	BYR	VVT	TDE	SKG	IAL

Test sensoriel de curcuma

Date : 15/10/2021 Nom : Nelly Forestier-Chiron

No. 1

Session 1

Famille d'attributs	Attribut	RDM	ITV	PZX	BYR
Apparence	Jaune				
	Terne				
	La taille des particules				
Odeur	Curcuma				
	Terreux				
Saveur	Amer				
Arôme	Curcuma				
	Terreux				
	Boisé				
	Vert				
	Menthe				
	Florale				
Impression	Piquant				
	Frais				
Commentaires					

Test sensoriel de curcuma

Date : 15/10/2021 Nom : Nelly Forestier-Chiron

No. 1

Session 2

Famille d'attributs	Attribut	TDE	IAL	VVT	SKG
Apparence	Jaune				
	Terne				
	La taille des particules				
Odeur	Curcuma				
	Terreux				
Saveur	Amer				
Arôme	Curcuma				
	Terreux				
	Boisé				
	Vert				
	Menthe				
	Florale				
Impression	Piquant				
	Frais				
Commentaires					

Annex 7: List of scientific articles

Published papers

Yin M, Bohuon P, Avallone S, In S, Weil M. (2022) Postharvest treatments of turmeric (*Curcuma longa* L.) in Cambodia – impact on quality. *Fruits–International Journal of Tropical and Subtropical Horticulture*. <https://doi.org/10.17660/th2022/026>

Yin M, Weil M, Avallone S, Lebrun M, Conejero G, In S, Bohuon P. (2022) Impact of cooking and drying operations on colour, curcuminoids and aroma of *Curcuma longa* L. *Journal of Food Processing and Preservation*. <https://doi.org/10.1111/jfpp.16643>

Yin M, Weil M, Avallone S, Maraval I, Forestier-Chiron N, In S, Bohuon P. (2022) Impact of cooking, drying and grinding on sensorial and functional quality of *Curcuma longa* L. *Journal of Food Measurement and Characterisation*. <https://doi.org/10.1007/s11694-022-01683-w>

Poster Presentation at International Conferences

Yin M, Weil M, Avallone S, In S, Bohuon P. Evolution of colour and curcuminoids during the turmeric processing. 2021. Poster EFFoST 35th International EFFoST 2021, 1st – 4th November. Poster n°P2.2.50.

Postharvest treatments of turmeric (*Curcuma longa* L.) in Cambodia – Impact on quality

M. Yin^{1,2}, P. Bohuon¹, S. Avallone¹, S. In² and M. Weil^{1,3,a}

¹ Qualisud, Université Montpellier, CIRAD, Institut Agro, Avignon Université, Université de La Réunion, Montpellier, France

² Institut de Technologie du Cambodge, Food Technology and Nutrition Research Unit, Phnom Penh, Cambodia

³ CIRAD, UMR Qualisud, Montpellier, France

Summary

Introduction – A study on postharvest treatments of turmeric (*Curcuma longa* L.) was carried out in Cambodia with the aim of describing the local practices and measuring their impacts on the quality of the products. **Materials and methods** – Three case studies were observed, described and compared by using the 5M methodology. The impacts of sourcing and postharvest treatments on turmeric quality were assessed in samples collected in the case studies. **Results and discussion** – The local processing practices of turmeric were described in detail through the study of three turmeric production systems located in three areas (Siem Reap, Phnom Penh and Kampot), and known as the main turmeric processors in Cambodia. The essential oil, bioaccessible curcuminoids (both finger and mother) and total curcuminoids contents (mother only) of the rhizomes from different origins were different. The essential oil content of fingers was lower than that of mothers. The contents of total and bioaccessible curcuminoids also varied according to the rhizome parts analysed. After processing, no general rule was observed for essential oil and curcuminoid contents but the bioaccessible curcuminoids significantly decreased. **Conclusion** – Our findings clearly indicate that fresh turmeric from Siem Reap should be a good choice as it contains higher essential oil and equal curcuminoid contents compared to the turmeric from case study 2 (Phnom Penh). The postharvest treatment in Kampot had the shortest drying time and got the highest yield (16.2%), with the water content (about 6%) conforming with the specifications of the ISO standard 5562:1983.

Keywords

bioaccessibility, curcuminoids, essential oil, field study, particle size

Introduction

Turmeric (*Curcuma longa* L.) belongs to the Zingiberaceae family and is widely distributed throughout the tropical and subtropical regions of the world (Kutti Gounder and Lingamallu, 2012). In Cambodia, turmeric (local name: lami-et) is mainly consumed fresh as it is available throughout the year. Moreover, it is mixed with other spices or herbs to make *Kroeung* for traditional Cambodian foods (*Machou Kroeung*,

^a Corresponding author: mathieu.weil@cirad.fr

Significance of this study

What is already known on this subject?

- Pre-treatment and dehydration are known to highly affect the final quality of turmeric, but there is no study combining the description of turmeric processes and the assessment of the impact of those processes on the quality of turmeric.

What are the new findings?

- The study of several processes made it possible to identify the key parameters modulating quality (*i.e.*, peeling, cooking, slicing and drying). The postharvest treatment in Kampot appeared to be the easiest to implement, could save drying time and got the highest yield (16.2%); the essential oil and curcuminoid contents loss along the process were less than for the other two processes.

What is the expected impact on horticulture?

- This study provides decision rules for turmeric processors to determine which origin of turmeric and postharvest treatment should be privileged to save drying time and get the highest essential oil and curcuminoid contents.

Korko, Kari, Amok and so on) to enhance their aroma and color and to marinate meat by mixing it with other seasonings or spices to boost the flavour of the meat. Turmeric powder has been used in cosmetic products (body lotion and scrap to whiten the skin) and medicine; it has been produced mainly for export to the international market. The export value of turmeric from Cambodia was 1.55 million U.S. dollars with an export volume of 512.64 tons in 2021. This allowed Cambodia to rank at 21st with a share in export of 0.44%. The top export destination of turmeric from Cambodia in 2021 was India (94.16% of share in export equal to 1.46 million U.S. dollars of export value) (Tridge, 2022).

After harvest, fresh turmeric rhizome undergoes continuous physical, chemical and microbiological degradation. These changes are particularly influenced by the moisture content of the material, relative humidity of ambient air and the drying and storage conditions (Bambirra *et al.*, 2002). To preserve its quality and reduce its weight during transportation, it must be subjected to specific technological treatment such as drying. Sun-drying has traditionally been the dehydration method used for turmeric rhizomes. It has been practised extensively in hot climates and tropical countries (including Cambodia) due to its low cost and simple

technology. However, it is extremely weather-dependent and may, therefore, require long processing times and it affects the quality of the product, especially in the curcuminoid content (Hirun *et al.*, 2014). Hence, each company does its best to find an acceptable process, *i.e.*, a set of operations to obtain good quality turmeric at a reasonable price. Parameters such as complexity and duration of the process or even sustainability can also be taken into account.

Currently, there is no study combining the description of turmeric processes and the assessment of the impact of those processes on quality. Thus, in this study, we aimed to describe the main local postharvest treatments of turmeric (*Curcuma longa* L.) in Cambodia and assess the impacts of raw material sourcing (origin and part of the rhizome) and postharvest treatments (full processes and unit operations of peeling and cooking) on turmeric quality. The main quality characteristics considered in this study were essential oil content, total and bioaccessible curcuminoid contents (curcumin: C, demethoxycurcumin: DMC, and bisdemethoxycurcumin: BDMC) and their bioaccessibility. Moreover, the impact of origin and part of the rhizomes on colour values (L^* , a^* and b^*) and particle characterisation (sizes and distribution) of turmeric powders were also assessed.

Materials and methods

Description of turmeric production systems

The harvest season of turmeric in Cambodia is from January to April. Our study (sampling included) was carried out from January to February 2022 in three different areas, *i.e.*, Siem Reap (point: 13.325749382221119, 103.91928620819341), Phnom Penh (point: 11.538663924648885, 104.8845437152102), and

Kampot (point: 10.6126459894834, 104.31763155656039) (Figure 1). These areas were selected because they are known as the main production areas in Cambodia. In all three cases, the surveys were carried out in medium-sized companies with a number of employees of approximately 30. These actors produce annually about 10 tons of dried turmeric powders. The target market of case study 1 (Siem Reap), case study 2 (Phnom Penh), and case study 3 (Kampot) are tourism, local market and export, respectively. A checklist was used for interviewing 33 actors in order to describe the turmeric process. We used the 5M methodology – a widely utilized tool in developing hazard analysis critical control point (HACCP) systems – to describe each step of the three turmeric production systems accurately and exhaustively through five dimensions: material (turmeric), machines (equipment tools), mother nature (environment, conditions), methods and men (persons, staff).

Determination of turmeric quality

1. Sampling procedure. About 200 g of fresh turmeric and turmeric powders were sampled for quality analysis. Samples were packed in a zip-lock aluminium bag (primarily packaging) and put in secondary packaging, *i.e.*, zip-lock plastic bag. The samples were stored in an icebox containing refrigerant gel and transported to Institut de Technologies du Cambodge (ITC) by car and frozen at -20 °C in ITC's laboratory (Cambodia) for further transportation to CIRAD's laboratory (France). The samples were transported by airplane from Phnom Penh (Cambodia) to Montpellier (France) within 48 h and refrozen at -20 °C on arrival for further analysis.

2. Sample preparation. About 100 g of fresh turmeric were cleaned and cut into small pieces. Next, they were frozen by

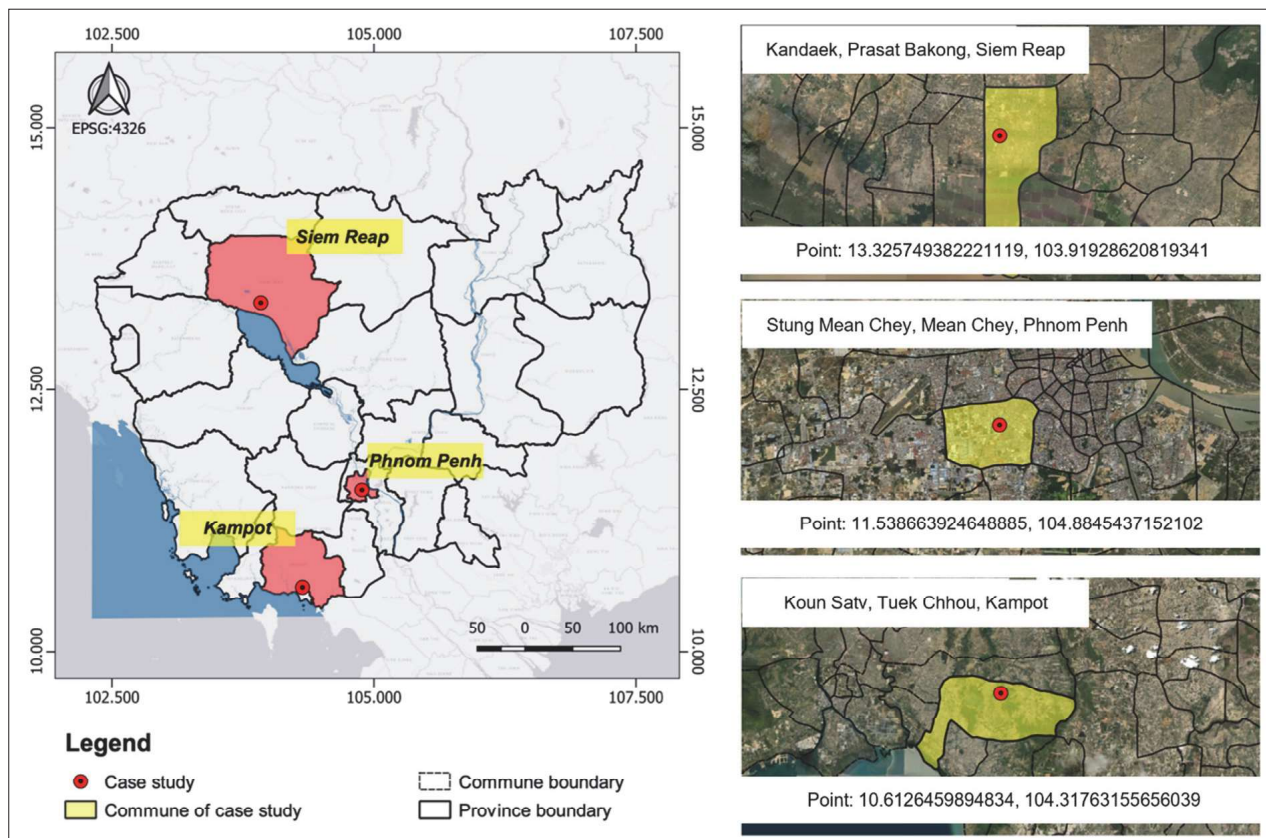

FIGURE 1. Location of the case studies selected for studying postharvest treatments of turmeric (*Curcuma longa* L.) in Cambodia: Case study 1 (Siem Reap); Case study 2 (Phnom Penh); Case study 3 (Kampot). See also Supplemental Information – Table 1.

using liquid nitrogen and ground for 10 s at 10,000 rpm in a mill (Retsch Grindomix GM200, Retsch GmbH, Germany) for immediate analyses of water content, essential oil content, curcuminoids and their bioaccessibility whereas the turmeric powders sampled from each case study were analysed directly.

3. Analytical methods.

Dry matter and water contents – The dry matter content (means “dry matter free of essential oil”) was obtained by drying 1 g of ground turmeric in an aluminium cup in an oven (Gefran 800, Italy) at 105 °C for 30 h (*i.e.*, until constant weight). The mean relative deviation of repeatability was $\pm 1.5\%$ ($n=3$). Water content, expressed on a dry basis, was deduced from essential oil and dry matter contents.

Colour measurements – Colour values, *i.e.*, lightness (L^*), redness (a^*) and yellowness (b^*) of ground turmeric samples were determined using a Colorimeter (CM-5; Konica-Minolta, Tokyo, Japan). The mean relative deviation of repeatability was 0.7%, 0.4% and 0.3%, respectively, for L^* , a^* and b^* ($n=3$).

Particle characterization – A laser granulometry instrument (Mastersizer 3000, Malvern Instruments Ltd., Malvern, Worcestershire, U.K.) was used to measure the turmeric powders' particle diameter and particle size distribution. The particle size was reported as the surface mean diameter (D [3;2]), the volume-weighted mean diameter (D [4;3]), and median Dx (50). The mean relative deviation of repeatability was 1.8%, 10.0% and 1.6%, respectively, for D [3;2], D [4;3] and Dx (50) ($n=5$).

Essential oil content – The essential oil content, expressed in mL 100 g⁻¹ on a dry weight basis (mL 100 g⁻¹ db), was determined using a method adapted from the international official standard method ISO 6571:2008 (International Organization for Standardization, 2008). The only modification in the method we applied was the elimination of xylene. The mean relative deviation of repeatability was $\pm 1.2\%$ ($n=3$).

Curcuminoid contents – Approximately 0.3 g of turmeric sample was mixed with 30 mL of 60 °C ethanol (99.8%) and homogenized for 2 min at 30,000 rpm (IKA T10 basic Ultra-Turrax, ProLabo, France). The samples were heated for 30 min at 60 °C (Sogi *et al.*, 2010). After cooling, the extracts were diluted 1/10 with ethanol and filtered on 0.45 µm PTFE Minisart SRP4 membrane (Sartorius, Palaiseau, France). Curcuminoids were analysed by high-performance liquid chromatography (Agilent System 1200 series, Massy, France). The column was a polymeric ACE C₁₈ (250 × 4.6 mm, 5 µm particle size, Inc., Wilmington, NC) and the injection volume was 5 µL. The quantification of curcuminoids was carried out according to the method of Sepahpour *et al.* (2018) with small modifications. The elution was done isocratically with a mixture of acetonitrile and 0.1% acetic acid (40:60) at a flow rate of 1.0 mL min⁻¹. The temperature of the column was set at 25 °C. Chromatograms were recorded over a 30 min period with a UV-visible photodiode array detector (Agilent Technologies 1200 series) at 425 nm, the wavelength of maximum absorption of the curcuminoids in the mobile phase. The curcuminoids were identified by their retention time and spectrum. External calibration was realized weekly with standard solutions of the pure chemicals in ethanol in the range of 1 to 200 mg L⁻¹. The curcuminoid contents were expressed in g 100 g⁻¹ on a dry weight basis (g 100 g⁻¹ db). The mean relative deviation of repeatability was 2.8%, 2.2%, 2.4% and 2.5%, respectively, for C, DMC, BDMC and total curcuminoid contents ($n=3$).

Assessment of bioaccessible curcuminoids – A static *in vitro* gastrointestinal tract model was used to study the potential

gastrointestinal fate and bioaccessibility of curcuminoids in turmeric powders. The simulated gastrointestinal tract used in our study was based on one described previously (Minnekus *et al.*, 2014; Yerramilli *et al.*, 2018) with some slight modifications. The stock solutions were prepared before the experiments while the enzymatic solutions were prepared at the last moment. About 1.0 g of fresh turmeric or 0.3 g of dried turmeric was weighed and distilled water was added into the sample to get the total weight about 5.0 g that was left at room temperature for 15 min. Then, 5 mL of salivary solution was added and the sample was incubated for 2 min at 37 °C with gentle stirring (Oral phase). Next, 10 mL of gastric phase was added and incubated for 2 h at 37 °C with gentle stirring (Gastric phase). The solution was adjusted to pH 5.0 with sodium hydroxide at 2 M and then 20 mL of intestinal phase was added. The sample was incubated for 2 h at 37 °C with gentle stirring (Intestinal phase). After that, the digest phases were separated from the solid residue by centrifugation at 10,000 g for 30 min at 15 °C (Avanti™ J-E, Beckman Coulter®). The liquid phase was weighed accurately. To extract the bioaccessible curcuminoids, 10 mL of the digesta was mixed with 10 mL of chloroform ($\geq 99.8\%$) and vortexed for 10 s (Fisherbrand™ Classic Vortex Mixer). Next, the samples were centrifuged at 10,000 g for 10 min at 15 °C. After that, 5 mL of yellow phase was evaporated at 50 °C for 3 min using a rotary evaporator (Heidolph Laborota 4000, Schwabach, Germany). Then, the residue was solubilized in 10 mL ethanol ($\geq 99.8\%$) and filtered on 0.45 µm PTFE Minisart SRP4 membrane. Finally, the bioaccessible curcuminoids were analysed by HPLC following the same method as the curcuminoid analysis. The content of bioaccessible curcuminoids was expressed in g 100 g⁻¹ on a dry weight basis (g 100 g⁻¹ db) by using the total content in the sample. The mean relative deviation of repeatability was 6.0%, 4.4%, 4.1% and 4.8%, respectively, for C, DMC, BDMC and total curcuminoids ($n=3$). The bioaccessibility (in %) corresponds to the amount of compounds transferred to the micellar phase compared to the initial contents in the products.

Statistical analysis

The results were expressed as means \pm standard deviations. To study the impact of the origin of the raw material, the significant differences were treated by analysis of variance (ANOVA) and Duncan's Multiple Range Test. To study the impact of the part of the rhizome, the impact of full processes and the impact of peeling and cooking, the significant differences were determined by the Independent-Samples *t*-test. SPSS v. 26.0 (SPSS Inc., Chicago, IL, U.S.A.) was used for the statistical analysis and the level of significance was set at $p < 0.05$.

Results and discussion

Description of turmeric postharvest treatments

The case studies took place in three areas of Cambodia where turmeric processing was observed, described and sampled (Figure 1). The observed processes were precisely detailed hereafter (Figure 2). Some process steps were common to all processes, whereas others were specific.

1. Reception of fresh turmeric. The turmeric roots were harvested a day before transporting them to processors. When there was a large purchase order from a processor, sometimes a farmer would act as a collector who collected the fresh turmeric from other farmers who lived in their village and then sold them to the processor. Transport could take

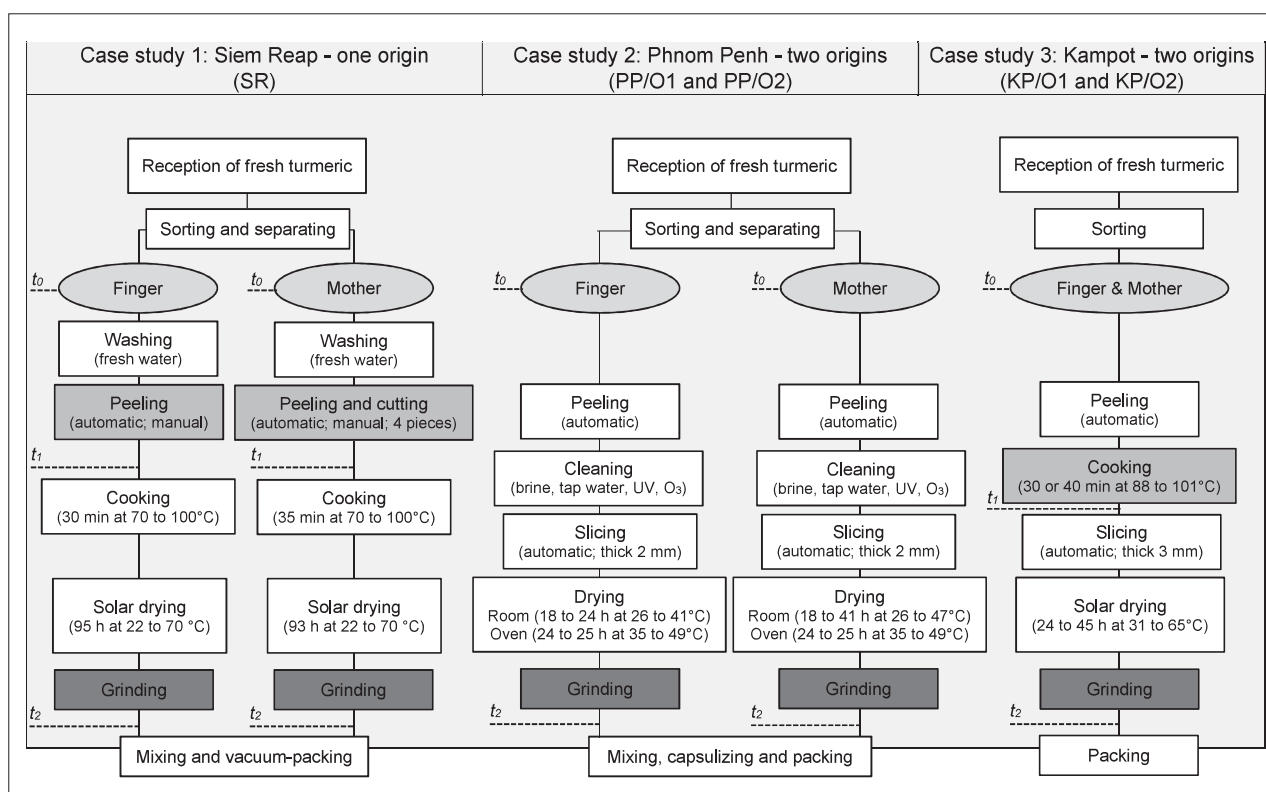

FIGURE 2. Diagram of processes of three distinct turmeric production case studies in Cambodia (Siem Reap, SR; Phnom Penh, PP/O1, PP/O2; Kampot, KP/O1, KP/O2) and indication of sampling points. See also Supplemental Information – Figure S1.

from a couple of hours to a day, depending on the distances and means used: trailer or truck. There was one origin of turmeric for case study 1 (SR: purchased from farmers in Siem Reap province) and two origins for case study 2 (PP/O1: grown in their own farm and PP/O2: purchased from Kampong Speu province) and for case study 3 (KP/O1: grown in their own farm in Kampot province and KP/O2: purchased from Pursat province). Turmeric roots harvested on the farm were usually kept in big plastic baskets (approximately 30 kg basket⁻¹) while those from the farmers were kept in plastic bags (10 kg pack⁻¹) (case studies 1 and 2) or in sacks (about 30 kg sack⁻¹) (case study 3) during the transport. According to their origins, the turmeric rhizomes were very different in size, shape and colour. This can be explained by the fact that species, age/maturity of the rhizome, soil, climate and growing technics that are different according to origins, affect the phenotype (Figure 3, fresh turmeric at t_0). Great differences on rhizomes dimensions were observed according to their origins; SR being the smallest rhizome and PPO1 the biggest. The length of the fingers ranged from 3.0 to 10.5 cm while their diameters ranged from 1.1 to 2.4 cm. Mothers, ovate in shape, are of shorter length (from 2.5 to 9.5 cm) and have a larger diameter (from 2.5 to 4.7 cm) than the fingers.

2. Sorting and separating. Sorting and separating were usually done manually. The processors separated the finger and mother rhizomes to process them separately (case studies 1 and 2 only). At the same time, foreign matter, small rootlets and adherent soil were removed. In case study 3, foreign matter, small rootlets and adherent soil were also removed during sorting but the turmeric rhizomes (finger and mother) were processed together. The quantity of turmeric processed varied from 100 to 200 kg day⁻¹ and required 4 (case study 2) to 13 (case studies 1 and 3) persons (mainly women).

3. Washing, peeling and cleaning. Washing and peeling were usually done at the same time by using a peeling machine that requires water for its functioning. In case study 1, the turmeric rhizomes were hand-washed twice with underground water to remove adhering soil and other foreign materials and then they were peeled (SY-PP8, Guangzhou Sunrly Kitchen Equipment Co., Ltd., China) (2 kg of finger rhizome batch⁻¹ for 2 min and 2.5 kg of mother rhizome batch⁻¹ for 5 min). Next, the peeled rhizomes were re-peeled manually using knives by 10 people to make sure that all the peel was completely removed. It is not only a time-consuming and low-yield process, but it also has an impact on quality as we could observe browning (enzymatic or non-enzymatic oxidation) on the peeled rhizomes. Mother rhizomes were cut into 4 pieces before subjecting to the next step. In case study 2, after separating finger and mother rhizomes, the rhizomes were peeled (CY-WP08, Zhengzhou Chenyue Machinery Equipment Co., Ltd., China) (10 kg of rhizome batch⁻¹ for 15 min and 30 min for finger and mother rhizomes, respectively). Then, the peeled rhizomes were cleaned in brine (75 g salt 300 L⁻¹ of water), tap water and treated water (UV and O₃) and then drained on a sieve tray. In case study 3, after sorting, the turmeric rhizomes were washed and slightly peeled (MSTP-80, Zhaoqing Fengxiang Food Machinery Co., Ltd., China) (20 kg batch⁻¹) which took about 30 min to process 100 kg of turmeric.

4. Cooking (case studies 1 and 3 only). In case study 1, the peeled turmeric rhizomes were cooked in hot water (between 70 and 100 °C) with a ratio of 1:1 w/v (10 kg of turmeric: 10 L of water) for 30 min and 35 min for finger and mother rhizomes, respectively. In case study 3, the cleaned turmeric rhizomes were cooked in hot water (between 88 to 101 °C) for 30 min or 40 min for turmeric roots from their own farm and only for 40 min for the turmeric roots purchased from the farmers with a ratio of 1:2 w/v (30–33 kg of turmeric:

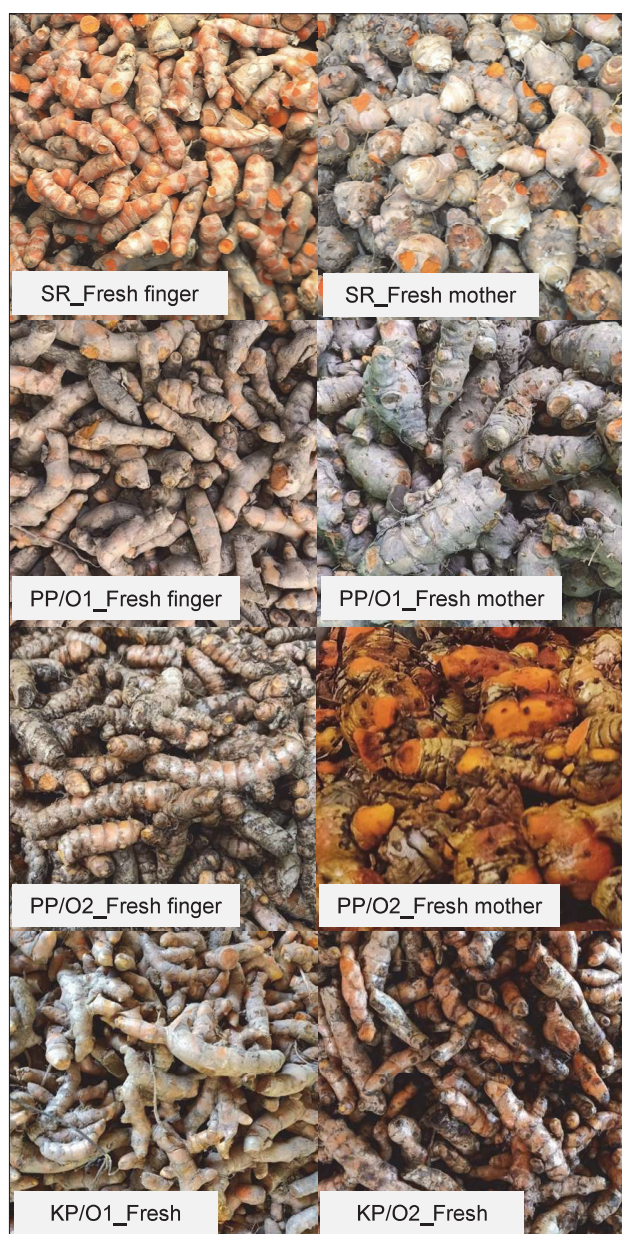

FIGURE 3. Fresh turmeric finger and mother rhizomes from three distinct case studies: Case study 1 (Siem Reap); Case study 2 (Phnom Penh); Case study 3 (Kampot).

60 L of water). The cooked turmeric rhizomes were then drained. Cooking was used not only to remove impurities (dust and foreign matter) but also to decrease the microbial load.

5. Slicing (case studies 2 and 3 only). In case study 2, after cleaning, the rhizomes were hand-cut into small pieces before being sliced to a thickness of 1–2 mm by using a slicing machine. In case study 3, slicing was done after the turmeric rhizomes were cooked. The cooked rhizomes were sliced to a thickness of 3 mm by a slicing machine; it took about 20 min for 100 kg of turmeric.

6. Drying. The drying time of all samples in the three case studies is shown in Supplemental Information – Figure S1. In case study 1, the cooked turmeric rhizomes were spread on trays (2.5 kg tray⁻¹) and dried in a solar dryer at 22–70 °C for 93–95 h. The large difference in drying temperatures was due to day and night periods. The dried turmeric rhizomes (finger and mother) were put separately in plastic bags (10–15 kg pack⁻¹), kept in a big plastic box and stored at ambient tem-

perature. In case study 2, the sliced turmeric rhizomes (2–3 kg tray⁻¹) were put on tray and dried in a room (with iron roof) at 26–47 °C for 18–41 h by using fans to speed up the drying process. Before drying in an oven, the semi-dried turmeric chips were sieved manually to separate between small and big turmeric chips. The small turmeric chips were collected but the big ones were dried in an oven dryer at 35–49 °C for 24–25 h. After drying, the turmeric chips were put in plastic bags (20–25 kg pack⁻¹) and stored at 25 °C. In case study 3, the sliced-cooked turmeric rhizomes were spread on trays (2.5–3 kg tray⁻¹) and dried in a solar dryer at 31–65 °C for 24–45 h. The drying time depends on the temperatures reached during the day and night. As there was heavy rain during drying, the drying time was increased up to 45 h for turmeric from their own farm (KP/O1_Ground). The turmeric chips were put in plastic bags (about 10 kg pack⁻¹) and stored at 25 °C. The processors checked if the turmeric rhizomes were completely dried by visual observation and by evaluating with their hands if they were crispy or easy to crack. The drying process would be stopped according to these empiric criteria. The dried turmeric rhizomes in the three case studies were then stored for a few days to a few months and the grinding operation was carried out just before sale or expedition, depending on market demand.

7. Grinding and packing. In case study 1, the dried finger and mother turmeric rhizomes were ground separately by a grinder until “fine” particles were obtained. However, in case studies 2 and 3, the dried turmeric rhizomes were normally ground by a big-scale grinder (10 kg batch⁻¹) and then reground by using a small-scale grinder (2–3 times) until “fine” particles were obtained. Then, the ground turmeric rhizomes were sieved and the particles remaining on the sieve would be reground to complete the process. Finally, the finger and mother turmeric powders were mixed together before being vacuum-packed in plastic bags and repacked in various packaging with various net contents of different prices (case study 1). In case study 2, the finger and mother turmeric powders were mixed together and then it was made as a capsule for selling to the market. In case study 3, the turmeric powders were vacuum-packed in plastic bags and repacked in various packaging with various net contents of different prices and they were also used as an ingredient to make other products (*e.g.*, *Kari* paste, *Kroeung* to marinate meat...). The highest yield of final products was found in case study 3 (16.2%), followed by case study 2 (between 10.8–14.2%) and case study 1 (10.0%), respectively (Supplemental Information – Table S1). The water content of fresh turmeric rhizomes ranged from 77.1 ± 0.1 to 84.3 ± 0.1 % (w/w); that of turmeric (dried) powders ranged from 3.3 ± 0.1 to 8.2 ± 0.1% (w/w) (Supplemental Information – Table S1). These values were in accordance with the specifications of the ISO standard 5562:1983 (International Organization for Standardization, 1983), indicating that the maximum water content in turmeric powder is 10% (w/w). Hence, there is a potential saving to be made by the companies on drying: they could dry less and obtain a better yield.

8. Selling price. The average selling prices (in U.S. dollars kg⁻¹) by each supply chain actor were as follows: farmer 0.45, collector 0.55, company (the prices varied according to net contents and packaging types) or shops on local market 20, and shops on European market 63. If we reason in equivalent water content, means if we consider the loss of water during the process, we can consider that the selling price was multiplied by 3 from farmer to company or local shops and by 10 from farmer to European shops.

TABLE 1. Impact of sourcing (origins and part of rhizomes) on the contents of essential oil, curcuminoids and their bioaccessibility (%) of turmeric obtained from different origins.

Sample	Essential oil (mL 100 g ⁻¹ db)			Curcuminoids (g 100 g ⁻¹ db)			Bioaccessible curcuminoids (g 100 g ⁻¹ db)			Bioaccessibility (%)	
	C	DMC	BDMC	Total	C	DMC	BDMC	Total	Total		
SR_Fresh finger	3.94±0.11 ^{ba}	1.87±0.07 ^{bb}	2.60±0.10 ^{bb}	8.42±0.27 ^{ab}	0.41±0.00 ^{bb}	0.29±0.01 ^{bb}	0.28±0.01 ^{bb}	0.99±0.01 ^{bb}	12.3±0.2 ^{ba}		
PP/O1_Fresh finger	4.04±0.18 ^{bb}	2.03±0.09 ^{ba}	2.66±0.10 ^{ba}	8.73±0.37 ^{ba}	0.64±0.03 ^{ba}	0.34±0.02 ^{ba}	0.22±0.02 ^{ba}	1.20±0.06 ^{ba}	13.6±0.8 ^{ba}		
PP/O2_Fresh finger	4.62±0.05 ^{ba}	1.98±0.01 ^{aba}	1.72±0.04 ^{bb}	8.32±0.08 ^{ba}	0.42±0.02 ^{bb}	0.16±0.01 ^{cb}	0.07±0.00 ^{cb}	0.64±0.02 ^{cb}	7.0±0.2 ^{cb}		
SR_Fresh mother	3.75±0.19 ^{ba}	2.09±0.06 ^{ba}	3.71±0.15 ^{ba}	9.54±0.40 ^{ba}	0.46±0.01 ^{ba}	0.36±0.01 ^{ba}	0.34±0.02 ^{ba}	1.16±0.04 ^{ba}	12.9±0.6 ^{ba}		
PP/O1_Fresh mother	4.48±0.02 ^{ba}	2.10±0.05 ^{ba}	2.41±0.02 ^{cb}	8.99±0.09 ^{ba}	0.46±0.02 ^{bb}	0.26±0.01 ^{cb}	0.14±0.02 ^{bb}	0.86±0.05 ^{bb}	9.5±0.7 ^{cb}		
PP/O2_Fresh mother	3.33±0.02 ^{cb}	1.87±0.01 ^{bb}	2.89±0.01 ^{ba}	8.08±0.01 ^{cb}	0.58±0.04 ^{ba}	0.40±0.03 ^{ba}	0.33±0.03 ^{ba}	1.31±0.10 ^{ba}	16.8±1.3 ^{ba}		

Means with the same superscript (a-c) within the same column do not differ significantly (Duncan's test, *p*-value < 0.05).

Means with the same superscript (A-B) at each column of each pair of the part of the rhizome (finger and mother) do not differ significantly (Independent-Samples *t*-test, *p*-value < 0.05). Curcumin (C); demethoxycurcumin (DMC); bisdemethoxycurcumin (BDMC); Siem Reap (SR); Phnom Penh (PP); and origin (O).

Impact of sourcing and postharvest treatments on turmeric quality

1. Impact of sourcing.

Impact of the origins on the essential oil, curcuminoid contents and their bioaccessibility of raw material – Different “Origins” could mean different terroir/climate (for sure), and also different species/varieties, different cultural practices and different maturities. The essential oil content of the turmeric rhizomes (both finger and mother) from different origins was significantly different (Table 1). The highest essential oil content of fresh finger rhizome was observed in the turmeric from case study 1 (SR_Fresh finger: 9.76 mL 100 g⁻¹ db) followed by PP/O1_Fresh finger (8.21 mL 100 g⁻¹ db) and PP/O2_Fresh finger (6.68 mL 100 g⁻¹ db), respectively. These values were lower than the value of 10.72 mL 100 g⁻¹ db (equal to 1.32 mL 100 g⁻¹ wb) found by Yin *et al.* (2022), on fresh turmeric from Thailand. However, the values were in agreement with Garg *et al.* (1999), who found that the essential oil content of turmeric collected from the sub-Himalayan Tarai region of India ranged from 0.16 to 1.94 mL 100 g⁻¹ wb. Fresh mother rhizome from case study 1 (Siem Reap) had the highest essential oil content (17.84 mL 100 g⁻¹ db), followed by PP/O2_Fresh finger (10.85 mL 100 g⁻¹ db) and PP/O1_Fresh finger (7.90 mL 100 g⁻¹ db), respectively.

The total curcuminoid content of the fresh finger rhizomes from different origins was not significantly different (Table 1), an average of 8.49 g 100 g⁻¹ db (equal to 1.36 g 100 g⁻¹ wb). This value was lower than the values found by Yin *et al.* (2022) (14.86 g 100 g⁻¹ db) and Hirun *et al.* (2014) (9.39 g 100 g⁻¹ db), but in accordance with the data of Govindarajan and Stahl (1980) (2–9 g 100 g⁻¹ db). In contrast, the total curcuminoid content of the fresh mother rhizomes from different origins was significantly different (Table 1). The highest total curcuminoid content of fresh mother rhizome was found in the turmeric from case study 1 (SR_Fresh mother: 9.54 g 100 g⁻¹ db) followed by PP/O1_Fresh mother (8.99 g 100 g⁻¹ db) and PP/O2_Fresh mother (8.08 g 100 g⁻¹ db), respectively.

Different origins of the turmeric rhizomes (both finger and mother) provided different bioaccessible curcuminoid contents (Table 1). The bioaccessibility of curcuminoids of fresh finger rhizomes ranged from 7.0% to 13.6% while that of fresh mother rhizomes ranged from 9.5% to 16.8%.

Impact of part of the rhizomes on the essential oil, curcuminoid contents and their bioaccessibility of raw material – The mass ratio of finger and mother in rhizomes (data not shown) in Siem Reap and Phnom Penh was the same and ranged from 89 to 92% (w/w) for the finger and 8 to 11% (w/w) for the mother rhizomes. The mass ratio of mother rhizome was even lower (between 2% to 3%) in Kampot. The essential oil content in mothers was 59% higher than in fingers for the sample in Siem Reap but these differences were not so high for the other origins (samples in case study 2).

Within the same rhizome, fingers and mothers can have different levels of total and bioaccessible curcuminoids (Table 1). In case study 1, the curcuminoid content of fresh mother rhizomes from case study 1 (Siem Reap) was 15% higher than the fresh finger rhizomes. This value was in agreement with Choudhury *et al.* (2017) who found that the phytochemical constituents are not evenly distributed in all plant parts and curcumin content (average) of fresh mother rhizomes was 15–38% higher than in the fresh finger rhizomes. In case study 2, the curcuminoid content in finger and mother rhizomes was not different for samples from the farm (PP/O1) but the curcuminoid content of PP/O2_Fresh finger was 2.9%

TABLE 2. Impact of the full processes on the contents of essential oil, curcuminoids and their bioaccessibility (%) of turmeric obtained from different origins.

Sample	Essential oil (mL 100 g ⁻¹ db)	Curcuminoids (g 100 g ⁻¹ db)			Bioaccessible curcuminoids (g 100 g ⁻¹ db)			Bioaccessibility (%)		
		C	DMC	BDMC	Total	C	DMC		BDMC	Total
<i>Case study 1</i>										
SR_Fresh finger	9.76±0.16 ^A	3.94±0.11 ^B	1.87±0.07 ^A	2.60±0.10 ^B	8.42±0.27 ^B	0.41±0.00 ^A	0.29±0.01 ^A	0.28±0.01 ^A	0.99±0.01 ^A	12.3±0.2 ^A
SR_Ground finger	9.12±0.06 ^B	4.59±0.14 ^A	1.93±0.06 ^A	2.86±0.09 ^A	9.38±0.29 ^A	0.25±0.05 ^B	0.24±0.01 ^B	0.24±0.01 ^B	0.73±0.06 ^B	8.7±0.5 ^B
SR_Fresh mother	17.84±0.03 ^A	3.75±0.19 ^A	2.09±0.06 ^A	3.71±0.15 ^A	9.54±0.40 ^A	0.46±0.01 ^A	0.36±0.01 ^A	0.34±0.02 ^A	1.16±0.04 ^A	12.9±0.6 ^A
SR_Ground mother	13.60±0.00 ^B	3.88±0.04 ^A	1.89±0.01 ^B	2.92±0.02 ^B	8.69±0.06 ^A	0.29±0.03 ^B	0.26±0.01 ^B	0.25±0.01 ^B	0.80±0.06 ^B	10.0±0.6 ^B
<i>Case study 2</i>										
PP/O1_Fresh finger	8.21±0.12 ^A	4.04±0.18 ^A	2.03±0.09 ^A	2.66±0.10 ^A	8.73±0.37 ^A	0.64±0.03 ^A	0.34±0.02 ^A	0.22±0.02 ^A	1.20±0.06 ^A	13.6±0.8 ^A
PP/O1_Ground finger	7.01±0.13 ^B	3.76±0.20 ^A	1.67±0.08 ^B	2.29±0.11 ^B	7.72±0.40 ^B	0.30±0.03 ^B	0.23±0.01 ^B	0.24±0.01 ^A	0.76±0.05 ^B	10.6±0.6 ^B
PP/O2_Fresh finger	6.68±0.16 ^B	4.62±0.05 ^B	1.98±0.01 ^A	1.72±0.04 ^B	8.32±0.08 ^B	0.42±0.02 ^A	0.16±0.01 ^B	0.07±0.00 ^B	0.64±0.02 ^B	7.0±0.2 ^B
PP/O2_Ground finger	9.02±0.06 ^A	4.86±0.07 ^A	1.92±0.03 ^B	3.09±0.05 ^A	9.88±0.14 ^A	0.33±0.04 ^B	0.21±0.01 ^A	0.22±0.01 ^A	0.76±0.06 ^A	8.3±0.6 ^A
PP/O1_Fresh mother	7.90±0.18 ^B	4.48±0.02 ^B	2.10±0.05 ^B	2.41±0.02 ^B	8.99±0.09 ^B	0.46±0.02 ^A	0.26±0.01 ^B	0.14±0.02 ^B	0.86±0.05 ^A	9.5±0.7 ^A
PP/O1_Ground mother	8.78±0.02 ^A	4.65±0.09 ^A	2.26±0.04 ^A	3.03±0.06 ^A	9.94±0.19 ^A	0.39±0.01 ^B	0.29±0.01 ^A	0.24±0.01 ^A	0.92±0.01 ^A	9.8±0.2 ^A
PP/O2_Fresh mother	10.85±0.35 ^A	3.33±0.02 ^B	1.87±0.01 ^B	2.89±0.01 ^B	8.08±0.01 ^B	0.58±0.04 ^A	0.40±0.03 ^A	0.33±0.03 ^A	1.31±0.10 ^A	16.8±1.3 ^A
PP/O2_Ground mother	10.87±0.06 ^A	4.11±0.07 ^A	2.18±0.03 ^A	3.26±0.05 ^A	9.55±0.15 ^A	0.39±0.01 ^B	0.33±0.01 ^B	0.30±0.00 ^A	1.03±0.01 ^B	11.4±0.1 ^B
<i>Case study 3</i>										
KP/O1_Fresh	10.29±0.05 ^A	4.22±0.25 ^A	2.37±0.10 ^A	3.84±0.11 ^A	10.42±0.45 ^A	0.64±0.02 ^A	0.40±0.01 ^A	0.32±0.01 ^A	1.36±0.03 ^A	13.5±0.2 ^A
KP/O1_Ground	9.32±0.16 ^B	4.04±0.05 ^A	2.20±0.02 ^B	2.85±0.04 ^B	9.10±0.10 ^B	0.36±0.03 ^B	0.33±0.02 ^B	0.26±0.00 ^B	0.95±0.05 ^B	11.0±0.6 ^B
KP/O2_Fresh	12.08±0.04 ^A	6.16±0.31 ^A	2.59±0.03 ^A	5.20±0.20 ^A	13.95±0.52 ^A	0.93±0.05 ^A	0.45±0.03 ^A	0.46±0.02 ^A	1.84±0.10 ^A	13.8±0.8 ^A
KP/O2_Ground	12.65±0.25 ^A	5.38±0.03 ^B	2.02±0.01 ^B	4.13±0.03 ^B	11.53±0.06 ^B	0.40±0.01 ^B	0.27±0.00 ^B	0.37±0.01 ^B	1.04±0.01 ^B	9.9±0.1 ^B

Means with the same superscript (A-B) at each column of each pair of the fresh and ground turmeric do not differ significantly (Independent-Samples t-test, p-value < 0.05). Curcumin (C); demethoxycurcumin (DMC); bisdemethoxycurcumin (BDMC); Siem Reap (SR); Phnom Penh (PP); Kampot (KP); and origin (O).

TABLE 3. Impact of peeling and cooking at different time (i.e., 30 min and 40 min) on the contents of essential oil, curcuminoids and their bioaccessibility (%) of turmeric.

Sample	Essential oil (mL 100 g ⁻¹ db)		Curcuminoids (g 100 g ⁻¹ db)				Bioaccessible curcuminoids (g 100 g ⁻¹ db)				Bioaccessibility (%)
	C		C	DMC	BDMC	Total	C	DMC	BDMC	Total	
Case study 1											
SR_Fresh finger	9.76±0.16 ^B	3.94±0.11 ^A	1.87±0.07 ^A	2.60±0.10 ^B	8.42±0.27 ^A	0.41±0.00 ^A	0.29±0.01 ^A	0.28±0.01 ^B	0.99±0.01 ^B	12.3±0.2 ^A	
SR_Peeled finger	10.26±0.17 ^A	4.02±0.19 ^A	1.89±0.05 ^A	2.87±0.08 ^A	8.77±0.31 ^A	0.49±0.04 ^A	0.34±0.03 ^B	0.34±0.02 ^A	1.17±0.07 ^A	14.1±0.9 ^A	
SR_Fresh mother	17.84±0.03 ^A	3.75±0.19 ^A	2.09±0.06 ^A	3.71±0.15 ^A	9.54±0.40 ^A	0.46±0.01 ^A	0.36±0.01 ^A	0.34±0.02 ^A	1.16±0.04 ^A	12.9±0.5 ^A	
SR_Peeled mother	16.91±0.03 ^A	3.56±0.18 ^A	1.98±0.06 ^A	3.51±0.14 ^A	9.05±0.38 ^A	0.43±0.02 ^A	0.34±0.01 ^A	0.33±0.01 ^A	1.10±0.04 ^A	12.9±0.5 ^A	
Case study 3											
KP/O1_Ground (40 min)	9.32±0.16 ^A	4.04±0.05 ^B	2.20±0.02 ^B	2.85±0.04 ^B	9.10±0.10 ^B	0.36±0.03 ^A	0.33±0.02 ^A	0.26±0.00 ^A	0.95±0.05 ^A	11.0±0.6 ^A	
KP/O1_Ground (30 min)	9.35±0.13 ^A	4.27±0.11 ^A	2.32±0.05 ^A	3.06±0.07 ^A	9.65±0.22 ^A	0.36±0.05 ^A	0.34±0.03 ^A	0.27±0.02 ^A	0.96±0.09 ^A	10.6±1.0 ^A	

Case study 1, means with the same superscript (A–B) at each column of the fresh and peeled turmeric do not differ significantly (Independent-Samples t-test, p-value < 0.05).

Case study 3, means with the same superscript (A–B) within the same column do not differ significantly (Independent-Samples t-test, p-value < 0.05).

Siem Reap (SR); Kampot (KP); and origin (O).

higher than that of PP/O2_Fresh mother. Moreover, overall, regardless of the sourcing, C, DMC and BDMC represented 46±6%, 23±1% and 31±6% of the total curcuminoids respectively.

Overall, regardless of the sourcing, the bioaccessibility of C, DMC and BDMC reached 50±9%, 29±2% and 21±1% of total curcuminoids, respectively. No general rule was observed for the contents of bioaccessible curcuminoids and their bioaccessibility in different parts of fresh rhizomes (i.e., finger and mother). In case study 1, the bioaccessible curcuminoid contents of SR_Fresh finger were significantly lower than those of SR_Fresh mother; however, there was no significant difference in the bioaccessibility of curcuminoid between SR_Fresh finger and SR_Fresh mother (Table 1). In case study 2, the bioaccessible curcuminoid contents and their bioaccessibility of PP/O1_Fresh finger were significantly higher than those of PP/O1_Fresh mother. In contrast, the bioaccessible curcuminoid contents and their bioaccessibility of PP/O2_Fresh finger were significantly lower than those of PP/O2_Fresh mother.

2. Impact of the process on quality.

Impact of the full processes on the essential oil, curcuminoid contents and their bioaccessibility – The impact of the full processes on the essential oil, curcuminoid contents and their bioaccessibility was assessed (Table 2). Compared to fresh rhizomes, the essential oil content of turmeric powders in case study 1 decreased significantly by 6.6% for fingers and 23.8% for mother rhizomes. The drying condition of these samples was the same but the relative loss of essential oil content was different. This may be due to the different particle sizes of fresh and ground turmeric. In case study 2, the essential oil content of PP/O1_Ground finger significantly decreased (relative loss of 14.6%). However, in two cases the essential oil content increased during the process with a relative gain of 11.1% (PP/O1_Ground mother) and 35.0% (PP/O2_Ground finger), respectively. This is probably a bias due to the unhomogenized dried samples (not well represent the whole rhizome). Before drying in an oven, the semi-dried turmeric chips were sieved manually to separate between small and big turmeric chips. Then, the small turmeric chips (semi-dried) were collected and put in one bag and the dried turmeric were sampled after completing the oven drying. In case study 3 at Kampot, the essential oil content of KP/O1_Ground significantly decreased (relative loss of 9.4%) while that of KP/O2_Ground was stable. This may be due to the large difference in drying time applied to these turmeric. KP/O1_Ground was dried up to 45 h because there was heavy rain during its drying process, while KP/O2_Ground was dried just for 24 h. The essential oil content of turmeric powders from the three case studies ranged from 7.01±0.13 mL 100 g⁻¹ db to 13.60±0.01 mL 100 g⁻¹ db. The drying decreases the essential oil content more or less depending on the drying technique (Kutti Gounder and Lingamallu, 2012). The relative loss of essential oil content in our case studies were lower than the value of 25% found by Ararsa (2018).

The behaviour of curcuminoids was variable depending on the case study (Table 2). No general rule was observed; in some cases, the curcuminoid content decreased (up to 17.3%) and in other cases increased (up to 18.8%). The total curcuminoid content of turmeric powders from the three case studies ranged from 7.72±0.40 g 100 g⁻¹ db to 11.53±0.06 g 100 g⁻¹ db. These values were in accordance with the specifications of the ISO standard 5562:1983 (International Organization for Standardization, 1983), indicating that the minimum curcuminoids in turmeric powder is

TABLE 4. Impact of the origins (case study 3) and the part of the rhizomes (case studies 1 and 2) on colour values and particle sizes of turmeric powders.

Samples	Colour values			Particle size (µm)		
	L*	a*	b*	D [3;2]	D [4;3]	Dx (50)
<i>Case study 1</i>						
SR_Ground finger	55.69±0.02 ^A	28.42±0.01 ^A	66.25±0.06 ^A	97.0±0.8 ^B	238.1±10.8 ^A	105.1±0.7 ^B
SR_Ground mother	53.31±0.17 ^B	25.44±0.11 ^B	64.62±0.20 ^B	105.6±3.2 ^A	236.0±32.9 ^A	118.4±2.1 ^A
<i>Case study 2</i>						
PP/O1_Ground finger	51.10±0.74 ^B	24.61±0.10 ^B	59.30±0.24 ^B	53.8±0.9 ^B	227.1±21.1 ^B	68.5±1.7 ^B
PP/O1_Ground mother	55.02±0.43 ^A	32.18±0.18 ^A	67.09±0.17 ^A	69.5±0.5 ^A	292.7±0.2 ^A	86.7±0.5 ^A
PP/O2_Ground finger	48.09±0.18 ^B	25.12±0.08 ^B	56.26±0.51 ^B	65.6±1.1 ^B	191.3±40.3 ^B	89.9±1.5 ^B
PP/O2_Ground mother	50.14±0.58 ^A	27.71±0.16 ^A	59.61±0.26 ^A	102.0±0.8 ^A	290.0±8.3 ^A	124.6±1.2 ^A
<i>Case study 3</i>						
KP/O1_Ground	53.49±0.36 ^A	28.82±0.15 ^B	62.71±0.08 ^B	135.7±1.9 ^A	310.8±26.8 ^A	163.9±3.0 ^A
KP/O2_Ground	54.33±0.65 ^A	33.45±0.23 ^A	64.95±0.10 ^A	125.1±4.9 ^B	232.1±49.0 ^B	137.3±3.1 ^B

Case study 1 and 2, means with the same superscript (A–B) at each column of each pair of the part of the rhizome (finger and mother) do not differ significantly (Independent-Samples *t*-test, *p*-value < 0.05).

Case study 3, means with the same superscript (A–B) within the same column do not differ significantly (Independent-Samples *t*-test, *p*-value < 0.05).

2% (w/w) db. Suresh *et al.* (2007) found that the curcumin loss from heat processing of turmeric was in the range of 27–53%, with maximum loss in pressure cooking (at high temperature) for 10 min. However, Choudhury *et al.* (2017) reported that the processing of fresh rhizomes (mother and finger) to yield dry powder resulted in a significant reduction of curcumin just only between 2.0 to 8.0%.

It was in agreement with the literature (Yin *et al.*, 2022; Monton *et al.*, 2019) which indicated that the texture of turmeric is hard after drying. The hypothesis is that the biological fluids from *in vitro* digestion did not diffuse well into the powder particles. As a result, their constituents were

less well solubilised in the digestive tract than the ones of fresh turmeric. Globally, in powders, the bioaccessibility of curcuminoids significantly decreased (case study 1: 29.0% for finger and 22.3% for mother; case study 2: 22.2% for finger and 32.3% for mother; case study 3: between 18.1% to 27.9% for mixture of finger and mother). The bioaccessibility of curcuminoids of turmeric powders from three distinct case studies ranged from 8.3 ± 0.6% to 11.4 ± 0.1% (Table 2). These values were lower than the value of 17 ± 4.1% found by Park *et al.* (2018).

Impact of peeling and cooking on the essential oil, curcuminoid contents and their bioaccessibility – The impact of

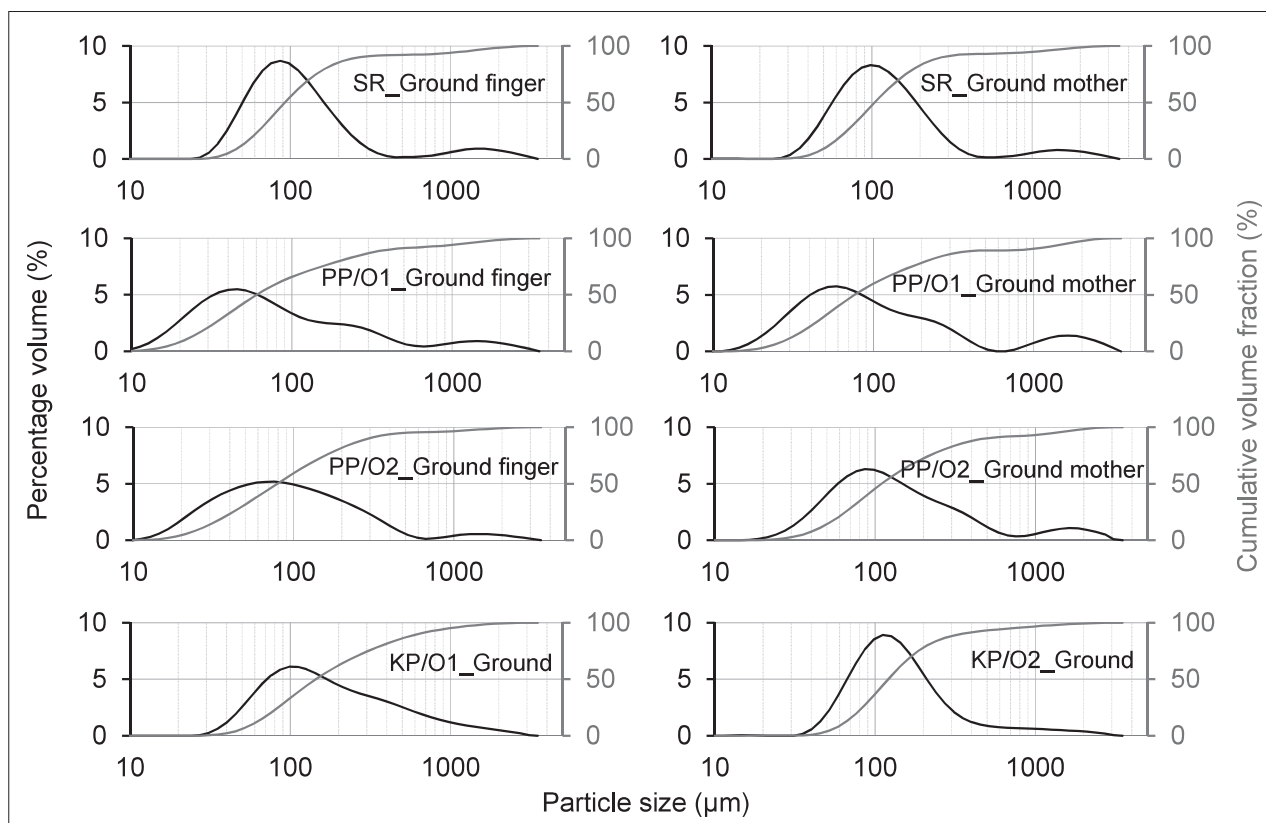

FIGURE 4. Particle size distribution of turmeric powders from distinct case studies, origins and processes.

peeling and cooking time (*i.e.*, 30 min and 40 min) on the essential oil, curcuminoid contents and their bioaccessibility were studied on the samples from case study 1 (Siem Reap) and case study 3 (Kampot) (Table 3). Peeling significantly increased the contents of essential oil up to 5.1% (finger only) and bioaccessible curcuminoids up to 18.2% (finger only). However, it had no impact on curcuminoid contents and their bioaccessibility. Cooking (for 30 or 40 min at 88 to 101 °C) had no impact on essential oil content. However, the curcuminoid contents decreased as the cooking time increased to 40 min. This may be due to the fact that their drying time was different (4 h 20 min): the KP/O1_Ground (30 min) was dried for a shorter time than the KP/O1_Ground (40 min). However, cooking time had no impact on bioaccessible curcuminoid contents and their bioaccessibility even though the whole rhizomes were cooked in water for 30 to 40 min at boiling temperature.

Impact of origins and part of the rhizomes on colour and particle characterisation of turmeric powders – The impact of origins (case study 3) and part of the rhizomes (case studies 1 and 2) on colour values and particle sizes of turmeric powders were illustrated in Table 4. Different origins of turmeric (KP/O1_Ground and KP/O2_Ground) presented different a^* and b^* values (case study 3) and particle sizes, *i.e.*, D [3;2], D [4;3] and Dx (50). Different parts of the rhizomes (finger and mother) also had different colour values. L^* , a^* and b^* values of finger rhizome were significantly higher than those of mother rhizome as there were significant differences between SR_Ground finger and SR_Ground mother (case study 1). However, the results of case study 2 showed that L^* , a^* and b^* values of finger rhizomes were significantly lower than those of mother rhizomes. Different parts of the rhizomes (finger and mother) had an impact on the particle size of turmeric powders. The particle sizes of mother rhizomes were significantly larger than those of finger rhizomes even though they were ground under same conditions (same time and same grinder). This may be due to the fact that the texture and the size of dried mother rhizomes were harder and larger than those of finger rhizomes (based on observation). The particle sizes, *i.e.*, D [3;2], D [4;3] and Dx (50) of turmeric powders from the three case studies ranged from $53.8 \pm 0.9 \mu\text{m}$ to $135.7 \pm 1.9 \mu\text{m}$, from $227.1 \pm 21.2 \mu\text{m}$ to $310.8 \pm 26.8 \mu\text{m}$ and from $68.5 \pm 1.7 \mu\text{m}$ to $163.9 \pm 3.0 \mu\text{m}$, respectively. These values were in accordance with the ISO Standard 5562:1983 (International Organization for Standardization, 1983). This standard indicates that the turmeric powder is classified into two groups according to its granulometry, *i.e.*, coarse powder (98% of the product must pass through a sieve of 500 μm mesh opening) and fine powder (98% of the product must pass through a sieve of 300 μm mesh opening). The turmeric powders from all case studies are considered as fine powder. Moreover, the turmeric powders from case study 1 (Siem Reap) and case study 2 (Phnom Penh) had bimodal distribution while those from case study 3 (Kampot) had monomodal distribution (Figure 4).

Conclusion

The local processing practices of turmeric were described in detail through the study of three turmeric production systems located in three areas (Siem Reap, Phnom Penh and Kampot), known as the main turmeric processors in Cambodia. The turmeric rhizomes from Siem Reap had higher essential oil content than those from Phnom Penh. The essential oil content in mother was quite higher than in finger for the sample in Siem Reap, but these differences

were not so high for the other origins. The total curcuminoid contents of the fresh finger rhizome from Siem Reap and Phnom Penh were not significantly different, while that of the fresh mother rhizome from Siem Reap was significantly higher than those from Phnom Penh. Different origins of turmeric rhizomes provided different bioaccessible curcuminoids and their bioaccessibility. In most cases, after processing, the essential oil content, total curcuminoid content, bioaccessible curcuminoids and their bioaccessibility of the turmeric powders decreased (in powders compared to raw material). Peeling had no impact on curcuminoid contents and their bioaccessibility but it increased the essential oil content (finger only). Cooking had no impact on essential oil content, bioaccessible curcuminoids and their bioaccessibility. We recommend fresh turmeric from Siem Reap as it contains higher essential oil and equal curcuminoid contents compared to the turmeric from case study 2 (Phnom Penh). There is a potential saving to be made by all the companies on drying. Indeed, they could dry less, obtain better yield and still comply with ISO standards (water content <10% w/w). The postharvest treatment in Kampot appeared to be the easiest to implement, had the shortest drying time and got the highest yield (16.2%), with the water content (about 6%) conforming the specification of the ISO standard 5562:1983 (International Organization for Standardization, 1983).

Acknowledgments

We would like to thank Servent Adrien (CIRAD – UMR QualiSud), Soukim Heng, Seanghai Hoeun, Davin Sang and Vuthy Men (RIC – ITC) for their contribution to this study and Rithy Kan (RIC – ITC) for his facilitation in fieldwork. Unforgettable thanks to the directors and staffs of the three companies where we conducted our research for allowing us to study their processes.

Funding

This work was supported by the French Government Scholarships cofounded by the Ministry of Education, Youth and Sports of Cambodia, CIRAD – UMR Qualisud, Cambodia Higher Education Improvement Project (Credit No. 6221-KH), Erasmus Camfoodtech Project and Agence Universitaire de la Francophonie.

Conflict of interest

The authors declare no conflict of interest.

Availability of data and material

The data supporting this study's findings are available from the corresponding author upon reasonable request.

Authors' contributions

MY: Formal analysis; methodology; writing – original draft; writing – review and editing. MW: Funding acquisition; project administration; supervision; writing – review and editing. SA: Conceptualization; methodology; writing – review and editing. SI: Project administration; supervision. PB: Conceptualization; supervision; validation; writing – review and editing.

References

Ararsa, B.H. (2018). Effect of processing methods on quality of turmeric (*Curcuma longa* L.) finger rhizome grown in Teppi, Sheka zone, Ethiopia. (Haramaya Inst. of Technology). <http://localhost:8080/xmlui/handle/123456789/646>.

- Bambirra, M.L.A., Junqueira, R.G., and Glória, M.B.A. (2002). Influence of post harvest processing conditions on yield and quality of ground turmeric (*Curcuma longa* L.). *Braz. Arch. Biol. Technol.* *45*, 423–429. <https://doi.org/10.1590/S1516-89132002000600004>.
- Choudhury, B.U., Nath, A., Hazarika, S., Ansari, M.A., Buragohain, J., and Mishra, D. (2017). Effects of pre-harvest soil management practices and post-harvest processing on phytochemical qualities of turmeric (*Curcuma longa*). *Indian J. Agric. Sci.* *87*, 1002–1007.
- Garg, S.N., Bansal, R.P., Gupta, M.M., and Kumar, S. (1999). Variation in the rhizome essential oil and curcumin contents and oil quality in the land races of turmeric *Curcuma longa* of North Indian plains. *Flavour Fragr. J.* *14*, 315–318. [https://doi.org/10.1002/\(SICI\)1099-1026\(199909/10\)14:5<315::AID-FFJ838>3.0.CO;2-U](https://doi.org/10.1002/(SICI)1099-1026(199909/10)14:5<315::AID-FFJ838>3.0.CO;2-U).
- Govindarajan, V.S., and Stahl, W.H. (1980). Turmeric – Chemistry, technology, and quality. *CRC Crit. Rev. Food Sci. Nutr.* *12*, 199–301. <https://doi.org/10.1080/10408398009527278>.
- Hirun, S., Utama-Ang, N., and Roach, P.D. (2014). Turmeric (*Curcuma longa* L.) drying: An optimization approach using microwave-vacuum drying. *J. Food Sci. Technol.* *51*, 2127–2133. <https://doi.org/10.1007/s13197-012-0709-9>.
- International Organization for Standardization (1983). Turmeric, whole or ground (powdered) – Specification (ISO Standard No. 5562:1983).
- International Organization for Standardization (2008). Spices, condiments and herbs – Determination of volatile oil content (hydrodistillation method) (ISO Standard No. 6571:2008).
- Kutti Gounder, D., and Lingamallu, J. (2012). Comparison of chemical composition and antioxidant potential of volatile oil from fresh, dried and cured turmeric (*Curcuma longa*) rhizomes. *Ind. Crops Prod.* *38*, 124–131. <https://doi.org/10.1016/j.indcrop.2012.01.014>.
- Minekus, M., Alminger, M., Alvito, P., Ballance, S., Bohn, T., Bourlieu, C., Carrière, F., Boutrou, R., Corredig, M., Dupont, D., *et al.* (2014). A standardised static in vitro digestion method suitable for food – An international consensus. *Food Funct.* *5*, 1113–1124. <https://doi.org/10.1039/C3FO60702J>.
- Monton, C., Luprasong, C., and Charoenchai, L. (2019). Convection combined microwave drying affect quality of volatile oil compositions and quantity of curcuminoids of turmeric raw material. *Rev. Bras. Farmacogn.* *29*, 434–440. <https://doi.org/10.1016/j.bjp.2019.04.006>.
- Park, S.J., Garcia, C.V., Shin, G.H., and Kim, J.T. (2018). Improvement of curcuminoid bioaccessibility from turmeric by a nanostructured lipid carrier system. *Food Chem.* *251*, 51–57. <https://doi.org/10.1016/j.foodchem.2018.01.071>.
- Sepahpour, S., Selamat, J., Abdul Manap, M., Khatib, A., and Abdull Razis, A. (2018). Comparative analysis of chemical composition, antioxidant activity and quantitative characterization of some phenolic compounds in selected herbs and spices in different solvent extraction systems. *Molecules* *23*, 402. <https://doi.org/10.3390/molecules23020402>.
- Sogi, D.S., Sharma, S., Oberoi, D.P.S., and Wani, I.A. (2010). Effect of extraction parameters on curcumin yield from turmeric. *J. Food Sci. Technol.* *47*, 300–304. <https://doi.org/10.1007/s13197-010-0047-8>.
- Suresh, D., Manjunatha, H., and Srinivasan, K. (2007). Effect of heat processing of spices on the concentrations of their bioactive principles: Turmeric (*Curcuma longa*), red pepper (*Capsicum annum*) and black pepper (*Piper nigrum*). *J. Food Compos. Anal.* *20*, 346–351. <https://doi.org/10.1016/j.jfca.2006.10.002>.
- Tridge (2022). Overview of turmeric market in Cambodia. Tridge.com. <https://www.tridge.com/intelligences/turmeric1/KH>.
- Yerramilli, M., Longmore, N., and Ghosh, S. (2018). Stability and bioavailability of curcumin in mixed sodium caseinate and pea protein isolate nanoemulsions. *J. Am. Oil Chem. Soc.* *95*, 1013–1026. <https://doi.org/10.1002/aocs.12084>.
- Yin, M., Weil, M., Avallone, S., Lebrun, M., Conejero, G., In, S., and Bohuon, P. (2022). Impact of cooking and drying operations on color, curcuminoids, and aroma of *Curcuma longa* L. *J. Food Process. Preserv.* *46*(5), e16643. <https://doi.org/10.1111/jfpp.16643>.

Received: Sep. 2, 2022

Accepted: Nov. 1, 2022

SUPPLEMENTAL INFORMATION

SUPPLEMENTAL INFORMATION – TABLE S1. Influence of different types of processing on mass, yield, dehydration time and water content of ground turmeric.

Samples	Yield after cooking (g 100 g ⁻¹)	Yield after grinding (g 100 g ⁻¹)	Drying time (hours)	Yield (g 100 g ⁻¹)	Water content (g 100 g ⁻¹)	
					Fresh	Final
<i>Case study 1</i>						
SR_Ground finger	96.4	83.1	95	10.0	79.9±0.0	4.4±0.0
SR_Ground mother	96.8	86.0	93		77.5±0.0	3.3±0.1
<i>Case study 2</i>						
PP/O1_Ground finger	–	87.1	42.5	10.8	84.3±0.1	7.9±0.1
PP/O1_Ground mother	–	87.0	42.5		79.4±0.1	7.9±0.0
PP/O2_Ground finger	–	87.2	49.5	14.2	83.8±0.0	8.2±0.1
PP/O2_Ground mother	–	87.1	65.5		77.1±0.1	8.1±0.1
<i>Case study 3</i>						
KP/O1_Ground	96.3	87.0	45	–	78.9±0.0	6.3±0.1
KP/O2_Ground	91.4	87.3	24	16.2	83.5±0.0	5.0±0.2

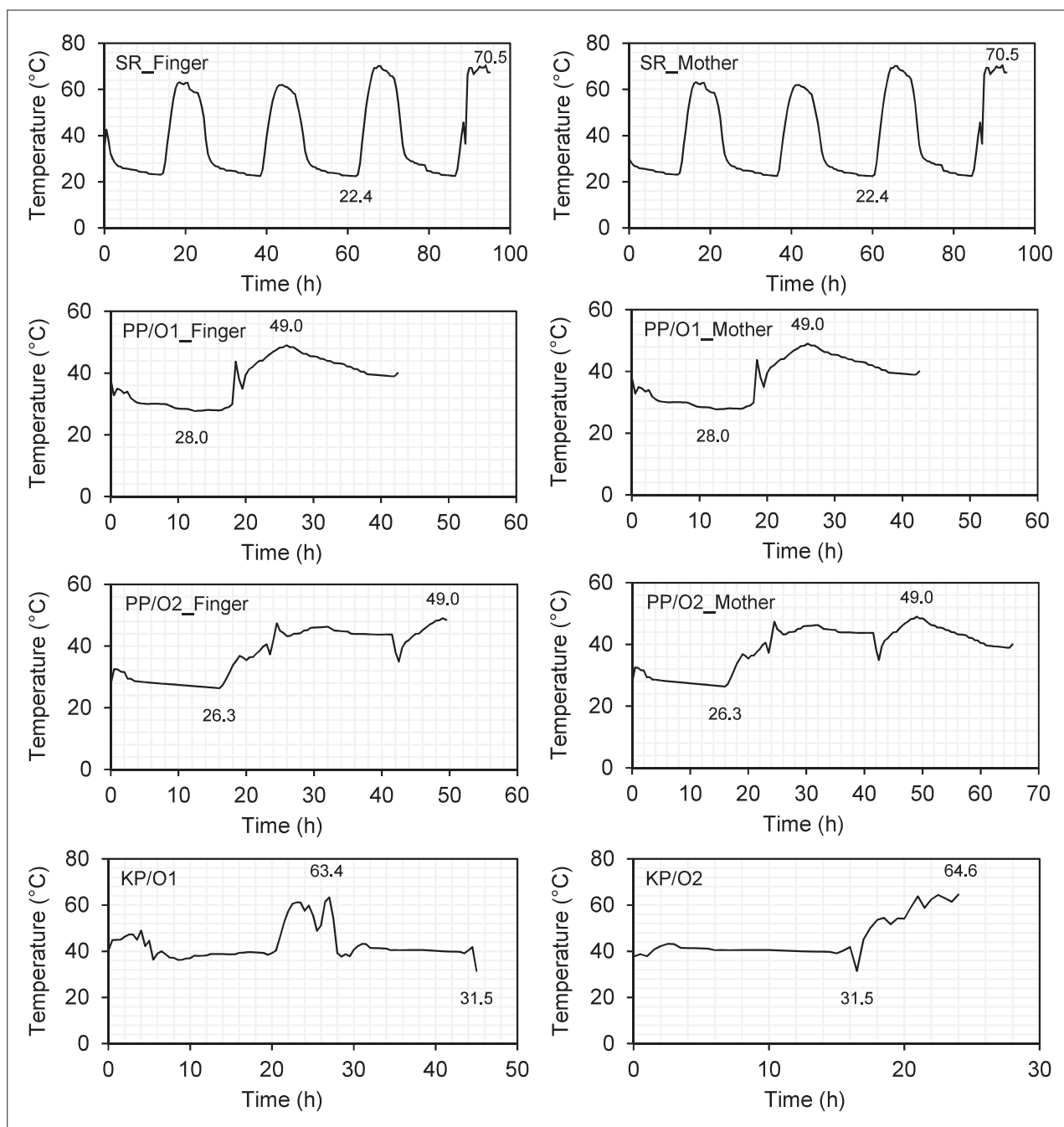

SUPPLEMENTAL INFORMATION – FIGURE S1. Drying temperature profile of turmeric from three distinct case studies: Case study 1 (Siem Reap); Case study 2 (Phnom Penh); Case study 3 (Kampot).

Impact of cooking and drying operations on color, curcuminoids, and aroma of *Curcuma longa* L.

Molika Yin^{1,2}  | Mathieu Weil^{1,3}  | Sylvie Avallone¹ | Marc Lebrun^{1,3} | Geneviève Conejero⁴ | Sokneang In² | Philippe Bohuon¹

¹Qualisud, Univ Montpellier, CIRAD, Institut Agro, Avignon Université, Univ de La Réunion, Montpellier, France

²Institut de Technologie du Cambodge, Food Technology and Nutrition Research Unit, Phnom Penh, Cambodia

³CIRAD, UMR Qualisud, Montpellier, France

⁴BPMP, CNRS, INRAE, Institut Agro, University of Montpellier, Montpellier, France

Correspondence

Mathieu Weil, CIRAD, UMR Qualisud, F-34398 Montpellier, France.
Email: mathieu.weil@cirad.fr

Funding information

Cambodia Higher Education Improvement Project, Grant/Award Number: 6221-KH; CIRAD UMR QualiSud; French Government Scholarships Cofounded by the Ministry of Education, Youth and Sports of Cambodia

Abstract

Effects of cooking and drying on color, curcuminoids, essential oil, and aroma compounds of *Curcuma longa* L. were assessed. Sliced fresh turmeric rhizomes were air-dried at 60°C directly or after cooking at 95°C for 3 or 90 min. Microscopic observations showed that curcuminoids and essential oil are located in different dedicated cells. Curcuminoids and essential oil of dried turmeric were both around 10% db. After processing, curcuminoids were dispersed throughout the matrix. Drastic cooking and drying operations decreased chromatic values more than smooth cooking. Cooking had no impact on curcuminoid and essential oil contents and slightly modified the aromatic profile of essential oils. Drying decreased the curcuminoid (<38%) and essential oil (<13%) contents. Turmeric starchy matrix preserves the curcuminoids and essential oil during the process. We recommend a preliminary smooth cooking step to reduce the drying time, save energy consumption and preserve turmeric quality.

Novelty impact statement: Our study brings us to propose better practices for turmeric processing. A smooth cooking (95°C/3 min) before drying is recommended to preserve the quality of the turmeric as the curcuminoids and essential oil are preserved during cooking. This protection could be linked to the starchy structure of the turmeric matrix.

1 | INTRODUCTION

Turmeric (*Curcuma longa* L.) belongs to the Zingiberaceae family and is widely distributed throughout tropical and subtropical regions of the world (Kutti Gounder & Lingamallu, 2012). Curing turmeric is a significant postharvest processing operation that involves cooking fresh turmeric in boiling water. The goals of curing are to reduce microbial load, inactivate enzymes, avoid unpleasant odors, gelatinize the starch, and change the cell walls of the turmeric facilitating its permeability and reducing resistance to mass transfer which leads to an increase in the drying rate (Jayashree et al., 2018). The main aim of drying is to reduce the moisture present in turmeric, from 2.3 to 4.0 (kg kg⁻¹ db) at the time of harvest to a safe value of 0.11 (kg kg⁻¹ db) (International Organization for Standardization, 2015).

Air drying is an alternative to sun drying, not only to increase the drying rate and reduce drying time but also to better preserve the quality of the product (Prathapan et al., 2009). The optimum drying conditions for best product quality were found to be air temperature of 55–60°C and air velocity of 2 ms⁻¹ (Singh et al., 2010). High air temperature (>60°C) caused the degradation of volatile compounds and curcuminoids.

Traditionally, the rhizomes are dried directly or cooked and then dried. We question the value of using these operations in a combined way, as cooking transfers water inside the product and drying will have to remove the water from the cooked rhizome. In the traditional process, whole rhizomes are cooked for a long time at high temperatures. Moreover, numerous studies have demonstrated the impact of processes on the quality of turmeric powder. However, they did not focus on the impact of each unit operation (cooking

and drying) on turmeric's quality. In our study, we applied, as an alternative, short cooking time to sliced rhizomes, and microscopic observation and biochemical contents evolution during the process were studied.

Our objective was to assess the impact of cooking and drying in controlled conditions on the quality of *Curcuma longa* L. turmeric. The quality characteristics considered in this study were color, curcuminoids, and aromatic profiles. The impact of cooking on drying kinetics was studied. Mass balances of dry matter, water, and curcuminoids were assessed. Microscopic analysis was realized to localize essential oil, starch, and curcuminoids and to assess process effects.

2 | MATERIALS AND METHODS

2.1 | Materials

Solvents (ethanol and dichloromethane), sodium sulfate, homologous series of C8–C20 n-alkanes standards, and HPLC standards (curcumin, demethoxycurcumin, and bisdemethoxycurcumin) were obtained from Sigma–Aldrich (Saint Quentin Fallavier, France). The polytetrafluoroethylene (PTFE) membranes were obtained from Sartorius (Palaiseau, France). The water used in all the experiments was purified water (milli-Q reference water purification). Turmeric, *Curcuma longa* L., used in this study was a product of Thailand which was purchased (4 kg) from an Asian grocery store (Wei Sin) in Montpellier, France, on February 20, 2020. Fresh turmeric rhizomes were stored at 4°C until being processed. Before processing, the fresh turmeric rhizomes were cleaned and washed thoroughly under running water to remove adhering soil and mud, spray residues, roots, and other foreign materials. Then, the excess water was drained and the cleaned turmeric rhizomes were sliced manually to a thickness of 5 mm. The sliced turmeric is called “fresh” turmeric.

2.2 | Processing experiments

2.2.1 | Cooking

Two-unit operations were applied to obtain different samples (Figure 1). The sliced fresh turmeric (F) was divided into two lots of 420g for cooking experiments and one lot of 360g for direct drying assessment. Cooking treatment consisted of soaking sliced turmeric in a nylon net in hot water at a ratio of 1:10 w/w material to water under two different conditions: FC1: 95°C/3 min and FC2: 95°C/60 min. The starch could be completely gelatinized in these cooking conditions. After cooking, the cooked turmeric was immediately soaked in an ice water bath for 1 min to stop the cooking process, before being drained. About 60g of each sample was collected for further analysis.

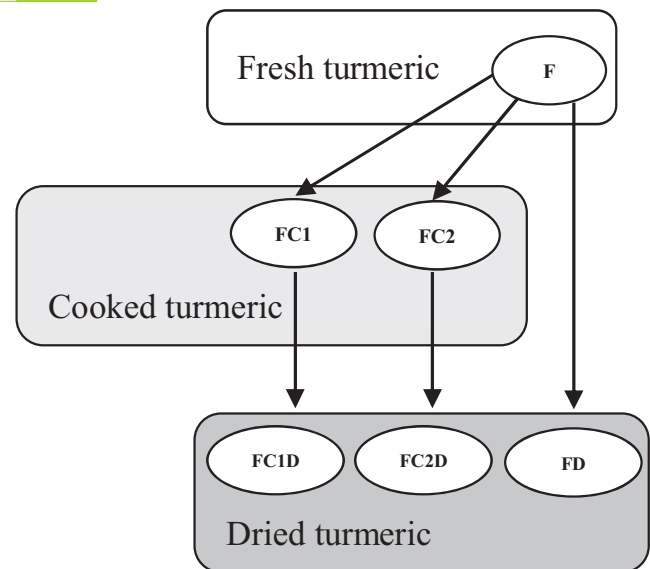

FIGURE 1 Processes applied to turmeric. F: fresh turmeric; C: cooking (C1: 95°C/3 min; C2: 95°C/60 min); D: drying (60°C, 40% RH)

2.2.2 | Drying and drying kinetics

A hot air dryer, developed in our laboratory, was used for drying the sliced turmeric. In the vertical drying chamber, 360g of sliced turmeric were spread on-grid rack (0.25m long × 0.25m wide × 0.06m high). Hot air (60±1°C, RH 40±2%) was circulated downwards through the layer of sliced turmeric by a high-capacity fan. The drying times are different for each treatment, *that is*, 7 h 14 min, 4 h 29 min, and 3 h 38 min for fresh turmeric (F), FC1 (cooking at 95°C/3 min), and FC2 (cooking at 95°C/60 min), respectively. Airspeed was measured thanks to an anemometer (ALMEMO® 2690-8A, Ahlborn Mess, Germany). The air velocity was just high enough (2.1±0.1 m s⁻¹) to have no significant effect on temperature when passing through the layer of sliced turmeric. Monitoring by weighing was carried out continuously during the drying process, every 10 min for the first hour and then every 15 min after the first hour. The water content, which was measured on a dry basis (noted X) as a function of time, was estimated in line, using the mass reading of the sieve. Water content kinetics X^(t) were fitted with a cubic smoothing spline (Matlab® Version 5.2, The Mathworks Inc., USA). The drying rate (dX/dt) was calculated as the direct analytical derivative of the cubic smoothing spline function on X^(t).

2.3 | Microscopic analysis

Thick cross-sections (100–135 μm) were obtained from fresh (F), cooked (FC), cooked and dried (FCD) and dried (FD) turmeric rhizomes using a microtome with a vibrating blade (Thermo Scientific, Microm HM650V, Walldorf, Germany) and then dipped in 10 mM phosphate buffer saline (7 mM Na₂HPO₄, 3 mM NaH₂PO₄, 120 mM NaCl, 2.7 mM KCl). Starch

and terpenes were, respectively, stained dipping cross-sections in Lugol solution (2 g KI and 1 g I₂ dissolved in 100 ml distilled water) for 5 min or NADI solution (0.001% 1-naphthol, 0.001% *N,N*-dimethyl-*p*-phenylenediamine dihydrochloride and 0.4% ethanol in 100 mM sodium cacodylate-HCl buffer (pH 7.2) for 45 min (David & Carde, 1964). Rhizomes tissues were observed with a wide-field microscope Eclipse Ni-E (Nikon Instruments Inc., NY, USA). The pictures were obtained with 4×0.2 NA, 10×0.45 NA, or 20×0.75 NA Plan-APO objectives under transmitted light. The autofluorescence of curcuminoids was visualized with a multiphoton microscope (Zeiss 880, Jena, Germany, infra-red laser Chameleon Ultra II, Coherent, CA, USA) and an objective 20X Plan APO 1.0 NA. The spectral detector of this microscope was used at 720 nm (UV-like excitation) to obtain emission spectra of pure curcuminoids (curcumin, demethoxycurcumin, and bisdemethoxycurcumin) between 400 and 690 nm, and to visualize the fluorescence of these molecules in the rhizome tissues (Talamond et al., 2015).

2.4 | Sample preparation for color, curcuminoids, and essential oil measurements

The samples resulting from the different processing operations (approximately 50 g of each treatment) were frozen using liquid nitrogen and then ground for 10 s at 10,000 rpm in a mill (Retsch Grindomix GM200, Retsch GmbH, Germany) for immediate analyses of dry matter and color. The samples for further essential oil and curcuminoids analyses were put in glass bottles and frozen at -80°C. The samples dedicated to curcuminoids analysis were made on the sliced rhizome.

2.5 | Analytical methods

2.5.1 | Dry matter and water contents

The dry matter content (means "dry matter free of essential oil") was obtained by drying 1 g of ground turmeric in an aluminum cup in the oven (Gefran 800, Italy) at 105°C for 30 h (i.e., until constant weight). The mean relative deviation of repeatability was ±4.4% ($n = 4$). Water content expressed on a dry basis was deduced from essential oil and dry matter contents.

2.5.2 | Color measurements

Color values, that is, lightness (L^*), redness (a^*), and yellowness (b^*) of ground turmeric samples were determined using a chromameter (Minolta CR-400, Minolta, Osaka, Japan). The illuminant was D65, and an incidence angle of 0° was used. Each data point was the mean of three replications measured on the surface of the samples at randomly selected positions. Chroma value (C^*) was calculated following this equation: $C^* = \sqrt{a^{*2} + b^{*2}}$. The mean relative deviation of repeatability was 3.5%, 4.2%, 5.8%, and 5.4%, respectively, for L^* , a^* , b^* , and C^* ($n = 6$).

2.5.3 | Curcuminoid contents

Approximately 0.3 g of sliced turmeric was mixed with 30 ml of 60°C ethanol (99.8%) and homogenized for 2 min at 30,000 rpm (IKA T10 basic Ultra-Turrax, Prolabo, France). The samples were heated for 30 min at 60°C (Sogi et al., 2010). After cooling, the extracts were diluted 1/10 with ethanol and filtered on 0.45 μm PTFE Minisart SRP4 membrane (Sartorius, Palaiseau, France). Curcuminoids were analyzed by high-performance liquid chromatography (Agilent System 1200 series, Massy, France). The column was a polymeric ACES C₁₈ (250 × 4.6 mm, 5 μm particle size, Inc Wilmington NC) and the injection volume was 5 μl. The quantification of curcuminoids was carried out according to the method of Sepahpour et al. (2018) with small modifications. The elution was done isocratically with a mixture of acetonitrile and 0.1% acetic acid (40:60) at a flow rate of 1.0 ml/min and the temperature of the column was set at 25°C. Chromatograms were recorded over 30 min period with a UV-visible photodiode array detector (Agilent Technologies 1200 series) at the wavelength of maximum absorption of the curcuminoids in the mobile phase (i.e., 425 nm). The curcuminoids were identified by their retention time and spectrum. External calibration was realized weekly with standard solutions of the pure chemicals in ethanol in the range of 1 to 50 mg/L. The curcuminoid contents were expressed in g/100 g of initial dry weight basis (g/100 g db). The mean relative deviation of repeatability was 12.5%, 11.2%, 16.8%, and 13.5%, respectively, for curcumin, demethoxycurcumin, bisdemethoxycurcumin, and total curcuminoids ($n = 4$).

2.5.4 | Essential oil content

The essential oil content was determined using a method adapted from the international official standard method ISO 6571:2008 (International Organization for Standardization, 2008). The modification in the applied method was the elimination of xylene. Approximately 20 g of ground turmeric samples were weighed and transferred to 1 L of a round bottom flask, then 250 ml of distilled water was added and about 10 pieces of pumice stones were added to homogenize boiling. It was heated at medium heat for 4 h and the condensed vapor was separated. The essential oil present at the uppermost layers was collected and put in a vial containing sodium sulfate and then stored at -20°C for later essential oil compounds analysis by gas chromatography-mass spectrometry (GC-MS). The essential oil content was expressed in ml/100 g of initial dry weight basis (ml/100 g db). The mean relative deviation of repeatability was ±4.7% ($n = 4$).

2.5.5 | Identification of essential oil compounds

Separation on a polar column

An Agilent 6890 series GC (Agilent Technologies, Palo Alto, CA, USA) equipped with a DB-WAX UI column (60 m × 250 μm, 0.25 μm phase film thickness, Agilent J&W GC column) coupled to an Agilent 5973 mass

spectrometer detector (Agilent Technologies) was used. Hydrogen was used as carrier gas at 1.5 ml/min at a constant flow. Column temperature program was 100°C to 200°C at the rate of 2°C/min, then to 250°C at the rate of 10°C/min. The sample injection volume was 1.0 µl with a split ratio of 100:1. The samples (essential oils) were diluted 1/10 with dichloromethane before injecting. The retention indices were calculated using a homologous series of n-alkanes C8–C20.

Separation on a non-polar column

On the same GC–MS with the same column program temperature, a DB-5MS column (60 m × 250 µm, 0.25 µm phase film thickness, Agilent J&W GC column) was used. The retention indices were calculated using a homologous series of n-alkanes C8–C20.

Identification

The aroma compounds separated on both polar and apolar columns were identified by comparing their mass spectrum to those available in commercial libraries (NIST 14 and PubChem). The mean relative deviation of repeatability was ±13.2% ($n = 8$).

2.5.6 | Statistical analysis

Differences in the mean values of color (L^* , a^* , b^* , and C^* values), curcuminoid contents, essential oil content, and its composition were tested by analysis of variance (ANOVA); the significance of differences between samples was determined using Duncan's test. The level of significance was $p \leq .05$.

3 | RESULTS AND DISCUSSION

3.1 | Characterization of fresh turmeric

3.1.1 | Localization of essential oil, starch, and curcuminoids

The distribution of essential oil, starch, and curcuminoids was represented in Figures 2 and 3. The essential oils (Figure 2, I) were particularly abundant in the cortex. They were more concentrated under the epidermis and in the endoderm than in other parts. Starch was present in amyloplasts throughout the whole rhizome and was most abundant in the cortex (Figure 2, IV). The curcuminoids were distributed throughout the whole rhizome; two cells containing curcuminoids were never adjacent (Figure 3, I). Curcuminoids occupied the entire cell volume in fresh turmeric (Figure 3, I). They were recognizable by their orange color, but as they had the property of fluorescing in UV, they could be identified more specifically. Curcuminoids had the property of being fluorescent under UV light; they emitted in yellow (Figure 3). The observed fluorescence was obtained between 500 and 650 nm. The maximum fluorescence emission of the three curcuminoids (curcumin, demethoxycurcumin, and bisdemethoxycurcumin) was observed between 500 and 600 nm (Figure 3, III).

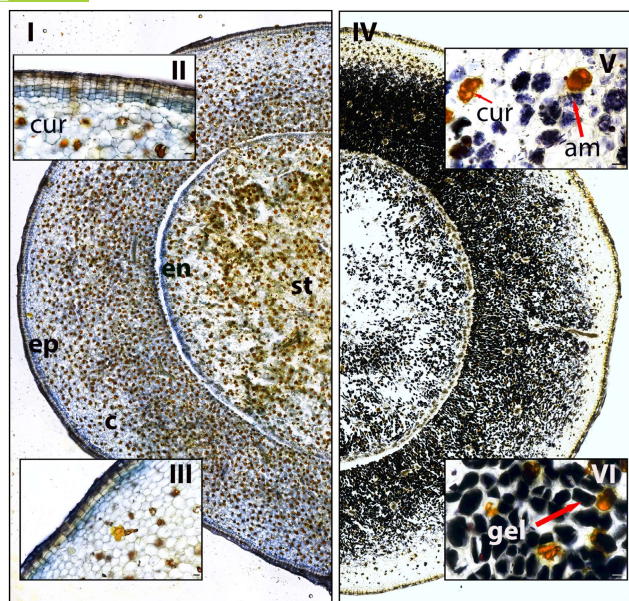

FIGURE 2 Visualization of essential oil, starch, and curcuminoids distribution in turmeric rhizome by wide-field microscopy. (I) essential oil distribution (blue Nadi coloration) in a cross-section of turmeric rhizome, (II) essential oil distribution in the epidermis of fresh (F) turmeric, curcuminoid distribution (natural orange color) in the epidermis of fresh (F) turmeric, (III) essential oil distribution in the epidermis of cooked (FC1) turmeric, curcuminoid distribution in epidermis cooked (FC1) turmeric, (IV) starch distribution (black Lugol coloration) in a cross-section of turmeric rhizome, (V) starch distribution in the cortex of fresh (F) turmeric, curcuminoid distribution in the cortex of fresh (F) turmeric, and (VI) starch distribution in the cortex of cooked (FC1) turmeric. am, amyloplast; c, cortex; cur, curcuminoids cell; en, endodermis; ep, epidermis; gel, gelatinized starch; st, stele; bar = 500 µm (I and IV) or 50 µm (II, III, V and VI)

3.1.2 | Curcuminoid and essential oil contents

The major curcuminoid compound found in our fresh turmeric was curcumin (6.24 g/100 g db) followed by bisdemethoxycurcumin (5.70 g/100 g db) and demethoxycurcumin (2.92 g/100 g db). Moreover, the total curcuminoid contents (the sum of the three curcuminoids) in the turmeric was 14.86 g/100 g db (equal to 1.95 g/100 g wb). This value was higher than the values found by Hirun et al. (2014) (9.39 g/100 g db), Govindarajan and Stahl (1980) (2–9 g/100 g db), and Garg et al. (1999) (0.61–1.45 g/100 g wb). The essential oil content of our fresh turmeric was 10.72 ml/100 g db (equal to 1.32 ml/100 g wb). This value was higher than that reported by Govindarajan and Stahl (1980) who found the content of essential oil up to 6.3% db. However, the value was in agreement with Garg et al. (1999) who stated that the essential oil contents of *Curcuma longa* rhizomes collected from the sub-Himalayan Tarai region of India were in the range of 0.16–1.94 ml/100 g wb. The disparity in the content of active phytochemicals could be due to environmental factors of each growing location, plant development stage, planting period, harvesting season, and turmeric varieties (Hirun et al., 2014; Monton et al., 2019b).

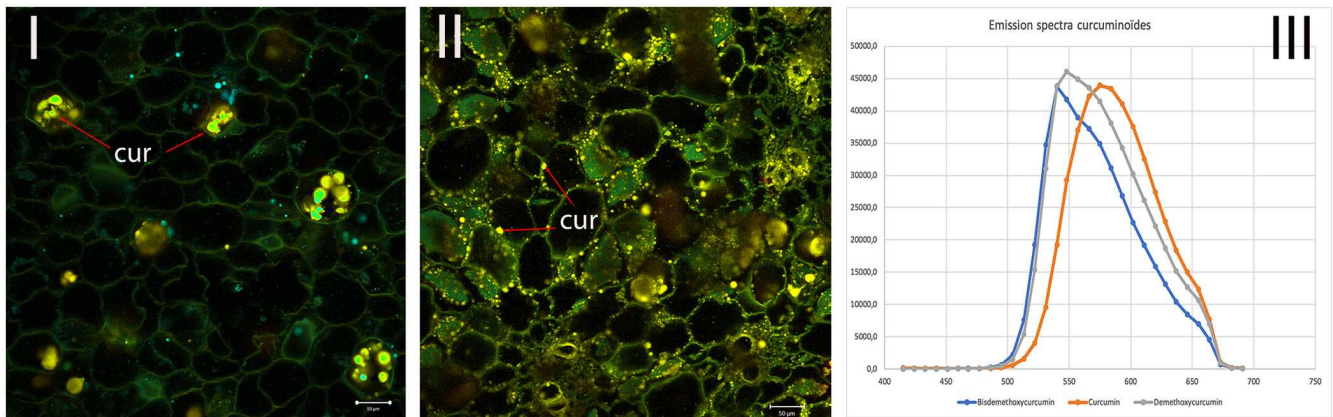
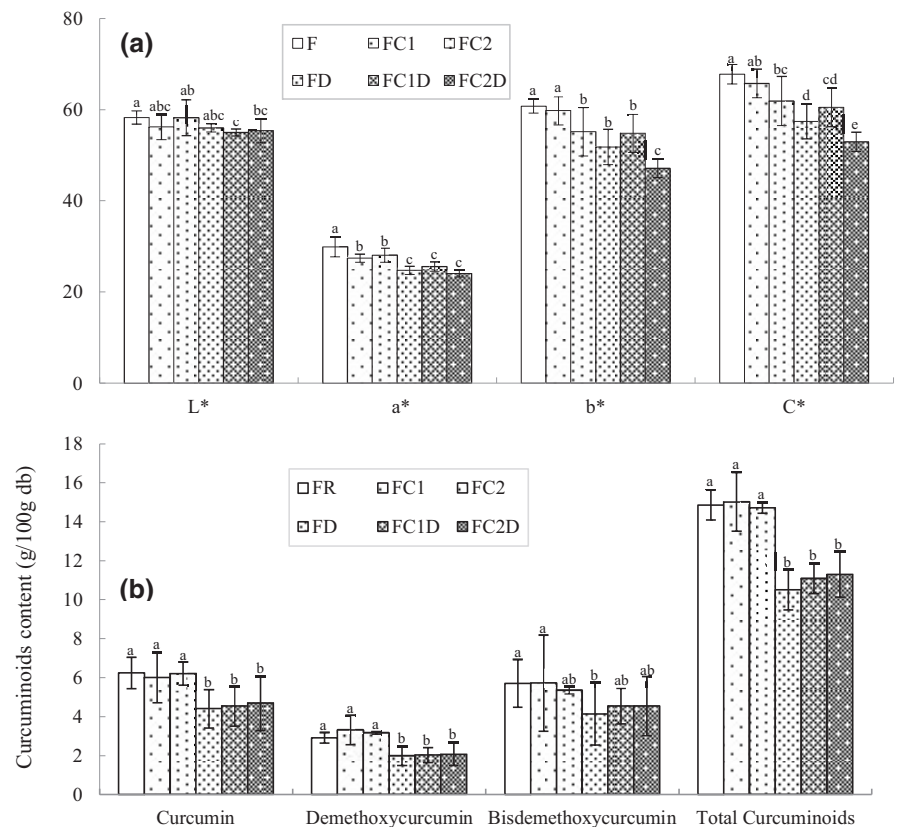

FIGURE 3 Visualization of curcuminoids distribution by multiphotonic microscopy. (I) curcuminoids distribution in the cortex of fresh turmeric, (II) curcuminoids distribution in the cortex of cooked and dried (FC2D) turmeric, and (III) Emission spectra of curcuminoids between 400 and 700nm, excitation 720nm, bar = 50 μ m

FIGURE 4 Impact of processes on (a) color values (L^* , a^* , b^* and C^*) and (b) curcuminoid content (g/100g initial dry weight basis). FR: frozen rhizome; F: fresh turmeric; C: cooking (C1: 95°C/3 min; C2: 95°C/60min); D: drying (60°C, 40% RH). The error bars represent the standard error ($n = 6$). Within the same parameters, the values followed by the same superscript letters are not significantly different ($p \leq .05$)



3.2 | Impacts of the unit processing operations

3.2.1 | Impact of cooking on color values, curcuminoid content, essential oil content, and drying curve

By mass balances (data not shown), we measured low water gain (whether for short or long cooking time); the water gain was lower than 3.0% (kg water per 100kg initial product). Moreover, very little dry matter and curcuminoids were transferred from the turmeric to the cooking water (not significantly different from zero).

Thus, the cooking process only slightly increased the water amount, which must be removed during drying. Cooking had a slight impact on color values (Figure 4). Our results showed that both cooking conditions had no impact on L^* ; however, smooth cooking significantly decreased a^* value (8.3%), while drastic cooking significantly decreased a^* (6.1%), b^* (9.3%), and C^* (8.6%) values. Heat treatment of the rhizome before dehydration can inactivate oxidative enzymes and limit the browning of the products. The browning of the turmeric during drying could be due to the Maillard reaction. However, rhizomes subjected to immersion cooking should have limited Maillard reactions because some of the reducing sugars could have diffused

into the cooking water. Overall, drastic cooking impacted b^* and C^* color values more than smooth cooking.

Cooking had no impact on curcuminoid content (Figure 4). This may be because curcuminoid is an oil-soluble pigment, practically insoluble in water at acidic and neutral pH, soluble in alkali. Moreover, it is stable at high temperatures and in acids, but unstable in alkaline conditions and the presence of light (Lee et al., 2013). Curcumin, demethoxycurcumin, bisdemethoxycurcumin and total curcuminoid contents of fresh and cooked turmeric (F, FC1, and FC2) ranged from 6.00–6.24, 2.92–3.31, 5.35–5.71, and 14.71–15.02 g/100 g db, respectively.

Cooking had no impact on essential oil content (Figure 5) as evidenced by the absence of a significant difference ($p \leq .05$) in the results obtained for essential oil in samples F, FC1, and FC2. The essential oil contents of fresh and cooked turmeric (F, FC1, and FC2) ranged from 10.70 to 11.06 ml/100 g db). The results of microscopic analysis (Figure 2, II and III) also confirmed that the essential oils were not affected by cooking.

The impact of cooking on the drying curves is shown in Figure 6. Cooking saved 38.1% and 49.8% of drying time for FC1 (cooking at 95°C/3 min) and FC2 (cooking at 95°C/60 min), respectively. About 59 min, 48 min, and 45 min were required to obtain a 50% reduction in the initial water content of fresh turmeric (F) and cooked turmeric, that is, FC1 and FC2, respectively. Drying kinetics presented a classical behavior: an intense water loss during the initial stage and slowly at a later stage. This can be attributed to the fact that the moisture from the surface is easily evaporated while it takes time for the moisture to be removed from the interior. The comparison of the drying curves showed a much higher initial drying rate ($5.05 \pm 0.25 \text{ kg} \cdot \text{kg}^{-1} \cdot \text{h}^{-1}$ for FC2 and $5.01 \pm 0.23 \text{ kg} \cdot \text{kg}^{-1} \cdot \text{h}^{-1}$ for FC1) in cooked turmeric than in fresh ones ($4.83 \pm 0.33 \text{ kg} \cdot \text{kg}^{-1} \cdot \text{h}^{-1}$). Govindarajan and Stahl (1980) observed that when turmeric rhizomes are cooked, the starch granules gelatinize as a result of the heat treatment, which facilitates drying and increases the rate of dehydration; as a result, the total drying time is reduced. The results of the microscopic analysis confirmed that cooking for 3 min at 95°C was enough to completely gelatinize the starch (Figure 2, VI). The amyloplasts were clearly visible in fresh (F) turmeric (Figure 2, V) while they were no longer visible in cooked (FC1) turmeric (Figure 2, VI). Moreover, cooking combined

with drying caused the partial exit (dispersion) of the curcuminoids from their dedicated cells; curcuminoids were then found throughout the whole rhizome and seem to be partly adsorbed on the starch cells (Figure 3, II). The degradation of the cell walls allowing curcuminoid to exit could also explain the easier water removal when turmeric was cooked prior to drying. Cooking at 95°C/3 min is the optimum cooking condition for turmeric sliced rhizome (5 mm thick) because it is a good compromise between drying time and the quality of turmeric in terms of b^* and C^* color chromatic values and it is also less energy-consuming than cooking at 95°C/60 min.

3.2.2 | Impact of drying on color values, curcuminoid content, and essential oil content

Drying did have a marked impact on color and curcuminoid contents (Figure 4). There were significant differences between samples F/FD, FC1/FC1D, and FC2/FC2D considered in pairs for all values (a^* , b^* , and C^*) except for L^* . The greatest differences were observed between sample F and FD with reductions of 17.3%, 14.8%, and 15.3% for a^* , b^* , and C^* values, respectively. Similar results were described by Bambilra et al. (2002). In the absence of heat treatment, a product with lower intensity of a^* and b^* was obtained. These results indicated that cooking the turmeric prior to dehydration is essential to obtain a product with higher intensity of a^* and b^* .

There were significant differences ($p > .05$) between the F/FD, FC1/FC1D, and FC2/FC2D samples considered in pairs for all curcuminoids and total curcuminoids with the exception of FC1/FC1D and FC2/FC2D for bisdemethoxycurcumin content. Direct drying significantly decreased curcumin, demethoxycurcumin, and bisdemethoxycurcumin contents by 29.5%, 32.3%, and 27.4%, respectively, while drying with previous cooking significantly decreased curcumin and demethoxycurcumin contents 24.5% and 34.6%–38.8%, respectively. These results were in agreement with Madhusankha et al. (2018) who indicated that there was an evident and clear relationship between the curcuminoid content and the color values. When the curcuminoid content decreased, a^* , b^* , and C^* values also decreased. Curcumin, demethoxycurcumin, bisdemethoxycurcumin, and total curcuminoid contents of our dried

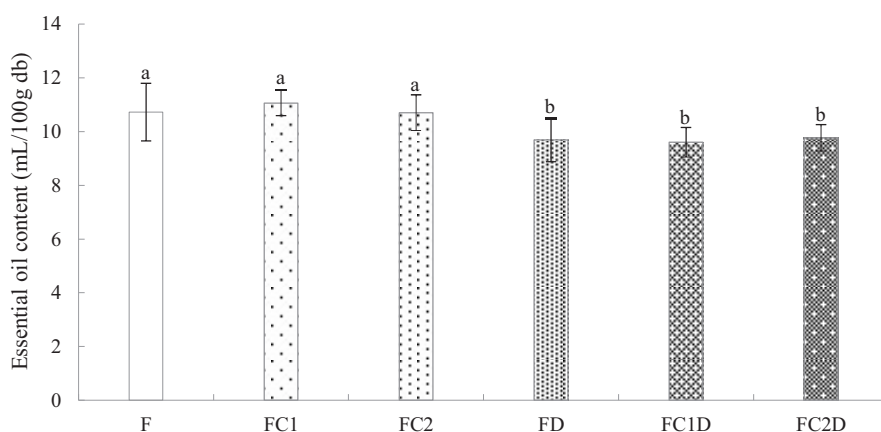

FIGURE 5 Impact of processes on essential oil content (ml/100g initial dry weight basis). F: fresh turmeric, C: cooking (C1: 95°C/3 min; C2: 95°C/60 min); D: drying (60°C, 40% RH). The error bars represent the standard error ($n = 4$). Within the same parameters, the values followed by the same superscript letters are not significantly different ($p \leq .05$)

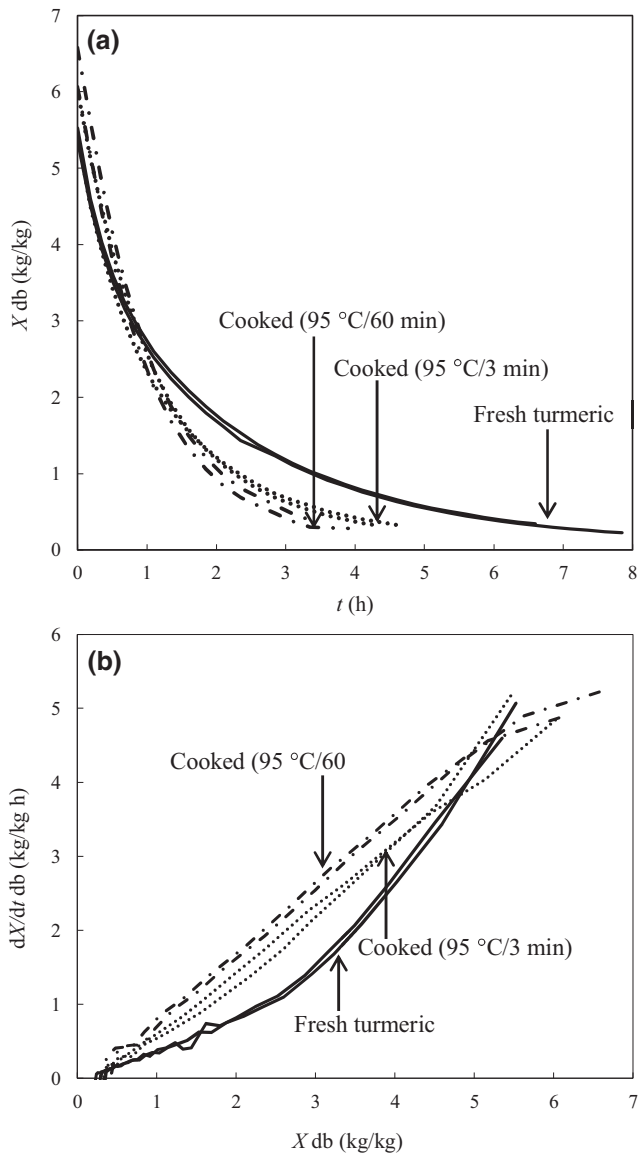

FIGURE 6 Drying curves of fresh and cooked turmeric. (a) water content (X) on a dry basis as a function of time (t) and (b) drying rate (dX/dt) as a function of X . Drying curves recorded by an air dryer (60°C, RH 40%, air velocity at $2.1 \pm 0.1 \text{ ms}^{-1}$). The different dash types on curves correspond to different trials

turmeric (FD, FC1D, and FC2D) ranged from 4.40 to 4.68, 1.98 to 2.07, 4.14 to 4.54, and 10.51 to 11.29 g/100 g db, respectively. These values were comparable to those found by Monton et al. (2016). These authors found that: the contents of curcumin, demethoxycurcumin, bisdemethoxycurcumin, and total curcuminoids were 6.61–7.67, 2.76–3.33, 2.64–3.47, and 12.02%–14.36% w/w, respectively. However, our turmeric contained a higher amount of curcuminoids than those found by Monton et al. (2019a) who reported that their turmeric powders contained 2.3%–3.6% curcumin, 1.0%–1.6% demethoxycurcumin, 1.5%–2.3% bisdemethoxycurcumin and 4.8%–7.3% (w/w) total curcuminoids.

Drying did have an impact on essential oil content (Figure 5) as significant visible differences ($p > .05$) were observed between

samples F/FD, FC1/FC1D, and FC2/FC2D considered in pairs (relative loss of 8.8%–13.2%). The method of drying usually has a significant effect on the contents of the essential oil (Kutti Gounder & Lingamallu, 2012). The essential oil is present in the specific cells and ducts present in the meristematic region of the rhizome. These oleaginous cells are damaged during the cooking of the rhizome and the exposure of the essential oil to the atmosphere induces a loss by volatilization during drying (Díaz-Maroto et al., 2002). The essential oil content of our dried turmeric (FD, FC1D, and FC2D) ranged from 9.60 to 9.76 ml/100 g db. These values were higher than that found by Monton et al. (2016) (7.00%–8.00% v/w) and Monton et al. (2019b) (5.20%–8.50% v/w). The factors that might affect the content of curcuminoids and essential oil were seasonal variation, environmental condition, post-harvest handling, storage, manufacturing, and microbial contamination (Monton et al., 2016).

3.3 | Impacts of “full” processes

In this study, a “full” process referred either to a single drying or to a process including cooking before drying (Figure 1). The impacts of the “full” processes on color and curcuminoid content (Figure 4), essential oil content (Figure 5), and aroma profile (Table 1 and Figure 7) were described.

3.3.1 | Impact of the “full” processes on color and curcuminoids content

The impact of the “full” processes on color and curcuminoid content were illustrated in Figure 4. There were significant differences ($p > .05$) between samples F/FD, F/FC1D, and F/FC2D considered in pairs for all color values (L^* , a^* , b^* , and C^*). When turmeric was cooked for short time (95°C/3 min; FC1D) prior to the drying, the color values decreased less than during drying alone. However, when drying was preceded by drastic cooking (95°C/60 min; FC2D), the color values decreased more than during drying alone (FC1D > FD > FC2D). By comparing the three finished products (FD, FC1D, and FC2D), the results showed that there were no significant differences ($p \leq .05$) between FD and FC1D for all color values, while FC2D had more impact on b^* and C^* values as compared to FD and FC1D. The “full” processes did have a marked impact on curcuminoid content (Figure 4). There were significant differences ($p > .05$) between samples F/FD, F/FC1D, and F/FC2D considered in pairs for all curcuminoid contents and total curcuminoids except that there were no significant differences ($p \leq .05$) between samples F/FC1D and F/FC2D considered in pairs for bisdemethoxycurcumin content. The greatest differences were observed between sample F and FD with reductions of 29.5%, 32.3%, 27.4%, and 29.3% for curcumin, demethoxycurcumin, bisdemethoxycurcumin, and total curcuminoids, respectively. These results were in agreement with Suresh et al. (2007) who stated that curcumin loss from heat processing of turmeric was in the

Aroma compounds	DB-wax UI column		DB-5MS column		Area (%)
	RI ^a	RI ^b	RI ^a	RI ^b	
Turmerone	2198	2245	1682	1650	37.8±3.4
aR-Turmerone	2274	-	1678	1637	16.8±1.9
β-Turmerone	2261	-	1711	1680	16.1±0.8
α-Terpinolene	1307	1283	1096	1079	8.1±1.4
β-Sesquiphellandrene	1771	1772	1527	1515	4.0±0.6
α-Zingiberene	1724	1724	1497	1488	3.7±0.7
α-Phellandrene	1197	1167	1016	998	1.9±0.3
Caryophyllene	1610	1595	1425	1419	1.6±0.4
α-Curcumene	1773	1777	1482	1473	1.3±0.3
Eucalyptol	1240	1213	1041	1022	0.7±0.1
Total					92.1±1.0

TABLE 1 Major aroma compounds in *Curcuma longa* L. fresh turmeric (F) essential oil

Notes: Mean values ($n = 8$) ± 95% confidence interval. RI^a is retention indices relative to C8–C20 n-alkanes (Experimental value) and RI^b is retention indices from NIST and PubChem (literatures).

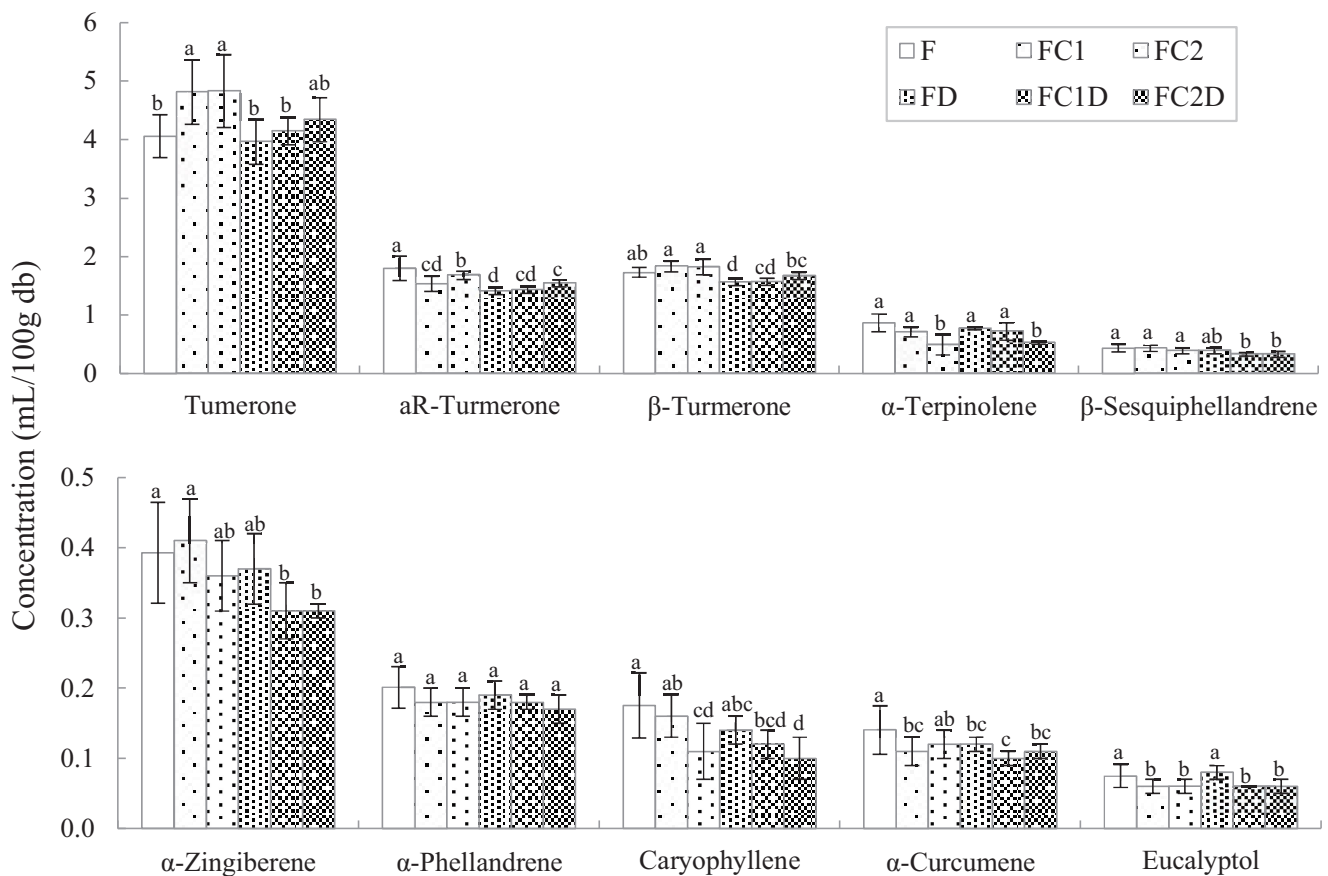

FIGURE 7 Composition of essential oil of fresh and processed turmeric. F: fresh turmeric; C: cooking (C1: 95°C/3 min; C2: 95°C/60 min); D: drying (60°C, 40% RH). The error bars represent the standard error ($n = 8$). Within the same parameters, the values followed by the same superscript letters are not significantly different ($p \leq .05$)

range of 27%–53%, with maximum loss in pressure cooking (at high temperature) for 10 min. However, Bambilra et al. (2002) indicated that heat treatment (up to 100°C) had no effect on curcuminoids in turmeric. Therefore, an appropriate treatment (not too high nor not too low) to dry the turmeric may play a vital role

in preserving curcuminoids in the turmeric (Hirun et al., 2014). The ground turmeric obtained without heat treatment was the one of worst quality with respect to curcuminoid pigments and good quality ground turmeric can be obtained by cooking in plain water as cooking favors diffusion of pigments from cells to adjacent

tissue, contributing to a better pigment homogenization (Bambirra et al., 2002). There were no significant differences ($p \leq .05$) between the three finished products (FD, FC1D, and FC2D) for curcuminoid content compared between them. These results were in accordance with Prathapan et al. (2009) who found no significant differences in curcuminoid contents between turmeric samples submitted to different cooking and drying conditions.

3.3.2 | Impact of the “full” processes on essential oil content

The “full” processes did have a marked impact on essential oil content (Figure 5). There were significant differences ($p > .05$) between samples F/FD, F/FC1D, and F/FC2D considered in pairs for essential oil content (relative loss of 9.0%–10.0%). This relative loss was lower than that of the traditional drying method which could result in the loss of volatile oil up to 25% by evaporation and in the destruction of some light-sensitive oil constituents (Ararsa, 2018). Though, there were no significant differences ($p \leq .05$) between the three finished products (FD, FC1D, and FC2D) for essential oil content compared between them. These results were in agreement with those found by Jayashree and John Zachariah (2016) who reported that there were no significant differences in essential oil content once the duration of cooking in boiling water increased up to 60 min.

3.3.3 | Impact of the “full” processes on aroma composition

Fresh sample (F) was used as a reference and 15 aroma compounds representing 95.0% of the total essential oil were identified. Among these, 10 major compounds, all of which present at a rate greater than 7.0%, represented 92.1% (Table 1) of the total essential oil. The major compounds in fresh turmeric were sesquiterpenes, that is, turmerone (37.9%), aR-turmerone (16.8%), and β -turmerone (16.1%). These turmerones have similar chemical structures, physical properties, and molecule weights, although they have different tastes (Kao et al., 2007) and they are believed to be an intermediate for the formation of zingiberene and sesquiphellandrene (Asghari et al., 2009). α -terpinolene (8.1%), β -sesquiphellandrene (4.0%), α -zingiberene (3.7%), α -phellandrene (1.9%), caryophyllene (1.6%), α -curcumene (1.3%), and eucalyptol (0.7%) were also identified. Raina et al. (2005) reported that the major components of essential oils from turmeric were α -turmerone (44.1%), β -turmerone (18.5%), and aR-turmerone (5.4%), while Naz et al. (2010) reported that the most abundant components of the oils were aR-turmerone (25.3%), α -turmerone (18.3%), and β -turmerone (12.5%). The aroma composition of the fresh turmeric rhizome oils varies with species, origin, agricultural system, climate, or maturity.

The impact of the “full” processes on the aroma profile was shown in Figure 7. There were significant differences ($p > .05$) between

samples F/FD, F/FC1D, and F/FC2D considered in pairs for all molecules, except for turmerone and α -phellandrene. For aR-turmerone and β -turmerone, the greatest differences were observed between sample F and FD with relative loss of 21.6% and 9.8%, respectively. For α -curcumene, the greatest difference (30.8%) was observed between sample F and FC1D. For α -terpinolene, β -sesquiphellandrene, α -zingiberene, caryophyllene, and eucalyptol, the greatest differences were observed between sample F and FC2D with a reduction in the range of 19.7%–46.3%.

Cooking slightly impacted the concentration of aroma compounds (Figure 7). Smooth cooking significantly decreased 14.9%, 21.7%, and 19.7% of aR-turmerone, α -curcumene, and eucalyptol, respectively. Drastic cooking significantly decreased aR-turmerone, α -terpinolene, caryophyllene, and eucalyptol with a reduction of 6.5%, 43.4%, 37.2%, and 19.7%, respectively. Conversely, cooking (smooth and drastic) significantly increased turmerone up to 19.0%. The major aroma compounds in our fresh and cooked turmeric (F, FC1, and FC2) were turmerone (37.9%–44.6%), aR-turmerone (14.0%–16.8%), and β -turmerone (16.1%–16.8%) (data not shown).

Drying also had a slight impact on the concentration of aroma compounds (Figure 7) as there were significant differences ($p > .05$) between samples F/FD, FC1/FC1D, and FC2/FC2D considered in pairs. Direct drying significantly decreased aR-turmerone, β -turmerone, and α -curcumene with relative loss of 21.6%, 9.8%, and 14.5%, respectively. Drying with previous smooth cooking significantly decreased turmerone, β -turmerone, β -sesquiphellandrene, and α -zingiberene with relative loss of 13.9%, 14.2%, 23.3%, and 24.4%, respectively. Drying with previous drastic cooking significantly decreased aR-turmerone (8.3%), β -turmerone (8.2%), and β -sesquiphellandrene (15.4%). The changes in the percentage of each aroma compound may be due to the complete release of these compounds during cooking and drying processes and another reason may be due to oxidation or rearrangement of less stable compounds to the more stable compounds (Kutti Gounder & Lingamallu, 2012). The major aroma compounds in our dried turmeric (FD, FC1D, and FC2D) were turmerone (40.9%–44.4%), aR-turmerone (14.6%–15.8%), and β -turmerone (16.1%–17.1%) (data not shown). The major aroma compounds of dried turmeric from Thailand found by Monton et al. (2019a) were aR-turmerone (43%–49%), turmerone (13%–16%), and β -turmerone (17%–18%) and by Thongphasuk and Thongphasuk (2013) were aR-turmerone (32%), α -turmerone (16%), and β -turmerone (13%).

4 | CONCLUSION

Our original approach combining microscopy and biochemistry brought interesting results. Curcuminoid and essential oil were found in different dedicated cells. After processing, curcuminoids were dispersed throughout the matrix. This starchy matrix seems to protect essential oil and curcuminoid to a certain extent. Drastic cooking (95°C/60 min) and drying operations impacted b^* and C^* color values

more than smooth cooking (95°C/3 min). Cooking (either smooth or drastic) had no impact on curcuminoid and essential oil contents and only a slight impact on essential oil composition. Drying significantly decreased curcuminoid (between 24.5% and 38.8%) and essential oil (between 8.8% and 13.2%) contents. There is a real interest in combining cooking and drying unit operations. Indeed, cooking turmeric before drying saved 38.1% to 49.8% of the drying time. Cooking at 95°C/3 min is the optimum cooking condition for turmeric sliced rhizome (5 mm thick) because it is a good compromise between drying time and the quality of turmeric considering color and aroma. It is also less energy-consuming than cooking at 95°C/60 min. For further studies, we should focus on the impact of unit operations (cooking, drying, and grinding) on the functional and sensory qualities of turmeric.

ACKNOWLEDGMENTS

The authors are grateful to the French Government Scholarships Cofounded by the Ministry of Education, Youth and Sports of Cambodia, CIRAD—UMR QualiSud and Cambodia Higher Education Improvement Project (Credit No. 6221-KH) for financial support of this study. We also would like to thank Delpech Charlotte, Ollier Léa, Boulanger Renaud, Meot Jean-Michel, and Servent Adrien (CIRAD—UMR QualiSud) for their contribution to this study.

AUTHOR CONTRIBUTIONS

Molika Yin: Conceptualization; formal analysis; methodology; software; visualization; writing – original draft; writing – review and editing. **Mathieu Weil:** Funding acquisition; project administration; supervision; writing – original draft; writing – review and editing. **Sylvie Avallone:** Conceptualization; methodology; validation; writing – review and editing. **Marc Lebrun:** Formal analysis; methodology; software. **Genevieve Conejero:** Formal analysis; methodology; visualization; writing – original draft. **Sokneang In:** Conceptualization; project administration; supervision. **Philippe Bohuon:** Conceptualization; funding acquisition; methodology; supervision; validation; writing – review and editing.

CONFLICTS OF INTEREST

The authors have declared no conflicts of interest for this article.

DATA AVAILABILITY STATEMENT

The data that support the findings of this study are available from the corresponding author upon reasonable request.

ORCID

Molika Yin  <https://orcid.org/0000-0002-9359-8464>

Mathieu Weil  <https://orcid.org/0000-0002-9256-6348>

REFERENCES

- Ararsa, B. H. (2018). *Effect of processing methods on quality of turmeric (Curcuma longa L.) finger rhizome growing in Teppi, Sheka zone, Ethiopia* (Issue November, p. 84). Haramaya University.
- Asghari, G., Mostajeran, A., & Shebli, M. (2009). Curcuminoid and essential oil components of turmeric at different stages of growth cultivated in Iran. *Research in Pharmaceutical Sciences*, 4(1), 55–61.
- Bambirra, M. L. A., Junqueira, R. G., & Glória, M. B. A. (2002). Influence of post harvest processing conditions on yield and quality of ground turmeric (*Curcuma longa* L.). *Brazilian Archives Biology and Technology*, 45(4), 423–429. <https://doi.org/10.1590/S1516-89132002000600004>
- David, R., & Carde, J. P. (1964). Coloration différentielle des inclusions lipidique et terpeniques des pseudophylles du pin maritime au moyen du reactif Nadi. *Comptes Rendus de l'Academie Des Sciences Paris*, 258, 1338–1340.
- Díaz-Maroto, M. C., Pérez-Coello, M. S., & Cabezudo, M. D. (2002). Effect of drying method on the volatiles in bay leaf (*Laurus nobilis* L.). *Journal of Agricultural and Food Chemistry*, 50(16), 4520–4524. <https://doi.org/10.1021/jf011573d>
- Garg, S. N., Bansal, R. P., Gupta, M. M., & Kumar, S. (1999). Variation in the rhizome essential oil and curcumin contents and oil quality in the land races of turmeric *Curcuma longa* of north Indian plains. *Flavour and Fragrance Journal*, 14, 315–318.
- Govindarajan, V. S., & Stahl, W. H. (1980). Turmeric—Chemistry, technology, and quality. *CRC Critical Reviews in Food Science and Nutrition*, 12(3), 199–301. <https://doi.org/10.1080/10408398009527278>
- Hirun, S., Utama-ang, N., & Roach, P. D. (2014). Turmeric (*Curcuma longa* L.) drying: An optimization approach using microwave-vacuum drying. *Journal of Food Science and Technology*, 51(9), 2127–2133. <https://doi.org/10.1007/s13197-012-0709-9>
- International Organization for Standardization. (2008). *Spices, condiments and herbs—Determination of volatile oil content (hydrodistillation method)* (ISO Standard No. 6571:2008). <https://www.iso.org/standard/66816.html>
- International Organization for Standardization. (2015). *Turmeric, whole or ground (powdered)—Specification* (ISO Standard No. 5562:1983). <https://www.iso.org/standard/11632.html>
- Jayashree, E., & John Zachariah, T. (2016). Processing of turmeric (*Curcuma longa*) by different curing methods and its effect on quality. *Indian Journal of Agricultural Sciences*, 86(5), 696–698.
- Jayashree, E., Zachariah, T. J., & Rakhi, R. (2018). Comparison of quality of dry turmeric (*Curcuma longa*) produced by slicing and other curing methods. *Journal of Spices and Aromatic Crops*, 27(2), 138–144. <https://doi.org/10.25081/josac.2018.v27.i2.1102>
- Kao, L., Chen, C.-R., & Chang, C.-M. J. (2007). Supercritical CO₂ extraction of turmerones from turmeric and high-pressure phase equilibrium of CO₂ + turmerones. *The Journal of Supercritical Fluids*, 43(2), 276–282. <https://doi.org/10.1016/j.supflu.2007.06.007>
- Kutti Gounder, D., & Lingamallu, J. (2012). Comparison of chemical composition and antioxidant potential of volatile oil from fresh, dried and cured turmeric (*Curcuma longa*) rhizomes. *Industrial Crops and Products*, 38(1), 124–131. <https://doi.org/10.1016/j.indcrop.2012.01.014>
- Lee, W.-H., Loo, C.-Y., Bebawy, M., Luk, F., Mason, R., & Rohanizadeh, R. (2013). Curcumin and its derivatives: Their application in neuropharmacology and neuroscience in the 21st century. *Current Neuropharmacology*, 11(4), 338–378. <https://doi.org/10.2174/1570159X11311040002>
- Madhusankha, G., Thilakarathna, R., Liyanage, T., & Navaratne, S. (2018). Analysis of curcumin content in Sri Lankan and Indian turmeric rhizomes and investigating its impact on the colour. *International Journal of Food Science and Nutrition*, 3(4), 3–5.
- Monton, C., Charoenchai, L., Suksaeree, J., & Sueree, L. (2016). Quantitation of curcuminoid contents, dissolution profile, and volatile oil content of turmeric capsules produced at some secondary government hospitals. *Journal of Food and Drug Analysis*, 24(3), 493–499. <https://doi.org/10.1016/j.jfda.2016.01.007>
- Monton, C., Luprasong, C., & Charoenchai, L. (2019a). Convection combined microwave drying affect quality of volatile oil

- compositions and quantity of curcuminoids of turmeric raw material. *Revista Brasileira de Farmacognosia*, 29(4), 434–440. <https://doi.org/10.1016/j.bjp.2019.04.006>
- Monton, C., Luprasong, C., & Charoenchai, L. (2019b). Acceleration of turmeric drying using convection and microwave-assisted drying technique: An optimization approach. *Journal of Food Processing and Preservation*, 43(9), 1–10. <https://doi.org/10.1111/jfpp.14096>
- Naz, S., Ilyas, S., Parveen, Z., & Javed, S. (2010). Chemical analysis of essential oils from turmeric (*Curcuma longa*) rhizome through GC-MS. *Asian Journal of Chemistry*, 22(4), 3153–3158.
- Prathapan, A., Lukhman, M., Arumughan, C., Sundaresan, A., & Raghu, K. G. (2009). Effect of heat treatment on curcuminoid, colour value and total polyphenols of fresh turmeric rhizome. *International Journal of Food Science and Technology*, 44(7), 1438–1444. <https://doi.org/10.1111/j.1365-2621.2009.01976.x>
- Raina, V. K., Srivastava, S. K., & Syamsundar, K. V. (2005). Rhizome and leaf oil composition of curcuma longa from the lower Himalayan region of northern India. *Journal of Essential Oil Research*, 17(5), 556–559. <https://doi.org/10.1080/10412905.2005.9698993>
- Sepahpour, S., Selamat, J., Manap, M. Y. A., Khatib, A., & Razis, A. F. A. (2018). Comparative analysis of chemical composition, antioxidant activity and quantitative characterization of some phenolic compounds in selected herbs and spices in different solvent extraction systems. *Molecules*, 23(2), 1–17. <https://doi.org/10.3390/molecules23020402>
- Singh, G., Arora, S., & Kumar, S. (2010). Effect of mechanical drying air conditions on quality of turmeric powder. *Journal of Food Science and Technology*, 47(3), 347–350. <https://doi.org/10.1007/s13197-010-0057-6>
- Sogi, D. S., Sharma, S., Oberoi, D. P. S., & Wani, I. A. (2010). Effect of extraction parameters on curcumin yield from turmeric. *Journal of Food Science and Technology*, 47(3), 300–304. <https://doi.org/10.1007/s13197-010-0047-8>
- Suresh, D., Manjunatha, H., & Srinivasan, K. (2007). Effect of heat processing of spices on the concentrations of their bioactive principles: Turmeric (*Curcuma longa*), red pepper (*Capsicum annum*) and black pepper (*Piper nigrum*). *Journal of Food Composition and Analysis*, 20(3–4), 346–351.
- Talamond, P., Verdeil, J.-L., & Conéjéro, G. (2015). Secondary metabolite localization by autofluorescence in living plant cells. *Molecules*, 20, 5024–5037. <https://doi.org/10.3390/molecules20035024>
- Thongphasuk, P., & Thongphasuk, J. (2013). Effects of gamma-irradiation on free radicals, active components and toxicity of turmeric rhizomes. *Rangsit Journal of Arts and Sciences*, 3(2), 169–177. <https://doi.org/10.14456/RJAS.2013.4>

How to cite this article: Yin, M., Weil, M., Avallone, S., Lebrun, M., Conejero, G., In, S., Bohuon, P. (2022). Impact of cooking and drying operations on color, curcuminoids, and aroma of *Curcuma longa* L.. *Journal of Food Processing and Preservation*, 00, e16643. <https://doi.org/10.1111/jfpp.16643>



Impact of cooking, drying and grinding operations on chemical content, functional and sensorial qualities of *Curcuma longa* L.

Molika Yin^{1,2} · Mathieu Weil^{1,3} · Sylvie Avallone¹ · Isabelle Maraval^{1,3} · Nelly Forestier-Chiron^{1,3} · Adrien Servent^{1,3} · Sokneang In² · Philippe Bohuon¹

Received: 20 July 2022 / Accepted: 25 October 2022

© The Author(s), under exclusive licence to Springer Science+Business Media, LLC, part of Springer Nature 2022

Abstract

The impact of cooking, drying and grinding on essential oil content, curcuminoid contents and their bioaccessibility and sensorial quality of *Curcuma longa* L. was assessed. Sliced fresh turmeric rhizomes (5 mm thick) were air-dried at 60 °C, 40% RH directly or pre-cooked (95 °C/3 min) before drying at different conditions (50, 60 or 80 °C; 40% RH). Dried slices, at 0.11 kg kg⁻¹ db water content, were ground to obtain two powders of different particle sizes (*i.e.* fine < 500 µm and coarse < 750 µm). Cooking had no impact on essential oil content, curcuminoid contents and their bioaccessibility but reduced drying time. Drying decreased essential oil content (– 22.5%), curcuminoid contents (– 11.0%) and their bioaccessibility (– 28.6%). Surprisingly, grinding had no impact on curcuminoid contents and their bioaccessibility. The combination of the tested unit operations produced final products with the same quality in terms of total curcuminoid contents (12.1 g/100 g db) and bioaccessible curcuminoids (1.0 g/100 g db). However, consumers detected significant differences in colour, texture and overall liking between processed turmeric powders (dried and cooked-dried). Our results demonstrate that smooth cooking (95 °C/3 min) followed by drying (60 °C, 40% RH) is the most appropriate process to produce a curcuminoid-rich powder and improve consumer acceptance.

Keywords Bioaccessibility · Curcuminoids · Consumer acceptance · Descriptive attributes · Essential oil · Particle size

Introduction

Turmeric (*Curcuma longa* L.) has been used for years all over the world to prepare a large number of recipes and improve their aroma and colour. Consumers are also increasingly attracted to its anti-inflammatory potential and health properties. As a spice, turmeric is used fresh or processed in the formulation of sauces, soups, seasonings and marinades to enhance the sensory profile of many foods, particularly meat products. Rhizomes of dried *Curcuma longa* L. contain carbohydrates (60–70%), protein (6–8%), fibre (2–7%), minerals (3–7%), fat (5–10%), essential oil (3–7%)

and curcuminoid pigments (2–6%). The essential oil and the curcuminoid pigments are active components of turmeric. The essential oil is composed mainly of sesquiterpenes *i.e.* α- (30–32%), β- (15–18%) and ar-turmerone (17–26%). Curcuminoids are a mixture of curcumin (52–63%) and its two derivatives demethoxycurcumin (19–27%) and bisdemethoxycurcumin (18–28%) [1]. These are considered bioactive polyphenols with beneficial health properties and are responsible for the yellow-orange colouration of turmeric powder [2]. Although turmeric has been used as a food colourant and functional ingredient, these uses have remained challenging due to its low solubility in water, which limits its dispersion in food matrices and its bioaccessibility [3, 4].

After harvest, fresh turmeric rhizome undergoes continuous physical, chemical and microbiological changes. These changes are particularly influenced by the moisture content of the material, relative humidity of ambient air and storage conditions [5]. To preserve its quality and make it available throughout the year, it must be subjected to specific technological treatment such as drying. Depending on the geographical area of production,

✉ Mathieu Weil
mathieu.weil@cirad.fr

¹ Qualisud, Univ Montpellier, CIRAD, Institut Agro, Avignon Université, Univ de La Réunion, Montpellier, France

² Institut de Technologie du Cambodge, Food Technology and Nutrition Research Unit, Phnom Penh, Cambodia

³ CIRAD, UMR Qualisud, 34398 Montpellier, France

turmeric is either dried directly or bleached and then dried; depending on local consumer preferences, it may also be ground more or less finely. Air drying is an alternative to sun drying, not only to increase the drying rate and reduce drying time but also to better preserve the quality of the product [5, 6]. However, it is recognised that it is time- and energy-consuming when whole rhizomes are dried directly or pre-cooked for a long time at a high temperature (≥ 100 °C) and then dried [7, 8]. Heat applied to turmeric may inactivate enzymes and soften the tissue to prevent phytochemical degradation and improve their release from plant matrix and therefore, turmeric powder functionality (*i.e.* curcuminoids bioaccessibility).

This study aimed to assess the impact of unit operations and their combinations on the essential oil content, curcuminoid contents and their bioaccessibility and sensorial quality of *Curcuma longa* L. In order to determine optimum transformation conditions, the impact of cooking, drying and grinding was studied through different process conditions on sliced rhizomes. The impact of cooking and drying on drying kinetics was also studied.

Materials and methods

Materials

Fresh turmeric rhizome (*Curcuma longa* L.) was purchased from a farmer in Kampong Cham (Cambodia) in November 2020. It was packed and transported to Montpellier (France) by airplane in the next 2 days. Turmeric rhizomes were stored at 4 °C before processing. About 60 g of fresh turmeric rhizome was cleaned and sliced to a thickness of 5 mm. Next, it was frozen by using liquid nitrogen and ground for 10 s at 10,000 rpm in a mill (Retsch Grindomix GM200, Retsch GmbH, Germany) prior to immediate analyses of water content, essential oil content, curcuminoids and their bioaccessibility. About 360 g of fresh turmeric rhizome was cleaned and sliced then frozen at -80 °C overnight before being freeze-dried in a vacuum freeze-dryer (Cryonext, France) for 48 h. It was ground following the same method as for the fresh turmeric. The commercial turmeric powder (Ducros) was purchased from a supermarket in Montpellier (France) in February 2021. It was packed in glass bottle with a net content of 45 g. HPLC standards curcumin (C), demethoxycurcumin (DMC), bisdemethoxycurcumin (BDMC), α -amylase from human saliva (5 units/mg protein), pepsin from porcine gastric mucosa (3200–4500 units/mg protein) and pancreatin from porcine pancreas (8 \times USP specifications) were purchased from Sigma-Aldrich (Saint Quentin Fallavier, France).

Processing experiments

The fresh turmeric rhizomes were cleaned and washed thoroughly under running water to remove adhering soil and mud and other foreign materials. Then, the excess water was drained and the cleaned turmeric rhizomes were sliced manually to a thickness of 5 mm. The sliced turmeric (420 g) were cooked at 95 °C/3 min by immersion in a nylon net in hot water at a ratio of 1:10 w/w material to water. The cooked turmeric were immediately soaked in an ice water bath for 1 min to stop the heat exposure, before being drained. Then, the cooked turmeric were dried in a hot air dryer, developed in our laboratory at three conditions (D1: 60 °C, 40% RH; D2: 50 °C, 40% RH; D3: 80 °C/1 h + 50 °C, 40% RH) until reaching a water content of 0.11 kg kg⁻¹ db [9]. In the vertical drying chamber, the sliced turmeric were spread on a grid sieve (0.25 m \times 0.25 m \times 0.06 m). Hot air was circulated downwards through the layer of sliced turmeric by a high-capacity fan. Airspeed was measured thanks to an anemometer (ALMEMO® 2690-8A, Ahlborn Mess, Germany). The air velocity was set to 2.1 ± 0.1 m s⁻¹ to have no significant effect on temperature when passing through the layer of sliced turmeric. Monitoring by weighing was carried out continuously during the drying process, every 10 min for the first hour and then every 15 min. The water content, which was expressed on a dry basis (noted X) as a function of time, was estimated in line, using the mass reading of the sieve. Water content kinetics $X^{(t)}$ were fitted with a cubic smoothing spline (Matlab® Version 5.2, The Mathworks Inc., USA). The drying rate (dX/dt) was calculated as the direct analytical derivative of the cubic smoothing spline function on $X^{(t)}$. Next, the dried turmeric were ground at 10,000 rpm for 10 s by using an ultracentrifugal mill (Retsch ZM 200, Retsch GmbH, Germany) with two different sieves (500 μ m and 750 μ m) in order to produce two different particle size powders (P1: < 500 μ m; P2: < 750 μ m) (Fig. 1). For essential oil content determination, the dried turmeric were ground following the same method as for the fresh turmeric (“Materials” section). The samples were put in glass bottles and frozen at -80 °C for further analysis.

Analytical methods

Dry matter and water contents

The dry matter content (means “dry matter free of essential oil”) was obtained by drying 1 g of ground turmeric in an aluminium cup in an oven (Gefran 800, Italy) at 105 °C for 30 h (*i.e.* until constant weight). The mean relative

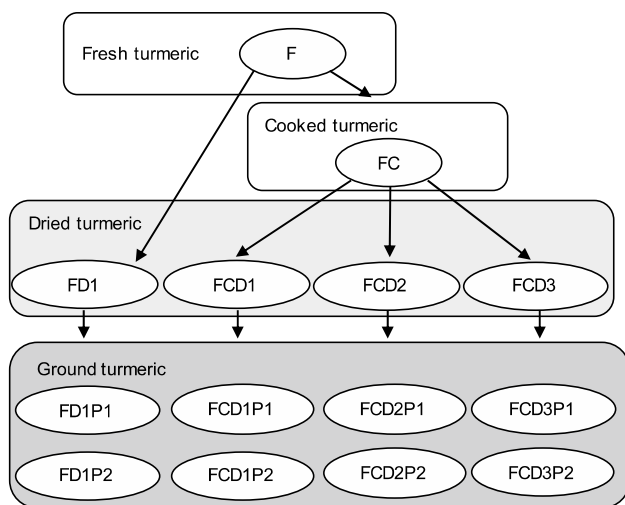

Fig. 1 Processes applied to turmeric. F: fresh; C: cooking (95 °C/3 min); D: drying (D1: 60 °C, 40% RH; D2: 50 °C, 40% RH; D3: 80 °C/1 h + 50 °C, 40% RH); Grinding leading to different particle size (P1: < 500 μ m; P2: < 750 μ m)

deviation of repeatability was $\pm 1.9\%$ ($n = 4$). Water content, expressed on a dry basis, was deduced from essential oil and dry matter contents.

Essential oil content

The essential oil content, expressed in ml/100 g on a dry weight basis (ml/100 g db), was determined using a method adapted from the international official standard method ISO 6571:2008 [10]. The only modification in the method we applied was the elimination of xylene. About 20 g of fresh turmeric or 5 g of dried turmeric was weighed and transferred to 1 l round bottom flask, then 250 ml of distilled water was added with 10 pieces of pumice stones to homogenize boiling. It was heated at medium heat for 4 h and the condensed vapour was separated. The essential oil present in the uppermost layers was measured. The mean relative deviation of repeatability was $\pm 3.8\%$ ($n = 4$).

Particle characterisation

A laser granulometry instrument (Mastersizer 3000, Malvern Instruments Ltd., Malvern, Worcestershire, UK) was used to measure the particle diameter and particle size distribution of the turmeric powders. The particle size was reported as the surface mean diameter ($D_{3,2}$). The mean relative deviation of repeatability was $\pm 15.9\%$ ($n = 6$).

Curcuminoid contents

Approximately 0.3 g of turmeric sample was mixed with 30 ml of 60 °C ethanol (99.8%) and homogenized for 2 min

at 30,000 rpm (IKA T10 basic Ultra-Turrax, Prolabo, France). The samples were heated for 30 min at 60 °C [11]. After cooling, the extracts were diluted 1/10 with ethanol and filtered on 0.45 μ m PTFE Minisart SRP4 membrane (Sartorius, Palaiseau, France). Curcuminoids were analysed by high-performance liquid chromatography (Agilent System 1200 series, Massy, France). The column was a polymeric ACE C_{18} (250 \times 4.6 mm, 5 μ m particle size, Inc Wilmington NC) and the injection volume was 5 μ l. The quantification of curcuminoids was carried out according to the method of Sepahpour et al. [12] with small modifications. The elution was done isocratically with a mixture of acetonitrile and 0.1% acetic acid (40:60) at a flow rate of 1.0 ml/min. The temperature of the column was set at 25 °C. Chromatograms were recorded over 30 min period with a UV-visible photodiode array detector (Agilent Technologies 1200 series) at 425 nm, the wavelength of maximum absorption of the curcuminoids in the mobile phase. The curcuminoids were identified by their retention time and spectrum. External calibration was realized weekly with standard solutions of the pure chemicals in ethanol in the range of 1 to 50 mg/l. The curcuminoid contents were expressed in g/100 g on a dry weight basis (g/100 g db). The mean relative deviation of repeatability was 2.5%, 3.6%, 4.2% and 3.5%, respectively for C, DMC, BDMC and total curcuminoid contents ($n = 4$).

Assessment of bioaccessible curcuminoids

A static in vitro gastrointestinal tract model was used to study the potential gastrointestinal fate and bioaccessibility of curcuminoids in turmeric powders. The simulated gastrointestinal tract used in our study was based on one described previously [13, 14] with some slight modifications. The stock solutions were prepared before the experiments while the enzymatic solutions were prepared at the last moment. About 1.0 g of fresh turmeric or 0.3 g of dried turmeric was weighed and distilled water was added into the sample to get the total weight about 5.0 g that was left at room temperature for 15 min. Then, 5 ml of salivary solution was added and the sample was incubated for 2 min at 37 °C with gentle stirring (Oral phase). Next, 10 ml of gastric phase was added and incubated for 2 h at 37 °C with gentle stirring (Gastric phase). The solution was adjusted to pH 5.0 with sodium hydroxide at 2 M and then 20 ml of intestinal phase was added. The sample was incubated for 2 h at 37 °C with gentle stirring (Intestinal phase). After that, the digest phases were separated from the solid residue by centrifugation at 10,000 \times g for 30 min at 15 °C (Avanti™ J-E, Beckman Coulter®). The liquid phase was weighed accurately. To extract the bioaccessible curcuminoids, 10 ml of the digesta was mixed with 10 ml of chloroform ($\geq 99.8\%$) and vortexed for 10 s (Fisherbrand™ Classic Vortex Mixer). Next, the

samples were centrifuged at $10,000\times g$ for 10 min at 15 °C. After that, 5 ml of yellow phase was evaporated at 50 °C for 3 min using a rotary evaporator (Heidolph Laborota 4000, Schwabach, Germany). Then, the residue was solubilized in 10 ml ethanol ($\geq 99.8\%$) and filtered on a 0.45 μm PTFE Minisart SRP4 membrane. Finally, the bioaccessible curcuminoids were analysed by HPLC following the same method as the curcuminoids analysis (“[Curcuminoid contents](#)” section). The chromatogram figure of curcuminoids separated in the total extract and after digestion was shown in the supplementary information (Fig. SI). The bioaccessible curcuminoids were expressed in g/100 g on a dry weight basis (g/100 g db) by using the total content in the sample. The mean relative deviation of repeatability was 10.4%, 6.4%, 5.6% and 7.5%, respectively for C, DMC, BDMC and total curcuminoids ($n=4$).

Sample preparation for the focus group, consumer acceptance and quantitative descriptive analysis

As turmeric is not consumed alone, the consumer evaluation was carried out by mixing the powders with cooked rice. For this purpose, plain rice was cooked in a pressure cooker with a ratio of rice/water equal to 1/1.5 (w/w). Then, it was mixed (in bowls) with the processed turmeric in a w/w ratio of 1.5% (kept warm by covering). About 20 g of sample per tasting glass was prepared for each panellist. The “turmeric rice samples” were kept warm (between 60 and 70 °C) in a heated cabinet and tested by using a teaspoon. The panellists were recommended to rinse their mouths with white rice and/or water between the samples, to minimise any residual effect.

Focus group and consumer acceptance

The focus group and consumer acceptance tests were conducted at the Institut de Technologie du Cambodge (Phnom Penh, Cambodia). The consumers were informed prior to the study that their participation was entirely voluntary, that they could stop the interview at any point/time and that their responses would remain anonymous. A focus group discussion was performed to collect the perceptions and attitudes of consumers towards turmeric powders. Six volunteers (three females and three males) of different ages (20 to 60-year-old) were invited to evaluate two turmeric powders and to taste two turmeric rice samples. We asked them to give their impressions about the samples, main product attributes and their motivations to buy and to consume turmeric powders. The results from the focus group discussion were used to develop a survey for the consumer acceptance test. The consumer acceptance test was carried out with 120 non-trained consumers.

Since there were eight samples, two sessions were held on four consecutive days. The samples were presented in random order and labelled with three-digit numbers. We asked the participants to provide information on their gender, age, occupation, marital status, turmeric consumption pattern and frequency. For each sample, the consumers were asked to score their appreciation of each attribute (colour, texture, odour, taste and overall liking) on a structured nine-point hedonic scale (1: dislike extremely, 5: neither like nor dislike, 9: like extremely). After tasting, we asked them to provide their appreciation of turmeric powder: general appreciation, purposes of buy/use, ways of consuming and occasion of consumption.

Quantitative descriptive analysis

A quantitative descriptive analysis was carried out to characterize four turmeric rice samples. The panellists were recruited and selected in compliance with ISO Standard 8586:2012 [15] and panel performance was evaluated in compliance with ISO Standard 11132:2012 [16]. Twelve trained panellists (seven females and five males) were selected from researchers and staff in the UMR—Qualisud of CIRAD (Montpellier, France). We provided two training sessions to the panellists in order to determine the consensus list of quality attributes. In the first session, the panellists were specifically asked to identify and describe the quality attributes perceived and to memorize the perception and trained how to use the scale. After the individual assessment, an open discussion was held to assess the evaluation results. From this discussion, the terms were selected and the mean of each attribute was calculated for the second training session. The list of descriptors, their definitions and the assessment protocols were developed (Table 1). In the second session, the panellists were trained to assess warm-up samples using the same sensory sheets to be used in the main sensory evaluation. All panellists were asked to compare their results with the previous ones and the mean scale. We made sure that all the panellists were able to identify each attribute and score them in accordance with the entire panel. Sensory evaluation was performed in random order and the samples were coded with three alphabets. We asked the panellists to evaluate the samples in monadic service and to participate in two sessions with a 15 min break after the 1st session. The intensity of each attribute was scaled from 0 to 10 on which 0 corresponded to “low intensity” and 10 to “high intensity”. The laboratory met the requirements of the international norm ISO 8589 [17] *i.e.* it was air-conditioned with a controlled temperature ($22\text{ °C} \pm 1\text{ °C}$) and humidity ($75\% \pm 10\%$). The panellists tasted in individual tasting booths.

Table 1 Definition of sensory attributes used to describe turmeric powders

Attribute family	Attribute	Definition	Assessment protocol	Rating scale
Appearance	Yellow	Yellow colour intensity	Observe the colour of the sample and note its intensity ranging from yellow to yellow-orange	0: Yellow 10: Yellow orange
	Dull	Opposite to the brightness of rice colour	Observe the colour brightness of the sample and note its intensity ranging from bright to dull colour	0: Bright; 10: Dull
	Particle size	Size and shape of particles in the sample	Take a spoon of sample and observe the size and shape of the particles in the sample. Note the finesse of the sample	0: Fine; 10: Coarse
Odour	Turmeric	Odour of turmeric produced by the essential oil and the compounds called “turmerones”	Smell the sample and note the intensity of the turmeric odour	0: Weak; 10: Strong
	Earthy	Odour of earth, cultivated soil	Smell the sample and note the intensity of the earthy odour	0: Weak; 10: Strong
Taste	Bitter	Basic taste of quinine or caffeine	Put a spoon of sample in your mouth, chew it and swirl it around your tongue to detect the bitter taste	0: Weak; 10: Strong
Aroma	Turmeric	Aroma of turmeric produced by the essential oil and the compounds called “turmerones”	Put a spoon of sample in your mouth, chew and note the intensity of the aromas	0: Weak; 10: Strong
	Earthy	Aroma of earth corresponding to an organic compound present in the soil		0: Weak; 10: Strong
	Woody	Aroma reminiscent of wood, ...		0: Weak; 10: Strong
	Green	Aroma reminiscent of grass, vegetables, ...		0: Weak; 10: Strong
	Minty	Aroma of mint		0: Weak; 10: Strong
	Floral	Aroma reminiscent of flowers: rose, jasmine, ...		0: Weak; 10: Strong
Mouthfeel	Piquant	Feeling of piquant	Evaluate the feeling of piquant in the mouth after swallowing	0: Weak; 10: Strong
	Fresh	Feeling of freshness in the mouth, like menthol, liquorice, camphor, eucalyptus, ...	Evaluate the feeling of freshness in the mouth after swallowing	0: Weak; 10: Strong
Comments		Specify the other odours-aromas felt and note their intensity		0: Weak; 10: Strong

Statistical analysis

The results were expressed as means \pm standard deviations. The significance of differences was determined by analysis of variance (ANOVA) and Duncan's test using SPSS version 26.0 (SPSS Inc., Chicago, IL, USA). The level of significance was set at $p < 0.05$.

Results and discussion

Essential oil content

The essential oil content of our fresh turmeric was 13.25 ml/100 g db (equal to 1.51 ml/100 g wb). This value was higher than the value of 10.72 ml/100 g db (equal to 1.32 ml/100 g wb) found in our previous study [18], on

fresh turmeric from Thailand. However, the value was in agreement with Garg et al. [19] who found that the essential oil content of turmeric collected from the sub-Himalayan Tarai region of India ranged from 0.16 to 1.94 ml/100 g wb. The difference may be due to turmeric variety, planting period, environmental conditions, plant development stage, and harvesting season [20, 21]. Cooking had no impact on essential oil content but drying significantly decreased it with a relative loss of 22.5%. This result was in agreement with Ararsa [22] who found a loss of essential oil up to 25% by evaporation and destruction of some light-sensitive oil constituents. The essential oil contents of freeze-dried and hot air-dried turmeric were not significantly different ($p < 0.05$) and the average value (10.30 ml/100 g db) was much higher than that of commercial turmeric powder (2.44 ml/100 g db). The essential oil content was quite stable during the tested unit operations.

Table 2 Particle size (Sauter mean diameter $D_{3,2}$) of turmeric powder; curcumin (C), demethoxycurcumin (DMC), bisdemethoxycurcumin (BDMC), total curcuminoids content; total and relative bioaccessible curcuminoids of fresh (F) and processed turmeric samples obtained by cooking (C: 95 °C/3 min) or not, drying (D) and grinding with fine (P1) or coarse (P2) particle sizes

Samples	Curcuminoids (g/100 g db)				Bioaccessible curcuminoids (g/100 g db)					
	$D_{3,2}$ (μm)	C	DMC	BDMC	Total	C	DMC	BDMC	Total	Relative (%)
F	–	5.29 ± 0.21 ^b	3.50 ± 0.12 ^a	4.77 ± 0.20 ^b	13.56 ± 0.52 ^b	0.87 ± 0.01 ^a	0.51 ± 0.02 ^a	0.35 ± 0.02 ^{ab}	1.72 ± 0.04 ^a	12.7 ^a
Freeze-dried	63 ± 5 ^c	5.80 ± 0.34 ^a	3.31 ± 0.25 ^a	5.33 ± 0.36 ^a	14.44 ± 0.95 ^a	0.50 ± 0.06 ^b	0.41 ± 0.04 ^b	0.36 ± 0.03 ^a	1.27 ± 0.13 ^b	9.2 ^b
FD1P1	444 ± 149 ^b	5.38 ± 0.23 ^b	2.53 ± 0.14 ^b	4.38 ± 0.21 ^c	12.30 ± 0.58 ^c	0.37 ± 0.04 ^{cd}	0.32 ± 0.01 ^c	0.31 ± 0.02 ^d	1.00 ± 0.06 ^c	8.9 ^b
FCD1P1	335 ± 37 ^b	5.35 ± 0.04 ^b	2.48 ± 0.01 ^b	4.18 ± 0.10 ^c	12.01 ± 0.14 ^c	0.34 ± 0.04 ^{cd}	0.32 ± 0.01 ^c	0.33 ± 0.00 ^{abcd}	0.99 ± 0.05 ^c	9.0 ^b
FCD2P1	467 ± 80 ^b	5.30 ± 0.11 ^b	2.41 ± 0.08 ^b	4.11 ± 0.26 ^c	11.81 ± 0.43 ^c	0.35 ± 0.05 ^{cd}	0.31 ± 0.02 ^c	0.33 ± 0.03 ^{abcd}	0.98 ± 0.08 ^c	9.1 ^b
FCD3P1	454 ± 56 ^b	5.46 ± 0.01 ^b	2.43 ± 0.03 ^b	4.12 ± 0.08 ^c	12.01 ± 0.11 ^c	0.33 ± 0.05 ^d	0.30 ± 0.02 ^c	0.33 ± 0.02 ^{abcd}	0.97 ± 0.07 ^c	8.9 ^b
FD1P2	645 ± 72 ^a	5.35 ± 0.12 ^b	2.49 ± 0.08 ^b	4.31 ± 0.09 ^c	12.14 ± 0.30 ^c	0.41 ± 0.05 ^c	0.32 ± 0.02 ^c	0.31 ± 0.02 ^{cd}	1.04 ± 0.08 ^c	9.2 ^b
FCD1P2	738 ± 159 ^a	5.40 ± 0.03 ^b	2.46 ± 0.03 ^b	4.17 ± 0.03 ^c	12.03 ± 0.08 ^c	0.36 ± 0.03 ^{cd}	0.30 ± 0.02 ^c	0.32 ± 0.01 ^{bed}	0.98 ± 0.06 ^c	8.9 ^b
FCD2P2	740 ± 115 ^a	5.44 ± 0.22 ^b	2.46 ± 0.10 ^b	4.22 ± 0.35 ^c	12.12 ± 0.67 ^c	0.40 ± 0.05 ^{cd}	0.32 ± 0.03 ^c	0.35 ± 0.03 ^{abc}	1.06 ± 0.11 ^c	9.5 ^b
FCD3P2	723 ± 34 ^a	5.49 ± 0.10 ^b	2.45 ± 0.14 ^b	4.19 ± 0.20 ^c	12.12 ± 0.42 ^c	0.37 ± 0.05 ^{cd}	0.31 ± 0.03 ^c	0.34 ± 0.02 ^{abcd}	1.01 ± 0.08 ^c	9.1 ^b

Values are the mean ± standard deviation ($n = 6$ for $D_{3,2}$, $n = 4$ for curcuminoids analysis)

Means with the same superscript (a–d) within the same column do not differ significantly different (Duncan's test, p value < 0.05)

Drying conditions: D1: 60 °C, 40% RH; D2: 50 °C, 40% RH; D3: 80 °C/1 h + 50 °C, 40% RH

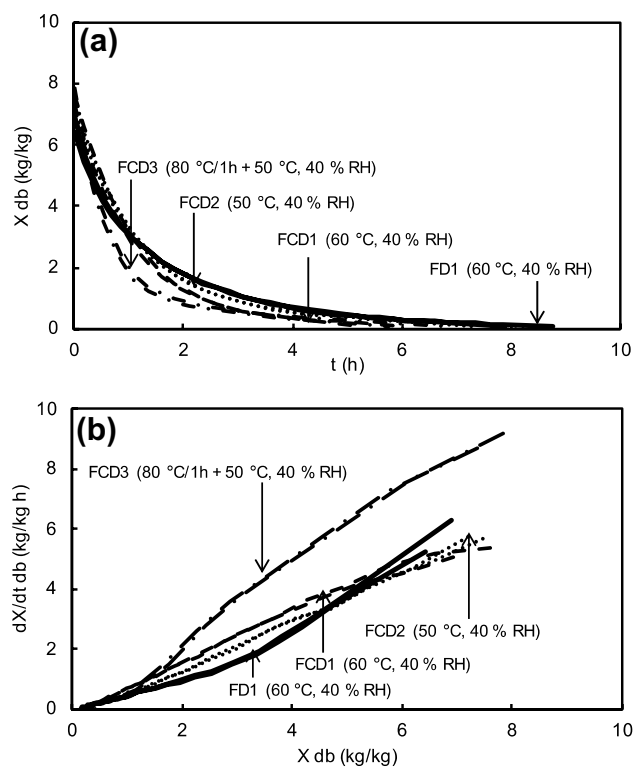

Fig. 2 Drying curves of fresh and cooked turmeric. **a** water content (X) on a dry basis as a function of time (t) and **b** drying rate (dX/dt) as a function of X . Drying curves recorded by an air dryer at different temperatures with an air velocity at $2.1 \pm 0.1 \text{ m s}^{-1}$. The different dash types on curves correspond to different trials

Particle characterization

Different drying conditions had no impact on the particle size of turmeric powders obtained by grinding (Table 2). Our turmeric powders (both fine and coarse particle size groups) had bimodal distribution (data not shown). The average of $D_{3,2}$ of fine and coarse particle size groups was $425 \pm 49 \mu\text{m}$ and $711 \pm 54 \mu\text{m}$, respectively. The particle size distribution is dependent on the mill used for the grinding [23]. Here, the results were relevant with the use of two different sieves ($< 500 \mu\text{m}$ for fine and $< 750 \mu\text{m}$ for coarse). Different drying conditions, but with the same final water content ($0.11 \pm 0.01 \text{ kg kg}^{-1} \text{ db}$), had no impact on the particle size distribution and surface mean diameter of turmeric powders. We can notice that the freeze-dried powder with low water content ($0.06 \text{ kg kg}^{-1} \text{ db}$) has a very low $D_{3,2}$ ($63 \mu\text{m}$).

Impact of cooking and drying on drying curves

The water content of our fresh turmeric was $86.9 \pm 0.5 \text{ g/100 g wb}$ (equal to $6.7 \pm 0.3 \text{ kg kg}^{-1} \text{ db}$). The drying time required to reach a water content of 0.11 kg

kg^{-1} db for FD1, FCD1, FCD2 and FCD3 was 8 h 19 min, 5 h 37 min, 7 h 48 min and 6 h 17 min, respectively. The use of a pre-cooking step saved 32.4% of drying time; increasing drying temperature reduced drying time (Fig. 2). Drying the cooked turmeric at 60 °C (FCD1) saved 11.8% and 38.7% as compared to drying at 80 °C/1 h + 50 °C (FCD3) and 50 °C (FCD2), respectively. The initial drying rate of FCD3 ($9.0 \pm 0.3 \text{ kg kg}^{-1} \text{ h}^{-1}$) was much higher than FCD2 ($5.7 \pm 0.1 \text{ kg kg}^{-1} \text{ h}^{-1}$), FCD1 ($5.2 \pm 0.2 \text{ kg kg}^{-1} \text{ h}^{-1}$) and FD1 ($5.8 \pm 0.7 \text{ kg kg}^{-1} \text{ h}^{-1}$). The drying rate increased with the drying temperature. This behaviour is due to higher temperature increasing the system's enthalpy, which increases the transfer of mass and energy, accelerating the migration of the water [24]. Llano et al. [25] evaluated different temperatures (between 50 and 80 °C) in a fluidized bed dryer on turmeric, finding that the efficiency of dehydration was better at a higher temperature (80 °C) which can reduce drying time up to 37.5% as compared to drying at 50 °C. Drying kinetics presented a classical behaviour with an intense water loss during the initial stage and a lower one at a later stage. This can be attributed to the fact that water on the surface of the food evaporates easily at the beginning of the drying process, whereas it takes longer to remove the water inside the product.

Impacts of unit operations on curcuminoid contents and their bioaccessibility

The C, DMC, BDMC and total curcuminoid contents of fresh turmeric were 5.29, 3.50, 4.77 and 13.56 g/100 g, respectively on a dry weight basis (Table 2). Cooking had no significant impact on curcuminoid contents; the average contents of C, DMC, BDMC and total curcuminoid contents of final products were 5.40, 2.46, 4.21 and 12.07 g/100 g db respectively. Among all the samples, the freeze-dried had the highest curcuminoid contents. Air drying (≥ 50 °C) decreased DMC, BDMC and total curcuminoid contents while grinding had no impact. At the end, the combination of the distinct unit operations produced final products with the same quality in terms of curcuminoid profiles. The curcuminoids were rather stable during the tested unit operations. Indeed, they are known to resist at high temperatures (above 100 °C) and in acidic conditions; however, they can be degraded by reactions in alkaline conditions and by light [26]. Our previous study [18] showed that the turmeric starchy matrix could preserve the curcuminoids and essential oil during cooking. Prathapan et al. [6] found no significant differences in curcuminoid content when comparing fresh and heat-treated material (between 50 and 100 °C for 30 min). Heat treatment of turmeric immersed in water produced good-quality turmeric with respect to curcuminoid; cooked turmeric showed higher uniformity or better pigment distribution

[5]. Llano et al. [25] found no significant differences in the C, DMC and BDMC concentrations between the dried turmeric obtained under different drying conditions (between 50 and 80 °C). The total curcuminoid content of a commercial turmeric powder was assessed and it reached 1.94 g/100 g db, a value greatly lower than ours. The differences may be due to different turmeric crop origins, seasonal variation, environmental conditions and the post-harvest process operations [27].

The bioaccessible C, DMC, BDMC and total curcuminoids of fresh turmeric were 0.87, 0.51, 0.35 and 1.72 g/100 g db, respectively which correspond to an average bioaccessibility equal to 12.7% (Table 2). Regardless of the treatment applied, cooking had no impact on the average contents of bioaccessible curcuminoids. Only fresh turmeric differs from other products with a higher bioaccessibility of curcuminoids. Drying decreased the contents of C, DMC and total bioaccessible curcuminoids while grinding had no impact. The bioaccessible curcuminoids of the commercial turmeric powder was 0.42 g/100 g db, a value greatly lower than ours. The average relative bioaccessibility of curcuminoids in the final products (9.1%) and in the freeze-dried turmeric (9.2%) was identical although their particle sizes were very different (ranging from 63 to 711 μm). Our previous results [18] showed that starch could be completely gelatinized when the sliced turmeric (thickness of 5 mm) was cooked at 95 °C for 3 min. Here, even though starch was gelatinised or not, we observed that the bioaccessibility of the curcuminoids was not significantly different. We also observed that after drying, the texture of turmeric was hard. Our hypothesis is that the biological fluids from in vitro digestion did not diffuse well into the powder particles. As a result, their constituents were less well solubilised in the digestive tract than the ones of fresh turmeric.

Impacts of unit operations on sensorial quality

Focus group

The participants observed both turmeric powders and turmeric rice samples and made some considerations and reactions as follows:

- Local consumers use turmeric in a fresh form as it is easy to grow and available throughout the year.
- Turmeric is mixed with other spices or herbs to make *Kroeung* for traditional Cambodian foods (*Machu Kroeung*, *Korko*, *Kari*...) to enhance their aroma and colour and to marinate meat by mixing it with other seasonings or spices to boost the flavour of the meat.
- Turmeric is also used in cosmetic products (body lotion and scrap to whiten the skin) and medicine.

Table 3 Impact of processes on consumer preference and descriptive attributes of processed turmeric samples obtained by cooking (C: 95 °C/3 min) or not, drying (D) and grinding with fine (P1) or coarse (P2) particle sizes

Samples	Consumer test 9-point hedonic ($n=120$)				Descriptive test (1–10 scales) ($n=12$)						
	Colour	Texture	Odour ^{*ns}	Taste ^{*ns}	Overall	Yellow	Dull	Size	Turmeric odour	Bitter	Pungency mouthfeel
FD1P1	5.9 ± 1.6 ^b	5.7 ± 1.8 ^{bc}	6.3 ± 1.7	5.5 ± 1.8	5.8 ± 1.6 ^{ab}	8.0 ± 1.0 ^a	6.2 ± 1.1 ^a	5.8 ± 1.1 ^b	7.4 ± 1.0 ^a	6.0 ± 1.4 ^a	3.0 ± 1.7 ^b
FCD1P1	6.8 ± 1.1 ^a	6.4 ± 1.3 ^a	6.4 ± 1.3	6.0 ± 1.8	6.3 ± 1.4 ^a	6.9 ± 0.8 ^{bc}	4.6 ± 1.2 ^b	5.5 ± 0.6 ^b	6.2 ± 1.1 ^b	4.9 ± 1.1 ^b	4.4 ± 1.2 ^a
FCD2P1	6.9 ± 1.1 ^a	6.6 ± 1.3 ^a	6.6 ± 1.0	6.0 ± 1.8	6.3 ± 1.3 ^a	–	–	–	–	–	–
FCD3P1	6.5 ± 1.2 ^a	6.4 ± 1.3 ^a	6.5 ± 1.3	5.9 ± 1.5	6.2 ± 1.4 ^a	–	–	–	–	–	–
FD1P2	6.0 ± 1.7 ^b	5.4 ± 1.7 ^c	6.1 ± 1.6	5.7 ± 1.9	5.6 ± 1.6 ^b	7.3 ± 1.0 ^b	6.0 ± 1.0 ^a	7.0 ± 1.3 ^a	7.2 ± 1.0 ^a	5.9 ± 1.1 ^a	2.8 ± 1.8 ^b
FCD1P2	6.7 ± 1.3 ^a	6.2 ± 1.5 ^{ab}	6.4 ± 1.3	6.0 ± 1.5	6.3 ± 1.3 ^a	6.7 ± 0.9 ^c	4.7 ± 0.9 ^b	6.9 ± 0.8 ^a	6.4 ± 0.8 ^b	4.8 ± 1.1 ^b	4.3 ± 1.5 ^a
FCD2P2	6.7 ± 1.2 ^a	6.1 ± 1.3 ^{ab}	6.3 ± 1.3	5.8 ± 1.6	6.2 ± 1.3 ^a	–	–	–	–	–	–
FCD3P2	6.6 ± 1.3 ^a	6.0 ± 1.6 ^{ab}	6.3 ± 1.5	5.9 ± 1.5	6.2 ± 1.3 ^a	–	–	–	–	–	–

Means with the same superscript (a–c) within the same column do not differ significantly different (Duncan's test, p value < 0.05)

Drying conditions: D1: 60 °C, 40% RH; D2: 50 °C, 40% RH; D3: 80 °C/1 h + 50 °C, 40% RH

*ns: no significance

Consumer study

The consumer panel was constituted by 73.3% women, 91.7% young adults aged between 18 and 35 years old, 65.0% university students and 91.7% single. Almost all of them (96.7%) ate turmeric and mainly in fresh form (76.1%). About 25.9% ate turmeric once a week, 24.1% ate several times a month, 22.4% ate several times a week and 13.8% ate once a month and rarely. The results of the consumer acceptance showed that cooking improved colour, texture and overall liking while drying and grinding had no impact. The score of the sensory attributes was 6.2 on a 1–9 scale (Table 3). The samples that looked more like the ones they usually consumed were direct-dried samples (FD1P1: 16.3% and FD1P2: 14.0%). Surprisingly, both of them were also the most disliked (FD1P1: 27.1% and FD1P2: 23.7%). In contrast, they liked the most the samples that were cooked-dried at 60 °C and 40% RH (FCD1P2: 19.0% and FCD1P1: 14.9%) (Fig. 3a). The reasons for disliking direct-dried samples (FD1P1 and FD1P2) that appear most frequently are the perception of a strong bitterness (25.9–33.3%), strong odour (33.3–34.6%) and dark/brown colour (12.5–29.6%) (Fig. 3b). Approximately 47.5% of consumers would use this type of dried turmeric for cooking purposes (to enhance colour and odour), followed by 30.3% for health and 22.2% for cosmetics. Moreover, about 28.9% of them preferred to use this dried turmeric in soup or Khmer foods and 24.3% and 22.5% preferred to use it to prepare marinade and paste, respectively and 34.7% of them preferred to eat the turmeric at lunch and dinner (Fig. 3c). Madhusankha et al. [28] reported that once the curcuminoid contents decreased, yellowness and redness also decreased. The curcuminoid contents of our final products were not significantly different, however, the consumers detected a significant difference in colour, texture and overall liking between dried and cooked-dried samples. Heat treatment of the rhizome before dehydration can inactivate oxidative enzymes, avoid unpleasant odours and limit enzymatic browning reactions [29]. Boiling comprises the removal of boiled water after cooking so as to reduce the bitterness of some species [30]. These might be reasons why the consumers could detect higher intensity of bitter taste, odour and colour in direct-dried samples. Cooking the turmeric followed by drying at 60 °C and 40% RH (FCD1) improved the consumer's perception of taste by reducing bitterness, odour and dark colour. Based on these data, four samples (*i.e.* FD1P1, FD1P2, FCD1P1 and FCD1P2) were selected for quantitative descriptive analysis to see if trained panellists detected differences in sensory profile.

Descriptive attributes

The results of the descriptive test indicated that cooking decreased yellowness, turmeric odour and bitterness while it

Fig. 3 The appreciation of consumers on turmeric powder. **a** general appreciation, **b** reasons of dislike and **c** purposes of buy/use, ways of consuming and occasion of consumption. F: fresh; C: cooking (95 °C/3 min); D: drying (D1: 60 °C, 40% RH; D2: 50 °C, 40% RH; D3: 80 °C/1 h + 50 °C, 40% RH); P: particle size (P1: <500 µm; P2: <750 µm)

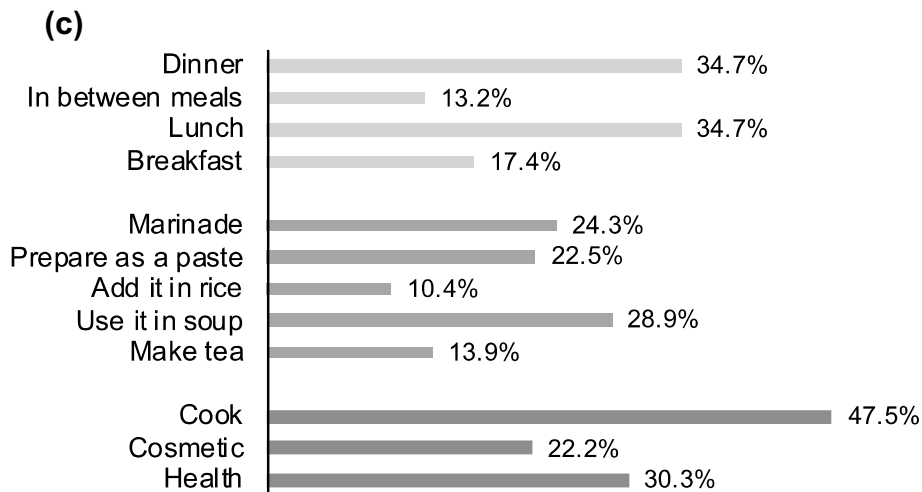
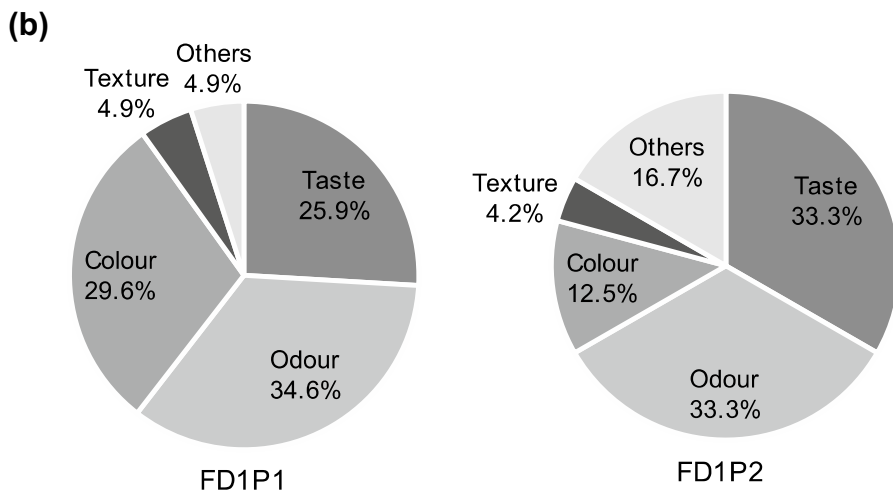
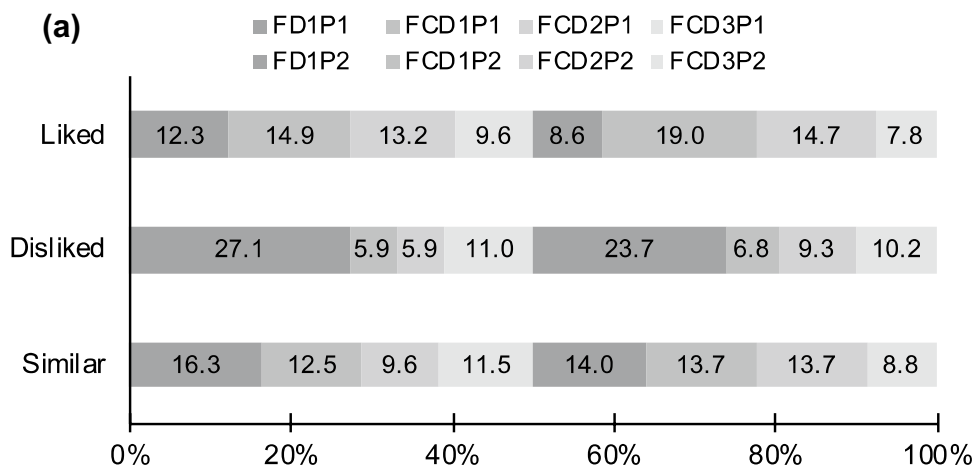

increased brightness and pungency mouthfeel; grinding had no impact on all descriptive attributes (Table 3). However, all the tested unit operations had no impact on earthy odour,

aroma (turmeric, earthy, woody, green, minty and floral) and fresh mouthfeel. From consumer acceptance and quantitative descriptive analysis, the overall quality of turmeric powder

is linked to low yellowness, turmeric odour, bitterness and high brightness and pungency mouthfeel.

Conclusion

Our findings clearly indicate that cooking saved drying time and improved overall liking with no impact on the essential oil, curcuminoid contents and their bioaccessibility. Drying decreased essential oil, curcuminoid contents and their bioaccessibility while grinding had no impact at all. Although starch was gelatinised or not, the bioaccessibility of the curcuminoids was not significantly different. The combination of the tested unit operations produced identical final products in terms of curcuminoid contents and their bioaccessibility. However, the consumers detected significant differences in colour, texture and overall liking between dried and cooked-dried samples. The overall quality of turmeric powder is correlated to low yellowness, turmeric odour, bitterness and high brightness and pungency mouthfeel. Therefore, it is necessary to process turmeric with a smooth cooking (95 °C/3 min) followed by drying at 60 °C and 40% RH (FCD1) to reduce drying time and improve consumer liking. This study shows that it is possible to master turmeric processing to preserve bioactive compounds and improve consumer acceptability. The technological conditions identified in this work allow the production of interesting turmeric powders in terms of sensorial and nutritional qualities for consumers. However, as Cambodian consumers prefer fresh turmeric, this processing could be used for export to the international market, and thus contribute to the improvement of the income of local producers and processors.

Supplementary Information The online version contains supplementary material available at <https://doi.org/10.1007/s11694-022-01683-w>.

Acknowledgements We would like to thank researchers and staff of UMR—Qualisud of CIRAD and lecturers/researchers, staff and students of Institut de Technologie du Cambodge for their participation in the sensory test.

Author contributions MY: Formal analysis; methodology; writing—original draft; writing—review and editing. MW: Funding acquisition; project administration; supervision; writing—review and editing. SA: Conceptualization; methodology; validation; writing—review and editing. IM: Formal analysis; methodology. NF-C: Formal analysis; methodology. AS: Formal analysis; methodology. SI: Project administration; supervision. PB: Conceptualization; supervision; validation; writing—review and editing.

Funding This work was supported by the French Government Scholarships Cofounded by the Ministry of Education, Youth and Sports of Cambodia, CIRAD—UMR Qualisud, Cambodia Higher Education Improvement Project (Credit No. 6221-KH), Erasmus Camfoodtech Project and Agence Universitaire de la Francophonie.

Data availability The data supporting this study's findings are available from the corresponding author upon reasonable request.

Declarations

Conflict of interest The authors declare no conflict of interest.

Ethical approval The studies involving human participants did not require approval, in line with national guidelines. The participants provided their written informed consent to take part in this study. This study does not need to be supported by IRB approval.

References

1. P.N. Ravindran, K. NirmalBabu, K. Sivaraman, *Turmeric: The Genus Curcuma*, 1st edn. (CRC Press Taylor & Francis Group, New York, 2007)
2. T. Jiang, W. Liao, C. Charcosset, *Food Res. Int.* **132**, 109035 (2020)
3. S. Calligaris, M. Alongi, P. Lucci, M. Anese, *Food Chem.* **314**, 126146 (2020)
4. J. Gómez-Estaca, R. Gavara, P. Hernández-Muñoz, *Innov. Food Sci. Emerg. Technol.* **29**, 302 (2015)
5. M.L.A. Bambirra, R.G. Junqueira, M.B.A. Glória, *Braz. Arch. Biol. Technol.* **45**, 423 (2002)
6. A. Prathapan, M. Lukhman, C. Arumugan, A. Sundaresan, K.G. Raghu, *Int. J. Food Sci. Technol.* **44**, 1438 (2009)
7. R. Pethkar, A. Ujwal, K. Siddhesh, K. Avadhoot, K. Shrikant, *Int. J. Innov. Eng. Res. Technol.* **4**, 128 (2017)
8. D. Suresh, H. Manjunatha, K. Srinivasan, *J. Food Compos. Anal.* **20**, 346 (2007)
9. International Organization for Standardization, *Turmeric, Whole or Ground (Powdered)—Specification (ISO Standard No. 5562:1983)* (1983)
10. International Organization for Standardization, *Spices, Condiments and Herbs—Determination of Volatile Oil Content (Hydrodistillation Method) (ISO Standard No. 6571:1984)* (1984)
11. D.S. Sogi, S. Sharma, D.P.S. Oberoi, I.A. Wani, *J. Food Sci. Technol.* **47**, 300 (2010)
12. S. Sepahpour, J. Selamat, M.Y.A. Manap, A. Khatib, A.F.A. Razis, *Molecules* **23**, 1 (2018)
13. M. Minekus, M. Alming, P. Alvito, S. Ballance, T. Bohn, C. Bourlieu, F. Carrière, R. Boutrou, M. Corredig, D. Dupont, C. Dufour, L. Egger, M. Golding, S. Karakaya, B. Kirkhus, S. Le Feunteun, U. Lesmes, A. Macierzanka, A. Mackie, S. Marze, D.J. McClements, O. Ménard, I. Recio, C.N. Santos, R.P. Singh, G.E. Vegarud, M.S.J. Wickham, W. Weitschies, A. Brodkorb, *Food Funct* **5**, 1113 (2014)
14. M. Yerramilli, N. Longmore, S. Ghosh, *J. Am. Oil Chem. Soc.* **95**, 1013 (2018)
15. International Organization for Standardization, *Sensory Analysis. General Guidelines for the Selection, Training and Monitoring of Selected Assessors and Expert Sensory Assessors (ISO Standard No. 8586:2012)* (2012)
16. International Organization for Standardization, *Sensory Analysis. Methodology. Guidelines for Monitoring the Performance of a Quantitative Sensory Panel (ISO Standard No. ISO 11132:2012)* (2012)
17. International Organization for Standardization, *Sensory Analysis. General Guidance for the Design of Test Rooms (ISO Standard No. 8589:2007)* (2007)
18. M. Yin, M. Weil, S. Avallone, M. Lebrun, G. Conejero, S. In, P. Bohuon, *J. Food Process. Preserv.* **46**(5), e16643 (2022)
19. S.N. Garg, R.P. Bansal, M.M. Gupta, S. Kumar, *Flavour Fragr. J.* **14**, 315 (1999)
20. S. Hirun, N. Utama-ang, P.D. Roach, *J. Food Sci. Technol.* **51**, 2127 (2014)

21. C. Monton, C. Luprasong, L. Charoenchai, J. Food Process. Preserv. **43**, 1 (2019)
22. B.H. Ararsa, *Effect of Processing Methods on Quality of Turmeric (Curcuma Longa L.) Finger Rhizome Grown in Teppi, Sheka Zone* (Haramaya University, Ethiopia, 2018)
23. E. de la Hera, M. Gomez, C.M. Rosell, Carbohydr. Polym. **98**, 421 (2013)
24. J. Osorio-Arias, S. Delgado-Arias, L. Cano, S. Zapata, M. Quintero, H. Nuñez, C. Ramírez, R. Simpson, O. Vega-Castro, Waste Biomass Valoriz. **11**, 5015 (2020)
25. S.M. Llano, A.M. Gómez, Y. Duarte-Correa, Processes **10**, 702 (2022)
26. W.-H. Lee, C.-Y. Loo, M. Bebawy, F. Luk, R. Mason, R. Rohanizadeh, Curr. Neuropharmacol. **11**, 338 (2013)
27. C. Monton, L. Charoenchai, J. Suksaeree, L. Sueree, J. Food Drug Anal. **24**, 493 (2016)
28. G. Madhusankha, R. Thilakarathna, T. Liyanage, S. Navaratne, Int. J. Food Sci. Nutr. **3**, 3 (2018)
29. E. Jayashree, T.J. Zachariah, R. Rakhi, J. Spices Aromat. Crops **27**, 138 (2018)
30. M. Faber, A. Oelofse, P. Van Jaarsveld, F. Wenhold, W. Jansen van Rensburg, S. Afr. J. Clin. Nutr. **23**, 30 (2010)

Publisher's Note Springer Nature remains neutral with regard to jurisdictional claims in published maps and institutional affiliations.

Springer Nature or its licensor (e.g. a society or other partner) holds exclusive rights to this article under a publishing agreement with the author(s) or other rightsholder(s); author self-archiving of the accepted manuscript version of this article is solely governed by the terms of such publishing agreement and applicable law.

Evolution of colour and curcuminoids during the turmeric processing

Molika Yin^{a,c*}, Mathieu Weil^{a,b}, Sylvie Avallone^a, Sokneang In^c, Philippe Bohuon^a

^aQualisud, Univ Montpellier, CIRAD, Institut Agro, Avignon Université, Univ de La Réunion, Montpellier, France

^bCIRAD, UMR Qualisud, F-34398 Montpellier, France

^cInstitut de Technologie du Cambodge, Food Technology and Nutrition Research Unit, Phnom Penh, Cambodia

*CONTACT: yinmolika@gmail.com

Introduction



Curcuma longa L.

- Classification: Zingiberaceae family
- Region: tropical and subtropical [1]
- Asian traditional process: whole rhizomes are cooked long time (60 min) at high temperature
- Our study: we applied short cooking time (3 min) to sliced rhizomes before drying them at 60°C

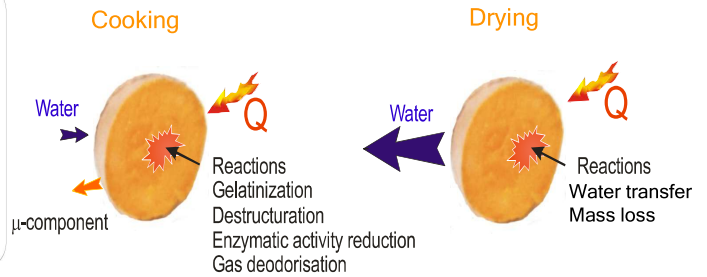

Objective

To assess the impact of cooking and drying on colour (L^* , a^* , b^* and C^*) and curcuminoids of turmeric

Materials and Methods

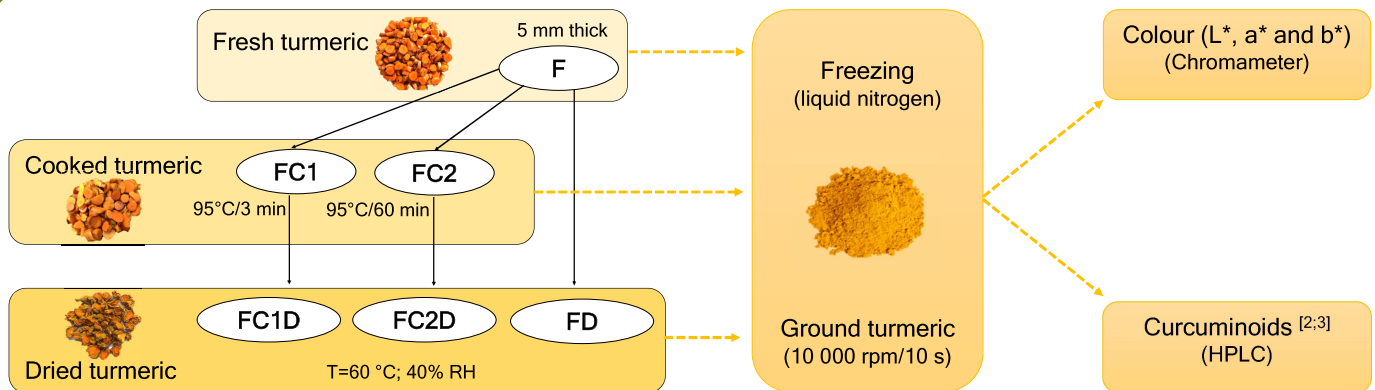

Results

Impact of processes on colour values (L^* , a^* , b^* and C^*)

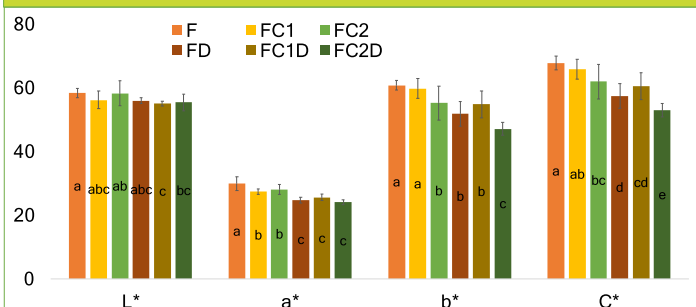

- Drastic cooking (95°C/60 min) and drying operations decreased b^* and C^* colour values more than smooth cooking (95°C/3 min).

Impact of processes on curcuminoid content (g/100g db)

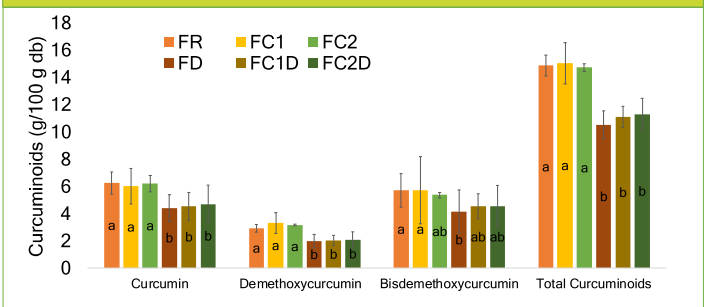

- Cooking (either smooth or drastic) had no impact on curcuminoids content.
- Drying significantly decreased curcuminoids content (between 27.9 - 48.2%).

Conclusions

- Cooking turmeric before drying saved 47% to 66% of the drying time (data not shown).
- Cooking sliced turmeric at 95°C/3 min is the optimum cooking condition because it is a good compromise between drying time and the quality of turmeric in term of colour values and curcuminoids content. It is also less energy consuming than cooking at 95°C/60 min.

References

- Kutti Gounder, D., & Lingamallu, J. (2012). Comparison of chemical composition and antioxidant potential of volatile oil from fresh, dried and cured turmeric (*Curcuma longa*) rhizomes. *Industrial Crops and Products*, 38(1), 124-131.
- Sogi, D. S., Sharma, S., Oberoi, D. P. S., & Wani, I. A. (2010). Effect of extraction parameters on curcumin yield from turmeric. *Journal of Food Science and Technology*, 47(3), 300-304.
- Sepahpour, S., Selamat, J., Manap, M. Y. A., Khatib, A., & Razis, A. F. A. (2018). Comparative analysis of chemical composition, antioxidant activity and quantitative characterization of some phenolic compounds in selected herbs and spices in different solvent extraction systems. *Molecules*, 23(2), 1-17.

October 2021

Étude des procédés de transformation du curcuma (*Curcuma longa* L.) au Cambodge - impact sur la qualité sensorielle et fonctionnelle

RESUME : L'objectif de cette thèse était de décrire les traitements post-récolte du curcuma (*Curcuma longa* L.) mis en œuvre au Cambodge et de comprendre l'impact des opérations unitaires (cuisson, séchage et broyage) sur la qualité sensorielle et fonctionnelle du curcuma. L'étude de terrain menée au Cambodge a révélé que les principales différences entre les trois processus, correspondant à trois zones différentes au Cambodge, étaient : (i) cuisson avant séchage (étude de cas 1 : Siem Reap) ; (ii) tranchage avant séchage (étude de cas 2 : Phnom Penh) ; (iii) cuisson et tranchage avant séchage (étude de cas 3 : Kampot). Parmi ceux-ci, le procédé de Kampot correspond au temps de séchage le plus court tout en présentant le rendement le plus élevé (16,2 %), avec une teneur en eau finale d'environ 6 %, conformément à la norme ISO 5562 :1983. L'épluchage n'a eu aucun impact sur la teneur en curcuminoïdes et leur bioaccessibilité mais a eu l'effet d'augmenter la teneur en huile essentielle (dans les doigts de rhizomes uniquement). Les opérations unitaires testées en conditions maîtrisées ont montré que la cuisson n'a aucun impact sur la teneur en huile essentielle, la teneur en curcuminoïdes et leur bioaccessibilité mais modifie légèrement le profil aromatique de l'huile essentielle. Le séchage a diminué la teneur en huiles essentielles (-22,5 %), la teneur en curcuminoïdes (-11,0 %) et leur bioaccessibilité (-28,6 %). En contradiction avec la littérature concernant la bioaccessibilité des curcuminoïdes, la taille des particules (entre 63 et 711 µm) après broyage, n'a eu aucun impact sur leur bioaccessibilité. La bioaccessibilité des curcuminoïdes variait de 9,1 à 12,7 % et l'état de l'amidon (natif ou gélatinisé) n'a eu aucun impact sur la bioaccessibilité. La combinaison des opérations unitaires testées a engendré des produits finaux de même qualité en termes de teneur totale en curcuminoïdes (valeur moyenne : 12,1 g/100 g db) et en curcuminoïdes bioaccessibles (valeur moyenne : 1,0 g/100 g db). Cependant, les tests consommateurs ont mis en évidence des différences de couleur, de texture et d'appréciation générale entre les poudres de curcuma transformées (séchées et cuites-séchées). Les résultats révèlent qu'une cuisson (95 °C/3 min) suivie d'un séchage (60 °C, 40 % RH) est le procédé le plus approprié pour produire une poudre riche en curcuminoïdes et améliorer l'acceptabilité par le consommateur.

Study of turmeric (*Curcuma longa* L.) processes in Cambodia - impact on sensorial and functional quality

ABSTRACT: The objective of this thesis was to describe postharvest treatments of turmeric (*Curcuma longa* L.) in Cambodia and their impact on quality and to study, under controlled conditions, the impact of the combination of unit operations (cooking, drying and grinding) on the quality of turmeric. The field study revealed that the main difference(s) among the three different processes, corresponding to three different areas in Cambodia, were: (i) cooking before drying (case study 1: Siem Reap); (ii) slicing before drying (case study 2: Phnom Penh); (iii) cooking and slicing before drying (case study 3: Kampot). Among these, the process in Kampot had the shortest drying time and got the highest yield (16.2 %), with a final water content of about 6 %, conforming with the specifications of the ISO standard 5562:1983. Peeling had no impact on curcuminoid contents and their bioaccessibility but it increased the essential oil content (in finger rhizomes only). The unit operations tested under controlled conditions revealed that cooking had no impact on essential oil content, curcuminoid contents and their bioaccessibility but slightly modified aromatic profile of essential oil. Drying decreased essential oil content (- 22.5 %), curcuminoid contents (- 11.0 %) and their bioaccessibility (- 28.6 %). In contradiction with literature concerning curcuminoids bioaccessibility, particle sizes (between 63 and 711 µm) after grinding, had no impact on their bioaccessibility. Curcuminoids bioaccessibility ranged from 9.1 to 12.7 % and the state of starch (native or gelatinized) had no impact on bioaccessibility. The combination of the tested unit operations produced final products with the same quality in terms of total curcuminoid contents (mean value: 12.1 g/100 g db) and bioaccessible curcuminoids (mean value: 1.0 g/100 g db). However, consumers detected differences in colour, texture and overall liking between processed turmeric powders (dried and cooked-dried). The results revealed that cooking (95 °C/3 min) followed by drying (60 °C, 40 % RH) is the most suitable process to produce a curcuminoid-rich powder and improve consumer acceptance.

DISCIPLINE : Sciences des aliments et nutrition

MOTS CLES : bioaccessibilité, composés aromatiques, cuisson, séchage, traitements post-récolte

INTITULE ET ADRESSE DU LABORATOIRE

CIRAD UMR QualiSud : TA B95/16 – 73 rue Jean-François Breton 34398 Montpellier Cedex 5

Food Technology and Nutrition Unit: PO Box 86, Russian Conference Boulevard, Phnom Penh, Cambodia
