



HAL
open science

Improving and optimizing the performance of the supply chain : The case of coffee production in Vietnam

Thi Thuy Hanh Nguyen

► **To cite this version:**

Thi Thuy Hanh Nguyen. Improving and optimizing the performance of the supply chain : The case of coffee production in Vietnam. Business administration. Université Polytechnique Hauts-de-France, 2023. English. NNT : 2023UPHF0008 . tel-04265675

HAL Id: tel-04265675

<https://theses.hal.science/tel-04265675>

Submitted on 31 Oct 2023

HAL is a multi-disciplinary open access archive for the deposit and dissemination of scientific research documents, whether they are published or not. The documents may come from teaching and research institutions in France or abroad, or from public or private research centers.

L'archive ouverte pluridisciplinaire **HAL**, est destinée au dépôt et à la diffusion de documents scientifiques de niveau recherche, publiés ou non, émanant des établissements d'enseignement et de recherche français ou étrangers, des laboratoires publics ou privés.

PhD Thesis

Submitted for the degree of Doctor of Philosophy from

UNIVERSITÉ POLYTECHNIQUE HAUTS-DE-FRANCE

And INSA HAUTS-DE-FRANCE

Subject:

Computer Science and Applications

Presented and defended by Thi Thuy Hanh NGUYEN.

On 23/01/2023, Valenciennes, France.

Doctoral school:

Doctoral School Polytechnique Hauts-de-France (ED PHF n°635)

Research unit:

Laboratory of Industrial and Human Automation control Mechanical engineering and Computer science (LAMIH – UMR CNRS 8201)

Research Laboratory Societies & Humanities (LARSH)

**Improving and optimizing the performance of the supply chain- The case of
coffee production in Vietnam**

JURY

President of jury

BERTELLE, Cyrille. Professor at University of Le Havre.

Reviewers

- ALLAOUI, Hamid. Professor at Artois University, France.

- SAHNOUN, M'hammed, HDR- Researcher lecturer in the LINEACT laboratory of the CESI Group, France.

Examiners

- NOUIRI, Maroua. Associate Professor at IUT de Nantes, France.

- BOUKADI, Khoulood. Associate Professor at MCF Université de Sfax Tunisie, Tunisia.

Thesis director

ABED, Mourad. Professor at Polytechnic University of Hauts-De-France, France.

Co-supervisor:

- BEKRAR, Abdelghani. Associate Professor at Polytechnic University of Hauts-De-France, France.

- LE, Thi Muoi. Associate Professor at Polytechnic University of Hauts-De-France, France.

Thèse de doctorat
Pour obtenir le grade de Docteur de
l'UNIVERSITÉ POLYTECHNIQUE HAUTS-DE-FRANCE
et de l'INSA HAUTS-DE-FRANCE

Discipline, spécialité selon la liste des spécialités pour lesquelles l'École Doctorale est accréditée :

Informatique et Applications

Présentée et soutenue par Thi Thuy Hanh NGUYEN.

Le 23/01/2023, à Valenciennes, France.

École doctorale:

École Doctorale Polytechnique Hauts-de-France (ED PHF n°635)

Unité de recherche :

Laboratoire d'Automatique, de Mécanique et d'Informatique Industrielles et Humaines (LAMIH – UMR CNRS 8201)

Laboratoire de Recherche Sociétés & Humanités (LARSH)

Améliorer et optimiser les performances de la chaîne logistique-Le cas de la production de café au Vietnam

JURY

Président du jury

BERTELLE, Cyrille. Professeur à Université Le Havre.

Rapporteurs

- ALLAOUI, Hamid. Professeur des Universités chez Université d'Artois, France.

- SAHNOUN, M'hammed, HDR au laboratoire LINEACT du Groupe CESI, France.

Examineurs

- NOURI, Maroua. Maître de conférences à IUT de Nantes, France.

- BOUKADI, Khoulood. Maître de conférences à MCF Université de Sfax Tunisie, Tunisie.

Directeur de thèse

ABED, Mourad. Professeur à l'Université Polytechnique Hauts-De-France, France.

Co-encadrant

- BEKRAR, Abdelghani. Maître de conférences à l'Université Polytechnique Hauts-De-France, France.

- LE, Thi Muoi. Maître de conférences à l'Université Polytechnique Hauts-De-France, France.

ACKNOWLEDGEMENT

I would like to express my gratitude to all the people who have contributed to my thesis's realization.

Firstly, I would like to express my sincere gratitude to my advisor Prof. Mourad Abed, for his continuing support of my Ph.D. studies and related work, as well as his patience, encouragement, and vast expertise. I would like to thank you for giving me an excellent opportunity to learn how to do advanced research professionally and respect research ethics.

I would like to thank Dr. Abdelghani Bekrar and Dr. Thi-Muoi Le for being my co-advisors. I'd like to express my gratitude for the many hours of meetings and the advice and guidance that assisted me in finishing this work. This research would not be accomplished without your valuable assistance. Dr. Abdelghani BEKRAR is intelligent, knowledgeable, and warm-hearted. He was always by my side when I encountered troubles and encouraged me to advance and be a better researcher. He teaches me how to choose a suitable topic, conduct research, write an article, and even make a submission. Dr. Thi Muoi Le is diligent and has innovative thinking and a solid management background. She always invested so much effort in helping me with my work. I also want to thank you for your guidance and encouragement, which helped me overcome the Ph.D. challenges.

Besides my advisor and co-advisors, I would like to thank my thesis committees: Prof. Cyrille Bertelle, Prof. Hamid Allaoui, Prof. M'hammed Sahnoun, Dr. Maroua Nouiri, and Dr. Khouloud Boukadi, for their insightful comments and feedback, but also for the interesting question which incited me to widen my research from various perspectives.

I would like to thank the professors who taught me so many valuable courses. I wish to express my appreciation to the current and former members of the LAMIH team. I want to give special thanks to my Ph.D. colleagues, Dr. Anirut Kantasa-ard, Dr. Tarik Chargui, Dr. Ahmed Snoun, Dr. Afaf Aloullal, Dr. Miratul Mufida for all their kind support and valuable suggestions during this journey. Thank you to all of my Ph.D. friends for all the fun we have had in the last three years. Thank you for always being my friend and assisting me during difficult times and situations.

I would like to thank Campus France for the financial support that made this doctoral research possible. I would like to thank The University of Danang for allowing me to pursue my Ph.D. in France.

Last but not least, I would like to express my gratitude to my parents and family for always being by my side, supporting, encouraging, and motivating me to complete my Ph.D. studies. I want to thank my sweetest child, Vo Thanh Phuc, for being the best gift in my life, who motivated and heartened me to overcome all obstacles. It was significant for me during the doctoral journey.

REMERCIEMENTS

Je tiens à exprimer ma gratitude à toutes les personnes qui ont contribué à ce réalisation de la thèse.

Tout d'abord, je tiens à exprimer ma sincère gratitude à mon directeur, le professeur Mourad Abed, pour le soutien continu de mon doctorat études et travaux connexes, ainsi que sa patience, ses encouragements et sa vaste expertise. Je tiens à vous remercier de m'avoir donné une excellente occasion d'apprendre comment faire de la recherche avancée de façon professionnelle et dans le respect de l'éthique de la recherche. Ses conseils m'ont aidé tout au long de la recherche et de la rédaction de cette thèse.

Je tiens à remercier le Dr Abdelghani Bekrar et le Dr Thi-Muoi Le d'être mes co-conseillers. Je tiens à vous remercier infiniment pour les nombreuses heures de rencontres, ainsi que pour plusieurs conseils et orientations qui m'ont aidé à mener à bien ce travail. Cette recherche ne serait pas accomplie sans votre aide précieuse. Le Dr Abdelghani BEKRAR est intelligent, compétent et chaleureux. Il était toujours à mes côtés lorsque je rencontrais des problèmes et m'encourageait à avancer et à être un meilleur chercheur. Il m'apprend à choisir un sujet approprié, à mener des recherches, à écrire un article et même à faire une soumission. La Dr Thi Muoi Le est diligent et a une pensée novatrice et une expérience en gestion. Elle a toujours investi tant d'efforts pour m'aider dans mon travail. Je tiens également à vous remercier pour vos conseils et vos encouragements qui m'ont aidé à surmonter le doctorat défis.

En plus de mon directeur et co-directeur, je tiens à remercier le reste de mon comité de thèse : Prof. Cyrille Bertelle, Prof. Hamid Allaoui, Prof. M'hammed Sahnoun, Dr. Maroua Nouiri, and Dr Khoulood Boukadi, pour leurs commentaires et réactions perspicaces, mais aussi pour la question intéressante qui m'a incité à élargir mes recherches à partir de diverses perspectives.

Je tiens à remercier tous les professeurs qui m'ont enseigné tant de cours précieux. Je tiens à exprimer ma gratitude aux membres actuels et anciens de l'équipe LAMIH. Je tiens à remercier tout particulièrement mes collègues doctorants, le Dr Anirut Kantasa-ard, le Dr Tarik Chargui, le Dr Ahmed Snoun, le Dr Afaf Aloullal, le Dr Miratul Mufida pour leur aimable soutien et leurs précieuses suggestions au cours de ce voyage. Merci à tous mes doctorants. amis pour tout le plaisir que nous avons eu au cours des trois dernières années. Merci d'être toujours mes amis et de m'aider dans les moments et les situations difficiles.

Je tiens à remercier Campus France pour le soutien financier qui a rendu possible cette recherche doctorale. Je tiens à remercier l'Université de Danang de m'avoir permis de poursuivre mon doctorat en France.

Enfin, je tiens à exprimer ma gratitude à mes parents et à ma famille pour avoir toujours été à mes côtés, me soutenant, m'encourageant et me motivant à terminer mon doctorat. études. Je voudrais remercier mon enfant le plus adorable, Vo Thanh Phuc, pour avoir été le plus beau cadeau de ma vie, qui m'a motivé et encouragé à surmonter tous les obstacles. Cela a été important pour moi pendant le parcours doctoral.

ABSTRACT

Improving and optimizing the performance of the supply chain- The case of coffee production in Vietnam

Customer demand variability is one of the most severe issues that lead to an imbalance between demand and supply. Therefore, demand forecasting is crucial in supply chain management because it predicts future customer demand, eliminates uncertainty and stabilizes the supply chain. This thesis develops a novel hybrid intelligent model for demand forecast using hybrid algorithms. The coffee supply chain in Vietnam is studied as a case study. Coffee is a globally essential agricultural commodity that considerably influences the national economies of many countries. This thesis focuses on two parts: supply chain performance and demand forecasting.

In the first part, this thesis models and evaluates the coffee supply chain using the latest version of SCOR (Version 12). The score of coffee supply chain performance is average. Plan process has the highest performance scores. Demand management is a critical process in supply chain management that enables businesses to reach their consumers' demands and balance supply and demand. Therefore, improving demand planning and forecasting is the most critical solution for achieving effective demand and supply chain management.

Hence, in the second part of this thesis, we focus on two main aspects: demand planning and forecasting. Firstly, this section introduces and evaluates the demand planning process, including five main elements of goal formulation, forecasting techniques, information sources, forecasting and decision-making, and synchronizing supply with demand. Demand planning as a higher-order construct relates strongly to cost and delivery performance. Besides, among the elements, demand forecasting has the most significant impact on the demand planning process. Secondly, this thesis proposed a new ARIMAX-LSTM hybrid forecasting model that integrates the advantages of two well-known models, Autoregressive Integrated Moving Average with Exogenous factor (ARIMAX) and Long Short-Term Memory (LSTM) models. Our proposed model was validated in a case study of coffee demand in Vietnam. Besides, to prove the method's robustness, we tested our proposed model on the same data from previous authors for Thailand's agricultural products (pineapple, corn, and cassava). Computational results demonstrated that our hybrid model is superior in most experiments. Moreover, the suggested hybrid model also enhances supply chain performance as evaluated by operational and

financial metrics. Additionally, it enhances the performance of sustainable supply chains by improving environmental metrics. Lastly, it offers accurate sales forecasting because the difference between predicted and actual sales is slight.

As a result, our proposed approach is simple and easy to implement, which makes the technique more appealing to practitioners. The proposal forecasting model will assist supply chain managers in anticipating demand, planning better, minimizing inventory, making better use of their suppliers, and increasing the overall supply chain's efficiency. Furthermore, this thesis provides some practical insights into supply chain performance evaluation, the design of demand planning, the implementation of demand forecasting, and issues that organizations may face.

Keywords: Performance management, Supply chain, Optimization, Demand forecasting, Hybrid method, Deep learning, Vietnam.

RÉSUMÉ

Améliorer et optimiser les performances de la chaîne logistique- Le cas de la production de café au Vietnam.

La variabilité de la demande des clients est l'un des problèmes les plus pertinents qui entraînent un déséquilibre entre la demande et l'offre. Par conséquent, la prévision de la demande est essentielle dans la gestion de la chaîne logistique, car elle prédit la demande future des clients, éliminera l'incertitude et stabilisera la chaîne logistique. Cette thèse développe un nouveau modèle intelligent et hybride pour la prévision de la demande à l'aide d'algorithmes hybrides. La chaîne logistique du café au Vietnam fait l'objet d'une étude de cas. Le café est un produit agricole mondial essentiel qui a un impact significatif sur les économies nationales de plusieurs pays. Ce mémoire est divisé en deux parties: la performance de la chaîne logistique et la prévision de la demande.

Dans une première partie, cette thèse modélise et évalue la chaîne logistique du café en utilisant la dernière version de SCOR (Version 12). Le score total de la performance de la chaîne logistique est moyen. Le processus de plan a les scores de performance les plus élevés parmi les processus. La gestion de la demande est un processus clé dans la gestion de la chaîne logistique qui permet aux entreprises de répondre aux demandes de leurs consommateurs et d'équilibrer l'offre et la demande. Par conséquent, l'amélioration du processus de planification de la demande et prévision de la demande est considérée comme la solution la plus importante pour parvenir à une gestion efficace de la demande et de la chaîne logistique.

Ainsi, dans la seconde partie de ce mémoire, nous nous concentrons sur deux aspects majeurs: la planification de la demande et la prévision de la demande. Premièrement, cette section présente et évalue le processus de planification de la demande, y compris cinq aspects principaux de la formulation des objectifs, les techniques de prévision, la source d'information, la prévision et la prise de décision, et la synchronisation de l'offre avec la demande. Nous constatons que la planification de la demande en tant que construction d'ordre supérieur est étroitement liée aux coûts et aux performances de livraison. Par ailleurs, c'est la prévision de la demande qui influence le plus le processus de planification de la demande parmi les entreprises. Deuxièmement, cette thèse propose un nouveau modèle de prévision hybride ARIMAX-LSTM qui intègre les avantages de deux modèles bien connus, les modèles Autoregressive Integrated Moving Average with Exogenous factor (ARIMAX) et Long Short-Term Memory (LSTM). Le modèle a été validé lors d'une étude de cas de café au Vietnam. De

plus, nous avons testé notre modèle proposé sur les mêmes données des auteurs précédents pour les produits agricoles thaïlandais (ananas, maïs et manioc). Les résultats indiquent que notre modèle hybride est supérieur dans la plupart des expériences. De plus, le modèle hybride proposé améliore le rendement de la chaîne logistique mesuré au moyen de mesures opérationnelles et financières. Il favorise aussi le rendement durable de la chaîne logistique en améliorant les mesures environnementales. En outre, cela aide à fournir des prévisions de ventes exactes, car la différence entre les prévisions et les ventes réelles est très faible.

Par conséquent, notre approche proposée est simple et facile à mettre en œuvre, ce qui rend la technique plus attrayante pour les praticiens. Le modèle de prévision des propositions aidera les responsables de la chaîne logistique à anticiper la demande, à mieux la planifier, à minimiser les stocks, à mieux utiliser leurs fournisseurs et à accroître l'efficacité globale de la chaîne logistique. En outre, cette thèse fournit des informations pratiques sur l'évaluation des performances de la chaîne logistique, la conception de la planification de la demande, la mise en œuvre de la prévision de la demande ainsi que les problèmes auxquels les organisations peuvent être confrontées.

Mots clés: Gestion de la performance, Chaîne logistique, Optimisation, Prévision de la demande, Méthode hybride, Deep learning, Vietnam.

CONTENTS

ACKNOWLEDGEMENT	3
REMERCIEMENTS	4
ABSTRACT	5
RÉSUMÉ	7
LIST OF TABLES	12
LIST OF FIGURES	13
LIST OF ABBREVIATIONS	14
INTRODUCTION	15
1.1 Background	15
1.2 Research questions	17
1.3 Thesis contribution	17
1.4 Thesis structure	18
CHAPTER 1: GENERAL CONTEXT IN COFFEE SUPPLY CHAIN	23
1.1 Introduction	23
1.2 Background and problems in the coffee supply chain management	23
1.3 Supply chain performance evaluation	27
1.4 The relationship between demand planning and demand forecasting in the supply chain management	29
1.4.1 Demand planning process	30
1.4.2 Demand forecasting	32
1.5 The relationship between demand forecasting and supply chain performance	34
1.5.1 The relationship between demand planning and supply chain performance	34
1.5.2 The relationship between demand forecasting and supply chain performance	35
1.6 Summary	36
CHAPTER 2: LITERATURE REVIEW	37
2.1 Introduction	37
2.2 Overview of the SCOR model	37
2.2.1 SCOR model version 12.0	37
2.2.2 SCOR model-related research	40
2.2.3 Steps of performance measurement	41
2.3 Demand forecasting in the supply chain	43
2.3.1 Demand planning process	43
2.3.1.1 Demand planning practices	43
2.3.1.2 The effect of demand planning practices on supply chain performance	45
2.3.2 Evolution of the forecasting models	46
2.3.2.1 Utilized models	52
2.3.2.2 Existing hybrid models	55
2.3.2.3 Performance metrics	57
2.4 Literature discussion and gaps	60
2.4.1 Supply chain modeling and performance measurement	60
2.4.2 Demand planning and demand forecasting	60
2.5 Summary	61
CHAPTER 3: CONTRIBUTION OF DEMAND FORECASTING IN THE SUPPLY CHAIN	63
3.1 Introduction	63
3.2 Demand planning in the supply chain	63
3.2.1 Demand planning problems	63

3.2.2 Proposed demand planning approach	64
3.2.2.1 Demand planning process as a higher-order construct	64
3.2.2.2 The effect of demand planning process as high-order construct on supply chain performance	65
3.2.3 The implementation of the demand planning approach	66
3.3 Demand forecasting in the supply chain	70
3.3.1 Demand forecasting problems in the supply chain.....	70
3.3.2 Proposed hybrid demand forecasting model	71
3.3.3 The implementation of the forecasting model.....	73
3.3.3.1 Data gathering.....	75
3.3.3.2 Data pre-processing	75
3.3.3.3 Tuning hyperparameters	76
3.3.3.4 Implementing the forecasting models and computing the forecast	77
3.3.3.5 Calculating final hybrid forecast values and evaluating the model	77
3.3.3.6 Finding the best model	78
3.3.4 The impact of the proposed model on supply chain performance.....	78
3.3.4.1 Performance metrics	78
3.3.4.2 The impact of the proposed model on supply chain performance	83
3.4 Summary	83
CHAPTER 4: CASE STUDY, RESULT ANALYSIS, AND MANAGERIAL INSIGHTS ..	85
4.1 Introduction	85
4.2 Overview of the case study	85
4.3 Modeling and measuring the coffee supply chain.....	86
4.3.1 Experiment data.....	86
4.3.2. Descriptive statistics	87
4.3.2.1 Farmers	87
4.3.2.2 Traders	88
4.3.2.3 Coffee companies	89
4.3.3 Modeling the coffee supply chain	90
4.3.3.1 SCOR level 1 modeling.....	90
4.3.3.2 SCOR level 2 modeling.....	91
4.3.3.3 SCOR level 3 modeling.....	92
4.3.4 Performance measurement of the coffee supply chain.....	96
4.3.5 Managerial insight discussion on the coffee supply chain	98
4.4. Demand forecasting.....	99
4.4.1. Implementation of the demand planning process to improve the coffee supply chain performance	99
4.4.1.1 Experiment data.....	99
4.4.1.2 Measurement model	101
4.4.1.3 The demand planning process in the Vietnamese coffee industry.....	105
4.4.1.4 Influence of the demand planning process as a higher-order construct on operational performance	106
4.4.1.5 The effect of individual demand planning practices on performance	109
4.4.1.6 Managing a Portfolio of Demand Planning Practices	111
4.4.1.7. Challenges and Potential Concerns for Demand Planning Practices Management.....	113
4.4.2 Implementation of a proposed hybrid model for forecasting demand.....	114
4.4.2.1 Data description	114
4.4.2.2 Evaluation of the forecasting model performance	115
4.4.2.3 Supply chain performance evolution.....	122
4.4.2.4 Managerial insights.....	131

4.5 Summary	134
CHAPTER 5: CONCLUSION AND FUTURE PERSPECTIVES	136
5.1. Conclusion.....	136
5.2 Future perspectives.....	138
5.2.1 Short-term perspectives	138
5.2.2 Long-term perspectives	139
REFERENCES	142
APPENDIX.....	156
QUESTIONNAIRE	156
Part A- Modeling and measuring the performance of the coffee supply chain.....	156
Farmers.....	156
Traders.....	159
Companies.....	162
Part B- Demand planning.....	166
Coffee Companies	166

LIST OF TABLES

Table 1: World Supply/Demand Balance (International Coffee Organization, 2021)	26
Table 2: Coffee production and consumption in Vietnam (International Coffee Organization, 2021)	26
Table 3: SCOR performance attribute (American Production and Inventory Control Society, 2017).	39
Table 4 : Fundamental scale of saaty (Leal, 2020)	42
Table 5: Performance indicator (Kusrini et al., 2019)	42
Table 6: Demand planning practices and supply chain performance	46
Table 7: A Literature review	50
Table 8: Constructs, items, and sources	68
Table 9: Stated values for each hyperparameter	77
Table 10: Descriptive statistics about farmers	87
Table 11: Descriptive statistics about the traders	88
Table 12: Company size.....	89
Table 13: Sales.....	89
Table 14: Job title.....	89
Table 15: Year stayed at the organization.....	90
Table 16: Notations of the SCOR level 3 modeling (American Production and Inventory Control Society, 2017).....	95
Table 17: Metrics normalization	97
Table 18: Final score based on a process approach	97
Table 19: Final score based on a performance approach	98
Table 20: Sample characteristics	101
Table 21: Descriptive statistics of the forecasting activity	101
Table 22: Measurement model results	103
Table 23: Discriminant validity	105
Table 24: The effect of individual demand planning practices on operational performance	110
Table 25: The regression results	111
Table 26: Descriptive statistics of daily coffee demand	114
Table 27: ADF test results	115
Table 28: Optimal hyperparameters results for LSTM model in hybrid models.....	116
Table 29: Comparison performance of forecasting hybrid models and others for future demand of coffee	118
Table 30: Examples of actual and forecast daily coffee demand with several forecasting models	118
Table 31. Performance of models in forecasting demand for agricultural products.....	122
Table 32: The BWE of forecasting models.....	123
Table 33: BWE of forecasting models for the year 2020 (L=3).....	124
Table 34: The NSamp of forecasting models	124
Table 35: NSamp of forecasting models for the year 2020 (L=3).....	125
Table 36: Some examples of transportation costs (TC) values of hybrid, LSTM, and ARIMAX in 2020	126
Table 37: Inventory turn (IT) values generated by forecasting models in 2020 (L=3)	128
Table 38: Regression coefficient	128
Table 39. Environment performance based on different forecasting techniques.....	129
Table 40: Some examples of actual sales and predicted sales using our hybrid and LSTM model	130

LIST OF FIGURES

Figure 1: Thesis’s structure.....	19
Figure 2: Supply chain management model (Mentzer et al., 2001).....	24
Figure 3: Coffee value chain (Botero Lopez & Salman Chaudhry, 2020)	25
Figure 4: Coffee balance in Vietnam	26
Figure 5: The relationship between demand planning and demand forecasting in supply chain management (Croxtton et al., 2002).....	29
Figure 6: Evolution of demand management (Crum & Palmatier, 2003).....	31
Figure 7: Main forecasting methods (Kilimci et al., 2019).....	33
Figure 8: Main processes of SCOR Model version 12.0 (American Production and Inventory Control Society, 2017).....	38
Figure 9: SCOR process hierarchy (American Production and Inventory Control Society, 2017)	39
Figure 10: Steps in measuring performance	41
Figure 11: The demand planning process and its primary practices.....	44
Figure 12: The LSTM framework (Abbasimehr et al., 2020).....	54
Figure 13: Sustainability (Carter and Rogers 2008)	59
Figure 14: The theoretical model under investigation	66
Figure 15: Proposed ARIMAX-LSTM hybrid forecast model.....	72
Figure 16: The proposed framework for demand forecasting.	74
Figure 17: Hyper-parameter tuning process (Yadav et al., 2020).....	77
Figure 18: Bullwhip Effect in a supply chain (Aburto and Weber, 2007).....	79
Figure 20: Education level of farmers	87
Figure 21: Education level of traders.....	88
Figure 22: SCOR level 1 modeling (based on SCOR version 12, 2017).....	91
Figure 23: SCOR level 2 modeling (based on SCOR version 12, 2017).....	92
Figure 24: SCOR level 3 modeling (based on the SCOR version 12, 2017).....	94
Figure 25: Reflective-formative research model demonstrating the influence of demand planning in improving operational performance.....	108
Figure 26: Coffee daily demand in Vietnam from 2000 to 2020.....	114
Figure 27: Forecasting coffee demand using LSTM and ARIMAX models.....	117
Figure 28: ARIMA-LSTM hybrid models.....	120
Figure 29: The effect of lead time on the BWE measure	123
Figure 30: The effect of lead time on the NSamp measure	125
Figure 31: Transportation costs (TC) value generated from hybrid, LSTM and ARIMAX models.....	126
Figure 32: Monthly IT value with L=1 and L=3	127

LIST OF ABBREVIATIONS

ADF	Augmented-Dickey Fuller test
APICS	American Production and Inventory Control Society
ARIMA	Auto-regressive Integrated Moving Average
ANN	Artificial Neural Network
ARIMAX	Auto-regressive Integrated Moving Average with Exogeneous factor
BWE	Bullwhip Effect
C&S	Communication of the demand predictions and Synchronization of supply with demand
CF	Carbon Footprint
DL	Deep Learning
DF	Demand Forecasting
DPP	Demand Planning Process
FI	Forecasting Techniques
GF	Goal Formulation
ICO	International Coffee Organization
IT	Inventory Turn
LSTM	Long Short-Term Memory
ML	Machine Learning
MAE	Mean Absolute Error
MAPE	Mean Absolute Percentage Error
NSAmp	Net stock amplification
PLS-SEM	Partial Least Squares Structural Equation Modeling
RF	Role of Forecasting in making a decision
RMSE	Root Mean Squared Error
SC	Supply Chain
SCC	Supply Chain Council
SCM	Supply Chain Management
SCOR	Supply Chain Operations Reference
SCP	Supply Chain Performance
SI	Source of Information
TC	Transportation Cost
WF	Water Footprint

INTRODUCTION

1.1 Background

In this era, globalization, rapid trade growth, and many participants make supply chains more complex, thus, difficult to control and manage. Additionally, with rapid technological change and fierce supply chain competition, today's market is volatile. Organizations that want to compete and survive must develop and improve abilities such as responding quickly to market changes, meeting better customer needs, effectively using resources, and performing better and faster than competitors. One of the critical tools for assisting and developing these abilities for organizations and effective logistics and supply chain management is Information Technology (IT). Indeed, IT offers various advantages to organizations, such as practical information management, good customer service, effective inventory management, smart manufacturing, and forecasting. Thanks to technological advancements (for example, big data and machine learning), organizations can now process large amounts of data much faster and analyze the data in practical ways to support data-driven decision-making. Forecasting is thus one of the most valuable contributions of IT to supply chain management. Managers can obtain more accurate forecasting (for example, demand, sales, and price) to understand customer trends better and develop more proper strategic and operational plans.

Moreover, competition has already become the competition among supply chains. To better meet customer expectations, supply chains are becoming more global. As sophisticated production, logistics, transportation, and communication networks, global supply chains are complex, diverse, and vulnerable. Consequently, disruptions and volatility affect specific and global supply chains ranging from technological to agricultural. Supply chain disruptions harm the performance of each participant and the entire global supply chain. The global economy will be suffered. For example, lower rural income means less consumption of industrial goods. They cannot make infrastructure investments or purchase new electronics or clothing. With better accuracy in demand prediction, manufacturers may minimize overproduction induced by uncertainty and enhance their production planning. Also, producers and retailers can cut inventory levels and supply fresher goods to final customers. Thus, demand forecasting accuracy will decrease volatility and ensure supply chain stability. As a result, we would like to propose a novel demand forecasting method to improve and optimize supply chain performance. In addition, we chose a coffee case study to validate our proposed approach due to its practical and theoretical significance.

Coffee is a critical agricultural product with high economic value and social benefits. Coffee is also one of the most traded agricultural products (Valencia-Payan et al., 2022). However, forecasting coffee demand in the supply chain encounters several practical and theoretical significant issues. Indeed, demand unpredictability is one of the enormous concerns of supply chain managers because it may lead to uncertainties in the upstream supply chain and increasing expenditures (Abolghasemi et al., 2020). Besides, technological innovation has been a major factor in boosting agricultural production and supporting agricultural growth. Big data technology is the key to success and sustainable supply chain growth (Kittichotsatsawat et al., 2021).

However, developing nations have faced several obstacles and challenges in adopting new technology, such as a lack of computers, internet access, financial support, and an inability to understand the advantages of these technologies. Indeed, there is a lack of investment in productivity-boosting technology and knowledge (Putri & Retnoningsih, 2022). Thus, developing a practical forecasting technique that is simple, easy to use, efficient, and adaptable to the conditions of developing countries is one urgent task. Various methods and techniques have been used to forecast demand. However, each method has its strengths and weakness. Previous scholars emphasized that there is no best method for all situations and products. In addition, some forecasting methods have been developed to predict coffee demand in the literature. However, most of them rely on single models incapable of solving complex problems smoothly, mainly when the need for coffee products fluctuates. Indeed, coffee has both linear and nonlinear patterns that are difficult to forecast. Hence, the hybrid method can be an effective solution due to combining the advantages of different ways.

Therefore, this thesis proposes two primary solutions to fulfill such a necessity by combining quantitative and qualitative methods. Firstly, this thesis proposes a standard coffee supply chain model with the process elements' detailed level by using the newest Supply Chain Operations Reference (SCOR) model. Also, each process's performance and overall supply chain performance are evaluated. Secondly, this thesis examines the role of the demand planning process and proposes a new concept of the demand planning process. A novel hybrid forecasting method is developed to improve demand forecasting performance and compares its results with several existing methods. Furthermore, this thesis provides empirical proof of the effect of demand forecasting methods on supply chain performance. These novel perspectives would help supply chain managers understand the coffee supply chain's bottlenecks, anticipate demand, use their suppliers better, and potentially increase the overall supply chain's efficiency.

1.2 Research questions

Based on the background mentioned above, there are two main research questions.

- How to evaluate coffee supply chain performance?
- How does demand forecasting impact supply chain performance?

According to these questions, accurate demand forecasting is essential in improving supply chain performance. The following section demonstrates all guidelines for innovative approaches.

1.3 Thesis contribution

The primary goal of this thesis is to increase the performance of the coffee supply chain. This thesis comprises two main contributions focusing on supply chain performance and demand forecasting.

- *Supply chain performance*: This section proposes a new solution to model and evaluates the supply chain performance. This thesis adopts the latest SCOR model, SCOR version 12.0, one of the most well-known assessment models for supply chain performance. In the beginning, this thesis standardizes the coffee supply chain model with the process elements' detailed level. Then, this thesis applies the SCOR model for performance measurement. This thesis collects data through interviews and questionnaires in Kon Tum, Vietnam. Finally, this section indicates the main issues that decrease the coffee supply chain's efficiency and proposes some recommendations to improve the coffee supply chain's efficiency in Kon Tum of Vietnam. Improving demand forecasting accuracy is regarded as one of the critical solutions.

- *Demand forecasting*: This section proposes an innovative approach to predicting customer demand. Demand forecasting plays the most vital role in the demand planning process. Firstly, this thesis develops a new and deeper comprehension of the demand planning process as a higher-order construct and its relationship to operational performance (cost and delivery) using Partial Least Squares Structural Equation Modeling (PLS-SEM). Secondly, the thesis proposes an innovative solution to improve the accuracy of the forecasting method and supply chain performance. A novel ARIMAX-LSTM hybrid forecasting model is proposed. This model integrates the advantages of two well-known methods, ARIMAX (Auto-Regressive Integrated Moving Average with exogenous factors as a traditional method) and LSTM (Long Short-Term Memory as a machine learning method). Besides, the random method is selected to find the LSTM model's best configuration by tuning different LSTM hyperparameters. The proposed hybrid model is examined using real-time data, including

Vietnamese coffee demand and Thailand agricultural products. The performance of the proposed model is compared to other existing single and hybrid forecasting models. Finally, this section also provides empirical evidence on the magnitude of savings as observable supply chain performance results. Financial and operational metrics are employed to measure supply chain performance. Due to limited data, three relevant operating and one financial metric are selected, such as bullwhip effect (BWE), net stock amplification (NSAmp), transportation cost (TC), and inventory turn (IT), respectively. Moreover, the impact of the proposed model on environmental performance will be investigated. Two single forecasting models were benchmarked: ARIMAX (AutoRegressive Integrated Moving Average with exogenous factors) and LSTM (Long Short-Term Memory) have been selected.

1.4 Thesis structure

The structure of this thesis is shown in Figure 1. There are five chapters, and each has two primary contributions: a blue contribution for supply chain performance and a pink contribution for demand forecasting.

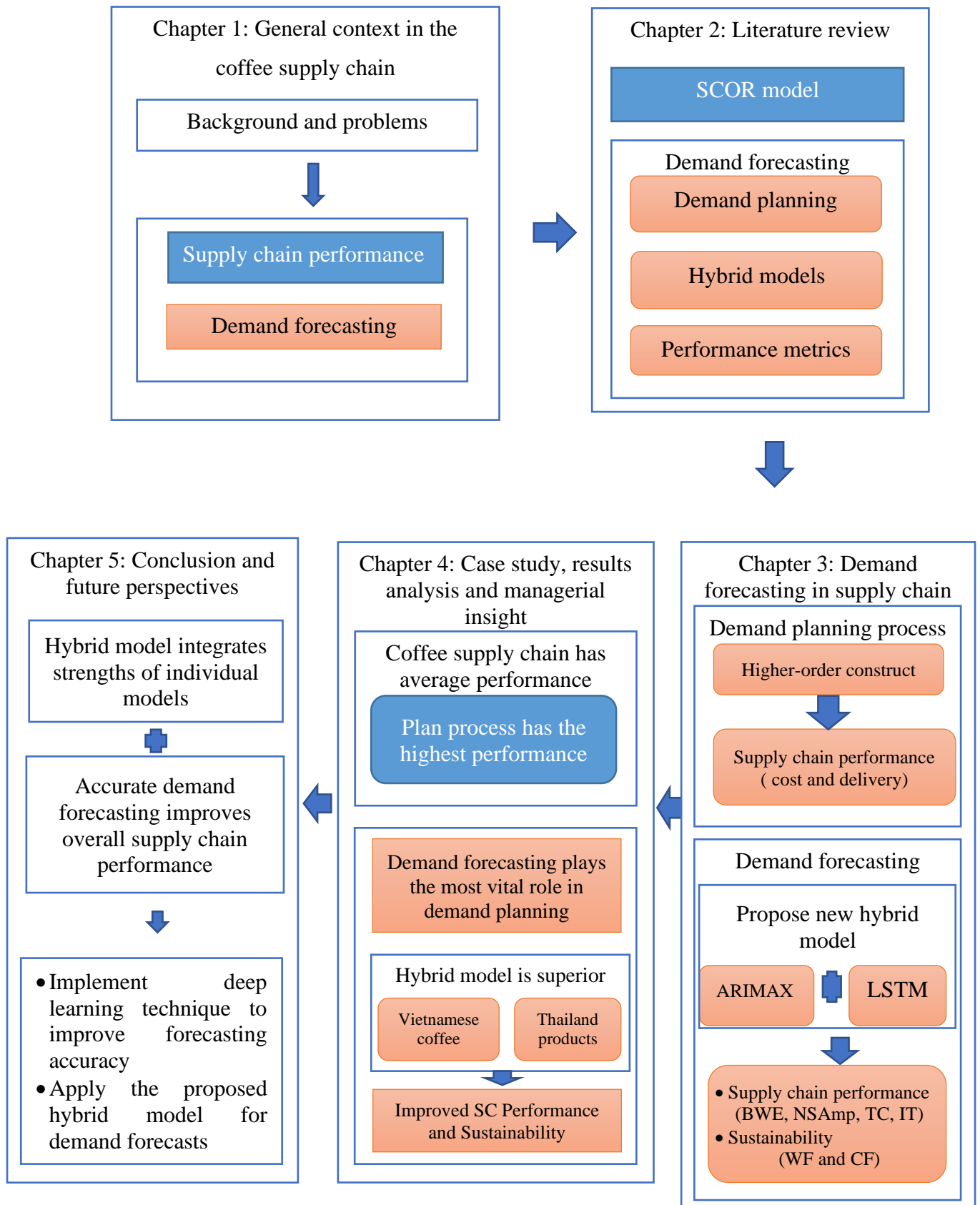

Figure 1: Thesis's structure

The first chapter, "General context in the coffee supply chain," discusses the general background and problems of the coffee supply chain. In addition, this chapter will present the role of demand forecasting in the supply chain. Also, the demand planning process will be mentioned in this chapter. Next, the relationship between demand forecasting and supply chain performance will be described. This section will serve as the foundation for the contribution to this thesis.

The second chapter, "Literature review," reviews the SCOR model and demand forecasting literature. First, a summary of the SCOR model and related studies will be provided. Then, this chapter will present steps for evaluating supply chain performance. Second, this chapter will discuss the underlying practices of the demand planning process and how they affect supply chain performance. In addition, a review of the literature on the development of hybrid forecasting methods will be presented. Two main forecasting techniques, ARIMAX and LSTM, will be described. In addition, this chapter will illustrate several existing hybrid models based on ARIMAX and LSTM that have been chosen as benchmarks. The gaps in existing works will be discussed at the end of this chapter. This part will lead to the proposal of novel methods for this thesis.

The third chapter, entitled "Demand forecasting in the supply chain," is the thesis's essential section. Firstly, this chapter will discuss demand planning problems and propose a novel approach. The demand planning process is considered a higher-order construct comprised of five lower-order constructs: goal formulation, forecasting techniques, information sources, forecasting roles in decision-making, and communicating the predictions and synchronizing supply with demand. Partial Least Squares Structural Equation Modeling (PLS-SEM) will be employed to demonstrate the notion of the demand planning concept and its effect on operational performance measured by cost and delivery. Secondly, the demand forecasting problems and proposed approaches will be presented in this chapter. All proposed methods will be centered on: the ARIMAX-LSTM hybrid model. Finally, the relationship between the proposed hybrid model and supply chain performance (financial and operational performance) will be examined. They include the Bullwhip Effect (BWE), Net Stock Amplification (NSAmp), Transportation Cost (TC), and Inventory Turn (IT). Eventually, the thesis will study how the proposed hybrid model impacts environmental performance, one of three sustainable supply chain performance dimensions. Carbon Footprint (CF) and Water Footprint (WF) will be used. These approaches will improve forecasting accuracy as well as supply chain performance.

The fourth chapter, entitled "Case study, Result analysis, and Managerial insight, " exhibits the proposed approaches' implementation validation. The overview case study will be presented at the start of this chapter. Following that, the result and discussion of each approach will be provided. The modeling and performance evaluation of the coffee supply chain will be shown in the performance section. Then, the demand forecasting section will present the influence of the demand planning process on operational performance. In addition, this section will offer the forecasting performance of the proposed hybrid model and various benchmark models. The discussion of real-life applications will present at the end of each part of the managerial insight.

The last chapter, "Conclusion and Future Perspectives," outlines the recommended methodologies for coffee supply chain performance and demand forecasts. Furthermore, positive suggestions for progressively improving this thesis will be made.

The works featured in all chapters are also presented in the following articles.

International Journal paper

Published

- T. T. H. Nguyen, T. M. Le, A. Bekrar and M. Abed, "Some Insights Into Effective Demand Planning," in IEEE Engineering Management Review, vol. 50, no. 3, pp. 141-148, 1 thirdquarter, Sept. 2022, doi: 10.1109/EMR.2022.3189028. (Scopus)

Submitted

- T. T. Hanh Nguyen, A. Bekrar, T. M. Le, M. Abed and Kantasa-ard, A. "Toward a smart forecasting model in supply chain management: a case study of coffee in Vietnam. Central European Journal of Operations Research.

Book Chapter

Published

- T. T. Hanh Nguyen, A. Bekrar, T. M. Le and M. Abed. The Effect of Machine Learning Demand Forecasting on Supply Chain Performance - The Case Study of Coffee in Vietnam. In: Le Thi, H.A., Pham Dinh, T., Le, H.M. (eds) Modelling, Computation and Optimization in Information Systems and Management Sciences. MCO 2021. Lecture Notes in Networks and Systems, vol 363. Springer, Cham. https://doi.org/10.1007/978-3-030-92666-3_21. (Book chapter, Scopus).

International Conference paper

Published

- T. T. Hanh Nguyen, A. Bekrar, T. M. Le and M. Abed, "Supply Chain Performance Measurement using SCOR Model: a Case Study of the Coffee Supply Chain in Vietnam," 2021 1st International Conference On Cyber Management And Engineering (CyMaEn), 2021, pp. 1-7, IEEE, doi: 10.1109/CyMaEn50288.2021.9497309. (Scopus)
- T. T. Hanh Nguyen, A. Bekrar, T. M. Le and M. Abed. Impact of demand forecasting on performance of sustainable coffee supply chain in Vietnam [Conference presentation abstract]. GIN 2022 - New Tech & An Effective Circular Economy (6-8 Jul 2022 Valenciennes (France)).
- T. T. Hanh Nguyen, A. Bekrar, T. M. Le and M. Abed. How to drive coffee supply chain toward sustainability: a case study in Vietnam. [Conference presentation abstract]. GIN 2022 - New Tech & An Effective Circular Economy (6-8 Jul 2022 Valenciennes (France)).

Processing

- T. T. Hanh Nguyen, A. Bekrar, T. M. Le and M. Abed. Impact of forecasting techniques on the environmental performance of supply chain. A case study of Vietnam.

CHAPTER 1: GENERAL CONTEXT IN THE COFFEE SUPPLY CHAIN

1.1 Introduction

The purpose of this chapter is to present a primary background on the coffee supply chain and the thesis's problem. Also, this chapter will provide an intriguing perspective and lead to the development of the proposed approaches. This introductory chapter is divided into four main parts. First, the fundamental principles and general concerns in the coffee supply chain are provided in the Background and Problematic section. Second, the "Supply chain modeling and Supply chain performance evaluation" section introduces the importance of supply chain modeling and measuring and the widely-used models. Third, Demand forecasting is an essential part of supply chain management. Hence, this part introduces the fundamental concept of demand planning and forecasting and their roles in supply chain management. The fourth section will discuss the link between demand forecasting and supply chain performance. Finally, the summary will bring to a close all the specifics discussed in the preceding four sections.

1.2 Background and problems in the coffee supply chain management

In the global context, rivalry occurs between supply chains rather than associations (SCs) (Mentzer et al., 2001; Trkman et al., 2010). Successful companies painstakingly connect their internal processes with external providers and clients in unique supply chains (Zailani & Rajagopal, 2005). A supply chain comprises a series of raw materials vendors, factories converting raw materials into applicable products, and a distribution system for delivering goods to the purchasers (Zailani & Rajagopal, 2005). There are several definitions of supply chain management (SCM). Authors (Mentzer et al., 2001) reviewed, categorized, and combined some of the most famous concepts to develop a comprehensive definition of supply chain management. These authors defined supply chain management as systemic, strategic coordination of traditional business functions and tactics across these business operations within a specific firm and throughout businesses within the supply chain to improve the long-term performance of individual firms and the overall supply chain. Figure 2 presents all business functions and inter-functional collaboration in supply chain management. Forecasting is a crucial business function along with production and logistics. Demand Forecasting is one

of the main supply chain flows. Therefore, accurate demand forecasting is vital for organizations to achieve supply chain management goals such as higher profitability, improved consumer satisfaction, and competitive advantage.

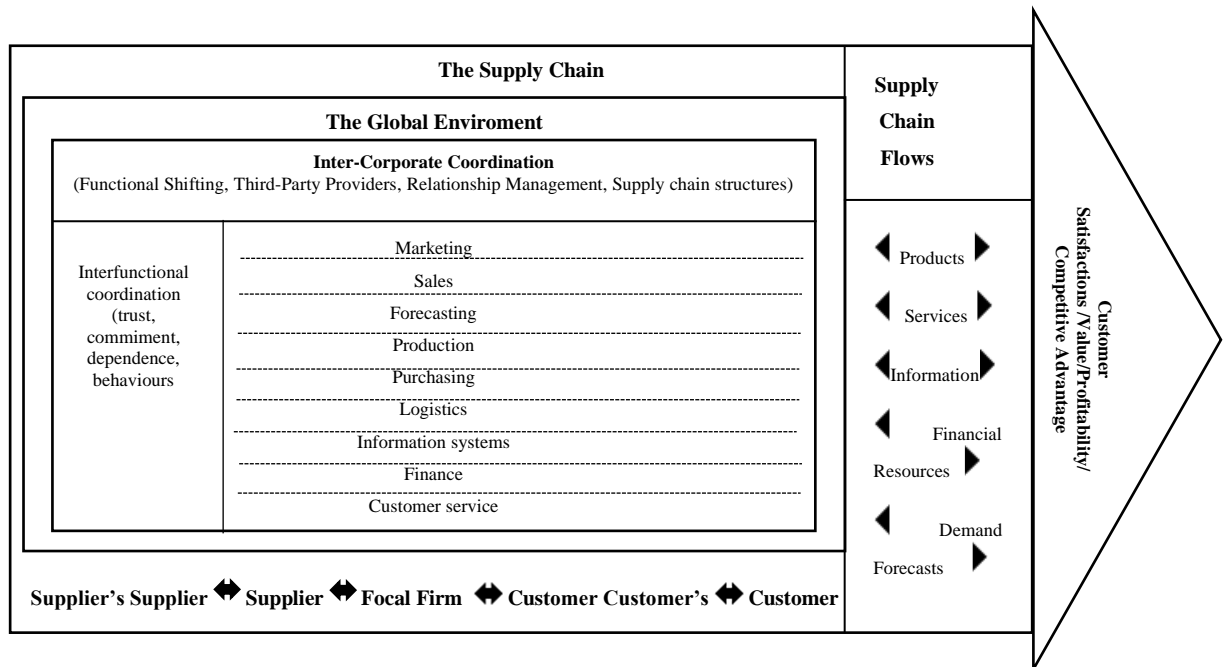

Figure 2: Supply chain management model (Mentzer et al., 2001)

Moreover, recent research has proven the importance of SCM. For example, scholars (Rao Tummala et al., 2006) suggested that SCM combines all business operations across improved connections to achieve a long-term competitive advantage, with the ultimate objectives of lower expenses and higher service levels. Hence, SCM aims to decrease the costs of production operations and suppliers/customers' service tasks (Rao Tummala et al., 2006). Also, it creates value for companies, customers, and stakeholders interacting throughout a supply chain (Estampe et al., 2013).

Several studies have discovered that effective supply chain management significantly impacts company success (Hofmann & Reiner, 2006). Nonetheless, many businesses struggle to adopt supply chain management practices in their organizations and the supply chain (Croxtton et al., 2002). Consequently, a small portion of supply chains is successfully managed (Hofmann & Reiner, 2006).

Furthermore, there is growing attention to the agricultural supply chain. Researchers have focused on international agricultural products such as coffee and tea in developing countries such as Vietnam, Rwanda, Indonesia, and Peru (Courville, 2003; Laderach et al., 2011;

Loveridge et al., 2002; G. N. T. Nguyen & Sarker, 2018; T. V. Nguyen et al., 2015; T. Van Nguyen et al., 2017; Palomino et al., 2017). However, researchers have encountered many challenges and difficulties in managing agricultural supply chain efficiency because of the long production and harvesting processes (Kantasa-Ard, 2021).

Coffee is one of the most popular and favorable beverages in the world. The worldwide coffee market was worth 102.02 billion USD in 2020 and is predicted to grow at a CAGR of 4.28% from 2021 to 2026 (ResearchAndMarkets.com, 2021). Coffee is one of the globally essential agricultural commodities and plays a considerable role in the national economy of many countries. However, the coffee industry encounters various problems that impact coffee quality, volume, and, ultimately, competitiveness. Figure 3 describes the phases in the coffee value chain. Two issues can be explored: the lack of information flow between customers and producers and the existence of intermediates between members. As a result, according to (Botero Lopez & Salman Chaudhry, 2020), the coffee loses 89% of its bulk through three major transformation phases: pulping at a farm, milling, and roasting. Intermediaries, such as roasters and retailers, gain the most.

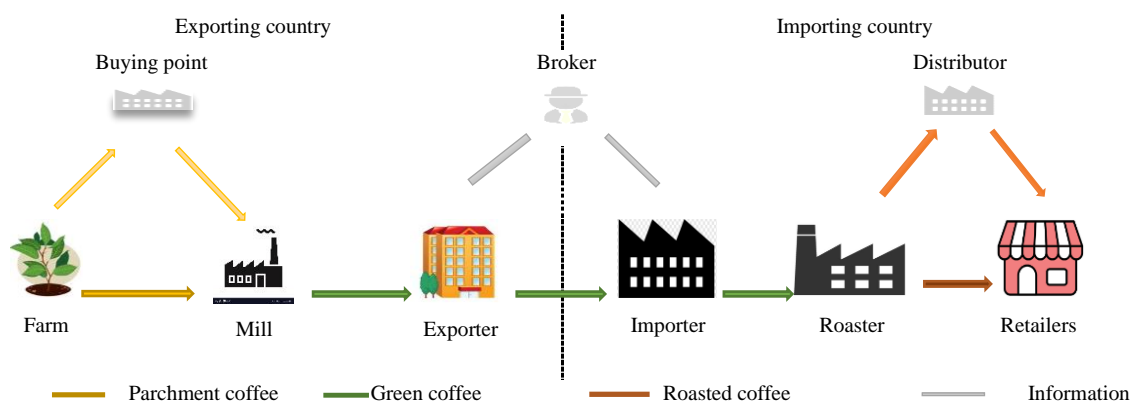

Figure 3: Coffee value chain (Botero Lopez & Salman Chaudhry, 2020)

Table 1 illustrates the global coffee balance from 2017/18 to 2020/21. As seen in Table 1, the worldwide coffee surplus was 2.316 million bags in 2017/18 before falling to 0.751 million bags in 2019/20. Nevertheless, it grew to 9.001 million bags in 2020/21. It indicates that the number of safety stocks changed dramatically. This issue has occurred in the world's top coffee producers, including Brazil (Bacci et al., 2019) and Vietnam (see Table 2). Table 2 displays Vietnamese coffee's supply/demand balance from 2017/2018 to 2020/2021.

Table 1: World Supply/Demand Balance (International Coffee Organization, 2021)

In thousand 60-kg bags

Crop year	2017/18	2018/19	2019/20	2020/21
World production	163,693	172,461	164,953	175,347
World consumption	161,377	168,492	164,202	166,346
Difference (Production-Consumption)	2,316	3,969	751	9,001

According to Table 2, Vietnamese output has fallen over the crop years. The balance has shifted dramatically, from 1.2 million bags in 2017/2018 to -0.6 million bags in 2018/2019, then rising to 1.3 million bags in 2019/2020. This table demonstrates how coffee inventories change rapidly throughout the year. Furthermore, it was evident that coffee consumption does not match production capacity (see Figure 4).

Table 2: Coffee production and consumption in Vietnam (International Coffee Organization, 2021)

In thousand 60-kg bags

Crop Year	Total production	Consumption		Difference (production-consumption)
		Domestic consumption	Real export	
2017/2018	33,432	2,500	29,732	1,200
2018/2019	30,283	2,600	28,283	-600
2019/2020	30,487	2,650	26,537	1,300
2020/2021	29,000	2700	25,805	495

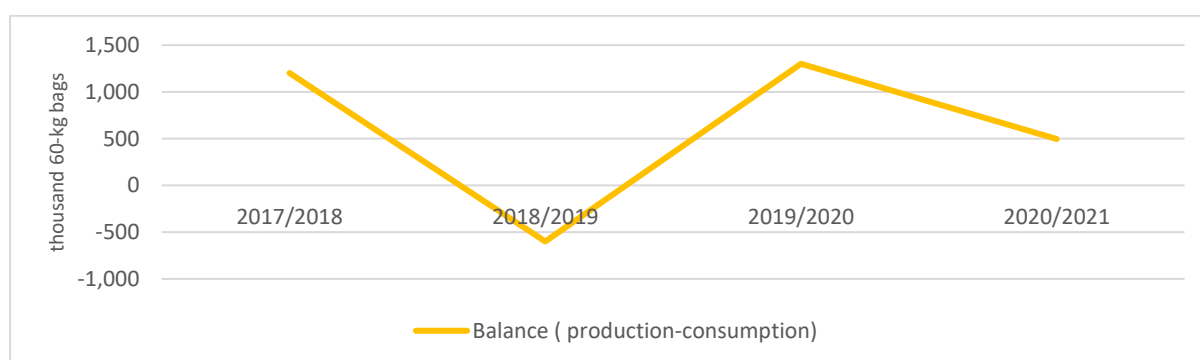

Figure 4: Coffee balance in Vietnam

Moreover, many other issues have existed in the Vietnamese coffee supply chain. For example, production is predominantly a 'family' operation on smallholders (T. V. Nguyen et al., 2015). As a result, coffee farmers use traditional intensive farming practices to extend coffee

yield (G. N. T. Nguyen & Sarker, 2018) but negatively affect the environment and lower coffee beans' quality (G. N. T. Nguyen & Sarker, 2018). Also, most companies prefer to engage with traders than individual farmers because coffee growers are small household farmers. However, they needed to pay more for intermediaries (G. N. T. Nguyen & Sarker, 2018). Therefore, it ends up in a rise in production costs. In addition, these issues can be seen in the coffee supply chain of other countries such as India (Arifin, 2010); Peru (Palomino et al., 2017), Malaysia (Zailani et al., 2012), and Indonesia (Ibrahim, H. W., & Zailani, 2010), Rwanda (Murekezi et al., 2012).

All issues mentioned above have substantially impacted the coffee supply chain's performance, decreasing stakeholders' profits. Consequently, many coffee producers have relocated to cultivate other agricultural products such as durian, lemon, and tea. As we can see, many problems in the coffee supply chain must be addressed to improve supply chain efficiency. Therefore, evaluating supply chain performance is critical to investigate priority solutions influencing the coffee supply chain's efficiency. Besides, demand forecast is crucial so that the members of the coffee supply chains may plan future production activities, such as demand planning and supply of green coffee beans. Also, it contributes to reducing and avoiding shortages or overproduction (Bacci et al., 2019).

Modeling and measuring supply chain performance is vital for efficient supply chain management because it helps identify the problems existing in the current supply chain and thus select appropriate actions to improve supply chain performance (Kocaoğlu et al., 2013). Also, it can give helpful feedback information to managers, allowing them to monitor performance, expose progress, increase motivation and communication, and diagnose problems (Ramaa et al., 2009). The following section will describe the details of supply chain modeling and measurement.

1.3 Supply chain performance evaluation

Supply chain performance measurement has become a rapidly expanding field of study that has seen considerable advancement in recent decades. Thus, various famous models for evaluating supply chain performance presented have been published in the literature, such as Supply Chain Operations Reference (SCOR), Supply Chain Balanced Scorecard, Hierarchical Based Measurement System, Interface Based Measurement System (Estampe et al., 2013; Jagan Mohan Reddy et al., 2019; Ramaa et al., 2009). For example, according to the study by (Ramaa et al., 2009), seven well-known systems of supply chain performance measurement are

studied as follows: Function-Based Measurement System (FBMS), Dimension Based Measurement System (DBMS), Supply Chain Operations Reference Model (SCOR), Supply Chain Balanced Scorecard (SCBS), Hierarchical Based Measurement System (HBMS), Interface Based Measurement System (IBMS), Perspective Based Measurement System (PBMS). The SCOR model is one of the most well-known and widely applied models since it aids practitioners and researchers in modeling and evaluating the supply chain.

The SCOR model has viewed the supply chain ranging from suppliers' suppliers to customers' customers, toward measuring all of the chain members and targeting companies, incorporating the financial, organizational, and societal aspects of performance (Estampe et al., 2013). The SCOR model provides standardized processes and metrics (Persson et al., 2012). Thus, many practitioners and academicians have adopted it for modeling and evaluating supply chain performance (Lima-Junior & Carpinetti, 2019, 2020; Öztayşi & Sürer, 2014). Previous studies indicated that designing an appropriate supply chain network impacts the supply chain's cost and performance (Tarasewicz, 2016; Wibowo & Sholeh, 2015). The supply chain network model helps understand complexity, supports re-configuration, re-engineers, identifies bottlenecks, and prioritizes corporate resources (Cheng et al., 2010). As a result, this thesis employs SCOR version 12, the most recent SCOR version, to model and measure the performance of the coffee supply chain.

Furthermore, previous authors revealed that the Plan process, which entails specifying requirements and corrective measures to achieve supply chain goals, is the most important of all SCOR processes (Lockamy & McCormack, 2004; T. T. Hanh Nguyen et al., 2021). Also, supply chain executives need to focus on the customers' needs and demands (Hadaya & Cassivi, 2007; Raza & Kilbourn, 2017; Swierczek, 2020). Demand forecasting is a process that assists in forecasting and fulfilling customers' future needs and expectations (Benkachcha et al., 2014). Prior studies have demonstrated that demand planning and forecasting are the most crucial factors influencing supply chain performance (Basson et al., 2019; Hofmann & Reiner, 2006; Raza & Kilbourn, 2017; Thomé et al., 2014). Unfortunately, there is a scarcity of research on coffee demand forecasting in developing countries where economic development needs to undertake adequate planning for sustainable growth, overall development, and poverty alleviation, as indicated by the authors (Naveena et al., 2017). This research attempt to develop a new demand forecasting model that provides more accurate forecasting results of coffee consumption and a better balance with coffee production. The following section will present the concept of demand forecasting in the supply chain.

1.4 The relationship between demand planning and demand forecasting in the supply chain management

Supply chain management (SCM) is an activity that includes managing the entire process flow of goods and business processes of a company from upstream to downstream (Kusrini et al., 2019). According to (Croxtan et al., 2002), demand management is one of the eight SCM processes that balances the customers' requirements with the capabilities of the supply chain (as shown in Figure 5). Moreover, previous researchers have indicated that demand management entails more than demand planning (Basson et al., 2019; Vlckova & Patak, 2011). Demand management focuses on forecasting consumer demand and synchronizing demand and supply chain capabilities. While demand planning is a collection of methods and information technologies for exploiting demand forecasting in the planning process (Vlckova & Patak, 2011). Thus, demand planning will be an essential part of demand management. In addition, demand forecasting is one of the critical elements in demand management, as well as demand planning. Indeed, previous studies found that demand forecasting is an essential factor in demand planning (Croxtan et al., 2002; Crum & Palmatier, 2003; Swierczek, 2020; Świerczek, 2019; Vlckova & Patak, 2011). As a result, Figure 5 displays the relationship between demand forecasting and demand planning in supply chain management.

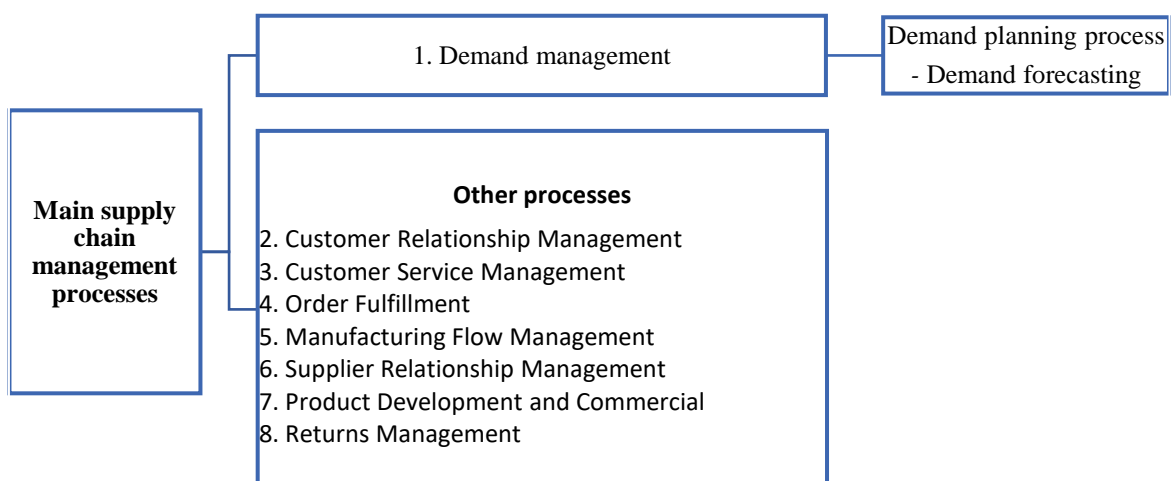

Figure 5: The relationship between demand planning and demand forecasting in supply chain management (Croxtan et al., 2002)

1.4.1 Demand planning process

Supply chain executives have encountered obstacles in today's marketplaces due to globalization, outsourcing, a substantial rise in supply and demand unpredictability, more items with short life cycles, and product proliferation (Hofmann & Reiner, 2006). The most challenging task for supply chain management has been responding to market instability and accompanying changes in consumer demand trends (Raza & Kilbourn, 2017). Volatile demand is manufacturers' primary source of environmental uncertainty because it is distorted throughout the supply chain (Hadaya & Cassivi, 2007). Failures of supply chains are frequently due to a misunderstanding of the composition and behavior of customer demand (Raza & Kilbourn, 2017). Therefore, supply chain executives must focus on customers' needs (Hadaya & Cassivi, 2007; Raza & Kilbourn, 2017; Swierczek, 2020). Demand planning enables supply chain participants to concentrate on the customer and achieve maximum value (Raza & Kilbourn, 2017). As a result, demand planning is one of the critical issues to consider to accomplish successful supply chain analytics (C. H. Wang & Yun, 2020).

Demand planning, a modern demand management tool, gets closer to consumers and structures internal corporate operations to match their demands (Vlckova & Patak, 2011). Demand planning helps enterprises understand customers' needs better and guarantees that supply and demand are balanced (Swierczek, 2020). Demand planning, the initial stage in supply chain planning, determines the efficacy of the supply chain's manufacturing and logistic activities. Supply chain planning aims to achieve synchronous and reactive material flow, information, finance, procedures, and services (A. Chen & Blue, 2010). Besides, (Raza & Kilbourn, 2017) indicated that demand planning is a part of the supply chain that aims to develop a demand plan based on sales predictions and other data sources from different departments. Planning is the most vital process in all SCOR processes (Lockamy & McCormack, 2004; T. T. Hanh Nguyen et al., 2021). Figure 6 displays the evolution of demand management. The first critical factor in demand development is forecasting, which helps develop demand plans. Then, organizations can communicate demand plans to supply. As can be seen, there is no effective demand management without forecasting. As a result, better forecasting leads to better demand management.

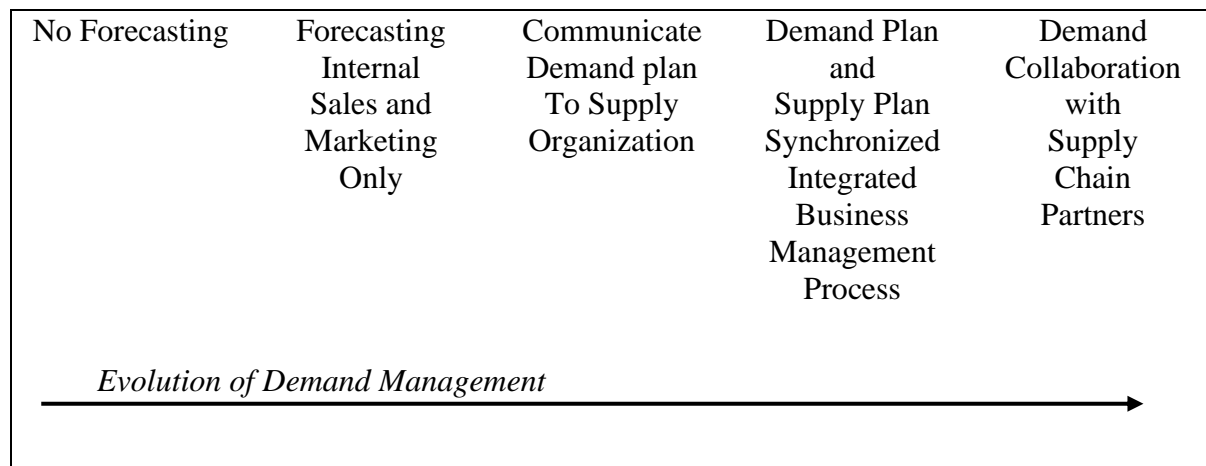

Figure 6: Evolution of demand management (Crum & Palmatier, 2003)

However, gaps still prevail between studies on demand planning (Basson et al., 2019; Swierczek, 2020). Consequently, organizations and supply chain executives frequently misunderstand this process (Basson et al., 2019). This issue has become more severe because demand planning has the most significant relationship with supply chain performance among the supply chain planning processes (Lockamy III & McCormack, 2004). Previous researchers have found a positive relationship between demand planning and supply chain performance (Basson et al., 2019; Raza & Kilbourn, 2017; Thomé et al., 2014). However, they concentrated on specific demand planning practices such as sales and operations planning practices (Thomé et al., 2014), data source (Raza & Kilbourn, 2017), and forecast accuracy (Basson et al., 2019), whereas DPP includes several primary practices. A comprehensive notion of the DPP has not yet been previously defined. Recently, researchers (Swierczek, 2020) provided the first empirical research to investigate the impact of the demand planning process as a higher-order concept in mitigating risk disruptions. The results demonstrated that this process minimizes interruptions caused by all operational risks. However, this author has not studied supply chain performance. According to (Sarstedt et al., 2019), higher-order constructs are referred to as hierarchical component models in partial least squares structural equation modeling (PLS-SEM). Higher-order constructs enable the modeling of a construct on a more complex, higher-level dimension and its specific components. Their benefits comprise reducing the number of path model linkages, addressing the issue of bandwidth fidelity (information consistency), and lowering collinearity between formative indicators. Hence, this thesis proposes a new and more profound comprehension of DPP as a higher-order construct and its relationship to supply chain performance.

Moreover, DPP inaccuracies and poor DPP may lead to business failure, particularly for small businesses, which are already vulnerable in terms of management and financial resources. Effective demand planning generates profit and customer satisfaction by assisting the company in reaching the appropriate balance between adequate inventory levels and consumer demand. Given these situations and initial research evidence, we provide a more profound comprehension of DPP—with additional insights into its relationship to supply chain performance.

Prior studies indicated that demand forecasting is the most critical practice in demand planning (Swierczek, 2020; Vlckova & Patak, 2011). Also, the quality of the forecasting and planning process impacts the supply-demand balance and supply chain performance (Feizabadi, 2020). Thus, enhancing demand forecasting accuracy is a high-priority task. The details of demand forecasting will be presented in the next part.

1.4.2 Demand forecasting

Demand Forecasting predicts future demand for a given product so that supply chain operations can be planned to reduce delivery times, stock levels, and operating costs (Kantasa-ard et al., 2021). Indeed, demand forecasting is essential because supply chain management aims to offer the right product at the right place, time, and price to satisfy final customers' expectations (College et al., 2000). Demand forecasting is a primary process of supply chain management that predicts future demands and customers' expectations (Benkachcha et al., 2014). Based on demand forecast information, the supply chain members make many proper operational, tactical, and strategic decisions in a variety of sectors, including production planning, sales budgeting, new product launches, and promotion planning (Abolghasemi et al., 2020; Danese & Kalchschmidt, 2011; Perera et al., 2019). Hence, demand forecasting is critical in successfully implementing a supply chain management strategy. Accurate forecasting will minimize uncertainty and stabilize the supply chain (Bhadouria & Jayant, 2017). As a result, it increases substantial financial savings, greater competitiveness, effective supply chain collaborations, and satisfies customers (Perera et al., 2019). In contrast, incorrect predictions can lead to excessive expenditures on procurement and shipping, human resources, level of service, and inventories (Abolghasemi et al., 2020).

However, many organizations and predictors struggle to conduct scientific forecasts because demand forecasting is complex (Abolghasemi et al., 2020). Customer behavior fluctuation increases the demand forecasting process's complexity (Kantasa-ard et al., 2021).

Therefore, forecasting is considered the most vulnerable part of any organization, regardless of whether it is in charge of finance, marketing, sales, or logistics. Many firms know their predictions are unrealistic but do not know how to fix them. Therefore, they ignore the issue and hope to solve it later (College et al., 2000).

Various predictive methods and techniques have been developed and employed to anticipate future demand. According to prior researchers (Kilimci et al., 2019), forecasting methods can be divided into traditional and machine learning (ML) (as shown in Figure 7). Both have achieved success in various fields. However, there is no optimal method for all situations (Khashei & Bijari, 2011) and all datasets (Babu & Reddy, 2014; Panigrahi & Behera, 2017). A recent study (Abolghasemi et al., 2020) emphasized that no one approach can overcome all forecasting issues and provide the best forecasting results of all the models. Each forecasting method has advantages and limitations compared to others (Aburto & Weber, 2007). Thus, hybrid forecasting methods have been proposed to incorporate the advantages of each method (Aburto & Weber, 2007; Kantasa-ard et al., 2021; Soy Temür et al., 2019).

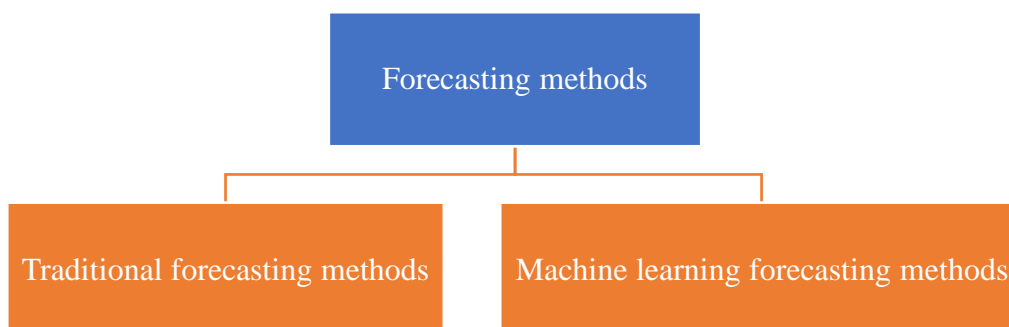

Figure 7: Main forecasting methods (Kilimci et al., 2019)

Deep learning (DL) methods apply deep neural network architectures to solve complex problems among ML methods. They have provided predictions with more accuracy than traditional ML algorithms in numerous research pieces (Kilimci et al., 2019). DL methods, specifically Long Short-Term Memory (LSTM), can be employed to predict time series data with sophisticated and non-linear structures ((Kantasa-ard et al., 2021; Siami-Namini et al., 2019)). LSTM has been widely adopted in various forecasting areas in recent years by experts and researchers, such as financial time series data (Choi, 2018; Siami-Namini et al., 2019; Yadav et al., 2020), housing sales (Soy Temür et al., 2019), and local export (Dave et al., 2021). However, a lack of research adopts LSTM in coffee and agricultural products.

As a result, this thesis proposes a new hybrid intelligent model for demand forecast using hybrid algorithms to increase forecasting accuracy. The hybrid model combines the advantages of two famous models: ARIMAX and LSTM. LSTM can capture the data's non-linear component, while ARIMAX captures the linear component (Dave et al., 2021; Kantasa-ard et al., 2021; Soy Temür et al., 2019).

To sum up, the previous two sections introduced demand planning and demand forecasting. Both play an essential role in supply chain management. Previous researchers have identified demand planning and forecasting as the most crucial factors influencing supply chain performance (Basson et al., 2019; Raza & Kilbourn, 2017; Thomé et al., 2014). The following section will discuss their influence on supply chain performance.

1.5 The relationship between demand forecasting and supply chain performance

1.5.1 The relationship between demand planning and supply chain performance

Many studies have provided evidence of the influence of demand planning on supply chain performance. For example, researchers (Thomé et al., 2014) conducted the first empirical study investigating the relationship between individual sales and operations planning practices and operational performance. They used three primary sales and operations planning practices: internal sales and operations planning, suppliers' integration, and customer integration. As a result, the internal Sales and Operation Planning practices positively affect operational performance (delivery, quality, and flexibility). Besides, scholars (Raza & Kilbourn, 2017) examined the effect of Point-of-Sale (POS) data on demand planning in the clothes retail sector of South Africa. POS data is a critical input component in demand forecasting. The value of POS data in demand planning is expected to grow as customer expectations rise. They also discovered that demand planning impacts many supply chain operations, such as inventory positioning, replenishment, ordering, and production.

Additionally, the authors (Basson et al., 2019) compared pre and post-intervention demand planning activities in the case study of a South African fast-moving consumer goods company by using metrics, including customer service levels, logistics cost, and internal supply chain ranking. As a result, overall supply chain performance has increased through demand planning interventions. In addition, these authors focused on demand forecast accuracy in the DPP. Overall, the demand planning practices have been examined individually rather than as an ensemble of multidimensional constructs.

Moreover, higher-order constructs are increasingly being utilized to minimize model complexity, describe and assess multidimensional notions, and broaden and generalize concepts (Wetzels et al., 2009). Moreover, to the best authors' knowledge, a lack of studies has been conducted to evaluate the relationship between the demand planning process as a higher-order construct and supply chain performance. Therefore, this thesis fills this gap.

The next part will explain demand forecasting and supply chain performance.

1.5.2 The relationship between demand forecasting and supply chain performance

Demand predictions are the backbone of supply chains (Perera et al., 2019). It enables predicting and satisfying future customer needs and desires (Benkachcha et al., 2014). Regardless of the industry and the type of company, accurate demand forecasting helps identify market opportunities, strengthen channel relationships, boost customer satisfaction, decrease inventory spending, eliminate product obsolescence, optimize distribution operations, and schedule more effective production. Also, it predicts future financial and capital requirements (Moon et al., 2003). As a result, forecasting is critical to increasing a company's efficiency (Zotteri & Kalchschmidt, 2007). Supply chain managers depend on accurate and reliable demand prediction to aid planning and decision-making (Abolghasemi et al., 2020). Forecasting approaches influence supply chain performance (Danese & Kalchschmidt, 2011; George & Madhusudanan Pillai, 2019; Moon et al., 1998, 2003).

Previous studies have discovered a positive relationship between forecasting and supply chain performance (Feizabadi, 2020; Jaipuria & Mahapatra, 2014; Kantasa-ard et al., 2021). Accurate forecasting decreases transportation and holding costs (Kantasa-ard et al., 2021). On the other hand, improper demand forecasting increases total supply chain costs, such as shortage and backorder costs (Jaipuria & Mahapatra, 2014). Therefore, this thesis aims to give proof of the influence of our proposed hybrid model on supply chain performance.

Moreover, different Key Performance Indicators (KPIs) or metrics can measure supply chain performance. However, previous studies have commonly used predicting accuracy (Kantasa-ard et al., 2021; Mccarthy et al., 2006; Mentzer & Kahn, 1995; Moon et al., 2003; Soy Temür et al., 2019). However, forecast accuracy is considered an operational measure (Feizabadi, 2020). Besides, according to (I. J. Chen & Paulraj, 2004), a supply chain measurement system is inadequate based solely on financial or operational measures. As a result, this thesis will employ both financial and operational metrics to measure supply chain performance, such as the bullwhip effect, net stock amplification, transportation cost, and

inventory turn. Furthermore, we will investigate the relationship between demand forecasting and the performance of a sustainable supply chain through environmental performance.

1.6 Summary

The context and issues in the coffee supply chain were covered in this chapter. Many problems have affected the coffee supply chain's efficiency. Hence, supply chain modeling and performance evaluation are essential to help stakeholders understand operations and priority problems. Demand forecasting has been identified as the most critical factor influencing supply chain performance. Then, the roles of demand forecasting and demand planning in the supply chain are discussed. Also, the relationship between these processes and supply chain performance is described. The next chapter proposes a literature review on the SCOR, the famous model of supply chain modeling and assessment, the primary practices of the demand planning process, and the evolution of forecasting methods.

CHAPTER 2: LITERATURE REVIEW

2.1 Introduction

This chapter concentrates on the literature on the SCOR model and demand forecasting. The following is the structure of the literature review. Firstly, the latest version of the SCOR model-version 12.0, will be described and followed by related studies that use this model. Secondly, the description of primary demand planning practices and their impact on supply chain performance will be presented in this thesis. Besides, this chapter discusses the evolution of hybrid forecasting models. Next, ARIMAX, LSTM, and selected ARIMA-LSTM hybrid models will be addressed in this thesis. This part also focuses on how demand forecasting affects supply chain performance. Thirdly, the last section discusses the research gaps in the existing literature.

2.2 Overview of the SCOR model

This part of the thesis will detail the SCOR, a process reference model. The SCOR model illustrates the business operations involved in all stages of meeting consumer demand. This model is used to aid in supply chain analysis at different levels (American Production and Inventory Control Society, 2017).

2.2.1 SCOR model version 12.0

The Supply Chain Council (SCC) built up the SCOR to present the business operations related to all periods of fulfilling customer requirements in 1996. The SCC and American Production and Inventory Control Society (APICS) were combined in 2014. As a result, they produced the newest SCOR version, 12.0, in 2017 (American Production and Inventory Control Society, 2017). In contrast to previous versions, this version added and updated several metrics and processes. Perfect Order Fulfillment, RL.1.1, Return Cycle Time, and RS.2.5 are a few examples. In addition, the SCOR divided supply chain management into six key processes between the supplier's providers and the final client. They are as follows: Plan, Source, Make, Deliver, Return, and Enable. The "Enable" process was first presented in version 11 of SCOR.

The primary SCOR processes are presented in Figure 8. Plan involves identifying necessities and corrective actions to accomplish the supply chain goals. Source is the activity of

requesting, delivering, receiving, and movement of raw material items. Thus, it is related to suppliers. Make represent adding value through manufacturing or creating a product. Deliver refers to distributing products to customers. Return moves products from customers back through the supply chain to address faults in requesting or producing. Finally, Enable concerns building up, keeping up, and checking data, connections, resources, properties, business rules, compliance, and agreements needed to perform, monitor, and manage the entire supply chain.

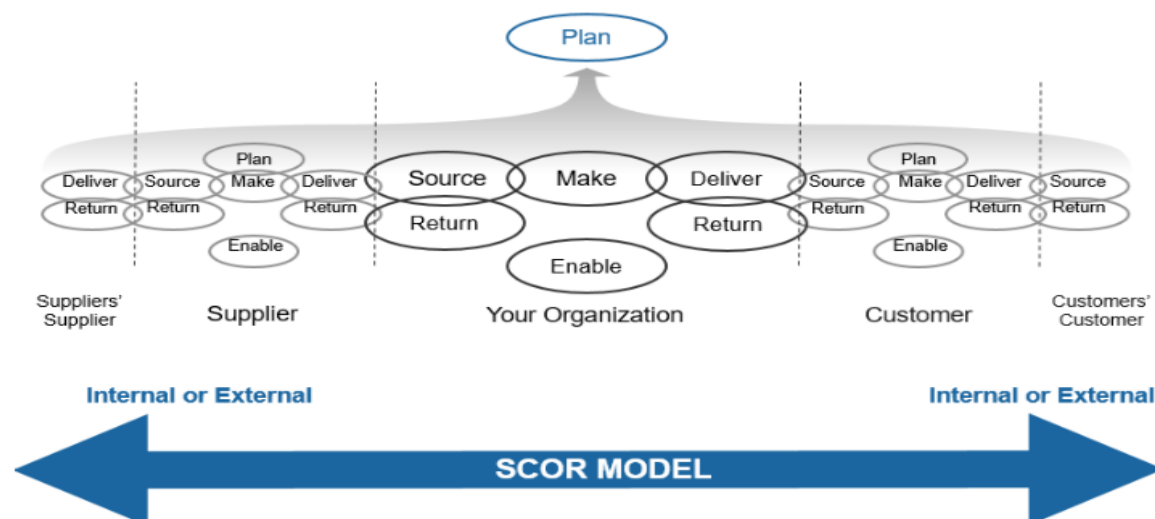

Figure 8: Main processes of SCOR Model version 12.0 (American Production and Inventory Control Society, 2017)

The SCOR model has a hierarchical structure with four different degrees of decomposition (as shown in Figure 9). However, it concentrates on the first three levels. Level 1 presents process types that identify the supply chain's scope and content such as Plan (sP), Source (sS), Make (sM), Deliver(sD), Return(sR), and Enable(sE). Then, Level 2 presents process categories that define the operations, for example, Plan process(sP) has Plan Supply Chain(sP1), Plan Source(sP2), Plan Make(sP3), Plan Deliver(sP4), Plan Return(sP5). Level 3 describes process elements that define the individual process's configuration; for example, Plan Supply Chain includes Identify, Prioritize and Aggregate Supply Chain Requirements (sP1.1), Identify, Prioritize and Aggregate Supply Chain Resources (sP1.2), Balance Supply Chain Resources with SC Requirements(sP1.3) and Establish and Communicate Supply Chain Plans(sP1.4)

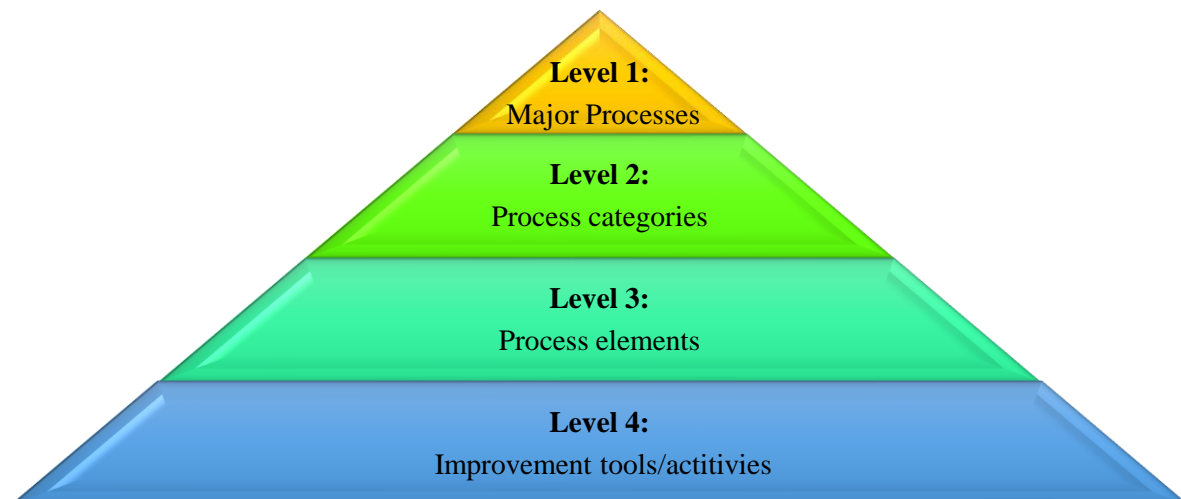

Figure 9: SCOR process hierarchy (American Production and Inventory Control Society, 2017)

The SCOR model also provides hierarchy standard metrics to explain process performance following hundreds of Key Performance Indicators (KPIs) (American Production and Inventory Control Society, 2017). In the SCOR, performance will be divided into five attributes: Reliability, Responsiveness, Agility, Costs, and Assets (as seen in Table 3). The first three elements are focused on the customer. The remaining elements are regarded as internal-focused: Costs and Asset Management Efficiency. The Reliability attribute measures the capacity to conduct tasks as needed. The Responsiveness attribute defines how quickly tasks can be performed. The Agility assesses the ability to react to outer impacts, while the Costs attribute evaluates the supply chain's expenses. Workforce, materials, frameworks, and transportation costs are examples of general expenses. Finally, Assets, the last feature, measure the ability to operate assets efficiently (American Production and Inventory Control Society, 2017).

Table 3: SCOR performance attribute (American Production and Inventory Control Society, 2017).

	Performance Attribute	Definition
Customer-focused	Reliability	The ability to perform tasks
	Responsiveness	The speed at which tasks
	Agility	The ability to respond to external influences
Internal-focused	Costs	The cost of operating the supply chain processes
	Asset Management Efficiency	The ability to efficiently utilize assets

2.2.2 SCOR model-related research

SCOR facilitates supply chain mapping and analysis in different areas, such as construction supply chains (Cheng et al., 2010), pharmaceuticals supply chains (Essajide & Rachidi, 2017), and coffee supply chains (Palomino et al., 2017). The SCOR captures the "as-is" process state to achieve the desired "to-be" future state (Irfan et al., 2008). However, the SCOR model has been produced and tested based on companies' experiences in developed countries. The SCOR model is excessively general and needs adaptation to the local operating environment (Essajide & Rachidi, 2017). Thus, the SCOR model application in developing countries needs to be concerned.

Lots of studies employed the SCOR for the supply chain performance evaluation in many countries like the USA (Dissanayake & Cross, 2018), Yogyakarta (Bukhori et al., 2015), and Brazil (Sellitto et al., 2015), New Zealand (Moazzam et al., 2018). However, they adopted the previous version of the SCOR. Only a few researchers used the most recent SCOR to model and evaluate the supply chain's overall performance. For example, a recent study (Kusrini et al., 2019) used the SCOR 12.0 version to measure the leather supply chain for bag products in the specific region of Yogyakarta Province. In the case of Vietnam, some authors studied the coffee supply chain in Vietnam (G. N. T. Nguyen & Sarker, 2018; T. V. Nguyen et al., 2015; T. Van Nguyen et al., 2017). However, they have not paid attention to the model coffee supply chain as well as the evaluation of its performance. Moreover, a lack of research adopts the SCOR in the context of coffee in Vietnam to be the best authors' knowledge.

The SCOR model provides hundreds of Key Performance Indicators (KPIs) for describing process performance (American Production and Inventory Control Society, 2017). Hence, several criterion decision-making techniques will be applied to determine the suitable KPIs (Chorfi et al., 2018). Several multiple criteria decision-making techniques have been employed, such as Analytic Hierarchy Process – AHP (Bukhori et al., 2015; Chorfi et al., 2018; Elgazzar et al., 2012; Wibowo & Sholeh, 2015); Technique for Order Preference by Similarity to Ideal Solution (TOPSIS) (Jothimani & Sarmah, 2014; Kocaoğlu et al., 2013). Indeed, AHP is one of the well-known multiple-criteria decision-making techniques used in past research (Bukhori et al., 2015; Prasetya et al., 2017; Wibowo & Sholeh, 2015). For example, authors (Wibowo & Sholeh, 2015) have used the AHP to compare different Key Performance Indicators (KPI) from SCOR. For instance, reliability with flexibility, responsiveness with flexibility, and cost with assets. Also, the authors (Bukhori et al., 2015) have employed AHP and Cause Effect-Diagram to rank performance issues and provide an alternative recommendation from the three worst

performance scores. Scholars (Prasetya et al., 2017) used the SCOR version 8.0 and AHP to measure the performance of the coffee supply chain in North Sumatera, Indonesia. The results showed that the supply chain performance score was 48.224 with a marginal category and the Deliver process had the lowest score performance. Thus, this thesis will employ AHP to weigh each process and metric. The AHP determines the relative performance of all alternatives based on actual data. It has scale from 1 to 9 (Bukhori et al., 2015). The AHP customizes the supply chain performance measurement systems based on Decision-Makers' interests (Chorfi et al., 2018).

Based on the prior studies above, the following section will present the stages of performance measurement.

2.2.3 Steps of performance measurement

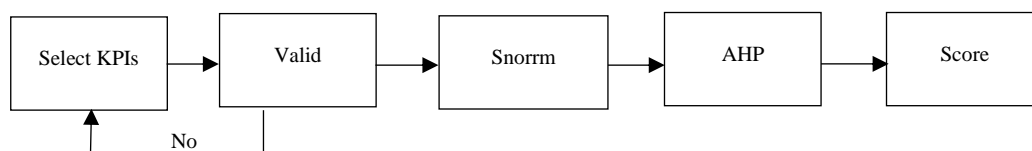

Figure 10: Steps in measuring performance

Figure 10 displays the steps of performance evaluation, which involve selecting the KPIs, validating them, normalizing them using Snorm, weight KPIs with AHP, and scoring KPIs. First of all, KPIs are chosen from the SCOR model. They have been identified as affecting coffee supply chain performance. Second, these KPIs will be valid if data can be found. Third, KPIs will be normalized using the Snorm de Boer method because of the data's different units and size scales (Kusrini et al., 2019). Equation (1) and Equation (2) are the Snorm de Boer method formulas (Kusrini et al., 2019):

Larger is better

$$Snorm = \frac{(Si - Smin)}{(Smax - Smin)} \times 100 \quad (1)$$

Lower is better

$$Snorm = \frac{(Smax - Si)}{(Smax - Smin)} \times 100 \quad (2)$$

Where Snorm = Normalized Score; Si = Valued actual indicator; Smin = Lowest valued actual indicator; Smax = Highest valued actual indicator.

Then, KPIs will be weighted by adopting the AHP technique. AHP is used to select the priority of indicators of performance. It is a measurement theory through pair comparisons and evaluation experts to get the priority scales and an algorithm capable of solving complex decision-making problems into a hierarchy system (Wibowo & Sholeh, 2015). The study adopts the AHP method of (Leal, 2020), which consists of two main stages. First, construct a pairwise comparison survey each participant must fill out (Table 4).

Table 4 : Fundamental scale of saaty (Leal, 2020)

Intensity of importance	Definition
1	Equal importance
3	Moderate importance
5	Strong importance
7	Very strong importance
9	Extreme importance

The second stage of AHP is to calculate the priorities vector by the formula below:

$$pr_j = \frac{1}{a_{ij} * \sum_{k=1}^n \frac{1}{a_{ik}}} \quad (3)$$

Where j is the element for which one wishes to calculate the priority, i is the element taken as the basis for the comparison, a_{ij} is the comparison value of alternative i with alternative j , and pr_j is the priority of alternative j against the criterion considered, n is the number of measures.

The final step will calculate each process's score, overall supply chain, and performance. So, we multiply the normalization score with each KPI, process, and performance attribute weight. Table 5 explains the performance indicators' degree.

Table 5: Performance indicator (Kusrini et al., 2019)

Performance Values	Performance indicator
<40	Poor
40-50	Marginal
50-70	Average
70-90	Good
>90	Excellent

Since the importance of demand planning and forecasting was already mentioned in chapter 1, the following section will discuss demand planning practices and hybrid forecasting methods. Additionally, their influence on supply chain performance will be highlighted.

2.3 Demand forecasting in the supply chain

This section has two main parts: the demand planning process and demand forecasting. In the first part, we discuss the leading practices and their impact on supply chain performance. In the second part, we concentrate on the evolution of hybrid models and performance indicators.

2.3.1 Demand planning process

2.3.1.1 Demand planning practices

Previous studies have highlighted the primary practices for a successful demand planning process (DPP). For example, researchers (Croxtton et al., 2002) highlighted that demand management is concerned with estimating consumer demand and establishing how the order is synced with supply chain capabilities. Scholars (Vlckova & Patak, 2011) defined two necessities for successfully implementing demand planning: first, the use of appropriate forecasting techniques and software to analyze sufficient information with performance evaluation; second, the communication, coordination, and collaboration of functional departments and the simultaneous integration of forecasting and operational planning. Recently, a researcher (Swierczek, 2020) developed the DPP consisting of four essential practices: goal formulation, data collection, demand forecasting, and communicating the predictions and synchronizing supply with demand. Besides, demand forecasting only focuses on demand forecasting techniques. Many studies found that the forecasting process consists of three essential variables: methods adopted, the information sources, and the roles of forecasting in supporting decision-making (Croxtton et al., 2002; Danese & Kalchschmidt, 2011; Moon et al., 1998, 2003). They suggested that when combined with appropriate forecasting-process design, forecasting techniques effectively increase forecast accuracy (Danese & Kalchschmidt, 2011; Moon et al., 1998, 2003). Recent research (Danese & Kalchschmidt, 2011) demonstrated that the forecasting process (the techniques adopted, the source of information, and the forecasting roles in decision-making) had a considerable influence on the operational performance of 343 manufacturing companies from six different countries.

Thus, drawing upon these prior studies and the definitions of each practice, this thesis considers that the demand forecasting factor contains three variables: forecasting technique, information source, and forecasting roles in decision-making. Therefore, the demand planning process includes five primary practices: goal formulation, forecasting technique, information

source, forecasting roles in decision-making, and communicating the predictions and synchronizing supply with demand (as shown in Figure 11). The following are the details of these practices.

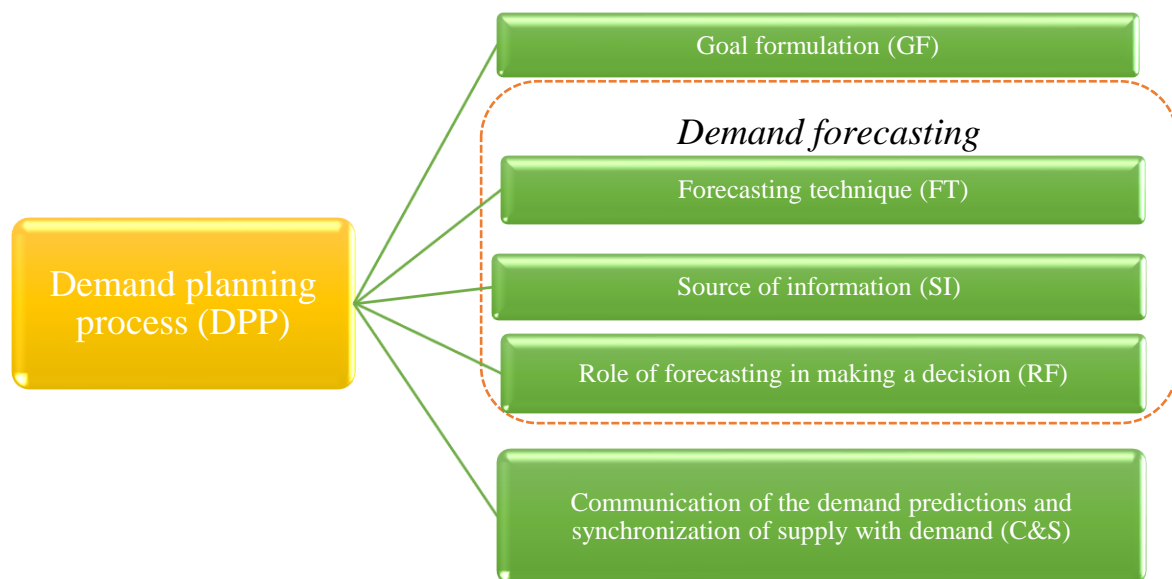

Figure 11: The demand planning process and its primary practices

The first practice, goal formulation (GF), aims to fully comprehend the customers, their expectations, and the manufacturing capacity (Swierczek, 2020; Świerczek, 2019). The process team must deeply understand the company’s strategy, consumers' requirements, production capabilities, and supply chain network (Croxtton et al., 2002). The DPP aims to establish a supply and demand balance by effectively catering to different market expectations through various supply chain abilities (Świerczek, 2019).

Forecasting techniques (FT) are the second practice employed to predict demand throughout the DPP. Effective DPP requires appropriate forecasting techniques (Croxtton et al., 2002; Vlckova & Patak, 2011). Furthermore, (Swierczek, 2020) discovered that forecasting techniques had the most significant effect on operational risks. Many forecasting techniques have been developed and implemented in the literature. According to the authors (Croxtton et al., 2002), the forecasting context will decide the best techniques. Quantitative techniques based on past data are ideal for products with minor uncertainties. On the other hand, qualitative methods, such as sales reports or consumer research, are suitable for products with high demand volatility.

The third practice, the source of information (SI), is critical to the DPP. Historical data, sales predictions, promotion strategies, business goals, market share statistics, and market research are all examples of data sources (Croxtton et al., 2002). Gathering data from various sources may be beneficial because forecasters better understand and analyze future customer demand and market change, particularly purchasing behaviors and trends (Danese & Kalchschmidt, 2011).

Fourth, the role of forecasting in making a decision (RF) is a crucial component that contributes to successful DPP. Based on demand forecast information, the supply chain managers make lots of proper operational, tactical, and strategic decisions in many areas, such as production planning, sales budgeting, new product launches, and promotion planning (Danese & Kalchschmidt, 2011; Perera et al., 2019; Abolghasemi et al., 2020). Also, they found that the role of forecasting in decision-making significantly affects cost and delivery performance. Demand forecasting anticipates future product or service consumption to plan operations to reduce delivery times, stock levels, and operating costs (Kantasa-ard et al., 2021).

The final practice in the DPP is to communicate the forecasts and synchronize supply and demand (C&S). The communication process should give appropriate information on actual consumer needs, which may effectively coordinate supply and demand (Croxtton et al., 2002), (Swierczek, 2020). Synchronization processes aim to align demand forecasts to the supply chain's production, supply, and logistics capacity. Synchronization involves collaboration with marketing, production and procurement, logistics, and finance (Croxtton et al., 2002). The better demand planners can synchronize their efforts with sales and the market, the more effectively they can support operations of procurement, production, and distribution (Vlckova & Patak, 2011). Supply-chain synchronization is a dynamic competence that increases the competitive advantage (Swierczek, 2020).

2.3.1.2 The effect of demand planning practices on supply chain performance

Table 6 summarizes the recent works that have been conducted on the relationship between demand planning practices and supply chain performance. This table divides into the five categories identified in our work: goal formulation, forecasting techniques, information source, forecasting roles in making a decision, and communicating the predictions and synchronizing supply with demand. Their effects on supply chain performance have been linked. As shown in Table 6, most prior researchers discovered a positive relationship between specific demand planning practices and supply chain performance, especially operational

performance. Unfortunately, no research has been conducted to investigate the DPP as a higher-order concept on supply chain performance. Supply chain performance comprises the entire supply chain's operations in satisfying final customer requirements, such as order fulfillment, on-time shipment, and all the necessary inventory and capacity required in the supply chain to achieve that performance responsively (Hausman, 2005). Hence, improving supply chain performance results in organizational success. Operational performance (cost, delivery speed, reliability, quality, and flexibility) is used to assess the efficiency and effectiveness of a company's internal activities (I. J. Chen & Paulraj, 2004). Previous scholars measured operational performance using various performance categories, for example, cost and delivery (Danese & Kalchschmidt, 2011); delivery, quality and flexibility (Thomé et al., 2014); forecast accuracy, cost reduction, and delivery performance (Doering & Suresh, 2016); forecast accuracy (Basson et al., 2019). As we can see, cost and delivery have been prominently employed in previous research.

Table 6: Demand planning practices and supply chain performance

Variable	(Danese & Kalchschmidt, 2011)	(Thomé et al., 2014)	(Doering & Suresh, 2016)	(Raza & Kilbourn, 2017)	(Basson et al., 2019)	(Świerczek, 2019)	(Swierczek, 2020)
Goal formulation						X	X
Forecasting techniques	X		X		X	X	X
Information sources	X		X	X	X	X	X
Forecasting roles in making a decision	X						
Communication of the demand predictions and synchronization of supply with demand		X	X		X	X	X
Operational performance	Operational performances (cost and delivery performances)	Operational performance (delivery, quality and flexibility)	Forecast accuracy, cost reduction and delivery performance		Forecast accuracy		

In this section, we described five elements of DPP and its relationship with operational performance. The following section will focus on the evolution of hybrid forecasting models, which have recently become prominent for predicting future customer demand.

2.3.2 Evolution of the forecasting models

Various famous forecasting methods have been utilized to forecast demand in the

literature. However, each method's success is affected by the properties of the data (Abolghasemi et al., 2020; Bennett et al., 2014; Feizabadi, 2020; Kantasa-ard et al., 2021; Siami-Namini et al., 2019; Spiliotis et al., 2020). For instance, ARIMAX models outperformed in predicting considerable surges in demand, whereas the neural network (NN) models work well with minor variations in the market (Bennett et al., 2014). Also, the author (Feizabadi, 2020) found similar findings in homogenous datasets. Researchers (Siami-Namini et al., 2019) indicated that LSTM performed better than ARIMA concerning financial time series. In contrast, the authors (Spiliotis et al., 2020) discovered that some statistical methods performed as well as ML methods in the case of intermittent and lumpy series.

Consequently, many studies have revealed that there is no ideal method for all circumstances (Khashei & Bijari, 2011) and all datasets (Babu & Reddy, 2014; Panigrahi & Behera, 2017). For example, the researchers (Abolghasemi et al., 2020) proved that dynamic linear regression (DLR) and support vector regression (SVR) exhibited stable performance and high accuracy levels across the various volatility demand groups as compared to earlier statistical and ML models. On the other hand, an artificial neural network (ANN) produces better performance when the demand series is low volatility, but it fails miserably when the demand series is high volatility. Recently, (Kantasa-ard et al., 2021) found that LSTM performed well with continuous variability, while Multiple Linear Regression (MLR) and ARIMAX are preferable for discrete variability. Hence, the models should be adaptable depending on the dataset's characteristics and the forecasting method's particularities (Spiliotis et al., 2020). Thus, many authors have recently paid attention to hybrid models that combine single models' power.

Hybrid models have the potential to overcome the limits of single models while enhancing prediction accuracy and reliability (Babu & Reddy, 2014; Panigrahi & Behera, 2017; P. Wang et al., 2017). A single model has strengths and weaknesses (Aburto & Weber, 2007). For example, some models are only capable of forecasting the linear component. While other models perform better when dealing with a non-linear element (Kantasa-ard et al., 2021). Hence, when both models are merged, the strengths of each model can then be fully exploited (Y. Chen et al., 2015). Several previous studies highlighted the benefits of hybrid forecasting methods. For instance, combining different models might significantly increase forecast accuracy (Ayyanathan & Kannammal, 2015). A study by (Bacci et al., 2019) indicated seven major strengths of combining forecasting methods, such as higher forecasting accuracy, lower volatility, and being safer and less expensive. Moreover, combining forecasts from different

methods minimized uncertainty and improved the management of volatility, inventory, and order variation (Abolghasemi et al., 2020).

Table 7 details relevant studies using different hybrid models released in recent years. This table summarizes each study's contribution, modeling methods, area, strengths, and limitations. It can be seen that lots of hybrid models have been developed and implemented in various applications. Most of them are derived from the combination of traditional and ML methods to maximize the advantages of both approaches. ARIMA is commonly employed among traditional forecasting methods. At the same time, the artificial neural network (ANN) is a widespread technique in ML methods. However, because of the abilities of LSTM, some articles have recently employed it instead of ANN in hybrid models (Choi, 2018; Dave et al., 2021; Soy Temür et al., 2019). Unfortunately, no empirical evidence has been done for mixing ARIMA and LSTM models in the context of coffee or agricultural products.

Furthermore, coffee demand time-series data contain various temporal fluctuations and trend changes, making precise prediction challenging (Peng et al., 2017). Nonetheless, coffee demand forecasting gains little attention. As indicated in Table 7, there is only one publication on the hybrid model for forecasting coffee demand. Researchers (Naveena et al., 2017) proposed a novel ARIMA-ANN hybrid model that predicts Indian Robusta coffee monthly prices. They showed that their hybrid model outperforms single models (ARIMA and ANN). The hybrid model helps to improve forecasting accuracy and balance future supply and demand. Besides, there are few papers on coffee demand forecasts in the literature. Most researchers have relied on a single technique (Sharma et al., 2018), (Rincón et al., 2020). For instance, the authors (Sharma et al., 2018) developed an ARIMA model to predict the quantity of coffee production in India from 2015 to 2026 using monthly time-series data for six years from 2010 to 2015. Also, the authors (Rincón et al., 2020) employed and compared different statistical techniques for predicting Colombian coffee demand in South Korea.

Moreover, most studies on coffee demand forecasting have been tested in newly industrialized countries, such as South Korea ((Rincón et al., 2020), Greece (Spiliotis et al., 2020), China (Peng et al., 2017), and Brazil (Bacci et al., 2019). Unfortunately, there is a lack of research on coffee demand forecasting in developing countries where economic development needs to undertake adequate planning for sustainable growth, overall development, and poverty alleviation (Naveena et al., 2017). Indeed, the forecasting models' performance relies on the dataset's properties and external factors such as price and macroeconomic variables (Feizabadi, 2020). Thus, some studies were conducted in India and

Indonesia, but they focused on predicting coffee production (Sharma et al., 2018) and coffee price (Naveena et al., 2017; Novanda et al., 2018). Besides, there is a lack of studies on forecasting coffee demand, particularly in Vietnam. According to the ICO (International Coffee Organization, 2021), Vietnam is the world's second-largest coffee producer. Thus, anticipating the demand for Vietnamese coffee plays a vital role in the global coffee supply chain.

Therefore, by using actual data obtained in Vietnam, we aim to develop a new hybrid model that provides more accurate predictions of coffee consumption and a better balance with coffee production. The following section will describe the ARIMAX, LSTM, and selected ARIMA-LSTM hybrid models and performance indicators.

Table 7: A Literature review

Authors name	Contribution	Methods and techniques		Domain	Superiority (S)/ Drawback (D)
		Used models	Benchmark models		
Part A: Hybrid model					
(Khashei & Bijari, 2011)	Proposing a new hybrid ANN-ARIMA model	ARIMA, ANN	ARIMA, ANN, Zhang's hybrid model	Three data sets: Wolf's sunspot data, the Canadian lynx data, and the British pound/US dollar exchange rate data	S: Time series consist of a linear and a non-linear component D: Proposed model has the potential to achieve lower precision if the time series includes only non-linear elements
(Zheng & Zhong, 2011)	Proposing a hybrid method	radial basis function (RBF) neural network and autoregression (AR) model		Data of Canadian Lynx data	S: AR model models the residuals, which are considered to be stationary linear. S: Use binomial smoothing technique smoothes data sets D: RBF neural network with binomial smoothing is unable to catch all of the data patterns
(Jaipuria & Mahapatra, 2014)	Proposing integrated discrete wavelet transforms and ANN (DWT-ANN model)	DWT-ANN model	ARIMA model	Three different firms	S: Studying effects of the proposed model to supply chain performance such as BWE and NSAm D: Not compared to other deep learning methods D: Not consider different lead time
(Babu & Reddy, 2014)	Proposing a new hybrid ARIMA-ANN model	ARIMA and ANN models	ARIMA and ANN models and some hybrid ARIMA-ANN models	Sunspot data, electricity price data of New South Wales, and stock market data	S: MA filter decomposes time series into two data sets. D: More data is missing as time series are decomposed
(Y. Chen et al., 2015)	Proposing a new combined forecasting method (ESPLSSVM)	Particle swarm optimization (PSO) and least squares support vector machine (LSSVM) model	LSSVM, ELSSVM	Electric load in New South Wales	S: Combine several models D: Remove seasonality first before forecasting so some data will be lost
(Naveena et al., 2017)	Proposing a new hybrid ARIMA-ANN model	ARIMA-ANN	ARIMA; ANN	Indian Robusta coffee monthly wholesale price	S: Application of Zhang's hybrid model in case of coffee price time series D: Limited validation (3-month dataset used)
(P. Wang et al., 2017)	Proposing a novel hybrid-Garch model	ARIMA and SVM	ARIMA and SVM	10-day hourly PM2.5 concentrations data, in Shenzhen, China	S: Using Garch model to estimate the coefficients of each model D: Actual and dynamic emission data for the study area were not available
(Panigrahi & Behera, 2017)	Proposing hybrid ETS-ANN model	ETS-ANN model	ARIMA, ETS, multi-layer perceptron (MLP), and some existing hybrid ARIMA-ANN models.	Sixteen time-series datasets	S: Exploring the performance of exponential smoothing models in hybrid models D: There were no deep learning techniques used
(Sarica et al., 2018)	Proposing new hybrid forecasting method (AR-ANFIS)	autoregressive (AR), adaptive network fuzzy inference system (ANFIS)	ARIMA, ANFIS, and MANFIS methods	12 time-series datasets	S: Using one-stage Guaranteed convergence particle swarm optimization (GCPSO) for estimating weights of ANFIS and estimating in a hybrid model D: Methods focused on deep learning were not included
(Du et al., 2019)	Proposing a novel hybrid forecasting model	ensemble empirical mode decomposition (CEEMD) with adaptive noise (CEEMDAN), Wavelet neural network (WNN), and Multi-objective Moth-flame	GRNN, WNN, CEEMD-WNN, CEEMD-MFO-WNN and CEEMD-MOMFO-WNN	Four wind power time series in Spain	S: MOMFO algorithm is first employed D: Decompose data that may be lost in data

				Optimization algorithm (MOMFO)			
(Pham & Pham, 2020)	Proposing new hybrid model			ANN-ES3	ANN, Triple exponential smoothing methods ES3, and ANN-ES1	ten datasets belonging to different areas in Australia and the US	S: Predict data that are non-linear, trending, and seasonal S: Propose a new way to calculate the weight of each model D: Suggest using ARIMA instead of ES3
Elattar et al., 2020	Proposing hybrid method	LWSVR-MGOA		Locally Weighted Support Vector Regression (LWSVR) and Modified Grasshopper Optimization Algorithm (MGOA)	ARIMA, ANN, ANN+RF, HEFM	SVR, six different real-world datasets	S: MGOA is employed to optimally the LWSVR's parameters D: Focus on short-term load forecasting
1(Guo et al., 2021)	Proposing hybrid approach	PROPHET-SVR		PROPHET-SVR	7 selected hybrid models in the literature	fire protection industry in China	S: Prophet is used to forecast the seasonal fluctuations D: Focus on forecasting seasonal product demand
Part B: hybrid models using LSTM and ARIMA							
(Choi, 2018)	Proposing hybrid model	ARIMA-LSTM	hybrid	ARIMA-LSTM	full historical model, constant correlation model, single-index model, and the multi-group model	The correlation coefficient between the prices of two different stocks	S: ARIMA predicts linearity, then LSTM predict nonlinearly S: Develop a hybrid model for portfolio optimization D: Not cover periods before the year 2008 D: Not considering the influence of exogenous variables
(Soy Temür et al., 2019)	Proposing hybrid (LSTM and ARIMA) model			LSTM and ARIMAX	LSTM and ARIMAX	124-month data of housing sales in Turkey	S: Calculating weights of each model based on obtained error values S: Consider price as an exogenous variable D: LSTM trained with different epoch numbers D: limiting the number of data that could be used
(Dave et al., 2021)	Proposing a hybrid model	ARIMA and LSTM models		ARIMA, LSTM	ARIMA, LSTM	Monthly Indonesian exports data	S: Time-series data divide into trend, seasonality, and residuals S: ARIMA model is used for trend component, while LSTM for seasonal component and residual component D: Limited dataset (Validation set includes 12 months) D: Decomposition can lose some data D: Not considering the influence of exogenous variables
(Zhou et al., 2019)	Proposing heterogeneous structure LSTM with SMBO			LSTM series	Traditional machine learning models include SVR, Backpropagation neural networks (BPNN), Gradient boosting regressor (GTB), and Decision tree regressor (DTR)	electricity markets of Pennsylvania–New Jersey–Maryland	S: Use sequence model-based optimization to optimize hyperparameters D: Not considering the influence of exogenous variables such as load and holidays
<i>Thesis's goal</i>	<i>Proposing a new hybrid LSTM model</i>	<i>ARIMAX-LSTM</i>		<i>ARIMAX, LSTM</i>	<i>ARIMAX, LSTM, ANN, two previous hybrid ARIMA-LSTM models (Soy Temür et al., 2019 and Dave et al., 2021)</i>	<i>Vietnamese coffee demand and Thailand product demand</i>	<i>S: Can capture different combinations of linear and nonlinear patterns in time series S: Considering the influence of exogenous variables (price) D: Focus on agricultural time series data</i>

2.3.2.1 Utilized models

a. Autoregressive Integrated Moving Average with exogenous factors (ARIMAX)

The ARIMAX model is a subset of the ARIMA model that can be developed by applying a parameter to the original Autoregressive Integrated Moving Average (ARIMA) model (Abolghasemi et al., 2020). ARIMA models are among the most common linear models used for time series forecasting in many domains, such as social, economic, engineering, foreign exchange, and stock problems (Choi, 2018; Khashei & Bijari, 2011; Panigrahi & Behera, 2017). ARIMA is the most common traditional forecasting method applied to find the optimal match for historical values (Choi, 2018; Kilimci et al., 2019). ARIMA models assume that future time series are linearly connected with the current and prior values (Abbasimehr et al., 2020; Khashei & Bijari, 2011). When predicting the subsequent lags of time series, the ARIMA models outperformed other traditional techniques in terms of accuracy (Kilimci et al., 2019). As a result, ARIMA has been commonly used to create more robust hybrid models (Babu & Reddy, 2014; Khashei & Bijari, 2011; Naveena et al., 2017; Soy Temür et al., 2019; P. Wang et al., 2017).

ARIMA is made up of three phases: autoregression (AR), integration, and moving average (MA) (Abbasimehr et al., 2020). ARIMA is the acronym for ARIMA (p, d, q). The integer values p, d, and q determine the time series model's composition. The order of the AR model and MA model is parameter p and q, respectively. The degree of data differencing is represented by parameter d. ARIMA's "integrate" phase allows it to work with non-stationary time series data (Naveena et al., 2017; Siami-Namini et al., 2019).

ARIMA has the following mathematical representation (Siami-Namini et al., 2019):

$$y_t = c + \phi_1 y_{t-1} + \phi_2 y_{t-2} + \dots + \phi_p y_{t-p} + \varepsilon_t + \theta_1 \varepsilon_{t-1} + \dots + \theta_q \varepsilon_{t-q} \quad (4)$$

Alternatively, Equation 4 can be written as follow:

$$y_t = c + \sum_{i=1}^p \phi_i y_{t-i} + \varepsilon_t + \sum_{i=1}^q \theta_i \varepsilon_{t-i}$$

Besides, ARIMAX can be built by adding a price PR_t , as the covariate to the right-hand side of Equation 4 (Abolghasemi et al., 2020).

$$y_t = c + \beta PR_t + \sum_{i=1}^p \phi_i y_{t-i} + \varepsilon_t + \sum_{i=1}^q \theta_i \varepsilon_{t-i} \quad (5)$$

Where $\beta \neq 0$, $\phi_i \neq 0$; $\theta_i \neq 0$; and $\sigma_\varepsilon^2 > 0$; y_t : the stationary variable; c : constant; ϕ : autocorrelation coefficients at lags 1,2,...,p; ε_t : Gaussian white noise series with mean zero and

variance σ_ε^2 ; θ : the weights assigned to the stochastic term's current and prior values in the time series, and $\theta_0 = 1$; p : lagged observations; q : the size of moving average window; (d) : difference, PR_t : price at time t , y_t : the value to predict at time t .

b. Long Short-Term Memory (LSTM)

A recurrent neural network (RNN) is a neural network that anticipates the next step in a sequence of observations based on the previous stages in the series (Siarni-Namini et al., 2019). Because RNNs work the same role with each part of the sequence, with the ability to forecast future unknown sequential data using previously collected information, RNNs are named "recurrent" (Siarni-Namini et al., 2019). However, the vanishing and exploding gradient problem is a limitation of RNNs, making them difficult to practice. Hence, LSTM can be utilized with gated architectures to eliminate this issue (Abbasimehr et al., 2020). Moreover, LSTM is the most robust RNN model that depends on a memory cell concept (Kantasa-ard et al., 2021). This model gathers and transfers relevant memories from previous time frames into the current one (Dave et al., 2021).

LSTM offers various advantages over other ML forecasting models, making them ideal for forecasting tasks. Firstly, LSTM is effective for dealing with complex data and non-linear patterns (Kantasa-ard et al., 2021; Soy Temür et al., 2019). Secondly, LSTM is a kind of RNN designed to learn long-term dependencies (Soy Temür et al., 2019). LSTM used a memory cell concept to build the neural network structure (Kantasa-ard et al., 2021). Thirdly, several articles have shown empirical evidence that the LSTM network outperforms other ML and traditional methods. For example, (Abbasimehr et al., 2020) proved that the multi-layer LSTM network performs better than other methods, such as ARIMA and RNN. Similarly, (Kantasa-ard et al., 2021) demonstrated that LSTM is better than ARIMAX, MLR, and SVR in capturing future and current demand patterns in terms of the coefficient of determination.

Figure 12 presents the structure of LSTM. LSTM includes an input gate, a forget gate, an internal state (cell memory), and an output gate. LSTM operates as follows:

Using a sigmoid activation, the forget gate $f(t_i)$ uses $x(t_i)$ and $h(t_{i-1})$ as input to calculate the information that has to be saved in $c(t_{i-1})$. Then, to calculate the value of $c(t_i)$, the input gate $a(t_i)$ uses $x(t_i)$ and $h(t_{i-1})$. By taking into account $c(t_i)$ and using both sigmoid and tanh layers, the output gate $o(t_i)$ controls an LSTM cell's output.

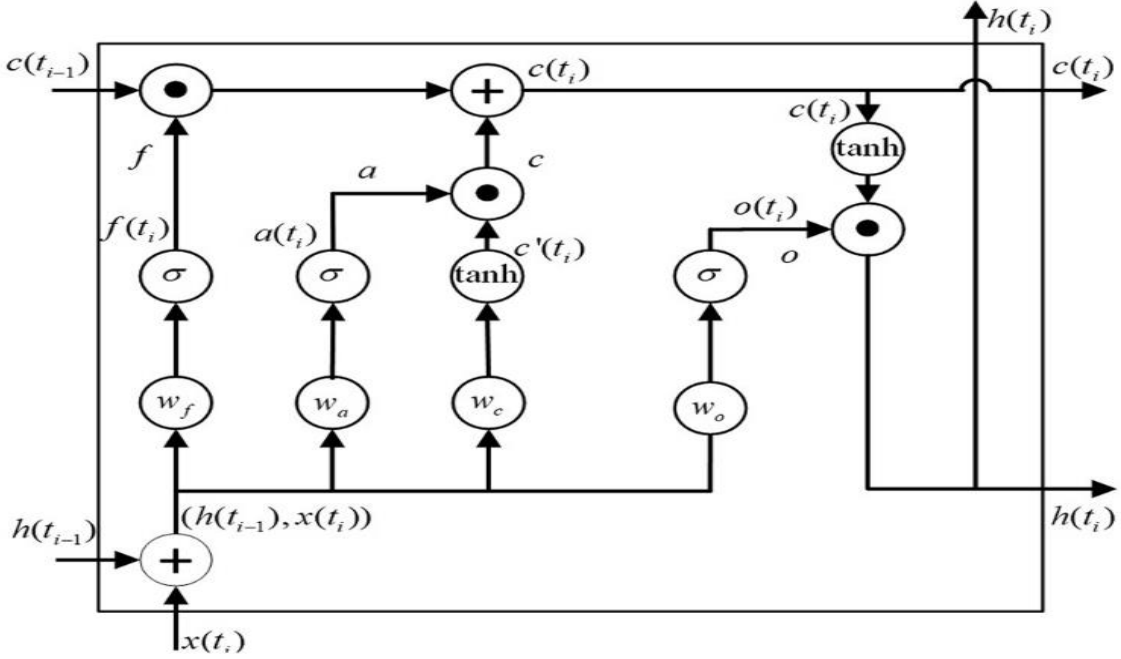

Figure 12: The LSTM framework (Abbasimehr et al., 2020)

The LSTM forward learning is calculated (Abbasimehr et al., 2020) as follows:

$$a(t_i) = \sigma(w_a x(t_i) + w_{ha} h(t_{i-1}) + b_a) \quad (6)$$

$$f(t_i) = \sigma(w_f x(t_i) + w_{hf} h(t_{i-1}) + b_f) \quad (7)$$

$$c(t_i) = f_t \times c(t_{i-1}) + a_t \times \tanh(w_c x(t_i) + w_{hc} h(t_{i-1}) + b_c) \quad (8)$$

$$o(t_i) = \sigma(w_o x(t_i) + w_{ho} h(t_{i-1}) + b_o) \quad (9)$$

$$h(t_i) = o(t_i) \times \tanh(c(t_i)) \quad (10)$$

Notations:

σ and \tanh are activation functions, and \times indicates point-wise multiplication.

$x(t_i)$: The input value

$h(t_{i-1})$ and $h(t_i)$: The output value at the time point t_{i-1} and t_i

$c(t_{i-1})$ and $c(t_i)$: Cell states at time points t_{i-1} and t_i

$b = \{b_a, b_f, b_c, b_o\}$: Biases of input gate, forget gate, internal state, and output gate.

$\vec{w}_1 = \{w_a, w_f, w_c, w_o\}$: Weight matrixes of input gate, forget gate, internal state, and output gate.

$\vec{w}_2 = \{w_{ha}, w_{hf}, w_{hc}, w_{ho}\}$: The recurrent weights of each gate

$\vec{a} = \{a(t_i), f(t_i), c(t_i), o(t_i)\}$: The output outcomes for input gate, forget gate, internal state, and output gate.

Then, each layer's error between the output and the input data is computed. Next, the error is propagated back to the input gate, cell, and forget gate. Finally, an optimization algorithm adjusts each gate's weight depending on the error expression, such as the Adam algorithm (Abbasimehr et al., 2020).

This thesis aims to find the best accurate forecasting model. Hence, we compare our proposed ARIMAX-LSTM hybrid model to single and existing hybrid models. The next part will discuss the current hybrid models.

2.3.2.2 Existing hybrid models

As seen in table 7, many researchers have adopted ANN to forecast non-linear time series data. Besides, there is a lack of empirical evidence for combining ARIMA and LSTM, especially in coffee. Therefore, this thesis contributes to the literature by providing a new combination of ARIMAX and LSTM for coffee daily demand forecasting. Prior hybrid models have been mainly examined using monthly data (Choi, 2018; Dave et al., 2021). Daily demand forecasting is critical in many industrial contexts (Spiliotis et al., 2020). Besides, neural networks require much historical time series and information from monthly and daily data (Kantasa-ard et al., 2021). Moreover, several hybrid models combined ARIMA and LSTM models in the literature (Choi, 2018; Dave et al., 2021; Soy Temür et al., 2019). To the best of our knowledge, no studies have been conducted to compare the performance of various ARIMA-LSTM hybrid models.

Three ARIMA-LSTM hybrid models can be found in Table 7. They demonstrated that the ARIMA-LSTM hybrid models provide higher forecast accuracy than individual models. We selected two models by authors (Soy Temür et al., 2019) and (Choi, 2018) as a benchmark for the following reasons: First, the author (Choi, 2018) developed the first ARIMA-LSTM hybrid model that followed a hybrid strategy of (Zhang, 2003). The researcher (Zhang, 2003) provided the first method for combining the advantages of ANN and ARIMA by modeling ARIMA's residual with the ANN model. Many papers applied Zhang's approach in the context of a supermarket (Aburto & Weber, 2007), sunspot data, electricity prices, stock prices (Babu & Reddy, 2014), and coffee prices (Naveena et al., 2017). Second, the authors (Soy Temür et al., 2019) proposed a different ARIMAX-LSTM hybrid model. The outcomes of single models are combined in this second hybrid model. Although this second hybrid model considered the effect of price as an exogenous factor, the differences between the model of Soy Temür et al. (Soy Temür et al., 2019) and our proposed model are the weights calculation of each model

and the final output. We don't consider the model (Dave et al., 2021) for two main reasons. First, they did not investigate the impact of any exogenous factor on forecasting Indonesia's exports. Second, they decompose time series data into trend, seasonality, and residuals.

Both selected hybrid models are illustrated as follows.

a. Choi's ARIMA-LSTM hybrid model

The author (Choi, 2018) proposed an ARIMA-LSTM hybrid model for forecasting stock prices. This model is called Choi's ARIMA-LSTM hybrid model. These authors use ARIMA to run the initial time series. Then, the residuals of the ARIMA model are performed by LSTM. The final output of Choi's ARIMA-LSTM hybrid model is calculated as Equation 11 (Zhang, 2003).

$$\hat{Y}_t^{hybrid} = \hat{L}_t + \hat{N}_t \quad (11)$$

Where \hat{Y}_t^{hybrid} : the ultimate hybrid forecast at time t; \hat{L}_t : linear forecast at time t by using ARIMA; \hat{N}_t : non-linear forecast at time t by using LSTM

b. Soy's ARIMAX-LSTM hybrid model

The second hybrid model chosen is Soy's ARIMAX-LSTM model, developed by authors (Soy Temür et al., 2019) for predicting house sales. These authors also follow (Zhang, 2003) concept that the hybrid prediction formula is the sum of linear (L_t) and nonlinear components (N_t) of the time series. However, ARIMAX and LSTM run original time series to capture (L_t) and (N_t), respectively. Then the error value and the final hybrid are measured as follows (Equation 12):

$$\hat{Y}_t^{hybrid}[t] = (LSTM_{weight} \times LSTM_{error}[t] + ARIMAX_{weight} \times ARIMAX_{predict}[t])/2 \quad (12)$$

Where:

$$LSTM_{weight} = \left(1 - \left(\frac{LSTM_{error}}{LSTM_{error} + ARIMAX_{error}} \right) \right) \times 2$$

$$ARIMAX_{weight} = 2 - LSTM_{weight}$$

$$LSTM_{error} = LSTM_{mean}[error]$$

$$ARIMAX_{error} = ARIMAX_{mean}[error]$$

$$\text{error} = \text{real value} - \text{predicted value}$$

2.3.2.3 Performance metrics

a. Financial and operational metrics

Demand forecasting accuracy improves the supply chain's performance (Feizabadi, 2020; Jaipuria & Mahapatra, 2014). As a result, this thesis examines the influence of the proposed forecasting model on supply chain performance.

Various KPIs or metrics can measure supply chain performance (SCP). According to (I. J. Chen & Paulraj, 2004), supply chain performance consists of financial and operational performance. The financial performance focuses on using financial indicators based on outcomes, for example, sales growth, profitability, and earnings per share. Financial metrics represent a company's evaluation by external variables of its border. In contrast, operational metrics are used to assess the efficiency and effectiveness of a company's internal activities. These performance categories indicate supply chain abilities in certain aspects, such as cost, delivery speed, reliability, quality, and flexibility. Thus, our study follows this definition to categorize the financial and operational indicators.

In the previous studies, only a few authors have studied how the forecasting model affects supply chain performance, but they focused on operational metrics rather than financial ones (Feizabadi, 2020; Jaipuria & Mahapatra, 2014). For instance, a recent study by (Feizabadi, 2020) selected three performance metrics, but two of them are non-financial (forecast accuracy, inventory turns), and only one is financial (cash-conversion cycle). The results show that ML-based forecasting methods improve supply chain performance better than the traditional forecasting method in steel manufacturing companies. Although our purpose is similar to this study, there are differences between the modeling approach, performance metrics, and dataset. Due to the limited data and the evaluation of each metric, our study selects the relevant performance metrics comprised of financial and operational metrics. They are the Bullwhip Effect (BWE), Net Stock Amplification (NSAmp), Transportation Cost (TC), and Inventory Turn (IT), respectively. They can fully assess the influence of demand forecasting on different SCP dimensions.

Prior researchers have used different operational performance measures in the literature, such as cost and delivery (Danese & Kalchschmidt, 2011), BWE and NSAmp (Jaipuria & Mahapatra, 2014), holding cost, and transportation costs (Kantasa-ard et al., 2021). The scholars (Jaipuria & Mahapatra, 2014) used BWE and NSAmp to evaluate supply chain costs

and customer service levels. According to Vietnam Logistics Report 2020, transportation cost is the most considerable logistics cost, accounting for 59%. In coffee production in Vietnam, the logistics cost accounts for 9.5% GDP of the country (Ministry of Industry and Trade of Vietnam, 2020). Thus, our study selects transportation cost as one of the operational metrics.

This study selects inventory turn (IT) in terms of financial metrics. Previous authors indicated that forecasters have rarely used financial metrics (Mccarthy et al., 2006; Mentzer & Kahn, 1995; Moon et al., 2003). One study by (Feizabadi, 2020) assesses the impact of forecasting techniques on financial performance using a cash conversion cycle. However, the data for this metric is not available. The findings also demonstrated that better demand prediction increases inventory performance and working capital quality, resulting in a higher return on assets (ROA) and profitability. However, this scholar considered inventory turn as a non-financial metric. However, based on the classification of a previous study (I. J. Chen & Paulraj, 2004), IT is treated as financial performance. Also, another study (Kwak, 2019) investigated the relationship between inventory turn metric and other financial metrics in various segments of Korean manufacturing enterprises. This author indicated that inventory turnover was a critical financial ratio to show how quickly the goods left the plant. The results revealed a positive link between inventory turn and turnover ratio of total liabilities and net worth in most segments, demonstrating how successfully a firm utilizes its capital. In addition, this research discovered a positive linkage between inventory turn and operating profit per share in several segments, such as textile and clothing, rubber, and plastics. Therefore, inventory turn is an essential metric that correlates well with other financial metrics.

b. Environmental metrics

Furthermore, all supply chain members, including growers, manufacturers, policymakers, and customers worldwide, have recently paid close attention to the sustainable supply chain. Based on the literature review, moving toward sustainability is critical for the business to maintain stable output, manage natural resources sustainably, and increase profits. Indeed, companies must efficiently include environmental concerns and sustainable practices in their daily business operations, particularly logistics and supply chain activities, in response to strict laws and growing customer awareness. As a result, it would be fascinating to examine whether our proposed method could improve sustainable supply chain performance.

According to (Carter and Rogers 2008), sustainability is interpreted as the capability to fulfill current demands without compromising the ability of future generations to meet their

needs. True sustainability happens at the intersection of all three elements: economic performance, environmental performance, and social performance (as shown in Figure 13). Thus, three components of sustainability can assess the performance of a sustainable supply chain. Besides, financial and operational performance is regarded as the economic performance of sustainability. Also, to the best authors' knowledge, no study has been conducted to compare the influence of the forecasting model on environmental performance. Additionally, there is a lack of available data for measuring social performance, such as health, safety, spending, social policy, workforce, job satisfaction, and employee ethics (Narimissa et al., 2020). Therefore, this study will evaluate the environmental performance of sustainability.

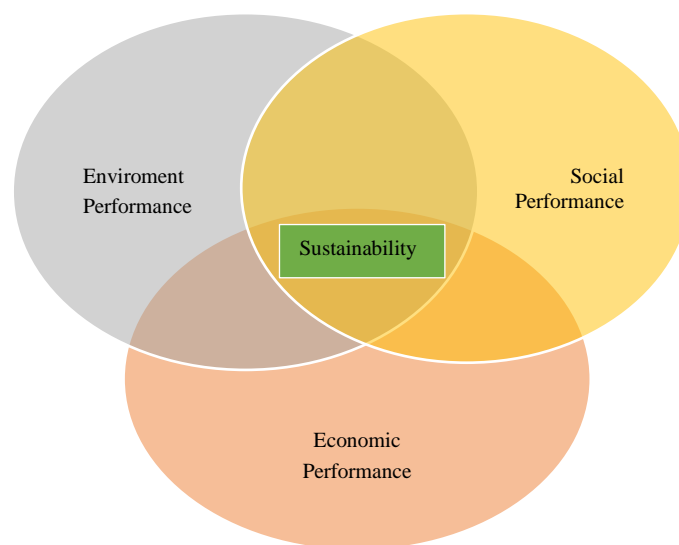

Figure 13. Sustainability (Carter and Rogers 2008)

According to (International Coffee Organization (ICO), 2022), climate change, caused by global warming, is expected to drive fundamental shifts in where and how coffee is harvested. Agricultural products are threatened strongly by climate change (Birkenberg & Birner, 2018), which is one of humanity's most serious environmental concerns (Williams, 2012). Besides, (Kittichotsawat et al., 2021) clarified that the environmental aspect of sustainability is ecologically friendly production (reuse, reverse, and recycle) in the long term without polluting the environment. In the literature, various indicators can be used to measure environmental performance. Carbon Footprint and Water Footprint are commonly used to assess the environmental impacts of any processes or products on greenhouse gas emissions

and water consumption (Ratchawat et al., 2020). As a result, in this study, we will use Carbon Footprint (CF) and Water Footprint (WF) to assess environmental performance. In the following section, we will discuss each indicator in detail.

To summarize, four famous metrics are adopted to measure SCP: three operational and one financial. These include the BWE, NSamp, TC, and IT, respectively. Also, two indicators (CF and WF) will be used to measure sustainable SCP. The formula of all selected performance measures will be described in Chapter 3.

2.4 Literature discussion and gaps

This section will explore literature gaps in supply chain modeling, assessment, and demand forecasting.

2.4.1 Supply chain modeling and performance measurement

This section aims to fill in the gaps in the literature mentioned above. Firstly, insufficient research has been conducted on modeling the coffee supply chain at a detailed process level and performance evaluation. Secondly, a few studies have been on applying the most recent version of SCOR, especially in coffee. Thirdly, to be the best authors' knowledge, there is a shortage of studies that proposes a coffee supply chain model of level 3. One study (Palomino et al., 2017) used a part of the SCOR to model the first two levels but did not mention the performance evaluation of Peru's organic coffee supply chain. Last, there is no study using the SCOR to dissect the essential processes and performance in the supply chain of Vietnamese coffee to the best authors' knowledge.

Therefore, this study will employ the latest version of SCOR) model, to propose standard coffee supply chain models that are hierarchical from level 1 to level 3. These proposal models facilitate the investigation of external and internal problems that decrease the coffee supply chain's efficiency. Also, this thesis will apply the SCOR model for performance measurement in the coffee supply chain.

2.4.2 Demand planning and demand forecasting

a. Demand planning

Based on the presented literature, several scholars have provided empirical evidence that demand planning practices positively influence supply chain performance (Basson et al., 2019; Raza & Kilbourn, 2017; Thomé et al., 2014). However, they have investigated demand planning

practices separately and independently. Also, they focused on different elements of the demand planning process. In addition, previous studies have not paid attention to the demand planning process in the context of coffee. Moreover, there is a lack of studies that examine how the demand planning process as a higher-order construct affects operational performance via cost and delivery performance. Therefore, this thesis fills these gaps in the literature.

b. Demand forecasting

Hybrid models are becoming more popular because of the benefits of mixing multiple models. There are numerous approaches to developing hybrid models. However, there is no empirical evidence of combining ARIMA and LSTM models in the context of coffee and agricultural products. As shown in Table 7, most hybrid models have been developed by combining traditional and ML methods. But they mainly used ANN as a representation of ML methods. Moreover, several papers have used LSTM instead of ANN in hybrid models due to the strengths of LSTM for forecasting demand (Choi, 2018; Dave et al., 2021; Soy Temür et al., 2019). Therefore, this thesis proposes a new hybrid model that integrates the advantages of two well-known models, including the ARIMAX and LSTM.

Furthermore, demand forecasting accuracy enhances supply chain performance. However, most scholars have focused on forecasting accuracy as the primary criterion for evaluating forecasting performance (Choi, 2018; Dave et al., 2021; Mccarthy et al., 2006; Mentzer & Kahn, 1995; Moon et al., 2003; Soy Temür et al., 2019). Some authors have not paid attention to supply chain performance. Many metrics have been employed in the literature to assess supply chain performance (Choi, 2018; Dave et al., 2021; Soy Temür et al., 2019). Hence, this thesis employs operational, financial, and environmental metrics to measure supply chain performance fully. As a result, this thesis demonstrates that our new hybrid model improves prediction accuracy and supply chain performance.

The next part will present a summary of all literature.

2.5 Summary

This chapter focuses on two aspects of the literature: supply chain performance and demand forecasting. In the first section, the SCOR model version 12.0 is selected to model and measure the performance of the coffee supply chain. The primary practices of DPP and their relationship with supply chain performance are mentioned in the second part. Five underlying practices of DPP are defined: goal formulation, forecasting techniques, information sources,

forecasting roles in decision-making, and communicating the predictions and synchronizing supply with demand. Moreover, this part presents various well-established methods that have been utilized to forecast demand. However, there is no best forecasting method for all situations. Therefore, a hybrid model is increasingly being adopted. After that, this thesis also mentions performance measures used to evaluate the impact of hybrid demand forecasting. All of the literature discussed above would aid in discovering new methodologies and algorithms to fulfill all gaps in the coffee supply chain.

CHAPTER 3: CONTRIBUTION OF DEMAND FORECASTING IN THE SUPPLY CHAIN

3.1 Introduction

Several significant problems in the coffee supply chain were identified in the previous chapters. The most crucial of them are the issues related to demand forecasting. Improving demand forecasting performance is the most effective solution to address these issues since it increases forecast accuracy and supply chain performance. Furthermore, demand forecasting is the most impactful aspect of the demand planning process, allowing firms to meet their customer's requests while also balancing supply and demand. Therefore, this chapter focuses on demand planning and demand forecasting. Initially, this chapter will discuss the main problems and approaches of the demand planning process and demand forecasting. A new notion of the demand planning process will then be proposed. Moreover, this chapter develops a new demand forecasting model that uses hybrid algorithms. Finally, we will show how to implement the approaches through unique methods, algorithms, and techniques.

3.2 Demand planning in the supply chain

This section presents demand planning issues in the supply chain. Then, we propose an approach to solve them. Besides, the influence of the demand planning process on supply chain performance will be investigated in this section.

3.2.1 Demand planning problems

In demand planning, there are two main issues.

First, there are various underlying practices in the demand planning process. For example, according to (Vlckova & Patak, 2011), demand planning encompasses several operations such as demand forecasting, inventory management, capacity planning, production planning, scheduling, and materials requirements planning. Recent studies by (Świerczek, 2019) (Swierczek, 2020) considered that the demand planning process consists of four practices: goal formulation, data collection, demand forecasting, communicating forecasts and syncing supply with demand. Consequently, companies and supply chain managers commonly misunderstand this process (Basson et al., 2019; Swierczek, 2020). Hence, they struggle to interpret the nature and behavior of client demand (Raza & Kilbourn, 2017), resulting in overproduction or shortage circumstances (Bacci et al., 2019).

Second, researchers have examined the impact of each demand planning practice on supply chain performance (Basson et al., 2019; Hofmann & Reiner, 2006; Raza & Kilbourn, 2017; Thomé et al., 2014). As a result, there is a scarcity of research considering the demand planning process as a higher-order factor organized by several underlying practices. Therefore, this issue leads to a lack of awareness about the efficacy of demand planning practices when combined.

All the issues discussed above highlighted the importance of an effective demand planning process. Defining fundamental parts of the demand planning process is vital to contribute to a reliable demand planning process. A better demand planning process could improve supply chain performance by assisting organizations in making better decisions relying on an insight into client behavior. Therefore, this section develops a novel concept of the demand planning process.

3.2.2 Proposed demand planning approach

3.2.2.1 Demand planning process as a higher-order construct

In a global business environment with a dynamic nature, assessing the environment and making rapid changes are critical factors in achieving supply chain and organizational success. According to (Grimm, 2008), applying dynamic capability theory benefits the supply chain. Authors (Barreto, 2010) reviewed the critical conceptual and empirical articles on dynamic capabilities published in leading management journals between 1997 and 2007. These authors reviewed dynamic capabilities as the abilities of an organization to react rapidly to changing environments. Hence, they proposed a new definition of dynamic capability: the firm's ability to systematically address issues thanks to its capability to detect opportunities and risks, make immediate and market-oriented decisions, and adjust its resource base. The notion of dynamic capabilities is an extension of the resource-based view that advocates resources as a key to achieving competitive advantage, the company's vital, uncommon, and inimitable aspects (Grimm, 2008). According to (Swanson et al., 2017), integration and reconfiguration are mainly mentioned in the literature on dynamic capabilities that clarify that a firm can gain a competitive advantage by working together across boundaries. Regarding the dynamic capabilities perspective, as a higher-order construct, demand planning can also be a higher-order dynamic capability that offers numerous advantages from organizational learning.

This work considers the demand planning process (DPP) as a dynamic capability to organize and quantify five practices. Past scholars have used similar approaches (Doering &

Suresh, 2016) and (Swierczek, 2020). For instance, authors (Doering & Suresh, 2016) explored forecasting management as a second-order competency construct consisting of four essential factors: internal integration, forecasting process quality, effective use of advanced systems, and forecasting assessment. Their work was done in the United States with a concentration on demand planning and the purpose of reaching top-level managers involved in predicting. The findings supported that forecasting management competency directly influences three performance outcomes: forecast accuracy, cost reduction, and delivery performance. For (Swierczek, 2020), the concept of the DPP consists of four practices, and he examined the influence of demand planning in reducing supply chain interruptions caused by operational risks. However, the sample used in this study was mostly made up of medium and big enterprises in European supply chains, so it does not represent demand planning conducted by the whole market's companies. As a result, our work will fill in the blanks by expanding on earlier research of (Swierczek, 2020) regarding the concept of the DPP and its influences on supply chain performance. In our work, we make some distinctions to understand the DPP better. Specifically, we added and classified five demand planning practices and focused solely on one industry, primarily small coffee companies. Furthermore, we examine the influence of the demand planning process as a higher-order construct on supply chain performance instead of supply chain risks. Hence, we propose the first hypothesis.

H1. The demand planning process (DPP) is a higher-order construct comprising five practices: goal formulation, forecasting techniques, information sources, forecasting roles in decision-making, and communicating the predictions and synchronizing supply with demand.

3.2.2.2 The effect of demand planning process as high-order construct on supply chain performance

Based on the literature, most prior researchers discovered a positive relationship between certain demand planning practices and supply chain performance, mainly operational performance. However, there is no evidence of studying the relationship between the DPP as a higher-order notion and operational performance. In addition, most scholars have evaluated operational performance through cost and delivery. Thus, we develop the following hypothesis that illustrates the relationship between the DPP and operational performance measured by cost and delivery.

H2. The demand planning process improves cost performance

H3. The demand planning process improves delivery performance

Figure 14 shows the theoretical research model. The model is developed following the relevant studies' findings and hypotheses. The DPP is supposed to affect operational performance (cost and delivery performance) positively.

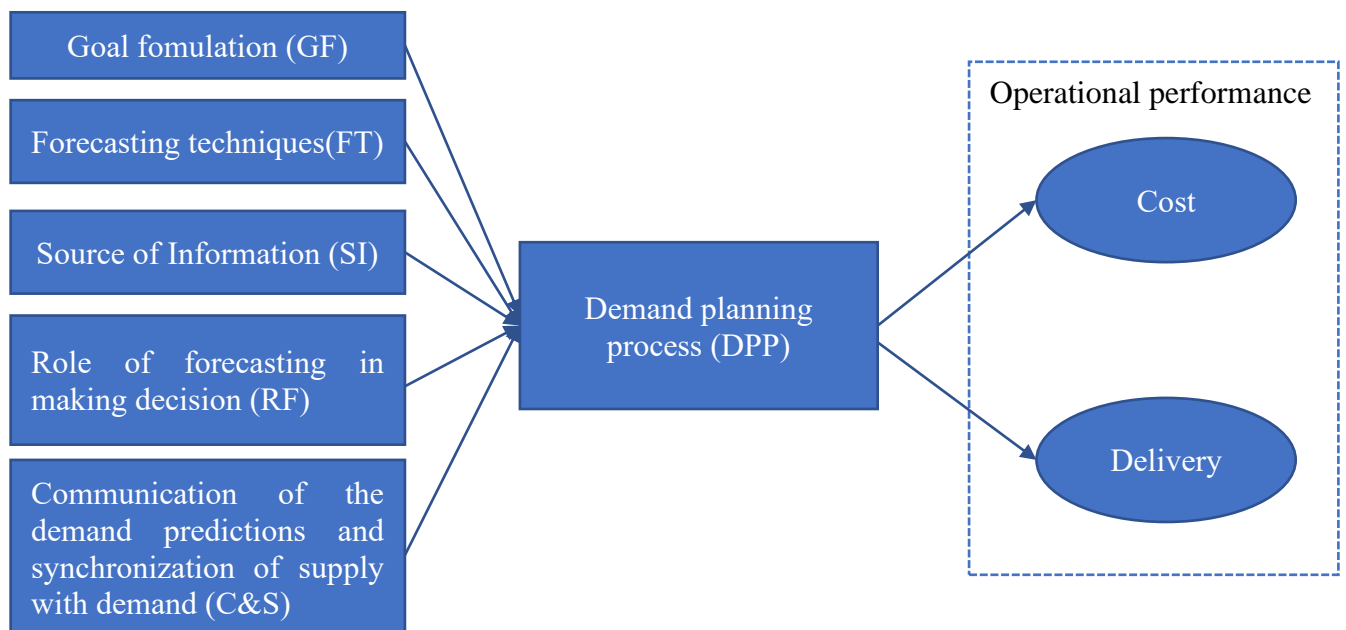

Figure 14: The theoretical model under investigation

3.2.3 The implementation of the demand planning approach

Following prior research (Swierczek, 2020), a quantitative survey was used to obtain data for our investigation. The survey is divided into three categories that match the research's purpose. The first part of the survey investigates the demography of the sample, including firm size and forecasting activity. Following that, the variables of demand planning practices are described in the second part. The questionnaire's final part contains six items for evaluating the performance of the supply chain.

To test the hypothesis, we employed the PLS-SEM, a widely used method in operation management (Sarstedt et al., 2014, 2019; Swierczek, 2020). This method was selected for the following reasons. First, PLS-SEM performs effectively with a small sample size (Hair et al., 2011). Second, PLS-SEM makes no assumptions about the underlying data (Sarstedt et al., 2014). Third, PLS-SEM is the recommended method when the study's goal is theory

development and prediction (Hair et al., 2011). Finally, it can estimate higher-order constructs such as the reflective-formative higher-order type (Sarstedt et al., 2019; Swierczek, 2020).

Table 8 presents indicators for the theoretical constructs employed in this thesis. All of the variables have already been used and validated in previous articles. This table is organized into three sections: constructs, items, and reference sources. The first column displays constructs in our research, including demand planning practices and operational performance. Our proposed DPP contains five core practices: goal formulation, forecasting techniques, information sources, forecasting roles in decision-making, and communicating the predictions and synchronizing supply with demand. Cost and delivery will be used to assess operational performance. The second column lists all of the items used to measure each construct. We employ seven constructs with 39 items to achieve the research goal. The last column illustrates the primary references.

Seven-point Likert scales are used in each question. We asked participants to evaluate the extent to which specific demand planning practices were used in their firms for the most vital product line with scales anchored by “1 – Not at all; [...]7 – Great extent”. In terms of supply chain performance, respondents were asked to rate the following performance in comparison to their rivals (1 for "far worse than" and 7 for "far better than").

Table 8: Constructs, items, and sources

Construct	Items	Sources
Demand planning practices		
Goal formulation (GF)	Identifying the customer priorities	(Swierczek, 2020; Świerczek, 2019)
	Identifying the product priorities	
	Tracking the proportion of completed client orders delivered on time	
	Customers are satisfied with the current on-time delivery performance	
	Ability to react to unanticipated, drop-in orders to unanticipated drop-in orders	
	Meeting short-term customer demands from the completed products inventory	
	Evaluating the "out-of-stock" position	
Forecasting techniques (FT)	Using quantitative time series models (e.g., exponential smoothing)	(Danese & Kalchschmidt, 2011; Swierczek, 2020; Świerczek, 2019)
	Using a single model	
	Using a combination of different models	
	Using quantitative causal models (e.g., regression or econometric analysis)	
	Using qualitative models	
	(e.g., market survey or sales quota)	
	The jury of executive opinion	
	Sales force composite	
Sources of information (SI)	Customer expectations	(Danese & Kalchschmidt, 2011; Swierczek, 2020; Świerczek, 2019)
	Using past data in generating a prediction	
	Using sales estimates in developing prediction	
	Using promotion plans to build demand forecasting	
	Using market share data in the predicting process	
	Considering the company's goal when developing predictions	
	Considering the inventory in demand prediction	
	Using information from the supplier	
	Using market research	
Roles of forecasting in decision-making (RF)	Taking the current economic situation	(Danese & Kalchschmidt, 2011)
	Developing sales and budget preparation	
	Developing Production planning	
	New product development	
Communication of the demand predictions and synchronization of supply with demand	Equipment planning	(Croxtton et al., 2002; Swierczek, 2020; Świerczek, 2019)
	Assisting the demand planning process using inter-organizational information	

(C&S)	Supporting the order commitment process using inter-organizational information	
	Sharing demand forecasting insights within supply chains	
	Accessing free forecasting data	
	Accessing online prediction data	
Operational performance		
Cost	Direct manufacturing costs	(Danese & Kalchschmidt, 2011)
	Total product costs	
	Raw material costs	
Delivery	Order fulfillment speed	
	Delivery speed	
	Delivery as promised	

3.3 Demand forecasting in the supply chain

The previous section identifies demand forecasting as a vital component of the demand planning process. As a result, better demand forecasting performance leads to better demand planning. This section will go through demand forecasting issues. Next, we will propose a new hybrid model that combines the strengths of ARIMAX and LSTM. The performance of the proposed model is then demonstrated in terms of forecast errors and performance indicators. All details will be presented as follows.

3.3.1 Demand forecasting problems in the supply chain

There are four main problems in forecasting demand in the supply chain.

- First, various forecasting methods have been developed and utilized to predict customer demand. However, their performance is depending on on the features of the data ((Abolghasemi et al., 2020; Bennett et al., 2014; Feizabadi, 2020; Kantasa-ard et al., 2021; Siami-Namini et al., 2019; Spiliotis et al., 2020)).
- Second, there is no appropriate method for all scenarios (Khashei & Bijari, 2011) and all datasets (Babu & Reddy, 2014; Panigrahi & Behera, 2017). Since each forecasting approach has its advantages and disadvantages (Aburto & Weber, 2007), thus, hybrid models that combine the strengths of multiple models can be an effective solution. Because they can overcome the constraints of each component model while improving forecasting accuracy (Babu & Reddy, 2014; Panigrahi & Behera, 2017; P. Wang et al., 2017).
- Third, agricultural data are complicated because they comprise linear and non-linear patterns (Naveena et al., 2017). Also, coffee demand time-series data contain high temporal fluctuation and trend shift, making precision prediction difficult(Peng et al., 2017).
- Finally, hybrid forecasting methods, which combine traditional techniques with machine learning, are superior (Aburto & Weber, 2007; Kantasa-ard et al., 2021). However, there is no proof of combining ARIMAX and LSTM methods in the context of coffee and agricultural products.

In response to the abovementioned concerns, this thesis proposed a novel ARIMAX-LSTM hybrid forecasting model that integrates the advantages of two well-known models,

ARIMAX and LSTM. LSTM and ARIMAX can capture the data's non-linear and linear components. Also, our study examines the effect of coffee prices on demand forecasting. The housing price is an indicator that provides helpful information to accurately predict housing sales (Soy Temür et al., 2019). Moreover, the price of products helps reduce the difference between the forecast and actual demand of a fast-moving consumer goods food company (Abolghasemi et al., 2020).

3.3.2 Proposed hybrid demand forecasting model

As mentioned in the literature review, each method has positive and negative sides (Aburto & Weber, 2007). Combining different forecasting models assists in capturing various kinds of patterns in time series (Abdollahi & Ebrahimi, 2020; Safari & Davallou, 2018). Therefore, many authors have shown that hybrid forecasting models, which combine linear and nonlinear models, outperform other kinds of hybrid models (Xu & Zhang, 2022); (Safari & Davallou, 2018); (Purohit et al., 2021). Regarding linear models, the ARIMAX model is among the most extensively utilized in time series forecasting (Shahwan & Odening, 2007). ARIMAX forecasts future demand using historical time-series data (Kilimci et al., 2019). It performs well with seasonal and stationary demand (Kantasa-ard et al., 2021). However, it employs a small historical data set and struggles with non-linear time series (Dave et al., 2021). In comparison, LSTM is considered one of the best-performance recurrent neural networks representatives of nonlinear models. LSTM is ideal for dealing with complex data and nonlinear trends (Kantasa-ard et al., 2021). Unfortunately, LSTM takes a long time to train, and there is no best method for selecting the optimal hyperparameters (Dave et al., 2021; Kantasa-ard et al., 2021). Therefore, a hybrid model allows these models to combine to optimize their advantages while eliminating each other's weaknesses (Dave et al., 2021).

This thesis proposes the novel ARIMAX-LSTM hybrid model, as shown in Figure 15. We model the original time series in our hybrid model using ARIMAX and LSTM, respectively. Then, the hybrid model combines Forecasting 1 and 2 results to generate synergy effects. As a result, the final output is calculated as Equation 13 (Lai et al., 2006; Mohammed et al., 2017; Pham & Pham, 2020).

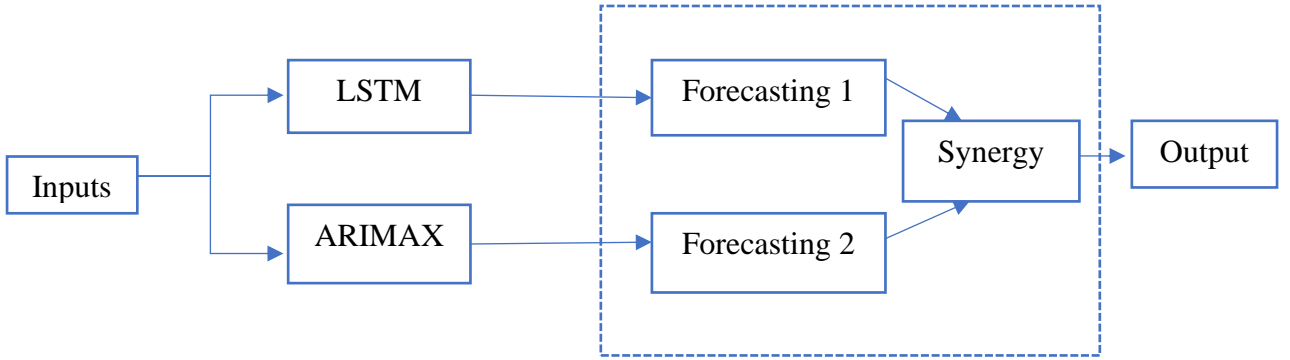

Figure 15: Proposed ARIMAX-LSTM hybrid forecast model

$$\hat{Y}_t^{hybrid} = \alpha \hat{Y}_t^{LSTM} + (1 - \alpha) \hat{Y}_t^{ARIMAX} \quad (13)$$

Where \hat{Y}_t^{hybrid} , forecast results of the hybrid model; \hat{Y}_t^{LSTM} , forecast results of the LSTM module; \hat{Y}_t^{ARIMAX} , forecast results of ARIMAX; α , the weight parameter, $0 < \alpha < 1$.

A synergetic effect will improve prediction performance by integrating linear and nonlinear time series patterns (Lai et al., 2006). Previous studies have demonstrated the superiority of synergetic forecast results by combining different models, such as the back-propagation neural network and exponential smoothing models (Lai et al., 2006); Exponential Smoothing (ES) model, and the ANN model (Mohammed et al., 2017); ANN and Triple exponential smoothing methods (Pham & Pham, 2020).

In Equation 13, a critical problem is determining the weight parameter α . Several papers have proposed different ways to find the optimal value of the weight parameter α , such as linear programming (Lai et al., 2006), selecting the random values (Mohammed et al., 2017), and hybridization formula (Pham & Pham, 2020).

In this study, the value α is calculated as Equation 14 using the hybridization formula inspired by (Pham & Pham, 2020) because it is accurate and straightforward. A study (Pham & Pham, 2020) employed this formula to get the optimal weight between the ANN and exponential smoothing in ten datasets that provide good forecast results.

$$\alpha = \frac{\sum_{t=1}^n (\hat{Y}_t^{LSTM} - \hat{Y}_t^{ARIMAX})(Y_t - \hat{Y}_t^{ARIMAX})}{\sum_{t=1}^n (\hat{Y}_t^{LSTM} - \hat{Y}_t^{ARIMAX})^2} \quad (14)$$

(Y_t , is the actual demand at time t ; if $\alpha < 0$, choose $\alpha = 0$, if $\alpha > 1$, choose $\alpha = 1$).

3.3.3 The implementation of the forecasting model

The implementation of the forecasting model is illustrated in Figure 16. This work aims to develop the most accurate model for predicting future demand. Forecasting future demand is done in six steps: Data collection; Data pre-processing; Hyperparameters tuning; Forecasting models implementation and forecast computation; Calculating final hybrid forecast values and evaluating the model; Finding the best model. These steps are implemented in Python because its syntax is more straightforward and compact than other programming languages like Java, C#, or C++ (Kantasa-Ard, 2021).

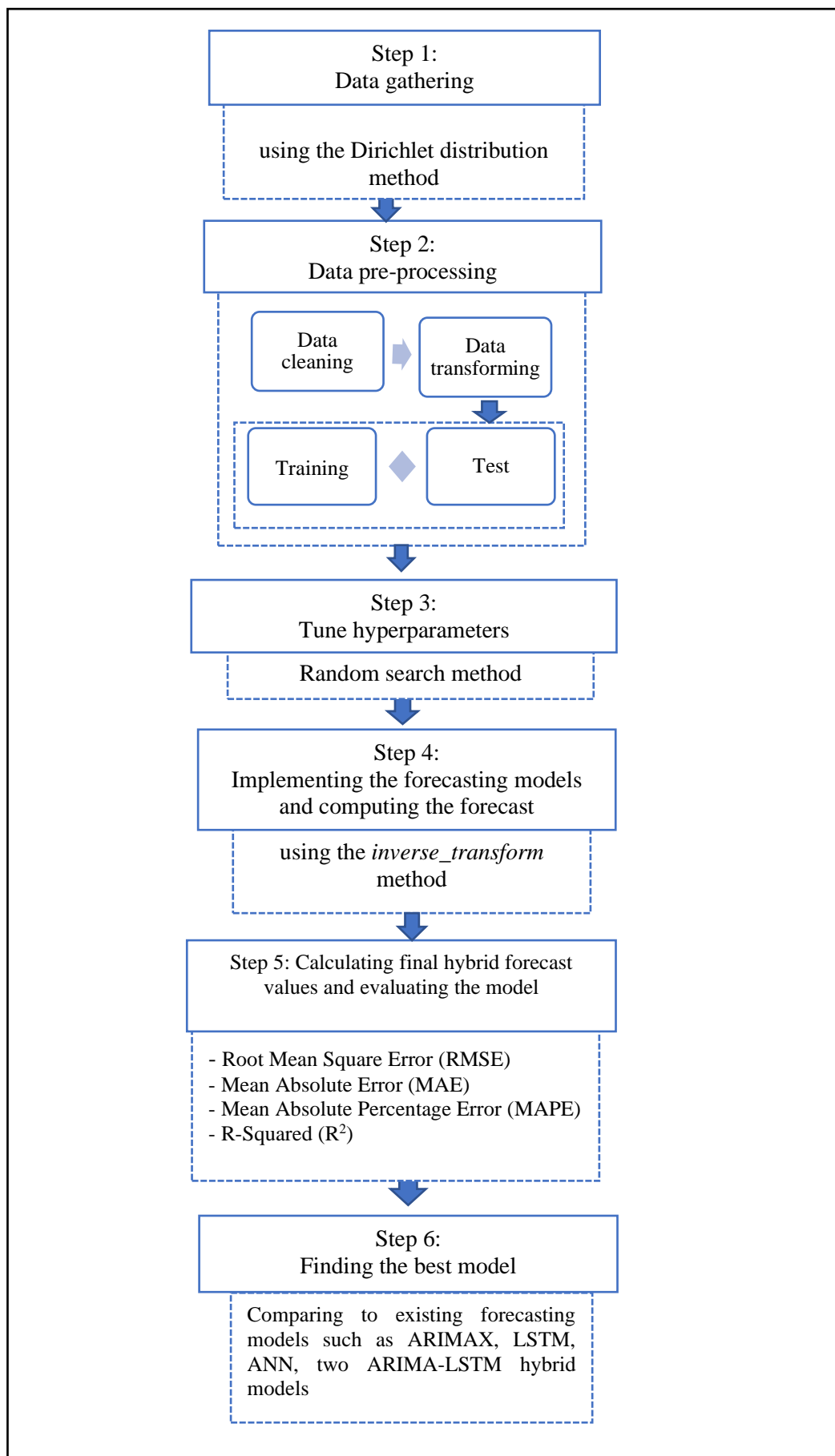

Figure 16: The proposed framework for demand forecasting.

3.3.3.1 Data gathering

The International Coffee Organization (ICO) is the primary intergovernmental coffee organization that has provided information and updated coffee data for many years. Only annual data is accessible on the ICO website (https://www.ico.org/trade_statistics.asp). Hence, we request access to the coffee's detailed data. There is no available daily export data and monthly domestic consumption. If we use only monthly data, it is not enough for learning techniques. Also, prior researchers have mainly employed monthly data due to a lack of available daily data. Hence, we obtain Vietnam's monthly export data and daily price data from January 2000 to December 2020.

Then, we generate daily demand data from monthly export data. There are two main assumptions for customer demand in our case. *First*, Vietnamese coffee is mainly exported, as seen in Table 2. Indeed, exports account for 89% of total Vietnamese production. Thus, daily customer demand is assumed as daily export. Following a prior study by (Kantasa-ard et al., 2021), we employed the Dirichlet distribution method to produce random daily demand from the monthly export quantity. This distribution method effectively predicts uncertainty probabilities for all variables in a model in symmetric and asymmetric modes (Kantasa-ard et al., 2021). *Second*, based on an equal probability per day, the overall daily demand equals the monthly amount. Each month, the total possibility of daily data equal one. Authors (Kantasa-ard et al., 2021) used this method in previous research and assumed 31 days in January. However, in our case, the generated daily demand is based on days of daily price data. Since daily price data is based on working days, every day from Monday to Friday, except holidays, is considered a working day. In our study, let (X_1, \dots, X_N) indicate a collection of N monthly data, with each X_i having the dimension of daily data. For example, X_i equals (X_{i1}, \dots, X_{i22}) for daily data in January or the months of 22 working days.

3.3.3.2 Data pre-processing

When using neural networks and ML techniques to train and forecast data, data pre-processing eliminate noise and boosts efficiency (Abbasimehr et al., 2020). Data cleaning, data transformation, and error validation are also part of data pre-processing. Before training and forecasting, the data are transformed into the same units (Kantasa-ard et al., 2021). Data can be normalized to reduce duplicate data, redundancy and improve data integrity (Abbasimehr et al., 2020). Thus, this study transfers the data using the *inverse_transform* method (Kantasa-ard et al., 2021). As suggested by prior researchers (Feizabadi, 2020; Kantasa-ard et al., 2021), we

split the data into two sets: training and testing. The training set comprises the first 80% of data used to determine the model parameters. The remaining data is referred to as the test set, used to assess the forecasting models' efficiency and precision.

3.3.3.3 Tuning hyperparameters

DL model performance is affected by hyper-parameters, which are manually set training variables determined before to training model (Yadav et al., 2020; Zhou et al., 2019). It is challenging to obtain successful outcomes with LSTM networks (Abbasimehr et al., 2020) because it relies on selecting hyper-parameters (Yadav et al., 2020). The essential hyperparameters consist of lag size (number of past observations), the number of hidden layers, the dropout rate, the number of neurons in each layer, the optimization algorithm, the learning rate, the epoch size, the batch size, activation function (sigmoid, tanh, softmax etc.), optimizer (Adam, Adadelata, RMSprop etc.) (Abbasimehr et al., 2020; Yadav et al., 2020).

Previous researchers have used some tuning hyperparameters techniques, such as the random search (Bergstra & Bengio, 2012), grid search method (Abbasimehr et al., 2020), differential evolution algorithm (Nakisa et al., 2018), hybrid genetic algorithm, and scatter search (Kantasa-ard et al., 2021). Moreover, there is no generic ideal setup for all problem domains (Nakisa et al., 2018) and no established guidelines for configuring LSTM (Yadav et al., 2020). The two most commonly used hyper-parameter optimization strategies are grid search and random search (Bergstra & Bengio, 2012). Grid search experiments are famous in practical machine learning literature, optimizing the hyperparameters of learning algorithms (Abbasimehr et al., 2020; Bergstra & Bengio, 2012). However, it takes a long time to search for the optimal parameters (Nakisa et al., 2018). The study (Bergstra & Bengio, 2012) demonstrated that randomly chosen trials are more advantageous than trials on a grid for hyperparameter tuning.

Thus, this study employs a random search to find optimal hyperparameters. According to (Abbasimehr et al., 2020), seven different hyperparameters have been determined: Lag size, Number of hidden layers, Number of neurons, Dropout rate, Learning rate, Batch size, and Epoch size. A list of parameter combinations is presented in Table 9.

Figure 17 displays the hyperparameter tuning process. Values for each hyperparameter are defined in Table 9. The LSTM network is built and trained for each set of hyperparameters. All constructed LSTM networks use the Adam algorithm as an optimizer and the mean of squared error (MSE) as a loss. The Adam optimization algorithm is a stochastic gradient

descent extension recently adopted for optimizing LSTM (Abbasimehr et al., 2020; Yadav et al., 2020).

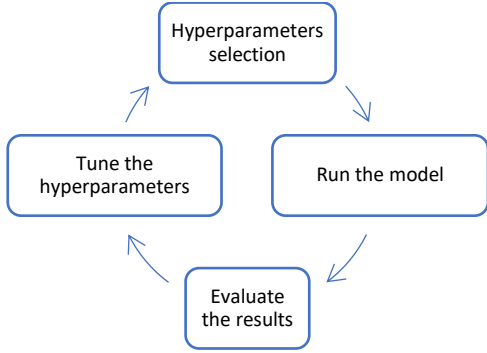

Figure 17: Hyper-parameter tuning process
(Yadav et al., 2020)

Table 9: Stated values for each hyperparameter

Hyperparameter	Values
Lag	[10,11]
The number of hidden layers	[2,3]
The number of neurons in each layer	[32, 64,128]
Dropout rate	[0.05, 0.1, 0.15]
Batch size	[5, 10, 20]
Epoch size	[50,100]
Learning rate	[0.01, 0.001, 0.0001]

3.3.3.4 Implementing the forecasting models and computing the forecast

After tuning hyperparameters, the best configuration of LSTM will be chosen. Before calculating forecasting performance, we transform the normalized data to its original state with the *inverse_transform* method of the *MinMaxScaler* function (Kantasa-ard et al., 2021).

3.3.3.5 Calculating final hybrid forecast values and evaluating the model

The ultimate hybrid forecast values are calculated based on Equations 11, 12, and 13. Then, the prediction method's accuracy is measured by analyzing the predicted errors (Soy Temür et al., 2019). Some famous forecasting error scores have been used to measure the predictive successes of models, such as Mean Square Error (MSE), Root Mean Square Error (RMSE), Mean Absolute Percentage Error (MAPE), and Mean Absolute Error (MAE), and Mean Absolute Scale Error (MASE). These error scores provide similar outcomes (Dave et al., 2021; Soy Temür et al., 2019). Besides, numerous authors have used more than two scores, such as (Kantasa-ard et al., 2021; Kilimci et al., 2019; Naveena et al., 2017; Soy Temür et al., 2019). Thus, this study uses several error scores, such as RMSE, MAE, and MAPE. Besides, R-Squared (R^2) also is selected to measure the degree of association between actual and predicted values in a model (Kantasa-ard et al., 2021).

They are expressed in Equations (15)-(18), respectively.

$$RMSE = \sqrt{\frac{\sum_t^n (Y_t - \hat{Y}_t)^2}{n}} \quad (15)$$

$$MAE = \frac{\sum_t^n |Y_t - \hat{Y}_t|}{n} \quad (16)$$

$$MAPE = \frac{1}{n} \sum_t^n \frac{|Y_t - \hat{Y}_t|}{|Y_t|} \times 100 \quad (17)$$

$$R^2 = 1 - \frac{\sum_t^n (Y_t - \hat{Y}_t)^2}{\sum_t^n (Y_t - \bar{Y}_t)^2} \quad (18)$$

Where Y_t is the actual demand at time t ; \hat{Y}_t is the forecast demand at time t ; \bar{Y}_t is the average of actual demand; n is the forecasting period, $Y_t - \hat{Y}_t$ measures the forecast error.

3.3.3.6 Finding the best model

In this step, we compute various well-known models from the literature, such as ARIMAX, ANN, LSTM, Choi's ARIMA – LSTM hybrid model, and Soy's ARIMAX-LSTM hybrid model. The best model is then selected with the performance's lowest error values obtained with the above formulas.

All models have been performed on Google Colab, which contains eight Tensor processing units (TPUs). Deep learning techniques require substantial computing (Yadav et al., 2020). ARIMA parameters are fitted and forecasted with the '*auto.arima*' function (Abolghasemi et al., 2020). The best model has the lowest Akaike Information Criterion (AIC) (Abolghasemi et al., 2020), which is an estimate of lost information (Feizabadi, 2020).

3.3.4 The impact of the proposed model on supply chain performance

The preceding section goes over how to build the proposed hybrid model. This section will show the key performance indicators used to assess the impact of the hybrid model on supply chain and environmental performance. Based on Chapter 2, few authors investigate how forecasting models affect supply chain performance. In addition, no papers assess the impact of forecasting on long-term supply chain performance, particularly environmental performance. As a result, we'd like to fill the gaps.

Furthermore, as mentioned in the preceding chapter, although only a few metrics are chosen, these performance indicators are linked to demand forecasting and fully measure supply chain performance. Thus, they can help to achieve the thesis's goal.

3.3.4.1 Performance metrics

Based on Chapter 2, three operational and financial indicators will be chosen to evaluate supply chain performance. Two environmental indicators were also used to investigate the

impact of the hybrid model on the performance of the sustainable supply chain. The following part will explain the formula of each measure.

a) *Operational metrics*

1. *Bullwhip effect (BWE)*

Various metrics and measures have been employed to assess supply chain performance. One of those essential performance measures is the bullwhip effect (BWE) (Jaipuria & Mahapatra, 2014). BWE is related to demand information distortion when it moves upstream (H. T. Luong, 2007). Specifically, BWE is one of the problems that cause a substantial variation in demand due to a lack of collaboration and exchange of information throughout the supply chain (Aburto & Weber, 2007). According to (Jaipuria & Mahapatra, 2014), a better forecasting model enhances supply chain performance by reducing the bullwhip effect (BWE). Figure 18 displays the BWE in a supply chain. Due to the existence of the BWE, a slight fluctuation in the end customer's demand may result in a considerable variation in manufacturers' demand.

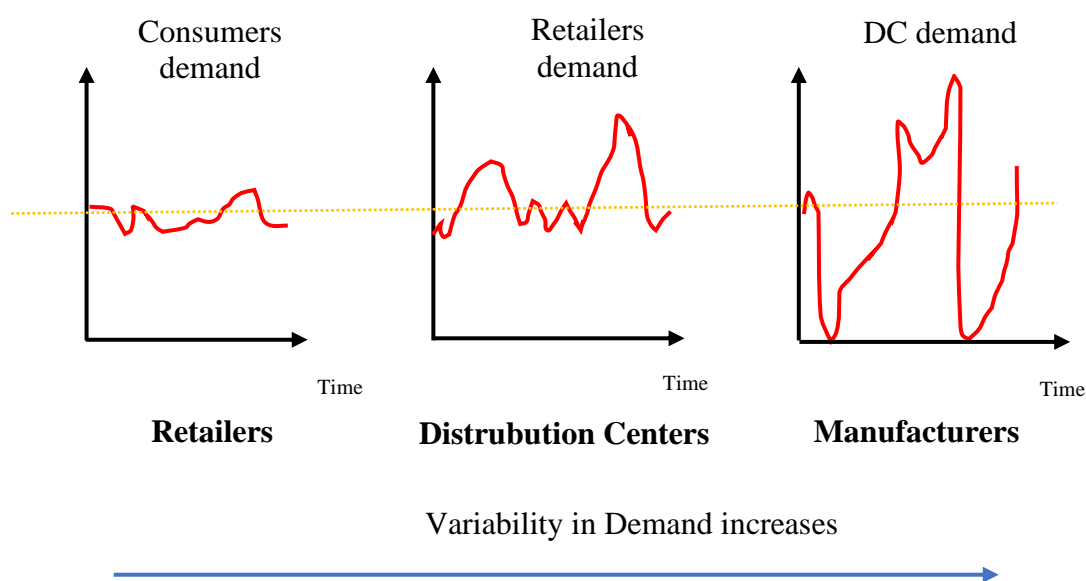

Figure 18. Bullwhip Effect in a supply chain (Aburto and Weber, 2007)

Based on earlier research (Jaipuria & Mahapatra, 2014), (H. T. Luong, 2007), (H. T. Luong & Phien, 2007), BWE is the ratio of the order quantity variance and demand variance as given in Equation 19.

$$BWE = \frac{\text{Variance of order}}{\text{Variance of demand}} = \frac{VAR(q_t)}{VAR(D)} \quad (19)$$

When the ratio is bigger than one, the bullwhip effect occurs.

Relying on a base-stock policy, the order quantity can be determined using Equation 20 (Jaipuria & Mahapatra, 2014; H. T. Luong, 2007; H. T. Luong & Phien, 2007). According to authors (H. T. Luong, 2007; H. T. Luong & Phien, 2007), the base stock policy is a simple case of the order-up-to inventory policy that an order will be placed at the beginning of each period to increase the inventory level up to a pre-defined level.

$$q_t = (\widehat{D}_t^L - \widehat{D}_{t-1}^L) + D_{t-1} \quad (20)$$

$$VAR(D) = VAR(D_t) = VAR(D_{t-1})$$

\widehat{D}_t^L and \widehat{D}_{t-1}^L can be calculated as follows (H. T. Luong, 2007; H. T. Luong & Phien, 2007)

$$\begin{aligned} \widehat{D}_t^L &= \widehat{D}_t + \widehat{D}_{t+1} + \dots + \widehat{D}_{t+L-1} \\ \widehat{D}_{t-1}^L &= \widehat{D}_{t-1} + \widehat{D}_t + \dots + \widehat{D}_{t-1+L-1} \end{aligned}$$

Where

q_t estimated order quantities (or production quantities) in which lead time (L)

\widehat{D}_t forecasted demand at period t

\widehat{D}_{t-1} forecasted demand at period t-1

\widehat{D}_t^L forecasted demand during the lead time L at period t

\widehat{D}_{t-1}^L forecasted demand during the lead time L at period t-1

D_{t-1} actual demand at period t-1

$VAR(D)$ variance of real demand

D_t actual demand of period t

Higher BWE suggests rapidly changing orders, which means that the output level often varies, leading to increased average production switching costs each period (Boute & Lambrecht, 2009). Hence, lowering BWE reduces production and supply chain costs (Jaipuria & Mahapatra, 2014).

2. Net stock amplification (NSAmp)

Net-stock amplification (NSAmp) is a variation in net stock concerning demand. Thus, it influences customer service enormously. The higher the net stock variance, the more safety stock is required. As a result, high NSAmp results in high holding and backlog costs (Boute & Lambrecht, 2009).

The NSAmp is estimated using Equation 21 ((Jaipuria & Mahapatra, 2014))

$$NSAmp = \frac{\text{Variance of net stock (inventory level)}}{\text{Variance of demand}} \quad (21)$$

Based on the authors (Boute & Lambrecht, 2009), the order quantity equals production quantity, Net stock can be calculated by Equation 22 in this study.

$$Net\ stock_t = Remaining\ stock_t + Order_t - Real\ demand_t \quad (22)$$

$$\text{Or} \quad Net\ stock_t = q_{t-1} - D_{t-1} + q_t - D_t$$

Where:

q_t order_t can be calculated in Equation 20.

D_t real demand at period t

remaining stock_t is assumed as $(q_{t-1} - D_{t-1})$

3. The transportation cost (TC)

The transportation cost is inspired by authors (Kantasa-ard et al., 2021) as follows:

$$Daily\ TC = predicted\ daily\ demand \times unit\ transportation\ cost \quad (23)$$

Based on the interviews with Vietnamese coffee companies, the average unit transportation cost is assumed to equal 1500 VND/kg or approximately 65.38 USD/tons.

b) Financial measures

The inventory turn ratio is used to measure inventory performance which is essential in manufacturing processes (Mccarthy et al., 2006), (Kwak, 2019), (Feizabadi, 2020). A higher inventory turn is better because less cash is tied up in products (Kwak, 2019). The inventory turn is measured using Equation 24 (Feizabadi, 2020).

$$IT = \frac{\text{Cost of Goods Sold}}{\text{Average Inventory}} \quad (24)$$

Where:

$$\text{Cost of Goods Sold} = Real\ demand \times Production\ cost\ unit$$

$$Average\ inventory = \frac{(\text{Beginning Inventory} + \text{Ending Inventory})}{2}$$

Based on a study (Q. V. Luong & Tauer, 2006), the total cost of coffee producers is 29.3 cents/lb or 645.95 USD/tonnes.

c) Environmental measures

Carbon Footprint and Water Footprint will be used to assess environmental performance. We will discuss each indicator in detail as follow:

1. Carbon Footprint (CF)

The CF is a valuable indicator of greenhouse gas emissions (Williams, 2012). Understanding the coffee supply's greenhouse gas emissions is critical for evaluating options for climate change mitigation within the sector (Maina et al., 2015). According to authors (Nab & Maslin, 2020), the CF of Vietnamese coffee is 16,040 tons of CO₂e/ ton of green coffee.

2. Water Footprint (WF)

Due to the impact of climate change, the water stress situation in Vietnam has become more severe due to the high-water consumption of coffee planting and production. Furthermore, Vietnam's location downstream of international river basins makes it more vulnerable to the water policies of upstream countries such as China and Lao. Water pollution from wet processing is one of the significant issues in coffee production (International Coffee Organization (ICO), 2022). According to (Ngo et al., 2018), Vietnam's WF per ton of green coffee is 12,829 m³ /ton.

The following two environmental indicators will be computed as follows.

$$CF_t = y_t \times 16,040$$

$$WF_t = y_t \times 12,829$$

$$\widehat{CF}_t = \widehat{y}_t \times 16,040$$

$$\widehat{WF}_t = \widehat{y}_t \times 12,829$$

$$Difference_carbon\ footprint = \frac{\sum_t^n |CF_t - \widehat{CF}_t|}{n}$$

$$Difference_water\ footprint = \frac{\sum_t^n |WF_t - \widehat{WF}_t|}{n}$$

\widehat{y}_t is the forecast demand at timet (ton green beans), y_t is the real demand at timet (ton green bean), CF_t is the carbon footprint at timet, \widehat{CF}_t is the carbon footprint at timet, WF is the water footprint at timet, \widehat{WF}_t is the water footprint at timet

3.3.4.2 The impact of the proposed model on supply chain performance

This thesis adopts the regression model (Feizabadi, 2020) to study the impact of the hybrid model on supply chain performance. The regression model will be explained as follows:

$$Y = \alpha + \beta X + \varepsilon \quad (25)$$

Where:

Y is the monthly economic performance metrics, α constant, X is a dummy variable (X coded 0 for traditional forecasting approach, and X coded 1 for hybrid approach), β is the coefficient of dummy variable X, ε error term in predicting the value of Y. Further, α represents the average value of the economic metrics when traditional forecasting approach is used; and β is the mean incremental change in supply chain performance metric when the hybrid forecasting approach is used.

$$\text{Monthly metric} = \sum_{t=1}^T \text{daily metric}$$

T is the number of days in a month

3.4 Summary

This chapter describes the main issues in demand planning and demand forecasting. This thesis proposes a new demand planning approach based on the conception of the demand planning process. As a result, the demand planning process is regarded as a dynamic capability in the form of a higher-order construct formed by five lower-order factors: goal formulation, forecasting technique, information source, forecasting roles in decision-making, and communicating the predictions and synchronizing supply with demand. In addition, the influence of this approach on supply chain performance in terms of cost and delivery performance will be investigated. The objective is to assess the benefits of designing an effective demand planning process. Hence, if there is a positive relationship, demand planning offers a faster and more effective response due to integrating practices and the learning processes.

Demand forecasting is an essential part of the DPP concept. Thus, enhancing the performance of demand forecasting is a critical task. This thesis develops a new hybrid model for coffee demand forecasting by combining the strengths of ARIMAX and LSTM models. In addition, this section uses the random method to tune different LSTM hyperparameters. Moreover, this thesis analyzes the proposed model's impact on supply chain and environmental

performance. Therefore, this thesis provides empirical proof of the magnitude of savings as observable supply chain performance results.

The following chapter will present the findings, discussion analysis, and managerial insights from case studies of Vietnamese coffee.

CHAPTER 4: CASE STUDY, RESULT ANALYSIS, AND MANAGERIAL INSIGHTS

4.1 Introduction

This chapter displays the outcome analysis and managerial insights drawn from the case studies for the abovementioned approaches. This thesis employs a case study of coffee in Vietnam. In this chapter, a standard model of the coffee supply chain will be proposed. Also, the coffee supply chain performance will be evaluated. Moreover, the results of the demand planning process and demand forecasting models will be presented. All details are described as follows.

4.2 Overview of the case study

Coffee is one of the primary goods for the exportation of Vietnam. Indeed, Vietnam is one of the biggest coffee exporters globally, with 683,800 ha of land cultivated with coffee. According to (General Statistics Office of Vietnam, 2020b), Vietnamese coffee export value rose from 2.671 billion dollars in 2015 to 3.536 billion dollars in 2018. Coffee exports accounted for nearly twenty percent of the country's total agricultural exports, contributing one percent of the total value of all commodities, goods, and service exports. However, increasing globalization, improved information availability, and environmental concerns have threatened Vietnamese coffee competitiveness. Consequently, the performance of the coffee supply chain will suffer, resulting in lower profitability for supply chain participants. After studying the literature, we could not access any research articles on modeling and measuring the coffee supply chain in Vietnam. In addition, there is scant research in the literature on agricultural demand forecasting, particularly in coffee demand. As a result, we are particularly interested in understanding problems and solutions to improve the performance of the coffee supply chain. Therefore, Vietnamese coffee is chosen as a case study.

The case study is the methodology employed by lots of previous research (Essajide & Rachidi, 2017; Kusriani et al., 2019; Ntabe et al., 2015; Ramaa et al., 2009). Researchers used the case study approach to extend the SCOR model and verify the suitability of developed models (Essajide & Rachidi, 2017; Ntabe et al., 2015). The case study method has many advantages. First, its findings are employed as the foundation for more complex models and empirical research. Second, its adaptability is well-matched to emerging research areas with no

well-established theories or hypotheses. Last, based on the data and observations, this method helps analyze, develop frameworks and draw findings (Banker & Mitra, 2007). The scholars (Essajide & Rachidi, 2017) emphasized that the case study is the accurate method to employ and examine whether the model is appropriate.

Three experiment datasets are implemented in this thesis. Firstly, this thesis proposes a standard coffee supply chain model in the context of the coffee supply chain in Kon Tum, Vietnam. Secondly, the demand planning process of coffee companies in the central highlands of Vietnam will be studied. Finally, we use datasets of Vietnamese coffee demand and three Thailand agricultural products to assess the performance of demand forecasting methods.

The following parts will include the specific experimental data for the case study and the finding discussion based on the methodologies mentioned in previous chapters.

4.3 Modeling and measuring the coffee supply chain

4.3.1 Experiment data

This thesis collects data through interviews and questionnaires. We aim to comprehensively understand the supply chain framework and make recommendations for enhancing coffee supply chain performance. The questionnaire analyzes the key processes and metrics selected from the SCOR model. Questions will be simple and require little time to finish, encouraging respondents to complete the survey. Five-point Likert scales are used in each question. Respondents were asked to indicate their level of implementation with each item, where 1 represented “Not implement” and 5 defined “Fully implement”. According to the SCOR model, the questionnaire's content will focus on key supply chain processes such as Plan, Source, Make, Deliver and, Return. In addition, the study will look at the supply chain performance indicators gathered from the SCOR model and references from prior studies of coffee supply chains. The final part of the survey aims to discover the viewpoints and main challenges in the coffee supply chain.

The survey sample includes 60 farmers, 20 traders, and 10 companies in Kontum province, Vietnam. The samples are chosen with non-probability. The study focuses on green beans, which account for the highest percentage of coffee products (USDA Foreign Agricultural Service, 2019).

The next part describes the statistical analysis of farmers, traders, and coffee companies. Then, a standard model of the coffee supply chain will be proposed. Also, the coffee supply chain performance is evaluated regarding the approach of the process and performance.

4.3.2. Descriptive statistics

4.3.2.1 Farmers

According to Table 10, coffee growers are middle ages (40.37 years old). They have considerable experience (more than 12 years) in cultivating coffee, but they are mainly small-scale, with an average of 2.87ha. A family plants coffee with an average of 2.17 workers. Most householders are male (71.7%). Besides, coffee trees in this area are mature, with an average year is 12.88 years. Hence, coffee farms here are highly productive. Coffee is the main crop of local people, with 83.50% of the total land area. Thus, income depends mainly on coffee which accounts for about 70% of total income. Some primary occupation responders work in companies and organizations such as banks and insurance firms. Besides, the majority of respondents have a poor educational degree. Most farmers finished secondary (20%) and high school (40%). A few coffee growers pursued further education, such as intermediate (8%), college (5%), and university (18%) (see Figure 19).

Table 10: Descriptive statistics about farmers

	N	Minimum	Maximum	Mean	Std. Deviation
Age	60	20	68	40.37	12.408
Labors	60	1	6	2.17	1.060
Total coffee area (ha)	60	1	15	2.87	2.607
Percentage of area of coffee/total area (%)	60	5	100	83.50	24.980
Percentage of coffee income/total income (%)	60	0	100	70.03	28.147
Experience years	60	2	30	12.87	8.117
Years of coffee trees	60	3	30	12.88	7.646
Number of respondents	60				

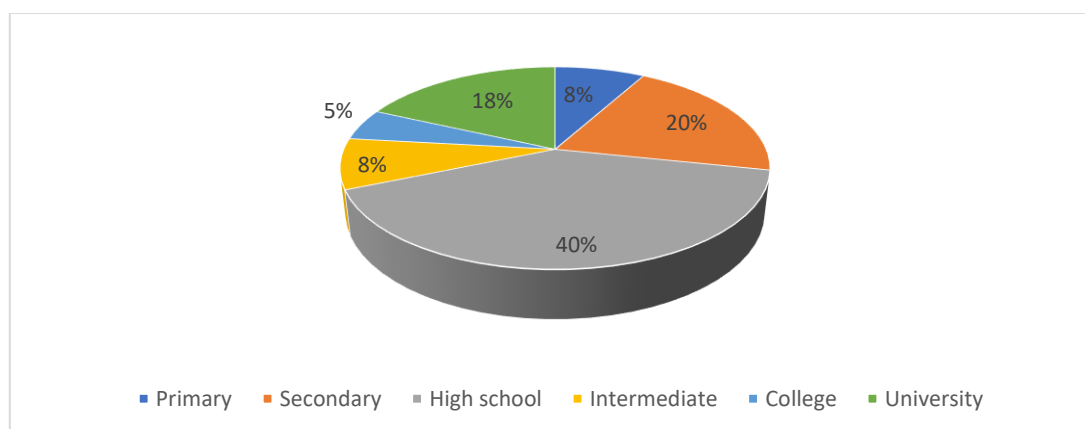

Figure 19: Education level of farmers

4.3.2.2 Traders

Local traders are the main dealers selling coffee to exporters or companies. According to the survey results in Table 11, the total number of respondents is 20, including 10 females and 10 males. Coffee collectors in the surveyed area have considerable experience of more than 7 years in collecting coffee, with the average age being 43. Traders collect fresh cherries coffee, dry cherries coffee, and green beans with an average price are 6 million Vietnamese dongs (VND), 12 million VND, and 32 million VND per ton at the time of the survey, respectively. Figure 20 displays the educational levels of traders. Similar to farmers, traders have a low level of education. For example, many collectors studied high school (30%) and secondary (25%). Only 15% of traders graduated from university.

Table 11: Descriptive statistics about the traders

	N	Minimum	Maximum	Mean	Std. Deviation
Age	20	25	65	43.10	12.29
Employees	20	20	12.0	6.150	3.013
Total quantity collected per year fresh cherries coffee	20	.0	1500.0	487.75	518.46
Total quantity collected per year tons of dry cherries coffee	20	.0	500.0	108.00	125.82
Total quantity collected per year tons of green beans	20	.0	1200.0	114.80	289.24
Years of experience in coffee collecting	20	1.0	33.0	7.55	7.38
Number of respondents	20				

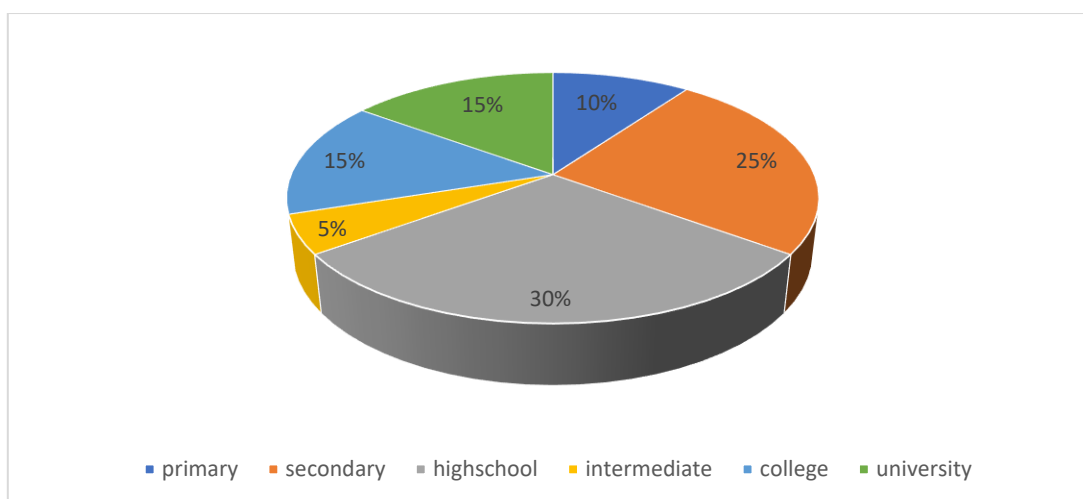

Figure 20: Education level of traders

4.3.2.3 Coffee companies

A sample of 17 companies was contacted in 2020. Only ten companies responded. The response rate was 58.8%. Table 12 displays the breakdown of the respondents categorized by company size. The results show that 20% of respondents have less than 10 employees, 70% of respondents have less than 30 employees. Only 10% of samples have 400 people.

Table 12: Company size

Employees	N	Percent
<10	2	20
10-30	7	70
>30	1	10
Total	10	100

Table 13 provides information on sales value in VND. More than 80% of firms have a sales value of fewer than 100 billion VND. Based on the laws of Vietnam, they are small companies.

Table 13: Sales

Sales (million VND)	Number of respondents	Percent
<500	2	20
1000-25000	5	50
25001-40.000	1	10
40.001-150.000.000	1	10
150.000.001-2500.000.000	1	10
Total	10	100

Most of the respondents are the director (40%), vice directors (10%), managers (10%), heads of the accountant department (20%), and leaders of the production department (as shown in Table 14). All respondents clearly understand the production of companies. In addition, they have more experience. Indeed, 70% of respondents have worked for more than five years (see Table 15).

Table 14: Job title

Job title	Number of respondents	Percent
Director	4	40
Head of the accounting department	2	20
Head of the production department	1	10
Manager	1	10
Vice Director	2	20
Total	10	100

Table 15: Year stayed at the organization

Year stayed at the organization	Number of respondents	Percent
1	1	10
2	1	10
3	1	10
5	2	20
8	2	20
11	1	10
15	2	20
Total	10	100.0

4.3.3 Modeling the coffee supply chain

4.3.3.1 SCOR level 1 modeling

The coffee supply chain includes six tiers following (as shown in Figure 21):

Tier 1: Farmers

Farmers are in charge of growing coffee trees.

Tier 2: Collectors

Collectors gather coffee beans from farmers and resell them to enterprises.

Tier 3: Coffee companies

Coffee firms process coffee beans to create coffee products such as roast ground coffee, whole-bean coffee, and instant coffee.

Tier 4: Distributors: exporters, roasters

Roasters distribute coffee products through wholesale channels and offer coffee to restaurants, hotels, aircraft, and supermarkets.

Tier 5: Retailers: grocery shops, supermarkets, and coffee shops

These retailers operate as middlemen, selling the coffee at a higher price to customers.

Tier 6: Final customers.

The scope of research focuses on farmers, collectors, and coffee companies (principal producers of coffee products in Kontum).

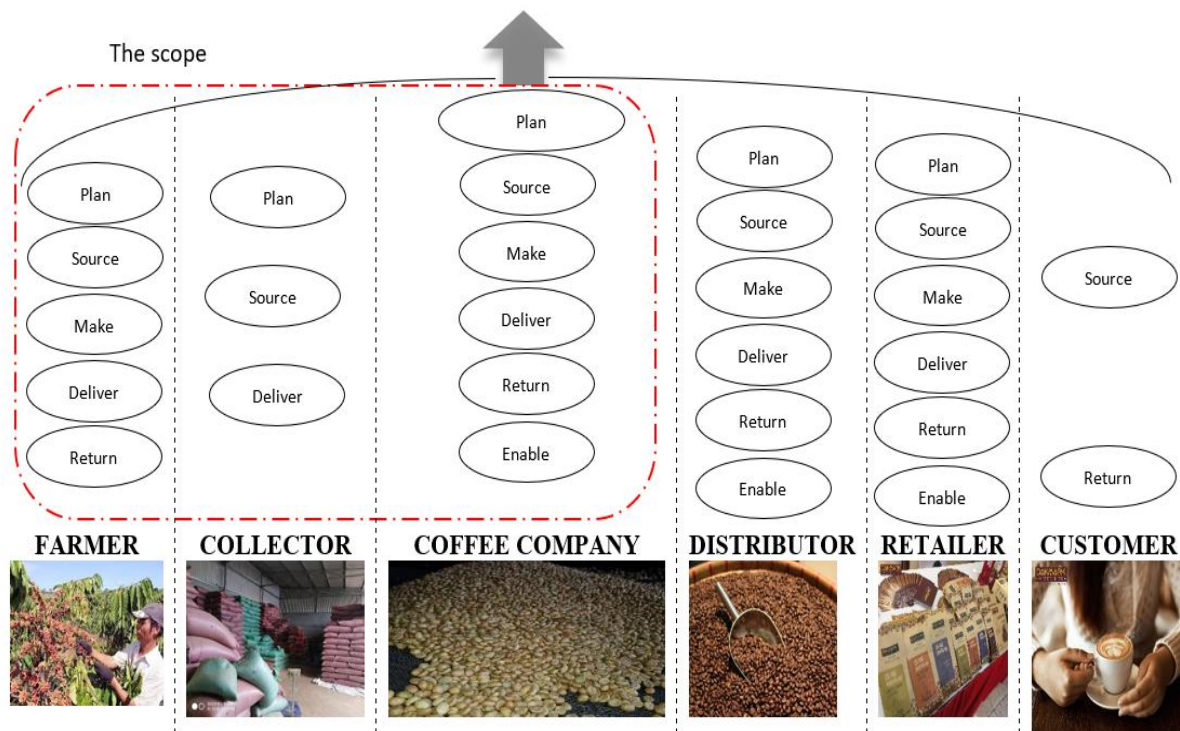

Figure 21: SCOR level 1 modeling (based on SCOR version 12, 2017)

4.3.3.2 SCOR level 2 modeling

Figure 22 presents the SCOR level 2 modeling of the coffee supply chain. The SCOR level 2 describes the information and inventory movements in the supply chain (Essajide & Rachidi, 2017). According to survey results, phone and face-to-face are the primary means of communication among farmers, traders, and companies. No software or technology is employed to communicate with each other. Therefore, it is hard for them to make clear the details of the whole process operations and update information and changes. Make-to-stock¹ products represent the highest level of coffee production, whereas Make-to-order² products account for a small number. The reason is financial constraints to investing in machines and equipment. The main product of coffee firms is roast. Other coffee products like instants accounted for a small scale.

¹ Make to stock products are generally produced to a planned schedule in accordance with a sales forecast

² The products is produced for a specific customer order using the company's existing designs.

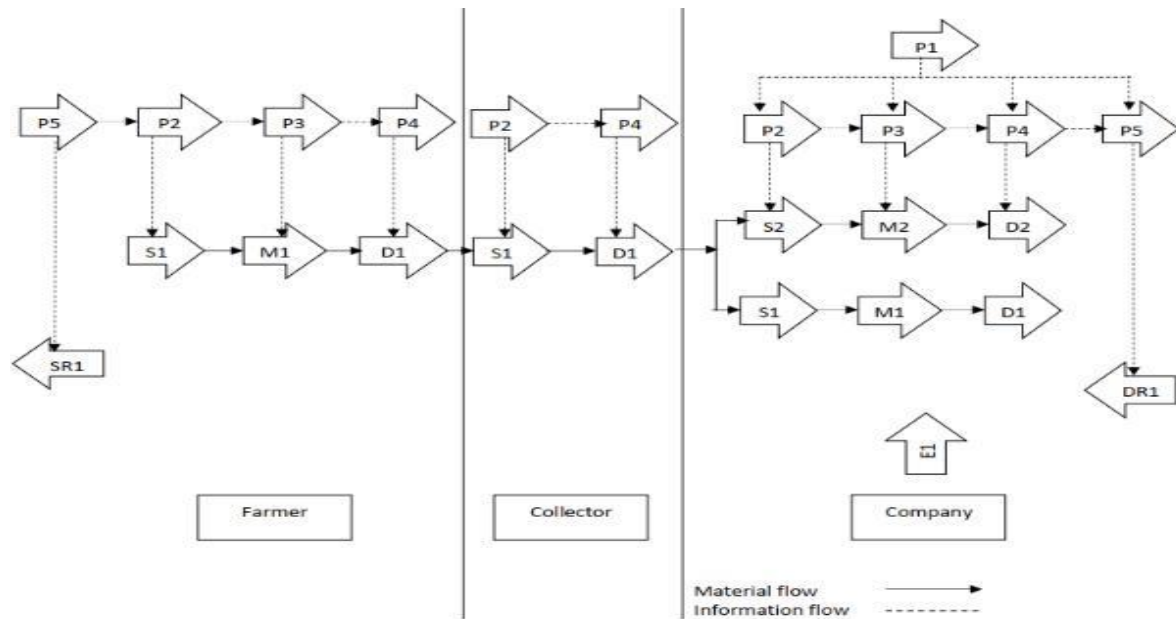

Figure 22: SCOR level 2 modeling (based on SCOR version 12, 2017)

(P1:Plan supply chain, P2:Plan Source, P3:Plan make, P4:Plan Deliver, P5:Plan Return, S1: Source Stocked Product, S2: Source Make-to-Order Product, M1:Make-to-Stock, M2:Make-to-Order, D1:Deliver Stocked Product, D2: Deliver Make-to-Order Product, SR1: Source Return Defective Product, DR1: Deliver Return Defective Product, E1:Manage Supply Chain Business Rules)

4.3.3.3 SCOR level 3 modeling

Based on the SCOR level 3 modeling, the study maps and identifies all the coffee production activities, as shown in Figure 23 and Table 16. SCOR level 3 focuses on the process's details in the supply chain (Cheng et al., 2010).

Engineer-to-order products are designed, engineered, collected, and built based on specific customer orders (American Production and Inventory Control Society, 2017). Therefore, some processes are not analyzed: Source Engineer-to-order product, Make Engineer-to-order product, Deliver engineer-to-order product, and Deliver retail product.

This thesis has observed several problems in the Vietnamese coffee supply chain. For farmers and traders, there is no P1 process (Plan supply chain). Supply chain members did not pay sufficient attention to the demand forecast. Due to pricing fluctuations of agricultural products and lack of appropriate planning, many farmers who change their lands to coffee farms and start cultivating coffee can cause new issues. They do not comprehend how to manage this "new" crop.

Besides, they also did not concern with customer demand. This issue exists in many coffee-producing countries. The coffee planted area has increased moderately in Vietnam and in many countries worldwide in the past few years. Consequently, the world's supply is higher than the

world's demand, so coffee prices decrease yearly in the international market (International Coffee Organization, 2021). Remarkably, the coffee area in Vietnam increased by over 6% from 2015 to 2019 (General Statistics Office of Vietnam, 2020).

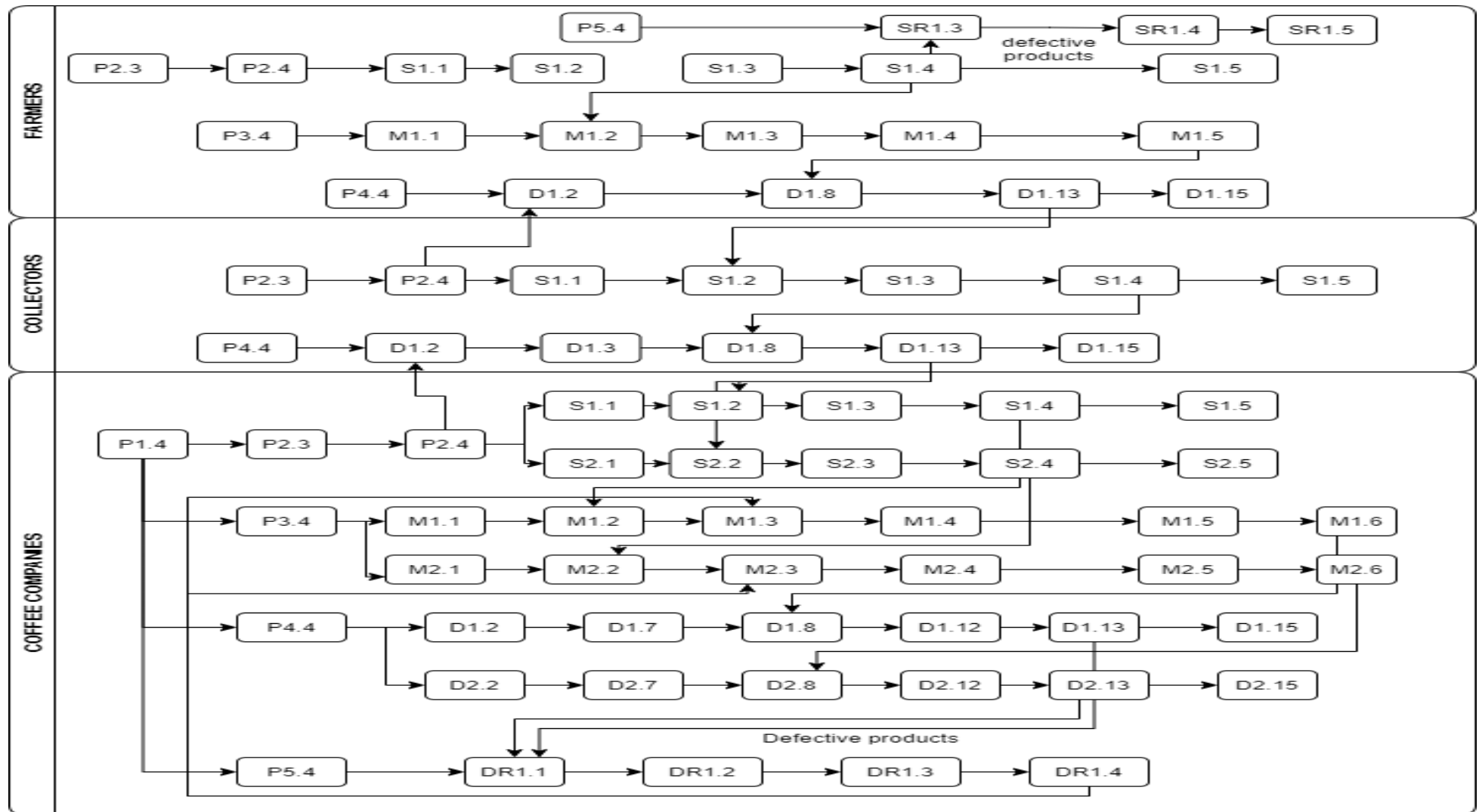

Figure 23: SCOR level 3 modeling (based on the SCOR version 12, 2017)

Table 16: Notations of the SCOR level 3 modeling (American Production and Inventory Control Society, 2017)

Code	Process	Code	Process	Code	Process	Code	Process	Code	Process
P1.4	Establish and Communicate Supply Chain Plans	S1.5	Authorize Supplier Payment	M1.4	Package	D1.2	Receive, Enter, and Validate Order	D2.13	Receive and Verify Product by Customer
P2.3	Balance Product Resources with Product Requirements	S2.1	Schedule coffee Deliveries	M1.5	Stage	D1.8	Receive Cofee Product from Source or Make	D2.15	Invoice
P2.4	Establish Sourcing Plans	S2.2.	Receive coffee	M1.6	Release coffee to Deliver	D.12	Ship Product	SR1.3	Request Defective Product Return Authorization
P3.4	Establish Production Plans	S2.3	Verify coffee	M2.1	Schedule Production Activities	D.13	Receive and Verify Product by Customer	SR1.4	Schedule Defective Product Shipment
P4.4	Establish Delivery Plans	S2.4	Transfer coffee	M2.2	Issue Sourced/In-Process Product	D1.15	Invoice	SR1.5	Return Defective Product
P5.4	Establish and Communicate Return Plans	S2.5	Authorize Supplier Payment	M2.3	Produce and Test	D2.2	Receive, Configure, Enter and Validate Order	DR1.1	Authorize Defective Product Return
S1.1	Schedule Product Deliveries	M1.1	Schedule Production Activities	M2.4	Package	D2.7	Select Carriers and Rate Shipments	DR1.2	Schedule Defective Return Receipt
S1.2	Receive Product	M1.2	Issue Material	M2.5	Stage Finished Product	D2.8	Receive coffee from Source or Make	DR1.3	Receive Product (includes verify)
S1.3	Verify Product	M1.3	Produce and Test	M2.6	Release Finished Product to Deliver	D2.12	Ship Product	DR1.4	Transfer Defective coffee
S1.4	Transfer coffee								

4.3.4 Performance measurement of the coffee supply chain

Table 17 provides the metrics normalization. Then, the AHP method is applied to calculate the weights of metrics. Regarding the process approach, the overall coffee supply chain performance is 68.28 (see Table 18). It belongs to the average category (see Table 5 in Chapter 2). Plan has the best performance value with 38.20 but still ranks poor. Besides, the Source, Make, Deliver, and Return scores have a little value, around 10. The results indicate that they need to be improved. The following reasons can explain the low weight of supply chain performance.

Firstly, farmers, traders, and companies produced based on their capacities. They were not concerned about demand prediction nor used any method or technique to forecast demand accurately. Plan has the highest weight compared to other processes because the respondents indicated that the Plan is the most vital step in coffee production. The author (Kusrini et al., 2019) proved that stakeholders who have not used prediction methods have low performance. Because forecasting methods help to improve operations, such as "plan supply chain", "plan source", "plan make", "plan deliver" and "plan return". Thus, adopting demand forecasting methods is one of the critical keys to increasing supply chain efficiency. Demand forecasting is the foundation of all planning activities. The fluctuation of product demand causes uncertainty in the supply chain (Abolghasemi et al., 2020). Therefore, in managing advanced logistics networks, demand prediction is critical. It offers valuable data for various logistics tasks, such as ordering, inventory control, and transportation (Benkachcha et al., 2014).

Secondly, Deliver and Return have the lowest value because of outdated transportation and inadequate infrastructure. Therefore, investing in facilities, science, and technology is necessary. For example, adopting the application of Information Communication Technologies will promote communication among members.

Table 17: Metrics normalization

Process	Attribute	Metric	Max	Actual	Min	Snorm	Explanation
PLAN	Asset Management Efficiency	AM.1.1 Cash-To-Cash Cycle Time	1020	326.95	5	68.28	Lower is better
	Reliability	RL.3.21 % Orders received with correct content	300	257.5	150	71.67	Larger is better
SOURCE	Responsiveness	RS.3.140 Verify Product Cycle Time	43	11.5	1.5	24.10	Larger is better
	Agility	AG.3.40 Current Purchase Order Cycle Times	105	23.05	2	79.56	Lower is better
MAKE	Responsiveness	RS.3.123 Schedule Production Activities Cycle Time	455	49.12	2.5	89.70	Lower is better
	Responsiveness	RS.3.101 Produce and Test Cycle Time	495	412.02	302	42.99	Lower is better
	Costs	CO.1.2 Cost of Goods Sold	1.25E+09	1.32E+08	152	89.44	Lower is better
	Asset Management Efficiency	AM.3.9 Capacity Utilization	300	213.5	96	57.60	Larger is better
DELIVER	Responsiveness	RS.1.1 Order Fulfillment Cycle Time	120	32.375	3	74.89	Lower is better
RETURN	Asset Management Efficiency	AM.3.12 Deliver Return Cycle Time	67	15.45	0	76.94	Lower is better

Table 18: Final score based on a process approach

Process	Metric	Snorm (1)	Metric weight (2)	Metric value (3)=(1)*(2)	Score of attribute (4)	Attribute weight (5)	Total each attribute (6)=(4)*(5)	Score of process (7)	Process weight (8)	Final score (9)=(7)*(8)
PLAN	AM.1.1	68.28	1	68.28	68.28	1.00	68.28	68.28	0.56	38.20
	RL.3.21	71.67	1	71.67	71.67	0.76	54.66			
SOURCE	RS.3.140	24.10	1	24.10	24.10	0.08	2.04	68.84	0.19	12.84
	AG.3.40	79.56	1	79.56	79.56	0.15	12.14			
MAKE	RS.3.123	89.70	0.9	80.73	85.03	0.76	64.85	80.87	0.08	6.46
	RS.3.101	42.99	0.1	4.30						
	CO.1.2	89.44	1	89.44	89.44	0.11	9.75			
	AM.3.9	57.60	1	57.60	57.60	0.11	6.28			
DELIVER	RS.1.1	74.89	1	74.89	74.89	1.00	74.89	74.89	0.08	5.99
RETURN	AM.3.12	76.94	1	76.94	76.94	1.00	76.94	76.94	0.06	4.78
TOTAL SCORE										68.28

Moreover, according to Table 19, the value of Reliability, Asset management efficiency, and Responsiveness are in the average category. Reliability has the highest score, followed by assets and Responsiveness. During this study, Reliability is evaluated by the metric of the correct quality. It demonstrates the need to increase the predictability of a process's outcome. Also, the average value of Reliability indicates that the precision in production in terms of preparation, procurement, and execution must be enhanced (Kusrini et al., 2019). Thus, sorting coffee cherries before packaging and shipping is the key to increasing coffee bags' purity. The average performance of Asset management shows that the exploitation of manufacturing plants remains inefficient. Also, the level of stocks is incredibly high. Besides, the Agility attribute has a small value. Agility is a customer-focused characteristic that assesses the ability to react to external fluctuation. As a result, improved demand forecasting will help to increase this quality.

Table 19: Final score based on a performance approach

Attribute	Total Score (1)	Number of Processes (2)	Final Score (3)=(1)/(2)
Reliability	54.66	1.00	54.66
Responsiveness	141.79	3.00	47.26
Agility	12.14	1.00	12.14
Costs	9.75	1.00	9.75
Asset Management Efficiency	151.50	3.00	50.50

Costs have the lowest score. Such a situation may reveal a high level of production costs and logistics costs. Indeed, the authors (Kusrini et al., 2019) indicated that a low Costs score implies production inefficiency. Also, the supply chain costs, particularly those related to logistics for delivery and return, need to be considered. Other authors specify that coffee companies' logistics costs were mainly due to transportation and storage (G. N. T. Nguyen & Sarker, 2018). In the case of Kon Tum province, stakeholders have their storage, but there is no sharing of information or collaboration within processes, especially Deliver and Return. Besides, most respondents solve the problem by themselves without cooperation. As a result, a possible suggestion could be to define the optimal warehouse locations to lower transportation costs and thus to better respond to customer demand.

4.3.5 Managerial insight discussion on the coffee supply chain

This thesis proposes a standard coffee supply chain model with the process elements' detailed level. This proposal model facilitates the investigation of external and internal problems that decrease the coffee supply chain's efficiency in Kontum province, Vietnam. This model can support supply chain members, especially coffee companies in countries with the same coffee supply chain characteristics as Vietnam, to map and evaluate the supply chain's success.

Moreover, our findings suggest that SC members should pay close attention to the Plan process. Some recommendations would be made to improve this process, such as implementing information technology, developing a communication plan, and building a process improvement plan. For example, information technology provides numerous benefits for better process management, including practical information management, good customer service, effective inventory management, smart manufacturing, and forecasting. Thus, using advanced forecasting techniques (Artificial Intelligence, Machine Learning) to predict future demand reliably, generate demand management, and better respond to customer expectations. Utilizing

technology applications results in improved processes, lower costs and increased competitiveness.

Besides, developing a communication plan would help communicate with employees and managers about their activities and help them understand their roles in the company and the supply chain. Also, SC managers could develop a process improvement strategy to analyze and improve existing processes to meet new targets and goals.

Furthermore, all functions have a low-performance value and belong to a lower class. Thus, stakeholders could consider other improvements, such as determining the best warehouse locations, delivering materials on time, and sorting coffee cherries.

Moreover, this thesis adopts the latest SCOR model, SCOR version 12.0. Therefore, it contributes to the literature on using this new version for specific conditions of developing countries such as Vietnam. Such an application could be a valuable tool to assess the supply chain performance of other agricultural products to enhance their contribution to the country's economy, which depends mainly on agriculture.

As mentioned earlier in the literature, the quality of demand forecasting will assist supply chain managers in better planning numerous operations, thus boosting supply chain performance. Therefore, the preceding chapter offered novel techniques and algorithms for improving forecasting accuracy. All findings of the demand forecasting aspect will be detailed in the next section.

4.4. Demand forecasting

This section is divided into two parts. The first part discusses the demand planning process carried out by Vietnamese coffee companies. Then, its influence on operational performance is examined. The second part shows the performance of the proposed models developed in the previous chapter. Also, it is compared to other benchmark models. The proposed model's impact on supply chain performance is then computed. All details are given as follows.

4.4.1. Implementation of the demand planning process to improve the coffee supply chain performance

4.4.1.1 Experiment data

Coffee is one of the first exported agricultural products of Vietnam. This crop is primarily grown in the Central Highlands, a remote rural area where infrastructures (roads and

telecommunication) remain poor. Because of its specific geographical conditions, this highland area is frequently ignored by researchers. However, the Central Highlands produce more than 90 percent of the country's coffee output (International Coffee Organization, 2019), and coffee cultivation is this region's leading source of income. Paradoxically, most coffee producers in the Central Highlands are small farms with poor or outdated facilities and minimal access to information. These problems, coupled with the high distance from training centers in the big cities, lead to coffee producers in the Central Highlands having neither qualified personnel nor knowledge about established effective processes in supply chain management, such as demand planning. This reality explains why coffee production in the Central Highlands remains low despite a heavyweight in national coffee production, leading to low competitiveness and low incomes for coffee producers. Therefore, this study, focusing on the demand planning process, attempts to provide insights to improve the performance of coffee producers in the Central Highlands of Vietnam, which in turn contributes to the socio-economic growth of Vietnam in general and of the Central Highlands in particular.

Our survey was carried out in the Central Highlands of Vietnam during the summer of 2021. Conducting the study was challenging because this is still a new and unusual practice for most small businesses in Vietnam's central highlands. Adding to that, several restrictions due to the Covid-19 pandemic engendered the survey to be longer and more complex. We sent out the survey to 200 coffee companies. After 4 months of the study, we collected 68 questionnaires, which gave us a response rate of 34%. A low response rate has also been registered in previous studies, such as 18% (Doering & Suresh, 2016), and 15.2% (Swierczek, 2020), even in developed countries. Our sample size corresponds to the "10-times rule" method provided by (Hair et al., 2011). Following (Hair et al., 2011), the minimum sample size for PLS-SEM should be more than ten times the most significant number of formative indicators used to measure one construct. Thus, our study's number of formative indicators is 5, so the minimum sample size should be 50. According to (Hofmann & Reiner, 2006), the small sample size is usually the trade-off when examining non-disclosure data.

The survey questionnaire was mainly filled in by high-level managers (see Table 20): directors (37%), vice directors (25%), and the head of the accounting department (38%) who know very well DPP of companies. Table 20 also displays the company size in terms of the number of employees. All coffee firms are tiny, with 94% having less than 50 employees.

Table 20: Sample characteristics

Job title			Company size		
Job title	Number of respondents	%	Size	Number of respondents	%
Director	25	37	Small (≤ 50 employees)	64	94
Vice Director	17	25	Medium (51–250 employees)	2	3
Head of the accounting department	26	38	Large (≥ 250 employees)	2	3

Table 21 gives some descriptive information about the forecasting activities of these firms. We asked respondents about forecasting duration and the number of prediction modifications per year to obtain general forecasting activities. Most companies produce predictions within a time horizon of less than one year, with the sample's median being eight months. The number of forecast modifications is small, with an average of 1.77.

Table 21: Descriptive statistics of the forecasting activity

	Mean	Median	Standard deviation	Min	Max
Time horizon (months)	8.29	8	3.88	1	12
Number of forecast modifications in one year	1.77	2	1.35	0	6

4.4.1.2 Measurement model

This section focuses on the measurement model assessment of all constructs following the steps of prior studies (Hair et al., 2011; Sarstedt et al., 2014). First, we evaluated the loadings indicators that should be above 0.7 recommended by (Sarstedt et al., 2014). Thus, items not fulfilling this criterion will be removed to increase the average variance extracted scores (Swierczek, 2020). As a result, twelve items were dropped for further analysis (see Table 5). Then, we examine the internal consistency reliability through composite reliability (CR). Higher composite reliability states a higher level of reliability (Sarstedt et al., 2014). According to (Hair et al., 2011), composite reliability should be above 0.7. Next, we examine the convergent validity that assesses the magnitude of correlations between item measures of a construct (Hadaya & Cassivi, 2007). The average variance extracted (AVE) is used to determine convergent validity for all items associated with each construct. The AVE values of the construct should be greater than 0.5 (Hair et al., 2011; Sarstedt et al., 2014). Finally, according to Fornell and Larcker's (1981), the general rule to assess discriminant validity is that the square root of the AVE for each construct should surpass all correlations between that construct and other constructs (Hair et al., 2011; Sarstedt et al., 2014).

Table 22 shows all constructs' results in loadings, Cronbach's Alpha, CR, and AVE. Loadings are significant and above 0.7 for all remaining scale items. All composite reliability scores are higher than 0.8, suggesting good internal consistency (Swierczek, 2020). The AVE values of all constructs are more significant than 0.5, indicating that, on average, the construct explains over 50% of the variance of its items (Sarstedt et al., 2014). As a result, all measures meet convergent validity and internal consistency reliability criteria.

Table 22: Measurement model results

Constructs	Variable	Item	Loading ^a	Cronbach's Alpha	composite reliability (CR)	average variance extracted (AVE)
Goal formulation (GF)				0.797	0.868	0.623
	Identifying the product priorities	F2	0.708			
	Tracking the proportion of completed client orders delivered on time	F3	0.847			
	Customers are satisfied with the current on-time delivery performance	F4	0.870			
	Meeting short-term customer demands from the completed products inventory	F6	0.719			
	Identifying the customer priorities	F1	*			
	Ability to react to unanticipated, drop-in orders	F5	*			
	Evaluating the "out-of-stock" position	F7	*			
Demand forecasting				0.882	0.927	0.810
Forecasting techniques (FT)	Using quantitative time series models (e.g., exponential smoothing)	D1	0.853			
	Using a combination of different models	D3	0.933			
	Using quantitative causal models (e.g., regression or econometric analysis)	D4	0.912			
	Using a single model	D2	*			
	Using qualitative models (e.g., market survey or sales quota)	D5	*			
	The jury of executive opinion	D6	*			
	Sales force composite	D7	*			
	Customer expectations	D8	*			
Sources of information (SI)	Using sales estimates in developing prediction	S2	0.717	0.889	0.914	0.602
	Using promotion plans to build demand forecasting	S3	0.853			
	Using market share data in the predicting process	S4	0.775			
	Considering the company's goal when developing predictions	S5	0.736			
	Considering the trade inventory in demand prediction	S6	0.788			
	Using information from the supplier	S7	0.791			
	Using market research	S8	0.765			
	Taking the current economic situation	S9	*			
	Using past data in generating a prediction	S1	*			
Roles of forecasting in decision-making (RF)	Developing Sales and budget preparation	R1	0.881	0.881	0.927	0.808
	New product development	R3	0.915			

	Equipment planning	R4	0.900			
	Developing Production planning	R2	*			
Communication of the demand predictions and synchronization of supply with demand (C&S)				0.909	0.936	0.785
	Assisting the demand planning process using inter-organizational information	C1	0.876			
	Supporting the order commitment process using inter-organizational information	C2	0.923			
	Sharing demand forecasting insights within supply chains	C3	0.871			
	Accessing online prediction data	C5	0.873			
	Accessing free forecasting data	C4	*			
Operational performance						
Cost				0.862	0.914	0.779
	Direct manufacturing costs	OP1	0.887			
	Total product costs	OP2	0.889			
	Raw material costs	OP3	0.872			
Delivery				0.908	0.941	0.843
	Order fulfillment speed	OP4	0.885			
	Delivery speed	OP5	0.939			
	Delivery as promised	OP6	0.930			
<i>Note(s): ^aItem loadings are significant at $p < 0.000$; [*]Insignificant items are excluded since their loadings are less than 0.7</i>						

Discriminant validity implies that a construct is experimentally distinctive and reflects observed phenomena that other variables in a structural equation model do not (Henseler et al., 2015). Table 23 exhibits discriminant validity based on Fornell and Larcker's. The results indicate that the AVE's square root values are more significant than the construct correlations for all constructs. Therefore, discriminant validity between the reflective constructs is established, providing confidence in the measuring model's adequacy.

Table 23: Discriminant validity

Constructs	GF	FT	SI	RF	C&S	Cost	Delivery
Goal formulation (GF)	<i>0.789</i>						
Forecasting techniques (FT)	0.393	<i>0.900</i>					
Sources of information (SI)	0.586	0.470	<i>0.755</i>				
Role of forecasting in decision-making (RF)	0.510	0.157	0.423	<i>0.898</i>			
Communicating the forecasts and synchronizing demand with supply (C&S)	0.351	0.713	0.573	0.264	<i>0.886</i>		
Cost	0.406	0.061	0.376	0.408	0.172	<i>0.882</i>	
Delivery	0.440	0.226	0.425	0.317	0.161	0.834	<i>0.918</i>

4.4.1.3 The demand planning process in the Vietnamese coffee industry

The statistical data analysis of the Vietnamese coffee industry reveals that companies use straightforward methods in demand planning. Indeed, they conduct demand planning once a year and do not use advanced technologies, such as artificial intelligence (AI) and machine learning. For example, to determine future consumer demand, most companies call or visit current customers to inquire about their orders or contracts, then plan production accordingly. Thus, with this approach to demand planning, the final demand plan cannot be correct because the market trends and consumer order insights are considered. Consequently, numerous inaccuracies in the demand planning process may lead to business failure, particularly for tiny businesses which are already fragile in terms of management and financial resources. In fact, despite the mutual professional relationship between these companies, there is no typical pattern for the demand planning process because each company has its specific situation and resources. However, several commonalities were observed as follows.

- All participating companies recognized that demand planning is a critical process in the supply chain because it influences all other operations and procedures, particularly inventory

management. It also assists in developing other plans such as new product launching, sales forecasting, and budgeting.

- They were unconcerned about the historical data because they did not comprehend the roles of these data. Hence, they have never tried to access or exploit this valuable information source. Yet, it is known that historical data plays a vital role in demand forecasting, which is a critical component of the demand planning process. The primary challenge of the demand planning process is generating an accurate forecast of customer demand. Inaccurate forecasts cause huge issues, such as lost revenue opportunities and increased expenses (Abby, 2020). Unfortunately, these firms ignored this element due to insufficient knowledge of historical data and advanced forecasting techniques. Consequently, they cannot correctly identify trends and patterns of customer demand.
- Vietnamese coffee companies know that collaboration between departments and supply chain partners is vital to an effective demand plan. So they attempt to reinforce this collaboration. However, until now, their demand planning process still relies mainly on experiences or following customers' orders, lacking the application of information and communication technologies. Consequently, demand planning cannot be accurate, especially in the case of an extension of the company's activities or a high variation of consumer orders.

Effective demand planning generates profit and customer satisfaction by assisting the company in reaching the appropriate balance between adequate inventory levels and consumer demand. Balancing supply and demand will help avoid shortages or overproduction (Bacci et al., 2019). Thus, demand planning assists in lowering supply chain expenses and improving supply chain performance. So, our interest is to study the impact of the demand planning process as a higher-order concept on operational performance.

4.4.1.4 Influence of the demand planning process as a higher-order construct on operational performance

The Repeated Indicators Approach is employed to evaluate higher-order constructs using PLS to determine the path coefficients (Sarstedt et al., 2019), (Swierczek, 2020). Following this approach, we incorporate all indicators of lower-order components under the higher-order component. This approach allows assessing all constructs together rather than individually assessing lower-order and higher-order features. Also, it provides lower biases in evaluating the measurement model of the higher-order construct. Hence, considering the reflective-formative and formative-formative is preferable (Becker et al., 2012).

Figure 24 displays the reflective-formative research model demonstrating the influence of demand planning in improving cost and delivery performance. Figure 24a illustrates the primary constructs, items, and their relationship. In addition, Figure 24b depicts the path coefficients of each construct. Path coefficients of all first-order constructs are 0.243; 0.171; 0.453; 0.191, and 0.239 for goal determination, forecasting techniques, source of information, the role of forecasting in decision making, and communicating the demand predictions, and synchronizing supply with demand, respectively. Path coefficients between all practices and DPP are positively significant at 0.001 levels. This finding demonstrates a strong relationship between constructs and implies that all practices contribute to the DPP pattern. As a result, H1 is supported. This result is in line with an earlier study of (Swierczek, 2020) for whom DPP should be considered a higher-order dynamic capability.

Demand forecasting contributed most to the DPP among demand planning practices. Indeed, demand forecasting has the most significant coefficient value due to the total coefficient of three components (forecasting techniques, information sources, and forecasting roles). Similar findings can be found in a previous study (Swierczek, 2020). Forecasting and demand planning are primarily responsible for estimating future demand to maintain appropriate inventory amounts at different locations along the supply chain (Raza & Kilbourn, 2017). Prior scholars (Myerholtz, B. & Caffrey, 2014) indicated that better forecasts could improve organizational and business performance. As a result, the company has fewer missing sales, better customer service levels, smaller working capital, more excellent and effective production, lower trash wastage, and less work. Enhanced forecasting tools and effective demand-planning processes can be the foundation for a more responsive and flexible supply chain while delivering a more extensive set of benefits. Selecting valuable data and employing a suitable forecasting method creates accurate and robust demand forecasts, subsequently forming decision-making procedures (Blackburn et al., 2015).

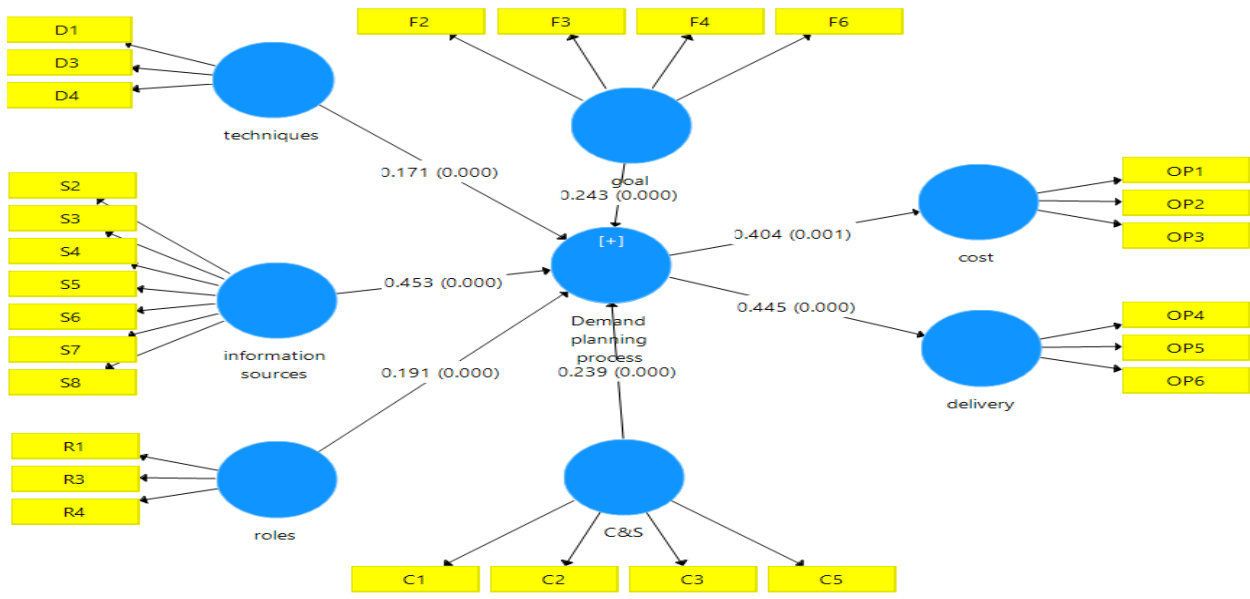

(a) Screenshot of variables in Smart PLS (v.3.3.7)

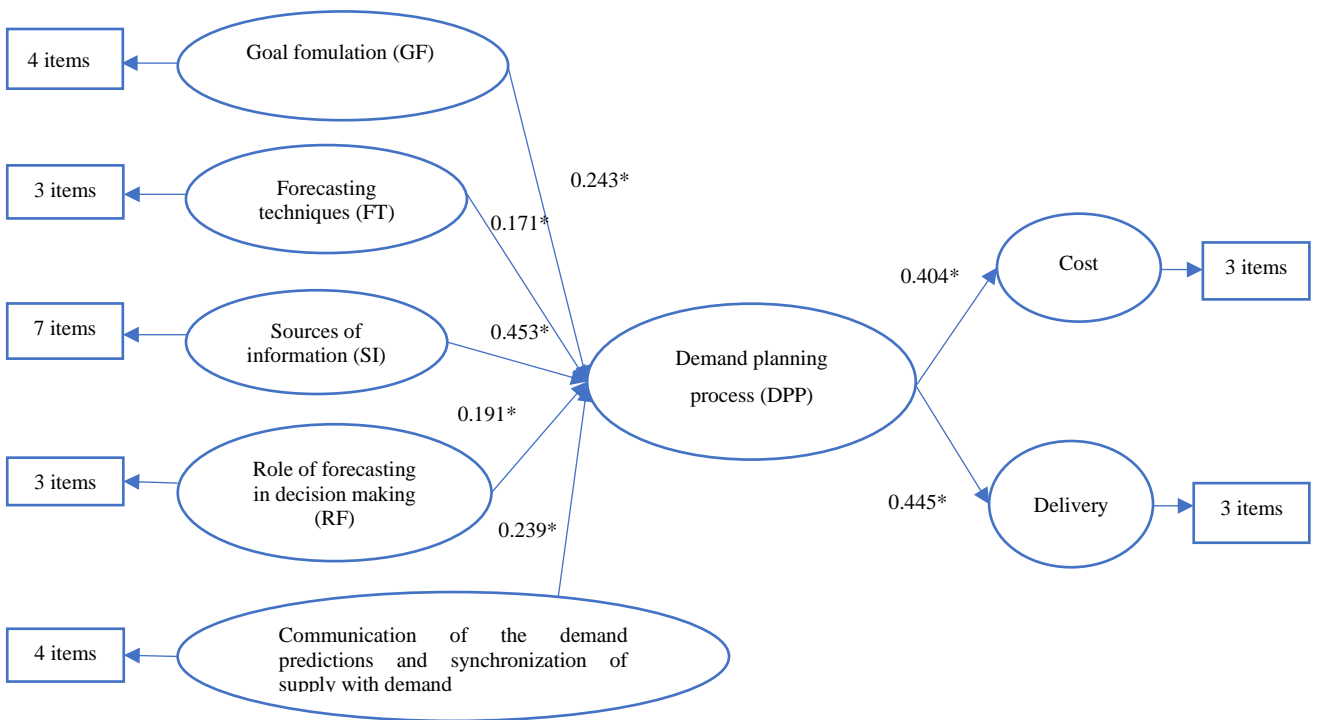

Note(s): *All path coefficients significant at p < 0.001

(b) Path coefficients

Figure 24: Reflective-formative research model demonstrating the influence of demand planning in improving operational performance

Moreover, the DPP positively impacts operational performance, such as cost and delivery. As shown in Figure 24, all path coefficient between DPP and operational performance is significant at $p < 0.001$. The DPP positively affects cost performance (0.404) and delivery performance (0.445). These findings support H2 and H3. Thus, our results are consistent with previous studies. According to (Swierczek, 2020), balancing supply and demand is the foundation of efficient demand planning. Also, the quality of the forecasting and planning process impacts the supply-demand balance (Feizabadi, 2020). According to authors (George & Madhusudanan Pillai, 2019), forecasting methods were one of seven significant factors affecting supply chain performance, along with supply chain structure, inventory management, knowledge exchange, consumer demand, lead time, and the review period. Demand forecasting anticipates future product or service consumption to plan operations to reduce delivery times, stock levels, and operating costs (Kantasa-ard et al., 2021).

Nevertheless, a recent study (Swierczek, 2020) found that when demand planning practices are examined independently, the impact of each construct can be different compared to the case when they were analyzed together. Hence, in this study, we also explore the effects of DPP individual components on cost and delivery performance dimensions.

4.4.1.5 The effect of individual demand planning practices on performance

This section investigates the direct links between each demand planning practice and operational performance. Table 24 shows the path coefficients of all first-order constructs. Only the path coefficient between information source and delivery performance, which values 0.337, is statistically significant at 0.1. It can be seen that individual demand planning practices have little effect on operational performance. A similar finding in a prior study (Swierczek, 2020) regarding operational risks: demand planning is a dynamic routine accomplished by combining practices and learning processes. R^2 of cost and delivery is 0.26 and 0.257, respectively. Following (Kock, 2018), these R^2 values are acceptable.

Table 24: The effect of individual demand planning practices on operational performance

	Path coefficients	T Statistics	Significance (P values)
<i>Goal formulation</i>			
-> cost	0.198	1.062	0.288
-> delivery	0.190	1.217	0.223
<i>Forecasting techniques</i>			
-> cost	-0.248	1.327	0.184
-> delivery	0.081	0.419	0.675
<i>Information sources</i>			
-> cost	0.190	0.890	0.374
-> delivery	0.337*	1.785	0.074
<i>Forecasting roles</i>			
-> cost	0.215	1.509	0.131
-> delivery	0.095	0.754	0.452
<i>Communication and synchronization</i>			
-> cost	0.170	0.671	0.502
-> delivery	-0.125	0.492	0.623
*Sig.<0.1			

Besides, we run multiple regressions to examine the relationship between practices and cost and delivery performance. Regarding delivery performance, the regression reveals a similar finding (as seen in Table 25). Information sources considerably affect delivery performance, with a 0.05 significant level. Also, this practice has the highest coefficient with a value of 0.321. This finding is consistent with (Danese & Kalchschmidt, 2011). Getting information from many sources leads to better customer relations and supplier management. As a result, delivery performance will be improved because the material and elements are accessible at the correct time and in the proper amount, and the delivery date is simply estimable.

Regarding cost performance, goal formulation is the only demand planning practice that significantly influences cost performance. The coefficient of goal formulation is 0.323. Goal setting is the first demand planning practice that helps define customers' needs and production capabilities (Croxtton et al., 2002).

Furthermore, forecasting techniques do not significantly impact cost and delivery performance because of a lack of using advanced and suitable methods in the DPP. Some companies believe that forecasting demand is unnecessary because of high coffee demand. The obtained data showed that only basic quantitative techniques such as Excel, Word, and

Regression,...have been employed to predict coffee demand. However, authors (Raza & Kilbourn, 2017) recommend using new and appropriate technologies in the modern demand planning process. Therefore, effective coffee forecasting technologies must be developed to optimize the demand planning process, especially in developing countries such as Vietnam.

Table 25: The regression results

	Standardized Coefficients	
	Cost performance	Delivery performance
Goal formulation	.323**	.224
Forecasting techniques	-.198	.146
Forecasting roles	.068	-.040
Information source	.142	.321**
Communication and synchronization	.077	-.205
F	2.740**	3.414***
R ²	.181	.216

*Sig.<0.1; **Sig.<0.05; *** Sig.<0.01

We shall first look at each major dimension and briefly link specific practices organizations need to manage. Then we will identify some challenges and potential issues.

4.4.1.6 Managing a Portfolio of Demand Planning Practices

As we have mentioned, five significant groups of practices are confirmed. What does each mean to an organization and the demand planning team? We summarize some of the items.

First, *goal formulation*, the process team should carefully understand a company’s overall strategy—for example, is the company trying to sell low-priced, standard products or higher-priced but customized products? There should also be an understanding of consumer requirements, production capabilities, and the supply chain network design and strategy. It can help achieve supply and demand balance by effectively catering to different market expectations through various supply chain abilities.

These issues can be monitored through many key performance indicators and practices, as shown in Table 22. Thus, an excellent strategic performance measurement system will help the DPP, given that many goal formulations are based on these key performance indicators (goals)—such as meeting customer demand and timely delivery performance monitoring.

Second, *forecasting techniques* support estimating future demand to maintain appropriate inventory amounts at different locations along the supply chain (Raza & Kilbourn, 2017). Thus, a suitable forecasting method creates accurate and robust demand forecasts, subsequently forming decision-making procedures. Some of the practices organizations should pursue along this

dimension include using a mixed model approach to forecasting, which could and should consist of time-series and causal models.

Third, the *source of information* has the highest path coefficient of 0.453—representing the strongest (statistically) DPP dimension. Gathering data from multiple sources enables enterprises to support organizational functions with in-depth demand evaluations, contributing to low volatility from future occurrences and planning suitable responses. Collecting information from various sources may be advantageous because predictors better understand and assess future customer demand and market change, especially purchasing behaviors and trends.

There is a need for cross-functional organizational coordination and cooperation to acquire the necessary information. As can be seen, by the many items, information about company goals needs to come from executive and even board information that filters down to DPP planners. Function-level information from marketing needs to include promotion and market share data, for example. Function-level data from operations would consist of supplier and inventory data. Thus, multi-level and multi-functional data sources are necessary for effective DPP.

Fourth, *using forecasting in the decision-making* dimension supports the role of forecasting models for managerial decisions and support for managerial practices in general. This information allows managers to make more proper operational, tactical, and strategic decisions in many areas. These administrative decisions are also across functions. For example, finance and accounting will need to make sales and budget decisions; forecasting data will be critical. This is an outcome of forecasting data and models that goes beyond a single function (e.g. marketing and operations managers need to base their budgets on forecasted data). Broader examples of managerial decision practices also include capital equipment planning and new product launches.

Fifth, *communication of demand predictions and synchronization of supply with demand* has the second biggest path coefficient among practices of DPP—further supporting the communication of the information as a critical DPP activity. The most significant synchronizing efforts seem to be about inter-organizational information.

This dimension and our results point to two main issues. First, there will be a need for cross-organizational coordination for information and sharing. Partners in the supply chain should be involved in sharing information for effective DPP. Also, it is necessary to share this information internally, externally focused functions such as supply chain management and purchasing must be shared with other parties, and communicate this information effectively.

Given that DPP is informed and requires managing across five dimensions and multiple sub-practices. This characteristic produces many challenges for organizations. Some challenges and

concerns are now identified; some will be more difficult to overcome, while others may not be faced by all organizations and their managers.

4.4.1.7. Challenges and Potential Concerns for Demand Planning Practices Management

Investments in information technology: Historical data plays a vital role in demand forecasting—a key component of DPP. However, some organizations may undervalue and ignore this element due to insufficient knowledge of historical data and advanced forecasting techniques. Many of the organizations surveyed were small organizations, and investments in information technology may not be as extensive beyond potentially a stand-alone personal computer.

Consequently, many organizations, especially smaller organizations, may be unable to correctly identify trends and patterns of customer demand—which can impact the overall supply chain performance with larger partners. Senior managers consider forecasting a considerable expense and may not see the returns on investment (ROI). Overcoming these information technology investment barriers will require showing that adopting good DPP practices with supporting information technology can lead to high cost and delivery performance improvements. Managers should ask whether these performance metrics are essential to their competitive advantages and long-term financial returns.

Choosing appropriate forecasting techniques has been challenging for practitioners due to the large range of accessible forecasting methodologies. For example, all companies in our survey have not paid close attention to forecasting techniques because they have no knowledge about the utility of these models, nor do they have the expertise to use them. To overcome this challenge, companies should provide the personnel of the planning department with sufficient training on forecasting tools. Also, their application and implementation will need to be carefully monitored and managed. In many cases, companies can rely on educational institutions to hire people. But, smaller companies may not have the necessary resources to hire skilled employees and train them on the job.

Adaptation of the demand planning process. The demand planning process might require organizational change—depending on the products and supply chain specificities. Thus, implementing the proposed demand planning process can be challenging and complicated to accomplish in small companies, especially in developing countries—as established ways may become ingrained and the lack of strategic outlook, in general, may limit extending the formalization of DPP. Before applying advanced methodologies or knowledge, demand planners must first comprehend these differences to adapt the best practice to specific products and the country's particular circumstances.

4.4.2 Implementation of a proposed hybrid model for forecasting demand

In this section, the performance of the proposed forecasting model will be calculated. In addition, its performance will be compared to many benchmark models. Further, the relationship between this new model and supply chain performance will be evidenced. The final section will provide managerial insights.

4.4.2.1 Data description

Figure 25 presents the time series plot of the daily demand for Vietnamese coffee from January 2000 to December 2020. The graph shows a positive trend and seasonality in the time series data. The series starts with a downtrend and is then followed by an uptrend. It continues to replay for the remainder of its life. These abrupt changes in patterns make predicting challenging. Non-stationary is caused by two typical elements of time series: trends and seasonality (Abbasimehr et al., 2020).

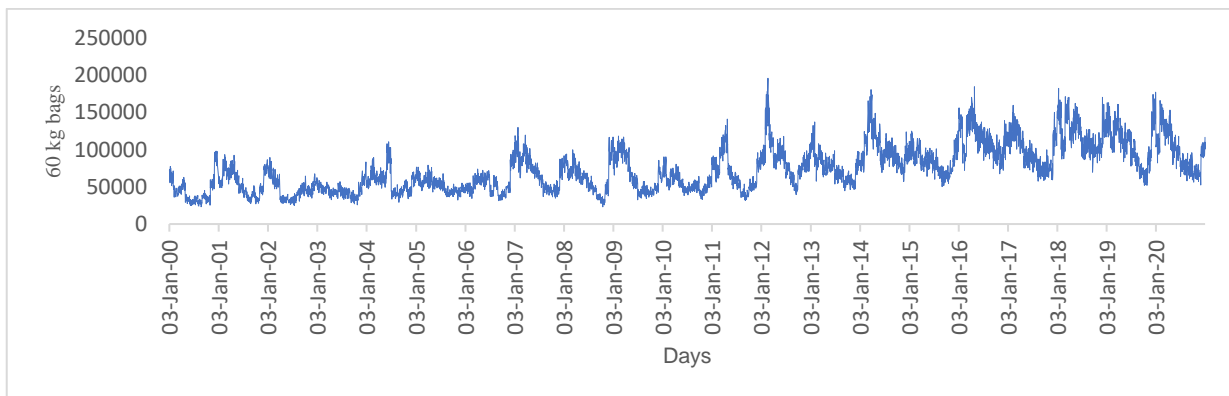

Figure 25: Coffee daily demand in Vietnam from 2000 to 2020

Table 26: Descriptive statistics of daily coffee demand

Measures	Value
Count	5360.00
Mean	74080.07
Median	68535.03466
Standard Deviation	30658.12361
min	23099.54
25%	48946.12
50%	68582.96
75%	94013.66
max	196126.80
Kurtosis	-0.037
Skewness	0.733

Table 26 presents descriptive statistics of daily coffee demand data. Data consist of 5360 observations, 4288 data for the training set, and 1072 data for the test set. The dataset is slightly

positively skewed with 0.733. The standard deviation is high at 30658.12361. It states that data are more spread out.

The stationarity degree of a given sequence is critical for time series forecasting. Stationary time series is a time series in which mean and variance remain constant (Abbasimehr et al., 2020; Soy Temür et al., 2019). Therefore, using the Augmented Dickey-Fuller (ADF), the data can be determined as stationary or non-stationary (Kantasa-ard et al., 2021). Table 27 provides ADF statistics results by using the ADF test on the time series. The ADF score is -4.667, below the crucial value of -3.432. As a result, the unit root's null hypothesis will be dismissed at the 99% confidence level. Therefore, the demand data are stationary based on the ADF score.

Table 27: ADF test results

ADF Statistic	-4.667
p-value	0.000097
Confidence level	Critical Values:
99%	-3.432
95%	-2.862
90%	-2.567

4.4.2.2 Evaluation of the forecasting model performance

a) Performance of LSTM and ARIMAX models

After going through many random search stages, the optimal LSTM configuration is determined when it has the lowest error values (see Table 28). The best configuration of LSTM in the proposed ARIMAX-LSTM hybrid model is selected as lag 10; the number of hidden layers: 2, number of neurons in each layer: 64, epoch: 50, batch size:10, dropout rate: 0.1, learning rate 0.001. These values are the same for Soy's ARIMAX-LSTM hybrid model because LSTM is used to model original time series data. However, the tuning process was done for Choi's ARIMA-LSTM hybrid model. Thus, the hyperparameters are lag 10; the number of hidden layers: 2, number of neurons in each layer: 32, epoch: 100, batch size:5, dropout rate: 0.05, learning rate 0.0001.

Table 28: Optimal hyperparameters results for LSTM model in hybrid models

Model	Hyperparameters	Values
Choi's ARIMA-LSTM hybrid model	lag	10
	the number of hidden layers	2
	number of neurons in each layer	32
	epoch	100
	batch size	5
	dropout rate	0.05
	learning rate	0.0001
Soy's ARIMAX-LSTM hybrid model	lag	10
	the number of hidden layers	2
	number of neurons in each layer	64
	epoch	50
	batch size	10
	dropout rate	10
	learning rate	0.001
Our proposed model	lag	10
	the number of hidden layers	2
	number of neurons in each layer	64
	epoch	50
	batch size	10
	dropout rate	10
	learning rate	0.001

LSTM and ARIMAX performed well regarding the accuracy and the degree of determination (as shown in Table 29). In terms of accuracy, LSTM has lower errors compared to ARIMAX. Thus, LSTM provides a higher accuracy value than the ARIMAX model. LSTM's ability transfers the forecasting pattern to minimize the test dataset error (Kantasa-ard et al., 2021). LSTM also provides a higher degree of association, with an R2 value of 0.75. This comparison can indicate that the LSTM model outperforms the ARIMAX model. Figure 26 shows how the LSTM and ARIMAX models compare predicted and actual demand patterns. In ARIMAX, the predicted values are more prominent than the actual values. For LSTM, the predicted values follow the same patterns as actual data. However, the two models have a similar direction to the actual data. Hence, a hybrid model will take advantage of each model to improve forecast accuracy substantially.

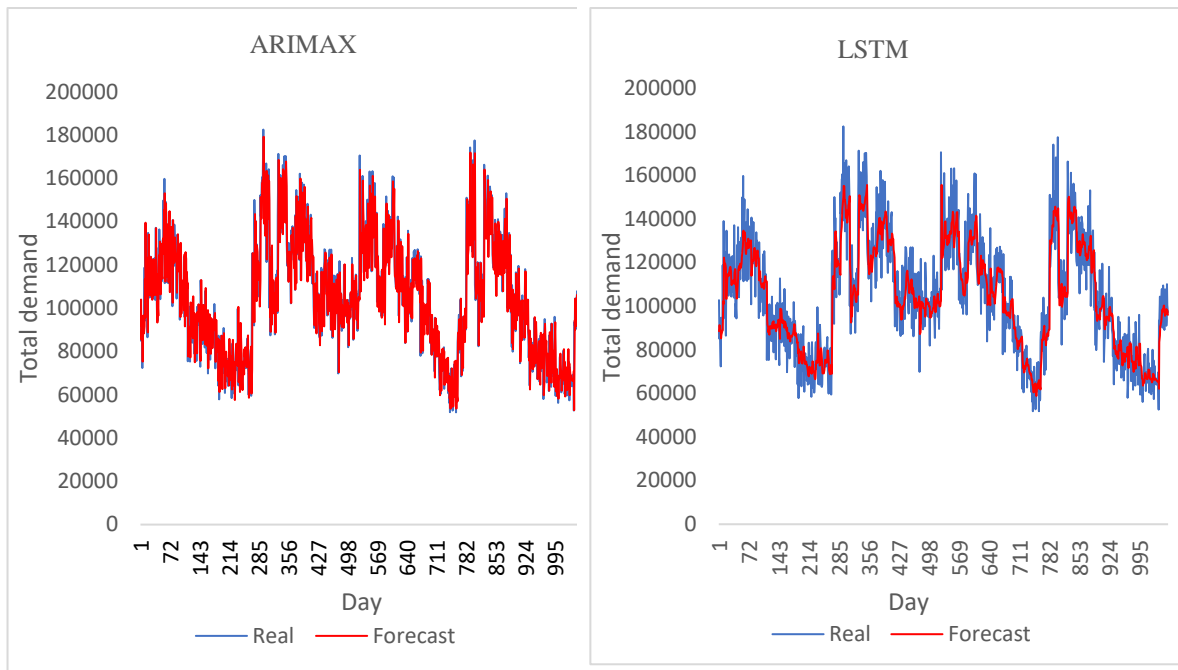

Figure 26: Forecasting coffee demand using LSTM and ARIMAX models

b) Performance of proposed hybrid models for coffee demand

Our proposed hybrid model is implemented for forecasting future coffee demand. It is benchmarked against other forecasting models: ARIMAX, ANN, LSTM, and two existing ARIMA-LSTM hybrid models.

Table 29 presents the performance scores and association degree of all models. The proposed ARIMAX-LSTM hybrid model produces better results than other models' accuracy and degree of association. It has the minimum errors with RMSE of 12962.59, MAE of 9765.68, MAPE of 9.38, and R^2 of 0.76. The proposed model performs better than the best scores obtained with single ones such as ARIMAX, ANN, and LSTM. Our results confirm the hybrid model's superiority over the individual ones, as reported in the literature. Moreover, LSTM produces lower error scores and higher R^2 compared to ANN. The results proved that deep learning outperforms classic machine learning methods.

Furthermore, although the proposed hybrid model and LSTM differ slightly, these gaps have significant implications. First, coffee companies are often small-scale in developing nations like Vietnam. Also, coffee production is predominantly a 'family' operation for smallholders (T. V. Nguyen et al., 2015). Hence, if the coffee demand prediction is faulty, growers and firms will produce more or less than the actual demand. It results in either overproduction or shortage. These issues may affect coffee prices and production costs. Second, forecasting provides essential information that is utilized to establish the demand planning of companies. Hence, producers

require additional capital for planting and manufacturing. Thus, a tiny inaccuracy will result in a considerable loss, especially for farmers and small companies. Last, forecasting also aids external members such as policymakers and investors in decision-making. For example, the government can design appropriate policies and manage supply chain resources to support planting, production, and export. As a result, accurate demand forecasting is critical in supply chain management in Vietnam as well as in emerging countries.

Table 29: Comparison performance of forecasting hybrid models and others for future demand of coffee

Model	RMSE	MAE	MAPE	R ²
ARIMAX	15545.14	11947.51	11.53	0.67
ANN	13894.41	10656.37	10.27	0.72
LSTM	12983.38	9780.02	9.40	0.75
Choi's ARIMA-LSTM hybrid model	15374.69	11759.77	11.37	0.68
Soy's LSTM – ARIMA hybrid model	14136.20	10828.40	10.44	0.71
Proposed ARIMAX-LSTM hybrid model	12962.59	9765.68	9.38	0.76

Table 30 provides the actual and estimated daily coffee demand series using single and hybrid models. The proposed ARIMAX-LSTM hybrid model produces a similar value corresponding to actual demand.

Table 30: Examples of actual and forecast daily coffee demand with several forecasting models

Day	Real	ARIMAX	LSTM	Choi's ARIMA-LSTM hybrid model	Soy's ARIMAX-LSTM hybrid model	Proposed ARIMAX-LSTM hybrid model
0	102812.90	91705.87	88560.52	90874.99	64398.73	88721.97
1	84986.16	104081.2	91362.64	101953.6	59582.13	92015.48
2	88571.65	85572.58	91007.34	85454.826	60623.74	90728.38
3	85611.42	92291.64	89484.04	91626.769	59128.52	89628.15
4	72340.67	84212.15	88696.32	84429.528	54537.99	88466.15
5	94678.55	75357.61	85268.98	76055.02	60602.80	84760.24
6	91574.09	96640.30	86951.15	93966.427	60181.60	87448.49
7	90926.31	92533.45	88061.12	91814.308	60359.11	88290.68
8	88887.09	88375.58	88783.03	88344.653	59948.49	88762.12
9	118749.50	91529.78	89069.44	91533.556	69758.58	89195.73
10	94262.54	113259.60	102329.20	111487.01	66433.27	102890.20
11	139057.30	95544.61	101010.20	94965.399	80537.33	100729.60
12	104864.40	139487.00	122324.60	149069.10	76872.66	123205.50
13	124818.40	105624.30	119599.20	105071.20	82407.79	118881.90
14	118114.10	123472.30	119377.30	122475.07	80150.26	119587.50

Moreover, the performance results differ from other hybrid models (shown in Table 29). As described in section 2.3.2.2, two different hybrid models are considered benchmarks. The

proposed ARIMAX-LSTM hybrid model produces the best forecasting results. Soy's ARIMAX-LSTM hybrid model outperforms Choi's ARIMA-LSTM model in terms of accuracy and association degree. The different results can be explained due to the different ways of model combination. The results proved that different hybrid methods produced different prediction accuracy. These results align with a previous study (Babu & Reddy, 2014) that demonstrated that the combination of ARIMA and ANN models produced different results. Although the combination of ARIMAX and LSTM exists, this thesis adds novel hybrid algorithms to the existing literature. This contribution is validated in the context of coffee.

According to the graphical representation in Figure 27, the forecasting data of the proposed ARIMAX-LSTM hybrid is similar to actual data compared to other hybrid models.

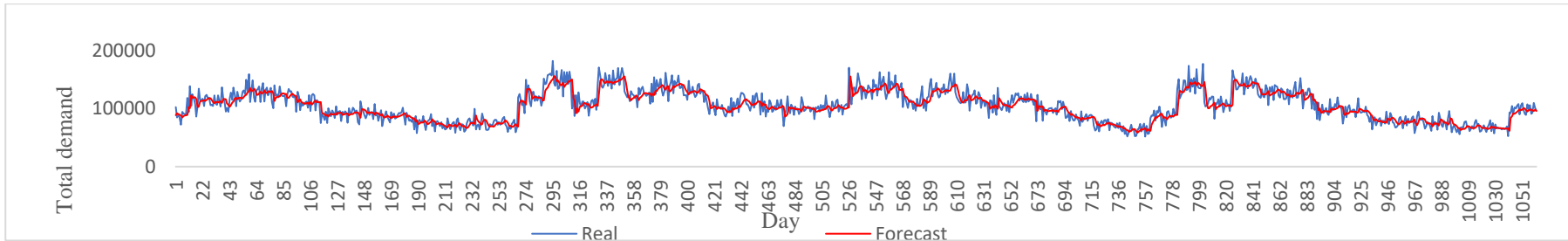

(a) Proposed ARIMAX-LSTM hybrid model

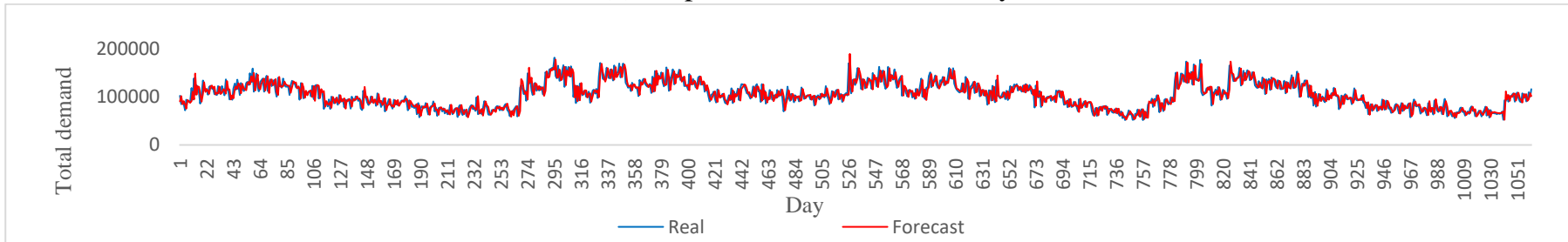

(b) Choi's ARIMA-LSTM hybrid model

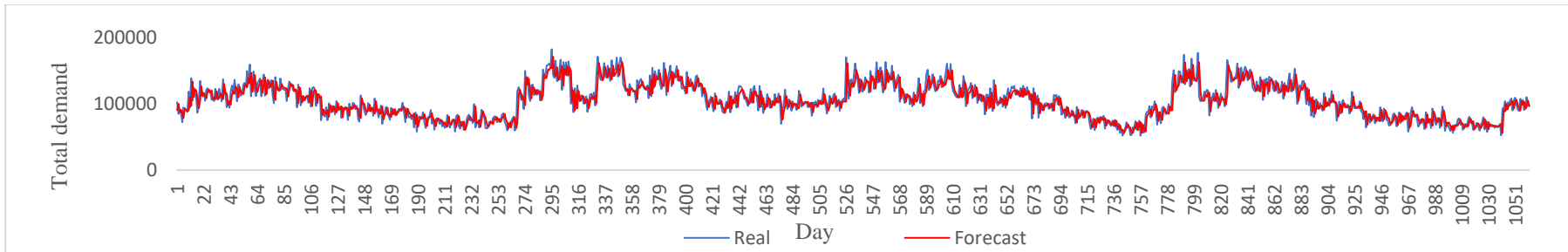

(c) Soy's ARIMAX-LSTM hybrid model

Figure 27: ARIMA-LSTM hybrid models

In conclusion, the proposed model has a lower error rate than the single model (ARIMAX, LSTM) and other hybrid models. In other words, our proposed model produces the best accurate prediction among the obtained models in the coffee sector. The results confirm that hybridizing ARIMAX and LSTM models can generate a synergetic effect that may yield a robust method and more satisfactory forecasting results.

In the following section, our hybrid model is applied to three Thailand agricultural product datasets to evaluate its performance.

c) Performance of proposed hybrid models for other agricultural products

In this section, we put our proposed model to the test in three agricultural products: pineapple, corn, and cassava. Because no data for other products are available in Vietnam, we would also like to test our model's performance on any available data in any country. As a result, we use the same datasets used in a recent study by (Kantasa-ard et al., 2021). Their study forecasted future demand for Thailand's agricultural products using single models such as LSTM, ARIMAX, MLR, and SVR. They discovered that the LSTM performed well with pineapple. MLR and ARIMAX, on the other hand, performed admirably for cassava and corn. They concluded that the performance of single models depends on the product type. As a result, we intend to demonstrate that our proposed model can produce better results.

For this objective, we obtained their data by asking for access. This data set consists of daily demand and price for three Thailand products: cassava, corn, and pineapple. Then, we use our proposed ARIMAX-LSTM hybrid model for three products: pineapple, corn, and cassava, respectively. Finally, we compare our model to the best results obtained by (Kantasa-ard et al., 2021).

Regarding pineapple's performance evaluation, our proposed ARIMAX-LSTM hybrid model provides the best performance. Our model produces lower errors of RMSE and MAPE. Similarly, it outperforms in the context of corn. Also, regarding the cassava dataset, our proposed model's accuracy scores are similar to the ARIMAX model (Kantasa-ard et al., 2021), which produces the highest forecasting accuracy with the lowest error scores. As a result, our proposed model produces better results than the previous study (Kantasa-ard et al., 2021).

Our proposed model performs well with three datasets, particularly pineapple and corn. Product trends do not influence it. These findings differ from those of (Kantasa-ard et al., 2021). Because hybrid models can capture both linear and non-linear trends by combining the

strengths of different models, thus, they are more effective than single models. This finding is consistent with previous scholars (Dave et al., 2021; Feizabadi, 2020; Soy Temür et al., 2019).

Furthermore, this section clarifies our model's performance. We proved our model's robustness which can leverage LSTM's strengths while minimizing its drawbacks thanks to the synergy produced by hybrid algorithms. Thus, the product pattern does not significantly influence the performance of the proposed model. These results demonstrated that our hybrid model is strong, stable, and capable of capturing many patterns.

Table 31. Performance of models in forecasting demand for agricultural products

Source: Results of SVR, MLR, ARIMAX, and LSTM obtained from (Kantasa-ard et al., 2021)

Model	RMSE	MAE	MAPE	R ²
<i>Pineapple</i>				
SVR	151.14	98.35	11.1	0.91
MLR	150.16	99.56	10.97	0.91
ARIMAX	150.15	99.75	11,00	0.91
LSTM	149.24	98.05	10.97	0.92
Our proposed hybrid model	149.04	98.05	10.89	0.91
<i>Corn</i>				
SVR	2465.06	1341.78	92.89	0.94
MLR	2380.15	1055.70	26.27	0.95
ARIMAX	2383.93	1056.88	26.62	0.94
LSTM	2365.03	1146.26	61.68	0.95
Our proposed hybrid model	2239.85	1008.63	44.48	0.95
<i>Cassava</i>				
SVR	8845.33	6563.01	3363.86	0.83
MLR	4445.96	1810.97	26.55	0.95
ARIMAX	4449.83	1808.88	25.30	0.96
LSTM	4699.50	2392.05	48.49	0.95
Our proposed hybrid model	4449.56	1811.94	25.46	0.96

The above results demonstrate that our proposed ARIMAX-LSTM hybrid model can predict demand in the supply chain more accurately than other well-known models. Further, this study provides evidence that adopting the proposed hybrid model improves the supply chain's performance and sustainability by studying BWE, NSAmP, TC, IT, CF, and WF.

4.4.2.3 Supply chain performance evolution

a) Operational measures

1. Bullwhip effect (BWE)

As seen in Table 32, the estimated BWE was higher than one for all models. Thus, the results indicated that the bullwhip effect exists. In such a situation, manufacturers need to manage frequent production levels and reflect average production switching costs (Boute & Lambrecht, 2009). LSTM and our proposed model reduce BWE better than ARIMAX. The decrease in BWE reduces the production switching cost. The results indicated that the hybrid model and LSTM control the order variance. It implies that deep learning methods produce better predictions and lower BWE than the traditional method. In addition, our proposed model reduces BWE better than the others. Hence, it contributes to enhancing the performance of the supply chain. From a managerial point of view, the reduction in BWE will lead to the production planning phase at the supplier becoming more manageable and helps stabilize the production process (H. T. Luong, 2007). The outcomes of this thesis demonstrated that adopting the hybrid forecasting model reduces BWE and the total cost of the supply chain. It matches the findings of a previous study (Jaipuria & Mahapatra, 2014).

Table 32: The BWE of forecasting models

Lead time L (Day)	ARIMAX	LSTM	Proposed hybrid model
L=1	1.687	1.147	1.163
L=2	1.372	1.176	1.173
L=3	1.351	1.175	1.172
L=4	1.375	1.188	1.186
L=5	1.423	1.206	1.205

Figure 28 presents the changes in BWE with different values of lead time. This figure indicates that when lead-time increases, BWE will increase. Thus, the shorter the lead time, the better the supply chain performance. Our finding is similar to previous authors (H. T. Luong & Phien, 2007).

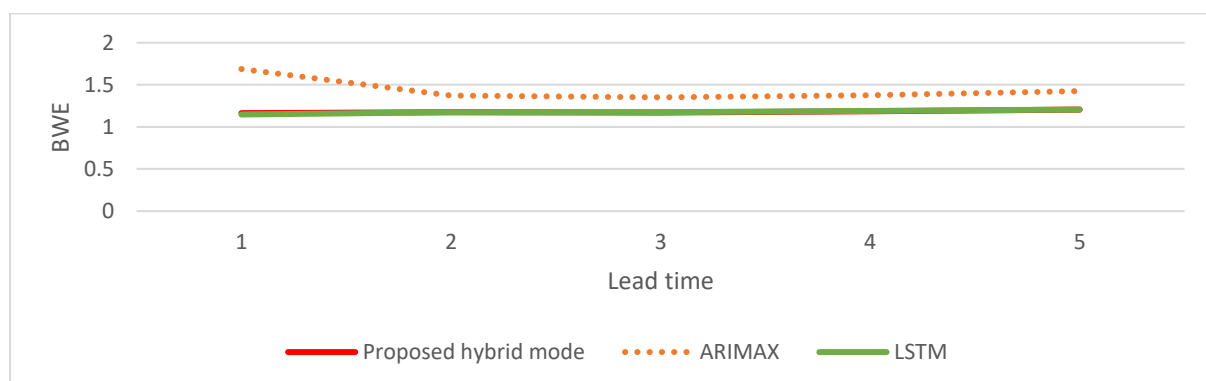

Figure 28: The effect of lead time on the BWE measure

As shown in Table 33, the BWE of the hybrid model in 2020 is 2.988. While LSTM and ARIMAX models in 2020 are 4.416 and 2.990, respectively. Thus, it can be seen that the BWE using the hybrid is more minor than LSTM and ARIMAX models. The findings imply that our hybrid model helps manage order variance. As a result, they reduce overall supply chain costs more effectively than single models.

Table 33: BWE of forecasting models for the year 2020 (L=3)

Month	ARIMAX	LSTM	Proposed hybrid model
1	5.958	4.114	4.097
2	3.119	3.184	3.113
3	2.813	1.682	1.663
4	2.241	1.715	1.677
5	4.809	1.967	2.037
6	2.557	1.638	1.617
7	2.558	1.658	1.648
8	2.044	1.397	1.363
9	2.313	1.675	1.653
10	2.799	1.739	1.721
11	4.526	1.672	1.729
12	17.250	13.435	13.542
Overall	4.416	2.990	2.988

2. Net Stock Amplification (NSAmp)

Table 34 reveals that most of the calculated NSAmp for the three selected models was less than one. In the case of L=1, the NSAmp value obtained by ARIMAX was 1.013. Like BWE, the hybrid model and LSTM provide lower NSAmp values than ARIMAX. It demonstrates that both models help to improve customer service and reduce holding and backlog costs. As seen in Figure 29, NSAmp values generated by the three models vary with lead time. They create the lowest score when lead time equals 2, but show an upward trend as lead time increases.

Table 34: The NSAmp of forecasting models

Lead time L (Day)	ARIMAX	LSTM	Proposed hybrid model
L=1	1.013	0.489	0.504
L=2	0.373	0.419	0.404
L=3	0.701	0.428	0.431
L=4	0.762	0.491	0.494
L=5	0.813	0.544	0.546
Average	0.732	0.475	0.476

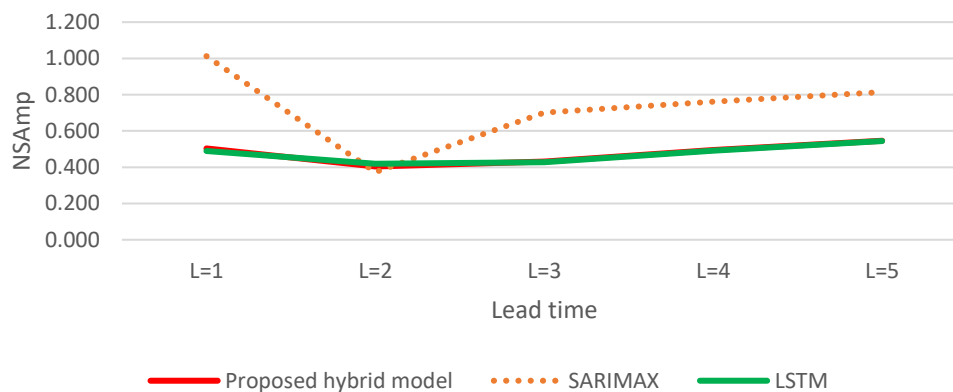

Figure 29: The effect of lead time on the NSamp measure

Moreover, the monthly values of the NSamp of the hybrid model, LSTM, and ARIMAX in 2020 are shown in Table 35. The hybrid produces lower NSamp than LSTM and ARIMAX. Indeed, the average NSamp value for the hybrid is computed as 5.720. While LSTM and ARIMAX equal 5.783, and 5.875, respectively. As a result, the hybrid model aids in lowering the NSamp values better than other models. Therefore, the hybrid model decreases holding and backlog costs, improving customer service. Prior studies indicated that lowering BWE and NSamp enhances supply chain performance (Boute & Lambrecht, 2009; Jaipuria & Mahapatra, 2014).

Table 35: NSamp of forecasting models for the year 2020 (L=3)

Month	ARIMAX	LSTM	Proposed hybrid model
1	5.72	5.80	5.55
2	3.58	4.90	4.65
3	1.56	2.81	2.61
4	1.54	2.31	2.13
5	1.84	2.01	1.95
6	2.89	2.41	2.27
7	2.54	2.31	2.22
8	1.67	2.13	1.92
9	1.37	2.05	1.91
10	2.83	2.13	1.97
11	2.35	2.42	2.29
12	41.49	39.23	39.20
Overall	5.783	5.875	5.720

3. Transportation costs (TC)

Figure 30 depicts the transportation costs of forecasting models. Because of the significant values, the differences between the two models are not visible in the graph. However, Table 36 provides the estimated monthly transportation costs for each model. The TC gap between the real TC and hybrid model is minor, with a value of 2.20%. The TC gaps produced by LSTM and our model are similar. As a result, adopting a hybrid model will anticipate the actual transportation cost. It enables supply chain managers to make more precise decisions like capacity, fee rates, and budgeting plans. Besides, managers can respond to interruptions more quickly.

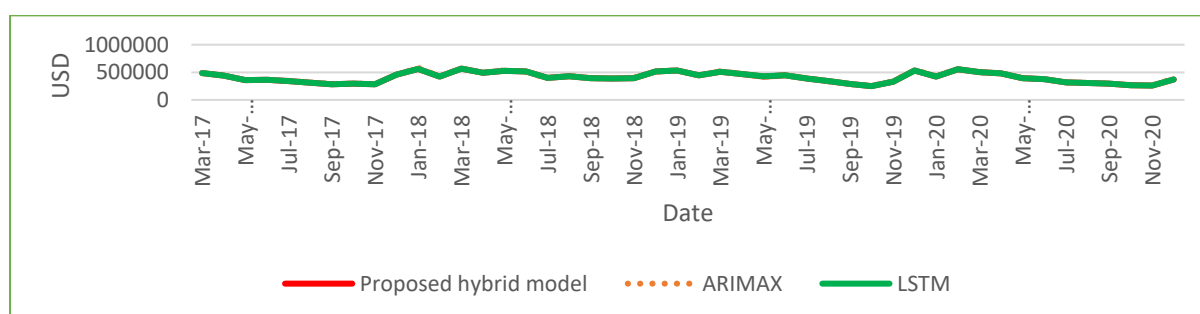

Figure 30: Transportation costs (TC) value generated from hybrid, LSTM and ARIMAX models.

Table 36: Some examples of transportation costs (TC) values of hybrid, LSTM, and ARIMAX in 2020

Month	TC real demand (USD)	TC hybrid model (USD)	TC ARIMAX (USD)	TC LSTM (USD)	Difference between real TC and predicted TC (%)		
					Using hybrid model	Using ARIMAX	Using LSTM
Jan-20	443596.7	425067.4	434765.1	424535.7	4.18	1.99	4.30
Feb-20	531475	554161.6	555533.7	554086.4	4.27	4.53	4.25
Mar-20	513495	505406.1	497879.4	505818.8	1.58	3.04	1.49
Apr-20	486842.3	483257.3	483565.1	483240.4	0.74	0.67	0.74
May-20	402988	392586.0	394701.9	392470.0	2.58	2.06	2.61
Jun-20	379139.7	375115.0	375393.4	375099.7	1.06	0.99	1.07
Jul-20	327049.9	317412.6	310880.7	317770.8	2.95	4.94	2.84
Aug-20	303231.1	306097.5	312141.7	305766.1	0.95	2.94	0.84
Sep-20	298561.7	297456.5	297396.2	297459.8	0.37	0.39	0.37
Oct-20	272602.8	267176.2	271945.3	266914.7	1.99	0.24	2.09
Nov-20	263484.8	261054.1	267877.8	260680.0	0.92	1.67	1.06
Dec-20	352478.8	369656.6	381662.4	368998.3	4.87	8.28	4.69
Average					2.20	2.64	2.20

All operational metrics, including BWE, NSamp, and TC, are lowered using the proposed hybrid forecasting model.

b) *Financial measure*

As a representative of the financial measures, Figure 31 displays the monthly inventory turn of the proposed hybrid model, ARIMAX, and LSTM. The proposed hybrid model and LSTM produces a higher inventory turn than ARIMAX.

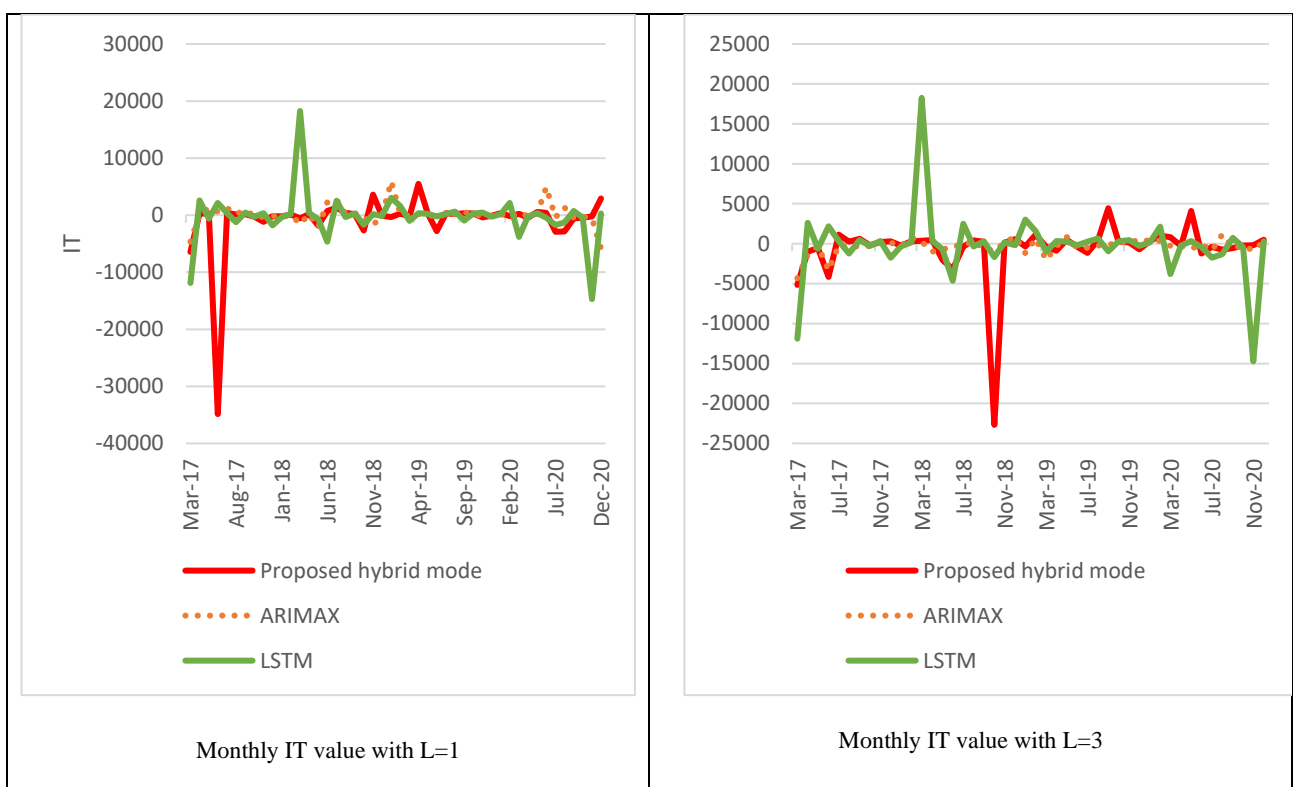

Figure 31: Monthly IT value with L=1 and L=3

As seen in Table 37, the overall inventory turns of the proposed hybrid model, ARIMAX and LSTM, are 263.8464, -140,5651, and -1582.7783, respectively. It is worth noting that the estimated IT values using our hybrid forecasting model are comparatively higher than LSTM and ARIMAX models. Therefore, the hybrid model enhances inventory performance and working capital efficiency. Adopting a hybrid model improves the financial performance of the coffee supply chain.

Table 37: Inventory turn (IT) values generated by forecasting models in 2020 (L=3)

Month	ARIMAX	LSTM	Proposed hybrid model
1	311.2191	159.9509	335.0955
2	365.0929	2132.532	1026.1855
3	-288.929	-3808.8	826.0926
4	-302.766	-222.395	-255.8574
5	-635.667	340.7193	4094.2007
6	-123.421	-425.281	-1219.1458
7	-823.693	-1735.18	-374.61828
8	1157.098	-1312.63	-760.4599
9	-531.638	749.076	-556.4241
10	-291.491	-417.782	-224.0729
11	-818.155	-14728.4	-202.8700
12	295.5672	274.8319	478.0314
Overall	-140.5651	-1582.7783	263.8464

c) *The impact of the proposed hybrid model on supply chain performance*

The results of the regression models are described in Table 38. In terms of operational measurements, all variable coefficients have negative values. It implies that our hybrid model reduces the bullwhip effect, net stock amplification, and transportation costs. Besides, BWE, with a value of -0.216, is statistically significant at the 0.01 level. Furthermore, in terms of financial measurement, IT has a value of 6639.134 and is significantly positive at the 0.001 level. According to a prior study of (Feizabadi, 2020), if the dummy variable's coefficient is not zero and statistically significant, there is empirical proof that the proposed models increase the performance of the supply chain, and the degree of the increase would be significant statistically. As a result, BWE and IT meet this criterion. Therefore, this provides tangible evidence that our hybrid model enhances the coffee supply chain's operational and financial performance. This finding contributes to the existing literature on supply chain performance measurement and forecasting methods.

Table 38: Regression coefficient

	Operational performance			Financial performance
	Model 1 BWE	Model 2 NSAmp	Model 3 TC	Model 4 IT
Intercept	1.346	3.233	406627.7	1730.468
Forecast approach (X)	-0.216***	-0.172	-0.340	6639.134***
Observations	46	46	46	46
Adjusted R square	0.082	-0.009	-0.022	0.422

** p < 0.05, *** p < 0.001.

d) *Environmental performance*

Table 39 compares the CF and WF of ARIMAX, LSTM, and our hybrid model. In both indicators, the hybrid model has smaller difference values than LSTM and ARIMAX. Thus, the hybrid model outperforms others regarding environmental performance. It also implies that different forecasting techniques produce different results. More advanced forecasting techniques improve environmental performance by lowering carbon and water footprints.

Table 39. Environment performance based on different forecasting techniques

ARIMAX	LSTM	Proposed hybrid model
The difference in carbon footprint between the predicted value and real value (ton CO2e /ton green coffee)		
12032399.12	10501095.44	10458054.18
The difference in water footprint between the predicted value and real value (m3 /ton green bean)		
9623668.849	8398912.303	8364487.351

According to our findings, using a hybrid model can result in a lower CF, thereby mitigating the effects of global climate change. Coffee is the primary income of smallholder farmers in developing countries. However, climate change is putting their lives at risk. Furthermore, companies are part of the solution to climate change. Thus, companies should make reducing the impact of climate change a long-term goal because they would not survive if there were no inputs or materials for production. Besides, consume’s purchasing decisions are shifting toward environmentally friendly products. Companies will not sell products that do not meet the needs and concerns of their customers. Thus, adopting advanced forecasting techniques brings economic benefits for companies and helps them develop an eco-friendly image.

Besides, water is critical for socio-economic development, healthy ecosystems, and human survival. As a result, reducing water consumption is now a vital management consideration for all organizations. Coffee is a water-intensive crop that uses more water during production. After harvesting, the ripe cherries are fermented and washed in water to remove the fruit from around the coffee bean. The coffee wet-processing method requires a considerable amount of water to produce the end product, which is clean green coffee beans. As a result, reducing water consumption can benefit businesses, including lower costs, reduced water scarcity, and a cleaner environment. Furthermore, the company can improve its public image, attract new loyal customers, and increase its competitiveness.

By employing hybrid forecasting techniques, managers can accurately predict future water consumption and determine adequate plans for initiatively using water resources and effectively allocating water.

e) Sales forecasting

Based on the results above, using the proposed hybrid model helps to improve demand forecasting accuracy and supply chain efficiency. This section explores how the hybrid model affects daily sales forecasting. As shown in previous tables, our hybrid and LSTM models provide better results than the others. Hence, Table 40 presents examples of actual sales and predicted sales for ten days using LSTM and our hybrid model. With our hybrid model, the average difference between actual and forecast sales is 9.39%, with a value of 1,646 USD. There are slightly different from the real ones. It can be seen that there are acceptable gaps between the two values. However, the average interval between actual and anticipated sales using LSTM is 9.48%. It implies that our model outperforms LSTM.

Hence, supply chain managers can adopt the hybrid model to forecast customer demand. Predicted sales play a vital role in supply chain management. It helps stakeholders make intelligent business decisions related to various activities such as inventory management, production planning, cash flow, and plant growth.

Table 40: Some examples of actual sales and predicted sales using our hybrid and LSTM model

Date	Actual sales (USD)	Predicted sales (USD)		Difference between actual sales and predicted sales (%)	
		Using LSTM	Using our hybrid model	Using LSTM	Using our hybrid model
1	196173.10	167996.8	169290.76	14.36	13.70
2	158490.34	171350.9	171614.81	8.11	8.28
3	164685.87	169821.5	168689.37	3.12	2.43
4	157543.16	164960.3	164938.18	4.71	4.69
5	134745.49	165517.5	164776.18	22.84	22.28
6	173153.81	155551.1	155002.74	10.17	10.48
7	165614.67	156228.7	158164.86	5.67	4.49
8	159486.20	154459.6	154868.40	3.15	2.89
9	156941.89	156514.7	156720.76	0.27	0.14
10	209322.98	157436.4	157230.64	24.79	24.88

Our finding indicates that the proposed hybrid model increases forecast accuracy and supply chain performance. Furthermore, this study provides helpful information for

stakeholders to make better decisions for planning the production and distribution of coffee. The proposed model helps predict the country's economy and creates valuable information for other sectors affected by the coffee industry. This method can adapt to the demand forecast for agricultural products in any country because it does not depend on specific product trends and situations.

Based on the chapter's analysis findings, the proposed hybrid model reduces forecasting errors and improves financial, operational, and environmental performance. As a result, this thesis demonstrates that better forecasting models will lead to more efficient supply chain performance and enhanced sustainability. The results of this chapter clarify our model's contribution to the literature review. Indeed, most forecasting articles emphasize forecast accuracy while paying little attention to their impact on long-term supply chain performance. Thus, this thesis added to the literature review by proposing a new hybrid model and investigating its impact on various aspects, including forecasting accuracy, supply chain performance, and environmental performance. The performance of our forecasting model has been studied in depth compared to previously proposed models in the current literature.

The following section will discuss several critical dimensions managers and organizations must consider when implementing new forecasting models.

4.4.2.4 Managerial insights

a) Understanding the roles of advanced forecasting methods

In previous sections, we proved the robustness of the proposed model and its relationship with supply chain performance. Thus, this section will discuss managerial insights. Understanding the role of advanced forecasting methods is vital to a specific department or function. A broader and more strategic managerial understanding is needed, especially for general improvements in supply chain performance.

Forecasting data is essential not only for particular departments but also for entire organizations. Based on this information, managers can make many proper managerial decisions that are cross-functional. For instance, the finance and accounting departments need demand forecasting when making sales and budget decisions. Also, forecasting customer demand is necessary when a company wants to launch a new product. The result from forecasting data and models go beyond a single function (Thi Thuy Hanh Nguyen et al., 2022). Moreover, managers may utilize forecasting data to make real-time adjustments in the supply chain operations (e.g., manufacturing, procurements, logistics).

Besides, as stated in the literature, no method can perform well in all contexts or data types. Hence, combining different techniques can improve forecast accuracy by addressing the limitations of one kind of technique with the strengths of another. Thus, it would be a practical and efficient way to predict demand in real life. As a result, managers should choose a combined approach to obtain the most accurate information and a deeper understanding of their customers' needs, ultimately leading to better, more informed decision-making.

Furthermore, advanced demand forecasting helps enhance supply chain performance by accurately predicting future demands and consumer satisfaction. The sophisticated forecasting method will boost supply chain performance measured by financial and operational results. Furthermore, it will aid in increasing the long-term performance of the coffee supply chain. As a result, better forecasting methods will improve the performance of a sustainable supply chain.

Thus, managers should use advanced forecasting methods to improve demand management and supply chain performance, thereby increasing competitiveness. The following section will go over managers' challenges when implementing novel methods.

b) Challenges and Potential concerns for implementing advanced demand forecasting techniques

There are three concerns that managers should consider when implementing new advanced demand forecasting techniques.

- *Resistance to change:*

Although forecasting is critical in organizations, many companies face challenges when implementing them due to several factors. These reasons, however, are raised by both managers and employees.

Regarding the manager's reason, there are three main reasons: a lack of confidence, financial support, and self-interest. First, some senior managers recognize the benefits of advanced technology; however, because technology evolves rapidly, some are unsure how to use it. Also, senior managers are often good at management but lack engineering knowledge. As a result, they lack confidence in the value of new technology change (For example, whether investing in complicated forecasting techniques is worth the expense or not). As a result, they ignore or resist change. Second, several leaders understand the advantages of technological applications. They see the benefits that the change will bring. They can build a better future. However, some managers cannot make investment decisions because they may impact

shareholder profits. Some investors, particularly risk-averse investors, are unwilling to invest in new technological practices because they are more concerned with earnings per share. As a result, managers must persuade and demonstrate the return on investment that the company will receive. Third, some managers may feel lost control or powerless. Companies can make better decisions based on forecasting data thanks to technological implementations; thus, some lower-level managers or workers can be replaced. To solve this issue, managers must develop the right mindset for themselves and those around them. They are using advanced forecasting techniques as an opportunity to strengthen the business by aligning operations with strategy, taking on new professional challenges and risks, and advancing their careers.

Employees resist learning and using new technological techniques due to a lack of competence and a communication strategy. First, employees must learn how to use and develop the necessary skills. As a result, they are concerned that they will be unable to perform as well as they did in previous systems. As a result, they may lose their jobs because some positions are reduceable. Second, employees do not understand the policies and strategies when implementing new forecasting systems. As a result, poor communication during the transition leads to dissatisfied and disengaged employees. Thus, to address this issue, businesses must engage in open dialogue to promote transparency and ease the transition from old to new technology. Companies, for example, communicate the benefits of new technology and encourage questions and feedback so that managers can understand what their employees are thinking and deal with any problems that may arise.

- *Impact of external events:*

Although advanced forecasting techniques aid in accurately forecasting customer trends, some unexpected events may influence consumer behavior decisions. For example, exploring product issues may be hazardous to one's health. Furthermore, some circumstances, such as pandemics, war, or foreign sanctions, are beyond the company's control.

- *Company's specificities:*

There are numerous forecasting techniques available. However, not all methods are appropriate for every business. Thus, before implementing new forecasting techniques, managers should be aware of the advantages and disadvantages of each method. Furthermore, managers must understand the organization's situation, requirements, and goals. For example, investing in the most advanced tools will be ineffective if the company has small data or a

small budget. However, the company can combine and use different forecasting techniques before making plans or decisions.

4.5 Summary

This chapter analyses and discusses the findings of modeling the coffee supply chain and demand prediction via a case study of coffee in Vietnam. This chapter employs the latest SCOR model, SCOR version 12.0, to develop a standard model of the coffee supply chain in Kontum, Vietnam. In addition, the coffee supply chain is evaluated regarding the approach of the process and performance. The supply chain's overall score reaches 68.28, with an average category in line with the process approach. All processes, especially Source, Make, Deliver, and Return, have a low-performance value. Therefore, demand forecasting is a critical aspect that need to consider in enhancing the coffee supply chain efficiency.

There are two main parts to the demand forecasting section. In the first part, this thesis develops the DPP as a higher-order construct composed of five lower-order constructs: goal formulation, forecasting techniques, information source, forecasting roles in decision-making, and communicating the predictions and synchronizing supply with demand. The PLS-SEM method was employed to validate the concept of DPP in the context of Vietnamese coffee companies. The results found that the DPP strongly influences both cost and delivery performance. However, when assessing demand planning practices separately, different results are obtained. In particular, only information sources significantly impact delivery performance. Similarly, goal formulation is the only demand planning practice that significantly affects cost performance. This article emphasizes that demand planning provides a more effective and faster response due to integrating practices and learning processes.

In the second part, the thesis proposed a new hybrid model for coffee demand forecasting by combining the strengths of ARIMAX and LSTM models. Some famous forecasting techniques were benchmarked, such as ARIMAX, ANN, LSTM, and two LSTM – ARIMA hybrid models. The proposed model was validated on Vietnamese coffee demand and agricultural products from Thailand, such as pineapple, corn, and cassava. Moreover, the proposed model improves supply chain performance through operational and financial measures. Also, it improves the sustainability of the supply chain as measured by environmental performance. Besides, the proposed model provides excellent accurate sales forecasting. Furthermore, we offer some practical insights into the design of demand planning, forecasting techniques implementation, and challenges that organizations may encounter.

The following chapter will discuss the abovementioned result analysis, the conclusion, and future perspective to complement all approaches.

CHAPTER 5: CONCLUSION AND FUTURE PERSPECTIVES

This chapter contains the conclusion as well as the thesis' prospects. The first section summarizes the proposed approaches' core principles, including applicable methodology, results analysis, and discussion. The second section discusses the thesis's potential improvements, both short-term and long-term. All of the information is provided below.

5.1. Conclusion

The dissertation has two parts: supply chain performance and demand forecasting. All the methods presented are critical to increasing the efficiency of the coffee supply chain. In the first part, the coffee supply chain was modeled and evaluated using the most recent version of the SCOR model. Then, in the second part, we proposed a reliable demand forecasting method for improving supply chain performance. This forecasting model will help supply chain managers anticipate demand, minimize inventory, better use their suppliers, and potentially increase the overall supply chain's efficiency. Also, it supports the government and policymakers in making policies concerning relative product consumption and establishing relations with other countries by making proper coffee export plans.

Three key contributions are made in the supply chain performance approach. First, the thesis proposed a standard model of the coffee supply chain in Kontum, Vietnam. This model presented standardized processes and process elements. This model can support supply chain members, especially coffee companies in countries with the same coffee supply chain characteristics as Vietnam, to map and evaluate the supply chain's success. Before making improvements, it is necessary to understand processes and process elements. Organizations can easily understand their operations thanks to SCOR. As a result, they can define current process strengths and weaknesses and, ultimately, identify areas for process improvement. Second, the coffee supply chain was evaluated regarding the approach of the process and performance. The supply chain's overall score reached 68.28, with an average category in line with the process approach. Most processes, including Source, Make, Deliver, and Return, had a low-performance value. The results score for Return is the lowest, followed by Deliver. Regarding the performance approach, the best value is Reliability, which is 54.66. In contrast, Costs has the lowest value, scoring 9.75. Third, this article uses the latest SCOR model, version 12.0. Therefore, it contributes to the literature on using this new version for specific conditions of developing countries such as Vietnam. Such an application could be a valuable

tool to assess the supply chain performance of other agricultural products to enhance their contribution to the country's economy, which depends mainly on agriculture.

Moreover, demand forecasting is regarded as having the most significant impact on the efficiency of the coffee supply chain. Therefore, in the second section, this thesis makes two significant contributions.

Firstly, the demand planning process is vital in supply chain management. As a result, various academics and practitioners have expressed a strong interest in its impact. To the best of our knowledge, this is the first empirical research to explore the influence of demand planning, as a higher-order construct, on operational performance using PLS-SEM. The findings demonstrated that five first-order elements of the DPP are goal formulation, forecasting technique, information source, the role of forecasting in decision-making, and communicating the predictions and synchronizing supply with demand. Furthermore, our study discovered that as a higher-order construct, the demand planning process significantly positively impacts operational performance (cost and delivery performance). Therefore, demand planning offers a more effective and faster response thanks to integrating practices and the learning processes. A deep understanding of the concept of demand planning as a higher-order construct may be beneficial to managers aiming at better operational performance. Managers should be aware that the demand planning process encompasses several essential factors. Therefore, the organization may benefit by designing an effective demand planning process by integrating these factors.

Secondly, this thesis proposed a new hybrid model for coffee demand forecasting by combining the strengths of ARIMAX and LSTM models. Some famous forecasting techniques were benchmarked, such as ARIMAX, ANN, LSTM, and other ARIMA-LSTM hybrid models. Our proposed model was tested using two datasets (Vietnamese coffee demand and agricultural products from Thailand, such as pineapple, corn, and cassava). The findings showed that our hybrid model outperforms other models. Besides, the study selected the best configuration of LSTM by tuning different LSTM hyperparameters using the random method. Thus, this work contributed to optimizing LSTM hyperparameters in the literature. Also, the proposed model improved supply chain performance via operational measures (BWE, NSamp, and TC) and financial measures (IT). Also, it enhances environmental performance measured by CF and WF. Also, it provides accurate sales forecasting since the gap between predicted sales and actual sales is minor. The proposed ARIMAX-LSTM hybrid model is a robust, reliable, and valid forecasting model for coffee and other agricultural products. Although all findings shown

above are significant to validate all recommended approaches, some areas can be enhanced in this thesis. All specifics will be provided in the next section.

5.2 Future perspectives

Our proposed methodologies are critical in improving demand planning and forecasting from operational and management perspectives in various areas, particularly coffee products. Our approach proposed a standard coffee supply chain model that facilitates the investigation of external and internal problems in the coffee supply chain. Then, we concentrate on improving the efficacy of demand forecasting so that firms can meet their customer's requests while also balancing supply and demand. Although this thesis found a strong relationship between demand forecasting and supply chain performance, several improvements can be made for further research.

This section covers the dissertation's short-term and long-term perspectives. The short-term perspective is concerned with technical aspects, whereas the long-term focuses on management.

5.2.1 Short-term perspectives

- *Hybridizing with different traditional forecasting methods*

ARIMA is frequently combined with machine learning methods to create hybrid forms. However, each forecasting method has advantages and disadvantages. Thus, to develop a new hybrid method, LSTM may be hybridized with different traditional forecasting methods, such as Exponential Smoothing.

- *Hyperparameters tuning*

This thesis determined the optimum LSTM configuration by randomly tuning various LSTM hyperparameters. Several methods can be used to tune LSTM hyperparameters automatically, such as Genetics Algorithm and Scatter Search (Kantasa-ard et al., 2021).

- *Considering other input factors*

This thesis only considered the effect of price on customer demand. It would be interesting to investigate the hybrid model's performance with other exogenous factors such as promotion and exchange rate. Furthermore, the impact of the Covid-19 pandemic on demand

forecasts needs to examine due to the closure of many coffee shops, bars, and restaurants. These input factors can potentially improve the effectiveness of demand forecasting algorithms.

- *Hybrid algorithms*

There are various ways to combine different forecasting methods. Each hybrid model has a specific forecast weighting scheme. As a result, we can employ a different approach to determine the optimal weights of combination, such as the Normal Boundary Intersection method (Bacci et al., 2019).

- *Using different performance indicators to measure sustainable supply chain performance*

The impact of the proposed forecasting method on supply chain performance is investigated in this thesis. However, we chose four key metrics due to a lack of data. As a result, future research can use different metrics to assess supply chain performance.

Furthermore, this study discovered a link between the proposed forecasting method and sustainable supply chain performance. However, we have only used two metrics to assess environmental performance (CF and WF). Examining the impact of our proposed hybrid model on various sustainability metrics would thus be an intriguing topic. Further work could measure social performance using metrics such as human rights, health, safety, and community initiatives. Sustainable growth in the agricultural supply chain is a hot topic these days. Big data technology can improve efficiency and quality throughout the coffee supply chain, moving it toward sustainable growth.

5.2.2 Long-term perspectives

- *Larger sample size*

Our sample consists mainly of small coffee companies. The survey sample has been limited due to the severe pandemic of Covid-19 during the survey. Therefore, future works can examine our model with a larger sample.

- *Investigate other agricultural products and other countries*

Moreover, demand forecasting and planning performance might change depending on product and supply chain specificities. This study investigates coffee demand planning in

Vietnam, a developing country where implementing demand planning seems challenging and hard to accomplish. Thus, researching other agricultural products, such as rubber and pepper, or comparing our approach to other nations may provide meaningful results.

- *Developing a standard demand planning process*

Another aspect is that demand planning can be a challenge for many small companies, especially in developing countries. As a consequence, researchers might suggest tools and procedures of a standard demand planning process suitable for the specificities of these companies. Such a standard DPP will help to set a framework for close coordination of all activities and, thus, create synergies within the company. It enables companies to satisfy customer demand while limiting inventory levels and mitigating supply chain interruptions. These factors are determinants in reducing production costs and increasing consumer satisfaction.

- *Toward supply chain sustainability*

Growers, manufacturers, policymakers, and customers worldwide have recently paid significant attention to sustainable agriculture. Hence, moving toward sustainability is critical for developing countries like Vietnamese to maintain stable output, manage natural resources sustainably, and increase profits. Therefore, understanding the determinants that impact adopting sustainable practices has been a long-standing concern in agribusiness management studies. For instance, according to previous studies, the percentage of Vietnamese coffee grown sustainably is small, less than 10 %. Although sustainability is a critical competitive priority, few researchers have studied Vietnam's sustainable coffee supply chain. Therefore, it is necessary to investigate the primary factors influencing key stakeholders' decisions to adopt sustainable practices.

- *Governmental policies*

The government plays a critical role in supply chain management by assisting, stabilizing, and regulating supply chains. As previously stated, our findings demonstrated a strong relationship between advanced forecasting methods and supply chain performance. Developing flexible and adaptable supply chains through technological advances is an indispensable factor in the sustainable development trend. Hence, the government should establish numerous policies that facilitate and support the development and use of advanced

information technology applications to boost productivity and competitiveness, particularly in the country's major economic sectors. These policies allow private economic industries to grow and contribute to developing countries like Vietnam. For example, the government can provide financial assistance or free courses related to statistical training tools and machine learning forecasting techniques. As a result, companies can adopt advanced forecasting techniques to improve forecast accuracy, better demand planning, and higher performance in supply chain management and resulting in more efficient revenue and profitability. Furthermore, some policies should prioritize investment projects that support and develop new tools or techniques for forecasting demand for a country's leading products.

REFERENCES

- Abbasimehr, H., Shabani, M., & Yousefi, M. (2020). An optimized model using LSTM network for demand forecasting. *Computers and Industrial Engineering*, 143(July 2019), 106435. <https://doi.org/10.1016/j.cie.2020.106435>
- Abby, J. (2020). Demand Planning: What It Is and Why It's Important. *Netsuite.Com*, 1. <https://www.netsuite.com/portal/resource/articles/erp/demand-planning.shtml>
- Abdollahi, H., & Ebrahimi, S. B. (2020). A new hybrid model for forecasting Brent crude oil price. *Energy*, 200, 117520. <https://doi.org/10.1016/j.energy.2020.117520>
- Abolghasemi, M., Beh, E., Tarr, G., & Gerlach, R. (2020). Demand forecasting in supply chain: The impact of demand volatility in the presence of promotion. *Computers and Industrial Engineering*, 142(July 2019), 106380. <https://doi.org/10.1016/j.cie.2020.106380>
- Aburto, L., & Weber, R. (2007). Improved supply chain management based on hybrid demand forecasts. *Applied Soft Computing Journal*, 7(1), 136–144. <https://doi.org/10.1016/j.asoc.2005.06.001>
- American Production and Inventory Control Society. (2017). Supply Chain Operations Reference Model. In *American Production and Inventory Control Society*).
- Arifin, B. (2010). Global Sustainability Regulation and Coffee Supply Chains in Lampung Province, Indonesia. *Asian Journal of Agriculture and Development*, 7(2), 67–89. [http://www.6ghasae.searca.org/ajad/files/060612151523_5_Arifin 7.2.pdf](http://www.6ghasae.searca.org/ajad/files/060612151523_5_Arifin%207.2.pdf)
- Ayyanathan, N., & Kannammal, A. (2015). Combined forecasting and cognitive Decision Support System for Indian green coffee supply chain predictive analytics. *Proceedings - 2015 International Conference on Cognitive Computing and Information Processing, CCIP 2015*. <https://doi.org/10.1109/CCIP.2015.7100735>
- Babu, C. N., & Reddy, B. E. (2014). A moving-average filter based hybrid ARIMA-ANN model for forecasting time series data. *Applied Soft Computing Journal*, 23, 27–38. <https://doi.org/10.1016/j.asoc.2014.05.028>
- Bacci, L. A., Mello, L. G., Incerti, T., Paulo de Paiva, A., & Balestrassi, P. P. (2019). Optimization of combined time series methods to forecast the demand for coffee in Brazil: A new approach using Normal Boundary Intersection coupled with mixture designs of experiments and rotated factor scores. *International Journal of Production Economics*, 212(March 2018), 186–211. <https://doi.org/10.1016/j.ijpe.2019.03.001>
- Banker, R. D., & Mitra, S. (2007). Procurement models in the agricultural supply chain: A case study of online coffee auctions in India. *Electronic Commerce Research and Applications*,

- 6(3), 309–321. <https://doi.org/10.1016/j.elerap.2006.06.002>
- Barreto, I. (2010). Dynamic Capabilities: A review of past research and an agenda for the future. *Journal of Management*, 36(1), 256–280. <https://doi.org/10.1177/0149206309350776>
- Basson, L. M., Kilbourn, P. J., & Walters, J. (2019). Forecast accuracy in demand planning: A fast-moving consumer goods case study. *Journal of Transport and Supply Chain Management*, 13, 1–9. <https://doi.org/10.4102/jtscm.v13i0.427>
- Becker, J. M., Klein, K., & Wetzels, M. (2012). Hierarchical Latent Variable Models in PLS-SEM: Guidelines for Using Reflective-Formative Type Models. *Long Range Planning*, 45(5–6), 359–394. <https://doi.org/10.1016/j.lrp.2012.10.001>
- Benkachcha, S., Benhra, J., & El Hassani, H. (2014). Demand forecasting in supply chain: Comparing multiple linear regression and artificial neural networks approaches. *International Review on Modelling and Simulations*, 7(2), 279–286. <https://doi.org/10.15866/iremos.v7i2.641>
- Bennett, C., Stewart, R. A., & Lu, J. (2014). Autoregressive with exogenous variables and neural network short-term load forecast models for residential low voltage distribution networks. *Energies*, 7(5), 2938–2960. <https://doi.org/10.3390/en7052938>
- Bergstra, J., & Bengio, Y. (2012). Random search for hyper-parameter optimization. *Journal of Machine Learning Research*, 13, 281–305.
- Bhadouria, S., & Jayant, A. (2017). *Development of ANN Models for Demand Forecasting American Journal of Engineering Research (AJER)*. 12, 2012–2017.
- Birkenberg, A., & Birner, R. (2018). The world’s first carbon neutral coffee: Lessons on certification and innovation from a pioneer case in Costa Rica. *Journal of Cleaner Production*, 189, 485–501. <https://doi.org/10.1016/j.jclepro.2018.03.226>
- Blackburn, R., Lurz, K., Priese, B., Göb, R., & Darkow, I. L. (2015). A predictive analytics approach for demand forecasting in the process industry. *International Transactions in Operational Research*, 22(3), 407–428. <https://doi.org/10.1111/itor.12122>
- Botero Lopez, S., & Salman Chaudhry, M. (2020). *Designing an Efficient Supply Chain for Specialty Coffee from Caldas-Colombia*. 2016. <https://dspace.mit.edu/handle/1721.1/126376>
- Boute, R. N., & Lambrecht, M. R. (2009). Exploring the Bullwhip Effect by Means of Spreadsheet Simulation. *INFORMS Transactions on Education*, 10(1), 1–9. <https://doi.org/10.1287/ited.1090.0038>
- Bukhori, I. B., Widodo, K. H., & Ismoyowati, D. (2015). Evaluation of Poultry Supply Chain

- Performance in XYZ Slaughtering House Yogyakarta Using SCOR and AHP Method. *Agriculture and Agricultural Science Procedia*, 3, 221–225. <https://doi.org/10.1016/j.aaspro.2015.01.043>
- Chen, A., & Blue, J. (2010). Performance analysis of demand planning approaches for aggregating, forecasting and disaggregating interrelated demands. *International Journal of Production Economics*, 128(2), 586–602. <https://doi.org/10.1016/j.ijpe.2010.07.006>
- Chen, I. J., & Paulraj, A. (2004). Understanding supply chain management: Critical research and a theoretical framework. *International Journal of Production Research*, 42(1), 131–163. <https://doi.org/10.1080/00207540310001602865>
- Chen, Y., Yang, Y., Liu, C., Li, C., & Li, L. (2015). A hybrid application algorithm based on the support vector machine and artificial intelligence: An example of electric load forecasting. *Applied Mathematical Modelling*, 39(9), 2617–2632. <https://doi.org/10.1016/j.apm.2014.10.065>
- Cheng, J. C. P., Law, K. H., Bjornsson, H., Jones, A., & Sriram, R. D. (2010). Modeling and monitoring of construction supply chains. *Advanced Engineering Informatics*, 24(4), 435–455. <https://doi.org/10.1016/j.aei.2010.06.009>
- Choi, H. K. (2018). Stock Price Correlation Coefficient Prediction with ARIMA-LSTM Hybrid Model. *ArXiv*.
- Chorfi, Z., Benabbou, L., & Berrado, A. (2018). An integrated performance measurement framework for enhancing public health care supply chains. *Supply Chain Forum*, 19(3), 191–203. <https://doi.org/10.1080/16258312.2018.1465796>
- College, D. S., Helms, M. M., & Chapman, S. (2000). supply chain management Supply chain forecasting. *Business Process Management Journal*, 6(5), 392–407.
- Courville, S. (2003). Use of indicators to compare supply chains in the coffee industry. *Greener Management International*, 43, 93–105. <https://doi.org/10.9774/GLEAF.3062.2003.au.00010>
- Croxton, K. L., Lambert, D. M., García-Dastugue, S. J., & Rogers, D. S. (2002). The Demand Management Process. *The International Journal of Logistics Management*, 13(2), 51–66. <https://doi.org/10.1108/09574090210806423>
- Crum, C., & Palmatier, G. E. (2003). *Demand Management Best Practices: Process, Principles, and Collaboration*. Boca Raton, FL: J. Ross Publishing. <http://books.google.at/books?id=6l3iWbGM-54C>
- Danese, P., & Kalchschmidt, M. (2011). The role of the forecasting process in improving forecast accuracy and operational performance. *International Journal of Production*

- Economics*, 131(1), 204–214. <https://doi.org/10.1016/j.ijpe.2010.09.006>
- Dave, E., Leonardo, A., Jeanice, M., & Hanafiah, N. (2021). ScienceDirect Forecasting Indonesia Exports using a Hybrid Model ARIMA- LSTM. *Procedia Computer Science*, 179(2020), 480–487. <https://doi.org/10.1016/j.procs.2021.01.031>
- Dissanayake, C. K., & Cross, J. A. (2018). Systematic mechanism for identifying the relative impact of supply chain performance areas on the overall supply chain performance using SCOR model and SEM. *International Journal of Production Economics*, 201(March), 102–115. <https://doi.org/10.1016/j.ijpe.2018.04.027>
- Doering, T., & Suresh, N. C. (2016). Forecasting and Performance: Conceptualizing Forecasting Management Competence as a Higher-Order Construct. *Journal of Supply Chain Management*, 52(4), 77–91. <https://doi.org/10.1111/jscm.12111>
- Du, P., Wang, J., Yang, W., & Niu, T. (2019). A novel hybrid model for short-term wind power forecasting. *Applied Soft Computing Journal*, 80, 93–106. <https://doi.org/10.1016/j.asoc.2019.03.035>
- Elgazzar, S. H., Tipi, N. S., Hubbard, N. J., & Leach, D. Z. (2012). Linking supply chain processes' performance to a company's financial strategic objectives. *European Journal of Operational Research*, 223(1), 276–289. <https://doi.org/10.1016/j.ejor.2012.05.043>
- Essajide, D., & Rachidi, L. (2017). Planning and modelling of Pharmaceuticals Wholesale-Distributors supply Chain using SCOR model : A Moroccan case study I . *International Journal of Management Sciences and Business Research*, 6(3), 35–51.
- Estampe, D., Lamouri, S., Paris, J. L., & Brahim-Djelloul, S. (2013). A framework for analysing supply chain performance evaluation models. *International Journal of Production Economics*, 142(2), 247–258. <https://doi.org/10.1016/j.ijpe.2010.11.024>
- Feizabadi, J. (2020). Machine learning demand forecasting and supply chain performance. *International Journal of Logistics Research and Applications*, 0(0), 1–24. <https://doi.org/10.1080/13675567.2020.1803246>
- General Statistics Office of Vietnam. (2020). *Agriculture, forestry and fishery*. https://www.gso.gov.vn/default_en.aspx?tabid=780
- George, J., & Madhusudanan Pillai, V. (2019). A study of factors affecting supply chain performance. *Journal of Physics: Conference Series*, 1355(1). <https://doi.org/10.1088/1742-6596/1355/1/012018>
- Grimm, C. M. (2008). The application of industrial organization economics to supply chain management research. *Journal of Supply Chain Management*, 44(3), 16–21. <https://doi.org/10.1111/j.1745-493X.2008.00063.x>

- Guo, L., Fang, W., Zhao, Q., & Wang, X. (2021). The hybrid PROPHET-SVR approach for forecasting product time series demand with seasonality. *Computers and Industrial Engineering*, *161*(February), 107598. <https://doi.org/10.1016/j.cie.2021.107598>
- Hadaya, P., & Cassivi, L. (2007). The role of joint collaboration planning actions in a demand-driven supply chain. *Industrial Management and Data Systems*, *107*(7), 954–978. <https://doi.org/10.1108/02635570710816694>
- Hair, J. F., Ringle, C. M., & Sarstedt, M. (2011). PLS-SEM: Indeed a silver bullet. *The Journal of Marketing Theory and Practice*, *19*(2), 139–152. <https://doi.org/10.2753/MTP>
- Hausman, W. H. (2005). Supply Chain Performance Metrics. *The Practice of Supply Chain Management: Where Theory and Application Converge*, 61–73. https://doi.org/10.1007/0-387-27275-5_4
- Henseler, J., Ringle, C. M., & Sarstedt, M. (2015). A new criterion for assessing discriminant validity in variance-based structural equation modeling. *Journal of the Academy of Marketing Science*, *43*(1), 115–135. <https://doi.org/10.1007/s11747-014-0403-8>
- Hofmann, P., & Reiner, G. (2006). Drivers for improving supply chain performance: An empirical study. *International Journal of Integrated Supply Management*, *2*(3), 214–230. <https://doi.org/10.1504/IJISM.2006.008594>
- Ibrahim, H. W., & Zailani, S. (2010). A_Review_on_the_Competitiveness_of_Globa.pdf. In *International Business Management* (Vol. 4, Issue 3, pp. 105–115).
- International Coffee Organization. (2019). *Country Coffee Profile: Vietnam*. <Http://Www.Ico.Org/Documents/Cy2018-19/Icc-124-9e-Profile-Vietnam.Pdf>.
- International Coffee Organization. (2021). *World production, Export, Domestic consumption and World consumption*. https://www.ico.org/trade_statistics.asp
- International Coffee Organization (ICO). (2022). *Developing a sustainable coffee economy*. https://www.ico.org/sustaindev_e.asp
- Irfan, D., Xiaofei, X., & Chun, D. S. (2008). A SCOR reference model of the supply chain management system in an enterprise. *International Arab Journal of Information Technology*, *5*(3), 288–295.
- Jagan Mohan Reddy, K., Neelakanteswara Rao, A., & Krishnanand, L. (2019). A review on supply chain performance measurement systems. *Procedia Manufacturing*, *30*, 40–47. <https://doi.org/10.1016/j.promfg.2019.02.007>
- Jaipuria, S., & Mahapatra, S. S. (2014). An improved demand forecasting method to reduce bullwhip effect in supply chains. *Expert Systems with Applications*, *41*(5), 2395–2408. <https://doi.org/10.1016/j.eswa.2013.09.038>

- Jothimani, D., & Sarmah, S. P. (2014). Supply chain performance measurement for third party logistics. *Benchmarking*, 21(6), 944–963. <https://doi.org/10.1108/BIJ-09-2012-0064>
- Kantasa-Ard, A. (2021). *Towards a smart prediction and optimization model in the context of Physical Internet Supply Chain Network*. <http://www.theses.fr/2021UPHF0024>
- Kantasa-ard, A., Nouiri, M., Bekrar, A., Ait el cad, A., & Sallez, Y. (2021). Machine learning for demand forecasting in the physical internet: a case study of agricultural products in Thailand. *International Journal of Production Research*, 59(24), 7491–7515. <https://doi.org/10.1080/00207543.2020.1844332>
- Khashei, M., & Bijari, M. (2011). A novel hybridization of artificial neural networks and ARIMA models for time series forecasting. *Applied Soft Computing Journal*, 11(2), 2664–2675. <https://doi.org/10.1016/j.asoc.2010.10.015>
- Kilimci, Z. H., Akyuz, A. O., Uysal, M., Akyokus, S., Uysal, M. O., Atak Bulbul, B., Ekmis, M. A., & Silva, T. C. (2019). An improved demand forecasting model using deep learning approach and proposed decision integration strategy for supply chain. *Complexity*, 2019. <https://doi.org/10.1155/2019/9067367>
- Kittichotsawat, Y., Jangkrajarn, V., & Tippayawong, K. Y. (2021). Enhancing coffee supply chain towards sustainable growth with big data and modern agricultural technologies. *Sustainability (Switzerland)*, 13(8), 1–20. <https://doi.org/10.3390/su13084593>
- Kocaoğlu, B., Gülsün, B., & Tanyaş, M. (2013). A SCOR based approach for measuring a benchmarkable supply chain performance. *Journal of Intelligent Manufacturing*, 24(1), 113–132. <https://doi.org/10.1007/s10845-011-0547-z>
- Kock, N. (2018). Minimum sample size estimation in PLS-SEM: An application in tourism and hospitality research. *Applying Partial Least Squares in Tourism and Hospitality Research*, 1–16. <https://doi.org/10.1108/978-1-78756-699-620181001>
- Kusrini, E., Caneca, V. I., Helia, V. N., & Miranda, S. (2019). Supply Chain Performance Measurement Using Supply Chain Operation Reference (SCOR) 12.0 Model: A Case Study in A A Leather SME in Indonesia. *IOP Conference Series: Materials Science and Engineering*, 697(1), 0–10. <https://doi.org/10.1088/1757-899X/697/1/012023>
- Kwak, J. K. (2019). Analysis of Inventory Turnover as a Performance Measure in Manufacturing Industry. *Processes*, 7(760), 1–11. <https://doi.org/10.3390/pr7100760>
- Laderach, P., Lundy, M., Jarvis, A., Ramirez, J., Portilla, E. P., Schepp, K., & Eitzinger, A. (2011). Predicted Impact of Climate Change on Coffee Supply Chains. *Springer-Verlag Berlin Heidelberg, October*, 703–723. <https://doi.org/10.1007/978-3-642-14776-0>

- Lai, K. K., Yu, L., Wang, S., & Huang, W. (2006). Hybridizing exponential smoothing and neural network for financial time series predication. *Lecture Notes in Computer Science (Including Subseries Lecture Notes in Artificial Intelligence and Lecture Notes in Bioinformatics)*, 3994 LNCS, 493–500. https://doi.org/10.1007/11758549_69
- Leal, J. E. (2020). AHP-express: A simplified version of the analytical hierarchy process method. *MethodsX*, 7. <https://doi.org/10.1016/j.mex.2019.11.021>
- Lima-Junior, F. R., & Carpinetti, L. C. R. (2019). Predicting supply chain performance based on SCOR ® metrics and multilayer perceptron neural networks. *International Journal of Production Economics*, 212(January), 19–38. <https://doi.org/10.1016/j.ijpe.2019.02.001>
- Lima-Junior, F. R., & Carpinetti, L. C. R. (2020). An adaptive network-based fuzzy inference system to supply chain performance evaluation based on SCOR® metrics. *Computers and Industrial Engineering*, 139, 106191. <https://doi.org/10.1016/j.cie.2019.106191>
- Lockamy, A., & McCormack, K. (2004). Linking SCOR planning practices to supply chain performance: An exploratory study. *International Journal of Operations and Production Management*, 24(12), 1192–1218. <https://doi.org/10.1108/01443570410569010>
- Lockamy III, A., & McCormack, K. (2004). The development of a supply chain management process maturity model using the concepts of business process orientation. *Supply Chain Management: An International Journal*, 9(4), 272–278.
- Loveridge, S., Mpyisi, E., & Weber, M. T. (2002). *Farm level perspectives in Rwanda's coffee supply chain coordination challenge*. 2, 1–6.
- Luong, H. T. (2007). Measure of bullwhip effect in supply chains with autoregressive demand process. *European Journal of Operational Research*, 180(3), 1086–1097. <https://doi.org/10.1016/j.ejor.2006.02.050>
- Luong, H. T., & Phien, N. H. (2007). Measure of bullwhip effect in supply chains: The case of high order autoregressive demand process. *European Journal of Operational Research*, 183(1), 197–209. <https://doi.org/10.1016/j.ejor.2006.09.061>
- Luong, Q. V., & Tauer, L. W. (2006). A real options analysis of coffee planting in Vietnam. *Agricultural Economics*, 35(1), 49–57. <https://doi.org/10.1111/j.1574-0862.2006.00138.x>
- Maina, J. J., Mutwiwa, U. N., Kituu, G. M., & Githiru, M. (2015). Evaluation of Greenhouse Gas Emissions along the Small-Holder Coffee Supply Chain in Kenya. *Open Access Journal Journal of Sustainable Research in Engineering*, 2(4), 111–120.
- Mccarthy, T. M., Davis, D. F., Golicic, S. L., & Mentzer, J. T. (2006). The evolution of sales forecasting management: A 20-year longitudinal study of forecasting practices. *Journal of Forecasting*, 25(5), 303–324. <https://doi.org/10.1002/for.989>

- Mentzer, J. T., & Kahn, K. B. (1995). Forecasting technique familiarity, satisfaction, usage, and application. *Journal of Forecasting*, 14(5), 465–476. <https://doi.org/10.1002/for.3980140506>
- Mentzer, J. T., Keebler, J. S., Nix, N. W., Smith, C. D., & Zacharia, Z. G. (2001). Defining supply chain management. *Journal of Business*, 22(2), 1–25.
- Ministry of Industry and Trade of Vietnam. (2020). Vietnam logistics report 2020. In *Ministry of Industry and Trade of Vietnam*.
- Moazzam, M., Akhtar, P., Garnevska, E., & Marr, N. E. (2018). Measuring agri-food supply chain performance and risk through a new analytical framework: a case study of New Zealand dairy. *Production Planning and Control*, 29(15), 1258–1274. <https://doi.org/10.1080/09537287.2018.1522847>
- Mohammed, J., Bahadoorsingh, S., Ramsamooj, N., & Sharma, C. (2017). Performance of exponential smoothing, a neural network and a hybrid algorithm to the short term load forecasting of batch and continuous loads. *2017 IEEE Manchester PowerTech, Powertech 2017*. <https://doi.org/10.1109/PTC.2017.7980816>
- Moon, M. A., Mentzer, J. T., & Smith, C. D. (2003). Conducting a sales forecasting audit. *International Journal of Forecasting*, 19(1), 5–25. [https://doi.org/10.1016/S0169-2070\(02\)00032-8](https://doi.org/10.1016/S0169-2070(02)00032-8)
- Moon, M. A., Mentzer, J. T., Smith, C. D., & Garver, M. S. (1998). Seven keys to better forecasting. *Business Horizons*, 41(5), 44–52. [https://doi.org/10.1016/S0007-6813\(98\)90077-5](https://doi.org/10.1016/S0007-6813(98)90077-5)
- Murekezi, A., Jin, S., & Loveridge, S. (2012). Do organisational forms of the coffee supply chain matter in poverty reduction? *Development in Practice*, 22(7), 962–977. <https://doi.org/10.1080/09614524.2012.697127>
- Myerholtz, B. & Caffrey, H. (2014). Demand forecasting: The key to better supply-chain performance. *The Boston Consulting Group*. <https://www.bcg.com/publications/2014/supply-chain-management-retail-demand-forecasting-the-key-to-better-supply-chain-performance>
- Nab, C., & Maslin, M. (2020). Life cycle assessment synthesis of the carbon footprint of Arabica coffee: Case study of Brazil and Vietnam conventional and sustainable coffee production and export to the United Kingdom. *Geo: Geography and Environment*, 7(2), 1–19. <https://doi.org/10.1002/geo2.96>
- Nakisa, B., Rastgoo, M. N., Rakotonirainy, A., Maire, F., & Chandran, V. (2018). Long short term memory hyperparameter optimization for a neural network based emotion

- recognition framework. *IEEE Access*, 6, 49325–49338. <https://doi.org/10.1109/ACCESS.2018.2868361>
- Narimissa, O., Kangarani-Farahani, A., & Molla-Alizadeh-Zavardehi, S. (2020). Evaluation of sustainable supply chain management performance: Indicators. *Sustainable Development*, 28(1), 118–131. <https://doi.org/10.1002/sd.1976>
- Naveena, K., Singh, S., Rathod, S., & Singh, A. (2017). Hybrid ARIMA-ANN Modelling for Forecasting the Price of Robusta Coffee in India. *International Journal of Current Microbiology and Applied Sciences*, 6(7), 1721–1726. <https://doi.org/10.20546/ijcmas.2017.607.207>
- Ngo, T. T., Le, N. T., Hoang, T. M., & Luong, D. H. (2018). Water Scarcity in Vietnam: a Point of View on Virtual Water Perspective. *Water Resources Management*, 32(11), 3579–3593. <https://doi.org/10.1007/s11269-018-2007-4>
- Nguyen, G. N. T., & Sarker, T. (2018). Sustainable coffee supply chain management: a case study in Buon Me Thuot City, Daklak, Vietnam. *International Journal of Corporate Social Responsibility*, 3(1), 1–17. <https://doi.org/10.1186/s40991-017-0024-x>
- Nguyen, T. T. Hanh, Bekrar, A., Abed, M., & Le, T. . (2021). Supply Chain Performance Measurement using SCOR Model: a Case Study of the Coffee Supply Chain in Vietnam. *2021 1st International Conference On Cyber Management And Engineering (CyMaEn)*, 1–7. <https://doi.org/10.1109/CyMaEn50288.2021.9497309>.
- Nguyen, Thi Thuy Hanh, Le, T. M., Bekrar, A., & Abed, M. (2022). Some Insights into Effective Demand Planning. *IEEE Engineering Management Review*, 1–10. <https://doi.org/10.1109/EMR.2022.3189028>.
- Nguyen, T. V., Nguyen, N. C., & Bosch, O. J. H. (2015). Contribution of the systems thinking approach to reduce production cost and improve the quality of Vietnamese coffee. *International Journal of Markets and Business Systems*, 1(1), 53–67. <https://doi.org/10.1504/ijmabs.2015.070272>
- Nguyen, T. Van, Nguyen, N. C., & Bosch, O. J. H. (2017). Identifying key success factors in supply chain management for increasing the competitive advantages of Vietnamese coffee. *An International Business Journal*, 27(5), 438–461.
- Novanda, R. R., Sumartono, E., Asriani, P. S., Yulianti, E., Sukiyono, K., Priyono, B. S., Irnad, I., Reswita, R., Suryanty, M., & Octalia, V. (2018). A Comparison of Various Forecasting Techniques for Coffee Prices. *Journal of Physics: Conference Series*, 1114(1). <https://doi.org/10.1088/1742-6596/1114/1/012119>
- Ntabe, E. N., LeBel, L., Munson, A. D., & Santa-Eulalia, L. A. (2015). A systematic literature

- review of the supply chain operations reference (SCOR) model application with special attention to environmental issues. *International Journal of Production Economics*, 169, 310–332. <https://doi.org/10.1016/j.ijpe.2015.08.008>
- Öztayşi, B., & Sürer, Ö. (2014). Supply Chain Performance Measurement Using a SCOR Based Fuzzy VIKOR Approach. *Supply Chain Management Under Fuzziness*, 313, 199–224. <https://doi.org/10.1007/978-3-642-53939-8>
- Palomino, E. R., Meza, S. H., Raffo, D. R. M. F. S., & Lo, W.-S. (2017). Organic Coffee Supply Chain Management in the San Martin Region of Peru. *International Journal of Innovation, Management and Technology*, 9–16. <https://doi.org/10.18178/ijimt.2017.8.1.694>
- Panigrahi, S., & Behera, H. S. (2017). A hybrid ETS–ANN model for time series forecasting. *Engineering Applications of Artificial Intelligence*, 66(June), 49–59. <https://doi.org/10.1016/j.engappai.2017.07.007>
- Peng, M.-C., Hu, Y.-C., & Jiang, H. (2017). Predicting Quantity of Coffee Consumption in China Using Grey Prediction with Fourier Series. *Article in Journal of Grey System*, 20(3), 163–169. <https://www.researchgate.net/publication/322888816>
- Perera, H. N., Hurley, J., Fahimnia, B., & Reisi, M. (2019). The human factor in supply chain forecasting: A systematic review. *European Journal of Operational Research*, 274(2), 574–600. <https://doi.org/10.1016/j.ejor.2018.10.028>
- Persson, F., Bartoll, C., Ganovic, A., Lidberg, M., Nilsson, M., Wibaeus, J., & Winge, F. (2012). Supply chain dynamics in the SCOR model - A simulation modeling approach. *Proceedings - Winter Simulation Conference, 2011*. <https://doi.org/10.1109/WSC.2012.6465030>
- Pham, V. C., & Pham, N. C. (2020). DEVELOPING THE HYBRID FORECASTING MODEL ON THE SHORT-TERM. *ICIC Express Letters*, 14(October), 1017–1021. <https://doi.org/10.24507/icicel.14.10.1017>
- Prasetya, W., Natalia, C., Dias, S., Elnath, B., Silalahi, A., & Monique, K. (2017). Performance measurement and analysis of coffee supply chain with SCOR method (case study of north Sumatera coffee). *JRDO-Journal of Business Management*, 11, 1–17.
- Purohit, S. K., Panigrahi, S., Sethy, P. K., & Behera, S. K. (2021). Time Series Forecasting of Price of Agricultural Products Using Hybrid Methods. *Applied Artificial Intelligence*, 00(00), 1–19. <https://doi.org/10.1080/08839514.2021.1981659>
- Putri, R. W., & Retnoningsih, D. (2022). *The Effect of Sustainable Supply Chain Management on the Performance of Certified Organic Coffee at Malang Regency*. 33(1), 74–85.

<https://doi.org/10.21776/ub.habitat.2022.033.1.8>

- Ramaa, A., Rangaswamy, T. M., & Subramanya, K. N. (2009). A review of literature on performance measurement of supply chain network. *2009 2nd International Conference on Emerging Trends in Engineering and Technology, ICETET 2009*, 802–807. <https://doi.org/10.1109/ICETET.2009.18>
- Rao Tummala, V. M., Phillips, C. L. M., & Johnson, M. (2006). Assessing supply chain management success factors: A case study. *Supply Chain Management*, *11*(2), 179–192. <https://doi.org/10.1108/13598540610652573>
- Ratchawat, T., Panyatona, S., Nopchinwong, P., Chidthaisong, A., & Chiarakorn, S. (2020). Carbon and water footprint of Robusta coffee through its production chains in Thailand. *Environment, Development and Sustainability*, *22*(3), 2415–2429. <https://doi.org/10.1007/s10668-018-0299-4>
- Raza, D. N., & Kilbourn, P. J. (2017). The impact of point-of-sale data in demand planning in the South African clothing retail industry. *Journal of Transport and Supply Chain Management*, *11*(0), 1–8. <https://doi.org/10.4102/jtscm.v11i0.304>
- ResearchAndMarkets.com. (2021). *Coffee Market Report 2021 - Global \$100+ Billion Market Growth, Trends, COVID-19 Impacts, and Forecasts to 2026*. <https://www.businesswire.com/news/home/20210601005832/en/Coffee-Market-Report-2021---Global-100-Billion-Market-Growth-Trends-COVID-19-Impacts-and-Forecasts-to-2026---ResearchAndMarkets.com>
- Rincón, R. D., Palacios, W., & Paipa, H. O. (2020). Comparison of statistical forecasting techniques for Colombian coffee demand in South Korea. *Journal of Physics: Conference Series*, *1448*(1). <https://doi.org/10.1088/1742-6596/1448/1/012023>
- Safari, A., & Davallou, M. (2018). Oil price forecasting using a hybrid model. *Energy*, *148*, 49–58. <https://doi.org/10.1016/j.energy.2018.01.007>
- Sarıca, B., Eğrioğlu, E., & Aşıkil, B. (2018). A new hybrid method for time series forecasting: AR–ANFIS. *Neural Computing and Applications*, *29*(3), 749–760. <https://doi.org/10.1007/s00521-016-2475-5>
- Sarstedt, M., Hair, J. F., Cheah, J. H., Becker, J. M., & Ringle, C. M. (2019). How to specify, estimate, and validate higher-order constructs in PLS-SEM. *Australasian Marketing Journal*, *27*(3), 197–211. <https://doi.org/10.1016/j.ausmj.2019.05.003>
- Sarstedt, M., Ringle, C. M., Smith, D., Reams, R., & Hair, J. F. (2014). Partial least squares structural equation modeling (PLS-SEM): A useful tool for family business researchers. *Journal of Family Business Strategy*, *5*(1), 105–115.

<https://doi.org/10.1016/j.jfbs.2014.01.002>

- Sellitto, M. A., Pereira, G. M., Borchardt, M., Da Silva, R. I., & Viegas, C. V. (2015). A SCOR-based model for supply chain performance measurement: Application in the footwear industry. *International Journal of Production Research*, 53(16), 4917–4926. <https://doi.org/10.1080/00207543.2015.1005251>
- Shahwan, T., & Odening, M. (2007). Forecasting agricultural commodity prices using hybrid neural networks. *Computational Intelligence in Economics and Finance: Volume II*, 63–74. https://doi.org/10.1007/978-3-540-72821-4_3
- Sharma, P. K., Dwivedi, S., Ali, L., & Arora, R. K. (2018). Forecasting maize production in India using ARIMA model. *Agro-Economist*, 5(1), 1–6.
- Siami-Namini, S., Tavakoli, N., & Siami Namin, A. (2019). A Comparison of ARIMA and LSTM in Forecasting Time Series. *Proceedings - 17th IEEE International Conference on Machine Learning and Applications, ICMLA 2018*, 1394–1401. <https://doi.org/10.1109/ICMLA.2018.00227>
- Soy Temür, A., Akgün, M., & Temür, G. (2019). Predicting housing sales in turkey using arima, lstm and hybrid models. *Journal of Business Economics and Management*, 20(5), 920–938. <https://doi.org/10.3846/jbem.2019.10190>
- Spiliotis, E., Makridakis, S., Semenoglou, A. A., & Assimakopoulos, V. (2020). Comparison of statistical and machine learning methods for daily SKU demand forecasting. *Operational Research, September*. <https://doi.org/10.1007/s12351-020-00605-2>
- Swanson, D., Jin, Y. H., Fawcett, A. M., & Fawcett, S. E. (2017). Collaborative process design: A dynamic capabilities view of mitigating the barriers to working together. *International Journal of Logistics Management*, 28(2), 571–599. <https://doi.org/10.1108/IJLM-02-2016-0044>
- Swierczek, A. (2020). Investigating the role of demand planning as a higher-order construct in mitigating disruptions in the European supply chains. *International Journal of Logistics Management*, 31(3), 665–696. <https://doi.org/10.1108/IJLM-08-2019-0218>
- Świerczek, A. (2019). The effects of demand planning on the negative consequences of operational risk in supply chains. *Logforum*, 15(3), 315–329. <https://doi.org/10.17270/J.LOG.2019.340>
- Tarasewicz, R. (2016). Integrated Approach to Supply Chain Performance Measurement - Results of the Study on Polish Market. *Transportation Research Procedia*, 14, 1433–1442. <https://doi.org/10.1016/j.trpro.2016.05.216>
- Thomé, A. M. T., Sousa, R. S., & Do Carmo, L. F. R. S. (2014). The impact of sales and

- operations planning practices on manufacturing operational performance. *International Journal of Production Research*, 52(7), 2108–2121. <https://doi.org/10.1080/00207543.2013.853889>
- Trkman, P., McCormack, K., De Oliveira, M. P. V., & Ladeira, M. B. (2010). The impact of business analytics on supply chain performance. *Decision Support Systems*, 49(3), 318–327. <https://doi.org/10.1016/j.dss.2010.03.007>
- USDA Foreign Agricultural Service. (2019). *Vietnam Coffee Annual 2019*. https://apps.fas.usda.gov/newgainapi/api/report/downloadreportbyfilename?filename=Coffee Annual_Hanoi_Vietnam_5-20-2019.pdf.
- Valencia-Payan, C., Grass-Ramirez, J. F., Ramirez-Gonzalez, G., & Corrales, J. C. (2022). A Smart Contract for Coffee Transport and Storage With Data Validation. *IEEE Access*, 10, 37857–37869. <https://doi.org/10.1109/ACCESS.2022.3165087>
- Vlckova, V., & Patak, M. (2011). Barriers of Demand Planning Implementation. *Economics & Management*, 16(May 2012), 1000–1005. <http://search.ebscohost.com/login.aspx?direct=true&db=buh&AN=61822099&site=ehost-live>
- Wang, C. H., & Yun, Y. (2020). Demand planning and sales forecasting for motherboard manufacturers considering dynamic interactions of computer products. *Computers and Industrial Engineering*, 149(January), 106788. <https://doi.org/10.1016/j.cie.2020.106788>
- Wang, P., Zhang, H., Qin, Z., & Zhang, G. (2017). A novel hybrid-Garch model based on ARIMA and SVM for PM2.5 concentrations forecasting. *Atmospheric Pollution Research*, 8(5), 850–860. <https://doi.org/10.1016/j.apr.2017.01.003>
- Wetzels, M., Odekerken-Schröder, G., & Van Claudia, O. (2009). Using PLS Path Modeling for Assessing Hierarchical Construct Models: Guidelines and Empirical Illustration. *MIS Quarterly*, 33(1), 177–195. <https://doi.org/https://doi.org/10.2307/20650284>
- Wibowo, M. A., & Sholeh, M. N. (2015). The analysis of supply chain performance measurement at construction project. *Procedia Engineering*, 125, 25–31. <https://doi.org/10.1016/j.proeng.2015.11.005>
- Williams, M. (2012). Tackling climate change: What is the impact on air pollution? *Carbon Management*, 3(5), 511–519. <https://doi.org/10.4155/cmt.12.49>
- Xu, X., & Zhang, Y. (2022). Soybean and Soybean Oil Price Forecasting through the Nonlinear Autoregressive Neural Network (NARNN) and NARNN with Exogenous Inputs (NARNN-X). *Intelligent Systems with Applications*, 13, 200061. <https://doi.org/10.1016/j.iswa.2022.200061>

- Yadav, A., Jha, C. K., & Sharan, A. (2020). Optimizing LSTM for time series prediction in Indian stock market. *Procedia Computer Science*, 167(2019), 2091–2100. <https://doi.org/10.1016/j.procs.2020.03.257>
- Zailani, S., Jeyaraman, K., Vengadasan, G., & Premkumar, R. (2012). Sustainable supply chain management (SSCM) in Malaysia: A survey. *International Journal of Production Economics*, 140(1), 330–340. <https://doi.org/10.1016/j.ijpe.2012.02.008>
- Zailani, S., & Rajagopal, P. (2005). Supply chain integration and performance: US versus East Asian companies. *Supply Chain Management*, 10(5), 379–393. <https://doi.org/10.1108/13598540510624205>
- Zhang, P. G. (2003). Time series forecasting using a hybrid ARIMA and neural network model. *Neurocomputing*, 50, 159–175. [https://doi.org/10.1016/S0925-2312\(01\)00702-0](https://doi.org/10.1016/S0925-2312(01)00702-0)
- Zheng, F., & Zhong, S. (2011). Time series forecasting using a hybrid RBF neural network and AR model based on binomial smoothing. *World Academy of Science, Engineering and Technology*, 51(3), 1464–1468. <https://doi.org/10.5281/zenodo.1072611>
- Zhou, S., Zhou, L., Mao, M., Tai, H. M., & Wan, Y. (2019). An Optimized Heterogeneous Structure LSTM Network for Electricity Price Forecasting. *IEEE Access*, 7, 108161–108173. <https://doi.org/10.1109/ACCESS.2019.2932999>
- Zotteri, G., & Kalchschmidt, M. (2007). Forecasting practices: Empirical evidence and a framework for research. *International Journal of Production Economics*, 108(1–2), 84–99. <https://doi.org/10.1016/j.ijpe.2006.12.004>

APPENDIX

QUESTIONNAIRE

Part A- Modeling and measuring the performance of the coffee supply chain

FARMERS



Dear Sir / Madam.

I am currently a doctoral student at the Université Polytechnique Hauts-de-France, France. This survey is a part of doctoral dissertation research. Your participation in the survey will help me have enough data to analyze and evaluate coffee production and contribute to improving coffee production efficiency in Vietnam. The information collected below will be confidential and used for research purposes only. I would appreciate it if you could take a moment to answer the following questions.

Thank you for your participation.

PART I- GENERAL INFORMATION

1. Name:
2. Email:
3. Tel:
4. Age:
5. Gender: Male Female
6. Main Occupation:
7. Name of company (if yes):
8. Employees:
9. Total coffee area(ha):
10. Percentage of the area of coffee/total area (%):
11. Percentage of coffee income/ total income (%):
12. Quantity (green bean tonnes)
13. Productivity:
14. Experience years:
15. Years of farms:
16. Education level:
Primary school Secondary High school Intermediate College University Postgraduate

PART II- COFFEE PRODUCTION

For each statement, please show the extent of your implementation by putting a cross in the onebox which best reflects your current action based on a scale from 1 to 5:

1. Not implemented 2. Poor implemented 3. Moderately implemented 4. Good implemented 5. Fully implemented

	1	2	3	4	5
PLAN					
1. Designing production plan	<input type="checkbox"/>	<input type="checkbox"/>	<input type="checkbox"/>	<input type="checkbox"/>	<input type="checkbox"/>
2. Forecasting customer's demands	<input type="checkbox"/>	<input type="checkbox"/>	<input type="checkbox"/>	<input type="checkbox"/>	<input type="checkbox"/>

3. Communication among trading partners on-demand plan	<input type="checkbox"/>	<input type="checkbox"/>	<input type="checkbox"/>	<input type="checkbox"/>	<input type="checkbox"/>
4. Having an information system for managing customer's needs	<input type="checkbox"/>	<input type="checkbox"/>	<input type="checkbox"/>	<input type="checkbox"/>	<input type="checkbox"/>
5. Long-term relationships with strategic customers	<input type="checkbox"/>	<input type="checkbox"/>	<input type="checkbox"/>	<input type="checkbox"/>	<input type="checkbox"/>
SOURCE					
1. Long-term relationships with strategic suppliers	<input type="checkbox"/>	<input type="checkbox"/>	<input type="checkbox"/>	<input type="checkbox"/>	<input type="checkbox"/>
2. Raw materials and components always being readily available for the production	<input type="checkbox"/>	<input type="checkbox"/>	<input type="checkbox"/>	<input type="checkbox"/>	<input type="checkbox"/>
3. Ensuring quality raw material	<input type="checkbox"/>	<input type="checkbox"/>	<input type="checkbox"/>	<input type="checkbox"/>	<input type="checkbox"/>
4. Only purchase the necessary raw materials and components	<input type="checkbox"/>	<input type="checkbox"/>	<input type="checkbox"/>	<input type="checkbox"/>	<input type="checkbox"/>
5. Just-in-time delivery from suppliers	<input type="checkbox"/>	<input type="checkbox"/>	<input type="checkbox"/>	<input type="checkbox"/>	<input type="checkbox"/>
MAKE					
1. Ensuring quality in production	<input type="checkbox"/>	<input type="checkbox"/>	<input type="checkbox"/>	<input type="checkbox"/>	<input type="checkbox"/>
2. Comply with a specified production process	<input type="checkbox"/>	<input type="checkbox"/>	<input type="checkbox"/>	<input type="checkbox"/>	<input type="checkbox"/>
3. Using integrated information systems and the internet to communicate with supply chain partners	<input type="checkbox"/>	<input type="checkbox"/>	<input type="checkbox"/>	<input type="checkbox"/>	<input type="checkbox"/>
4. Using skilled labor	<input type="checkbox"/>	<input type="checkbox"/>	<input type="checkbox"/>	<input type="checkbox"/>	<input type="checkbox"/>
5. Participating in a training course to improve skills and knowledge in coffee production activities	<input type="checkbox"/>	<input type="checkbox"/>	<input type="checkbox"/>	<input type="checkbox"/>	<input type="checkbox"/>
6. Enough and Using standard warehousing and storage facilities	<input type="checkbox"/>	<input type="checkbox"/>	<input type="checkbox"/>	<input type="checkbox"/>	<input type="checkbox"/>
7. Considering environmental issues	<input type="checkbox"/>	<input type="checkbox"/>	<input type="checkbox"/>	<input type="checkbox"/>	<input type="checkbox"/>
DELIVER					
1. Just-in-time delivery to customers	<input type="checkbox"/>	<input type="checkbox"/>	<input type="checkbox"/>	<input type="checkbox"/>	<input type="checkbox"/>
2. Share information of delivery to SC members	<input type="checkbox"/>	<input type="checkbox"/>	<input type="checkbox"/>	<input type="checkbox"/>	<input type="checkbox"/>
3. Enough and Ready- to ship product inventory	<input type="checkbox"/>	<input type="checkbox"/>	<input type="checkbox"/>	<input type="checkbox"/>	<input type="checkbox"/>
RETURN					
1. Receiving returned defective products	<input type="checkbox"/>	<input type="checkbox"/>	<input type="checkbox"/>	<input type="checkbox"/>	<input type="checkbox"/>
2. Returning material to the supplier	<input type="checkbox"/>	<input type="checkbox"/>	<input type="checkbox"/>	<input type="checkbox"/>	<input type="checkbox"/>

PART III- PERFORMANCE

Performance	Results
1. The time needed to arrange the production schedule? days	
2. The time between the pays the material to the supplier and receiving payment from the customer for the product made from the material? days	
3. Percentage of consistency in supplying raw materials? (%)	
4. The time it takes to produce goods from raw materials to cultivate goods? days	
5. The time does it take to harvest coffee cherries? days	
6. The time does it take to dry coffee cherries? days	
7. The time estimated to keep coffee beans in a warehouse? days	
8. Purchase order lead time? (POLT) refers to the number of days from when a company places an order for production inputs it needs, to when those items arrive at the manufacturing plant	

9. Customer lead time? Days Customer lead time or Total lead time is defined as the time it takes for a customer to receive a good or service from the time the customer places the order or performs a purchase transaction	
10. Costs incurred from raw material to finished goods? Million dong	

PART IV- OPINION DIVERSE

1. What is the most important factor for successful coffee production in Vietnam?
 - Technical equipment
 - Access to capital
 - Close relationships with partners
 - Access to information markets
 - Government’s policy regime
2. What is the most difficult that you face in coffee production in Kon Tum?.....
3. If coffee production in Kon Tum is not effective (productivity, interest rate, and product quality), what is the main reason?.....
4. To improve coffee production efficiency, what is the most important factor that needs to be improved?.....
5. When facing difficulties, do you often solve them yourself or ask for the support of partners?
 - Solve it yourself
 - Ask for the support of partners
6. Which partner plays the most important role in supporting your production?
 - Supplier of raw materials such as seeds, fertilizers, and pesticides
 - Other coffee producers
 - Collection
 - Coffee companies
 - State agencies
7. If you ask for partner assistance, will they respond?
 - Yes
 - No
8. Are you satisfied with their support?
 - Yes
 - No
9. How important is a relationship with partners for coffee production efficiency?
 - Reduce production costs
 - Improve the competitiveness of coffee products
 - Improve the quality of coffee
 - Others
10. What factors can improve the relationship with supply chain partners such as raw material suppliers, collectors, and coffee companies?.....
11. What kind of support would you like to receive?
 - Capital
 - Technology
 - Market Information
 - Others.....



Thank you for your cooperation!

TRADERS



Dear Sir / Madam.

I am currently a doctoral student at the Université Polytechnique Hauts-de-France. This survey is a part of doctoral dissertation research. Your participation in the survey will help me have enough data to analyze and evaluate coffee production and contribute to improving coffee production efficiency in Vietnam. The information collected below will be confidential and used for research purposes only. I would appreciate it if you could take a moment to answer the following questions.

Thank you for your participation.

PART I- GENERAL INFORMATION

1. Name:
2. Email:
3. Tel:
4. Age:
5. Gender: Male Female
6. Main Occupation:
7. Name of company (if yes):
8. Employees:
9. The total quantity collected per year (tonnes of coffee cherries):
10. The total quantity collected per year (tonnes of dry coffee cherries)
11. The total quantity collected per year (tonnes of green beans)
12. Years of experience in the coffee collection?
13. Education level:
Primary school Secondary High school Intermediate College University Postgraduate

PART II- COFFEE COLLECTION

For each statement, please show the extent of your implementation by putting a cross in the onebox which best reflects your current action based on a scale from 1 to 5:

1. Not implemented 2. Poor implemented 3. Moderately implemented 4. Good implemented 5. Fully implemented

	1	2	3	4	5
PLAN					
1. Forecasting customer's demand	<input type="checkbox"/>	<input type="checkbox"/>	<input type="checkbox"/>	<input type="checkbox"/>	<input type="checkbox"/>
2. Designing coffee collection plan	<input type="checkbox"/>	<input type="checkbox"/>	<input type="checkbox"/>	<input type="checkbox"/>	<input type="checkbox"/>
3. Communication among trading partners on a collection plan	<input type="checkbox"/>	<input type="checkbox"/>	<input type="checkbox"/>	<input type="checkbox"/>	<input type="checkbox"/>
4. Has an information system for managing customer's needs	<input type="checkbox"/>	<input type="checkbox"/>	<input type="checkbox"/>	<input type="checkbox"/>	<input type="checkbox"/>
5. Long-term relationships with strategic customers	<input type="checkbox"/>	<input type="checkbox"/>	<input type="checkbox"/>	<input type="checkbox"/>	<input type="checkbox"/>
6. Estimates the number of finished products available in the face of a surge in demand	<input type="checkbox"/>	<input type="checkbox"/>	<input type="checkbox"/>	<input type="checkbox"/>	<input type="checkbox"/>
SOURCE					
1. Long-term relationships with strategic suppliers	<input type="checkbox"/>	<input type="checkbox"/>	<input type="checkbox"/>	<input type="checkbox"/>	<input type="checkbox"/>

2. Just-in-time delivery from suppliers	<input type="checkbox"/>	<input type="checkbox"/>	<input type="checkbox"/>	<input type="checkbox"/>	<input type="checkbox"/>
3. Pay attention to the quality of raw material	<input type="checkbox"/>	<input type="checkbox"/>	<input type="checkbox"/>	<input type="checkbox"/>	<input type="checkbox"/>
4. Enough and Using standard warehousing and storage facilities	<input type="checkbox"/>	<input type="checkbox"/>	<input type="checkbox"/>	<input type="checkbox"/>	<input type="checkbox"/>
5. Enough financial capital to collect coffee as planned	<input type="checkbox"/>	<input type="checkbox"/>	<input type="checkbox"/>	<input type="checkbox"/>	<input type="checkbox"/>
MAKE					
1. Selection and classification of coffee product	<input type="checkbox"/>	<input type="checkbox"/>	<input type="checkbox"/>	<input type="checkbox"/>	<input type="checkbox"/>
2. Using skilled labor	<input type="checkbox"/>	<input type="checkbox"/>	<input type="checkbox"/>	<input type="checkbox"/>	<input type="checkbox"/>
3. Facilitate staff participation in coffee training courses	<input type="checkbox"/>	<input type="checkbox"/>	<input type="checkbox"/>	<input type="checkbox"/>	<input type="checkbox"/>
4. Using integrated information systems and the internet to communicate with supply chain partners	<input type="checkbox"/>	<input type="checkbox"/>	<input type="checkbox"/>	<input type="checkbox"/>	<input type="checkbox"/>
5. Using environmental -friendly bags for packaging	<input type="checkbox"/>	<input type="checkbox"/>	<input type="checkbox"/>	<input type="checkbox"/>	<input type="checkbox"/>
DELIVER					
1. Just-in-time delivery to customers	<input type="checkbox"/>	<input type="checkbox"/>	<input type="checkbox"/>	<input type="checkbox"/>	<input type="checkbox"/>
2. Share information of delivery to SC members	<input type="checkbox"/>	<input type="checkbox"/>	<input type="checkbox"/>	<input type="checkbox"/>	<input type="checkbox"/>
3. Using automatic identification during the delivery process to track order status	<input type="checkbox"/>	<input type="checkbox"/>	<input type="checkbox"/>	<input type="checkbox"/>	<input type="checkbox"/>
4. Ready-to-ship product inventory	<input type="checkbox"/>	<input type="checkbox"/>	<input type="checkbox"/>	<input type="checkbox"/>	<input type="checkbox"/>
5. Consider environmental problems in delivery	<input type="checkbox"/>	<input type="checkbox"/>	<input type="checkbox"/>	<input type="checkbox"/>	<input type="checkbox"/>
6. Outsourced transportation services	<input type="checkbox"/>	<input type="checkbox"/>	<input type="checkbox"/>	<input type="checkbox"/>	<input type="checkbox"/>
RETURN					
1. Receiving returned defective products	<input type="checkbox"/>	<input type="checkbox"/>	<input type="checkbox"/>	<input type="checkbox"/>	<input type="checkbox"/>
2. Returned defective products from source	<input type="checkbox"/>	<input type="checkbox"/>	<input type="checkbox"/>	<input type="checkbox"/>	<input type="checkbox"/>

PART III- PERFORMANCE

Performance	Results
1. The time needed to arrange the production schedule? Days	
2. The time between the pays the material to the supplier and receiving payment from the customer for the product made from the material? Days	
3. Purchase order lead time? (POLT) refers to the number of days from when a company places an order for production inputs it needs, to when those items arrive at the manufacturing plant. Days	
4. Customer lead time? Days Customer lead time or Total lead time is defined as the time it takes for a customer to receive a good or service from the time the customer places the order or performs a purchase transaction	
5. Percentage of the number of requests that the supplier can meet? (%)	
6. The number of suppliers available in a day? (people)	
7. Percentage of consistency in supplying raw materials? (%)	
8. The time required to check coffee beans? Days	
9. The average cost of shipping coffee products for 1 year? Million dong	
10. Costs incurred from raw material to finished goods? Million dong	
11. The number of customer complaints to the collectors?	
12. The time does it take to replace a defective product? Days	

PART IV- OPINION DIVERSE

1. What is the essential factor for successful coffee production in Vietnam?
 - Technical equipment
 - Access to capital
 - Close relationships with partners
 - Access to information markets
 - Government's policy regime
2. What is the most difficult that you face in coffee production in Kon Tum?.....
3. If coffee production in Kon Tum is not effective (productivity, interest rate, and product quality), what is the main reason?.....
4. To improve coffee production efficiency, what is the essential factor that needs to be improved?.....
5. What is the most difficult that you face in the coffee collection?
6. When facing difficulties, do you often solve them yourself or ask for the support of partners?
 - Solve it yourself
 - Ask for the support of partners
7. Which partner plays the most critical role in supporting your collection?
 - Supplier of raw materials such as seeds, fertilizers, and pesticides
 - Coffee producers
 - Other collectors
 - Coffee companies
 - State agencies
8. If you ask for partner assistance, will they respond?
 - Yes
 - No
9. Are you satisfied with their support?
 - Yes
 - No
10. How important is a relationship with partners for coffee production efficiency?
 - Reduce production costs
 - Improve the competitiveness of coffee products
 - Improve the quality of coffee
 - Others
11. What factors can improve the relationship with supply chain partners such as raw material suppliers, collectors, and coffee companies?.....
12. What kind of support would you like to receive?
 - Capital
 - Technology
 - Market Information
 - Others.....



Thank you for being so cooperative!

COMPANIES



Dear Sir / Madam.

I am currently a doctoral student at the Université Polytechnique Hauts-de-France. This survey is a part of doctoral dissertation research. Your participation in the survey will help me have enough data to analyze and evaluate coffee production and contribute to improving coffee production efficiency in Vietnam. The information collected below will be confidential and used for research purposes only. I would appreciate it if you could take a moment to answer the following questions.

Thank you for your participation.

PART I- GENERAL INFORMATION

1. Name of company
2. Email:
3. Tel:
4. The number of employees:
5. Sales volume in a million VND:
6. Years of company foundation:
7. Job title:
8. Years stayed at the organization:
9. Quantity of coffee produced annually? (Ton of roasted coffee):
10. Quantity of coffee produced annually? (Ton of green bean coffee):
11. Quantity of coffee produced annually? (Ton of instant coffee):
12. Quantity of green bean coffee purchased annually? Tons
13. Quantity of fresh coffee cherries purchased annually? Tons
14. Quantity of dry coffee cherries purchased annually? Tons

PART II- COFFEE PRODUCTION

For each statement, please show the extent of your implementation by putting a cross in the onebox which best reflects your current action based on a scale from 1 to 5:

1. Not implemented 2. Poor implementation 3. Moderately implemented 4. Good implemented 5. Fully implemented

	1	2	3	4	5
PLAN					
1. Forecasting of customer demands accurate	<input type="checkbox"/>	<input type="checkbox"/>	<input type="checkbox"/>	<input type="checkbox"/>	<input type="checkbox"/>
2. Forecasting of raw material demand accurate	<input type="checkbox"/>	<input type="checkbox"/>	<input type="checkbox"/>	<input type="checkbox"/>	<input type="checkbox"/>
3. Communication frequently among trading partners	<input type="checkbox"/>	<input type="checkbox"/>	<input type="checkbox"/>	<input type="checkbox"/>	<input type="checkbox"/>
4. Works with supply chain partners to design a plan	<input type="checkbox"/>	<input type="checkbox"/>	<input type="checkbox"/>	<input type="checkbox"/>	<input type="checkbox"/>
5. Has an information system for managing customer's needs	<input type="checkbox"/>	<input type="checkbox"/>	<input type="checkbox"/>	<input type="checkbox"/>	<input type="checkbox"/>
6. Long-term relationships with strategic customers	<input type="checkbox"/>	<input type="checkbox"/>	<input type="checkbox"/>	<input type="checkbox"/>	<input type="checkbox"/>
6. Estimates the number of finished products available in the face of a surge in demand	<input type="checkbox"/>	<input type="checkbox"/>	<input type="checkbox"/>	<input type="checkbox"/>	<input type="checkbox"/>

SOURCE					
1. Long-term relationships with strategic suppliers	<input type="checkbox"/>	<input type="checkbox"/>	<input type="checkbox"/>	<input type="checkbox"/>	<input type="checkbox"/>
2. Raw materials and components always being readily available for the production	<input type="checkbox"/>	<input type="checkbox"/>	<input type="checkbox"/>	<input type="checkbox"/>	<input type="checkbox"/>
3. Only purchase the necessary raw materials and components	<input type="checkbox"/>	<input type="checkbox"/>	<input type="checkbox"/>	<input type="checkbox"/>	<input type="checkbox"/>
4. Just-in-time delivery from suppliers	<input type="checkbox"/>	<input type="checkbox"/>	<input type="checkbox"/>	<input type="checkbox"/>	<input type="checkbox"/>
5. Warehousing system can be adjusted all the time	<input type="checkbox"/>	<input type="checkbox"/>	<input type="checkbox"/>	<input type="checkbox"/>	<input type="checkbox"/>
MAKE					
1. Inventory or stock levels kept at minimum levels in respective warehouses	<input type="checkbox"/>	<input type="checkbox"/>	<input type="checkbox"/>	<input type="checkbox"/>	<input type="checkbox"/>
2. Current production schedule carried out as planned	<input type="checkbox"/>	<input type="checkbox"/>	<input type="checkbox"/>	<input type="checkbox"/>	<input type="checkbox"/>
3. Inform in advance of any changes be made to the current production schedule	<input type="checkbox"/>	<input type="checkbox"/>	<input type="checkbox"/>	<input type="checkbox"/>	<input type="checkbox"/>
4. Measure and assess quality frequently	<input type="checkbox"/>	<input type="checkbox"/>	<input type="checkbox"/>	<input type="checkbox"/>	<input type="checkbox"/>
5. Using integrated information systems and the internet to communicate with supply chain partners	<input type="checkbox"/>	<input type="checkbox"/>	<input type="checkbox"/>	<input type="checkbox"/>	<input type="checkbox"/>
6. Using skilled labor	<input type="checkbox"/>	<input type="checkbox"/>	<input type="checkbox"/>	<input type="checkbox"/>	<input type="checkbox"/>
7. Facilitate staff participation in training courses to enhance skills and knowledge	<input type="checkbox"/>	<input type="checkbox"/>	<input type="checkbox"/>	<input type="checkbox"/>	<input type="checkbox"/>
8. Enough and Using standard warehousing and storage facilities	<input type="checkbox"/>	<input type="checkbox"/>	<input type="checkbox"/>	<input type="checkbox"/>	<input type="checkbox"/>
9. Consider environmental issues	<input type="checkbox"/>	<input type="checkbox"/>	<input type="checkbox"/>	<input type="checkbox"/>	<input type="checkbox"/>
10. The machine is maintained as planned	<input type="checkbox"/>	<input type="checkbox"/>	<input type="checkbox"/>	<input type="checkbox"/>	<input type="checkbox"/>
11. Product is produced according to customer's orders	<input type="checkbox"/>	<input type="checkbox"/>	<input type="checkbox"/>	<input type="checkbox"/>	<input type="checkbox"/>
DELIVER					
1. Just-in-time delivery to customers	<input type="checkbox"/>	<input type="checkbox"/>	<input type="checkbox"/>	<input type="checkbox"/>	<input type="checkbox"/>
2. Share information of delivery to SC members	<input type="checkbox"/>	<input type="checkbox"/>	<input type="checkbox"/>	<input type="checkbox"/>	<input type="checkbox"/>
3. Using automatic identification during the delivery process to track order status	<input type="checkbox"/>	<input type="checkbox"/>	<input type="checkbox"/>	<input type="checkbox"/>	<input type="checkbox"/>
4. Has a transport management system	<input type="checkbox"/>	<input type="checkbox"/>	<input type="checkbox"/>	<input type="checkbox"/>	<input type="checkbox"/>
5. Outsourced transportation services	<input type="checkbox"/>	<input type="checkbox"/>	<input type="checkbox"/>	<input type="checkbox"/>	<input type="checkbox"/>
6. Aware of lead time in each unit within the supply chain	<input type="checkbox"/>	<input type="checkbox"/>	<input type="checkbox"/>	<input type="checkbox"/>	<input type="checkbox"/>
RETURN					
1. Receiving returned defective products	<input type="checkbox"/>	<input type="checkbox"/>	<input type="checkbox"/>	<input type="checkbox"/>	<input type="checkbox"/>
2. Solve problems of returned products from the customer	<input type="checkbox"/>	<input type="checkbox"/>	<input type="checkbox"/>	<input type="checkbox"/>	<input type="checkbox"/>
3. Collecting customer assessment	<input type="checkbox"/>	<input type="checkbox"/>	<input type="checkbox"/>	<input type="checkbox"/>	<input type="checkbox"/>
4. Returned defective products from the source	<input type="checkbox"/>	<input type="checkbox"/>	<input type="checkbox"/>	<input type="checkbox"/>	<input type="checkbox"/>

PART III- PERFORMANCE

Performance	Results
1. What is the time needed to arrange the production schedule? Days	
2. What is the time between the payment of the material to the supplier and receiving payment from the customer for the product made from the material? Days	
3. Percentage of the number of requests that the supplier can meet? (%)	
4. Percentage of consistency in supplying raw materials? (%)	
5. The number of suppliers available in a day? (people)	
6. Fulfillment of ready-to-ship inventory. Percentage of existing inventory quantities by customer demand?	
7. The time does it take to produce goods from raw materials to finished goods? (days) (days) “ production cycle time.”	
8. The time it takes to put coffee into the sacks? (days)	
9. What is the time required to check coffee beans? days	
10. The number of days required to produce unexpected activities?	
11. Purchase order lead time? (POLT) refers to the number of days from when a company places an order for production inputs it needs, to when those items arrive at the manufacturing plant	
12. Customer lead time? Days Customer lead time or Total lead time is defined as the time it takes for a customer to receive a good or service from the time the customer places the order or performs a purchase transaction	
13. What is the average time it takes to respond to an order? days	
14. What is the average cost of shipping coffee products for one year? Million dong	
15. Costs incurred from raw material to finished goods? Million dong	
16. Average years for machine usage?	
17. What is the number of customer complaints to the companies in one year?	
18. The time does it take to replace a defective product? days	
19. Direct and indirect costs are returned because the product is damaged. Million dong	
20. Percentage of number units returned/ number of products shipped.? (%)	

PART IV- OPINION DIVERSE

1. What is the most important factor for successful coffee production in Vietnam?
 - Technical equipment
 - Access to capital
 - Close relationships with partners
 - Access to information markets
 - Government’s policy regime
2. What is the most difficult that you face in coffee production in Kon Tum?.....
3. If coffee production in Kon Tum is not effective (productivity, interest rate, and product quality), what is the main reason?.....
4. To improve coffee production efficiency, what is the most important factor that needs to be improved?.....

5. When facing difficulties, do you often solve them yourself or ask for the support of partners?
 - Solve it yourself
 - Ask for the support of partners
6. Which partner plays the most important role in supporting your collection?
 - Supplier of raw materials such as seeds, fertilizers, and pesticides
 - Coffee producers
 - Other collectors
 - Coffee companies
 - State agencies
7. If you ask for partner assistance, will they respond?
 - Yes
 - No
8. Are you satisfied with their support?
 - Yes
 - No
9. How important is a relationship with partners for coffee production efficiency?
 - Reduce production costs
 - Improve the competitiveness of coffee products
 - Improve the quality of coffee
 - Others
10. What factors can improve the relationship with supply chain partners such as raw material suppliers, collectors, and coffee companies?.....
11. What kind of support would you like to receive?
 - Capital
 - Technology
 - Market Information
 - Others.....



Thank you for being so cooperative!

Part B- Demand planning

COFFEE COMPANIES



Dear Sir / Madam.

This survey is a part of doctoral dissertation research at the Université Polytechnique Hauts-de-France. This questionnaire aims to collect data for the research on demand planning activities. Please fill in the entire questionnaire by ticking the box of your answer. This questionnaire is confidential and will only take a few minutes to complete. There are no false or true answers. All that we care about is your honest answers.

Thank you for your participation.

PART I- GENERAL INFORMATION

1. Company size:
2. Your position in the company:.....
3. Forecasting activity.
 - 1.1. Time horizon (months):
 - 1.2. A number of forecast modifications in one year:

PART II- CONTENTS

A. DEMAND PLANNING PROCESS

For each statement, please show the extent of your opinion by putting a cross in the one box which best reflects current activities based on a scale from 1 to 7:

1. Not at all
2. Very Small Extent
3. Small Extent
4. Moderate Extent
5. Large Extent
6. Very Large Extent
7. Great Extent

		1	2	3	4	5	6	7
GOAL FORMULATION (GF)								
1. Identifying the customer priorities	F1	<input type="checkbox"/>	<input type="checkbox"/>	<input type="checkbox"/>	<input type="checkbox"/>	<input type="checkbox"/>	<input type="checkbox"/>	<input type="checkbox"/>
2. Identifying the product priorities	F2	<input type="checkbox"/>	<input type="checkbox"/>	<input type="checkbox"/>	<input type="checkbox"/>	<input type="checkbox"/>	<input type="checkbox"/>	<input type="checkbox"/>
3. Tracking the proportion of completed client orders delivered on time	F3	<input type="checkbox"/>	<input type="checkbox"/>	<input type="checkbox"/>	<input type="checkbox"/>	<input type="checkbox"/>	<input type="checkbox"/>	<input type="checkbox"/>
4. Customers are satisfied with the current on-time delivery performance	F4	<input type="checkbox"/>	<input type="checkbox"/>	<input type="checkbox"/>	<input type="checkbox"/>	<input type="checkbox"/>	<input type="checkbox"/>	<input type="checkbox"/>
5. Ability to react to unanticipated, drop-in orders to unanticipated drop-in orders	F5	<input type="checkbox"/>	<input type="checkbox"/>	<input type="checkbox"/>	<input type="checkbox"/>	<input type="checkbox"/>	<input type="checkbox"/>	<input type="checkbox"/>
6. Meeting short-term customer demands from the completed products inventory	F6	<input type="checkbox"/>	<input type="checkbox"/>	<input type="checkbox"/>	<input type="checkbox"/>	<input type="checkbox"/>	<input type="checkbox"/>	<input type="checkbox"/>
7. Evaluating the "out-of-stock" position	F7	<input type="checkbox"/>	<input type="checkbox"/>	<input type="checkbox"/>	<input type="checkbox"/>	<input type="checkbox"/>	<input type="checkbox"/>	<input type="checkbox"/>
DEMAND FORECASTING								
FORECASTING TECHNIQUES (FI)								
1. Using quantitative time series models (e.g., exponential smoothing)	D1	<input type="checkbox"/>	<input type="checkbox"/>	<input type="checkbox"/>	<input type="checkbox"/>	<input type="checkbox"/>	<input type="checkbox"/>	<input type="checkbox"/>
2. Using a single model	D2	<input type="checkbox"/>	<input type="checkbox"/>	<input type="checkbox"/>	<input type="checkbox"/>	<input type="checkbox"/>	<input type="checkbox"/>	<input type="checkbox"/>
3. Using a combination of different models	D3	<input type="checkbox"/>	<input type="checkbox"/>	<input type="checkbox"/>	<input type="checkbox"/>	<input type="checkbox"/>	<input type="checkbox"/>	<input type="checkbox"/>
4. Using quantitative causal models	D4	<input type="checkbox"/>	<input type="checkbox"/>	<input type="checkbox"/>	<input type="checkbox"/>	<input type="checkbox"/>	<input type="checkbox"/>	<input type="checkbox"/>

(e.g., regression or econometric analysis)								
5. Using qualitative models (e.g., market survey or sales quota)	D5	<input type="checkbox"/>	<input type="checkbox"/>	<input type="checkbox"/>	<input type="checkbox"/>	<input type="checkbox"/>	<input type="checkbox"/>	<input type="checkbox"/>
6. The jury of executive opinion	D6	<input type="checkbox"/>	<input type="checkbox"/>	<input type="checkbox"/>	<input type="checkbox"/>	<input type="checkbox"/>	<input type="checkbox"/>	<input type="checkbox"/>
7. Sales force composite	D7	<input type="checkbox"/>	<input type="checkbox"/>	<input type="checkbox"/>	<input type="checkbox"/>	<input type="checkbox"/>	<input type="checkbox"/>	<input type="checkbox"/>
8. Customer expectations	D8	<input type="checkbox"/>	<input type="checkbox"/>	<input type="checkbox"/>	<input type="checkbox"/>	<input type="checkbox"/>	<input type="checkbox"/>	<input type="checkbox"/>
SOURCES OF INFORMATION (SI)								
1. Using past data in generating a prediction	S1	<input type="checkbox"/>	<input type="checkbox"/>	<input type="checkbox"/>	<input type="checkbox"/>	<input type="checkbox"/>	<input type="checkbox"/>	<input type="checkbox"/>
2. Using sales estimates in developing prediction	S2	<input type="checkbox"/>	<input type="checkbox"/>	<input type="checkbox"/>	<input type="checkbox"/>	<input type="checkbox"/>	<input type="checkbox"/>	<input type="checkbox"/>
3. Using promotion plans to build demand forecasting	S3	<input type="checkbox"/>	<input type="checkbox"/>	<input type="checkbox"/>	<input type="checkbox"/>	<input type="checkbox"/>	<input type="checkbox"/>	<input type="checkbox"/>
4. Using market share data in the predicting process	S4	<input type="checkbox"/>	<input type="checkbox"/>	<input type="checkbox"/>	<input type="checkbox"/>	<input type="checkbox"/>	<input type="checkbox"/>	<input type="checkbox"/>
5. Considering the company's goal when developing predictions	S5	<input type="checkbox"/>	<input type="checkbox"/>	<input type="checkbox"/>	<input type="checkbox"/>	<input type="checkbox"/>	<input type="checkbox"/>	<input type="checkbox"/>
6. Considering the trade inventory in demand prediction	S6	<input type="checkbox"/>	<input type="checkbox"/>	<input type="checkbox"/>	<input type="checkbox"/>	<input type="checkbox"/>	<input type="checkbox"/>	<input type="checkbox"/>
7. Using information from the supplier	S7	<input type="checkbox"/>	<input type="checkbox"/>	<input type="checkbox"/>	<input type="checkbox"/>	<input type="checkbox"/>	<input type="checkbox"/>	<input type="checkbox"/>
8. Using market research	S8	<input type="checkbox"/>	<input type="checkbox"/>	<input type="checkbox"/>	<input type="checkbox"/>	<input type="checkbox"/>	<input type="checkbox"/>	<input type="checkbox"/>
9. Taking the current economic situation	S9	<input type="checkbox"/>	<input type="checkbox"/>	<input type="checkbox"/>	<input type="checkbox"/>	<input type="checkbox"/>	<input type="checkbox"/>	<input type="checkbox"/>
THE ROLE OF FORECASTING IN DECISION-MAKING (RF)								
1. Developing sales and budget preparation	R1	<input type="checkbox"/>	<input type="checkbox"/>	<input type="checkbox"/>	<input type="checkbox"/>	<input type="checkbox"/>	<input type="checkbox"/>	<input type="checkbox"/>
2. Developing production planning	R2	<input type="checkbox"/>	<input type="checkbox"/>	<input type="checkbox"/>	<input type="checkbox"/>	<input type="checkbox"/>	<input type="checkbox"/>	<input type="checkbox"/>
3. New product development	R3	<input type="checkbox"/>	<input type="checkbox"/>	<input type="checkbox"/>	<input type="checkbox"/>	<input type="checkbox"/>	<input type="checkbox"/>	<input type="checkbox"/>
4. Equipment planning	R4	<input type="checkbox"/>	<input type="checkbox"/>	<input type="checkbox"/>	<input type="checkbox"/>	<input type="checkbox"/>	<input type="checkbox"/>	<input type="checkbox"/>
COMMUNICATING THE FORECASTS AND SYNCHRONIZING DEMAND WITH SUPPLY (C&S)								
1. Assisting the demand planning process using inter-organizational information	C1	<input type="checkbox"/>	<input type="checkbox"/>	<input type="checkbox"/>	<input type="checkbox"/>	<input type="checkbox"/>	<input type="checkbox"/>	<input type="checkbox"/>
2. Supporting the order commitment process using inter-organizational information	C2	<input type="checkbox"/>	<input type="checkbox"/>	<input type="checkbox"/>	<input type="checkbox"/>	<input type="checkbox"/>	<input type="checkbox"/>	<input type="checkbox"/>
3. Sharing demand forecasting insights within supply chains	C3	<input type="checkbox"/>	<input type="checkbox"/>	<input type="checkbox"/>	<input type="checkbox"/>	<input type="checkbox"/>	<input type="checkbox"/>	<input type="checkbox"/>
4. Accessing free forecasting data	C4							
5. Accessing online prediction data	C5	<input type="checkbox"/>	<input type="checkbox"/>	<input type="checkbox"/>	<input type="checkbox"/>	<input type="checkbox"/>	<input type="checkbox"/>	<input type="checkbox"/>

B. PERFORMANCE

For each statement, please show the extent of your opinion by putting a cross in the onebox which best reflects current performance compared with your competitors based on a scale from 1 to 7:

1. Far worse than 2. Worse than 3. Fairly worse than 4. Same 5. Fairly better than 6. Better than 7. Far better than

		1	2	3	4	5	6	7
OPERATIONAL PERFORMANCE								
1. COST								
1.1. Direct manufacturing costs	OP1	<input type="checkbox"/>	<input type="checkbox"/>	<input type="checkbox"/>	<input type="checkbox"/>	<input type="checkbox"/>	<input type="checkbox"/>	<input type="checkbox"/>
1.2. Total product costs	OP2	<input type="checkbox"/>	<input type="checkbox"/>	<input type="checkbox"/>	<input type="checkbox"/>	<input type="checkbox"/>	<input type="checkbox"/>	<input type="checkbox"/>
1.3. Raw material costs	OP3	<input type="checkbox"/>	<input type="checkbox"/>	<input type="checkbox"/>	<input type="checkbox"/>	<input type="checkbox"/>	<input type="checkbox"/>	<input type="checkbox"/>
2. DELIVERY								
2.1. Order fulfillment speed	OP4	<input type="checkbox"/>	<input type="checkbox"/>	<input type="checkbox"/>	<input type="checkbox"/>	<input type="checkbox"/>	<input type="checkbox"/>	<input type="checkbox"/>
2.2. Delivery speed	OP5	<input type="checkbox"/>	<input type="checkbox"/>	<input type="checkbox"/>	<input type="checkbox"/>	<input type="checkbox"/>	<input type="checkbox"/>	<input type="checkbox"/>
2.3. Delivery as promised	OP6	<input type="checkbox"/>	<input type="checkbox"/>	<input type="checkbox"/>	<input type="checkbox"/>	<input type="checkbox"/>	<input type="checkbox"/>	<input type="checkbox"/>

I appreciate your cooperation!