



Porto Alegre - Brésil



Toulouse - France

Un Mécanisme Constructiviste d'Apprentissage Automatique d'Anticipations pour des Agents Artificiels Situés

Filipo Studzinski PEROTTO

Jean-Christophe BUISSON, Luís Otávio ALVARES

Table des Matières

1. Introduction

2. CAES (*Coupled Agent-Environment System*)

3. CALM (*Constructivist Anticipatory Learning Mechanism*)

4. Expériences

5. Conclusions

Situation de la Discipline

1. Introduction



Problèmes Spécifiques
Appliqués
(comportement intelligent)

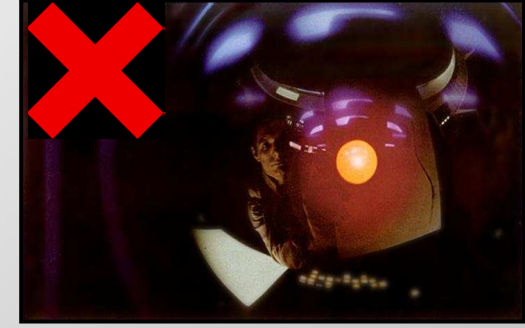
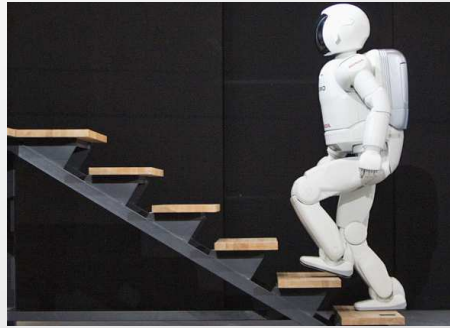

Problèmes Générales
de Monde Réel
(mécanisme intelligent)



Réflexion sur le
Paradigme

- Mécanismes d'IA Générale
 - pour aider à comprendre la nature de l'intelligence
 - pour surpasser les limites de la technologie actuelle





**Psychologie
Constructiviste**



CALM

Constructivist
Anticipatory
Learning
Mechanism



Psychologie
Constructiviste



IA Constructiviste



CALM

**Drescher
(1991)**

H. Minsky (1992)
Ramstad (1992)
Wazlawick (1993)
Müller, Rodriguez (1996)
Muñoz (1999)
Yavuz, Davenport (1997)
Stolzmann (1998)
DeJong (1999)
Birck, Paul (2000)
Morrison (2001)
Butz, Goldberg (2003)
Stojanov (2003)
Buisson (2004)
Chaput (2004)

**Holmes, Isbell
(2005, 2006)**

Boden (1979)
Cellérier (1992)
Costa (1993)
Costa, Dimuro (2005)
Christensen (2000)

IA Générale

Franklin (2007)
Pennachin, Goertzel (2007)



Chaines Stochastiques
Automates Finis
Théorie du Contrôle

IA Constructiviste

CALM

Framework
MDP

FPOMDP

Markov
Decision
Process

Guestrin (2001, 2003)
Boutilier (2000)
Hansen (2000)
Sallans (2004)
Poupart (2005)
Shani (2005, 2008)
Sim (2008)
Strehl (2007)
Ortner (2008)
Madani (2009)

Degrès, Sigaud
(2006, 2008)

CALM

FPOMDP



Cybernétique



Interactivisme
IA Située / Incarnée
Systèmes Dynamiques
IA Affective / Emotions

Coupled
Agent -
Environment
System

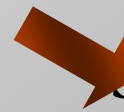

CALM



FPOMDP



CAES

Contextualisation et Objectifs

1. Introduction

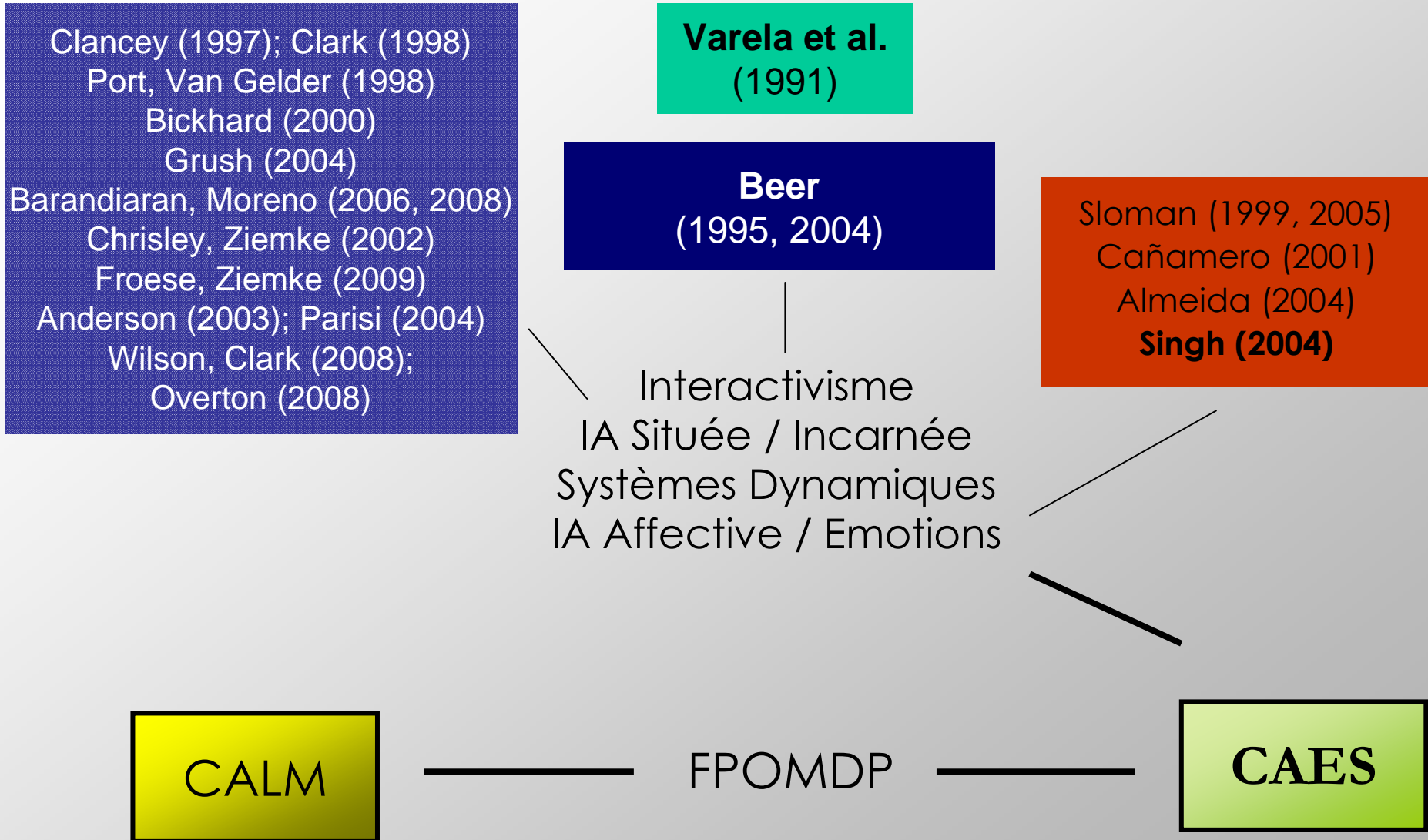

Table des Matières

1. Introduction

2. CAES (*Coupled Agent-Environment System*)

3. CALM (*Constructivist Anticipatory Learning Mechanism*)

4. Expériences

5. Conclusions

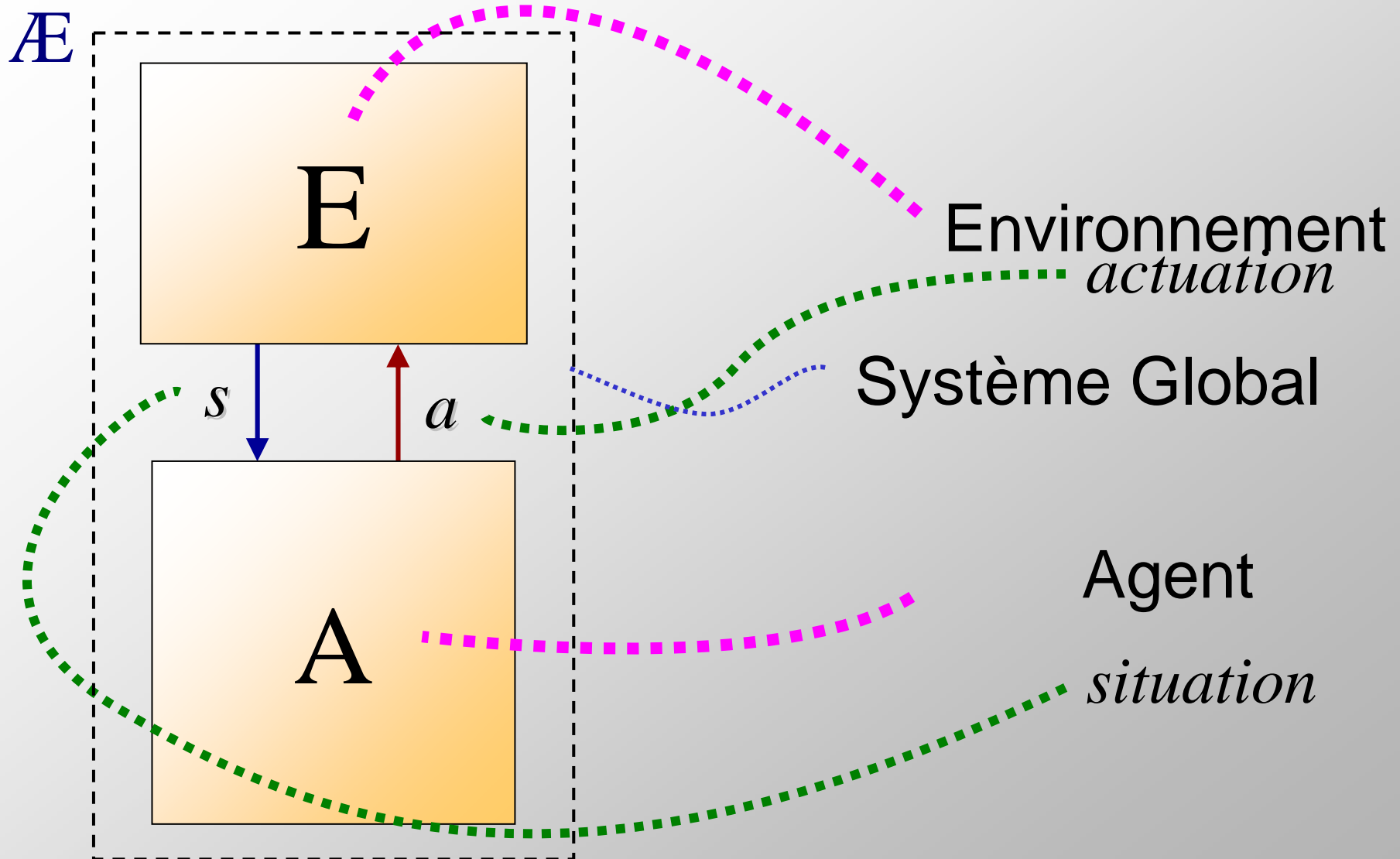

Æ

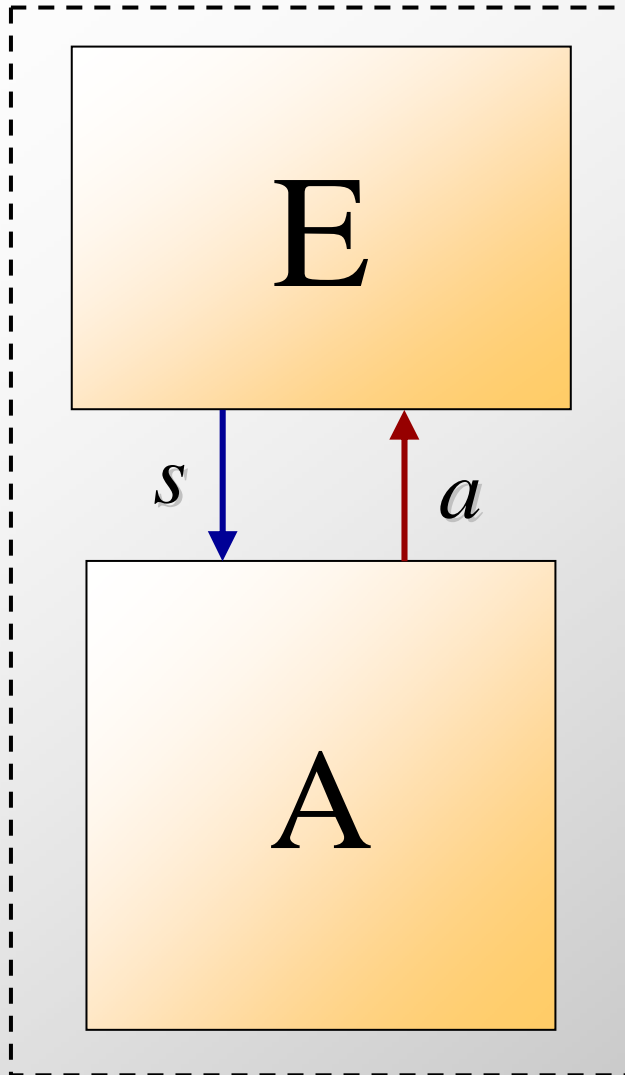

■ Non-Omniscience

- senseurs limités
- point de vue local
- « perceptual aliasing »
 - situations différentes
 - apparence similaire

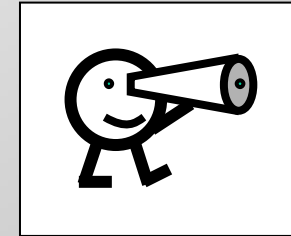

■ Non-Omnipotence

- effecteurs limités
- actuation locale
- une force parmi d'autres

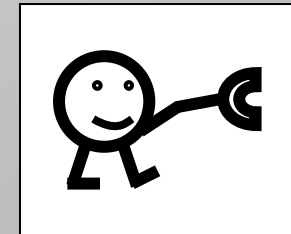

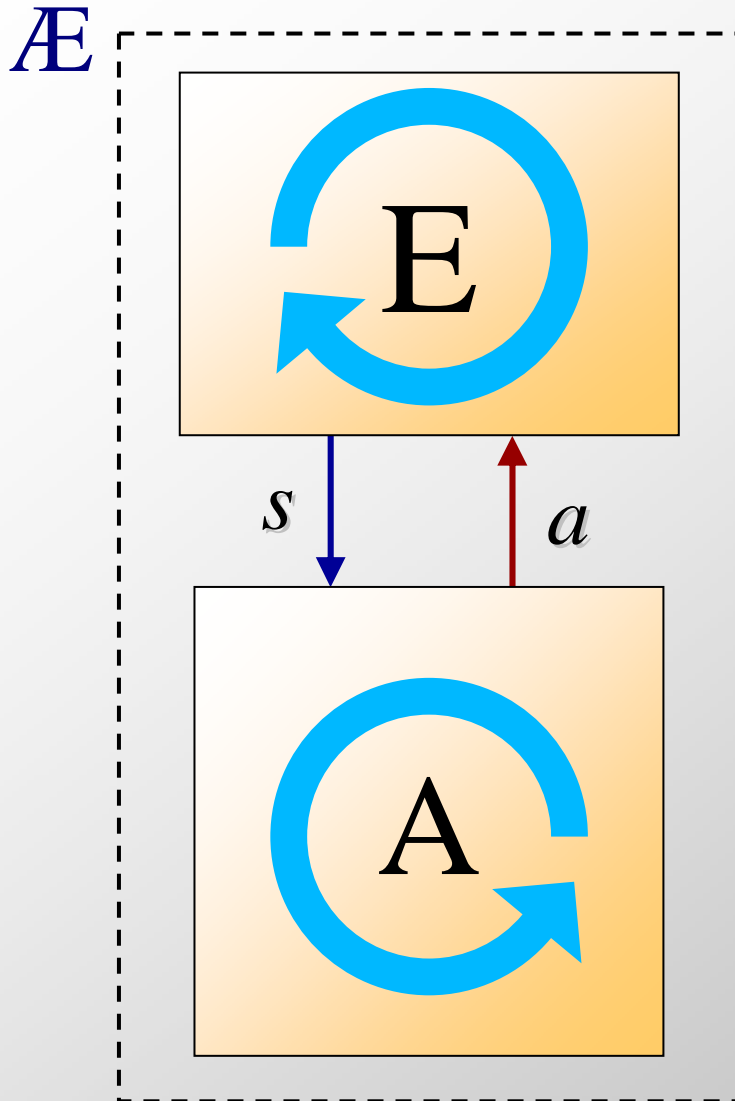

- Ouverture Partielle
 - interférence mutuelle
 - interdépendance
- Interaction Continue
 - déformation des trajectoires

$$x'_E = f_E(x_E, a)$$

$$x'_A = f_A(x_A, s)$$

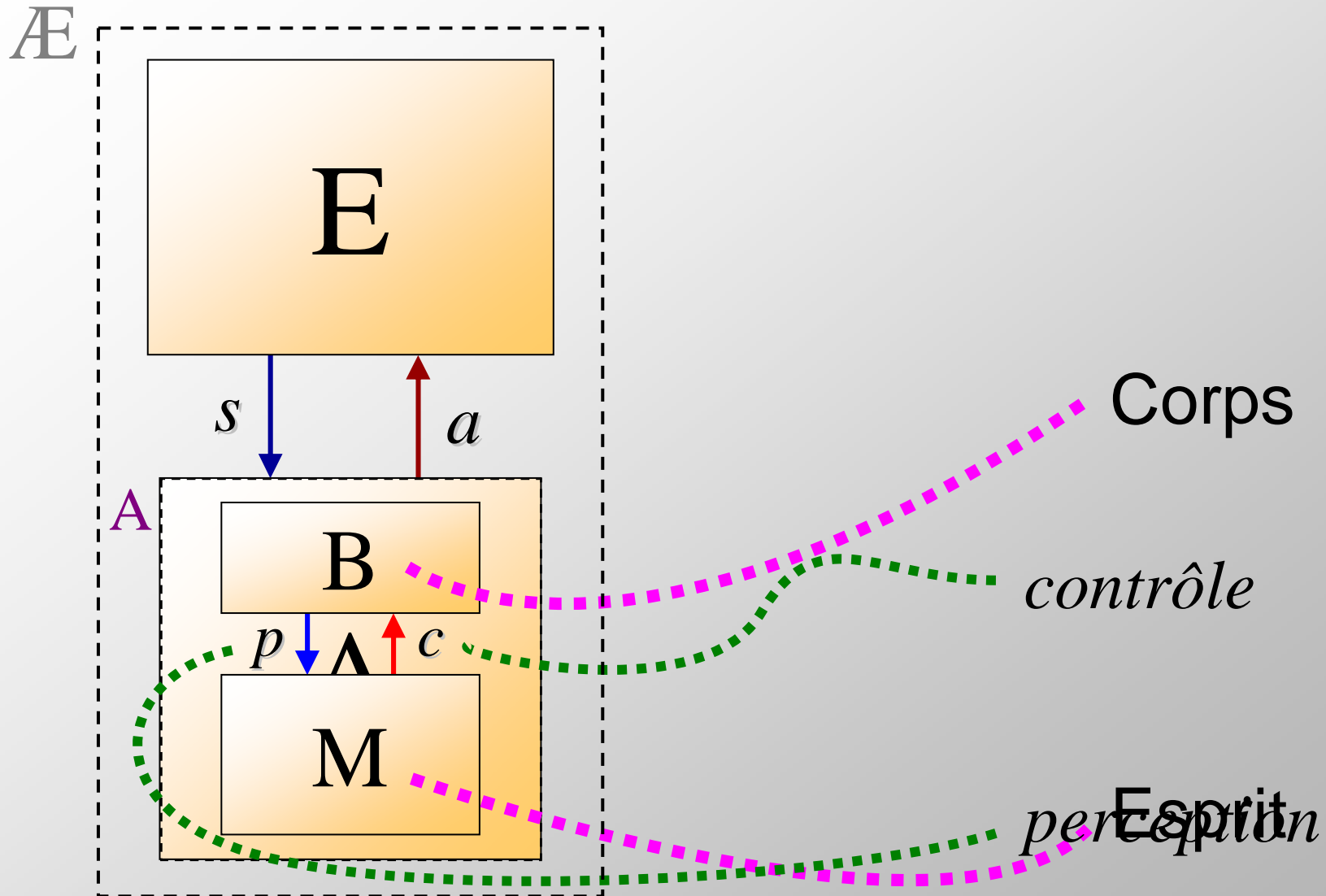

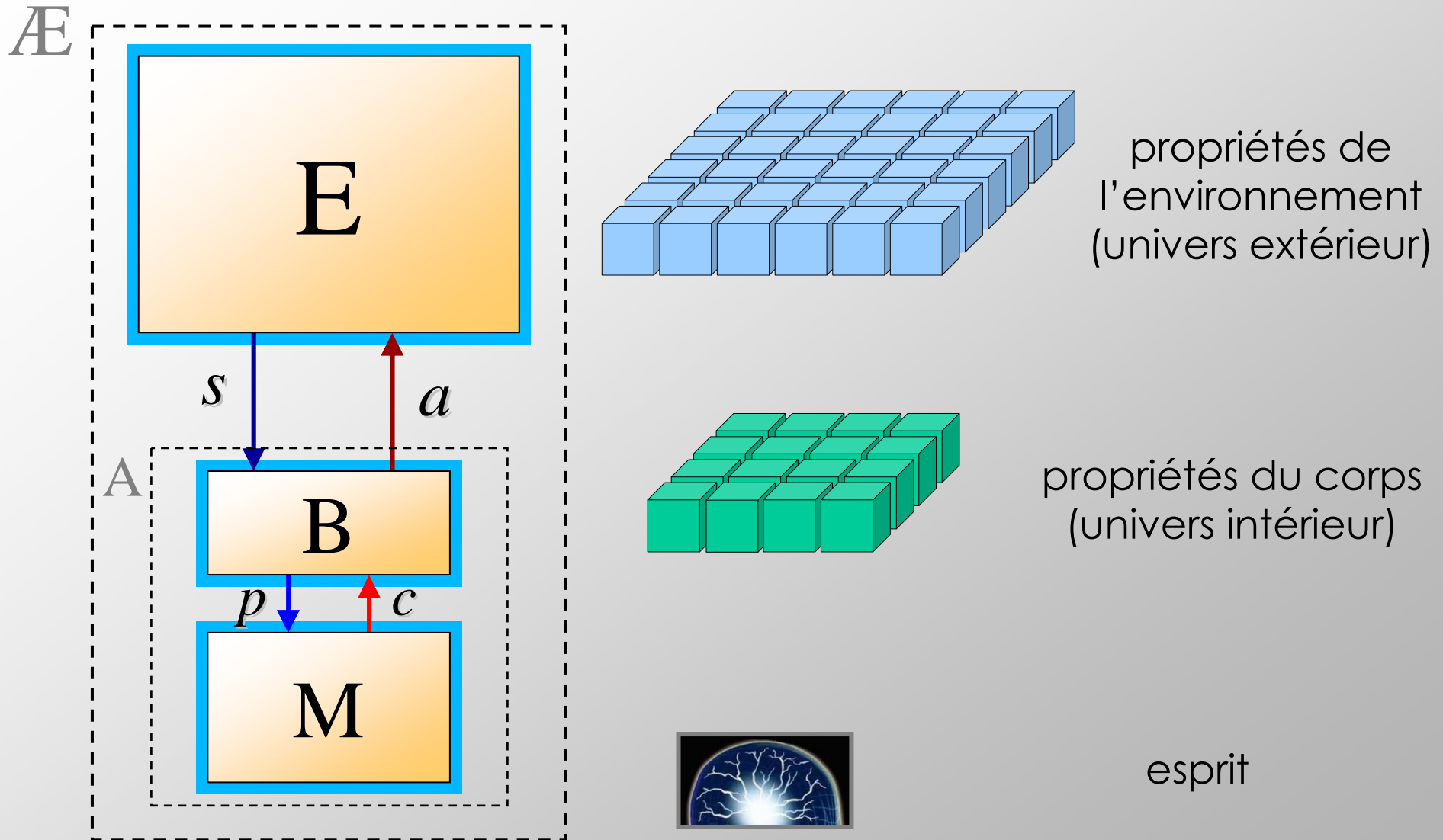

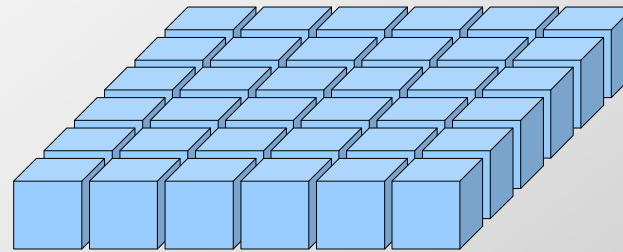
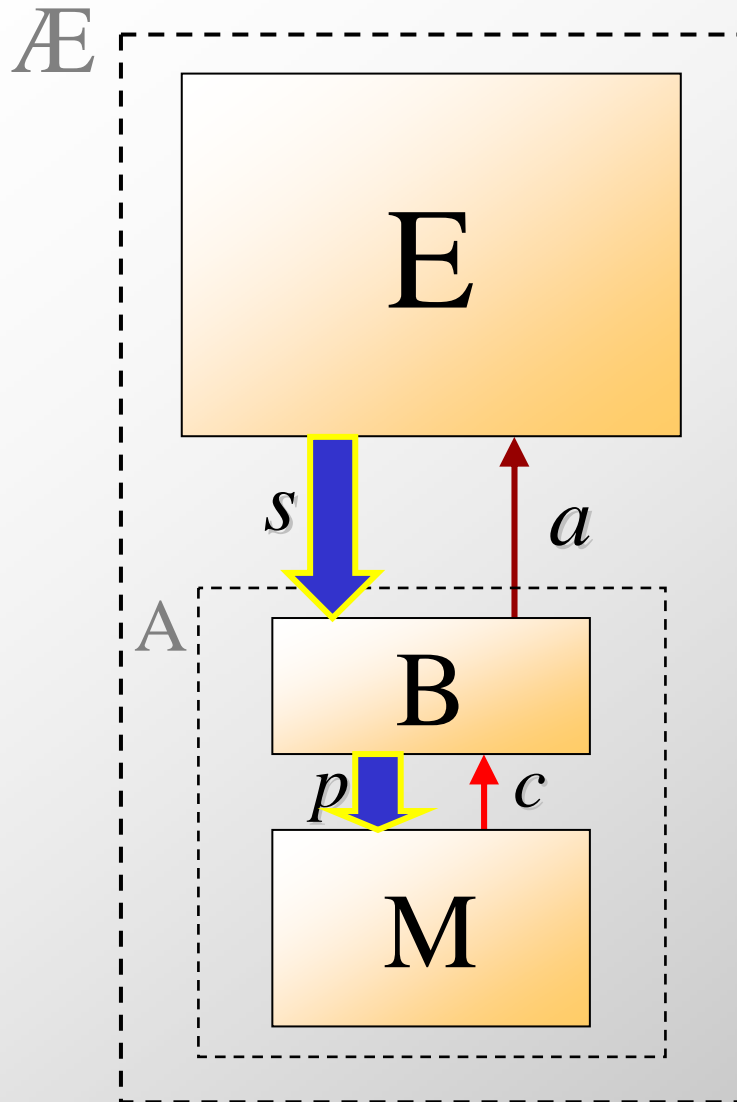

signal de situation

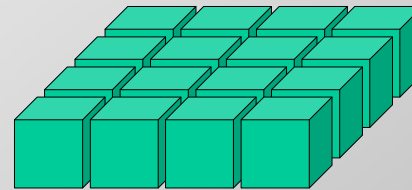

Intérférence
sur le corps

signal de perception



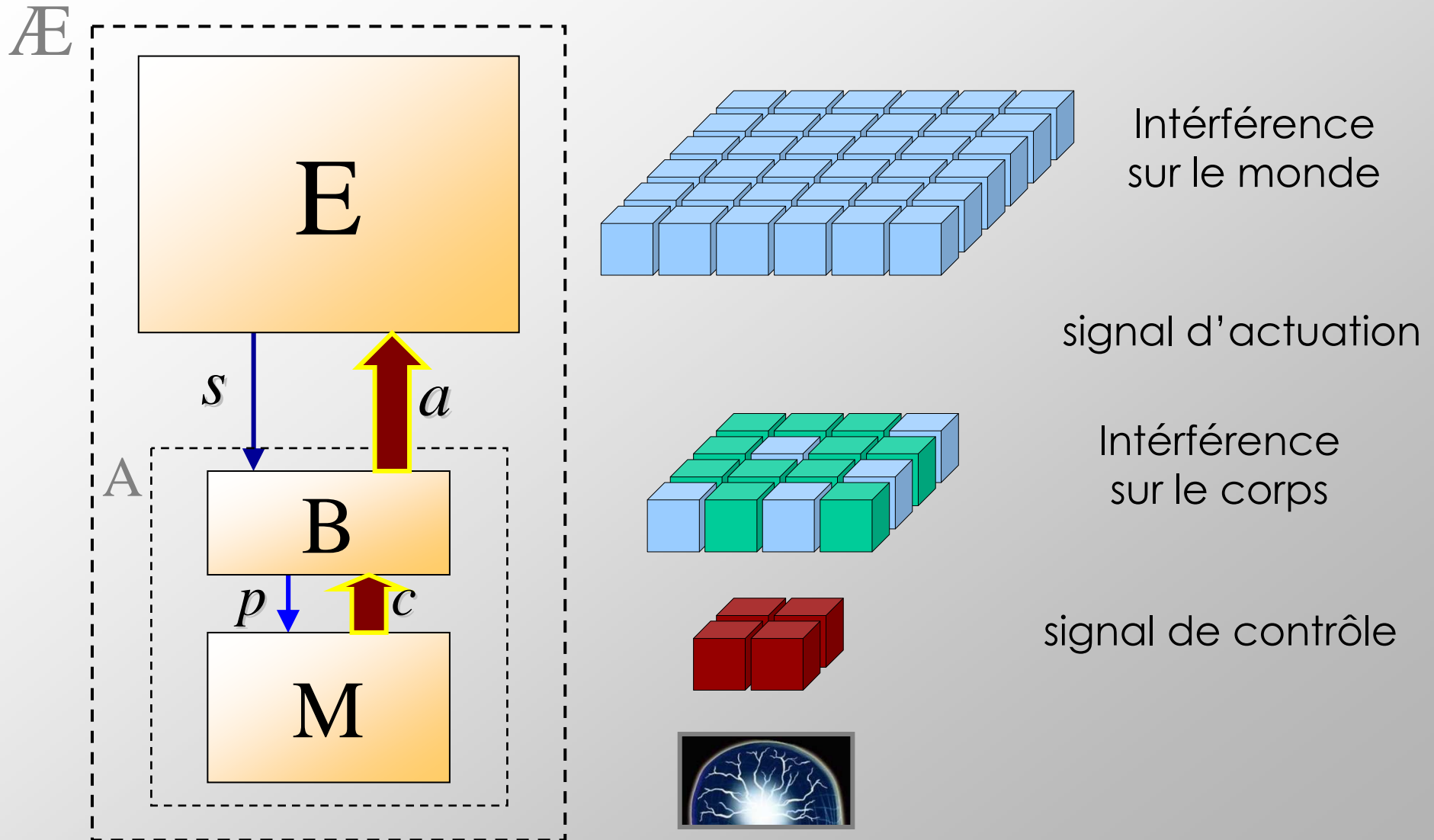

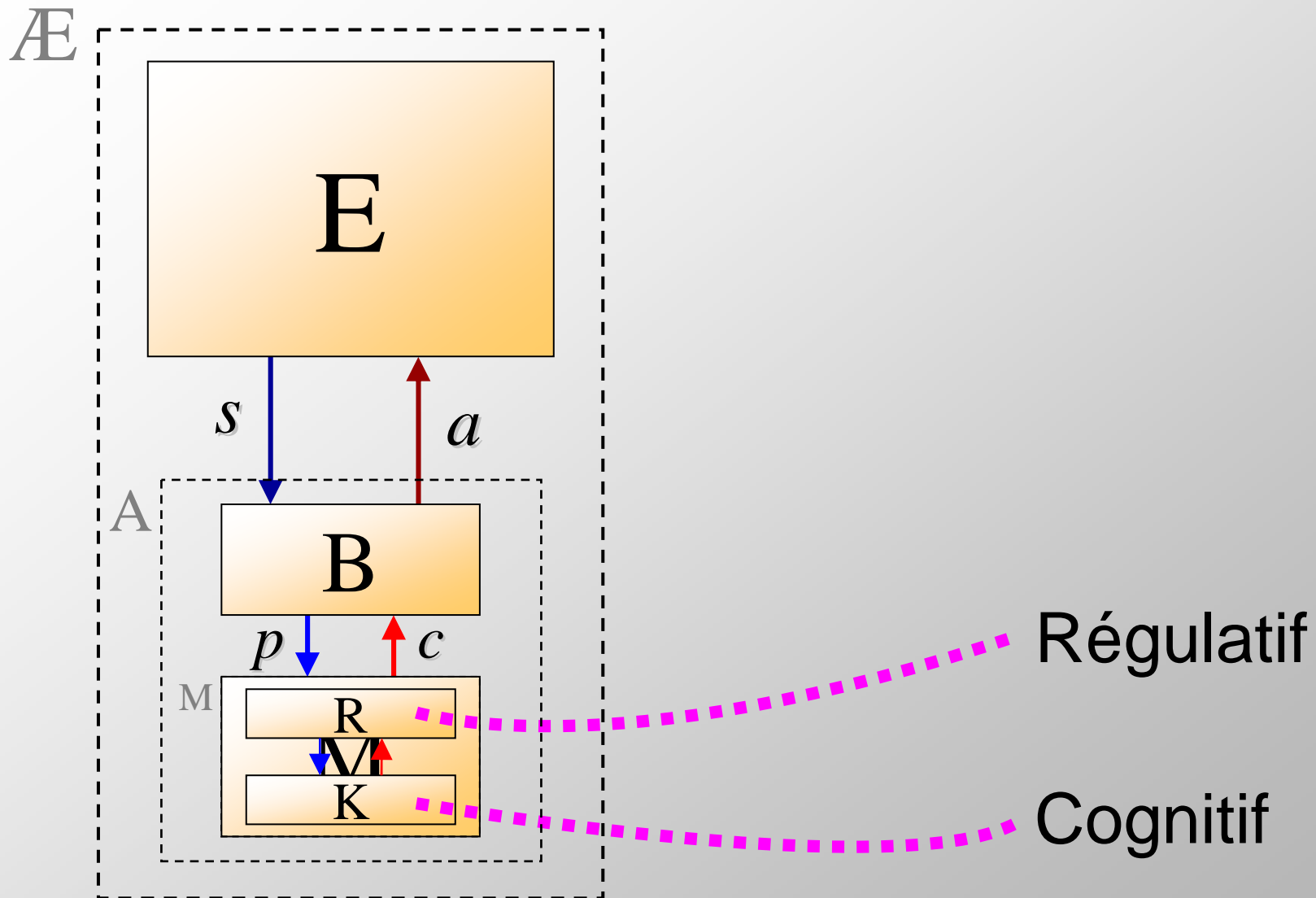

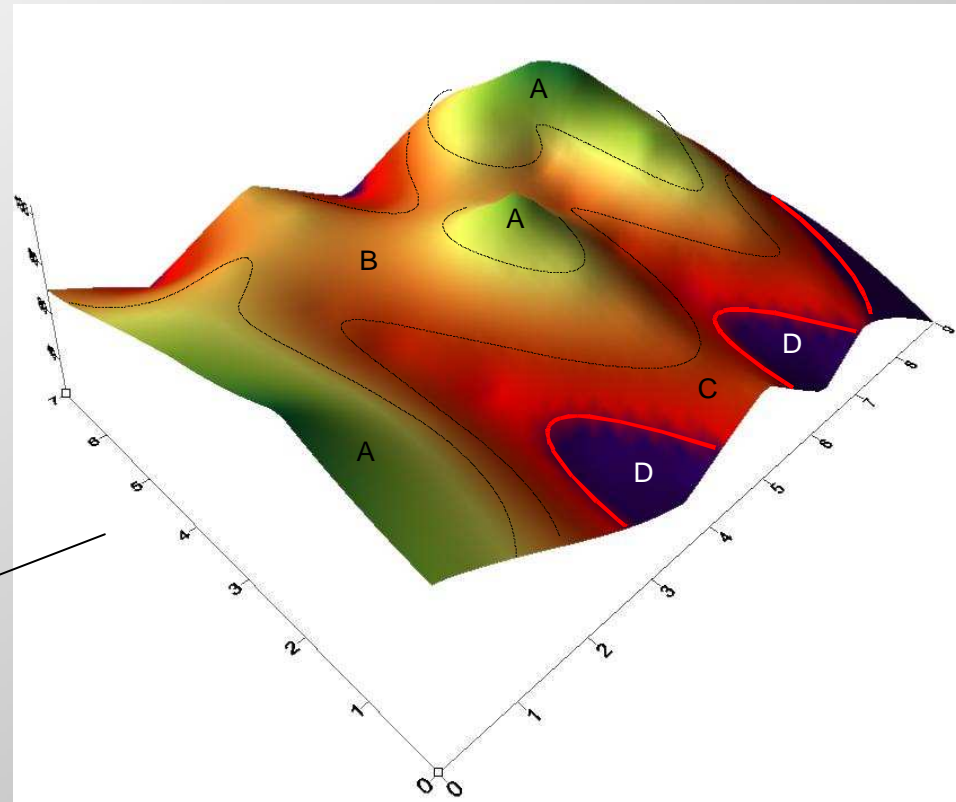
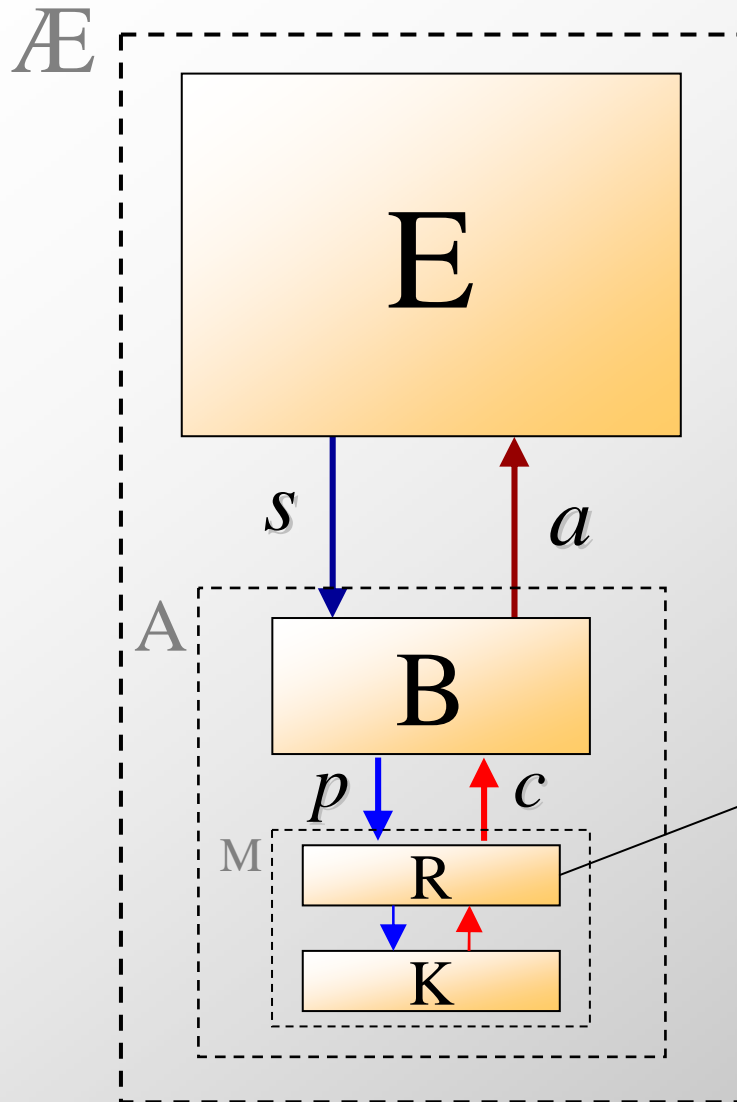

Rélief Affectif

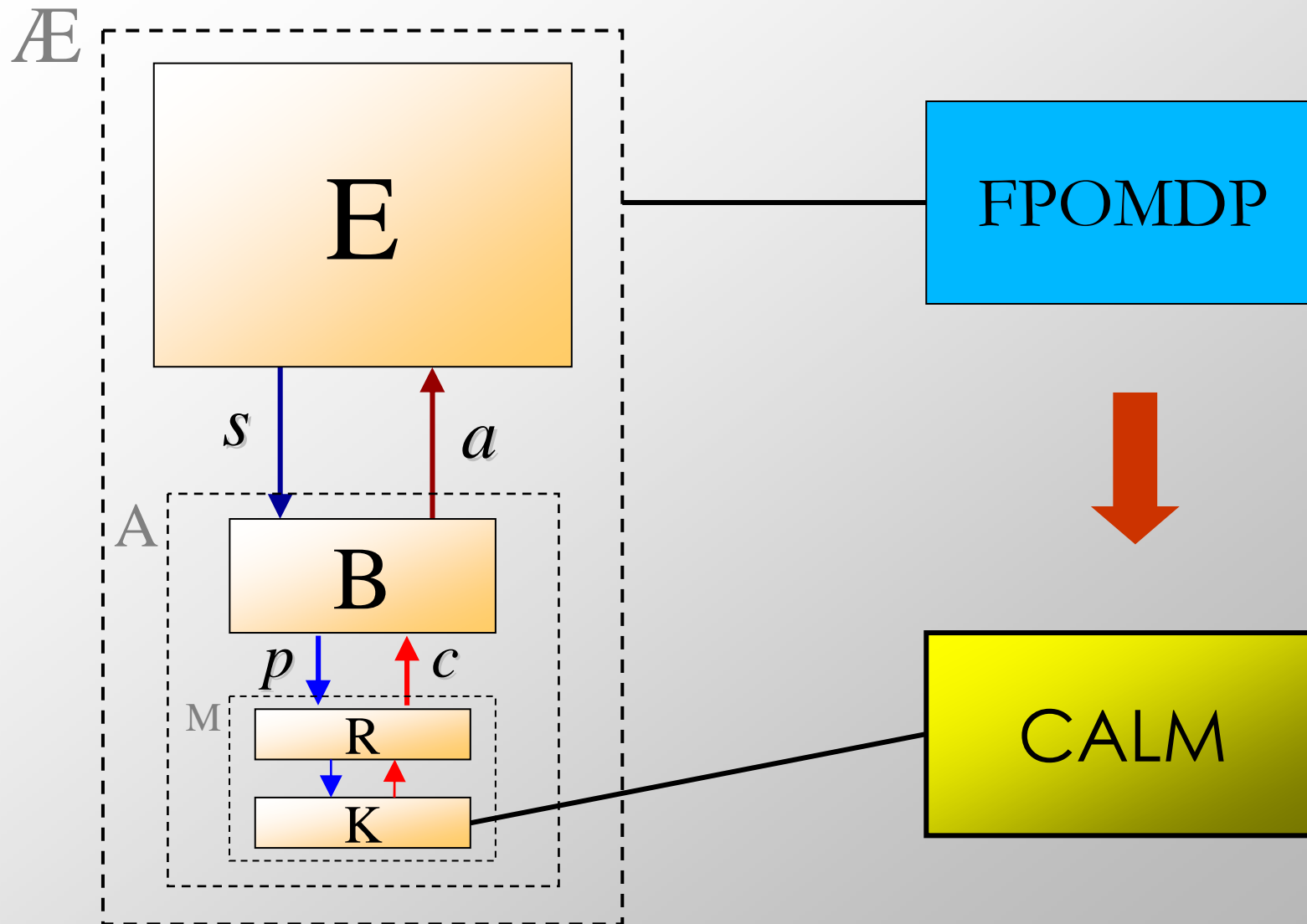

1. Introduction

2. CAES (*Coupled Agent-Environment System*)

3. CALM (*Constructivist Anticipatory Learning Mechanism*)

4. Expériences

5. Conclusions

- **Cognition** (représentation et apprentissage)
 - Construction d'un **modèle de la dynamique du monde**
 - Induire une structure anticipative de l'interaction
 - À partir de (p, c) , cette structure doit prévoir p'
 - Apprentissage Incrementale sur Horizon Infini
 - Découvrir la structure du FPOMDP

- **Délibération** (planification et décision)
 - Définition d'une **politique d'actions**
 - Établir des stratégies de comportement
 - Maximiser la moyenne du résultat affectif futur
 - Résoudre le FPOMDP

- **Processus de Décision Markovien**
 - Factorisé
 - Partiellement Observable

- **FPOMDP = { P, H, C, R, T }**
 - **$P = P_1 \times P_2 \times \dots \times P_n$: propriétés perceptives**
 - **$H = H_1 \times H_2 \times \dots \times H_k$: propriétés cachées**
 - **$C = C_1 \times C_2 \times \dots \times C_m$: contrôle**
 - **$R = \{R_1, R_2, \dots, R_n\}$ récompense** $R_i : P_i \rightarrow \mathfrak{R}$
 - **$T = \{T_1, T_2, \dots, T_n\}$ transformation** $T_i : P \times \mathcal{A} \rightarrow \Pi(P_i)$

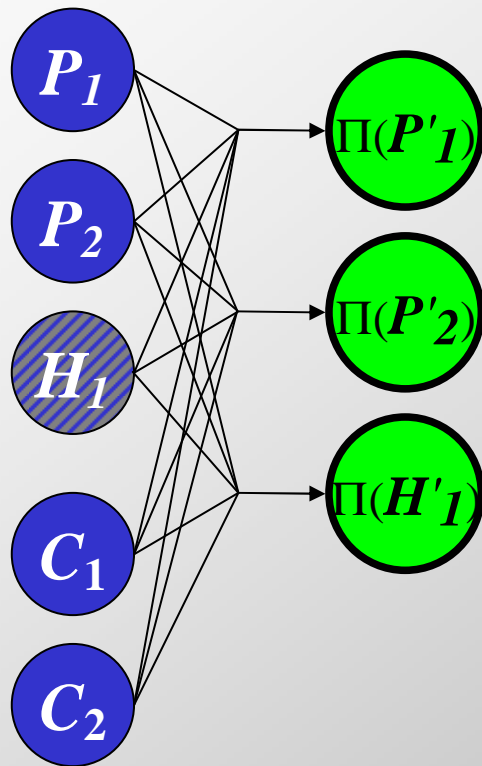

Réseau Bayésien Dynamique (DBN)

*Description complète
des transformations
(dynamique) du système*

*Selon la situation précédente
on détermine la situation suivante*

- Bien Structurés
 - $0 \ll \text{Structuration} < 1$
 - causes bien délimités pour la majorité des phénomènes
- Partiellement Déterministes
 - $0 \ll \text{Déterminisme} < 1$
 - régularité dans la majorité des transformations
- Partiellement Observables
 - $0 \ll \text{Observabilité} < 1$
 - Propriétés pertinentes sont dans la plus partie observables

*On apprend à anticiper
chaque propriété
séparement*

Parallélisation

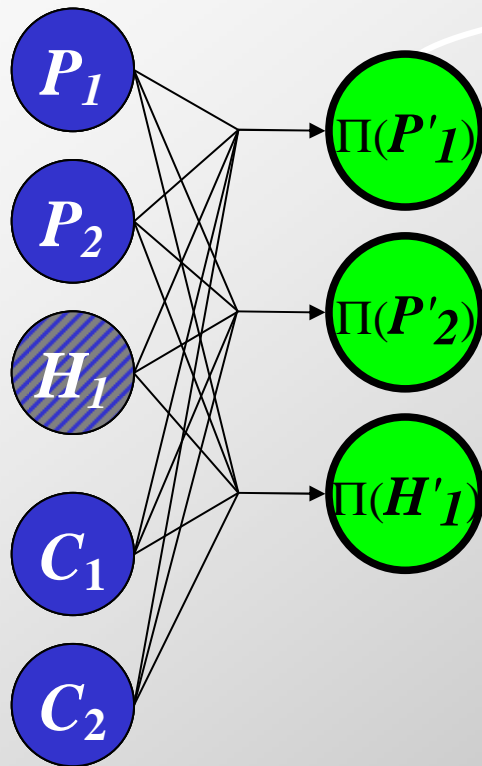

Sélection de Propriétés Pertinentes

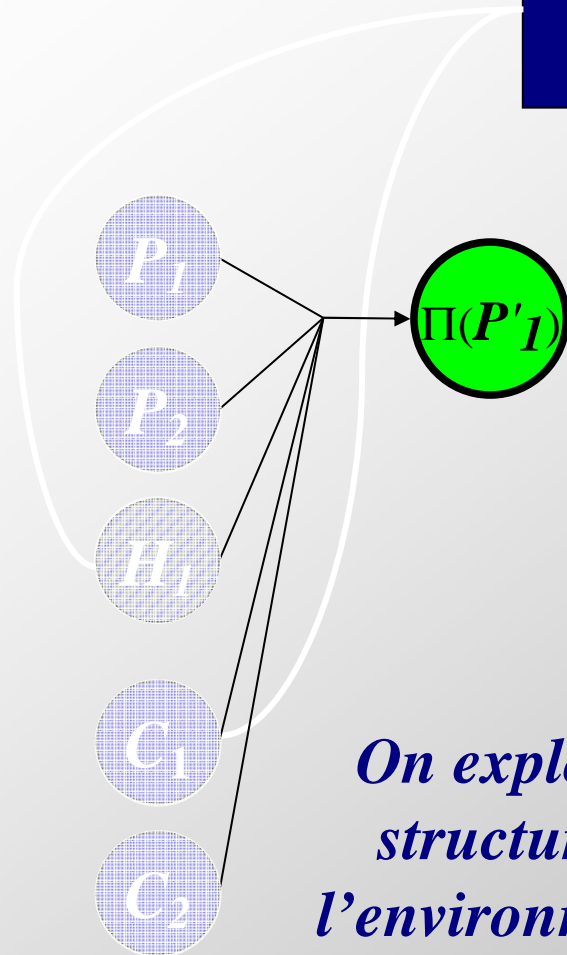

On explore la structure de l'environnement

Représentation compacte des transformations

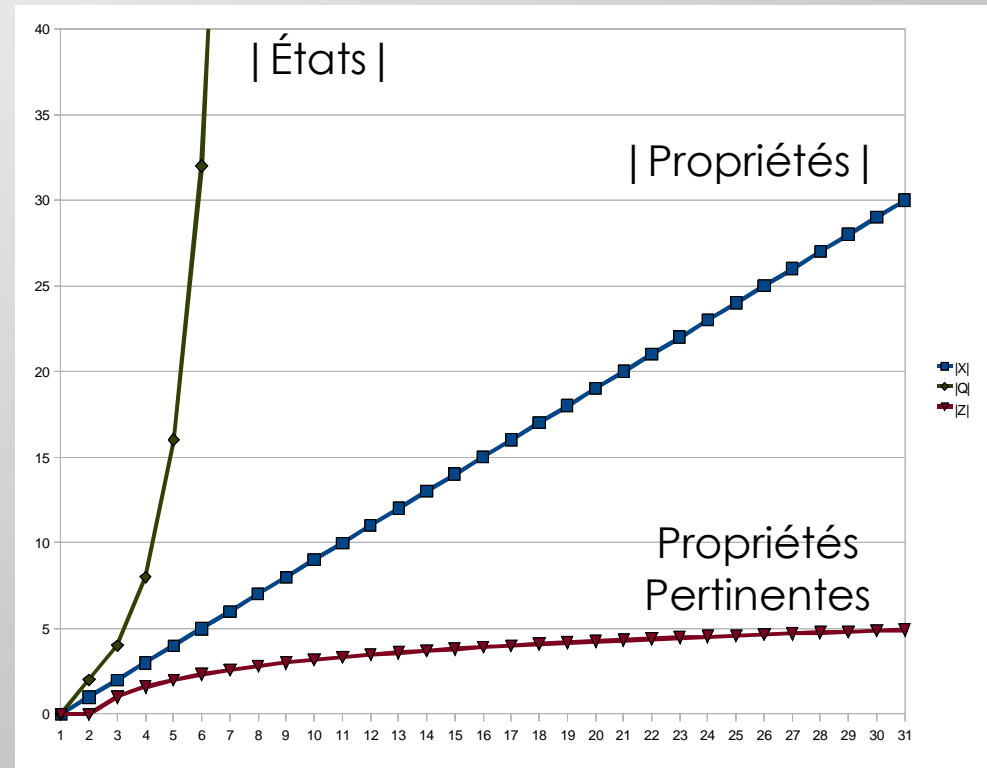

Recherche de Régularités

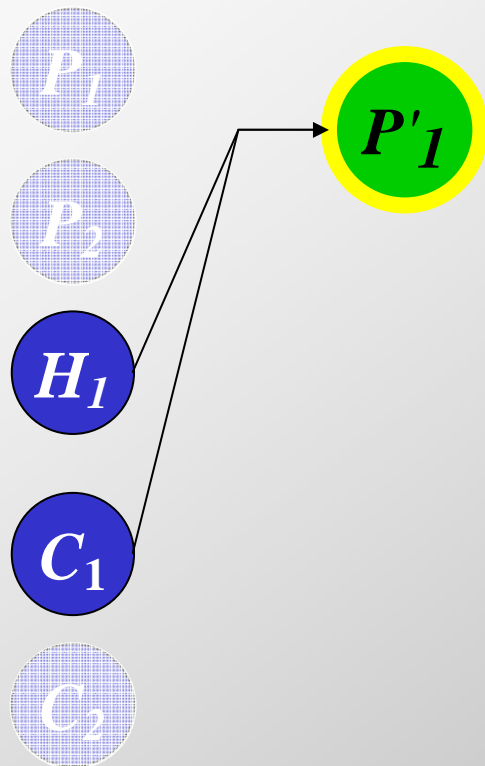

On ne cherche pas les probabilités!

On s'occupe de trouver par induction directe les transformations déterministes

- Apprendre les modèles d'anticipation

- à travers l'expérience
- en découvrant de l'existence de propriétés non-observables
- en calculant les pertinences
- en gérant la mémoire épisodique

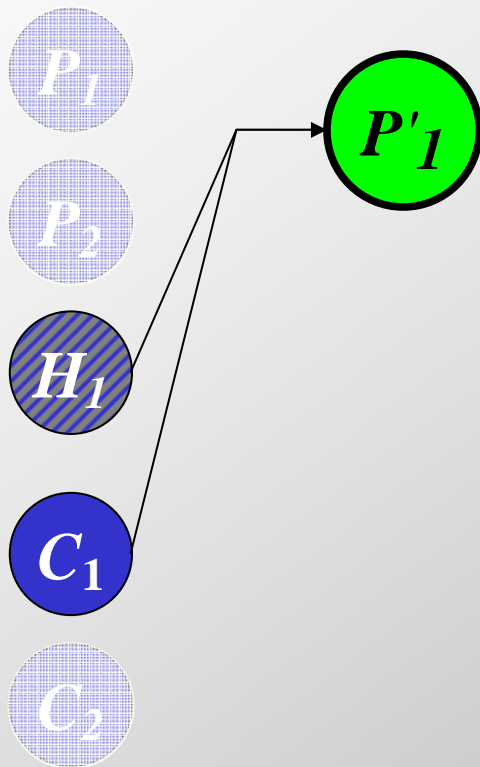

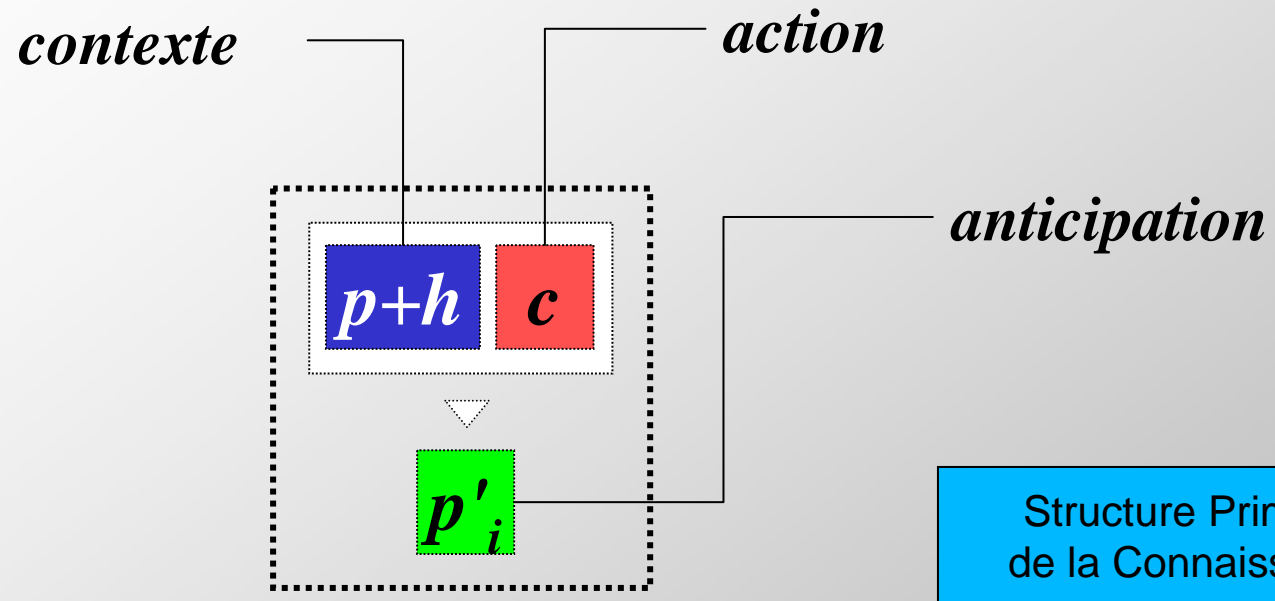

Déterminisme Partiel

$$\{\#\} \cup \{0, 1\}$$

(*indéfini*) (*valeurs discrètes*)

Arbre d'Anticipation

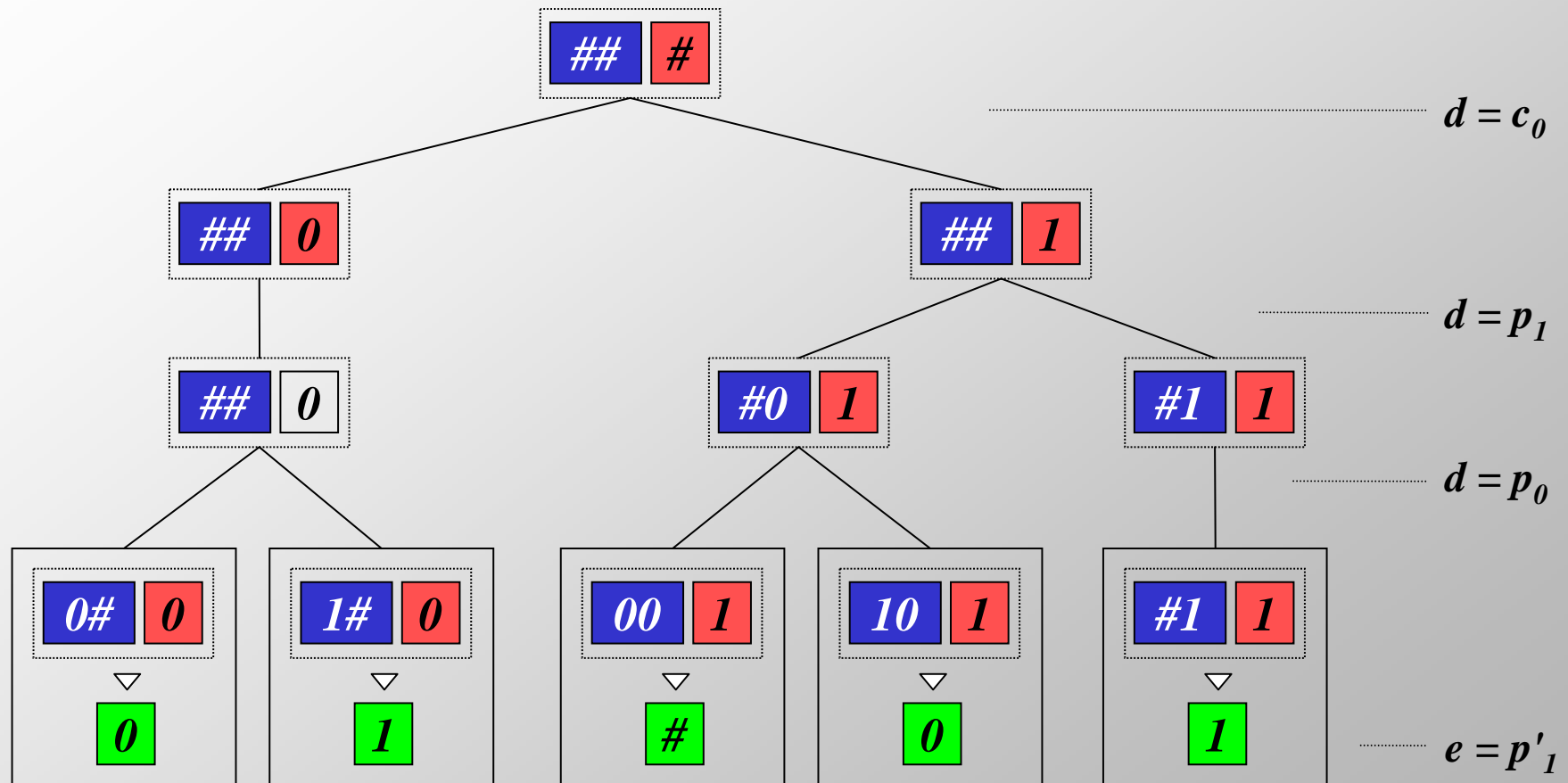

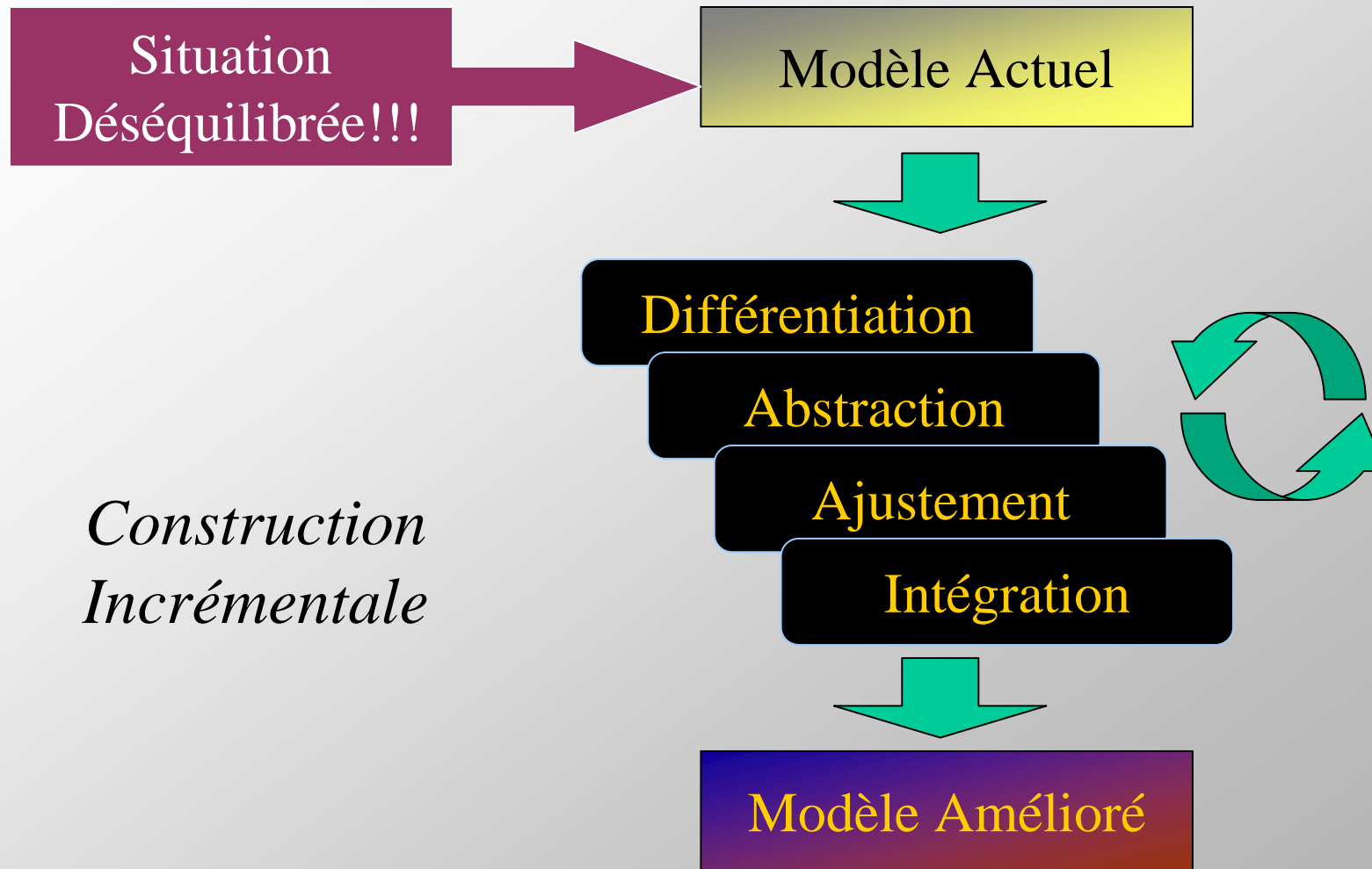

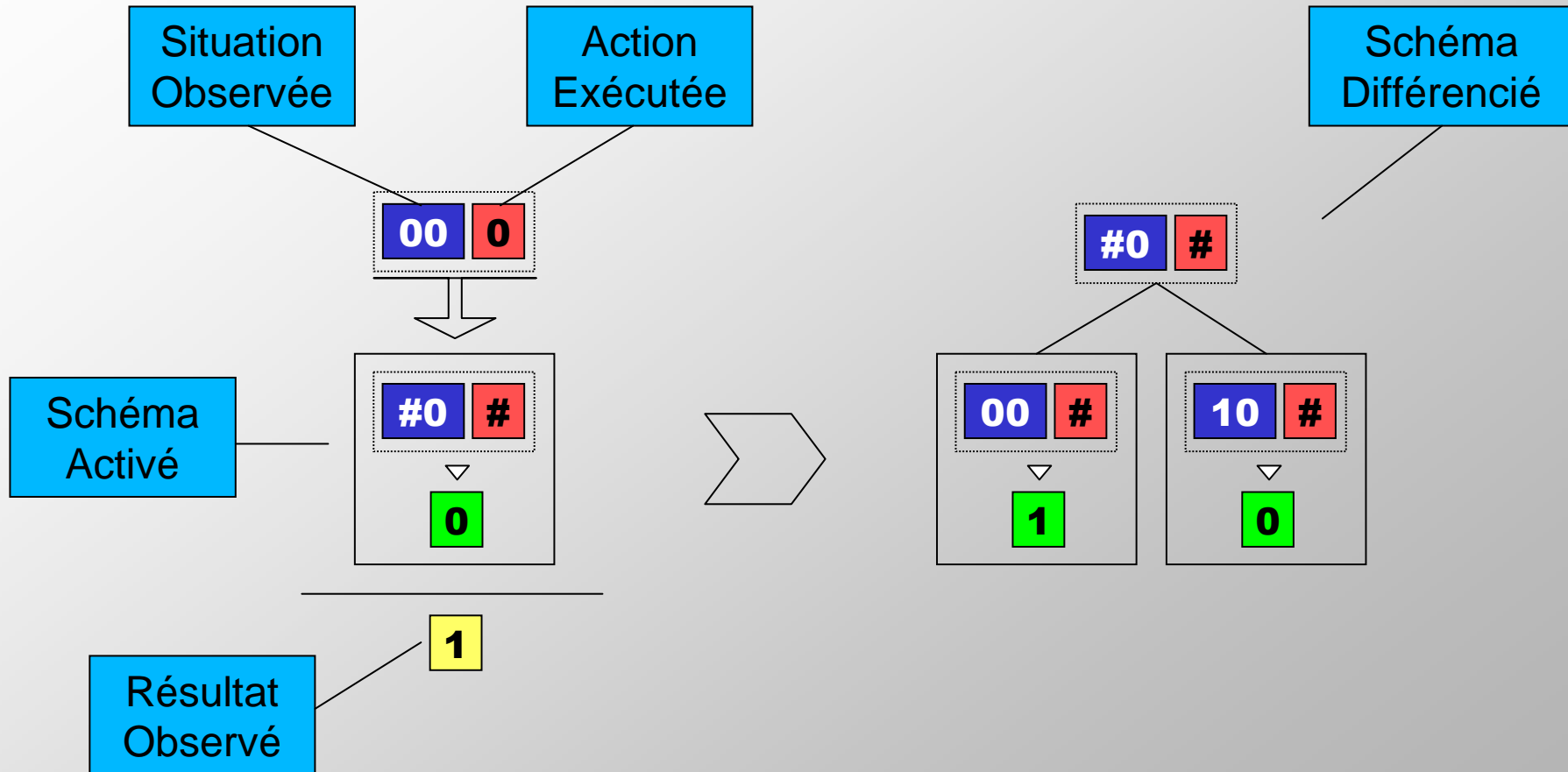

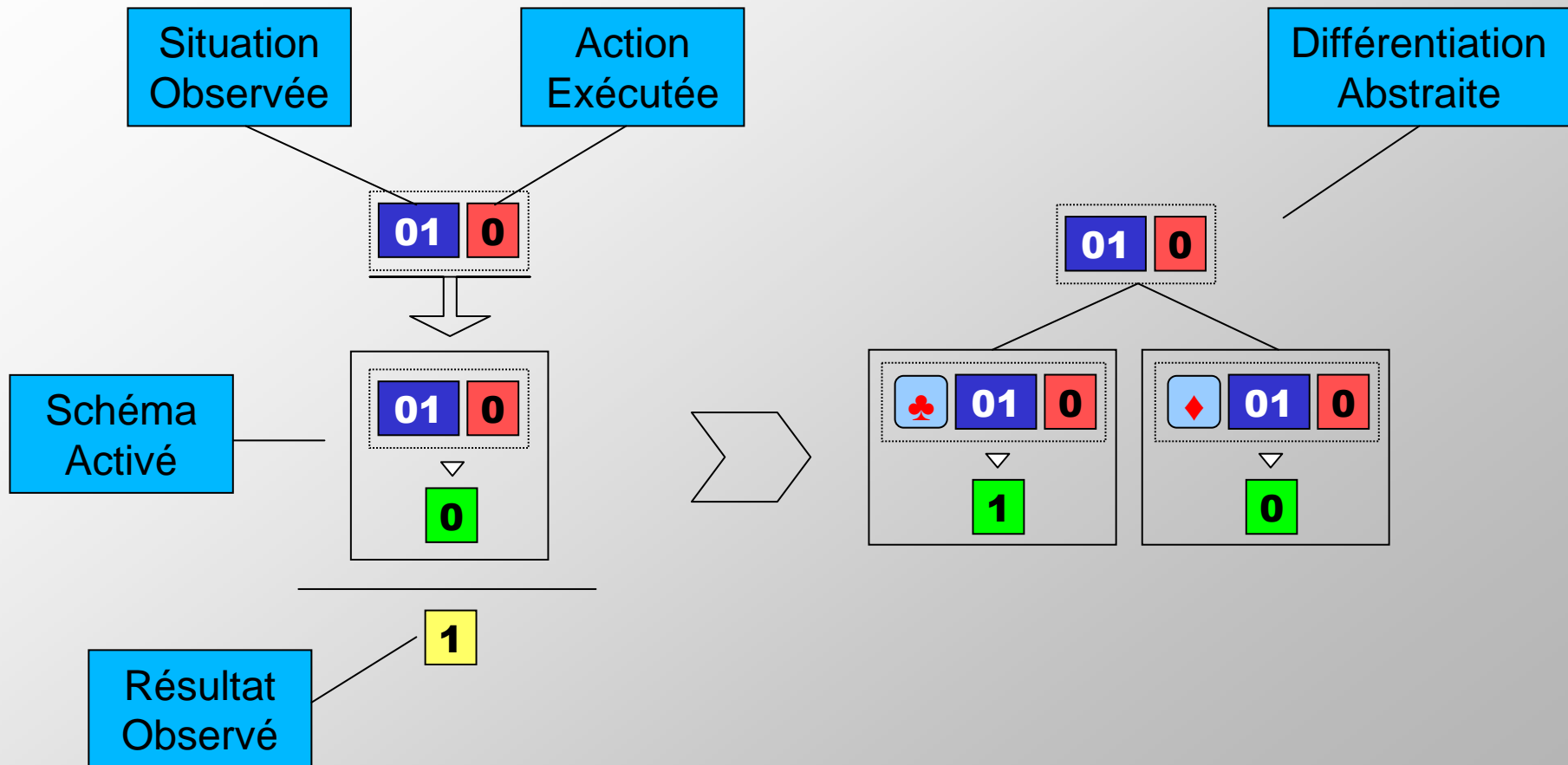

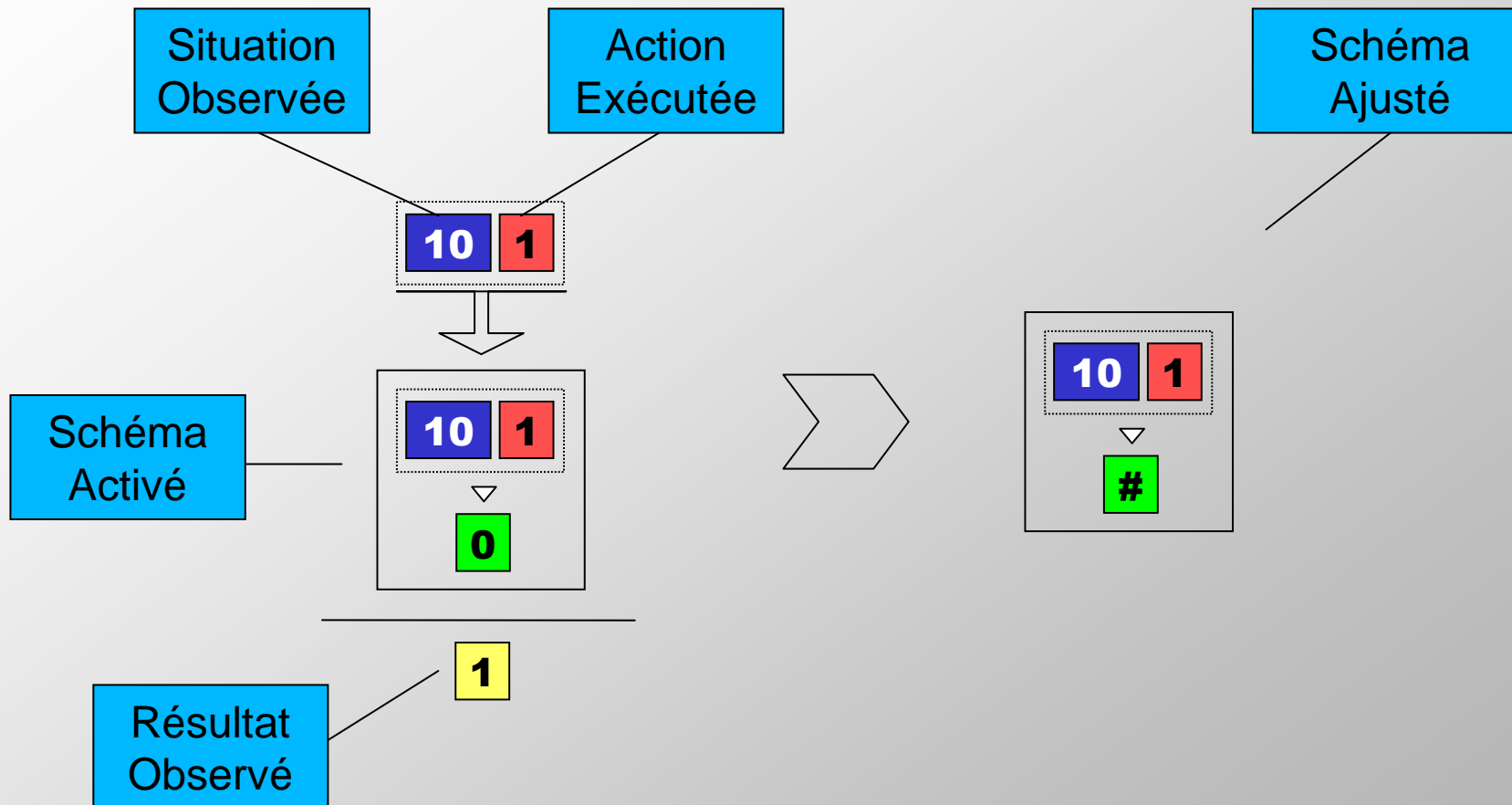

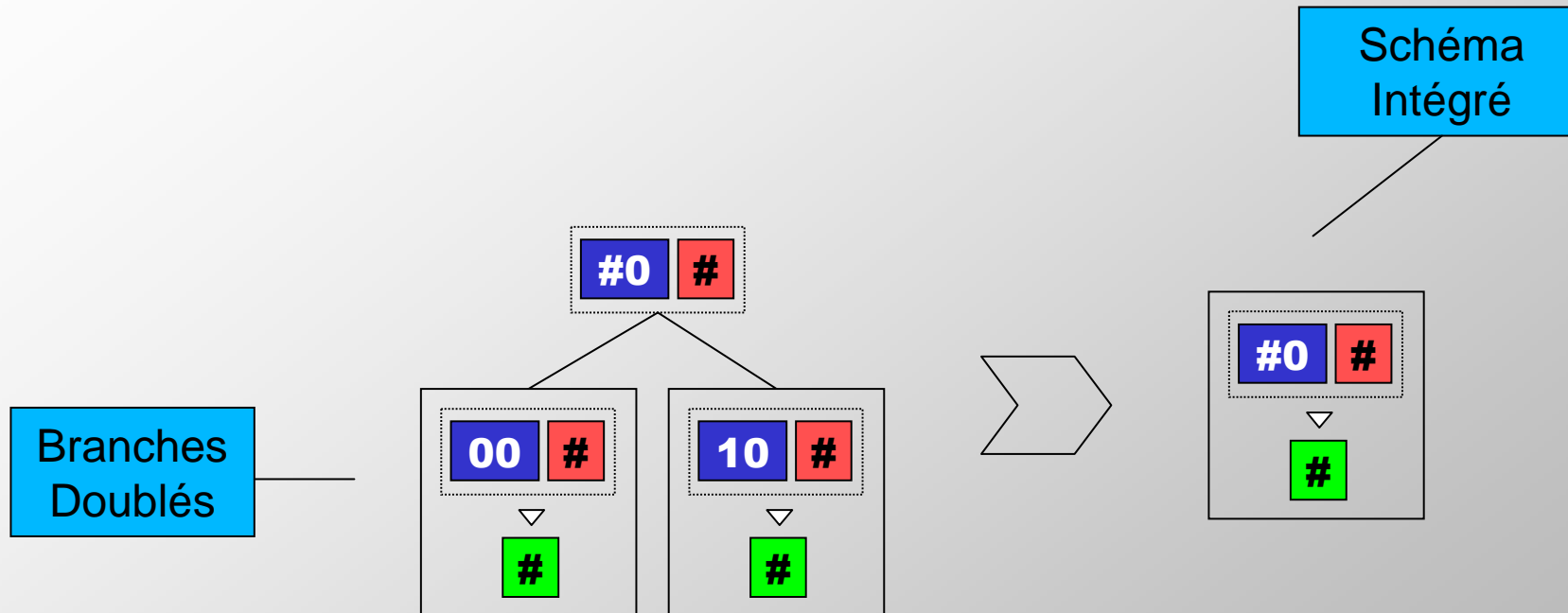

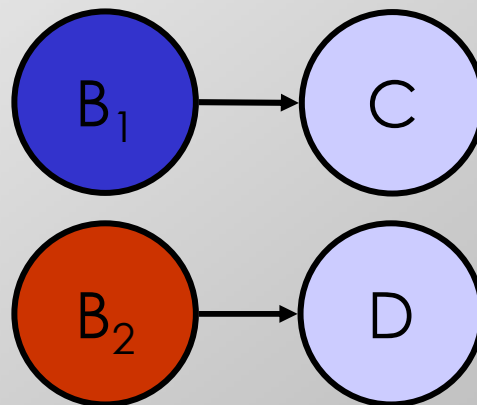
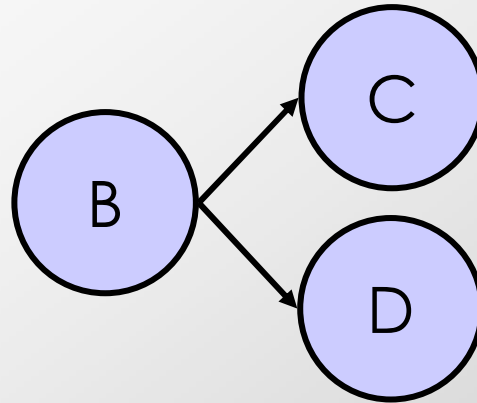

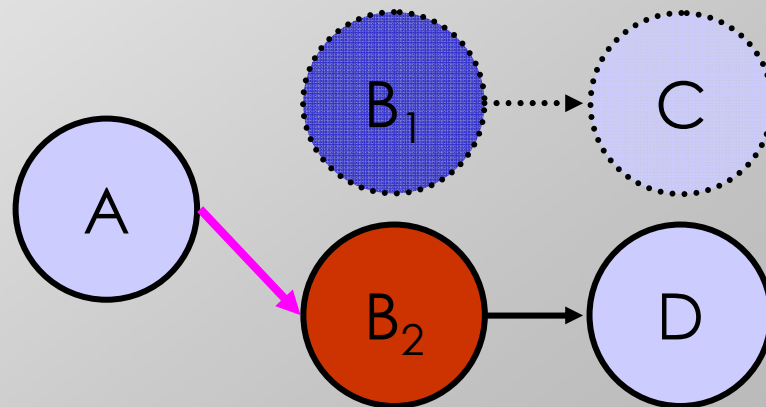
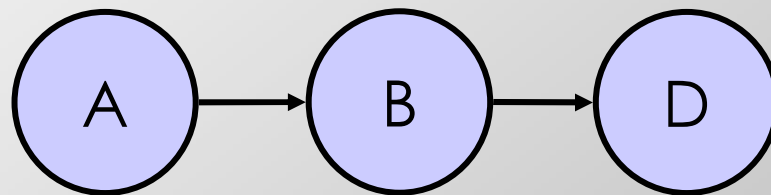
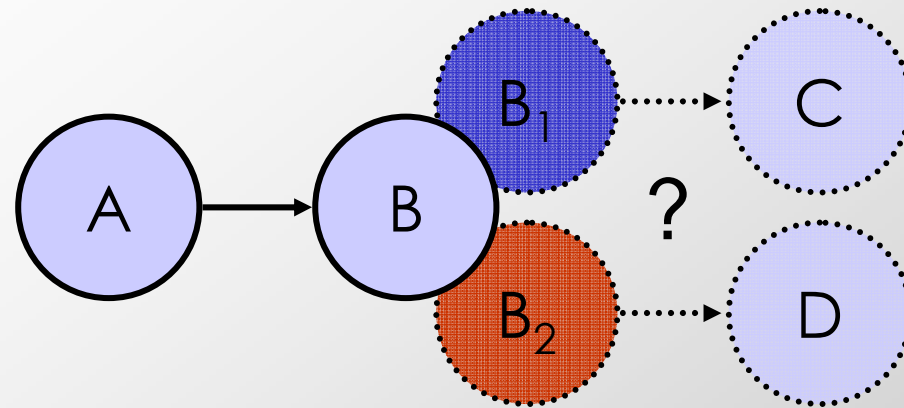

- Table d'Observations
 - base pour créer les arbres d'anticipation
 - souvenirs d'observations contextualisés
 - limite de dépendences analysées = $\alpha = \log |X|$

1. Introduction

2. CAES (*Coupled Agent-Environment System*)

3. CALM (*Constructivist Anticipatory Learning Mechanism*)

4. Expériences

5. Conclusions

Walking – Exhaustion – Pain – Pleasure

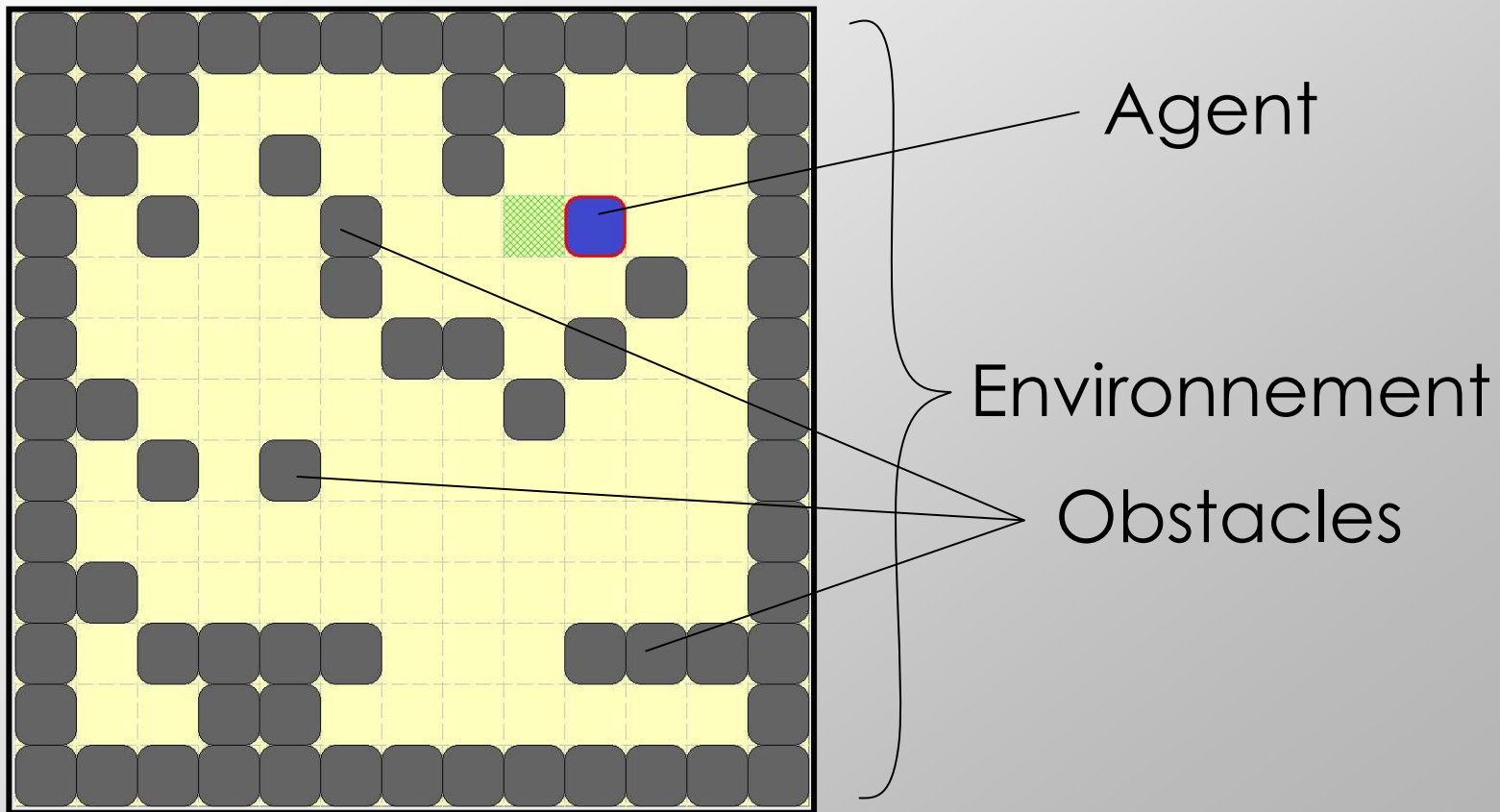

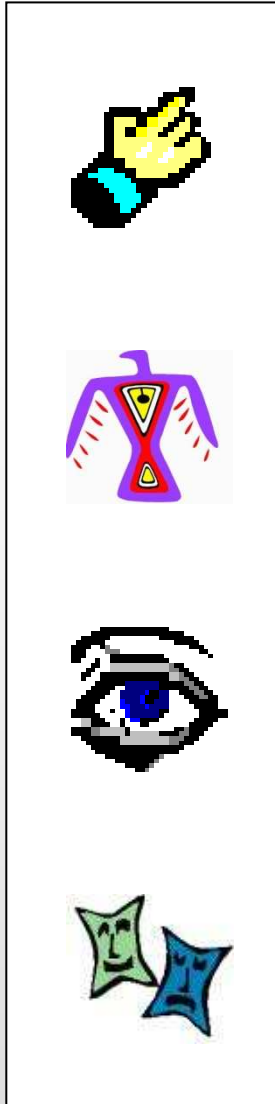

- Actions
 - Marcher
 - Pivoter

- Perceptions Internes
 - Douleur
 - Fatigue
 - Épuisement
 - Plaisir

- Perceptions Externes
 - Vision

- Valeurs Affectives
 - Douleur -1.0
 - Épuisement -0.7
 - Plaisir +0.4

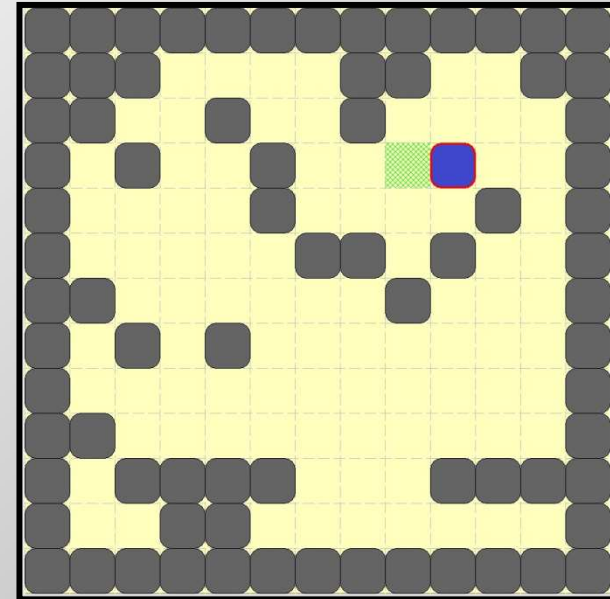

- Scénarios
 - 5 x 5
 - 25 cellules
 - 25 x 25
 - 625 cellules
 - 125 x 125
 - 15625 cellules
 - 10% obstacles
 - 20% obstacles
 - 30% obstacles
- $\times 10$

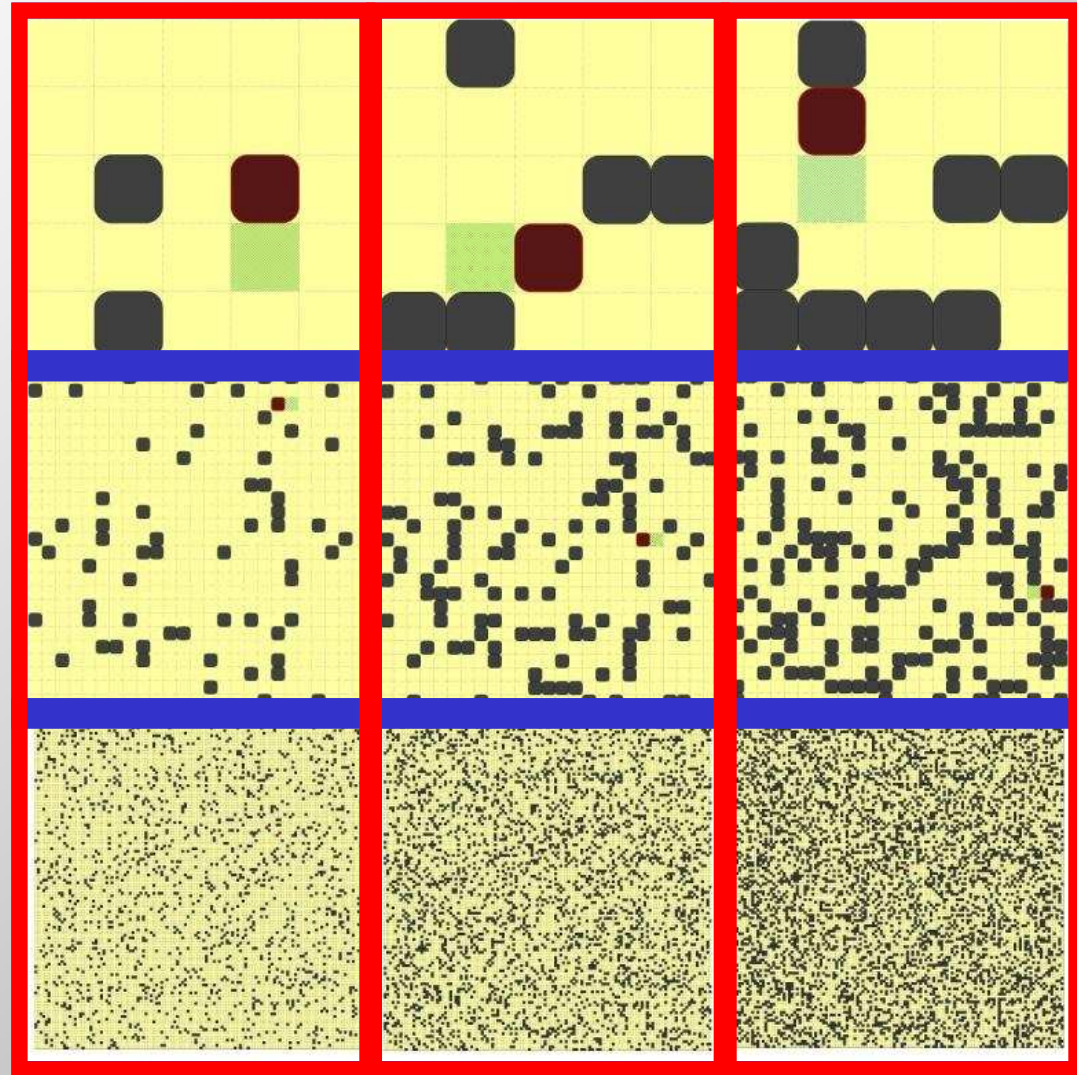

▪ WEPP : 1



Situé (CAES)
Vision 1x1

\times



Non-Situé
Coord {x, y}

– Algorithmme: *Q-Learning*

Wepp 5 x 5 (20%)

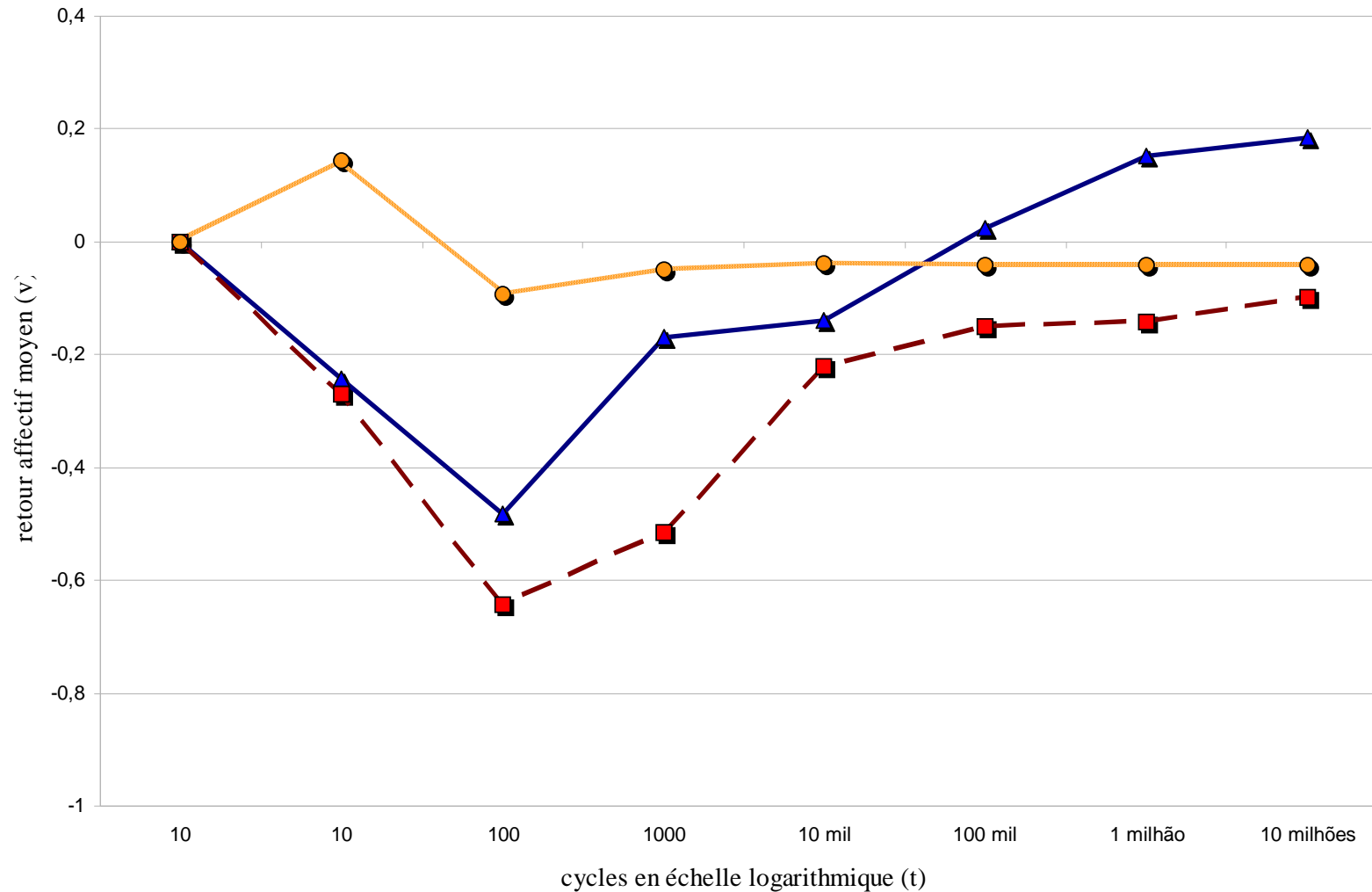

CAES
Random
Classic

Wepp 25 x 25 (20%)

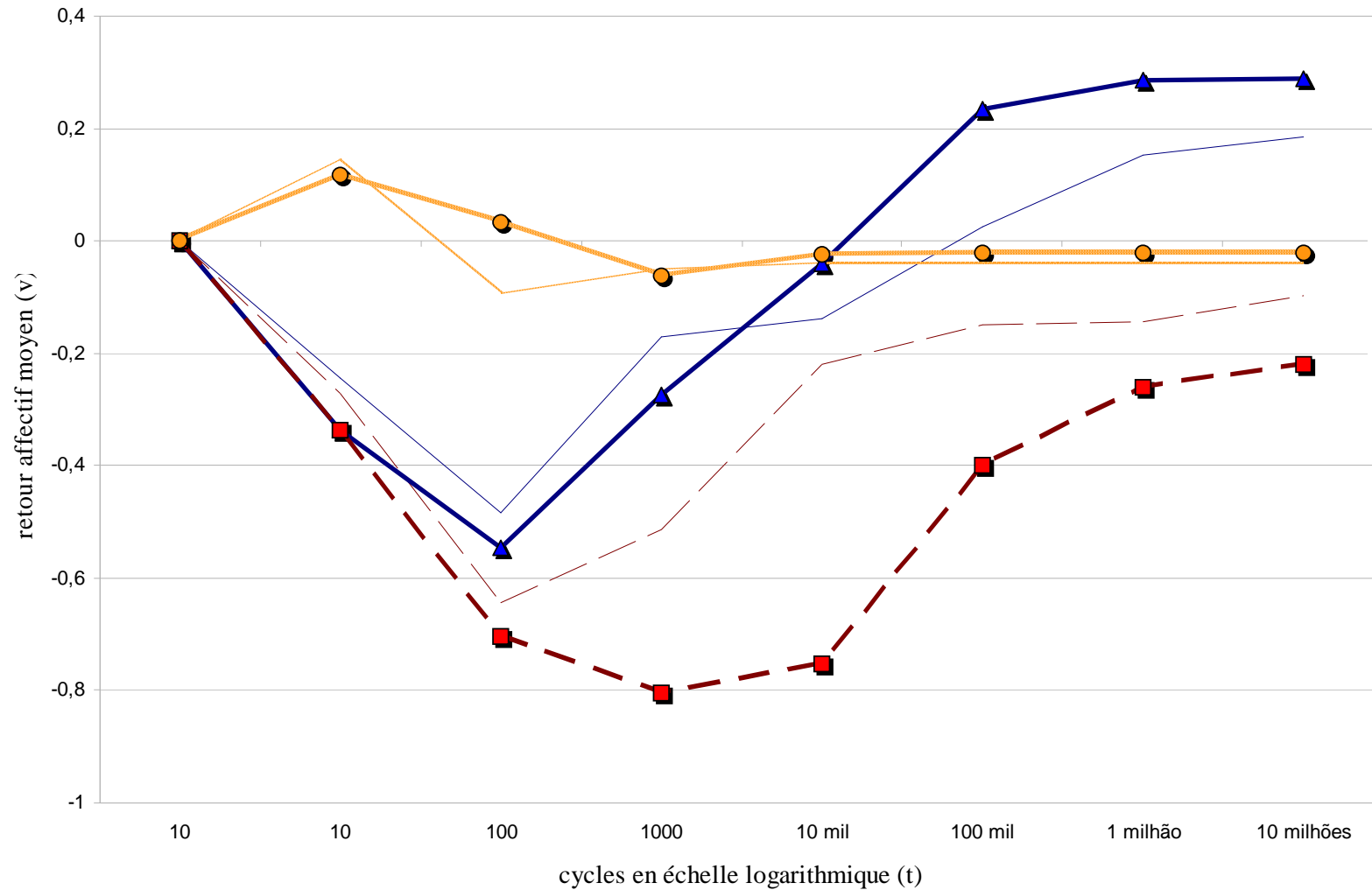

CAES

Random

Classic

Wepp 125 x 125 (20%)

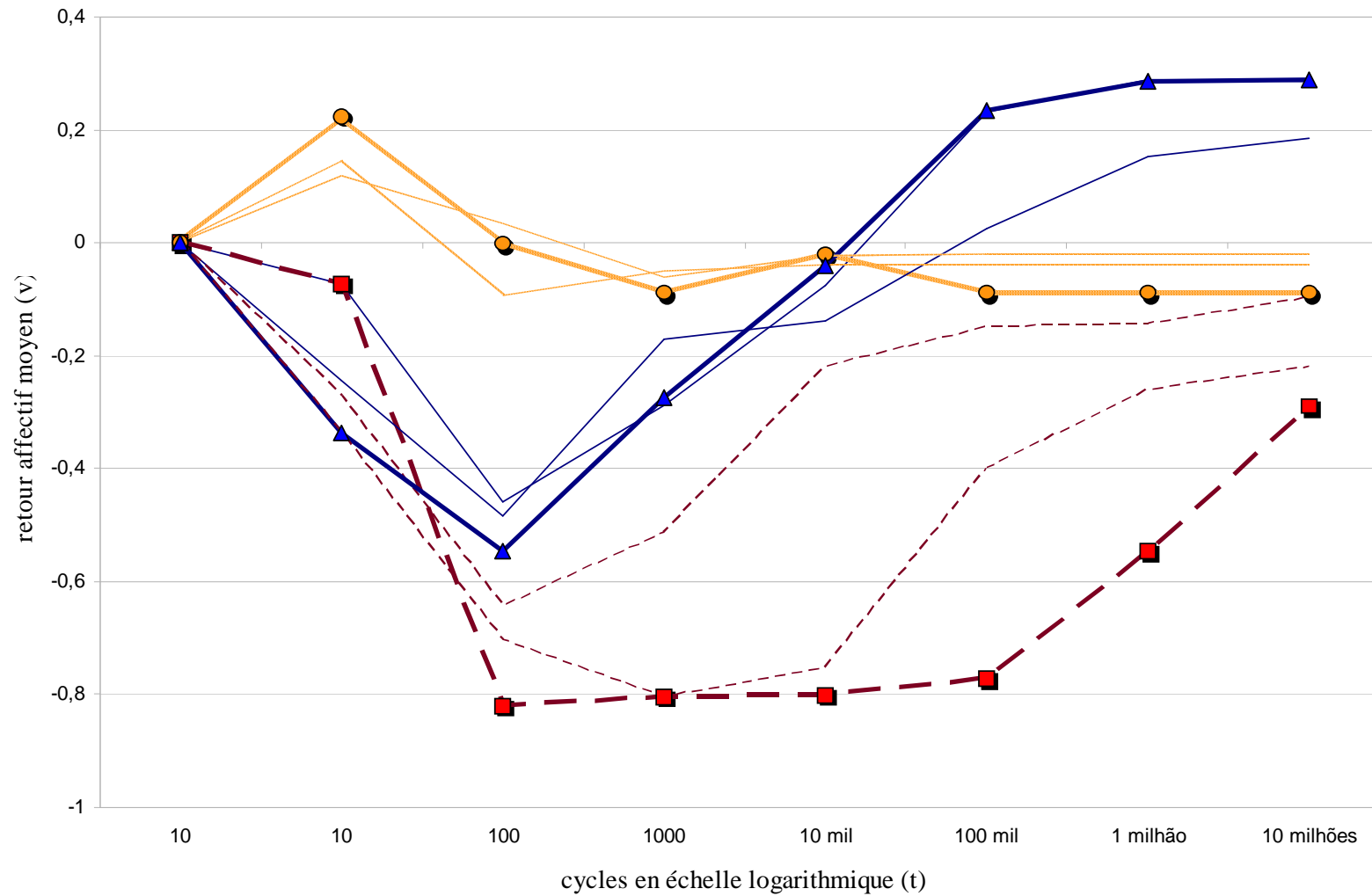

CAES

Random

Classic

Résultats CAES x Classique

4. Expériences

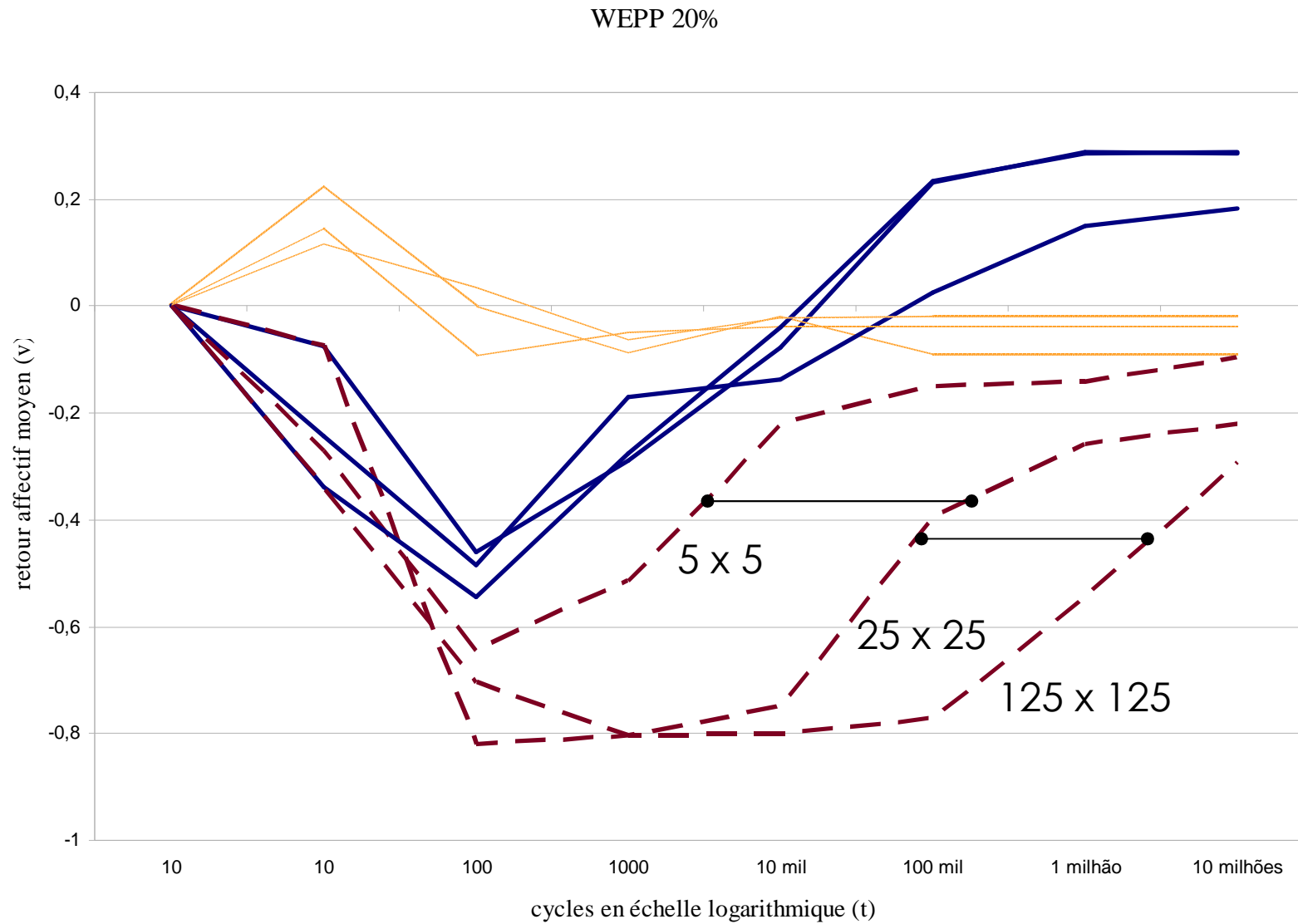

▪ WEPP : 2

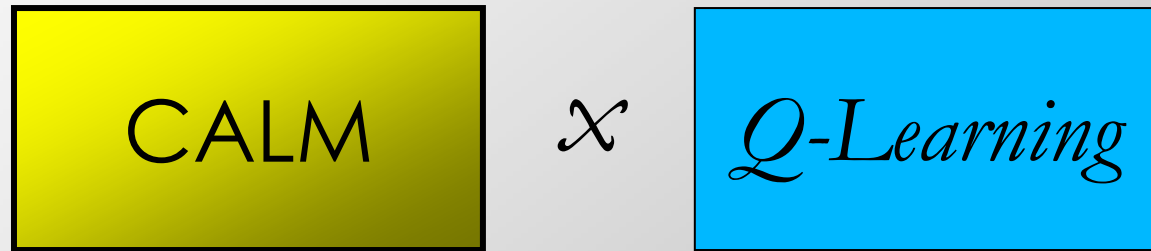

- Architecture: CAES (situé)

Wepp 5 x 5 (20%)

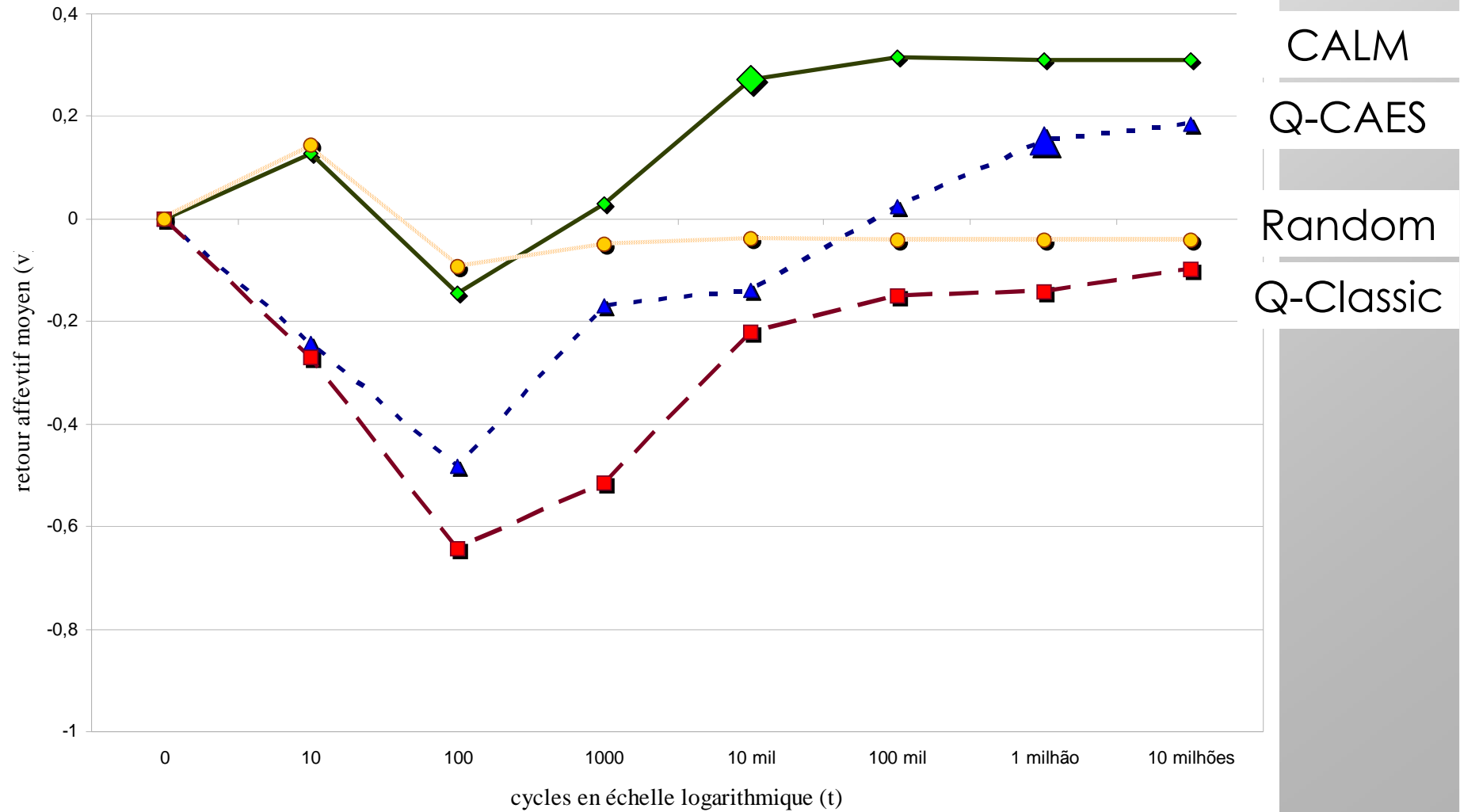

25x25

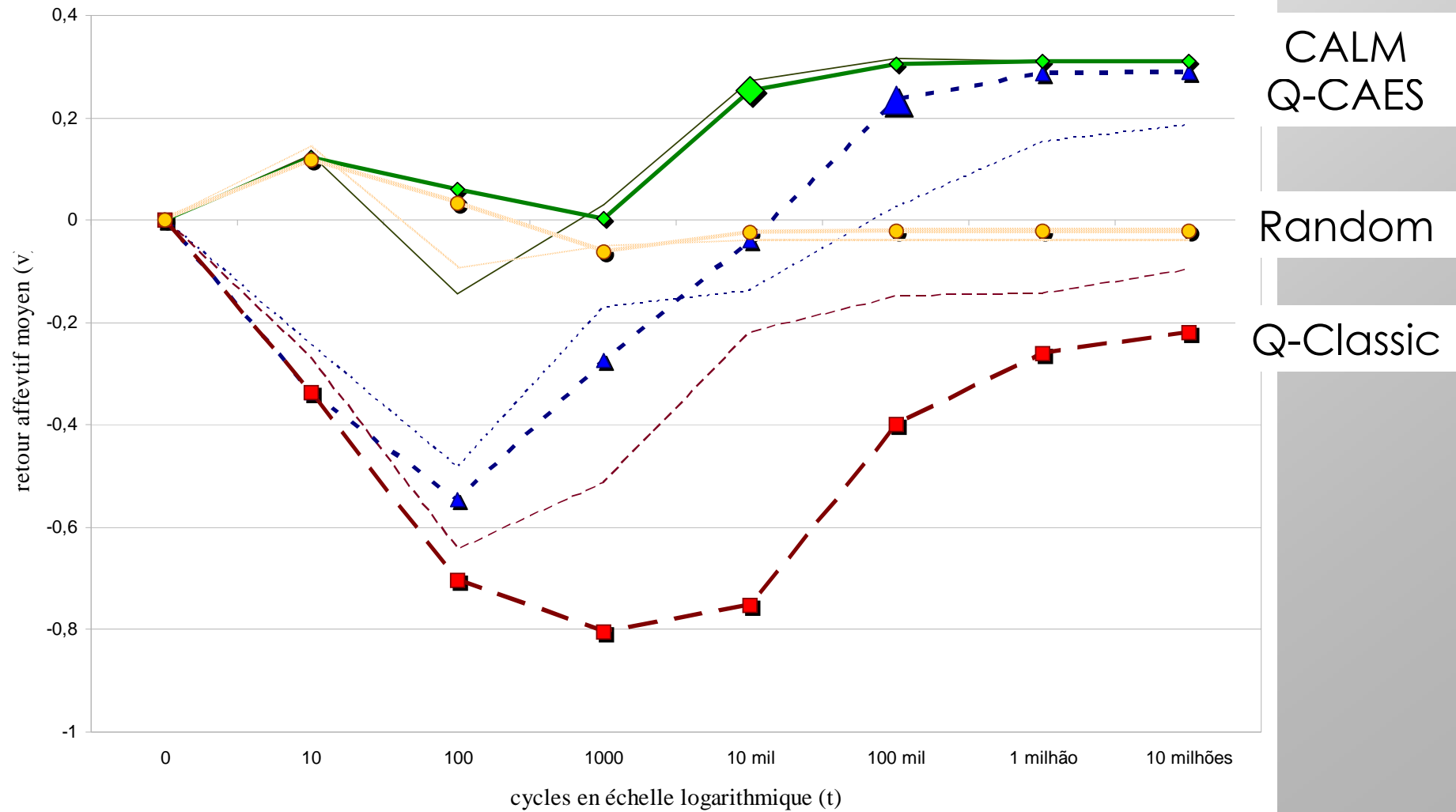

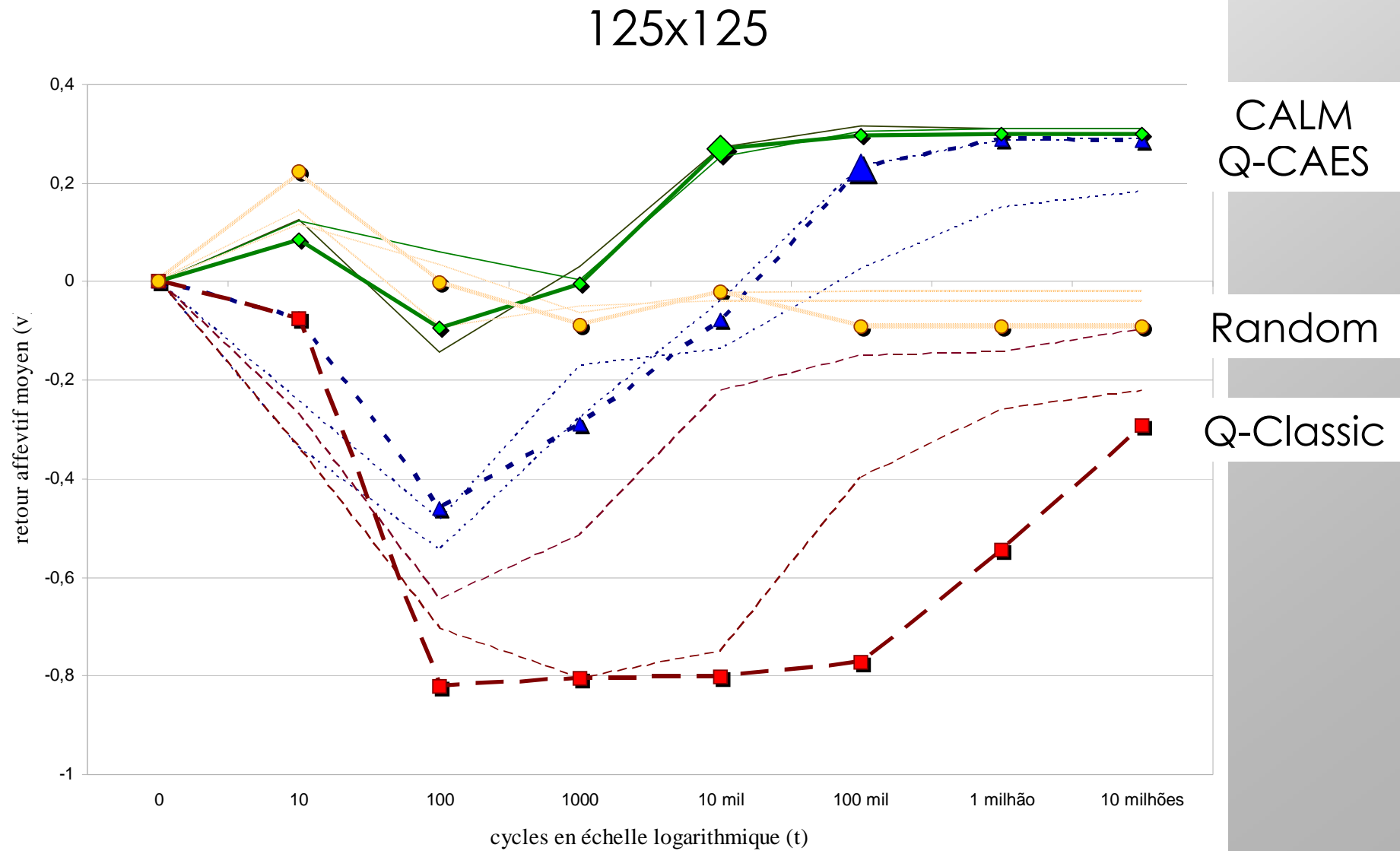

Wepp (20%)

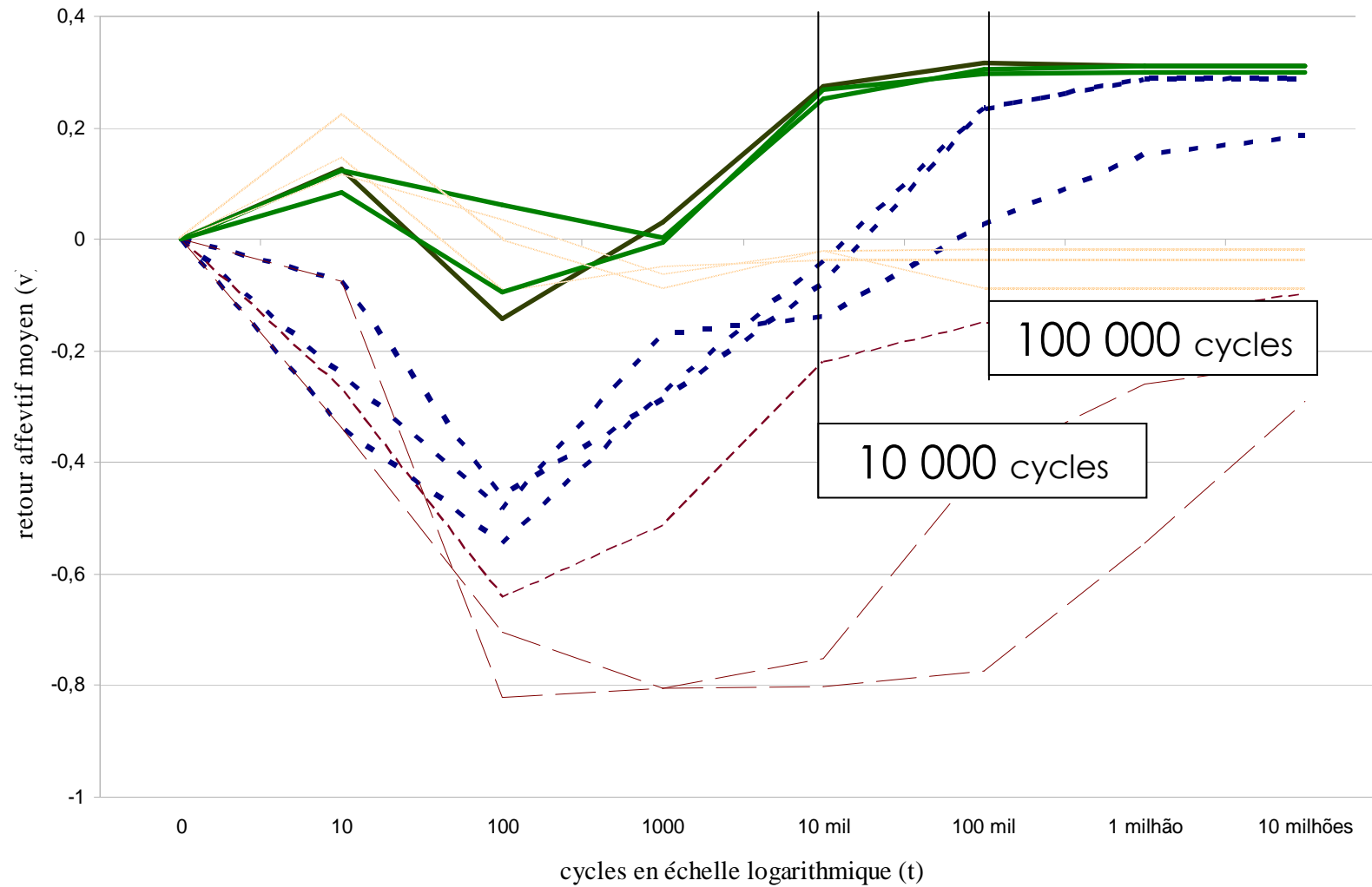

CALM

Q-CAES

Résultats CALM

4. Expériences

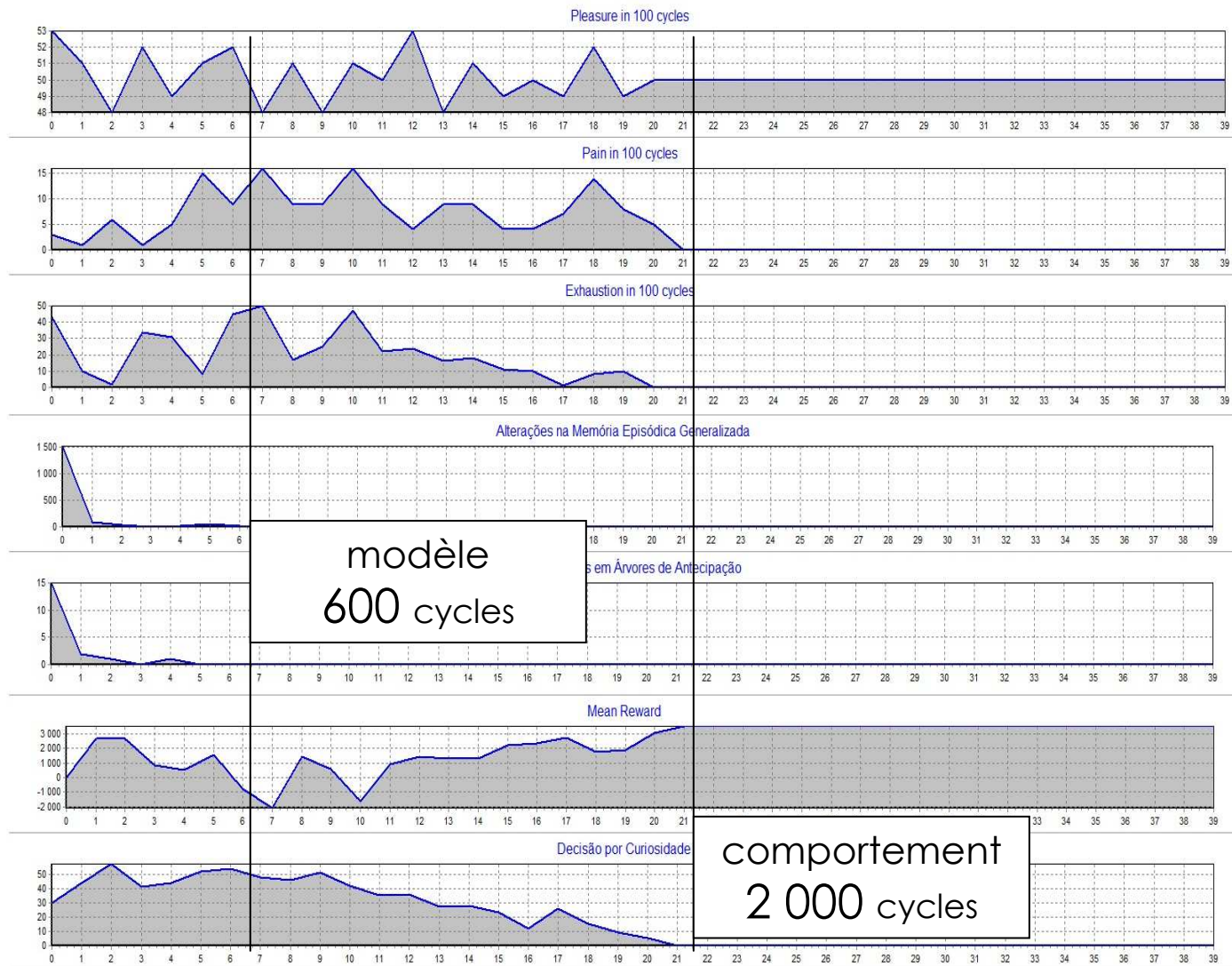

Plaisir



Douleur



Épuisement



Apprentissage



Affective



Exploration

- **WEPP : 3**

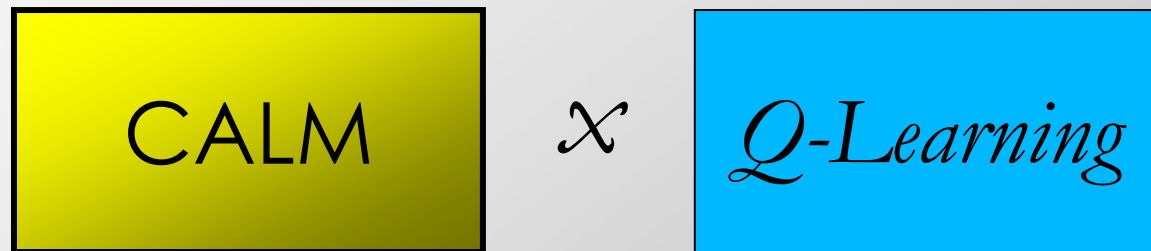

– Variables Non-Pertinentes

25x25 (20%) + Variables Non-Pertinentes

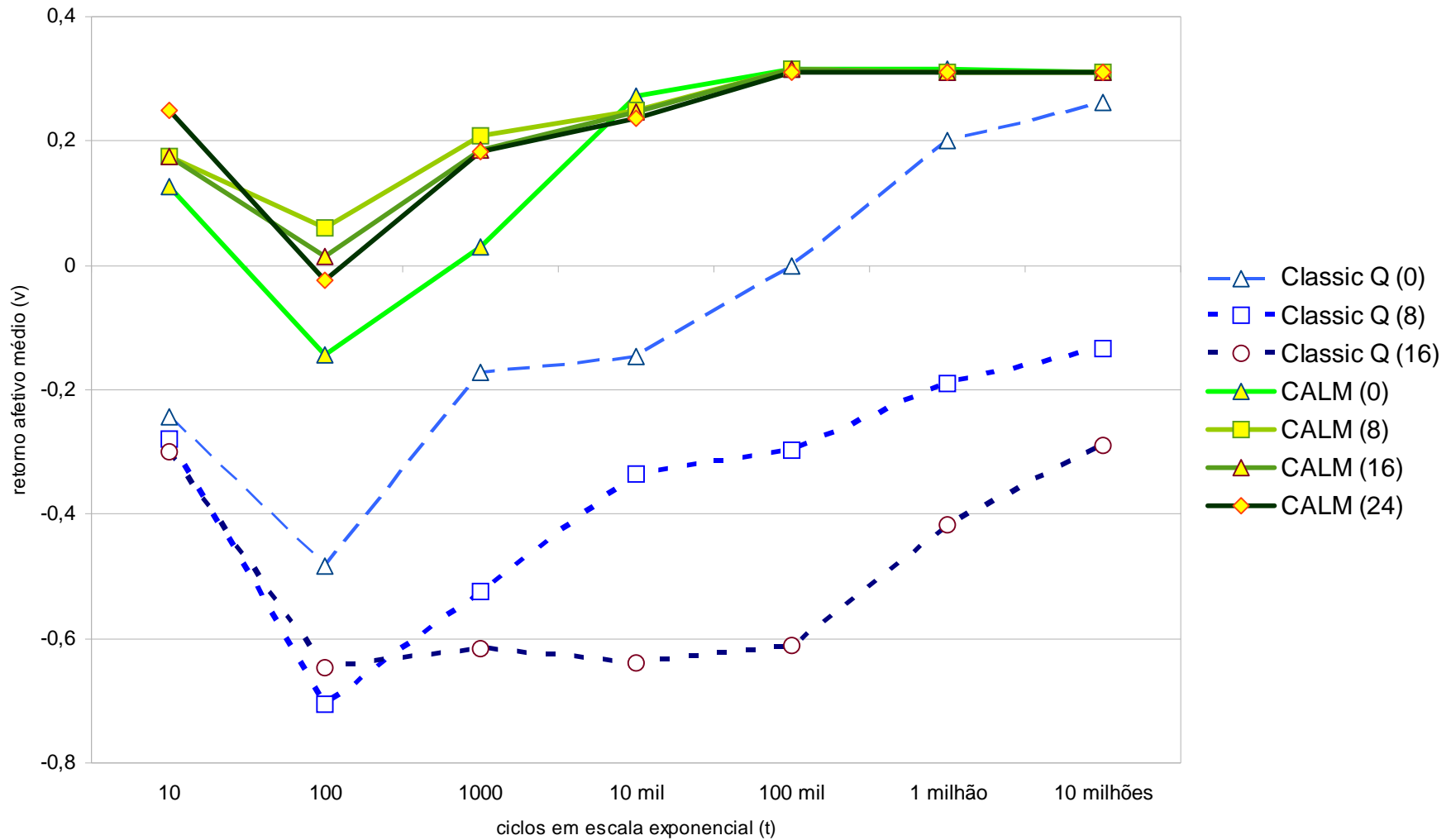

- **FLIP**



CALM

– Observabilité Partielle

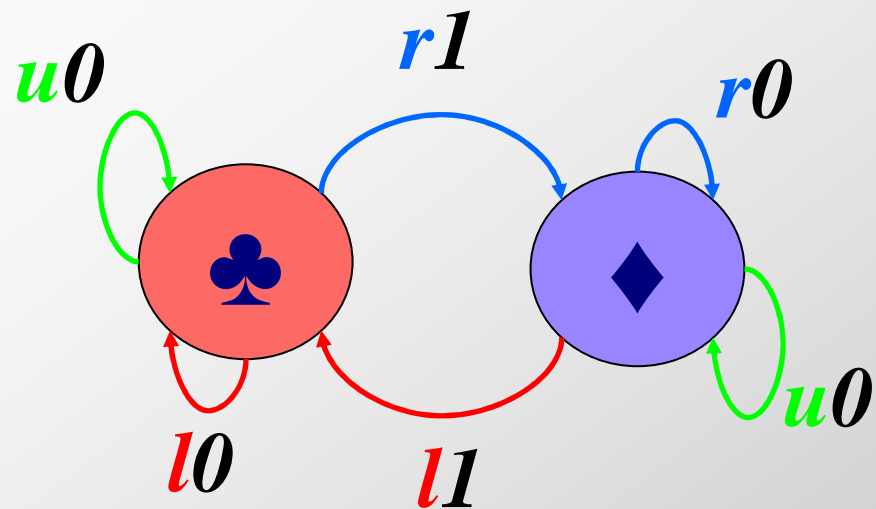

Actions:

U (rien)
R (aller à droite)
L (aller à gauche)

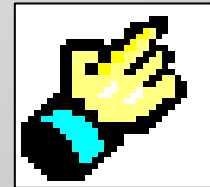

Perception

0 (rien)
1 (flip)

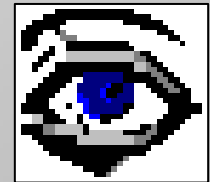

Propriété Caché

♣ (état à gauche)
♦ (état à droite)



Anticipation de la
Propriété Perceptive

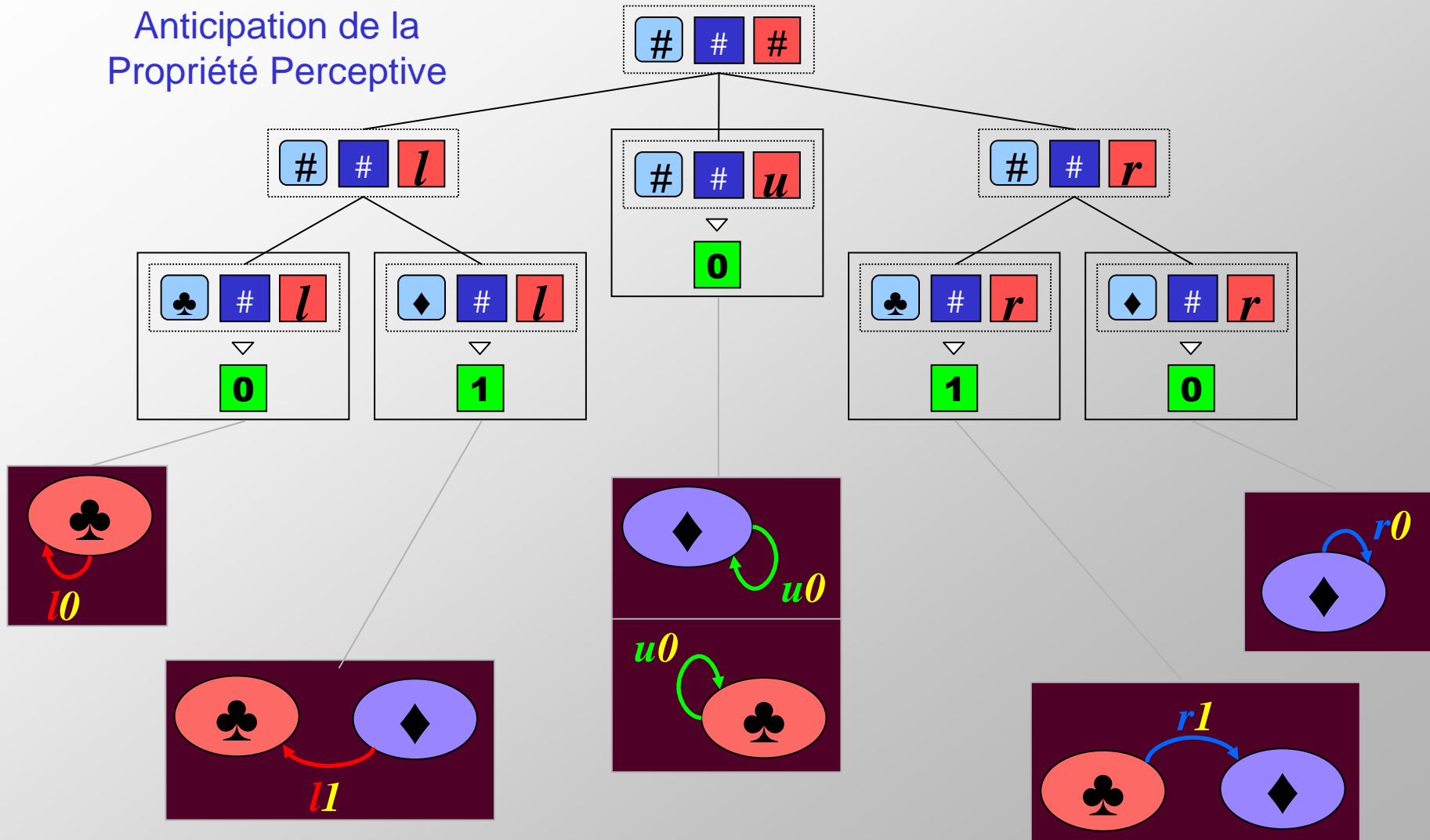

Anticipation de la Propriété Cachée

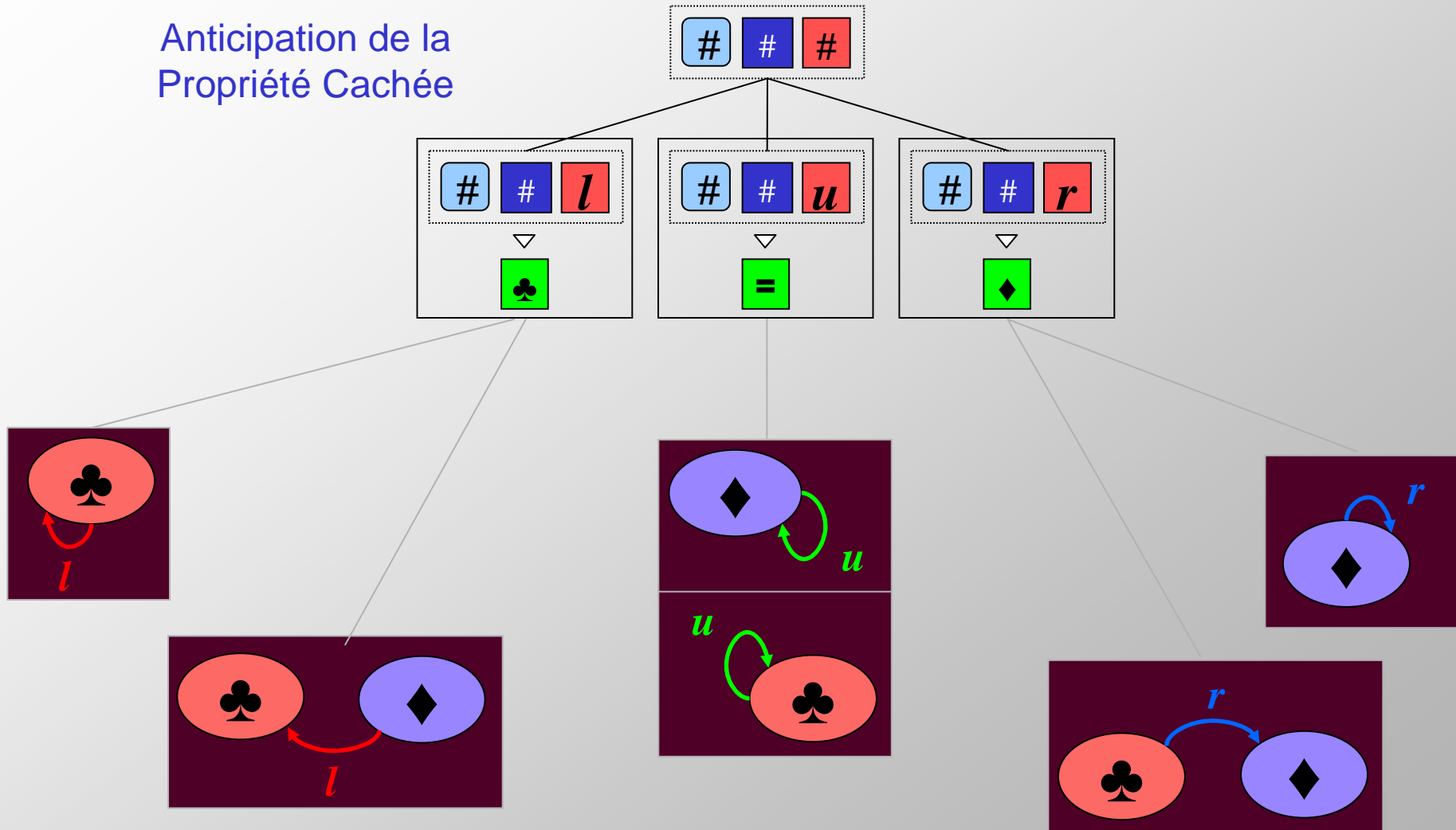

1. Introduction

2. **CAES** (*Coupled Agent-Environment System*)

3. **CALM** (*Constructivist Anticipatory Learning Mechanism*)

4. Expériences

5. Conclusions

■ CAES

– Pratiques:

- Plus de performance pour certaines problèmes
- Portabilité de la solution

– Théoriques

- Approche plus proche d'un agent naturel
- Situativité / Incarnation
- Motivation Intrinsèque
- Adaptation / Couplage
- Solipsisme / Phénoménalisme

- CALM :
 - Pratiques:
 - Nouveau Mécanisme d'Apprentissage Automatique
 - Découverte de Régularités de l'Environnement
 - Inductive, Incrémentale, Interactive
 - Déterminisme Partiel
 - Observation Partiel
 - Théoriques
 - Version informatique du Modèle Constructiviste
 - Du Sensorimoteur vers le Symbolique / Abstrait

- Implémentation
- Univers Continu
- Expériences et Comparaisons
- Modèles Théoriques



Porto Alegre - Brésil



Toulouse - France

Un Mécanisme Constructiviste d'Apprentissage Automatique d'Anticipations pour des Agents Artificiels Situés

Filipo Studzinski PEROTTO

Jean-Christophe BUISSON, Luís Otávio ALVARES

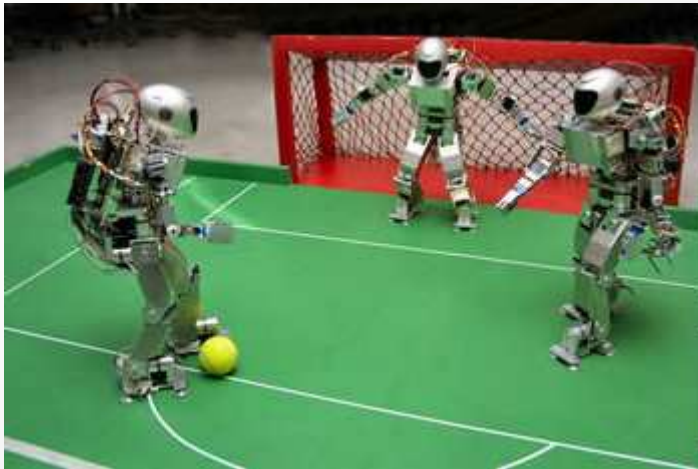

Propriété Temporel

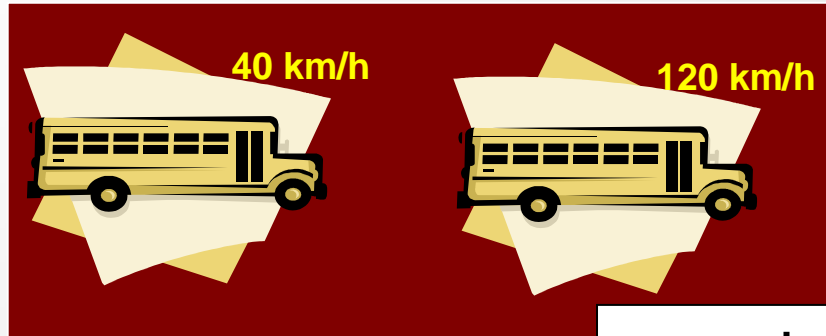

Propriété Opérationnel

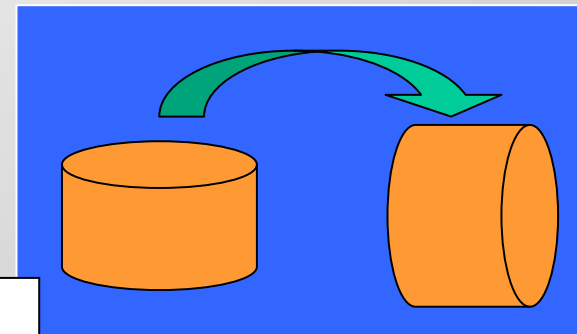

Propriété Cachée

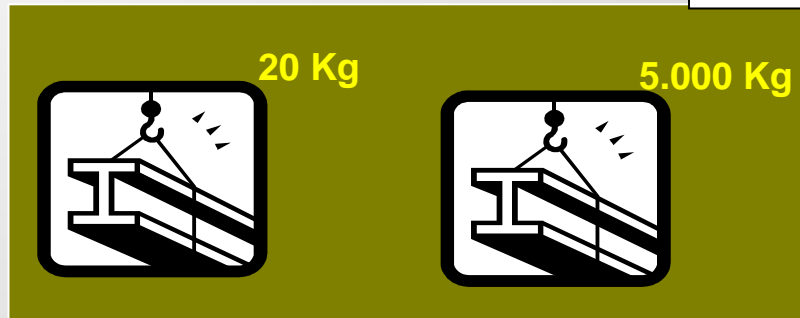

Propriété Fonctionnel



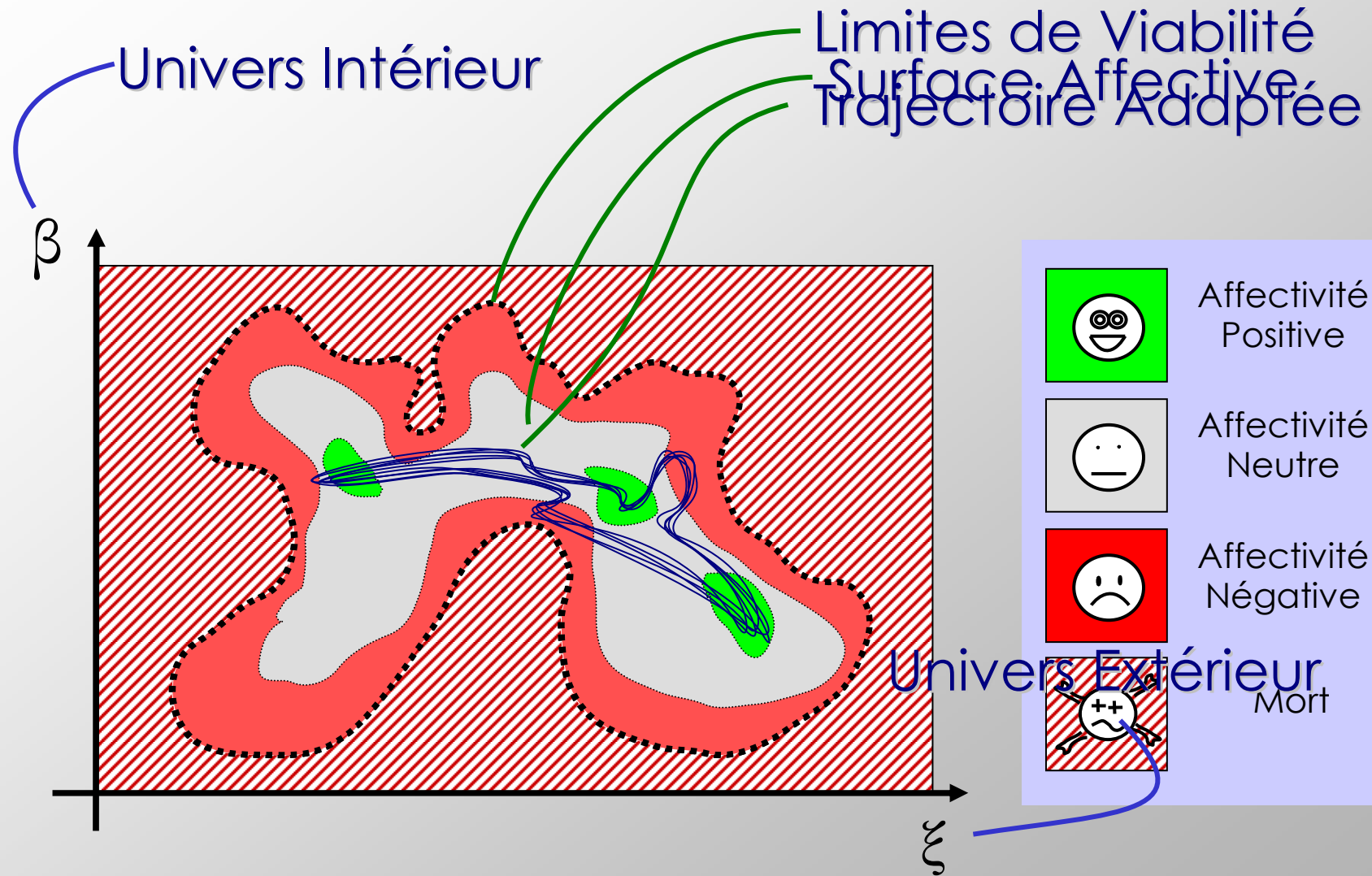

- Trop Comportamentaliste
 - Récompense exogène
- Observation Complète
 - Agent non-situé
- Représentation Plate
 - Énumération d'états
 - Dimensionnalité exponentiel

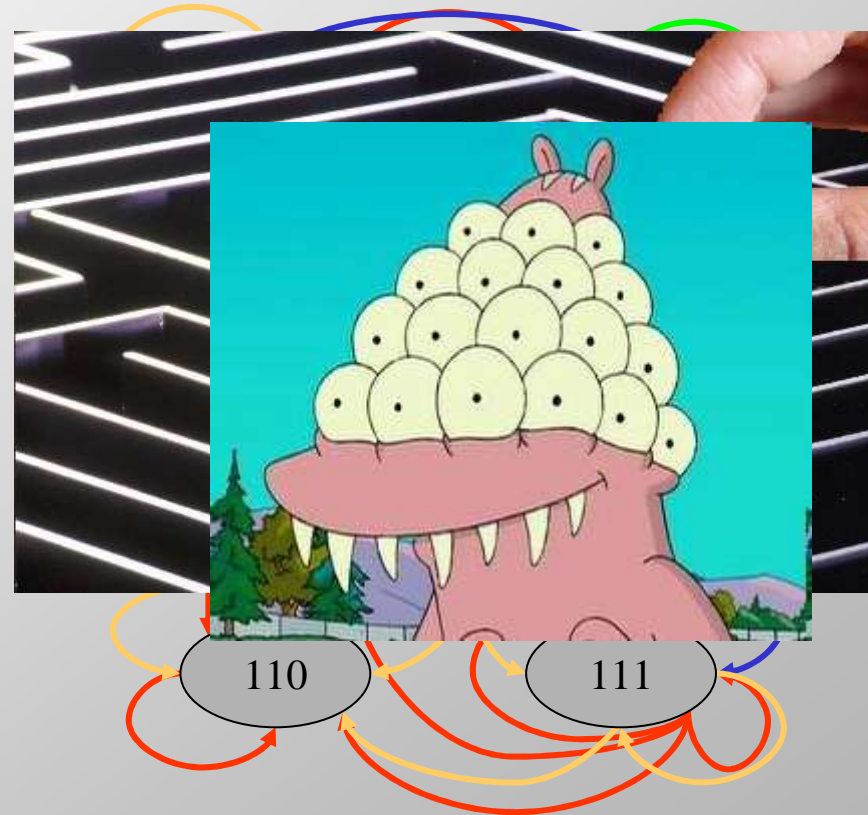

5 x 5

