



**HAL**  
open science

## Some Results on Reset Control systems

Thomas Loquen

► **To cite this version:**

Thomas Loquen. Some Results on Reset Control systems. Mathematical Physics [math-ph]. Institut National Polytechnique de Toulouse - INPT, 2010. English. NNT : 2010INPT0117 . tel-04278709v2

**HAL Id: tel-04278709**

**<https://theses.hal.science/tel-04278709v2>**

Submitted on 10 Nov 2023

**HAL** is a multi-disciplinary open access archive for the deposit and dissemination of scientific research documents, whether they are published or not. The documents may come from teaching and research institutions in France or abroad, or from public or private research centers.

L'archive ouverte pluridisciplinaire **HAL**, est destinée au dépôt et à la diffusion de documents scientifiques de niveau recherche, publiés ou non, émanant des établissements d'enseignement et de recherche français ou étrangers, des laboratoires publics ou privés.



Université  
de Toulouse

# THÈSE

En vue de l'obtention du  
**DOCTORAT DE L'UNIVERSITÉ DE TOULOUSE**

**Délivré par :**  
Institut National Polytechnique de Toulouse (INP Toulouse)

**Discipline ou spécialité :**  
Systèmes Automatiques

---

**Présentée et soutenue par :**  
Loquen Thomas

**le :** vendredi 7 mai 2010

**Titre :**

Some Results on Reset Control systems

---

**JURY**

M. Ugo Boscain, Ecole Polytechnique, Président  
M. Jamal Daafouz, Centre de Recherche en Automatique de Nancy, Rapporteur  
M. Luca Zaccarian, University of Roma, Italy, Rapporteur  
M. Eduardo F. Camacho, University of Sevilla, Examineur

---

**Ecole doctorale :**  
Systèmes (EDSYS)

**Unité de recherche :**  
Méthodes et Algorithmes en Commande (LAAS-CNRS)

**Directeur(s) de Thèse :**  
Sophie Tarbouriech, LAAS-CNRS  
Christophe Prieur, LAAS-CNRS

**Rapporteurs :**  
Jamal Daafouz, Centre de Recherche en Automatique de Nancy  
Luca Zaccarian, University of Roma, Italy



# Avant propos

Le Laboratoire d'Analyse et d'Architecture des Systèmes du Centre National de la Recherche Scientifique (LAAS-CNRS), c'est, en 2009, plus de 270 doctorants et le souci de tous les accueillir dans les meilleures conditions possibles. Je remercie, tout d'abord, M. Raja Chatila, directeur du LAAS, d'avoir mis à ma disposition les moyens - techniques et administratifs - nécessaires au bon déroulement de ma thèse.

Je remercie aussi tous les membres du groupe Méthode et Algorithmes en Commandes. Au-delà des séminaires MAC, des pôts et des fartlek, je les remercie de voir dans les doctorants un peu plus que des étudiants.

Je remercie plus particulièrement mes directeurs de thèse, Sophie et Christophe, pour leur encadrement du "stage de préparation" jusqu'à la soutenance, pour m'avoir confié ce sujet de recherche et de leur patience pour le mener à terme.

Je suis reconnaissant aux professeurs Luca Zaccarian, de l'Université de Rome, et Jamal Daafouz du Centre de Recherche en Automatique de Nancy d'avoir examiné ma thèse en tant que rapporteurs et d'avoir participé au jury de soutenance, en compagnie des professeurs Ugo Boscain, de l'École Polytechnique et Eduardo Camacho de l'Université de Séville. Je les remercie de leurs commentaires et réflexions constructives.

Enfin, je remercie tous les enseignants avec qui j'ai pu travailler ces quatre dernières années à l'Université Paul Sabatier, à l'IUT de Mesures Physiques et à l'INSA. Grâce à eux, je suis passé du côté obscur de l'enseignement, pour mon plaisir ... et peut-être celui des étudiants.

J'ai aussi une pensée pour ceux dont l'exemple m'a permis de jouer mon rôle jusqu'au bout : Schtroumpf Grognon, Grincheux, Herbert de Vaucanson, Marvin le Rouge ... et autres habitués du Fort Grognon !



# Contents

<b>Avant propos</b>	<b>3</b>
<b>Notation</b>	<b>9</b>
<b>Introduction</b>	<b>11</b>
<b>1 Basic concepts</b>	<b>15</b>
1.1 Introduction . . . . .	15
1.2 Stability and $\mathcal{L}_2$ gain . . . . .	15
1.3 Lyapunov second method for stability analysis . . . . .	16
1.3.1 Continuous-time system . . . . .	16
1.3.2 Discrete-time system . . . . .	17
1.3.3 Quadratic Lyapunov function . . . . .	17
1.4 Some LMI tools . . . . .	18
1.4.1 Definition . . . . .	18
1.4.2 The S-procedure . . . . .	18
1.4.3 The Schur's complement . . . . .	19
1.4.4 The Finsler's lemma . . . . .	19
1.4.5 Numerical complexity . . . . .	20
1.5 Local stability . . . . .	20
1.6 Conclusion . . . . .	21
<b>2 Reset control system model</b>	<b>23</b>
2.1 Introduction . . . . .	23
2.2 Reset systems: hybrid behavior . . . . .	23
2.3 Closed-loop system including a reset element . . . . .	27
2.3.1 How to choose $\rho$ ? . . . . .	30
2.3.2 Description of flow and jump sets . . . . .	31
2.4 Influence of reset controller dynamics . . . . .	32
2.5 Conclusion . . . . .	34
<b>3 Stability analysis with uncertainties and non-zero references</b>	<b>35</b>
3.1 Introduction . . . . .	35
3.2 Parametric uncertainties . . . . .	35
3.2.1 Norm-bounded uncertainties . . . . .	36

3.2.2	Stability analysis . . . . .	36
3.2.3	Stability conditions . . . . .	38
3.2.4	Quadratic constructive conditions . . . . .	39
3.2.5	Polytopic uncertainties . . . . .	43
3.3	Non-zero reference . . . . .	43
3.3.1	Preliminaries . . . . .	44
3.3.2	Constant reference . . . . .	45
3.3.3	Tracking Amelioration . . . . .	48
3.3.4	Decreasing reference . . . . .	50
3.4	Conclusion . . . . .	52
<b>4</b>	<b>Saturation</b> . . . . .	<b>53</b>
4.1	Introduction . . . . .	53
4.2	Problem statement - magnitude limitation . . . . .	53
4.3	Stability analysis . . . . .	56
4.3.1	Stability quadratic conditions . . . . .	56
4.3.2	Global Stability . . . . .	58
4.4	$\mathcal{L}_2$ -gain computation . . . . .	59
4.4.1	Local stability . . . . .	59
4.4.2	Global stability . . . . .	61
4.5	Other Reset Conditions . . . . .	62
4.5.1	Stability analysis . . . . .	63
4.5.2	New reset law . . . . .	64
4.6	Anti-windup synthesis . . . . .	65
4.6.1	Modified closed-loop model . . . . .	66
4.6.2	Stability analysis and anti-windup synthesis . . . . .	68
4.6.3	Another reset law . . . . .	73
4.7	Conclusion . . . . .	76
<b>5</b>	<b>Convex optimization problems</b> . . . . .	<b>77</b>
5.1	Introduction . . . . .	77
5.2	Admissible uncertainties . . . . .	77
5.3	Non-zero references . . . . .	79
5.4	System subject to saturation . . . . .	79
5.4.1	Stability domain analysis . . . . .	80
5.4.2	Anti-windup synthesis . . . . .	81
5.5	Conclusion . . . . .	82
<b>6</b>	<b>Illustrative examples</b> . . . . .	<b>83</b>
6.1	Introduction . . . . .	83
6.2	System analysis . . . . .	84
6.2.1	Admissible uncertainties . . . . .	84
6.2.2	Constant reference . . . . .	85
6.2.3	Decreasing reference . . . . .	86

---

6.2.4	Application to a DC motor . . . . .	86
6.3	System subject to saturation . . . . .	88
6.3.1	Local stability analysis . . . . .	89
6.3.2	Stability domain increasing: first step . . . . .	89
6.3.3	Stability domain increasing: second step . . . . .	91
6.3.4	Anti-windup compensator . . . . .	91
6.4	Conclusion . . . . .	94
<b>7</b>	<b>Stability conditions with piecewise quadratic functions</b>	<b>97</b>
7.1	Introduction . . . . .	97
7.2	Angular sectors . . . . .	98
7.3	Stability analysis result . . . . .	100
7.3.1	Sectors and numerical complexity . . . . .	101
7.3.2	Optimization problem . . . . .	102
7.3.3	Numerical example . . . . .	102
7.3.4	Performance level analysis . . . . .	102
7.3.5	Numerical example . . . . .	103
7.4	Conclusion . . . . .	104
	<b>Conclusion</b>	<b>107</b>
	<b>Resumé étendu</b>	<b>111</b>
	<b>Bibliography</b>	<b>135</b>





# Notation

$ x $	absolute value of each component of vector $x$
$\ A\ $	norm of a matrix
$\ x\ $	Euclidean norm of $x$
$\ x\ _2$	$\mathcal{L}_2$ norm of $x$
$\dot{x}$	time-derivative of $x$
$x^+$	value of $x$ after a jump
$\mathbb{R}$	set of real numbers
$\mathbb{R}_+$	The set of non-negative real numbers
$\mathbb{R}^n$	$n$ -dimensional Euclidean space
$\mathbb{R}^{m \times n}$	set of real matrices of dimension $m \times n$
$I_n$	identity matrix of dimension $n$
$0_{n \times m}$	null matrix of dimension $n \times m$
	When no confusion is possible, identity and null matrices are denoted by $I$ and $0$
$A'$	transpose of matrix $A$
$tr(A)$	trace of matrix $A$
$det(A)$	determinant of matrix $A$
$A > 0$	matrix $A$ is positive definite
$A > B$	$A - B$ is positive definite
$diag(A, B)$	diagonal matrix obtained from matrices $A$ and $B$
$\begin{bmatrix} A & B \\ \star & C \end{bmatrix}$	$\star$ denotes symmetric blocks $B'$
$0, \dots, N$	set of $N + 1$ positive numbers
$\partial\mathcal{E}$	boundary of a set $\mathcal{E}$
$int\mathcal{E}$	interior of a set $\mathcal{E}$
$cv\{v_i, i = 1, \dots, q\}$	convex hull of the set of vectors $v_1, \dots, v_q$
SISO	Single Input Single Output
MIMO	Multiple Input Multiple Output
FORE	First Order Reset Elements
LMI	Linear Matrix Inequality



# Introduction

To constrain a dynamical system to carry out correctly user demands (in terms of stability, performance, precision,...), control theory community has developed several approaches around the key point of the synthesis of an additional dynamical system, called the controller. Often, the system to be controlled and the associated controller have the same dynamic nature, namely, continuous-time or discrete-time dynamics. In the quest for providing more flexible tools to achieve stabilization and/or performance improvement tasks, an approach consists in using controllers with mixed dynamics: discrete and continuous ones. Such a control system belongs to the class of hybrid control systems. A hybrid control system could, in particular, offer advantages over linear controllers for linear plants: the interaction of continuous- and discrete-time dynamics in a hybrid controller leads to rich dynamical behaviors and phenomena not encountered in purely continuous-time system [29]. So, hybrid controller enriches the spectrum of achievable trade-offs by the control system [23], [49].

Moreover, recent technological and theoretical advances, related for example to embedded systems, allow the combination of continuous changes (or flowing) and discontinuous changes (or jumping). On a practical point of view, the use of digital processors to control continuous-time process have led to more sophisticated and complex controllers (hybrid automata [36], switching systems [50], reset controllers [6], ...). The practical impact of hybrid systems has motivated intensive researches for analyzing and synthesizing such complex systems (see [29] and references therein for a large overview). Many important questions remain open and this thesis aims to answer to some of them for a special case of hybrid systems : reset control systems.

The model of a hybrid dynamical system, studied thereafter, has to exhibit continuous behavior (differential equation) and discrete behavior (difference equation), depending on the state space region. Such a model can be described by:

$$\begin{cases} \dot{x} = f(x) & \text{if } x \in \mathcal{F} \\ x^+ = g(x) & \text{if } x \in \mathcal{J} \end{cases} \quad (1)$$

In model (1),  $x \in \mathbb{R}^n$  is the state vector and sets  $\mathcal{F}$  and  $\mathcal{J}$  are subsets of  $\mathbb{R}^n$ . They are respectively called flow and jump sets and describe the region of the state space where the hybrid system has a continuous or discrete behavior. Further details on the hybrid modeling will be given in Chapter 2. The model (1) includes a wide variety of dynamic hybrid systems and in particular those studied in this thesis: systems in closed-loop with reset controllers.

The first reset controller was introduced by Clegg in 1958 [15]. By resetting to zero the state of an analog integrator under special conditions, the phase lag property of a linear plant is improved. This first ad-hoc analog scheme is the origin of other reset controllers (as the well-known First Order Reset Element) and systematic procedure for the controller design [38], [47]. During some years, reset controllers has been forgotten and in the 90's, there have been a renewed interest for this class of systems. Further theoretical works exposed conditions for internal stability of a closed-loop system including a Clegg Integrator or an FORE. A wide overview of the history and developed techniques between the year 1970 to the begin of the century are given in [5]. We can also cite the two thesis dedicated to this topic [4], [14].

In addition to these works, other recent researches on reset control systems have enriched the literature [2], [13]. Beyond theoretical tools developments and efforts made to better understand reset phenomena, we can cite several applied works using reset controllers. In [35], resetting actuators are used to control combustion instabilities. A tape-speed control system is used in [73] to demonstrate how reset laws can go past limitations of linear control. In [72], experimental results on an PZT microactuator positioning stage show that an improved reset control can completely remove the overshoot and thus achieve shorter settling time. Finally, in [3], the transient behavior of a marine vehicle is improved by resetting internal states of an PI controller.

Recently, more efficient descriptions to characterize hybrid system solutions and behaviors (hybrid time-domain, Zeno solutions, ...) have been proposed in [28]. These new modeling tools were extended to reset control systems in [68] and led to Lyapunov-like results to analyze stability and performance of a closed-loop system including a reset element [56], [67].

Results of this thesis are the logical continuation of previous cited works. The objective is not to improve existing approaches (in terms of numerical precision or computation time), but based on it, we aim at expanding the class of studied reset systems (and by the way complexifying the mathematical model of the studied system). In this framework, we are interested in augmenting a nominal system with model uncertainties and in considering different classes of exogenous input signals (perturbation and reference). Most of previous works highlight that adding a reset law to a linear controller could often improve closed-loop performances. Obviously, the presence of a saturating actuator could be the source of undesirable effects on these performances, including instability [11]. Then, the main contribution of our works is to take into account the presence of a saturation map in the closed-loop systems and to analyze consequences on the stability and performance. In such a case, a problem of interest is to characterize the basin of attraction of the origin for the saturated hybrid system, or at least, an estimate of it. By using Lyapunov-like approaches, we propose constructive conditions to estimate such a stability region. Beyond analysis results, we propose design methods to obtain a stability domain as large as possible. We emphasize that such design methods are based on both continuous-time approaches (anti-windup compensator) and hybrid-time approaches (design of adapted reset rules).

This manuscript is organized as follows.

The second chapter is dedicated to technical aspects used in this thesis. We describe how Lyapunov functions can be used to guarantee the stability of a dynamical system. In

---

particular, in the case of quadratic Lyapunov functions, we introduce the concept of Linear Matrix Inequalities. Such a formulation is very useful to write constructive conditions and then we present associated tools to manipulate this kind of expressions. Finally, the way to characterize the attraction domain of a dynamical system is addressed.

In the third chapter, reset control systems are introduced. We model such systems and illustrate their behaviors on two reset systems well-known examples. We also describe some key parameters of this class of systems (flow and jump sets, temporal regularization, ...). Note that this chapter contains a main theorem, from which we have built our works. This chapter is concluded by an example which highlights benefits of a reset law with respect to a linear controller.

Our first results on stability and performance of a closed-loop system including a reset element are developed in Chapter 3. Two main model extensions are considered: parametric uncertainties and non-zero reference. In both cases, we propose constructive conditions, i.e. our results are presented through LMI conditions to which convex optimization problems can be associated. They are based on the use of a quadratic Lyapunov function for the stability analysis, the estimation of admissible uncertainty bounds and of a performance level. In the case of non-zero reference, the performance level traduces also the rate at which the system output tends to a desired reference.

Chapter 4 contains the main results of this thesis, namely the study of reset control systems with magnitude limitation on the output. From an analysis point of view, we aim at estimating the stability region and performance level of such a saturated hybrid system. In both cases, constructive conditions are developed. This chapter addresses also first steps for the design of additional control laws to improve the stability region of the system. The first approach rests on the definition of new reset rules. By increasing the admissible set of controller initial conditions, we enlarge the stability domain of the closed-loop system. The second approach is certainly more usual, but applies for the first time on reset control systems. Given a reset law which improves closed-loop system behavior, we propose constructive conditions to design an anti-windup compensator which enlarges the set of admissible initial state values of the system from which the asymptotic stability is ensured. Finally, we expose a result which combines the two previous methods: the resulting quasi-LMIs allow us to synthesize adapted reset rules and anti-windup controller.

To use results of Chapters 3 and 4 in an efficient way, corresponding convex optimization problems are needed. This is the purpose of Chapter 5. For each theorem or proposition, we associate the minimization (or the maximization) of some decision variables in a specific way: best performance estimation, attraction domain as large as possible ... These objectives ask sometimes to deal with the minimum (or the maximum) of further variables. The classical paradigm is retrieved: to solve a multi-objective problem, a trade-off have often to be done.

The seventh chapter is dedicated to numerical examples. All almost optimization problems of Chapter 5 are addressed with the same example. The considered system is issued from the literature to compare, in particular, our hybrid techniques for saturated systems with existing approaches. Temporal simulations highlight theoretical aspects. Moreover, a real application is presented. We actually consider also the position control of a DC motor in feedback with a reset controller. We use our analysis tools to guarantee

the stability and we check in simulations the correct behavior of the closed-loop system.

Some temporal simulations have revealed a lack in our methods. Indeed, our theorems or propositions could have no solutions, whereas the hybrid system is stable. This conservatism could be partially reduced by using piecewise quadratic Lyapunov functions. In Chapter 7, we show how to construct such functions. We rewrite theorems concerning saturated reset controller: beyond the consideration of more efficient reset controller, a problem of interest is the reconstruction of a stability region based on piecewise subregions.

A general conclusion and some perspectives end this manuscript.

# Chapter 1

## Basic concepts

### 1.1 Introduction

This chapter is devoted to a general presentation of stability for non-linear systems. In particular, we focus on theoretical concepts useful for the following chapters.

This presentation is organized as follows. We first give the definition of input-output stability. We also introduce the principle of the second method of Lyapunov. Secondly, we specify how quadratic Lyapunov functions could be used to solve a stability analysis problem. In particular, we introduce Linear Matrix Inequalities formulation and associate Semi-Definite Programming techniques, which are known as very efficient numerically. Finally some theorems and lemmas on LMIs manipulation are exposed.

This chapter does not provide an exhaustive presentation of manipulated concepts which are classical and well-known but points out their interest for dynamic system analysis. More details regarding the results and their proofs could be found in literature. We can cite, for example, [46], [60], [48], [16].

### 1.2 Stability and $\mathcal{L}_2$ gain

To tackle the stability of a dynamical system  $\Sigma$  with input (Figure 1.1), a general property of interest is the  $\mathcal{L}_2$ -stability. The  $\mathcal{L}_2$  set consists of all measurable functions  $f : \mathbb{R}_+ \rightarrow \mathbb{R}$  such that

$$\int_0^\infty \|f(t)\|^2 dt < \infty \quad (1.1)$$

where  $\|\cdot\|$  denotes the Euclidian norm.

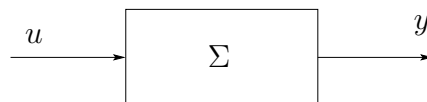

Figure 1.1: System with input  $u$  and output  $y$



**Definition 1.1** *System in Figure 1.1 is  $\mathcal{L}_2$ -stable (with respect to input  $u$ ) if for every signal  $u \in \mathcal{L}_2$  the output  $y \in \mathcal{L}_2$ . In addition, system  $\Sigma$  has a finite  $\mathcal{L}_2$ -gain, if there exist positive scalars  $\gamma$  and  $\eta$  such that*

$$\|y\|_2 \leq \gamma\|u\|_2 + \eta\|\Sigma_0\| \quad (1.2)$$

where  $\Sigma_0$  represents the initial condition of the considered system.

Thereafter, a signal  $v : [0, \infty) \mapsto \mathbb{R}^q$  is said  $\mathcal{L}_2$ -bounded if

$$\|v\|_2^2 = \int_0^\infty \|v(\tau)\|^2 d\tau = \int_0^\infty v(\tau)'v(\tau) d\tau < \infty \quad (1.3)$$

where  $\|v\|_2$  denotes the  $\mathcal{L}_2$  norm of a signal  $v(t)$ . If relation (1.3) holds, we say also that  $v$  is limited in energy.

In this framework, with null initial conditions, the  $\mathcal{L}_2$ -gain  $\gamma$  of system  $\Sigma$  can be seen as the energy ratio between input and output signals. Beyond the  $\mathcal{L}_2$ -stability, the  $\mathcal{L}_2$ -gain gives an idea of the system performance: smaller is the area of the output signal (normalized by the input signal energy), smaller is the  $\mathcal{L}_2$ -gain (or its estimation) and better is the behavior of the system. For more details on input-output stability see, for example, [46] and [61].

## 1.3 Lyapunov second method for stability analysis

The Lyapunov second method is a classical approach in stability analysis of non-linear systems. The objective is to study trajectories behavior in a neighborhood of the origin (or an equilibrium point of interest) without explicit computation of these trajectories. Asymptotic stability of the origin can be checked via this method if one can find a positive definite function whose time-derivative is negative definite along solutions of the system, in case of continuous-time system. In case of a discrete-time system, the Lyapunov function must decrease along time. Such a function is not unique and it could be difficult to find a candidate Lyapunov function. Note however, that if we are not able to exhibit such a function, then it does not mean that the system is unstable. For more details, see for example [46].

### 1.3.1 Continuous-time system

Consider the dynamic system described by:

$$\dot{x}(t) = f(x(t)) \quad (1.4)$$

with  $f : \mathbb{R}^n \rightarrow \mathbb{R}^n$  an enough regular function (for example  $f$  is of class  $C^1$ ),  $f(0) = 0$ . We suppose, without loss of generality, that the origin ( $x = 0$ ) is an equilibrium point of system (1.4). The following theorem guarantees the global asymptotic stability of system (1.4) around the origin.

**Theorem 1.1** *The origin  $x = 0$  is a globally asymptotically stable equilibrium point for system (1.4) if there exists a function  $V : \mathbb{R}^n \rightarrow \mathbb{R}_{\geq 0}$  such that*

$$V(x) > 0, \forall x \neq 0, \text{ and } V(0) = 0 \quad (1.5)$$

$$\dot{V}(x) < 0, \forall x \neq 0 \quad (1.6)$$

$$V(x) \rightarrow \infty \text{ when } x \rightarrow \infty \quad (1.7)$$

*i.e. there exists a Lyapunov function  $V(x)$  positive definite such that its time-derivative, defined for all  $x$ ,  $\dot{V}(x) = \frac{dV}{dx} \cdot f(x)$  is negative definite.*

### 1.3.2 Discrete-time system

Consider the dynamic system described by:

$$x(k+1) = g(x(k)) \quad (1.8)$$

with  $g : \mathbb{R}^n \rightarrow \mathbb{R}^n$ . We suppose, without loss of generality, that the origin ( $x = 0$ ) is an equilibrium point of system (1.8).

The following theorem guarantees global asymptotic stability around the origin for system (1.8).

**Theorem 1.2** *The origin  $x = 0$  is a globally asymptotically stable equilibrium point for system (1.8) if there exists a function  $V : \mathbb{R}^n \rightarrow \mathbb{R}_{\geq 0}$  such that*

$$V(x) > 0, \forall x \neq 0, \text{ and } V(0) = 0 \quad (1.9)$$

$$\Delta V(x) < 0, \forall x \neq 0 \quad (1.10)$$

$$V(x) \rightarrow \infty \text{ when } x \rightarrow \infty \quad (1.11)$$

*i.e. there exists a Lyapunov function  $V(x)$  positive definite such that the function  $\Delta V(x(k))$ , defined as  $\Delta V(x(k)) = V(x(k+1)) - V(x(k))$  is negative, for all  $k$ , as soon as  $x(k) \neq 0$ .*

### 1.3.3 Quadratic Lyapunov function

A problem of interest is the choice of a "good" Lyapunov function for Theorem 1.1 or 1.2. An important class of Lyapunov functions for stability analysis is the class of quadratic ones defined, for all  $x \in \mathbb{R}^n$ , as

$$V(x) = x'Px \quad (1.12)$$

where  $P \in \mathbb{R}^{n \times n}$  is a symmetric positive definite matrix.

Based on the use of the quadratic Lyapunov function (1.12), a classical result regarding the stability of the linear system

$$\dot{x}(t) = Ax(t); x(t_0) = x_0 \quad (1.13)$$

with  $x \in \mathbb{R}^n$  and  $A \in \mathbb{R}^{n \times n}$  can be stated.

**Theorem 1.3** *The origin  $x = 0$  is an asymptotically stable equilibrium point for system (1.13) if and only if there exists a symmetric positive definite matrix  $P \in \mathbb{R}^{n \times n}$  such that*

$$A'P + PA < 0 \quad (1.14)$$

Inequality (1.14) is a necessary and sufficient stability condition which does not need to compute the explicit solutions of equation (1.13).

Similarly, let us define the discrete time system

$$x(k+1) = Ax(k); \quad x(k_0) = x_0 \quad (1.15)$$

with  $x \in \mathbb{R}^n$  and  $A \in \mathbb{R}^{n \times n}$ . With the quadratic Lyapunov function (1.12), Theorem 1.2 is rewritten as

**Theorem 1.4** *The origin  $x = 0$  is an asymptotically stable equilibrium point for system (1.15) if and only if there exists a symmetric and positive definite matrix  $P \in \mathbb{R}^{n \times n}$  such that*

$$A'PA - P < 0 \quad (1.16)$$

## 1.4 Some LMI tools

A very wide variety of problems arising in system and control theory can be stated through a few standard convex or quasi convex optimization problems involving linear matrix inequalities (LMIs). In this section, we recall miscellaneous theorems and tools regarding LMIs and, associated tools used in this manuscript. Proofs and others results are presented in [10].

### 1.4.1 Definition

A Linear Matrix Inequality is an affine expression in a variable  $x$  of the form

$$F(x) = F_0 + x_1F_1 + \cdots + x_mF_m \geq 0 \quad (1.17)$$

where  $F_0, \dots, F_m$  are symmetric matrices a priori known.

The previous inequalities (1.14) and (1.16) are LMIs in which the decision variable is the matrix  $P$ .

### 1.4.2 The S-procedure

We will often encounter some quadratic functions (or quadratic form) which have to be negative whenever some other quadratic functions (or quadratic forms) are all negative. In some cases, we can form an unique LMI: that is a conservative way, but that it is an useful approximation of the constraint.

Let  $F_0, \dots, F_p$  be quadratic functions of variable  $\xi \in \mathbb{R}^n$ :

$$F_i(\xi) = \xi'T_i\xi + 2u'_i\xi + v_i, \quad i = 0, \dots, p$$

where  $T_i = T'_i$ . We consider the following condition on  $F_0, \dots, F_p$ :

$$F_0(\xi) \geq 0 \quad \forall \xi \text{ such that } F_i(\xi) \geq 0, \quad i = 1, \dots, p \quad (1.18)$$

Hence, if there exist  $\tau_1 \geq 0, \dots, \tau_p \geq 0$  such that

$$F_0(\xi) - \tau_i F_i(\xi) \geq 0, \quad \forall \xi \quad (1.19)$$

then (1.18) holds. Note that when  $p = 1$ , relations (1.18) and (1.19) are equivalent. The writing of (1.19) instead of (1.18) is called the S-procedure.

### 1.4.3 The Schur's complement

Nonlinear (convex) inequalities may be converted to LMI form using Schur's complement [10]. The inequality

$$\begin{bmatrix} Q & S \\ S' & R \end{bmatrix} > 0 \quad (1.20)$$

where  $Q$  and  $R$  are symmetric matrices, is equivalent to

$$\begin{cases} Q > 0 \\ Q - SR^{-1}S' > 0 \end{cases} \quad (1.21)$$

and

$$\begin{cases} R > 0 \\ R - S'Q^{-1}S > 0 \end{cases} \quad (1.22)$$

### 1.4.4 The Finsler's lemma

Let  $x \in \mathbb{R}^n$ ,  $Q \in \mathbb{R}^{n \times n}$  and  $B \in \mathbb{R}^{m \times n}$  such that  $\text{rank}(B) < n$ . The Finsler's lemma [20] gives equivalence for the following inequalities:

- 1)  $B_\perp Q B'_\perp \leq 0$
- 2)  $x' Q x < 0, \quad \forall Bx = 0, \quad x \neq 0$
- 3)  $\exists \tau \in \mathbb{R} : Q \leq \tau B B'$
- 4)  $\exists \chi \in \mathbb{R}^{n \times m} : Q + B' \chi' + \chi B < 0$

where  $B_\perp$  is any matrix of maximum rank such that  $B_\perp B = 0$ .

Finsler's Lemma has been often used in the literature, mainly with the purpose of eliminating design variables in matrix inequalities. In this manuscript, we particularly use items 2) and 3), i.e. the constrained quadratic form 2) is equivalently rewritten as an unconstrained quadratic form 3) by introducing the scalar multiplier  $\tau$ .

### 1.4.5 Numerical complexity

The main advantage of problems involving LMI constraints resides in the powerful tools to solve such problems with weak numerical complexity in polynomial time [10]. The efficiency of an LMI solver depends directly on the number of lines and variables of the considered inequalities. Indeed, the computation gets more and more complex when these parameters become larger: see, for example, the complexity analysis of interior point method [24], or the complexity analysis for a primal method (Theorem 5.1 in [19]) or a dual method (Theorem 5.2 in [19]). LMIs conditions can be solved in polynomial time as in [24], with complexity proportional to  $\mathcal{D}^3\mathcal{L}$ , where  $\mathcal{D}$  is the number of decision variables and  $\mathcal{L}$  is the number of lines. Other LMI solvers may however perform differently.

## 1.5 Local stability

In paragraph 1.3, the second method of Lyapunov is described for linear systems, in a global context. For some non-linear systems (for example, saturated system), it can be however difficult, even impossible to obtain to global stability of the origin. Stability analysis of such non-linear systems has then to be studied in a local context, i.e. stability and convergence properties have to be guaranteed in a set of the state space. In fact, positively invariant sets play a main role, motivated by practical problems, of "confinement sets". This key notion has been widely exploited, especially in the case of systems subject to constraints [9].

The definition of positively invariant set is stated as follows.

**Definition 1.2** *The set  $\mathcal{E}$  is said to be positively invariant for a system of the form*

$$\dot{x}(t) = f(x(t)) \quad (1.23)$$

*if for all  $x(0) \in \mathcal{E}$ , the solution  $x(t) \in \mathcal{E}$ , for  $t > 0$ . If  $x(0) \in \mathcal{E}$  implies  $x(t) \in \mathcal{E}$  for all  $t \in \mathbb{R}$  then we say that  $\mathcal{E}$  is invariant.*

Definition 1.2 says that for all initial conditions in a invariant set, the corresponding trajectories remain confined in this set.

Another important property needed to characterize stability domain for nonlinear system is the contractivity. If at instant  $t$ , the solution  $x(t)$  of (1.23) belongs to the boundary of a set  $\mathcal{E}$ , it follows that, at the instant  $(t + \tau)$ , with  $\tau$  infinitesimal,  $x(t + \tau)$  belongs to the interior or to the boundary of this set. Such property is summarized in the following definition, where the boundary and the interior of a set  $\mathcal{E}$  are respectively denoted as  $\partial\mathcal{E}$  and  $int\mathcal{E}$  [30].

**Definition 1.3** *A set  $\mathcal{E}$  is said contractive w.r.t. the trajectories of system (1.23), if for all  $x(t) \in \mathcal{E}$ ,  $t > 0$  the implication*

$$x(t) \in \partial\mathcal{E} \implies x(t + \tau) \in int\mathcal{E}$$

*holds for all  $\tau > 0$  sufficiently small.*

Definitions 1.2 and 1.3 allow us to define the larger set of initial conditions from which the resulting trajectories converge to the origin.

**Definition 1.4** Consider  $\mathcal{T}(t, x_0)$  a trajectory starting at  $t = 0$  from the initial condition  $x_0$ . The basin of attraction of the origin is defined as

$$\mathcal{E} = \{x_0 \in \mathbb{R}^n; \mathcal{T}(t, x_0) \rightarrow 0 \text{ when } t \rightarrow \infty\} \quad (1.24)$$

**Remark 1.1** If the system is globally asymptotically stable, the basin of attraction is all the state space.

The exact determination of such a stability region is often very difficult if not impossible [46]. If a candidate Lyapunov function  $V$  is known for the system, it could help us to determine sets of the state space where convergence to the origin is guaranteed. Indeed, If we consider a Lyapunov function such that  $\dot{V}(x) < 0$  along system trajectories in a region:

$$\mathcal{E}_c = \{x \in \mathbb{R}^n; V(x) \leq c\}$$

we ensure that for all initial conditions in  $\mathcal{E}_c$ , corresponding trajectories remain in  $\mathcal{E}_c$  and converge to the origin.

## 1.6 Conclusion

In this chapter, we have introduced concepts of stability and performance for a dynamic system. Such properties can be analyzed by using the Lyapunov theory, more particularly by using quadratic Lyapunov functions, which often lead to quadratic constrained forms.

Since along the manuscript, several conditions are formulated as Linear Matrix Inequalities (LMIs), main definitions and lemmas related to LMIs were briefly presented. Despite the possible conservatism of such a formulation, we recalled that it can be associated to programming techniques which are numerically efficient.



# Chapter 2

## Reset control system model

### 2.1 Introduction

In this chapter, we focus on a particular class of nonlinear systems: the reset control systems. Since the first reset system, the well-known Clegg Integrator [15], further models have been developed to describe such hybrid behavior [68], [5], [38]. Based on theoretical considerations in [28] and motivations exposed in [56], we first introduce the mathematical framework to model such hybrid systems. In the context of control theory, we also present the model of a closed-loop system including a reset element. This chapter ends by a stability result. Several examples illustrate theoretical points and motivate the works developed in the following chapters.

### 2.2 Reset systems: hybrid behavior

Considered hybrid systems are those that combine continuous dynamics (represented by differential equations) with discrete-time dynamics (instantaneous jumps of variables). Continuous trajectories of the type  $\dot{x} = f(x)$  are active in a subset of the state space  $\mathcal{F}$ , the so-called *flow set*. Resets of whole or part of system states correspond to an instantaneous jump of the type  $x^+ = g(x)$  and are only active in the subset of the state space  $\mathcal{J}$  called *jump set*. Then a general model for a linear reset system could be written as

$$\left. \begin{aligned} \dot{x}(t, j) &= A_f x(t, j) \\ y(t, j) &= C x(t, j) \end{aligned} \right\} \text{ if } x(t, j) \in \mathcal{F} \quad (2.1)$$
$$\left. \begin{aligned} x(t_{j+1}, j+1) &= A_j x(t_{j+1}, j) \end{aligned} \right\} \text{ if } x(t_{j+1}, j) \in \mathcal{J}$$

where  $x(t, j) \in \mathbb{R}^{n_r}$  is the state of the hybrid system at time  $t$  with  $j$  occurred resets before time  $t$ ,  $x(t_{j+1}, j)$  is the state value before a jump and  $x(t_{j+1}, j+1)$  after a jump (see also [28]).

For an extended introduction of hybrid systems see the recent survey [29]. In equation (2.1),  $A_f$  and  $C$  are constant matrices of appropriate dimensions, and constitute the so-called linear-based dynamic of the hybrid controller. The instantaneous transitions are described by the constant matrix  $A_j$  of appropriate dimension.



**Remark 2.1** *The discrete dynamic matrix  $A_j$  has a specific form. Elements of vector  $x$  are not all modified by jumps. Without loss of generality, we note  $n_{\bar{j}}$  the number of states which remains constant during a jump transition and  $n_j = n_r - n_{\bar{j}}$ , the discrete dynamic of (2.1) reads*

$$\begin{bmatrix} x_{n_{\bar{j}}} \\ x_{n_j} \end{bmatrix}^+ = \begin{bmatrix} I_{n_{\bar{j}}} & 0_{n_{\bar{j}} \times n_j} \\ X & Y \end{bmatrix} \begin{bmatrix} x_{n_{\bar{j}}} \\ x_{n_j} \end{bmatrix} \quad (2.2)$$

where  $Y \in \mathbb{R}^{n_j \times n_{\bar{j}}}$  and  $X \in \mathbb{R}^{n_j \times n_j}$ .

For example, let us consider an DC motor controlled by an analog PID. By using dynamic components, states of the PID can be reset, but we cannot modify instantaneously current or speed of the engine.

In hybrid system (2.1), continuous trajectories are active if states  $x$  are in a subset of the state space, the flow set  $\mathcal{F}$ . Discrete transitions occur when the variable  $x$  is in the jump subset  $\mathcal{J}$ . A necessary requirement of the corresponding description is that the union of the flow and the jump sets coincides with the whole state space: sets  $\mathcal{F}$  and  $\mathcal{J}$  are closed and such that  $\mathcal{F} \cup \mathcal{J} = \mathbb{R}^{n_r}$ . So that a jump or a flow rule will be available for any initial condition.

**Hybrid domains** Moreover, solutions of system (2.1) have to be defined on a hybrid time domain, in the sense of [28], i.e. the product of two domains: the first one related to the elapsed time and the other one related to the number of jumps that occurs from the initial time. In this framework, the hybrid time domain is defined as a subset of  $[0, \infty) \times \mathbb{N}_0$  given as a union of finite or infinite intervals  $[t_j, t_{j+1}] \times \{j\}$ , where the numbers  $0 = t_0, t_1, \dots$  form a finite or infinite and non-decreasing sequence. The last interval is allowed to be of the form  $[t_j, T) \times \{j\}$  with  $T$  finite or not.

- Throughout the manuscript, we will often use the notation  $\dot{x}$  for  $\dot{x}(t, j)$  and  $x^+$  for  $x(t_{j+1}, j+1)$ .
- The continuous part of hybrid system (2.1) is called, in the literature, the linear-based system. It often corresponds to a continuous controller design to satisfy some objectives or performances. This nominal controller is augmented with instantaneous jumps in order to improve the closed-loop behaviour.

**Example 2.1 First reset control system: The Clegg Integrator [15]**

The Clegg integrator was first proposed in [15] as a modification to an existing analog control scheme to reduce the phase induced by a linear integrator. The modification proposed by Clegg leads to the analogue scheme proposed in Figure 2.1. And by assuming that active components, operational amplifier and diodes, are ideal (infinite gain, infinite input impedance, zero output impedance, ...) and according to [68], the integrating and reset conditions for such a circuit can be written as

$$\begin{aligned} \dot{x}_r(t, j) &= \frac{1}{RC}u(t) & \text{if } x_r(t, j)u(t) &\geq 0 \\ x_r(t_{j+1}, j+1) &= 0 & \text{if } x_r(t_{j+1}, j)u(t_{j+1}) &\leq 0 \end{aligned} \quad (2.3)$$

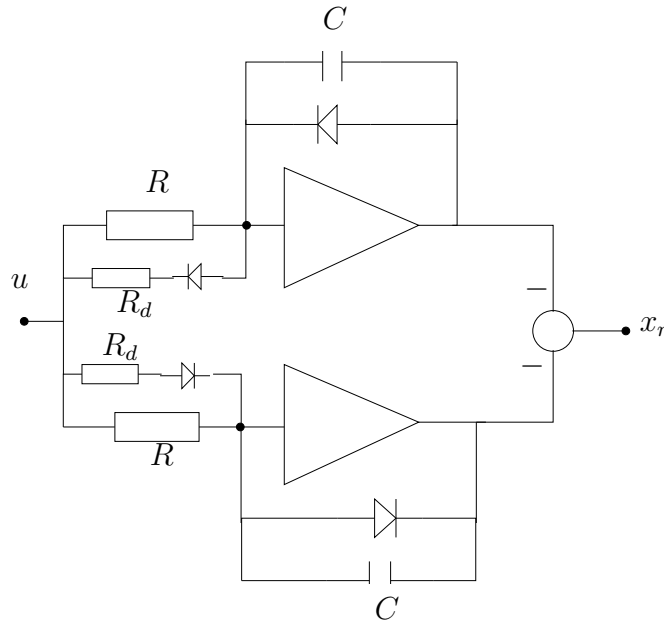

Figure 2.1: The Clegg Integrator

where  $u$  and  $x_r$  stand for the input and output voltages of the Clegg Integrator respectively.

The flow set corresponds to the region where input and output of system (2.3) have the same sign. According to [56], [68], we can use the following representation for the flow and jump sets:

$$\begin{aligned} \mathcal{F} &= \left\{ (u, x_r) \in \mathbb{R} \times \mathbb{R}; \begin{bmatrix} x_r \\ u \end{bmatrix}' M \begin{bmatrix} x_r \\ u \end{bmatrix} \geq 0 \right\} \\ \mathcal{J} &= \left\{ (u, x_r) \in \mathbb{R} \times \mathbb{R}; \begin{bmatrix} x_r \\ u \end{bmatrix}' M \begin{bmatrix} x_r \\ u \end{bmatrix} \leq 0 \right\} \end{aligned} \quad (2.4)$$

with  $M = \begin{bmatrix} 0 & 1 \\ 1 & 0 \end{bmatrix} \in \mathbb{R}^{2 \times 2}$ . In particular, in the  $(u, x_r)$  plane, the flow set corresponds to the first and third quadrants and the jump set to the second and fourth quadrants, as illustrated in Figure 2.2. In Figure 2.3, the time evolution of the output (the red solid line) of a Clegg Integrator corresponding to a sinusoidal input (the dashed blue line) is depicted.

**Zeno solutions and Temporal Regularization** Without care, hybrid systems could suffer from Zeno solutions: situations where the system makes an infinite number of discrete transitions in a finite amount of time (so that, the corresponding hybrid time domain is unbounded in the jump direction thereby remaining bounded in the flow direction) [28]. The Zeno phenomenon can make hybrid simulation imprecise and time-consuming [41]. To avoid such a behavior, the hybrid system is augmented with a variable  $\tau$ . The role of  $\tau$  is to achieve "time regularization" by imposing a minimum time  $\rho \in \mathbb{R}_+$  between discrete transitions. Note that the temporal regularization is also a solution to the lack of

- existence of solutions for some initial conditions
- uniqueness of solutions

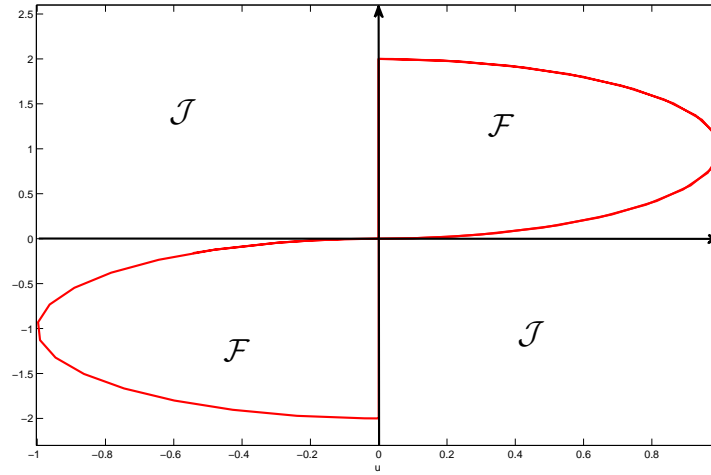

Figure 2.2: Description of the flow and jump sets for the system (2.3).

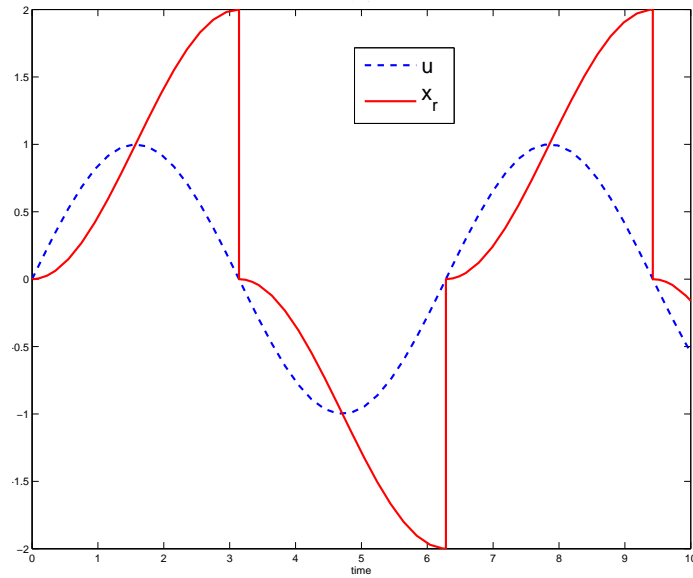

Figure 2.3: Clegg Integrator response to a sinusoidal input.

When augmenting the system (2.1) with temporal regularization, the overall dynamics becomes

$$\left. \begin{array}{l} \dot{x} = A_f x \\ y = Cx \\ \dot{\tau} = 1 \end{array} \right\} \text{if } x \in \mathcal{F} \text{ or } \tau \leq \rho \quad (2.5)$$

$$\left. \begin{array}{l} x^+ = A_j x \\ \tau^+ = 0 \end{array} \right\} \text{if } x \in \mathcal{J} \text{ and } \tau \geq \rho$$

**Example 2.2** Let us now present a second example of reset control systems: the First Order Reset Element (FORE) which is an extension of the Clegg Integrator (2.3). Proposed in [38], the FORE is a linear first order system if its input and output have the same sign. Otherwise, its state is reset to zero. The associated model with temporal regularization is

$$\left. \begin{aligned} \dot{x}_r &= \lambda_r x_r + e \\ y_r &= x_r \\ \dot{\tau} &= 1 \end{aligned} \right\} \text{if } ey_r \geq 0 \text{ or } \tau \leq \rho \quad (2.6)$$

$$\left. \begin{aligned} x_r^+ &= 0 \\ \tau^+ &= 0 \end{aligned} \right\} \text{if } ey_r \leq 0 \text{ and } \tau \geq \rho$$

where  $x_r \in \mathbb{R}$  is the FORE state,  $y_r \in \mathbb{R}$  and  $e \in \mathbb{R}$  denotes the FORE output and the FORE input respectively.

Note that, by choosing  $\lambda_r = 0$ , the resulting system (2.6) corresponds to the Clegg Integrator.

## 2.3 Closed-loop system including a reset element

In this section, we discuss how to model a closed-loop system consisting of a linear system interconnected with a reset controller as proposed in Figure 2.4.

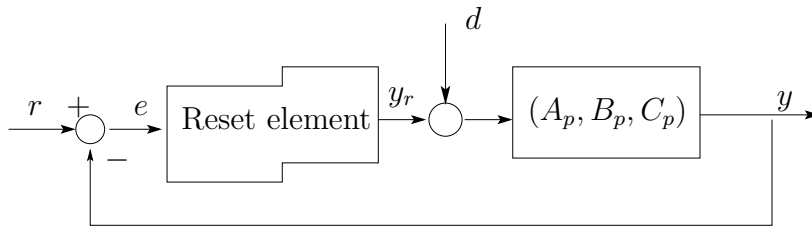

Figure 2.4: Closed-loop system including a reset element

The linear time-invariant SISO system to be controlled is supposed to be as follows:

$$\begin{aligned} \dot{x}_p &= A_p x_p + B_p y_r + B_{pd} d \\ y &= C_p x_p \end{aligned} \quad (2.7)$$

where  $x_p \in \mathbb{R}^{n_p}$  is the state space vector,  $y \in \mathbb{R}$  the measured output,  $y_r \in \mathbb{R}$  the controller output and  $d \in \mathbb{R}^{n_d}$  an external perturbation. For system (2.7),  $A_p$ ,  $B_p$ ,  $C_p$ ,  $B_{pd}$  are constant matrices of appropriate dimensions. Furthermore, pairs  $(A_p, B_p)$  and  $(C_p, A_p)$  are respectively controllable and observable.

The disturbance vector  $d : [0, \infty) \rightarrow \mathbb{R}^{n_d}$  is assumed to be limited in energy, i.e. satisfying (1.3):

$$\|d\|_2^2 = \int_0^\infty \|d(\tau)\|^2 d\tau < \delta^{-1} \quad (2.8)$$

with  $\delta$  a finite positive scalar.

Connecting to previous system, we consider the following reset control system:

$$\left. \begin{array}{l} \dot{x}_r = A_c x_r + B_c e \\ y_r = C_c x_r + D_c e \\ \dot{\tau} = 1 \end{array} \right\} \text{if } x_r \in \mathcal{F} \text{ or } \tau \leq \rho \quad (2.9)$$

$$\left. \begin{array}{l} x_r^+ = A_r x_r + B_r e \\ \tau^+ = 0 \end{array} \right\} \text{if } x_r \in \mathcal{J} \text{ and } \tau \geq \rho$$

where  $x_r \in \mathbb{R}^{n_r}$  is the state of the controller. In (2.9),  $A_c$ ,  $B_c$ ,  $C_c$  and  $D_c$  are constant matrices of appropriate dimensions, and constitute the so-called linear-based part of the hybrid controller. Matrices  $A_r$  and  $B_r$  are constant and of appropriate dimensions; they describe the reset effect. The variable  $e \in \mathbb{R}$  stands for controller input and  $y_r$  its output. Most of the time, the input variable  $e$  corresponds to the error between the output  $y$  of system (2.7) and a reference  $r$  as in Figure 2.4.

**Closed-loop model** Let us define an augmented state vector

$$x = \begin{bmatrix} x_p \\ x_r \end{bmatrix} \in \mathbb{R}^n \quad (2.10)$$

with  $n = n_p + n_r$ .

Hence, by combining (2.7) and (2.9) (where we consider  $e = r - y$ ) the closed-loop system augmented with temporal regularization can be re-written as:

$$\left. \begin{array}{l} \dot{x} = A_f x + B_d d + B r \\ \dot{\tau} = 1 \end{array} \right\} \text{if } x \in \mathcal{F} \text{ or } \tau \leq \rho \quad (2.11)$$

$$\left. \begin{array}{l} x^+ = A_j x + B_j r \\ \tau^+ = 0 \\ y = C x \end{array} \right\} \text{if } x \in \mathcal{J} \text{ and } \tau \geq \rho$$

with

$$A_f = \begin{bmatrix} A_p - B_p D_c C_p & B_p C_c \\ -B_c C_p & A_c \end{bmatrix}, \quad A_j = \begin{bmatrix} I_{n_p} & 0 \\ -B_r C_p & A_r \end{bmatrix}, \quad B = \begin{bmatrix} B_p D_c \\ B_c \end{bmatrix} \quad (2.12)$$

$$B_d = \begin{bmatrix} B_{pd} \\ 0 \end{bmatrix}, \quad C = [C_p \quad 0], \quad B_j = \begin{bmatrix} 0 \\ B_r \end{bmatrix}$$

The flow and jump sets,  $\mathcal{F}$  and  $\mathcal{J}$ , are respectively described by:

$$\mathcal{F} = \left\{ x \in \mathbb{R}^n ; \begin{bmatrix} x \\ r \end{bmatrix}' M \begin{bmatrix} x \\ r \end{bmatrix} \geq 0 \right\} \quad (2.13)$$

$$\mathcal{J} = \left\{ x \in \mathbb{R}^n ; \begin{bmatrix} x \\ r \end{bmatrix}' M \begin{bmatrix} x \\ r \end{bmatrix} \leq 0 \right\}$$

with  $M$  a symmetric reset matrix of appropriate dimensions.

**Remark 2.2** *The determination of the matrix  $M$  is a key tool for modeling and analyzing reset control systems. Such a computation will be addressed in Chapters 3 and 4.*

With  $\epsilon \geq 0$  and  $M = M'$ , we define also the inflated subset:

$$\mathcal{F}_\epsilon = \left\{ x \in \mathbb{R}^n ; \begin{bmatrix} x \\ r \end{bmatrix}' (M + \epsilon I) \begin{bmatrix} x \\ r \end{bmatrix} \geq 0 \right\} \quad (2.14)$$

**Another property** Due to temporal regularization, some defective trajectories may appear. Indeed, there could exist some solutions that keep flowing and jumping in the set  $\mathcal{J}$ , so that it would be impossible to establish that all solutions flow only in the set  $\mathcal{F}_\epsilon$ . In this framework, we consider the following assumption:

**Assumption 2.1** *For the system (2.11), the reset map  $A_j$  is such that*

$$x \in \mathcal{J} \implies A_j x \in \mathcal{F} \quad (2.15)$$

Condition (2.15) guarantees that after each jump corresponding solutions will be mapped in the flow set, where continuous dynamics are imposed so that flowing is possible from there.

The following theorem, proved in [56], provides sufficient conditions to analyze  $\mathcal{L}_2$  stability of system (2.11).

**Theorem 2.1** *Consider system (2.11). Assume Assumption 2.1 holds and  $r = 0$ . If there exist a Lyapunov function  $V : \mathbb{R}^n \rightarrow \mathbb{R}_+$ , positive scalars  $\gamma, a_1, a_2, a_3, a_4, a_5$  and  $\epsilon$  such that the following inequalities hold for all  $d \in \mathbb{R}^{n_d}$  satisfying relation (2.8):*

$$a_1 \|x\|^2 \leq V(x) \leq a_2 \|x\|^2, \forall x \in \mathbb{R}^n \quad (2.16)$$

$$\frac{\partial V}{\partial x} (A_f x + B_d d) \leq -a_3 \|y\|^2 + \gamma \|d\|^2, \text{ for almost all } x \in \mathcal{F}_\epsilon \quad (2.17)$$

$$V(A_j x) - V(x) \leq 0, \forall x \in \mathcal{J} \quad (2.18)$$

$$\left\| \frac{\partial V}{\partial x} \right\| \leq a_4 V(x) + a_5 \|x\| \|d\|, \text{ for almost all } x \in \mathbb{R}^n \quad (2.19)$$

Then for any  $L > 1$  there exists  $\rho^*$  such that for all  $\rho \in (0, \rho^*]$ , solutions of system (2.11) are such that, for all  $t \geq 0, \tau(0, 0) \geq 0, x(0, 0) = x_0 \in \mathbb{R}^n$  :

$$\int_0^t \|y(\tau)\|^2 d\tau \leq \frac{L a_2}{a_3} \|x_0\|^2 + \frac{\gamma}{a_3} \int_0^t \|d(\tau)\|^2 d\tau$$

In particular, we can take  $\rho^* = \min(\rho_1^*, \rho_2^*, \rho_3^*)$  with

$$\begin{aligned}
\rho_1^* &= \varphi_1^{-1}(\gamma), \quad \rho_2^* = \varphi_2^{-1}\left(\frac{\varepsilon}{a_2}\right), \quad \rho_3^* = \varphi_1^{-1}(L-1) \\
\varphi_1(s) &= k_1(s) + k_2(s) + \frac{\|C\|^2 a_3}{a_1} s(1 + k_1(s) + k_2(s)) \\
\varphi_2(s) &= L_1 \frac{s}{a_1} [1 + k_1(s) + k_2(s)] + L_2 \left( \frac{s}{a_1} [1 + k_1(s) + k_2(s)] \right)^{\frac{1}{2}} \\
k(s) &= \frac{\gamma_1}{\sqrt{2\alpha}} (\exp(2\alpha s) - 1)^{1/2} \\
k_1(s) &= \exp(\alpha s) k(s) + \frac{2\alpha}{\gamma_1^2} k^2(s) \\
k_2(s) &= \exp(\alpha s) k(s) + k^2(s) \\
\alpha &= \frac{a_4}{2}; \quad \gamma_1 = \frac{a_5}{2\sqrt{a_1}} \\
L_1 &= \|2(M + \epsilon I)A\|, \quad L_2 = \|2(M + \epsilon I)B_d\|
\end{aligned} \tag{2.20}$$

where the matrix  $M = M'$  comes from (2.13).

**Some remarks on  $\mathcal{F}_\varepsilon$**  A key point of Theorem 2.1 is that even if the behavior of system (2.11) depends on sets  $\mathcal{F}$  and  $\mathcal{J}$ , the stability of such a hybrid system is studied in  $\mathcal{F}_\varepsilon$  and  $\mathcal{J}$ . Thus, in Theorem 2.1, the inequality (2.17) imposes that the time-derivative of the Lyapunov function must be bounded in the inflated set  $\mathcal{F}_\varepsilon$  (defined in (2.14)). Indeed, if the temporal regularization is a guarantee to avoid Zeno behavior, it could be the source of undesirable trajectories or instability. When the additional condition  $\tau \leq \rho$  is satisfied, the reset system is flowing from the subset  $\mathcal{F}$  (see Assumption 2.1), but we have no idea of the trajectory direction. In particular, continuous-time trajectories could exist in the jump set  $\mathcal{J}$ . To illustrate the importance of imposing an overlapping on the sets  $\mathcal{F}$  and  $\mathcal{J}$ , let us consider the following example.

**Example 2.3** We consider the system (2.11) with  $r = 0$  and  $d = 0$ . The system (2.7) to be controlled is characterized by  $A_p = 0.5, B_p = -1, C_p = 1$ . This system is interconnected with a first order reset controller, with a pole  $p_r = -1$ . We impose the initial condition  $x_0 = [x_{p0} \ x_{r0}]' = [10 \ -10]'$ . Despite the fact that the system without reset is stable (in blue solid line in Figure 2.5), by adding reset law, trajectories can go to infinity. Note that by increasing the value of  $\rho$  (which corresponds to larger value of  $\varepsilon$ ), the reset system is asymptotically stable (see the dashed line in Figure 2.5).

### 2.3.1 How to choose $\rho$ ?

To simulate reset control systems, the choice of an appropriate  $\rho$  is a key tool. Some theoretical and practical remarks could help us:

- The main result of [56] presents sufficient conditions for the existence of a superior bound  $\rho^*$  with  $\rho \in (0, \rho^*]$  such that the reset system augmented with temporal regularization is  $\mathcal{L}_2$  and exponentially stable.

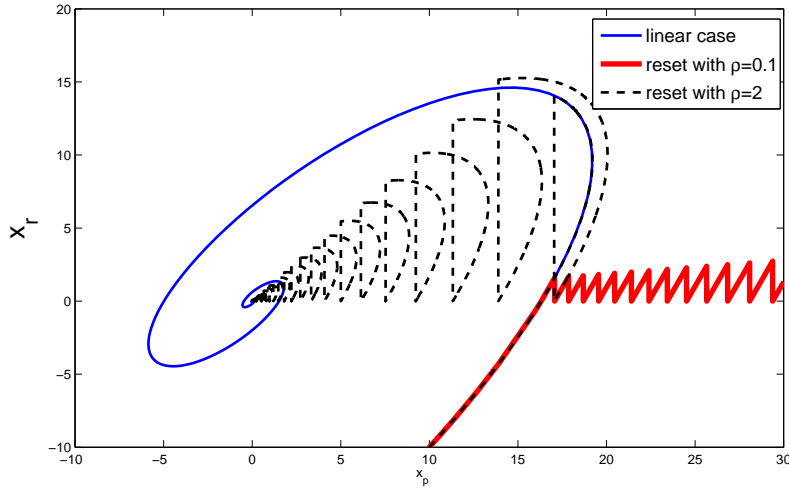

Figure 2.5: Closed-loop trajectories depending on the temporal regularization.

- The value of  $\rho$  has to be greater than the sampled step chosen for the simulation software. Otherwise, temporal regularization conditions would not be correctly implemented and verified.
- Too large values of  $\rho$  must be avoided. Indeed, if resets are not present enough often, any improvements will be added by the reset law to the linear-based system. Moreover, states could reach values which conduct the closed-loop system to instability.
- Note that even simulation packages like Matlab/Simulink will not be able to compute the solution forward in time if the simulation scheme is not implemented with some kinds of temporal regularization.

### 2.3.2 Description of flow and jump sets

In this manuscript, we consider quadratic-defined subsets: see (2.13) and (2.14). This kind of mathematical description is needed in Theorem 2.1 to apply the S-procedure. To describe flow and jumps sets, other descriptions could be used. For example in [43], [42] a region of the state space  $X$  is defined from a sector matrix  $E$  such that:

$$Ex \succeq 0 \text{ if } x \in X \quad (2.21)$$

However, note that, such set partition can lead to a quadratic description. Let  $U$  be a matrix with non-negative entries and let  $E$  satisfy (2.21). Then, it follows that

$$x'E'UEx \geq 0 \text{ if } x \in X \quad (2.22)$$



## 2.4 Influence of reset controller dynamics

In the literature, it is shown that the use of reset controller as Clegg Integrator or FORE could give more flexibility in controller design and may remove some fundamental limitations of linear controller [5]. Indeed, the reset action could lead to a faster system response without output excessive overshoot.

To illustrate this, let us consider a FORE controller, as that one presented in Example 2.2, interconnected with an integrator. In the absence of exogenous signals ( $r = 0$  and  $d = 0$ ), the closed-loop system (2.11) is described by the following data:

$$A_f = \begin{bmatrix} 0 & 1 \\ -1 & \lambda_r \end{bmatrix}, C = [1 \ 0], A_j = \begin{bmatrix} 1 & 0 \\ 0 & 0 \end{bmatrix}, M = \begin{bmatrix} 0 & -1 \\ -1 & 0 \end{bmatrix}$$

In a linear case, i.e. without reset, we can show that by decreasing the value of  $\lambda_r$  the time-response of the system decreases, but implies important overshoot on the output. Positive values of  $\lambda_r$  conduct to instability. By applying the reset law of the FORE, this overshoot disappears as illustrated on Figure 2.6 with  $\lambda_r = -0.5$ .

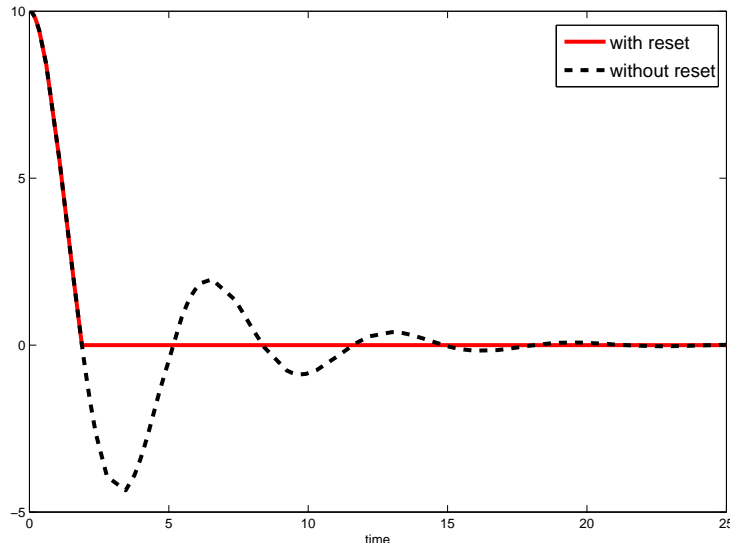

Figure 2.6: Output of the closed-loop system with reset (solid line) and without reset (dashed line).

We are now interested in the influence of  $\lambda_r$  on system states and output behavior. Figure 2.7 depicts the evolution of states  $x_p$  and  $x_r$ , in the state space. We observe that by increasing the pole of the FORE (including positive values), states converge faster to the origin. In Figure 2.8, we compare the behavior of the closed-loop system output and the FORE controller output, for different values of  $\lambda_r$ . As expected (see also [69]), when  $\lambda_r$  increases, the FORE output grows faster (exponentially) and allows the closed-loop system output to achieve faster the desired point. At this point, the reset action prevents states explosion, which could happen for positive values of  $\lambda_r$ .

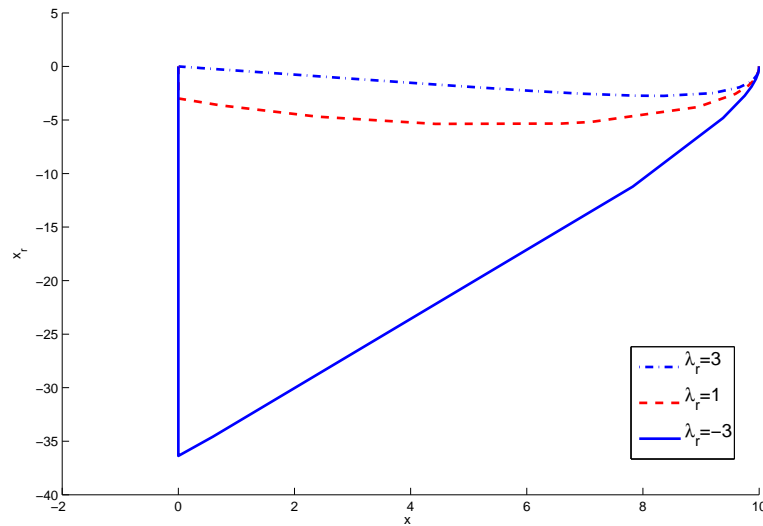

Figure 2.7: Trajectories in flow and jump sets for different values of  $\lambda_r$  with the initial condition  $[x_{p0} \ x_{r0}]' = [10 \ 0]'$

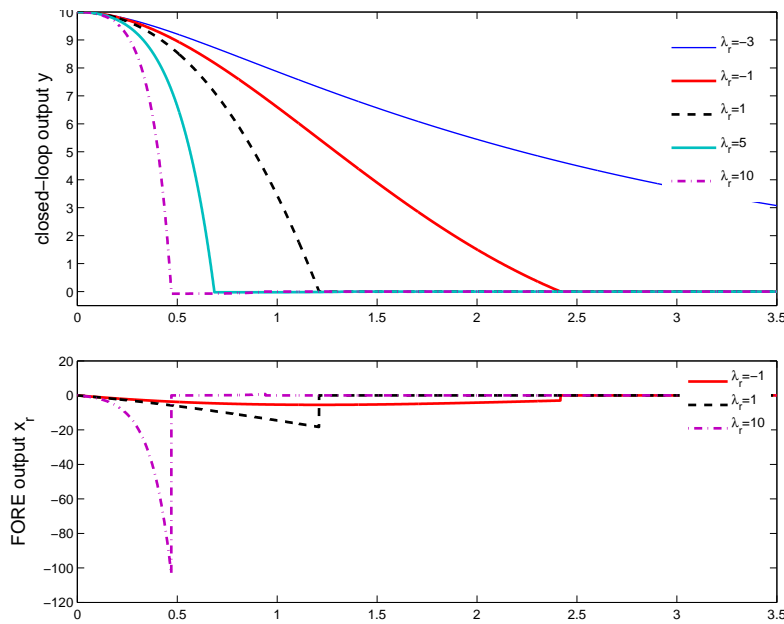

Figure 2.8: Top: Output of the closed-loop system. Down: Output of the FORE for different values of  $\lambda_r$ .

Moreover, in Figure 2.8, it clearly appears that performance improvement is obtained to the detriment of larger values of the control variable (the FORE output  $x_r$ ). Actually, many physical control systems are subject to magnitude saturation in the input. A natural point of interest is to study stability and performance of reset closed-loop systems subject to saturation. This topic will be addressed in Chapter 4.

## 2.5 Conclusion

In this chapter, we described the state space model of a closed-loop system including a reset control element. Several examples have been presented to introduce classical reset controller. We also presented a theoretical result to analyze such hybrid systems. We can also cite results proposed in [68], [56], [5] which propose to analyze stability and performance of such systems in presence of external perturbations. Finally, we have motivated the interest of such reset controllers in order to improve the performance.

In the next chapter, we extend cited works and particularly Theorem 2.1 by considering non null reference and parametric uncertainties. In this framework, the problems of characterizing the admissible uncertainties bounds and of reference tracking will be addressed by using LMI-based constructive conditions.

# Chapter 3

## Stability analysis with uncertainties and non-zero references

### 3.1 Introduction

Based on Theorem 2.1 of Chapter 2, some extensions allowing to deal with non-zero references or the presence of parametric uncertainties, are developed, in this chapter. In both cases, to design constructive conditions, an interesting way is to consider a quadratic Lyapunov function, for all  $x \in \mathbb{R}^n$ :

$$V(x) = x'Px, \quad P = P' > 0$$

Associated with such a quadratic Lyapunov function, efficient algorithms based on convex optimization problems with LMI constraints allow to:

- guarantee that the origin is a globally asymptotically stable point for system (2.11) in the absence of external perturbations;
- characterize the input-output behavior of the closed-loop system submitted to a perturbation satisfying (2.8). To this end, we will estimate the  $\mathcal{L}_2$ -gain of the considered system.

We first focus on the analysis of system (2.11) with null reference ( $r = 0$ ) and uncertain dynamic matrices. Beyond the stability and performance analysis, a problem of interest is to characterize admissible uncertainties, i.e. to estimate the range of possible variations such that nominal (known) system properties are conserved.

Secondly, we add non null reference as input for system (2.11). Stability property must be extended to the "null error" property, i.e. the system output follows a given reference input with zero steady-state error.

### 3.2 Parametric uncertainties

In this section, we propose to consider system (2.11) with null reference ( $r = 0$ ) and uncertainties on continuous and discrete dynamic matrices. When designing a control

system, users must ensure that the closed-loop behavior is robust to reasonable levels on plant uncertainty. Among main reasons, which motivate the consideration of parametric uncertainties, we can cite:

- an imperfect knowledge of model parameters numerical values;
- modeling approximations or errors;
- neglected dynamics ...

There exist different choices for modeling parametric uncertainties in a state space representation. However, we focus in the following section on norm-bounded uncertainties. The interested reader can consult [18], [22], [17] for different types of parametric uncertainty.

### 3.2.1 Norm-bounded uncertainties

An uncertain matrix  $\tilde{X}$  can be described as :

$$\tilde{X} = X + \Delta_X \quad (3.1)$$

where  $X \in \mathbb{R}^{n \times n}$  is a known matrix and  $\Delta_X$  corresponds to the uncertainty matrix. In the norm-bounded uncertainty case, the matrix  $\Delta_X$  can be written as

$$\Delta_X = D_X F_X E_X \quad (3.2)$$

where  $D_X \in \mathbb{R}^{n \times r}$  and  $E_X \in \mathbb{R}^{l \times n}$  are constant and a priori known matrices. The uncertainty matrix  $F_X$  is supposed to belong to the following domain:

$$\Omega = \{F_X \in \mathbb{R}^{r \times l}; F_X' F_X \leq I_l\} \quad (3.3)$$

### 3.2.2 Stability analysis

By considering that uncertainties affect both the continuous and discrete parts, the system (2.11) reads:

$$\left. \begin{array}{l} \dot{x} = \tilde{A}_f x + B_d d \\ \dot{\tau} = 1 \end{array} \right\} \text{if } x \in \mathcal{F} \text{ or } \tau \leq \rho$$

$$\left. \begin{array}{l} x^+ = \tilde{A}_j x \\ \tau^+ = 0 \\ y = \tilde{C}x \end{array} \right\} \text{if } x \in \mathcal{J} \text{ and } \tau \geq \rho \quad (3.4)$$

with sets  $\mathcal{F}$  and  $\mathcal{J}$  defined as

$$\begin{aligned} \mathcal{F} &= \{x \in \mathbb{R}^n ; x' M x \geq 0\} \\ \mathcal{J} &= \{x \in \mathbb{R}^n ; x' M x \leq 0\} \end{aligned} \quad (3.5)$$

with  $M$  a symmetric reset matrix of appropriate dimensions.

The uncertain matrices  $\tilde{A}_f$  and  $\tilde{C}$  are defined as in (3.1):

$$\begin{aligned}\tilde{A}_f &= A_f + \Delta_{A_f} = A_f + D_{A_f} F_{A_f} E_{A_f} \\ \tilde{C} &= C + \Delta_C = C_f + D_C F_C E_C\end{aligned}\quad (3.6)$$

Matrices  $D_{A_f}$ ,  $D_C$ ,  $E_{A_f}$ ,  $E_C$  are constant, a priori known and define the uncertainty structure (see Remark 2.1). Matrices  $F_A$  and  $F_C$  are unknown, but norm-bounded as follows:

$$\begin{aligned}F'_{A_f} F_{A_f} &\leq \Delta_1 \\ F'_C F_C &\leq \Delta_3\end{aligned}\quad (3.7)$$

where  $\Delta_1$  and  $\Delta_3$  are symmetric positive definite matrices of appropriate dimensions. Note that the uncertainty on matrix  $A_j$  is constrained in terms of structure. Indeed, all states of system (3.4) are not reset and then should not be modified, only controller states,  $x_r$ , are affected by the jumps. This consideration leads to

$$\tilde{A}_j = A_j + \Delta_{A_j} = \begin{bmatrix} I_{n_p} & 0 \\ 0 & 0 \end{bmatrix} + \begin{bmatrix} 0 & 0 \\ \delta_1 & \delta_2 \end{bmatrix}\quad (3.8)$$

The parametric uncertainty covers only the "reset quality" of  $x_r$ : in other words

$$D_{A_j} = \begin{bmatrix} 0 \\ I_{n_r} \end{bmatrix} \quad E_{A_j} = I_n \quad F_{A_j} = [\delta_1 \ \delta_2] \in \mathbb{R}^{n_r \times (n_p + n_r)}$$

and

$$F'_{A_j} F_{A_j} \leq \Delta_2\quad (3.9)$$

with  $\Delta_2$  a symmetric positive definite matrix of appropriate dimensions.

Finally, the first problem that we intend to solve in this chapter, can be summarized as follows.

**Problem 3.1** *Provide conditions to address:*

- *Internal stability.* When  $d = 0$ , system (3.4) is asymptotically stable.
- *$\mathcal{L}_2$ -performance.* When  $d \neq 0$ , trajectories of system (3.4) remain bounded for all external perturbations satisfying the relation (2.8). Moreover, for all initial conditions  $x_0$  and all admissible perturbations, the  $\mathcal{L}_2$ -norm of the output is bounded, i.e. there are finite positive scalars  $\eta_1$  and  $\eta_2$  such as:

$$\|y\|_2^2 \leq \eta_1 \|x_0\|^2 + \eta_2 \|d\|_2^2\quad (3.10)$$

### 3.2.3 Stability conditions

By considering norm-bounded uncertainties, Theorem 2.1 could be extended to analyze stability and  $\mathcal{L}_2$ -gain of system (3.4) by simply redefining relations (2.20) by relations (3.16). This result and more details are available in [52] and its full proof is reported in [53]. In this paragraph, we only recall the main result.

**Theorem 3.1** *Consider system (3.4). Assume Assumption 2.1 holds and  $r = 0$ . If there exist a Lyapunov function  $V : \mathbb{R}^n \rightarrow \mathbb{R}_{\geq 0}$ , positive scalars  $\gamma$ ,  $a_1$ ,  $a_2$ ,  $a_3$ ,  $a_4$ ,  $a_5$  and  $\varepsilon$  such that the following hold for all  $d \in \mathbb{R}^{n_d}$  satisfying relation (2.8):*

$$a_1 \|x\|^2 \leq V(x) \leq a_2 \|x\|^2, \forall x \in \mathbb{R}^n \quad (3.11)$$

$$\frac{\partial V}{\partial x}(\tilde{A}_f x + B_d d) \leq -a_3 \|y\|^2 + \gamma \|d\|^2, \forall x \in \mathcal{F}_\varepsilon \quad (3.12)$$

$$V(\tilde{A}_j x) - V(x) \leq 0, \forall x \in \mathcal{J} \quad (3.13)$$

$$\left\| \frac{\partial V}{\partial x} \right\| \leq a_4 V(x) + a_5 \|x\| \|d\|, \text{ for almost all } x \in \mathbb{R}^n \quad (3.14)$$

Then for any  $L > 1$  there exists  $\rho^*$  such that for all  $\rho \in (0, \rho^*]$ , solutions of system (2.11) are such that, for all  $t \geq 0$ ,  $\tau(0, 0) \geq 0$ ,  $x(0, 0) = x_0 \in \mathbb{R}^n$  :

i) For  $d = 0$ , the system is asymptotically stable and its output satisfies:

$$\|y\|_2^2 \leq \frac{La_2}{a_3} \|x_0\|^2 \quad (3.15)$$

ii) and for all  $d \neq 0$ , the relation

$$\int_0^t \|y(\tau)\|^2 d\tau \leq \frac{La_2}{a_3} \|x_0\|^2 + \frac{\gamma}{a_3} \int_0^t \|d(\tau)\|^2 d\tau$$

is satisfied.

In particular, we can take  $\rho^* = \min(\rho_1^*, \rho_2^*, \rho_3^*)$  with

$$\begin{aligned}
\rho_1^* &= \varphi_1^{-1}(\gamma) \rho_2^* = \varphi_2^{-1}\left(\frac{\varepsilon}{a_2}\right) \rho_3^* = \varphi_1^{-1}(L - 1) \\
\varphi_1(\rho) &= k_1(\rho) + k_2(\rho) + \frac{a_3(\|C\|^2 + \|D_C\|^2 \Delta_3 \|E_C\|^2) \rho (1 + k_1(\rho) + k_2(\rho))}{a_1} \\
\varphi_2(s) &= L_1 \frac{s}{a_1} [1 + k_1(s) + k_2(s)] + L_2 \left( \frac{s}{a_1} [1 + k_1(s) + k_2(s)] \right)^{\frac{1}{2}} \\
k(s) &= \frac{\gamma_1}{\sqrt{2\alpha}} (\exp(2\alpha s) - 1)^{1/2} \\
k_1(s) &= \exp(\alpha s) k(s) + \exp(2\alpha s) - 1 \\
k_2(s) &= \exp(\alpha s) k(s) + k^2(s) \\
\alpha &= \frac{a_4 \|A\|}{a_1} + \alpha_2 = \frac{a_4 \|D_A\| \Delta_1^{\frac{1}{2}} \|E_A\|}{a_1} \\
\gamma_1 &= \frac{a_4 \|B_d\|}{\sqrt{a_1}} \\
L_1 &= \|2(M + \varepsilon I)A\|^2 + \|2(M + \varepsilon I)\|^2 \|D_A\|^2 \Delta_1 \|E_A\|^2 \\
L_2 &= \|2(M + \varepsilon I)B_d\|^2
\end{aligned} \tag{3.16}$$

Note that, uncertainties bounds  $\Delta_1$  and  $\Delta_2$  on matrices  $A_f$  and  $C$  have to be a priori known to use Theorem 3.1. There is no condition on the uncertainty of matrix  $\tilde{A}_j$ . But this matrix has to be such that Assumption 2.1 is satisfied.

More generally, it could be interesting to estimate such uncertainty limits. The next paragraph is dedicated to this problem.

### 3.2.4 Quadratic constructive conditions

By exploiting properties of quadratic Lyapunov function and by considering norm-bounded uncertainties, the following theorem addresses Problem 3.1. Furthermore, this theorem allows to estimate the domain of admissible uncertainties.

Let us define the quadratic Lyapunov function for all  $x \in \mathbb{R}^n$

$$V(x) = x' P x \tag{3.17}$$

with  $P \in \mathbb{R}^{n \times n}$  a symmetric positive definite matrix.



**Theorem 3.2** Consider system (3.4) with Assumption 2.1. If there exist a symmetric positive definite matrix  $P$ , positive scalars  $\bar{\Delta}_2$ ,  $\tau_F$ ,  $\tau_R$ ,  $\gamma$ ,  $\alpha_j$ ,  $j = 1, \dots, 4$  and  $\bar{\epsilon}_2$  such that:

$$\begin{bmatrix} A'_f P + P A_f + \tau_F M + \alpha_1 E'_{A_f} E_{A_f} & P B_d & P D_{A_f} \\ * & -\gamma I & 0 \\ * & * & -\alpha_2 I \\ * & * & * \\ * & * & * \\ * & * & * \\ C' & C' D_C & E'_C \\ 0 & 0 & 0 \\ 0 & 0 & 0 \\ -\gamma I & 0 & 0 \\ * & -\alpha_3 I + \gamma D'_C D_C & 0 \\ * & * & -\alpha_4 I \end{bmatrix} < 0 \quad (3.18)$$

$$\begin{bmatrix} A'_j P A_j - P - \tau_R M + E'_{A_j} \bar{\Delta}_2 E_{A_j} & A'_j P D_{A_j} \\ * & -(\bar{\epsilon}_2 I - D'_{A_j} P D_{A_j}) \end{bmatrix} \leq 0 \quad (3.19)$$

$$\bar{\epsilon}_2 I - D'_{A_j} P D_{A_j} > 0 \quad (3.20)$$

then, there exists small enough  $\rho^* > 0$  such that for all fixed  $\rho \in (0, \rho^*]$ ,  $F_{A_f}$  such that  $\|F_{A_f}\|^2 \leq \Delta_1 := \frac{\alpha_1}{\alpha_2}$ ,  $F_{A_j}$  such that  $\|F_{A_j}\|^2 \leq \Delta_2 := \frac{\bar{\Delta}_2}{\bar{\epsilon}_2}$  and  $F_C$ , such that  $\|F_C\|^2 \leq \Delta_3 := \frac{\gamma^2}{\alpha_3 \alpha_4}$ :

- if  $d = 0$ , system (3.4) is asymptotically stable;
- and if  $d \neq 0$ , the  $\mathcal{L}_2$ -gain between  $d$  and  $y$  is smaller than  $\gamma$ , i.e. the relation (3.10) is satisfied with  $\eta_2 = \gamma^2$  for all  $x_0 = 0$ .

**Proof** In this proof, we show how inequalities (3.18)-(3.20) correspond to (3.11)-(3.14) of Theorem 3.1 in the quadratic Lyapunov function framework. First note that (3.11) and (3.14) are always satisfied for quadratic Lyapunov functions. Next, we successively transform conditions (3.13) and (3.12) of Theorem 3.1 into LMIs.

**Condition (3.13).** First, let us consider the relation:

$$V(\tilde{A}_j x) - V(x) \leq 0, \text{ if } x' M x \leq 0 \quad (3.21)$$

or again with the S-procedure

$$V(\tilde{A}_j x) - V(x) - \tau_R x' M x \leq 0, \quad \tau_R \in \mathbb{R}_+$$

Relation (3.21) corresponds to equation (3.13) evaluated for a quadratic Lyapunov function (3.17).

We define  $\Delta\mathcal{V} = V(\tilde{A}_j x) - V(x) - \tau_R x' M x$ , with  $V$  defined in (3.17), and then we have:

$$\Delta\mathcal{V} = x' \left( A'_j P A_j - P - \tau_R M \right) x + x' \left( 2A'_j P D_{A_j} F_{A_j} E_{A_j} + E'_{A_j} F'_{A_j} D'_{A_j} P D_{A_j} F_{A_j} E_{A_j} \right) x \quad (3.22)$$

We now wish to remove the term  $F_{A_j}$  and to reveal the maximum norm of the uncertainty. To do this we use Lemma 5 of [26], which we recall.

**Lemma 3.1** *Consider  $D$ ,  $A$ ,  $E$  matrices of appropriate dimensions. Let us also consider  $F \in \Omega$  where  $\Omega$  is defined as in (3.3). If there exist a symmetric positive definite matrix  $P$  and a positive scalar  $\varepsilon$  satisfying:*

$$\varepsilon^{-1} I - D' P D > 0$$

then it follows:

$$A' P D F E + E' F' D' P A + E' F' D' P D F E \leq A' P D \left( \varepsilon^{-1} I - D' P D \right)^{-1} D' P A + \varepsilon^{-1} E' E.$$

Thus, by applying Lemma 3.1 to equation (3.22) one gets:

$$\Delta\mathcal{V} \leq x' \left( A'_j P A_j - P - \tau_R M \right) x + x' \left( \varepsilon_2^{-1} E'_{A_j} \Delta_2 E_{A_j} + A'_j P D_{A_j} \left( \varepsilon_2^{-1} I - D'_{A_j} P D_{A_j} \right)^{-1} D'_{A_j} P A_j \right) x$$

and also  $\varepsilon_2^{-1} I - D'_{A_j} P D_{A_j} > 0$ .

The condition (3.13) of Theorem 3.1 imposes  $\Delta\mathcal{V} \leq 0$ . This will be satisfied if:

$$A'_j P A_j - P - \tau_R M + \varepsilon_2^{-1} E'_{A_j} \Delta_2 E_{A_j} + A'_j P D_{A_j} \left( \varepsilon_2^{-1} I - D'_{A_j} P D_{A_j} \right)^{-1} D'_{A_j} P A_j \leq 0$$

To make this inequality linear in the decision variables, we consider the following change of variables:

$$\bar{\varepsilon}_2 = \varepsilon_2^{-1}, \text{ and } \bar{\Delta}_2 = \varepsilon_2^{-1} \Delta_2.$$

Relation (3.20) directly follows. Furthermore, by applying the Schur's complement, we obtain (3.19).

**Condition (3.12)** Let us now transform the following inequality:

$$\frac{\partial V}{\partial x} (\tilde{A}_f x + B_d d) + \theta \|x\|^2 + \frac{1}{\gamma} \|y\|^2 - \gamma \|d\|^2 < 0, \text{ if } x' M x + \varepsilon \|x\|^2 \geq 0 \quad (3.23)$$

which corresponds to equation (3.12) with  $a_3 = \frac{1}{\gamma}$  and to which we have added the term  $\theta \|x\|^2$ . Then, in the disturbance free-case, the decay rate of the Lyapunov function (3.17) will be exponential in the flow subset.

By using the S-procedure, there exists a positive scalar such that  $\tau_F$ , equation (3.23) reads:

$$\begin{aligned} x' \left( \tilde{A}_f' P + P \tilde{A}_f + \theta I + \tau_F (M + \varepsilon) \right) x &+ x' P B_d d + d' B_d' P x \\ &+ \frac{1}{\gamma} y' y - \gamma d' d < 0 \end{aligned} \quad (3.24)$$

With the notation (3.6), previous relation (3.24) is written as:

$$\begin{aligned} x' \left( A_f' P + P A_f + \theta I + P D_{A_f} F_{A_f} E_{A_f} + E_{A_f}' F_{A_f}' D_{A_f}' P + \tau_F (M + \varepsilon) \right) x \\ + 2x' P B_d d + \frac{1}{\gamma} \|y\|^2 - \gamma \|d\|^2 < 0 \end{aligned} \quad (3.25)$$

By bounding all terms including  $F_{A_f}$  in left part of (3.25), it follows that if the following inequality:

$$\begin{aligned} x' \left( A_f' P + P A_f + \theta I + P D_{A_f} \alpha_2^{-1} D_{A_f}' P + E_{A_f}' \alpha_2 \Delta_1 E_{A_f} + \tau_F (M + \varepsilon) \right) x \\ + 2x' P B_d d + \frac{1}{\gamma} y' y - \gamma d' d < 0 \end{aligned} \quad (3.26)$$

is satisfied with  $\alpha_2$  a positive real, then inequality (3.25) also holds.

We have now to consider the output matrix uncertainty, i.e. on matrix  $\tilde{C}$ . We have  $y = \tilde{C}x = (C + D_C F_C E_C)x$  and we denote by  $Z$  the terms of (3.26) independent of  $y$ . With this notation, we have:

$$Z + \frac{1}{\gamma} x' (C' + E_C' F_C' D_C') (C + D_C F_C E_C) x < 0 \quad (3.27)$$

By using Lemma 3.1, with  $\epsilon_C$  a positive scalar, we can write (3.27) as follows:

$$Z + \frac{1}{\gamma} x' (C' C + C' D_C (\epsilon_C^{-1} I - D_C' D_C)^{-1} D_C' C + E_C' \epsilon_C^{-1} \Delta_3 E_C) x < 0 \quad (3.28)$$

with:

$$\epsilon_C^{-1} I - D_C' D_C > 0 \quad (3.29)$$

Finally, by applying two times the Schur's complement, we obtain the following linear matrix inequality:

$$\left[ \begin{array}{ccc} A_f' P + P A_f + \tau_F (M + \varepsilon I) + \alpha_1 E_{A_f}' E_{A_f} + \theta I & P B_d & P D_{A_f} \\ * & -\gamma I & 0 \\ * & * & -\alpha_2 I \\ * & * & * \\ * & * & * \\ * & * & * \\ C' & C' D_C & E_C' \\ 0 & 0 & 0 \\ 0 & 0 & 0 \\ -\gamma I & 0 & 0 \\ * & -\alpha_3 I + \gamma D_C' D_C & 0 \\ * & * & -\alpha_4 I \end{array} \right] < 0 \quad (3.30)$$

We have defined  $\alpha_1 = \alpha_2 \Delta_1$ ,  $\alpha_3 = \gamma \epsilon_C^{-1}$ ,  $\alpha_4 = \gamma \epsilon_C \Delta_3^{-1}$  to linearize the condition. Inequality (3.28) is satisfied when (3.30) is verified. Moreover, in relation (3.30), we can consider small enough values for variables  $\varepsilon$  and  $\theta$  such that the term  $\tau_F \varepsilon + \theta$  is negligible. Note that a necessary condition to satisfy LMI (3.30) is:

$$-\alpha_3 I + \gamma D_C' D_C < 0 \quad (3.31)$$

with  $\gamma$  a positive real and the proposed change of variables which is equivalent to consider relation (3.29). Hence the proof of Theorem 3.2 is complete. ■

Beyond the characterization of the Lyapunov matrix  $P$  and of the  $\mathcal{L}_2$ -gain  $\gamma$ , LMIs (3.18), (3.19) and (3.20) allow us to estimate uncertainty bounds  $\Delta_i$ ,  $i = \{1, 2, 3\}$  such that stability and performance are preserved. Such estimations could be done individually or simultaneously. Several associated optimization problems in this sense will be presented in Chapter 5.

### 3.2.5 Polytopic uncertainties

Paragraphs 3.2.3 and 3.2.4 highlight the interest to consider norm-bounded uncertainties. In a practical point of view, uncertainties are often modeling by using polytopic sets. A matrix  $X$  belongs to a polytopic set defined as:

$$X \in \mathcal{D}_X = \left\{ X = \sum_{i=1}^N \alpha_i X_i, \alpha_i > 0, \sum_{i=1}^N \alpha_i = 1 \right\} \quad (3.32)$$

where  $X_i, i = 1, \dots, N$ , are the vertices of the polytope  $\mathcal{D}_X$ .

If dynamic matrices  $\tilde{A}_f$ ,  $\tilde{C}$  and  $\tilde{A}_j$  of system (3.4) are described in such a way with  $\alpha_i$ ,  $i = 1, \dots, N$ , a priori known, Theorem 2.1 could be easily rewritten (by replacing matrices  $A_f$ ,  $C$  and  $A_j$  by  $\tilde{A}_f$ ,  $\tilde{C}$  and  $\tilde{A}_j$  respectively, with respect to (3.32)). Furthermore, LMI constructive conditions could also be derived (see the ones depicted in [68]). Stability and performance conditions have however to be checked in each vertex  $i = 1, \dots, N$  of each dynamic matrix. With large value of  $N$ , solving such a problem could be numerically difficult (see remark on numerical complexity in paragraph 1.4.5)

## 3.3 Non-zero reference

We suppose now that we wish to force the output of the considered plant to converge asymptotically to a desired path  $r$  in presence of an external perturbation  $d$ . We present, in this section, results to solve such a tracking problem. In this way, we consider a closed-loop system including a reset controller a priori synthesized to satisfy some performance requirements (note that it is not necessarily dedicated to the cancellation of the steady-state error). In this context, by exploiting properties of suitable Lyapunov functions, LMI-based conditions are proposed to guarantee asymptotic stability and minimize an upper-bound of a tracking criterion. For different classes of references, we prove the asymptotic stability and the converge of the output to a reference (a priori known). Or equivalently, we prove that the steady-state error tends to zero.

### 3.3.1 Preliminaries

We recall that the hybrid system under consideration is defined as

$$\left. \begin{aligned} \dot{x} &= A_f x + Br + B_d d \\ \dot{\tau} &= 1 \end{aligned} \right\} \text{ if } x \in \mathcal{F} \text{ or } \tau \leq \rho \quad (3.33)$$

$$\left. \begin{aligned} x^+ &= A_j x \\ \tau^+ &= 0 \end{aligned} \right\} \text{ if } x \in \mathcal{J} \text{ and } \tau \geq \rho$$

and the output is defined by  $y = Cx$ . In system (3.33),  $r \in \mathbb{R}$  is a reference to be tracked. We also consider an external perturbation  $d$  such as the disturbance vector  $d : [0, \infty) \mapsto \mathbb{R}^q$  is assumed to be limited in energy, as defined in (2.8). The error  $e \in \mathbb{R}$  (see Figure 2.4) is the tracking error defined as

$$e = r - y \quad (3.34)$$

In system (3.33), we consider that discrete transitions do not depend on the reference  $r$ . The problem we intend to solve is summarized as follows.

**Problem 3.2** *Given flow and jump sets,  $\mathcal{F}$  and  $\mathcal{J}$ , find a Lyapunov function such as*

- *if  $d = 0$ , system (3.33) is asymptotically stable;*
- *if  $d \neq 0$ , the tracking error  $e$  defined in (3.34) converges asymptotically to zero, for all admissible disturbances  $d$  satisfying (2.8).*

To address Problem 3.2, let us consider the following lemma.

**Lemma 3.2** *Let  $e : [0, \infty) \rightarrow \mathbb{R}^n$  be a continuously differentiable function such that  $\|e\|_2 < \infty$  and its time-derivative  $\dot{e}$  satisfies  $\|\dot{e}\|_2 < \infty$ .*

*Then we have  $e \rightarrow 0$ , as  $t \rightarrow \infty$ .*

**Proof** Let us assume the contrary. Then there exist a positive scalar  $\varepsilon$  and a sequence  $(t_n)_{n \in \mathbb{N}}$  such that  $t_n \rightarrow \infty$  and  $\|e(t_n)\| \geq \varepsilon$ .

If necessary we may consider  $-e$  instead of  $e$  and assume that there exists an infinite number of  $n$  such that  $e(t_n)$  is positive. Up to extracting a subsequence of  $(t_n)$ , we may assume that we have, for all  $n$ ,  $\|e(t_n)\| \geq \varepsilon$ .

Since  $\|e\|_2 < \infty$ , we have the existence, for all  $n \in \mathbb{N}$ , of a time  $t > t_n$  such that  $\|e(t)\| \leq \varepsilon/2$ . Let us denote  $s_n$  the minimal time larger than  $t_n$  such that  $\|e(s_n)\| \leq \varepsilon/2$ . In other words, we have

$$\begin{aligned} \|e(t_n)\| &\geq \varepsilon \\ \|e(t)\| &\geq \varepsilon/2, \quad \forall t \in [t_n, s_n] \\ \|e(s_n)\| &= \varepsilon/2 \end{aligned}$$

Let us consider the subsequence of  $(t_n)$  such that, for all  $n \in \mathbb{N}$ ,  $t_n < s_n < t_{n+1}$ .

Now we have

$$\begin{aligned} \int_0^\infty \|e(t)\|^2 dt &\geq \sum_n \int_{t_n}^{s_n} \|e(t)\|^2 dt \\ &\geq \sum_n (s_n - t_n) \varepsilon^2 / 4 \end{aligned}$$

Note that  $(s_n - t_n)\varepsilon^2/4$  is the general term of a converging series, and thus

$$s_n - t_n \rightarrow 0, \quad n \rightarrow \infty. \quad (3.35)$$

Now we compute

$$\varepsilon \leq \|e(t_n)\| \leq \|e(t_n) - e(s_n)\| + \|e(s_n)\| = \|e(t_n) - e(s_n)\| + \frac{\varepsilon}{2}$$

And then

$$\begin{aligned} \varepsilon/2 &\leq \|e(t_n) - e(s_n)\| \\ &\leq - \int_{t_n}^{s_n} \dot{e}(t) dt \\ &\leq \int_{t_n}^{s_n} \|\dot{e}(t)\| dt \\ &\leq \sqrt{s_n - t_n} \sqrt{\int_{t_n}^{s_n} \|\dot{e}\|^2} \\ &\leq \sqrt{s_n - t_n} \|\dot{e}\|_2 \end{aligned}$$

The latter inequality is a contradiction with (3.35). This concludes the proof of the lemma.  $\blacksquare$

**Remark 3.1** *According to Lemma 3.2, if the  $\mathcal{L}_2$ -norm of a function  $e$  and its time-derivative are bounded as*

$$\|e\|_2^2 + \|\dot{e}\|_2^2 \leq \eta \quad (3.36)$$

*then such a function converges asymptotically to zero.*

In the sequel, Problem 3.2 is addressed by considering two kinds of references: constant and decreasing references.

### 3.3.2 Constant reference

In this section, we assume that the reference is constant

$$r = r_0 \quad (3.37)$$

The closed-loop system becomes, in the absence of perturbation:

$$\left. \begin{aligned} \dot{x} &= A_f x + B r_0 \\ \dot{\tau} &= 1 \end{aligned} \right\} \text{if } x \in \mathcal{F} \text{ or } \tau \leq \rho \quad (3.38)$$

$$\left. \begin{aligned} x^+ &= A_j x \\ \tau^+ &= 0 \end{aligned} \right\} \text{if } x \in \mathcal{J} \text{ and } \tau \geq \rho$$

To analyze the stability of system (3.38), let us consider the following change of variables:

$$\tilde{x} = \begin{bmatrix} \tilde{x}_p \\ \tilde{x}_r \end{bmatrix} = x - x_e \in \mathbb{R}^n \quad (3.39)$$

where  $x_e$  is the equilibrium state. Due to Assumption 2.1, we have  $x_e \in \mathcal{F}$ . Indeed,  $x_e \in \mathcal{J}$  implies  $x_e^+ = A_j x_e = x_e \in \mathcal{F}$  and the vector  $x_e$  satisfies:

$$x_e = -A_f^{-1} B r_0 \quad (3.40)$$

$$C x_e = r_0 \quad (3.41)$$

provided that  $A_f$  is non-singular. If  $A_f$  is singular,  $x_e$  has to satisfy

$$A_f x_e + B r_0 = 0 \quad (3.42)$$

instead of (3.40). Hence,  $x_e$  corresponds to an equilibrium point, in the case  $d = 0$ . Note that relation (3.41) means that  $y_e = r_0$ , that is,  $e_e = 0$ . Then, performing the change of variables (3.39), (3.40) and (3.41), the closed-loop reset system reads:

$$\left. \begin{array}{l} \dot{\tilde{x}} = A_f \tilde{x} + B_d d \\ \dot{\tau} = 1 \end{array} \right\} \text{if } \tilde{x} \in \mathcal{F} \text{ or } \tau \leq \rho$$

$$\left. \begin{array}{l} \tilde{x}^+ = A_j \tilde{x} \\ \tau^+ = 0 \end{array} \right\} \text{if } \tilde{x} \in \mathcal{J} \text{ and } \tau \geq \rho$$

$$y = C \tilde{x} + r_0 \quad (3.43)$$

with the error written as:

$$e = -C \tilde{x} = -C_p \tilde{x}_p. \quad (3.44)$$

In general, the flow set and the jump set have to be rewritten as

$$\begin{aligned} \mathcal{F} &:= \{\tilde{x} \in \mathbb{R}^n ; \tilde{x}' \tilde{M} \tilde{x} \geq 0\} \\ \mathcal{J} &:= \{\tilde{x} \in \mathbb{R}^n ; \tilde{x}' \tilde{M} \tilde{x} \leq 0\} \end{aligned} \quad (3.45)$$

where  $\tilde{M}$  is a symmetric reset matrix of appropriate dimensions. For proof purposes, we also define an inflated flow set

$$\mathcal{F}_\varepsilon := \{\tilde{x} \in \mathbb{R}^n ; \tilde{x}'(\tilde{M} + \varepsilon I)\tilde{x} \geq 0\} \quad (3.46)$$

**Remark 3.2** When the flow and the reset conditions depend on the sign of the input and the output of the controller (see the Clegg Integrator or the FORE), we have  $M = \tilde{M}$ . Indeed, by noting that

$$y_r = C_c x_r + D_c e = C_c \tilde{x}_r - D_c C_p \tilde{x}_p \quad (3.47)$$

the matrix  $\tilde{M}$  allowing to define  $\mathcal{F}$  and  $\mathcal{J}$  in (3.46) with respect to  $\tilde{x}$ , is rewritten using (3.44) and (3.47) by  $\tilde{M} = Q' \mathcal{M} Q$  with  $\mathcal{M} = \begin{bmatrix} 0 & 1 \\ 1 & 0 \end{bmatrix}$  and  $Q = \begin{bmatrix} -C_p & 0 \\ -D_c C_p & C_c \end{bmatrix}$ .

The following result provides constructive conditions to solve Problem 3.2 by exploiting the properties of quadratic Lyapunov functions.

**Theorem 3.3** *If there exist a symmetric positive definite matrix  $P \in \mathbb{R}^{n \times n}$ , a scalar  $\tau$  and positive scalars  $\tau_F$ ,  $\tau_J$  and  $\gamma$  satisfying:*

$$\begin{bmatrix} A_f'P + PA_f - \tau A_f' A_f + \tau_F \tilde{M} & \tau A_f' & (P - \tau A_f')B_d & C' & 0 \\ \star & -\tau I & \tau B_d & 0 & C' \\ \star & \star & -\tau B_d' B_d - \gamma I & 0 & 0 \\ \star & \star & \star & -\gamma I & 0 \\ \star & \star & \star & \star & -\gamma I \end{bmatrix} < 0 \quad (3.48)$$

$$A_J' P A_J - P - \tau_J \tilde{M} \leq 0 \quad (3.49)$$

then, there exists small enough  $\rho^* > 0$  such that for all fixed  $\rho \in (0, \rho^*]$  such that

- when  $d = 0$ , the reset control system (3.43) is globally asymptotically stable;
- when  $d \neq 0$ , relation (3.36) holds with

$$\eta = \gamma \tilde{x}_0' P \tilde{x}_0 + \gamma^2 \|d\|_2^2 \quad (3.50)$$

for all disturbances  $d$  satisfying (2.8) and thus, with Lemma 3.2,  $\lim_{t \rightarrow \infty} e(t) = 0$ .

**Proof** Let us consider the quadratic Lyapunov function for all  $\tilde{x}$  in  $\mathbb{R}^n$

$$V(\tilde{x}) = \tilde{x}' P \tilde{x}, \quad P = P' > 0 \quad (3.51)$$

By derivating (3.51) along the continuous trajectories of system (3.43), we obtain  $\dot{V} = \tilde{x}'(A_f'P + PA_f)\tilde{x} + 2d'B_d'P\tilde{x}$ . Let us define the quantity  $L$  as

$$L = \dot{V}(\tilde{x}) + \frac{1}{\gamma}(e'e + e'\dot{e}) - \gamma d'd \quad (3.52)$$

where  $e$  is defined in (3.44) and  $\dot{e} = -C\dot{\tilde{x}}$ . Along the continuous trajectories of system (3.43), we want to satisfy  $L < 0$ , if  $\tilde{x} \in \mathcal{F}_\varepsilon$ , or equivalently  $L < 0$ , if  $\tilde{x}'(\tilde{M} + \varepsilon I)\tilde{x} \geq 0$ . This condition can be rewritten as follows by using the S-procedure ([10], see also paragraph 1.4.2)

$$L + \tau_F \tilde{x}'(\tilde{M} + \varepsilon I)\tilde{x} < 0 \quad (3.53)$$

with  $\tau_F$  a positive scalar. Moreover, the variables  $\tilde{x}$ ,  $\dot{\tilde{x}}$ , and  $d$  satisfy the following equality  $N \begin{bmatrix} \tilde{x}' & \dot{\tilde{x}}' & d' \end{bmatrix}' = 0$  with  $N = \begin{bmatrix} A_f & -I & B_d \end{bmatrix}$ . By applying the Finsler's lemma ([10], see also paragraph 1.4.4), inequality (3.53) is equivalent to

$$L + \tau_F \tilde{x}'(\tilde{M} + \varepsilon I)\tilde{x} \leq \tau \begin{bmatrix} \tilde{x}' & \dot{\tilde{x}}' & d' \end{bmatrix} N' N \begin{bmatrix} \tilde{x} \\ \dot{\tilde{x}} \\ d \end{bmatrix} \quad (3.54)$$

with  $\tau$  a scalar and  $L$  a function of  $\tilde{x}$  and  $d$ .

The satisfaction of relation (3.48) implies that (3.54) holds, for all  $\varepsilon$  small enough.



Regarding the discrete part, the satisfaction of relation (3.49) guarantees that the candidate quadratic Lyapunov function (3.17) is non-increasing along resets:

$$\Delta V(\tilde{x}) \leq 0 \text{ if } \tilde{x}' \tilde{M} \tilde{x} \leq 0 \quad (3.55)$$

Hence, in the case  $d = 0$ , the satisfaction of relations (3.48) and (3.49) ensures the global asymptotic stability of reset system (3.43) or equivalently the asymptotic convergence of the error  $e$  to 0.

For  $d \neq 0$ , the satisfaction of relations (3.48) and (3.49) implies, in particular, that  $L \leq 0$  and  $\Delta V(\tilde{x}) \leq 0$ . Let us introduce the following notation. The values of the Lyapunov function (3.17) and of its time-derivative at  $\tilde{x}(t_i, i)$  will be noted  $V(t_i, i)$  and  $\dot{V}(t, i)$ , respectively. By integrating relation (3.52) along the continuous trajectories of the system, it follows:

$$\sum_{i=0}^T \int_{t_i}^{t_{i+1}} \dot{V}(t, i) dt + \gamma^{-1} \left( \int_0^\infty e' e dt + \int_0^\infty \dot{e}' \dot{e} dt \right) - \gamma \int_0^\infty d' d dt \leq 0 \quad (3.56)$$

Moreover, note that one gets

$$\begin{aligned} \sum_{i=0}^T \int_{t_i}^{t_{i+1}} \dot{V}(t, i) dt &= V(t_{T+1}, T+1) - V(t_0, 0) \\ &\quad - \sum_{i=0}^T [V(t_{i+1}, i+1) - V(t_i+1, i)] \end{aligned} \quad (3.57)$$

From the satisfaction of (3.55)-(3.56) and from (3.57) one gets:

$$V(t_{T+1}, T+1) - V(t_0, 0) + \gamma^{-1} \left( \|e\|_2^2 + \|\dot{e}\|_2^2 \right) - \gamma \|d\|_2^2 \leq 0$$

or equivalently, with  $V(t_{T+1}, T+1) > 0$ , it follows

$$\|e\|_2^2 + \|\dot{e}\|_2^2 \leq \gamma V(t_0, 0) + \gamma^2 \|d\|_2^2 \quad (3.58)$$

and by noting  $x(T_0, 0) = x_0$ , relation (3.50) is obtained. LMIs (3.48)-(3.49) correspond to conditions (3.12) and (3.13) of Theorem 2.1 evaluated for a quadratic Lyapunov function (which imply conditions (3.11) and (3.14)), then the proof of Theorem 3.3 is complete. ■

### 3.3.3 Tracking Amelioration

The reference tracking depends on the presence of one integrator in the linear-based system. When an integrator is not present the reset to zero of controller states could lead to undesirable closed-loop behavior, including instability. In [70], a modification of reset rules and jump values is introduced. These results are introduced thereafter.

For the following SISO linear

$$\begin{aligned} \dot{x}_p &= A_p x_p + B_p y_r \\ y &= C_p x_p \end{aligned} \quad (3.59)$$

we assume that control system is designed for stabilization purposes only with  $r = 0$ , where the FORE element dynamics and the interconnection equation correspond to

$$\begin{aligned} \dot{x}_r &= \lambda_r x_r + e \text{ if } ex_r \geq 0 \\ x_r^+ &= 0 \text{ if } ex_r \leq 0 \end{aligned} \quad (3.60)$$

$$\begin{aligned} y_r &= kx_r \\ e &= -y \end{aligned} \quad (3.61)$$

where  $k > 0$  denotes the loop gain and  $\lambda_r \in \mathbb{R}$  is the pole of the FORE.

**Proposition 3.1** (*FORE set point stabilizer*) [70] *Suppose that the transfer function of the plant (3.59) from  $y_r$  to  $y$  has not zeros at the origin. Also suppose that  $k \neq 0$  and the origin of the reset control system (2.7), (3.60), (3.61) with temporal regularization is asymptotically stable. Then the following quantity is well defined:*

$$F = \begin{cases} \frac{1}{C_p A_p^{-1} B_{pu} k} & \text{if } A_p \text{ is invertible} \\ 0 & \text{otherwise} \end{cases} \quad (3.62)$$

Moreover, for any constant reference  $r \in \mathbb{R}$ , the following FORE implementation

$$\begin{aligned} \dot{x}_r &= \lambda_r x_r + e \text{ if } (r - y)(x_r + Fr) \geq 0 \\ x_r^+ &= -Fr \text{ if } (r - y)(x_r + Fr) \leq 0 \end{aligned} \quad (3.63)$$

$$\begin{aligned} y_r &= kx_r \\ e &= (1 + \lambda_r F)r - y \end{aligned} \quad (3.64)$$

guarantees asymptotic stability of the equilibrium point  $x^* = [x_p^* \ x_r^*]'$ , where  $y^* = C_p x_p^* = r$ .

**Example 3.1** *To illustrate such a behavior of a reset control system with a constant reference, we consider system (3.38) with the reference defined as:*

$$r(t) = \begin{cases} r_0, & 0 \leq t \leq 30s \\ 0, & \text{otherwise} \end{cases} \quad (3.65)$$

The system to be controlled is characterized by

$$A_p = -1.5, B_p = 1, C_p = 1$$

connected to a FORE as defined in (3.63) and (3.64) with  $\lambda_r = 1$  and  $k = 2$ .

In Figure 3.1, the dashed line represents the response of the system without reset. Note that such a linear-based system is exponentially stable. With classical reset rules, the reset control system does not satisfy LMI conditions of Theorem 3.3. In Figure 3.1, the corresponding trajectory is the oscillated one: the system does not answer to the tracking problem. With the modified reset rules, the output converges to the reference and overshoot is reduced (solid line in Figure 3.1). As expected, when  $r = 0$  (i.e.  $t > 30s$ ), the two reset rules lead to the same system output behavior and to better performance than the linear case.

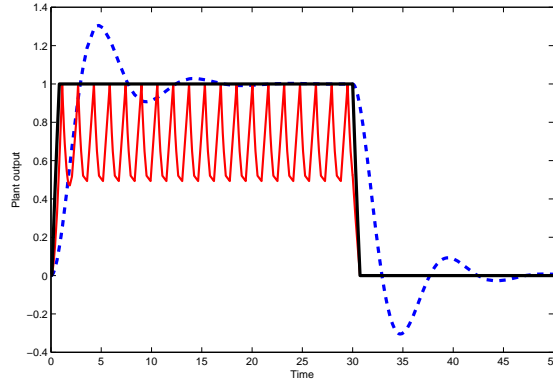

Figure 3.1: Time response of  $y$  with classical and modified reset rules.

**Remark 3.3** Note that when the matrix  $A_p$  is non-invertible (i.e.  $F = 0$ ), the reset law implementation (3.63)-(3.64) does not lead to any improvement. In particular, it is true for examples proposed in [55], where reset control systems in presence of non-zero reference and external perturbation are considered. A FORE controller is connected via a negative output feedback to a plant characterized by  $A_p = \begin{bmatrix} 0 & 0 \\ 1 & -0.2 \end{bmatrix}$ ,  $B_p = \begin{bmatrix} 1 \\ 1 \end{bmatrix}$ ,  $C_p = \begin{bmatrix} 0 & 1 \end{bmatrix}$ . Implementing the FORE with reset law (3.60)-(3.61) or (3.63)-(3.64) leads to the same output trajectories.

### 3.3.4 Decreasing reference

In this section, we consider system (3.33) with a decreasing reference signal

$$r = r_0 e^{-\zeta t} \quad (3.66)$$

where  $\zeta$  is a positive scalar and  $r_0$  a given scalar.

Hence, by defining the augmented state vector

$$\bar{x} = \begin{bmatrix} x_p \\ x_r \\ r \end{bmatrix} = \begin{bmatrix} x \\ r \end{bmatrix} \in \mathbb{R}^{n+1}$$

the system (3.33) with the relation (3.66) reads:

$$\left. \begin{aligned} \dot{\bar{x}} &= A_f \bar{x} + B_d d \\ \dot{\tau} &= 1 \end{aligned} \right\} \text{if } \bar{x} \in \mathcal{F} \text{ or } \tau \leq \rho \quad (3.67)$$

$$\left. \begin{aligned} \bar{x}^+ &= \tilde{A}_j \bar{x} \\ \tau^+ &= 0 \end{aligned} \right\} \text{if } \bar{x} \in \mathcal{J} \text{ and } \tau \geq \rho$$

Furthermore, the output  $y$  and the error  $e$  are defined as follows

$$y = C \bar{x} \quad (3.68)$$

$$e = r - y = Z \bar{x} \quad (3.69)$$

with

$$\begin{aligned}
A_f &= \begin{bmatrix} A_p - B_p D_c C_p & B_p C_c & B_p D_c \\ -B_c C_p & A_c & B_c \\ 0 & 0 & -\zeta \end{bmatrix} & C &= \begin{bmatrix} C_p & 0 & 0 \end{bmatrix} \\
A_j &= \begin{bmatrix} I_{n_p} & 0 & 0 \\ 0 & 0 & 0 \\ 0 & 0 & 1 \end{bmatrix} & Z' &= \begin{bmatrix} -C'_p \\ 0 \\ 1 \end{bmatrix} & B_d &= \begin{bmatrix} B_{pd} \\ 0 \\ 0 \end{bmatrix}
\end{aligned} \tag{3.70}$$

Due to the reference  $r$ , the inflated flow set and the jump set,  $\mathcal{F}_\varepsilon$  and  $\mathcal{J}$ , have to be rewritten for  $(x, r) \in \mathbb{R}^n \times \mathbb{R}$ :

$$\begin{aligned}
\mathcal{F}_\varepsilon &:= \{\bar{x} \in \mathbb{R}^{n+1}; \bar{x}'(M + \varepsilon I)\bar{x} \geq 0\} \\
\mathcal{J} &:= \{\bar{x} \in \mathbb{R}^{n+1}; \bar{x}'M\bar{x} \leq 0\}
\end{aligned} \tag{3.71}$$

In this context of a decreasing reference, the following theorem proposes constructive conditions to address Problem 3.2.

**Theorem 3.4** *If there exist a symmetric positive definite matrix  $P \in \mathbb{R}^{(n+1) \times (n+1)}$ , a scalar  $\tau$  and positive numbers  $\tau_f$ ,  $\tau_r$  and  $\gamma$  satisfying:*

$$\begin{bmatrix} A'_f P + P A_f - \tau A'_f A_f + \tau_f M & \tau A'_f & (P - \tau A'_f) B_d & Z' & 0 \\ * & -\tau I & \tau B_d & 0 & Z' \\ * & * & -\tau B'_d B_d - \gamma I & 0 & 0 \\ * & * & * & -\gamma I & 0 \\ * & * & * & * & -\gamma I \end{bmatrix} \leq 0 \tag{3.72}$$

$$A'_j P A_j - P - \tau_r M \leq 0 \tag{3.73}$$

then

- when  $d = 0$ , the reset control system (3.67) is globally asymptotically stable;
- when  $d \neq 0$ , relation (3.36) holds with

$$\eta = \gamma \bar{x}'_0 P \bar{x}_0 + \gamma^2 \|d\|_2^2 \tag{3.74}$$

for all disturbances  $d$  limited in energy (i.e. satisfying (2.8)) and, thus with Lemma 3.2, we have  $\lim_{t \rightarrow \infty} e(t) = 0$ .

**Proof** The proof of Theorem 3.4 follows the same lines as that one of Theorem 3.3 (consider in particular (3.58)). ■

## 3.4 Conclusion

In this chapter we presented some extensions of existing works on reset control systems. We proposed constructive conditions to characterize stability and performance of a closed-loop system including a reset controller in presence of parametric uncertainties or non-zero references. Note that the main theorems proposed in Paragraphs 3.2.4, 3.3.2 and 3.3.4 could be mixed to solve, for example, a tracking problem with an uncertain system and two different classes of references. Associated optimization problems and numerical illustrations will be presented respectively in Chapter 5 and Chapter 6.

# Chapter 4

## Saturation

### 4.1 Introduction

The introduction of a reset control law in a closed-loop system aims at upgrading performances (steady-state, overshoot, ...). Such improvements imply often larger signal values and fast dynamics sent to the actuator of the controlled system. Unfortunately, the actuators which deliver the control signal in physical applications are always subject to limits in their magnitude or rate. Hence, such limits restrict the performance achievable by the system or can cause some peculiar and pernicious behavior if they are not treated carefully or if the controller does not take into account them [1], [39], [62], [44].

This chapter is devoted to the stability and performance analysis for a class of hybrid systems, such as those including a reset controller and subject to input saturation. Similarly to the previous chapter, constructive conditions, allowing to characterize the region of stability of the saturated closed-loop system are developed by using some suitable Lyapunov functions and a modified sector condition. Reset controllers are used to improve closed-loop performances in presence of an additive disturbance or to enlarge the stability region. At this aim, different reset rules are considered, in particular in order to enlarge the estimate of the region of stability of the closed-loop saturated system.

### 4.2 Problem statement - magnitude limitation

We suppose that the input of the system to be controlled is limited in magnitude. In other words, the plant under consideration reads

$$\begin{aligned}\dot{x}_p &= A_p x_p + B_p \text{sat}(y_r) + B_{pd} d \\ y &= C_p x_p\end{aligned}\tag{4.1}$$

where  $x_p \in \mathbb{R}^{n_p}$  is the state vector,  $y \in \mathbb{R}$  is the measured output of the plant and  $y_r \in \mathbb{R}$  is the controller output. In (4.1),  $A_p$ ,  $B_p$ ,  $C_p$  are constant matrices of appropriate dimensions. The presence of an external perturbation  $d$  is included by considering a matrix  $B_{pd}$  of appropriate dimensions.

The saturation map is the classical function defined as

$$\text{sat}(y_r) = \begin{cases} -u_{min} & \text{if } y_r < -u_{min} \\ y_r & \text{if } -u_{min} \leq y_r \leq u_{max} \\ u_{max} & \text{if } y_r > u_{max} \end{cases} \quad (4.2)$$

where positive scalars  $u_{min}$  and  $u_{max}$  denote the levels of saturation (see Figure 4.1). In the sequel, we suppose that the saturation is symmetric:  $u_{min} = u_{max} = u_0$ .

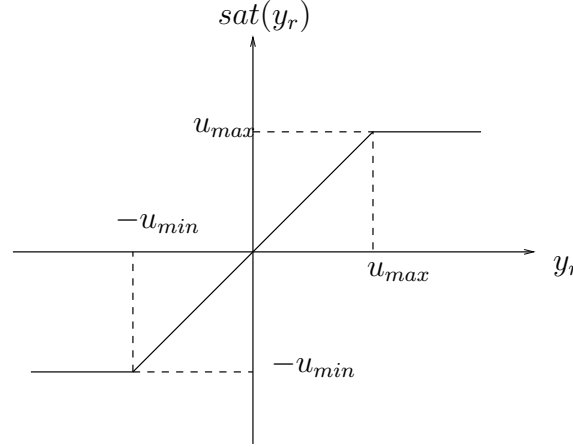

Figure 4.1: Saturation function

## Closed-loop model

Associated with system (4.1), we consider a reset controller (2.9) recalled below:

$$\left. \begin{array}{l} \dot{x}_r = A_c x_r + B_c e \\ y_r = C_c x_r + D_c e \\ \dot{\tau} = 1 \end{array} \right\} \text{if } x_r \in \mathcal{F} \text{ or } \tau \leq \rho \quad (4.3)$$

$$\left. \begin{array}{l} x_r^+ = A_r x_r + B_r e \\ \tau^+ = 0 \end{array} \right\} \text{if } x_r \in \mathcal{J} \text{ and } \tau \geq \rho$$

with  $e = r - y$ , or again in absence of reference,  $e = -y = -C_p x_p$ .

Let us define an augmented state vector

$$x = \begin{bmatrix} x_p \\ x_r \end{bmatrix} \in \mathbb{R}^n \quad (4.4)$$

with  $n = n_p + n_r$  and the following deadzone nonlinearity:

$$\psi(Kx) = \text{sat}(Kx) - Kx, \quad K = [-D_c C_p \ C_c] \in \mathbb{R}^{n_r \times n} \quad (4.5)$$

Hence, by combining (4.1), (4.3), (4.4) and (4.5), the closed-loop system can be re-written as:

$$\left. \begin{aligned} \dot{x} &= A_f x + B\psi(Kx) + B_d d \\ \dot{\tau} &= 1 \end{aligned} \right\} \text{if } x \in \mathcal{F} \text{ or } \tau \leq \rho$$

$$\left. \begin{aligned} x^+ &= A_j x \\ \tau^+ &= 0 \end{aligned} \right\} \text{if } x \in \mathcal{J} \text{ and } \tau \geq \rho$$

$$y = Cx$$
(4.6)

with

$$A_f = \begin{bmatrix} A_p - B_p D_c C_p & B_p C_c \\ -B_c C_p & A_c \end{bmatrix} \quad A_j = \begin{bmatrix} I_{n_p} & 0 \\ -B_r C_p & A_r \end{bmatrix}$$

$$B = \begin{bmatrix} B_p \\ 0 \end{bmatrix} \quad B_d = \begin{bmatrix} B_{pd} \\ 0 \end{bmatrix} \quad C = [C_p \quad 0]$$
(4.7)

The flow and jump sets,  $\mathcal{F}$  and  $\mathcal{J}$ , are respectively described by:

$$\mathcal{F} = \{x \in \mathbb{R}^n ; x' M x \geq 0\}$$

$$\mathcal{J} = \{x \in \mathbb{R}^n ; x' M x \leq 0\}$$
(4.8)

with  $M$  a reset matrix of appropriate dimensions.

System (4.6) clearly lies in the set of hybrid and nonlinear control systems. Due to the presence of the saturation map, a problem of interest consists in characterizing the exact basin of attraction of the origin for the system (4.6), i.e. the set of all initial states  $x(0) \in \mathbb{R}^n$  for which the corresponding trajectory converges asymptotically to the origin [62], [39]. In particular when global stability of the closed-loop saturated system holds, the basin of attraction corresponds to the whole state space. Nevertheless, similarly to the classical case (without reset), the determination of the exact basin of attraction is, in general, impossible. Thus, it is interesting to be able to provide an estimate of the basin of attraction. At this aim, regions of asymptotic stability can be used to estimate the basin of attraction. One of the purposes of this chapter is therefore to characterize a stability region in the state space for the system (4.6).

Hence, the problem we intend to solve, by exploiting quadratic Lyapunov functions and properties of the deadzone nonlinearity  $\Psi(Kx)$ , can be summarized as follows.

**Problem 4.1** *Given flow and jump sets  $\mathcal{F}$  and  $\mathcal{J}$ , determine a region  $\mathcal{E}$ , as large as possible, such that for all initial conditions  $\tau(0) = 0$  and  $x(0) = x_0 \in \mathcal{E}$ , the asymptotic stability of the  $x$ -variable of system (4.6) is guaranteed.*

To address such a problem, we first develop quadratic conditions to analyze asymptotic stability and  $\mathcal{L}_2$ -performance of system (4.6). Secondly, we propose modifications of the flow and jump sets and new reset rules to improve the size of the estimated stability domain.



### 4.3 Stability analysis

In this section, we are interested in solving Problem 4.1 for system (4.6) without external perturbation ( $d = 0$ ):

$$\left. \begin{aligned} \dot{x} &= A_f x + B\psi(Kx) \\ \dot{\tau} &= 1 \end{aligned} \right\} \text{if } x \in \mathcal{F} \text{ or } \tau \leq \rho$$

$$\left. \begin{aligned} x^+ &= A_j x \\ \tau^+ &= 0 \end{aligned} \right\} \text{if } x \in \mathcal{J} \text{ and } \tau \geq \rho$$

$$y = Cx$$
(4.9)

Moreover, the reset rules considered are the classical ones, i.e. the flow and jump sets depend on the sign of the controller input and output. According to relation (4.8), we define the reset matrix  $M$  as  $M = Q'MQ$  with

$$\mathcal{M} = \begin{bmatrix} 0 & 1 \\ 1 & 0 \end{bmatrix} \in \mathbb{R}^{2 \times 2} \text{ and } Q = \begin{bmatrix} -C_p & 0 \\ -D_c C_p & C_c \end{bmatrix} \in \mathbb{R}^{2 \times n}$$
(4.10)

#### 4.3.1 Stability quadratic conditions

The following theorem provides constructive conditions to address Problem 4.1 for system (4.9).

**Theorem 4.1** *If there exist a symmetric positive definite matrix  $P \in \mathbb{R}^{n \times n}$ , a matrix  $G \in \mathbb{R}^{1 \times n}$ , positive scalars  $U$ ,  $\tau_F$  and  $\tau_R$  satisfying:*

$$\begin{bmatrix} A_f'P + PA_f + \tau_F M & PB - G' \\ * & -2U \end{bmatrix} < 0$$
(4.11)

$$A_j'PA_j - P - \tau_R M \leq 0$$
(4.12)

$$\begin{bmatrix} P & K'U - G' \\ * & u_0^2 \end{bmatrix} \geq 0$$
(4.13)

then the ellipsoid  $\mathcal{E}(R) = \{x \in \mathbb{R}^n; x'Rx \leq 1\}$ , with  $R = \frac{P}{U^2}$ , is an asymptotic stability region for system (4.9).

**Proof** Consider a matrix  $G \in \mathbb{R}^{1 \times n}$  and define the following polyhedral set

$$\Gamma = \{x \in \mathbb{R}^n; -u_0 \leq (K - GU^{-1})x \leq u_0\}$$
(4.14)

where  $U$  is a positive scalar and matrix  $K$  is defined in (4.5).

Before stating the stability result, let us remind the following lemma proposed in [33], adapted to our case.

**Lemma 4.1** *Consider the deadzone function defined in (4.5). If  $x$  belongs to  $\Gamma$ , defined in (4.14), then the relation*

$$\Psi(Kx)'U^{-1} [\Psi(Kx) + GU^{-1}x] \leq 0$$
(4.15)

is verified for any positive scalar  $U^{-1}$ .

Consider the quadratic Lyapunov function  $V(x) = x'Rx$ ,  $R = R' > 0$ , and the following change of variables:

$$P = U^2R, \quad \tau_F = \bar{\tau}_F U^2, \quad \tau_R = \bar{\tau}_R U^2 \quad (4.16)$$

Using Lemma 4.1, it follows that

$$-2\Psi(Kx)'U^{-1}(\Psi(Kx) + GU^{-1}x) \geq 0 \quad (4.17)$$

By using the change of variables (4.16) and the Schur's complement, it follows that the satisfaction of relation (4.13) guarantees that the ellipsoid  $\mathcal{E}(R)$  is included in the polyhedral set  $\Gamma$  [10].

The time-derivative of  $V(x)$  along flow trajectories of system (4.6), without perturbation  $d$ , reads

$$\dot{V}(x) = x'(A_f'R + RA_f)x + 2x'RB\psi(Kx)$$

Thus with inequality (4.17), it follows that:

$$\dot{V}(x) \leq \dot{V}(x) - 2\psi(Kx)'U^{-1}\psi(Kx) - 2\psi(Kx)'U^{-2}Gx, \quad \forall x \in \mathcal{E}(R) \quad (4.18)$$

The hand-right side of (4.18) writes:

$$\xi' L \xi = \xi' \begin{bmatrix} A_f'R + RA_f & RB - G'U^{-2} \\ * & -2U^{-1} \end{bmatrix} \xi, \quad \text{with } \xi = \begin{bmatrix} x \\ \psi(Kx) \end{bmatrix} \quad (4.19)$$

We want to impose  $\xi(\tilde{t})'L\xi(\tilde{t}) < 0$  for all  $\tilde{t}$  such that the system (4.9) is flowing. Due to the continuous part of (4.9), two cases may occur:  $x(\tilde{t}) \in \mathcal{F}$  or  $\tau \leq \rho$ .

**Case 1** If  $x(\tilde{t}) \in \mathcal{F}$ , then  $\dot{V}(x) < 0$  as soon as  $\xi' L \xi < 0$  for all  $x \in \mathcal{F}$ . Hence, by using the S-procedure [10], this is equivalent to satisfy:

$$\begin{bmatrix} A_f'R + RA_f + \bar{\tau}_F M & RB - G'U^{-2} \\ * & -2U^{-1} \end{bmatrix} < 0 \quad (4.20)$$

with  $\bar{\tau}_F > 0$ .

**Case 2** Assume now that  $\tau \leq \rho$ . Let us denote  $\underline{t} \leq \tilde{t}$  the smallest time where we are flowing in  $[\underline{t}, \tilde{t}]$ . We have  $x(\underline{t}) \in \mathcal{F}$  since either  $\underline{t} = 0$ , or we have a jump at  $\underline{t}$  and due to Assumption 2.1 for all  $x \in \mathcal{J}$ , we have  $A_j x \in \mathcal{F}$ . Then, there exists a positive scalar  $\epsilon$  such that for all  $t \in [\underline{t}, \rho)$  we have  $x(t) \in \mathcal{F}_\epsilon$  with  $\mathcal{F}_\epsilon = \{x \in \mathbb{R}^n ; x'Mx + \epsilon x'x \geq 0\}$ . Thus, we remain in  $\mathcal{E}(R)$  and we have  $\dot{V}(x(t)) < 0$  for all  $t \in [\underline{t}, \rho)$  as soon as  $\xi' L \xi < 0$  for all  $x \in \mathcal{F}_\epsilon$ , which is equivalent to

$$\begin{bmatrix} A_f'R + RA_f + \bar{\tau}_F(M + \epsilon I) & G'U^{-2} \\ * & -2U^{-1} \end{bmatrix} < 0 \quad (4.21)$$

Moreover, note that  $\epsilon \rightarrow 0$  as  $\rho \rightarrow 0$ . Therefore, by considering a small enough value for  $\rho$ , we can consider small enough  $\epsilon$  to be neglected and it follows that the satisfaction of relation (4.20) guarantees that (4.21) holds. Finally, relation (4.11) is obtained by pre and post-multiplying (4.20) by  $\text{diag}(UI_n, U)$  and considering the change of variables (4.16).

Moreover, we want also to prove that the Lyapunov function is non-increasing along jump trajectories. In other words one wants to verify:

$$V(x^+) - V(x) \leq 0 \text{ if } x \in \mathcal{J}$$

By using the S-procedure [10], this condition holds if the following relation is satisfied:

$$A'_j R A_j - R - \bar{\tau}_R M \leq 0 \quad (4.22)$$

with  $\bar{\tau}_R > 0$ . The multiplication of (4.22) by  $U^2$  and the use of relation (4.16) lead to the LMI (4.12).

Thus, the satisfaction of relations (4.11)-(4.13) ensures that for any initial condition  $x(0)$  in  $\mathcal{E}(R)$  corresponding trajectories belong to  $\mathcal{E}(R)$  and converge to the origin. Moreover, inequalities (4.11), (4.12) and (4.13) satisfy relations (2.16)-(2.19) of Theorem 2.1 for quadratic Lyapunov functions, then the asymptotic stability of the system (4.9) is guaranteed. ■

**Remark 4.1** *Thanks to the adequate change of variables, Theorem 4.1 gives LMI conditions to estimate a stability region for the closed-loop system (4.6) at the inverse of the results provided in [54]. Indeed, in [54], bilinear matrix inequalities conditions were presented to solve the same problem.*

### 4.3.2 Global Stability

In some cases, the global stability of the saturated system could be ensured. Indeed, if  $A$  is Hurwitz and  $K = GU^{-1}$ , the domain  $\Gamma$  defined in (4.14) corresponds to the whole state-space, that is the global asymptotic stability corresponds to asymptotic stability for any initial condition  $x_0 \in \mathbb{R}^n$ . In this framework, Theorem 4.1 could be rewritten to analyze the global stability of system (4.9).

**Theorem 4.2** *If there exist a symmetric positive definite matrix  $P \in \mathbb{R}^{n \times n}$  and positive scalars  $U$ ,  $\tau_F$  and  $\tau_R$  satisfying*

$$\begin{bmatrix} A'_f P + P A_f + \tau_F M & P B - K' U \\ \star & -2U \end{bmatrix} < 0 \quad (4.23)$$

$$A'_j P A_j - P - \tau_R M \leq 0 \quad (4.24)$$

*then the system (4.9) is globally asymptotically stable.*

**Proof** With the LMI (4.23), the relation (4.11) of Theorem 4.1 is satisfied for any  $x \in \mathbb{R}^n$ , this is  $\dot{V}(x) < 0$ ,  $\forall x \in \mathbb{R}^n$  and in particular  $\forall x \in \mathcal{F}$ . As in the proof of Theorem 4.1, relation (4.24) guarantees that  $V(x)$  is non-increasing during jumps. ■

**Remark 4.2** *It is important to underline that every system, involving saturation-type nonlinearities, may be easily rewritten with deadzone nonlinearities. Hence it is quite natural to consider Lemma 4.1 proposing a modified sector condition associated with a*

deadzone nonlinearity. Nevertheless several ways to mathematically represent the saturation, with the aim to study stability analysis in control design, can derive constructive conditions. Hence, the exact representation through regions of saturation consists of dividing the state space into  $3^m$  regions (where  $m$  is the number of saturated inputs) [44], [31]. Such a representation however leads to numerically complex conditions and is in general rather used in the case of low order systems. Another approach based on differential inclusion could also be used as an alternative way to exhibit conditions [1], [39].

Beyond the characterization of global or local stability for the system (4.6) without perturbation, we are also interested in answering to the following question "Does a reset controller preserve its advantages in presence of magnitude saturation?"

This is the goal of the next section.

## 4.4 $\mathcal{L}_2$ -gain computation

In this section, we address the issue of  $\mathcal{L}_2$ -performance of system (4.6) in presence of an external perturbation. In other words, in addition to asymptotic stability consideration, we consider the  $\mathcal{L}_2$ -gain estimation of the system:

$$\left. \begin{aligned} \dot{x} &= A_f x + B\psi(Kx) + B_d d \\ \dot{\tau} &= 1 \end{aligned} \right\} \text{if } x \in \mathcal{F} \text{ or } \tau \leq \rho$$

$$\left. \begin{aligned} x^+ &= A_j x \\ \tau^+ &= 0 \end{aligned} \right\} \text{if } x \in \mathcal{J} \text{ and } \tau \geq \rho$$

$$y = Cx$$
(4.25)

where  $B_d$  is defined in (4.7), flow and jump sets  $\mathcal{F}$  and  $\mathcal{J}$  are defined as in (4.8). The disturbance vector  $d : [0, \infty) \mapsto \mathbb{R}^q$  is assumed to be limited in energy, i.e. satisfying (2.8)

In this framework, we intend to solve the following problem:

**Problem 4.2** *Given flow and jump sets  $\mathcal{F}$  and  $\mathcal{J}$*

- *Internal stability.* When  $d = 0$ , determine a region  $\mathcal{E}$ , as large as possible, such that for any initial condition  $\tau(0) = 0$  and  $x(0) = x_0 \in \mathcal{E}$ , the asymptotic stability of system (4.25) is guaranteed.
- *$\mathcal{L}_2$ -performance.* When  $d \neq 0$ , the  $\mathcal{L}_2$ -gain from  $d$  to  $y$ , in the case  $x_0 = 0$ , for all disturbances  $d$  satisfying (2.8) is such that:  $\|y\|_2^2 \leq \gamma \|d\|_2^2$ .

### 4.4.1 Local stability

The following theorem addresses Problem 4.2, by exploiting properties of quadratic Lyapunov functions.

**Theorem 4.3** *If there exist a symmetric positive definite matrix  $P \in \mathbb{R}^{n \times n}$ , a matrix  $Z \in \mathbb{R}^{1 \times n}$ , positive scalars  $\eta$ ,  $S$ ,  $\gamma$ ,  $\tau_F$  and  $\tau_R$  satisfying:*

$$\begin{bmatrix} A_f'P + PA_f + \tau_F M & PB - Z' & PB_d & C' \\ * & -2S & 0 & 0 \\ * & * & -I_q & 0 \\ * & * & 0 & -\gamma \end{bmatrix} < 0 \quad (4.26)$$

$$A_j'PA_j - P - \tau_R M \leq 0 \quad (4.27)$$

$$\begin{bmatrix} P & K'S - Z' \\ * & \eta u_0^2 \end{bmatrix} \geq 0 \quad (4.28)$$

then

- When  $d = 0$ , the ellipsoid  $\mathcal{E}(P) = \{x \in \mathbb{R}^n; x'Px \leq \delta^{-1}\}$ , with  $\delta = \frac{\eta}{S^2}$ , is an asymptotic stability region for reset control system (4.25).
- When  $d \neq 0$  and  $x_0 = 0$ , the finite  $\mathcal{L}_2$ -gain from  $d$  to  $y$  is less than or equal to  $\sqrt{\gamma}$ , that is, for all  $d$  satisfying (1.3), we have  $\|y\|_2 \leq \sqrt{\gamma}\|d\|_2$ .

**Proof** The proof of this result follows the same lines as the proof of Theorem 4.1. In presence of perturbation, one has to satisfy

$$\dot{V} + \frac{1}{\gamma}y'y - d'd < 0, \quad \forall x \in \mathcal{F} \quad (4.29)$$

with  $V(x) = x'Px$ ,  $P = P' > 0$ , and  $\gamma$  a positive scalar. With Lemma 1 in [33] and the S-procedure, we want to satisfy, along the flow trajectories

$$x'Rx + x'R\dot{x} + \frac{1}{\gamma}y'y - d'd + \bar{\tau}_F x'Mx - 2\psi(Kx)'U^{-1}(\psi(Kx) + GU^{-1}x) < 0. \quad (4.30)$$

$$\begin{bmatrix} A_f'P + PA_f + \bar{\tau}_F M + \frac{C'C}{\gamma} & PB - U^{-2}G' & PB_d \\ * & -2U^{-1} & 0 \\ * & * & -\gamma I_q \end{bmatrix} < 0 \quad (4.31)$$

The changes of variables  $Z = U^{-2}G$  and  $S = U^{-1}$  and the Schur's complement lead to LMI (4.26).

Condition (4.27) implies that during a jump the candidate Lyapunov function must be at least non-increasing, i.e.  $V(x^+) - V(x) \leq 0$ , or again

$$x'(A_j'PA_j - P)x \leq 0 \text{ if } x'Mx \leq 0 \quad (4.32)$$

By applying the S-procedure to inequalities (4.32), LMI (4.27) is obtained.

The ellipsoid  $\mathcal{E}(P)$  must be included in the polyhedral set  $\Gamma = \{x \in \mathbb{R}^n; -u_0 \leq (K - GU^{-1})x \leq u_0\}$ , or again

$$x' \frac{(K - GU^{-1})'(K - GU^{-1})}{u_0^2} x \leq x' \frac{P}{\delta^{-1}} x \leq 1$$

which leads to (by applying the Schur's complement)

$$\begin{bmatrix} P & K' - U^{-1}G' \\ \star & \delta u_0^2 \end{bmatrix} \geq 0 \quad (4.33)$$

By considering the pre and post-multiplication of (4.33) by  $\text{diag}(I_n, U^{-1})$  and with  $\eta = U^{-2}\delta$ , we obtain the inclusion relation (4.28).

Hence in the case  $d = 0$ , the satisfaction of relations (4.26)-(4.28) implies that the asymptotic stability of system (4.25) is guaranteed for any  $x_0 \in \mathcal{E}(P)$ .

By considering  $x_0 = 0$ ,  $d \neq 0$ , along the interval  $[0, \infty)$ , we obtain  $0 < V(x) \leq \gamma \|d\|_2^2 - \|y\|_2^2$ , then the  $\mathcal{L}_2$ -gain from  $d$  to  $y$  is less or equal than a positive scalar  $\sqrt{\gamma}$ . To address the presence of temporal regularization in system (4.25), and by considering an inflating set  $\mathcal{F}_\varepsilon = \{x \in \mathbb{R}^n ; x'(M + \varepsilon I)x \geq 0\}$ , the same approach as in the proof of Theorem 4.1 can be developed. Thus, relations (2.16)-(2.19) of Theorem 2.1 are satisfied, and the proof is completed. ■

**Remark 4.3** *Some remarks have to be done to complete the proof Theorem 4.3.*

- *The external perturbation  $d$  is supposed to be limited in energy:*

$$\|d\|_2^2 = \int_0^\infty d(\tau)'d(\tau)d\tau < \frac{1}{\delta}. \quad (4.34)$$

*In such a case, for null initial conditions  $x(0) = x_0 = 0$ , the relation (4.29) implies for a positive time  $T$  that  $x(T)'Px(T) \leq \int_0^T d(t)'d(t)dt \leq \delta^{-1}$ . In other words, the corresponding trajectories of system (4.25) belong to the ellipsoidal set  $\mathcal{E}(P)$ .*

- *If the initial state value is  $x(0) = x_0 \neq 0$ , the relation between the  $\mathcal{L}_2$ -norms  $\|y\|_2$  and  $\|d\|_2$  depends on the value of the Lyapunov function at the initial time ( $V(x(0)) = x_0'Px_0$ ) and reads*

$$\|y\|_2^2 \leq \gamma \|d\|_2^2 + \gamma V(x(0)) \quad (4.35)$$

#### 4.4.2 Global stability

As in paragraph 4.3.2, the global  $\mathcal{L}_2$ -performance of system (4.25) can be analyzed. We only present the corresponding theorem (the proof is quite similar to the ones of Theorem 4.2 and Theorem 4.3).

**Theorem 4.4** *If there exist a symmetric positive definite matrix  $P \in \mathbb{R}^{n \times n}$ , a matrix  $Z \in \mathbb{R}^{1 \times n}$ , positive scalars  $S$ ,  $\gamma$ ,  $\tau_F$  and  $\tau_R$  satisfying:*

$$\begin{bmatrix} A_f'P + PA_f + \tau_F M & PB - K'S & PB_d & C' \\ * & -2S & 0 & 0 \\ * & * & -I_q & 0 \\ * & * & 0 & -\gamma \end{bmatrix} < 0 \quad (4.36)$$

$$A_j'PA_j - P - \tau_R M \leq 0 \quad (4.37)$$

then

- When  $d = 0$ , the reset control system (4.25) is globally asymptotically stable.
- When  $d \neq 0$  and  $x_0 = 0$ , the finite  $\mathcal{L}_2$  gain from  $d$  to  $y$  is less than or equal to  $\sqrt{\gamma}$ , that is for all  $d$  satisfying (4.34), this is  $\|y\|_2 \leq \sqrt{\gamma}\|d\|_2$ .

Note that in the context of global stability, the  $\mathcal{L}_2$ -gain of the system can be studied for any initial state  $x(0) = x_0$ . Hence, the second item of Remark 4.3 is also valid for Theorem 4.4, i.e. for  $x(0) = x_0 \neq 0$ , the  $\mathcal{L}_2$ -norm of the output  $y$  depends on the  $\mathcal{L}_2$ -norm of the input  $d$  and on the value of the Lyapunov function at the initial time, as shown in (4.35).

## 4.5 Other Reset Conditions

In this section, we modify the usual definition of the flow and jump sets (previously described by relations (4.8) and (4.10)). This leads to a study of a hybrid system different from system (4.6). Moreover, we introduce control modifications in order to enlarge the stability region of the closed-loop system. Since, the reset acts only on controller state  $x_r$ , a natural approach is then to exploit flexibility of the reset controller to increase the stability region in the  $x_r$ -direction. Hence, we propose to estimate the basin of attraction, denoted  $\mathcal{E}$ , of the saturated system without reset by using frameworks proposed in [33]. This stability region is considered as the flow set and resets are allowed outside  $\mathcal{E}$ . These considerations lead to the following hybrid system (without additive perturbation):

$$\left. \begin{array}{l} \dot{x} = A_f x + B\Psi(Kx) \\ y = Cx \\ x^+ = A_j x \end{array} \right\} \begin{array}{l} \text{if } x \in \mathcal{E}(P) \\ \\ \text{if } x \in \text{clos}(\mathbb{R}^n \setminus \mathcal{E}(P)) \end{array} \quad (4.38)$$

with

$$A_f = \begin{bmatrix} A_p - B_p D_c C_p & B_p C_c \\ -B_c C_p & A_c \end{bmatrix} \quad A_j = \begin{bmatrix} I_{n_p} & 0 \\ -B_r C_p & A_r \end{bmatrix} \quad B = \begin{bmatrix} B_p \\ 0 \end{bmatrix} \quad C = \begin{bmatrix} C_p' \\ 0 \end{bmatrix}'$$

and where  $\mathcal{E}(P) = \{x \in \mathbb{R}^n; x' P x \leq 1\}$  with  $P = P' > 0$ ,  $P \in \mathbb{R}^{n \times n}$ . The notation  $\text{clos}(\mathbb{R}^n \setminus \mathcal{E}(P))$  stands for the closure of  $\mathbb{R}^n \setminus \mathcal{E}(P)$ .

**Remark 4.4** Due to the form of matrix  $A_j$  and the invariance property of set  $\mathcal{E}$ , Zeno solutions for hybrid system (4.38) are avoided. Assumption 2.1 is then always satisfied and temporal regularization can be avoided.

**Remark 4.5** Flow and jump sets of system (4.38) could be written as

$$\begin{aligned} \mathcal{F} &= \mathcal{E}(P) = \{x \in \mathbb{R}^n; x' P x \leq 1\} \\ \mathcal{J} &= \text{clos}(\mathbb{R}^n \setminus \mathcal{F}) \end{aligned} \quad (4.39)$$

### 4.5.1 Stability analysis

In this subsection, we consider the reset rule  $x_r^+ = 0$ , i.e.

$$A_j = \begin{bmatrix} I_{n_p} & 0 \\ 0 & 0 \end{bmatrix}$$

and we develop constructive conditions to estimate the stability region of system (4.38).

**Proposition 4.1** *Let  $N = \begin{bmatrix} I_{n_p} & 0 \end{bmatrix} \in \mathbb{R}^{n_p \times n}$ . If there exist a symmetric positive definite matrix  $W \in \mathbb{R}^{n \times n}$ , a matrix  $Y \in \mathbb{R}^{1 \times n}$  and two positive scalars  $U$  and  $\alpha$  satisfying:*

$$\begin{bmatrix} WA'_f + A_f W & BU - Y' \\ * & -2U \end{bmatrix} < 0 \quad (4.40)$$

$$\begin{bmatrix} W & WK' - Y' \\ * & u_0^2 \end{bmatrix} \geq 0 \quad (4.41)$$

$$\begin{bmatrix} W & N' \\ * & \alpha I_{n_p} \end{bmatrix} \geq 0 \quad (4.42)$$

then the domain  $\mathcal{E}(P) \cup \mathcal{D}$ , with  $\mathcal{E}(P) = \{x \in \mathbb{R}^n; x'Px \leq 1\}$ ,  $P = W^{-1}$  and  $\mathcal{D} = \{x \in \mathbb{R}^n; |Nx| \leq \sigma^{-1}\}$ ,  $\sigma = \sqrt{\alpha}$ , is an asymptotic stability region for reset control system (4.38).

**Proof** We consider the quadratic Lyapunov function  $V(x) = x'Px$ ,  $P = P' > 0$  and we denote  $W = P^{-1}$ . According to Lemma 1 in [33], the satisfaction of relations (4.40) and (4.41) with  $Y = GW$  implies that

$$\dot{V}(x) \leq \dot{V}(x) - 2\Psi(Kx)'U^{-1}(\Psi(Kx) + YW^{-1}x) < 0, \text{ for all } x \in \mathcal{E}(P)$$

It follows that the set  $\mathcal{E}(P)$  is a positively invariant and contractive region for the continuous part of system (4.38), i.e. for any  $x(0) \in \mathcal{E}(P)$ , the corresponding trajectory remains confined in  $\mathcal{E}(P)$  and converges to the origin.

The possibility of reset allows us to consider initial conditions outside of  $\mathcal{E}(P)$ . Indeed, if  $x_0 = x(0)$  is such as  $x_0^+ \in \mathcal{E}(P)$ , the asymptotic stability of reset control system (4.38) is guaranteed. Then, we are searching for a domain  $\mathcal{D}$ , as large as possible, such that

$$x_0 \in \mathcal{D} \implies x_0^+ \in \mathcal{E}(P), \text{ i.e. } \begin{bmatrix} x_{p0}^+ \\ 0 \end{bmatrix} \in \mathcal{E}(P)$$

It appears that  $\mathcal{D}$  is not limited in the direction  $x_r$  (due to  $x_{r0}^+ = 0$ ). Hence, we can define  $\mathcal{D} = \{x \in \mathbb{R}^n; |Nx| \leq \sigma^{-1}\}$  with  $\sigma$  a positive scalar and  $N = \begin{bmatrix} I_{n_p} & 0 \end{bmatrix}$ . By applying the S-procedure, the condition

$$|Nx| \leq \sigma^{-1} \implies x'A'_j P A_j x \leq 1$$

reads as  $\sigma^2 N'N - A'_j P A_j \geq 0$ . By noting that in our case  $N'N = A_j$ , this inequality can be rewritten as  $N'(\sigma^2 I_{n_p} - N P N')N \geq 0$  or with the Schur's complement [10] as relation (4.42), by setting  $\alpha = \sigma^2$ .

Thus, for any initial state in  $\mathcal{D}$  or in  $\mathcal{E}(P)$ , the resulting closed-loop trajectory asymptotically converges to the origin. Hence we can conclude that the union  $\mathcal{E}(P) \cup \mathcal{D}$  is an asymptotic stability region for the system (4.38). ■



**Remark 4.6** *It is important to note that differently from both Theorems 4.1 and 4.3, matrix  $A_f$  must be Hurwitz. This is due to the form of the block (1, 1) of the matrix in relation (4.40).*

**Remark 4.7** *Moreover, the chosen flow and jump sets lead to a particular system behavior. There is at most one jump: if controller states are initialized in  $\mathcal{D}$  but outside of the nominal stability domain  $\mathcal{E}(P)$ . Then, such flow and jump sets are a first step in proposing new reset controller to increase a nominal stability domain. Improvements concern only the controller state direction but the initialization error could be large. The next section follows this line.*

### 4.5.2 New reset law

In this subsection, we aim to increase the stability domain by synthesizing a new reset law. Then, we write the jump equation as follows (with  $r = 0$ ):

$$x_r^+ = A_r x_r + B_r e = A_r x_r - B_r C_p x_p, \quad (4.43)$$

where  $A_r$  and  $B_r$  are constant matrices of appropriate dimensions. In such conditions, the discrete dynamic matrix  $A_j$  could be rewritten:

$$A_j = \overline{A}_j + E_r \Theta F_r,$$

where  $\overline{A}_j = \begin{bmatrix} I_{n_p} & 0 \\ 0 & 0 \end{bmatrix}$ ,  $E_r = \begin{bmatrix} 0 \\ I_{n_r} \end{bmatrix}$ ,  $\Theta = \begin{bmatrix} A_r & B_r \end{bmatrix}$  and  $F_r = \begin{bmatrix} C_p & 0 \\ 0 & 1 \end{bmatrix}$ .

The following proposition provides constructive conditions to design matrices  $A_r$  and  $B_r$  in order to enlarge the nominal stability domain of system (4.38).

**Proposition 4.2** *If there exist symmetric positive definite matrices  $W \in \mathbb{R}^{n \times n}$  and  $P_1 \in \mathbb{R}^{n \times n}$ , a matrix  $Y \in \mathbb{R}^{1 \times n}$ ,  $\Theta \in \mathbb{R}^{2n_r \times (n_r+1)}$  and a positive scalar  $S$  such that*

$$\begin{bmatrix} W A_f' + A_f W & B S - Y' \\ S B' - Y & -2S \end{bmatrix} < 0 \quad (4.44)$$

$$\begin{bmatrix} W & W K' - Y' \\ K W - Y & u_0^2 \end{bmatrix} \geq 0 \quad (4.45)$$

$$\begin{bmatrix} P_1 & (\overline{A}_j + E_r \Theta F_r)' \\ \overline{A}_j + E_r \Theta F_r & W \end{bmatrix} \geq 0, \quad (4.46)$$

*then the domain  $\mathcal{E}(P) \cup \mathcal{D}(P_1)$ , with  $\mathcal{E}(P) = \{x \in \mathbb{R}^n; x' P x \leq 1\}$ ,  $P = W^{-1}$  and  $\mathcal{D}(P_1) = \{x \in \mathbb{R}^n; x' P_1 x \leq 1\}$  is an asymptotic stability region for the system (4.38).*

**Proof** Inequalities (4.44) and (4.45) are obtained as in Proposition 4.1. They guarantee that for all initial conditions in  $\mathcal{E}(P) = \{x \in \mathbb{R}^n; x' P x \leq 1\}$  the corresponding closed-loop trajectories stay in  $\mathcal{E}(P)$  and converge toward the origin.

As previously in Proposition 4.1, we are searching for a set  $\mathcal{D}(P_1) = \{x \in \mathbb{R}^n; x'P_1x \leq 1\}$  (where  $P_1$  is a symmetric positive definite matrix), such that the following implication holds

$$x \in \mathcal{D}(P_1) \implies x^+ \in \mathcal{E}(P) \quad (4.47)$$

By using successively the S-procedure and the Schur's complement, the relation (4.47) could be written as relation (4.46). ■

**Remark 4.8** *In Proposition 4.1 (and 4.2), Zeno solutions do not occur. The LMI (4.42) (respectively (4.46)) implies flowing after jumping. Thus temporal regularization is not needed.*

**Remark 4.9** *Both propositions are quite similar, but the design of matrices  $A_r$  and  $B_r$  in relation (4.43) allow us to obtain a larger stability domain, in particular in the  $x_p$ -direction.*

**Remark 4.10** *We emphasize that Propositions 4.1 and 4.2 could easily apply to MIMO systems contrarily to Theorem 4.1, for example. This is mainly due to the way chosen for describing the flow and jump sets. Indeed, in Theorem 4.1,  $\mathcal{F}$  and  $\mathcal{J}$  are defined with controller input(s) and output(s), while they depend on states value in Propositions 4.1 and 4.2.*

**Remark 4.11** *If the system (4.38) is subject to an external perturbation  $d$  such that*

$$\left. \begin{array}{l} \dot{x} = A_f x + B\Psi(Kx) + B_d d \\ y = Cx \\ x^+ = A_j x \end{array} \right\} \begin{array}{l} \text{if } x \in \mathcal{E}(P) \\ \text{if } x \in \text{clos}(\mathbb{R}^n \setminus \mathcal{E}(P)) \end{array} \quad (4.48)$$

where  $B_d$  is matrix of appropriate dimensions. To avoid pernicious behavior, in particular Zeno phenomena, the continuous-time trajectories of system (4.48) in presence of external perturbation must belong to the ellipsoid  $\mathcal{E}(P)$ , defined in (4.39). In other words, the perturbation must be limited in energy such that  $\|d\|_2 \leq 1$ .

The work exposed in sections 4.3, 4.4 and 4.5, can be summarized as the stability and performance analysis of a closed-loop system including a saturation. The controller of this system is augmented with a reset law to improve some properties: performance or stability domain. In the framework of actuator saturation, a common approach to limit the influence of the saturation, or at least its bad effects, is to consider anti-windup strategy. The next section is dedicated to this topic.

## 4.6 Anti-windup synthesis

The anti-windup strategy is a well-known and efficient technique to cope with undesirable effects (on both performance and stability) induced by actuator saturation in control loops. The design of anti-windup compensator was first motivated by dealing with the

degradation of the transient performance induced by saturation in feedback control systems containing integral actions [27]. More recently, the anti-windup compensator design through formal and systematic methods has emerged (see, for example, [62], [65], [25] for a large recent overview). In particular many LMI-based approaches now exist to design anti-windup compensator. Then conditions developed in the sequel lie in this framework and rest on a recent characterization of the deadzone nonlinearity using some local representation like in previous Sections 4.3, 4.4 and 4.5. The results presented in the sequel are contained in [63].

### 4.6.1 Modified closed-loop model

We consider the input saturated plant (4.1) and the reset control system (4.3), with a null reference.

For presentation purpose, we define the interconnection as  $e = y$ .

The anti-windup strategy leads to consider the following anti-windup compensator:

$$\begin{aligned} \dot{x}_a &= A_a x_a + B_a (\text{sat}(y_r) - y_r) \\ y_a &= C_a x_a + D_a (\text{sat}(y_r) - y_r) \end{aligned} \quad (4.49)$$

which yields the modified controller:

$$\left. \begin{aligned} \dot{x}_r &= A_c x_r + B_c e + y_a \\ y_r &= C_c x_r + D_c y \\ \dot{\tau} &= 1 \end{aligned} \right\} \text{if } (x_p, x_r, x_a) \in \mathcal{F} \text{ or } \tau \leq \rho \quad (4.50)$$

$$\left. \begin{aligned} x_r^+ &= 0 \\ \tau^+ &= 0 \end{aligned} \right\} \text{if } (x_p, x_r, x_a) \in \mathcal{J} \text{ and } \tau \geq \rho$$

where  $x_a \in \mathbb{R}^{n_a}$ ,  $(\text{sat}(y_r) - y_r) \in \mathbb{R}$ ,  $y_a \in \mathbb{R}^{n_r}$  are the state, the input and the output vectors of the anti-windup compensator.  $A_a$ ,  $B_a$ ,  $C_a$  and  $D_a$  are matrices of appropriate dimensions to be designed. We recall that  $y_r \in \mathbb{R}$  acts as the input of the plant (4.1) and  $y \in \mathbb{R}$  is the output of the plant (4.1).

To write the resulting closed-loop system, let us define the augmented state vector

$$x = \begin{bmatrix} x_p \\ x_r \\ x_a \end{bmatrix} \in \mathbb{R}^n \quad (4.51)$$

with  $n = n_p + n_r + n_a$  and the following deadzone nonlinearity:

$$\phi(Kx) = \text{sat}(Kx) - Kx, \quad K = \begin{bmatrix} D_c C_p & C_c & 0 \end{bmatrix} = \begin{bmatrix} K_1 & 0 \end{bmatrix} \in \mathbb{R}^{n_r \times n} \quad (4.52)$$

For performance purpose, we also define the controlled output  $z \in \mathbb{R}^{n_z}$  for the plant (4.1):

$$z = C_z x_p + D_z y \quad (4.53)$$

where  $C_z$  and  $D_z$  are constant matrices of appropriate dimensions.

**Remark 4.12** *In some cases, it is interesting to characterize the behavior of the studied system by an output  $z$  different from the real measured output  $y$ . It is often enough to consider  $z = y$  and then  $n_z = n$ .*

Hence, by combining (4.49), (4.50), (4.51), (4.52) and (4.53), the closed-loop system reads:

$$\left. \begin{aligned} \dot{x} &= A_F x + B_F \phi(Kx) + B_d d \\ y_r &= Kx \\ y &= Cx \\ z &= C_2 x + D_z \phi(Kx) \\ \dot{\tau} &= 1 \\ x^+ &= A_J x \\ \tau^+ &= 0 \end{aligned} \right\} \begin{array}{l} \text{if } x \in \mathcal{F} \text{ or } \tau \leq \rho \\ \text{if } x \in \mathcal{J} \text{ and } \tau \geq \rho \end{array} \quad (4.54)$$

with

$$\begin{aligned} A_F &= \begin{bmatrix} A_p + B_p D_c C_p & B_p C_c & 0 \\ B_c C_p & A_c & C_a \\ 0 & 0 & A_a \end{bmatrix} = \begin{bmatrix} A & RC_a \\ 0 & A_a \end{bmatrix}, \quad B_F = \begin{bmatrix} B_p \\ D_a \\ B_a \end{bmatrix} = \begin{bmatrix} B + RD_a \\ B_a \end{bmatrix} \\ B_d &= \begin{bmatrix} B_{pd} \\ 0 \\ 0 \end{bmatrix} = \begin{bmatrix} \mathbb{B}_d \\ 0 \end{bmatrix}, \quad B = \begin{bmatrix} B_p \\ 0 \end{bmatrix}, \quad R = \begin{bmatrix} 0 \\ I_{n_r} \end{bmatrix}, \quad C = \begin{bmatrix} C_p & 0 & 0 \end{bmatrix} = \begin{bmatrix} C_1 & 0 \end{bmatrix} \\ C_2 &= \begin{bmatrix} C_z + D_z D_c C_p & D_z C_c & 0 \end{bmatrix} = \begin{bmatrix} \mathbb{C}_z & 0 \end{bmatrix} \end{aligned} \quad (4.55)$$

In the sequel, two possible structures for the desired matrix  $A_J \in \mathbb{R}^{n \times n}$  can be considered:

$$A_J = \begin{bmatrix} I_{n_p} & 0 & 0 \\ 0 & 0 & 0 \\ 0 & 0 & 0 \end{bmatrix} = \begin{bmatrix} A_{J0} & 0 \\ 0 & 0 \end{bmatrix} \quad \text{or} \quad A_J = \begin{bmatrix} I_{n_p} & 0 & 0 \\ 0 & 0 & 0 \\ 0 & 0 & I_{n_a} \end{bmatrix} = \begin{bmatrix} A_{J0} & 0 \\ 0 & I_{n_a} \end{bmatrix} \quad (4.56)$$

That means that both the states of the controller and of the anti-windup compensator are reset (first structure) or only the state of the controller is reset (second structure).

Moreover, we consider the case where the flow and jump sets are defined from the classical reset rule depending on the sign of the product between  $e$  (input of the controller) and  $y_r$  (output of the controller) (see for example [68], [54]). Hence, the sets  $\mathcal{F}$  and  $\mathcal{J}$  are defined by:

$$\begin{aligned} \mathcal{F} &= \{x \in \mathbb{R}^n ; x' M x \geq 0\} \\ \mathcal{J} &= \{x \in \mathbb{R}^n ; x' M x \leq 0\} \end{aligned} \quad (4.57)$$

In (4.57), matrix  $M$  is a reset matrix of appropriate dimensions satisfying  $M = Q' \mathcal{M} Q$  with:

$$\begin{aligned} \mathcal{M} &= \begin{bmatrix} 0 & -1 \\ -1 & 0 \end{bmatrix} \in \mathbb{R}^{2 \times 2} \\ Q &= \begin{bmatrix} C_p & 0 & 0 \\ D_c C_p & C_c & 0 \end{bmatrix} = \begin{bmatrix} C \\ K \end{bmatrix} = \begin{bmatrix} C_1 & 0 \\ K_1 & 0 \end{bmatrix} = \begin{bmatrix} Q_1 & 0 \end{bmatrix} \in \mathbb{R}^{2 \times n} \end{aligned} \quad (4.58)$$

Hence, inspired from Problems 4.1 and 4.2, the objective of this section is the following issue:

**Problem 4.3** Given flow and jump sets  $\mathcal{F}$  and  $\mathcal{J}$ .

1. When  $d = 0$ , determine the anti-windup compensator, i.e., matrices  $A_a$ ,  $B_a$ ,  $C_a$  and  $D_a$ , and a region  $\mathcal{E}$ , as large as possible, such that for any initial condition  $x_0 \in \mathcal{E}$ ,  $\tau(0) = 0$ , the asymptotic stability of the closed-loop system (4.54) is guaranteed.
2. When  $d \neq 0$ , the  $\mathcal{L}_2$  gain from  $d$  to  $z$ , in the case of null initial condition ( $x(0) = 0$ ), for all disturbances  $d$  satisfying (2.8) is such that:  $\|z\|_2^2 \leq \gamma \|d\|_2^2$ .

### 4.6.2 Stability analysis and anti-windup synthesis

In this paragraph, we propose a result to address Problem 4.3.

**Theorem 4.5** If there exist symmetric positive definite matrices  $X \in \mathbb{R}^{(n_p+n_r) \times (n_p+n_r)}$ ,  $Y \in \mathbb{R}^{(n_p+n_r) \times (n_p+n_r)}$ ,  $M_1 \in \mathbb{R}^{2 \times 2}$ , a positive diagonal matrix  $S \in \mathbb{R}^{1 \times 1}$ , matrices  $Z_1 \in \mathbb{R}^{1 \times (n_p+n_r)}$ ,  $\mathcal{Z} \in \mathbb{R}^{1 \times (n_p+n_r)}$ ,  $\Omega_1 \in \mathbb{R}^{(n_p+n_r) \times (n_p+n_r)}$ ,  $\Omega_2 \in \mathbb{R}^{(n_p+n_r) \times 1}$ ,  $\Omega_3 \in \mathbb{R}^{n_r \times (n_p+n_r)}$ ,  $\Omega_4 \in \mathbb{R}^{n_r \times 1}$ , positive scalars  $\tau_F$ ,  $\tau_R$ ,  $\delta$ ,  $\gamma$  such that the following conditions hold:

$$\begin{bmatrix} XA' + AX & XA' + AY + R\Omega_3 + \Omega_1 & BS + R\Omega_4 + \Omega_2 - \mathcal{Z}' \\ \star & AY + YA' + R\Omega_3 + \Omega_3'R' & BS + R\Omega_4 - Z_1' \\ \star & \star & -2S \\ \star & \star & \star \\ \star & \star & \star \\ \star & \star & \star \\ \mathbb{B}_w & XC'_z & \tau_F XQ'_1 \\ \mathbb{B}_w & YC'_z & \tau_F YQ'_1 \\ 0 & SD'_z & 0 \\ -I_{n_d} & 0 & 0 \\ \star & -\gamma I_{n_z} & 0 \\ \star & \star & -\tau_F M_1^{-1} \end{bmatrix} < 0 \quad (4.59)$$

$$\begin{bmatrix} X & X & XK'_1 - \mathcal{Z}' \\ \star & Y & YK'_1 - Z_1' \\ \star & \star & \delta u_0^2 \end{bmatrix} \geq 0 \quad (4.60)$$

$$\begin{bmatrix} -X & -X & XA'_{J_0} & XA'_{J_0} & \tau_R XQ'_1 \\ \star & -Y & YA'_{J_0} & YA'_{J_0} & \tau_R YQ'_1 \\ \star & \star & -X & -X & 0 \\ \star & \star & \star & -Y & 0 \\ \star & \star & \star & \star & -\tau_R M_1^{-1} \end{bmatrix} \leq 0 \quad (4.61)$$

$$-M_1 \leq \mathcal{M} \leq M_1 \quad (4.62)$$

then the anti-windup controller defined by

$$\begin{aligned} A_a &= (\mathcal{U}')^{-1} X^{-1} \Omega_1 N^{-1} \\ B_a &= (\mathcal{U}')^{-1} X^{-1} \Omega_2 S^{-1} \\ C_a &= \Omega_3 N^{-1} \\ D_a &= \Omega_4 S^{-1} \end{aligned} \quad (4.63)$$

where matrices  $\mathcal{U}$ ,  $N$  verify  $N'\mathcal{U} = I_{n_p+n_r} - YX^{-1}$ , is a solution to Problem 4.3, that is,

1. When  $d = 0$ , the nonlinear closed-loop system (4.54), with  $A_J$  defined as the first structure in (4.56), remains stable for any initial condition belonging to the set  $\mathcal{E}(P, \delta)$

$$\mathcal{E}(P, \delta) = \{x \in \mathbb{R}^n; x'Px \leq \delta^{-1}\} \quad (4.64)$$

with

$$P = W^{-1} = \begin{bmatrix} X^{-1} & \mathcal{U}' \\ \star & F \end{bmatrix}; W = \begin{bmatrix} Y & N' \\ \star & H \end{bmatrix} \quad (4.65)$$

2. When  $d \neq 0$ , for  $x(0) = 0$ ,

- the closed-loop trajectories remain bounded in  $\mathcal{E}(P, \delta)$ ,
- the map from  $z$  to  $d$  is finite  $\mathcal{L}_2$  stable and satisfies, for  $x(0) = 0$ ,  $\|z\|_2^2 \leq \gamma\|d\|_2^2$ .

**Proof** The first step of the proof is similar to the one presented in paragraph 4.4 for Theorem 4.3, which we recall briefly the sketch. Note that, we do not develop how to address the presence of the temporal regularization (for details, see the proof of Theorem 4.1).

Consider the quadratic Lyapunov function  $V(x) = x'Px$ . We suppose that the ellipsoid  $\mathcal{E}(P, \delta)$  is included in the polyhedral set

$$S(u_0) = \{x \in \mathbb{R}^n; -u_0 \leq (K - G)x \leq u_0\}$$

with  $GW = Z$ .

By using Lemma 4.1 (see also [64]), we can verify that  $-\phi(Kx)'S^{-1}(\phi(Kx) + Gx) \geq 0$ , with  $S$  a positive diagonal matrix, provided that  $x \in S(u_0)$ . Thus, for any  $x \in \mathcal{E}(P, \delta)$  one gets:

$$\dot{V}(x) + \frac{1}{\gamma}z'z - d'd \leq \dot{V}(x) + \frac{1}{\gamma}z'z - d'd - 2\phi(Kx)'S^{-1}(\phi(Kx) + Gx)$$

We then want to verify that

$$\dot{V}(x) + \frac{1}{\gamma}z'z - d'd - 2\phi(Kx)'S^{-1}(\phi(Kx) + Gx) \leq 0 \text{ for } x \in \mathcal{F}$$

Moreover, we want also to prove that  $V(x^+) - V(x) \leq 0$  for  $x \in \mathcal{J}$ . These considerations lead to the following inequalities:

$$\begin{bmatrix} A'_F P + P A_F + \tau_F M & P B_F S - G' & P B_d & C'_2 \\ \star & -2S & 0 & S D'_z \\ \star & \star & -I_{n_d} & 0 \\ \star & \star & \star & -\gamma I_{n_z} \end{bmatrix} < 0 \quad (4.66)$$

$$\begin{bmatrix} P & K' - G' \\ \star & \delta u_0^2 \end{bmatrix} \geq 0 \quad (4.67)$$

$$A'_J P A_J - P - \tau_R M \leq 0 \quad (4.68)$$

With  $P = P' = W^{-1} > 0$ , the pre and post multiplication of (4.66) by  $\text{diag}(W, I, I, I)$  allows to write

$$\begin{bmatrix} WA'_F + A_FW + \tau_F WMW & B_FS - Z' & B_d & WC'_2 \\ \star & -2S & 0 & SD'_z \\ \star & \star & -I_{n_d} & 0 \\ \star & \star & \star & -\gamma I_{n_z} \end{bmatrix} < 0 \quad (4.69)$$

$$(4.70)$$

From relations (4.57)-(4.58) and (4.62), inequality (4.69) holds if

$$\begin{bmatrix} WA'_F + A_FW + \tau_F WQ'M_1QW & B_FS - Z' & B_d & WC'_2 \\ \star & -2S & 0 & SD'_z \\ \star & \star & -I_{n_d} & 0 \\ \star & \star & \star & -\gamma I_{n_z} \end{bmatrix} < 0$$

By using the Schur's complement, this inequality reads

$$\begin{bmatrix} WA'_F + A_FW & B_FS - Z' & B_d & WC'_2 & \tau_F WQ' \\ \star & -2S & 0 & SD'_z & 0 \\ \star & \star & -I_{n_d} & 0 & 0 \\ \star & \star & \star & -\gamma I_{n_z} & 0 \\ \star & \star & \star & \star & -\tau_F M_1^{-1} \end{bmatrix} < 0 \quad (4.71)$$

Similarly, we pre and post multiply (4.67) by  $\text{diag}(W, 1)$ . This leads to

$$\begin{bmatrix} W & WK' - Z' \\ \star & \delta u_0^2 \end{bmatrix} \geq 0 \quad (4.72)$$

The relation (4.68) reads by using the Schur's complement upon a pre- and post-multiplication by  $W$ :

$$\begin{bmatrix} -W - \tau_R WQ'MQW & WA'_J \\ \star & -W \end{bmatrix} \leq 0 \quad (4.73)$$

From relation (4.62) one can overbound the term  $-\tau_R WQ'MQW$  by  $\tau_R WQ'M_1QW$ . Thus, by using the Schur's complement, condition (4.73) can be rewritten as:

$$\begin{bmatrix} -W & WA'_J & \tau_R WQ' \\ \star & -W & 0 \\ \star & \star & -\tau_R M_1^{-1} \end{bmatrix} \leq 0 \quad (4.74)$$

Hence, the satisfaction of relations (4.71), (4.72), (4.74) and (4.62) ensures that conditions (2.16)-(2.19) of Theorem 2.1 are satisfied.

The second part of the proof is dedicated to the synthesis issue as stated in Problem 4.3. In particular, different frameworks can be adapted in order to obtain quasi-convex or convex conditions in the case  $n_a = n_p + n_r$ : one can, for example, cite the framework used in [8], [25], based on the projection lemma, or that one based on a change of variables [59], [7].

At this aim, let us define:  $W = \begin{bmatrix} Y & N' \\ \star & H \end{bmatrix}$  and  $P = W^{-1} = \begin{bmatrix} X^{-1} & \mathcal{U}' \\ \star & F \end{bmatrix}$ , where  $X$ ,  $Y$ ,  $N$ ,  $\mathcal{U}$ ,  $F$  and  $H$  are decision variables of appropriate dimensions. Then, it follows:  $YX^{-1} + N'\mathcal{U} = I_{n_a}$ ,  $Y\mathcal{U}' + N'F = 0$ ,  $NX^{-1} + H\mathcal{U} = 0$  and  $N\mathcal{U}' + HF = I_{n_a}$ . Similarly to [59], we use the matrix  $\Gamma = \begin{bmatrix} I_{n_a} & I_{n_a} \\ \mathcal{U}X & 0 \end{bmatrix}$ . From this, one gets:

$$\begin{aligned} \Gamma'W &= \begin{bmatrix} X & 0 \\ Y & N' \end{bmatrix}; \Gamma'W\Gamma = \begin{bmatrix} X & X \\ X & Y \end{bmatrix} \\ \Gamma'WA'_F\Gamma &= \begin{bmatrix} XA' & XA' \\ YA' + N'C'_aR' + N'A'_a\mathcal{U}X & YA' + N'C'_aR' \end{bmatrix} \\ \Gamma'(B_FS - Z') &= \begin{bmatrix} BS + RD_aS + X\mathcal{U}'B_aS - (Z'_1 + X\mathcal{U}'Z'_2) \\ BS + RD_aS - Z'_1 \end{bmatrix} \\ \Gamma'B_2 &= \begin{bmatrix} \mathbb{B}_d \\ \mathbb{B}_d \end{bmatrix}; \Gamma'WC'_2 = \begin{bmatrix} XC'_z \\ YC'_z \end{bmatrix}; \Gamma'WQ' = \begin{bmatrix} XQ'_1 \\ YQ'_1 \end{bmatrix} \end{aligned}$$

where the variable  $Z$  can be partitioned as  $Z = \begin{bmatrix} Z_1 & Z_2 \end{bmatrix} \in \mathbb{R}^{1 \times n}$ , with  $Z_1 \in \mathbb{R}^{1 \times (n_p + n_r)}$  and  $Z_2 \in \mathbb{R}^{1 \times (n_p + n_r)}$  (since  $n_a = n_p + n_r$ ).

Hence, relation (4.59) is obtained by pre- and post-multiplying relation (4.71) by  $\text{diag}(\Gamma', I, I, I, I)$  and by  $\text{diag}(\Gamma, I, I, I, I)$ , respectively and by using the following change of variables:

$$\Omega_1 = X\mathcal{U}'A_aN; \Omega_2 = X\mathcal{U}'B_aS; \Omega_3 = C_aN; \Omega_4 = D_aS; \mathcal{Z} = Z_1 + Z_2\mathcal{U}X \quad (4.75)$$

By the same way, relation (4.60) is obtained by pre- and post-multiplying relation (4.72) by  $\text{diag}(\Gamma', I)$  and by  $\text{diag}(\Gamma, I)$  and by using the change of variables (4.75).

Finally, relation (4.61) is obtained by pre- and post-multiplying relation (4.74) by  $\text{diag}(\Gamma', \Gamma', I)$  and by  $\text{diag}(\Gamma, \Gamma', I)$  and by considering the first structure of matrix  $A_J$  given in (4.56). Then, it follows:

$$\Gamma'WA'_J\Gamma = \begin{bmatrix} XA'_{J0} & XA'_{J0} \\ YA'_{J0} & YA'_{J0} \end{bmatrix} \quad (4.76)$$

This completes the proof of Theorem 4.5. ■

**Remark 4.13** *A key tool, in the previous theorem, is the form of the matrix  $\mathcal{M}$  that is bounded by an unknown positive definite matrix  $M_1 \in \mathbb{R}^{2 \times 2}$ , being a decision variable. Moreover Theorem 4.5 presents quasi-convex conditions because one of the nonlinearities (or non-convexity) is due to the presence of both  $M_1$  and  $M_1^{-1}$  in the conditions,  $M_1^{-1} \in \mathbb{R}^{2 \times 2}$  being a decision variable. Nevertheless, a way to overcome such a problem consists of fixing  $M_1$  as a diagonal positive definite matrix. Then, a search for the optimal solution over a bi-dimensional grid (composed by the 2 elements of  $M_1$ ) can be considered. A sub-case can be to choose  $M_1 = m_1I_2$  implying to use an iterative line search. An alternative solution consists in using a relaxation scheme, which translates the problem into a sequence of iterative LMI problems fixing  $M_1$  or the other variables at each step, can be considered.*



In this case, the convergence of the procedure is always ensured, but not necessarily to the global optimal value. Furthermore, the convergence value will depend on the initialization of  $M_1$  in the iterative procedure.

The two other nonlinearities are due to the products  $\tau_F X$ ,  $\tau_F Y$ ,  $\tau_R X$ ,  $\tau_R Y$ . Nevertheless, positive parameters  $\tau_F$  and  $\tau_R$  related to the use of the  $S$ -procedure may be a priori fixed. Although their numerical values may have an impact on the obtained solution, it remains limited and the a priori choice does not prevent from obtaining an admissible solution.

**Remark 4.14** The design of a static anti-windup gain can also be addressed by considering  $n_a = 0$ ,  $A_a = 0$ ,  $B_a = 0$ ,  $C_a = 0$  and by only computing the gain  $D_a$ .

Theorem 4.5 allows us to synthesize dynamic anti-windup compensator (4.49). As explained in Remark 4.13, adequate algorithms can be considered in order to deal with the nonlinearities into conditions of Theorem 4.5. From these, we are also able to estimate the basin of attraction and the  $\mathcal{L}_2$ -gain of the system (4.54). Actually, matrices  $A_a$ ,  $B_a$ ,  $C_a$  and  $D_a$  could be obtained in order to optimize the stability region and the performance estimation (or both). An associated convex optimization problem is presented in Chapter 5.

**Remark 4.15** The proof of Theorem 4.5 has been developed for the first structure of matrix  $A_J$  in definition (4.56). If the second structure is considered, i.e. anti-windup states remain constant during jump transition, only inequality (4.61) in Theorem 4.5 has to be modified. Indeed in such a case, relation (4.76) reads

$$\Gamma' W A'_J \Gamma = \begin{bmatrix} X & 0 \\ Y & N' \end{bmatrix} \begin{bmatrix} A'_{J0} & 0 \\ 0 & I_{n_a} \end{bmatrix} \begin{bmatrix} I_{n_a} & I_{n_a} \\ UX & 0 \end{bmatrix} = \begin{bmatrix} X A'_{J0} & X A'_{J0} \\ Y A'_{J0} + N' U X & Y A'_{J0} \end{bmatrix}$$

or again with  $N' U = I - Y X^{-1}$ ,

$$\begin{bmatrix} X A'_{J0} & X A'_{J0} \\ Y A'_{J0} + X - Y & Y A'_{J0} \end{bmatrix} \quad (4.77)$$

Thus, to use Theorem 4.5 with  $x_a^+ = x_a$ , relation (4.61) has to be replaced by

$$\begin{bmatrix} -X & -X & X A'_{J0} & X A'_{J0} & \tau_R X Q'_1 \\ \star & -Y & Y A'_{J0} + X - Y & Y A'_{J0} & \tau_R Y Q'_1 \\ \star & \star & -X & -X & 0 \\ \star & \star & \star & -Y & 0 \\ \star & \star & \star & \star & -\tau_R M_1^{-1} \end{bmatrix} \leq 0 \quad (4.78)$$

**Remark 4.16** Under some conditions, the order,  $n_a$ , of the anti-windup compensator can be reduced. In the special case where the matrices  $A_a$  and  $C_a$  of the anti-windup compensator are a priori fixed. This allows not only to control the order of the anti-windup compensator but also to reduce the computational efforts. The main difficulty however resides in choosing the matrices  $A_a$  and  $C_a$  adequately. According to the approach developed

in [8] for instance (see also [66], [45]) this choice may be carried out by considering the poles of the anti-windup controller. These poles can be chosen by selecting a part of poles obtained in the full order design case ( $n_a = n_p + n_r$ ). Typically, the slow and fast dynamics are eliminated. Alternatively, an iterative procedure starting from the static case can be used. The list of poles is then progressively enriched until the gap between the full and reduced order cases becomes small enough. Note then that the order of the controller is now given by  $n_a = n_1 + 2n_2$ , where  $n_1$  and  $n_2$  correspond respectively to real and complex poles and have to be chosen sufficiently small, so that  $n_a < n_p + n_r$ . The algorithm proposed in [45] is based on a different decomposition of the anti-windup controller using dyadic forms and the associated procedure requires the user to specify output pole directions which may not be trivial.

Another interesting way consists in imposing a particular architecture to the anti-windup compensator, quite different from the anti-windup scheme (4.49) and in copying in part the plant as follows [34], [40]:

$$\begin{aligned} \dot{x}_a &= (A_p + B_p F_a)x_a + B_p(\text{sat}(y_r + y_{a1}) - (y_r + y_{a1})) \\ y_{a1} &= F_a x_a \\ y_{a2} &= C_p x_a \end{aligned} \quad (4.79)$$

leading to the modified controller:

$$\left. \begin{aligned} \dot{x}_c(t, j) &= A_c x_c(t, j) + B_c(y(t) + y_{a2}) \\ y_r(t, j) &= C_c x_r(t, j) + D_c(y(t) + y_{a2}) \\ \dot{\tau}(t, j) &= 1 \end{aligned} \right\} \text{if } (x_p, x_r, x_a) \in \mathcal{F} \text{ or } \tau \leq \rho \quad (4.80)$$

$$\left. \begin{aligned} x_r(t_{j+1}, j+1) &= 0 \\ \tau(t_{j+1}, j+1) &= 0 \end{aligned} \right\} \text{if } (x_p, x_r, x_a) \in \mathcal{J} \text{ and } \tau \geq \rho$$

where  $x_a \in \mathbb{R}^{n_p}$ ,  $\text{sat}(y_r + y_{a1}) - (y_r + y_{a1})$ ,  $y_{a2} \in \mathbb{R}$ ,  $y_{a1} \in \mathbb{R}$  are the state, the input and the outputs of the anti-windup compensator. Using the augmented state vector  $x$ , as defined in (4.51), similar closed-loop system as described in (4.54) can be obtained. The anti-windup design then consists in synthesizing the gain  $F_a$  such that matrix  $A_p + B_p F_a$  is Hurwitz. Similarly to section 4.5 we can adapt the conditions in the case where the flow and jump sets are defined from the region of stability.

### 4.6.3 Another reset law

The approach to design an anti-windup compensator developed in Paragraph 4.6.2 can be easily extended to the framework described in Section 4.5. In this framework, we can also design new reset laws for the controller and/or the anti-windup compensator. The following theorem proposes constructive conditions to address Problem 4.3 in this way.

Let us first define the structure of the desired matrix  $A_J$ :

$$A_J = \begin{bmatrix} A_{J0} & 0 \\ 0 & 0 \end{bmatrix} + E_r \Theta F_r = A_{J1} + E_r \Theta F_r \quad (4.81)$$

with

$$A_{J0} = \begin{bmatrix} I_{n_p} & 0 \\ 0 & 0 \end{bmatrix}; E_r = \begin{bmatrix} 0 & 0 \\ I_{n_r} & 0 \\ 0 & I_{n_p+n_r} \end{bmatrix}; F_r = \begin{bmatrix} C_p & 0 & 0 \\ 0 & I_{n_r} & 0 \\ 0 & 0 & I_{n_p+n_r} \end{bmatrix} \quad (4.82)$$

$$\Theta = \begin{bmatrix} A_{r1} & B_{r1} & C_{r1} \\ A_{r2} & B_{r2} & C_{r2} \end{bmatrix} = \begin{bmatrix} A_r & B_r & C_r \end{bmatrix}$$

In the proposed structure (4.82), matrices  $A_r \in \mathbb{R}^{(n_p+2n_r) \times 1}$ ,  $B_r \in \mathbb{R}^{(n_p+2n_r) \times n_r}$ ,  $C_r \in \mathbb{R}^{(n_p+2n_r) \times (n_p+n_r)}$  are decision variables, which correspond to the jump equations:

$$\begin{aligned} x_p^+ &= x_p \\ x_r^+ &= A_{r1}C_p x_p + B_{r1}x_r + C_{r1}x_a \\ x_a^+ &= A_{r2}C_p x_p + B_{r1}x_r + C_{r1}x_a \end{aligned} \quad (4.83)$$

Let us remind that the anti-windup compensator has a dimension  $n_a = n_p + n_r$ . Furthermore, the flow and jump sets are defined as

$$\begin{aligned} \mathcal{F} &= \mathcal{E}(P, \delta) = \{x \in \mathbb{R}^n; x'Px \leq \delta^{-1}\} \\ \mathcal{J} &= \text{clos}(\mathbb{R}^n \setminus \mathcal{E}(P, \delta)) \end{aligned} \quad (4.84)$$

where  $\text{clos}(\cdot)$  stands for the closure.

**Theorem 4.6** *If there exist four symmetric positive definite matrices  $X \in \mathbb{R}^{(n_p+n_r) \times (n_p+n_r)}$ ,  $Y \in \mathbb{R}^{(n_p+n_r) \times (n_p+n_r)}$ ,  $P_{11} \in \mathbb{R}^{(n_p+n_r) \times (n_p+n_r)}$ ,  $P_{13} \in \mathbb{R}^{(n_p+n_r) \times (n_p+n_r)}$ , a positive diagonal matrix  $S \in \mathbb{R}^{1 \times 1}$ , matrices  $Z_1 \in \mathbb{R}^{1 \times (n_p+n_r)}$ ,  $Z \in \mathbb{R}^{1 \times (n_p+n_r)}$ ,  $P_{12} \in \mathbb{R}^{(n_p+n_r) \times (n_p+n_r)}$ ,  $\Omega_1 \in \mathbb{R}^{(n_p+n_r) \times (n_p+n_r)}$ ,  $\Omega_2 \in \mathbb{R}^{(n_p+n_r) \times 1}$ ,  $\Omega_3 \in \mathbb{R}^{n_r \times (n_p+n_r)}$ ,  $\Omega_4 \in \mathbb{R}^{n_r \times 1}$ ,  $\Omega_5 \in \mathbb{R}^{(2n_r+n_p) \times 1}$ ,  $\Omega_6 \in \mathbb{R}^{(2n_r+n_p) \times n_r}$ ,  $\Omega_7 \in \mathbb{R}^{(2n_r+n_p) \times (n_r+n_p)}$ , positive scalars  $\delta, \gamma$  satisfying*

$$\begin{bmatrix} XA' + AX & XA' + AY + R\Omega_3 + \Omega_1 & BS + R\Omega_4 + \Omega_2 - Z' & \mathbb{B}_w & XC'_z \\ * & AY + YA' + R\Omega_3 + \Omega'_3 R' & BS + R\Omega_4 - Z'_1 & \mathbb{B}_w & YC'_z \\ * & * & -2S & 0 & SD'_z \\ * & * & * & -I_{n_d} & 0 \\ * & * & * & * & -\gamma I_{n_z} \end{bmatrix} < 0 \quad (4.85)$$

$$\begin{bmatrix} X & X & XK'_1 - Z' \\ * & Y & YK'_1 - Z'_1 \\ * & * & \delta u_0^2 \end{bmatrix} \geq 0 \quad (4.86)$$

$$\begin{bmatrix} P_{11} & P_{12} & A'_{J0} + C'_1 \Omega'_5 + R\Omega'_6 & A'_{J0} \\ * & P_{13} & \Omega'_7 & 0 \\ * & * & X & X \\ * & * & * & Y \end{bmatrix} \geq 0 \quad (4.87)$$

then the anti-windup controller defined by

$$\begin{aligned} A_a &= (\mathcal{U}')^{-1} X^{-1} \Omega_1 N^{-1} \\ B_a &= (\mathcal{U}')^{-1} X^{-1} \Omega_2 S^{-1} \\ C_a &= \Omega_3 N^{-1} \\ D_a &= \Omega_4 S^{-1} \end{aligned} \quad (4.88)$$

is a solution to Problem 4.3 with  $A_J$  defined from (4.81) with

$$\begin{aligned} A_r &= (\mathcal{U}')^{-1} X^{-1} \Omega_5 \\ B_r &= (\mathcal{U}')^{-1} X^{-1} \Omega_6 \\ C_r &= (\mathcal{U}')^{-1} X^{-1} \Omega_7 \end{aligned} \quad (4.89)$$

where matrices  $\mathcal{U}$ ,  $N$  verify  $N'\mathcal{U} = I_{n_p+n_r} - YX^{-1}$ . In other words:

1. When  $d = 0$ , the nonlinear closed-loop system (4.54) remains stable for any initial condition belonging to the set  $\mathcal{E}(P, \delta) \cup \mathcal{E}(P_1, \delta)$ , where  $\mathcal{E}(P, \delta)$  is defined as in (4.64) and  $\mathcal{E}(P_1, 1) = \{x \in \mathbb{R}^n; x' P_1 x \leq \delta^{-1}\}$  with

$$P = W^{-1} = \begin{bmatrix} X^{-1} & \mathcal{U}' \\ \star & F \end{bmatrix}; W = \begin{bmatrix} Y & N' \\ \star & H \end{bmatrix}; P_1 = \begin{bmatrix} P_{11} & P_{12} \\ \star & P_{13} \end{bmatrix} \quad (4.90)$$

2. When  $w \neq 0$ , for  $x(0) = 0$ ,

- the closed-loop trajectories remain bounded in  $\mathcal{E}(P, \delta)$ ,
- the map from  $z$  to  $d$  is finite  $\mathcal{L}_2$  stable and satisfies, for  $x(0) = 0$ ,  $\|z\|_2^2 \leq \gamma \|d\|_2^2$ .

**Proof** This proof mimics in part that ones of Proposition 4.2 and Theorem 4.5. Similar definitions and changes of variables as in the proof of Theorem 4.5 are used to derive the conditions in the continuous part (flow case).

Let us focus on the discrete part (jump case) of the proof. We want verify that  $x_0^+ \in \mathcal{E}(P, \delta)$  if  $x_0 \in \mathcal{E}(P_1, \delta)$ , that is,

$$x_0' A_J' P A_J x_0 \leq \delta^{-1} \text{ if } x_0' P_1 x_0 \leq \delta^{-1}$$

By using the S-procedure, it follows that this condition will be satisfied if one gets:  $\delta(P_1 - A_J' P A_J) \geq 0$ , or equivalently,  $P_1 - A_J' P A_J \geq 0$ . From the definition of  $A_J$  given by (4.81)-(4.82) and by applying the Schur's complement one gets the following relation:

$$\begin{bmatrix} P_1 & (A_{J1} + E_r \Theta F_r)' \\ \star & W \end{bmatrix} \geq 0 \quad (4.91)$$

Hence, relation (4.87) is obtained by pre- and post-multiplying relation (4.91) by  $diag(I_n, \Gamma')$  and by  $diag(I_n, \Gamma)$ , respectively and by using the following change of variables:

$$\Omega_5 = X\mathcal{U}' A_r; \Omega_6 = X\mathcal{U}' B_r; \Omega_7 = X\mathcal{U}' C_r \quad (4.92)$$

with  $\Gamma = \begin{bmatrix} I_{n_p+n_r} & I_{n_p+n_r} \\ \mathcal{U}X & 0 \end{bmatrix}$ . ■

**Remark 4.17** Note that, contrarily to relations in Theorem 4.5, conditions (4.85)-(4.87) are linear matrix inequalities. Moreover, in this case also MIMO systems could be easily considered.

**Remark 4.18** Contrarily to sections 4.3 and 4.4, we do not present the global case of Theorem 4.6. Indeed, if the studied saturated system is globally asymptotically stable, the design of a reset law to improve the stability domain is not needed.

## 4.7 Conclusion

In this chapter, we proposed constructive conditions (convex or quasi convex) to study a reset control system subject to input saturation. First results are presented to analyze the local (or global) stability and performance of such a system. We also introduced further approaches to improve these characteristics by enriching the reset controller with new reset law and/or anti-windup compensator. Due to the similarity of inequalities used in theorems presented in Chapters 3 and 4, the studied system could also be augmented with parametric uncertainties or non null reference.

An implicit objective of all theorems and propositions in this chapter is to optimize the estimation of the basin of attraction. At this aim, our convex or quasi convex conditions have to be solved using efficient optimization problems. Chapter 5 is dedicated to this point.

# Chapter 5

## Convex optimization problems

### 5.1 Introduction

In Chapters 3 and 4, LMI or quasi-LMI conditions have been proposed in the context of stability and  $\mathcal{L}_2$ -performance purposes for reset control systems subject to uncertainties, non-null reference or magnitude limitation. Behind the feasibility of the formulated inequalities, the implicit objectives of the problems addressed reside in the optimization of some decision variables (admissible uncertainty,  $\mathcal{L}_2$ -gain, size of the region of stability, ...). Hence convex optimization problems can be considered using LMI conditions as constraints [10], [24]. In the case of nonlinear conditions, relaxation schemes are suggested.

### 5.2 Admissible uncertainties

In this section, we consider the results exposed in Section 3.2. The objective of Theorem 3.2 is to obtain a better norm on uncertain matrices  $\tilde{A}_f$ ,  $\tilde{C}$ , and  $\tilde{A}_j$  (respectively denoted  $\Delta_1$ ,  $\Delta_2$  and  $\Delta_3$ ): see in particular relations (3.7) and (3.9). We develop one optimization for each uncertainty bound, the other ones being supposed null or known. In such a case, the corresponding lines and columns have to be canceled in the concerned inequalities.

#### Uncertain continuous dynamical matrix $A_f$

We suppose  $\Delta_{A_j} = 0$ ,  $\Delta_C = 0$  and we consider the following convex optimization problem

$$\begin{cases} \min_{P, \tau_F, \tau_R, \alpha_1, \alpha_2, \gamma} \alpha_2 - \alpha_1 \\ \text{subject to relations (3.18) - (3.19) - (3.20)} \end{cases} \quad (5.1)$$

By minimizing the value of  $\alpha_2$  and maximizing  $\alpha_1$ , we obtain the maximization of  $|F_{A_f}|^2 \leq \Delta_1 = \frac{\alpha_1}{\alpha_2}$ .

### Uncertain discrete dynamical matrix $A_j$

We suppose  $\Delta_{A_f} = 0$ ,  $\Delta_C = 0$  and we consider the following convex optimization problem

$$\begin{cases} \min_{P, \tau_F, \tau_R, \overline{\Delta}_2, \overline{\epsilon}_2, \gamma} & \overline{\epsilon}_2 - \overline{\Delta}_2 \\ \text{subject to relations} & (3.18) - (3.19) - (3.20) \end{cases} \quad (5.2)$$

By minimizing the value of  $\overline{\epsilon}_2$  and maximizing  $\overline{\Delta}_2$ , we obtain the maximization of  $|F_{A_j}|^2 \leq \Delta_2 = \frac{\overline{\Delta}_2}{\overline{\epsilon}_2}$ .

### Uncertain output matrix $C$

We suppose  $\Delta_{A_f} = 0$ ,  $\Delta_{A_j} = 0$  and we consider the following convex optimization problem

$$\begin{cases} \min_{P, \tau_F, \tau_R, \alpha_3, \alpha_4, \gamma} & \alpha_3 + \alpha_4 - \gamma \\ \text{subject to relations} & (3.18) - (3.19) - (3.20) \end{cases} \quad (5.3)$$

By minimizing the value of  $\alpha_3$  and  $\alpha_4$  and maximizing  $\gamma$ , we obtain the maximization of  $|F_C|^2 \leq \Delta_3 = \frac{\gamma}{\alpha_3 \alpha_4}$ .

**Remarks** Several comments regarding the optimization problems (5.1), (5.2) and (5.3) can be raised as follows.

- The true criteria allowing to maximize the bounds of admissible uncertainty,  $\Delta_1$ ,  $\Delta_2$ ,  $\Delta_3$  are non-convex. Optimization problems (5.1), (5.2) and (5.3) are a way to approximate them via convex criteria. Other methods could be considered, as for example the cone complementary linearization [21].
- Optimization problems (5.1), (5.2) and (5.3) could be considered separately or together. In this case, weighting parameters should be considered to balance the influence of each decision variable.
- These problems could be combined with performance consideration. The variable  $\gamma$  corresponds to the  $\mathcal{L}_2$ -gain of the system. By adding to each problem (5.1)-(5.2)-(5.3) the minimization of  $\gamma$  could allow to obtain an estimate of system performance in presence of uncertainties.
- Note that, by trying to maximize the admissible uncertainty norm of  $\tilde{C}$ , we degrade the estimation of the  $\mathcal{L}_2$ -gain. Indeed, considering larger existence domain (3.3) for uncertain matrix  $\tilde{C}$  leads to degrade the performance level. To solve such an analysis problem the classical trade-off between robustness and performance has to be managed.

### $\mathcal{L}_2$ -gain estimation

In some cases, the norm of uncertain matrices  $F_{A_f}$ ,  $F_C$  and  $F_{A_j}$  could be known and then fixed. The estimation of the performance level can be directly done by minimizing the decision variable  $\gamma$  (the  $\mathcal{L}_2$ -gain estimation). This is done by solving the following convex optimization problem

$$\begin{cases} \min_{P, \tau_F, \tau_R, \gamma} \gamma \\ \text{subject to relations (3.18) - (3.19) - (3.20)} \end{cases} \quad (5.4)$$

## 5.3 Non-zero references

This section is dedicated to the statement of a convex optimization problem to solve Problem 3.2. For each case (constant or decreasing reference) the tracking problem is addressed by solving LMIs (3.48)-(3.49) or (3.72)-(3.73). However to "measure" the reset controller efficiency, we need to estimate the positive scalar  $\eta$  in relation (3.36). Actually, smaller is  $\eta$ , faster the error  $e$  converges to the origin.

### Constant reference

With a constant reference  $r = r_0$ ,  $\eta$  is proportional to the variable  $\gamma$ , as shown in (3.50). In particular, if initial conditions are null, the variable  $\eta$  is proportional to  $\gamma^2$ . The optimization problem is as follows

$$\begin{cases} \min_{P, \tau_F, \tau_J, \tau, \gamma} \gamma \\ \text{subject to relations (3.48) - (3.49)} \end{cases} \quad (5.5)$$

### Decreasing reference

If  $r = r_0 e^{-\zeta t}$  the performance estimation variable  $\eta$  satisfies inequality (3.74) and the convex problem is

$$\begin{cases} \min_{P, \tau_F, \tau_J, \tau, \gamma} \gamma \\ \text{subject to relations (3.72) - (3.73)} \end{cases} \quad (5.6)$$

## 5.4 System subject to saturation

In this section, we address the definition of some convex optimization problems for a closed-loop system subject to saturating input handled in Chapter 4. The objective of Problem 4.1 is to maximize the size of the region of asymptotic stability for the system (4.6). Different linear optimization criteria, associated to the size of  $\mathcal{E}(P)$ , can be considered, like the volume, the size of the minor axis or the maximization of a scaling factor allowing to include a given shape in the ellipsoid [32], [39].



Consider an ellipsoid defined as

$$\mathcal{E} = \left\{ x \in \mathbb{R}^n, x'Px \leq \sigma^{-1} \right\} = \left\{ x \in \mathbb{R}^n, x'W^{-1}x \leq \sigma^{-1} \right\}, \quad (5.7)$$

with  $P = P' > 0$  and  $W = P^{-1}$ . The volume of ellipsoid (5.7),  $\mathcal{V}(\mathcal{E})$ , is proportional to the following quantity

$$\mathcal{V}(\mathcal{E}) = \sqrt{\det\left(\frac{P^{-1}}{\sigma}\right)} = \sqrt{\det\left(\frac{W}{\sigma}\right)} \quad (5.8)$$

In Theorems 4.1, 4.3 and Propositions 4.1 and 4.2 of Chapter 4, matrix  $P$  (or  $W$ ) is a decision variable, that we want to maximize  $\mathcal{V}(\mathcal{E})$ , for example. In this way, further convex criteria are available.

- A direct method is to minimize the trace of the considered matrix:  $\min tr(P) = \min tr(W^{-1})$ . To deal with the trace of  $W^{-1}$ , we can add the following constraint:

$$\begin{bmatrix} M_w & I_n \\ I_n & W \end{bmatrix} \geq 0$$

with  $M_w = M'_w > 0$  a new decision variable. Then the minimization of the trace of  $W^{-1}$  is done by minimizing  $tr(M_w)$ . Moreover, when  $W$  is a decision variable, one can just search to maximize the trace of  $W$ .

- It can also be interesting to choose a set of interesting directions along which we want to maximize the size of the ellipsoid. Thus, by considering the directions of interest:

$$v_i \in \mathbb{R}^n, \quad i = 1, \dots, q \quad (5.9)$$

the additional constraint can be added, with  $\mu$  a positive scalar

$$\mu - v'_i P v_i \geq 0, \quad i = 1, \dots, q \quad (5.10)$$

or equivalently

$$\begin{bmatrix} \mu & v'_i \\ v_i & W \end{bmatrix} \geq 0, \quad i = 1, \dots, q \quad (5.11)$$

then the maximization following the directions  $v_i, i = 1, \dots, q$  of the ellipsoid  $\mathcal{V}(\mathcal{E})$ , defined in (5.7) is done through the minimization of  $\mu$ .

### 5.4.1 Stability domain analysis

In this framework, the following convex optimization problem can be considered for Theorem 4.1:

$$\begin{cases} \min_{P, G, U, \tau_F, \tau_R, \mu} \eta_1 \mu - \eta_2 U \\ \text{subject to } \mu - v'_i P v_i \geq 0, \quad i = 1, \dots, q \text{ and relations (4.11) - (4.12) - (4.13)} \end{cases} \quad (5.12)$$

Positive scalars  $\eta_1$  and  $\eta_2$  are given weighting parameters. Since  $R = \frac{P}{U^2}$ , the minimization of  $\eta_1\mu - \eta_2U$  implies the maximization of the ellipsoid  $\mathcal{E}(R)$ .

An implicit objective of Proposition 4.1 is to compute sets  $\mathcal{E}(P)$  and  $\mathcal{D}$  as large as possible. This maximization can be accomplished by solving, for example, the following optimization problem:

$$\begin{cases} \min_{W, Y, U, \alpha, \mu} \mu - \alpha \\ \text{subject to } \begin{bmatrix} \mu & v'_i \\ v_i & W \end{bmatrix} \geq 0, \quad i = 1, \dots, q \text{ and relations (4.40) - (4.41) - (4.42)} \end{cases} \quad (5.13)$$

The minimization of  $\mu$  and the maximization of  $\alpha$  lead respectively to the maximization of domains  $\mathcal{E}(P)$  and  $\mathcal{D}$ .

The same approach is used for Proposition 4.2. The maximization of the stability domain is done through the maximization of  $\mathcal{E}(P)$  and  $\mathcal{D}(P_1)$  as follows:

$$\begin{cases} \min_{W, Y, U, P_1, \mu_2, \mu_2} \mu_1 + \mu_2 \\ \text{subject to } \mu_2 - v'_i P_1 v_i \geq 0, \quad i = 1, \dots, q, \\ \begin{bmatrix} \mu_1 & v'_j \\ v_j & W \end{bmatrix} \geq 0, \quad j = 1, \dots, q \text{ and relations (4.44) - (4.45) - (4.46)} \end{cases} \quad (5.14)$$

In the context of Theorem 4.3, the maximization of the disturbance rejection can be solved by the following convex optimization problem:

$$\min_{P, Z, S, \tau_F, \tau_R, \eta, \gamma} \gamma \text{ subject to relations (4.26) - (4.27) - (4.28)} \quad (5.15)$$

Optimization problem (5.15) minimizes the  $\mathcal{L}_2$  gain  $\sqrt{\frac{\delta_1}{U^2}}$  of system (4.25). It can be augmented to optimize both the stability domain and performance estimation:

$$\begin{cases} \min_{P, Z, S, \tau_F, \tau_R, \eta, \gamma} \gamma + \eta - S \\ \text{subject to } \mu - v'_i P v_i \geq 0, \quad i = 1, \dots, q \text{ and relations (4.26) - (4.27) - (4.28)} \end{cases} \quad (5.16)$$

In paragraph 4.4.2 of Chapter 4, the hybrid system performance is evaluated in all the state space. Then the optimization problem associated to Theorem 4.4 is only looking for  $\mathcal{L}_2$ -gain estimation:

$$\min_{P, S, \tau_F, \tau_R} \gamma \text{ subject to relations (4.36) - (4.37)} \quad (5.17)$$

### 5.4.2 Anti-windup synthesis

In paragraph 4.6.2, two results are proposed to design anti-windup compensator. The first one, Theorem 4.5, is presented in a quasi-convex form. To write a convex optimization based on LMI relation, the following issues are carried out.

- We suppose that scalars  $\tau_F$  and  $\tau_R$  are fixed. A solution is to consider, for example, the ones used for solving optimization problem (5.12).

- We let  $M_1 = m_1^{-1}I_2$  where  $m_1$  is a positive scalar. The inequality (4.62)  $-M_1 \leq \mathcal{M} \leq M_1$  could then be rewritten  $-I_2 \leq m_1\mathcal{M} \leq I_2$ .
- The anti-windup compensator is used to increase the stability domain, in particular in the directions  $x_p$  and  $x_r$ , the state of the system to be controlled and the state of the reset controller, respectively. Then, we are mainly interested by optimizing  $\mathcal{E}(P, \delta)$ , as defined in (4.64), in these directions, i.e. the associated optimization problem deals only with matrix  $X$  in the definition (4.65).

Thus matrix inequalities (4.59), (4.60), (4.61) and (4.62) are linear in decision variables  $X, Y, S, \mathcal{Z}, Z_1, \Omega_1, \Omega_2, \Omega_3, \Omega_4, \delta, \gamma, m_1, \mu$  and we define the following convex optimization problem:

$$\begin{cases} \min \mu \\ \text{subject to } \begin{bmatrix} \mu & v_i' \\ v_i & X \end{bmatrix} \geq 0, \quad i = 1, \dots, q \text{ and relations (4.59) - (4.60) - (4.61)} \end{cases} \quad (5.18)$$

The second theorem (Theorem 4.6) proposes directly Linear Matrix Inequalities under the variables  $X, Y, P_{11}, P_{13}, S, \mathcal{Z}, Z_1, P_{12}, \Omega_1, \Omega_2, \Omega_3, \Omega_4, \Omega_5, \Omega_6, \Omega_7, \delta, \gamma, \mu$ , and the associated optimization problem is:

$$\begin{cases} \min \mu \\ \text{subject to } \begin{bmatrix} \mu & v_i' \\ v_i & X \end{bmatrix} \geq 0, \quad i = 1, \dots, q \text{ and relations (4.85) - (4.86) - (4.87)} \end{cases} \quad (5.19)$$

## 5.5 Conclusion

In this chapter, convex optimization problems have been presented. Associated to theorems and propositions of Chapters 3 and 4, the objectives of this chapter were to propose some solutions to implement and solve previous exposed results in a relevant way. Such a way for describing problems is of course not unique. Other writings are possible, for example by adding weighting coefficients on optimized variables.

Based on these optimization problems, the next chapter is dedicated to numerical examples which illustrate the different theoretical points developed in Chapters 3 and 4.

# Chapter 6

## Illustrative examples

### 6.1 Introduction

The objective of this chapter is to implement theoretical results proposed in previous chapters. Indeed, we have made efforts to write constructive conditions and to associate convex optimization problems in order to achieve specific objectives. LMIs have been programmed by using the Matlab toolbox for advanced modeling and solution of convex and non-convex optimization problems associated with the interface YALMIP [51]. Obtained numerical results are compared to temporal simulations. With respect to comments of Chapter 2, regarding the framework of reset control systems, we have used the tools of Matlab/Simulink. We develop our own reset control system Simulink model, but note that others are available [57].

Throughout this chapter, we have chosen to deal with an example issued from the literature. It allows us to compare our numerical results with existing ones, in particular in regard to the estimation of stability regions. Indeed, we do not focus on  $\mathcal{L}_2$ -performance analysis; further approaches in the literature deal with the problem of improving performances by using reset controllers (see Chapter 2 and for example [56], [37], [73], [14], [5], [12], [35]).

The system under consideration in this chapter is the unstable open-loop system

$$\begin{aligned}\dot{x}_p &= 0.1x_p + u \\ y &= x_p\end{aligned}\tag{6.1}$$

connected to the stabilizing Proportional-Integrator controller [33]

$$\begin{aligned}\dot{x}_r &= 0.2e \\ y_r &= x_r + 2e\end{aligned}\tag{6.2}$$

The interconnection between systems (6.1) and (6.2) is defined as

$$\begin{aligned}e &= r - y \\ u &= y_r\end{aligned}\tag{6.3}$$

where  $r$  is an exogenous reference signal.

Beyond this academic example, we have also considered a real system by applying reset methods for the position control of a DC motor. First results are presented in this chapter.

## 6.2 System analysis

In this section, we address optimization problems of paragraphs 5.2 and 5.3 associated to Theorems 3.2, 3.3 and 3.4. We first estimate admissible norm bounded uncertainties of dynamic matrices of the closed-loop system (6.1)-(6.2)-(6.3). Secondly, we analyze tracking performance of such a system.

To complete the controller (6.2), we consider a reset rule based on the signs of the controller input and output, i.e.

$$\begin{aligned}\mathcal{F} &= \{(e, y_r) \in \mathbb{R}^2 ; ey_r \geq 0\} \\ \mathcal{J} &= \{(e, y_r) \in \mathbb{R}^2 ; ey_r \leq 0\}\end{aligned}\tag{6.4}$$

Let us point out that we first consider the case  $r = 0$ , i.e. the case where  $e = -y$ . Adding such reset rules leads to a few amelioration for system output behavior (see Figure 6.1). Indeed, the speed of convergence of the system output of the closed-loop system to the origin is improved thanks to the reset controller. Note however that by applying Theorem 2 of [68] the estimation of the  $\mathcal{L}_2$ -gain is the same with or without the reset law (6.4), since in both cases  $\gamma = 0.52$  is obtained.

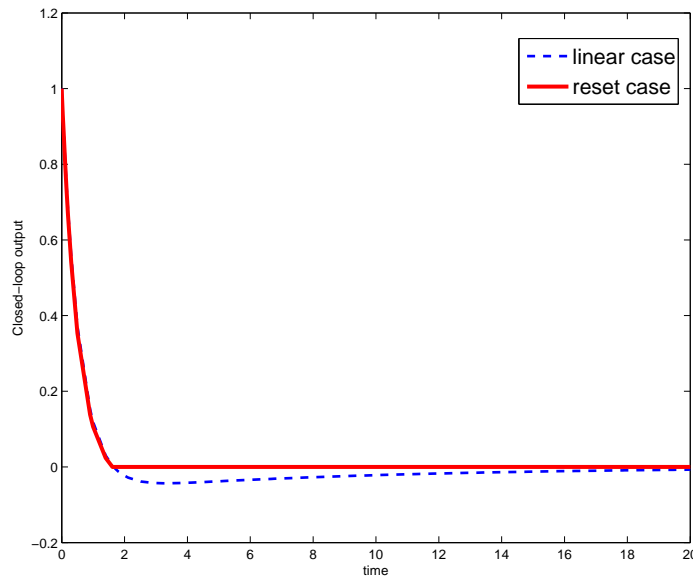

Figure 6.1: Output of the closed-loop system with initial conditions  $(x_p(0), x_r(0)) = (1, 0)$

### 6.2.1 Admissible uncertainties

We consider system (6.1)-(6.2) with  $r = 0$ . By considering optimization problems (5.1), (5.2) and (5.3), we obtain Table 6.1. Note that these results are obtained by neglecting the performance point of view (i.e. we do not minimize the  $\mathcal{L}_2$  gain estimation) and the maximal bound on admissible uncertainty have to be interpreted as a worst case, i.e. for a low level of performance. Moreover, in Table 6.1, the estimate of  $\Delta_2$  regarding

	with reset	without reset
$\Delta_1$	21.7	13.43
$\Delta_2$	1	-
$\Delta_3$	$9.8 \cdot 10e^7$	$1 \cdot 10e^8$

Table 6.1: norm bounded uncertainties estimation

the uncertainty of the discrete dynamic matrix  $A_j$  has only a sense only when resets are allowed.

According to numerical results proposed in Table 6.1, we note that flow and jump sets defined in (6.4) give a larger uncertainty domain for the dynamic matrix  $A_f$ . In the case of the output matrix  $C$ , the system with or without reset has quite the same robustness property. As a conclusion, adding the reset law (6.4) aims to improve closed-loop system performance and may have an influence on the closed-loop robustness. Furthermore by applying Theorem 3.2 and by considering associate optimization problems, we are able to easily analyze the robustness property of a given reset system.

### 6.2.2 Constant reference

In this paragraph, we consider closed-loop system (6.1)-(6.2) with a non-null reference  $r = r_0$  and at  $t = 30s$ , a perturbation of amplitude 1 is added during 2s. The corresponding trajectories with (the blue dashed line) or without reset (the red solid line) are reported in Figure 6.2.

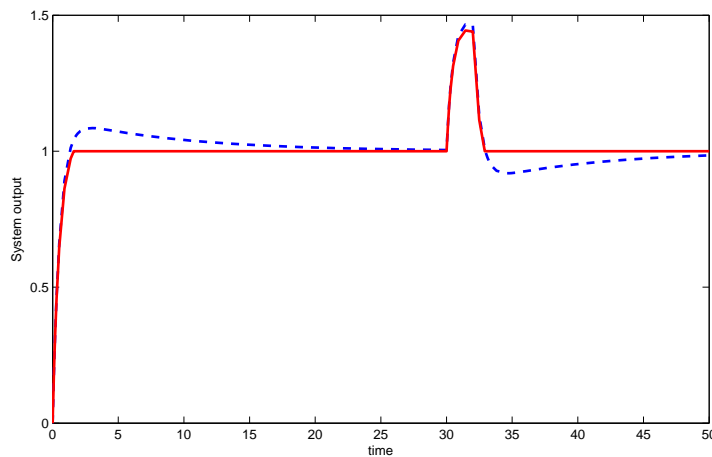

Figure 6.2: Output of the closed-loop system with a reference  $r = 1$ , with reset (solid line) and without (dashed line)

By solving optimization problem (5.5) for system (6.1)-(6.2) with or without reset, we find the same value for the performance level variable  $\eta = 1$ . Then, we guarantee the asymptotic stability of the closed-loop system and the convergence to zero of the error  $e = r - y$ . Benefits of implementing a reset controller appear in Figure 6.2, where tracking

property of the linear system is conserved and performance improved (in terms of time-response and overshoot). The relevance of the reset law (6.4) is then illustrated. By using, in Theorem 3.3, a unique quadratic Lyapunov function, our result is too conservative to highlight reset controller advantages. Nevertheless, it is an interesting tool, easily implementable, to analyze stability and tracking performance of such a hybrid system.

### 6.2.3 Decreasing reference

We can also address the case of decreasing reference by solving optimization problem (5.6). The exogenous input and the perturbation are respectively defined as

$$r = e^{-0.1t}$$

$$d = \begin{cases} 1 & \text{if } 30s \leq t \leq 32s \\ 0 & \text{else} \end{cases}$$

The results are depicted on Figure 6.3. The existence of solutions to problem (5.6) guarantees the stability and the tracking property of the reset control system in presence of a decreasing reference and additional perturbation. We observe that performance are improved by adding a reset control law on controller (6.2).

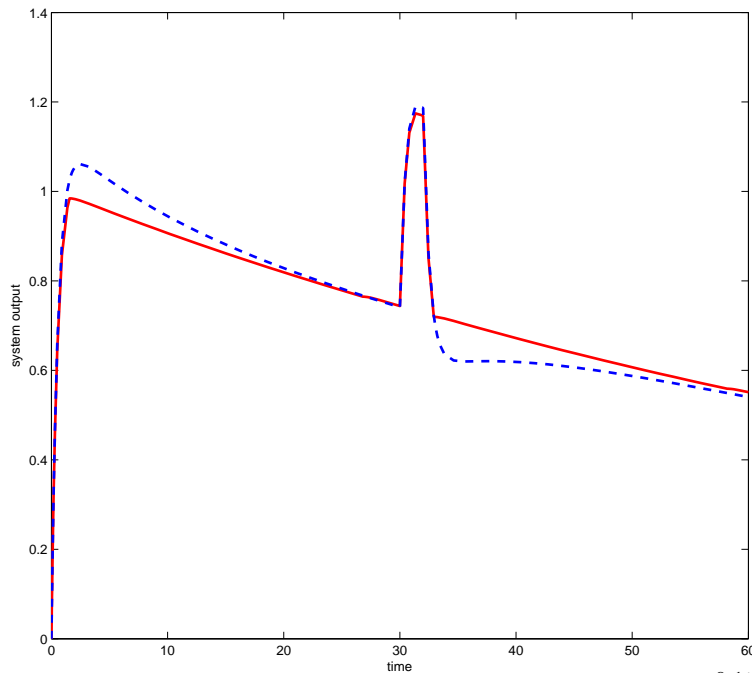

Figure 6.3: Output of the closed-loop system with a reference  $r = e^{-0.1t}$ , with reset (solid line) and without (dashed line)

### 6.2.4 Application to a DC motor

This paragraph is dedicated to position control of a DC motor. We aim to stabilize the angular position  $\Theta_s$  of the motor to a desired value  $\Theta_r$ . The resulting closed-loop system

is depicted on Figure 6.4, where

- $K_e, K_s$  are respectively input and output potentiometer gains.  $K_e = K_s = 10$ .
- $C(s)$  is the transfer function of a controller.
- $K_m, T_m$  are mechanical characteristics of the motor.  $T_m = 0.25, K_m = 9.6$
- $V_m$  is the input voltage of the motor.
- $\Omega_m$  is the motor speed.

Note that potentiometer gains and mechanical characteristics have been identified on the physical system.

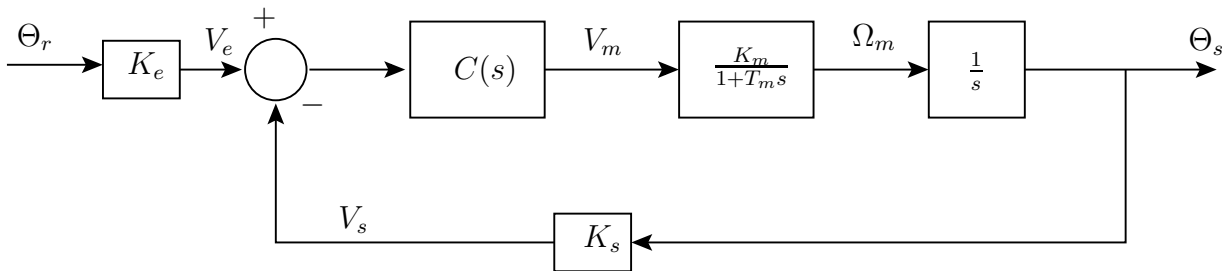

Figure 6.4: The closed-loop system of DC motor position control

Let us consider the transfer function

$$F(s) = \frac{K_m}{1 + T_m s} \quad (6.5)$$

The following controller has been designed to improve the margin phase of (6.5):

$$A_c = -0.5, B_c = 0.1675, C_c = 1, D_c = 0.1675 \quad (6.6)$$

We suppose that the reference is a decreasing step  $\Theta_r = e^{-0.01t}$ , and at  $t = 15s$  until  $t = 17s$ , we add a perturbation with an amplitude of 0.3. A reset map which reset to zero the state of the controller when  $V_m$  and  $\Omega_m$  have a different sign is considered. On Figure 6.5, corresponding trajectories with reset (black dashed-dotted line) or without reset (blue solid line) are reported.

Several comments can be formulated.

- Performances are better by considering a reset controller, and by solving optimization problem (5.5), the asymptotic stability and the correct positioning of the motor are guaranteed.
- We consider also an implementation error. Indeed, we suppose that  $B_c$  in (6.6) is replaced by  $B_c = -0.1675$ . With a classical linear-based controller, the closed-loop becomes unstable. By exploiting reset advantages, the closed-loop system remains



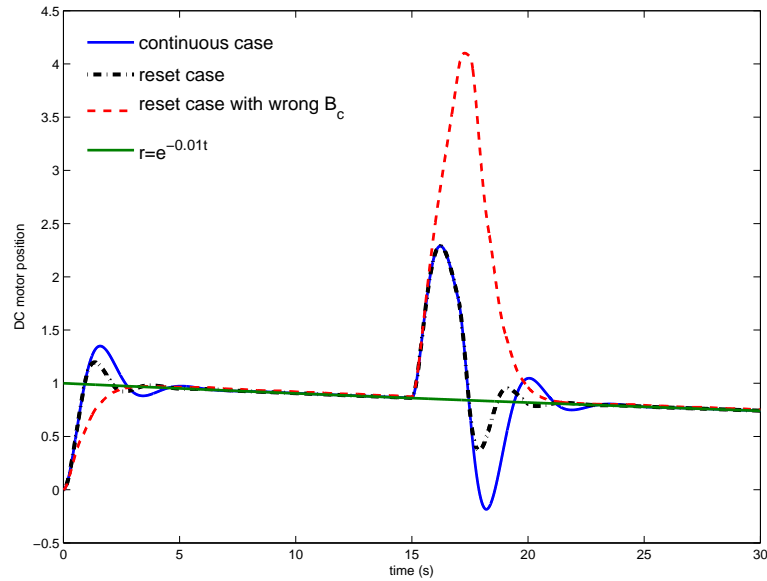

Figure 6.5: Temporal response with decreasing reference and a perturbation of DC motor position control

stable and with optimization problem (5.6) one gets  $\gamma = 60921$ . Such a value characterizes a bad performance level of the system. Nevertheless, the optimization problem (5.6) has a solution, which guarantees the asymptotic stability of the motor. If this controller is incorrectly implemented, the system output (the position of the DC motor) is more sensitive to external perturbation, but still converges to the reference.

### 6.3 System subject to saturation

In this section, we add a magnitude saturation block between the controller and the system to be controlled, as depicted in Figure 6.6. Then the closed-loop system studied

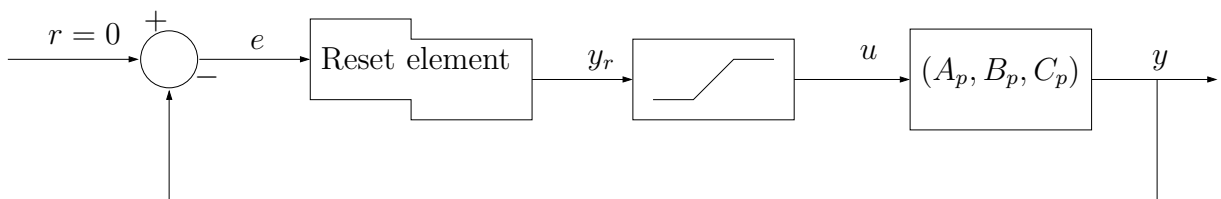

Figure 6.6: Closed-loop system with reset controller and saturation

is composed by plants (6.1)-(6.2) and the interconnection (6.3) is modified as follows, to consider the saturation map and null reference:

$$\begin{aligned} e &= -y \\ u &= \text{sat}(y_r), \quad u_0 = 1 \end{aligned} \quad (6.7)$$

### 6.3.1 Local stability analysis

We first consider a classical reset rule, based on the sign of the controller input  $e = -y$  and output  $y_r$ . Such a system is locally asymptotically stable. To estimate the stability domain, we solve optimization problem (5.13). On Figure 6.7, we compare two stability domains. The first one (red dashed line) is obtained by applying approach proposed in [33] and the second one (black solid line) by using Theorem 4.1. In both cases (with or without reset), the estimate of the stability domain is approximatively the same. Note however that performance properties are conserved in presence of saturation as depicted on Figure 6.8. Even if the saturation is active, the reset rule leads to better behavior.

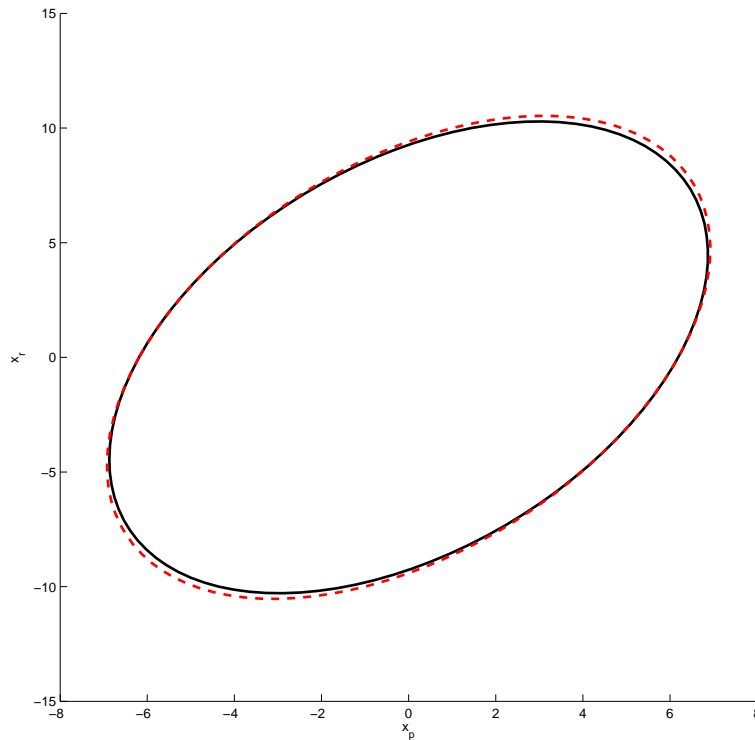

Figure 6.7: Stability domain of the saturated system with (black solid line) or without reset (red dashed line)

### 6.3.2 Stability domain increasing: first step

Beyond performance consideration, we change the reset rule to increase the stability domain as exposed in paragraph 4.5. At this aim, we consider optimization problem (5.13) corresponding to Proposition 4.1 where the resulting stability domain is  $\mathcal{E}(P) \cup \mathcal{D}$ , with

$$\mathcal{E}(P) = \{x \in \mathbb{R}^n; x'Px \leq 1\}, \text{ and } \mathcal{D} = \{x \in \mathbb{R}^n; |Nx| \leq \sigma^{-1}\}, \sigma = \sqrt{\alpha}.$$

On Figure 6.9, the ellipsoid with a black dashed boundary corresponds to the flow set (i.e. the nominal stability domain  $\mathcal{E}(P)$ ). The dotted line represents the domain  $\mathcal{D}$  with

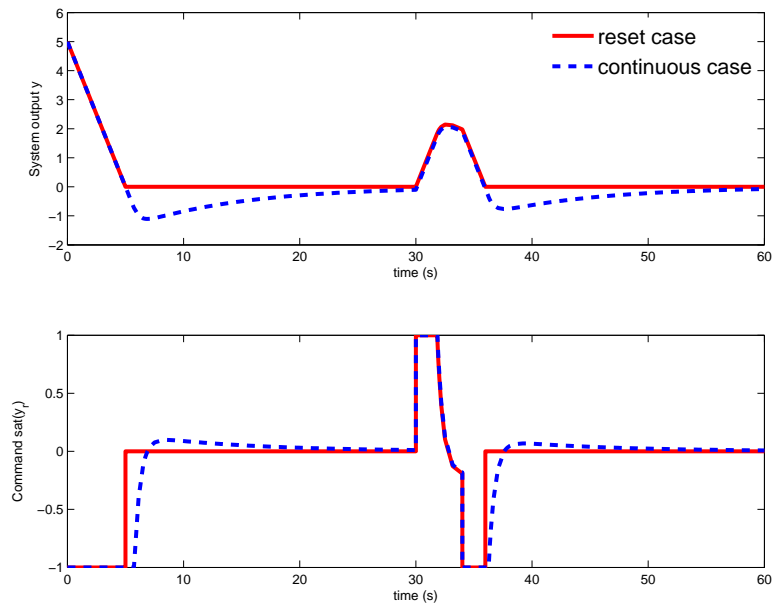

Figure 6.8: Time evolution of the outputs  $y$  and  $y_r$ . Top: system output. Down: saturated command

$\sigma^{-1} = 6.2$ . Note that these values correspond to the crossing between  $\mathcal{E}(P)$  and the  $x_r$ -axis; with such reset conditions,  $\mathcal{D}$  cannot be larger. The resulting stability domain  $\mathcal{E}(P) \cup \mathcal{D}$  is the blue solid line and associated closed-loop trajectories are proposed (red dashed-dotted lines).

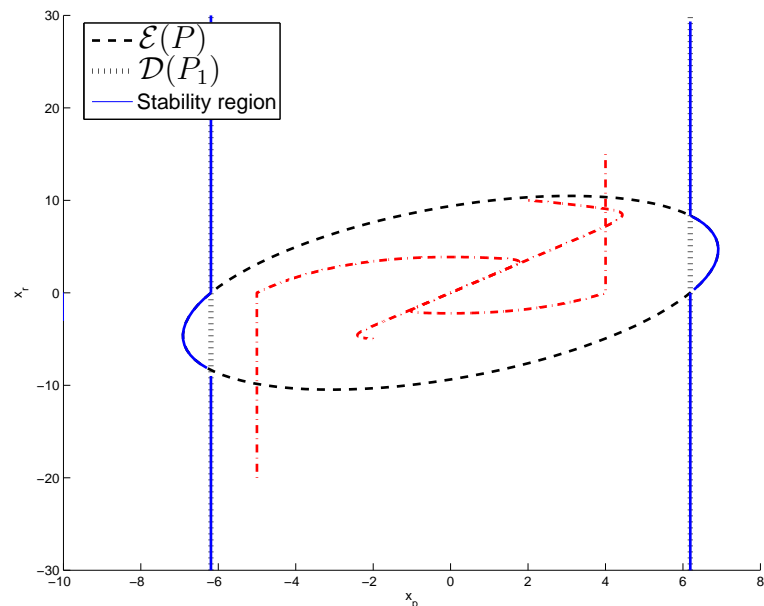

Figure 6.9: Stability domain of the saturated system with new reset conditions by solving problem (5.13)

### 6.3.3 Stability domain increasing: second step

In this paragraph, we design a new reset law for system (6.1)-(6.2) with the interconnection (6.7). We solve the optimization problem (5.14) associated with Proposition 4.2 to obtain a domain  $\mathcal{E}(P) \cup \mathcal{D}(P_1)$  as large as possible, with

$$\mathcal{E}(P) = \{x \in \mathbb{R}^n; x'Px \leq 1\} \text{ and } \mathcal{D}(P_1) = \{x \in \mathbb{R}^n; x'P_1x \leq 1\}$$

The result is reported in Figure 6.10, where the nominal attraction region is the red solid ellipsoid  $\mathcal{E}(P)$ . The dashed black line represents  $\mathcal{D}(P_1)$  and is almost the resulting stability domain.

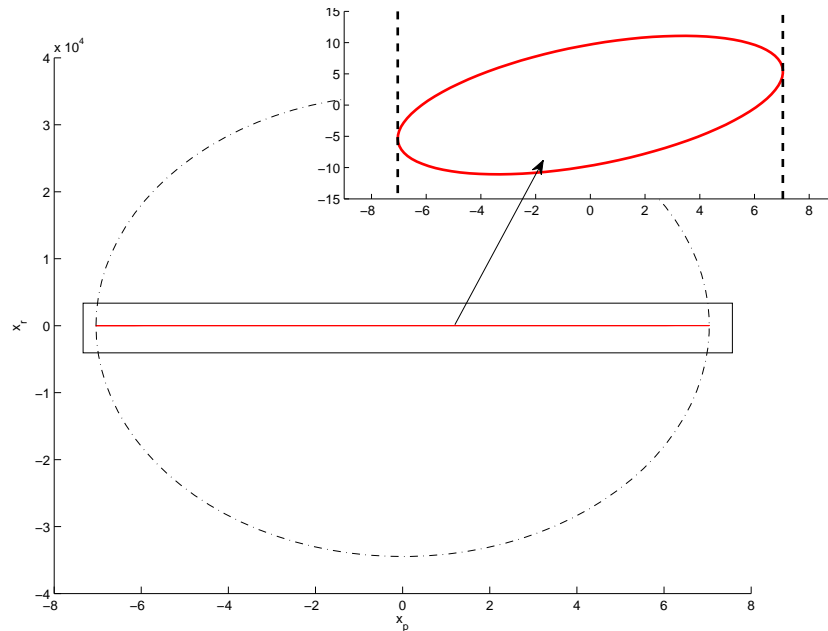

Figure 6.10: Stability domain of the saturated system with new reset law by solving problem (5.14). The dash-dotted line depicts  $\mathcal{D}(P_1)$  and the solid line depicts  $\mathcal{E}(p)$

An example of corresponding trajectories is proposed on Figure 6.11, where the solid blue line corresponds to available values of  $x_r$  after a jump, i.e.  $x_r^+ = A_r x_r - B_r C_p x_p$ .

### 6.3.4 Anti-windup compensator

In this paragraph, we are interested in the design of an anti-windup compensator for system (6.1)-(6.2) with the following interconnection:

$$\begin{aligned} e &= y \\ u &= \text{sat}(y_r) \end{aligned} \tag{6.8}$$

By solving optimization problems of paragraph 5.4.2, we would like to obtain stability domains as large as possible (at least larger than the ones of paragraphs 6.3.1 and 6.3.3).

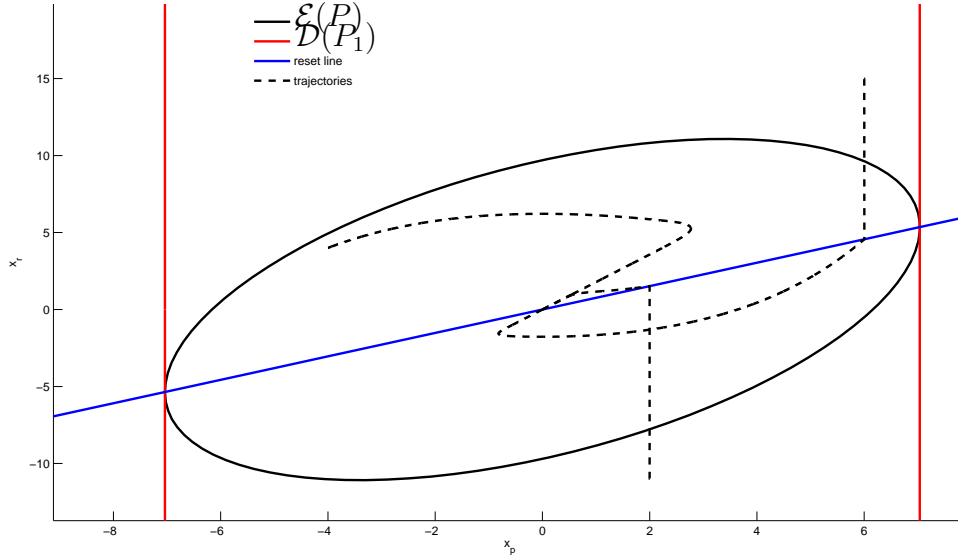

Figure 6.11: Stability domain of the saturated system and corresponding trajectories with new reset law

### Flow and jump set case 1

We first aim at applying Theorem 4.5 to solve the optimization problem (5.18) proposed in paragraph 5.4.2. Hence the saturated system (6.1)-(6.2)-(6.8) is completed by a reset law based on the sign of the controller input and output leading to the following flow and jump sets:

$$\begin{aligned}\mathcal{F} &= \{x \in \mathbb{R}^n ; x'Mx \geq 0\} \\ \mathcal{J} &= \{x \in \mathbb{R}^n ; x'Mx \leq 0\}\end{aligned}\quad (6.9)$$

In (6.9), matrix  $M$  is a reset matrix of appropriate dimensions satisfying  $M = Q'MQ$  with:

$$\begin{aligned}\mathcal{M} &= \begin{bmatrix} 0 & -1 \\ -1 & 0 \end{bmatrix} \in \mathbb{R}^{2 \times 2} \\ Q &= \begin{bmatrix} C_p & 0 & 0 \\ D_c C_p & C_c & 0 \end{bmatrix}\end{aligned}\quad (6.10)$$

We define the set of interesting directions, denoted  $\Xi_0$ , as a square region in  $\mathbb{R}^2$ :

$$\Xi_0 = cv \left\{ \begin{bmatrix} 1 \\ 1 \end{bmatrix}; \begin{bmatrix} 1 \\ -1 \end{bmatrix}; \begin{bmatrix} -1 \\ 1 \end{bmatrix}; \begin{bmatrix} -1 \\ -1 \end{bmatrix} \right\}\quad (6.11)$$

To apply Theorem 4.5, we consider scalars  $\delta$ ,  $\tau_F$  and  $\tau_R$  a priori fixed and  $M_1 = m_1 I_2$  (see paragraph 5.4.2). The estimation of the stability domain is depicted in Figure 6.12 where the dotted ellipsoid represents the estimation of the region of attraction without anti-windup. By applying the numerical procedure (4.63) proposed in paragraph 4.6.2, one obtains the following matrices

$$A_a = \begin{bmatrix} -0.0843 & 0.0130 \\ -0.1549 & -0.1907 \end{bmatrix}, B_a = \begin{bmatrix} -0.4e^{-3} \\ 0.17e^{-3} \end{bmatrix}, C_a = [2.4 \quad 2.3], D_a = 0.11 \quad (6.12)$$

The associated domain of stability is in solid line in Figure 6.12.

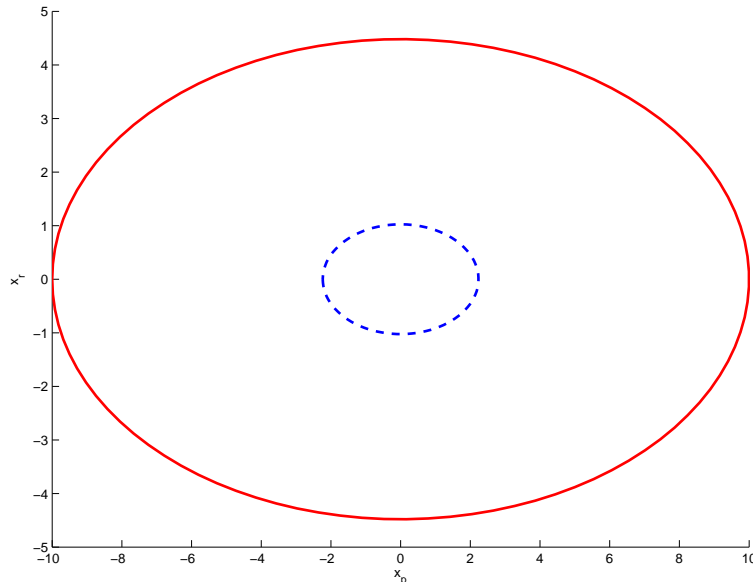

Figure 6.12: Region of attraction of the reset system with anti-windup (solid) and without (dotted)

Moreover, Theorem 4.5 allows us to estimate the performance level of the closed-loop system (augmented with the anti-windup compensator), by optimizing the variable  $\gamma$ . We note that for the same stability region, the performance is improved by applying the reset control law with an anti-windup compensator as expected. Hence, the values of  $\gamma$  are as follows:  $\gamma = 2.7$  in the linear case,  $\gamma = 0.8$  with reset and  $\gamma = 1.03$  with both reset and anti-windup. Such an observation is illustrated in Figure 6.13.

**Remark 6.1** *To compare stability domain of the reset control system with or without anti-windup compensator, we consider ellipsoids plotted in figures 6.7 and 6.12.*

- *We first note that the stability domain obtained without anti-windup action by Theorem 4.1 (black solid ellipsoid on Figure 6.7) is better than the one obtained with Theorem 4.5 (the blue dashed on Figure 6.12). Indeed, beyond the conservatism of LMIs, the fact to bound the reset matrix  $\mathcal{M}$  by  $\pm M_1$  yields to a lack of information on the reset system and is an additional source of conservatism.*
- *However as expected, by adding an anti-windup law, the stability domain of the reset control system is increased. This appears by comparing the black solid line on Figure 6.7 and the red solid line on Figure 6.12. The attraction domain is enlarged, in particular in the direction  $x_p$ . Note that, in the direction  $x_r$ , there is no significant improvement.*
- *To improve stability domain size in the direction  $x_r$ , we could consider another definition of flow and jump sets. The next paragraph is dedicated to this point.*

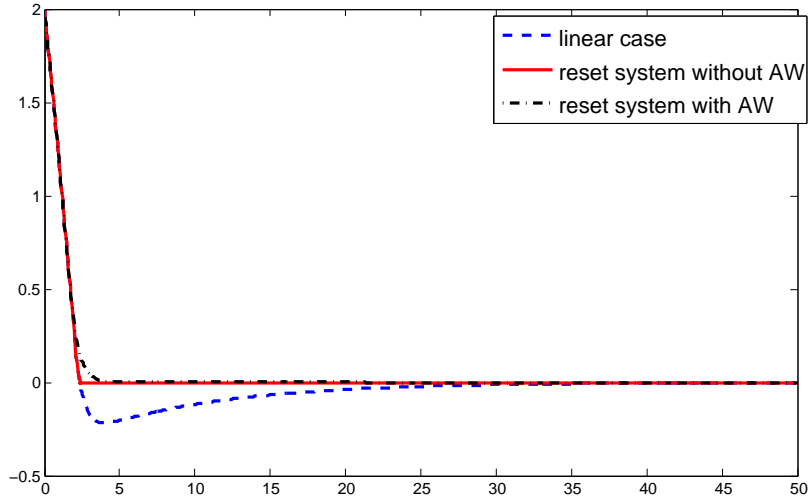

Figure 6.13: Output  $y(t)$  of system (6.1)-(6.2) in the linear case (dashed line,  $\gamma = 2.7$ ), with reset (solid line  $\gamma = 0.8$ ) and with reset and anti-windup (dotted line,  $\gamma = 1.03$ )

### Flow and jump set case 2

We are now applying Theorem 4.6. The objective is to synthesize a new reset control rule together with new flow and jump sets in order to obtain a stability domain as large as possible. We consider system (6.1)-(6.2)-(6.7) with the reset control law (4.83). Flow and jump sets are defined as

$$\begin{aligned}\mathcal{F} &= \mathcal{E}(P, \delta) \\ \mathcal{J} &= \text{clos}(\mathbb{R}^n \setminus \mathcal{E}(P, \delta))\end{aligned}\quad (6.13)$$

where  $P$  is a symmetric positive definite matrix to be determined. We solve the optimization problem (5.19) subject to relations of Theorem 4.6 (with  $\delta = 1$ ) to obtain sets  $\mathcal{E}(P, 1)$  and  $\mathcal{E}(P_1, 1)$  as large as possible. The anti-windup controller (4.88) leads to  $\mathcal{E}(P, 1)$  (in black dashed line on Figure 6.14). Note that this stability domain is close to the one obtained with a static anti-windup in [33]. By computing the reset law (4.89), we obtain a stability domain  $\mathcal{E}(P_1, 1)$  (in red solid line) quasi-tangent to  $\mathcal{E}(P, 1)$ , which allows to extend the region of stability in the direction  $x_r$ . The union of these two sets is the region of stability for the closed-loop system (in red solid line in Figure 6.14).

**Remark 6.2** *Figure 6.14 summarizes the benefits which can be resulting from relevant controller modifications. By comparing Figure 6.7 and Figure 6.14, we note that the anti-windup compensator leads to increase the nominal stability domain in the  $x_p$ -direction. Due to the design of new flow and jump sets together with new reset law, the resulting stability region is quasi infinitely increased in the  $x_r$ -direction.*

## 6.4 Conclusion

In this chapter, we have illustrated the main results of the manuscript. We were interested in analyzing stability and performance of two systems. The first one is issued from liter-

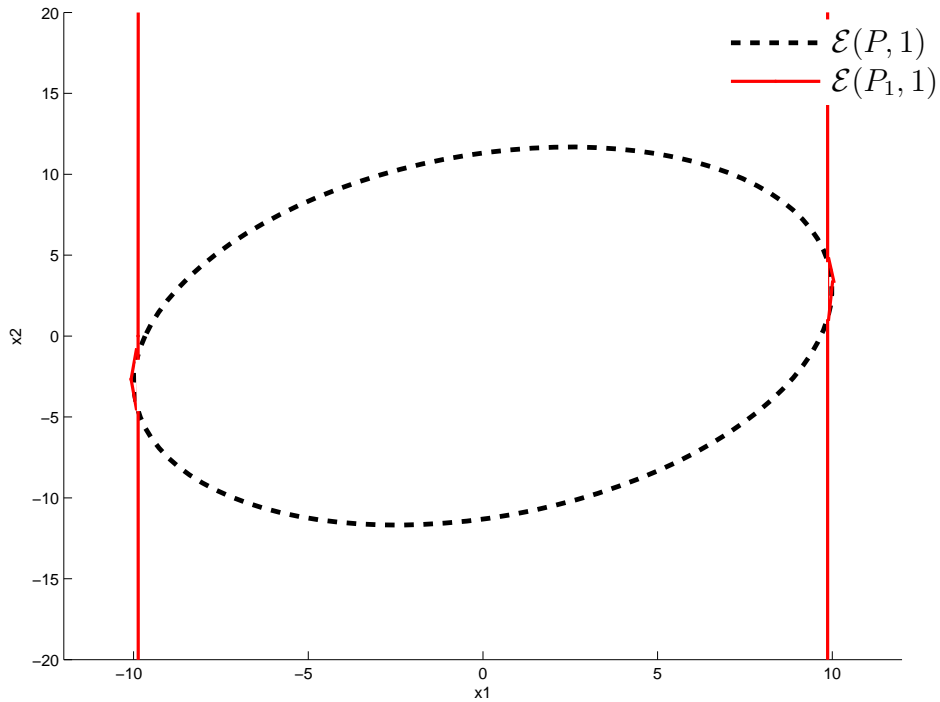

Figure 6.14: Stability domain of the reset control system with the designed reset control law and anti-windup

ature to support our simulations. The second one, a real system, illustrates how a reset law could be added to a general controller and therefore how our theoretical methods can be applied.

Regarding the stability analysis, different types of reset rules have been considered. Mainly, we illustrate how to estimate the stability domain of a hybrid saturated system. We also show that our first approaches, that are proposed to improve such a stability domain (by considering anti-windup strategy and/or synthesizing reset law), are efficient.

Regarding the performance level estimation, due to intrinsic conservatism, proposed constructive methods do not always highlight reset control system advantages. Recent results, based on piecewise quadratic Lyapunov functions, could raise such a conservatism. In Chapter 7, we present some results regarding piecewise Lyapunov functions for reset control systems.





# Chapter 7

## Stability conditions with piecewise quadratic functions

### 7.1 Introduction

In this chapter, we address an approach to relax the conservatism of constructive conditions based on quadratic Lyapunov function (as described in Chapters 3 and 4). Actually, in further cases proposed LMIs may be source of conservatism, due for example to severe structural limitations induced by the use of a unique quadratic Lyapunov function. Degrees of freedom could be found in piecewise quadratic Lyapunov functions: for more details, the reader can consult [68], [67], [43]. We present how to construct such a Lyapunov function for a closed-loop system including a saturation and a reset controller (see system (4.6)). The state space is partitioned in several sectors depending on flow and jump sets. Indeed, the stability analysis conditions are different if system states are in the flow or jump set. Then, flow and jump sets description have to be adapted to the state space partition. In this way, we consider the case where the flow and jump sets are defined from the classical reset rule depending on the sign of the product between controller input and controller output (see for example the Clegg Integrator (2.3) or the FORE (2.6)).

However, there exist further theoretical lacks which limit the generalization of this method to a large class of reset systems:

- A key point of such a technique is to guarantee the continuity of the piecewise function at the interconnection of sectors. Unfortunately, to the best of our knowledge, the constructive conditions we propose to guarantee such a property for piecewise quadratic Lyapunov function are only efficient for two states system ( $n = 2$ ).
- Either it is assumed that Zeno solutions are not present or a temporal regularization must be used. In this chapter, it is assumed that there is no zeno solutions.
- The flow and jump sets are supposed to be not overlapped. Therefore to derive conditions in this chapter, we only consider the decreasing of the Lyapunov function in the flow set  $\mathcal{F}$ , instead of  $\mathcal{F}_\varepsilon$  (as in previous chapters).

- In all this chapter, it is assumed that Assumption 2.1 holds: it guarantees that after a jump, states are in the flow set. This assumption can be checked by studying the jump matrix  $A_J$ .

Some works still in progress should provide additive conditions on the Lyapunov function construction to consider higher order systems and temporal regularization [71] and then relax the imposed hypothesis. Nevertheless, these approaches are not presented in this manuscript.

## 7.2 Angular sectors

In this section, we describe how angular sectors are used to split the state space in many small pieces for reset systems of order two (i.e.  $n_p + n_r = n = 2$ ).

Consider a SISO linear plant whose dynamics is described by

$$\begin{aligned} \dot{x}_p &= A_p x_p + B_p u \\ y &= C_p x_p \end{aligned} \quad (7.1)$$

with  $x_p \in \mathbb{R}$ , connected to the reset controller

$$\left. \begin{aligned} \dot{x}_r &= A_c x_r + B_c e \\ y_r &= C_c x_r + D_c e \end{aligned} \right\} \text{ if } e y_r \geq 0 \quad (7.2)$$

$$\left. \begin{aligned} x_r^+ &= A_r x_r + B_r e \end{aligned} \right\} \text{ if } e y_r \leq 0$$

where  $x_r \in \mathbb{R}$  is the state of the controller,  $e$  its input and  $y_r$  its output. In (7.2),  $A_c$ ,  $B_c$ ,  $C_c$ ,  $D_c$  are constant scalars of appropriate dimensions.

The interconnection between systems (7.1) and (7.2) is defined as

$$\begin{aligned} u &= \text{sat}(y_r) \\ e &= -y \end{aligned} \quad (7.3)$$

The closed-loop system (7.1)-(7.2)-(7.3) is supposed to be not affected by Zeno solutions. It is the reason for which we do not include the temporal regularization into the closed-loop system.

In this case, the flow and jump sets are described with respect to relation (2.13) with the reset matrix  $M$  such as

$$M = Q' \mathcal{M} Q \quad (7.4)$$

where  $\mathcal{M} = \begin{bmatrix} 0 & 1 \\ 1 & 0 \end{bmatrix}$  and  $Q = \begin{bmatrix} -C_p & 0 \\ -D_c C_p & C_c \end{bmatrix}$  is such that

$$\begin{bmatrix} e \\ y_r \end{bmatrix} = Q \begin{bmatrix} x_p \\ x_r \end{bmatrix} \quad (7.5)$$

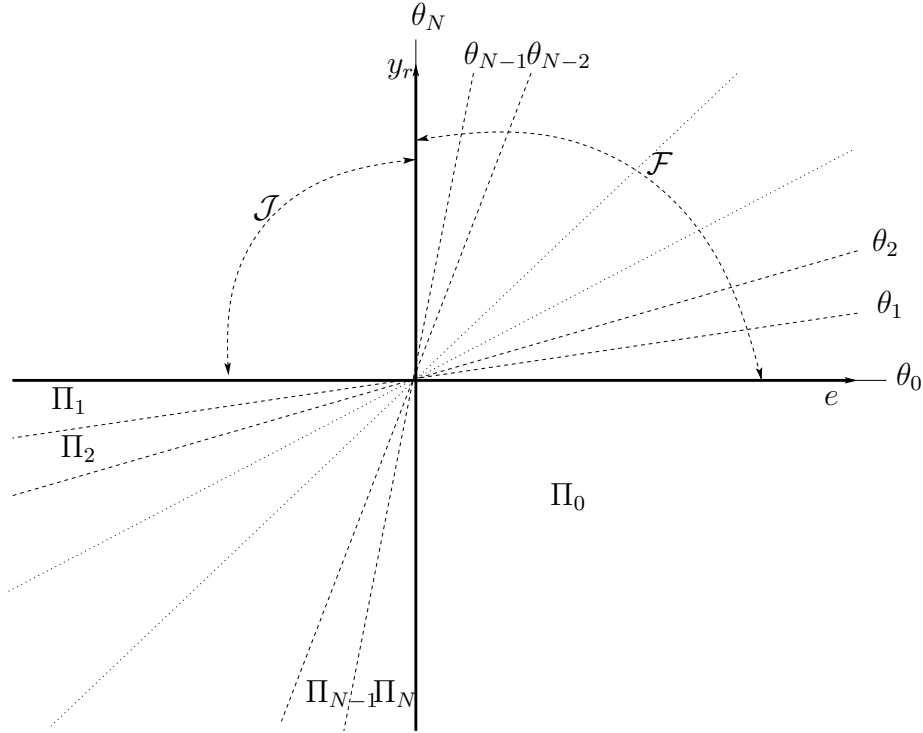

Figure 7.1: Graphical representation of angular sectors

As illustrated on Figure 7.1, we break up the state space in  $N + 1$  angular sectors. Choose any  $N \geq 2$  and define  $\theta_i$ ,  $i = 0, \dots, N$  such that  $0 = \theta_0 < \theta_1 < \dots < \theta_N = \frac{\pi}{2}$ . For example,  $\theta_N$  can be chosen as  $\theta_N = \frac{\pi}{2}$  with then  $\theta_i = \frac{i\pi}{2N}$ . Each sector  $\Pi_i$  satisfies

$$\Pi_i = \begin{cases} \begin{bmatrix} \sin \theta_i & -\cos \theta_i \end{bmatrix} \begin{bmatrix} e \\ y_r \end{bmatrix} \geq 0 \\ \begin{bmatrix} \sin \theta_{i-1} & -\cos \theta_{i-1} \end{bmatrix} \begin{bmatrix} e \\ y_r \end{bmatrix} \leq 0 \end{cases} \quad (7.6)$$

By denoting

$$\Theta_i = [\sin(\theta_i) \quad -\cos(\theta_i)]$$

the sectors  $\Pi_i$  can be defined as

$$\Pi_i = \left\{ (e, y_r) \in \mathbb{R}^2; \begin{bmatrix} e & y_r \end{bmatrix} (\Theta'_i \Theta_{i-1} + \Theta'_{i-1} \Theta_i) \begin{bmatrix} e \\ y_r \end{bmatrix} \leq 0 \right\} \quad (7.7)$$

We define also:

$$S_0 = Q' (\Theta_0 \Theta'_N + \Theta_N \Theta'_0) Q; \quad S_i = -Q' (\Theta_i \Theta'_{i-1} + \Theta_{i-1} \Theta'_i) Q, \quad i = 1, \dots, N \quad (7.8)$$

We denote  $W_i$  a basis of the null space of  $\Theta'_i Q$ .

**Remark 7.1** If  $Q^{-1}$  exists, we can write  $W_i = Q^{-1} \Theta_{i\perp}$  with  $(\Theta'_{i\perp} \Theta_i = 0)$  :  $\Theta'_{i\perp} = [-\cos(\theta_i) \quad \sin(\theta_i)]$ ,  $i = 0, \dots, N$ .

Then with relation (7.5), the sector definition (7.7) reads

$$\Pi_i = \{x \in \mathbb{R}^2; x' S_i x \geq 0\}, \quad i = 0, \dots, N \quad (7.9)$$

We attribute one quadratic Lyapunov function to each sector:

$$V_i(x) = x' R_i x, \quad i = 0, \dots, N \quad (7.10)$$

where  $R_i \in \mathbb{R}^{2 \times 2}$ ,  $i = 0, \dots, N$  are symmetric positive definite matrices.

Let us also consider the ellipsoids:

$$\mathcal{E}(R_i) = \{x \in \mathbb{R}^n; x' R_i x \leq 1\}, \quad i = 0, \dots, N \quad (7.11)$$

### 7.3 Stability analysis result

In this section, we release Theorem 4.1 with a piecewise Lyapunov function. The flow stability conditions have to be rewritten for sectors  $P_i$ ,  $i = 1, \dots, N$  and the discrete dynamic condition must be valid in the sector  $\Pi_0$ .

**Theorem 7.1** *If there exist symmetric positive definite matrices  $P_i \in \mathbb{R}^{2 \times 2}$ , positive numbers  $\tau_i$ ,  $i = 0, \dots, N$ , a matrix  $G \in \mathbb{R}^{1 \times 2}$  and a positive scalar  $U$  satisfying:*

$$\begin{bmatrix} A'_f P_i + P_i A_f + \tau_i S_i & P_i B - G' \\ * & -2U \end{bmatrix} < 0, \quad i = 1, \dots, N \quad (7.12)$$

$$A'_j P_0 A_j - P_0 + \tau_0 S_0 \leq 0 \quad (7.13)$$

$$W'_i (P_i - P_{i+1}) W_i = 0, \quad i = 1, \dots, N - 1 \quad (7.14)$$

$$W'_0 (P_1 - P_0) W_0 = 0, \quad W'_N (P_N - P_0) W_N = 0 \quad (7.15)$$

$$\begin{bmatrix} P_i & K' U - G' \\ * & u_0^2 \end{bmatrix} \geq 0, \quad i = 1, \dots, N, \quad (7.16)$$

then the set  $\bigcup_{i=0, \dots, N} \{x \in \mathbb{R}^2; x' R_i x \leq 1 \text{ if } x \in \Pi_i\}$ , with  $R_i = \frac{P_i}{U^2}$ , is an asymptotic stability region for the reset control system (7.1)-(7.2)-(7.3).

**Proof** Note that with the adopted convention, the jump set  $\mathcal{J}$  could be written as

$$\mathcal{J} = \{x \in \mathbb{R}^2; x' S_0 x \geq 0\}$$

and by patching together angular sectors  $\Pi_i$ ,  $i = 1, \dots, N$ , we can similarly define the flow set

$$\mathcal{F} = \bigcup_{i=1, \dots, N} \{x \in \mathbb{R}^2; x' S_i x \geq 0\} \quad (7.17)$$

Contrarily to the proof of Theorem 4.1, we don't have to consider two cases to guarantee the negativity of the Lyapunov function time-derivative along flow trajectories: the temporal

regularization has been removed. Then LMIs (7.12) are easily obtained by following the same steps as in the proof of Theorem 4.1, case 1 ( $x \in \mathcal{F}$ ).

Inequality (7.13) means that  $V_0(x)$  is decreasing or constant when the hybrid system is jumping. Note that, when the system is jumping, states are not submitted to the saturation influence. Then the inclusion relation has not to be verified in the sector  $\Pi_0$ , i.e. the inclusion relation has to be satisfied only in domains  $\mathcal{E}(R_i)$ ,  $i = 1, \dots, N$ .

Conditions (7.14)-(7.15) ensure that the patched Lyapunov function

$$V(x) = x'R_i x, \text{ if } x \in \Pi_i, \text{ } i = 0, \dots, N$$

with  $R_i = \frac{P_i}{U^2}$ , is continuous on the patching surface. Then it guarantees also that the boundary of two consecutive angular sectors belongs to the two concerned ellipsoids. Then, when the trajectory is changing from an angular sector to another one, it remains in a stability region. Therefore, the region of stability is the union of the ellipsoids  $\mathcal{E}(R_i)$  defined in (7.11) intersected with sectors  $\Pi_i$ ,  $i = 0, \dots, N$  defined in (7.9). ■

### 7.3.1 Sectors and numerical complexity

The correct split of the state space supposes a number of sectors  $N \geq 2$ . Some remarks on the choice of  $N$  will be useful.

**$N$  minimal** Consider the case  $N = 1$ . The relations (7.15) read

$$\begin{aligned} W'_0(P_1 - P_0)W_0 &= 0, \\ W'_1(P_1 - P_0)W_1 &= 0 \end{aligned}$$

The unique solution is to impose  $P_1 = P_0$  (or equivalently  $R_1 = R_0$ ), which is equivalent to consider a unique quadratic Lyapunov function and then we do not add any additional degree of freedom. Then we must consider  $N \geq 2$ .

**$N$  maximal** There is a priori no limit on the maximal value of  $N$ . However, we have to verify  $3N + 2$  LMIs. Moreover, we can note that the optimization problem associated with Theorem 7.1 will aim at optimizing each matrix  $R_i$ ,  $i = 0, \dots, N$ . The computation time and the numerical complexity could then limit the choice of high value for  $N$ . Indeed, the numerical complexity is proportional to  $\mathcal{L}\mathcal{D}^3$  [19] (see paragraph 1.4.5) with, in the case of Theorem 7.1

$$\begin{aligned} \mathcal{L} &= \frac{n(n+1)}{2}(N+1) + N + n + 2 \\ \mathcal{D} &= 2N(n+1) + n + (N+1)(n-1) \end{aligned} \tag{7.18}$$

In the case of Theorem 4.1, the number of variables and lines are given by

$$\begin{aligned} \mathcal{L} &= \frac{n(n+1)}{2} + n + 3 \\ \mathcal{D} &= 3n + 2 \end{aligned} \tag{7.19}$$

Thus, it clearly appears that numerical complexity computed from  $\mathcal{L}\mathcal{D}^3$  will grow in function of  $N$ .

**Remark 7.2** *In the numerical example given in paragraph 7.3.3, we have  $N = 2$  and  $n = 2$ . Relations (7.18) and (7.19) show that the numerical complexity, computed from  $\mathcal{LD}^3$ , of Theorem 7.1 is 18 times greater than the one of Theorem 4.1. Note that this ratio is 63 if  $N = 3$ , 167 if  $N = 4$  ...*

### 7.3.2 Optimization problem

The optimization problem (5.12), presented in Section 5.4, can be easily extended to deal with Theorem 7.1. In this case, we can minimize a linear combination of  $N + 1$  scaling factors  $\mu_i$  (for each ellipsoid  $\mathcal{E}(R_i)$ ).

The key point of Theorem 7.1 is the interpretation of the stability domain

$$\mathcal{E}(R_i) \cap \Pi_i, \quad i = 0, \dots, N.$$

To illustrate this theoretical formulation, we develop the following example.

### 7.3.3 Numerical example

Let us consider the following open-loop unstable system:

$$\dot{x}_p = 0.1x_p + \text{sat}(y_r), \quad y = x_p \quad (7.20)$$

interconnected to a FORE controller ( $\lambda_r = 1$ ,  $B_c = 1$ ,  $C_c = 1$ ,  $D_c = 0$ ) via a negative feedback with a null reference. Note that without reset, the linear closed-loop is unstable. Let the set  $\Xi_0$  be defined by a square region in  $\mathbb{R}^2$

$$\Xi_0 = cv \left\{ \left[ \begin{array}{c} 1 \\ 1 \end{array} \right]; \left[ \begin{array}{c} 1 \\ -1 \end{array} \right]; \left[ \begin{array}{c} -1 \\ 1 \end{array} \right]; \left[ \begin{array}{c} -1 \\ -1 \end{array} \right] \right\}. \quad (7.21)$$

Considering the control level  $u_0 = 1$ , we solve the optimization problem (5.12) in the case of Theorem 7.1, with  $N = 2$  angular sectors,  $\eta_1 = 1$  and  $\eta_2 = 5$ . In Figure 7.2, the stability domain is depicted in solid line, the ellipsoids  $\mathcal{E}(P_0)$ ,  $\mathcal{E}(P_1)$ ,  $\mathcal{E}(P_2)$  are in dashed lines. As expected with continuity conditions (7.14)-(7.15), the ellipsoids cross on the limit between each sector. Thus moving from one sector to another one, the trajectory remains confined in the stability domain.

### 7.3.4 Performance level analysis

The use of piecewise quadratic Lyapunov functions and the angle sector approach, presented in Section 7.1, can also be applied to Theorem 4.3 to estimate the  $\mathcal{L}_2$ -performance of a reset control system with input saturation.

**Theorem 7.2** *If there exist a symmetric positive definite matrices  $P_i \in \mathbb{R}^{2 \times 2}$ ,  $i = 0, \dots, N$ ,*

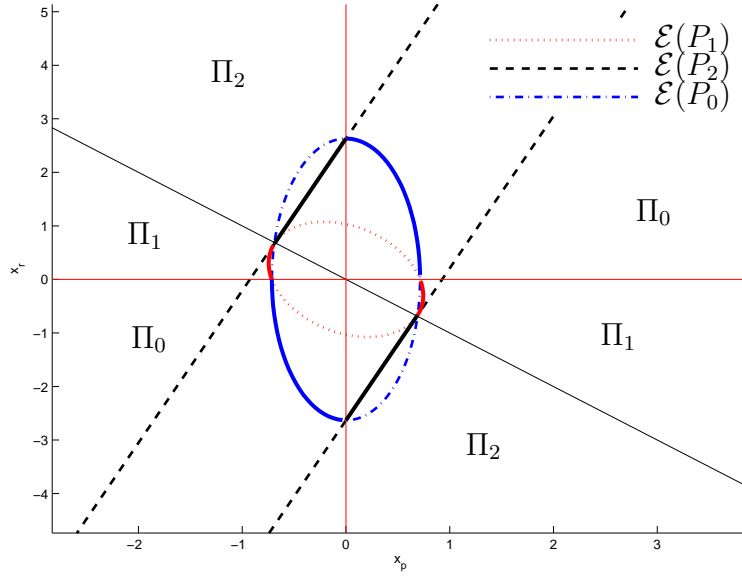
Figure 7.2: Stability domain with  $\lambda_r = 1$ .

a matrix  $Z \in \mathbb{R}^{1 \times 2}$ , positive scalars  $\delta, S, \gamma, \tau_{F_i}, i = 1, \dots, N$  and  $\tau_R$  satisfying:

$$\begin{bmatrix} A'_f P_i + P_i A_f + \tau_{F_i} M & P_i B - Z' & P_i B_d & C' \\ * & -2S & 0 & 0 \\ * & * & -I_q & 0 \\ * & * & 0 & -\gamma \end{bmatrix} < 0, \quad i = 1, \dots, N \quad (7.22)$$

$$A'_j P_0 A_j - P_0 - \tau_R M \leq 0 \quad (7.23)$$

$$\begin{bmatrix} P_i & K'S - Z' \\ * & \delta u_0^2 \end{bmatrix} \geq 0, \quad i = 1, \dots, N \quad (7.24)$$

$$W'_i (P_i - P_{i+1}) W_i = 0, \quad i = 1, \dots, N-1, \quad (7.25)$$

$$W'_0 (P_1 - P_0) W_0 = 0, \quad W'_N (P_N - P_0) W_N = 0, \quad (7.26)$$

then

- When  $d = 0$ , the set  $\bigcup_{i=0, \dots, N} \{\mathcal{E}(P_i) \cap \Pi_i\}$  is an asymptotic stability region for reset control system (4.25);
- When  $d \neq 0$  and  $x_0 = 0$ , the finite  $\mathcal{L}_2$ -gain from  $d$  to  $y$  is less than or equal to  $\sqrt{\gamma}$ , that is, for all  $d$  satisfying (2.8), we have  $\|y\|_2 \leq \sqrt{\gamma} \|d\|_2$ .

### 7.3.5 Numerical example

We consider the system of Paragraph 7.3.3. A problem of interest consists in estimating the performance level for different poles  $\lambda_r$  of the FORE controller and in observing the influence on this estimation of  $N$ , the number of sectors. In this framework, we consider Table 7.1.

Table 7.1 shows us further things on the piecewise Lyapunov function approach.



$\lambda_r$	-5	-3	-2	-1	0	1	2	3	5
$\gamma$ (N=2)	10	4.28	2.5	1.5	1.32	1.34	1.46	1.72	2.56
$\gamma$ (N=10)	10	4.28	2.5	1.2	0.7	0.52	0.43	0.36	0.29
$\gamma$ (N=20)	10	4.28	2.5	1.16	0.63	0.46	0.37	0.32	0.24

Table 7.1:  $\mathcal{L}_2$ -gain estimation

- An important point is that we are able to guarantee stability of the reset system with positive value of  $\lambda_r$ , which it is not possible by using a unique quadratic Lyapunov function.
- By increasing the number  $N$  of subregions, the performance level estimation is more accurate.
- By increasing the value of  $\lambda_r$ , performance are improved, even if the saturation is active. This behaviour is confirmed by time evolutions presented in Figure 7.3, where several responses to a disturbance  $d$  are reported (see the time evolution of the plant input and output for  $\lambda_r = -1, 1, 5$ ). As expected, the closed-loop system is less sensitive to the disturbance when  $\lambda_r$  is increasing. And this improvement leads to large values of  $x_r$  which implies that the saturation occurs (see the cases  $\lambda_r = -1$  and 5).

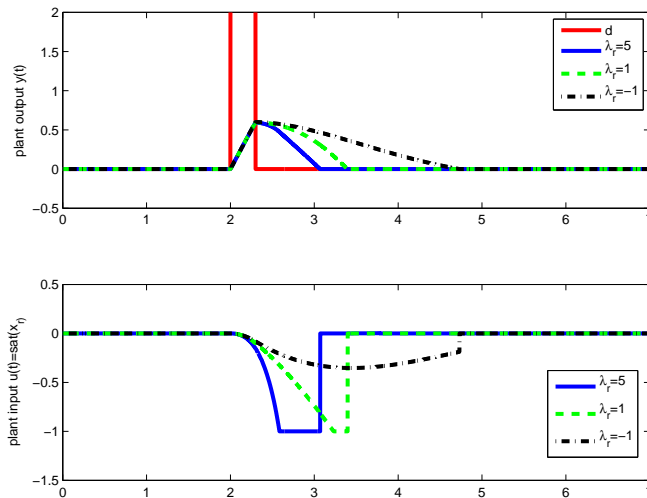
Figure 7.3: Time evolution of the closed-loop output (up) and of the controller output (down), for different  $\lambda_r$ .

## 7.4 Conclusion

In this chapter, we presented a first step to relax LMIs of our previous results on the stability and performance analysis of closed-loop system including a reset element. This

---

method rests on the use of piecewise quadratic Lyapunov functions. We have exposed how to split the state space to construct such functions and how theorems have to be rewritten. We have focused on the study of a saturated system, but, under hypothesis, piecewise Lyapunov function construction can be extended to all theorems we have developed.

In the present form, the approach cannot be extended directly to general reset controller (with temporal regularization for example); further precautions must be taken. This is part of works in progress. However, we have illustrated that, such a method allows us to analyze reset control system, even when the controller or the closed-loop system contains some positive poles (in the continuous-time dynamic).



# Conclusion

The analysis of stability and performance of hybrid systems, in particular of reset control systems is a problem of interest which was recently addressed in the literature of control theory. This thesis is an additional step in the research of theoretical methods concerning such problems, by applying Lyapunov-like techniques. When invoking the Lyapunov second principle, a key point is to find a candidate Lyapunov function which helps us to conclude on the stability and to estimate a level of performance. In order to propose constructive conditions, i.e. conditions which construct the candidate function, we have considered quadratic (or under some hypothesis piecewise quadratic) Lyapunov functions. In this framework, we have developed further theorems or propositions which enrich available methods to the analysis of dynamical systems subject to state reset. Such works have also led to synthesis methods for reset control systems.

Dealing with reset control systems is not trivial. Thus, in Chapter 2 of this manuscript, the reader can find some precisions on the mathematical model associated with such systems. We also proposed examples to highlight hybrid behavior of reset systems and to motivate our works.

Based on these remarks, different problems were successively addressed. We have first extended existing approaches to the case of closed-loop system including a reset element and subject to parametric uncertainties and/or non-zero reference (Chapter 3). In the uncertain system case, we have focused on norm bounded uncertainties, and proposed results to estimate the maximal admissible norms on uncertainties such that stability of the reset control system is guaranteed. An estimation of the performance level via the  $\mathcal{L}_2$ -gain was also possible. By adding a nonzero reference, we have introduced a tracking problem, i.e. guarantee that, in presence of exogenous inputs (reference and disturbance), the error tends to zero, or the output tends to a desired trajectory. By using a reset control system, tracking properties of a linear plant are conserved and the convergence time could be improved.

Based on the observation that one of the drawback of the performance improvement by a reset controller is a larger amplitude of the control variable, we have taken into account the presence of a limited actuator (Chapter 4). Such nonlinearities are often associated with the determination of a stability region allowing to estimate the basin of attraction of the origin for the closed-loop system. Beyond the estimation of such a state space domain, we have presented methods to design continuous-time or hybrid-time controllers in order to enlarge the basin of attraction.

Variables used to characterize properties of the considered reset system are sometimes hidden in constructive conditions. Then to help the reader who would like to numerically

implement and to exploit our results, we have exposed convex optimization problems in Chapter 5. By minimizing (or maximizing) some decision variables of proposed LMIs, some objectives (such as best level performance estimation, stability region as large as possible, ...) can be achieved.

In Chapter 6, further simulations of reset control system were proposed. We have considered linear controller designed to control a linear (or saturated) plant and we have augmented the controller dynamics with a reset law. By solving our convex optimization problems, we studied stability and performance properties of such a hybrid closed-loop system. Temporal simulations are also proposed to confirm the theoretical behavior. The main part of this chapter is dedicated to the estimation of a basin of attraction when the studied system is subject to magnitude limitation in the input. These simulations highlight the efficiency of our design methods to obtain controllers which enlarge a nominal domain of attraction.

During this thesis, we have tested our methods on different examples. This tests showed the need to develop less conservative conditions to be able to analyze a larger range of reset systems (in particular those that have an unstable linear-based dynamic). Such a problem could be partially addressed by using piecewise quadratic Lyapunov functions. Under strong hypothesis, we have extended previous theorems or propositions. Hence Chapter 7 contains constructive algorithms to construct piecewise quadratic Lyapunov functions in order to conclude on the stability and performance of a saturated reset system.

This last remark leads to several open questions.

First, some works are in progress to raise strong hypothesis needed in Chapter 7 to use piecewise quadratic Lyapunov functions [71]. The proposed method considers a linear plant interconnected to a FORE and would be extended to a general class of controllers.

We have proposed first ideas for the modification of reset rules to enlarge the stability domain of a saturated system. It gave positive results. Efforts can be pursued in this sense. In particular, it could be interesting to consider resets that depend on the anti-windup compensator or that directly act on the anti-windup loop behavior. Similarly, for reset control systems without saturation, the design of the reset loop in order to the hybrid trajectories satisfy some required properties is a very challenging problem. It is important to underline that the hybrid controller design is instrumental to improve performance not only for nonlinear systems but also for linear systems [58], [56].

From a practical point of view, most of controller are now implemented on Digital Signal Processor (including those that controls a continuous-time system). Such a technology is particularly adapted to programming reset controller. We began to look at the use of reset control system for a real DC motor. Implementation has to be done.

Most of experimentations have highlighted the importance of considering the rate saturation of actuator. For example, if the controller output is subject to instantaneous jumps, the DC motor input voltage does not accept it. In this framework, an interesting future work is to take into account rate saturation in the output of the reset control system and study its influence on the closed-loop system behavior.

Finally, let us recall that a first motivation for this thesis was aerospace applications, where reset of whole or part of system states could appear, wished or not. In the case of satellite control, engineers can decide to reset the system if its behavior is not the desired

one or if degradation of the required performance becomes too important. This done without care. Applying our results to such a system could be a way to present theoretical arguments for ensuring the stability and the correct behavior of the reset system.



# Resumé étendu

## Introduction générale

Pour forcer un système dynamique à respecter correctement les exigences d'un utilisateur (en terme de stabilité, de performances, de précision ...), il existe plusieurs méthodes. La plupart sont articulées autour d'une même idée : connecter le système à commander à un autre système dynamique, appelé contrôleur. De nombreuses approches pour synthétiser un contrôleur sont disponibles dans la littérature, mais souvent les deux systèmes doivent être de même nature, c'est-à-dire avec des dynamiques à temps continu ou à temps discret. Dans la recherche d'outils plus flexibles pour mieux répondre aux problèmes de stabilisation et/ou d'amélioration de performance, il peut être intéressant d'utiliser des contrôleurs à dynamiques mixtes, continue et discrète. Ces systèmes, caractérisés par des comportements de natures différentes, sont plus généralement appelés contrôleurs hybrides. Dans le cadre de la théorie du contrôle, ils permettent de dépasser les limites intrinsèques de contrôleurs linéaires, en particuliers pour la commande de systèmes linéaires [23], [49]. En effet, un système hybride permet l'interaction entre variables continues et variables discrètes. Cela conduit naturellement à des dynamiques plus riches que celles des systèmes seulement à temps continu [29].

Le modèle associé aux systèmes dynamiques hybrides, que nous souhaitons étudier dans cette thèse, doit rendre compte des comportements temps-continu (ou caractérisés par des équations différentielles) et des comportements temps-discret (ou équations de différence), en fonction de régions de l'espace d'état

$$\begin{cases} \dot{x} = f(x) & \text{if } x \in \mathcal{F} \\ x^+ = g(x) & \text{if } x \in \mathcal{J} \end{cases} \quad (1)$$

Dans l'équation (1),  $x \in \mathbb{R}^n$  est le vecteur d'état du système, les régions  $\mathcal{F}$  et  $\mathcal{J}$  sont des sous-espaces de l'espace  $\mathbb{R}^n$ . Ils sont respectivement appelés espace de flux et espace de saut, et décrivent les domaines dans lesquels le système hybride sera caractérisé par des trajectoires de type soit continue, soit discrète. La modélisation hybride de tels systèmes sera abordée plus précisément dans le Chapitre 3. Le modèle (1) couvre une large gamme de systèmes hybrides et en particulier ceux étudiés dans ce manuscrit : les systèmes à réinitialisation.

Le premier contrôleur à réinitialisation a été introduit par Clegg en 1958 [15]. Il s'agit d'un circuit analogique, modifié pour remettre à zéro sa sortie sous certaines conditions et qui possède ainsi une meilleur marge de phase que le circuit linéaire. Ce premier montage



est à l'origine d'autres contrôleurs à réinitialisation (comme le First Order Reset Elements ou FORE) ainsi qu'à la proposition de méthodes systématiques pour la synthèse de tels systèmes [38], [47]. Si par la suite cette classe de systèmes a été un peu oubliée, elle a connu un regain d'intérêt à la fin du 20ème siècle. Cela s'est traduit par plusieurs travaux théoriques portant sur l'étude de la stabilité interne de boucles de commande comprenant un intégrateur de Clegg ou un FORE. Un large historique des résultats concernant les contrôleurs à réinitialisation, des années 1970 à aujourd'hui, est proposé dans [5]. Deux thèses ont aussi abordé ces problématiques [4], [14].

Au delà des efforts faits pour enrichir les outils théoriques pour l'analyse des systèmes à réinitialisation (par exemple [2], [13]) et pour mieux comprendre le phénomène de remise à zéro, plusieurs travaux ont mis en évidence l'intérêt pratique de ces systèmes hybrides. Dans [35], des actionneurs subissent des réinitialisations pour le contrôle de vibrations thermo-acoustiques dans une chambre de combustion. Un enrouleur de bandes magnétiques est utilisé dans [73] pour mettre en évidence l'intérêt d'une loi de remise à zéro pour dépasser les limites d'un contrôleur continu. Dans [72], des résultats expérimentaux sur des actionneurs piezo-électriques montrent que la réinitialisation permet de supprimer complètement le dépassement et ainsi obtenir un meilleur temps de réponse du système. Ou encore, dans [3], le régime transitoire d'une torpille sous-marine est amélioré en réinitialisant les états d'un contrôleur PI.

Récemment, une description plus précise des solutions et des comportements des systèmes hybrides (domaine temporel hybride, solution de "Zeno", ...) a été proposée dans [28]. Cette nouvelle manière de modéliser les systèmes hybrides a été étendue au cas des systèmes à réinitialisation [68] et a conduit à des résultats d'analyse en stabilité et performance de systèmes de commande comprenant un élément à réinitialisation, en s'appuyant sur les méthodes de Lyapunov [56], [67].

Cette thèse se place dans le prolongement des travaux cités précédemment. L'objectif n'est pas d'améliorer les techniques existantes (en termes d'efficacité ou de temps de calcul), mais en nous appuyant sur ces approches, nous souhaitons complexifier le modèle du système hybride étudié et montrer comment les méthodes d'analyse doivent être modifiées. Dans ce cadre, nous nous sommes intéressés à des systèmes à réinitialisation au modèle mal-connu (ou incertain) et nous avons considéré la présence de différents signaux exogènes (entrée de perturbation ou de référence). La plupart des travaux cités précédemment ont mis en évidence l'intérêt des lois de réinitialisation pour améliorer les performances d'un système dynamique à temps continu. Ces améliorations sont parfois limitées par la présence d'actionneur saturant. En effet, une saturation dans une boucle de contrôle peut être source de dégradation des performances, voir d'instabilité [11]. Ainsi, la contribution principale de cette thèse est la prise en compte de saturation en amplitude pour l'analyse en stabilité et performance d'un système à réinitialisation. Il s'agit, dans ce cas, de caractériser le bassin d'attraction de l'origine du système hybride saturé, ou au moins de l'estimer. En nous appuyant sur les méthodes de Lyapunov, nous proposons des conditions constructives pour approcher cette région de stabilité. Au-delà de résultats d'analyse, nous développons des méthodes de synthèse de contrôleurs à réinitialisation pour obtenir un domaine aussi grand que possible. Notons que les méthodes exposées reposent sur des approches temps-continu (compensateur anti-windup) et temps-hybride

(calcul de lois de sauts).

La thèse reprend ces différents points et s'organise comme suit.

Le second chapitre est dédié à la présentation des outils théoriques utilisés dans nos travaux. Nous décrivons comment se servir des fonctions de Lyapunov pour garantir la stabilité d'un système dynamique. En particulier pour des fonctions de Lyapunov quadratiques, nous introduisons le concept d'Inégalité Matricielle Linéaire (LMI) et des outils mathématiques associés. Cette formulation de contraintes est souvent utilisée pour l'écriture de conditions constructives. Enfin, nous définissons le domaine d'attraction de l'origine d'un système dynamique.

Dans la troisième partie, nous présentons, plus précisément, les contrôleurs à réinitialisation. Nous présentons le cadre mathématique associé à ces systèmes et nous illustrons le phénomène de réinitialisation, en nous appuyant sur des exemples simples. Nous introduisons aussi des éléments clés pour la modélisation et la simulation de cette classe de système (espaces de flux et de saut, solution de Zeno, régulation temporelle, ...). Nous concluons ce chapitre par un exemple qui met en évidence les avantages de l'enrichissement un contrôleur continu par une loi de remise à zéro. Notons qu'un théorème, sur lequel nous appuyons par la suite, est aussi présenté.

Nos premiers résultats sur l'analyse en stabilité et performance d'une boucle de commande contenant un élément à réinitialisation sont développés Chapitre 3. Ils portent sur la prise en compte, dans le modèle du système étudié, d'incertitudes paramétriques et de référence non-nulle. Dans les deux cas, nous proposons des conditions constructives, c'est-à-dire des contraintes sous forme LMI. Elles sont obtenues à l'aide de fonctions de Lyapunov quadratiques et permettent l'analyse en stabilité, l'estimation des bornes des incertitudes et d'un niveau de performance. Dans le cas d'une référence non-nulle, ce niveau de performance se traduit par l'estimation de la vitesse de convergence de la sortie du système vers la référence.

Le Chapitre 4 contient les résultats principaux de cette thèse : l'étude de contrôleurs à réinitialisation soumis à une saturation en amplitude. D'un point de vue de l'analyse, il s'agit d'estimer la région de stabilité et les performances du système hybride saturé. Pour ces deux problèmes, nous proposons des conditions constructives. Du point de vue synthèse, nous proposons de premières conditions pour la mise au point de lois de réinitialisation qui améliorent la région de stabilité d'un système saturé. La première méthode repose sur la définition de nouvelle condition de saut. En élargissant la région d'initialisation des états du contrôleur, nous agrandissons la région de stabilité de la boucle de commande. La seconde approche est plus classique, mais appliquée pour la première fois à des contrôleurs à réinitialisation. Nous supposons connu un système contenant un élément à réinitialisation et nous construisons un compensateur anti-windup pour élargir le domaine des conditions initiales admissibles (ou domaine d'attraction) pour le système hybride. Enfin, nous présentons un résultat qui unifie ces deux stratégies de synthèse: des conditions sous forme quasi-LMI nous permettent de calculer une loi de réinitialisation et un compensateur anti-windup pour obtenir une région de stabilité la plus grande possible.

Les conditions présentées aux Chapitres 3 et 4 peuvent être résolues dans un but précis : obtenir la plus grande norme sur les incertitudes, la meilleure estimation des performances, une région de stabilité aussi grande que possible ... ou tout à la fois.

Pour cela, le Chapitre 5 réunit tous les problèmes d'optimisation convexes associés aux théorèmes ou propositions des chapitres précédents. Il est parfois nécessaire de chercher le minimum (ou le maximum) de plusieurs variables de décision. Ainsi, pour répondre à plusieurs objectifs simultanément, un compromis devra être trouvé.

L'avant dernier chapitre est dédié aux exemples numériques. Presque tous les problèmes d'optimisation du Chapitre 5 sont abordés, autour du même exemple. Cet exemple, tiré de la littérature, nous permet de comparer nos résultats avec ceux existants, en particulier pour tester l'efficacité de nos techniques hybrides pour la synthèse de correcteur qui agrandissent le domaine de stabilité d'un système saturé. Des simulations temporelles illustrent les aspects théoriques. Nous nous sommes aussi intéressés à un cas pratique : le contrôle de position angulaire d'un moteur à courant continu par un contrôleur à réinitialisation. En utilisant nos résultats d'analyse, la stabilité d'un tel système est garantie et nous vérifions en simulation le bon comportement de la boucle de commande.

Certaines simulations temporelles ont fait apparaître un certain conservatisme dans nos méthodes. Dans certains cas, nos conditions n'ont pas de solution, alors que le système hybride est stable. Ce conservatisme peut être, en partie, levé en utilisant des fonctions de Lyapunov quadratiques par morceaux. Dans le Chapitre 7, nous montrons comment construire de telles fonctions. Dans ce cadre, nous récrivons les théorèmes et propositions du Chapitre 4, en particulier pour expliquer comment reconstruire une région de stabilité à partir de fonctions de Lyapunov quadratiques par morceaux.

Une conclusion générale et des perspectives de travail terminent ce manuscrit.

Nous présentons ici un résumé des travaux de cette thèse. Chaque chapitre est résumé pour mettre en évidence les différents problèmes abordés. Nous présentons aussi les principaux théorèmes ou propositions, ainsi que les exemples numériques associés.

## Outils mathématiques

Dans ce chapitre, nous présentons les outils utilisés par la suite pour étudier les systèmes non-linéaires. En particulier, nous introduisons les notions de stabilité et de performance pour de tels systèmes dynamiques. Dans notre cas, ces propriétés sont étudiées par la seconde méthode de Lyapunov. En nous appuyant sur des fonctions de Lyapunov quadratiques, les conditions de stabilité qui en découlent sont écrites sous forme d'Inégalités Matricielles Linéaires (LMIs). Les LMIs, et les techniques de programmation semi-définie associées, sont numériquement efficaces et souvent utilisées pour la proposition de conditions constructives qui répondent aux problèmes d'analyse en stabilité et performance. Ainsi, ce chapitre contient plusieurs définitions et lemmes utiles à la manipulation des LMIs.

La présentation des méthodes et outils n'est pas exhaustive, mais rappelle quelques points clés pour la compréhension des résultats développés dans ce manuscrit. Ces concepts sont largement utilisés dans la théorie du contrôle et plus de détails concernant leurs preuves sont disponibles dans la littérature. Nous pouvons citer par exemple [46], [60], [48], [16].

## Les systèmes à réinitialisation

Ce chapitre est dédié à la présentation de la classe de systèmes non-linéaires qui nous intéresse dans cette thèse : les systèmes à réinitialisation.

En nous appuyant sur les travaux présentés dans [28], nous présentons d'abord le modèle associé à ce type de systèmes. En particulier, nous précisons comment définir le domaine de temps hybride dans lequel les solutions d'un système hybride existent, comment définir les espaces de flux et de saut. Nous présentons enfin ce que sont les solutions dites de Zeno et comment éviter ce type de phénomène, via l'ajout d'une variable additionnelle, appelée régulation temporelle. Une introduction plus large des systèmes hybrides est proposée dans [29].

Nous nous basons sur ces considérations théoriques pour expliciter le modèle d'une boucle de commande incluant un contrôleur à réinitialisation (voir Figure 4).

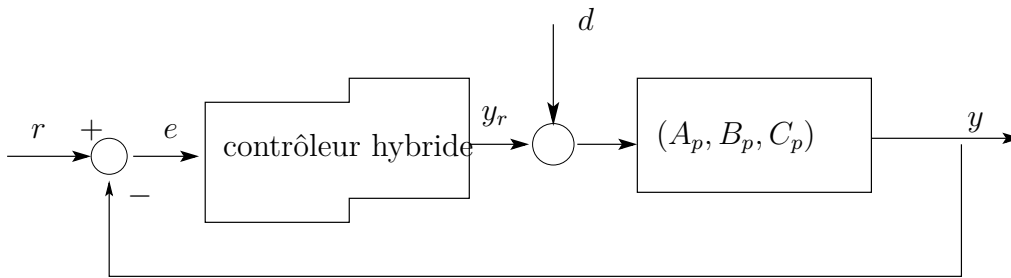

Figure 4: Boucle de commande contenant un contrôleur à réinitialisation

Le système SISO à contrôler est défini comme :

$$\begin{aligned} \dot{x}_p &= A_p x_p + B_p y_r + B_{pd} d \\ y &= C_p x_p \end{aligned} \quad (2)$$

où  $x_p \in \mathbb{R}^{n_p}$  est le vecteur d'état,  $y \in \mathbb{R}$  la sortie mesurée,  $y_r \in \mathbb{R}$  la sortie du contrôleur et  $d \in \mathbb{R}^{n_d}$  une perturbation. Pour le système (2),  $A_p$ ,  $B_p$ ,  $C_p$ ,  $B_{pd}$  sont des matrices constantes et de dimensions appropriées. De plus, les paires  $(A_p, B_p)$  et  $(C_p, A_p)$  sont respectivement commandable et observable.

La perturbation  $d : [0, \infty) \rightarrow \mathbb{R}^{n_d}$  est supposée limitée en énergie, c'est-à-dire satisfaisant :

$$\|d\|_2^2 = \int_0^\infty |d(\tau)|^2 d\tau < \delta \quad (3)$$

où  $\delta$  est un scalaire positif.

Connecté au système (2), nous définissons un contrôleur à réinitialisation :

$$\left. \begin{aligned} \dot{x}_r &= A_c x_r + B_c e \\ y_r &= C_c x_r + D_c e \\ \dot{\tau} &= 1 \end{aligned} \right\} \text{ si } x_r \in \mathcal{F} \text{ ou } \tau \leq \rho \quad (4)$$

$$\left. \begin{aligned} x_r^+ &= A_r x_r + B_r e \\ \tau^+ &= 0 \end{aligned} \right\} \text{ si } x_r \in \mathcal{J} \text{ et } \tau \geq \rho$$

où  $x_r \in \mathbb{R}^{n_r}$  est l'état du contrôleur. Dans (4),  $A_c$ ,  $B_c$ ,  $C_c$  et  $D_c$  sont des matrices constantes et de dimensions appropriées. Les matrices  $A_r$  et  $B_r$  sont constantes et de dimensions appropriées. Elles décrivent l'effet de la réinitialisation sur les états du contrôleur. Il est important de noter que la réinitialisation ne consiste pas simplement à remettre tout ou partie des états du contrôleur à zéro, d'autres lois de réinitialisation sont accessibles avec la modélisation proposée. La variable  $e \in \mathbb{R}$  est l'entrée du système et  $y_r$  sa sortie. La plupart du temps,  $e$  correspond à l'erreur entre la sortie  $y$  et  $r$  une entrée de référence (voir Figure 4). La régulation temporelle est modélisée par la variable  $\tau$ . Elle impose un temps minimum  $\rho$  entre deux sauts.

Soit le vecteur d'état augmenté

$$x = \begin{bmatrix} x_p \\ x_r \end{bmatrix} \in \mathbb{R}^n \quad (5)$$

avec  $n = n_p + n_r$ .

Ainsi en combinant les relations (2) et (4) (avec  $e = r - y$ ), la boucle de commande, augmentée avec la régulation temporelle, s'écrit :

$$\left. \begin{array}{l} \dot{x} = A_f x + B_d d + B_r r \\ \dot{\tau} = 1 \end{array} \right\} \text{ si } x \in \mathcal{F} \text{ ou } \tau \leq \rho$$

$$\left. \begin{array}{l} x^+ = A_j x + B_j r \\ \tau^+ = 0 \\ y = Cx \end{array} \right\} \text{ si } x \in \mathcal{J} \text{ et } \tau \geq \rho \quad (6)$$

avec

$$A_f = \begin{bmatrix} A_p - B_p D_c C_p & B_p C_c \\ -B_c C_p & A_c \end{bmatrix}, \quad A_j = \begin{bmatrix} I_{n_p} & 0 \\ -B_r C_p & A_r \end{bmatrix}, \quad B = \begin{bmatrix} B_p D_c \\ B_c \end{bmatrix}, \quad (7)$$

$$B_d = \begin{bmatrix} B_{pd} \\ 0 \end{bmatrix}, \quad C = [C_p \quad 0], \quad B_j = \begin{bmatrix} 0 \\ B_r \end{bmatrix}$$

Les sous-espaces de flux et de saut,  $\mathcal{F}$  et  $\mathcal{J}$ , sont respectivement définis comme :

$$\mathcal{F} = \left\{ x \in \mathbb{R}^n ; \begin{bmatrix} x \\ r \end{bmatrix}' M \begin{bmatrix} x \\ r \end{bmatrix} \geq 0 \right\}$$

$$\mathcal{J} = \left\{ x \in \mathbb{R}^n ; \begin{bmatrix} x \\ r \end{bmatrix}' M \begin{bmatrix} x \\ r \end{bmatrix} \leq 0 \right\} \quad (8)$$

où  $M$  est une matrice symétrique de dimension appropriée.

Nous présentons ensuite un premier résultat, proposée dans [56]. Il propose des conditions suffisantes pour garantir la stabilité  $\mathcal{L}_2$  d'un système à réinitialisation en présence d'une perturbation extérieure. Notons que c'est à partir de ce résultat fondamental que nous dérivons les différents théorèmes ou propositions de cette thèse.

Toutes les remarques de ce chapitre sont illustrées par des exemples et des simulations. Il s'agit de mettre en évidence le comportement hybride des systèmes à réinitialisation. En utilisant deux contrôleurs bien connus, l'Intégrateur de Clegg et le FORE, nous illustrons aussi les précautions à prendre lors de la simulation de cette classe de systèmes.

Enfin, un dernier exemple nous permet de motiver brièvement l'intérêt des contrôleurs à réinitialisation et donc la suite de nos travaux.

Pour cela, nous considérons un contrôleur FORE interconnecté à un intégrateur. En l'absence de perturbation et de référence ( $r = 0$ ,  $d = 0$ ), le système (6) s'écrit :

$$A_f = \begin{bmatrix} 0 & 1 \\ -1 & \lambda_r \end{bmatrix}, C = [1 \ 0], A_j = \begin{bmatrix} 1 & 0 \\ 0 & 0 \end{bmatrix}, M = \begin{bmatrix} 0 & -1 \\ -1 & 0 \end{bmatrix}$$

La Figure 5 propose les trajectoires avec ou sans réinitialisation, correspondant à  $\lambda_r = -0.5$ . En ajoutant la loi de saut, nous réduisons fortement le dépassement.

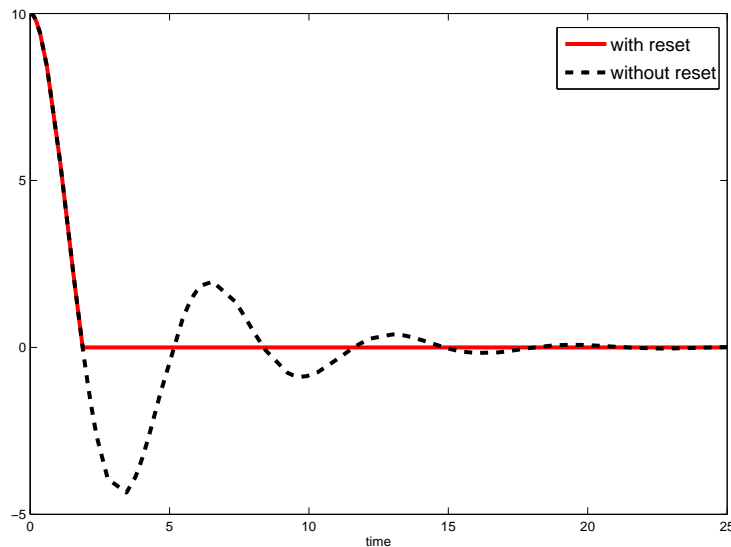

Figure 5: Sortie du système avec remise à zéro (ligne continue) ou sans (ligne pointillée).

En augmentant la valeur de  $\lambda_r$ , et avec réinitialisation, la Figure 6 montre l'amélioration des performances du système. Mais ces améliorations se traduisent par de plus grandes valeurs de la variable de commande. Cette remarque fait apparaître la nécessité de prendre en compte la présence d'un actionneur saturé.

## Système à réinitialisation avec incertitudes paramétriques et référence non-nulle.

Dans le Chapitre 4, nous nous intéressons à l'analyse en stabilité et performance d'un système à réinitialisation soumis à des incertitudes paramétriques ou à une entrée de référence non-nulle. En nous appuyant sur les résultats présentés dans [56], et en exploitant les propriétés des fonctions de Lyapunov quadratiques, nous proposons des conditions constructives pour

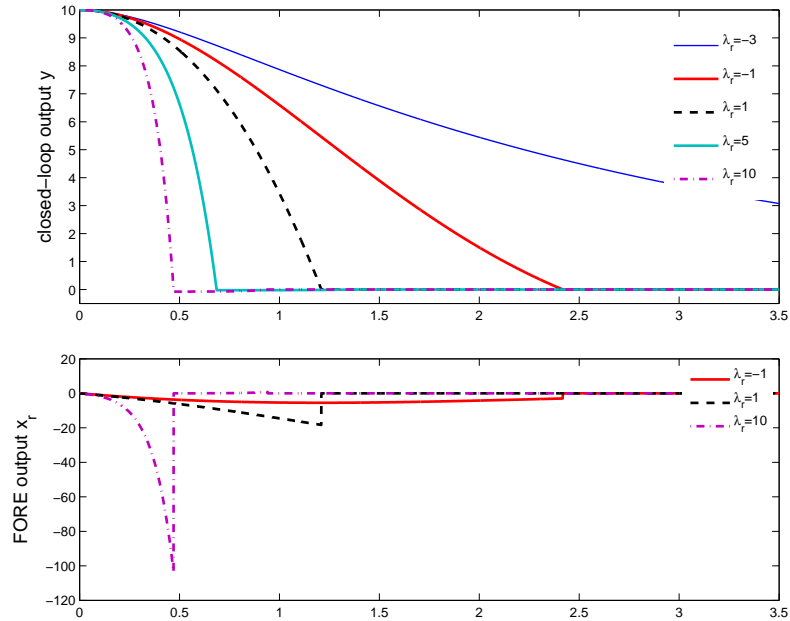

Figure 6: Haut : sortie du système. Bas : sortie du contrôleur pour différente valeur de  $\lambda_r$ .

- garantir la stabilité asymptotique de l'origine du système (6), en absence de perturbation ( $d = 0$ );
- caractériser le comportement entrée-sortie du système (6), soumis à une perturbation limitée en énergie. Pour cela nous estimerons le gain  $\mathcal{L}_2$  du système hybride.

Dans le cas d'incertitudes paramétriques sur les matrices caractéristiques des dynamiques continue et discrète du système hybride, nous avons considéré des incertitudes bornées en norme, qui peuvent traduire

- une connaissance imparfaite des valeurs numériques des paramètres du modèle;
- des erreurs d'approximation lors de la définition du modèle;
- des dynamiques négligées ...

Notons qu'il existe d'autres représentations pour modéliser des incertitudes paramétriques (voir par exemple [18], [22], [17]).

Dans ce contexte, le problème que nous cherchons à résoudre s'écrit

**Problem .1** Soit le système (6) avec incertitudes et  $r = 0$ . Connaissant une matrice de réinitialisation  $M$ , trouver une fonction de Lyapunov quadratique telle que

- *stabilité interne.* Lorsque  $d = 0$ , le système (6) avec incertitudes est asymptotiquement stable.
- *performance  $\mathcal{L}_2$ .* Lorsque  $d \neq 0$ , les trajectoires du système (6) avec incertitudes restent bornées. De plus, pour toute condition initiale  $x_0$  et toute perturbation admissible, la norme  $\mathcal{L}_2$  de la sortie est aussi bornée, c'est-à-dire qu'il existent deux scalaires positifs  $\eta_1$  et  $\eta_2$  tels que

$$\|y\|_2^2 \leq \eta_1 \|x_0\|^2 + \eta_2 \|d\|_2^2 \quad (9)$$

Des conditions constructives pour résoudre ce problème sont proposées dans [52].

Dans le cas d'une référence non-nulle en entrée, nous souhaitons forcer la sortie  $y$  du système à converger vers une référence  $r$ , en présence d'une perturbation extérieure  $d$ . Là encore, en utilisant une fonction de Lyapunov quadratique nous souhaitons prouver la stabilité asymptotique du système, et au-delà montrer que l'erreur en régime permanent tend vers zéro. Soit encore, résoudre le problème suivant :

**Problem .2** *Soit le système (6) avec  $r \neq 0$ . Connaissant une matrice de réinitialisation  $M$ , trouver une fonction de Lyapunov quadratique telle que*

- *stabilité interne.* Lorsque  $d = 0$ , le système (6) est asymptotiquement stable.
- *Lorsque  $d \neq 0$ , l'erreur  $e = r - y$  converge asymptotiquement vers zéro, pour toute perturbation  $d$  bornée en énergie.*

Des conditions constructives pour résoudre ce problème sont proposées dans [55], pour deux classes de références; constante et décroissante.

De plus ce chapitre développe un résultat de [70], qui propose de modifier la loi de réinitialisation pour améliorer, dans certains cas, la convergence de l'erreur vers zéro.

## Prise en compte de saturation.

Le Chapitre 5 contient les résultats principaux de cette thèse concernant l'analyse en stabilité et performance d'une boucle de commande incluant un contrôleur à réinitialisation et une saturation en amplitude. L'introduction d'une loi de réinitialisation dans une boucle de commande permet d'améliorer les performances de celui-ci (dépassement, temps de réponse,...). Ces améliorations impliquent une sollicitation plus importante des actionneurs en entrée du système à commander. Ces actionneurs sont, dans la pratique, limités en amplitude et/ou en vitesse. Ainsi, cela restreint les performances atteignables par de tels systèmes et peut causer une dégradation des performances, voir provoquer l'instabilité du système [1], [39], [62], [44].

Nous considérons donc un système à commander saturé en entrée. En modélisant cette saturation comme une non-linéarité de type zone morte

$$\psi(Kx) = \text{sat}(Kx) - Kx, \quad K = [-D_c C_p \quad C_c] \in \mathbb{R}^{n_r \times n} \quad (10)$$



le système hybride saturé s'écrit (avec une référence nulle,  $r = 0$ )

$$\left. \begin{array}{l} \dot{x} = A_f x + B\psi(Kx) \\ \dot{\tau} = 1 \end{array} \right\} \text{ si } x \in \mathcal{F} \text{ ou } \tau \leq \rho$$

$$\left. \begin{array}{l} x^+ = A_j x \\ \tau^+ = 0 \end{array} \right\} \text{ si } x \in \mathcal{J} \text{ et } \tau \geq \rho$$

$$y = Cx$$
(11)

Les espaces de flux et de saut,  $\mathcal{F}$  et  $\mathcal{J}$ , sont respectivement définis comme :

$$\mathcal{F} = \{x \in \mathbb{R}^n ; x' M x \geq 0\}$$

$$\mathcal{J} = \{x \in \mathbb{R}^n ; x' M x \leq 0\}$$
(12)

avec  $M$  une matrice de réinitialisation de dimension appropriée. Dans le cas où la loi de réinitialisation est définie de manière classique à partir du signe de l'entrée et de la sortie du contrôleur (voir l'Intégrateur de Clegg ou le FORE), cette matrice s'écrit  $M = Q' \mathcal{M} Q$  avec

$$\mathcal{M} = \begin{bmatrix} 0 & 1 \\ 1 & 0 \end{bmatrix} \in \mathbb{R}^{2 \times 2} \text{ and } Q = \begin{bmatrix} -C_p & 0 \\ -D_c C_p & C_c \end{bmatrix} \in \mathbb{R}^{2 \times n}$$
(13)

Le système (11) se comporte clairement comme un système hybride et non-linéaire. La présence d'une saturation en amplitude pose le problème de la caractérisation du bassin d'attraction de l'origine du système (11), c'est-à-dire le domaine de toutes les conditions initiales  $x(0) \in \mathbb{R}^n$  tel que les trajectoires correspondantes convergent vers l'origine [62], [39]. Notons que lorsque le système saturé est globalement stable, ce domaine correspond à l'ensemble de l'espace d'état. Cependant, la détermination exacte de ce bassin d'attraction est en général difficile voir impossible (y compris dans un cas sans réinitialisation). Ainsi, il est nécessaire de pouvoir l'estimer par le calcul d'une région de stabilité. C'est l'un des objectifs de ce chapitre. Dans un second temps, nous proposons une modification de la définition des espaces de flux et de saut et de la loi de réinitialisation pour améliorer l'estimation de la région de stabilité.

Ainsi, le problème que nous cherchons à résoudre, en exploitant des fonctions de Lyapunov quadratiques et les propriétés de la zone morte  $\psi(Kx)$  est décrit comme suit.

**Problem .3** *Connaissant des espaces de flux et de saut,  $\mathcal{F}$  et  $\mathcal{J}$ , déterminer une région  $\mathcal{E}$ , aussi grande que possible, telle que pour toutes conditions initiales  $\tau(0) = 0$  et  $x(0) = x_0 \in \mathcal{E}$ , la stabilité asymptotique du système (11) est garantie.*

Le théorème suivant propose des conditions constructives pour répondre à ce problème.

**Theorem .3** *S'il existe une matrice symétrique définie positive  $P \in \mathbb{R}^{n \times n}$ , une matrice  $G \in \mathbb{R}^{1 \times n}$ , des scalaires positifs  $U$ ,  $\tau_F$  et  $\tau_R$  satisfaisants :*

$$\begin{bmatrix} A_f' P + P A_f + \tau_F M & P B - G' \\ * & -2U \end{bmatrix} < 0$$
(14)

$$A_j' P A_j - P - \tau_R M \leq 0$$
(15)

$$\begin{bmatrix} P & K' U - G' \\ * & u_0^2 \end{bmatrix} \geq 0$$
(16)

alors l'ellipsoïde  $\mathcal{E}(R) = \{x \in \mathbb{R}^n; x'Rx \leq 1\}$ , avec  $R = \frac{P}{U^2}$ , est une région de stabilité asymptotique pour le système(11).

**Proof** Considérons la matrice  $G \in \mathbb{R}^{1 \times n}$  et définissons le domaine polyédral

$$\Gamma = \{x \in \mathbb{R}^n; -u_0 \leq (K - GU^{-1})x \leq u_0\} \quad (17)$$

où  $U$  est un scalaire positif et  $K$  la matrice définie en (10).

Avant de considérer la preuve du résultat, nous rappelons le lemme proposé dans [33], et adapté à notre cas.

**Lemma .1** *Soit la fonction zone morte (10). Si  $x$  appartient au domaine  $\Gamma$ , défini en (17), alors la relation*

$$\Psi(Kx)'U^{-1} [\Psi(Kx) + GU^{-1}x] \leq 0 \quad (18)$$

est vérifiée pour tout scalaire positif  $U^{-1}$ .

Considérons la fonction de Lyapunov quadratique  $V(x) = x'Rx$ ,  $R = R' > 0$ , et le changement de variables :

$$P = U^2R, \quad \tau_F = \bar{\tau}_F U^2, \quad \tau_R = \bar{\tau}_R U^2 \quad (19)$$

En utilisant le Lemme .1, nous avons

$$-2\Psi(Kx)'U^{-1} (\Psi(Kx) + GU^{-1}x) \geq 0 \quad (20)$$

En utilisant le changement de variable (19) et le complément de Schur [10], la satisfaction de la relation (16) garantie que l'ellipsoïde  $\mathcal{E}(R)$  est incluse dans le domaine  $\Gamma$  [10].

La dérivée temporelle de  $V(x)$ , le long des trajectoires continues, du système (11) s'écrit

$$\dot{V}(x) = x'(A_f'R + RA_f)x + 2x'RB\psi(Kx)$$

ou encore avec l'inégalité (20)

$$\dot{V}(x) \leq \dot{V}(x) - 2\psi(Kx)'U^{-1}\psi(Kx) - 2\psi(Kx)'U^{-2}Gx, \quad \forall x \in \mathcal{E}(R) \quad (21)$$

La partie droite de (21) s'écrit :

$$\xi' L \xi = \xi' \begin{bmatrix} A_f'R + RA_f & RB - G'U^{-2} \\ * & -2U^{-1} \end{bmatrix} \xi, \quad \text{avec } \xi = \begin{bmatrix} x \\ \psi(Kx) \end{bmatrix} \quad (22)$$

Nous souhaitons imposer  $\xi(\tilde{t})'L\xi(\tilde{t}) < 0$ , pour tout  $\tilde{t}$ , lorsque le système (11) a des trajectoires continues. Cela est possible dans deux cas :  $x(\tilde{t}) \in \mathcal{F}$  ou  $\tau \leq \rho$ .

**Case 3** *Si  $x(\tilde{t}) \in \mathcal{F}$ , alors  $\dot{V}(x) < 0$  lorsque  $\xi' L \xi < 0$  pour tout  $x \in \mathcal{F}$ . Ainsi en appliquant la S-procédure [10], cela est équivalent à vérifier :*

$$\begin{bmatrix} A_f'R + RA_f + \bar{\tau}_F M & RB - G'U^{-2} \\ * & -2U^{-1} \end{bmatrix} < 0 \quad (23)$$

avec  $\bar{\tau}_F > 0$ .

**Case 4** Supposons maintenant que  $\tau \leq \rho$ . Soit  $\underline{t} \leq \tilde{t}$  le plus petit temps tel que le système a une trajectoire continue avec  $\tilde{t} \in [\underline{t}, \tilde{t}]$ . Nous avons  $x(\underline{t}) \in \mathcal{F}$  pour  $\underline{t} = 0$ . Donc, il existe un scalaire positif  $\epsilon$ , tel que pour tout  $t \in [\underline{t}, \rho)$ , nous avons  $x(t) \in \mathcal{F}_\epsilon$  avec  $\mathcal{F}_\epsilon = \{x \in \mathbb{R}^n ; x' M x + \epsilon x' x \geq 0\}$ , un domaine un petit peu plus grand que  $\mathcal{F}$ .

Ainsi, les trajectoires restent dans le domaine  $\mathcal{E}(R)$  et  $\dot{V}(x(t)) < 0$  pour tout  $t \in [\underline{t}, \rho)$ , soit  $\xi' L \xi < 0$  pour tout  $x \in \mathcal{F}_\epsilon$ , ce qui est équivalent à

$$\begin{bmatrix} A_f' R + R A_f + \bar{\tau}_F (M + \epsilon I) & G' U^{-2} \\ * & -2U^{-1} \end{bmatrix} < 0 \quad (24)$$

De plus, nous pouvons remarquer que  $\epsilon \rightarrow 0$  si  $\rho \rightarrow 0$ . Ainsi, en considérant une valeur de  $\rho$  suffisamment petite, nous pouvons négliger  $\epsilon$  et la satisfaction de la relation (23) garantie que la relation (24) est vérifiée. Finalement, la relation (14) est obtenue en multipliant à droite et à gauche la relation (23) par  $\text{diag}(U I_n, U)$ , et en utilisant le changement de variables (19).

De plus, nous souhaitons aussi montrer que la fonction de Lyapunov n'est pas croissante au cours des sauts. Autrement dit, nous voulons vérifier :

$$V(x^+) - V(x) \leq 0 \text{ si } x \in \mathcal{J}$$

En utilisant la S-procédure [10], cette condition existe si la condition suivante est satisfaite :

$$A_j' R A_j - R - \bar{\tau}_R M \leq 0 \quad (25)$$

avec  $\bar{\tau}_R > 0$ . La multiplication de (25) par  $U^2$  et le changement de variables (19) amènent la LMI (15).

Ainsi, la satisfaction des relations (14)-(16) assure que pour toutes conditions initiales  $x(0) \in \mathcal{E}(R)$ , les trajectoires correspondantes restent confinées dans  $\mathcal{E}(R)$  et convergent vers l'origine. Ainsi la stabilité asymptotique du système hybride (11) est garantie. ■

**Remark .3** Grâce à un changement de variable, le Théorème .3 propose des conditions LMIs pour estimer la région de stabilité du système (11). Notons que dans [54], les conditions proposées sont sous formes d'inégalités bilinéaires.

**Remark .4** Notons que des conditions constructives peuvent être inspirées du Théorème .3 pour analyser la stabilité globale du système (11) ainsi qu'évaluer ses performances en calculant le gain  $\mathcal{L}_2$  en présence d'une perturbation extérieure.

## Nouvelle loi de réinitialisation

Il peut être intéressant de modifier la définition des espaces  $\mathcal{F}$  et  $\mathcal{J}$ , ainsi que de la loi de réinitialisation pour essayer d'agrandir la région de stabilité du système (11). La méthode que nous proposons repose sur l'estimation du bassin d'attraction  $\mathcal{E}$  en utilisant

les résultats de [33]. Ce domaine est considéré comme l'espace de flux et en dehors, le système subit des sauts. Ces remarques amènent le système suivant :

$$\left. \begin{array}{l} \dot{x} = A_f x + B\Psi(Kx) \\ y = Cx \\ x^+ = A_j x \end{array} \right\} \begin{array}{l} \text{si } x \in \mathcal{E}(P) \\ \text{si } x \in \text{clos}(\mathbb{R}^n \setminus \mathcal{E}(P)) \end{array} \quad (26)$$

où  $\mathcal{E}(P) = \{x \in \mathbb{R}^n; x'Px \leq 1\}$  avec  $P = P' > 0$ ,  $P \in \mathbb{R}^{n \times n}$ .

**Remark .5** Les espaces de flux et de sauts du système (26) se réécrivent

$$\begin{aligned} \mathcal{F} &= \mathcal{E}(P) = \{x \in \mathbb{R}^n; x'Px \leq 1\} \\ \mathcal{J} &= \text{clos}(\mathbb{R}^n \setminus \mathcal{F}) \end{aligned} \quad (27)$$

La matrice  $A_j$  (7) correspond aux sauts instantanés des états du contrôleur

$$x_r^+ = A_r x_r + B_r y = A_r x_r - B_r C_p x_p, \quad (28)$$

où  $A_r$  et  $B_r$  sont des matrices constantes et de dimensions appropriées. Nous pouvons alors écrire

$$A_j = \overline{A}_j + E_r \Theta F_r,$$

$$\text{où } \overline{A}_j = \begin{bmatrix} I_{n_p} & 0 \\ 0 & 0 \end{bmatrix}, E_r = \begin{bmatrix} 0 \\ I_{n_r} \end{bmatrix}, \Theta = \begin{bmatrix} A_r & B_r \end{bmatrix} \text{ et } F_r = \begin{bmatrix} C_p & 0 \\ 0 & 1 \end{bmatrix}.$$

Le résultat suivant propose des conditions constructives pour le calcul de  $A_r$  et  $B_r$  afin d'obtenir un domaine de stabilité aussi grand que possible.

**Proposition .1** S'il existe des matrices symétriques définies positives  $W \in \mathbb{R}^{n \times n}$  et  $P_1 \in \mathbb{R}^{n \times n}$ , une matrice  $Y \in \mathbb{R}^{1 \times n}$ ,  $\Theta \in \mathbb{R}^{2n_r \times (n_r+1)}$  et un scalaire positif  $S$  tels que

$$\begin{bmatrix} W A_f' + A_f W & B S - Y' \\ S B' - Y & -2S \end{bmatrix} < 0 \quad (29)$$

$$\begin{bmatrix} W & W K' - Y' \\ K W - Y & u_0^2 \end{bmatrix} \geq 0 \quad (30)$$

$$\begin{bmatrix} P_1 & (\overline{A}_j + E_r \Theta F_r)' \\ \overline{A}_j + E_r \Theta F_r & W \end{bmatrix} \geq 0, \quad (31)$$

alors le domaine  $\mathcal{E}(P) \cup \mathcal{D}(P_1)$ , avec  $\mathcal{E}(P) = \{x \in \mathbb{R}^n; x'Px \leq 1\}$ ,  $P = W^{-1}$  et  $\mathcal{D}(P_1) = \{x \in \mathbb{R}^n; x'P_1x \leq 1\}$  est une région de stabilité asymptotique pour le système (26).

**Proof** Les inégalités (29) et (30) sont tirées de [33] et garantissent que pour toutes conditions initiales dans  $\mathcal{E}(P) = \{x \in \mathbb{R}^n; x'Px \leq 1\}$ , les trajectoires correspondantes restent confinées dans  $\mathcal{E}(P)$  et convergent vers l'origine.

De plus, nous cherchons un domaine  $\mathcal{D}(P_1) = \{x \in \mathbb{R}^n; x'P_1x \leq 1\}$  (avec  $P_1 = P_1' > 0$ ) tel que l'implication suivante soit satisfaite

$$x \in \mathcal{D}(P_1) \implies x^+ \in \mathcal{E}(P) \quad (32)$$

En appliquant successivement la S-procédure et le complément de Schur, la relation (32) s'écrit comme la relation (31).

Ainsi, pour tout  $x_0$  dans  $\mathcal{E}(P)$  ou  $\mathcal{D}(P_1)$ , les trajectoires correspondantes convergent asymptotiquement vers l'origine. Ainsi, le domaine  $\mathcal{E}(P) \cup \mathcal{D}(P_1)$  est bien une région de stabilité pour le système (26). ■

## Synthèse anti-windup

Les stratégies dites "anti-windup" sont des techniques efficaces pour limiter l'influence (en terme de stabilité et de performance) d'une saturation dans une boucle de commande. La conception de contrôleurs anti-windup a d'abord été motivée par la dégradation du régime transitoire des intégrateurs dans une boucle de commande [27]. Plus récemment, des méthodes systématiques, pour la synthèse de tels compensateurs, ont été développées utilisant, en particulier des LMIs (voir par exemple [62], [65], [25]). Nous proposons par la suite une méthode de synthèse d'un compensateur anti-windup pour les systèmes à réinitialisation. Ce résultat (et sa preuve) est exposé dans [63].

Nous considérons le système saturé (11) et le contrôleur à réinitialisation (4), avec une référence nulle.

L'interconnexion entre les deux systèmes est donnée par

$$\begin{aligned} e &= y \\ u &= \text{sat}(y_r) \end{aligned}$$

Le compensateur anti-windup est défini comme suit :

$$\begin{aligned} \dot{x}_a &= A_a x_a + B_a (\text{sat}(y_r) - y_r) \\ y_a &= C_a x_a + D_a (\text{sat}(y_r) - y_r) \end{aligned} \quad (33)$$

Le contrôleur devient alors

$$\left. \begin{aligned} \dot{x}_r &= A_c x_r + B_c y_r + y_a \\ y_r &= C_c x_r + D_c y \\ \dot{\tau} &= 1 \end{aligned} \right\} \text{if } (x_p, x_r, x_a) \in \mathcal{F} \text{ ou } \tau \leq \rho \quad (34)$$

$$\left. \begin{aligned} x_r^+ &= 0 \\ \tau^+ &= 0 \end{aligned} \right\} \text{if } (x_p, x_r, x_a) \in \mathcal{J} \text{ et } \tau \geq \rho$$

où  $x_a \in \mathbb{R}^{n_a}$ ,  $(\text{sat}(y_r) - y_r) \in \mathbb{R}$ ,  $y_a \in \mathbb{R}^{n_r}$  sont les états, l'entrée et la sortie du compensateur anti-windup.  $A_a, B_a, C_a$  et  $D_a$  sont des matrices de dimensions appropriées à calculer. Nous rappelons que  $y_r \in \mathbb{R}$  est l'entrée du système (11) et  $y \in \mathbb{R}$  sa sortie.

Soit le vecteur d'état augmenté

$$x = \begin{bmatrix} x_p \\ x_r \\ x_a \end{bmatrix} \in \mathbb{R}^n \quad (35)$$

avec  $n = n_p + n_r + n_a$  et la zone morte :

$$\phi(Kx) = \text{sat}(Kx) - Kx, \quad K = \begin{bmatrix} D_c C_p & C_c & 0 \end{bmatrix} = \begin{bmatrix} K_1 & 0 \end{bmatrix} \in \mathbb{R}^{n_r \times n} \quad (36)$$

Pour l'analyse en performance, nous définissons aussi  $z \in \mathbb{R}^{n_z}$  :

$$z = C_z x_p + D_z y \quad (37)$$

où  $C_z$  et  $D_z$  sont des matrices constantes et de dimensions appropriées.

Ainsi, en associant les relations (33), (34), (35), (36) et (37), le système complet s'écrit

$$\left. \begin{array}{l} \dot{x} = A_F x + B_F \phi(Kx) + B_d d \\ y_r = Kx \\ y = Cx \\ z = C_2 x + D_z \phi(Kx) \\ \dot{\tau} = 1 \\ x^+ = A_J x \\ \tau^+ = 0 \end{array} \right\} \begin{array}{l} \text{si } x \in \mathcal{F} \text{ ou } \tau \leq \rho \\ \\ \\ \\ \\ \text{si } x \in \mathcal{J} \text{ et } \tau \geq \rho \end{array} \quad (38)$$

avec

$$\begin{aligned} A_F &= \begin{bmatrix} A_p + B_p D_c C_p & B_p C_c & 0 \\ B_c C_p & A_c & C_a \\ 0 & 0 & A_a \end{bmatrix} = \begin{bmatrix} A & RC_a \\ 0 & A_a \end{bmatrix}, \quad B_F = \begin{bmatrix} B_p \\ D_a \\ B_a \end{bmatrix} = \begin{bmatrix} B + RD_a \\ B_a \end{bmatrix} \\ B_d &= \begin{bmatrix} B_{pd} \\ 0 \\ 0 \end{bmatrix} = \begin{bmatrix} \mathbb{B}_d \\ 0 \end{bmatrix}, \quad B = \begin{bmatrix} B_p \\ 0 \end{bmatrix}, \quad R = \begin{bmatrix} 0 \\ I_{n_r} \end{bmatrix}, \quad C = \begin{bmatrix} C_p & 0 & 0 \end{bmatrix} = \begin{bmatrix} C_1 & 0 \end{bmatrix} \\ C_2 &= \begin{bmatrix} C_z + D_z D_c C_p & D_z C_c & 0 \end{bmatrix} = \begin{bmatrix} \mathbb{C}_z & 0 \end{bmatrix} \end{aligned} \quad (39)$$

Par la suite, deux structures sont possibles pour la matrice  $A_J \in \mathbb{R}^{n \times n}$  : le saut remet à zéro les états du contrôleur et du compensateur anti-windup ou seulement les états du contrôleur.

$$A_J = \begin{bmatrix} I_{n_p} & 0 & 0 \\ 0 & 0 & 0 \\ 0 & 0 & 0 \end{bmatrix} = \begin{bmatrix} A_{J0} & 0 \\ 0 & 0 \end{bmatrix} \quad \text{ou} \quad A_J = \begin{bmatrix} I_{n_p} & 0 & 0 \\ 0 & 0 & 0 \\ 0 & 0 & I_{n_a} \end{bmatrix} = \begin{bmatrix} A_{J0} & 0 \\ 0 & I_{n_a} \end{bmatrix} \quad (40)$$

De plus, en nous plaçant à nouveau dans le cas de règles de flux et de saut classiques, c'est-à-dire dépendant du signe du produit entre  $e$  (entrée du contrôleur) et  $y_r$  (sortie du contrôleur) (voir par exemple [68], [54]), les espaces  $\mathcal{F}$  et  $\mathcal{J}$  sont définis comme :

$$\begin{aligned} \mathcal{F} &= \{x \in \mathbb{R}^n ; x' M x \geq 0\} \\ \mathcal{J} &= \{x \in \mathbb{R}^n ; x' M x \leq 0\} \end{aligned} \quad (41)$$

Dans (41), la matrice  $M$  est une matrice de réinitialisation satisfaisant  $M = Q' M Q$  avec :

$$\begin{aligned} \mathcal{M} &= \begin{bmatrix} 0 & -1 \\ -1 & 0 \end{bmatrix} \in \mathbb{R}^{2 \times 2} \\ Q &= \begin{bmatrix} C_p & 0 & 0 \\ D_c C_p & C_c & 0 \end{bmatrix} = \begin{bmatrix} C \\ K \end{bmatrix} = \begin{bmatrix} C_1 & 0 \\ K_1 & 0 \end{bmatrix} = \begin{bmatrix} Q_1 & 0 \end{bmatrix} \in \mathbb{R}^{2 \times n} \end{aligned} \quad (42)$$

Le problème que nous souhaitons résoudre est :

**Problem .4** Soient les espaces de flux et de saut,  $\mathcal{F}$  et  $\mathcal{J}$ .

1. Si  $d = 0$ , déterminer un compensateur anti-windup, i.e. des matrices  $A_a, B_a, C_a$  et  $D_a$ , et une région  $\mathcal{E}$ , aussi grande que possible, tels que pour toutes conditions initiales  $x_0 \in \mathcal{E}$ ,  $\tau(0) = 0$ , la stabilité asymptotique du système (38) soit garantie.
2. Si  $d \neq 0$ , déterminer le gain  $\mathcal{L}_2$  entre l'entrée  $d$  et la sortie  $z$ . En particulier, pour des conditions initiales nulles ( $x(0) = 0$ ), et pour toute perturbation  $d$  limitée en énergie, la relation suivante est vérifiée

$$\|z\|_2^2 \leq \gamma \|d\|_2^2$$

Pour répondre au Problème .4, nous proposons le résultat suivant.

**Theorem .4** S'il existe des matrices symétriques définies positives  $X \in \mathbb{R}^{(n_p+n_r) \times (n_p+n_r)}$ ,  $Y \in \mathbb{R}^{(n_p+n_r) \times (n_p+n_r)}$ ,  $M_1 \in \mathbb{R}^{2 \times 2}$ , une matrice diagonale positive  $S \in \mathbb{R}^{1 \times 1}$ , des matrices  $Z_1 \in \mathbb{R}^{1 \times (n_p+n_r)}$ ,  $\mathcal{Z} \in \mathbb{R}^{1 \times (n_p+n_r)}$ ,  $\Omega_1 \in \mathbb{R}^{(n_p+n_r) \times (n_p+n_r)}$ ,  $\Omega_2 \in \mathbb{R}^{(n_p+n_r) \times 1}$ ,  $\Omega_3 \in \mathbb{R}^{n_r \times (n_p+n_r)}$ ,  $\Omega_4 \in \mathbb{R}^{n_r \times 1}$ , des scalaires positifs  $\tau_F, \tau_R, \delta, \gamma$  tels que les conditions suivantes soient satisfaites :

$$\left[ \begin{array}{ccc} XA' + AX & XA' + AY + R\Omega_3 + \Omega_1 & BS + R\Omega_4 + \Omega_2 - \mathcal{Z}' \\ * & AY + YA' + R\Omega_3 + \Omega_3'R' & BS + R\Omega_4 - Z_1' \\ * & * & -2S \\ * & * & * \\ * & * & * \\ * & * & * \\ \mathbb{B}_w & XC'_z & \tau_F XQ'_1 \\ \mathbb{B}_w & YC'_z & \tau_F YQ'_1 \\ 0 & SD'_z & 0 \\ -I_{n_q} & 0 & 0 \\ * & -\gamma I_{n_z} & 0 \\ * & * & -\tau_F M_1^{-1} \end{array} \right] < 0 \quad (43)$$

$$\left[ \begin{array}{ccc} X & X & XK'_1 - \mathcal{Z}' \\ * & Y & YK'_1 - Z_1' \\ * & * & \delta u_0^2 \end{array} \right] \geq 0 \quad (44)$$

$$\left[ \begin{array}{ccccc} -X & -X & XA'_{J0} & XA'_{J0} & \tau_R XQ'_1 \\ * & -Y & YA'_{J0} & YA'_{J0} & \tau_R YQ'_1 \\ * & * & -X & -X & 0 \\ * & * & * & -Y & 0 \\ * & * & * & * & -\tau_R M_1^{-1} \end{array} \right] \leq 0 \quad (45)$$

$$-M_1 \leq \mathcal{M} \leq M_1 \quad (46)$$

le contrôleur anti-windup définit comme

$$\begin{aligned} A_a &= (\mathcal{U}')^{-1} X^{-1} \Omega_1 N^{-1} \\ B_a &= (\mathcal{U}')^{-1} X^{-1} \Omega_2 S^{-1} \\ C_a &= \Omega_3 N^{-1} \\ D_a &= \Omega_4 S^{-1} \end{aligned} \quad (47)$$

où les matrices  $\mathcal{U}$ ,  $N$  vérifient  $N\mathcal{U} = I_{n_p+n_r} - YX^{-1}$ , est une solution au Problème .4, c'est-à-dire

1. Lorsque  $d = 0$ , le système hybride (38), avec  $A_J$  définie comme la première structure de (40), est stable pour toutes conditions initiales dans le domaine  $\mathcal{E}(P, \delta)$

$$\mathcal{E}(P, \delta) = \{x \in \mathbb{R}^n; x'Px \leq \delta^{-1}\} \quad (48)$$

avec

$$P = W^{-1} = \begin{bmatrix} X^{-1} & \mathcal{U}' \\ \star & F \end{bmatrix}; W = \begin{bmatrix} Y & N' \\ \star & H \end{bmatrix} \quad (49)$$

2. Lorsque  $d \neq 0$ , pour  $x(0) = 0$ ,

- les trajectoires du système restent bornées dans  $\mathcal{E}(P, \delta)$ ,
- le gain  $\mathcal{L}_2$ , entre  $z$  et  $d$ , existe et est fini.

**Remark .6** La synthèse d'un compensateur anti-windup statique peut se faire en considérant  $n_a = 0$ ,  $A_a = 0$ ,  $B_a = 0$ ,  $C_a = 0$  et en calculant seulement le gain  $D_a$ .

Le Théorème .4 nous permet de synthétiser le contrôleur dynamique (33). Des algorithmes de relaxation doivent être utilisés pour gérer les non-linearités entre les variables de décision du théorème. Ainsi, nous sommes capables d'estimer le bassin d'attraction, mais aussi le gain  $\mathcal{L}_2$  du système (38). Notons que les matrices  $A_a$ ,  $B_a$ ,  $C_a$  et  $D_a$  peuvent être obtenues dans le but d'agrandir le domaine de stabilité ou d'améliorer les performances du système (ou les deux).

**Remark .7** La seconde structure pour la matrice  $A_J$  dans la définition (40) ( $x_a^+ = x_a$ ) peut être considérée en reportant le terme suivant dans l'inégalité (45)

$$\begin{bmatrix} XA'_{J0} & XA'_{J0} \\ YA'_{J0} + X - Y & YA'_{J0} \end{bmatrix} \quad (50)$$

**Remark .8** Notons enfin, que la Proposition .1 et le Théorème .4 peuvent être regroupés pour calculer simultanément un compensateur anti-windup et une nouvelle loi de réinitialisation.



## Problèmes d'optimisation

Les résultats de cette thèse sont présentés sous forme de contraintes LMI ou quasi-LMI pour répondre aux différents problèmes d'analyse et de synthèse. Derrière les tests de faisabilités de ces inégalités, d'autres objectifs peuvent être traités en optimisant certaines variables de décision : incertitudes admissibles, estimation du gain  $\mathcal{L}_2$ , taille de la région de stabilité ... La définition de problèmes d'optimisation convexes associés aux LMIs de nos théorèmes ou propositions permettent de remplir ces objectifs [10], [24]. Dans le cas de conditions quasi-LMIs, des schémas de relaxation doivent être utilisés. Le chapitre 6 de cette thèse est ainsi dédié à la définition de problèmes d'optimisation convexes pour chaque théorème ou proposition développé. Dans ce cadre, les différentes contraintes sont résolues de manière pertinente. Notons que ces problèmes ne sont pas uniques et d'autres formulations sont possibles. Par exemple en ajoutant des poids de pondération sur les variables à minimiser (ou à maximiser) plusieurs objectifs sont abordables simultanément.

## Exemples numériques

Le Chapitre 7 présente les résultats numériques des problèmes d'optimisation présentés au Chapitre 6. Pour l'implémentation des LMIs, nous avons utilisé l'interface de programmation Matlab pour la mise en forme et la résolution de problèmes d'optimisation convexes ou non-convexes YALMIP [51]. En respectant les remarques du Chapitre 3 concernant les précautions à prendre pour la simulation des systèmes hybrides, nous avons utilisé Matlab/Simulink pour nos simulations temporelles. Nous présentons dans ce résumé les simulations correspondant au cas d'un système comprenant un élément à réinitialisation et une saturation.

Soit le système instable

$$\begin{aligned} \dot{x}_p &= 0.1x_p + u \\ y &= x_p \end{aligned} \quad (51)$$

connecté à un contrôleur proportionnel-intégral [33]

$$\begin{aligned} \dot{x}_r &= 0.2e \\ y_r &= x_r + 2e \end{aligned} \quad (52)$$

L'interconnexion, correspondant à la Figure 7, entre les deux systèmes est :

$$\begin{aligned} e &= -y \\ u &= \text{sat}(y_r) \end{aligned} \quad (53)$$

## Analyse de la stabilité locale

Nous considérons d'abord une loi de réinitialisation classique, basée sur le signe de  $e$  et  $y_r$ . Sur la Figure 8, nous comparons le résultat du Théorème .3 (ellipsoïde noire continue) avec

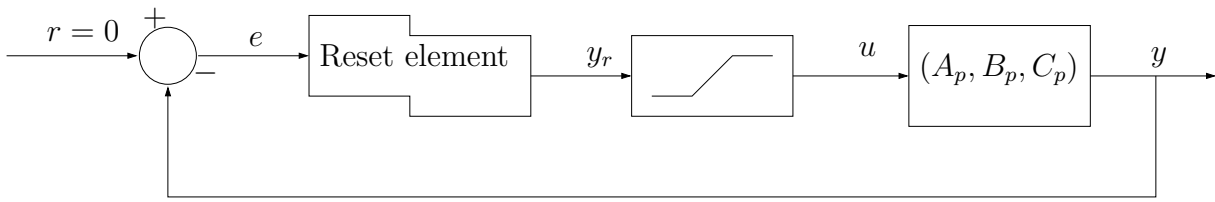

Figure 7: Boucle de commande avec contrôleur à réinitialisation et saturation

celui de l'approche proposée dans [33] (ellipsoïde rouge pointillée). Les deux domaines de stabilité sont très proches. Comme illustré sur la Figure 9, la loi de réinitialisation permet d'améliorer les performances du système, y compris lorsque la saturation est active.

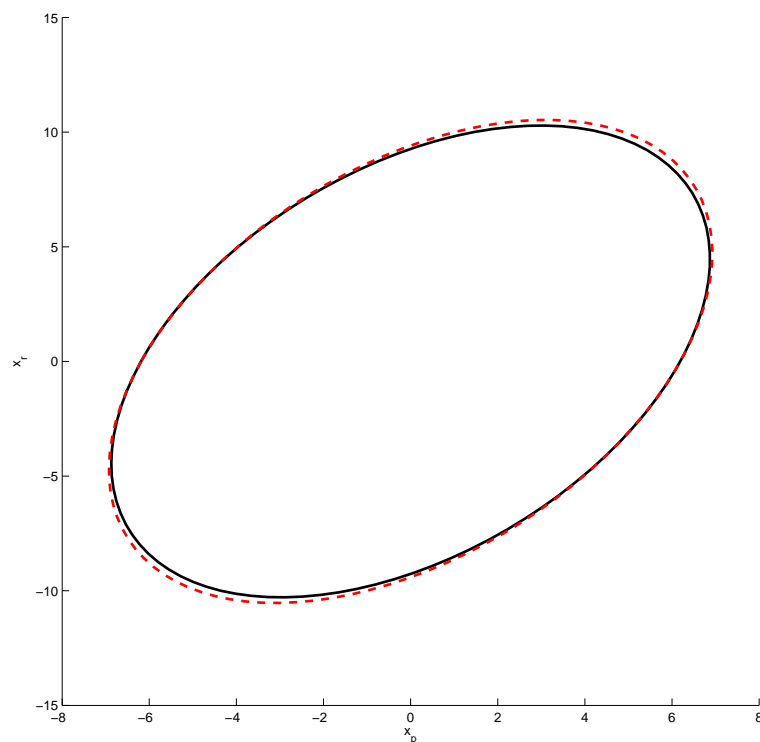

Figure 8: Domaine de stabilité du système saturé avec (ligne continue noire) ou sans réinitialisation (ligne pointillée rouge)

### Augmentation du domaine de stabilité : approche hybride

En résolvant les contraintes de la Proposition .1 pour obtenir un domaine  $\mathcal{E}(P) \cup \mathcal{D}(P_1)$  aussi grand que possible, avec  $\mathcal{E}(P) = \{x \in \mathbb{R}^n; x'Px \leq 1\}$  and  $\mathcal{D}(P_1) = \{x \in \mathbb{R}^n; x'P_1x \leq 1\}$ , nous obtenons les ellipses de la Figure 10. Les trajectoires correspondantes sont présentées Figure 11.

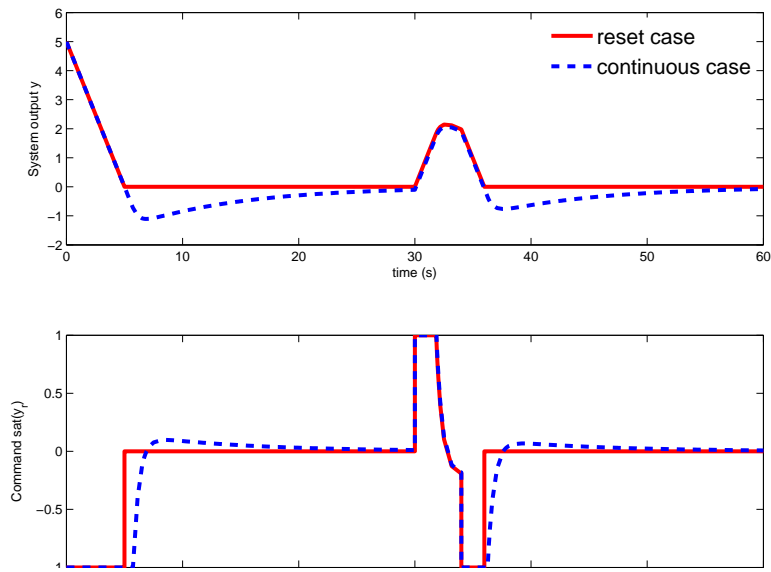

Figure 9: Haut : sortie du système. Bas : commande saturée

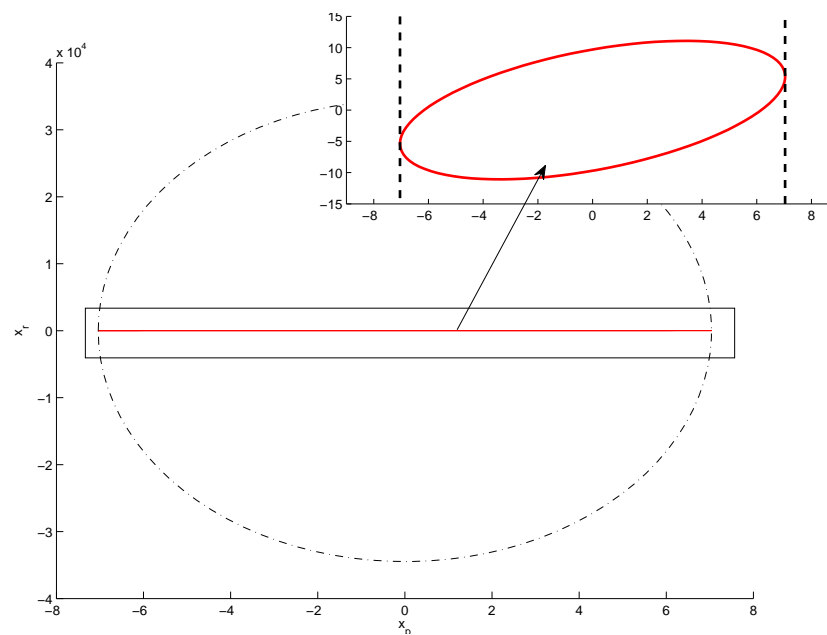

Figure 10: Domaine de stabilité du système saturé avec une nouvelle loi de saut

En combinant la Proposition .1 et le Théorème .4, nous profitons de la loi anti-windup pour augmenter le domaine de stabilité initial  $\mathcal{E}(P)$  et le calcul d'un loi de réinitialisation adaptée agrandit le domaine de stabilité dans la direction  $x_r$ , celle des états du contrôleur. La région de stabilité correspondante est présentée Figure 12

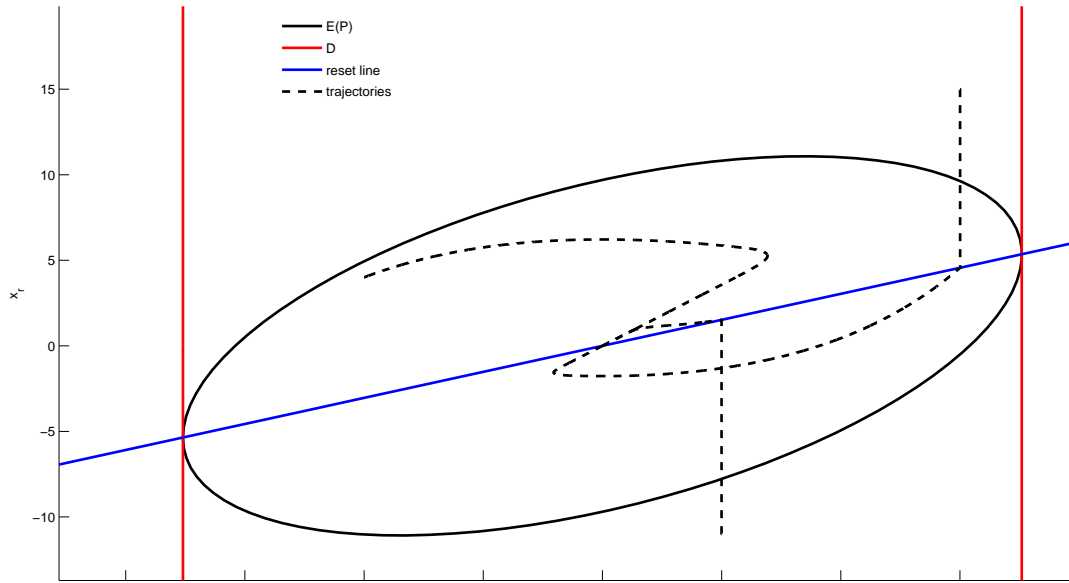

Figure 11: Domaine de stabilité du système saturé et trajectoires

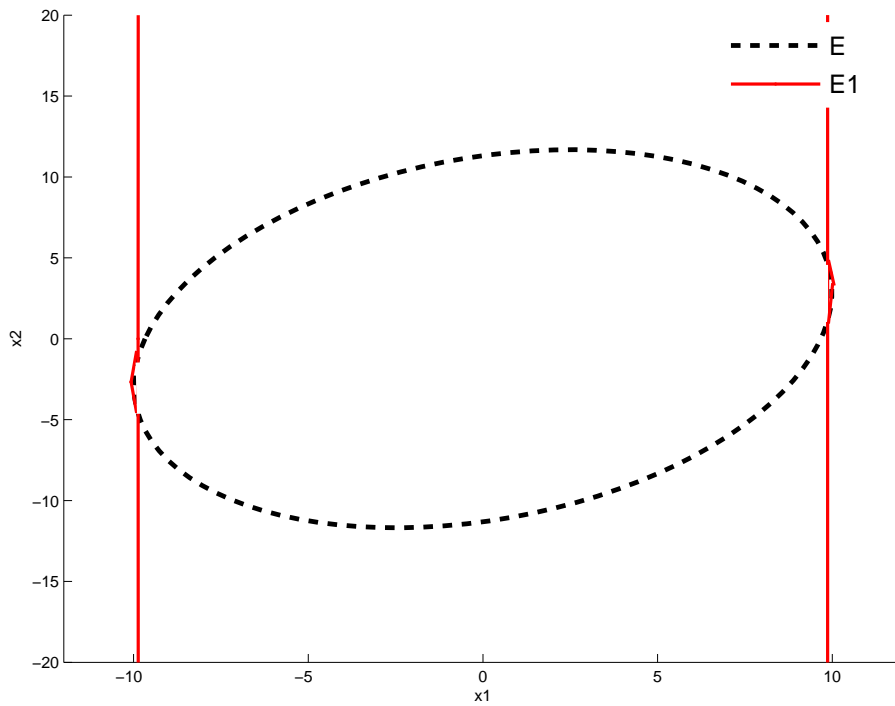

Figure 12: Domaine de stabilité du système saturé avec une nouvelle loi de saut et compensateur anti-windup

## Approche par secteurs angulaires

Le Chapitre 8 propose des conditions pour relaxer les théorèmes et propositions proposés dans cette thèse. En effet, dans certains cas (par exemple lorsque le système sans réinitialisation est instable), les conditions constructives proposées n'ont pas de solution. L'utilisation de LMIs et d'une unique fonction de Lyapunov quadratique sont source de conservatisme. Des degrés de liberté sont apportés par l'utilisation de fonctions de Lyapunov quadratiques par morceaux et ainsi lèvent une partie du conservatisme de nos conditions [68], [67], [43]. Dans ce chapitre, nous présentons comment construire de telles fonctions pour l'analyse de système comprenant un élément à réinitialisation et une saturation. L'espace d'état est découpé en différents secteurs et une fonction de Lyapunov est utilisée par secteur, conduisant ainsi à des conditions constructives différentes pour chaque secteur (en particulier pour l'espace de saut et de flux). Cependant, plusieurs limitations empêchent la généralisation de cette méthode à une large classe de contrôleur à réinitialisation.

- Il est indispensable de garantir la continuité de la fonction de Lyapunov quadratique par morceaux à l'intersection de chaque secteur. Les conditions de continuité proposées ne sont valables que pour un système d'ordre deux ( $n = 2$ ).
- Seuls les systèmes ne souffrant de pas de solution de Zeno peuvent être considérés. En effet, nos conditions ne permettent pas de traiter des systèmes hybrides avec une variable de régulation temporelle.

Des conditions supplémentaires sont en cours d'élaboration pour pouvoir analyser des systèmes à réinitialisation d'ordre supérieur et avec régulation temporelle [71]. Cependant elles ne sont pas présentées dans ce manuscrit.

Suite à ces remarques, nous montrons comment réécrire le Théorème 4.1 qui permet l'estimation de la région de stabilité du système hybride saturé, et nous l'étendons à l'analyse en performance. Plusieurs exemples illustrent l'efficacité de l'approche quadratique par morceaux, en particulier en considérant un contrôleur FORE à pôle continu instable. Notons que si ces méthodes permettent de lever le conservatisme des résultats précédents, elles entraînent une complexité numérique plus importante [19].

## Conclusion générale

L'analyse en stabilité et performance des systèmes hybrides, en particulier des systèmes à réinitialisation, est un problème complexe récemment abordé par la théorie du contrôle. Cette thèse est une étape supplémentaire dans la recherche de méthodes théoriques pour répondre à ce problème. Nous nous sommes concentrés sur l'utilisation des méthodes de Lyapunov pour les systèmes hybrides. Pour appliquer le second principe de Lyapunov, la recherche d'une fonction de Lyapunov candidate est un élément clé qui nous permet de conclure quant à la stabilité et un certain niveau de performance du système. Dans le but de proposer des conditions constructives, c'est-à-dire des conditions qui déterminent une fonction de Lyapunov candidate, nous avons considéré des fonctions de Lyapunov

---

quadratiques (ou sous certaines conditions quadratiques par morceaux). Dans ce cadre, nous avons développé plusieurs théorèmes et propositions qui complètent les méthodes existantes pour l'analyse des systèmes à réinitialisation. Des premières pistes pour des méthodes de synthèse ont aussi été présentées.

Travailler avec des systèmes à réinitialisation est parfois complexe. Pour cela, dans le Chapitre 3 de ce manuscrit, le lecteur peut trouver des précisions sur le modèle mathématique associé à ces systèmes et les précautions à prendre pour leur simulation. Plusieurs exemples mettent en évidence le comportement des systèmes à réinitialisation et motivent nos travaux.

En nous appuyant sur ces remarques, différents problèmes ont été successivement traités. Nous avons d'abord étendu des travaux existants pour l'analyse de système à réinitialisation sujet à des incertitudes paramétriques et/ou en présence de référence non-nulle (Chapitre 4). Dans le cas des systèmes incertains, nous avons considéré plus particulièrement des incertitudes bornées en norme. Les résultats proposés permettent d'estimer une borne maximale de ces incertitudes. Une estimation des performances, via l'estimation du gain  $\mathcal{L}_2$  du système, est aussi décrite. La présence de référence non-nulle pose un problème de poursuite, il s'agit de garantir qu'en présence d'une référence et d'une perturbation extérieure, la sortie du système converge bien vers la trajectoire désirée. En utilisant une loi de réinitialisation, les propriétés de convergence du système sont conservées et les performances améliorées.

Un inconvénient de cette amélioration est une plus grande amplitude du signal de commande. Ainsi, dans le Chapitre 5, nous prenons en compte la présence de saturation dans nos conditions d'analyse. La présence d'une telle non-linéarité implique souvent une estimation du bassin d'attraction de l'origine du système. Au-delà de cette estimation, nous avons présenté des approches temps-continu ou temps-hybride pour la synthèse de contrôleur qui améliore cette région de stabilité.

Pour aider le lecteur à implémenter et exploiter nos théorèmes ou propositions, des problèmes d'optimisation convexes sont proposés dans le Chapitre 6. En minimisant (ou maximisant) certaines variables de décision dans nos conditions, différentes directions peuvent être explorées : meilleure estimation du niveau de performance, estimation de la région de stabilité la plus grande possible ...

Dans le Chapitre 7, plusieurs simulations illustrent nos approches. Nous avons considéré un contrôleur linéaire augmenté par une loi de réinitialisation pour la commande d'un système linéaire saturé en entrée. En utilisant les problèmes d'optimisation du Chapitre 6, nous avons analysé les propriétés de stabilité et de performance de ce système hybride. Des simulations temporelles confirment nos résultats théoriques. Une importante partie de ce chapitre repose sur l'estimation du bassin d'attraction du système saturé. Plusieurs simulations mettent en évidence l'efficacité des différentes méthodes proposées pour élargir ce domaine.

Les différents systèmes sur lesquels nous avons travaillé pendant cette thèse ont fait apparaître un conservatisme important de nos méthode d'analyse. Pour lever ces limitations numériques, une solution peut être d'utiliser des fonctions de Lyapunov quadratique par morceaux. Sous de fortes hypothèses, le Chapitre 8 expose comment construire de telles fonctions pour l'analyse de systèmes à réinitialisation.

Cette dernière remarque pose plusieurs questions, encore ouvertes.

Dans un premier temps, plusieurs travaux en cours vont permettre de lever les hypothèses du Chapitre 8 pour l'utilisation de fonctions de Lyapunov quadratique par morceaux [71]. La méthode proposée considère un système linéaire contrôlé par un FORE et doit être étendue à une classe plus large de systèmes.

De premières pistes pour la modification des lois de réinitialisation ont été proposées, en particulier pour agrandir le domaine de stabilité d'un système saturé. Ces résultats sont positifs, mais doivent être approfondis. Une direction de recherche pourrait être de synthétiser des lois de saut qui dépendent du compensateur anti-windup ou qui agissent directement sur son comportement. Notons que les contrôleurs à réinitialisation sont des outils qui peuvent améliorer les performances des systèmes non-linéaires, mais aussi des systèmes linéaires [58], [56]. Des conditions de synthèse de tels contrôleurs pour atteindre certaines performances est aussi un problème intéressant.

D'un point de vue pratique, les cartes de commande numérique permettent d'implémenter facilement des contrôleurs à réinitialisation pour la commande de système continu. Nous nous sommes intéressés au contrôle de la position angulaire d'un moteur à courant continu. L'implémentation du contrôleur doit être poursuivie, en particulier pour prendre en compte les limitations en tension et courant du moteur.

Finalement, nous rappelons qu'une des premières motivations pour cette thèse concernaient certaines applications aérospatiales où la valeur de tout ou partie des états peut changer instantanément, de manière voulue ou non. Dans le cas du contrôle d'un satellite, les ingénieurs peuvent décider de réinitialiser le système si son comportement n'est pas celui souhaité ou si la dégradation des performances est trop importante. Pour l'instant cela est fait sans précaution particulière. Nos résultats pourraient être appliqués à ce type de problème pour garantir la stabilité et le comportement correct du système.

# Bibliography

- [1] T. Alamo, A. Cepeda, and D. Limon. Improved computation of ellipsoidal invariant sets for saturated control systems. In *Proceedings of the 44th IEEE Conference on Decision and Control, and European Control Conference*, pages 6216–6221, Sevilla, Spain, December 2005.
- [2] A. Baños and A. Barreiro. Delay-independent stability of reset control systems. In *IEEE 32nd Annual Conference on Industrial Electronics*, pages 665–670, November 2006.
- [3] J. Bakkeheim, T.A. Johansen, O.N. Smogeli, and A.J. Sorensen. Lyapunov-based integrator resetting with application to marine thruster control. *IEEE Transactions on Control Systems Technology*, 16(5):908–917, September 2008.
- [4] O. Beker. *Analysis of reset control systems*. PhD thesis, Department of Electrical and Computer Engineering, University of Massachusetts, Amherst, 2001.
- [5] O. Beker, C.V. Hollot, and Y. Chait. Plant with an integrator: an example of reset control overcoming limitations of linear feedback. *IEEE Transactions on Automatic Control*, 46:1797–1799, 2001.
- [6] O. Beker, C.V. Hollot, and Y. Chait. Fundamental properties of reset control system. *Automatica*, 40:905–915, 2004.
- [7] F.A. Bender, J. M. Gomes da Silva Jr., and S. Tarbouriech. A convex framework for the design of dynamic anti-windup for state-delayed systems. In *American Control Conference, to appear*, 2010.
- [8] J-M. Biannic and S. Tarbouriech. Optimization and implementation of dynamic anti-windup compensators with multiple saturations in flight control systems. *Control Engineering Practice*, 17:703–713, 2009.
- [9] F. Blanchini. Set invariance in control. *Automatica*, 35:1747–1767, 1999.
- [10] S. Boyd, L. El Ghaoui, E. Feron, and V. Balakrishnan. *Linear Matrix Inequalities in System and Control Theory*, volume 15. SIAM Studies In Applied Mathematics, 2nd edition, 1994.
- [11] P.J. Campo and M. Morari. Robust control of processes subject to saturation nonlinearities. *Computers and Chemical Engineering*, 14(4-5):343–359, 1990.



- 
- [12] J. Carrasco, A. Baños, and A. Barreiro. Stability of reset control systems with inputs. In *16th Mediterranean Conference on Control and Automation*, pages 1496–1501, June 2008.
- [13] J. Carrasco, A. Baños, and A. Van der Schaft. A passivity-based approach to reset control systems stability. *Systems and Control Letters*, 59(1):18–24, 2010.
- [14] Q. Chen. *Reset control systems: Stability, performance and application*. PhD thesis, Department of Electrical and Computer Engineering, University of Massachusetts, Amherst, 2000.
- [15] J.C. Clegg. A non-linear integrator for servomechanisms. *Trans A.I.E.E*, 77 (Part II):41–42, 1958.
- [16] J.M Coron. *Control and nonlinearity*, volume 136 of *Mathematical Surveys and Monographs*. American Mathematical Society, Providence, RI, 2007.
- [17] J. Daafouz. *Robustesse en performance des systèmes linéaires incertains : placement de pôles et coût garanti*. PhD thesis, INSA, LAAS report number 97472, 1997.
- [18] J. Daafouz and J. Bernussou. Parameter dependent Lyapunov functions for discrete time systems with time varying parametric uncertainties. *Systems and Control Letters*, 43:355–359, August 2001.
- [19] E. de Klerk. *Aspects of semidefinite programming. Interior Point Algorithms and selected applications*. Kluwer Academic Publishers, Dordrecht (The netherlands), 2002.
- [20] M. C. de Oliveira and R. E. Skelton. Stability test for constrained linear systems. In S. O. Reza Moheimani, editor, *Perspectives in Robust Control*, pages 241–257. 2001.
- [21] L. El Ghaoui, F. Oustry, and M. AitRami. A cone complementarity linearization algorithm for static output-feedback and related problems. *IEEE Transactions on Automatic Control*, 42(8):1171–1176, August 1997.
- [22] M.K.H. Fans, A.L. Tits, and J.C. Doyle. Robustness in the presence of mixed parametric uncertainty and unmodeled dynamics. *IEEE Transactions on Automatic Control*, pages 25–38, 1991.
- [23] A. Feuer, G.C. Goodwin, and M. Salgado. Potential benefits of hybrid control for linear time invariant plants. In *Proceedings of the American Control Conference*, volume 5, pages 2790–2794 vol.5, June 1997.
- [24] P. Gahinet, A. Nemirovski, A.J. Laub, and M. Chilali. *LMI Control Toolbox User's Guide*. Natick, MA: The MathWorks, INC., 1995.
- [25] S. Galeani, S. Tarbouriech, M.C. Turner, and L. Zaccarian. A tutorial on modern anti-windup design. *European Journal of Control*, 15(3-4):418–440, 2009.

- 
- [26] G. Garcia, J. Bernussou, and D. Arzelier. Robust stabilization of discrete-time linear systems with norm-bounded time varying uncertainty. *Systems and Control Letters*, 22:327–339, 1994.
- [27] A.H. Glattfelder and W. Schaufelberger. *Control Systems with Input and Output Constraints*. Springer, 2003.
- [28] R. Goebel, J. Hespanha, A.R. Teel, C. Cai, and R.G. Sanfelice. Hybrid Systems: Generalized Solutions and Robust Stability. *Proc. IFAC: Symp on Nonlinear Control Systems, Stuttgart, Germany*, pages 1–12, September 2004.
- [29] R. Goebel, R.G. Sanfelice, and A.R. Teel. Hybrid dynamical systems. *IEEE Control Systems Magazine*, 29(2):28–93, April 2009.
- [30] J.M. Gomes da Silva Jr. and S. Tarbouriech. Contractive polyhedra for linear continuous-time systems with saturating controls. In *American Control Conference*, volume 3, pages 2007–2011, San Diego, CA, USA, June 1999.
- [31] J.M. Gomes da Silva Jr and S. Tarbouriech. Polyhedral regions of local asymptotic stability of discrete-time linear systems with saturating controls. *IEEE Transactions on Automatic Control*, 44:2081–2085, November 1999.
- [32] J.M. Gomes da Silva Jr. and S. Tarbouriech. Local stabilization of discrete-time linear systems with saturating controls: an LMI-based approach. *IEEE Transactions on Automatic Control*, 46, 2001.
- [33] J.M. Gomes da Silva Jr. and S. Tarbouriech. Anti-windup design with guaranteed regions of stability: an LMI-based approach. *IEEE Transactions on Automatic Control*, 50:106–111, 2005.
- [34] G. Grimm, J. Hatfield, I. Postlethwaite, A.R. Teel, M.C. Turner, and L. Zaccarian. Anti-windup for stable linear systems with input saturation: An LMI-based synthesis. *IEEE Transactions on Automatic Control*, 48(9):1509–1525, 2003.
- [35] W.M. Haddad, V. Chellaboina, and N.A. Kablar. Active control of combustion instabilities via hybrid resetting controllers. In *American Control Conference*, volume 4, pages 2378–2382, June 2000.
- [36] T. A. Henzinger. The theory of hybrid automata. *11th Annu. Symp. Logic in Computer Science*, *IEEE CS Press*, pages 278–292, 1969.
- [37] C. Hollot, O. Beker, Y. Chait, and Q. Chen. On Establishing Classic Performance Measures, for Reset Control Systems. *Perspective in robust control*, Newcastle, 2000.
- [38] I. Horowitz and P. Rosenbaum. Non-linear design for cost of feedback reduction in systems with large parameter uncertainty. *International Journal of Control*, 24(6):977–1001, 1975.

- 
- [39] T. Hu and Z. Lin. *Control Systems with Actuator Saturation: Analysis and Design*. Boston, MA: Birkhäuser, 2001.
- [40] T. Hu, A.R. Teel, and L. Zaccarian. Anti-windup synthesis for linear control systems with input saturation: Achieving regional, nonlinear performance. *Automatica*, 44(2):515–519, 2008.
- [41] K.H. Johansson, J. Lygeros, S. Sastry, and M. Egerstedt. Simulation of Zeno hybrid automata. In *Proceedings of the 38th IEEE Conference on Decision and Control*, volume 4, pages 3538–3543, December 1999.
- [42] M. Johansson and A. Rantzer. On the computation of piecewise quadratic Lyapunov functions. In *Proceedings of the 36th IEEE Conference on Decision and Control*, volume 4, pages 3515–3520, December 1997.
- [43] M. Johansson and A. Rantzer. Computation of piecewise quadratic Lyapunov functions for hybrid systems. *IEEE Transactions on Automatic Control*, 43(4):555–559, April 1998.
- [44] V. Kapila and M. Grigoriadis Eds. *Actuator Saturation Control*. New York: Marcel Dekker, 2002.
- [45] M.L. Kerr, M.C. Turner, and I. Postlethwaite. Practical approaches to low-order anti-windup compensator design: a flight control comparison. In *World IFAC Congress*, Seoul, Korea, 2008.
- [46] H.K. Khalil. *Nonlinear systems*. Prentice Hall, 2nd edition, 1996.
- [47] K.R. Krishnan and I. Horowitz. Synthesis of a non-linear feedback system with significant plant-ignorance for prescribed system tolerances. *International Journal of Control*, 19:689–706, 1974.
- [48] M. Krstić, I. Kanellakopoulos, and P. V. Kokotović. *Nonlinear and Adaptive Control Design*. Communications and Control Engineering Series. Wiley, New York, 1995.
- [49] K. Lau and R. Middleton. On the use of switching control for systems with bounded disturbances. In *Proceedings of the 39th IEEE Conference on Decision and Control*, volume 4, pages 3598–3603, 2000.
- [50] D. Liberzon and A. S. Morse. Basic problems in stability and design of switched systems. *IEEE Control Systems Magazine*, 19:59–70, 1999.
- [51] J. Löfberg. Yalmip wiki. <http://users.isy.liu.se/johanl/yalmip>.
- [52] T. Loquen, C. Prieur, and S. Tarbouriech. Analyse de stabilité des systèmes avec réinitialisation en présence d’incertitudes. *Journal Européen des Systèmes Automatisés, Hermès Science Publications, France*, 41/7-8:941–962, 2007.

- [53] T. Loquen, C. Prieur, and S. Tarbouriech. Stabilité d'un système à réinitialisation soumis à des incertitudes paramétriques. *Technical report, LAAS-CNRS*, April 2007.
- [54] T. Loquen, S. Tarbouriech, and C. Prieur. Stability analysis for reset systems with input saturation. In *Proceedings of the 46th IEEE Conference on Decision and Control*, pages 3272–3277, New Orleans, LA, USA, 2007.
- [55] T. Loquen, S. Tarbouriech, and C. Prieur. Stability of reset control systems with nonzero reference. In *Proceedings of the 47th IEEE Conference on Decision and Control*, pages 3386–3391, Cancun, Mexico, December 2008.
- [56] D. Nešić, L. Zaccarian, and A.R. Teel. Stability properties of reset systems. *Automatica*, 44, 8:2019–2026, August 2008.
- [57] R.G. Sanfelice. Matlab/simulink hybrid systems simulator. <http://www.u.arizona.edu/~sricardo>.
- [58] R.G. Sanfelice, A.R. Teel, and R. Sepulchre. A hybrid systems approach to trajectory tracking control for juggling systems. *46th IEEE Conference on Decision and Control, New Orleans, LA, USA*, pages 5282–5287, December 2007.
- [59] C. Scherer, P. Gahinet, and M. Chilali. Multi-objective output-feedback control via LMI optimization. *IEEE Transactions on Automatic Control*, 42(7):896–911, 1997.
- [60] E.D. Sontag. A Lyapunov-like characterization of asymptotic controllability. *SIAM J. Control Optim.*, 21(3):462–471, 1983.
- [61] E.D. Sontag. *The ISS philosophy as a unifying framework for stability-like behavior*, volume 259 of *Lecture Notes in Control and Information Sciences*. Springer Berlin / Heidelberg, 2001.
- [62] S. Tarbouriech, G. Garcia, and A.H. Glattfelder (Eds.). *Advanced strategies in control systems with input and output constraints*. LNCIS, vol.346, Springer Verlag, 2007.
- [63] S. Tarbouriech, T. Loquen, and C. Prieur. Anti-windup strategy for reset control systems. *International Journal of Robust and Nonlinear Control*, 2010 submitted.
- [64] S. Tarbouriech, C. Prieur, and J.M. Gomes da Silva Jr. Stability analysis and stabilization of systems presenting nested saturations. *IEEE Transactions on Automatic Control*, 51(8):1364–1371, 2006.
- [65] S. Tarbouriech and M.C. Turner. Anti-windup design: an overview of some recent advances and open problems. *IET Control Theory and Application*, 3(1):1–19, 2009.
- [66] M.C. Turner and I. Postlethwaite. A new perspective on static and low order anti-windup synthesis. *International Journal of Control*, 77(1):27–44, 2004.

- 
- [67] G. Witvoet, W.H.T.M. Aangenent, W.P.M.H. Heemels, M.J.G. van de Molengraft, and M. Steinbuch.  $H_2$  performance analysis of reset control systems. In *Proceedings of the 46th IEEE Conference on Decision and Control*, pages 3278–3284, New Orleans, LA, USA, December 2007.
- [68] L. Zaccarian, D. Nešić, and A.R. Teel. First Order Reset Element and the Clegg integrator revisited. *American Control Conference, Portland, OR*, pages 563–568 vol. 1, June 2005.
- [69] L. Zaccarian, D. Nešić, and A.R. Teel. Explicit lyapunov functions for stability and performance characterizations of FOREs connected to an integrator. In *45th IEEE Conference on Decision and Control*, pages 771–776, San Diego, CA, USA, December 2006.
- [70] L. Zaccarian, D. Nešić, and A.R. Teel. Set-point stabilization of SISO linear systems using First Order Reset Elements. In *American Control Conference*, pages 5808–5809, New York City, USA, June 2007.
- [71] L. Zaccarian, D. Nešić, and A.R. Teel. Analytical and numerical lyapunov functions for SISO linear control systems with First Order Reset Elements. *International Journal of Robust and Nonlinear Control*, 2010 submitted.
- [72] J. Zheng, Y. Guo, M. Fu, Y. Wang, and L. Xie. Improved reset control design for a PZT positioning stage. In *IEEE International Conference on Control Applications*, pages 1272–1277, October 2007.
- [73] Y. Zheng, Y. Chait, C.V. Hollot, M. Steinbuch, and M. Norg. Experimental demonstration of reset control design. *Control Engineering Practice*, 8(2):113–120, 2000.

---

## Résumé : Sur la stabilité des systèmes à réinitialisation

Les contrôleurs à réinitialisation sont une classe de systèmes hybrides dont la valeur de tout ou partie des états peut être instantanément modifiée sous certaines conditions algébriques. Cette interaction entre dynamique temps-continu et temps-discret de ces contrôleurs permet souvent de dépasser les limites des contrôleurs temps-continu.

Dans cette thèse, nous proposons des conditions constructives (sous forme d'Inégalités Matricielles Linéaires) pour analyser la stabilité et les performances de boucle de commande incluant un contrôleur à réinitialisation. En particulier, nous prenons en compte la présence de saturation en amplitude des actionneurs du système. Ces non-linéarités sont souvent source d'une dégradation des performances voir d'instabilité. Les résultats proposés permettent d'estimer le domaine de stabilité et un niveau de performance pour ces systèmes, en s'appuyant sur des fonctions de Lyapunov quadratiques ou quadratiques par morceaux. Au delà de l'aspect analyse, nous exposons deux approches pour améliorer la région de stabilité (nouvelle loi de réinitialisation et stratégie « anti-windup »).

**Mots clés :** systèmes à réinitialisation, saturation, fonction de Lyapunov, LMI,

### Abstract

Hybrid controllers are flexible tools for achieving system stabilization and/or performance improvement tasks. More particularly, hybrid controllers enrich the spectrum of achievable trade-offs. Indeed, the interaction of continuous- and discrete-time dynamics in a hybrid controller leads to rich dynamical behavior and phenomena not encountered in purely continuous-time system. Reset control systems are a class of hybrid controllers whose states are reset depending on an algebraic condition.

In this thesis, we propose constructive conditions (Linear Matrix Inequalities) to analyze stability and performance level of a closed-loop system including a reset element. More particularly, we consider a magnitude saturation which could be the source of undesirable effects on these performances, including instability. Proposed results estimate the stability domain and a performance level of such a system, by using Lyapunov-like approaches. Constructive algorithms are obtained by exploiting properties of quadratic - or piecewise quadratic - Lyapunov functions. Beyond analysis results, we propose design methods to obtain a stability domain as large as possible. Design methods are based on both continuous-time approaches (anti-windup compensator) and hybrid-time approaches (design of adapted reset rules).

**Key words:** reset control systems, saturation, Lyapunov functions, Linear Matrix Inequalities.