



HAL
open science

Eco-design of chemical processes : an integrated approach coupling process modeling, life cycle assessment and multi-objective optimization

Luis Fernando Morales Mendoza

► To cite this version:

Luis Fernando Morales Mendoza. Eco-design of chemical processes : an integrated approach coupling process modeling, life cycle assessment and multi-objective optimization. Chemical and Process Engineering. Institut National Polytechnique de Toulouse - INPT, 2013. English. NNT : 2013INPT0106 . tel-04298650

HAL Id: tel-04298650

<https://theses.hal.science/tel-04298650>

Submitted on 21 Nov 2023

HAL is a multi-disciplinary open access archive for the deposit and dissemination of scientific research documents, whether they are published or not. The documents may come from teaching and research institutions in France or abroad, or from public or private research centers.

L'archive ouverte pluridisciplinaire **HAL**, est destinée au dépôt et à la diffusion de documents scientifiques de niveau recherche, publiés ou non, émanant des établissements d'enseignement et de recherche français ou étrangers, des laboratoires publics ou privés.



Université
de Toulouse

THÈSE

En vue de l'obtention du

DOCTORAT DE L'UNIVERSITÉ DE TOULOUSE

Délivré par :

Institut National Polytechnique de Toulouse (INP Toulouse)

Discipline ou spécialité :

Génie des Procédés et de l'Environnement

Présentée et soutenue par :

M. LUIS FERNANDO MORALES MENDOZA

le mercredi 4 décembre 2013

Titre :

ECOCONCEPTION DE PROCÉDES : APPROCHE SYSTEMIQUE
COUPLANT MODELISATION GLOBALE, ANALYSE DU CYCLE DE VIE
ET OPTIMISATION MULTIOBJECTIF.

Ecole doctorale :

Mécanique, Energétique, Génie civil, Procédés (MEGeP)

Unité de recherche :

Laboratoire de Génie Chimique (L.G.C.)

Directeur(s) de Thèse :

MME CATHERINE AZZARO PANTEL

M. LUC PIBOULEAU

Rapporteurs :

Mme GENEVIÈVE GESAN GUIZIOU, INRA RENNES

M. XI-GANG YUAN, UNIVERSITE DE TIANJIN CHINE

Membre(s) du jury :

M. SERGE DOMENECH, INP TOULOUSE, Président

M. JEAN PIERRE BELAUD, INP TOULOUSE, Membre

Mme CATHERINE AZZARO PANTEL, INP TOULOUSE, Membre

M. PHILIPPE BAUDET, PROSIM SA, Membre

Abstract

The objective of this work is to propose an integrated and generic framework for eco-design coupling traditional modelling and flowsheeting simulation tools (HYSYS, COCO, ProSimPlus and Ariane), Life Cycle Assessment, multi-objective optimization based on Genetic Algorithms and multiple criteria decision-making methods MCDM (Multiple Choice Decision Making, such as ELECTRE, PROMETHEE, M-TOPSIS) that generalizes, automates and optimizes the evaluation of the environmental criteria at earlier design stage. The approach consists of three main stages. The first two steps correspond respectively to process inventory analysis based on mass and energy balances and impact assessment phases of LCA methodology. Specific attention is paid to the main issues that can be encountered with database and impact assessment i.e. incomplete or missing information, or approximate information that does not match exactly the real situation that may introduce a bias in the environmental impact estimation. A process simulation tool dedicated to production utilities, Ariane, ProSim SA is used to fill environmental database gap, by the design of specific energy sub modules, so that the life cycle energy related emissions for any given process can be computed. The third stage of the methodology is based on the interaction of the previous steps with process simulation for environmental impact assessment and cost estimation through a computational framework. The use of multi-objective optimization methods generally leads to a set of efficient solutions, the so-called Pareto front. The next step consists in identifying the best ones through MCDM methods. The approach is applied to two processes operating in continuous mode. The capabilities of the methodology are highlighted through these case studies (benzene production by HDA process and biodiesel production from vegetable oils). A multi-level assessment for multi-objective optimization is implemented for both cases, the explored pathways depending on the analysis and antagonist behaviour of the criteria.

Keywords: Eco-design, Multi-objective Optimization, Life-Cycle Assessment (LCA), Genetic Algorithm (GA), Multiple Criteria Decision Making (MCDM), Process simulators, Energy plant simulator

Résumé

L'objectif de ce travail est de développer un cadre méthodologique et générique d'éco-conception de procédés chimiques couplant des outils de modélisation et de simulation traditionnels de procédés (HYSYS, COCO, ProSimPlus et Ariane), d'Analyse du Cycle de Vie (ACV), d'optimisation multi-objectif basée sur des Algorithmes Génétiques et enfin des outils d'aide à la décision multicritère (ELECTRE, PROMETHEE, M-TOPSIS). Il s'agit de généraliser, d'automatiser et d'optimiser l'évaluation des impacts environnementaux au stade préliminaire de la conception d'un procédé chimique. L'approche comprend trois étapes principales. Les deux premières correspondent d'une part aux phases d'analyse de l'inventaire par calcul des bilans de matière et d'énergie et d'autre part à l'évaluation environnementale par ACV. Le problème du manque d'information ou de l'imprécision dans les bases de données classiques en ACV pour la production d'énergie notamment sous forme de vapeur largement utilisée dans les procédés a reçu une attention particulière. Une solution proposée consiste à utiliser un simulateur de procédés de production d'utilités (Ariane, ProSim SA) pour contribuer à alimenter la base de données environnementale en tenant compte de variations sur les conditions opératoires ou sur les technologies utilisées. Des sous-modules « énergie » sont ainsi proposés pour calculer les émissions relatives aux impacts liés à l'utilisation de l'énergie dans les procédés. La troisième étape réalise l'interaction entre les deux premières phases et l'optimisation multi-objectif qui met en jeu des critères économiques et environnementaux. Elle conduit à des solutions de compromis le long du front de Pareto à partir desquelles les meilleures sont choisies à l'aide de méthodes d'aide à la décision. L'approche est appliquée à des procédés de production continus : production de benzène par hydrodéalkylation du toluène HDA et production de biodiesel à partir d'huiles végétales. Une stratégie à plusieurs niveaux est mise en œuvre pour l'analyse de l'optimisation multi-objectif. Elle est utilisée dans les deux cas d'étude afin d'analyser les comportements antagonistes des critères.

Mots-clés: Éco-conception; optimisation multi-objectif; analyse du cycle de vie (ACV) Algorithmes génétiques (AG), méthodes d'aide à la décision multicritère; simulateurs de procédés, simulateur de production d'énergie.

Resumen

El objetivo de este trabajo es desarrollar una estrategia metodológica y genérica para el eco-diseño de procesos químicos utilizando herramientas tradicionales de modelado y de simulación (HYSYS, COCO, ProSim Plus et Ariane), de análisis de ciclo de vida (ACV), de optimización multi-objetivo (algoritmos genéticos) y finalmente métodos de ayuda a la decisión (ELECTRE, PROMETHEE, M-TOPSIS). El propósito es de generalizar, automatizar y de optimizar la evaluación de los impactos ambientales en las etapas preliminares de diseño de un proceso químico. La estrategia comprende tres etapas principales. Las dos primeras corresponden a la fase de análisis de inventario del cálculo de masa y energía del proceso y a la fase de la evaluación de impacto a través del ACV. El problema de falta de información o de la imprecisión en las bases de datos clásicas de ACV para la producción de energía, particularmente la producción de vapor ampliamente utilizado en los procesos químicos ha recibido una atención particular. Una solución propuesta consiste en utilizar un simulador de procesos de producción de utilidades (Ariane, ProSim SA) para contribuir a la alimentación de las bases de datos ambientales teniendo en cuenta variaciones sobre las condiciones operativas y las diferentes tecnologías. Sub-módulos de energía son diseñados para calcular las emisiones relacionadas a los impactos ligados a la consumación de energía por parte del proceso químico. La tercera etapa lleva a cabo la interacción entre las etapas anteriores y la optimización multi-objetivo que toma en cuenta criterios económicos y ambientales. La etapa conduce a soluciones de compromiso en el frente de Pareto a partir de las cuales las mejores son elegidas gracias a los métodos de ayuda a la decisión. La estrategia es aplicada a procesos continuos: producción de benceno a través de la Hidrodealquilación de Tolueno (HDA) y a la producción de Biodiesel a partir de aceites vegetales. Una estrategia multi-etapas es implementada para el análisis de la optimización multi-objetivo y es utilizada en los dos casos de estudio a fin de analizar los comportamientos antagonistas de los criterios.

Palabras clave: Eco-diseño, optimización multi-objetivo, Análisis de ciclo de vida (ACV), Algoritmos genéticos (GA), Métodos de ayuda a la decisión multicriterio; Simuladores de procesos; Simuladores de producción de energía; Software de ACV

Content

Abstract	iii
Résumé	v
Resumen	vii
Content	ix
Introduction	1
1 INTRODUCTION AND MOTIVATION	3
1.1 Introduction	6
1.2 Metrics for sustainability and eco-design for processes	8
1.2.1 General concepts on holistic approaches for sustainability assessment	8
1.2.2 AICHE and ICHEME metrics	10
1.2.2.1 AIChE metrics	11
1.2.2.2 IchemE metrics	11
1.2.3 Using metrics for sustainable development	12
1.2.4 Potential environmental impact index (Waste Reduction Algorithm, WAR)	13
1.2.4.1 Principles	13
1.2.4.2 Categories of environmental impact potential in the WAR method	14
1.2.4.3 Application of the WAR algorithm	16
1.2.5 SPI (Sustainable Process Index)	16
1.2.6 Exergy as a thermodynamic base for a sustainable development metrics	18
1.2.7 Indicators from life cycle assessment	18
1.2.8 Toward a sustainable life cycle assessment	20
1.3 Process design methods and sustainable systems	20
1.3.1 Positioning of chemical process industries	20
1.3.2 Several roads to more sustainable processes and systems	21
1.3.2.1 Industrial ecology	22
1.3.2.2 Life Cycle Assessment	22

1.3.2.3 Green chemistry / green engineering, process intensification and waste management.	23
1.3.3 Eco-design approaches	24
1.4 Main objectives of this work	27
2 LCA-BASED ENVIRONMENTAL ASSESSMENT APPROACH: BRIDGING DATA GAP WITH PROCESS SIMULATION FOR ENERGY GENERATION	29
2.1 Introduction	32
2.2 System-based environmental assessment management.....	33
2.3 LCA environmental impact assessment framework.....	35
2.3.1 LCA principles	35
2.3.2 Impact factors and databases	36
2.3.3 IMPACT 2002+.....	39
2.3.4 Database limitation for energy production for chemical processes.....	41
2.4 Impacts of process energy requirements	41
2.4.1 Energy production	42
2.4.2 Use of an energy production plant simulator.....	43
2.4.3 Modelling steam production in Ariane.....	44
2.4.3.1 Steam production by a bi-fuel furnace	45
2.4.3.1.1 Bi-fuel furnace modelling in Ariane.....	45
2.4.3.1.2 Calibration of emissions for the bi-fuel furnace model	46
2.4.3.2 Steam production by a gas turbine	47
2.4.3.2.1 Gas turbine modelling in Ariane	48
2.4.3.2.2 Calibration of emissions for the turbine model	50
2.4.4 Cradle to gate environmental assessment for a specific steam production.....	52
2.5 Conclusion.....	57
3 COUPLING PROCESS SIMULATION WITH LIFE CYCLE ASSESSMENT FOR ECO-EFFICIENT PROCESS DESIGN	59
3.1 Introduction	62
3.2 Synthesis of literature review in process modelling/ optimization techniques and tools based on LCA	64
3.3 Framework modelling development.....	65

3.3.1 Environmental impact model development.....	65
3.3.1.1 Product versus Process oriented LCA	66
3.3.1.2 LCA software tools.....	66
3.3.2. Process flowsheeting tools	68
3.2.2.1 Aspen HYSYS.....	72
3.2.2.2 COCO simulator.....	72
3.2.2.3 ProSimPlus	73
3.2.3 Economic model.....	74
3.4 Support example: benzene production by hydrodealkylation of toluene (HDA process)	75
3.4.1 Presentation of the HDA process	75
3.4.2 Operating conditions for the HDA simulation model	77
3.4.2.1 Process inputs	78
3.4.2.2 Reactions	78
3.4.2.3 Heating and cooling.....	78
3.4.2.4 Separation and Distillation	79
3.4.2.5 Pump and compressor in recycling.....	79
3.4.2.6 Economic data	79
3.4.3 HDA simulation with COCO, ProSimPlus and HYSYS.....	80
3.4.4 Energy production modelling and emission computation with Ariane	83
3.5 Inventory data.....	83
3.6 Identification of potential factors	86
3.6.1 Recovery of impact factors for environmental impact model design.....	86
3.6.2 Application to the HDA process.....	87
3.7 A framework for eco-efficient process design	89
3.7.1 Principles.....	89
3.7.2 Framework implementation.....	90
3.7.2.1 Setting the scene.....	90
3.7.2.2 Framework activity description.....	90
3.8 Environmental impact analysis of HDA chemical process	93

3.9 Sensitivity analysis	96
3.10 Results analysis	98
3.10.1 Comparison of scenarios in the midpoint and end-point categories	98
3.10.2 Environmental impact analysis of a specific scenario	102
3.11 Conclusions	104
4 MULTI-OBJECTIVE OPTIMIZATION AND MULTIPLE CRITERIA DECISION MAKING FOR ECO-DESIGN	105
4.1 Introduction	108
4.2 Multi-objective optimization (MOOP).....	109
4.2.1. Formulation of a MOOP problem and concept of Pareto dominance	109
4.2.2. Selection of a multi-objective optimization method.....	110
4.2.3. Selection of an evolutionary procedure	113
4.3 Multiple choice decision making (MCDM) methods.....	115
4.3.1 Principles	115
4.3.2 ELECTRE	116
4.3.3 PROMETHEE	118
4.3.4 M-TOPSIS	120
4.4 Integration of MOO and MCDM in the eco-design framework.....	122
4.4.1 Presentation	122
4.4.2 Framework implementation.....	122
4.4.2.1 Setting the scene	122
4.4.2.2 Eco-design framework.....	123
4.5 HDA process optimization	123
4.5.1 Optimization problem formulation.....	123
4.5.2 Genetic Algorithm implementation.....	125
4.5.3 Reducing the criteria number	125
4.5.4 A detailed analysis of Pareto front	128
4.5.4.1 Selecting potential solutions.....	128
4.5.4.2 Results analysis	129

4.5.4.2.1 Environmental impact analysis of the potential solutions	129
4.5.4.2.2 Comparison of potential solutions in environmental categories and operating cost	133
4.5.4.2.3 Environmental impact analysis of a specific scenario	135
4.6 Main contributions of this chapter and Conclusions	137
5 ECO-DESIGN OF BIODIESEL PRODUCTION PROCESS	141
5.1 Introduction	143
5.2 Biodiesel production: context and production processes	143
5.2.1. Introduction to biodiesel production	143
5.2.2. Biodiesel production processes	145
5.2.2.1 Alkali-catalyzed production process	146
5.2.2.2 Acid-catalyzed production process.....	147
5.3. Biodiesel production simulation with Hysys.....	148
5.3.1 General assumptions.....	148
5.3.1.1 Process inputs	148
5.3.1.2 Reactions	149
5.3.1.3 Cooling	149
5.3.1.4 Separation and Distillation	149
5.3.1.5 Pump and compressor in recycling.....	149
5.3.1.6 Economic data	150
5.3.2 Validation of Biodiesel simulation model in HYSYS.....	150
5.3.3 Flowsheet modification for Biodiesel simulation model in HYSYS.....	153
5.4 Inventory data and identification of potential factors.....	153
5.5 Optimization of biodiesel production.....	155
5.5.1 Optimization problem formulation.....	155
5.5.2 A detailed analysis of the Pareto front.....	156
5.5.2.1 Environmental impact analysis.....	158
5.5.3.2 Comparison of potential solutions in environmental categories and operating cost ...	161
5.5.3.3 Environmental impact analysis of a specific solution	162

5.6 Conclusions	164
6 CONCLUSIONS AND PERSPECTIVES	165
Bibliography	171
List of figures	185
List of tables	189
APPENDIX A. Material balance of HDA process from Douglas hypotheses	191

Introduction

The topic of this thesis is use of systems oriented methods in conceptual design and analysis of chemical processes, with respect to environmental performance following sustainable development guidelines. The scope is limited to the early design phase. Process design that has been identified as a main issue in chemical engineering background can be viewed as an iterative procedure that can be decomposed into conceptual design (process synthesis) and process analysis. The aim is to show how Life Cycle Assessment (LCA) and other system oriented methods can be applied in the early design phase of a system, combining process modelling with traditional flowsheeting tools, multiobjective optimization and multiple criteria decision making concepts. The main motivation of this work is to propose an integrated framework for “eco-design”, meaning that the environmental components are taken into consideration right from the design of the product and process. The “eco-design” term thus appears to be the operational contribution of sustainable development.

This research work was carried out in the Laboratoire de Génie Chimique, Toulouse France, in the Process Systems Engineering Department with financial support of CONACYT¹

Outline of the thesis

Chapter 1 introduces the reader to the general scope of the thesis in which systems oriented methodologies are the cornerstone of the eco-design issue. Process design is a multi-objective problem in the context of cleaner production that can be tackled by a combined approach involving:

- on the one hand, Life Cycle thinking and its metrics that can be particularly useful for the production of chemicals and utilities so that solutions for more efficient processing and energy systems for the process industry can be found;
- and on the other hand, process modelling, simulation and optimization for design and systems engineering methodologies, that are essential to optimize existing and prospective processes. Using process modelling based on eco-efficiency and economics is a requirement for knowledge-based decision making to enhance process sustainability.

In addition, Chapter1 provides an overview of the methodological framework that will be developed throughout the thesis within process synthesis and environmental assessment. The aim is not to present a thorough literature review of the field, but rather to present some of the previous contributions (to be familiarized with the terms) as well as important (and more recent) review articles. In particular, the

¹ Consejo Nacional de Ciencia y Tecnología (México)

chapter provides the basis for the following chapters. Methods and tools that will be finally adopted and used in this work will be gradually presented in the dedicated chapters.

Chapter 2 explains why a system-based environmental assessment management, particularly Life Cycle Assessment is sound in an eco-design perspective, which is the core of this work. Specific attention is paid to the main issues that can be encountered with database and impact assessment. When applying LCA for chemical processes, the practitioner often faces the frustration of incomplete or missing information as well as of approximate information that does not match exactly the real situation that may introduce a bias in the environmental impact estimation. This chapter shows how process simulation tool dedicated to production utilities, Ariane, ProSim SA, can be particularly useful to fulfill environmental database gap, by the design of specific energy sub modules, so that the life cycle energy related emissions for any given process can be computed. A case study developed in this chapter concerns the environmental impact assessment of steam production by a gas turbine.

Chapter 3 presents the approach used in this work for eco-efficient process design, coupling flowsheeting simulators both for production and energy processes with a life cycle assessment module that generalizes and automates the evaluation of the environmental criteria. The approach consists of three main stages. The first two steps correspond respectively to process inventory analysis and impact assessment phases of LCA methodology for identification of the involved chemical components. It must be yet emphasized at this level that the concepts of LCA do not embody the whole life-cycle thinking, but are restricted to a cradle to gate perspective. The third stage is based on the interaction of the previous steps with process simulation for environmental impact assessment and cost estimation through a computational framework. The well-known benzene production by Hydrodealkylation of Toluene (HDA) process illustrates the proposed approach.

Chapter 4 explores the potential of multi-objective optimization (MOO) to search for solutions that satisfy both economic and environmental criteria. The use of multi-objective optimization methods generally leads to a set of efficient solutions, the so-called Pareto front. The next step consists in identifying the best ones. This MCDM (Multiple Choice Decision Making) issue is also a complex problem, mainly because of its more subjective nature. The development of a decision-support system that automates the various elements of the framework will be presented.

Chapter 5 illustrates the framework on a biodiesel production process from vegetable oils which is one of the foremost alternative fuels to those refined from petroleum products.

Chapter 6 sums up the work and highlights its contributions before giving suggestions and directions for further research.

1 INTRODUCTION AND MOTIVATION

Résumé

Ce chapitre introductif a pour objectif de positionner ces travaux dans le domaine de l'éco-conception de procédés. Le concept d'éco-conception est défini et les métriques particulièrement adaptées aux industries de procédés sont présentés : métrique de l'AICHE, de l'ICHEME, impacts potentiels de la méthode WAR (Waste Algorithm Reduction), indice de durabilité (SPI), critère exergetique et indicateurs de la méthode d'Analyse du Cycle de Vie. Les principes et limitations de méthodes d'éco-conception de procédés sont ensuite exposés à partir d'une analyse bibliographique. Le cadre méthodologique des travaux est alors justifié et exposé : l'accent est clairement mis sur la nécessité de coupler des outils de simulation de procédé et de production d'énergie avec des outils systémiques de gestion environnementale notamment par Analyse du Cycle de Vie ainsi qu'avec des méthodes d'optimisation multi-objectif et d'aide à la décision multicritère.

Nomenclature

Acronyms

AIChE	American Institute of Chemical Engineers
AP	Acidification potential
ATP	Aquatic toxicity potential
CE	Carbon efficiency
CExC	Cumulative exergy consumption
CFC-11, CCl₃F	Trichlorofluoromethane
C₂H₄	Ethylene
CO	Carbon monoxide
CO₂	Carbon dioxide
CExC	Cumulative exergy consumption
EB	Environmental burden
EPA	Environmental Protection Agency
GHG	Greenhouse gas
GSK	GlaxoSmithKline
GWP	Global warming potential
HDA	Benzene production by toluene hydrodelakylation
HTPE	Human toxicity potential by inhalation or dermal exposure
HTPI	Human toxicity potential by ingestion
IChemE	Institution of Chemical Engineers
LCA	Life Cycle Assessment
LCC	Life Cycle Costing
LCSA	Life Cycle Sustainable Analysis
LC50	Lethal concentration 50
LD50	Lethal dose 50
NO_x	Nitrogen oxides
ODP	Ozone depletion potential
PCOP	Photochemical Oxidation Potential
PEP	Process Economic Program
PEI	Potential environmental impact
PSE	Process Systems Engineering
RME	Reaction mass efficiency
SETAC	Society of Environmental Toxicology and Chemistry
S-LCA	Social Life Cycle Assessment
SPI	Sustainable Process Index

TTP	Terrestrial toxicity potential
VOCs	Volatile Organic compounds
WAR	Waste Reduction Algorithm
<i>Symbols</i>	
a_{tot}	Impact per unit of good or service in a specific area
a_{in}	Available surface of goods and energy per person
H+	Hydrogen ions
I_{in}^{PC}	Input rates of the PEI for the chemical process
I_{out}^{PC}	Output rates of the PEI for the chemical process
I_{in}^{PE}	Input rates of the PEI for the energy production process
I_{out}^{PE}	Output rates of the PEI for the energy production process
I_{PEn}^{PC}	PEI outputs associated with the energy losses of the chemical and energy
I_{Gen}^t	Generation rate of the impact inside the system
FE_i	Environmental burden i
M_N	Mass of the emitted substance N
N_p	Number of goods or services produced by the process
$FP_{i,N}$	Impact potential factor of the substance N related to the environmental burden i
SO₂	Sulphur dioxide
Wm⁻²	Unit radiation

1.1 Introduction

The concept of sustainable development is based on the creation of transportation using processes and non-polluting systems, which preserve the energy resources and raw materials while being economically viable. The process industry has a unique position since it transforms raw material feedstock into intermediate and end-user products and thus sits at the core of almost all industrial value chains and applications. From this position, it fulfills an enabling role for improved competitiveness whilst drastically reducing resource and energy inefficiency and the environmental footprint of the industrial activities. It is now widely recognized that all the major components in the process industry holistic value chain have to be considered (see Figure 1.1), including raw materials, feedstocks and their source, conversion processes, intermediate and/or end-user needs and also waste streams. It is therefore important that both the separate components and especially the integrated holistic view are taken into account. For this purpose, the time of “eco-efficiency”, which aims to promote a more “efficient” use of raw materials and energy in order to reduce the economic costs and the environmental impact of production simultaneously must be followed by an era of “eco-design”, where environmental parameters are taken into consideration right from the design of the product and process. The “eco-design” thus appears to be the operational contribution of sustainable development.

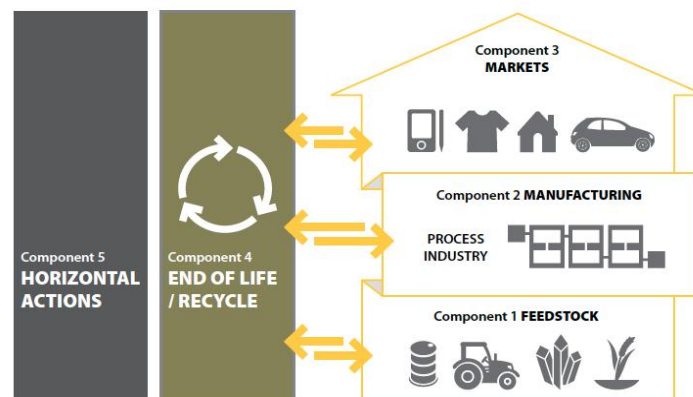

Figure 1.1 Value chain schematic from SPIRE [1]

In this context, process engineering must play an important role for two main reasons: **(i)** the production induced by this type of industry, which contributes significantly to the national income, is essential for the modern company: the development of the company depends on the chemical industry and vice versa; **(ii)** a large number of environmental issues are either directly related to such processes or to the use of chemical products through impacts on water, air, and soil. The chemical industry develops the products for multiple consumer markets, which have to be manufactured, used, and recycled by specific, safe, and economically viable processes. It is therefore necessary to improve the

existing processes and to invent new processes that avoid waste production at the beginning rather than collecting and treating waste products, thus passing from a curative approach to a preventive approach (see Figure 1.2).

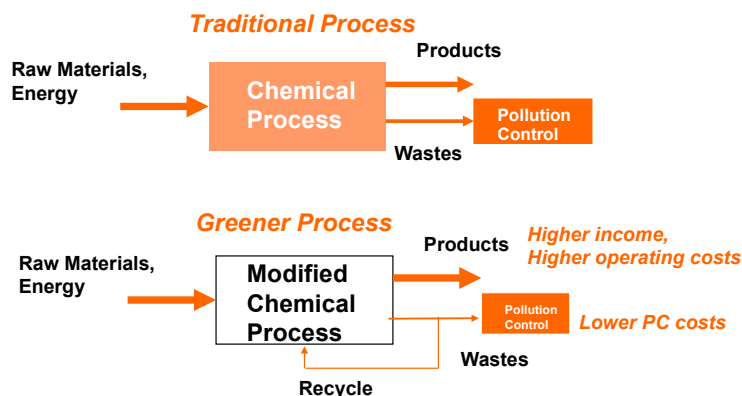

Figure 1.2 Comparison between traditional chemical process and greener process

This vision that takes into account the product–process lifecycle and expands the scope of investigation, involves a systemic approach. It is part of the concerns of the “roadmaps” published in the last 10 years and stated through the 12 principles of green chemistry [2], 12 principles of green engineering [3], challenges for engineering outlined by the American National Academy of Engineering [4], or the roadmap of the IChemE, 21st Century Chemical engineering (IChemE roadmap, UK, 2007, 2013) [5].

The present work deals with the development, implementation and application of economic and environmental concepts in the design stage of a chemical plant that will be further referred “eco-design”. It is recognized that process design reflecting an integrated perspective across all the environmental concerns will lead to significant environmental improvement. Instead of focusing on economic performance of chemical process, designers currently incorporate environmental concerns as design objectives at early stages of chemical process development in the context of environmental impact minimization. Environmental concerns are forcing chemical process designers to change their practices in process design and decision-making. In that context, process design methods and tools are required which help achieve environmental impact minimization at a desired economic performance. Therefore, process design is a multi-objective problem in the context of cleaner production and this work is a contribution to reach some of the strategic objectives described above and will be targeted at the development of an integrated approach between:

- Life Cycle thinking for the production of chemicals and utilities in order to find solutions for more efficient processing and energy systems for the process industry;
- and process modelling, simulation and optimization for design and systems engineering

methodologies, as essential to optimize existing and prospective processes. Using process modelling based on eco-efficiency and economics is a requirement for knowledge-based decision making to enhance process sustainability.

This introduction chapter is divided into 4 sections. Section 1 has just presented the general scope of this thesis that will be further refined along the presentation. Section 2 focuses on the presentation of the metrics that can be used for sustainability, more particularly on the metrics that is relevant to process eco-design. It begins with a classification of the sustainability metrics and then presents the metrics that are reported in the dedicated literature. Particular attention is given to AIChE and IChemE metrics and their applications; to the categories of environmental impact potential in the so-called WAR method that is largely reported in the process systems engineering community; to the aggregated Sustainable Process Index (SPI) that can be viewed as an ecological footprint of a process, to the exergy approach which has been receiving more attention and finally to the metrics developed in environmental system-based management tool such as Life Cycle Assessment. Section 3 shows an overview of the methods and approaches currently used for the design of sustainable systems and processes. It introduces major life cycle approaches such as life cycle analysis, industrial ecology, green chemistry, green engineering and waste management. Finally, Section 4 deals with the main objectives to be achieved in this work.

1.2 Metrics for sustainability and eco-design for processes

1.2.1 General concepts on holistic approaches for sustainability assessment

Sustainability is a holistic, multidimensional and multi-sectorial concept. Sustainability assessment is a combination of different assessment methods and tools including environmental, economic and social aspects. When assessing sustainability, a life cycle approach must be applied to avoid problems shifting from one life cycle stage to another. Life Cycle Assessment (LCA) is a methodology to evaluate the environmental impacts throughout the life cycle of a product. Life Cycle Costing (LCC) and Social Life Cycle Assessment (S-LCA) aim to complement the environmental LCA. Eco-design takes the environmental aspects into account already at the product design phase and aims at reducing the environmental impact of products throughout their entire life cycle. Eco-efficiency assessment is an environmental management tool that enables the consideration of life cycle environmental impacts of a product system alongside its product system value to a potential user or customer. It generally focuses on a more efficient use of raw materials and energy in order to reduce the economic costs and the environmental impact of production simultaneously whereas in eco-design, environmental parameters are taken into consideration from the earlier design stage of the product and process. Furthermore, methodologies like risk assessment can also be applied.

Azapagic proposed in [6] a classification of criteria (Table 1.1) for sustainable development. It must be highlighted that some of them are often considered routinely in conventional design, especially the microeconomic criteria (e.g. costs and profits), some environmental criteria (e.g. energy consumption and water), or social criteria (e.g. employee health and safety).

Table 1.1 Classification of criteria for sustainable development in process design according to [6]

Economic criteria	Environmental criteria	Social criteria
<ul style="list-style-type: none"> • Micro-economic <ul style="list-style-type: none"> ○ Capital costs ○ Operating costs ○ Profitability ○ Decommissioning costs • Macro-economic <ul style="list-style-type: none"> ○ Value –added ○ Taxes paid, including “green taxes” (e.g. carbon tax) ○ Investment (e.g. pollution prevention, health and safety, decommissioning and ethical investments) ○ Potential costs of environmental liability 	<ul style="list-style-type: none"> • Energy use • Water use • Water discharge • Solid waste • Abiotic reserve depletion • Global warming • Ozone depletion • Acidification • Summer smog • Eutrophication • Human toxicity • Eco-toxicity 	<ul style="list-style-type: none"> • Provision of employment • Employee health and safety • Citizens’ health and safety • Customer health and safety • Nuisance (odour, noise, visual impact and transport) • Public acceptability

It is generally accepted that sustainability results from a balance among the three components. The selection of an appropriate set of indicators for assessing the sustainability is essential for a comparative analysis between the different versions of a process. In order to provide a method applicable for the analysis of systems regarding to the sustainability aspect, a typology of indicators is proposed in [7], classifying the 3D of sustainable development into three distinct hierarchical groups: **(i)** 1D indicators that provide information on a single component: economic, ecological, or social component; **(ii)** 2D indicators that simultaneously provide information on two components: socio-ecological, socio-economical, or economic-ecological components; and **(iii)** 3D indicators that lead to 3D information on the three pillars.

To illustrate, let us consider the amount of non-renewable energy used to produce a unit quantity of final product, i.e., a criterion taken into account in the metric proposed by the AIChE [8]. This criterion does not provide the information on a single branch coming under the economic, environmental, or societal aspect alone. The 3D aspects are implicitly integrated and are called as a 3D indicator. Considering now the indicator based on manufacturing cost, it provides information on both the economic and social aspects, so that it can be viewed as 2D indicator. In this chapter, the goal is

not only on completely identifying all the metrics proposed and applied in the processes of chemical industry, but also on highlighting the most important in relation to a decision-making objective. It is useful to distinguish among the indicator, index, and metric beforehand. An indicator is a tool for simplification, quantification, and communication of the information; it is the first level of base series analysis. Ideally, according to the classification in [7], an indicator of sustainable development should satisfy the three components simultaneously. However, the construction and selection of such indicators are not direct and hence subjected to numerous studies (see for example [9]). A good indicator must meet several requirements related to the technical soundness, the relevance relative to the stakeholders, the cost relative to data collection, reliability, spatial and temporal boundaries, ease of interpretation, access to a comparison standard, and the ability to show trends in the evolution over time. However, a reliable indicator can be difficult to interpret, thus failing in its function of communication. In most of the cases, the assessment of indicators involves either a standardization or comparison with a predefined value, to facilitate its interpretation (e.g. the percentage of renewable energy used with respect to the national average). An indicator is therefore an observable variable, which is used to characterize the complexity of a phenomenon. The term index refers to a synthetic indicator built by aggregating other basic indicators. The other way to characterize the different aspects of a complex phenomenon is to use a set of indicators in a metric. The utility of a metric is necessarily related to the number of indicators: an inadequate number is likely to misrepresent the phenomenon and a large number may make the implementation cost prohibitive.

The advantage of a single index instead of a collection of indicators lies in the ease of communication (e.g. ecological footprint). However, many drawbacks can be highlighted: loss of details and accuracy due to the combination of parameters with different orders of magnitudes and levels of accuracy, and usage of conversion ratio to express all the variables with the same units. This chapter considers only the currently available approaches to assess the sustainability of processes and new or existing systems. It lists the most significant examples of indicators, indices, or metrics used in the process industries. The economic indicators, widely used in the traditional methods for process design will not be presented in detail. The reader can refer to reference books in this field (e.g. [10]). The design methods based on these indicators will complement this chapter.

1.2.2 AICHE and ICHEME metrics

In order to analyse the sustainability of a process, the two metrics developed by the AIChE (1D) and IChemE (3D) should be mentioned initially, which consider indicators that are particularly adapted to the process domain and to a production system. The works conducted in Canada (Canada's National Round Table on the Environment and the Economy) [11] can be mentioned beforehand. These works

recommend eco-efficiency measures defined by the ratios, by considering resource uses or environmental impacts as the numerator and value creation as the denominator or vice versa.

1.2.2.1 AIChE metrics

Following these principles, the eco-efficiency metrics are refined for applying at the operational level by the American Institute of Chemical Engineers (AIChE²) in collaboration with a non-profit organization, BRIDGES to Sustainability Institute (formerly known as BRIDGES to Sustainability).

The metrics, proposed in terms of eco-efficiency, includes:

- material consumption: the usage of materials, non-renewable materials, and in particular, materials with finite resources, affects the availability of resources and leads to environmental degradation relative to raw material extraction and during conversion as discharges;
- energy consumption: apart from the aspects related to its availability and usage as a resource, the use of energy leads to varied environmental impacts. For example, the burning of fossil fuels provides impact on global warming, oxidation of photochemical ozone, and acidification;
- water consumption: fresh water is essential for life and almost for all economic activities. As there is an increase in anthropogenic demands and depletion of water resources in some regions of the world, water consumption is a key factor;
- emission of polluting products;
- solid waste;
- land use: the soil is considered to be a finite resource that provides varied ecological and socio-economic services. However, the definition of an indicator seems to be complicated and does not appear explicitly in the basic metrics.

The choice of ratios to express the metrics facilitates the comparison between several options and, on the other hand, the choice of the process during the decision-making phase. Lower the indicator, weaker is the impact generated per unit of value created. Heuristics and decision rules were developed and tested on more than 50 industrial pilot projects involving more than 50 processes of the chemical industry from the data of the Process Economic Program (PEP) at SRI International (Menlo Park, California) [8]. The indicator values were calculated for standard flowsheets.

1.2.2.2 IChemE metrics

Significant efforts to establish the metrics for sustainable development have also been made under the aegis of the IChemE (UK) [12] by adding the economic and societal metrics to the metrics focused on the environmental aspects. The indicators are specifically grouped into environmental, economic, and

² <http://www.aiche.org/ifs>

social categories. The list is particularly suitable for a production site. The environmental indicators are related to the resources or categories of environmental impacts. The metrics involve two types of quantitative indicators, which are the environmental burdens and the impacts. The first group includes the use of material and energy, the emissions in air and water, and the amount of solid waste. It is obtained from the flowsheet and material and energy balances. The information obtained from the burdens can then be used to calculate the environmental impacts.

As mentioned above, most of the indicators of the metrics are calculated as ratios to provide the measure of impact regardless of the scale of the operation. They are based on a simple rule: the process is more efficient that the indicator is low. They involve both the process inputs (use of resources) and outputs (emissions, effluents, discharges, products, and services). They involve a subset of the impact factors used in environmental science, the most significant vis-à-vis the process industries, for the calculation of environmental burdens. The environmental burden (EB), caused by the emission of a range of substances, is calculated by adding the weighted emissions of each substance. The potential factor of the impact is identified as the impact factor of each substance. We note that a substance may contribute differently to different environmental burdens and have different impact factors:

$$FE_i = \sum M_N FP_{i,N}$$

The EB are determined with respect to a reference substance (e.g. SO₂ for air acidification). This approach involves a total of 49 indicators. However, the life of the chemical products in various media is not taken into account. In addition, the indicator on human health (normalized with respect to benzene) is limited to carcinogenic effects.

1.2.3 Using metrics for sustainable development

The metrics for sustainable development can be used at different levels in the process of decision-making:

- evaluation of technical (variety of raw materials, options of process improvements, etc.) or financial (variety of suppliers, etc.) alternatives;
- comparison of industrial units;
- identification of environmental impacts of an industrial unit.

They can also be used for communication with the stakeholders. It must be emphasized the metrics of sustainable development are becoming more and more complex by both their content and methodology [13]. The examples of the previous two metrics show that the choice of appropriate indicators depends on the specificities of the concerned industrial sector or even the product types.

According to Lapkin et al. [14], the indicators should reflect the by-products, discharges, and emissions characterizing the process or the product, and also the necessary resources to provide a service. It is therefore difficult to provide a universal list of indicators. It seems more appropriate to analyse and explain the choice of indicators in a number of typical situations. Two examples reported in the literature can be mentioned here:

- example of GlaxoSmithKline (GSK): the use of sustainable development metrics within this pharmaceutical company is described in [15]. In order to adapt the metrics for its own requirements, GSK has developed specific “green” metrics, including indicators related to the atom efficiency, carbon efficiency (CE), and reaction mass efficiency (RME) or the unavoidable energy of solvents. The CE indicator takes into account the efficiency and amount of carbon in the reactants, which is incorporated in the final product. RME takes into account the efficiency, molar amount of reactants, and atom efficiency. Examples of calculation are proposed in [16];
- example of BASF: an eco-efficiency analysis developed in BASF is described in detail in [17] and [18]. On the basis of the lifecycle assessment method, the approach used the metrics based on the usage of resources and calculations of environmental impacts, health, and safety. The usage of normalization and weighting method to generate an environmental performance index were illustrated through examples (particularly the production of indigo or ibuprofen). The approach extended to cover the aspects of “socio-effectiveness” by including the social aspects of sustainable development [19], and by developing a software tool SEEbalance™ [19]. The methodology was applied initially during the phases of product and process developments. It was then implemented for the development of industrial and communication strategies towards industrial customers and other partners in the value chain.

1.2.4 Potential environmental impact index (Waste Reduction Algorithm, WAR)

1.2.4.1 Principles

As it was difficult to provide all the information required for calculating the indicators of a metric at the preliminary design stage of a process, a number of studies were directed toward the development of an environmental balance. A method, commonly cited in the literature and identified by the term waste reduction algorithm (WAR), is based on the concept of environmental balance, similar to material and energy balances. This is not a tool for life cycle assessment, as the approach is essentially based on the process and generation of utilities associated with the lifecycle of the product and does not include the other phases: raw materials acquisition, distribution, usage, and recycling of the product (see Figure 1.3).

This method is used in the design phase of a process and uses the process information (flow rates and mass fractions) as well as the toxicological data to calculate the environmental impact of a process. It requires the usage of flowsheeting software. This American method was developed in the EPA (Environmental Protection Agency, National Risk Management Research Laboratory) which take into account the environmental aspect right from the design phase of the process. The approach is based on the calculation of the potential environmental impact (PEI) of a process, which results from an environmental report. This type of balance must be carried out during the design phase of a process, similar to the material and energy balances. The result of the PEI balance is the calculation of an impact index (I) that provides a quantitative measure of the impact of the discharge of a process. The objective of the methodology is to minimize the PEI for a process rather than minimizing the amount of waste generated by the process. The concept of potential environmental impact of the WAR algorithm is based on the traditional mass and energy balances. The method is presented in [20].

The objective of the WAR algorithm is to provide a means for comparing the potential environmental impact between the process design alternatives: lower the index, more environmental friendly is the process.

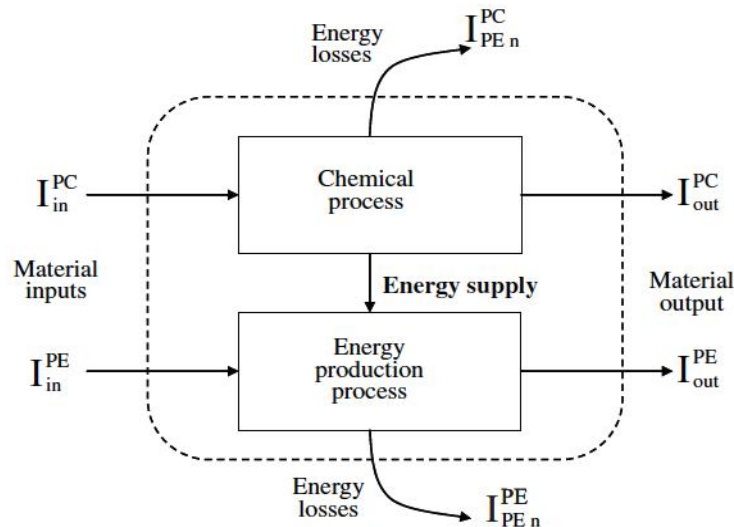

Figure 1.3 Inclusion of energy in the WAR algorithm (according to [21])

1.2.4.2 Categories of environmental impact potential in the WAR method

The toxicological data are classified into eight environmental impact categories: global warming potential, acidification potential, ozone depletion potential, photochemical oxidation or smog formation potential, human toxicity potential by ingestion and by inhalation, and aquatic and terrestrial toxicity potentials. The classification of these impact categories is based on a study in [22]. These categories have been proposed to highlight the most representative indicators in relation to the design

of a process. These indicators can be classified into two domains: global atmospheric domain and local toxicity domain. A brief description of these impacts categories is described below.

The global warming potential (GWP) is an index that compares the contribution of a greenhouse gas emissions to global warming with that of carbon dioxide (CO), Carbon dioxide (CO₂) being the reference substance, its GWP is equal to 1. The GWP takes into account the measurement of radiation force (amount of infrared that a substance can absorb, a_i in Wm^{-2}) induced by a molecule with concentration C_i in the atmosphere in ppm. This is followed by the integration of the radiation force over a given period of time (usually 100 years):

$$GWP_i = \frac{\int_0^n a_i C_i dt}{\int_0^n a_{CO_2} C_{CO_2} dt}$$

The Acidification Potential (AP) of a compound is related to the number of moles of H^+ created per number of moles of compound X according to the reaction:

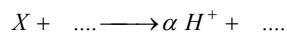

X denotes the chemical substance initiating the acidification, and the molar stoichiometric ratio α represents the ratio of the number of moles of H^+ per mole of X . Acidification is usually expressed in terms of mass (η_i , mole H^+ /kg):

$$\eta_i = \frac{\alpha_i}{M_i}$$

where M_i denotes the molecular weight of X (kg i /mole i). As mentioned before, a reference compound SO_2 is used to express the acidification potential:

$$AP_i = \frac{\eta_i}{\eta_{SO_2}}$$

Ozone depletion potential (ODP) in the stratosphere is based on the calculation of the variation in time and space of O_3 concentration ($\delta [O_3]$) due to the emission of a specific gas with respect to the same amount for a reference compound, trichlorofluoromethane (CFC-11, CCl_3F).

The photochemical oxidation potential or smog-forming potential (Photochemical Oxidation Potential, PCOP) quantifies the contribution to the smog phenomenon (photochemical oxidation of certain gases, which produces ozone). It is expressed in equivalent ethylene, C_2H_4 .

These four indicators (GWP, AP, ODP, and PCOP) depend on the global or regional atmospheric domain (see Table 1.2).

Table 1.2 Environmental impact categories used in the WAR algorithm

Local toxicological		Global atmospheric impact	Regional atmospheric impact
Impact on man	Ecological		
<ul style="list-style-type: none"> • Human toxicity potential by ingestion (HTPI) • Human toxicity potential by inhalation or dermal exposure (HTPE) 	<ul style="list-style-type: none"> • Aquatic toxicity potential (ATP) • Terrestrial toxicity potential (TTP) 	<ul style="list-style-type: none"> • Global warming potential (GWP) • Ozone depletion potential (ODP) 	<ul style="list-style-type: none"> • Acidification potential (AP) • Photochemical oxidation potential or “smog”-forming potential (PCOP)

The Human Toxicity Potential by Ingestion (HTPI), Human Toxicity Potential by Either inhalation or dermal Exposure (HTPE), Aquatic Toxicity Potential (ATP), and Terrestrial Toxicity Potential (TTP) are related to the local toxicological domain. As a first approximation, the lethal dose 50 (LD50) or LC50 (lethal concentration 50) is used to estimate HTPI. This indicator measures the dose of substance causing the death of 50% of a given animal population (often mice or rats) under specific experimental conditions. ATP is estimated from the study of the effects on the “fathead minnow” (*Pimephales promelas*). Data are expressed in the form of a concentration causing death (LC50) for 50% of the organisms exposed to a substance for a given limited duration.

1.2.4.3 Application of the WAR algorithm

The WAR algorithm has been used on many processes and the application process is well illustrated in process test cases (we can refer to the works in [23] and [24] on penicillin or benzene by toluene hydrodealkylation production processes).

1.2.5 SPI (Sustainable Process Index)

Another approach to analyse the sustainability of a process is based on the calculation of an aggregate indicator proposed by Krotscheck and Narodoslawsky [25], the SPI (Sustainable Process Index), an expression of the ecological footprint concept for a process that measures the total environmental impact of various human activities. The SPI calculation is based on the mass and energy balances of the process. It is independent of the legal standards that can vary over time, making it particularly attractive. The aim of the SPI is to compare the mass and energy flows generated by human activities to natural material flows, on a global and local scale. In this approach, the planet is seen as a

thermodynamically “open” system, i.e. open to the flow of solar radiations toward its surface and which emits energy in the universe. Solar radiations are the only natural driving forces for all the environmental processes and those resulting from human activities. They constitute a limited flow, although available indefinitely, which is received by the planet’s surface. This means that all natural processes or those induced by human activities require some part of this limited flow and a certain surface: in other words, technological processes compete with each other and with the natural processes for this surface, which is a limited resource. Human activities impact the environment in several ways: any process considered in a “cradle to grave” analysis requires raw materials, energy, facilities, staff, and rejects waste or emissions into the environment. The total area to integrate a specific process in the ecosphere in a sustainable manner is then given by:

$$A_{\text{tot}} = A_{\text{MP}} + A_{\text{E}} + A_{\text{I}} + A_{\text{S}} + A_{\text{D}} \quad [\text{m}^2]$$

where A_{MP} represents the area for the extraction of raw materials, A_{E} denotes the area relative to the energy resource, A_{I} denotes the area relative to facilities, A_{S} denotes the area relative to staff, and A_{D} denotes the area to discharge all waste and emissions. Processes produce services or goods. The impact per unit of good or service is represented by a specific area a_{tot} :

$$a_{\text{tot}} = \frac{A_{\text{tot}}}{N_{\text{p}}}$$

where N_{p} represents the number of goods or services produced by the process, such as the amount of kilowatt per hour produced by a specific energy system. The reference period is generally one year. Finally, we can link this specific area, for the production of a certain good or service, to the statistically available area per person to provide goods or services in a sustainable manner. The following ratio defines SPI as:

$$SPI = \frac{a_{\text{tot}}}{a_{\text{in}}}$$

where a_{in} is the available surface relative to the annual supply of goods and energy per person. It is usually estimated by dividing the total area of a region by the annual number of its inhabitants. Actually, the SPI indicates how much of the area, which is theoretically available per person to ensure their livelihood under sustainable conditions, is used for the production or the service in question: as the SPI (or a_{tot}) gets lower, the impact on the ecosphere to provide the good or service also becomes lower. A key point of the SPI assessment is the ability to specify and compare the different impacts of a technology. The detailed description of the SPI calculation and application would go beyond the scope of this chapter. Readers may refer to the articles by [25] and [26], which illustrate this approach. The authors propose correlations to determine the different areas [27]. An interesting case study of this indicator is proposed in [28] for the case of a bioprocess (penicillin production).

In order to provide a more comprehensive analysis of the interaction of environmental burdens and financial costs, an environmental performance strategic map has been proposed, based on the combination of different footprints [29]: carbon footprint [30], [31], water footprint [32], energy footprint (renewable, non-renewable) [33], and footprint due to emissions (air, water, and soil) [34].

1.2.6 Exergy as a thermodynamic base for a sustainable development metrics

Another way to define a sustainable development indicator is to use exergy. A presentation of all the concepts is proposed in two parts in [35], [36]. The use of exergy [37] makes it possible to quantify, on the whole, the resources consumed and the emissions into the environment, to the extent that it is a physical magnitude that can integrate mass and energy transfers. Exergy analysis is based on the combination of the first (energy conservation) and second principle (development of entropy, consideration of irreversibilities, and energy degradation) of thermodynamics [38], [39]. Due to the generation of entropy, the energy available in the outgoing products (exergy of outgoing products) is lower than the one available in the resources. This deterioration in quality is quantifiable by exergy destruction and is involved in physico-chemical processes, either in the natural ecosystem (biomass production, for example) or in the industrial ecosystem (production, consumption, etc.).

The first applications of exergy analysis in the 1980s mostly focused on the analysis of industrial systems. The research in this area includes both methodological developments and applications to specific industrial processes and to their supply chain. Let us note that many studies have been conducted on the combination of exergy analysis and “pinch” methods (e.g. [40], [41]). Cumulative exergy consumption (CExC) extends the exergy analysis beyond the simple process to consider all the processes from natural resource extraction up to the final product. Here again, the major interest of this overall analysis is to provide guidelines for the improvement of one of the involved processes and to compare several approaches [42][MOR 91].

Decision support systems and techniques based on the combination of exergy and economic analysis concepts have also been developed, thereby leading to an exergy cost. Exergy analysis was applied to various energy conversion and chemical processes, particularly comparing different energy sectors [43], [44]. It is particularly interesting for cogeneration systems, as it puts the various involved energy sources on the same energy sector ([45], [46] for example).

1.2.7 Indicators from life cycle assessment

Life Cycle Assessment (LCA) is an environmental management tool that enables us to identify and quantify the environmental impacts of a product, a service or activity from the “cradle to the grave”,

i.e. from the extraction of raw materials up to its end of life processing (waste, discharge, incineration, recycling, etc.). Its methodology will not be presented here in detail, since it is the subject of a specific chapter of this thesis (see Chapter 2) dedicated to the choice of a system-based environmental management technique. An excellent summary of the use of LCA and its prospects is proposed in [47].

Main methods of impact categories

There are different methods to translate the inventory results into environmental impact indicators at different levels. There are generally classified into two broad categories based on their position on the continuum of the cause and effect chain, the “mid-point” methods on the one hand, and the “end-point” methods on the other hand:

- “mid-point” methods, the most recognized and currently used methods, are used to characterize the inventoried flows into potential impact indicators (or mid-point indicators), of about a dozen in number. They model the impact relatively closer to the environmental flow and hence consider only part of the environmental mechanism. Their advantage is to reduce uncertainty. Mid-point methods include: the CML 2001 baseline method of the Leiden University in the Netherlands [22] which has a broad consensus, or the EDIP 97 or 2003 method [48]. This method, particularly used in Scandinavia, models the impacts corresponding to higher-order effects. It enables a better communication but is more uncertain because of the many hypotheses that it involves. The impact categories commonly considered in mid-point methods generally involve global warming, ozone layer depletion, tropospheric ozone formation, acidification, eutrophication, toxicity, ecotoxicity, resource depletion, and land use;
- “end-point” methods model the impacts relatively far in the environmental mechanism, i.e., which act directly as damages to human health, ecosystems, and resources. These indicators are more relevant in terms of communication and are therefore more simple to use, but their modelling is more uncertain due to the complexity of the mechanism and difficulties to completely model it. Typical methods are the EPS [49] and Eco-Indicator 99 [50] methods. The damage types concern human health, biotic and abiotic natural environment and resources, and the human environment;
- mid-point and end-point methods: some methods model the impacts both in terms of mid-point and end-point (Impact 2002 + method [51]).

The advantages and disadvantages of the methods of impact categories and indicators have been extensively presented [52]. Some users prefer mid-point indicators because they describe the impacts in the cause and effect mechanism at the earliest and prevent the accumulation of uncertainties when modelling the indicators to the closest end point [53].

1.2.8 Toward a sustainable life cycle assessment

In a review article on the past, present, and future of LCA [47], it is mentioned that the development of the LCA has undergone various phases, which eventually included the method as a decisional tool for environmental management, in order to design sustainable products, processes, and systems:

- past of LCA (1970–2000): there were two periods. Initially, the (1970–1990) period with two decades of method design with often divergent approaches, terminologies, or even results, thus showing the absence of scientific discussions and exchange platforms about this method. This was followed by a decade of standardization with efforts in the scientific activity and coordination of activities (works of the SETAC, definition of standardization activities (especially ISO 14040 Environmental management – life cycle assessment – principles and framework);
- current LCA (2000–2010): this period is characterized as the decade of development of the methodology.

However, the LCA method, as mentioned explicitly, is interested only in the environmental component of the life cycle assessment. The current challenge is clearly the extension of the methodology to other components of sustainable development (LCSA, Life Cycle Sustainable Analysis).

1.3 Process design methods and sustainable systems

1.3.1 Positioning of chemical process industries

Given their role as a large-scale provider of material goods within society, the chemical industries consume large amounts of non-renewable resources and emit wastes. The chemical and petrochemical sector is by far the largest industrial energy user, accounting for roughly 10% of total worldwide final energy demand and 7% of global GHG emissions [54]. The European chemical industry has already made significant efforts to reduce its GHG emissions. Between 1990 and 2008, it reduced its GHG emissions by 42% in absolute terms and by 66% in specific terms, i.e. per unit of production.

With a reduction of 96 million tonnes of carbon dioxide equivalents since 1990, the chemical industry alone has achieved nearly one third of the EU commitment under the Kyoto Protocol to reduce GHG emissions by 8% between 1990 and 2012.

Even if environmental gains are substantial, the situation needs to be further improved as a major user of raw materials, both for energy and as feedstocks, the chemicals industry still significantly impact on

the supply of non-renewable resources and, as these materials are, in general, based on hydrocarbons, combustion of these sources can lead to emissions of carbon dioxide (CO₂) – GHG – and volatile organic compounds (VOCs) and nitrogen oxides (NO_x) which contribute to the formation of tropospheric ozone or “smog”. Next, the processing of the raw materials and feedstocks can result in the release of hazardous pollutants to the environment (e.g. propylene) from emission stacks, discharge pipes, storage tanks and other equipment. Of all the sectors of the chemicals industry, the basic chemical sector is generally the largest emitter (by volume) of such pollutants because these bulk chemicals are usually produced in high volumes at large plants.

During normal operations, workers can be exposed to pollutants in a gaseous or liquid form, for example by inhaling a pollutant emitted from leaks in equipment or splashing the substance on the skin or in the eyes. Larger accidents involving chemicals can also occur due to equipment failures. Major spills can result in inadvertent releases to workers, the surrounding neighbourhood or perhaps even communities and the environment at some distance from the plant. At the conclusion of each stage of the process, the product is transported, via pipeline, rail, barge/tanker or truck, to the next user for further processing. This can be as close as another part of the same plant, or as far as another company located in another country.

Due to the complexity of the problem, this work will be restricted to the earlier design stage. At this level of the presentation, it can be said that the framework will be developed under the following assumptions:

- transportation will not be taken into account;
- only the case of normal operating conditions will be explored. The case of degraded conditions will not be considered;
- the case of fugitive emissions will not be taken into account even if they are among the major concerns of industrial process releases, since they cause problem to various aspects including the environment, health, and economic. We are aware that the early evaluation of process hazards is beneficial because process can be made inherently benign at lower cost. Their quantification and the prevention strategies are yet out of the scope of this work.
- at earlier design stage, the choice of the materials in which the different equipment items will be built is generally not finalized. This aspect will not be taken into account in the evaluation of the environmental component.

1.3.2 Several roads to more sustainable processes and systems

As abovementioned, chemical products have a twofold effect on greenhouse gas emissions. Greenhouse gases are emitted in the manufacturing of chemical products that is the focus of this PhD

work, while at the same time the use of many of these products enables significant reductions in global emissions. Clearly, the environmental impacts have to be assessed across the entire product lifecycle – from production to the final disposal.

Many chemical products enable GHG abatement either because their production footprint is smaller than that of the non-chemical alternatives, or because their use results in fewer emissions than would be the case without their use or with non-chemical alternatives. They therefore, have an important role in contributing toward sustainable development. Specifically, to enhance their long-term sustainability, various environmental considerations including reducing raw material and energy usage, switching to renewable feedstock, and waste reuse and recycling needs to be implemented. Certainly, such measures would require changes to existing processes – ranging from simple modifications of the design and operation to more intrusive options such as material substitution and technology upgradation.

Several techniques have been used for improving sustainability as well as value chain interaction: such as industrial ecology, life-cycle assessment (LCA), green chemistry/engineering, and waste minimization. These techniques are not mutually exclusive but each seeks to improve the sustainability of a plant from a different perspective.

1.3.2.1 Industrial ecology

At a geographical cluster level, the concept of industrial ecology tends to improve the environmental impact of a plant by favouring waste exchange, recycle, and reuse with other plants ([55], [56]) in proximity. The determination of the conditions that underpin industrial symbiosis and associated framework conditions, as well as how different actors within value chains establish and maintain inter-organisational relationships to develop processes for industrial symbiosis, i.e., optimizing waste valorisation within and between sectors, are receiving increasing attention. One example of the successful implementation of this industrial symbiosis is the Kalundborg industrial park in Denmark [57], where an oil refinery, power station, gypsum board facility, pharmaceutical plant, and the city itself, share water, steam, and electricity resources, and also exchange a variety of wastes. This leads to a 25% reduction of the fresh water usage, 2.9 million tons of material recycling, and energy for heating 5 000 homes.

1.3.2.2 Life Cycle Assessment

In the previous section, only the environmental metrics associated with LCA has been considered. Here, LCA is viewed as an environmental system-based management tool that can be used for elucidating the environmental burdens over the entire life-cycle of the product, starting from raw

material extraction to production process, point of use and final disposal (SETAC, 1994). It must be recognized that LCA initially and traditionally focuses on products and their impacts on the environment. It has also been applied as a decision-making tool during process design [58], where its strong interest has been highlighted. From the discussion in section 1.2, an environmental system-based approach seems particularly sound in the framework of this research. In that context, Life Cycle Assessment seems a good candidate due to its maturity as highlighted in [47]. The positioning of LCA among other environmental system-based management tools will be widely discussed in Chapter 2.

1.3.2.3 Green chemistry / green engineering, process intensification and waste management

While industrial ecology and LCA focus outwards from the process and plant, green chemistry/green engineering and waste minimization look inwards. The production process can be made inherently benign through green chemistry and green engineering, which involves designing new processes or products (such as catalysts) that eliminate or reduce the use and generation of hazardous substances (see the twelve principles of Green chemistry according to Anastas and Warner [2]; and more particularly the Twelve Principles of Green Engineering that are within the scope of this work). Let us recall that:

- green chemistry is the design of chemical products and processes that reduce or eliminate the use and generation of hazardous substances.
- green Engineering is the development and commercialization of industrial processes that are economically feasible and reduce the risk to human health and the environment. This work focuses on this issue.

Given its nature, this is mostly applicable in the initial design stages where changes to the process chemistry are still viable.

Process intensification is another cornerstone to improve sustainability. It is well recognized that process intensification can lead to large efficiency increases in the pharmaceutical and fine chemicals sectors and will start to become implemented in some first bulk chemicals production [59].

Besides, waste minimization is a manufacturing-centric activity which avoids, eliminates or reduces waste at its source, or allows reuse or recycling of the waste within a plant [59]. It is thus suited for initial process design as well as the retrofit situation, where different modifications can be proposed to the base case design and operation in order to improve the environmental performance.

1.3.3 Eco-design approaches

The above analysis shows that the recognition of sustainability criteria in the process design phase is not an easy task and that many scientific challenges are still open. Due to the central position of the chemical industries along the value chain, a major concern is related to the process design stage, which is at the core of the system and to its connection to the raw material and energy extraction phase, within the boundaries of the so-called cradle to gate system. This will constitute the study domain of this work.

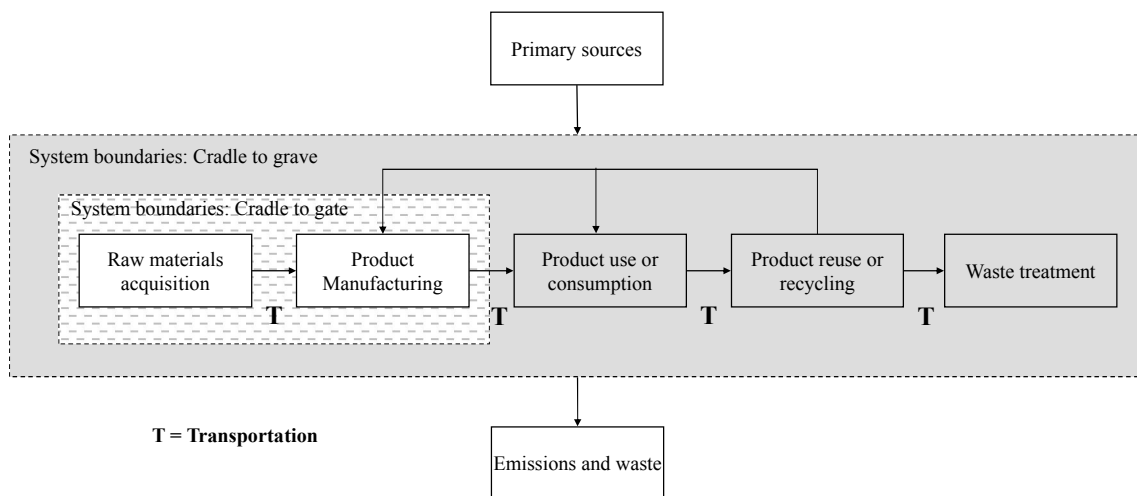

Figure 1.4 System boundaries Cradle-to gate

In general, process simulators are used to determine the material and energy flow on a boundary related to the process. Cost models combined with these performance models are used to study the process profitability. Till now, simulation and modelling tools had been used mainly to minimize an economic criterion under environmental constraints.

In the last 15 years, a substantial number of works in the PSE (Process Systems Engineering) domain dedicated to these themes (see the journal in [60]) is reported in the literature. The available methods can be classified into two categories: qualitative and quantitative methods. The qualitative methods include summary techniques based on the Douglas hierarchical procedure model [61], the onion diagram [62], or environmental optimization ENVOP [63], which can be applied to identify the solutions for minimizing the potential discharges of a process. Quantitative methods include the pinch technology [64], mass exchange networks [65], superstructure optimization [66], or simulation. All these methods can be used to better integrate the process and/or its utility network.

The process simulator has become a standard tool for process engineers. Its main advantage is the ability to easily evaluate process changes using commercial software (Aspen Plus, CHEMCAD, gPROMS, HYSYS, PRO/II, ProSimPlus, etc.) in a rather short time period without using difficult and expensive experiments or a pilot test. Such simulators have also been used for environmental studies. The Aspen Plus simulator was coupled with an optimizer to determine the optimal superstructure, thereby reducing waste generation and energy consumption while satisfying a profitability criterion. The methodology was applied for the production of methyl chloride. The CHEMCAD simulator coupled with the WAR algorithm was used in [20] to compare the environmental impacts induced by changes in the production unit. The objective was to reduce the environmental impact by recycling in a methyl ethyl ketone unit and an ammonia unit. Another study [67] combined the Aspen Plus simulator with multiobjective methods to reduce the environmental impact and maximize profitability. The methodology was illustrated in the process of benzene production by toluene hydrodealkylation (HDA process). The HYSYS simulator was used with an optimization module to evaluate the design alternatives for a maleic anhydride process [68]. More recently, several design choices relative to a biodiesel production process have been studied by combining the Aspen Plus simulator and multiobjective decision support tools [69].

Another approach to sustainable design is adopted in [70], based on a *SustainPro* indicator to identify, screen, and evaluate the design alternatives. *SustainPro* uses the process information in the form of mass and energy balances from a simulator and applies a set of mass and energy indicators. The methodology is based on a reverse design method, where target values are assigned to the indicators and where the most sensitive variables towards indicators are identified. The development of a software tool (*SustainPro*) and its application to chemical processes operating in batch or continuous modes is presented in [71]. The software tool is based on the implementation of an extended systematic methodology for sustainable process design using process information/data such as the process flowsheet, the associated mass/energy balance data and the cost data. *SustainPro* guides the user through the necessary steps according to work-flow of the implemented methodology. At the end the design alternatives are evaluated using environmental impact assessment tools and safety indices. The extended features of the methodology incorporate life cycle assessment analysis and economic analysis. The application and the main features of *SustainPro* are illustrated through a case study of β -galactosidase production. Yet *SustainPro* is still an evaluation tool and does not embed a multi-objective optimization framework.

A very interesting contribution is the work presented in [72] proposing a framework for conducting sustainability study implemented in the *ENVOPExpert* design support system. Different process systems engineering methodologies are combined – the knowledge-based approach for identifying the root cause of waste generation, the hierarchical design method for generating alternative designs,

sustainability metrics, and multi-objective optimization – into one coherent simulation-optimization framework. This is implemented as a decision-support system using Gensym's G2 and the HYSYS process simulator. The framework involves the following elements: (i)- process information representation, (ii)- waste source diagnosis, (iii)- knowledge-based alternative generation, (iv)- quantitative assessment of alternatives, and (v)- multi-objective optimization based on Simulated Annealing. Even if this contribution is particularly interesting, the environmental criteria are based on the output flows of the process and not evaluated as environmental impacts. The approach is only restricted to a gate to gate system and no decision aid method is implemented to provide valuable solution to the decision maker.

A study based on the combination of a simulator coupling the process and the utilities producing unit with a multi-objective optimizer of genetic algorithm type is proposed in [73], [74] and serves as an initiation of this work. A key point concerns the use of the Ariane ProSim software, a simulator dedicated to the production of utilities (steam, electricity, process water), to calculate the needs in primary energy and quantify the emissions of pollutants, which come from the energy production unit. Among the set of optimal solutions in the Pareto front, it is important to determine the one(s) that correspond(s) to the best choices, in order to guide decision-makers in these final task. A method for decision support has thus been used to establish the best compromise between the criteria (TOPSIS (Technique for Order Preference by Similarity to Ideal Solution) method [75]: the fundamental idea of this method is to choose a solution as close to the ideal solution (better on all criteria) as possible and as far from the negative-ideal solution (which degrades all the criteria) as possible. The general framework is illustrated in Figure 1.5.

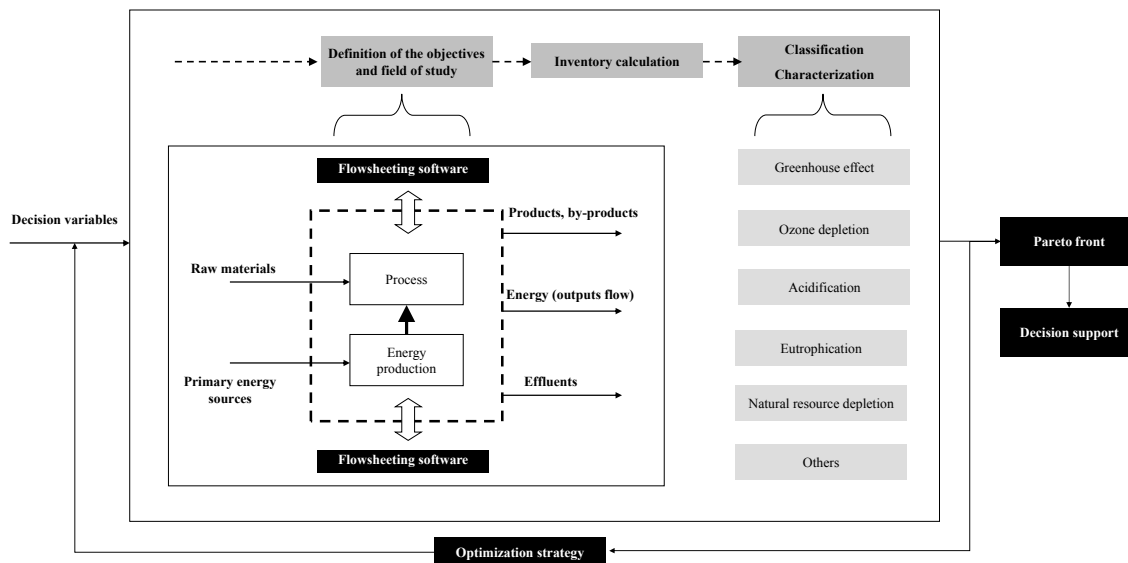

Figure 1.5 General framework for eco-design proposed in [73], [74]

1.4 Main objectives of this work

One main shortcoming of the abovementioned approach is yet the lack of genericity of the proposed approach. Even if the energy production stage was modelled by use of the Ariane software offering a large range of operation units dedicated to energy production, the process simulation was carried out by an internal code dedicated to a specific process used as a test bench, the well-known benzene production by toluene hydrodelakylation (HDA). The support example yet demonstrates the usefulness of such an approach coupling simulation, optimization and multiple criteria decision-making that must be extended. The objective of this work is clearly to develop a generic framework that can be used whatever the process that can be modelled by use of a classical flowsheet simulator.

Another limitation concerns the evaluation of environmental criteria resulting from the categories of environmental impact potentials from the WAR method. It must be recognized that the involved database is relatively limited: the extraction stage is not taken into account and the impact method assessment is relatively scarce.

Another objective is also to take into account the potential environmental impacts of the energy consumed in a chemical process since energy will have both an environmental impact as well as an economic impact on process design and analysis. For this purpose, the system boundaries must be extended to encompass the power plant that supplies the energy to the process and to incorporate the environmental effects of the power plant into the analysis. This issue has been tackled in the pioneering work of [76]: it involves the development of the WAR algorithm, a methodology for determining the potential environmental impact (PEI) of a chemical process, that was extended to account for the PEI of the energy consumed within that process. No optimization procedure was embedded in the framework proposed by these authors. Following the guidelines proposed in [77], the objective is to show how process simulation can also be used to bridge data gaps in LCA database concerning energy production units with varying conditions and technologies.

In this work, a particular emphasis will be focused on the antagonist behaviour of the various environmental impacts that may be encountered and to their simultaneous consideration in the resulting optimization problem, thus leading to a multi-objective optimization formulation. This contribution is thus devoted to the presentation of an eco-design approach for process design combining process and utility production modelling, multi-objective optimization, multiple criteria decision aid tools and Life Cycle Assessment.

The multi-objective optimization method that will be used does not need to aggregate the various impacts (objectives) in a valuation stage. Valuation is controversial, so the possibility to look at all the objective functions in a MO and choosing by trade-off is acknowledged. The thesis outline can be summarized as shown in Figure 1.6.

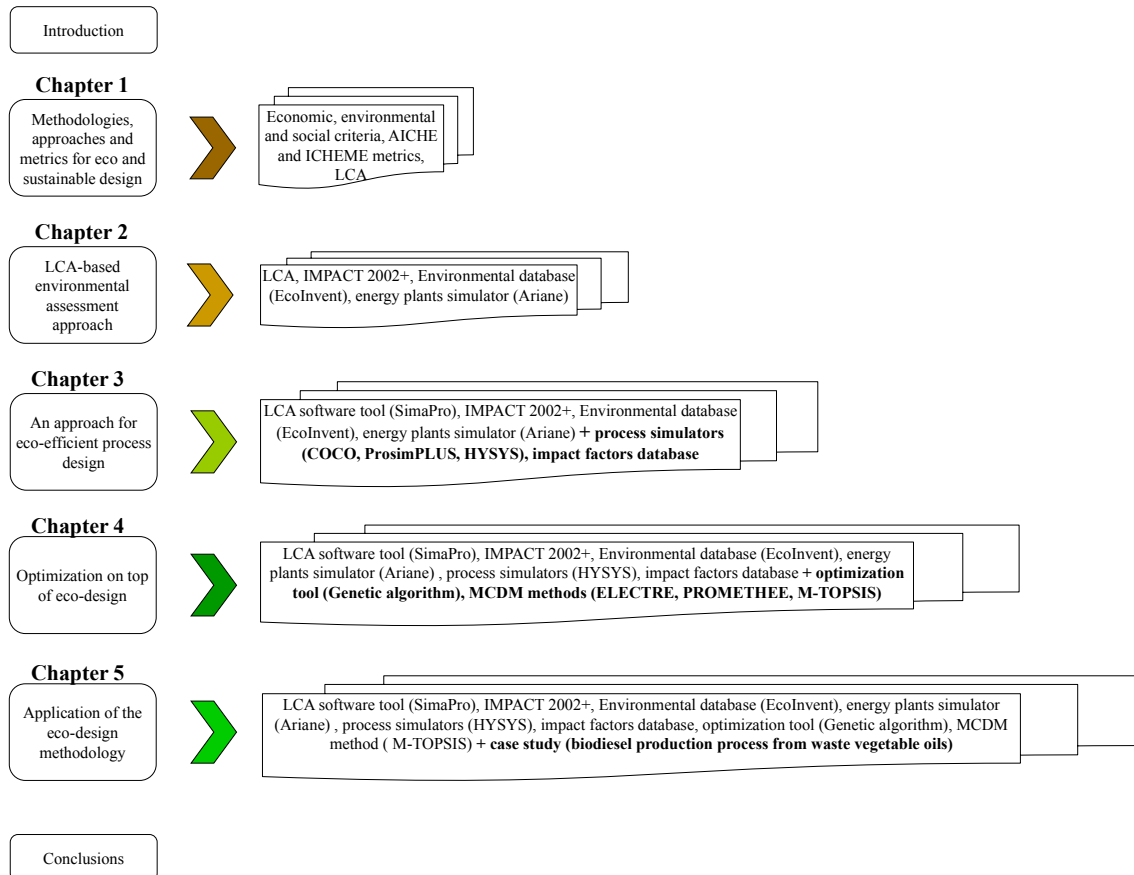

Figure 1.6 General outline of the thesis

2 LCA-BASED ENVIRONMENTAL ASSESSMENT APPROACH: BRIDGING DATA GAP WITH PROCESS SIMULATION FOR ENERGY GENERATION

Résumé

Ce chapitre met l'accent sur la nécessité de disposer d'un outil systémique de gestion environnementale dans un cadre d'éco-conception de procédés. Dans ce contexte, la méthodologie d'Analyse du Cycle de Vie, largement éprouvée en éco-conception de produits est retenue pour une déclinaison dans le domaine des procédés. Néanmoins, des lacunes apparaissent dans les bases de données, notamment en ce qui concerne les besoins en énergie des procédés, notamment en production de vapeur par des technologies variées. Nous montrons comment un simulateur de production d'énergie (logiciel Ariane, développé par Prosim SA) peut être utilisé pour calculer les émissions associées pour une gamme de conditions opératoires, en se basant sur des données expérimentales pour calibrer le modèle. Un cas d'étude de production de vapeur par turbine à gaz illustre l'approche.

Nomenclature

Acronyms

Bq	Becquerel
C-14	Carbon 14
CBA	Cost-Benefit Analysis
CFC-11	Trichlorofluorométhane
C₂H₃Cl	Polyvinyl chloride
C₂H₄	Ethylene
CHP	Combined heat and power
CO₂	Carbon dioxide
CO	Carbon monoxide
COM	Component Object Model
DALY	Disability Adjusted Life Years
EDIP	Environmental Design of Industrial Products
EIA	Environmental Impact Assessment
ERA	Environmental Risk Assessment
HDA	Benzene production by hydrodealkylation of toluene
HRSg	Heat-Recovery Steam Generator
Kg_{eq} Substance x	kg equivalent of a reference substance x
LCA	Life Cycle Assessment
LCI	Life Cycle Inventory
LCIA	Life Cycle Impact Assessment
LHV_i	Lower heating value of fuel <i>i</i>
MFA	Material Flow Analysis
MJ	Mega Joule
NO_x	Nitrogen oxides
org.arable	Organic arable land year
PM_{2.5}	Particulate matter smaller than 2.5 micrometers
PDF*m²*y	Potentially Disappeared Fraction of species per m ² per year
PO₄³	Phosphate
PO₄ P-lim	
Point	Points are equal to “pers*yr”
RER S	Europe System Processes
RER U	Europe Unit Processes
SEA	Strategic Environmental Assessment
SO₂	Sulphur oxides

TEG	Triethylene glycol
Terrestrial acid/nutri	Terrestrial acidification/nitrification
TRACI	Tool for the reduction and assessment of chemical and other environmental impacts
UO	Unit operation
VBA	Visual Basic for Applications
<i>Symbols</i>	
CF_{j, k}	Characterization factor of the component <i>j</i> in the category <i>k</i>
DF_k	Damage factor in the category <i>k</i>
Damage score_{j, k}	Score of the component <i>j</i> in the category <i>k</i>
kWh	Kilowatt hour
M_j	Flow rate amount emitted or extracted from the component <i>j</i>
mg	Milligram
NF_k	Normalization factor in the category <i>k</i>
Nm³ (Nm3)	Normal cubic meter
Score_{j, k}	Score of the component <i>j</i> in the category <i>k</i>
t/h	Tonnes per hour

2.1 Introduction

To improve the overall environmental performance of chemical products and processes, an environmental assessment of chemical substances with a life cycle perspective is useful. Among system-based environmental assessment techniques, Life Cycle Assessment (LCA) is a widely accepted tool to evaluate environmental effects of products, processes, and services. One focus is to implement energy-efficient processes and green technologies early in the process design to maximize environmental efficiency and to reduce costs. The collection of data is the most time-consuming part in an LCA and involves a great deal of work to obtain representative information about the many processes in a production system. Quite often, the practitioner faces the frustration of incomplete or missing information as well as of approximate information that does not match exactly the real situation that may introduce a bias in the environmental impact estimation. Many sustainability studies can therefore be hampered by the lack of information on production processes, and chemicals are often neglected or only crudely estimated. Even though the life cycle method is gradually becoming more important for industry to incorporate the environmental factor in processes, services and products, the information about the processes is not readily available. Unfortunately, the substances that are included in the most common LCA databases represent just a part of the raw materials used in chemical and biochemical companies. This situation is particularly valid for utility supply and process energy requirements, specifically steam requirements. Generally, the environmental impact associated with typical energy needs of process industries is an average impact of various processes in a specific area.

The aim of this chapter is to propose a framework to bridge data lack for energy requirements for chemical processes using process simulation dedicated to energy production. The ambition is not to provide at the end of the chapter a database dedicated to energy production for processes but rather to propose a methodological way to tackle the problem by coupling process simulation and data collection that is able to take into account variable operating conditions: choice of the technology production, fuel type, pressure, temperature, etc.

This chapter is divided into four sections following this introduction section:

- Section 2 explains why a system-based environmental assessment management is particularly sound in an eco-design perspective, which is the core of this work. The link with chemical engineering, especially with process systems engineering is justified. This analysis leads to select Life Cycle Assessment.
- Section 3 focuses on LCA with specific attention to database and impact assessment which motivates this investigation.

- Section 4 presents how a process simulation tool dedicated to production utilities, Ariane, ProSim SA, can be particularly useful to fill environmental database gap, by the design of specific energy sub modules, so that the life cycle energy related emissions for any given process can be computed. The case study developed in this chapter concerns the environmental impact assessment of steam production by a bi-fuel furnace and by a gas turbine
- Finally, the conclusions of this chapter are given in section 5.

2.2 System-based environmental assessment management

Environmental assessment can be defined as “a systematic process for evaluating and documenting information on the potentials, capacities and functions of natural systems and resources in order to facilitate sustainable development planning and decision making in general, and to anticipate and manage the adverse effects and consequences of proposed undertakings in particular” [78]. Many of the developments which underpin the system-based approach to managing environmental performance [79] derive from chemical engineering. They involve a fusion of chemical engineering with other disciplines including environmental sciences, toxicology and economics.

Many tools and indicators for assessing and benchmarking environmental impacts of different systems have been developed (e.g. [80]). Examples include Life Cycle Assessment (LCA), Strategic Environmental Assessment (SEA), Environmental Impact Assessment (EIA), Environmental Risk Assessment (ERA), Cost-Benefit Analysis (CBA), Material Flow Analysis (MFA), and Ecological Footprint. Four of the main tools are introduced here.

- **Environmental Risk Assessment (ERA)** [81]. Environmental risk management or risk assessment is the process of identifying, evaluating, selecting, and implementing actions to reduce risk to human health and to ecosystems. The terms risk assessment and risk management are both used to describe the whole framework, or specific parts of the framework, where risk assessment encompasses an analysis phase and risk management an implementation phase. This method does not determine the environmental impacts of a process; its main purpose is to measure the risk to human health and/or the environment caused by the use of hazardous substances in industry.
- **Environmental Impact Assessment (EIA)** [82]. EIA is an established tool mainly for assessing environmental impacts of projects. More precisely, this method aims at predicting the environmental impact of the modification or creation of a new project. EIA has three major phases: screening and scoping of the project, environmental impact assessment, and decision-making and review. The locations of the planned project and associated emissions are

often known and an EIA is often used to evaluate alternative locations. It is required in different regulations in many countries.

- **Material Flow Analysis (MFA)** [83]. MFA is an analytical method of quantifying flows and stocks of materials or substances in a system. It is an important tool to assess the physical consequences of human activities and needs, and is used to develop strategies for improving the material flow system in form of material flow management [84]. MFA can be assimilated as a form of material balance analysis, typically applied to one material or group of materials (such as iron, steel or copper) at a geographical area or an industrial sector scale. MFA is applied to obtain estimates for resource consumption, or of waste amounts. MFA can be useful to evaluate recycling rates, to improve waste recovery and to define waste management policies. This method analyses the flows in all chains of a process: Extraction of raw materials, Chemical Processing, Product Manufacturing, Recycling, and Removal of materials. A dynamic Material Flow Analysis Model for French Copper Cycle was developed by Bonnin et al. (2012) [85].
- **Life Cycle Assessment (LCA)** [86]. Life Cycle Assessment is a tool to assess the potential environmental impacts and resources used throughout a product's lifecycle, i.e., from raw material acquisition, via production and use phases, to waste management [87]. The waste management phase includes disposal as well as recycling. The term "product" includes both goods and services [87]. LCA is a comprehensive assessment and considers all attributes or aspects of natural environment, human health, and resources [87]. The unique feature of LCA is the focus on products in a life-cycle perspective. The scope of LCA is useful in order to avoid problem-shifting, for example, from one phase of the life-cycle to another or from one environmental problem to another.

The choice of tool depends on what types of impacts the decision-maker is interested and on the objective of the study. To summarize, any of the most often used tools have specific characteristics as environmental systems analysis tools. EIA is intended used for planned projects. One tool for studying environmental impacts from nations and regions is MFA, using different methods within the system. Risk assessments of chemicals are used for specific substances. Till now, LCA was particularly appropriate on products and services.

The methodological development in LCA has been strong, and LCA is broadly applied in practice. The literature on the application of life cycle assessment (LCA) to process industry products and particularly to chemical processes has been reviewed in [88] with some cases of the application of LCA to specific chemical processes. Azapagic [89] presents recent cases e.g. the Case of Vinyl Chloride Monomer.

It can be highlighted that most LCAs have focused on products, with limited application to processes. Azapagic [58] has reviewed LCA applications to process selection, design and operation. The implications of LCA for choosing the Best Practicable Option are discussed for end-of-pipe cases. Azapagic also reviews work on the use of LCA in conjunction with multi-objective optimization applied to process design and optimization [90]. This work lies in this perspective and intends to incorporate process evaluation in the LCA phase for process selection using multi-objective optimization tools.

2.3 LCA environmental impact assessment framework

2.3.1 LCA principles

LCA is a technique that aims at assessing the environmental impact of a product throughout its lifetime including the production process of raw materials used [87], which is a “from cradle to grave” analysis. The LCA framework includes four phases: goal and scope definition, life cycle inventory (LCI) analysis, life cycle impact assessment (LCIA) and interpretation of results (Figure 2.1).

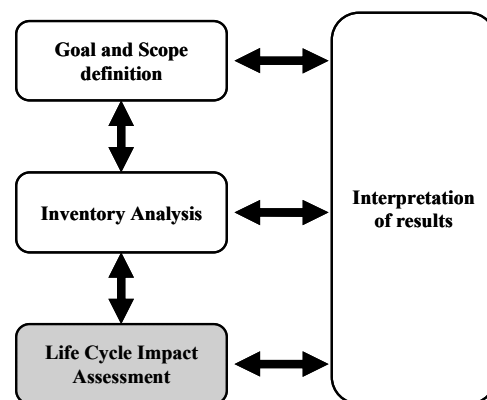

Figure 2.1 Life Cycle Assessment framework

- Goal and scope definition. The objectives and scope of the study are described and a functional unit to which emissions and extractions are reported is established. The system boundaries are fixed [91].
- Inventory analysis. It involves creating an inventory of flows from and to nature. Inventory flows include inputs of water, energy and raw materials as well as emissions to air, water and soil. The input and output data needed for the construction of the inventory are collected for all activities within the system boundary [91].
- Impact assessment. Evaluation of potential environmental impacts based on inventory flows made in the previous phase [92].

- Interpretation of results. Based on the results of the impact assessment, it is possible to establish a set of conclusions and recommendations for the study [93].

In summary, the “goal and scope” defines the limits of the study, the “inventory” will consist of a full listing and categorisation of the different elements involved in the cycle, the “impact assessment” describes and quantifies the impacts; the “improvement assessment” is the basis for improvement of the existing cycle.

The LCA can be viewed from two main perspectives:

- as a conceptual process that guides the selection of options from design and improvement;
- and methodologically, as a way to build a quantitative and qualitative inventory of environmental burdens or releases, to evaluate these impacts, and to identify alternatives to improve environmental performance.

These are the two main motivations to use LCA as environmental impact assessment framework in this work. Generally, two types of LCA can be distinguished, either attributional or consequential.

- In attributional LCA studies, the impacts are attributed to the considered system based on the input and output flows
- In consequential LCA studies, the question is to determine how the input and output flows of the system would change as a result of the potential decisions

It must be highlighted that the outcomes of both LCA types are quite different. In this work, LCA studies will be based on the attributional approach

2.3.2 Impact factors and databases

This section focuses on the LCIA methods and databases used to model and calculate the LCI environmental impact. The LCIA is aimed at evaluating the significance of potential environmental impacts from “cradle to grave” [87]. Various methods have been developed such as CML 2001 [94], Eco-Indicator 99 [95] and IMPACT 2002+ [51]: these methods are based on impact categories and are modelled according to their depth in the cause and effect chain [51], [96]. In the mid-point analysis, the environmental impacts are considered in relatively early stages of the cause and effect chain. The mid-point-oriented methods are associated with less uncertainty compared to the damage-oriented methods. The damage-oriented methods assess the environmental impacts at the end-point in the cause and effect chain and these methods are associated with high uncertainties [97]. Table 2.1 shows some main characteristics of the methods listed above.

Table 2.1 Impact assessment methods and their characteristics (Based on [98])

LCIA method	Country	Impact modelling depth		Normalization
		Mid-point categories	End-point categories	
CML 92	Netherlands	X		X
Eco-indicator 99	Netherlands		X	X
IMPACT 2002+	Switzerland	X	X	X
EDIP97/EDIP2003	Denmark	X		X
TRACI		X		X

The four mid-point-oriented LCIA methods are summarized as follows:

EDIP97/EDIP2003

The Danish method for Environmental Design of Industrial Products (EDIP) developed in 1996 is a mid-point approach covering most of the emission-related impacts, resource use and environmental impacts. The basis for normalization is person equivalents; weighting is based on political reduction targets for environmental impacts and supply horizon for resources. Compared to the other methods, EDIP97 emphasizes the category of toxicity but gives little consideration to resource depletion.

TRACI

The tool for the reduction and assessment of chemical and other environmental impacts (TRACI) is developed by the U.S. Environmental Protection Agency. This method adopts 12 impact categories at the mid-point level. Several benefits can be highlighted: *(i)* reducing uncertainties of prediction at the damage points, and *(ii)* decreasing the modelling complexity. The TRACI methodology reflects state-of-the-art developments and best practice of life-cycle impact assessment methods in the United States.

IMPACT2002+

IMPACT2002+ is one of the European LCIA methods, which represents a combination of mid-point and damage oriented approaches because it defines all types of life cycle inventory results in 14 mid-point categories and 4 damage categories [51]. IMPACT2002+ also improves upon IMPACT2002 by adding the considerations of human toxicity and ecotoxicity. Compared to the other methods, IMPACT 2002+ emphasizes the category of ecosystem quality but gives little consideration to resource depletion.

CML2001

CML developed by the Institute of Environmental Sciences at Leiden University of the Netherlands a mid-point-oriented method, which includes characterization and normalization in the impact assessment process. The CML2001 method defines three categories of impacts: (1) baseline impact

categories which are normally used in almost all LCA studies, (2) study-specific impact categories which are used depending on the available data and goal and scope of the study, and (3) other impact categories which require further elaboration.

Assessment methods use factors (Table 2.2) to estimate characterization, damage and normalization scores of components in the inventory analysis.

Table 2.2 Factor type provided by impact assessment methods [99]

Factor name	Description
Characterization factor	The importance of single flows in relation to a specific basic flow is characterized with a factor.
Damage factor	The possible damage due to an emission is described with a factor. This can include a modelling for the environmental fate, a characterization of the substances and a final weighting
Normalized factor	Another factor, e.g. characterization factor, is normalized by division through the total sum of characterized flows in a certain area and within a certain time.

An LCI requires a lot of data. Setting up inventory data can be one time-intensive stages of an LCA. This is often challenging due to the lack of appropriate data for the product system under study: this is particularly valid for chemicals production.

Many databases have therefore been developed in the last decades. These include public national or regional databases, industry databases, and consultants' databases that are often offered in combination with LCA software tools. In that context, EcoInvent [99], [100] is a widespread database including over 4000 industrial processes³ for environmental assessment grouped into the following categories [101]:

- Energy (including hard coal, oil, natural gas, nuclear power, hydroelectric power, wood energy, wind power, photovoltaic, solar heat, electricity supply and mixes, small scale CHP (combined heat and power) systems and biofuels)
- Materials (including building materials, metals, plastics and paper and board)
- Renewable materials (including wood, tropical wood and renewable fibres)
- Chemicals (including basic chemicals, petrochemical solvents and detergents)
- Transport services
- Waste treatment services
- Agricultural products and processes
- Electronics

³ <http://www.pre-sustainability.com/databases>

- Mechanical engineering (including metals processing and compressed air)
- Mechanical engineering (including metals processing and compressed air)

2.3.3 IMPACT 2002+

As above mentioned, IMPACT2002+ considers both mid and end-point categories. The categories are grouped and linked to the damage categories. In this way, users can better understand the cause and effect chain of the environmental impacts (Figure 2.2). This explains why it was adopted in this work.

Characterization and normalization scores are suggested in [51] for an adequate interpretation of the final results because the characterization represents the potential environmental impact through specific substances ($K_{g_{eq}}$ Substance x) with lower uncertainty compared to damage factors and the normalization standardizes characterization results for comparison between mid and end-point categories.

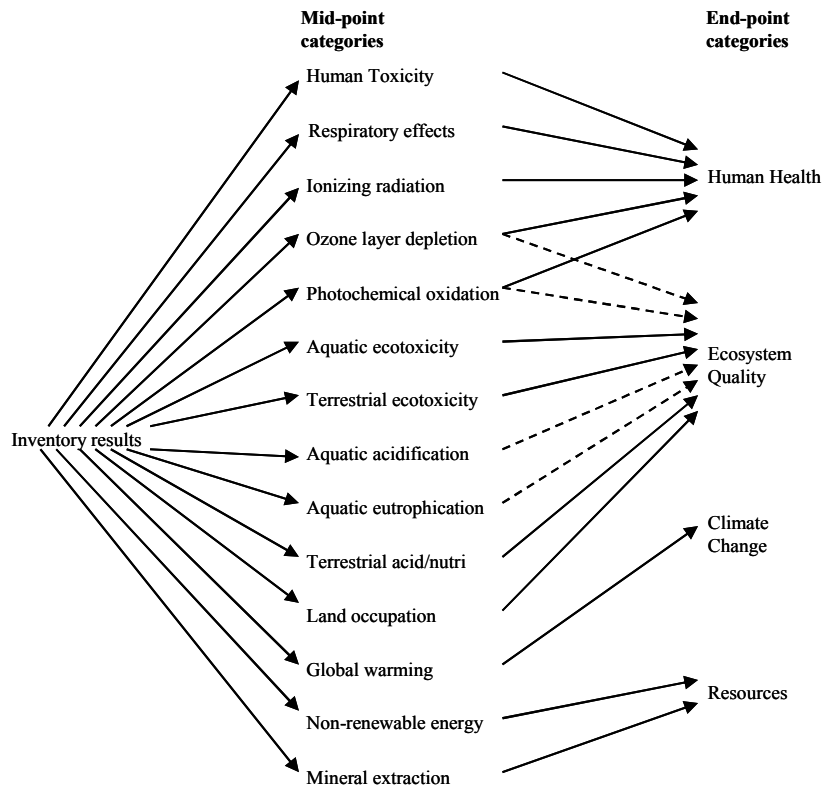

Figure 2.2 Impact 2002+ framework: mid and end-point categories (Based on [51])

Scores are obtained by the multiplication/division of the impact factors (Table 2.2) with the mass and energy flows of the life cycle inventory (LCI). There are different paths to get the characterization, damage and normalization scores of the mid-point and end-point categories. Equations 2.1, 2.2 and 2.3 allow calculating the scores of LCI elements in the corresponding category [96]:

$$\text{Mid-point score}_{j,k} = (CF_{j,k}) (M_j) \quad (2.1)$$

$$\text{Damage score}_{j,k} = (DF_k) (\text{Mid-point score}_{j,k}) \quad (2.2)$$

$$\text{Normalization damage score}_{j,k} = \frac{\text{Damage score}_{j,k}}{NF_k} \quad (2.3)$$

The characterization score is represented by a unit expressing the amount of a reference substance x that equals the impact of the considered pollutant ($K_{g_{eq}}$ substance x). The damage score units vary according to category:

- **DALY** characterizes the disease severity, accounting for both mortality and morbidity
- **PDF*m²*yr** is the unit to “measure” the impacts on ecosystems. PDF*m²*yr represents the fraction of species disappeared on 1 m² of earth surface during one year.

Finally, the score normalization unit is the Point, expressed in “persons*year”. A point represents the average impact in a specific category “caused” by a person during one year in Europe. Table 2.3 summarizes the characterization, damage and normalization units, and also indicates the relationship between the characterization and damage categories. End-point categories are estimated from the normalized damage score. For this purpose, the category scores linked to end-point categories are added (Figure 2.2).

Table 2.3 Characterization reference substances and units used in IMPACT 2002+ (Based on [96])

Category	Characterization reference substance	Damage category	Damage unit	Normalized damage unit	
Human Toxicity (carcinogens + non-carcinogens)	$K_{g_{eq}}$ chloroethylene into air			point	
Respiratory effects (inorganic)	$K_{g_{eq}}$ PM _{2.5} into air	Human Health	DALY	point	
Ionizing radiation	$B_{q_{eq}}$ carbon-14 into air			point	
Ozone layer depletion	$K_{g_{eq}}$ CFC-11 into air			point	
Photochemical oxidation (Respiratory organics)	$K_{g_{eq}}$ ethylene into air			point	
Aquatic ecotoxicity	$K_{g_{eq}}$ triethylene glycol into water	Ecosystem Quality	PDF * m ² * yr	point	
Terrestrial ecotoxicity	$K_{g_{eq}}$ triethylene glycol into water			point	
Terrestrial acidification/nutritification	$K_{g_{eq}}$ SO ₂ into air			point	
Land occupation	M^2_{eq} organic arable land-year			point	
Aquatic acidification	$K_{g_{eq}}$ SO ₂ into air			<i>Under development</i>	-
Aquatic eutrophication	$K_{g_{eq}}$ PO ₄ ³ into water			<i>Under development</i>	-
Global warming	$K_{g_{eq}}$ CO ₂ into air			Climate Change	$K_{g_{eq}}$ CO ₂ into air
Non-renewable energy	MJ Total primary non-renewable or kg_{eq} crude oil (860kg/m ³)	Resources	MJ	point	
Mineral extraction	MJ additional energy or kg_{eq} iron			point	

2.3.4 Database limitation for energy production for chemical processes

Databases play an important role in environmental impact assessment. Currently, there are millions of processes in the world with many configuration parameters. The majority of database systems are based on average data representing average production and supply conditions for goods and service. This situation is particularly valid for process energy requirements, specifically steam requirements. For instance, in EcoInvent database, two different types of steam production are available [102]:

Steam, for chemical processes, at plant/RER S AND Steam, for chemical processes, at plant/RER U

Included processes: Input of water and energy for the production of steam. No further infrastructure is included, as the heating infrastructure is part of the respective heating modules used; Geography: value represents average steam production of 11 European chemical sites

Technology: average steam production out of gas and heavy fuel oil by 11 European chemical producers

For both processes, the environmental impacts are based on average steam production of 11 European chemical sites. In these conditions, it is difficult to study the impact of steam production dedicated to a chemical complex. This impact of a change in the operating conditions is impossible to be taken into account, for example different technologies, different fuels, various steam pressures and temperatures, etc. This justifies the need of data modules used to build inventories on a unit-process level. This means that the inputs and outputs are recorded per production step. Unit process data, in contrast to average data, often refer to specific technologies. This provides the possibility for tailored inventories, choosing the technologies that are in place in the studied case, and allowing the study to focus on, for example, best available technologies, best operating conditions and different energy mixes. For this purpose, the use of process systems engineering background based on mass and energy balances is a cornerstone. In the following sections, an example of steam production is presented, in which the inputs (primary energy) and outputs (emissions) of the energy production process are evaluated.

2.4 Impacts of process energy requirements

The generation of energy (and utilities), while distinct from the main processing system is still part of the LCA system because the process consumes utilities that in turn have environmental impacts. In chemical processes, the energy required is mostly thermal or mechanical, with the latter provided by electricity in most cases). These requirements correspond to heating and electricity use. At the same time, heat has to be removed from the system, by cooling units. To satisfy these energy requirements, specific energy processes are implemented in the chemical complex, that have material input and outputs. A representative example of a heating (respectively cooling) requirement is the process of

producing steam (respectively the use of cooling water). For illustration purpose, the cases of steam production by a bi-fuel furnace and by a gas turbine are tackled in this work.

2.4.1 Energy production

Any chemical process needs energy so that its components can operate (reactors, distillation columns, pre-heaters, pumps, compressors, flashes or coolers). The required energy can come from different sources (steam for example) and can be obtained from different processes using different technologies and different fuels. Some examples of these various paths can be seen in Figure 2.3. This illustrates a representation of energy production for different uses in a chemical process through the use of different primary energy sources.

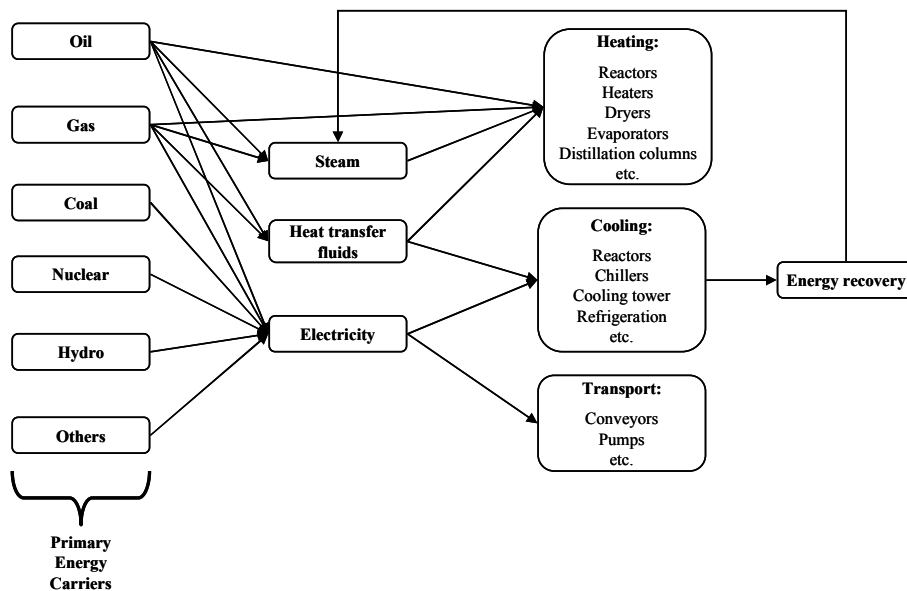

Figure 2.3 Potential energy paths in a chemical process [103]

The energy production process is well separate from the chemical process itself and shared among the different production units. This process includes inputs, outputs and emissions so that it is necessary to perform a life cycle assessment to take into account its environmental impact and add it to the whole chemical process impacts. To carry out the LCA, it is necessary to identify the inventory associated with the process. In this case, it is clear that the primary energy source (gas, oil, coal, etc.) is considered as the main input. The output is the produced energy (steam, electricity, etc.). Pollutant emissions taken into account are associated with the primary energy combustion. For example, the emissions from natural gas and fuel oil include carbon dioxide (CO_2), nitrogen oxides (NO_x), sulphur dioxide (SO_2) and carbon monoxide (CO). The mass flow of emissions depends on several factors including the type and purity of used fuels. Concerning for instance SO_2 formation, natural gas combustion generates a very low amount with a sulphur level of 2,000 grains per million cubic feet whereas fuel oil combustion converts 95% of the sulphur content in the fuel to SO_2 . In another

example, using natural gas, nitrogen oxides (NO_x) are formed through three mechanisms: thermal (dissociation and reaction of nitrogen and oxygen molecules in the combustion air), prompt (early reaction of nitrogen molecules in the combustion air and hydrocarbon radicals), and fuel (reaction of fuel-bound nitrogen compounds with oxygen) whereas using fuel oil leads to the formation of nitrogen oxides through thermal mechanism. In the case of carbon monoxide, the formation depends on fuel efficiency (either fuel oil or natural gas) [104].

One of the main abovementioned limitations of the EcoInvent database is the lack of specific environmental impacts in the energy compartment. When an environmental model is created from the life cycle inventory of energy production required by a process, it is often necessary to make assumptions distant from reality to choose an element from the database. A proposed solution to this problem is the design of specific energy sub modules, so that the life cycle energy related emissions for any given process can be computed. These impacts will depend on the specific characteristics of the process, such as the efficiency of the boiler, the types of materials used and the geographic area.

2.4.2 Use of an energy production plant simulator

The design of energy sub modules can be performed by the energy production simulator Ariane⁴ to compute primary energy requirements and quantify pollutant emissions from process operations units. This will serve in a larger extent as a basis to compute the corresponding environmental life cycle emissions and impacts of energy generation. Ariane is a tool developed by ProSim SA to assist in the design of optimal operation in energy plants, including:

- a full set of standard equipment (boilers, turbines, de-aerators, valves...), but also specific equipment for cogeneration and district heating networks (heat exchangers, water heaters...) to represent the energy plant;
- a thermodynamic model that represents accurately the properties of water, steam and fumes;
- a database that includes the most common fuel (natural gas, oil, coal.) and that can be enriched (biomass, black liquor, wastes ...) by the user.

Ariane also allows modelling conventional pollutant emissions such as:

- Nitrogen oxides (NO_x)
- Sulphur oxides (SO_2)
- Carbon monoxide (CO)
- Carbon dioxide (CO_2)
- Solid particles

⁴ <http://www.prosim.net/fr/logiciels-ariane-simulation-optimisation-des-centrales-production-denergie-10.php>

A key feature of Ariane is its interoperability that allows automating the model so that several configuration data and results can be sent, requested and received, thus guaranteeing a fast sensitivity analysis. Data exchange is accomplished through Plessala software, which pilots the simulator. Plessala is associated with Ariane control system from any language or application able to use Microsoft COM technology (Figure 2.4). This software tool allows linking Ariane with simulators, spreadsheets or word processors.

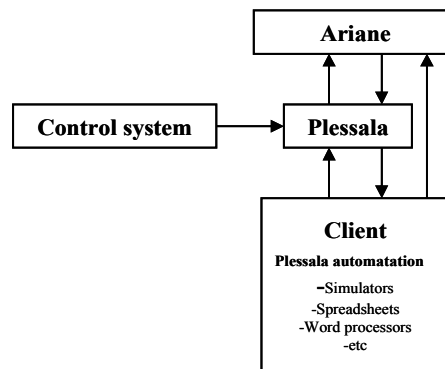

Figure 2.4 Overall architecture of ARIANE communication

To test the usefulness of the simulator, two examples are developed in the following section. Two steam production plants, i.e. a bi-fuel furnace and a gas turbine are designed and a sensitivity analysis with the most influential parameters [77] is conducted.

2.4.3 Modelling steam production in Ariane

The most common primary energy types to produce steam (see Figure 2.3) are natural gas and fuel oil or both. Figure 2.5 shows inputs and outputs of the production process steam [105], i.e.:

- Resources requirement: fuel, oxygen (air) and water
- Air emissions: emissions from fuel combustion
- Water emissions: emissions from boiler
- Electricity requirements: for water treating and pumping as well as vapour transport.

These elements are potential candidates to be included in the life cycle analysis.

There are several ways to produce steam but very interesting options are the production by a bi-fuel furnace and by a gas turbine [106], [107]. Indeed, the turbine has been widely used because it allows co-generation. In what follows, only steam production is taken into account.

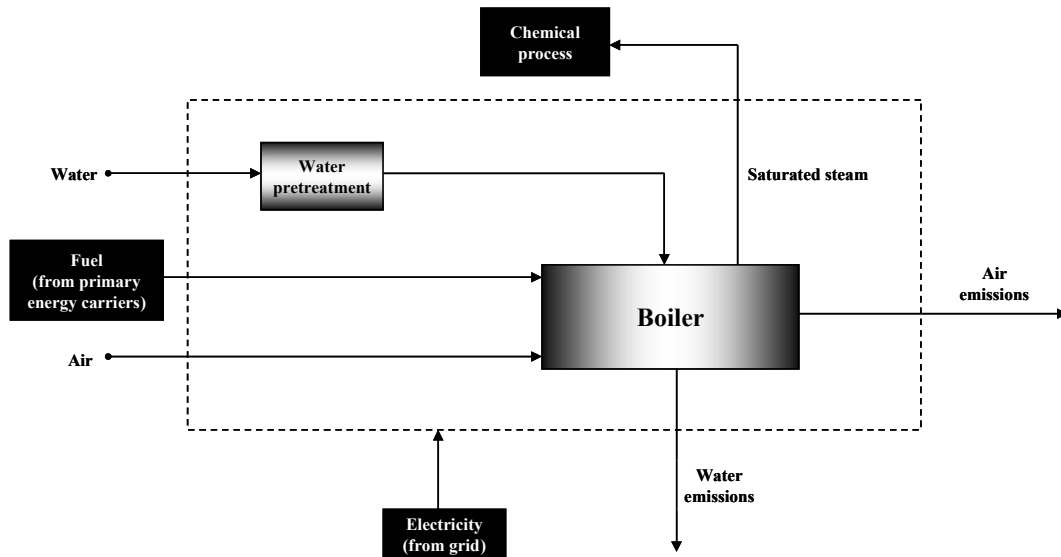

Figure 2.5 Mass and energy flows to steam production [105]

2.4.3.1 Steam production by a bi-fuel furnace

2.4.3.1.1 Bi-fuel furnace modelling in Ariane

Ariane can model various unit operations among them the bi-fuel furnace. The modelling of the furnace is used to steam production. Figure 2.6 illustrates the design and operation tabs of Ariane interface. Data for the design are: a name to identify the furnace, an output network, deaerator to provide feed water, reference conditions for specification of yield curve and finally the specification of used fuels.

The so-called energetic consumption ratio is defined to encompass the simultaneous use of two fuels in the furnace. This variable allows making a choice between the fuel proportion that is used in the furnace of the process and it calculated by:

$$\text{ratio} = \frac{\text{Energy supplied by the first fuel}}{\text{Total energy of the two fuels}}$$

and the consumption of both fuels is calculated by:

$$\text{Flow}_{\text{Fuel1}} = \frac{Q}{\eta_1 \cdot \text{LHV}_1 \cdot \text{ratio}}$$

$$\text{Flow}_{\text{Fuel2}} = \frac{Q}{\eta_1 \cdot \text{LHV}_2 \cdot (1 - \text{ratio})}$$

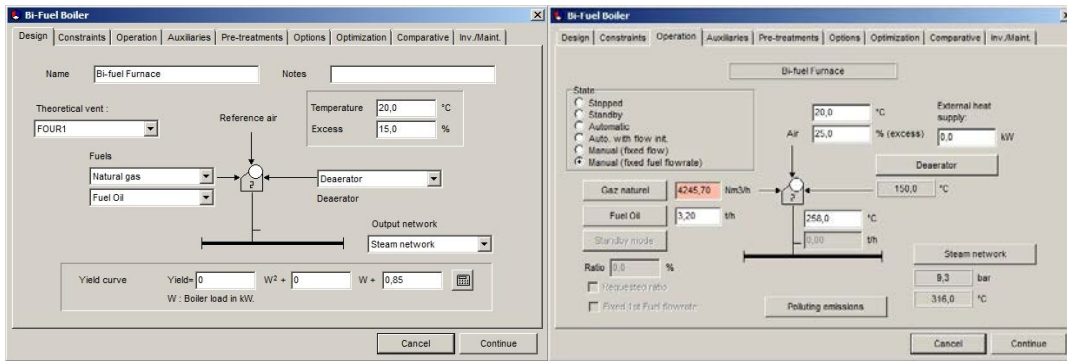

Figure 2.6 (a) Design and (b) operation tabs in Ariane user interface of bi-fuel furnace

The furnace operates according to the following modes: standby, automatic, automatic with user flowrate initialization, manual at fixed output flowrate and manual at fixed fuel flowrate. Furnace model is flexible and allows fixing the amount of fuel or steam output amount; if the output is set, then the fuel consumption is calculated and it is possible to set the energetic consumption ratio. Figure 2.7 shows an example of bi-fuel furnace model in Ariane.

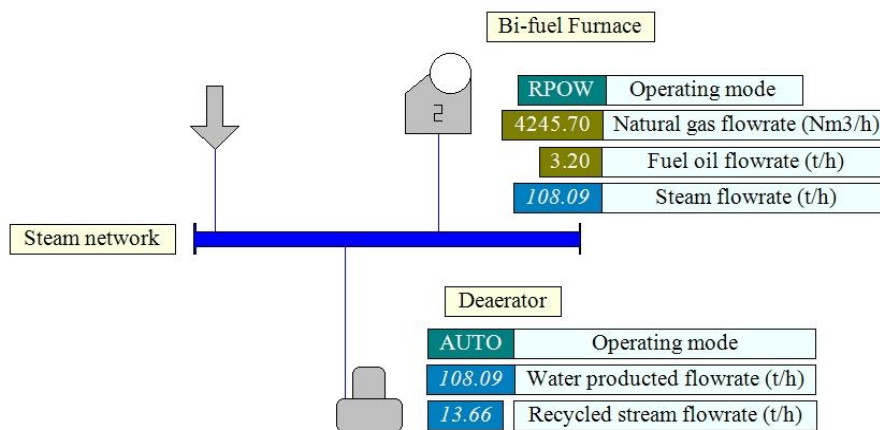

Figure 2.7 A flowsheet example of bi-fuel furnace in Ariane

2.4.3.1.2 Calibration of emissions for the bi-fuel furnace model

Furnace modelling must be calibrated to reproduce the emissions (CO_2 , CO , NO_x , and SO_2) that can be observed. To accomplish this, a combination of two sets of operating conditions from literature [105] and their corresponding experimental measurements are taken into account. Each set has a production 1 MJ of steam. The model is configured to operate at a pressure of 9.3 bar and the furnace is fed by natural gas and fuel oil. Ariane also allows setting the excess air (25%).

The fuel characteristics in Ariane are:

- Natural gas
 - Hydrocarbon purity 100%
 - Sulphur content 0%
 - LHV (0°C) 11.30 kWh/Nm³
 - Molar weight 16 g/mol
 - C/H ratio 3
 - Specific heat 0.540 cal/g/K
- Fuel oil
 - Hydrocarbon purity 99.69%
 - Sulphur content 0.31%
 - LHV (0°C) 9450 th/t
 - Molar weight 120 g/mol
 - C/H ratio 8
 - Specific heat 0.694 cal/g/K

As previously mentioned, furnace modelling in Ariane allows specifying the amount of fuels. The amount of natural gas used is 0.042 Nm³ and fuel oil is 0032 kg. These are equivalent to those proposed in [105]. Calibration was performed in an iterative process where the following emission factors for both fuels were found. Nitrogen oxides emission factor: 8714.6 mg/Nm³ for natural gas and 2809.3 mg/ton for fuel oil. In relation to sulphur dioxide emissions, they are produced according to the fuel purity. Finally, emission results obtained are shown in Table 2.4 along with the data found in [105] in order to make a comparison and validate the model of the bi-fuel furnace.

Table 2.4 Comparison of emissions from two steam productions (gate to gate emissions)

	Unit	Ariane model	Jimenez, 2011 [105]
Carbon dioxide	Kg	0.182	0.183
Carbon monoxide	Kg	2.01E-3	-
Nitrogen oxides	Kg	4.6E-4	4.599E-4
Sulphur dioxide	Kg	1.9E-4	1.99E-4

Data shown in Table 2.4 indicate that the emissions calculated by the simulator Ariane are in agreement with those obtained in [105].

2.4.3.2 Steam production by a gas turbine

Gas turbines for production of steam are widely used in the chemical process industry to satisfy their energy requirements. Figure 2.8 shows a diagram of a gas turbine with heat-recovery steam generators (HRSG). The turbine and HRSG produced steam following steps described below [106].

1. In point 1, air enters the compressor and once inside, is compressed to a high pressure without adding heat. However, air temperature increases.
2. The air from the compressor at high temperature and pressure enters the combustion chamber (point 2 where the fuel is injected). Combustion normally occurs at constant pressure. The combustion system is designed to provide mixing, burning, dilution and cooling.
3. In point 3, the combustion mixture enters the turbine, which converts the energy of hot gas into work.
4. Finally, the HRSG generates steam using the exhausted energy from the turbine (point 4).

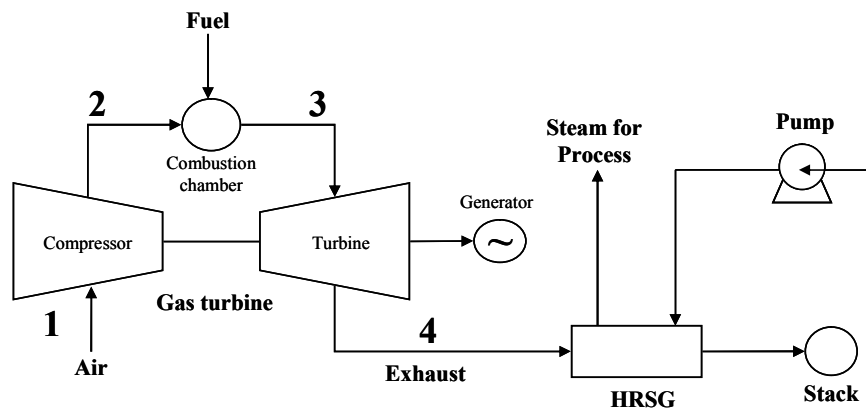

Figure 2.8 Principle of a gas turbine with heat-recovery steam generators (HRSGs)

Gas turbine modelling has received a lot of attention in the dedicated literature [108], [109]. The following section explains modelling of a gas turbine for steam production in Ariane simulator.

2.4.3.2.1 Gas turbine modelling in Ariane

The software tool Ariane includes unit operations that can be used to create a simulation model of energy production plants and among others a steam production plant. The main components for this plant are the gas turbine and the HRSG. Figure 2.9.a shows the configuration parameters for turbine design with Ariane that must be specified: device name, used fuel, parameters of isentropic compression efficiency curve and the temperature curve that calculates the actual temperature after combustion (called high-temperature turbine fuel).

One option is to introduce degassed water in the combustion chamber. If this option is selected, the mass ratio of water must be entered. Another possible option is to inject steam tapped from a central network. In this case, the mass ratio of steam (relative to the fuel flow rate) must be entered. At last, the theoretical vent must be selected at this level. Finally, the design data include the parameters of expansion achieved during turbine phase, combustion chamber pressure and the pressure downstream of the turbine.

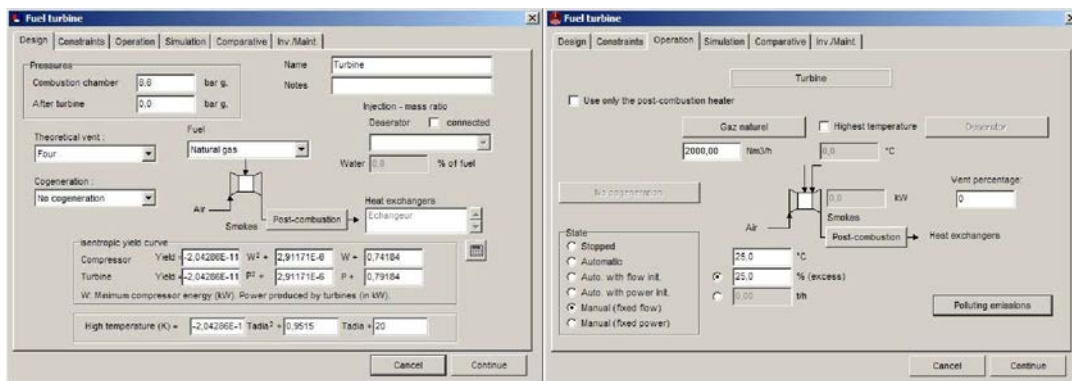

Figure 2.9 Ariane interface for fuel turbine (Design (2.9.a) and Operation tabs (2.9.b))

In operation tab (Figure 2.9 (b)), the operation mode of the turbine and the characterization of combustion must be specified. The turbine can operate in several modes: automatic (with flow or with power initialization), manual fixed fuel flow (flow to be specified) and manual fixed power (power to be specified). To characterize the combustion, the user can specify either the input parameters (temperature, excessive or constant flow fixed) or specify the high temperature air.

With regard to the design of the HRSG, two parameters must be defined in the “design tab” (Figure 2.10 (a)):

- Heater bypass: it represents a division of the flue gas stream, where exchangers are installed in parallel.
- When heater bypass is selected, it is possible to choose output smoke mixing option. This option is used to represent any nested exchangers in a sequential installation.

In operation tab (Figure 2.10(b)), if the exchanger is operating, an exit temperature of the steam or hot water produced must be specified. If the selected mode is "manual fixed flow", the flow must be also specified.

The technical constraints of a gas turbine concern fuel, inlet air and smoke generated flows. In addition, the electric power generated by the turbine is also bounded by a minimum and a maximum value. The constraints associated with the steam generator are linked to the flow and the temperature of the cold stream.

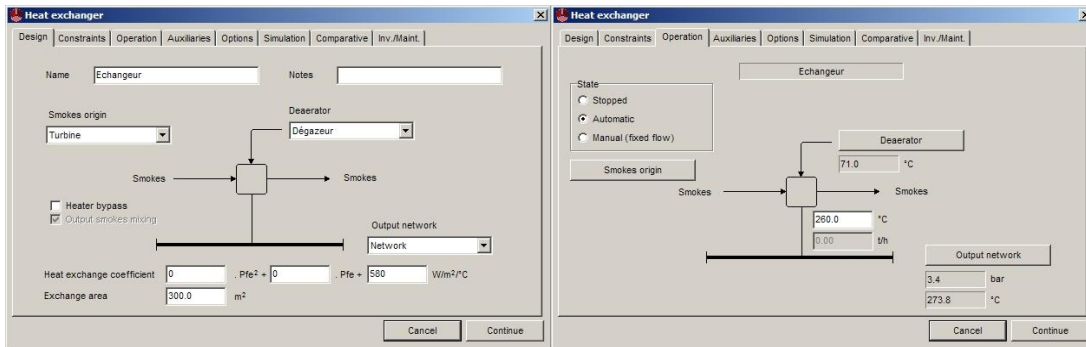

Figure 2.10 Ariane interface for heat exchanger (Design (2.10.a) and operation tabs (2.10.b))

Two scenarios can be thus studied: specifying either the amount of fuel to get a quantity of steam or the amount of steam, so that the amount of fuel needed for production is calculated with Ariane, in both cases, the corresponding emissions are estimated. Figure 2.11 shows a flowsheet example of gas turbine for steam production in Ariane.

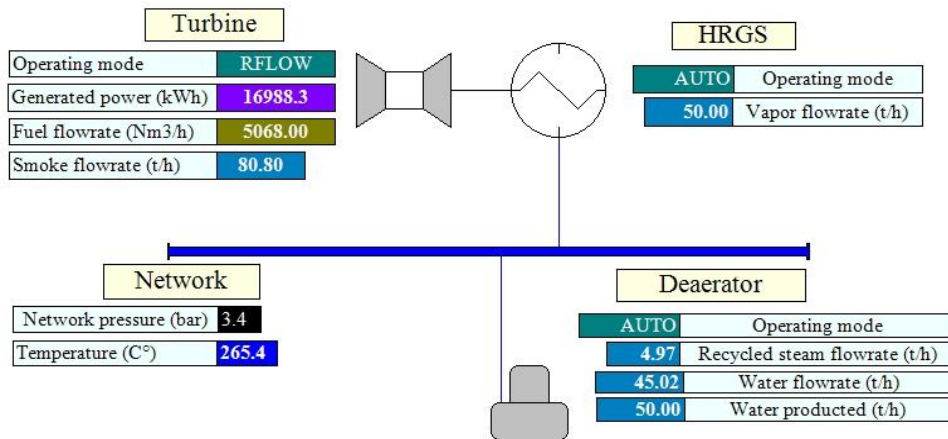

Figure 2.11 A flowsheet example of gas turbine in Ariane

2.4.3.2.2 Calibration of emissions for the turbine model

For the evaluation of the emissions for a gas turbine process, the Ariane model requires to be calibrated (in the same way as the bi-fuel furnace). For this purpose, two sets of operating conditions from literature data [105] and the experimental outputs were used. Four different configurations were tested with two pressure levels (i.e. 3.4 or 9.3 bar) and fed either with natural gas or fuel oil. It is impossible to strictly reproduce the conditions of steam production process proposed in [105]. The turbine model in Ariane is yet configured for the two abovementioned pressure values and the parameters shown in Table 2.5. Pressures, fuel amount, air excess percentage and fuel type parameters are specified in configuration tab in the turbine flowsheet (see Figure 2.9.a). The fuel characteristics are the same as in Section 2.4.3.1.2.

Table 2.5 Key parameter specification of the gas turbine in Ariane

	Configuration 1	Configuration 2	Configuration 3	Configuration 4
Combustion pressure	3.4 bar	9.3 bar	3.4 bar	9.3 bar
Fuel	Natural gas	Natural gas	Fuel oil	Fuel oil
Air excess	25%	25%	22%	22%
Cogeneration	No	No	No	No
Amount	0.04245 Nm ³	0.03912 Nm ³	0.032 kg	0.03 kg

The emissions factors are those identified in Section 2.4.3.1.2 and the result is presented in Table 2.6 for gate to gate life cycle inventory. The major energy related air emissions include CO₂, SO₂, CO and NO_x. The amount of each kind of emission generated is estimated as a linear function of the amount of a given fuel. The simulations results are then compared with the emissions from steam production reported in [28] and also with the emissions from steam production called "Steam, for chemical processes, at plant/RER S" in EcoInvent database (already mentioned in section 2.3.4). Figure 2.12 visualizes the emission amounts according to fuel type and pressure level.

Table 2.6 Comparison of emissions from various steam productions (gate to gate emissions)

Corresponding to operating conditions of Table 2.4

		Configuration 1			Configuration 2		
		Ariane	Jimenez [105]	EcoInvent	Ariane	Jimenez [105]	EcoInvent
	Unit						
Carbon dioxide	kg	7.00E-02	7.00E-02	0.082	8.00E-02	8.00E-02	0.082
Sulphur dioxide	kg	0	0	0.000141	0	0	0.000141
Nitrogen oxides	kg	3.41E-04	3.43E-04	7.38E-05	3.70E-04	3.70E-04	7.38E-05
Carbon monoxide	kg	1.49E-03	Undefined	2.10E-05	1.60E-03	Undefined	2.10E-05
		Configuration 3			Configuration 4		
		Ariane	Jimenez [105]	EcoInvent	Ariane	Jimenez [105]	EcoInvent
	Unit						
Carbon dioxide	kg	9.45E-02	9.52E-02	0.082	1.01E-01	1.03E-01	0.082
Sulphur dioxide	kg	1.86E-04	1.86E-04	0.000141	1.98E-04	1.99E-04	0.000141
Nitrogen oxides	kg	8.43E-05	8.33E-05	7.38E-05	8.99E-05	8.99E-05	7.38E-05
Carbon monoxide	kg	1.89E-03	Undefined	2.10E-05	2.02E-03	Undefined	2.10E-05

The identification process shows that a same set of emission factors lead to a good agreement between the predicted and experimental results for a given fuel. A larger discrepancy is observed with the order of magnitude of the emissions that can be obtained from EcoInvent, resulting from the average steam production of 11 European chemical sites.

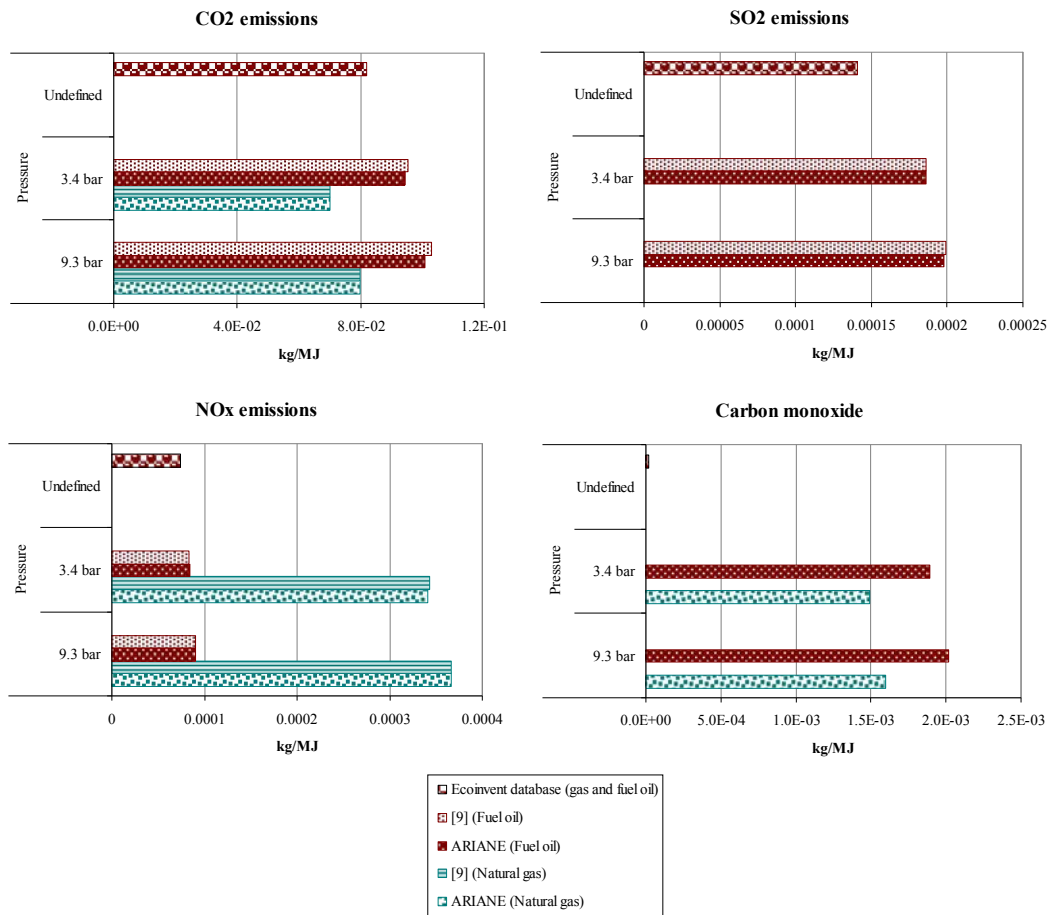

Figure 2.12 Comparison of emissions from various steam productions

2.4.4 Cradle to gate environmental assessment for a specific steam production

The approach that has just been presented can be extended to the cradle to gate boundary for steam production. For the sake of illustration, the steam requirement of the chemical process will serve in the following chapter as a test case (it will be presented in detail in Chapter 3), i.e., benzene production by HydroDealkylation of Toluene (HDA) process [61] and the gas turbine model in Ariane are considered. The research work carried out in [77] indicates that the HDA process requires an average of 50 tons of steam/hour (distillation columns, furnace and flashes included) at a pressure of 40 and 10 bar. The gas turbine is used for the steam production with natural gas as a fuel.

LCA analysis begins with the creation of an inventory that contains data that will be analysed. Then, the inventory data were identified and related to EcoInvent database (see Table 2.7). The next step is then to identify the potential impact factors. The IMPACT 2002+ method is chosen to evaluate the

environmental impact of the steam production because it has and end-point categories allowing a comprehensive analysis of the impacts.

Table 2.7 Matching between the inventory data and the EcoInvent database

Category	Inventory data	Identification of the EcoInvent components	Unit
Fuel	Natural gas	Heat, natural gas, at industrial furnace >100kW/RER S	MJ
Emissions	Carbon dioxide	Carbon dioxide	kg
	Sulphur dioxide	Sulphur dioxide	kg
	Nitrogen oxides	Nitrogen oxides	kg
	Carbon monoxide	Carbon monoxide	kg

Table 2.8 presents the characterization factors of the IMPACT 2002+ method. They serve to represent the environmental impact through a substance specified in mid-point categories. The factors used to estimate the impact in the categories of damage and end-point categories are found in Table 2.9.

Table 2.8 Characterization factors for IMPACT 2002+

	Unit	Natural gas	CO ₂	SO ₂	CO	NO _x
Aquatic acidification	kg SO ₂ eq	5,93E-05	0	1	0	0,7
Aquatic ecotoxicity	kg TEG water	6,56E-01	0	0	0	0
Aquatic eutrophication	kg PO ₄ P-lim	1,33E-07	0	0	0	0
Carcinogens	kg C ₂ H ₃ Cl eq	6,53E-04	0	0	0	0
Global warming	kg CO ₂ eq	6,86E-02	1	0	1,57	0
Ionizing radiation	Bq C-14 eq	8,02E-02	0	0	0	0
Land occupation	m ² org.arable	1,30E-05	0	0	0	0
Mineral extraction	MJ surplus	4,92E-05	0	0	0	0
Non-carcinogens	kg C ₂ H ₃ Cl eq	4,71E-05	0	0	0	0
Non-renewable energy	MJ primary	1,32E+00	0	0	0	0
Ozone layer depletion	kg CFC-11 eq	1,03E-08	0	0	0	0
Respiratory inorganics	kg PM _{2,5} eq	8,84E-06	0	0,078	1,04E-03	1,27E-01
Respiratory organics	kg C ₂ H ₄ eq	1,27E-05	0	0	0	0
Terrestrial acid/nutri	kg SO ₂ eq	2,70E-04	0	1	0	5,49E+00
Terrestrial ecotoxicity	kg TEG soil	1,60E-01	0	0	0	0

Finally, Table 2.10 shows the amount of fuel and emissions calculated by Ariane for the production of steam requirement of HDA process. The equations in section 2.3.3 allow calculating the environmental impact (characterization) of the steam production at different pressure conditions and (40 and 10 bars) using natural gas as fuel. Table 2.11 and Figure 2.13 show the results in the categories.

Table 2.9 Damage and normalization factors IMPACT 2002+ (Based on [51])

Category	Damage factors	Normalisation factors	End-point category
Human Toxicity (carcinogens + non-carcinogens)	2.80E-06 DALY/Kg _{eq} chloroethylene into air	0.0071 DALY/point	Human health
Respiratory effects (inorganic)	7.00E-04 DALY/Kg _{eq} PM2.5 into air	0.0071 DALY/point	
Ionizing radiation	2.10E-10 DALY/Bq _{eq} carbon-14 into air	0.0071 DALY/point	
Ozone layer depletion	1.05E-03 DALY/Kg _{eq} CFC-11 into air	0.0071 DALY/point	
Photochemical oxidation (Respiratory organics)	2.13E-06 DALY/Kg _{eq} ethylene into air	0.0071 DALY/point	
Aquatic ecotoxicity	5.02E-05 PDF * m ² * yr /Kg _{eq} triethylene glycol into water	13700 PDF * m ² * yr/point	Ecosystem quality
Terrestrial ecotoxicity	7.91E-03 PDF * m ² * yr /Kg _{eq} triethylene glycol into water	13700 PDF * m ² * yr/point	
Terrestrial acid/nutri	1.04 PDF * m ² * yr /Kg _{eq} SO ₂ into air	13700 PDF * m ² * yr/point	
Land occupation	1.09 PDF * m ² * yr /M ² _{eq} organic arable land-year	13700 PDF * m ² * yr/point	
Aquatic acidification	<i>n/a</i>	<i>n/a</i>	
Aquatic eutrophication	<i>n/a</i>	<i>n/a</i>	
Global warming	1 Kg CO ₂ into air	9950 Kg CO ₂ into air/point	Climate change
Non-renewable energy	45.8 MJ Total primary non-renewable or kg _{eq} crude oil (860kg/m ³)	152000 MJ/point	Resources
Mineral extraction	5.10e-02 MJ additional energy or kg _{eq} iron	152000 MJ/point	

Table 2.10 Inventory data of steam production

	Unit	Values
Natural gas	Nm ³	5392.04
Carbon dioxide (CO₂)	kg	10263
Sulfur dioxide (SO₂)	kg	0.1
Nitrogen oxides (NO_x)	kg	47
Carbon monoxide (CO)	kg	205.3

Table 2.11 Environmental impact of steam production (Characterization)

	Unit	Natural gas	CO ₂	SO ₂	NO _x	CO
Aquatic acidification	kg SO ₂ eq	11.518	0	0.1	32.9	0
Aquatic ecotoxicity	kg TEG water	127389.007	0	0	0	0
Aquatic eutrophication	kg PO ₄ P-lim	0.026	0	0	0	0
Carcinogens	kg C ₂ H ₃ Cl eq	126.931	0	0	0	0
Global warming	kg CO ₂ eq	13325.5	10263.0	0	0	322.3
Ionizing radiation	Bq C-14 eq	15584.691	0	0	0	0
Land occupation	m ² org.arable	2.533	0	0	0	0
Mineral extraction	MJ surplus	9.569	0	0	0	0
Non-carcinogens	kg C ₂ H ₃ Cl eq	9.154	0	0	0	0
Non-renewable energy	MJ primary	256085.934	0	0	0	0
Ozone layer depletion	kg CFC-11 eq	0.002	0	0	0	0
Respiratory inorganics	kg PM _{2.5} eq	1.7180	0	0.0078	5.9824	0.2143
Respiratory organics	kg C ₂ H ₄ eq	2.465	0	0	0	0
Terrestrial acid/nutri	kg SO ₂ eq	52.547	0	0.100	257.935	0
Terrestrial ecotoxicity	kg TEG soil	31094.723	0	0	0	0

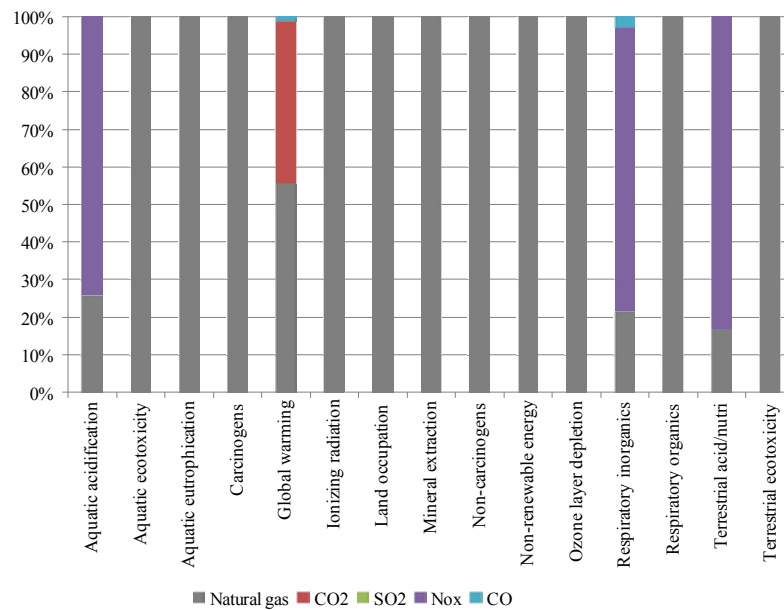

Figure 2.13 Analysis of elements contribution in the categories (Characterization)

The results indicate that natural gas (extraction) has a major contribution in all environmental impact categories while the energy-related impacts are dominated by Aquatic acidification, Global warming, Respiratory inorganics and Terrestrial acidification/nutrition. NO_x has a higher environmental impact than the extraction of natural gas in these categories, and although the turbine produces a large

quantity of CO₂ and CO, the impact factor of NO_x is higher except in the Global Warming where CO₂ is the most important contribution. The major contribution to these categories can be explained by the numerous detrimental effects of NO_x (Table 2.12).

Table 2.12 Adverse effects caused by NO_x in categories

Categories	Effects
Aquatic acidification Terrestrial acidification/nutritification	Acid rain, which may cause extensive damage to materials, vegetation, terrestrial and aquatic ecosystems.
Respiratory inorganics	Decreases in lung function, Bronchitis, Aggravated coughing, Chest pain, Asthma, and other respiratory illness

The amount of NO_x can be reduced using other fuels, such as fuel oil, but this would significantly increase the levels of CO₂, CO and SO₂ as shown in Table 2.6 and Figure 2.12. A different way of environmental impact assessment is presented in Figure 2.14. The impacts are grouped into two categories, i.e., extraction and process impacts. Finally, Figure 2.15 presents the end categories of the IMPACT 2002+ method.

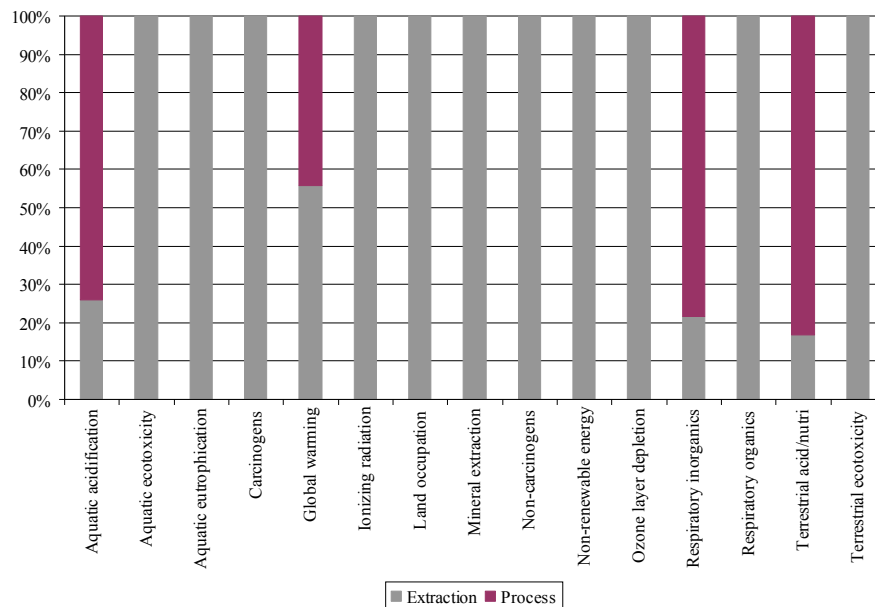

Figure 2.14 Environmental impacts of extraction and process in categories (Characterization)

End-point categories indicate the average impact of a person in a year; the units used are expressed in "points". According to the LCIA method (IMPACT 2002+) used, the average is calculated based on the population in Europe. The environmental impact represented in this way allows carrying out a comparison between the categories, where not surprisingly climate change has the most significant impact, followed by resource depletion and human health. The process related emissions are

predominant in aquatic acidification, respiratory inorganics, terrestrial acidification/nitrification and contribute largely (more than 40%) to global warming. This justifies that further improvement can be obtained by a rational use of energy in the process stage.

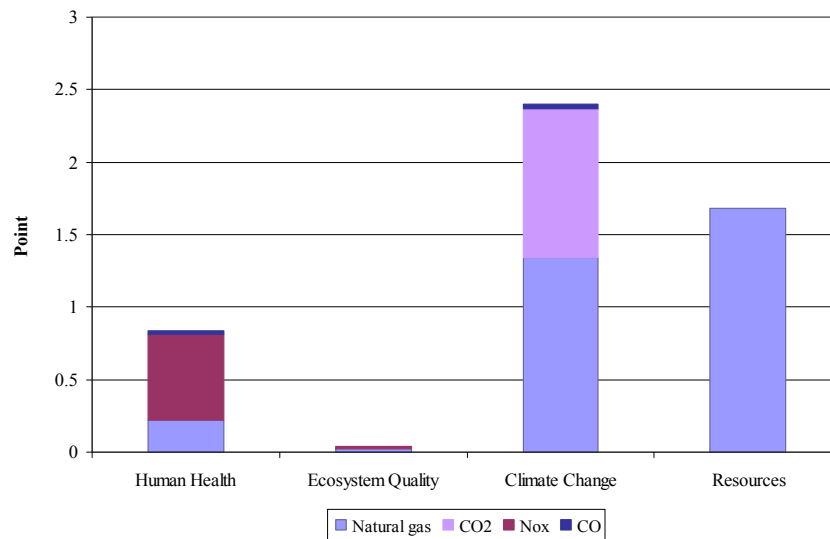

Figure 2.15 Environmental impacts in end-point categories (Normalization)

2.5 Conclusion

Energy is required for unit operations and processes in a chemical plant. In order to understand the impacts and improvement opportunities of any given process, it is useful to have the environmental life cycle profile of energy production that can be characterized by a system-based environmental assessment management. In that context, Life Cycle Assessment is a valuable tool and Life Cycle Inventory databases are largely implemented. It must be highlighted that information available about the chemical substances involved is still limited. Moreover, they suffer from a lack of precision to reproduce the condition of production of vapour, which is one of the most common utilities in chemical processes and that can be produced with different technologies under various operating conditions. In this chapter, the combined use of a process simulation tool dedicated to production utilities, Ariane, ProSim SA, experimental process data and Life Cycle Assessment implemented with a commercial software tool Simapro [102] turned out to be particularly useful to fill environmental database gap, by the design of specific energy sub modules, so that the life cycle energy related emissions for a given process can be computed. The case study developed in this chapter concerns the environmental impact assessment of steam production by a bi-fuel furnace on the one hand and by a gas turbine on the other hand. These concepts will now be embedded in the eco-design framework.

3 COUPLING PROCESS SIMULATION WITH LIFE CYCLE ASSESSMENT FOR ECO-EFFICIENT PROCESS DESIGN

Résumé

Le chapitre 3 présente le cœur de la méthodologie d'éco-conception basée sur des outils traditionnels de Génie des Procédés, à savoir la modélisation et la simulation de procédés à travers des logiciels de flowsheeting (Aspen Hysys, Coco, ProSim) et de génération d'énergie (Ariane) et leur couplage avec un modèle environnemental reprenant les points clés de l'Analyse du Cycle de Vie. Le développement d'une plateforme d'éco-conception générique et évolutive, conçue avec le souci d'interopérabilité des différents modèles impliqués est présenté. Une étude de cas concernant le procédé HDA (production de benzène à partir d'hydrodélakyalition du toluène) sert de guide méthodologique.

Nomenclature

Acronyms

CAPE	Computer-Aided Process Engineering
CH₄	Methane
C₆H₆	Benzene
C₇H₈	Toluene
C₁₂H₁₀	Biphenyl
CFC-11	Trichlorofluorométhane
CO₂	Carbon dioxide
CO	Carbon monoxide
COCO	CAPE-OPEN to CAPE-OPEN
COFE	CAPE OPEN Flowsheeting Environment
COM	Component Object Model
Cop	Process operating cost
COUSCOUS	CAPE OPEN Unit Operations
CORN	CAPE OPEN Reaction Numerics
DALY	Disability Adjusted Life Years
H₂	Hydrogen
HDA	Hydrodealkylation of Toluene
Kg_{eq} Substance x	kg equivalent of a reference substance x
LCA	Life Cycle Assessment
LCI	Life Cycle Inventory
LCIA	Life Cycle Impact Assessment
MJ	Mega Joule
NO_x	Nitrogen oxides
org.arable	Organic arable land year
PDF*m²*y	Potentially Disappeared Fraction of species per m ² per year
PHP	Hypertext Preprocessor
PM_{2.5}	Particulate matter smaller than 2.5 micrometers
PO₄³	Phosphate
Point	Points are equal to “pers*yr”
RER S	Europe System Processes
RER U	Europe Unit Processes
SO₂	Sulphur oxides
TEA	Thermodynamics for Engineering Applications
TEG	Triethylene glycol
Terrestrial acid/nutri	Terrestrial acidification/nitrification

UI	User interface
UNIQUAC	Universal QUAsiChemical
VBA	Visual Basic for Applications
<i>Symbols</i>	
C	Centigrade
C_{rate}	Conversion rate of toluene in reactor
E_i	Amount of energy type i
F_{H2}	Hydrogen flow rate to purge output
FI_{j,k}	Characterization factor of the component j in the category k
Impact_{j,k}	Environmental Impact of the component j in the category k
K	Kelvin
kg/h	Kilogramme per hour
kmol/h	Kilo mole per hour
LHV_i	Lower heating value of combustibile i
M_j	Flow rate amount emitted or extracted from the component j
Nm³/h	Normal Metres Cubed per Hour
P_T	Toluene flow rate in kmol/h
P_H	Hydrogen flow rate in kmol/h
P_B	Benzene flow rate rate in kmol/h
P_D	Biphenyl flow rate rate in kmol/h
psia	Pounds per square inch absolute
R_{Fuel}	Energetic ratio
RM_i	Amount of raw materials
T	Temperature in Kelvin
ton/h	Tonne per hour
UCe_j	Unit cost of energy type
UCrm_i	Unit cost of raw materials

3.1 Introduction

Process synthesis is a complex activity involving many decision makers and multiple levels of decisions steps. Some traditional methods exist such as the well-known Hierarchical Approach proposed by Douglas [61]. In applying the methodology, the designer has to identify dominant design variables and take design decisions. As a result, a number of alternatives are produced that are submitted to an evaluation procedure based on economic and technological criteria. In principle, at each level only one alternative could be retained for further development, so that the procedure leads finally to a good 'base-case'. This serves for improvement and optimization, namely by applying Process Integration techniques. In that context, the major merit of the Hierarchical Approach is that it offers a consistent frame for developing alternatives rather than a single design. The final solution is never unique, depending on a number of design decisions and constraints.

As process synthesis is a complex task, a series of different approaches have been developed and implemented to facilitate and optimize the design of a process. These approaches involve software tools involving mathematical algorithms to simplify and automate the computations. Traditionally, chemical process simulators and other design tools allow researches in academics and industry to model, design, and optimize operational conditions and evaluate different process configurations.

The quality of the design was traditionally based on techno-economic considerations: the environmental issue is generally addressed either as additional constraints to the design problem or as validation steps of end-of-pipe treatments. There is still a critical need to incorporate ecological considerations as environmental impact criteria at the preliminary stage of the process systematic design and not only at end-of-pipe stage. For this purpose, Life Cycle Assessment (LCA) has been identified as an efficient method to quantify environmental burdens. The choice of LCA has been justified in the previous chapter and will be used in the proposed framework.

This chapter presents the approach used in this work for eco-efficient process design, coupling flowsheeting simulators both for production and energy processes with a life cycle assessment module that generalizes and automates the evaluation of the environmental criteria. Basically, the approach consists of three main stages; the first two steps correspond respectively to process inventory analysis and impact assessment phases of LCA methodology for identification purpose of the involved chemical components. It must be yet emphasized at this level that LCA is used here only for impact evaluation at production stage and does not embody the whole life-cycle thinking. The third stage is based on the interaction of the previous steps with process simulation for environmental impact

assessment and cost estimation through a computational framework. Figure 3.6 shows the interaction between the three stages.

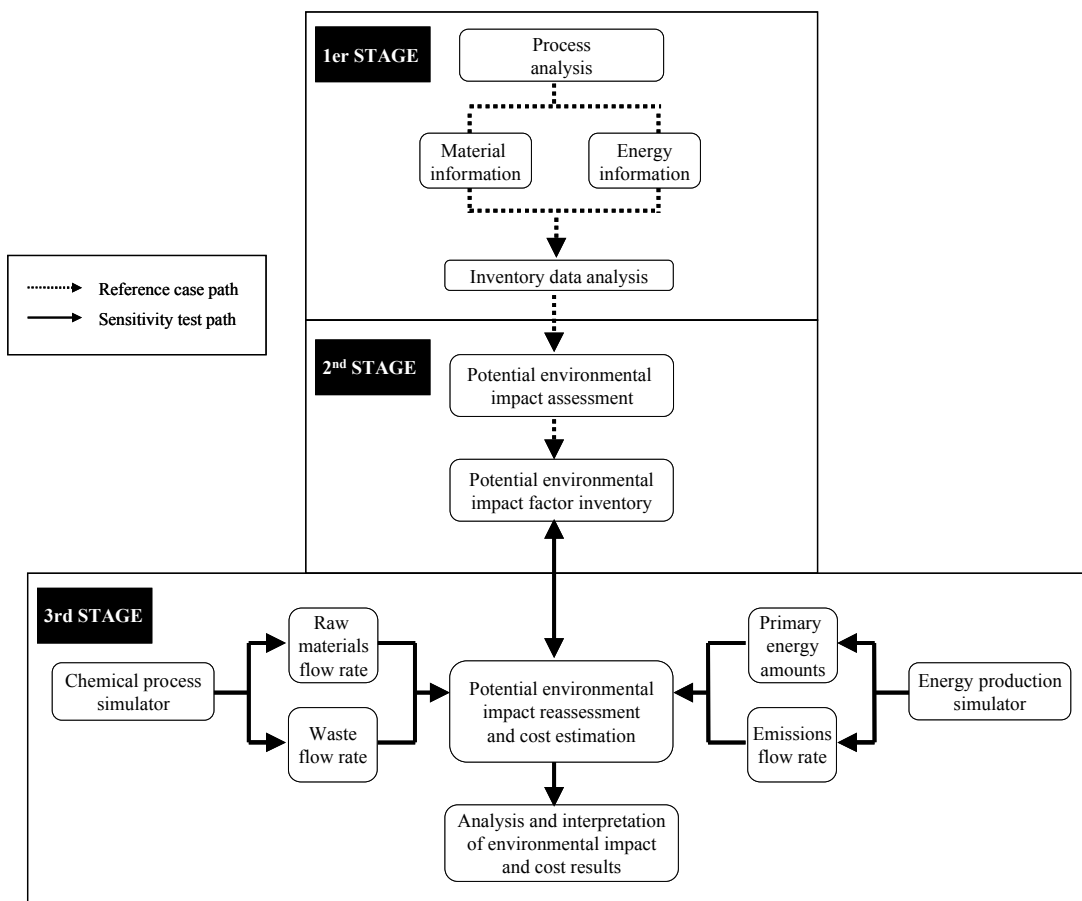

Figure 3.1 Overview of the integrated simulation approach for eco-efficient process design

The proposed approach starts with a reference case (i.e., fixed operating conditions) analysis of a given process in order to identify the chemical components and primary energy sources together with process inputs/outputs (dotted line). This reference data set is then used to perform Life Cycle Inventory to identify both inventory substances and their associated potential factors towards a chosen impact method. The reference design case serves as an initialization step for the process and energy simulators. The last stage is the cornerstone of the approach (bold line); its objective is to design a generic test platform so that the sensitivity of a set of design and operational variables can be investigated relative to environmental indicators and operating cost through data recovery from the first and the second stage. The sensitivity test can be done for several options in order to analyse the results and identify the operational variables that need to be changed to improve progress toward target indicators.

In the next sections, the proposed approach is presented. First, the required components are described, and then the three stages of the approach are detailed. The well-known benzene production by Hydrodealkylation of Toluene (HDA) process illustrates the proposed approach. It is noteworthy that the cost module has been developed specifically for the HDA process since it was not systematically embedded in all the used process simulators. The module is embedded in the framework of the approach. This chapter is divided into ten sections:

- Section 3.2 is dedicated to a literature review in process modelling/optimization techniques and LCA tools.
- Section 3.3 describes the main features of software tools i.e. process simulators, energy plant simulator and LCA tools used in the development of the approach.
- Section 3.4 presents the HDA process used as support example. In addition the parameters used for the construction of the flowsheet in the process simulators are described in detail.
- The stages of the approach are described in sections 3.5, 3.6 and 3.7, inventory data, identification of potential factors and creation of the framework respectively.
- Section 3.8 presents the environmental impact analysis of the HDA process; impact quantification is carried out using the IMPACT 2002 + method.
- Section 3.9 shows sensitivity analysis carried out to assess the behaviour of the process from an environmental and economic viewpoint.
- Finally, in Section 3.10, the general conclusions of this chapter are presented.

3.2 Synthesis of literature review in process modelling/ optimization techniques and tools based on LCA

Since the last decades, chemical and process industries are pushed by pressure groups requiring more environmental friendly processes, products and practices through ideas such as waste minimization, zero emission, and producer responsibility [58]. Nowadays, the Life Cycle Assessment (LCA) is an accepted environmental management tool to holistically and systematically quantify environmental burdens and their potential impacts over the whole life cycle of a product, process or activity. Azapagic [58], Burgess [88], Jacquemin [110], Pieragostini [98] carried out literature reviews about eco-efficient process design combining simulators with LCA.

Table 3.1 presents some examples of eco-efficient process design using the LCA methodology. Even if the core idea of the recent approaches dealing with design of sustainable chemical processes is not new [2], it must be yet recognized that the systematic use of LCA tools in the chemical engineering community is not generalized. It must also be emphasized that it is generally carried out for given and thus fixed operating conditions of a typical process at environmental evaluation stage.

Table 3.1 Some works on the application of LCA to process design

Author	Process
Azapagic and Clift [90]	Manufacturing of boron products from boron borax and kernite
Fu, Diwekar, Young and Cabezas [67]	Benzene production by Hydrodealkylation of Toluene
Fermeglia, Longo and Toma [111]	Production of phthalic anhydride by oxidation of o-xylene
Li, Zhang, Zhang and Suzuki [112]	Dimethyl carbonate production processes by pressure-swing distillation and extraction distillation process
Fermeglia, Longo and Toma [113]	Maleic anhydride production
Carvalho, Matos and Gani [71]	Insulin production
Kikuchi, Mayumi and Hirao [114]	Biomass-derived Polypropylene
Othman, Repke, Wozny and Huang [69]	Bio-diesel production using alkali-based catalyst
Halim and Srinivassan [72]	Benzene production by Hydrodealkylation of Toluene
Brunet, Carrasco, Munoz et al [115]	Biodiesel production

Two ways can be used to combine LCA with process simulation: a) embedding process description in an LCA tool or b) embedding LCA in process simulation. The former approach is far less flexible due to the lack of process models implemented in current LCA tools (for instance, the LCA tool GaBi 4.2 allows to create models based on physico-chemical processes) while the latter needs to broaden the scope of the studied system. Following these guidelines, a methodology proposed in Ouattara's PhD work which is intended to design eco-efficient processes has been developed in our laboratory [77] and applied in [73] and [74]. This work took into account economic and environmental considerations to obtain an eco-friendly and economically viable design. The methodology carried out environmental impact analysis considering not only the process but also the energy requirements by using process models and not average values that can be found in environmental database. Despite the assets of the work, some drawbacks can be yet highlighted: the proposed methodology is a gate to gate analysis and the used tools have been developed for a specific process, thus strongly affecting genericity. This current work aims at extending these concepts by proposing a generic cradle to gate approach and a compliant software framework to implement efficient LCIA (Life Cycle Inventory Assessment) method and automate environmental impact analysis.

3.3 Framework modelling development

3.3.1 Environmental impact model development

The following sections introduce the concept of product or process oriented LCA as well as different LCA software tools.

3.3.1.1 Product versus Process oriented LCA

So far, LCA has been applied mainly to products. LCA applied to processes has, however, been introduced and a limited number of studies has been performed. Traditionally, the chemical and process engineering approach to evaluate a process only takes the process itself into consideration whereas the life cycle assessment includes every activity that enters the system boundary including the complete system for the process, both upstream and downstream the process. LCA is said to have a “cradle to grave” approach, which means that all activities needed for the entire lifespan of a product, process or activity have to be included.

The main difference between process-oriented LCA and product-oriented LCA is that rather than evaluating various products that can fulfil a defined function, various process configurations that can produce a defined product are evaluated. When LCA is applied to processes, functional units can still be defined as the product from the system. Further, inventory analysis and impact assessment are carried out for the system evaluated. The objective consists here to evaluate the environmental impact of a process configuration and its associated operating conditions. A consistent analysis would consider transportation and materials involved in the manufacturing of the equipment items of the complete process. At preliminary design stage, these elements are not fully established. They will not be considered in the following. This could constitute a perspective of this work.

3.3.1.2 LCA software tools

In recent years, software tools have emerged due to the acceptance of the LCA methodology by industry and academics and almost all software packages comply with the ISO 14040 standard. The software usually includes a user interface where the user adds the operations and mass flows included in the assessment, a large database with average numbers for a large amount of processes, one or several weighting methods and presentation of the results as figures and tables. Even if some differences exist, their function is quite similar [116]. The tools share two key elements (among others) involved in the complete process of LCA:

- this concerns first the **life cycle inventory (LCI)**, which is the data collection portion of LCA, consisting of detailed tracking of all the flows in and out of the product system, including raw resources or materials, energy by type, water, and emissions to air, water and land by specific substance. This kind of analysis can be extremely complex and may involve dozens of individual unit processes in a supply chain (e.g., the extraction of raw resources) as well as numerous tracked substances
- the second involves **life cycle impact assessment (LCIA)** through environmental impact assessment methods and their corresponding impact factors

Despite their similarities, LCA tools can be compared by the structure and display of processes, transparency, flexibility and user friendliness, database number, calculation methods, uncertainty and variability analyses, methodological properties and service and support [117]. Besides these categories, other elements can be considered involving cost, geographic limitations, operating system environment and client-server capability [118]. Table 3.2 shows some of the most popular software. A degree of popularity can be found in the number of databases involved in the software tool.

Table 3.2 Life cycle assessment software tools

Software name	Supplier	Website	Databases ⁵
GaBi Software	PE INTERNATIONAL	http://www.gabi-software.com/france/software/	3
Umberto	ifu Hamburg GmbH	http://www.umberto.de/en/	2
SimaPro	PRé Consultants bv	http://www.pre-sustainability.com/simapro-lca-software	10
openLCA	GreenDelta GmbH	http://www.openlca.org/openlca	6

To our knowledge, the existing LCA tools suffer from a lack of interoperability. A key element for the development of the proposed approach is the design of an independent sub-database taking into account the impact factors of all the elements that are reported in life cycle inventory (LCI) of the process under study. This sub-database is extracted from the database considered for the environmental evaluation of the process. This step only requires that process inventory data and environmental impact assessment results are available to extract the factors for the process under study.

In this work, the SimaPro tool was selected: the approach is yet generic and could be reproduced for any other LCA tool. For a process under study with fixed operated conditions, inventory data and its respective mass and energy flows are saved as it can be shown in Figure 3.2. User interface allows creating an environmental model through the description of process inputs and outputs (including emissions). The model is created using the processes and substances of environmental databases. Databases included in the tool: EcoInvent v.2, US LCI, ELCD, US Input Output, EU and Danish Input Output, Swiss Input Output, LCA Food and Industry data v.2. An environmental impact assessment method must then be selected. Impact assessment methods included are: ReCiPe, Eco-indicator 99, USEtox, IPCC 2007, EPD, Impact 2002+, CML-IA, Traci 2, BEES, Ecological Footprint, EDIP 2003, Ecological scarcity 2006, EPS 2000, Greenhouse Gas Protocol and others. The impact factors are then deduced from the inventory and impact assessment results. Classically, the results provided by SimaPro (or any other LCA tool) include graph and data tables for inventory, impact assessment,

⁵ Database number can vary according to LCA tool version

process contributions and process trees. Similar visualization tools have been implemented for analysis purpose in the developed prototype.

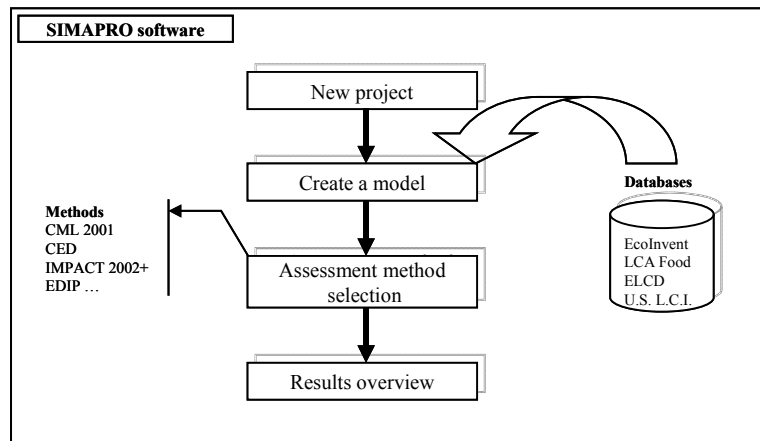

Figure 3.2 Design steps of the environmental impact model from SIMAPRO

3.3.2. Process flowsheeting tools

Process preliminary design is generally carried out with the help of simulators. They have become a standard tool to solve mass and energy balances, to calculate flow rates, compositions, temperature, pressure and physical properties for all streams circulating between unit operations [119], [120], [121], [122] and [123]. They also provide necessary elements for unit operations design and connections. A description of the detailed features of simulators is beyond the scope of this work, however it is interesting to highlight some ideal characteristics described in [124]:

- simulators should be easy to use;
- simulation should run even without a detailed knowledge of the system equations;
- the implementation of minor changes in the unit operation models and the performance of sensitivity studies should always be a relatively simple task;
- the modelling activity should not go beyond the connection of different unit operations and the specifications of their operating conditions;
- the process flowsheet should be visualized as the engineers can see it in the real plant.

A general description of process simulators is shown in Figure 3.3. Simulators have four essential parts [125]:

- User Interface (UI). User can draw the process flowsheet in the UI. The UI allows add, modify, and delete unit operations, mass and energy streams. In addition, it allows modify operation parameters such as temperature, pressure, mass flow rate, flow composition, conversion rate, etc. and design parameters such as distillation column number of stages

- Executive Program. In this part, modified data in the flowsheet are taken into account to find a solution following calculation sequence and convergence routines
- Thermodynamic, Constants Databases. They are dedicated to the computation of the chemical, physical, and thermodynamic properties. Databases store thermodynamics constants, correlation constants and limits of correlations and equations
- Unit operations modules, involving engineering calculations

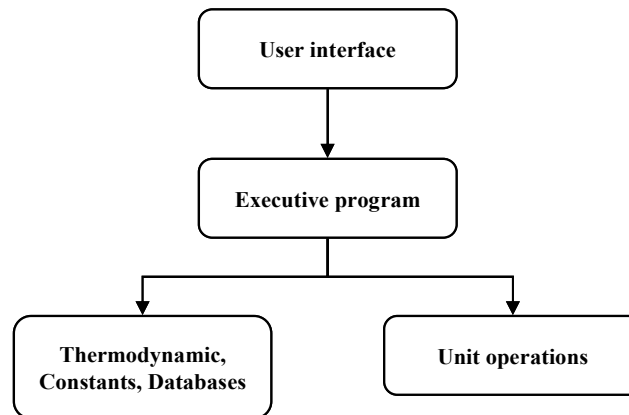

Figure 3.3 Process simulator structure

Chemical process simulation in most flowsheeting tools is performed using the following steps [126]:

1. Drawing the flowsheet with corresponding unit operations and streams
2. Defining the components that will be used in the flowsheet
3. Choosing transport and thermodynamic methods
4. Supplying data configuration for feed streams (raw material) and other data
5. Supplying operational conditions of the streams and unit operations
6. Running the simulation
7. Obtaining and analysing the results

Several simulators are available and used to model industrial processes. A major asset is the short computational time required to evaluate process changes without requiring expensive experiment or pilot tests. In addition, some simulators have the possibility of data exchange with spreadsheets, word processors or specialized programs. The exchange can be performed using Component Object Model (COM⁶). COM technology is a platform-independent, distributed and object-oriented system for creating binary software components that can interact (Figure 3.4) with other systems.

⁶ <http://msdn.microsoft.com/en-us/library/windows/desktop/ms694363%28v=vs.85%29.aspx>

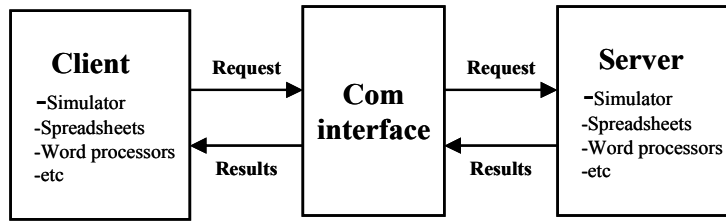

Figure 3.4 Data exchange through the interface com

There are several simulators on the market, among which are COCO, ProsimPlus, Aspen HYSYS, Aspen Plus, CHEMCAD, PRO II, etc. Table 3.3 shows some of them. The environmental impact evaluation requires a process simulator to calculate mass flow rates of the process inputs and outputs and to calculate the energy requirements of the process.

Table 3.3 Commercial and non-commercial process simulators

Simulator	Interfaces	Technology	Embedded programming interface
Prosim PLUS	Thermodynamics, physical properties, Unit operations	---	VBA
Aspen HYSYS	Thermodynamics, physical properties, Unit operations	COM	WinWrap Basic
COCO	Thermodynamics, physical properties, Unit operations	OLE/COM	---
CHEMCAD	Thermodynamics, physical properties, Unit operations	COM	VBA
PRO II	Thermodynamics, physical properties, Unit operations	OLE	---
WinSim	Thermodynamics, physical properties, Unit operations	OLE	VBA/C++
CADSIM	Thermodynamics, physical properties, Unit operations	OLE/COM	---

Process simulators can be divided into two types based on their architecture, namely sequential modular and equation-oriented. Sequential modular simulators are the most widely used simulators in the industry. The mathematical models representing individual units are coded separately as subroutines and are developed so that the output stream data including pressure, temperature, enthalpy, entropy, etc. can be calculated for given input stream data and equipment operating parameters such as pressure ratio, outlet pressure, efficiency of the equipment, etc. While simulating the performance of a process plant, the subroutines representing different units are called in succession, with the output of one unit serving as the input of the next. The computation proceeds unit by unit from the feed to the product streams. When there are recycle loops in the process, the recycle loops are torn at suitable

points and estimated values are assigned to these streams. Recycle loops are sequentially solved until the assumed values of the tear streams match the computed stream information.

Table 3.4 Advantages and drawbacks of sequential modular and equation-oriented simulators

Type of approach	Advantages	Drawbacks
Sequential modular	<ul style="list-style-type: none"> • Process computations follow the material flow through the process • Convergence failures are easier to be detected • The mathematical models of different units can be developed and coded separately with different solution procedures for different equipment modules • New types of equipment modules can be easily added • The overall solution procedure is not affected by the complexities incorporated in each module 	<ul style="list-style-type: none"> • Computations can sometimes fail to converge when the process is strongly interconnected or when the number of tear streams is large • The computation time is high when the number of tear streams is large
Equation-oriented	<ul style="list-style-type: none"> • Suitable for simulation of strongly interconnected processes with many recycle loops: all equations are solved simultaneously so there is no need for nested iteration • Best suited for design optimization and dynamic simulation studies: the process needs to be simulated thousands of times 	<ul style="list-style-type: none"> • Good initial estimates are required for all variables for convergence • The addition of new equipment modules is not simple • A general-purpose, robust, nonlinear equation solver is required • Inequality constraints involving design variables are harder to implement in design optimization studies compared to sequential and simultaneous modular approaches

The sequential modular approach is used in ProsimPlus and COCO while the equation-oriented is implemented in gPROMS for instance. Process simulators that have both sequential modular and equation-oriented capabilities such as the Aspen Plus are now commercially available.

The developed framework can work with different simulators, since the only requirement is the availability of data through programming scripts for environmental impact assessment. In this work, the chosen simulators are: ProSimPlus, COCO and Aspen HYSYS. Their choice was done since they are widespread flowsheeting tools with different modelling approaches and interfaces: Aspen HYSYS and COCO have a COM interface whereas ProSimPlus has a programming interface. These technical considerations must be highlighted since the idea is to link the process simulator with impact factor database and with the energy production simulator as discussed in chapter 2. A brief description of each flowsheeting tool is recalled in what follows.

3.2.2.1 Aspen HYSYS

Aspen HYSYS [127] is a process modelling environment that optimizes conceptual design and operations. It can model steady state and dynamic processes, for example, chemical, pharmaceutical, food, and petrochemical processes. HYSYS is used in the design, control, monitoring and optimization of processes within a modular environment. To create a simulation model, HYSYS contains a database of over 1500 solids, liquids and gases components with physicochemical properties of pure substances. Different models are implemented to evaluate the thermodynamic properties; these models can be classified into the following categories:

- equation-of-state models (Peng-Robinson, Soave-Redlich-Kwong, etc.);
- activity coefficient models (Redlich-Kister, UNIQUAC, Wilson, etc);
- vapour pressure and liquid fugacity models;
- heat of vaporization models;
- molar volume and density models;
- heat capacity models.

3.2.2.2 COCO simulator

The COCO [128] (i.e. the acronym of CAPE OPEN to CAPE OPEN) simulator is a free-of-charge CAPE-OPEN⁷ compliant steady-state simulation environment. Initially, the simulator was created as a testing and development platform for modelling tools. Actually, COCO is a steady-state simulation environment with CAPE-OPEN and COM interoperability. Its environment allows coupling unit operations with thermodynamic modules. The simulator has been used in various research works proving successful results [129], [130], [131], [132]. The so-called COCO “kitchen” is constituted by four main components that interact to develop and solve a flowsheet [133]:

- A simulation environment (COFE, CAPE OPEN Flowsheeting Environment). COFE is a graphical user interface that allows this interaction. Some features of the interface are: breaking recycles by automatic tearing, solving recycles by hybrid Newton/Wegstein approach, support for multiple material types and material, energy and information streams
- A thermodynamic property package (TEA, Thermodynamics for Engineering Applications). TEA performs calculations required to obtain model thermodynamic properties including pressure, temperature and other properties. Most of the calculation routines are based on the code of the thermodynamic library of ChemSep⁸. Some features of TEA include a data bank of over 430 commonly used chemicals and more than 100 property calculation methods with analytical or numerical derivatives

⁷ Computer-Aided Process Engineering

⁸ <http://www.chemsep.com/>

- A collection of unit operations (COUSCOUS, CAPE OPEN Unit Operations). COUSCOUS is a library that contains unit operations models including compressors, pumps, turbines, expanders, simple reactor models, flash unit operations, heaters, coolers, heat-exchangers, mixers and splitter. It must be yet emphasized that COUSCOUS currently provides only a limited number of unit operations (there is currently only one reactor for which conversions have to be specified) but since the interfaces are open, end users can add their own unit operation models. All unit operations can be linked with other models with CAPE-OPEN interface. Due to the nature of CO interfacing, COUSCOUS unit operations can be mixed transparently with 3rd party unit operations
- A reaction package (CORN, CAPE OPEN Reaction Numerics): CORN facilitates kinetic or equilibrium reactions. It is mostly used in CSTR reactors

Figure 3.5 illustrates the interaction between the COCO components and also shows how they are integrated with third party models through CAPE-OPEN interface. The major interest of using COCO is that CAPE OPEN modules are ready to be used in any process simulator with CO interfaces.

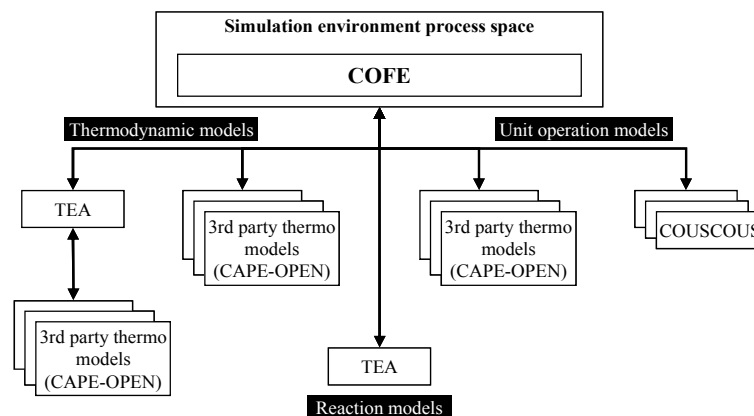

Figure 3.5 COCO components interaction

3.2.2.3 ProSimPlus

ProSimPlus [134] is a steady-state simulator performing mass and energy balances that can determine the flow rate, composition, temperature and other properties of the streams, as well as the design of the main unit operations. It is used in various industries (chemical, pharmaceutical, petrochemical, refinery, etc.) as well as in academic works [135], [129], [136]. The structure of ProSimPlus is based on the three following components:

- A graphical user interface
- An extensible library with programs for physical property estimation
- A mathematical model library of unit operations, which is extensible through CAPE-OPEN concepts

As usual with steady-state simulators, the use of ProSimPlus requires the identification of the chemical components of the process, thermodynamic properties, chemical reactions, kinetic parameters, some design parameters of the unit operations and their operating conditions. To fulfill the above requirements, ProSimPlus has a friendly user interface that allows access to the properties and parameters of the streams and unit operations. Around 70 unit operations are implemented including chemical reactors (CSTR, PFR, etc.) with a library of chemical reaction models (instantaneous, equilibrated, kinetic controlled, complex reactions), multi-stage Liquid-Vapour or Liquid-Liquid-Vapour columns, multi-stage separators for liquid-liquid extraction, multi-stage separators with transfer models, multi-fluids heat exchangers and solid treatment equipment.

In ProSimPlus, the calculation of the thermodynamic properties requires a thermodynamic profile setting. The profile must be configured with the following options: Thermodynamic approach (Equation of State, Gamma-Phi approach), Equations of State (Ideal Gas, Equations derived from Virial EoS, Equations derived from Van der Waals and others), Mixing rules for Cubic Equation of State (Standard, MHV2, MHV1 and PSRK), Activity coefficients (Ideal, MARGULES, SCATCHARD-HILDEBRAND, WILSON, WILSON Dechema compliant, UNIQUAC, predictive models and electrolytic systems), Standard state pure liquid fugacity (CHAO-SEADER, ENGELS, Henry's law with Pointing factor, etc.), Transport properties (Pure and Classic methods, ELY-HANLEY model, PETRO methods), Liquid molar volume (IDEAL, RACKETT, API 6A2.22, COSTALD, PENG-ROBINSON, etc.) and Enthalpy calculation. The correct setting of these parameters guarantees the accuracy of thermodynamic calculations of the simulation model.

The results are presented via tables and figures. They provide information relative to stream properties, composition, molar and mass flow rates, among others as well as detailed information about the unit operations.

3.2.3 Economic model

The eco-design approach takes into account both economic and environmental aspects at early design stage. The environmental impact categories described in Chapter 2 are taken into account as environmental criteria. Concerning the economic issue, the classical criteria that are reported in the literature involve [137]:

- different types of cost (total cost, operating cost, logistic and investment cost, etc.);
- profit or economic potential (a difference between the incomes and the costs);
- Net Present Worth (NPW);

- other criteria (cumulative cash flow, monetary value added, investment and inventory opportunity costs, etc.).

The most common criteria are simple cost or profit functions. In this work, the adopted criterion is based on variable process operating cost (Cop). This cost criterion was more consistent here since the treated examples only involve design variants based on different operating conditions and not on various design configurations. The cost comprises the use of raw materials and the use of required energy by the process (Equation 3.1).

$$Cop = \sum_{i=1}^n UCrm_i \cdot RM_i + \sum_{j=1}^m UCe_j \cdot E_j \quad (3.1)$$

3.4 Support example: benzene production by hydrodealkylation of toluene (HDA process)

The support example of benzene production by hydrodealkylation of toluene (the so-called HDA process) is used in this work. HDA process has been studied intensively both in education and research to illustrate fundamental issues in Process Systems Engineering such as process synthesis and energy integration, as well as in integrating design and control [138][139]. This test case was selected since its use is not affected by a lack of process data.

3.4.1 Presentation of the HDA process

Benzene is among the most widely produced petrochemicals in the world. Current production is approximately 37 million tons per year. All of the benzene used for petrochemical applications is created through hydrocarbon conversion processes. Benzene emanates from these processes through the formation of the ring structure from other hydrocarbons [140].

There are different benzene production routes including catalytic reforming, steam cracking and hydrodealkylation of toluene. This well-known benchmark problem for process design and synthesis studies, was first extensively studied by [61] using a hierarchical design/synthesis approach, and [141], [142]. The HDA process involves two reactions, the conversion of toluene to benzene according to (3.2):



In addition to this desired reaction, an undesired reaction occurs:



C_7H_8 : Toluene, H_2 : Hydrogen, C_6H_6 : Benzene, CH_4 : Methane $C_{12}H_{10}$: Biphenyl

These homogeneous gas phase reactions occur in the range of 894°K and 974°K. A molar ratio of at

least 5:1 hydrogen to aromatics is maintained to prevent coking. The reactor effluents must be quenched to 894°K to prevent coking in the heat exchanger following the reactor.

The HDA process is composed of three steps, which are the reaction between toluene and hydrogen that takes place in an adiabatic reactor, the liquid and steam separation phases and a purge of methane that prevents from its accumulation in the process. The classical HDA process is presented in Figure 3.6.

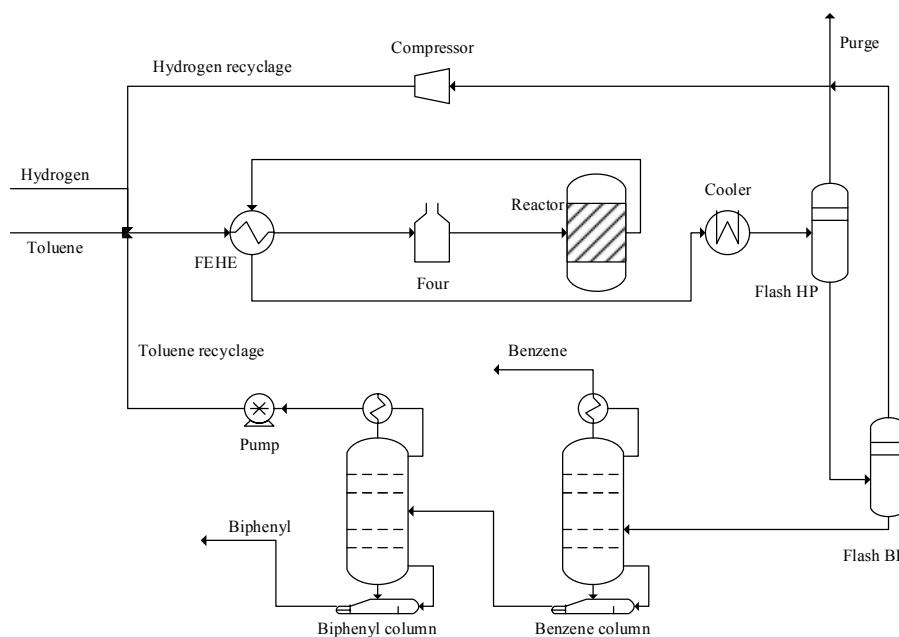

Figure 3.6 HDA Process proposed by [61]

The hydrogen feed stream has a purity of 95% and involves 5% of methane; this stream is mixed with a fresh inlet stream of toluene, recycled toluene, and recycled hydrogen. For control purposes, a furnace is included in the loop. The feed mixture is heated in a furnace before being fed to an adiabatic reactor. The reactor effluent contains unreacted hydrogen and toluene, benzene (the desired product), biphenyl, and methane; it is quenched and subsequently cooled in a high-pressure flash separator to condense the aromatics from the non-condensable hydrogen and methane. The vapour steam from the high-pressure flash unit contains hydrogen and methane that is recycled. The liquid stream contains traces of hydrogen and methane that are separated from the aromatics in a low-pressure flash drum. The liquid stream from the low-pressure flash drum consisting of benzene, biphenyl and toluene is separated in two distillation columns. The first column separates the product, benzene, from biphenyl and toluene, while the second one separates the biphenyl from toluene, which is recycled back at the reactor entrance. Energy is saved by using the outlet stream leaving the reactor as its temperature is in the range of 620 °C, to preheat the feed stream coming from the mixer, via a heat exchanger (FEHE), so some energy integration is achieved [61] (see Fig. 3.6).

Chapter 2 deals with process energy requirements for the HDA process. These involve steam for the distillation columns, flashes at high and low pressures and also electricity for pumps and compressors. In addition, water is needed to cool effluents leaving the reactor. As discussed in Chapter 2, the energy production can be viewed as a separate process, which is generally shared among the various production units. In this work, the decision support tool Ariane dedicated to the management of plants that produce energy under the form of utilities (steam, electricity, hot water...) and Plessala module developed by ProSim SA are used here both to compute the primary energy requirements of the process and to quantify the pollutant emissions due to energy production. Figure 3.7 shows the HDA process coupled with an energy production plant and the system boundaries.

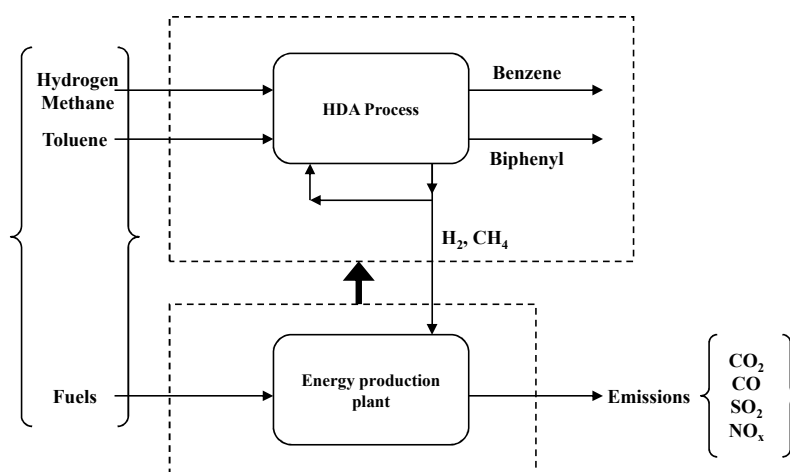

Figure 3.7 HDA process coupled to an energy production plant and work boundaries

3.4.2 Operating conditions for the HDA simulation model

The operating conditions of the HDA process are the same as in [61] and [73], [74], [77]. They are specified via the involved streams and the unit operations interface. The Peng-Robinson equation-of-state property model is chosen to describe the thermo physical properties of this hydrocarbon liquid mixture in the three simulators. The conditions are presented below:

- Production Capacity: 265 kmol/h with a purity of 99.97%
- Hydrogen lost in the purge: 197.8 kmol/h
- Conversion rate of toluene: 75%
- At the reactor inlet, hydrogen molar flow rate ratio to toluene is equal to 5,
- Selectivity: $Se = 0.9694$ (benzene moles at the reactor outlet to converted toluene moles).
- Temperature in reactor output stream must be below 704° C, to avoid hydrocracking phenomena.
- Rapid cooling of the effluent in reactor output stream is necessary to prevent coke formation.

3.4.2.1 Process inputs

Raw material inputs are represented as process input streams. Table 3.5 illustrates the operating conditions as proposed in [61].

Table 3.5 Operating conditions of HDA process inputs

	Input 1	Input 2
Components	Toluene pure	Hydrogen (95%) Methane (5%)
Flow rate	273.36 kmol/h	Hydrogen 466.98 kmol/h Methane 24.58 kmol/h
Temperature	311 K	311 K
Pressure	37 bar	37 bar

The values presented in Table 3.5 are valid for a complete model of the process. A simplified model without recycling is yet used for initialization purpose with the following values:

$$Flow_{Toluene} = \frac{Flow_{Benzene}}{0.75} = \frac{265}{0.75} = 353.33 \text{ kmol/h}$$

$$Flow_{Hydrogen} = (353.33)(5) = 1766 \text{ kmol/h}$$

Since hydrogen is not pure then:

$$Flow_{Hydrogen} = (1766)(0.95) = 1677.7 \text{ kmol/h}$$

$$Flow_{Methane} = (1766)(0.05) = 88.3 \text{ kmol/h}$$

3.4.2.2 Reactions

Two chemical reactions are involved (see (3.2) and (3.3)) in the HDA process. The reaction kinetics (r_1 and r_2) are given as functions of partial pressures (psia) of gaseous components for the two main reactions of the HDA:

$$r_1 = 3.685e^{-\frac{255616}{T}} P_T P_H^{\frac{1}{2}}$$

$$r_2 = 5.987 \times 10^4 e^{-\frac{255616}{T}} P_B - 2.553 \times 10^5 e^{-\frac{255616}{T}} P_D P_H$$

3.4.2.3 Heating and cooling

A first heat exchanger allows preheating the feed stream at 225° C at the reactor inlet. The furnace must be configured to increase the temperature to 621°. The flow at reactor output reaches a

temperature of about 685, due to the process exothermic reaction. A heat exchanger is then inserted to cool the stream to 38° (as specified the HDA process design in [61]).

3.4.2.4 Separation and Distillation

A two-phase separator (flash) is first used, where non-condensable gases (methane and hydrogen) are separated from the liquid mixture (see Figure 3.9). A flash pressure of 32 bar is selected. The other separations operate at lower pressures. A second flash (10 bar) eliminates traces of non condensable substances (hydrogen and methane) to facilitate further separation. Benzene is recovered in the first column with a purity of 0.997 at top and 0.994 at bottom. Pressure in the condenser is set at 2 bar. In the second column, toluene is recovered through recycling and biphenyl is considered as a by-product. Molar purity is 0.999 at the bottom column. Condenser pressure is equal to 1 bar.

3.4.2.5 Pump and compressor in recycling

The compressor used in hydrogen recycling has a discharge pressure of 37 bars and an isentropic efficiency of 65% whereas the centrifugal pump for toluene recycling has a discharge pressure of 37 bars.

3.4.2.6 Economic data

The operating cost module is based on the previous work of Ouattara [77]. The module calculates the operating cost for the HDA process with its related energy plant. The operating cost criterion is calculated by equation 3.1 using raw material and utilities costs as shown in Table 3.6.

Table 3.6 Summary of raw materials and utilities prices of HDA process

Raw materials	Price (\$/kg)
Toluene	0.648
Hydrogen	1
Utilities	Price (\$/Common unit)
Fuel	\$549/m ³
Natural gas	\$0.42/std m ³
Electricity	\$0.06/kWh
High pressure steam	\$29.97/1 ton
Medium pressure steam	\$28.31/ 1 ton
Low pressure steam	\$27.70/1 ton
Water	\$14.8/1 ton

3.4.3 HDA simulation with COCO, ProSimPlus and HYSYS

Figures 3.8 to 3.10 present respectively the COCO, ProsimPlus and HYSYS representation of the flowsheet where unit operation blocks, including splitters, separators and reactors, are used as building blocks to track the material and energy streams through the complete process. Material and energy balances are computed around each unit and the system state variables are calculated, including component flows and system thermodynamic properties like enthalpy and so on (see Appendix A).

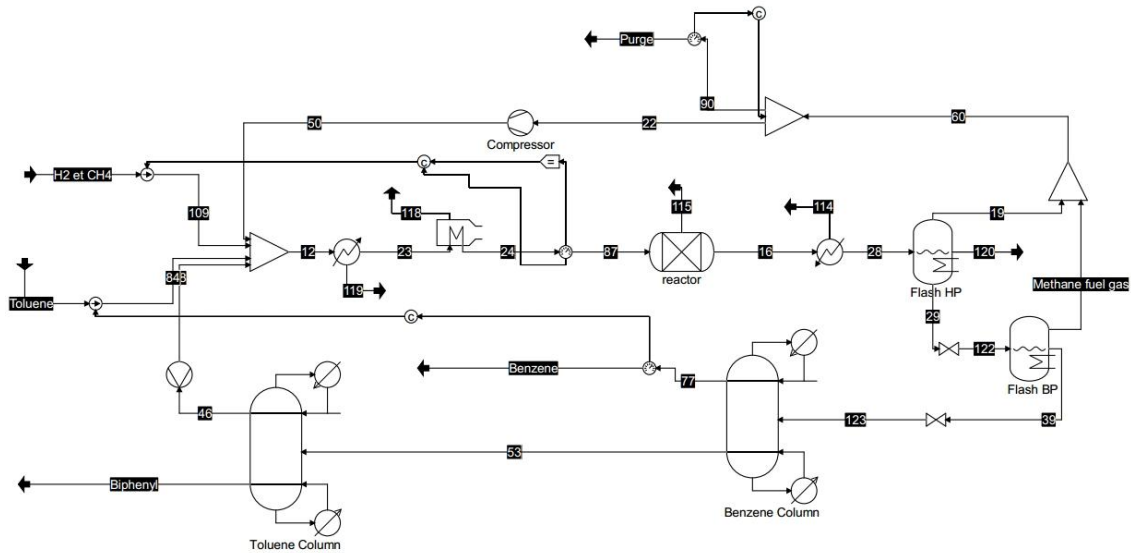

Figure 3.8 HDA flowsheet with COCO simulator

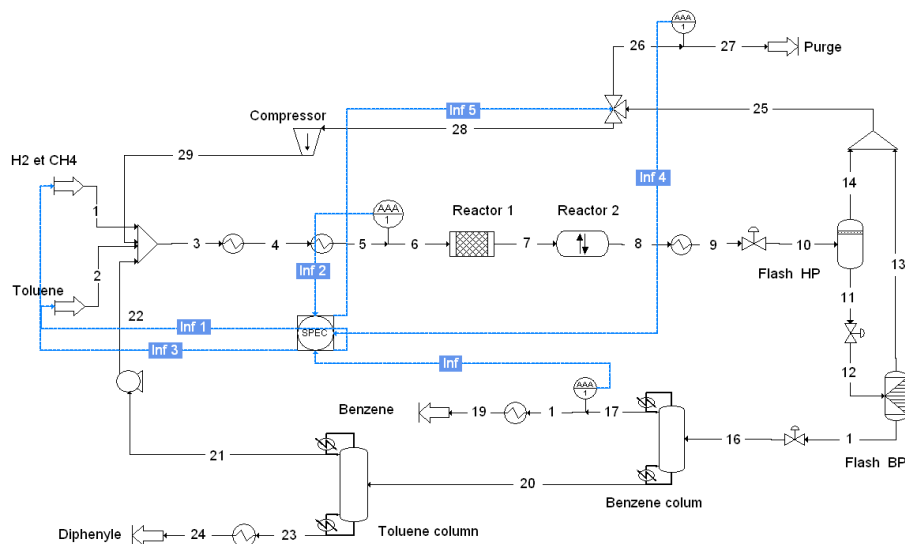

Figure 3.9 HDA flowsheet with Prosim PLUS simulator

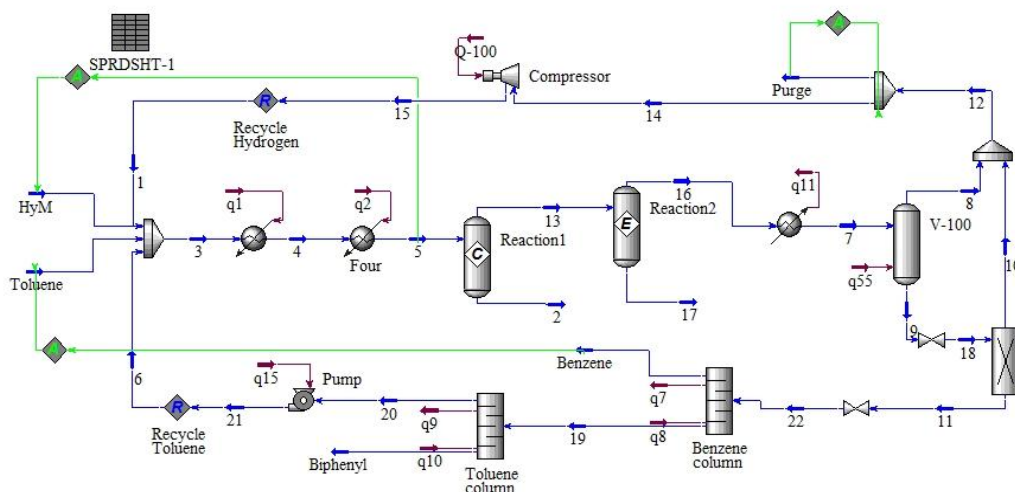

Figure 3.10 HDA flowsheet with Aspen HYSYS simulator

The flowsheet design exhibits minor changes with each simulator because of the dedicated interface for unit operations. Despite this, all the above conditions are set. Tables 3.7 to 3.9 show typical results obtained with each simulator for comparison purpose. The results relative to input streams show that the three simulators respect the abovementioned conditions (95% hydrogen and 5% methane in first input and pure toluene in second input). Regarding the outputs of the process, the production capacity is respected (265 kmol/h) with product purity equal to 99.97%. The hydrogen flow rate in the purge output is the same as in [61] with small traces of benzene, biphenyl and toluene. In the biphenyl output, HYSYS respects the condition imposed with a purity of 99.9% of biphenyl while only 98.5% in purity is obtained with ProsimPlus and COCO. The flow rates relative to the input and output streams of the reactor are also indicated in Table 3.9 to check that the involved reactions are well specified in the three simulators. A good agreement is observed for the results obtained with the three tools for this process under the studied operating conditions.

Table 3.7 Comparison of process output streams

Unit		Inputs					
		H ₂ et CH ₄ stream			Toluene stream		
		HYSYS	COCO	ProSimPlus	HYSYS	COCO	ProSimPlus
Hydrogen	kmol / h	471.09	472.79	472,92	0	0	0
Methane	kmol / h	24.79	22,83	24,59	0	0	0
Benzene	kmol / h	0	0	0	0	0	0
Toluene	kmol / h	0	0	0	278.11	281.39	281.50
Biphenyl	kmol / h	0	0	0	0	0	0
Enthalpy	kJ/kmol		459.78	389.82		-35429.5	-35811.5
Temperature	°C	38	38	38	38	38	38
Pressure	bar	38	38	38	38	38	38

Table 3.8 Comparison of process output streams

		Outputs					
		Benzene stream			Purge stream		
	Unit	HYSYS	COCO	ProSimPlus	HYSYS	COCO	ProSimPlus
Hydrogen	kmol / h	0	0	0	197.99	198.00	198.00
Methane	kmol / h	0	0	0	311.52	303.68	305.54
Benzene	kmol / h	264.99	265.00	265.00	3,85	3,73	3.88
Toluene	kmol / h	0,03	0,01	0	0,47	0,43	0,45
Biphenyl	kmol / h	0	0	0	0	0	0
Enthalpy	kJ/kmol	-22604.5	-22614.2	-22552.95	201.1	264.8	206.93
Temperature	°C	104	104	104.04	34.35	34.35	33.44
Pressure	bar	2	2	2	10	10	10
		Biphenyl stream					
		HYSYS	COCO	ProSimPlus			
Hydrogen	kmol / h	0	0	0			
Methane	kmol / h	0	0	0			
Benzene	kmol / h	0	0	0			
Toluene	kmol / h	0	0,09	0,09			
Biphenyl	kmol / h	4.37	6.07	6.04			
Enthalpy	kJ/kmol	5998.3	6161.2	6403.92			
Temperature	°C	265	264.84	265.79			
Pressure	bar	1.5	1.5	1.5			

Table 3.9 Comparison of reactor input/output streams

		Reactor					
		Input stream			Output stream		
		HYSYS	COCO	ProSimPlus	HYSYS	COCO	ProSimPlus
Hydrogen	kmol / h	1849.93	1872.42	1873.08	1576.80	1597.63	1598.15
Methane	kmol / h	2203.49	2169,50	2185.24	2480.98	2450.37	2466.19
Benzene	kmol / h	26.90	26,39	27.46	295.66	295.11	296.34
Toluene	kmol / h	369.98	374,48	374.61	92.50	93.62	93.65
Biphenyl	kmol / h	0.0094	0.0005	0.0065	4,37	6.07	6,05
Enthalpy	kJ/kmol	32540.0	32688.9	32543.08	35311.2	35329.5	35251.36
Temperature	°C	621	621	621	667.60	667.6	667.60
Pressure	bar	36	36	35.54	34.5	34.5	34.04

3.4.4 Energy production modelling and emission computation with Ariane

As shown in Chapter 2, the Ariane simulator can be used to model different routes for energy production. For instance, the gas turbine designed in Chapter 2 satisfies the energy requirements of HDA process (steam, electricity, etc.). Another advantage of the Ariane simulator is that it can also be used to model equipment items such as furnaces introduced in the reaction step for control purposes. The objective of using Ariane is twofold: first, its use can determine the primary energy requirement of the process and second, the emissions of the process can be computed so that they can be included in the inventory phase of the LCA procedure. It must be yet highlighted that for the HDA process, on the gas side, the separation of methane as a useful by-product and the recycling of hydrogen is today economically viable by using membranes. The operation would greatly reduce the cost of the gas compression, as well as the size of the chemical reactor. This technique is mentioned in [142] and [143]. Thus, a hydrogen and methane portion is recovered and then burned as fuel in a furnace in order to recover heat from combustion and use it in the process. An already obsolete alternative is sending the purge stream directly to combustion. This option was yet selected in this work due to data availability. Ariane also offers the possibility to model gas combustion via a burner and to compute gas emissions (a detailed explanation is found in chapter 2). Figure 3.11 shows the models created in Ariane to represent a burner for hydrogen and methane at purge output and a furnace used to heat the feed at reactor inlet. They are modelled as furnaces with a dual fuel mixture.

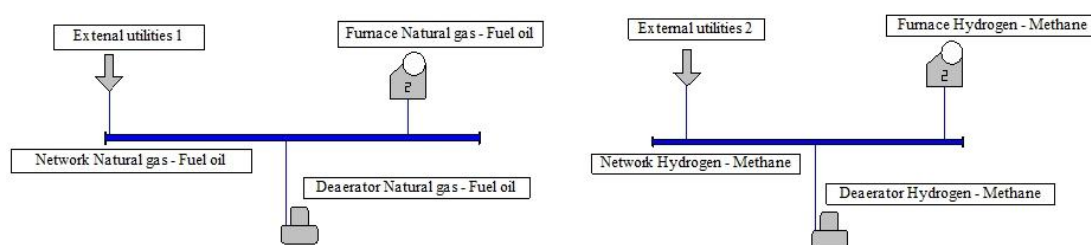

Figure 3.11 Natural gas/Fuel oil and H₂/CH₄ furnaces simulation models in ARIANE

3.5 Inventory data

The main objective at this first stage of the approach is to identify the inventory data of a given chemical process, here HDA and its associated energy requirements. An inventory data definition refers to the identification of the involved chemical components and energy sources. The inventory data process considered takes into account the components involved in raw material inputs and in waste/purge outputs of a given chemical process as well as the fuels used to produce the energy required for the process and their related emissions. Once more, the HDA case is used to illustrate the identification of inventory data.

Diagrams in Figures 3.6 and 3.7 indicate that the HDA process has two inputs, on the one hand toluene and a mixture of hydrogen and methane on the second hand. Within the boundaries of the HDA process, the three outputs concern the purge (H_2 and CH_4), the desired product output (benzene) and the by-product output (biphenyl). Since the purge is directed to combustion step, this one was included into the frontier of the studied domain. Benzene, which is the interest product, was not included in the inventory phase since its impact related to utilization phase will be taken into account in the further steps of the value-chain. The same assumption is valid for the raw materials of the process. The by-product, i.e. biphenyl is assumed to be valorised and reused for the formulation of dye carriers for textile dyeing [144], as an intermediate for polychlorinated biphenyls [144] and as an impregnate paper for citrus fruit where it acts as a fungicide [145]. So the same assumption as for benzene is adopted.

For energy requirements, the following assumptions are considered:

- Process energy requirement is provided by a gas turbine (as discussed in Chapter 2) that co-generates heat and electricity: energy can thus be used to generate steam or hot water that are necessary for the chemical process while electricity can be used in the process or injected in the plant grid
- The turbine operates with natural gas
- The furnace used for heating the mixture of components before entering the reactor operates with a mixture of oil fuel and natural gas
- The burner used for burning hydrogen and methane from the purge stream operates with a mixture of components. Because the flow of benzene, toluene and biphenyl flows of the purge stream are too low, they are neglected in the fuel feed of the burner so that only flows of hydrogen and methane are considered. This assumption includes the fact that the fuels used do not have a cost or environmental impact because they are process waste by which the energy produced by the furnace is deducted from the energy requirements of the process
- The emissions from the gas turbine and furnace are included in this work

Table 3.10 summarizes the inventory data of the HDA process and Table 3.11 shows the results of the simulations performed with Ariane from the results of HYSYS, ProSimPlus and COCO concerning the components of the inventory (which will be referred in the following as LCI according to LCA terminology even if we are aware that our assessment takes only into consideration a cradle to gate approach) and energy requirements with their associated emissions. Inventory data flow shown in Table 3.11 was compared with the flow obtained in Ouattara work [77] under the conditions proposed by Douglas [61]. The result of the comparison is that the flows have minimal differences explained by the fact that Ouattara [77] uses a simplified model for the simulation of HDA process.

Table 3.10 Classification of inventory data of the HDA process

Category	Sub-category	Inventory data
Process	Raw materials	Hydrogen
		Methane
		Toluene
Energy	Fuel	Fuel oil
		Natural gas
		Carbon dioxide
	Emissions	Sulphur dioxide
		Nitrogen oxides
		Carbon monoxide

Table 3.11 Results of inventory data from HDA process

	HYSYS	COCO	ProSimPlus
Raw Materials			
Hydrogen (kg/h)	949.71	953.1	953.36
Methane (kg/h)	397.77	366.29	394.48
Toluene (kg/h)	25625.24	25928	25938
Purge			
Hydrogen (kg/h)	399.14	399.14	399.14
Methane (kg/h)	4997.69	4871.9	4901.8
Energy			
Steam (ton/h)	53.78	52.61	51.55
Fuel Furnace (ton/h)	5.86	5.88	5.89
Natural gas – Furnace (Nm ³ /h)	6236.60	6257.70	6266.73
Natural gas - Turbine (Nm ³ /h)	5827.14	5291.96	5569.85
Emissions			
Process furnace			
CO ₂ (ton/h)	30.47	30.57	30.62
CO (kg/h)	311.6	312.7	313.1
SO ₂ (kg/h)	234.2	235.0	235.4
NO _x (kg/h)	70.8	71.1	71.2
H₂/CH₄ furnace			
CO ₂ (ton/h)	13.72	13.39	13.48
Gas turbine			
CO ₂ (ton/h)	11.09	10.83	10.60
CO (kg/h)	221.8	216.7	212.0
SO ₂ (kg/h)	0.1	0.1	0.1
NO _x (kg/h)	50.8	49.6	48.5

3.6 Identification of potential factors

The Life Cycle Impact Assessment (LCIA) is then implemented in order to identify the environmental impacts in all categories of a chosen impact assessment method. LCA software tools are used to perform the LCIA.

3.6.1 Recovery of impact factors for environmental impact model design

From an interoperability point of view, the SIMAPRO software tool does not exhibit a friendly interface to directly use the embedded life cycle assessment models from inventory data. This explains why an alternative method was selected in this work, thus requiring a preliminary use of the SIMAPRO interface. An LCIA method for the process under study (IMPACT 2002 + which is presented in Chapter 2) is first selected and the LCA process is carried out for the process under study. LCIA method results are presented by SIMAPRO in tables and graphs. The so-called characterization table is a key element because the impact is represented through a reference substance in the categories of the LCIA method. Table 3.12 shows the general layout of the characterization table.

Table 3.12 General layout of characterization table

	Component 1	Component 2	Component 3	...	Component j
Category 1	Impact _{1,1}	Impact _{2,1}	Impact _{3,1}	...	Impact _{j,1}
Category 2	Impact _{1,2}	Impact _{2,2}	Impact _{3,2}	...	Impact _{j,2}
Category 3	Impact _{1,3}	Impact _{2,3}	Impact _{3,3}	...	Impact _{j,3}
...
Category k	Impact _{1,k}	Impact _{2,k}	Impact _{3,k}	...	Impact _{j,k}

The environmental impacts are calculated using equation 3.4 [96]:

$$\text{Impact}_{j,k} = \text{FI}_{j,k} M_j \quad (3.4)$$

After carrying out the LCA, M_j and $\text{Impact}_{j,k}$ are known, it is then possible to compute the impact factor by equation 3.5.

$$\text{FI}_{j,k} = \frac{\text{Impact}_{j,k}}{M_j} \quad (3.5)$$

The characterization factors of all components in the inventory data can thus be recovered. The damage and normalization factors of the IMPACT2002+ method are presented in Table 2.9 (see Chapter 2).

3.6.2 Application to the HDA process

SIMAPRO software tool is used to design a LCA model from inventory data for the HDA process. Table 3.13 shows the selected items to represent the inventory data of the HDA process.

Table 3.13 Selected items in the SIMAPRO model for the HDA process

Category	Sub-category	Inventory data	Database elements names	Unit
Process	Raw materials	Hydrogen	Hydrogen (reformer) E	kg
		Methane	Methane, 96 vol.-% from synthetic gas, wood, at plant/CH S	m ³
		Toluene	Toluene, liquid, at plant/RER S	kg
Energy	Fuels	Fuel oil	Fuel oil lows 2000 boiler 100kW U	MJ
		Natural gas	Heat, natural gas, at industrial furnace >100kW/RER S	MJ
	Emissions	Carbon dioxide	Carbon dioxide	kg
		Sulphur dioxide	Sulphur dioxide	kg
		Nitrogen oxides	Nitrogen oxides	kg
		Carbon monoxide	Carbon monoxide	kg

Tables 3.14 to 3.16 show characterization factors obtained by (3.4) from the characterization results provided by SIMAPRO. The characterization factors, for mid-point evaluation are relative to raw materials, fuels and emissions sub-categories. Finally, damage and normalization factors listed in Table 2.9 and extracted from [43] can be used to evaluate the final damage. The identified impact factors are stored in a database for further stage of the eco-design framework.

Table 3.14 Raw materials characterization factors of HDA process

IMPACT 2002+	Toluene	Hydrogen	Methane	Unit
Aquatic acidification	3,7E-03	2,6E-02	3,8E-03	kg SO ₂ eq
Aquatic ecotoxicity	9,5E+00	6,6E+00	6,2E+01	kg TEG water
Aquatic eutrophication	6,0E-06	4,2E-07	3,9E-05	kg PO ₄ ³ P-lim
Carcinogens	4,6E-02	8,5E-04	6,7E-03	kg C ₂ H ₃ Cl eq
Global warming	1,3E+00	5,2E+00	3,6E-01	kg CO ₂ eq
Ionizing radiation	1,6E-02	0,0E+00	6,4E+01	kg Bq carbon 14 eq
Land occupation	4,2E-05	0,0E+00	3,5E-01	m ² org.arable
Mineral extraction	6,3E-05	7,3E-04	7,8E-03	MJ surplus
Non-carcinogens	2,2E-03	7,9E-05	1,5E-02	kg C ₂ H ₃ Cl eq
Non-renewable energy	6,5E+01	8,9E+01	1,1E+01	MJ primary
Ozone layer depletion	7,3E-11	0,0E+00	4,2E-08	kg CFC-11 eq
Respiratory inorganics	5,4E-04	5,7E-03	7,7E-04	kg PM _{2.5} eq
Respiratory organics	1,1E-03	8,5E-04	4,8E-04	kg C ₂ H ₄ eq
Terrestrial acid/nutri	1,4E-02	1,5E-01	2,5E-02	kg SO ₂ eq
Terrestrial ecotoxicity	2,0E+00	1,1E-02	3,5E+01	kg TEG soil

Table 3.15 Fuels characterization factors of HDA process

IMPACT 2002+	Fuel oil	Natural gas	Unit
Aquatic acidification	2,1E-04	5,9E-05	kg SO ₂ eq
Aquatic ecotoxicity	1,2E+01	6,6E-01	kg TEG water
Aquatic eutrophication	4,4E-07	1,3E-07	kg PO ₄ ³ P-lim
Carcinogens	4,3E-04	6,5E-04	kg C ₂ H ₃ Cl eq
Global warming	9,1E-02	6,9E-02	kg CO ₂ eq
Ionizing radiation	7,3E-01	8,0E-02	kg Bq carbon 14 eq
Land occupation	5,5E-04	1,3E-05	m ² org.arable
Mineral extraction	4,4E-04	4,9E-05	MJ surplus
Non-carcinogens	3,5E-04	4,7E-05	kg C ₂ H ₃ Cl eq
Non-renewable energy	1,3E+00	1,3E+00	MJ primary
Ozone layer depletion	1,3E-07	1,0E-08	kg CFC-11 eq
Respiratory inorganics	2,7E-05	8,8E-06	kg PM _{2.5} eq
Respiratory organics	1,3E-04	1,3E-05	kg C ₂ H ₄ eq
Terrestrial acid/nutri	6,7E-04	2,7E-04	kg SO ₂ eq
Terrestrial ecotoxicity	1,5E+00	1,6E-01	kg TEG soil

Table 3.16 Emissions characterization factors of energy production plant

IMPACT 2002+	Carbon dioxide	Sulfur dioxide	Carbon monoxide	Nitrogen oxides	Unit
Aquatic acidification	0	1	0	0,7	kg SO ₂ eq
Aquatic ecotoxicity	0	0	0	0	kg TEG water
Aquatic eutrophication	0	0	0	0	kg PO ₄ ³ P-lim
Carcinogens	0	0	0	0	kg C ₂ H ₃ Cl eq
Global warming	1	0	1,57	0	kg CO ₂ eq
Ionizing radiation	0	0	0	0	kg Bq carbon 14 eq
Land occupation	0	0	0	0	m ² org.arable
Mineral extraction	0	0	0	0	MJ surplus
Non-carcinogens	0	0	0	0	kg C ₂ H ₃ Cl eq
Non-renewable energy	0	0	0	0	MJ primary
Ozone layer depletion	0	0	0	0	kg CFC-11 eq
Respiratory inorganics	0	0,0780	0,0010	0,1273	kg PM _{2.5} eq
Respiratory organics	0	0	0	0	kg C ₂ H ₄ eq
Terrestrial acid/nutri	0	1	0	5,488	kg SO ₂ eq
Terrestrial ecotoxicity	0	0	0	0	kg TEG soil

3.7 A framework for eco-efficient process design

3.7.1 Principles

The final stage of the approach is based on the design of a framework to automate both the environmental impact assessment and operating cost estimation of a given process. The framework performs the exchange and retrieval of data between the simulation models and the impact factor database:

1. First, the user enters new values for the process operating variables concerning stream information or/and unit operations in process simulator
2. A simulation run is performed and the energy requirement and mass flow rates from process inputs/outputs are computed

Concerning steps 1 and 2, sensitivity tests are necessary to detect the significant variables of the process and also find their threshold limits. Once the sensitive variables have been identified, scripting allows configuring the flowsheet with the new values of the variable set

3. The next step is to transfer energy requirement to energy plant simulator in order to estimate the emissions from energy production
4. The characterization, damage and normalized factors are retrieved from the environmental impact database
5. Finally, environmental impact assessment and cost estimation are carried out and the evaluation criteria are computed (from equation 3.3 for environmental impact evaluation of the process)

Figure 3.12 shows the data flow between all the components of the framework that is now described in detail.

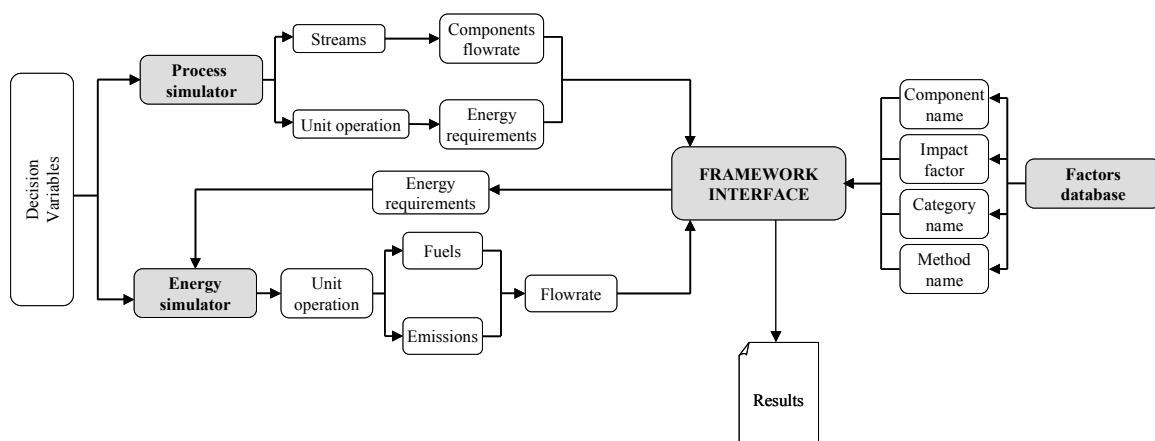

Figure 3.12 Data flow between energy and process simulators and impact factors database

3.7.2 Framework implementation

3.7.2.1 Setting the scene

The main objective of the framework is to link the software tools to analyse the environmental impact and estimate operating cost of a given process with its associated energy plant. To achieve the objective, it is necessary to use the interoperability feature of simulators and impact factors database. This feature allows data exchange between software tools used in the impact assessment. Figure 3.13 shows the overall possible architectures of the framework according to the used tools. The first architecture takes advantage of the programming interface embedded in simulators. Since the approach requires COM interface to link the tools, a programming language interface must support this interface. The second architecture exploits the COM interface that all the software tools involved in the approach have. In this architecture, the framework can be programmed in any language exhibiting a COM feature. It must be highlighted that the proposed approach can be implemented using both architectures.

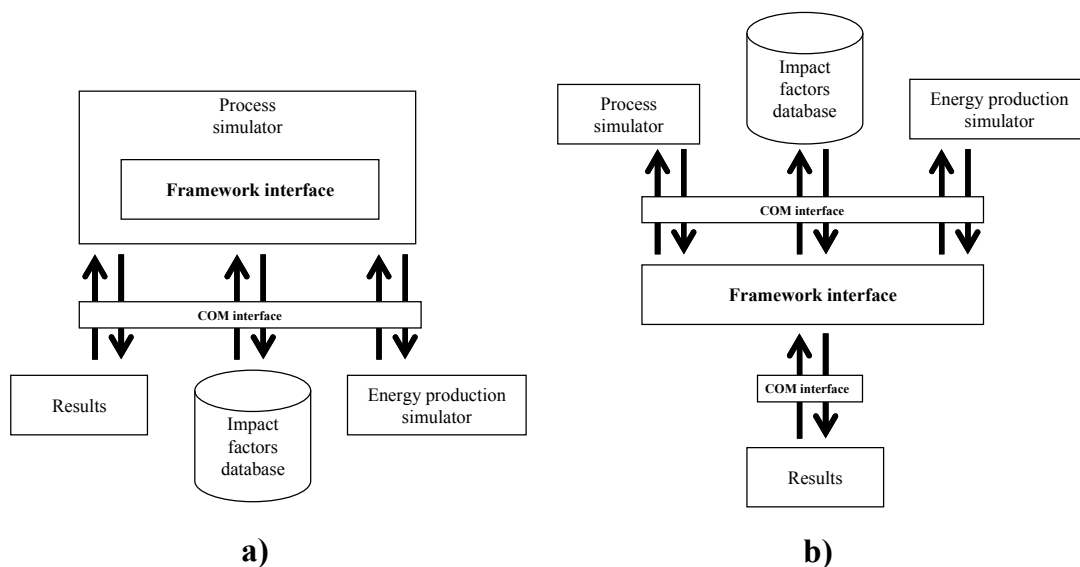

Figure 3.13 Frameworks architectures: **a)** embedded in process simulator **b)** with an independent platform

3.7.2.2 Framework activity description

The framework involves the operation of four main activities. Figure 3.14 illustrates the sequence of related activities and the corresponding software tools. The activities are embedded functions in the framework with a specific objective. All functions are coded with a programming language like Java™, Visual Basic™, VBA™, VBScript™, C, C++, PHP, Python etc. The use of a language depends on architectures as shown in Figure 3.14: the environmental impact re-assessment of a given

process is automated using a programming language, i.e., VBScript for embedded architecture and VBA language for independent architecture. The sequences of the four activities are described in the framework presentation (Figure 3.14) and their detailed flowchart is illustrated in Figures 3.15 to 3.17.

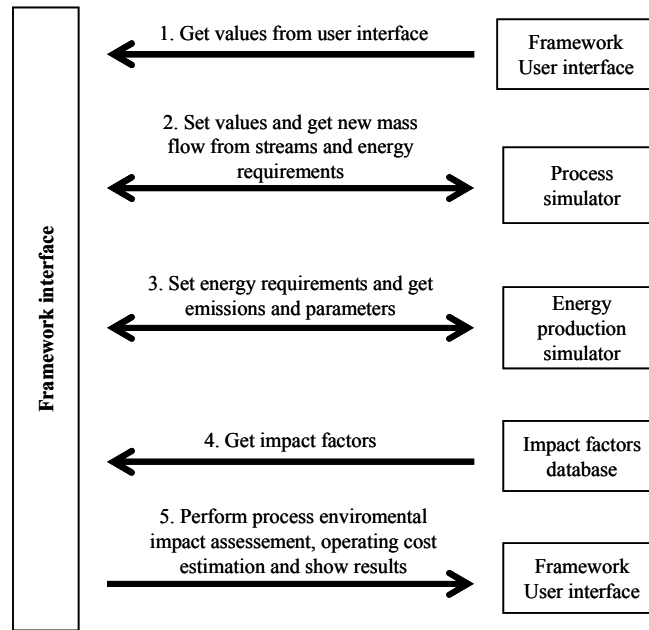

Figure 3.14 Sequence of framework activities

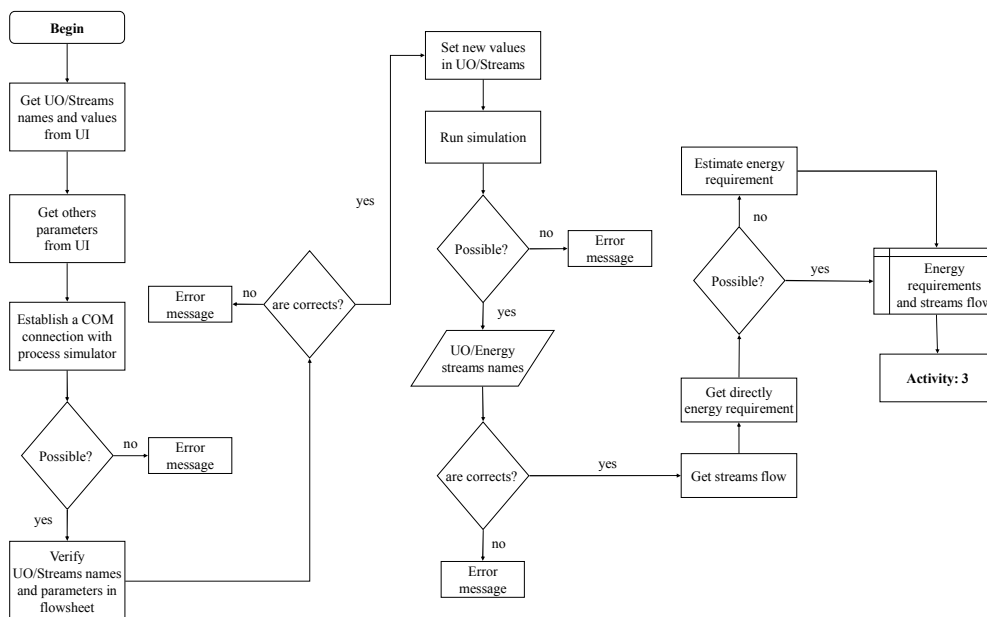

Figure 3.15 Flowchart of activities 1 and 2

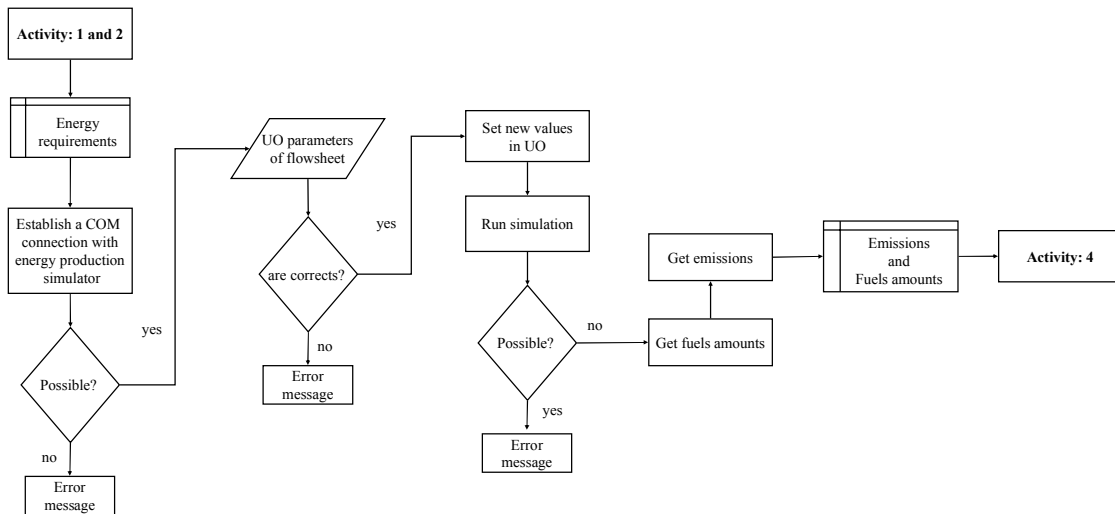

Figure 3.16 Flowchart of activity 3

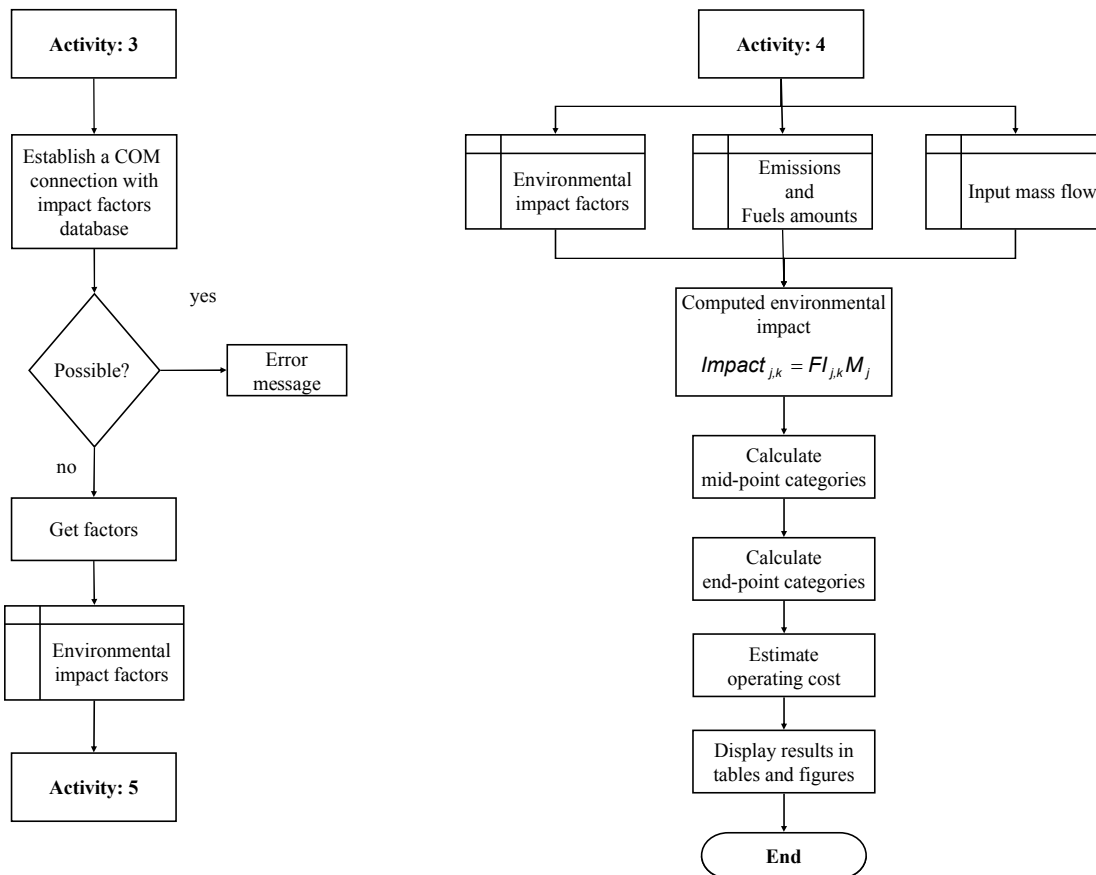

Figure 3.17 Flowchart of activities 4 and 5

Data exchange between the process simulator and the energy simulator is a cornerstone of framework. Figure 3.18 illustrates data exchange via COM technology.

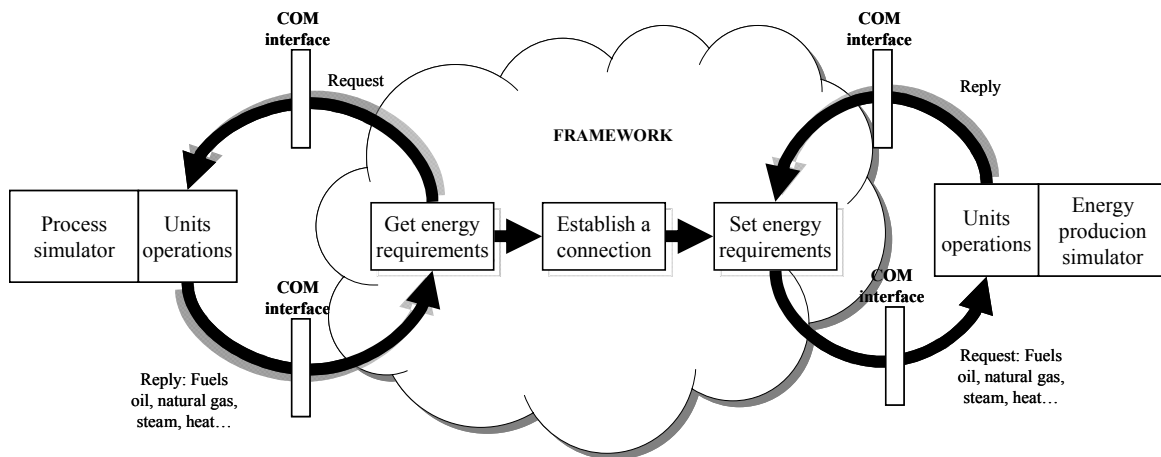

Figure 3.18 Data exchange between process and energy simulators

The initialization conditions for data exchange are:

- Process unit operations and streams energy must be identified
- The path and name of energy plant flowsheet must be identified
- The parameters of the unit operations corresponding to the energy plant flowsheet involved in data exchange must be identified

3.8 Environmental impact analysis of HDA chemical process

In the previous sections, the conditions for carrying out the environmental impact assessment of a given process were presented. A systematic framework for the environmental impact evaluation has also been developed. For this purpose, the mass flowrates, energy requirements and emissions estimated by the simulators as described in Section 3.5 are evaluated. Then, the environmental impact potential factors identified in the second stage of the approach (Section 3.6) are computed. Finally, the framework calculates the environmental impact and presents the results through mid-point categories and their damage consequences (end-point) of IMPACT2002+ method (as presented in Chapter 2). The score of damage categories is normalized using the factors as shown in Table 2.9 (see Chapter 2). The HDA process and energy production simulation models are coupled and serve as an example to validate the proposed approach presented in this Chapter. In the analysis, three scenarios are tested, each corresponding to the use of three simulators, i.e., HYSYS, COCO and ProSimPlus.

Figures 3.19 and 3.20 show the normalized results of main mid-point categories and damage categories (end-points) respectively in order to compare the environmental impact in all categories. Not surprisingly, it can be observed that the results of the three scenarios are very similar, since the mass and energy balances carried out by the three simulators lead to minor differences as shown in Table 3.10 in Section 3.5. The results show the contribution of the raw materials and the production of

the energy requirements of the process. Energy production contributes to all end-point categories and to the main mid-point categories.

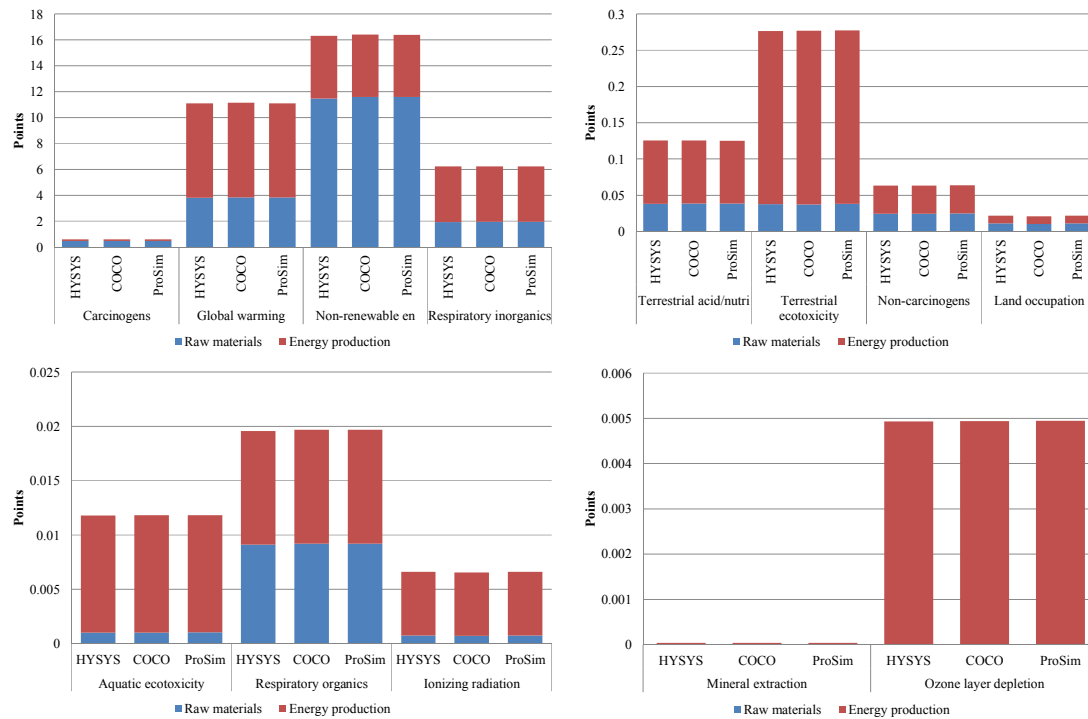

Figure 3.19 Comparison of simulation results in the thirteen mid-point categories (normalization)

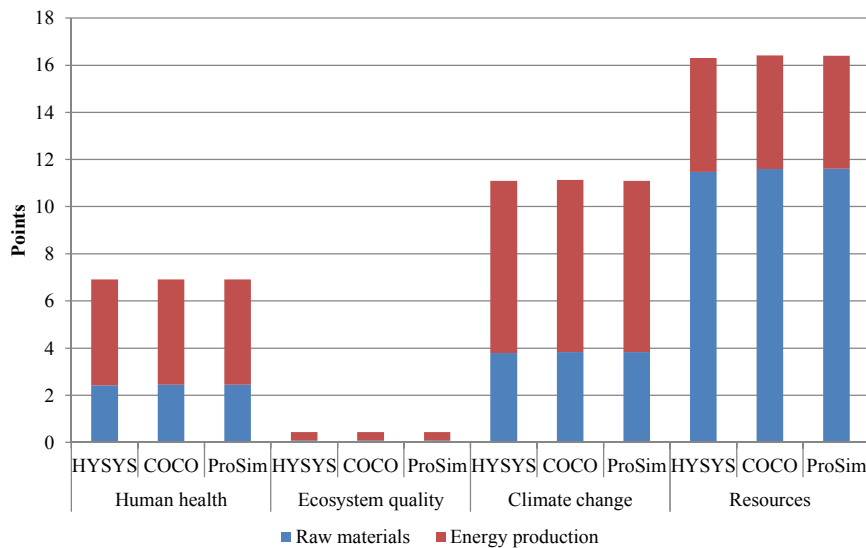

Figure 3.20 Comparison of simulation results in the four end-point categories (normalization)

Figure 3.21 shows a detailed analysis of the mid-point categories, with the individual contributions of all LCI components. The graphs indicate that the elements of the analysis contribute in different

proportion in each category, for example, toluene is the main contributor to the environmental impact in the non-renewable energy and respiratory organics categories whereas fuel oil is the main contributor in terrestrial and aquatic ecotoxicity, respiratory organics, ionizing radiation and ozone layer depletion categories. This reveals that a large amount of grey energy is involved, the energy hidden in a product, i.e. the amount of energy required to extract that product, i.e., toluene.

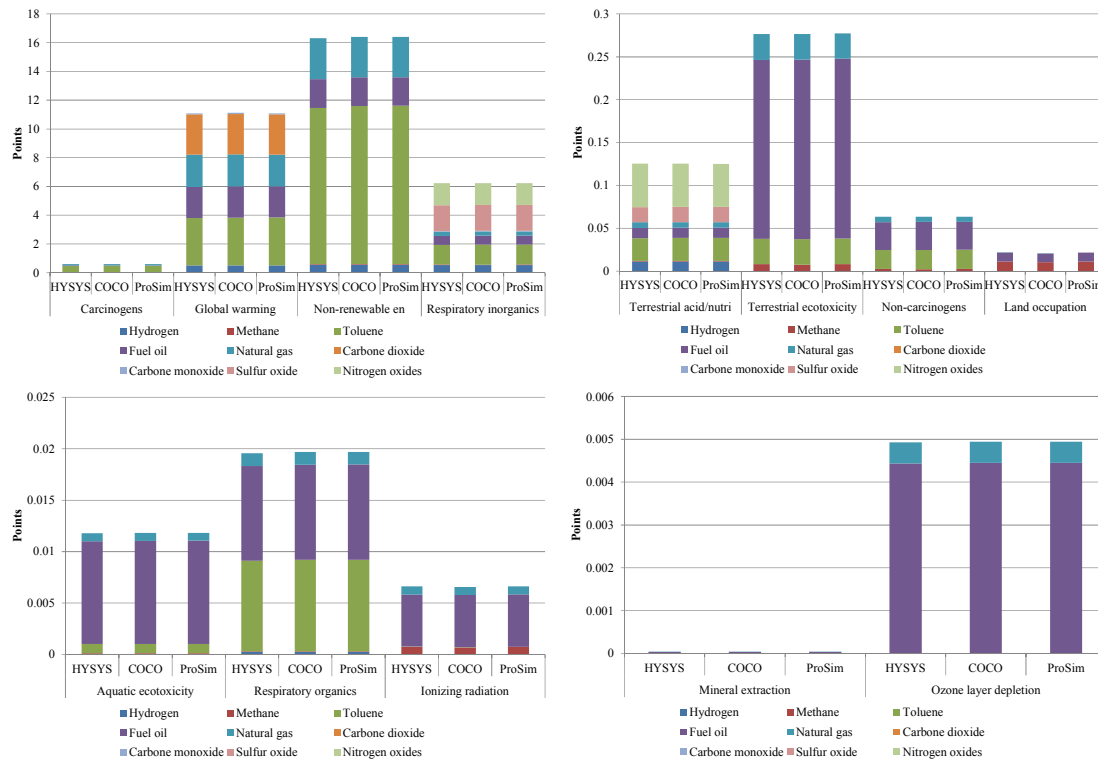

Figure 3.21 Analysis of the individual impact of the LCI elements in mid-point categories

Figure 3.22 shows a more detailed analysis of the terrestrial ecotoxicity and ozone layer depletion categories. In both categories, there is a low contribution from the direct emissions of the process and from the raw materials. In contrast, fuels contribute significantly, specifically fuel oil burned in the process furnace, since the impact factor of fuel oil that is significantly larger than the impact factor of natural gas. Here, the energetic ratio involved in the calculation of the proportion of fuels used in the furnace process plays an important role because it allows minimizing the environmental impact by reducing fuel oil utilization.

Figure 3.23 shows the detailed contribution in end-point categories. It can be observed that as for mid-point, fuels and raw materials (mainly toluene) are the main contributors to the environmental impact. It can be seen that carbon dioxide emission from the furnace with hydrogen and methane as fuels has a

negative scale; this is due to the fact that the energy produced by the furnace is subtracted from the energy requirements of the process (see assumptions for energy requirements in section 3.5).

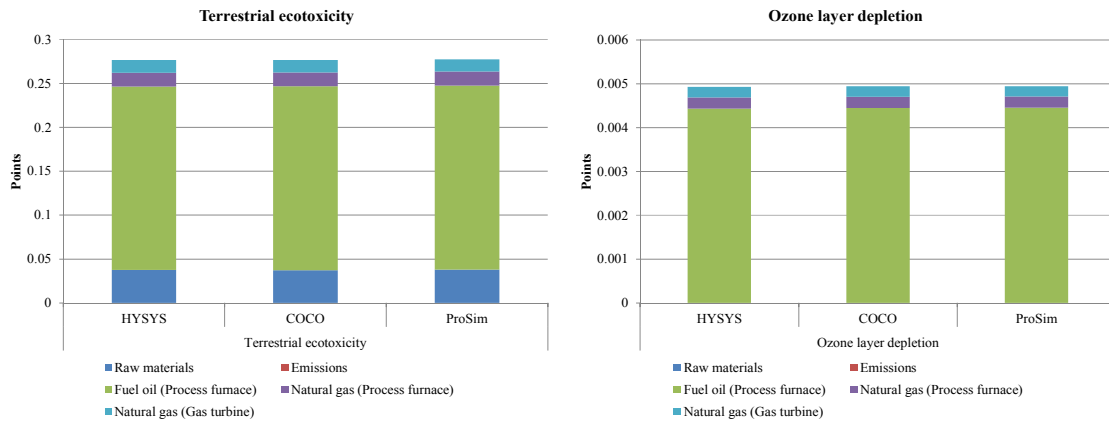

Figure 3.22 Analysis of the individual impact of the LCI elements

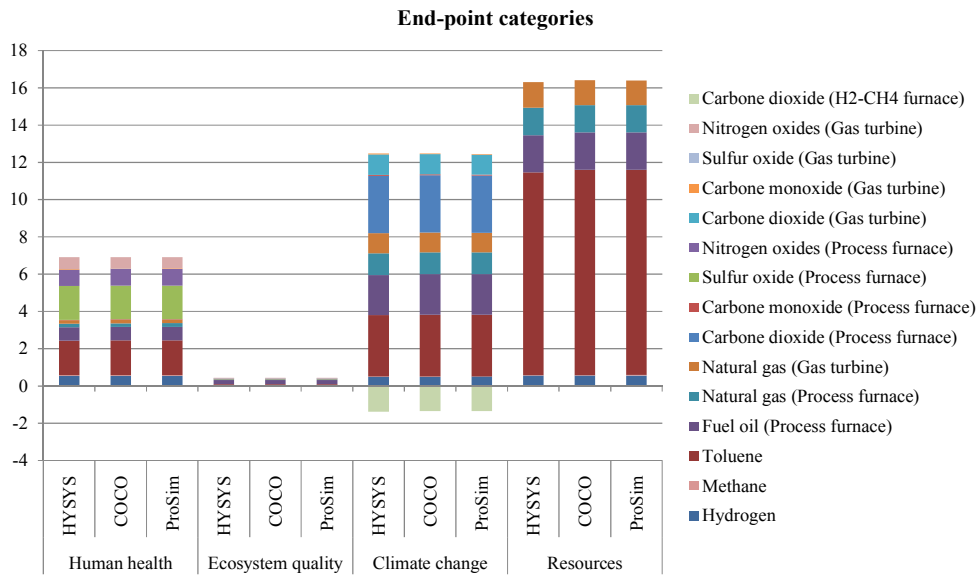

Figure 3.23 Analysis of the individual impact of the LCI elements in end-point categories

3.9 Sensitivity analysis

A systematic sensitivity analysis can be performed through the framework. First, it is necessary to identify the more significant variables on both economic and environmental viewpoints. Several studies were performed [61], [73], [77] and [74] showed that the conversion rate, the hydrogen flow rate relative to purge output and the so-called fuel ratio in the energy production process are the most influential variables.

- Conversion rate of toluene in reactor (C_{rate}) is a key variable. Lower conversion gives in general better selectivity, but higher costs of recycles. Higher conversion gives more by-products and impurities, sharply increasing the cost of separations.
- Hydrogen flow rate to purge output (F_{H_2}). Hydrogen is a reactant for the first reaction and a product for the second reaction. In the methane purge, a portion of the hydrogen is lost.
- Energetic ratio (R_{Fuel}). It represents the ratio fuel flow rate/gas flow rate at the furnace. This variable allows making a choice between fuels proportions used in the furnace of the process.

Other variables such as HP and LP pressure, and column pressure were investigated in our previous works and only have a weak influence. This explains why they have been discarded in the analysis. Several scenarios were used with the operating conditions of HDA process proposed in [61] used as a reference. Table 3.17 shows the set of values of the proposed scenarios for the sensitivity analysis.

Table 3.17 Proposed scenarios for sensitivity analysis

Scenario	R_{Fuel} (%)	C_{rate} (%)	F_{H_2} (kmol/h)
1	0.3	0.75	198
2	0.7	0.75	198
3	0.5	0.60	198
4	0.5	0.90	198
5	0.5	0.75	150
6	0.5	0.75	250

According to inventory data flow and environmental impact analysis, the three simulators lead to results with minor differences. The approach aims at generalizing the environmental impact assessment of any chemical process flowsheet: HYSYS simulator was then chosen to carry out the sensitivity analysis HDA process. The reasons for this choice are several among them:

- HYSYS has a large number of thermodynamic models, unit operations and chemical substances that allow designing a large number of chemical processes
- Another very important reason is the time of convergence to the solution. HYSYS converges faster than COCO and ProsimPlus. The difference can be measured in milliseconds but speaking in computational time this may lead to a large difference insofar as optimization will be further involved
- In addition, developing the framework as an independent platform (Figure 3.13.b) allows great flexibility and adaptation for coupling with other software tools

It is noteworthy that the sensitivity analysis can be carried out by COCO and ProSimPlus but it is necessary to make a choice to focus the work on the development of specific computational framework.

3.10 Results analysis

3.10.1 Comparison of scenarios in the midpoint and end-point categories

Table 3.18 shows the results obtained for all the tested scenarios. Not surprisingly, the flowrates of raw materials are very sensitive to F_{H_2} , since an increase in the purged hydrogen flowrate leads to an increase in the amount of raw material to satisfy production requirements.

Table 3.18 Results of the various scenarios

	Scenario						
	Douglas	1	2	3	4	5	6
Variables							
C_{rate} (%)	0.75	0.75	0.75	0.6	0.9	0.75	0.75
F_{H_2} (kmol/h)	198	198	198	198	198	150	250
R_{Fuel} (%)	0.5	0.3	0.7	0.5	0.5	0.5	0.5
Raw materials							
Hydrogen (kg/h)	949.71	949.71	949.71	947.21	952.34	852.57	1055.27
Methane (kg/h)	397.77	397.77	397.77	396.72	398.87	357.08	441.98
Toluene (kg/h)	25625.24	25625.24	25625.24	25309.01	25881.41	25565.42	25642.15
Purge							
Hydrogen (kg/h)	399.14	399.14	399.14	399.16	398.99	302.38	504
Methane (kg/h)	4997.69	4997.69	4997.69	4615.21	5016.49	4622.32	5002.68
Energy							
Steam (ton/h)	53.78	53.78	53.78	63.2	46.8	56.2	51.5
Fuel Furnace (ton/h)	5.86	4.16	9.70	7.09	4.81	6.58	5.19
Natural gas – Furnace (Nm ³ /h)	6236.6	10315.36	4420.87	7544.95	5117.60	6996.76	5523.73
Natural gas - Turbine (Nm ³ /h)	5827.14	5827.14	5827.14	7224.23	5187.57	6373.59	5771.76
Electricity (kW)	385.37	385.37	385.37	504.52	296.6	449.71	331.72
Water (Ton)	7918	7918	7918	9596	6649	8795	7191
Emissions							
Process furnace							
CO ₂ (ton/h)	30.47	32.83	39.2	36.86	25	34.2	26.98
CO (kg/h)	311.6	445.2	291.2	377	255.7	349.7	276
SO ₂ (kg/h)	234.2	166.4	387.7	283.4	192.3	263	207.5
NO _x (kg/h)	70.8	101.6	65.8	85.7	58.1	79.5	62.7
H₂/CH₄ furnace							
CO ₂ (ton/h)	13.72	13.72	13.72	12.67	13.77	12.7	13.75
Gas turbine							
CO ₂ (ton/h)	11.09	11.09	11.09	13.72	9.87	12.13	10.98
CO (kg/h)	221.8	221.8	221.8	274.3	197.5	242.6	219.7
SO ₂ (kg/h)	0.1	0.1	0.1	0.1	0.1	0.1	0.1
NO _x (kg/h)	50.8	50.8	50.8	62.65	45.2	55.5	50.3
Cost (\$)	144,636.47	143,066.75	140,591.06	167,390.77	121,799.57	154,818.51	130,320.16

The most important variations are observed when varying the energetic ratio at the furnace process, thus leading to a large discrepancy in the associated combustion emissions. All these variations affect the calculation of the cost and environmental impact assessment. Regarding the cost, it fluctuates in all scenarios based on process and energy variables (C_{rate} , F_{H2} and R_{Fuel}). The cost reduction is most significant when the conversion rate in the reactor increases while the other two variables are fixed (Scenarios: Douglas, 3 and 4).

The results of the environmental impact assessment (mid-point and end-point categories) and the cost calculation for each configuration are shown in Figures 3.24 and 3.25 by the use of radar charts. To facilitate the comparison, normalization was performed by assigning the value 1 to the maximum value of each category. The computed relative impacts represent the ratio between the environmental impact and this maximum value.

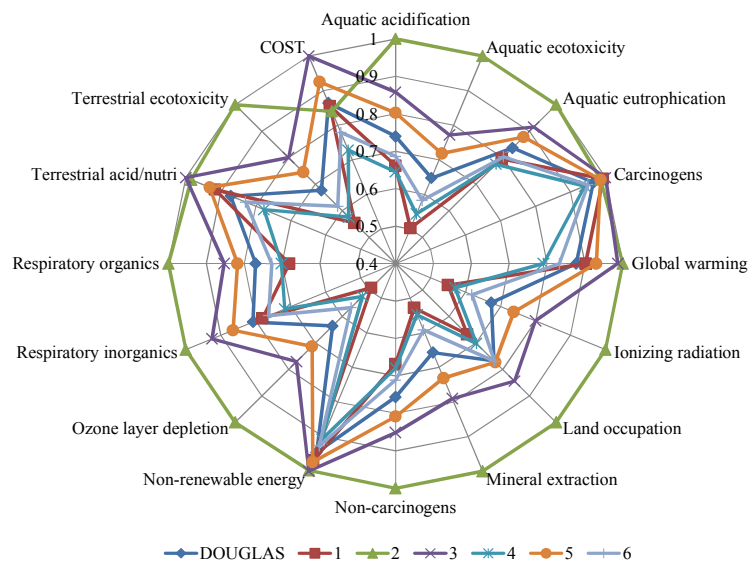

Figure 3.24 Comparison of normalization results in mid-point categories

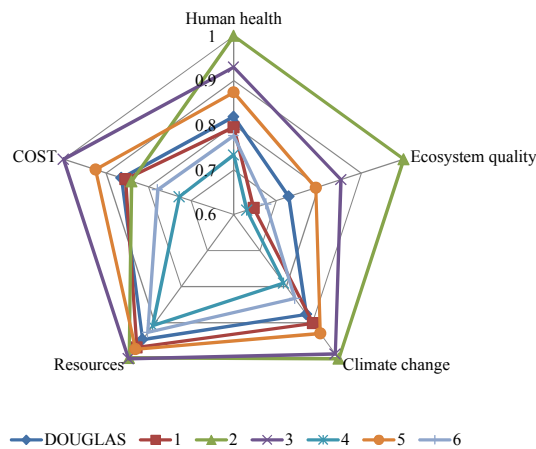

Figure 3.25 Comparison of normalization results in end-point categories

The scenario proposed by Douglas [61] is used as a reference to calculate the gain in the mid-point categories: it will be referred as “Douglas” in what follows. As reported in Table 3.19, a positive value represents an improvement in the environmental impact and cost while a negative value means that the impact and cost worse. The gain shows the variation in the cost and the mid-point categories, certain scenarios improve the cost but worsen the environmental impact and vice versa. Only scenario 4 improves both the cost and environmental impact in relation to the scenario used as reference (Douglas).

Table 3.19 Increase or decrease cost and environmental impact of IMPACT2002 + categories

	Scenario					
	1	2	3	4	5	6
	Gain (%)					
Aquatic acidification	10.61	-35.21	-15.97	12.82	-8.53	7.19
Aquatic ecotoxicity	22.38	-54.51	-19.24	16.06	-10.99	9.96
Aquatic eutrophication	4.92	-19.49	-9.40	7.40	-4.89	4.03
Carcinogens	-2.88	-2.23	-3.63	2.48	-2.15	1.59
Global warming	-2.85	-14.06	-12.55	9.83	-6.03	5.02
Ionizing radiation	18.33	-48.48	-18.76	15.41	-9.52	8.22
Land occupation	13.06	-30.36	-10.04	8.44	-0.64	-0.29
Mineral extraction	19.63	-52.17	-20.29	16.66	-11.22	9.89
Non-carcinogens	11.68	-32.20	-12.53	10.24	-6.87	6.02
Non-renewable energy	-2.34	-5.38	-5.65	4.05	-2.86	2.06
Ozone layer depletion	22.70	-57.31	-21.17	17.55	-12.10	10.86
Respiratory inorganics	3.32	-23.83	-14.53	11.23	-7.11	5.51
Respiratory organics	11.52	-29.86	-10.77	8.90	-6.19	5.56
Terrestrial acid/nutri	-5.18	-13.05	-14.78	10.86	-6.93	4.83
Terrestrial ecotoxicity	18.22	-47.74	-18.19	14.98	-10.10	8.95
COST	1.09	2.80	-15.73	15.79	-7.04	9.90

To understand the behaviour of variations in the cost and environmental impact, Figures 3.26 and 3.27 show a classification of the scenarios according to the variables C_{rate} , F_{H2} and R_{Fuel} . All scenarios are compared with the reference case, i.e. Douglas. This representation confirms that the most important variations are observed when varying the variable C_{rate} . It is noteworthy that the increase in the percentage of energetic ratio causes discrepancy between the environmental impact categories whereas the cost remains apparently unchanged. This behaviour can be attributed to the fact that the process uses the same amount of raw materials and has the same vapour requirements; on the one hand, the ratio of the fuels used in the furnace changes, which leads to different environmental impacts. On the

other hand, natural gas and fuel oil are not so expensive in relation to the costs of raw material and energy requirements for the set of economic data considered.

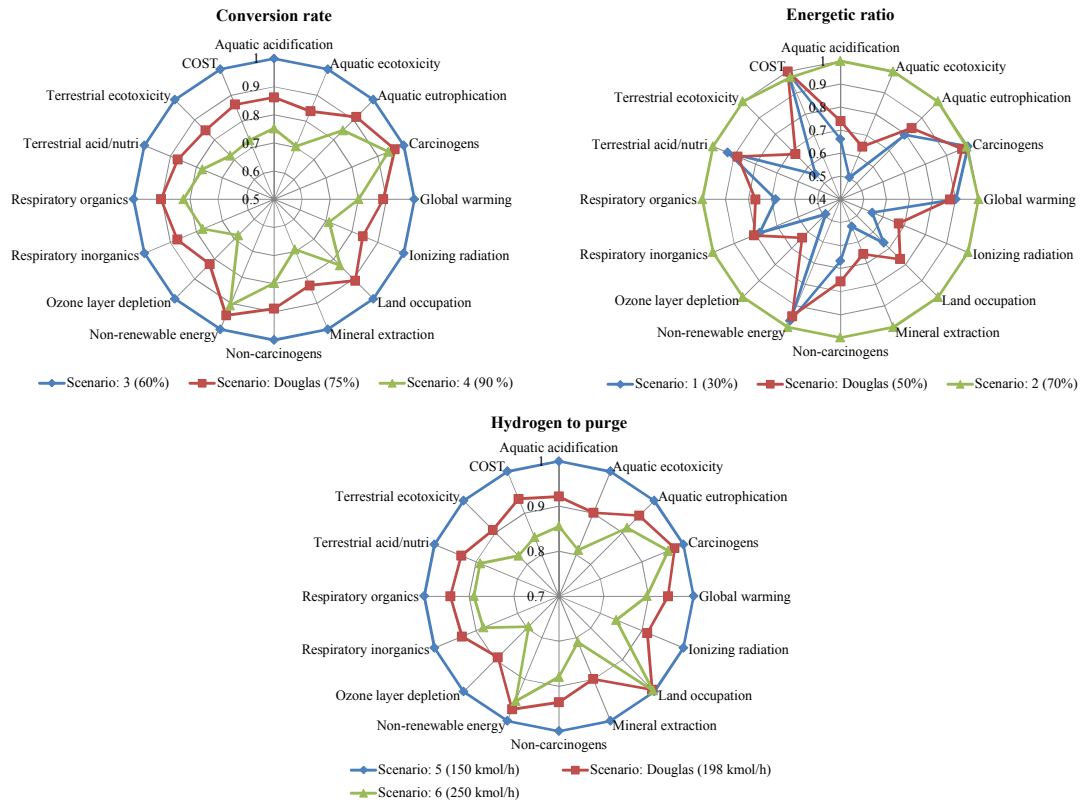

Figure 3.26 Classification of the environmental impact and cost according to the type of variable (mid-points)

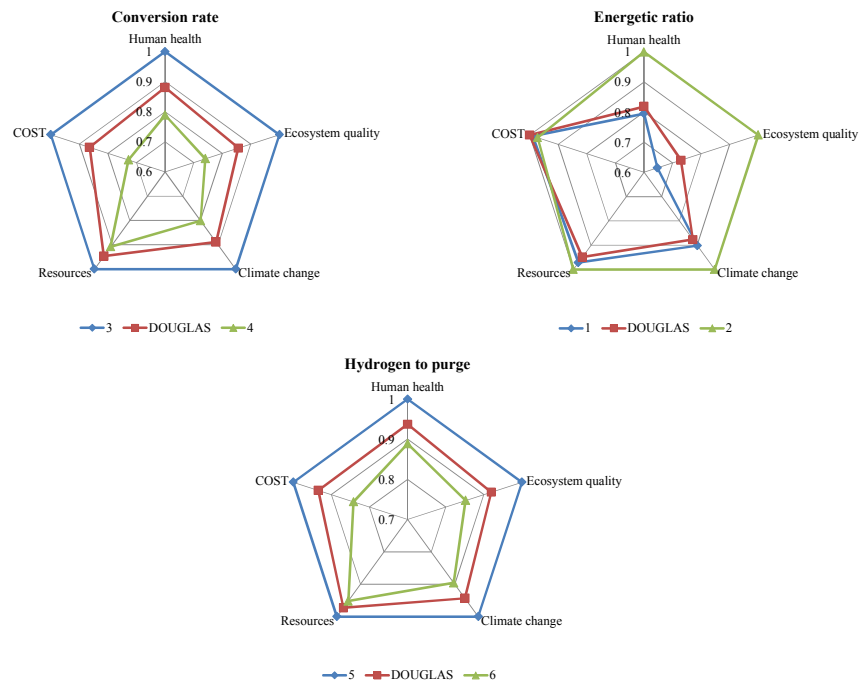

Figure 3.27 Classification of the environmental impact and cost according to the type of variable (end-points)

For mid-point categories, ozone layer depletion on the one hand and terrestrial and aquatic ecotoxicity on the other hand exhibit the largest variation range among the other criteria.

3.10.2 Environmental impact analysis of a specific scenario

Finally, Figures 3.28 to 3.30 show the individual analysis of the environmental impact of scenario 4 ($C_{\text{rate}} = 90\%$, $F_{\text{H}_2} = 198 \text{ kmol/h}$, and $R_{\text{Fuel}} = 50\%$). Figure 3.28 shows the contribution to environmental impact according to all sub-categories of inventory data as described in previous sections. The ozone layer depletion category is exclusively constituted by fuels requirements. Global warming is equally affected by raw materials, fuels and emissions, while raw materials correspond to 80% of carcinogens.

Figure 3.29 shows not surprisingly that the use of fossil fuels contributes to the environmental impact in each of the categories analysed. It must be also pointed out that aquatic ecotoxicity, mineral extraction, ozone layer depletion and terrestrial ecotoxicity categories are exclusively penalized by fuel oil. This confirms the influence of the fuel ratio variable in the HDA process environmental impact.

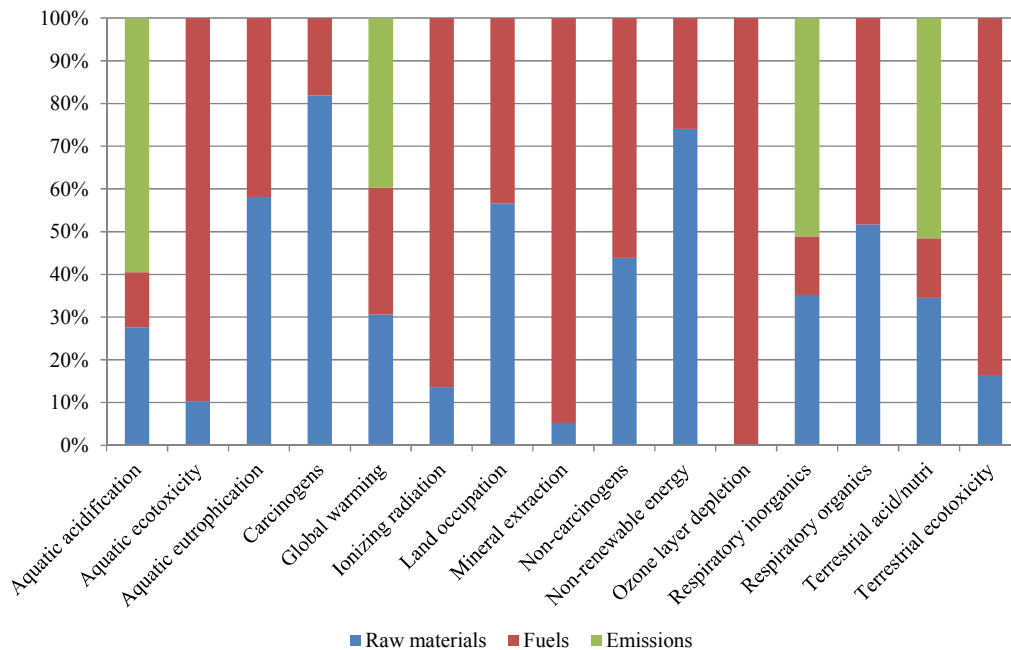

Figure 3.28 Mid-points categories analysis according to inventory data sub-categories (Characterization score)

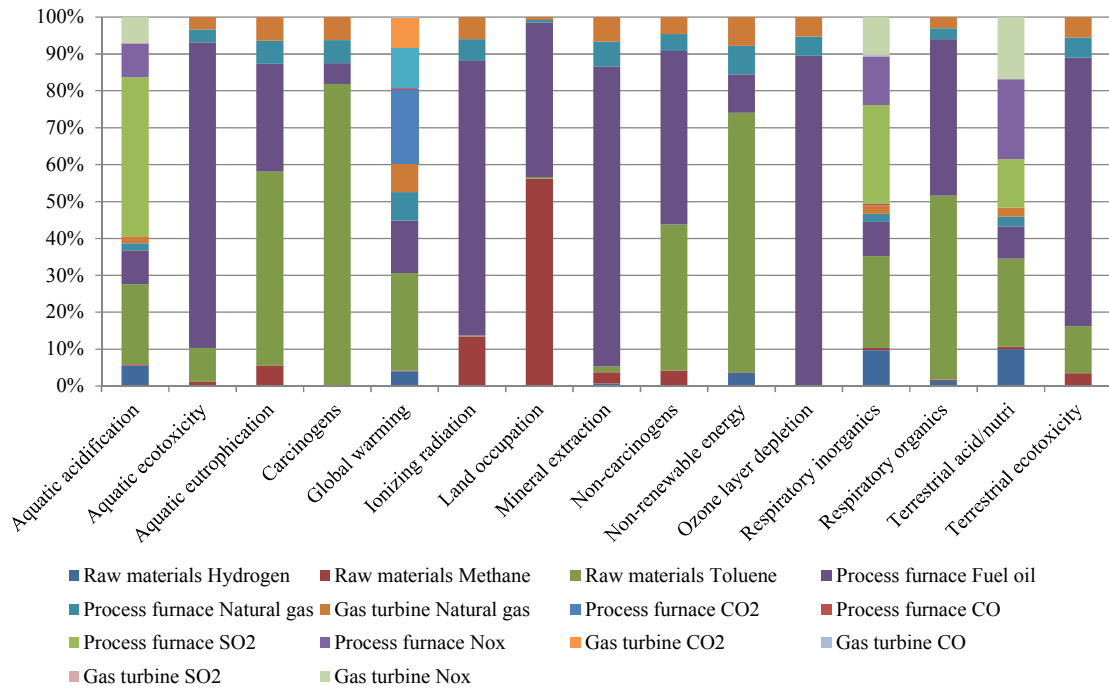

Figure 3.29 Mid-point categories analysis of the scenario 4 (Characterization score)

Figure 3.30 shows end-point categories; here toluene (raw material) is present significantly in resources, human health and climate change categories. Data in table 3.17 show that the toluene flow variation is very low between the 7 scenarios, so that the variation in the categories is mainly attributed to natural gas and fuel through the fuel ratio variable.

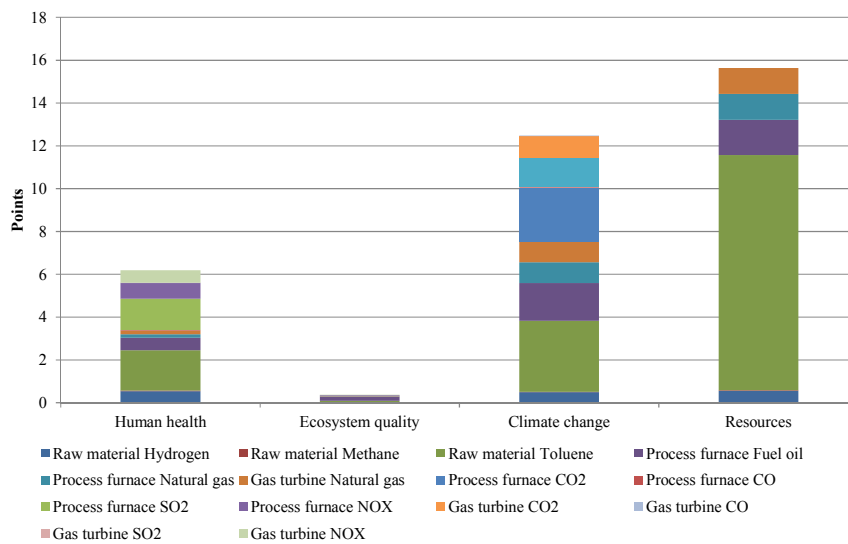

Figure 3.30 End-point categories analysis of the scenario 4 (Normalization score)

3.11 Conclusions

The process energy requirement is a very important consideration in the life cycle analysis; in this studied case, the results show that the fuel ratio is the variable that produces the most significant changes in the environmental impact of the HDA process. At least 7 of 15 mid-point categories are affected by at least a 50% contribution induced by energy requirements.

The need for sustainable development has challenged the chemical process industries to seek new approaches to tackle the eco-design problem. This includes exploitation of popular, commercial tools such as process simulators to evaluate process options. While process simulators are useful, their application to eco-design is not straightforward. This chapter has presented a methodology for eco-design of a chemical process coupling flowsheeting simulators both for process (HYSYS, COCO and ProsimPlus) and energy production (Ariane) with an environmental impact assessment module.

The well-known benchmark HDA process first developed by [61] illustrates the approach, which is totally different with the traditional end-of-pipe treatment methods. The process was designed under classical engineering objectives like benzene production and total annual cost, by also considering environmental impacts. The resulting multi-objective problem will be now solved in the following chapter.

4 MULTI-OBJECTIVE OPTIMIZATION AND MULTIPLE CRITERIA DECISION MAKING FOR ECO-DESIGN

RÉSUMÉ

L'objectif de ce chapitre est de présenter les approches d'optimisation multi-objectif et d'aide à la décision multicritère qui sont mises en œuvre comme procédures « maitres » de la méthodologie d'éco-conception. Le choix d'une procédure par Algorithmes Génétiques Multi-Objectifs (variante de NSGA-II) est justifié et explicité. Plusieurs procédures d'aide à la décision (M-TOPSIS, PROMETHEE et ELECTRE) permettent ensuite de trouver des solutions de compromis à partir de solutions du front de Pareto. Le cas du procédé HDA sert d'illustration dans la continuité du chapitre précédent. Une stratégie multi-niveaux est ensuite proposée pour faire face à la complexité du problème.

Nomenclature

<i>Acronyms</i>	
ABC	Artificial Bee Colony
AC	Ant Colony
AIS	Artificial Immune Systems
COCO	CAPE-OPEN to CAPE-OPEN
Cop	Operating cost
DE	Differential Evolution
DM	Decision maker
ϵ-C	ϵ -constraint
ELECTRE	Elimination Et Choix Traduisant la Réalité
GA	Genetic algorithm
HDA	Benzene production by hydrodealkylation of toluene
Kg_{eq} Substance x	kg equivalent of a reference substance x
LCA	Life Cycle Assessment
LCI	Life Cycle Inventory
LCIA	Life Cycle Impact Assessment
LP	Linear programming problems
MCDM	Multi Choice Decision Making
MOGA	Multi-Objective Genetic Algorithm
MOO	Multi-objective optimization
NFL	No Free Lunch
NLP	Non-linear programming problems
NN	Artificial Neural Networks
NPD	New Product Development
NSGA	Non-dominated Sorting Genetic Algorithm
NSGA-II	Fast Non-dominated Sorting Genetic Algorithm
PAES	Pareto-Archived Evolution Strategy Terrestrial
PROMETHEE	Preference Ranking Organization Method for Enrichment Evaluation
PS	Particle Swarm
PT	Parallel Tempering
SA	Simulated Annealing
SBX	Simulated Binary Crossover
SPEA	Strength Pareto Evolutionary Algorithm
STUN	Stochastic Tunnelling
TOPSIS	Technique for Order Preference by Similarity to Ideal Solution

WS	Weighted sum
<i>Symbols</i>	
A_m	Alternative <i>m</i>
C_n	Criteria <i>n</i>
E_i	Amount of energy type <i>i</i>
F_j	Preferences function for criterion <i>j</i>
g_j(a)g_j(b)	Alternatives “a” and “b” evaluated by the criterion <i>j</i>
kg/h	Kilogram per hour
kmole/h	Kilo mole per hour
Nm³/h	Normal Metres Cubed per Hour
RM_i	Amount of raw materials type <i>i</i>
R_{mn}	Results of alternative <i>m</i> in criteria <i>n</i>
ton/h	Tonne per hour
UCe_j	Unit cost of energy type <i>j</i>
UCrm_i	Unit cost of raw materials type <i>i</i>
w_n	Weight of criterion <i>n</i>

4.1 Introduction

The main purpose of this chapter is to indicate how optimization can be built on top of an eco-design procedure where LCA and process integration have been used to explore options for improved environmental performance and increased economic criteria. Chapter 3 has just presented the approach coupling process simulation tools both for production process and energy generation with LCA model and economic module. Due to the complexity of eco-design and to the antagonist behaviour that can be observed among some of the various criteria, multi-objective optimization (MOO) is particularly sound to find solutions that satisfy both economic and environmental criteria. The use of multi-objective optimization methods generally leads to a set of efficient solutions, the so-called Pareto front. The next step consists in identifying the best ones. This MCDM (Multiple Choice Decision Making) question is also a complex problem, mainly because of its more subjective nature. The development of a decision-support system that automates the various elements of the framework is also outlined in what follows. Figure 4.1 shows the overview of the approach with the integration of multi-objective optimization.

Figure 4.1 illustrates the interaction between all the component of the approach including multi-objective optimization and MCDM methods. Obviously, the first and second stages remain unchanged: the purpose of stage 3 is to couple the process, environmental and economic models with the optimization/decision-aid tools. Since the framework has been initially designed to evaluate different scenarios, the only change is now that scenarios have to be generated by the optimization tool.

More specifically, the aim of this chapter is to present the optimization/decision aid approaches to minimize simultaneously the environmental and economic criteria (operating cost and midpoint and endpoint categories respectively). The HDA process that was presented in Chapter 3 illustrates the methodological framework. This chapter comprises five sections following this introduction. Sections 2 and 3 present the methods, techniques and tools used respectively for multi-objective optimization and for multi-criteria decision making and also justify the choices made. Subsequently, the integration of MOO and MCDM in the framework is presented and described in detail in Section 4. Finally the HDA process design is optimized and analysed in Section 5. It must be highlighted that the framework was designed to interoperate with different process simulators: ProSimPlus, COCO and HYSYS were thus embedded in the eco-design framework as proposed in the previous chapter. According to the results obtained and to the interoperability offered in HYSYS, this flowsheet simulator is considered for further enhancement of the eco-design methodology. Section 6 summarizes the main contribution of this chapter.

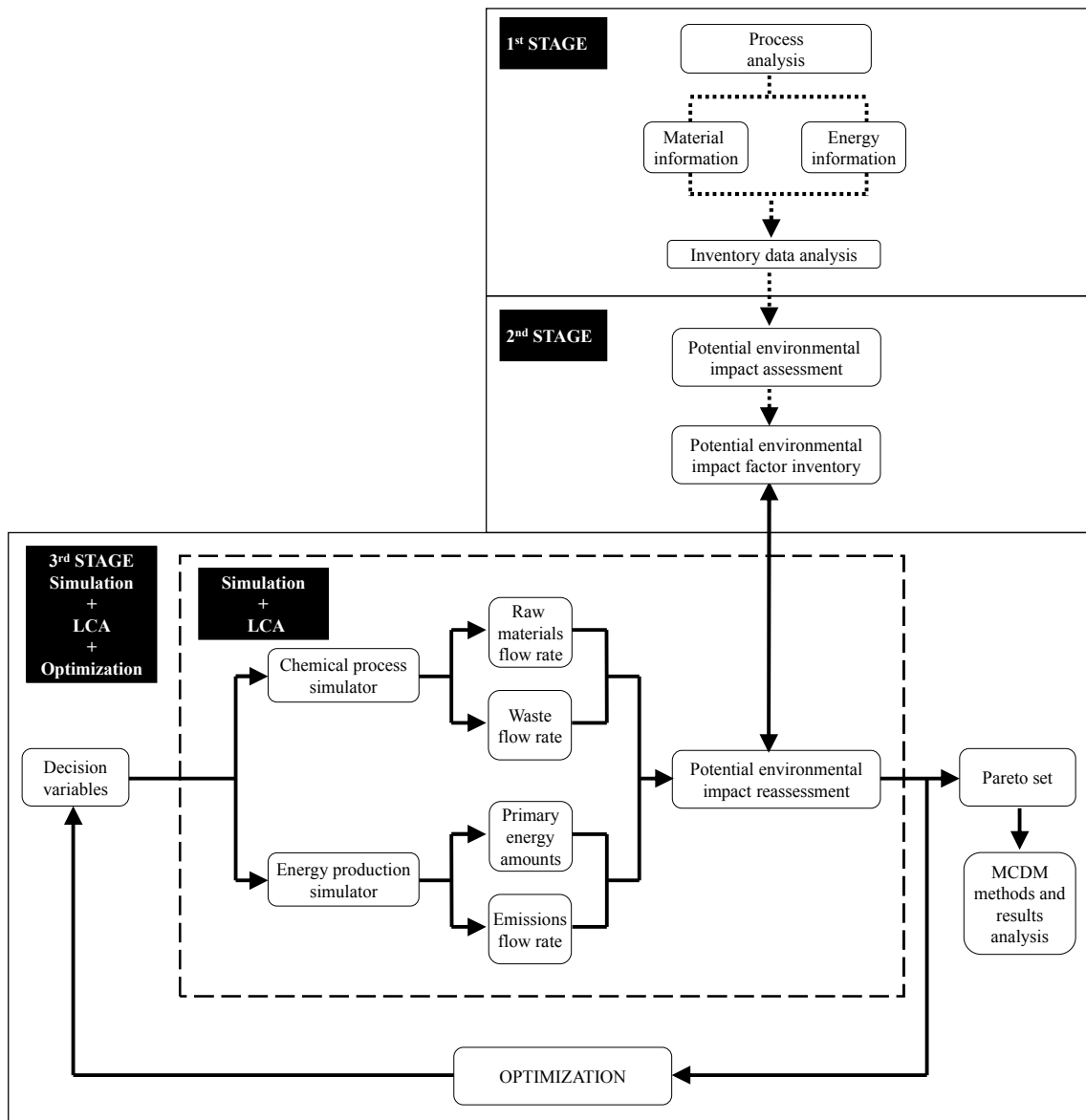

Figure 4.1 Overview of integrated approach for eco-efficient process design (Optimization)

4.2 Multi-objective optimization (MOOP)

A large number of objectives, generally more than ten are involved when carrying out Life Cycle Assessment. The objective of this section is to present the formulation of the multi-objective optimization problem and to determine the most relevant methods.

4.2.1. Formulation of a MOOP problem and concept of Pareto dominance

A multi-objective optimization problem (MOOP) can be expressed as follows:

Find the decision vector $\bar{X} \in \mathfrak{R}^n$

$$\vec{x} = (x_1, x_2, \dots, x_n)^T$$

which satisfies the m inequality constraints:

$$g_i(\vec{x}) > 0, i = 1, 2, \dots, m$$

the p equality constraints

$$h_i(\vec{x}) = 0, i = 1, 2, \dots, p$$

and optimizes the vector function:

$$\vec{f}(\vec{x}) = (f_1(\vec{x}), f_2(\vec{x}), \dots, f_k(\vec{x}))^T$$

A solution that satisfies all the constraints is called a feasible one. Due to the competing objectives, there is no single solution to the MOOP problem, but a set of alternative solutions. Candidate solutions to multi-objective problem are necessarily not dominated. The Pareto set consists of solutions that are not dominated by any other solution. A solution \vec{x} dominates \vec{y} if \vec{x} is better or equal to \vec{y} in all criteria, and strictly better in at least one attribute. Considering a minimization problem and two solution vectors of the solution space S , $\vec{x} = (x_1, x_2, \dots, x_n)^T$ and $\vec{y} = (y_1, y_2, \dots, y_n)^T$ \vec{x} is said to dominate \vec{y} if:

$$\forall_i \in \{1, 2, \dots, k\}: f_i(\vec{x}) \leq f_i(\vec{y}) \text{ and } \exists_j \in \{1, 2, \dots, k\}: f_j(\vec{x}) < f_j(\vec{y})$$

The space formed by the objective vectors of Pareto optimal solutions is known as the Pareto optimal frontier, P : any final design solution should preferably be a member of the Pareto optimal set. If the final solution is selected from the Pareto set optimal solutions, there would not exist any solutions that are better in all attributes. The Pareto front can be viewed as an equilibrium curve composed of good solutions for the MOOP, i.e., the set of problem solutions among which the decision maker has to perform his choice. Each objective function maps the input decision vector (point in the m dimensional decision space) to the target vector in the n dimensional objective space.

4.2.2. Selection of a multi-objective optimization method

There are two main categories of optimization methods: the methods applied to linear programming problems (LP) and those applied to non-linear programming problems (NLP). NLP methods are classified into deterministic and stochastic (see Table 4.1 and Figure 4.2). Deterministic methods are often used to solve mono-objective (with a unique optimal solution); they solve multi-objective problems transforming them into a mono-objective problem (combining the criteria into a single or performing a single-objective optimization fixing as constraints the others).

Table 4.1 Some stochastic methods for multi-objective optimization

Name	Source
Genetic Algorithm (GA)	[146]
Artificial Bee Colony (ABC)	[147]
Differential Evolution (DE)	[148]
Particle Swarm (PS)	[149]
Simulated Annealing (SA)	[150]
Artificial Immune Systems (AIS)	[151]
Ant Colony (AC)	[152]
Artificial Neural Networks (NN)	[153]
Stochastic Tunnelling (STUN)	[154]
Parallel Tempering (PT)	[155]

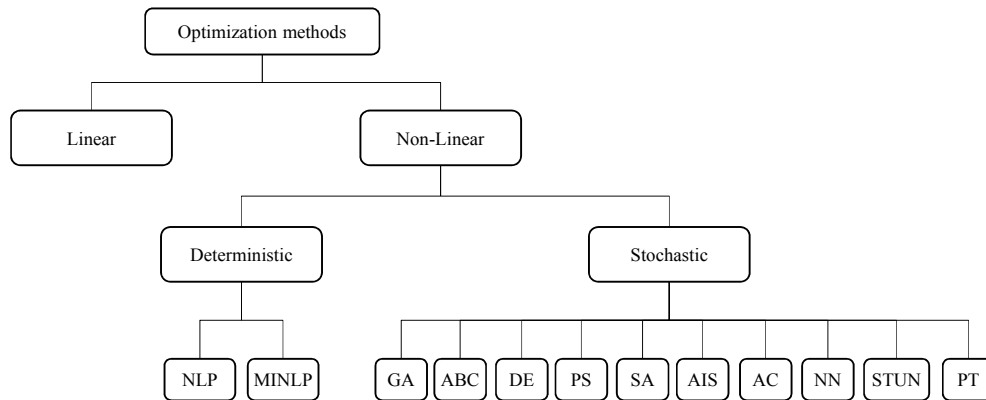

Figure 4.2 Classification of optimization methods

Considering now multi-objective optimization procedures, they can be broadly classified into two categories, i.e. scalarization methods on the one hand, and genetic and evolutionary methods on the other hand. Scalarization methods, based on deterministic approaches, apply in mathematically well-defined problems with explicit formulations of objectives and constraints, while genetic and evolutionary methods based on evolutionary strategies, mainly apply in black box problems, where objectives and/or constraints are evaluated by a computer code for each value of the optimization variable set. Besides the black box problems, the possibility to mutate out of a local optimum and the ability to compute the entire Pareto front in one run, make also this type of methods attractive. In the former group of methods, the multi-objective optimization problem is transformed into a single (or a series of) mono-objective problem(s). Miettinen [156] gives an interesting review of various techniques; Engau and Wiecek [157] present seven types of scalarization methods, but the two most popular ones are undoubtedly the weighted sum (WS) [158] and the ε -constraint (ε -C) [159] procedures.

In the latter class of genetic and evolutionary methods, the concept of dominance is general implemented to distinguish between dominated and non-dominated solutions. Both classes of methods have their own drawbacks: scalarization methods need to check mathematic properties such as convexity, which may be very difficult to check for complex engineering problems; for problems involving crisp equality constraints (like balance equations for example), an external solver has to be used for each point generated by a genetic and evolutionary method.

Besides, the efficiency of a given method for a particular example is hardly predictable and according to the No Free Lunch (NFL) Theory of Wolpert and Macready [160], there is no method which surpasses all the other ones for any considered problem. Insofar as external packages (HYSYS, ProSimPlus, COCO and Ariane) are used for mass and energy balances, the problem is a black box one, and an evolutionary strategy seems a good candidate to solve the problem.

Another interesting classification must be mentioned to justify the choice of the optimization method. According to the influence of the decision maker (DM) in the optimization process, multi-objective optimization problems can be classified as no-preference, a priori, a posteriori and interactive methods:

- in no-preference methods the multi-objective optimization problems are solved without the opinions of the DM, i.e., Min-Max formulation
- a priori methods are the methods where the DM must specify his preference before the solution process. Typical examples include utility functions, lexicographic ordering, goal programming and fuzzy logic
- in interactive methods, the DM provides his opinions during the solution process: STEM method [161], Steuer method, Interactive surrogate worth trade-off method belong to this category
- a posteriori methods are the methods where the DM gives his preference after the solution process: weighted sum, ϵ -C method, Genetic Algorithms, Evolutionary Algorithms, Simulated Annealing are typical representatives of this kind of method

The choice of an a posteriori method seems more consistent since a set of potential solution candidates can be generated without subjective judgement of the decision maker. The final choice can be then performed with an MCDM method, among optimal solutions, so that “sub-optimal” solutions have been discarded along the optimization process.

For all these reasons, an evolutionary procedure was adopted in this work.

4.2.3. Selection of an evolutionary procedure

An evolutionary procedure is a heuristic method that combines user-given black box procedures whose derivatives are not available, with heuristics in order to obtain a good solution for the problem. Some heuristics maintain at any time a current state, and replace that state by a new one (state transition or move). Heuristics often work on pool of states containing several candidate states, like in genetic algorithms. The new states (evolution) are generated by combination or crossover of two or more states of the pool. Since 1975, many evolutionary procedures appear (see Table 4.1), for example, genetic algorithms (Holland [146], Chafekar et al. [162]), simulated annealing (Kirkpatrick et al. [150]), artificial immune systems (Farmer et al. [151]), ant colonies (Dorigo [152]), particle swarms (Kennedy and Eberhart [149]), artificial bee colonies (Nakrani and Tovey [147]) and artificial neural networks (Ang et al. [153]).

The basic idea of GA's is the mechanics of natural selection inspired in the Darwinian-type survival-of-the-fittest strategy. Each optimization parameter (optimization variables) x_1 is coded into a gene. Then the corresponding genes for all parameters x_1, x_2, \dots, x_n form a chromosome, which describes each individual. A chromosome can be a vector of real numbers or a binary string, all depending on the specific problem. Each individual (chromosome) represents a possible solution and a collection of individuals forms a population. To find the best solutions within the generated population genetic algorithm has three fundamental genetic operations: selection, crossover and mutation. These operations are used in conjunction to the fitness function of individuals to modify the chosen solutions and select the most appropriate offspring to pass on to succeeding generations. The optimization loop continues until the population converges or the maximum number of generations predetermined has been reached. Figure 4.3 shows the structure of a simple genetic algorithm.

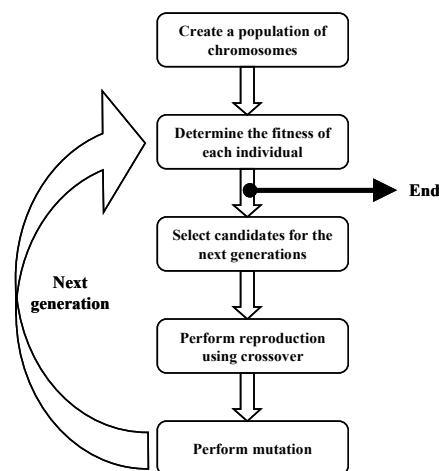

Figure 4.3 Representation of a single genetic algorithm

All these algorithms can be adapted to the multi-objective case, as it can be observed in the list of references proposed by Coello Coello [163]. Recently, Coello Coello and Becerra [164] indicate the most representative evolutionary algorithms in the fields of materials science and engineering and give some potential areas for future research in these domains. They distinguish three main classes of MGA (Multi-Objective Genetic Algorithm): MOGA (Multi-objective Genetic Algorithm) where the rank of an individual corresponds to the number of individuals in the current population by which it is dominated (Fonseca and Fleming [165]); NSGA (Non dominated Sorting Genetic Algorithm) where several layers of classifications of the individuals are established on the basis of non-domination (Srinivas and Deb [166]); NPGA (Niche Pareto Genetic Algorithm) where a binary tournament selection scheme based on Pareto domination is used (Horn et al. [167]). The book of Deb [168] presents several performance metrics for convergence, metrics for diversity, and metrics for both convergence and diversity. The book of Obayashi et al. [169] gives a good review of the domain. Another recent evolution concerns the evolutionary neural networks that evolve their architecture through multi-objective genetic algorithms as a Pareto trade-off between the accuracy of training and the problem complexity (Pettersson et al. [170], [171]).

Several multi-objective algorithms types have been developed such as Multi-objective Genetic Algorithm (MOGA) presented in [172], [173], Non-dominated Sorting Genetic Algorithm (NSGA) by [72], Strength Pareto Evolutionary Algorithm (SPEA) proposed by [174], Pareto-Archived Evolution Strategy (PAES) by [175] and Fast Non-dominated Sorting Genetic Algorithm (NSGA-II) presented by [176]. One of the most efficient genetic algorithm according to [177] is NSGA-II (Non dominated Sorting Genetic Algorithm) which estimates the density of solutions surrounding a particular solution. The NSGA-II is an improved version of NSGA; the structure of the algorithm is the same but includes special features to solve problems like: non-dominated sorting, the absence of elitism and a strong dependence on the so-called sharing parameter. Its main features include:

- an elitist non-dominated sorting by a comparison technique.
- the use of a crowding technique to eliminate the specification of additional parameters and thus preserve diversity in the population.
- assigning fitness values taking into account the level of non-dominance

The optimization problems studied in this work have been solved with the so-called genetic algorithm NSGAIIB. This procedure belongs to the genetic algorithm library (MULTIGEN) recently developed in [178]. The MULTIGEN tools (written in Visual Basic for Applications VBA) use Excel sheets as interface. The MULTIGEN library involves several algorithms, distinguishing them by their structure and by their type of variables (continuous, integer, binary); six different algorithms are available.

The MOO procedure implemented in this work is the NSGA II-modified SBX described in Gomez et al. [179]. Compared with the classical NSGA II algorithm described by Deb and Agrawal [180], this library involves the innovative following points:

- In NSGA II SBX, a new SBX crossover operator carries out more efficient gene mixing. Compared with the classical NSGA II version, the global probability of crossover per gene is higher in the modified SBX.
- The SBX crossover coded in NSGA IIb includes a forced mutation of children when they are identical to the parents (clone limiting strategy).
- The initial population may be generated according to a meshing strategy of the variable definition domains. Two options are provided in the MULTIGEN library for computing the initial population. The classical random generation of the initial population, may provide over-crowded or under-crowded zones. Another solution consists in meshing the definition domain of variables and randomly generating the same number of points into each cuboid of the mesh, in order to ensure a uniform overlapping on the entire domain.
- The implementation of an efficient stopping criterion is a key point for any iterative method. Classically genetic algorithms stop when a given maximum number of generations are reached. By observing the evolution of solutions, it can be noted that the number of generations necessary to reach the optimum is generally much better than this maximum number. Therefore, a more efficient stopping criterion may lead to big savings in computational times. However, despite the real impact of stopping criteria, no reliable bibliographical study is available, particularly in multi-objective optimization. In mono-objective optimization, a convergence threshold based of the stagnation of some statistical items (mean value, standard deviation) computed from the objective function values on the current population can be used. Such a threshold of convergence cannot be defined in the frame of multi-objective optimization. The stopping criterion implemented in MULTIGEN (in addition to the maximum number of generations) consists in comparing the Pareto fronts associated with not dominated solutions for populations n and $n + p$, where the period $p \in \{10, 20, 30, 40, 50\}$ for example. If the union of the two fronts provides a single non-dominated front, the procedure stops; else the iterations continue.

4.3 Multiple choice decision making (MCDM) methods

4.3.1 Principles

After the complete set of solutions of the multi-objective optimization problem (i.e. the Pareto front or set of efficient solutions) is found, the next step consists in identifying the best ones. This MCDM (Multiple Choice Decision Making) issue is complex, mainly because of its more subjective nature and by the presence of many often conflicting objectives. This raises the issue about how different

objectives should be combined to yield a final solution and to search for optimal solutions to the considered problem. From a mathematical point of view, this is a difficult problem, because an n -dimensional space is not provided with a total ordering relation. Other examples were tackled in previous works such as the determination of the best strategy for New Product Development (NPD) Morales et al. [181]. Pharmaceutical industries face these situations where a solution must be identified from a multitude of investment alternatives: the choice of the best solution is critical: if a bad choice is performed, the company will lose a lot of resources. To assist industrial practitioners in their decisions, several MCDM methods were implemented. A classification of such methods (see Figure 4.4) is carried out in [182] [183].

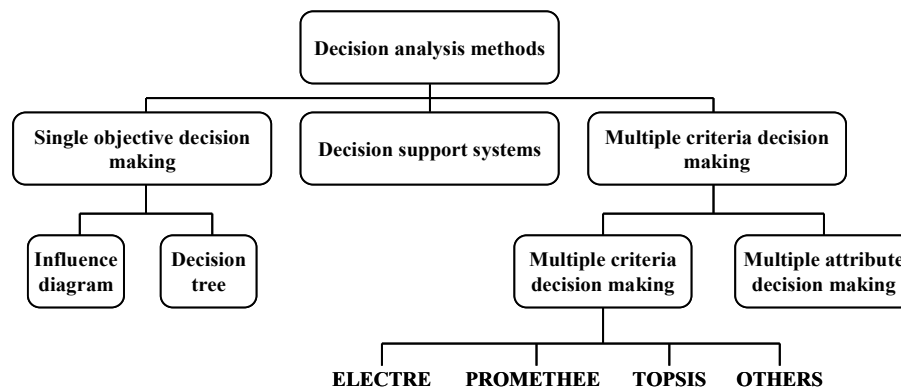

Figure 4.4 Classification of decision analysis methods

A variant of TOPSIS (M-TOPSIS) has been adopted in this work, integrating the guidelines proposed in [77]. Other classical methods such as ELECTRE and PROMETHEE are also implemented to compare their predictions with those obtained with TOPSIS. Their principles are briefly recalled.

4.3.2 ELECTRE

ELECTRE [184] is the acronym for *Elimination Et Choix Traduisant la Réalité* (Elimination and Choice Expressing the Reality); the method consists of a procedure to reduce the size of the set of alternatives through outranking relations. Outranking relations are built using the binary outranking relations “S” which means "at least as good as." The following cases may occur when building relationships:

- $a \mathcal{S} b$ and not $b \mathcal{S} a$ (a is strictly preferred to b).
- $b \mathcal{S} a$ and not $a \mathcal{S} b$ (b is strictly preferred to a).
- $a \mathcal{S} b$ and $b \mathcal{S} a$ (a is indifferent to b).
- Not $a \mathcal{S} b$ and not $b \mathcal{S} a$ (a is incomparable to b).

The construction of an outranking relation is based on:

- Concordance. A sufficient majority of criteria should be in favour of the assertion a S b.
- Non-discordance. When the concordance condition holds, none of the criteria in the minority should oppose strongly to the assertion a S b.

An important feature is the vector of weights that contains the value of the preference criteria. This method uses threshold values, which help to take into account the imperfect nature of relationships. Other items used are decision matrix, concordance matrix, weighted normalized decision matrix, discordance matrix and dominance matrix (concordance - discordance). The application of the method begins with the construction of a decision matrix (Table 4.2).

Table 4.2 Decision matrix in ELECTRE method

		Criteria				
		C ₁	C ₂	C ₃	...	C _n
Alternatives	A ₁	R ₁₁	R ₁₂	R ₁₃	...	R _{1n}
	A ₂	R ₂₁	R ₂₂	R ₂₃	...	R _{2n}
	A ₃	R ₃₁	R ₃₂	R ₃₃	...	R _{3n}

	A _m	R _{m1}	R _{m2}	R _{m3}	...	R _{mn}

A key point of the method is the preferential weight vector associated to each criterion; the assignment of these weights is subjective. $W = (W_1, W_2, \dots, W_n)$. The weights must be positive and the sum of all of them should be 1. The next step is to calculate the concordance matrix. This matrix is obtained by adding the weights associated with the criteria on which the alternative A_i is better than the next alternative. Properties of the concordance matrix are:

- It is a square matrix of order m
- Matrix elements are values between 0 and 1
- Main diagonal has no values
- The sum of symmetric elements relative the main diagonal is 1

The next step is to calculate the discordance matrix, for that, it is necessary to obtain the normalized decision matrix and then weighting it. For normalization purpose, each element of the initial decisional matrix is divided by its range (the difference between maximum and minimum value of each column). Then each column values are multiplied by their preferential weight for weighting the normalized matrix. The values discordance matrix are calculated as the ratio between the largest difference in absolute value of the criteria for which alternative i is worse than j and the largest difference in absolute value between the results achieved by the alternative i and j .

Concordant and discordant dominance matrices and aggregate dominance matrix are then calculated:

- Concordant dominance matrix. The value is 1 when a concordance matrix element is greater than the threshold value of concordance and 0 if less or equal to the threshold.
- Discordant dominance matrix. The value is 0 when a discordance matrix element is greater than the threshold value of discordance and 1 if less or equal to the threshold.
- Aggregate dominance matrix (Concordant - Discordant). The value is 1 when counterpart elements of the two previous matrices are 1 and 0 for other cases.

Finally, the graph ELECTRE is obtained. The vertices of the graph represent the alternatives; an arc is drawn from vertex A to B if and only if the corresponding element of the aggregate dominance matrix is 1. If there is a directed arc from A to B means that alternative A is superior to alternative B (A dominates B). Figure 4.5 summarizes the steps of the ELECTRE method.

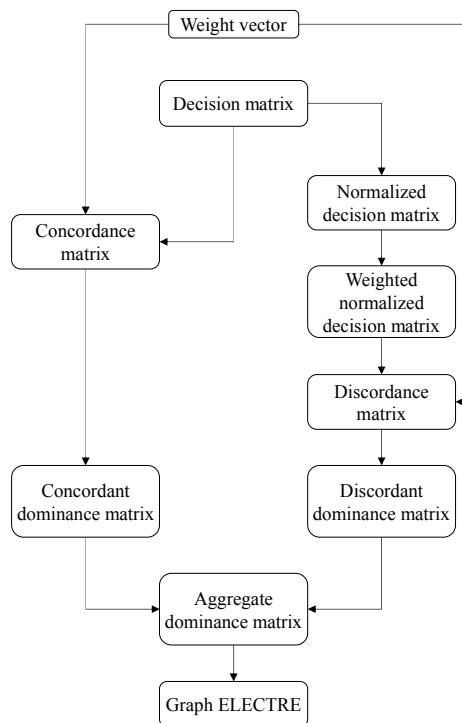

Figure 4.5 ELECTRE method elements

4.3.3 PROMETHEE

This method [185] (Preference Ranking Organization Method for Enrichment Evaluation) belongs to the class of outranking methods and is designed to deal with multi-criteria problems with a finite set of solutions. PROMETHEE needs information such as:

- Information between the criteria.
- Information within each criterion.

Information between criteria is the value of the weights or preferences for each criterion. The application of PROMETHEE requires the creation of a decision matrix (like Table 4.2) and a weights vector $W = (W_1, W_2 \dots, W_n)$. The assignment of these weights is subjective but the weights must be positive and the sum of all of them should be 1. The first step of the method is the pairwise comparison of alternatives within each criterion. With this comparison, a difference matrix is constructed for all criteria (Table 4.3).

Table 4.3 Difference matrix for all criteria involved in the analysis

		Alternatives				
		A ₁	A ₂	A ₃	...	A _m
Alternatives	A ₁	A ₁ - A ₁	A ₁ - A ₂	A ₁ - A ₃	...	A ₁ - A _m
	A ₂	A ₂ - A ₁	A ₂ - A ₂	A ₂ - A ₃	...	A ₂ - A _m
	A ₃	A ₃ - A ₁	A ₃ - A ₂	A ₃ - A ₃	...	A ₃ - A _m

	A _m	A _m - A ₁	A _m - A ₂	A _m - A ₃	...	A _m - A _m

The next step is to obtain the information for each criterion which is based on a preference function equation (4.1).

$$P_j(a, b) = F_j[g_j(a) - g_j(b)] \dots \dots \dots (4.1)$$

To implement equation 4.1, a preference function is chosen such as:

- Usual criterion
- U-shape Criterion
- V-shape Criterion
- Level Criterion
- V-Shape with indifference Criterion
- Gaussian Criterion

U and V shape functions take their names from the graph formed by the thresholds used to set preferences for the alternatives. If the criterion has to be minimized, function (4.1) becomes (4.2).

$$P_j(a, b) = F_j[(g_j(a) - g_j(b))] \dots \dots \dots (4.2)$$

The process ends with the computation of the positive and negative outranking flows, which indicate at which level an alternative is outranking or outranked by all the others.

4.3.4 M-TOPSIS

The fundamental concept of MCDM method TOPSIS [75] [186], [187] (Technique for Order Preference by Similarity to Ideal Solution) is the comparison of Euclidian distances to choose the best alternative. TOPSIS is a synthetic evaluation method, where the distance between available solutions and the “optimized ideal reference point” is calculated. TOPSIS is an evaluation method that is often used to solve MCDM problems [188]. The basic idea of TOPSIS method is to choose a solution that is closest to the ideal solution (better on all criteria) and away the worst (which degrades all criteria) The modification introduced by Ren et al. [189] in M-TOPSIS method could avoid rank reversals and solve the problem on evaluation failure when alternatives are symmetrical that often occurs in original TOPSIS.

As for the other MCDM methods, a specific module with M-TOPSIS has been implemented as a tool for multi-criteria decision, thus facilitating its use after obtaining Pareto fronts. Particular attention was paid to the simultaneous treatment of problems involving minimization and maximization criteria. The normalization of the matrix is performed according to the original work of Hwang and Yoon [75].

MCDM methods, especially TOPSIS, have often been used in multi-criteria optimization problem. Boix [190] used the TOPSIS method for selecting the best water network configuration involving three criteria: amount of fresh and treated water entering the network and the number of connections. Ouattara [77] shows how the results obtained by a MGA (NSGA II) can be connected to a MCDM method (TOPSIS) to solve a similar eco-design process problem. The stages of the M-TOPSIS procedure are listed below.

M-TOPSIS starts with a decision matrix that contains all the alternatives ordered by criterion (m alternatives evaluated by n criteria, see Table 4.4).

Table 4.4 Decision matrix X in TOPSIS method

		Criteria				
		C ₁	C ₂	C ₃	...	C _n
Alternatives	A ₁	R ₁₁	R ₁₂	R ₁₃	...	R _{1n}
	A ₂	R ₂₁	R ₂₂	R ₂₃	...	R _{2n}
	A ₃	R ₃₁	R ₃₂	R ₃₃	...	R _{3n}

	A _m	R _{m1}	R _{m2}	R _{m3}	...	R _{mn}

The next step is to calculate the normalized decision matrix A . Since different criteria have different dimensions, the values in the decision matrix X are first transformed into normalized, non-dimensional values in order to convert the original attribute values within the interval $[0, 1]$ under the following equation:

$$A = [a_{ij}]_{m \times n}, a_{ij} = \frac{R'_{ij}}{\sqrt{\sum_{i=1}^n (R'_{ij})^2}}$$

Then, the weighted normalized matrix V is calculated by multiplying each value within the individual criterion in the normalized matrix A by the weight of this criterion:

$$v_{ij} = w_j \cdot a_{ij}$$

After, the positive and negative ideal solutions are defined from the standardized matrix A . The ideal solution (A^+) is the group of the ideal criteria values (maximum value for benefit criteria and minimum value for cost criteria), and the non-ideal solution (A^-) is a group of the negative ideal criteria values (minimum value for benefit criteria and maximum value for cost criteria):

$$A^+ = \{v_1^+, v_2^+, \dots, v_n^+\}, v_j^+ = \left\{ \max_i (v_{ij}), j \in J^+; \min_i (v_{ij}), j \in J^- \right\}$$

$$A^- = \{v_1^-, v_2^-, \dots, v_n^-\}, v_j^- = \left\{ \min_i (v_{ij}), j \in J^+; \max_i (v_{ij}), j \in J^- \right\}$$

The ideal and non-ideal criteria values are using to calculate the separation measures, using the n -dimensional Euclidean distance [191].

$$D_i^+ = \sqrt{\sum_{j=1}^n (v_j^+ - v_{ij})^2}$$

$$D_i^- = \sqrt{\sum_{j=1}^n (v_j^- - v_{ij})^2}$$

Then, the $D^+ D^-$ -plane is constructed and set the *optimized ideal reference point*. After, the relative distance from each evaluated alternative to the ideal reference point is calculated. Set the point A in $[\min(D_i^+), \max(D_i^-)]$ as the *optimized ideal reference point* because the aim is to have the lowest distance between the ideal criteria set values (A^+) and get away as much as possible of non-ideal criteria set values (A^-). The ratio value of $Ratio_i$ is calculated as follows:

$$Ratio_i = \sqrt{(D_i^+ - \min(D_i^+))^2 + (D_i^- - \max(D_i^-))^2}$$

Finally, a ratio for each alternative is estimated. The alternatives are ranked according to their ratio, the best alternative is the one that having the M-TOPSIS coefficient ratio nearest to 0.

4.4 Integration of MOO and MCDM in the eco-design framework

4.4.1 Presentation

Chapter 3 has introduced an approach to find eco-efficient designs for a given process through a framework designed for the automation of sensitivity analysis of environmental impacts. This chapter is devoted to the implementation of a guided search coupling MOO and MCDM methods to select the best configurations for process design. Because of the flexible structure of the framework, the optimization tool can be easily integrated. Figure 4.6 shows the data flow among the various tools.

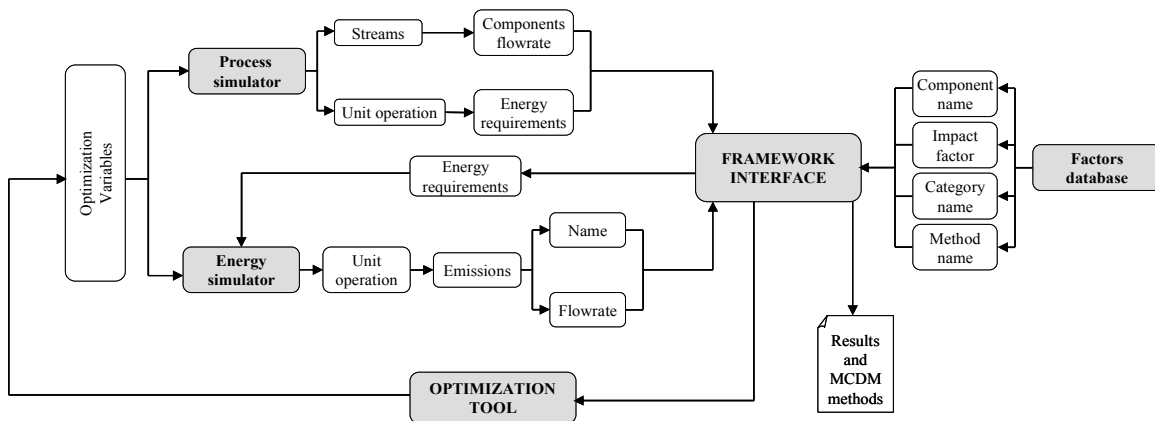

Figure 4.6 Data flow through the framework components (including optimization stage)

Data flow is modified compared to the one shown in Figure 3.9 of Chapter 3: the role of the framework interface is to capture the selected criteria evaluated by process and energy simulators as part of the optimization process and to give the results to the GA. The GA generates new values for the set of the identified optimization variables that are retrieved and the operations described in sections 3.4 of Chapter 3 are carried out. The results are then returned to the GA to continue the optimization process.

4.4.2 Framework implementation

4.4.2.1 Setting the scene

The insertion of a genetic algorithm in the framework requires that data exchange is possible among all the involved components. Figure 4.7 shows the selected architecture for framework development. All the involved tools exhibit the interoperability characteristic through the COM interface.

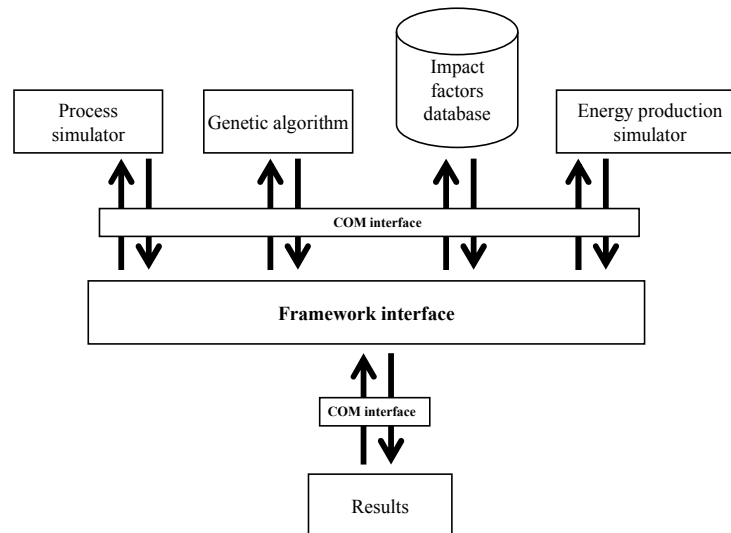

Figure 4.7 Architecture 3: Framework with integrated optimization

4.4.2.2 Eco-design framework

Extra activities are added to those described in Section 3.3.3.1 of Chapter 3 because of the optimization module insertion. New activities include the configuration of the genetic algorithm, i.e., (specifying GA parameters, i.e., number of generations, population size, mutation and crossover percentage...). Besides, it is necessary to link the operational variables with the optimization variables so that the framework can retrieve the values generated by the GA. Once the specifications are implemented by the user, the framework can start optimization runs. The genetic algorithm generates an initial population of solutions (operational/optimization variable values) that are transferred to the simulators (energy/process). The computed mass flow rates are used to carry out the environmental impact assessment process. Once the environmental impacts are calculated, the result is transferred to the genetic algorithm. The genetic operators accomplish their role to generate new solutions and transfer them to the simulator through the framework. The optimization cycle is repeated until the stopping criterion of genetic algorithm is reached.

4.5 HDA process optimization

4.5.1 Optimization problem formulation

This section defines criteria to use for the HDA process optimization in order to apply the proposed approach to a specific example in the context of process eco-design. The choice of environmental criteria is performed taking into account the analysis presented in chapter 3. The IMPACT 2002+ and LCIA method considering 15 intermediary subcategories and 4 end categories are selected. To reduce the complexity of the multi-objective optimization problem, preliminary optimization runs are implemented with the four end categories. Concerning economic performance, the criterion adopted is

the process operating cost, which can be defined as daily investment for the process to work. The cost comprises the use of raw materials and the use of required energy by the process (Equation 4.1).

$$Cop = \sum_{i=1}^n UCrm_i \cdot RM_i + \sum_{j=1}^m UCe_j \cdot E_j \dots\dots\dots (4.1)$$

The optimization problem can thus be formulated as follows:

Determine the decision variables (i.e., process operating conditions) in order to satisfy simultaneously the following objectives:

- Minimization (Human Health)
- Minimization (Ecosystem Quality)
- Minimization (Climate Change)
- Minimization (Resources)
- Minimization (Cop)

Subject to:

Decision variables ranges (see Table 4.6)

The following process constraints are also considered (the values are taken from [61]).

- Benzene purity is at least equal to 99.97%.
- Hydrogen purity in the process should be equal to 95%.
- Reactor effluent must be cooled to a temperature inferior to 621°C to avoid formation of coke.
- The range of the conversion rate is 0.5 to 0.9
- The range of hydrogen flow rate in purge is 30 to 300 kmol / h.
- All pollutant emissions flows (CO₂, NO_x, CO and SO₂) must be positive values.

Two types of thermal power stations for the production of required utilities in the operation of the HDA process have been proposed in chapter 2. For the optimization problem proposed here, the model of the gas turbine is used. The operating cost criterion is calculated by equation 4.1 using raw material and utilities costs presented in Table 4.5. The environmental criteria are calculated by equation 3.4. The required data for calculation are environmental impact factors shown in Tables 3.13, 3.14 and 3.15.

The decision variables used in the optimization runs concern:

- Fuel ratio (%)
- Conversion rate (%)
- Hydrogen flow (kmol/h)

These variables were determined through a sensitivity analysis performed in Chapter 3. Parallel to the optimization with five criteria, a mono-criterion optimization (operating cost) is carried out in order to have a reference of the cost increase or decrease.

Table 4.5 Raw materials and utilities costs

Raw materials	Price (\$/kg)
Toluene	0.648
Hydrogen	1
Utilities	Price (\$/Common unit)
Fuel	\$549/m ³
Natural gas	\$0.42/std m ³
Electricity	\$0.06/kWh
Steam	
High pressure	\$29.97/1 ton
Medium pressure	\$28.31/ 1 ton
Low pressure	\$27.70/1 ton
Water	\$14.8/1 ton

4.5.2 Genetic Algorithm implementation

From a preliminary sensitivity analysis, the following GA parameters were used in the optimization runs: number of individuals per population equal to 200; number of generations equal to 200, crossover rate equal to 0.75 and mutation rate equal to 0.5. Table 4.6 shows the variation range for the decision variables considered. To guarantee the stochastic nature of the algorithm, a run is repeated 5 times. The union of all the results is considered as a final result.

Table 4.6 Variation range for decision variables

Decision variables	Upper limit	Lower limit
Energetic ratio (%)	0.1	0.9
Conversion rate (%)	0.5	0.9
Hydrogen flow (kmol/h)	30	300

The initial population is randomly generated between these ranges. The other process operating conditions are the same as those described in Chapter 3.

4.5.3 Reducing the criteria number

With the abovementioned criteria and parameters settings, the genetic algorithm optimization process is carried out taking into account the five criteria (Human Health, Ecosystem Quality, Climate Change, Resources and Operating Cost) and the three decision variables (Fuel ratio, Conversion rate

and Hydrogen flow at purge output). The environmental criteria are based on end-point categories. The adopted strategy is first to analyse the obtained Pareto fronts in order to compare them and examine if a correlation between the criteria exists and to investigate the antagonist behaviour among the criteria. The Pareto fronts are plotted two-dimensionally, where the "x" axis of the graph represents the operating cost per year (Millions of dollars) while the "y" axis represents IMPACT 2002 + end-categories (points). Figure 4.8 shows the Pareto fronts obtained for the simultaneous optimization of the five criteria.

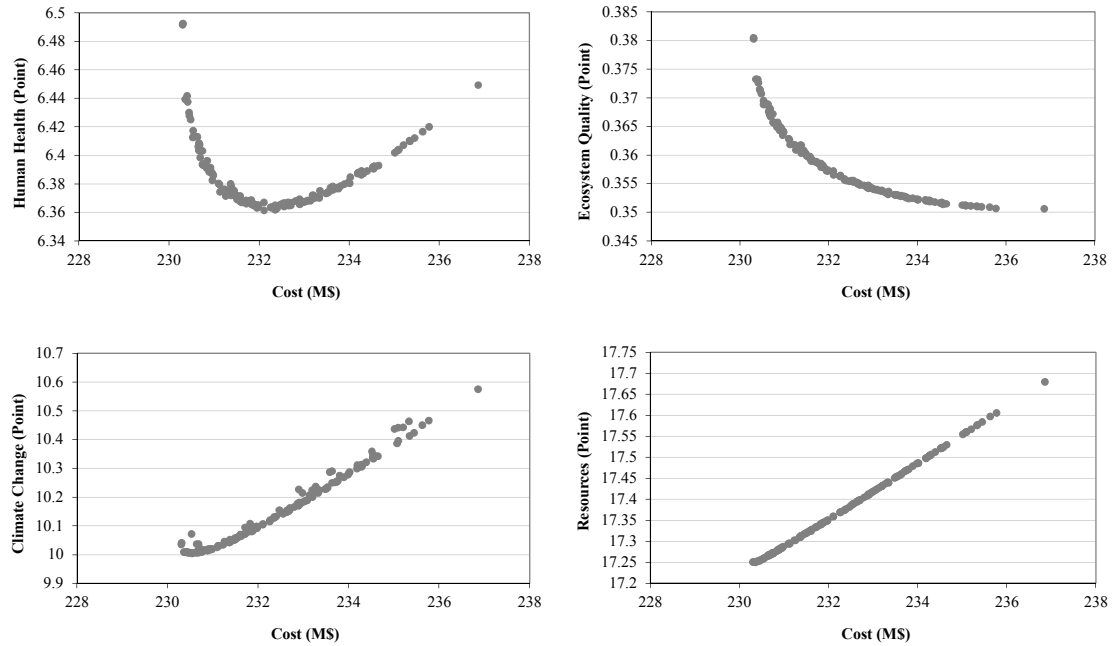

Figure 4.8 Two dimensionally comparisons of Pareto front (5 criteria optimization runs)

The results clearly show that there is a strong linear correlation between cost and climate change on the one hand and between resources and environmental criteria on the other hand. If the operation cost decreases then these environmental indicator decreases. This is confirmed by the value of the correlation coefficient (see Table 4.7). It must be also observed that lower and upper bounds of each criterion do not vary significantly.

Table 4.7 Correlation coefficient between environmental and economic criteria

	Cost	Human Health	Ecosystem Quality	Climate Change	Resources
Cost	-	-0,101	-0,888	0,987	0,998
Human Health	-0,101	-	0,547	0,030	-0,081
Ecosystem Quality	-0,888	0,547	-	-0,817	-0,879
Climate Change	0,987	0,030	-0,817	-	0,989
Resources	0,998	-0,081	-0,879	0,989	-

The obtained results lead us to consider a new optimization run with only 2 remaining criteria: Operating Cost and Human Health for which the lowest correlation coefficient is observed and exhibiting antagonist behaviour in a portion of the domain. Figure 4.9 shows the Pareto front obtained where the unit of "x" axis is millions of dollars per year and "y" axis unit is points.

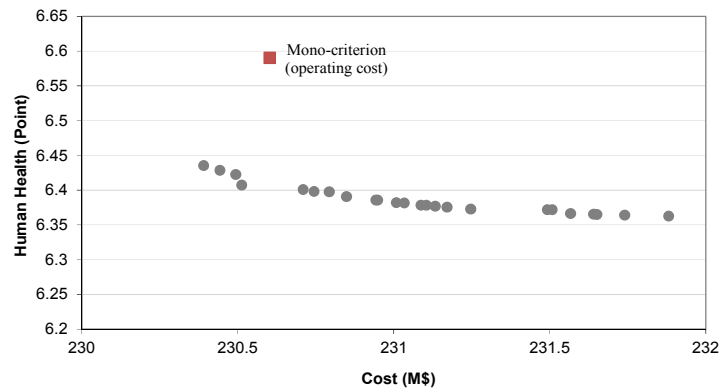

Figure 4.9 Pareto front obtained for bi-criteria optimization

Even if the reduction in the number of criteria makes the optimization process easier and facilitates interpretation, the domain variation of both criteria is narrow (very close values are obtained through a mono-criterion optimization), thus suggesting that the problem tend to exhibit a mono-criterion behaviour, requiring a further more detailed analysis on the solutions in the Pareto front. It is important to highlight that the end-categories are by nature computed from a weighting aggregation of intermediate categories. Table 4.8 shows the variability analysis of the corresponding mid-point categories for all the solutions in the Pareto Front.

Table 4.8 Variability analysis of mid-point categories for all the solutions in the Pareto Front

End criteria	Mid-point categories	Variability indicator (%)
Human Health	Carcinogens	0.05
	Ionizing radiation	0.15
	Non-carcinogens	0.08
	Ozone layer depletion	0.22
	Respiratory inorganics	0.02
	Respiratory organics	0.09

The results in Table 4.8 show that Carcinogens, Non-carcinogens, Respiratory inorganics, Respiratory organics categories exhibit a low variability indicator, while Ozone layer depletion category takes the highest value. The lack of variability of environmental criterion in the Pareto front of Figure 4.9 can

be explained by a predominant value of the category indicator with low variability that penalizes the other terms, so that optimization becomes inefficient.

Regarding cost criteria, lack of variability showed on the Pareto front is because optimization variables converge to the same value. For example, the process variables (Conversion rate and hydrogen flow in the purge) have a variability indicator nearly to zero (0.09% and 1.8% respectively). Since there is no variation of these variables, the costs associated with raw materials and utilities are practically the same in all solutions of the Pareto front and predominate the cost variation caused by the energetic ratio optimization variable (variability indicator = 18%). In the following optimization runs, the bi-criteria optimization is performed with ozone layer depletion mid-point category and operating cost as performance indicators.

4.5.4 A detailed analysis of Pareto front

4.5.4.1 Selecting potential solutions

A bi-criteria optimization corresponding now to ozone layer depletion and operational cost is run with the same configuration parameters of the genetic algorithm. Figure 4.10 shows the obtained Pareto front. A larger variation is observed for both criteria thus justifying that a bi-criteria analysis is relevant. To choose a unique solution, an analysis with MCDM methods M-TOPSIS, ELECTRE and PROMETHEE is performed to find the top-ranked solution; parameters required by the methods are shown in Table 4.9. As previously, a comparison between the chosen solutions from the Pareto front and the solution that can be obtained when considering a mono-criterion optimization (operating cost) corresponding to the traditional design methodology is carried out. An equal weight among the criteria is used for MCDM analysis carried out with ELECTRE, PROMETHEE and M-TOPSIS methods. Table 4.10 presents the optimized values of the variables corresponding to the solutions obtained after application of each MCMD method. It can be seen that a good agreement is observed for all methods, proving the robustness of the proposed solution for this choice of weight allocation.

Table 4.9 Parameters to configure the MCDM methods

M-TOPSIS	PROMETHEE	ELECTRE
<ul style="list-style-type: none"> • Weights criteria <ul style="list-style-type: none"> - see Table 4.10 • Optimized ideal reference point <ul style="list-style-type: none"> - [min, min] 	<ul style="list-style-type: none"> • Weights criteria <ul style="list-style-type: none"> - see Table 4.10 • Preference function <ul style="list-style-type: none"> - Usual criterion • Preference function threshold value <ul style="list-style-type: none"> - 0.003 	<ul style="list-style-type: none"> • Weights criteria <ul style="list-style-type: none"> - see Table 4.10 • Concordance threshold value <ul style="list-style-type: none"> - 0.1 • Discordance threshold value <ul style="list-style-type: none"> - 0.96

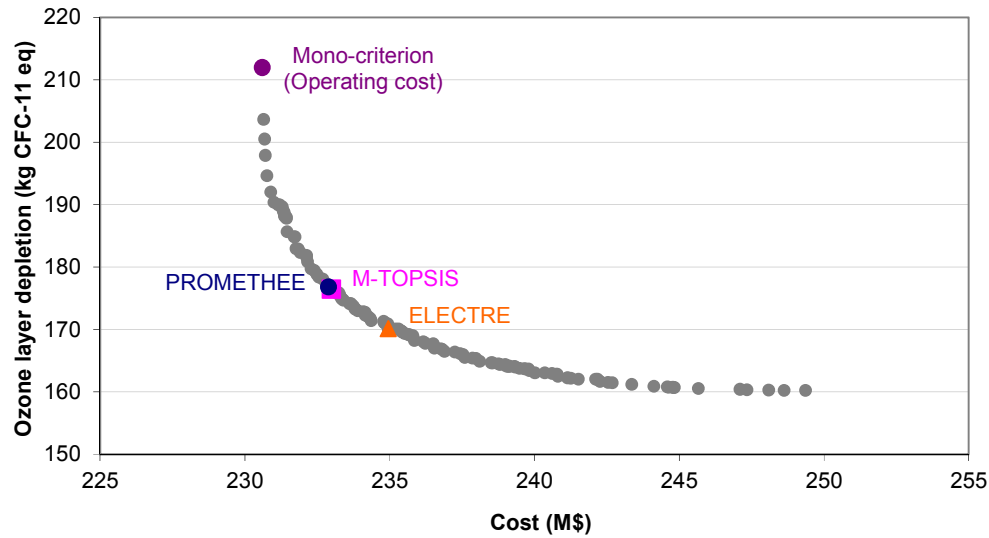

Figure 4.10 Pareto front with selected solutions by MCDM methods

The values of conversion rate and hydrogen flow rate variables indicate that they reach the upper limit of the range set in the genetic algorithm (Table 4.2) while fuel ratio variable takes a value within the proposed range.

Table 4.10 Optimization variables values from solutions selected by MCDM methods

	Mono-criterion	ELECTRE		PROMETHEE		M-TOPSIS	
	Cost	Cost(M\$)	OLD*	Cost(M\$)	OLD*	Cost(M\$)	OLD*
		230.6	234.95	170.04	232.89	176.78	232.99
MCDM weight	-	0.5	0.5	0.5	0.5	0.5	0.5
Conversion rate (%)	90	90		90.00		90	
Flow rate hydrogen (kmol/h)	287.5	299.6		296.5		287.6	
Energetic ratio (%)	0.49	0.31		0.35		0.35	

*Ozone layer depletion (kg CFC-11 eq)

4.5.4.2 Results analysis

4.5.4.2.1 Environmental impact analysis of the potential solutions

Table 4.11 presents the operating conditions corresponding to the three solutions corresponding to multi-objective optimization and to the mono-criterion solution. Not surprisingly, the three selected solutions exhibit quite similar values for the multi-objective case concerning raw materials, emissions and utilities flows (steam, water and electricity).

Table 4.11 Operating conditions from solutions selected by MCDM methods

	Mono-criterion	Bi-criteria (Cost-Ozone Layer Depletion)		
	Cost	ELECTRE	PROMETHEE	M-TOPSIS
Raw materials				
Toluene (kg/h)	29335.25	29376.42	29365.52	29365.52
Hydrogen (kg/h)	1207.58	1233.90	1232.71	1232.71
Methane (kg/h)	505.77	516.79	516.29	516.41
Purge				
Methane (kg/h)	5698.27	5700.67	5644.39	5474.34
Hydrogen (kg/h)	579.17	603.90	597.70	579.75
Energy				
Steam (ton/h)	50.73	50.45	50.43	50.44
Fuel Furnace (ton/h)	4.69	3.42	3.64	3.63
Natural gas – Furnace (Nm ³ /h)	5204.32	7963.67	7053.09	7091.26
Natural gas - Turbine (Nm ³ /h)	5475.74	5443.76	5442.41	5442.73
Emissions				
Process furnace				
CO ₂ (ton/h)	24.81	26.38	24.98	25.02
CO (kg/h)	257.58	346.44	314.52	315.84
SO ₂ (kg/h)	187.80	137.08	145.63	145.21
NO _x (kg/h)	58.55	79.03	71.69	72.00
H₂/CH₄ furnace				
CO ₂ (ton/h)	15.66	15.67	15.52	15.05
Gas turbine				
CO ₂ (ton/h)	10.42	10.36	10.35	10.35
CO (kg/h)	208.44	207.22	207.17	207.18
SO ₂ (kg/h)	0.07	0.07	0.07	0.07
NO _x (kg/h)	47.71	47.44	47.42	47.43

The main variation that can be observed is produced by the energetic ratio optimization variable controlling the percentage of fuel needed to operate the process furnace (the furnace operates both with natural gas and fuel). The CO₂ and NO_x emissions are related to the consumption of natural gas and this in turn is related to the variation of the ratio. So when the ratio indicates an increase in the amount of natural gas, there is an increase in the emissions related, the same situation occurs for the use of fuel oil.

The environmental impact of the selected solutions is presented in figures 4.11 and 4.12 through mid-point and end-point categories in normalization score in order to compare the environmental impact in all categories. The vertical axis unit in all graphs of this section is expressed in normalized points per hour. The figures show a strong effect of the energy contribution to environmental categories in terrestrial/aquatic ecotoxicity, mineral extraction, global warming and a quasi-exclusive one to ozone layer depletion.

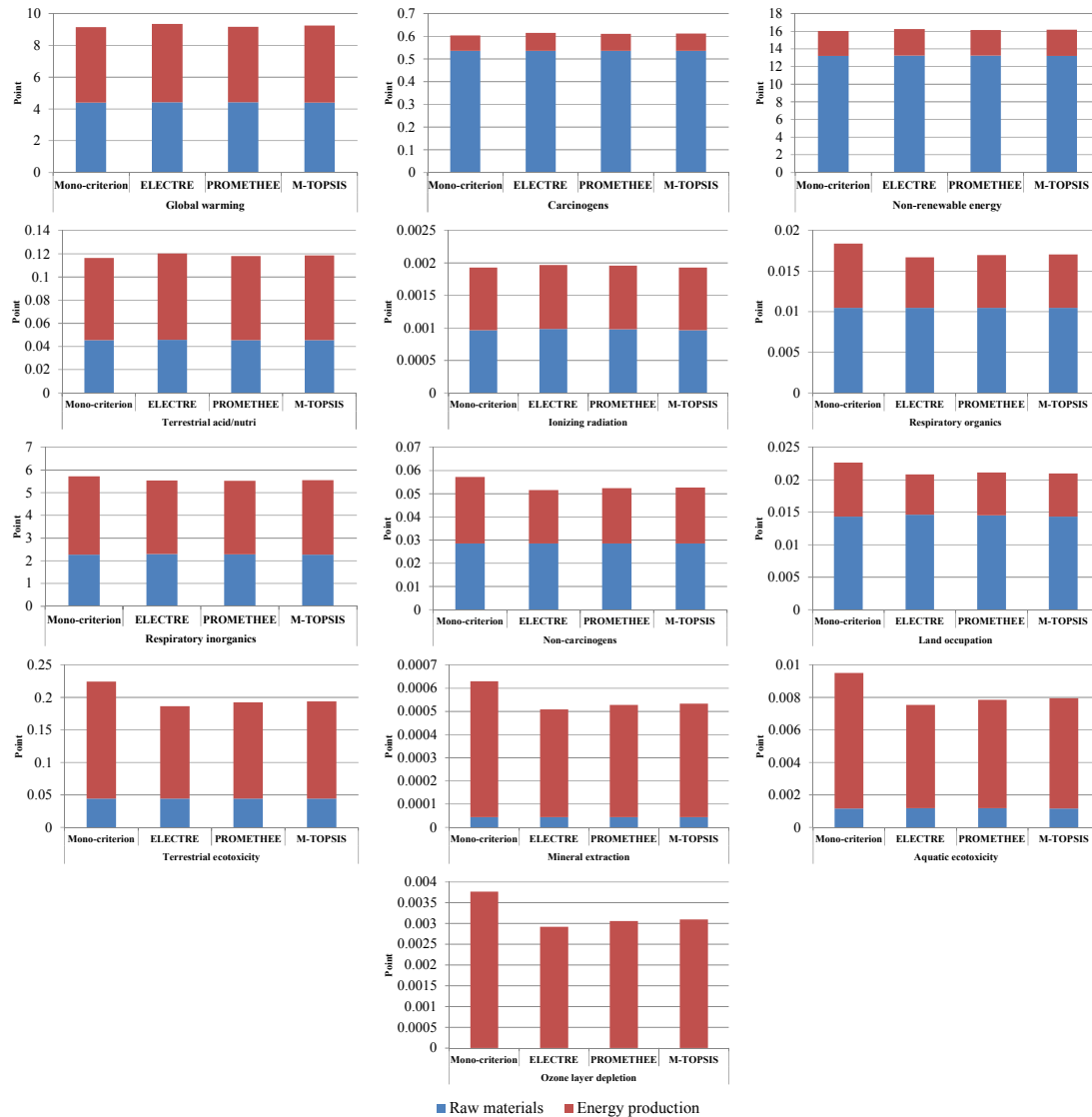

Figure 4.11 Comparison of normalization results in mid-point categories

The results demonstrate once more that even if the end-point categories are more interesting from an interpretation viewpoint in the cause and effect relationship, the benefit that can be obtained is not so significant and is masked by the contribution of one penalizing mid-point contribution. The life cycle perspective can also be quantified in the environmental results. These results show that process optimization can improve the quality of the LCA and vice versa.

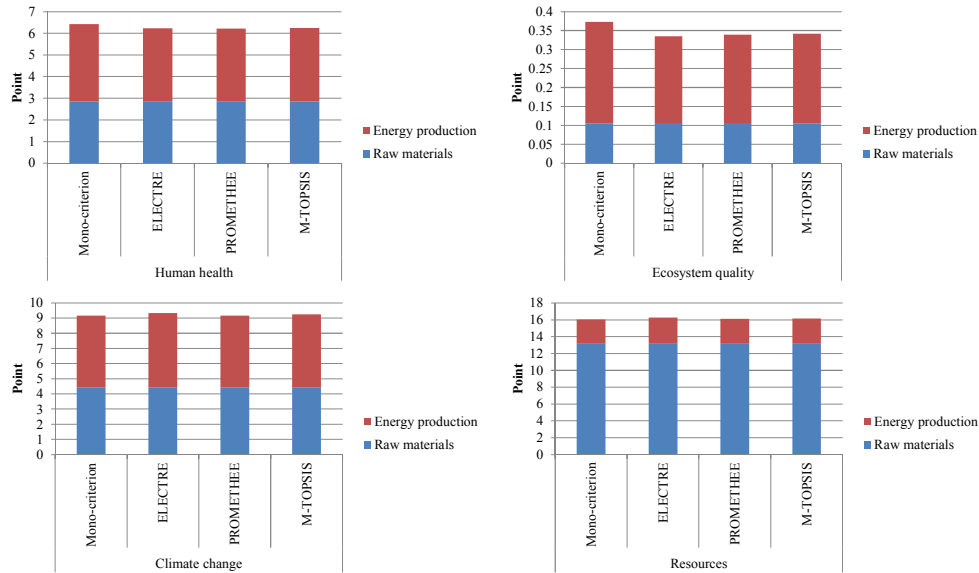

Figure 4.12 Comparison of simulation results in the four end-point categories (normalization)

Figure 4.13 shows a detailed analysis of some significant mid-point categories.

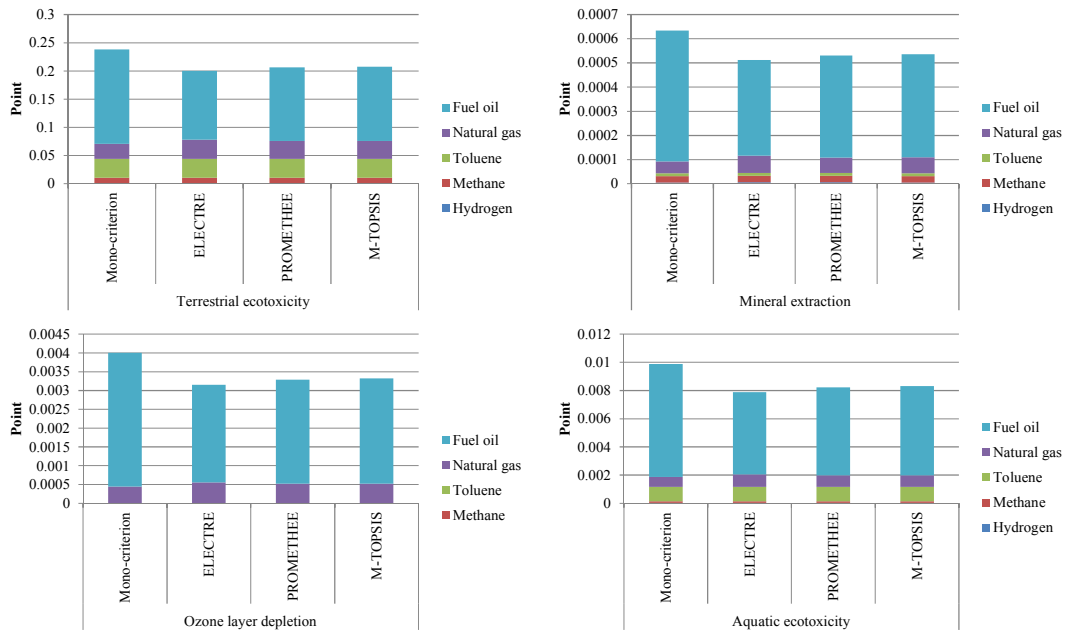

Figure 4.13 Analysis of the individual impact of the LCI components in mid-point categories

Clearly, fuel oil is the main contributor to these categories. The results show that there is a significant improvement in the environmental impacts the operational cost is practically not affected, which justifies the use of a multi-objective optimization framework. The “hot spots” of the system are the process furnace that uses both a mixture of fuel oil and natural gas and also the gas turbine that

consumes natural gas (see Figure 4.14). The relative use of these fuels is expressed via the energetic ratio.

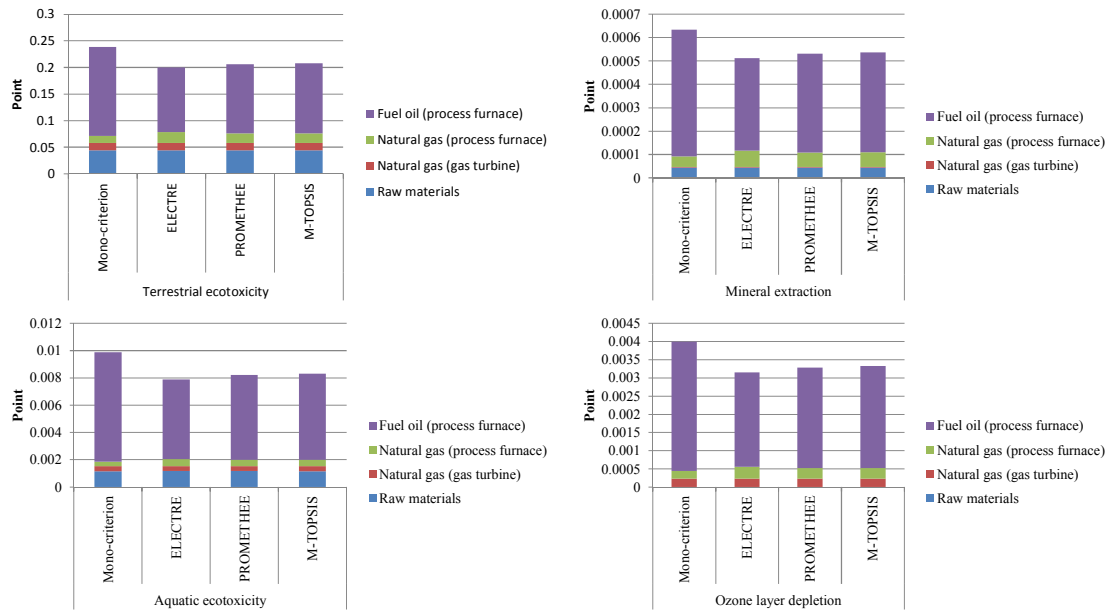

Figure 4.14 Analysis of the individual impact of the fuels in mid-point categories

4.5.4.2.2 Comparison of potential solutions in environmental categories and operating cost

The operating cost and the environmental impact of the selected solutions are now represented through radar charts in Figure 4.15 through mid-point and end-point categories respectively. Table 4.12 shows the calculated gain relative to the mono-criterion solution for MCDM solutions. The calculated gain means an increased (positive value) or decreased (negative value) percentage of the environmental impact and the operating cost.

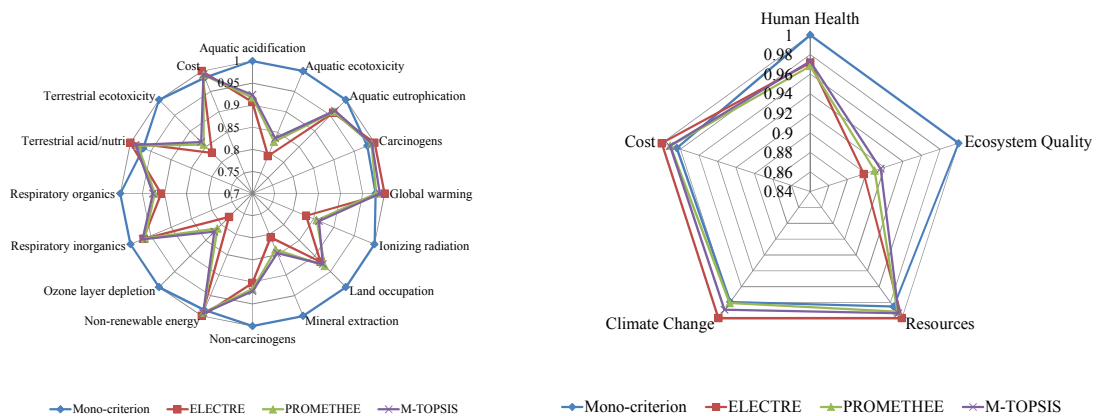

Figure 4.15 Comparison of operating cost and environmental results in mid- and end-point categories

Table 4.12 Gain calculated relative to the mono-criteria solution

	Gain		
	ELECTRE	PROMETHEE	M-TOPSIS
Aquatic acidification	9.33%	8.29%	7.64%
Aquatic ecotoxicity	20.84%	17.31%	16.46%
Aquatic eutrophication	4.09%	3.81%	3.50%
Carcinogens	-1.81%	-1.05%	-1.23%
Global warming	-2.09%	-0.12%	-1.00%
Ionizing radiation	16.82%	14.24%	13.64%
Land occupation	8.13%	6.79%	7.39%
Mineral extraction	19.25%	16.28%	15.37%
Non-carcinogens	9.76%	8.32%	7.87%
Non-renewable energy	-1.48%	-0.65%	-0.86%
Ozone layer depletion	22.46%	18.78%	17.77%
Respiratory inorganics	3.20%	3.54%	3.00%
Respiratory organics	9.24%	7.78%	7.38%
Terrestrial acid/nutri	-3.28%	-1.31%	-1.94%
Terrestrial ecotoxicity	16.97%	14.31%	13.54%
Cost	-1.65%	-0.71%	-0.75%

A significant reduction in the environmental impacts can be obtained by multi-objective optimization while the operating cost remains approximately the same, which justifies the eco-design phase at earlier design stage. To emphasize this comment, the potential solutions are now compared in Figure 4.16 with those of the Pareto front (Figure 4.8) obtained in the optimization case taking into account five criteria (cost and end-point categories). The final MCDM solutions all contribute to a reduced environmental impact at a competitive cost, thus confirming the efficiency of the criteria reduction strategy followed in Section 4.5.3.

The obtained results show that Figure 4.16, the solution founded by PROMETHEE MCDM method has the lowest environmental impact in end-point categories and is located in the narrow range of the operational cost that was observed. This solution that could be chosen by the decision maker is examined in more detail in the next section.

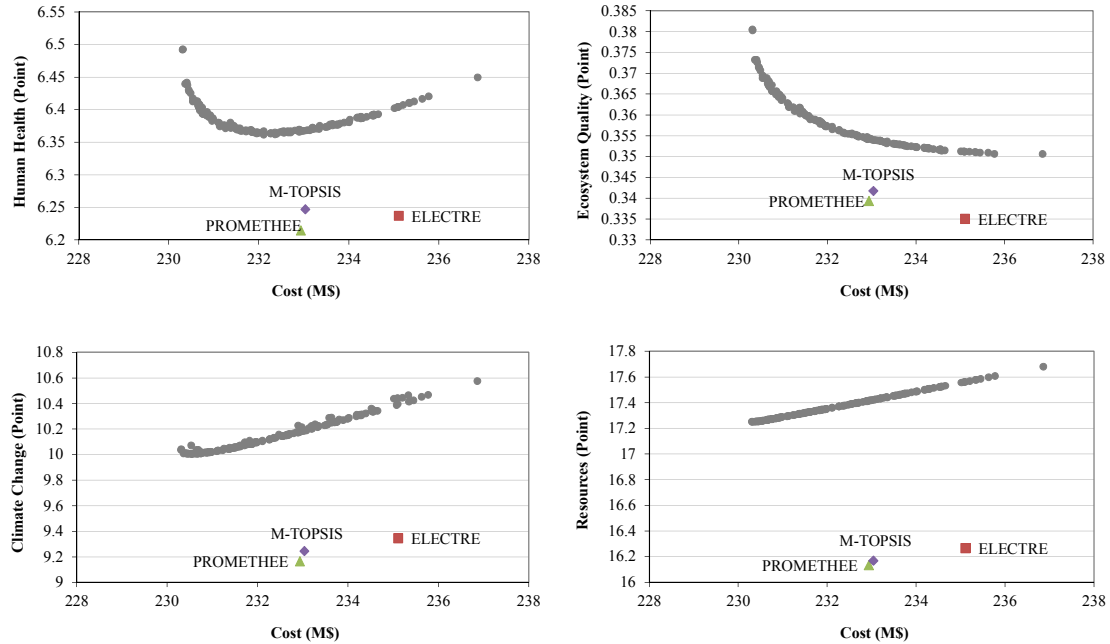

Figure 4.16 Comparison of the MCDM solutions versus 5 criteria optimization

4.5.4.2.3 Environmental impact analysis of a specific scenario

Figures 4.17 to 4.19 show the individual analysis of the environmental impact of PROMETHEE solution, in a more detailed way that it was proposed In Figures 4.12 and 4.13. Figure 4.17 shows that the use of fossil fuels and toluene as raw material contribute to the environmental impact in mid-point categories.

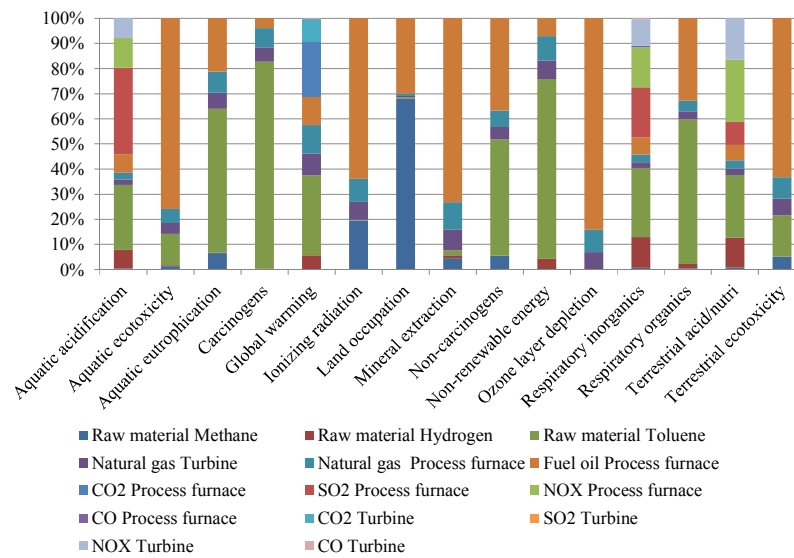

Figure 4.17 Mid-point categories analysis of the PROMETHEE solution (Characterization score)

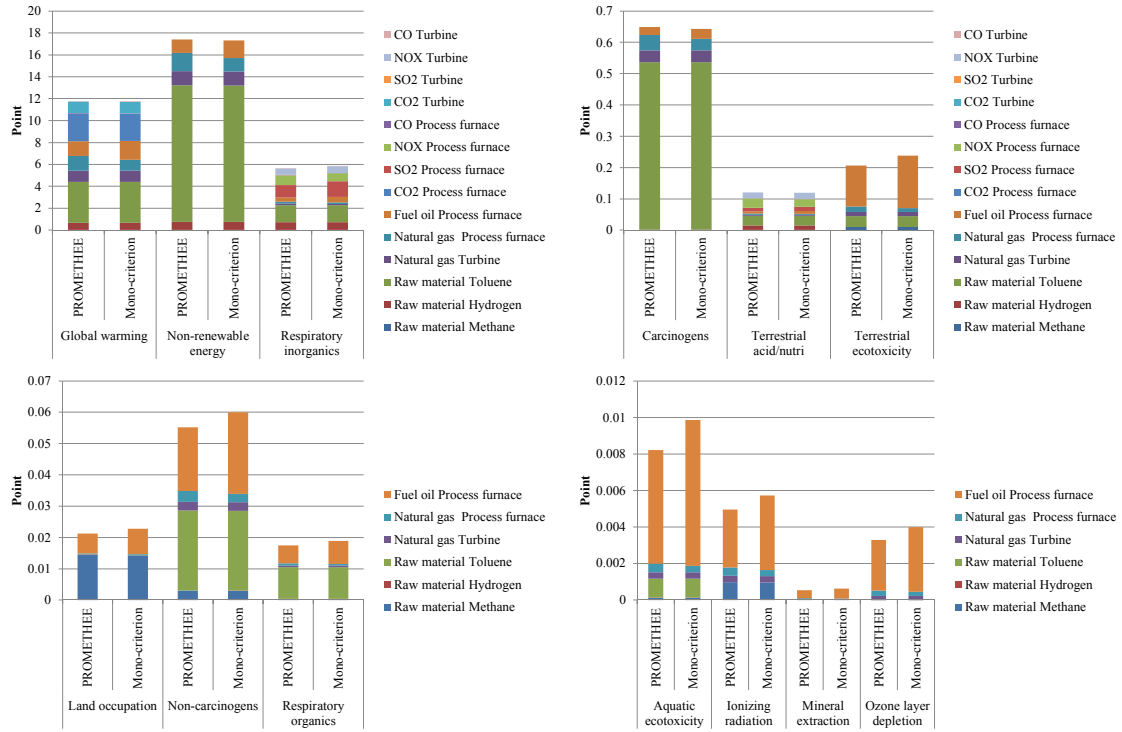

Figure 4.18 Comparison of the environmental impacts of the PROMETHEE and mono-criterion optimization

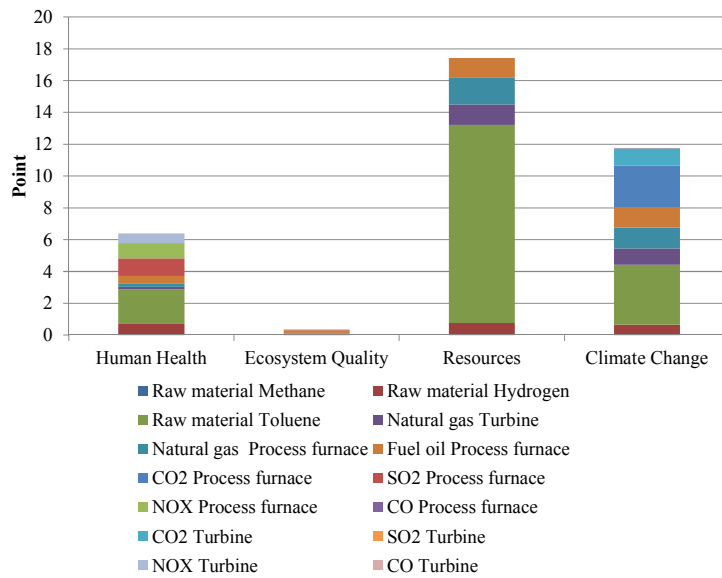

Figure 4.19 End-point analysis of the PROMETHEE solution

The interest of the approach coupling LCA and optimization is to have a complete cartography of the chosen scenario that can be obtained after the multi-level optimization strategy that was proposed. Even if the results show that the overall emissions are significantly decreased by multi-objective optimization, the contribution of fuels remains significant. The next step would be to perform energy integration of the process in a more systematic way in order to decrease the need for utilities.

4.6 Main contributions of this chapter and Conclusions

This chapter was dedicated to the optimization stage of the eco-design framework. LCA alone, or in combination with process simulation gives valuable information as highlighted in Chapter 3. Yet the information obtained from an LCA study even if systematically coupled with process simulation can be viewed as one component of a more comprehensive decision process. The main benefit in combining process simulation, LCA, multi-objective optimization and MCDM is that it enables the engineer to obtain compromise solutions taking into account the environmental impacts and an economic criterion related to the studied process unit and its associated energy production plant. The methodological approach that was presented leads to the development of a tool that combines process simulation, LCA, multi-objective optimization and MCDM.

Multi-objective genetic algorithms (GA) have been adopted to tackle the problem of optimization with conflicting objectives. The literature analysis and the background acquired in previous works (Gomez, 2008 [178], Aguilar, 2006 [192], Ponsich, 2006 [193]) confirmed this choice. As an a posteriori method, GA is particularly attractive since a set of potential solution candidates can be generated without subjective judgement of the decision maker. The final choice can then be performed with an MCDM method, among optimal solutions, so that “sub-optimal” solutions have been discarded along the optimization process.

A key issue that was considered first concerns the formulation of the eco-design problem based on LCA environmental impacts and the relevance of end-point or mid-points indicators due to the difficulty to consider simultaneously all these indicators. A large number of objectives, generally more than ten are involved when carrying out Life Cycle Assessment. According to the dedicated literature, multi-objective optimization methods are yet applied only to problems having a lower number of objectives. Among these methods, existing evolutionary multi-objective optimization methods, which turned out to be very attractive due to their ability to lead to a well-representative set of Pareto-optimal solutions in a single simulation run, are generally applied only to problems having about 5 objectives or so. The major impediments in handling a large number of objectives relate to stagnation of search process, increased dimensionality of Pareto-optimal front, large computational cost, and difficulty in visualization of the objective space. Furthermore, several objectives are redundant so that a multi-objective strategy is not, strictly speaking, necessary.

This explains why a multi-level assessment for multi-objective optimization was implemented. The case study considers the HDA process and the observed trends are obviously only valid for the considered scenario and no attempt to generalize the scope of the results could be made.

Level 1: *Multi-objective optimization with end-point category indicators.* First, end-point indicators were considered in the multi-objective optimization framework to limit the number of environmental objectives. The analysis reveals that some criteria exhibit the same trend, thus suggesting that it is not necessary to take them all into account in the optimization process. New optimization runs with only two criteria, i.e., operating cost and human health for which the lowest correlation coefficient are then performed. Even if the reduction in the number of criteria makes the optimization process easier and facilitates interpretation, the domain variation of both criteria is narrow (very close values are obtained through a mono-criterion optimization), thus suggesting that the problem tends to exhibit a mono-criterion behaviour, requiring a further more detailed analysis on the solutions in the Pareto front. It is important to highlight that the end-categories are by nature computed from a weighted aggregation of intermediate categories. The variability analysis of the corresponding mid-point categories for all the solutions in the Pareto Front has been examined.

Level 2: *Variability analysis of mid-point categories for all the solutions in Pareto Front.* The analysis of Carcinogens, Non-carcinogens, Respiratory inorganics, Respiratory organics categories exhibit a low variability indicator, while Ozone layer depletion category takes the highest value. This variability analysis was performed from the results of the previous 2D optimization. The lack of variability in the Pareto front can be explained by a predominant value of the category indicator with low variability that penalizes the other terms, so that optimization becomes inefficient. In the following optimization runs, the bi-criteria optimization is performed with ozone layer depletion mid-point category and operating cost as performance indicators.

Level 3: *Multi-objective optimization with mid-point category indicators corresponding to the highest level of variability.* A subsequent bi-criteria optimization corresponding to ozone layer depletion and operational cost is run with the same configuration parameters of the genetic algorithm. A larger variation is observed for both criteria thus justifying that a bi-criteria analysis is relevant.

Level 4: *MCDM assessment and selection of the potential solution.* To choose a unique solution, a comparative analysis with classical MCDM methods, i.e., M-TOPSIS, ELECTRE and PROMETHEE is performed to find the top-ranked solution. In the three cases, similar trends are obtained thus confirming the robustness of the approach with an identical set for the weights involved in the MCDM methods to represent the preference of the decision maker towards a criterion.

Level 5: *Cartography of the solution.* A more detailed analysis of the solution that exhibits the best performance is then performed both for mid-point and end-point levels. A significant reduction in the environmental impacts can be observed by multi-objective optimization while the operating cost

remains approximately the same, which justifies the eco-design phase at earlier design stage.

Level 6: *Suggestion for further improvement.* It has been shown that LCA and process simulation can be successfully combined in order to optimize the system with respect to emissions. The case study clearly highlights that the utilities used in the process strongly contribute to the emissions. The two models used for the process unit and the utility plant have the possibility to assign the corresponding emissions to the units in the process, in addition to distinguishing emissions from the process and the utilities. Further improvement could be twofold: performing energy integration of the process in a more systematic way in order to decrease the need for utilities and or suggesting new equipment items for energy generation, use of new fuels....

Although the eco-design treated in this work is an example of LCA applied to a process, the framework presented also applies to the traditional LCA; the one used to evaluate products. Traditional LCA also includes processes, where process optimization in general and process integration in particular can be introduced.

The eco-design approach has been developed by combining different process systems engineering methodologies – process simulation-multi-objective optimization-MCDM methods – into one coherent framework. It is now applied to the case of biodiesel process.

5 ECO-DESIGN OF BIODIESEL PRODUCTION PROCESS

Résumé

Le chapitre 5 vise à appliquer l'approche d'éco-conception développée dans les chapitres précédents. La production de biodiesel à partir d'huiles végétales usagées, en tant qu'alternative à des combustibles fossiles sert de cas d'étude. Une première analyse «porte à porte» est effectuée en vue de comparer et de valider le modèle de simulation développé à partir de résultats de la littérature. Ensuite, l'analyse est élargie "du berceau à la porte". Les outils utilisés sont les mêmes que dans les chapitres précédents: simulateur de procédé (HYSYS) simulateur de production d'énergie (Ariane), outil d'ACV (SimaPro) et procédure d'aide à la décision (M-TOPSIS). Là encore, l'ACV réalisée est de type attributionnel.

Nomenclature

Acronyms

acid/nutri	Acidification/nitrification
C₅₇H₁₀₄O₆	Triolein
FFA's	Free fatty acids
H₂SO₄	Acid sulphuric
KOH	Potassium hydroxide
LCA	Life Cycle Assessment
LCIA	Life Cycle Impact Assessment
MCDM	Multi Choosing Decision Making
MT	Million tons
MODE-TL	Multi-objective differential evolution with taboo list
NaOH	Sodium hydroxide
NRTL	Non-Random Two Liquid Model
NSGA-II	Non-dominated Sorting Genetic Algorithm-II
TOPSIS	Technique for Order Preference by Similarity to Ideal Solution
UNIQUAC	UNIversal QUAsiChemical Model
WVO	Waste vegetable oils
WAR	Waste reduction

Symbols

CostE_x	Energy cost of type x
CostRM_y	Raw material cost of type y
Costw_z	Waste cost of type z
EJ	Exajoule = 10^8 Joule
Flow_{bd}	Biodiesel flowrate in output stream
K	Kelvin
kg/h	Kilogram per hour
kPa	KiloPascal
kWh	Kilowatt per hour
Nm³/h	Normal Metres Cubed per Hour
Price_{bd}	Price of biodiesel (\$/kg)
QE_x	Energy amount of type x
QRM_y	Raw material amount of type y
Qw_z	Waste amount of type z
ton/h	Tonne per hour

5.1 Introduction

This chapter aims at presenting the application of the eco-design methodology to the biodiesel production. Chapter 3 has presented the approach coupling process simulation tools for both production process and energy generation with LCA model and economic module. The next step was to integrate multi-objective optimization in Chapter 4. The optimization/decision aid has been used to minimize simultaneously the environmental and economic criteria (midpoint and endpoint categories, and operating cost respectively). In this chapter, the combination of process modelling, multi-objective optimization and life cycle assessment is applied to the biodiesel production process from waste vegetable oils (WVO).

The choice of this study case is part and parcel of the global incentive of this work. The motivation for development and use of alternative fuels gathers the decreasing stock of readily recoverable oil, the concern about global climate change, the increase in fuel prices and the desire of energy independence. Alternative energy sources and fuels are being developed to make up energy deficit. In this context, producing biodiesel can be a very promising solution to overcome the difficulties linked to the energy crisis. Several processes exist in the literature to produce biodiesel and a bibliographic analysis is proposed in the next section of this chapter.

More specifically, the aim of this chapter is to model and optimize biodiesel production by acid-catalyzed process (section 5.2) as an illustration of the whole methodological framework presented in this manuscript. The following section details the operating conditions of the process. Then, the simulation is carried out with Aspen HYSYS software while energy production modelling and emission computation are analysed using Ariane (5.3). Section 5.4 determines the inventory data and potential environmental impact factors of the process. Section 5.5 is devoted to the embedding of the optimization step on top of the eco-design procedure where LCA and process integration have been used to increase both environmental performances and economic criteria. Finally, conclusions emerging from this analysis are highlighted.

5.2 Biodiesel production: context and production processes

5.2.1. Introduction to biodiesel production

The U.S. Energy Information Administration determined that total world energy consumption in 2005 was 488 EJ (Exajoule = 10^8 Joule). It has been shown that energy world consumption is expected to exceed 650 EJ, by 2025 (Energy Information Agency, 2007). The exhaustion of stocks of fossil fuel supplies in combination with significant environmental and human impacts of petroleum fuel usage make urgent the development of alternative fuels that come from renewable resources. In this context,

biofuels are a very promising solution. They include fuels derived from biomass conversion, as well as solid biomass, liquid fuels and various biogases. First, the scientific community was interested in the production of biofuel with vegetable oils [194], [195] because it is derived from renewable resources, which make biodiesel greener than petroleum diesel. However, the main drawback of producing a great quantity of biodiesel from vegetable oil is due to the lack of feedstock and then, some ethical problems arise because of the utilization of a food product to make biofuel. Recently, lignocellulosic biomass and waste vegetable oils seem to be good candidates as feedstock for the production of biodiesel [196]–[199].

Biodiesel is a renewable fuel for diesel engines and can be produced by vegetable oils or animal fats. To be called biodiesel, it must meet the strict quality specifications of ASTM D 6751. Biodiesel can then be used in any blend with petroleum diesel fuel (biodiesel.org). Biodiesel reduces net carbon dioxide emissions by 78% on a life-cycle basis as compared to conventional diesel fuel [200]. It has also been shown to have consequent improvements on engine exhaust emissions. Moreover, it is biodegradable and non-toxic and has a more favourable combustion emission profile than diesel, such as lower emissions of carbon monoxide, particulate matter and unburned hydrocarbons. Drapcho et al. [201] had shown that the main pollutant emissions can be greatly reduced with the use of a pure biodiesel by comparing the emissions between the use of 100% biodiesel (B100) and a blend of 20% biodiesel and 80% conventional diesel (B20) (Figure 5.1).

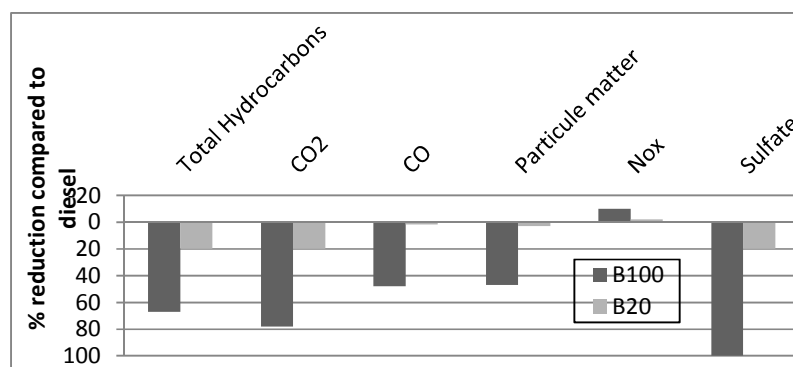

Figure 5.1 Percent reduction in emissions of pollutants for B100 (100% biodiesel) and B20 (20% biodiesel) compared to conventional diesel (adapted from [201])

Moreover, its high flash point ($>130^{\circ}\text{C}$) makes it less volatile than diesel and safer during its handling and transportation. The utilization of waste oils can help producing cheaper biodiesel and it can also solve the problem of waste oil disposal. Hence, waste oils can be considered as strong candidates for the production of biodiesel [202]. Waste oils represent a high quantity of cheap feedstock: 4-8 million tons (MT)/year in China [203], 1.4 MT/year in the USA, 150 KT/year in Canada [204], around 1MT/year in European countries and then around 600 KT/year in Japan [195]. A great variety of

sources of waste oils are explained in [205]: waste cooking oil, animal fats, yellow grease, brown grease or soapstock.

All these motivations lead the scientific community to investigate in this field in order to design a greener production process. Besides the numerous experimental studies dealing with the characteristics of biodiesel [206]–[208], numerous works studied the simulation and the environmental performances of biodiesel production processes. Zhang et al. [209] conducted an economic evaluation of four different processes, showing that the acid-catalyzed process is more economic than the others. The great majority of previous studies performed an optimization of the process with a single objective, mainly based on economic performance. West et al. [210] also model four alternative production processes and conducted a comparison between them through an economic objective. More recently, some researchers have evaluated environmental impacts of biodiesel production processes through a life cycle assessment methodology. For example, Morais et al. [196] and Varanda et al. [211] compared several production processes by assessing environmental and economic performances. They found that marine aquatic eco-toxicity and depletion of abiotic resources are the most relevant impact categories (PEI). These authors also showed that the acid-catalyzed process is particularly pollutant due to its high-energy requirements, given that the steam is produced using only fossil fuels.

Some studies deal about simulation coupled with an optimization step of biodiesel production process [212], [213]. However, only one recent study introduces a multi-objective optimization of the production process. Sharma and Rangaiah [214] have used a multi-objective differential evolution with taboo list (MODE-TL), with the aim at reducing the number of objective function evaluations to obtain the global optimum. In their study, the optimization is carried out with three objectives: maximum profit, minimum fixed capital investment and minimum organic waste after a step of simulation with HYSYS.

5.2.2. Biodiesel production processes

Among the several routes to transform oil in biodiesel such as pyrolysis or micro-emulsion, the transesterification reaction process is the most common method to obtain biodiesel. A lot of methods exist to carry out the transesterification reaction such as the common batch process, supercritical processes, ultrasonic methods, acid, alkali or enzyme-catalyzed processes and even microwave methods. However, the most studied and the most commonly used are the traditional acid or alkali processes, consequently, a particular focus on these two methods is presented in the following section.

The transesterification reaction of the oil composing feedstock is as follows:

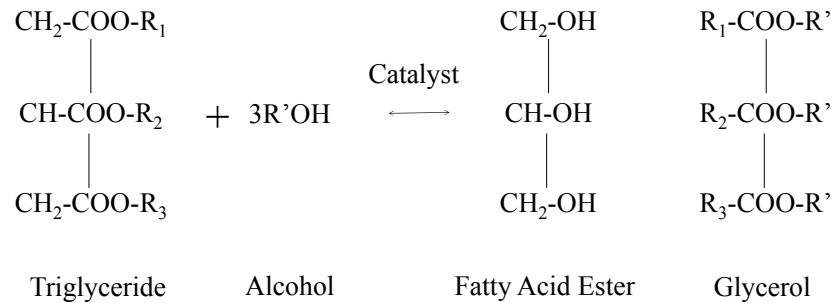

A catalyst needs to be introduced to enhance the reaction; commonly, it can be an acid such as H_2SO_4 or HCl , or a base such as KOH or NaOH . Usually, the transesterification reaction equilibrium for acid or base-catalyzed is forced toward the biodiesel production with an excess of alcohol (commonly ethanol or methanol). When waste vegetable oils (WVO) are used as a feedstock, it can also be necessary to remove the free fatty acids (FFA's) contained through an esterification reaction consisting of a pretreatment, depending on the catalyst used. The main differences between both production processes acid versus alkali-catalyzed reaction are summarized in the table 5.1.

Table 5.1 Characteristics of the two main biodiesel production processes: alkali-catalyzed versus acid-catalyzed processes

	Alkali-catalyzed process	Acid-catalyzed process
Ratio methanol:oil	4:1 to 9:1	30:1 to 50:1
Catalyst	NaOH , KOH	H_2SO_4 , HCl
Pre-treatment of feedstock	With an esterification reaction via an acid catalyst to remove water and FFA from feedstock.	No
T° (K) of reaction	333.15 to 335.15	333.15 to 353.15
Yield	92 to 100%	82 to 99%

5.2.2.1 Alkali-catalyzed production process

Figure 5.2 represents a general view of the flowsheet used to produce biodiesel through the alkali-catalyzed process from waste vegetable oils with FFA pre-treatment. First, in the pre-treatment stage, sulphuric acid is used as an acid-catalyst in order to remove water and FFA's from the waste vegetable oils. The esterification reactor is fed with a stream of pre-heated oil, a stream of methanol and a stream of sulphuric acid. This stage generally leads to a decrease of FFA's in the oil from 6% to 0.3% [196], which is acceptable to perform the transesterification reaction. Glycerol is then used in a washing column in order to wash out sulphuric acid and water. The pre-treated oil is sent to the transesterification reactor with methanol (generally, a molar ratio of 6:1 is used) and the reaction takes place at 333.15K and 405 kPa to reach a 95% conversion of oil to biodiesel after 2h [209].

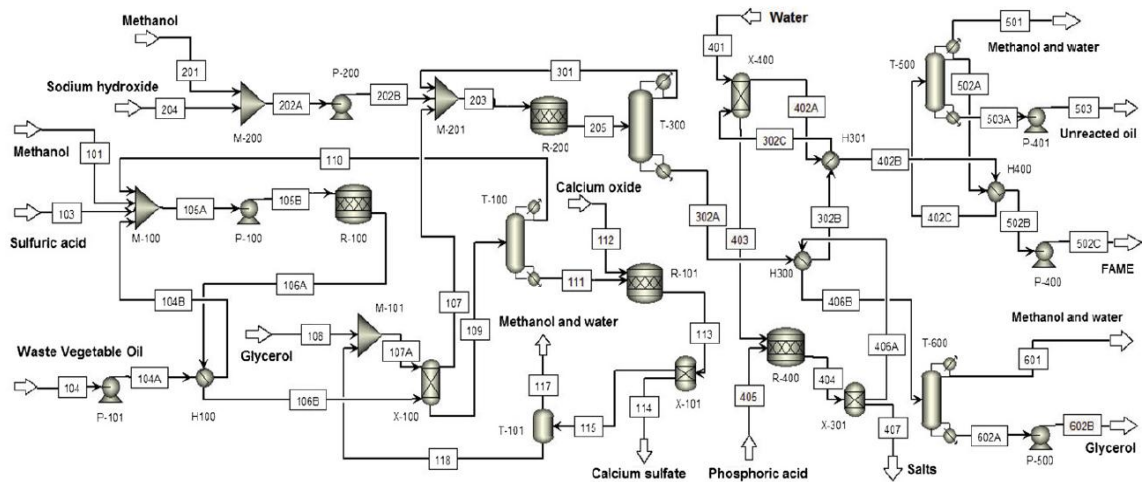

Figure 5.2 General flowsheet of the alkali-catalyzed biodiesel production process with the associated pre-treatment stage

5.2.2.2 Acid-catalyzed production process

Contrary to the alkali-catalyzed process, in the acid-catalyzed, there is no need to pretreat the oil because the reaction is less sensitive to the FFA's content of the feedstock [215]. In this process, methanol and sulphuric acid (used as a catalyzer) feed the transesterification reactor with a stream of pre-heated oil (Figure 5.3). The excess of methanol is then removed from the biodiesel in a distillation column and recycled back to the transesterification reactor. Introduction of calcium oxide [215] in the neutralization reactor leads to remove sulfuric acid from the transesterification products.

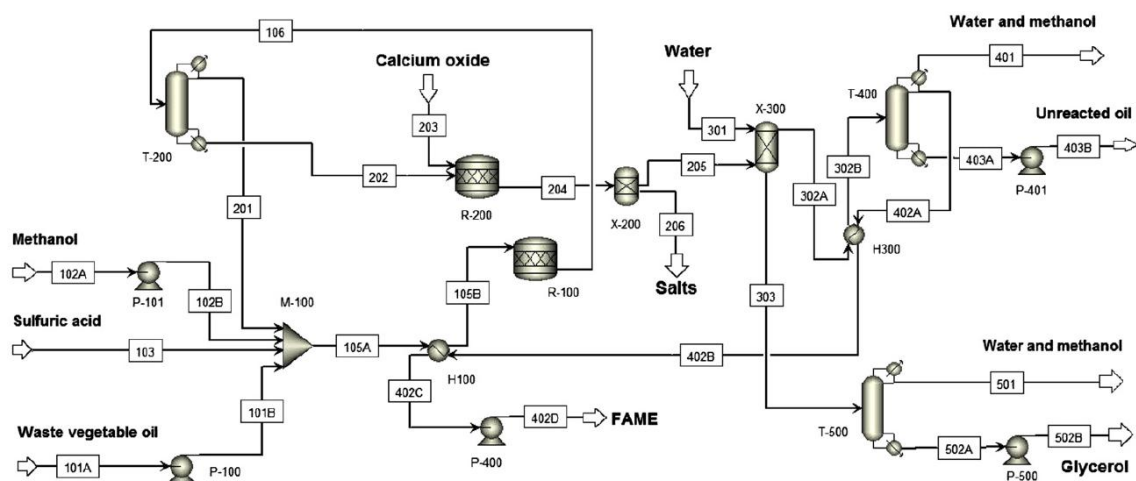

Figure 5.3 General flowsheet of the acid-catalyzed biodiesel production process

Morais et al. (2010) [196] have carried out a simulation and life cycle assessment of these two process design alternatives. Their results show that generally, higher potential environmental impacts

categories are obtained for the acid-catalyzed process. This process is particular pollutant due to the high-energy requirements of its methanol recovery unit [196]. The next sections of this chapter are dedicated to the application of the general methodology framework to the acid-catalyzed process in order to achieve a better design of this biodiesel production process. A comparison with a recent study in [214] who also studied this process is also done to validate the whole methodology.

According to the eco-design guidelines that have been proposed in the previous chapters of this PhD work, the following steps are considered: 1) a simulation of a production process with HYSYS including emission computation with Ariane, 2) a determination of inventory data to conduct an LCA analysis, 3) the multi-objective optimization of the process and 4) a detailed analysis of Pareto front and of some solutions highlighted by the decision-aid stage.

5.3. Biodiesel production simulation with Hysys

5.3.1 General assumptions

This section defines the conditions and parameters used to model the bio-diesel process using waste cooking oil with HYSYS software. Vegetable oil is a mixture of triglycerides of oleic, linoleic, linolenic, palmitic, stearic and other acids. Physical properties of different triglycerides present in vegetable oil are not much different [212]; hence, one of the triglycerides can be used to represent the vegetable oil. In this work, tri-olein ($C_{57}H_{104}O_6$). (i.e., triglyceride of oleic acid) is considered as the triglyceride in the waste cooking oil. Due to the high presence of polar components, a combination of thermodynamic/activity models is used (NRTL and UNIQUAC)

The conditions and parameters mentioned below initiate the flowsheet in HYSYS for comparison with the results obtained by Halim et al 2010 [72]. Then, the criteria are adapted to perform multi-criteria optimization taking into account the economic and environmental aspect by the IMPACT 2002+ method.

As highlighted in this thesis outline, only an attributional LCA is considered: impacts from the production of biodiesel from vegetable oil would be attributed based on the inputs and outputs from the considered system, not taking into account what happened with the other related activities in the economy. In other words, no consequential LCA approach is targeted here.

5.3.1.1 Process inputs

Raw material inputs are represented as process input streams. Table 5.2 illustrates the operating conditions. The flows of the raw materials corresponding to the base case are proposed in [72].

Table 5.2 Operating conditions of process inputs

	Input 1	Input 2	Input 2	Input 2	Input 2
Components	Methanol	Triolein	Sulphuric acid	Water	Calcium oxide
Flow rate	210 kg/h	1000 kg/h	150kg/h	110 kg/h	kg/h
Temperature	25°C	25°C	25°C	25°C	25°C
Pressure	1 bar	1 bar	1 bar	1 bar	1 bar

5.3.1.2 Reactions

The reaction set is established before starting flowsheet modelling. Two reactions are involved, one for transesterification and one for neutralization of sulphuric-acid:

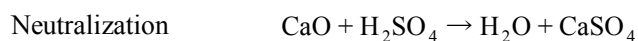

The transesterification reaction is achieved at 80°C, 4.05 bar. For these conditions, Zheng et al.[216] propose a conversion of 97% of oil to biodiesel.

5.3.1.3 Cooling

There are two coolers in the process, the first to cool the effluent from the transesterification reactor outlet and the second to cool the output of the first column responsible for the separation of methanol for recycling. The energy used in these coolers served later as an optimization variable. The energy is set at 18 and 5 kWh respectively.

5.3.1.4 Separation and Distillation

The first column of the process is used to separate the methanol from the remaining components. The second column serves to separate the product of interest; biodiesel is obtained here with a purity of 99.1%. The first and second columns are composed of 4 and 6 theoretical stages respectively. Both columns are set as a “Regular Hysys reboiler”. The pressure of the condenser and reboiler is 1 bar.

5.3.1.5 Pump and compressor in recycling

The pumps used in the process are positioned at the input of raw materials and in methanol recycling. Pressure is set at 3 and 4 bar respectively.

5.3.1.6 Economic data

The economic model used in this process is the same as in [72] and the economic criterion is based on the calculation of profit. The calculation is carried out using the basic operation:

$$\text{PROFIT} = (\text{Flow}_{\text{bd}} * \text{Price}_{\text{bd}}) - \sum_{x=1}^i \text{QE}_x * \text{CostE}_x - \sum_{y=1}^j \text{QRM}_y * \text{CostRM}_y - \sum_{z=1}^k \text{QW}_z * \text{Costw}_z$$

Where revenues derived from the sale of biodiesel and costs include raw materials, utilities and a cost for four waste streams: bottom liquid of the acid neutralization column, washwater waste of the extractor column, vent gas of the purifier column, and reboiler liquid. The price of biodiesel is 0.6 \$/kg while the cost of the other component is shown in Table 5.3.

Table 5.3 Summary of raw materials and utility prices of Biodiesel process

Raw materials	Cost (\$/kg)
Methanol	0.18
Sulphuric acid	0.06
Triolein (waste oil)	0.20
Water	0.01
Calcium oxide	0.04
Energy	Cost (\$/kWh)
Pump	0.062
Cooler	0.003
Reactor	0.003
Condenser	0.003
Reboiler1	0.01
Reboiler2	0.15
Neutralizer	0.03
Waste stream	Cost (\$/kg)
Waste vapour (vent gas)	0.05
Waste water (bottom liquid , reboiler liquid , washwater waste)	0.12

5.3.2 Validation of Biodiesel simulation model in HYSYS

The flowsheet of the process used for validation is displayed in Figure 5.4. The validation is carried out by comparing results obtained in [72] that performs an optimization of the biodiesel production process using simulated annealing tool for identifying sustainable solutions.

The economic criterion considered is the profit (as described in the previous section) whereas the environmental aspect is calculated by environmental impact factors from the WAR algorithm (see

Chapter 1) which assigns to each emitted component an index value to indicate its potential impact (Table 5.4). Let us recall at this level that each process component that is emitted is assigned an index value referred as its potential impacts to different environmental categories (ecotoxicity, global warming, ozone depletion and photochemical oxidation). In [72], the total impact of a waste stream in the plant is calculated as the sum of each component index of the waste stream weighted by its flowrate. The objective functions used in [72] are based both on the minimization of environmental impact attributed to the waste generated by the process and profit maximization.

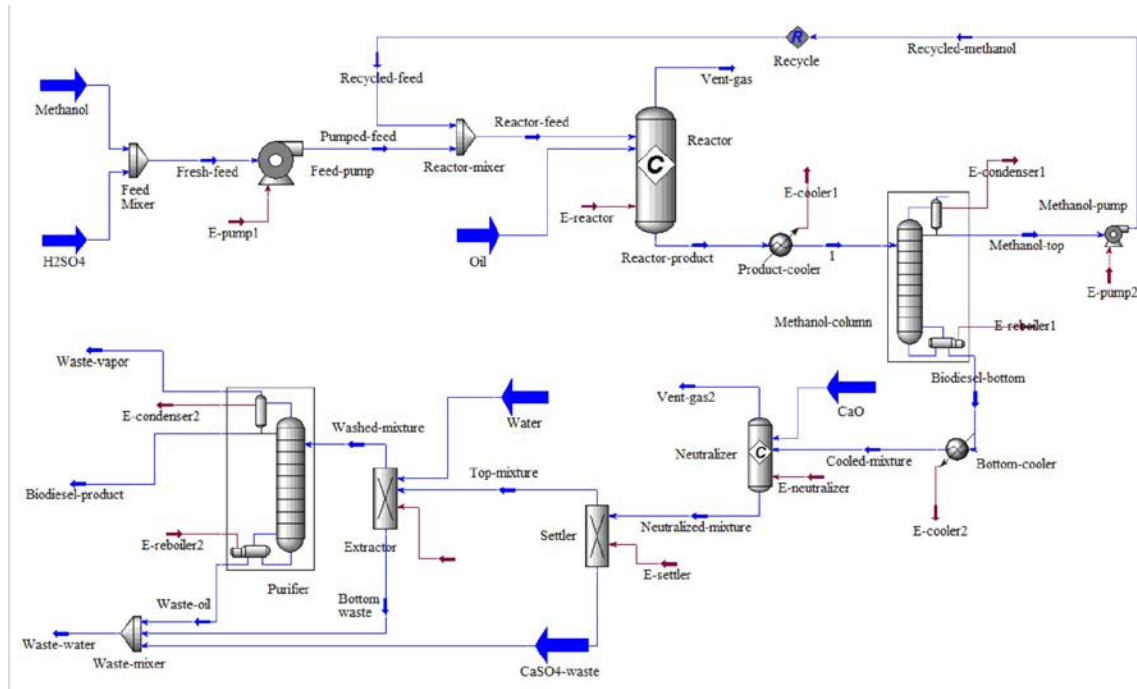

Figure 5.4 Flowsheet of biodiesel production process for gate to gate analysis from [72]

Table 5.4 Environmental data for biodiesel production (Gate to gate factors)

Environmental impact factor/kg	
Methanol	0.495
Triolein	0.020
Methyl-Oleate	0.056
Glycerol	1.838
Sulphuric acid	0.659
Water	0
Calcium oxide	0.511
Calcium sulphate	0.249

The optimization variables identified in [72] are relative to the amount of raw materials (oil, methanol, sulphuric acid and water) in addition to the energy used in the coolers as described in Section 5.3.1.3.

Table 5.5 shows the minimum and maximum bounds of each variable range used in the optimization process.

The optimization approach uses the NSGA-IIb genetic algorithm embedded in Multigen environment, with the following parameters: number of individuals in the population: 100; generation number: 50; crossover rate: 0,9; mutation rate: 0,5.

Table 5.5 Bounds for optimization variables in the biodiesel production process

Optimization variables	Minimum	Maximum
Triolein (kg/h)	975	1100
Methanol (kg/h)	208	218
Sulphuric acid (kg/h)	138	166
Water (kg/h)	103	117
Energy of cooler 1 (kWh)	17.7	18.6
Energy of cooler 2 (kWh)	4.7	5.3

The Pareto front of the optimization is compared with that obtained in [72] (see Figure 5.5). The comparison shows that the same trend is respected and that the order of magnitude of both criteria is the same on both fronts although the genetic algorithm finds better solutions for both criteria. For example, the point indicated as "Min impact" exhibits a higher profit with less environmental impact.

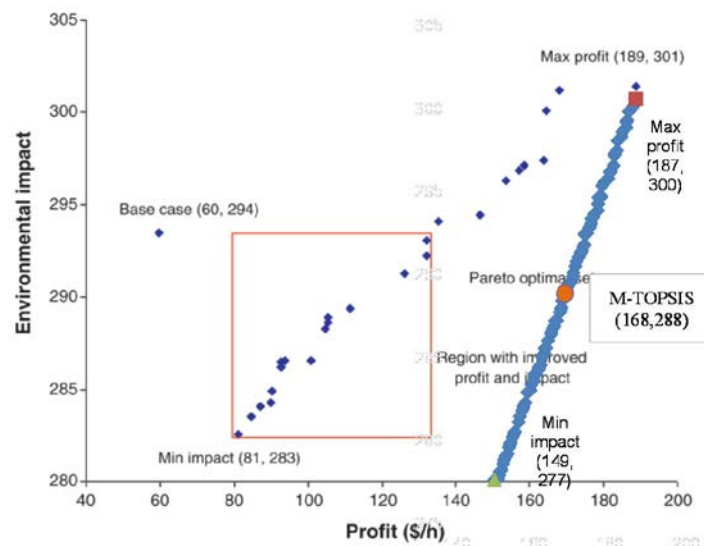

Figure 5.5 Comparison between the results obtained by MULTIGEN Front and obtained in Halim et al [72]

An analysis with MCM M-TOPSIS method is performed to find a better solution potential. The results are shown in the previous figure. Table 5.6 summarizes the operating conditions of this solution.

Table 5.6 Operating conditions of the solution proposed by M-TOPSIS

Triolein (kg/h)	Methanol (kg/h)	Sulphuric acid (kg/h)	Water (kg/h)	Calcium oxide (kg/h)	Profit (\$)	Environmental Impact
1037.03	208.1	138.07	107.23	78.94	168.16	288.9

5.3.3 Flowsheet modification for Biodiesel simulation model in HYSYS

The following analysis is then based on the environmental impact assessment using the IMPACT 2002+ LCIA method in order to perform a cradle to gate analysis. For this purpose, the previous flowsheet was modified in order to favour stream recycling. Methanol in vent gas output of the purifier column and triolein in reboiler liquid output are recycled with a purity of 99.97% and 99.99% respectively. Through recycling about 34 kg/h of methanol and 111 kg/h of triolein are recovered and injected into the process.

The modified flowsheet is presented in Figure 5.6. Subsequently, the inventory data are identified according to the stages of the approach proposed in this work.

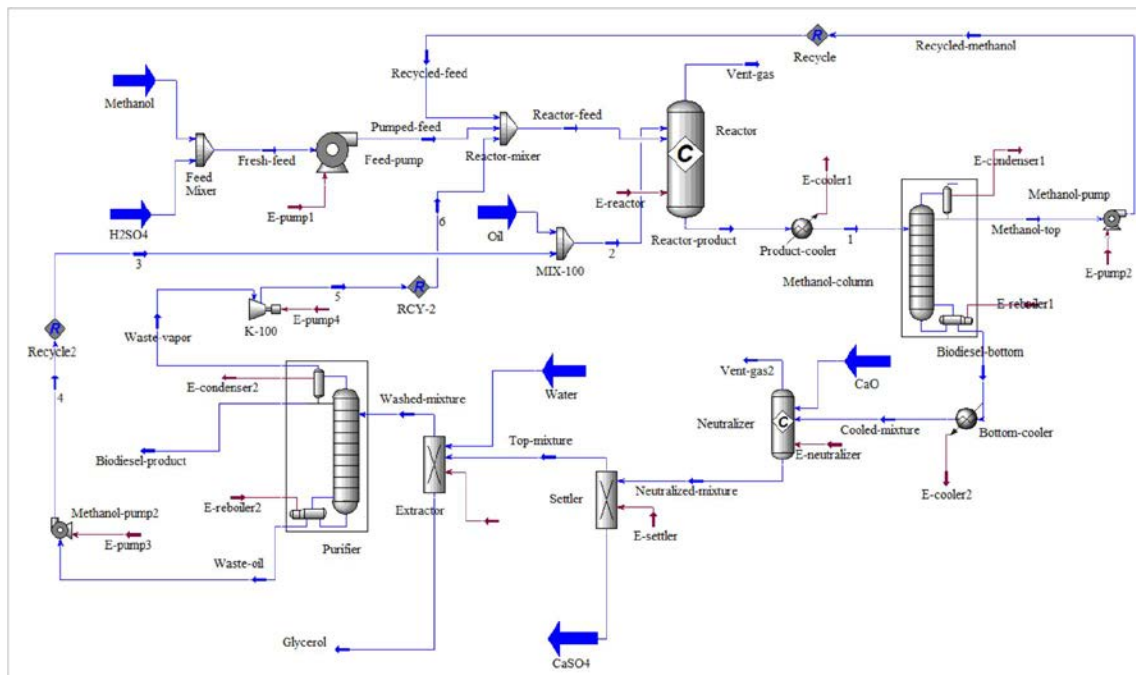

Figure 5.6 Flowsheet of biodiesel production process for gate to gate analysis (recycling paths)

5.4 Inventory data and identification of potential factors

Within the cradle to gate boundary, the environmental impact is now considered from the extraction of raw materials and primary energy needed to satisfy process energy requirements to the production of

biodiesel following the guidelines of the eco-design framework. For the identification of the inventory data of the process, some assumptions are made:

- The main raw material, triolein, is assumed to have no direct impact, i.e. which means that the production process of vegetable oil is not taken into account in the analysis
- In the process, there are two output streams that contain glycerol and calcium sulphate. These components are not taken into account in the environmental impact assessment because are considered as by-products to be valorised in another process as raw materials (as the case of waste oil). With a purity of 99.9% calcium sulphate be commercialized directly, in relation to glycerol this is obtained in a mixture where about 45% is water. For commercialization purpose, a separation process is required. This process is not considered this work; the sales of these by-products are not taken into account in the calculation of economic criteria that penalizes rentability.
- The energy requirements are provided by a gas turbine (as in the previous chapters) so that the fuel used is analysed from the extraction phase and the generated emissions are considered.

Inventory data elements are then identified in the EcoInvent database provided in SIMAPRO tool. Table 5.7 summarizes the inventory data of the biodiesel production process and their related database names.

Table 5.7 Inventory data and selected items in the SIMAPRO

Category	Sub-category	Inventory data	Database elements names	Unit
Process	Raw materials	Methanol		kg
		Sulphuric acid		kg
		Water		kg
		Calcium oxide		kg
Energy	Fuels	Natural gas	Heat, natural gas, at industrial	MJ
			furnace >100kW/RER S	MJ
	Emissions	Carbon dioxide	Carbon dioxide	kg
		Sulphur dioxide	Sulphur dioxide	kg
		Nitrogen oxides	Nitrogen oxides	kg
	Carbon monoxide	Carbon monoxide	kg	

According to the LCIA chosen method, the impact factors and characterization factors related to Impact 2002+ are shown in Table 5.8. The same characterization factors for fuel and emissions as presented in Tables 3.14 and 3.15 (Chapter 3) have been used and the damage and normalization factors correspond to the values of Table 2.9. The environmental sub-module has been designed taken into account these values extracted from EcoInvent.

Table 5.8 Raw materials characterization factors of biodiesel process

IMPACT 2002+	Methanol	Sulphuric acid	Calcium oxide	Unit
Aquatic acidification	1.31E-03	1.35E-02	4.94E-03	kg SO ₂ eq
Aquatic ecotoxicity	3.11E+01	1.08E+01	2.31E+01	kg TEG water
Aquatic eutrophication	8.08E-05	6.05E-05	8.07E-07	kg PO ₄ ³ P-lim
Carcinogens	1.03E-02	1.18E-03	1.04E-04	kg C ₂ H ₃ Cl eq
Global warming	6.82E-01	1.22E-01	1.37E+00	kg CO ₂ eq
Ionizing radiation	5.36E+00	3.12E+00	0.00E+00	kg Bq carbon 14 eq
Land occupation	8.20E-04	1.85E-03	0.00E+00	m ² org.arable
Mineral extraction	2.32E-03	1.19E-02	0.00E+00	MJ surplus
Non-carcinogens	1.85E-03	2.56E-03	4.19E-03	kg C ₂ H ₃ Cl eq
Non-renewable energy	3.93E+01	2.03E+00	7.50E+00	MJ primary
Ozone layer depletion	1.64E-07	1.27E-08	6.36E-09	kg CFC-11 eq
Respiratory inorganics	2.03E-04	1.15E-03	4.80E-04	kg PM _{2.5} eq
Respiratory organics	3.03E-04	3.65E-05	7.07E-05	kg C ₂ H ₄ eq
Terrestrial acid/nutri	5.69E-03	1.72E-02	1.15E-02	kg SO ₂ eq
Terrestrial ecotoxicity	6.66E+00	3.55E+00	5.41E-01	kg TEG soil

5.5 Optimization of biodiesel production

5.5.1 Optimization problem formulation

The formulation optimization problem proposed in this work is to maximize profit and minimize the environmental impact of biodiesel production process (see section 5.3.1.6 for the economic criterion). With regard to the environmental aspect, the end-point categories of IMPACT 2002+ LCIA method are used as criteria to minimize (Figure 2.2 in Chapter 2). The optimization problem can thus be formulated as follows:

Determine the decision variables (i.e., process operating conditions) in order to satisfy simultaneously the following objectives:

- Maximization (Profit)
- Minimization (Human Health)
- Minimization (Ecosystem Quality)
- Minimization (Climate Change)
- Minimization (Resources)

Subject to:

Amount of calcium oxide must be exact to remove sulphuric acid
Decision variables ranges (see Table 5.5)

The eco-design framework was then applied combining the process simulator (HYSYS), the energy plant simulator (Ariane), the environmental sub-module based on life cycle assessment and the genetic algorithm (NSGA IIb in Multigen) and an MCDM tool based on M-TOPSIS (the other decision tools are not applied here). The genetic algorithm parameters are the same as those used in Section 5.3 except for the number of generations, i.e. 200 in this case.

5.5.2 A detailed analysis of the Pareto front

Initially, a mono-criterion optimization (Profit) is carried out corresponding to the traditional design methodology. The multi-criteria optimization then follows considering simultaneously five criteria i.e.: one economic (Profit) and four environmental ones corresponding to the endpoint of IMPACT 2002+ (Human Health, Ecosystem Quality, Climate Change and Resources). The results will be analysed at the end of M-TOPSIS application (Profit and end-point categories). A same weight for all criteria is allocated. The comparison takes into account the top ranked solution for all criteria, the worst ranked solutions considering only the profit (respectively only environmental criteria). The last solution is calculated from the Human Health category because it presents the most important variation in relation to the profit criterion (see Figure 5.7) and an important antagonism in relation to the other environmental criteria (see Figure 5.8). Table 5.9 presents the optimized values of the variables corresponding both to the chosen solutions by M-TOPSIS and also to the mono-criterion solution.

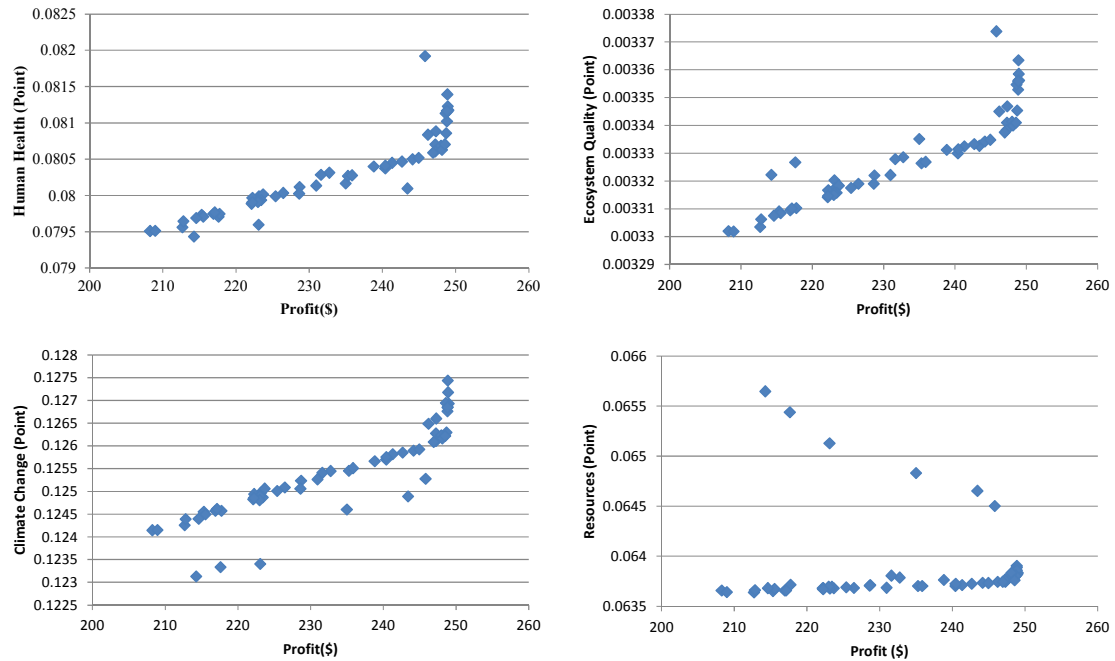

Figure 5.7 Two dimensionally comparisons of Pareto front (Profit – Environmental criteria)

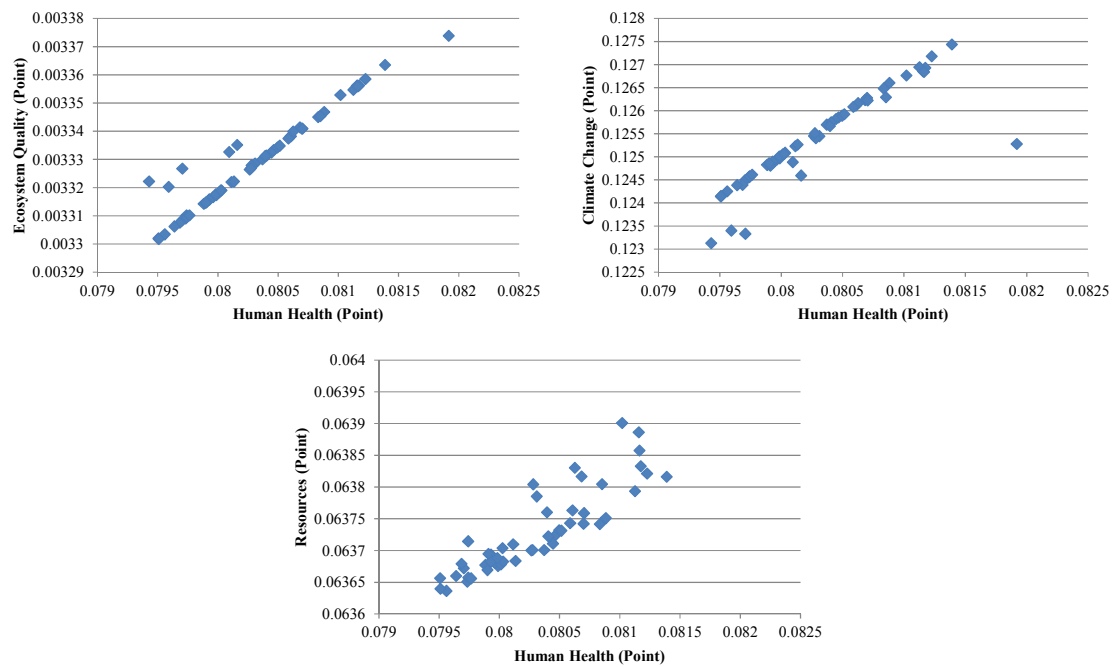

Figure 5.8 Two dimensionally comparisons of Pareto front (Environmental criteria)

The analysis of the data in Table 5.9 indicates that triolein has a great influence on the mono-criterion solutions and the chosen solution by M-TOPSIS. This is normal because Triolein is the main reactant and if the amount of this raw material increases, the profit criterion will also increase because the profit is a direct function of the sale of biodiesel. A comparison between the chosen solutions from the

Pareto front and the solution that can be obtained when considering a mono-criterion optimization (Profit) is carried out in the following sections.

Table 5.9 Optimization variables values for some solutions obtained by M-TOPSIS and for the mono-criterion solution.

Variables	Mono-criterion	Multi-criteria (Profit-Four end-point)		
	Profit	M-TOPSIS (Worst Impact)	M-TOPSIS (Worst Profit)	M-TOPSIS (Rank 1)
Triolein (kg/h)	1100	1090	975	1047
Methanol (kg/h)	208	208	208	208
Sulphuric acid (kg/h)	139	157	138	139
Water (kg/h)	111	116	113	111
Energy of cooler 1 (kWh)	18.09	17.86	17.76	17.81
Energy of cooler 2 (kWh)	5	4.89	4.87	4.80

5.5.2.1 Environmental impact analysis

Table 5.10 shows the operating conditions for the solutions chosen by the MCDM method and the mono-criterion solution. The solution with the worst profit has lower emissions compared to the other solutions, mainly because of a lower amount of steam requirement. The turbine needs less fuel to produce this amount, thus generating lower emissions.

The environmental impact of the chosen solutions is presented in figures 5.9 and 5.10 through mid-point and end-point categories in normalization score in order to compare the environmental impact in all categories. It must be emphasized that the categories of land occupation and non-carcinogens are composed almost entirely by the impact produced by the extraction, whereas categories such as global warming, respiratory inorganics and terrestrial acidification / nitrification are constituted mainly by the impact of the process (impact linked to energy production).

Table 5.10 Operating conditions from four solutions

	Mono-criterion	Multi-criteria (Profit-Four end-point)		
	Profit	M-TOPSIS (Worst Environmental Impact)	M-TOPSIS (Worst Profit)	M-TOPSIS (Rank 1)
Raw materials				
Triolein (kg/h)	1100	1090	975	1047
Methanol (kg/h)	208	208	208	208
Sulphuric acid (kg/h)	139	157	138	139
Water (kg/h)	111	116	113	111
Calcium oxide (kg/h)	79	90	79	79
Energy				
Steam (ton/h)	4.47	4.468	4.37	4.43
Natural gas - Turbine (Nm ³ /h)	474.09	473.57	463.87	470.15
Emissions				
Gas turbine				
CO ₂ (kg/h)	902	901	882	894
CO (kg/h)	18.04	18.02	17.65	17.89
SO ₂ (kg/h)	0	0	0	0
NO _x (kg/h)	4.13	4.12	4.04	4.09

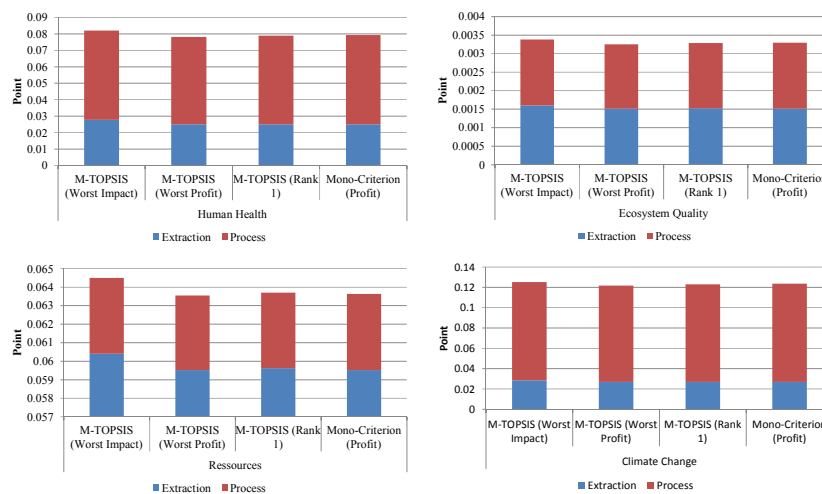

Figure 5.9 Comparison of optimization results in the four end-point categories (normalization)

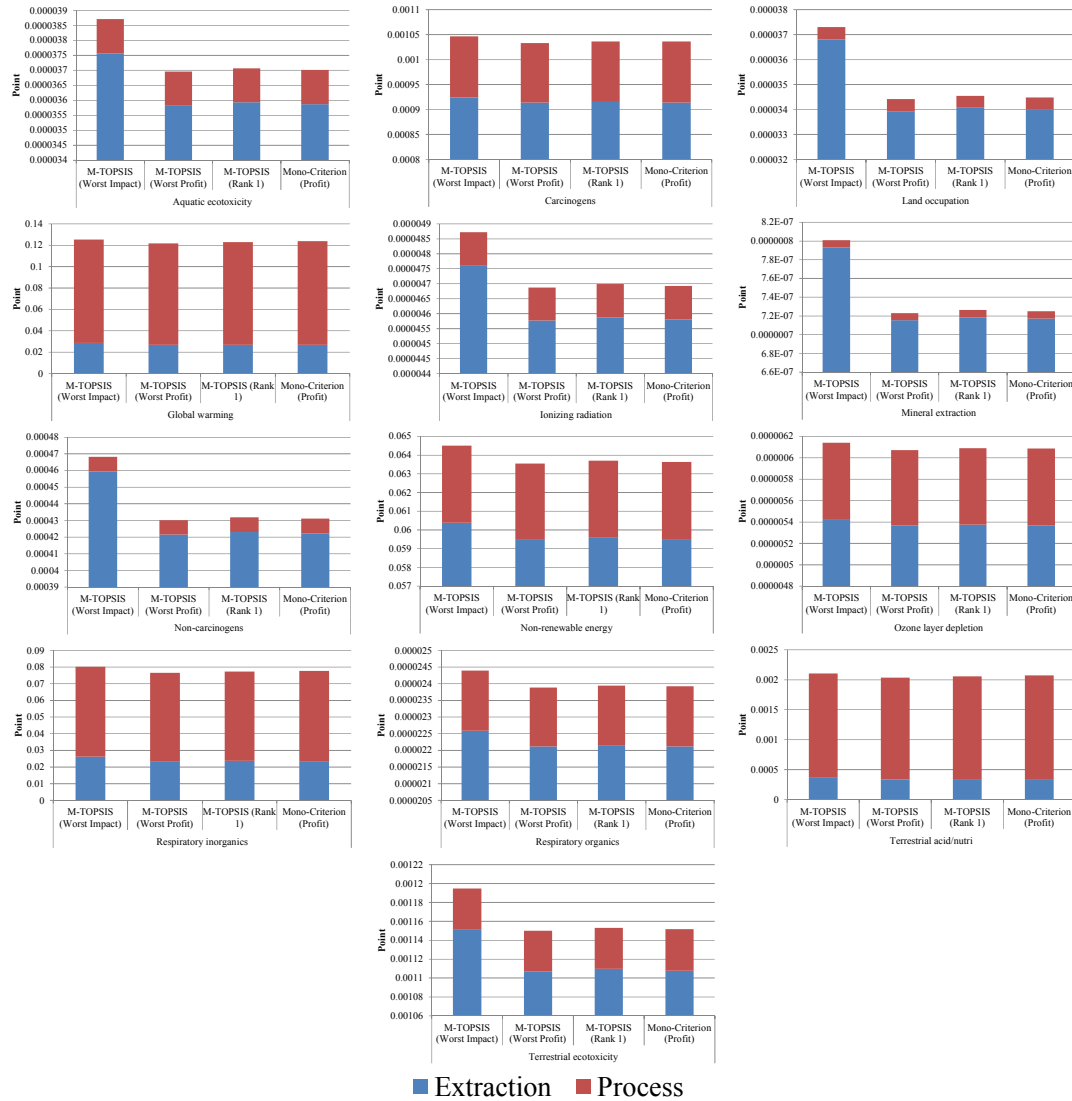

Figure 5.10 Comparison of normalization results in mid-point categories (normalization)

In the case of land occupation and non-carcinogens categories, the contribution is due to the use of sulphuric acid as raw material (see Figure 5.11), constituting the "hot spot" of the system, which is confirmed by the large amount of sulphuric acid corresponding to the worst environmental impact solution (see Table 5.10).

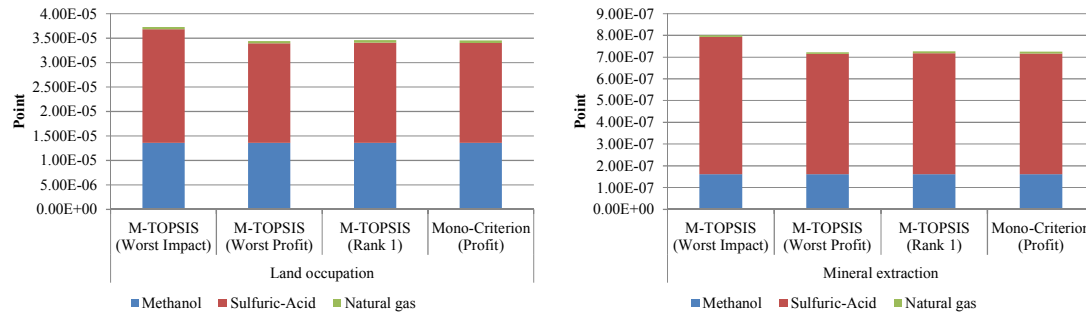

Figure 5.11 Analysis of the individual impact of the fuels in mid-point categories

5.5.3.2 Comparison of potential solutions in environmental categories and operating cost

The profit and environmental impact of the chosen solutions are represented through radar charts in Figure 5.12 representing mid-point and end-point categories respectively. Table 5.11 shows the calculated gain relative to the mono-criterion solution for MCDM solutions. The calculated gain means an increased (positive value) or decreased (negative value) percentage of the profit and environmental impact.

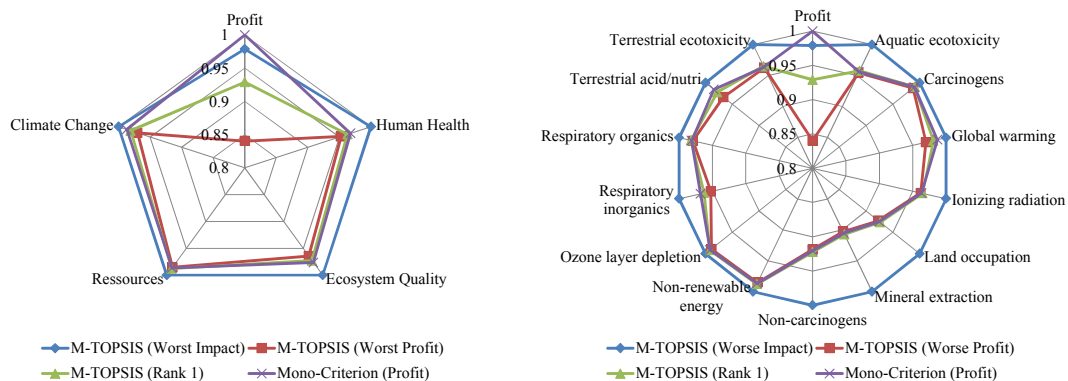

Figure 5.12 Comparison of profit and environmental impact in mid- and end-point categories

The radar charts show that all the solutions exhibit very similar performances for all the environmental indicators. All the values are normalized as previously presented. For this optimization case, the signature must be interpreted as follows: the lower the environmental impact value, the better whereas the higher the profit (near to unity), the better.

The best solution found by M-TOPSIS maintains a balance between all the criteria and with regard to the mono-criterion solution is not so environmentally unfriendly. The environmental gain obtained by the multi-objective framework is slight which can be attributed to the recycling steps that are introduced in the flowsheet. This explains why the multi-level assessment for multi-objective

optimization implemented in Chapter 4 is not necessary for this case study. Finally, the next section discusses the best solution found by M-TOPSIS (Rank 1).

Table 5.11 Gain calculated relative to the mono-criteria solution

	Gain (%)		
	M-TOPSIS (Worst Impact)	M-TOPSIS (Worst Profit)	M-TOPSIS (Rank 1)
Profit	-2.1	-16.0	-7.1
Aquatic ecotoxicity	4.6	-0.1	0.2
Carcinogens	1.0	-0.3	0.0
Global warming	1.3	-1.7	-0.6
Ionizing radiation	3.8	-0.1	0.2
Land occupation	8.1	-0.2	0.2
Mineral extraction	10.5	-0.3	0.2
Non-carcinogens	8.6	-0.2	0.2
Non-renewable energy	1.4	-0.1	0.1
Ozone layer depletion	0.9	-0.2	0.0
Respiratory inorganics	3.4	-1.6	-0.5
Respiratory organics	1.9	-0.2	0.1
Terrestrial acid/nutri	1.6	-1.8	-0.7
Terrestrial ecotoxicity	3.8	-0.1	0.1

5.5.3.3 Environmental impact analysis of a specific solution

Figures 5.13 to 5.15 show the individual analysis of the environmental impact of M-TOPSIS (Rank 1) solution, in a more detailed way that it was proposed.

The figures confirm the "hot spot" of the system described above, but also indicate other, such as emissions of carbon dioxide and nitrogen oxide in addition to the methanol raw material. This set of "hot spots" contributes substantially to total environmental impact of the process.

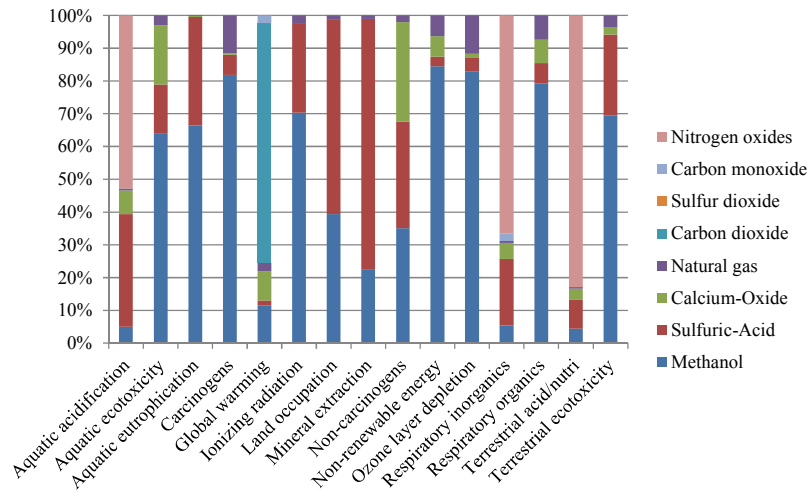

Figure 5.13 Mid-point categories analysis of the M-TOPSIS (rank 1) solution (Characterization score)

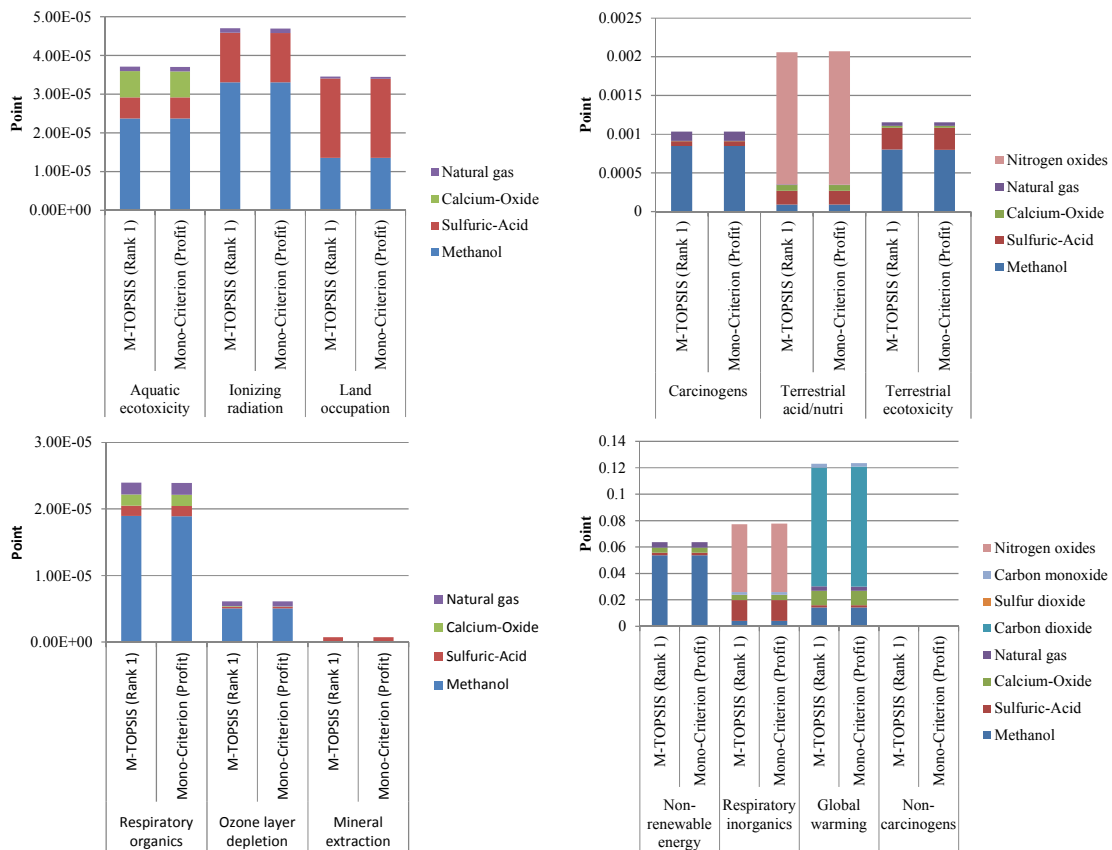

Figure 5.14 Comparison of the environmental impacts of the M-TOPSIS (rank 1) and mono-criterion solutions

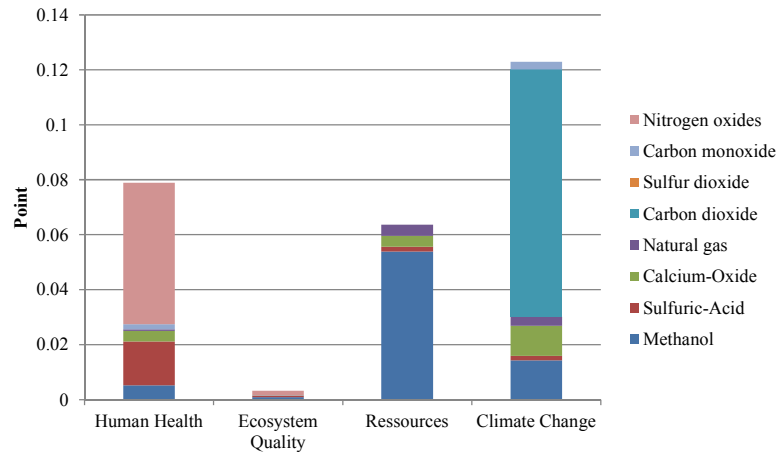

Figure 5.15 End-point analysis of the M-TOPSIS (rank 1) solution

5.6 Conclusions

Biodiesel is an alternative to fossil fuel use, which requires further studies to optimize the process in economic and environmental aspects. This chapter implements the eco-design framework developed in the previous chapters to the production of biodiesel through waste vegetable oils.

A comparison with literature results was conducted to validate process modelling with Hysys. The results obtained by Halim [72] served as reference point. The Pareto fronts exhibit very similar trends with the results obtained by Halim [72].

A cradle to gate assessment was then performed and the study was conducted with IMPACT 2002 + LCIA method. The results showed that it was not necessary to explore in depth the multi-level multi-objective assessment proposed in the previous chapter. The recycling strategy proposed in the flowsheet led to similar performances between the mono- and multi-objective cases.

This kind of analysis can yet be further developed in order to revisit LCA objectives and carry out consequential analysis that is particularly sound in the case of alternative fuels. The eco-design framework can be one of the pillars to assess sustainability.

6 CONCLUSIONS AND PERSPECTIVES

In this work, an eco-design methodology has been developed for process analysis combining process and energy production simulation, Life Cycle Assessment, multi-objective optimization and multiple criteria decision-making tools. The framework, based on process systems engineering concepts, is generic and systematic. The methodology has been presented for processes operating in continuous mode. The capabilities of the methodology have been presented and they were highlighted through case studies (HDA process and biodiesel production).

A major incentive of this work was to apply LCA in combination with process design. Traditionally, LCA has been used for comparison of various products that can fulfill the same function. In this work, following the guidelines proposed by Azapagic [52], [58], LCA is used for evaluation of process flowsheet variants that are generated systematically by an optimization procedure. The objective is to identify the main contributors to the overall emissions, making it possible to focus the improvement of the system at the bottlenecks. Two main areas of contributions have been identified; methodological development and applications. An overview of the main contributions within both areas is given in what follows.

The core of the methodology is based on the link between energy and process simulation tools.

Energy is required for unit operations and processes in a chemical plant. The emissions in the system can thus be divided into utility and process waste in order to increase the knowledge of the origin of the waste. This division into utility and process waste can be particularly useful in order to identify the areas with largest potential for improvement. Even if Life Cycle Assessment is a mature concept and if Life Cycle Inventory databases are now largely implemented, it must be yet recognized that information available about the conditions of production of vapour, which is one of the most common utilities in chemical processes and that can be produced with different technologies under various operating conditions is still limited.

For bridging this gap, Chapter 2 proposed the combined use of a process simulation tool dedicated to production utilities, Ariane, ProSim SA, experimental process data and Life Cycle Assessment implemented with a commercial software tool Simapro for the design of specific energy sub modules, so that the life cycle energy related emissions for a given process can be computed. The case study developed in this chapter concerned the environmental impact assessment of a bi-fuel furnace on the one hand and steam production by a gas turbine on the other hand. The interest of using such an approach is that different operating conditions and different technologies can be modelled and evaluated systematically by the energy simulator. Of course, some experimental data are necessary to identify the emission profile associated with an energy production unit under specific operating conditions. In this work, some available data reported in the literature have been used for feasibility

demonstration. The level of information required concerns the inventory and the amount of emitted components. This concept needs yet to be further developed.

The methodology then includes exploitation of popular, commercial tools such as process simulators to evaluate process options. While process simulators are useful, their application to eco-design is not straightforward. Chapter 3 has presented a methodology for eco-design of a chemical process coupling flowsheeting simulators both for process (HYSYS, COCO and Prosim PLUS) and energy production (ARIANE™) with an environmental impact assessment sub-module. The environmental sub-module is designed for a specific case study from the extraction of the LCIA and impact assessment factors of Ecoinvent and Simapro software. This implementation was necessary due to the lack of interoperability that can be yet observed with the available commercial LCA tools.

The well-known benchmark HDA process first developed by Douglas [61] illustrates the potentiality of the eco-design approach, which can thus extend the traditional hierarchical design approach [61]. The process was designed under classical engineering objectives like benzene production and total annual cost, by also considering the environmental impacts both at mid-point and end-point levels through the cause and effect chain. Division of the emissions into process and utility wastes has proven helpful in tracking of the origin of all emissions. While LCA has been used for a long time to assess the environmental performance of a product that serves a specific function, there are so far few studies where LCA has been used to analyse processes and production systems and the contribution of this thesis tends to fulfill this gap.

The division into utility and process waste has proven helpful in the LCA combined with process simulation in order to identify the areas with largest potential for improvement, but is most of all the more beneficial in the last approach where LCA, process and energy production simulation are coupled with multi-criteria techniques for a more comprehensive decision process. The use of LCA in combination with process simulation is interesting to measure environmental sustainability and to identify the “hot spots” of the systems and improvement options for more sustainable alternatives. Such an analysis is particularly sound to identify if the production stage is predominant in the cradle-to-gate analysis or if the extraction phase is the main contributor.

The thesis then demonstrates the benefits of combining process simulation, LCA, multi-objective optimization and MCDM so that the engineer can obtain compromise solutions taking into account the environmental impacts and an economic criterion related to the studied process unit with its associated energy production plant.

A multi-objective criteria strategy for combined use of LCA and process and energy production simulation has been developed with accompanying models in Excel, VBA and HYSYS.

Two steps are involved at the top of the eco-design framework:

- First, multi-objective genetic algorithms (GA) have been adopted to tackle the problem of optimization with conflicting objectives. The main motivation to use such algorithms is that a set of potential solution candidates can be generated without subjective judgement of the decision maker and that no mathematical property needs to be verified. This issue is particularly interesting since all the objective functions are computed by use of external simulators
- Second, the final choice is then performed with an MCDM method, among optimal solutions, so that “sub-optimal” solutions have been discarded along the optimization process. At this step, the subjective judgment of the decision maker can be introduced by weight allocation reflecting the preference towards some criteria. Several MCDM methods have been implemented, M-TOPSIS, PROMETHEE, ELECTRE

A key issue that was highlighted concerned the formulation of the eco-design problem based on LCA environmental impacts and the relevance of end-point or mid-point indicators due to the difficulty to consider simultaneously all these indicators. Even if it is emphasized in the dedicated literature that the eco-design problem is clearly a multi-criteria issue, the formulation of the optimization problem does not exhibit practically the same level of complexity as far as the number of antagonist criteria is involved. This suggests that the formulation of the problem must be clearly stated before process optimization implementation. A large number of objectives, generally more than ten are involved when carrying out Life Cycle Assessment. Yet, several objectives are generally redundant so that a multi-objective strategy is not, strictly speaking, necessary for all of them. Nevertheless, a multi-objective framework is justified to provide interesting compromise solutions.

A multi-level assessment for multi-objective optimization was implemented in the HDA case study. The observed trends are obviously only valid for the considered scenario and no attempt to generalize the scope of the results could be made. Yet, the suggested guidelines can be used to tackle a new eco-design case study. All the levels do not need to be explored (see for instance the biodiesel case), depending on the degree of complexity of the involved problem:

Level 1: Multi-objective optimization with end-point category indicators.

Level 2: Variability analysis of mid-point categories for all the solutions in the Pareto front.

Level 3: Multi-objective optimization with mid-point category indicators corresponding to the highest level of variability.

Level 4: MCDM assessment and selection of the potential solution.

Level 5: Cartography of the solution

Level 6: Suggestion for further improvement

This multi-level eco-design framework was used for both case studies, treated in this work i.e., HDA and biodiesel production: the explored pathways depend on the analysis and antagonist behaviour of the criteria.

Although the eco-design treated in this work focuses on LCA applied to a process, the framework presented also applies to the traditional LCA that evaluates products. Traditional LCA also includes processes, where process optimization in general and process integration in particular can be introduced.

When it comes to further development of the methodologies, there is still room for improvement and several perspectives can be highlighted, both from a methodological and a practical viewpoint.

First of all, data availability is one of the most important issues in LCA. This study demonstrates that classical process and energy production simulation tools can be useful to feed inventory databases that are embedded in LCA tools. The coupled use of process simulation and LCA needs to be systematically implemented, in order to reduce uncertainty and imprecision.

These are important issues in LCA. The results that have been presented do not take into account confidence limits so that the results may be viewed as questionable from the user viewpoint since they may lead to misjudgements. Further improvement of the eco-design needs to consider the modelling of the different errors that can occur in the LCA process. The wide spectrum of tools from statistical analysis to fuzzy concepts needs to be studied in order to be further incorporated in the eco-design framework.

A more systematic way to identify the redundant objectives in the multi-objective optimization framework must be explored. The PhD work of Perez-Gallardo dedicated to the eco-design of large-scale photovoltaic systems has shown that a multi-variable statistical method, i.e., Principal Component Analysis offers a promising way to detect and omit redundant objectives that can be left out of the analysis without disturbing the main features of the solution space.

A major barrier that can be encountered when developing multi-optimization approaches coupled with process simulation can be attributed to the exhaustive computational time that can be involved. In order to develop more efficient strategies, other guided exploration optimization methods such as multi-objective differential evolution (MODE) have been studied in our research group. Specific attention is paid to the formulation of an efficient criterion that is necessary in the case of the multi-objective optimization problem as judging the advance of the optimization. If the selection of an appropriate criterion has been identified as one of the fundamental topics, it must be highlighted that this issue has not been solved properly. This work has been now part and parcel of the PhD work of Ochoa Robles since 2012.

The eco-design framework can be also applied to other processes such as materials recycling. A lot of attention has been paid to such processes in a context of resource scarcity and limitation of greenhouse gas emissions. The choice of the most appropriate recycling route offers an investigation scope in which process design and Life Cycle Assessment must be conciliated with classical Process Systems Engineering concepts.

The design and development of sustainable processes is also targeted by other industrial sectors such food processes. The systemic approach combining modelling, simulation, and optimization can thus be applied to such sectors. Although methodological tools have been developed in the chemical industry, this kind of approach suffers from a lack of available models that can be applied in the food processing industry. A framework for the eco-design of food processes, with a focus on sustainable milk proteins concentrating systems has been investigated in the PhD work of Madoumier since 2012.

All these works also find applications in the framework of pre-normative research for product and process labelling both for production, energy generation and recycling in the process industries. It must be yet recognized that the initiatives towards the development of eco-labelling even if they are spreading around the word need to be more developed, particularly in the process industries.

The large list of perspectives that can be deduced from this work may contribute to the frustration feeling at this end of this PhD work. To end on a more positive note, it can be suggested that the major asset of this work was to open them. While information obtained from LCA and cost are useful, it should be borne in mind that one dimension of sustainability is still lacking, i.e. the social component. Multidisciplinary research involving engineering and social science can be a natural extension for application scope.

Bibliography

- [1] E. E. I. Association, "Spire sustainable process industry," Brussels, 2011.
- [2] P. T. Anastas and J. C. Warner, *Green Chemistry, Theory and Practice*. New, York: Oxford University Press, 1998.
- [3] P. T. Anastas and J. B. Zimmerman, "Design Through the 12 Principles of Green Engineering," *Environ. Sci. Technol.*, vol. 37, no. 5, p. 94A–101A, Mar. 2003.
- [4] U. S. N. A. of E. (NAE), "Grand Challenges for Engineering." [Online]. Available: <http://www.engineeringchallenges.org>.
- [5] IChemE, "A Roadmap for 21st Century Chemical Engineering," Rugby, UK, 2007.
- [6] A. Azapagic, *Sustainable Development in Practice*. Chichester, UK: John Wiley & Sons, Ltd, 2004, p. 446.
- [7] S. K. Sikdar, "Sustainable development and sustainability metrics," *AIChE J.*, vol. 49, no. 8, pp. 1928–1932, Aug. 2003.
- [8] J. Schwarz, B. Beloff, and E. Beaver, "Use sustainability metrics to guide decision-making," *Chem. Eng.*, no. July, pp. 58–63, 2002.
- [9] L. Segnestam, "Indicators of environment and sustainable development: Theories and practical experience," *Environ. Econ. Ser.*, no. Paper 89, 2003.
- [10] A. Chauvel and P. Leprince, *Manuel d'évaluation économique des procédés*. Technip, 2001, p. 488.
- [11] N. R. T. on the E. and the E. (NRTEE), "Measuring eco-efficiency in business: Feasibility of a core set of indicators." Renouf Publishing Co., Ottawa, 1999.
- [12] IChemE, "The Sustainability Metrics: sustainable development progress metrics recommended for the use in process industries, Institution of Chemical Engineers," 2013. [Online]. Available: <http://www.icheme.org/sustainability/>.
- [13] D. Tanzil and B. R. Beloff, "Assessing impacts: Overview on sustainability indicators and metrics," *Environ. Qual. Manag.*, vol. 15, no. 4, pp. 41–56, Jan. 2006.
- [14] A. Lapkin, L. Joyce, and B. Crittenden, "Framework for evaluating the 'greenness' of chemical processes: case studies for a novel VOC recovery technology.," *Environ. Sci. Technol.*, vol. 38, no. 21, pp. 5815–23, Nov. 2004.
- [15] D. J. C.] Constable, A. Curzons, A., Duncan, C. Jiménez- González, and V. L. Cunningham, "The GSK approach to metrics for sustainability," in in *Transforming Sustainability Strategy into Action: The Chemical Industry*, B. Beloff, M. Lines, and D. Tanzi, Eds. John Wiley and Sons, 2005.

- [16] D. J. C. Constable, A. D. Curzons, and V. L. Cunningham, "Metrics to 'green' chemistry- which are the best?," *Green Chem.*, vol. 4, no. 6, pp. 521–527, Dec. 2002.
- [17] P. Saling and A. Kicherer, "Eco-efficiency analysis by BASF: the method," *Int. J. Life Cycle Assess.*, vol. 7, no. 4, pp. 203–218, 2002.
- [18] E. Schwanhold, "The Eco-efficiency analysis developed by BASF," in *Transforming sustainability strategy into action: The chemical industry*, B. Beloff, M. Lines, and T. D., Eds. Hoboken, N.J.: Wiley, 2005.
- [19] I. Schmidt, M. Meurer, P. Saling, A. Kicherer, W. Reuter, and C. Gensch, "SEEBALANCE - Managing Sustainability of Products and Processes with the Socio-Eco-Efficiency Analysis by BASF," *Greener Manag. Int.*, no. 45, pp. 79 – 94, 2004.
- [20] H. Cabezas, J. C. Bare, and S. K. Mallick, "Pollution prevention with chemical process simulators: the generalized waste reduction (WAR) algorithm—full version," *Comput. Chem. Eng.*, vol. 23, no. 4–5, pp. 623–634, May 1999.
- [21] D. Young, R. Scharp, and H. Cabezas, "The waste reduction (WAR) algorithm: environmental impacts, energy consumption, and engineering economics," *Waste Manag.*, vol. 20, no. 8, pp. 605–615, Dec. 2000.
- [22] R. Heijungs, G. Huppes, J. Guinée, R. M. Lankreijer, H. A. Udo de Haes, and A. Wegener Sleswijk, "Environmental life cycle assessment of products: guide and backgrounds (part 1)," 1992.
- [23] A. K. Hilaly and S. K. Sikdar, "Pollution Balance Method and the Demonstration of Its Application to Minimizing Waste in a Biochemical Process," *Ind. Eng. Chem. Res.*, vol. 34, no. 6, pp. 2051–2059, Jun. 1995.
- [24] U. Diwekar and M. J. Small, "Process analysis approach to industrial ecology," in *A Handbook of Industrial Ecology*, R. U. Ayres and L. W. Ayres, Eds. Edward Elgar Publishing Limited, 2002, p. 704.
- [25] M. Narodoslawsky and C. Krotscheck, "The sustainable process index (SPI): evaluating processes according to environmental compatibility," *J. Hazard. Mater.*, vol. 41, pp. 383–397, 1995.
- [26] C. Krotscheck and M. Narodoslawsky, "The Sustainable Process Index a new dimension in ecological evaluation," *Ecol. Eng.*, vol. 6, no. 4, pp. 241–258, Jun. 1996.
- [27] M. Narodoslawsky and A. Niederl, "The Sustainable Process Index (SPI)," in *Renewables-Based Technology: Sustainability Assessment*, J. Dewulf and H. Van Langenhove, Eds. Chichester, UK: John Wiley & Sons, Ltd, 2006.
- [28] M. a. Steffens, E. S. Fraga, and I. D. L. Bogle, "Multicriteria process synthesis for generating sustainable and economic bioprocesses," *Comput. Chem. Eng.*, vol. 23, no. 10, pp. 1455–1467, Dec. 1999.
- [29] L. De Benedetto and J. Klemeš, "The Environmental Performance Strategy Map: an integrated LCA approach to support the strategic decision-making process," *J. Clean. Prod.*, vol. 17, no. 10, pp. 900–906, Jul. 2009.

- [30] M. a. J. Huijbregts, S. Hellweg, R. Frischknecht, K. Hungerbühler, and a. J. Hendriks, "Ecological footprint accounting in the life cycle assessment of products," *Ecol. Econ.*, vol. 64, no. 4, pp. 798–807, Feb. 2008.
- [31] T. Wiedmann and M. Lenzen, "On the conversion between local and global hectares in Ecological Footprint analysis," *Ecol. Econ.*, vol. 60, no. 4, pp. 673–677, Feb. 2007.
- [32] A. Y. Hoekstra and P. Q. Hung, "Virtual water trade: a quantification of virtual water flows between nations in relation to international crop trade," Delft, Netherlands, 2002.
- [33] G. Stöglehner, "Ecological footprint—a tool for assessing sustainable energy supplies," *J. Clean. Prod.*, vol. 11, pp. 267–277, 2003.
- [34] D. Sandholzer and M. Narodoslawsky, "SPionExcel—Fast and easy calculation of the Sustainable Process Index via computer," *Resour. Conserv. Recycl.*, vol. 50, no. 2, pp. 130–142, Apr. 2007.
- [35] G. Wall and M. Gong, "On exergy and sustainable development—Part 1: Conditions and concepts," *Exergy, An Int. J.*, vol. 1, no. 3, pp. 128–145, 2001.
- [36] M. Gong and G. Wall, "On exergy and sustainable development—Part 2: Indicators and methods," *Exergy, an Int. J.*, vol. 1, no. 4, pp. 217–233, 2001.
- [37] J. Dewulf and H. Van Langenhove, "Exergy: its potential and limitations in environmental science and technology," *Environ. Sci. Technol.*, vol. 42, no. 7, pp. 2221–2232, 2008.
- [38] J. E. Ahern, *Method of Energy Systems Analysis*. New York: John Wiley & Sons, 1980.
- [39] A. Bejan, G. Tsatsaronis, and M. Moran, *Thermal Design and Optimization*. John Wiley & Sons Inc, 1995, p. 560.
- [40] X. Feng and X. Zhu, "Combining pinch and exergy analysis for process modifications," *Appl. Therm. Eng.*, vol. II, no. 3, pp. 249–261, 1997.
- [41] M. Sorin and J. Paris, "Integrated exergy load distribution method and pinch analysis," *Comput. Chem. Eng.*, vol. 23, no. 4–5, pp. 497–507, May 1999.
- [42] D. Morris, "Exergy analysis and cumulative exergy consumption of complex chemical processes: the industrial chlor-alkali processes," *Chem. Eng. Sci.*, vol. 46, no. 2, pp. 459–465, 1991.
- [43] J. Dewulf, H. Van Langenhove, and B. Van De Velde, "Exergy-based efficiency and renewability assessment of biofuel production.," *Environ. Sci. Technol.*, vol. 39, no. 10, pp. 3878–82, May 2005.
- [44] J. Dewulf and H. Van Langenhove, Eds., *Renewables-Based Technology*. Chichester, UK: John Wiley & Sons, Ltd, 2006.
- [45] A. Gomez, C. Azzaro-Pantel, S. Domenech, L. Pibouleau, C. Latgé, D. Haubensack, and P. Dumaz, "Exergy analysis for Generation IV nuclear plant optimization," *Int. J. Energy Res.*, no. January 2008, p. n/a–n/a, 2009.

- [46] M. Kanoglu and I. Dincer, "Performance assessment of cogeneration plants," *Energy Convers. Manag.*, vol. 50, no. 1, pp. 76–81, Jan. 2009.
- [47] J. B. Guinée, R. Heijungs, G. Huppes, A. Zamagni, P. Masoni, R. Buonamici, T. Ekvall, and T. Rydberg, "Life cycle assessment: past, present, and future.," *Environ. Sci. Technol.*, vol. 45, no. 1, pp. 90–6, Jan. 2011.
- [48] M. Hauschild and Wenzel, H, *Environmental Assessment Of Products Volume 2: Scientific Background*. 1998.
- [49] C. for E. A. of P. and material S. (CPM), "A Systematic Approach to Environmental Priority Strategies in In Product Development (EPS). Version 2000 – General System Characteristics.," Gothenburg, 1999.
- [50] M. J. Goedkoop and R. S. Spriensma, "The Eco-indicator 99, Methodology report. A damage oriented LCIA Method," The Hague, The Netherlands, 1999.
- [51] O. Jolliet, M. Margni, and R. Charles, "IMPACT 2002+: A new life cycle impact assessment methodology," *Int. J. LCA*, vol. 8, no. 6, pp. 324–330, 2003.
- [52] A. Azapagic, "Life Cycle Assessment as an Environmental Sustainability Tool," in in *Renewables-Based Technology*, J. Dewulf and H. Van Langenhove, Eds. Chichester, UK: John Wiley & Sons, Ltd, 2006.
- [53] D. W. Pennington, J. Potting, G. Finnveden, E. Lindeijer, O. Jolliet, T. Rydberg, and G. Rebitzer, "Life cycle assessment part 2: current impact assessment practice.," *Environ. Int.*, vol. 30, no. 5, pp. 721–39, Jul. 2004.
- [54] I. E. Agency, "Technology Roadmap: Energy and GHG Reductions in the Chemical Industry via Catalytic Process," p. 56, 2013.
- [55] M. Boix, L. Pibouleau, L. Montastruc, C. Azzaro-Pantel, and S. Domenech, "Minimizing water and energy consumptions in water and heat exchange networks," *Appl. Therm. Eng.*, vol. 36, pp. 442–455, Apr. 2012.
- [56] J. Ehrenfeld and N. Gertler, "Industrial Ecology in Practice: The Evolution of Interdependence at Kalundborg," *J. Ind. Ecol.*, vol. 1, no. 1, pp. 67–79, Dec. 1997.
- [57] M. R. Chertow, "INDUSTRIAL SYMBIOSIS: Literature and Taxonomy," *Annu. Rev. Energy Environ.*, vol. 25, no. 1, pp. 313–337, Nov. 2000.
- [58] A. Azapagic, "Life cycle assessment and its application to process selection, design and optimisation," *Chem. Eng. J.*, vol. 73, no. 1385, 1999.
- [59] B. Crittenden and S. Kolaczowski, "Waste Minimization: A Practical Guide," *Dev. Chem. Eng. Miner. Process.*, vol. 3, no. 2, p. 82, May 1995.
- [60] J. A. Cano-Ruiz and G. J. McRae, "Environmentally conscious chemical process design," *Annu. Rev. Energy Environ.*, vol. 23, no. 1, pp. 499–536, Nov. 1998.
- [61] J. M. Douglas, *Conceptual Design of Chemical Processes*. McGraw Hill, 1998.
- [62] R. Smith, *Chemical process design*. New York: McGraw-Hill, 1995.

- [63] H. Isalski, "ENVOP for waste minimization," in *Speciality Conference on Environmental issues in the petroleum and petrochemical industries*, 1995, pp. 276–286.
- [64] B. Linnhoff, "Pinch analysis in pollution prevention," in *Waste minimization through process design*, A. P. Rossite, Ed. New York: McGraw-Hill, 1995.
- [65] M. M. El-Halwagi, *Pollution Prevention through Process Integration*. Academic Press, 1997, p. 334.
- [66] M. Dantus and K. High, "Economic evaluation for the retrofit of chemical processes through waste minimization and process integration," *Ind. Eng. Chem. Res.*, vol. 5885, no. 95, pp. 4566–4578, 1996.
- [67] Y. Fu, U. M. Diwekar, D. Young, and H. Cabezas, "Process design for the environment: A multi-objective framework under uncertainty," *Clean Prod. Process.*, vol. 2, no. 2, pp. 0092–0107, Sep. 2000.
- [68] H. Chen and D. R. Shonnard, "Systematic Framework for Environmentally Conscious Chemical Process Design: Early and Detailed Design Stages," *Ind. Eng. Chem. Res.*, vol. 43, no. 2, pp. 535–552, Jan. 2004.
- [69] M. R. Othman, J.-U. Repke, G. Wozny, and Y. Huang, "A Modular Approach to Sustainability Assessment and Decision Support in Chemical Process Design," *Ind. Eng. Chem. Res.*, vol. 49, no. 17, pp. 7870–7881, Sep. 2010.
- [70] A. Carvalho, H. a. Matos, and R. Gani, "SustainPro—A tool for systematic process analysis, generation and evaluation of sustainable design alternatives," *Comput. Chem. Eng.*, vol. 50, pp. 8–27, Mar. 2013.
- [71] A. Carvalho, H. Matos, and R. Gani, "Analysis and Generation of Sustainable Alternatives: Continuous and Batch Processes Using Sustainpro Package," *Proc. Seventh Int. Conf. Found. Comput. Process Des.*, pp. 243–251, 2009.
- [72] I. Halim and R. Srinivasan, "A knowledge-based simulation-optimization framework and system for sustainable process operations," *Comput. Chem. Eng.*, vol. 35, no. 1, pp. 92–105, Jan. 2011.
- [73] A. Ouattara, C. Azzaro-Pantel, L. Pibouleau, S. Domenech, P. Baudet, and B. Yao, "Eco-Efficiency Analysis For Chemical Process Design," *Comput. Aided Chem. Eng.*, vol. 28, pp. 1249–1254, 2010.
- [74] A. Ouattara, L. Pibouleau, C. Azzaro-Pantel, S. Domenech, P. Baudet, and B. Yao, "Economic and environmental strategies for process design," *Comput. Chem. Eng.*, vol. 36, pp. 174–188, Jan. 2012.
- [75] C.-L. Hwang and K. Yoon, *Multiple Attribute Decision Making: Methods and Applications; A State-of-the-Art Survey*, vol. 186. Berlin Heidelberg, 1981, p. 259.
- [76] D. M. Young and H. Cabezas, "Designing sustainable processes with simulation: the waste reduction (WAR) algorithm," *Comput. Chem. Eng.*, vol. 23, no. 10, pp. 1477–1491, Dec. 1999.
- [77] A. Ouattara, "Méthodologie d'éco-conception de procédés par optimisation multiobjectif et aide à la décision multicritère," Université de Toulouse, 2011.

- [78] B. Sadler and R. Verheem, *Strategic Environmental Assessment. Status, challenges and future directions*. Ministry of Housing, Spatial Planning and the Environment, 1996, p. 188.
- [79] N. Wrisberg, H. A. Udo de Haes, U. Triebswetter, P. Eder, and R. Clift, *Analytical Tools for Environmental Design and Management in a Systems Perspective*. Dordrecht: Kluwer Academic, 2002, p. 275.
- [80] G. Finnveden and Å. Moberg, "Environmental systems analysis tools – an overview," *J. Clean. Prod.*, vol. 13, no. 12, pp. 1165–1173, Oct. 2005.
- [81] P. P. Calow, *Handbook of Environmental Risk Assessment and Management*, 1st ed. United Kingdom: Blackwell Science Ltd., 1998.
- [82] A. Manuilova, J. Suebsiri, and M. Wilson, "Should Life Cycle Assessment be part of the Environmental Impact Assessment? Case study: EIA of CO₂ Capture and Storage in Canada," *Energy Procedia*, vol. 1, no. 1, pp. 4511–4518, Feb. 2009.
- [83] R. Ayres and L. Ayres, *A handbook of industrial ecology*. Edward Elgar Publishing Limited, 2002.
- [84] S. Bringezu and Moriguchi, "Material flow analysis," in in *A Handbook of Industrial Ecology*, R. Ayres and L. W. Ayres, Eds. Cheltenham: Edward Elgar Publishing Limited, 2002, p. 701.
- [85] M. Bonnin, C. Azzaro-Pantel, L. Pibouleau, S. Domenech, and J. Villeneuve, "Development and validation of a dynamic material flow analysis model for French copper cycle," *Chem. Eng. Res. Des.*, vol. 91, no. 8, pp. 1390–1402, Aug. 2013.
- [86] G. Finnveden, M. Z. Hauschild, T. Ekvall, J. Guinée, R. Heijungs, S. Hellweg, A. Koehler, D. Pennington, and S. Suh, "Recent developments in Life Cycle Assessment.," *J. Environ. Manage.*, vol. 91, no. 1, pp. 1–21, Oct. 2009.
- [87] ISO 14040, "Environmental management - Life Cycle Assessment - Principles and Framework," *Int. Organ. Stand.*, vol. 1997, 2006.
- [88] A. A. Burgess and D. J. Brennan, "Application of life cycle assessment to chemical processes," *Chem. Eng. Sci.*, vol. 56, no. 8, pp. 2589–2604, Apr. 2001.
- [89] A. Azapagic, "Sustainable Process Design: The Case of Vinyl Chloride Monomer (VCM)," in in *Sustainable Development in Practice: Case Studies for Engineers and Scientists*, Second Ed., no. Vcm, A. Azapagic and P. Slobodan, Eds. John Wiley & Sons, 2011.
- [90] A. Azapagic and R. Clift, "The application of life cycle assessment to process optimisation," *Comput. Chem. Eng.*, vol. 23, no. 10, pp. 1509–1526, Dec. 1999.
- [91] I. Standard, "ISO 14041. Environmental management — Life cycle assessment — Goal and scope definition and inventory analysis," vol. 1998, 1998.
- [92] I. Standard, "ISO 14042. Environmental management — Life cycle assessment — Life cycle impact assessment," vol. 2000, 2000.
- [93] I. Standard, "ISO 14043. Environmental management — Life cycle assessment — Life cycle interpretation," vol. 2000, 2000.

- [94] J. B. Guinée, “Life Cycle Assessment: An operational guide to the ISO standards. LCA in perspective; Guide; Operational Annex,” Netherlands, 2001.
- [95] M. J. Goedkoop, S. Effting, and M. Collignon, “The Eco-indicator 99 Manual for Designers A Damage Oriented Method for Life Cycle Impact Assessment,” *B.V. Amersfoort*, 2000.
- [96] S. Humbert, M. Margni, and O. Jolliet, “A user guide for the New Life Cycle Impact Assessment Methodology IMPACT 2002+,” *Ind. Ecol. Life Cycle Syst. Group, GECOS, Swiss Fed. Inst. Technol. Lausanne (EPFL), CH-1015 Lausanne, Switz.*, 2005.
- [97] P. Mizsey, L. Delgado, and T. Benko, “Comparison of environmental impact and external cost assessment methods,” *Int. J. Life Cycle Assess.*, vol. 14, no. 7, pp. 665–675, Jun. 2009.
- [98] C. Pieragostini, M. C. Mussati, and P. Aguirre, “On process optimization considering LCA methodology,” *J. Environ. Manage.*, vol. 96, no. 1, pp. 43–54, Apr. 2012.
- [99] R. Frischknecht, N. E. Jungbluth, H. Althaus, C. Bauer, G. Doka, R. Dones, R. Hischier, S. Hellweg, T. Köllner, Y. Loerincik, M. Margni, and T. Nemececk, “Implementation of life cycle impact assessment methods. Ecoinvent report No. 3, v2.0,” Dübendorf, 2007.
- [100] R. Frischknecht and N. Jungbluth, “The ecoinvent database: Overview and methodological framework (7 pp),” *Int. ...*, vol. 10, no. 1, pp. 3–9, 2005.
- [101] R. Frischknecht, N. Jungbluth, and H. Althaus, “Overview and methodology. Ecoinvent report No. 3, v2.0,” 2007.
- [102] PRé Consultants, “SimaPro.” Amersfoort The Netherlands.
- [103] S. Kim and M. Overcash, “Energy in chemical manufacturing processes: gate-to-gate information for life cycle assessment,” *J. Chem. Technol. Biotechnol.*, vol. 78, no. 9, pp. 995–1005, Sep. 2003.
- [104] U. S. Environmental Protection Agency, “Report on revisions to AP 42, 5th Edition, Volume I Chapter 1: External Combustion Sources,” EPA Publications (1998-2008), Washington, 1998.
- [105] C. Jiménez-Gonzalez and D. J. C. Constable, *Green Chemistry and Engineering: A Practical Design Approach*. John Wiley & Sons, Inc., 2011, p. 696.
- [106] A. Poullikkas, “An overview of current and future sustainable gas turbine technologies,” *Renew. Sustain. Energy Rev.*, vol. 9, no. 5, pp. 409–443, Oct. 2005.
- [107] V. Ganapathy, “Heat recovery steam generators: understand the basics.” Chemical Engineering Progress, 1996.
- [108] J. L. Silveira and C. E. Tuna, “Thermoeconomic analysis method for optimization of combined heat and power systems. Part I,” *Prog. Energy Combust. Sci.*, vol. 29, no. 6, pp. 479–485, Jan. 2003.
- [109] J. Silveira and C. Tuna, “Thermoeconomic analysis method for optimization of combined heat and power systems—part II,” *Prog. energy Combust. Sci.*, vol. 30, pp. 673–678, 2004.
- [110] L. Jacquemin, “Production d’hémicelluloses de pailles et de sons de blé à une échelle pilote. Etude des performances techniques et évaluation environnementale d’un agro-procédé,” 2012.

- [111] M. Fermeglia, G. Longo, and L. Toma, "COWAR: A CAPE OPEN software module for the evaluation of process sustainability," *Environ. Prog.*, vol. 27, no. 3, 2008.
- [112] C. Li, X. Zhang, S. Zhang, and K. Suzuki, "Environmentally conscious design of chemical processes and products: Multi-optimization method," *Chem. Eng. Res. Des.*, vol. 87, no. 2, pp. 233–243, Feb. 2009.
- [113] M. Fermeglia, G. Longo, and L. Toma, "Computer aided design for sustainable industrial processes: Specific tools and applications," *AIChE J.*, vol. 55, no. 4, pp. 1065–1078, 2009.
- [114] Y. Kikuchi, K. Mayumi, and M. Hirao, "Integration of CAPE and LCA tools in environmentally-conscious process design: A case study on biomass-derived resin," *Comput. Aided Chem. Eng.*, 2010.
- [115] R. Brunet, D. Carrasco, E. Muñoz, G. Guillén-gosálbez, I. Katakis, and L. Jiménez, "Economic and environmental evaluation of microalgae biodiesel production using process simulation tools," *Comput. Aided Chem. Eng.*, no. June, pp. 17–20, 2012.
- [116] G. Rice, R. Clift, and R. Burns, "Comparison of currently available european LCA software," ... *Int. J. Life Cycle Assess.*, vol. 2, pp. 53–59, 1997.
- [117] N. Unger, P. Beigl, and G. Wassermann, "General requirements for LCA software tools," ... *Nat. Resour. Appl. Life ...*, pp. 1–6, 2004.
- [118] C. P. Siegenthaler, A. Braunschweig, G. Oetterli, and S. Furter, *LCA Software Guide 2005: Market Overview-Software Portraits*. Zurich: ÖBU, 2005, p. 152.
- [119] T. E. Casavant and R. P. Côté, "Using chemical process simulation to design industrial ecosystems," *J. Clean. Prod.*, vol. 12, no. 8–10, pp. 901–908, Oct. 2004.
- [120] E. M. Rosen, "Steady State Chemical Process Simulation: A State-of-the-Art Review," *Comput. Appl. to Chem. Eng.*, 1980.
- [121] R. L. Motard, M. Shacham, and E. M. Rosen, "Steady state chemical process simulation," *AIChE J.*, vol. 21, no. 3, pp. 417–436, May 1975.
- [122] D. F. Schneider, C. Engineer, S. Engineering, and L. City, "Steady State Simulators for Your Project," vol. 77573, no. 281, 1998.
- [123] J. Spooner, *A Review of Computer Process Simulation in Industrial Pollution Prevention*. 1994.
- [124] F. Bezzo, R. Bernardi, and G. Cremonese, "Using process simulators for steady-state and dynamic plant analysis: An industrial case study," *Chem. Eng. Res. Des.*, vol. 82, no. April, pp. 499–512, 2004.
- [125] S. Bumble, *Computer Simulated Plant Design for Waste Minimization/Pollution Prevention*. Florida: Lewis Publisher, 2000.
- [126] L. Toma, "Computer aided design of sustainable industrial processes," UNIVERSITA' DEGLI STUDI DI PADOVA, 2008.
- [127] Aspen Technology, "Aspen HYSYS." Burlington, Massachusetts.

- [128] J. Van Baten, "COCO Simulator."
- [129] R. Morales-Rodríguez, R. Gani, S. Déchelotte, A. Vacher, and O. Baudouin, "Use of CAPE-OPEN standards in the interoperability between modelling tools (MoT) and process simulators (Simulis® Thermodynamics and ProSimPlus)," *Chem. Eng. Res. Des.*, vol. 86, no. 7, pp. 823–833, Jul. 2008.
- [130] J. van Baten and R. Szczepanski, "A thermodynamic equilibrium reactor model as a CAPE-OPEN unit operation," *Comput. Chem. Eng.*, vol. 35, no. 7, pp. 1251–1256, Jul. 2011.
- [131] M. Fermeglia and S. Prich, "Multiscale molecular modeling in nanostructured material design and process system engineering," *Comput. Chem. Eng.*, vol. 33, no. 10, pp. 1701–1710, Oct. 2009.
- [132] Y. Lang, A. Malacina, and L. Biegler, "Reduced Order Model Based on Principal Component Analysis for Process Simulation and Optimization†," *Energy & Fuels*, no. 3, pp. 1695–1706, 2009.
- [133] J. Van Baten, "An Introduction to COCO," in *4th US CAPE-OPEN conference, AIChE annual meeting*, 2007, pp. 1–24.
- [134] S. ProSim, "ProSimPlus," vol. 33, no. 0. Labege, France.
- [135] J. Bon, G. Clemente, H. Vaquiro, and a. Mulet, "Simulation and optimization of milk pasteurization processes using a general process simulator (ProSimPlus)," *Comput. Chem. Eng.*, vol. 34, no. 3, pp. 414–420, Mar. 2010.
- [136] X. Joulia, B. Koehret, and M. Enjalbert, "Simulateur modulaire séquentiel à convergence simultanée," *Chem. Eng. J.*, vol. 30, pp. 113–127, 1985.
- [137] Z. Pintarič and Z. Kravanja, "Selection of the economic objective function for the optimization of process flow sheets," *Ind. Eng. Chem.*, pp. 4222–4232, 2006.
- [138] A. C. B. de Araújo, M. Govatsmark, and S. Skogestad, "Application of plantwide control to the HDA process. I—steady-state optimization and self-optimizing control," *Control Eng. Pract.*, vol. 15, no. 10, pp. 1222–1237, Oct. 2007.
- [139] M. Mönnigmann and W. Marquardt, "Steady-State Process Optimization with Guaranteed Robust Stability and Flexibility: Application to HDA Reaction Section," *Ind. Eng. Chem. Res.*, vol. 44, no. 8, pp. 2737–2753, Apr. 2005.
- [140] J. Gentry, "Benzene production and economics: a review," *Asia-Pacific J. Chem. Eng.*, no. August, pp. 272–277, 2007.
- [141] R. Turton, R. C. Bailie, W. B. Whiting, and J. A. Shaeiwitz, *Analysis, Synthesis, and Design of Chemical Processes*. Upper Saddle River New Jersey: Prentice Hall PTR, 1998.
- [142] R. Turton, R. C. Bailie, W. B. Whiting, and J. A. Shaeiwitz, *Analysis, Synthesis, and Design of Chemical Processes*, Third Edit. Upper Saddle River, New Jersey: Prentice Hall PTR, 2009.
- [143] G. Kocis and I. Grossmann, "A modelling and decomposition strategy for the MINLP optimization of process flowsheets," *Comput. Chem. Eng.*, vol. 13, no. 7, pp. 797–819, 1989.

- [144] U. S. N. L. of Medicine, "Hazardous Substances Data Bank (HSDB)." Bethesda, Maryland, 1994.
- [145] Kirk-Othmer, *Concise Encyclopedia of Chemical Technology*, Third edit. New York: John Wiley and Sons, 1985.
- [146] J. H. Holland, *Adaptation in natural and artificial systems: An introductory analysis with applications to biology, control, and artificial intelligence*. Oxford, England: U Michigan Press, 1975, p. 183.
- [147] S. Nakrani and C. Tovey, "On honey bees and dynamic allocation in an internet server colony," *Adapt. Behav. - Anim. Animat. Softw. Agents, Robot. Adapt.*, vol. 12, no. 3–4, pp. 223 – 240, 2004.
- [148] R. Storn and K. Price, "Differential evolution—a simple and efficient heuristic for global optimization over continuous spaces," *J. Glob. Optim.*, pp. 341–359, 1997.
- [149] R. Eberhart and J. Kennedy, "A new optimizer using particle swarm theory," *MHS'95. Proc. Sixth Int. Symp. Micro Mach. Hum. Sci.*, pp. 39–43, 1995.
- [150] S. Kirkpatrick, C. D. Gelatt, and M. P. Vecchi, "Optimization by simulated annealing," *Science (80-.)*, vol. 220, pp. 671 – 680, 1983.
- [151] J. Farmer, N. Packard, and A. Perelson, "The immune system, adaptation, and machine learning," *Phys. D Nonlinear Phenom.*, pp. 187–204, 1986.
- [152] M. Dorigo, "Optimization, learning and natural algorithms," Politecnico di Milano, Italy, 1992.
- [153] J. Y. Lettvin, H. R. Maturana, W. S. McCulloch, and W. H. Pitts, "What the frog's eye tells the frog's brain," *Proc. IRE*, vol. 47, pp. 1940 – 1951, 1959.
- [154] W. Wenzel and K. Hamacher, "A Stochastic Tunneling Approach for Global Minimization of Complex Potential Energy Landscapes," *Phys. Rev. Lett.*, vol. 82, pp. 3003–3007, 1999.
- [155] R. Swendsen and J. Wang, "Replica Monte Carlo simulation of spin glasses," *Phys. Rev. Lett.*, vol. 57, 1986.
- [156] K. Miettinen, *Nonlinear Multiobjective Optimization*. Boston, MA, USA: Kluwer Academic Publishers, 1998, p. 298.
- [157] A. Engau, M. M. Wiecek, A. Engau, and M. M. Wiecek, "Technical Report TR2005 10 EWb Generating epsilon-efficient solutions in multiobjective programming This report is available online at Generating epsilon-efficient solutions in multiobjective programming," 2005.
- [158] I. Y. Kim and O. L. Weck, "Adaptive weighted sum method for multiobjective optimization: a new method for Pareto front generation," *Struct. Multidiscip. Optim.*, vol. 31, no. 2, pp. 105–116, Dec. 2005.
- [159] G. Mavrotas, "Effective implementation of the ϵ -constraint method in Multi-Objective Mathematical Programming problems," *Appl. Math. Comput.*, vol. 213, no. 2, pp. 455–465, Jul. 2009.

- [160] D. H. Wolpert and W. G. Macready, "No free lunch theorems for optimization," *IEEE Trans. Evol. Comput.*, vol. 1, no. 1, pp. 67–82, Apr. 1997.
- [161] R. Benayoun, J. De Montgolfier, T. J., and L. O., "Linear programming with multiple objective functions: Step method (STEM)," *Math. Program.*, vol. 1, pp. 366–375, 1971.
- [162] D. Chafekar, X. Jiang, and K. Rasheed, "Constrained multi-objective ga optimization using reduced models," *IEEE Trans. Syst. Man Cybern.*, pp. 261–265, 2005.
- [163] C. A. Coello Coello, "List of references on multiobjective optimization." [Online]. Available: <http://delta.cs.cinvestav.mx/~ccoello/EMOO/EMOObib.html>.
- [164] C. A. Coello Coello and R. Becerra, "Evolutionary multiobjective optimization in materials science and engineering," *Mater. Manuf. Process.*, vol. 24, pp. 119–129, 2009.
- [165] C. M. Fonseca and P. J. Fleming, "Genetic Algorithms for Multiobjective Optimization: Formulation Discussion and Generalization.," *Int. Conf. Genet. Algorithms*, no. July, 1993.
- [166] N. Srinivas and K. Deb, "Multiobjective Optimization Using Nondominated Sorting in Genetic Algorithms," *Evol. Comput.*, no. 0, pp. 221–248, 1994.
- [167] J. Horn, N. Nafpliotis, and D. E. Goldberg, "A niched Pareto genetic algorithm for multiobjective optimization," in *Evolutionary Computation, 1994. IEEE World Congress on Computational Intelligence, 1994*, vol. 1, pp. 82–87.
- [168] K. Deb, *Multi-Objective Optimization using Evolutionary Algorithms*. Chichester, UK: Wiley, 2001, p. 518.
- [169] S. Obayashi, K. Deb, C. Poloni, T. Hiroyasu, and T. Murata, *Evolutionary Multi-Criterion Optimization*. Springer, 2007, p. 954.
- [170] F. Pettersson, N. Chakraborti, and H. Saxén, "A genetic algorithms based multi-objective neural net applied to noisy blast furnace data," *Appl. Soft Comput.*, vol. 7, no. 1, pp. 387–397, Jan. 2007.
- [171] F. Pettersson, A. Biswas, P. K. Sen, H. Saxén, and N. Chakraborti, "Analyzing Leaching Data for Low-Grade Manganese Ore Using Neural Nets and Multiobjective Genetic Algorithms," *Mater. Manuf. Process.*, vol. 24, no. 3, pp. 320–330, Feb. 2009.
- [172] C. M. Fonseca and P. J. Fleming, "Multiobjective genetic algorithms made easy: selection sharing and mating restriction," *Genet. Algorithms Eng. Syst.*, no. 414, 1995.
- [173] C. M. Fonseca and P. J. Fleming, "Multiobjective optimization and multiple constraint handling with evolutionary algorithms. I. A unified formulation," *IEEE Trans. Syst. Man, Cybern. - Part A Syst. Humans*, vol. 28, no. 1, pp. 26–37, 1998.
- [174] D. E. Goldberg, *Genetic Algorithms in Search, Optimization and Machine Learning*, 1st ed. Boston, MA, USA: Addison-Wesley Longman Publishing Co., 1989.
- [175] A. M. Connor and D. G. Tilley, "A tabu search method for the optimization of fluid power circuits," *J. Syst. Control Eng.*, pp. 212:373–381, 1998.

- [176] K. Deb and A. Pratap, "A fast and elitist multiobjective genetic algorithm: NSGA-II," *IEEE Trans. Evol. Comput.*, vol. 6, no. 2, pp. 182–197, 2002.
- [177] C. A. Coello Coello, "Evolutionary multi-objective optimization: some current research trends and topics that remain to be explored," *Front. Comput. Sci. China*, vol. 3, no. 1, p. pp 18–30, 2009.
- [178] A. Gomez, "Optimisation technico-économique multi-objectif de systèmes de conversion d'énergie: cogénération électricité-hydrogène à partir d'un réacteur nucléaire de IVème génération," Institut National Polytechnique de Toulouse, 2008.
- [179] A. Gomez, L. Pibouleau, C. Azzaro-Pantel, S. Domenech, C. Latgé, and D. Haubensack, "Multiobjective genetic algorithm strategies for electricity production from generation IV nuclear technology," *Energy Convers. Manag.*, vol. 51, no. 4, pp. 859–871, Apr. 2010.
- [180] R. Agrawal and K. Deb, "Simulated binary crossover for continuous search space," *Complex Syst.*, vol. 9, pp. 115–148, 1995.
- [181] L. F. Morales Mendoza, J. L. Perez Escobedo, C. Azzaro-Pantel, L. Pibouleau, S. Domenech, and A. Aguilar-Lasserre, "Selecting the best portfolio alternative from a hybrid multiobjective GA-MCDM approach for New Product Development in the pharmaceutical industry," *2011 IEEE Symp. Comput. Intell. Multicriteria Decis.*, pp. 159–166, Apr. 2011.
- [182] M. Pirdashti and A. Ghadi, "Multi-criteria decision-making selection model with application to chemical engineering management decisions," *Int. J. Hum. Soc. Sci.*, pp. 1148–1153, 2009.
- [183] J. Figueira, S. Greco, and M. Ehrgott, *Multiple Criteria Decision Analysis: State Of The Art Surveys*. Boston, MA, USA: Springer Science + Business Media Inc., 205AD.
- [184] A. Teixeira de Almeida and C.M.G. de Miranda Cabral Seixas Costa A.P., "Multicriteria model for prioritization of research and development projects," *J. Acad. Bus. Econ.*, 2004.
- [185] S. D. Pohekar and M. Ramachandran, "Application of multi-criteria decision making to sustainable energy planning—A review," *Renew. Sustain. Energy Rev.*, vol. 8, no. 4, pp. 365–381, Aug. 2004.
- [186] S. Zhaoxu and H. Min, "Multi-criteria Decision Making Based on PROMETHEE Method," *2010 Int. Conf. Comput. Control Ind. Eng.*, pp. 416–418, 2010.
- [187] S. Opricovic and G.-H. Tzeng, "Compromise solution by MCDM methods: A comparative analysis of VIKOR and TOPSIS," *Eur. J. Oper. Res.*, vol. 156, no. 2, pp. 445–455, Jul. 2004.
- [188] U. Pinter and I. Pšunder, "Evaluating construction project success with use of the M-TOPSIS method," *J. Civ. Eng. Manag.*, vol. 19, no. 1, pp. 16–23, Feb. 2013.
- [189] L. Ren, Y. Zhang, Y. Wang, and Z. Sun, "Comparative Analysis of a Novel M-TOPSIS Method and TOPSIS," *Appl. Math. Res. eXpress*, vol. 2007, pp. 1–10, Jul. 2010.
- [190] M. Boix, "Optimisation multicritère de réseaux d'eau," Université de Toulouse - Institut National Polytechnique de Toulouse, 2011.
- [191] M. S. García-Cascales and M. T. Lamata, "On rank reversal and TOPSIS method," *Math. Comput. Model.*, vol. 56, no. 5–6, pp. 123–132, Sep. 2012.

- [192] A. Aguilar-Lasserre, "Approche multicritère pour la conception d'ateliers discontinus dans un environnement incertain.," Institut National Polytechnique de Toulouse, 2006.
- [193] A. Ponsich, "Strategies d'optimisation mixte en genie des procedes Application a la conception d'ateliers discontinus.," Institut National Polytechnique de Toulouse, 2005.
- [194] M. J. Haas, S. Bloomer, and K. Scott, "Process for the production of fatty acid alkyl esters," 6,399,8002002.
- [195] A. N. Phan and T. M. Phan, "Biodiesel production from waste cooking oils," *Fuel*, vol. 87, no. 17–18, pp. 3490–3496, Dec. 2008.
- [196] S. Morais, T. M. Mata, A. a. Martins, G. a. Pinto, and C. a. V. Costa, "Simulation and life cycle assessment of process design alternatives for biodiesel production from waste vegetable oils," *J. Clean. Prod.*, vol. 18, no. 13, pp. 1251–1259, Sep. 2010.
- [197] L. Simasatitkul, R. Gani, and A. Arpornwichanop, "Optimal Design of Biodiesel Production Process from Waste Cooking Palm Oil," *Procedia Eng.*, vol. 42, no. August, pp. 1292–1301, Jan. 2012.
- [198] B. B. Uzun, M. Kılıç, N. Özbay, A. E. Pütün, and E. Pütün, "Biodiesel production from waste frying oils: Optimization of reaction parameters and determination of fuel properties," *Energy*, vol. 44, no. 1, pp. 347–351, Aug. 2012.
- [199] M. Atapour, H.-R. Kariminia, and P. M. Moslehabadi, "Optimization of biodiesel production by alkali-catalyzed transesterification of used frying oil," *Process Saf. Environ. Prot.*, no. November 2011, pp. 1–7, Jan. 2013.
- [200] K. S. Tyson, "Biodiesel handling and use guidelines," 2001.
- [201] C. Drapcho, J. Nghiem, and T. Walker, *Biofuels engineering process technology*, 1st editio. USA: McGraw-Hill Professional, 2008, p. 371.
- [202] L. H. Huynh, N. S. Kasim, and Y. H. Ju, *Biodiesel production from waste oils in Biofuels: alternative feedstocks and conversion processes*, 1st editio. USA: Academic press, Elsevier Inc., 2011, pp. 375 – 396.
- [203] B. Fu, L. Gao, L. Niu, R. Wei, and G. Xiao, "Biodiesel from Waste Cooking Oil via Heterogeneous Superacid Catalyst SO₄ 2- /ZrO₂," *Energy & Fuels*, vol. 23, no. 1, pp. 569–572, Jan. 2009.
- [204] A. B. Chhetri, K. C. Watts, and M. R. Islam, "Waste Cooking Oil as an Alternate Feedstock for Biodiesel Production," *Energies*, vol. 1, no. 1, pp. 3–18, Apr. 2008.
- [205] W. H. Kemp, *Biodiesel: basic and beyond – A comprehensive guide to production and use for home and farm*. Ontario Canada: Azttext press, 2006, p. 588.
- [206] Y. Zhang, "Biodiesel production from waste cooking oil: 1. Process design and technological assessment," *Bioresour. Technol.*, vol. 89, no. 1, pp. 1–16, Aug. 2003.
- [207] E. Minami and S. Saka, "Kinetics of hydrolysis and methyl esterification for biodiesel production in two-step supercritical methanol process," *Fuel*, vol. 85, no. 17–18, pp. 2479–2483, Dec. 2006.

- [208] S. Behzadi and M. M. Farid, "Production of biodiesel using a continuous gas-liquid reactor.," *Bioresour. Technol.*, vol. 100, no. 2, pp. 683–9, Jan. 2009.
- [209] Y. Zhang, M. . Dubé, D. . McLean, and M. Kates, "Biodiesel production from waste cooking oil: 2. Economic assessment and sensitivity analysis," *Bioresour. Technol.*, vol. 90, no. 3, pp. 229–240, Dec. 2003.
- [210] A. H. West, D. Posarac, and N. Ellis, "Assessment of four biodiesel production processes using HYSYS.Plant.," *Bioresour. Technol.*, vol. 99, no. 14, pp. 6587–601, Sep. 2008.
- [211] M. G. Varanda, G. Pinto, and F. Martins, "Life cycle analysis of biodiesel production," *Fuel Process. Technol.*, vol. 92, no. 5, pp. 1087–1094, May 2011.
- [212] L. L. Myint and M. M. El-Halwagi, "Process analysis and optimization of biodiesel production from soybean oil," *Clean Technol. Environ. Policy*, vol. 11, no. 3, pp. 263–276, Jun. 2008.
- [213] G. Di Nicola, M. Moglie, M. Pacetti, and G. Santori, "Bioenergy II: Modeling and Multi-Objective Optimization of Different Biodiesel Production Processes," *Int. J. Chem. React. Eng.*, vol. 8, no. 1, Jan. 2010.
- [214] S. Sharma and G. P. Rangaiah, "Multi-objective optimization of a bio-diesel production process," *Fuel*, vol. 103, pp. 269–277, Jan. 2013.
- [215] M. Canakci and J. VAN Gerpen, "Biodiesel production via acid catalysis," *Trans. ASAE*, vol. 42, no. 1984, pp. 1203–1210, 1999.
- [216] S. Zheng, M. Kates, M. a. Dubé, and D. D. McLean, "Acid-catalyzed production of biodiesel from waste frying oil," *Biomass and Bioenergy*, vol. 30, no. 3, pp. 267–272, Mar. 2006.

List of figures

Figure 1.1 Value chain schematic from SPIRE [1]	6
Figure 1.2 Comparison between traditional chemical process and greener process	7
Figure 1.3 Inclusion of energy in the WAR algorithm (according to [21]).....	14
Figure 1.4 System boundaries Cradle-to gate.....	24
Figure 1.5 General framework for eco-design proposed in [73], [74].....	26
Figure 1.6 General outline of the thesis.....	28
Figure 2.1 Life Cycle Assessment framework	35
Figure 2.2 Impact 2002+ framework: mid and end-point categories (Based on [51])	39
Figure 2.3 Potential energy paths in a chemical process [103]	42
Figure 2.4 Overall architecture of ARIANE communication.....	44
Figure 2.5 Mass and energy flows to steam production [105]	45
Figure 2.6 (a) Design and (b) operation tabs in Ariane user interface of bi-fuel furnace	46
Figure 2.7 A flowsheet example of bi-fuel furnace in Ariane.....	46
Figure 2.8 Principle of a gas turbine with heat-recovery steam generators (HRSGs).....	48
Figure 2.9 Ariane interface for fuel turbine (Design (2.9.a) and Operation tabs (2.9.b)).....	49
Figure 2.10 Ariane interface for heat exchanger (Design (2.10.a) and operation tabs (2.10.b)).....	50
Figure 2.11 A flowsheet example of gas turbine in Ariane.....	50
Figure 2.12 Comparison of emissions from various steam productions	52
Figure 2.13 Analysis of elements contribution in the categories (Characterization)	55
Figure 2.14 Environmental impacts of extraction and process in categories (Characterization)	56
Figure 2.15 Environmental impacts in end-point categories (Normalization)	57
Figure 3.1 Overview of the integrated simulation approach for eco-efficient process design	63
Figure 3.2 Design steps of the environmental impact model from SIMAPRO.....	68
Figure 3.3 Process simulator structure	69
Figure 3.4 Data exchange through the interface com.....	70
Figure 3.5 COCO components interaction	73
Figure 3.6 HDA Process proposed by [61]	76
Figure 3.7 HDA process coupled to an energy production plant and work boundaries.....	77
Figure 3.8 HDA flowsheet with COCO simulator	80
Figure 3.9 HDA flowsheet with Prosim PLUS simulator	80
Figure 3.10 HDA flowsheet with Aspen HYSYS simulator.....	81
Figure 3.11 Natural gas/Fuel oil and H ₂ /CH ₄ furnaces simulation models in ARIANE	83

Figure 3.12 Data flow between energy and process simulators and impact factors database	89
Figure 3.13 Frameworks architectures: a) embedded in process simulator b) with an independent platform	90
Figure 3.14 Sequence of framework activities	91
Figure 3.15 Flowchart of activities 1 and 2	91
Figure 3.16 Flowchart of activity 3	92
Figure 3.17 Flowchart of activities 4 and 5	92
Figure 3.18 Data exchange between process and energy simulators	93
Figure 3.19 Comparison of simulation results in the thirteen mid-point categories (normalization)....	94
Figure 3.20 Comparison of simulation results in the four end-point categories (normalization).....	94
Figure 3.21 Analysis of the individual impact of the LCI elements in mid-point categories.....	95
Figure 3.22 Analysis of the individual impact of the LCI elements.....	96
Figure 3.23 Analysis of the individual impact of the LCI elements in end-point categories	96
Figure 3.24 Comparison of normalization results in mid-point categories	99
Figure 3.25 Comparison of normalization results in end-point categories.....	99
Figure 3.26 Classification of the environmental impact and cost according to the type of variable (mid-points).....	101
Figure 3.27 Classification of the environmental impact and cost according to the type of variable (end-points).....	101
Figure 3.28 Mid-points categories analysis according to inventory data sub-categories (Characterization score)	102
Figure 3.29 Mid-point categories analysis of the scenario 4 (Characterization score).....	103
Figure 3.30 End-point categories analysis of the scenario 4 (Normalization score)	103
Figure 4.1 Overview of integrated approach for eco-efficient process design (Optimization)	109
Figure 4.2 Classification of optimization methods.....	111
Figure 4.3 Representation of a single genetic algorithm	113
Figure 4.4 Classification of decision analysis methods.....	116
Figure 4.5 ELECTRE method elements	118
Figure 4.6 Data flow through the framework components (including optimization stage).....	122
Figure 4.7 Architecture 3: Framework with integrated optimization	123
Figure 4.8 Two dimensionally comparisons of Pareto front (5 criteria optimization runs)	126
Figure 4.9 Pareto front obtained for bi-criteria optimization	127
Figure 4.10 Pareto front with selected solutions by MCDM methods	129
Figure 4.11 Comparison of normalization results in mid-point categories	131
Figure 4.12 Comparison of simulation results in the four end-point categories (normalization).....	132
Figure 4.13 Analysis of the individual impact of the LCI components in mid-point categories.....	132
Figure 4.14 Analysis of the individual impact of the fuels in mid-point categories	133

Figure 4.15 Comparison of operating cost and environmental results in mid- and end-point categories	133
Figure 4.16 Comparison of the MCDM solutions versus 5 criteria optimization	135
Figure 4.17 Mid-point categories analysis of the PROMETHEE solution (Characterization score)..	135
Figure 4.18 Comparison of the environmental impacts of the PROMETHEE and mono-criterion optimization.....	136
Figure 4.19 End-point analysis of the PROMETHEE solution.....	136
Figure 5.1 Percent reduction in emissions of pollutants for B100 (100% biodiesel) and B20 (20% biodiesel) compared to conventional diesel (adapted from [201]).....	144
Figure 5.2 General flowsheet of the alkali-catalyzed biodiesel production process with the associated pre-treatment stage	147
Figure 5.3 General flowsheet of the acid-catalyzed biodiesel production process.....	147
Figure 5.4 Flowsheet of biodiesel production process for gate to gate analysis from [72].....	151
Figure 5.5 Comparison between the results obtained by MULTIGEN Front and obtained in Halim et al [72]	152
Figure 5.6 Flowsheet of biodiesel production process for gate to gate analysis (recycling paths)	153
Figure 5.7 Two dimensionally comparisons of Pareto front (Profit – Environmental criteria).....	157
Figure 5.8 Two dimensionally comparisons of Pareto front (Environmental criteria).....	157
Figure 5.9 Comparison of optimization results in the four end-point categories (normalization)	159
Figure 5.10 Comparison of normalization results in mid-point categories (normalization)	160
Figure 5.11 Analysis of the individual impact of the fuels in mid-point categories	161
Figure 5.12 Comparison of profit and environmental impact in mid- and end-point categories	161
Figure 5.13 Mid-point categories analysis of the M-TOPSIS (rank 1) solution (Characterization score)	163
Figure 5.14 Comparison of the environmental impacts of the M-TOPSIS (rank 1) and mono-criterion solutions	163
Figure 5.15 End-point analysis of the M-TOPSIS (rank 1) solution.....	164

List of tables

Table 1.1 Classification of criteria for sustainable development in process design according to [6]	9
Table 1.2 Environmental impact categories used in the WAR algorithm	16
Table 2.1 Impact assessment methods and their characteristics (Based on [98]).....	37
Table 2.2 Factor type provided by impact assessment methods [99].....	38
Table 2.3 Characterization reference substances and units used in IMPACT 2002+ (Based on [96]) .	40
Table 2.4 Comparison of emissions from two steam productions (gate to gate emissions).....	47
Table 2.5 Key parameter specification of the gas turbine in Ariane	51
Table 2.6 Comparison of emissions from various steam productions (gate to gate emissions)	51
Corresponding to operating conditions of Table 2.4	51
Table 2.7 Matching between the inventory data and the EcoInvent database.....	53
Table 2.8 Characterization factors for IMPACT 2002+.....	53
Table 2.9 Damage and normalization factors IMPACT 2002+ (Based on [51]).....	54
Table 2.10 Inventory data of steam production.....	54
Table 2.11 Environmental impact of steam production (Characterization)	55
Table 2.12 Adverse effects caused by NO _x in categories.....	56
Table 3.1 Some works on the application of LCA to process design.....	65
Table 3.2 Life cycle assessment software tools.....	67
Table 3.3 Commercial and non-commercial process simulators.....	70
Table 3.4 Advantages and drawbacks of sequential modular and equation-oriented simulators	71
Table 3.5 Operating conditions of HDA process inputs.....	78
Table 3.6 Summary of raw materials and utilities prices of HDA process	79
Table 3.7 Comparison of process output streams.....	81
Table 3.8 Comparison of process output streams.....	82
Table 3.9 Comparison of reactor input/output streams	82
Table 3.10 Classification of inventory data of the HDA process	85
Table 3.11 Results of inventory data from HDA process.....	85
Table 3.12 General layout of characterization table.....	86
Table 3.13 Selected items in the SIMAPRO model for the HDA process	87
Table 3.14 Raw materials characterization factors of HDA process.....	87
Table 3.15 Fuels characterization factors of HDA process	88
Table 3.16 Emissions characterization factors of energy production plant.....	88

Table 3.17 Proposed scenarios for sensitivity analysis	97
Table 3.18 Results of the various scenarios	98
Table 3.19 Increase or decrease cost and environmental impact of IMPACT2002 + categories.....	100
Table 4.1 Some stochastic methods for multi-objective optimization	111
Table 4.2 Decision matrix in ELECTRE method.....	117
Table 4.3 Difference matrix for all criteria involved in the analysis.....	119
Table 4.4 Decision matrix X in TOPSIS method	120
Table 4.5 Raw materials and utilities costs	125
Table 4.6 Variation range for decision variables.....	125
Table 4.7 Correlation coefficient between environmental and economic criteria.....	126
Table 4.8 Variability analysis of mid-point categories for all the solutions in the Pareto Front.....	127
Table 4.9 Parameters to configure the MCDM methods.....	128
Table 4.10 Optimization variables values from solutions selected by MCDM methods	129
Table 4.11 Operating conditions from solutions selected by MCDM methods	130
Table 4.12 Gain calculated relative to the mono-criteria solution	134
Table 5.1 Characteristics of the two main biodiesel production processes: alkali-catalyzed versus acid-catalyzed processes.....	146
Table 5.2 Operating conditions of process inputs	149
Table 5.3 Summary of raw materials and utility prices of Biodiesel process	150
Table 5.4 Environmental data for biodiesel production (Gate to gate factors)	151
Table 5.5 Bounds for optimization variables in the biodiesel production process.....	152
Table 5.6 Operating conditions of the solution proposed by M-TOPSIS.....	153
Table 5.7 Inventory data and selected items in the SIMAPRO.....	154
Table 5.8 Raw materials characterization factors of biodiesel process	155
Table 5.9 Optimization variables values for some solutions obtained by M-TOPSIS and for the mono-criterion solution.....	158
Table 5.10 Operating conditions from four solutions.....	159
Table 5.11 Gain calculated relative to the mono-criteria solution	162



APPENDIX A. Material balance of HDA process from
Douglas hypotheses

Aspen HYSYS

		HyM	Toluene	3	4	5	7	8	9	10
Methane	Kgmole/h	24.81	0.00	2066.77	2066.77	2066.77	2344.5	2327.5 4	17.02	17.02
Hydrogen	Kgmole/h	471.47	0.00	1851.92	1851.92	1851.92	1578.5	1576.8 7	1.64	1.64
Toluene	Kgmole/h	0.00	278.26	370.39	370.39	370.39	92.60	3.72	88.88	0.00
Benzene	Kgmole/h	0.00	0.00	26.89	26.89	26.89	295.89	30.82	265.0 7	0.00
Biphenyl	Kgmole/h	0.00	0.00	0.01	0.01	0.01	4.40	0.00	4.40	0.00
Molar enthalpy	kcal/kgmole	-807.16	3638.52	6989.00	5356.18	331.66	-8662.6	-10363.	9111. 1	- 16250.0
Temperature	C	38 38.0032	38	114.75	225	621	38	38	38 31.99	38.186
Pressure	bar	5	38	37.9995	36.9995	35.9995	31.9	31.99	9	9.9995

		11	12	Purge	14	15	1	2	13	16
Methane	Kgmole/h	0.00	2344.56	294.16	2050.40	2050.40	2041.95	0.00	2344. 5	2344.56
Hydrogen	Kgmole/h	0.00	1578.51	198.05	1380.46	1380.46	1380.44	0.00	1574. 1	1578.51
Toluene	Kgmole/h	88.88	3.72	0.47	3.25	3.25	3.24	0.00	92.60 304.6	92.60
Benzene	Kgmole/h	265.07	30.82	3.87	26.96	26.96	26.88	0.00	8	295.89
Biphenyl	Kgmole/h	4.40	0.00	0.00	0.00	0.00	0.00	0.00	0.01	4.40
Molar enthalpy	kcal/kgmole	10431.8	-10391	-10391	-10391	-9116.36	9098.63	330.99	- 331.6 7	331.67
Temperature	C	38.1873	33.32	33.32	33.32	183.02	183.09	668.09	668.0 9	665.90
Pressure	bar	9.9995	9.9995	9.9995	9.9995	38	38	34.49	34.49	34.4995

		17	Benzen e	19	20	Bipheny l	6	21	18	22
Methane	Kgmole/h	0.00	0.00	0.00	0.00	0.00	0.00	0.00	17.02	0.00
Hydrogen	Kgmole/h	0.00	0.00	0.00	0.00	0.00	0.00	0.00	1.64	0.00
Toluene	Kgmole/h	0.00	0.03	88.85	88.85	0.00	88.89	88.85	88.88	88.88
Benzene	Kgmole/h	0.00	265.06	0.01	0.01	0.00	0.01	0.01	265.0	265.07
Biphenyl	Kgmole/h	0.00	0.00	4.40	0.01	4.39	0.01	0.01	4.40	4.40
Molar enthalpy	kJ/kgmole	330.85	14505.7	9144.56	7025.14	55284.8	7165.12	7165.1	9111	10431.8
Temperature	C	666	104	138	125	274	127	127 37.999	38 9.999	39
Pressure	bar	34.4995	2	2	1.5	1.5	37.9995	5	5	2.9995

COCO simulator

		H2 and CH4	Toluene	12	16	19	22	50	23	24
Hydrogen	kgmole/h	472.79	0.00	1872.42	1597.63	1596.49	1399.6	1399.63	1872.42	1872.42
Methane	kgmole/h	22.83	0.00	2169.58	2450.44	2430.82	2146.7	2146.75	2169.58	2169.58
Benzene	kgmole/h	0.00	0.00	26.39	295.11	30.09	26.36	26.36	26.39	26.39
Toluene	kgmole/h	0.00	281.39	374.48	93.62	3.44	3.02	3.02	374.48	374.48
Biphenyl	kgmole/h	0.00	0.00	0.00	6.07	0.00	0.00	0.00	0.00	0.00
Enthalpy	kJ/kmole	459.78	35429.50	1977.84	35329.50	264.40	264.80 34.350	5688.24	8793.64	32688.90
Temperature	°C	38	38	115.733	667.6	38	4	184.336	225	621
Pressure	bar	38	38	38	34.5	32	10	38.3	37	36

		28	29	122	39	123	gas	46	48	53
Hydrogen	kgmole/h	1597.63	1.14	1.14	0.00	0.00	1.14	0.00	0.00	0.00
Methane	kgmole/h	2450.44	19.62	19.62	0.00	0.00	19.62	0.00	0.00	0.00
Benzene	kgmole/h	295.11	265.02	265.02	265.02	265.02	0.00	0.03	0.03	0.03
Toluene	kgmole/h	93.62	90.18	90.18	90.18	90.18	0.00	90.07	90.07	90.16
Biphenyl	kgmole/h	6.07	6.07	6.07	6.07	6.07	0.00	0.00	0.00	6.07
Enthalpy		-	-	-	-	-	-	-	-	-
Enthalpy		2452.20	-31328.9	31328.9	33083.70	33083.7	342.83	20756.2	20097.00	19055.70
Temperature	°C	38	38	38.4076	38.4076	38.7791	38.407	125.248	127.63	139.251
Pressure	bar	32	32	10	10	3	10	1.5	38	2

		60	77	Purge	Benzene	Biphenyl
Hydrogen	kgmole/h	1597.63	0.00	198.00	0.00	0.00
Methane	kgmole/h	2450.44	0.00	303.69	0.00	0.00
Benzene	kgmole/h	30.09	265.00	3.73	265.00	0.00
Toluene	kgmole/h	3.44	0.01	0.43	0.01	0.09
Biphenyl	kgmole/h	0.00	0.00	0.00	0.00	6.07
Enthalpy		-	-	-	-	-
Enthalpy		264.80	22614.20	264.80	-22 614.2	6 161.20
Temperature	°C	34.3504	103.999	34.35	104.00	264.84
Pressure	bar	10	2	10	2	1.5

ProSimPlus

		1	10	11	12	13	14	15	16
HYDROGEN	kmol/h	473.56	1606.00	2.22	2.22	2.22	1603.79	0.00	0.00
METHANE	kmol/h	24.59	2488.67	19.97	19.97	19.97	2468.70	0.00	0.00
BENZENE	kmol/h	0.00	296.50	265.01	265.01	0.00	31.49	265.01	265.01
TOLUENE	kmol/h	0.00	94.08	90.42	90.42	0.00	3.66	90.42	90.42
BIPHENYL	kmol/h	0.00	6.68	6.68	6.68	0.00	0.00	6.68	6.68
Temperature	°C	38.00	37.70	38.00	38.39	38.39	38.00	38.39	38.76
Pressure	bar	38.00	32.00	32.00	10.20	10.00	32.00	10.00	3.00
Molar enthalpy	kJ/kmol	389.82	-2511.22	-31369.86	-31369.86	343.34	206.19	-33256.69	-33256.69

		17	18	19	2	20	21	22	25
HYDROGEN	kmol/h	0.00	0.00	0.00	0.00	0.00	0.00	0.00	1606.00
METHANE	kmol/h	0.00	0.00	0.00	0.00	0.00	0.00	0.00	2488.67
BENZENE	kmol/h	265.00	265.00	0.01	0.00	0.01	0.00	0.01	31.49
TOLUENE	kmol/h	0.00	0.00	90.42	282.77	90.33	0.09	90.33	3.66
BIPHENYL	kmol/h	0.00	0.00	6.68	0.00	0.01	6.68	0.01	0.00
Temperature	°C	104.04	104.04	139.51	38.00	125.22	265.79	128.11	33.44
Pressure	bar	2.00	2.00	2.00	38.00	1.50	1.50	38.00	10.00
Molar enthalpy	kJ/kmol	-22552.95	-22552.95	-19455.41	-35811.49	-21070.10	6403.92	-20313.24	206.93

		26	27 PURGE	28	29	3	4	5	6
HYDROGEN	kmol/h	198.00	198.00	1408.00	1408.00	1881.56	1881.56	1881.56	1881.56
METHANE	kmol/h	306.82	306.82	2181.85	2181.85	2206.44	2206.44	2206.44	2206.44
BENZENE	kmol/h	3.88	3.88	27.60	27.60	27.62	27.62	27.62	27.62
TOLUENE	kmol/h	0.45	0.45	3.21	3.21	376.31	376.31	376.31	376.31
BIPHENYL	kmol/h	0.00	0.00	0.00	0.00	0.01	0.01	0.01	0.01
Temperature	°C	33.44	33.44	33.44	202.75	122.39	225.00	621.00	621.00
Pressure	bar	10.00	10.00	10.00	38.00	37.54	36.54	35.54	35.54
Molar enthalpy	kJ/kmol	206.93	206.93	206.93	6383.62	2525.70	8709.28	32543.08	32543.08

		7	8	9
HYDROGEN	kmol/h	1599.33	1606.00	1606.00
METHANE	kmol/h	2488.67	2488.67	2488.67
BENZENE	kmol/h	309.85	296.50	296.50
TOLUENE	kmol/h	94.08	94.08	94.08
BIPHENYL	kmol/h	0.01	6.68	6.68
Temperature	°C	667.60	667.60	38.00
Pressure	bar	34.04	34.04	33.54
Molar enthalpy	kJ/kmol	35251.36	35272.00	-2511.22