



HAL
open science

Computability of Topological Spaces

Djamel Eddine Amir

► **To cite this version:**

Djamel Eddine Amir. Computability of Topological Spaces. Logic in Computer Science [cs.LO].
Université de Lorraine, 2023. English. NNT : 2023LORR0187 . tel-04324721

HAL Id: tel-04324721

<https://theses.hal.science/tel-04324721v1>

Submitted on 5 Dec 2023

HAL is a multi-disciplinary open access archive for the deposit and dissemination of scientific research documents, whether they are published or not. The documents may come from teaching and research institutions in France or abroad, or from public or private research centers.

L'archive ouverte pluridisciplinaire **HAL**, est destinée au dépôt et à la diffusion de documents scientifiques de niveau recherche, publiés ou non, émanant des établissements d'enseignement et de recherche français ou étrangers, des laboratoires publics ou privés.



**UNIVERSITÉ
DE LORRAINE**

**BIBLIOTHÈQUES
UNIVERSITAIRES**

AVERTISSEMENT

Ce document est le fruit d'un long travail approuvé par le jury de soutenance et mis à disposition de l'ensemble de la communauté universitaire élargie.

Il est soumis à la propriété intellectuelle de l'auteur. Ceci implique une obligation de citation et de référencement lors de l'utilisation de ce document.

D'autre part, toute contrefaçon, plagiat, reproduction illicite encourt une poursuite pénale.

Contact bibliothèque : ddoc-theses-contact@univ-lorraine.fr
(Cette adresse ne permet pas de contacter les auteurs)

LIENS

Code de la Propriété Intellectuelle. articles L 122. 4

Code de la Propriété Intellectuelle. articles L 335.2- L 335.10

http://www.cfcopies.com/V2/leg/leg_droi.php

<http://www.culture.gouv.fr/culture/infos-pratiques/droits/protection.htm>

Calculabilité des Espaces Topologiques

Computability of Topological Spaces

Thèse

Présentée et soutenue publiquement le 06 Octobre 2023
pour l'obtention du titre de

Docteur de l'Université de Lorraine

Mention : Informatique

par

Djamel Eddine AMIR

Membres du jury :

Directeurs :	Mathieu HOYRUP	INRIA, Nancy
	Emmanuel JEANDEL	University of Lorraine, Nancy
Rapporteurs :	Olivier BOURNEZ	École Polytechnique, LIX, Paris
	Vasco BRATTKA	University of the Bundeswehr Munich, Germany University of Cape Town, South Africa
Examinatrice :	Nathalie AUBRUN	CNRS, Paris
Examinateur :	Laurent BIENVENU	CNRS, Bordeaux
Présidente :	Monique TEILLAUD	INRIA, Nancy
Membre invité :	Pierre GUILLON	CNRS, Marseille

Résumé

L'OBJECTIF principal de cette thèse est d'examiner le concept de "**type calculable**" et d'améliorer notre compréhension globale de cette notion, ainsi que de fournir des techniques pour vérifier ou réfuter cette propriété. Un espace métrisable compact est dit de type calculable si pour tout ensemble homéomorphe à cet espace, semi-calculabilité et calculabilité sont équivalentes. Cette étude s'appuie sur les travaux de Miller, qui a démontré que les sphères de dimension finie sont de type calculable, ainsi que sur les travaux d'Iljazović et d'autres auteurs, qui ont étendu cette propriété à divers espaces tels que les variétés compactes.

Pour commencer, nous établissons l'équivalence entre deux définitions distinctes de type calculable présentes dans la littérature, impliquant respectivement des espaces métriques et des espaces de Hausdorff. Nous soutenons que la version relativisée et plus forte du type calculable présente des propriétés plus favorables et se prête bien à l'analyse topologique. Nous obtenons ainsi des caractérisations du "**type calculable fort**" de nature purement topologiques, et en lien avec la **complexité descriptive des invariants topologiques**.

Cela nous amène naturellement à notre deuxième objectif, l'étude du pouvoir expressif des invariants topologiques de faible complexité descriptive et de leur capacité à distinguer des espaces différents. Plus précisément, nous étudions deux familles d'invariants topologiques de faible complexité qui capturent l'extensibilité et la trivialité homotopique des fonctions continues. En utilisant ce cadre, nous revisitons les résultats précédents sur le type calculable et découvrons de nouvelles perspectives. Notamment, nous identifions la complexité du problème de séparation des graphes topologiques finis.

Enfin, notre troisième objectif se concentre sur l'application de la théorie de l'homologie à l'étude de ce que nous appelons la "**propriété de surjection**", qui caractérise la propriété de type calculable. Par exemple, nous prouvons qu'un complexe simplicial fini est de type calculable (fort) si et seulement si l'étoile de chaque sommet satisfait la propriété de surjection. De plus, la réduction à l'homologie implique que la propriété de type calculable est décidable pour les complexes simpliciaux finis de dimension au plus 4.

Abstract

THE main objective of this thesis is to examine the concept of "**computable type**" and enhance our overall understanding of this notion, as well as provide techniques for verifying or disproving this property. A compact metrizable space is said to have computable type if any semicomputable homeomorphic copy of that space is actually computable. This study builds upon the work of Miller, who demonstrated that finite-dimensional spheres have computable type, and Iljazović and other authors, who extended this property to various spaces, including compact manifolds.

To begin, we establish the equivalence between two distinct definitions of computable type present in the literature, involving metric spaces and Hausdorff spaces, respectively. We contend that the stronger, relativized version of computable type exhibits more favorable properties and lends itself well to topological analysis. Consequently, we derive characterizations of "**strong computable type**" in purely topological terms as well as the **descriptive complexity of topological invariants**.

It naturally leads to our second objective, which is the study of the expressive power of topological invariants of low descriptive complexity and their ability to differentiate between spaces. Specifically, we investigate two families of low descriptive complexity topological invariants that capture the extensibility and null-homotopy of continuous functions. Using this framework, we revisit previous findings on computable type and discover new insights. Notably, we identify the complexity of the finite topological graph separation problem.

Lastly, our third objective revolves around applying homology theory to study what we term the "**surjection property**" which characterizes the computable type property. For instance, we prove that a finite simplicial complex has (strong) computable type if and only if the star at each vertex satisfies the surjection property. Furthermore, the reduction to homology implies that the computable type property is decidable, for finite simplicial complexes of dimension at most 4.

Acknowledgment

ABOVE all, I would like to express my deepest gratitude to the Almighty God for establishing me, guiding me on the right path, inspiring me to take the right steps and the right reflexes, giving me the strength and the composure to complete this thesis and allowing me to fulfill my dreams...

At the very beginning, I wish to express my sincere thanks to Mathieu Hoyrup for his exceptional supervision, unwavering guidance, invaluable support, constant availability, insightful remarks, and invaluable advice throughout the duration of these three years. It is thanks to his patient and comprehensive approach that I not only acquired a foundation in computability theory but also learned the art of becoming a researcher. It is worth noting that any mistakes made along the way are entirely my own.

I would like to express my sincere appreciation to my second supervisor, Emmanuel Jeandel, first for accepting my registration into the Ph.D. program. Throughout my academic journey, I have greatly valued the numerous insightful discussions I have had with him. His expertise, guidance, and thought-provoking conversations have played a vital role in shaping my research.

I would like to express my heartfelt thanks to Olivier Bournez and Vasco Brattka for serving as referees for my dissertation, and to Nathalie Aubrun, Laurent Bienvenu and Monique Teillaud for being part of my defense committee. Their contributions and expertise are invaluable for the completion and evaluation of my research. I thank Horatiu Cirstea and Monique Teillaud again for being members of my individual follow-up committee.

I wholeheartedly thank Pierre Guillon, without whom this thesis would not have been possible.

I would like to thank Guilhem Gamard and Arno Pauly for engaging in discussions about some of our results. I thank Joseph Miller and Zvonko Iljazović for introducing the beautiful notion of computable type.

I take this opportunity to thank: Lionel Nguyen Van Thé, Pascal Vanier, Benoit Monin and Laurent Régnier for their help in my PhD application.

I would like to thank Lorraine University and LORIA laboratory for giving me the chance to do this PhD. Special thanks to our research team MOCQUA.

I place on record, Michel Mehrenberger for accepting me to join the master degree and François Hamel for accepting me in Archimedes Institute scholarship and for their invaluable assistance; and Boban Velickovic for suggesting my master internship with Mathieu.

I also place on record, Tarik Ali-ziane and my master 1 professors Aissa Naima and Ouahiba Zair for their unvaluable help.

My special thanks go to my USTHB professors: Toufik Laadj, Ammar Khemmoudj, Mourad Rahmani, Mehdi Belraouti, Mohamed Belache, Salim Khelifa, Chahrazad Titri and Yazid Raffed for their help.

In addition to Abdelghani Zeghib, a source of motivation, the MathCamps leaders and the ones of African Institute for Mathematical Sciences, Nabila Belhamra for her peaces of advice, my high school teacher Djemmel, my college teacher Bouchina, my primary school teachers Redouani and Mustapha. Nabil Zahra and many of my professors during my studies.

I would like to wholeheartedly express my deepest appreciation, thanks, and utmost regards to my family. Their constant support, prayers, boundless love, unwavering tenderness, and invaluable advice have been instrumental in my entire life:

I would like to dedicate this achievement to my father, whose tireless sacrifices and selflessness over the years have paved the way for my progress in life. May God bless this endeavor and grant it success. I am deeply grateful for the noble values, education, strong moral compass and passion for knowledge and personal growth instilled in me by my father. His guidance and wisdom have been invaluable in guiding me towards a meaningful path. May God grant him eternal mercy and make the highest paradise his share. Thank you infinitely!

I want to express my heartfelt appreciation and deepest gratitude to my mother, who dedicated herself to ensuring my success. I am grateful for the countless sacrifices she made, her endless support, and her constant presence in my life. From the smallest acts of care to the most significant challenges she has faced on my behalf, she has exemplified a love that knows no bounds. Through this work, humble as it may be, I hope to convey my profound emotions and eternal gratitude to her. May God protect you, prolong your life and increase your work. I love you so much!

I would like to extend my deepest gratitude to my brother Ahmed, and my sisters Imene and Nour El-Houda, who have consistently exemplified perseverance, courage, and generosity throughout my life. Their unwavering support and inspiring presence have been a constant source of motivation for me. I am forever grateful for their invaluable influence on my journey. May God protect you. I wish you all the best. Thank you very much!

In addition to special thanks to my grandmother, my uncles and my aunts for their help and support.

I want to thank people and their families without whom my life would be very different, may God protect them. First and foremost, misters: Mahfoud Redouani, Lyas Belaa and Mohsin Belaa, they really changed my life, many thanks to them.

In addition to Karim Laayaida, Lotfi Zebiri, Amirouche Hadjam, Rabah Djouada, Toufik Makhoulouf and Slimen Zareb.

Lastly, I want to extend a special thank you to my wife, Sarah, for her constant support, presence, encouragement, love and brilliant companionship. May God protect us and make affection between us.

I will not forget to thank my friends and all those who have contributed directly or indirectly to my success.

Dedecation

I would like to dedicate this humble work:

To the memory of my father AMIR Yahia, my hero

To my mother CHERIFI Keltoum, my love

To the memory of my grandfathers Ahmed and Saïd

and of my grandmother Sakhria

To my grandmother Warda

To my sister Imene

To my brother Ahmed

To my sister Nour El-Houda

To my uncles and aunts

To Imene's kids, Mouadh and Yousra

To my wife Sarah

AMIR Djamel Eddine

Contents

Résumé	i
Abstract	iii
Acknowledgment	v
Dedecation	vii
Contents	ix
How to read this thesis	xiii
Introduction in French	xv
Introduction in English	xxi
List of Papersxxvii
1 Overview	1
1.1 General Results about (Strong) Computable Type	2
1.1.1 Computable Type and the Hilbert Cube	2
1.1.2 Strong Computable Type	2
Relative Strong Computable Type	2
1.1.3 Computable Type vs Topological Invariants	3
1) Σ_2^0 Invariants and Strong Computable Type	3
2) The invariants E_n and H_n	3
3) Some Applications	4
4) Uniformity	4
1.1.4 The ϵ -Surjection Property	5
A Necessary Condition to have Strong Computable Type	5
1.1.5 Failing to have Computable Type	5
1) Computable Witnesses	5
2) Spaces without proper copies of themselves	6
1.2 Descriptive Complexity of Topological Invariants	6
1.2.1 Characterization of the Π_1^0 Topological Invariants	6
1.2.2 The Σ_2^0 Invariants	6
1) Strong Approximation and Σ_2^0 Invariants	6
2) Some Applications	7
1.2.3 Separating Finite Topological Graphs	7
1.3 The Surjection Property	8
1.3.1 The (ϵ -)Surjection Property and Unions	8
1.3.2 Finitely Conical Spaces	9
1.3.3 The Surjection Property for Cone Pairs	9
1) Quotients and Retractions to Spheres	9
2) Cycles	9
1.3.4 Applications to Computable Type	11
1) A Characterization for Finite Simplicial Complexes	11
2) Finite 2-Dimensional Simplicial Complexes	11
3) Boundaries and the Odd Subcomplex	11

4)	Computable Type is Not Preserved by Products	12
I	Preliminaries	13
2	Background on Computable Topology	15
2.1	Effective countably-based T_0 -spaces	16
2.1.1	Classes of Computable T_0 -spaces	18
2.1.2	The Hilbert Cube	19
2.2	Computable Type	20
2.2.1	State of the Art	21
2.3	Vietoris Topology, Topological Invariant and Descriptive Complexity	22
2.3.1	State of the Art	24
2.4	Weihrauch reducibility	24
3	Background on General and Algebraic Topology	27
3.1	Point-Set Topology	28
3.2	Cone and join	29
3.2.1	Cone and Cone Pair	30
	Special Symbol	30
3.2.2	Join	31
	Join of pairs	32
3.3	Homotopy and Absolute Neighborhood Retracts (ANRs)	33
3.3.1	Homotopy	33
3.3.2	Homotopy extension property	33
3.3.3	Absolute Neighborhood Retracts (ANRs)	34
3.3.4	ANRs and Homotopy	34
3.3.5	Pair vs quotient	35
3.4	Homology and Cohomology	36
3.4.1	Hopf's extension and classification theorems	37
3.5	Simplicial Complexes	38
II	Main contributions	41
4	Strong Computable Type	43
4.1	Introduction	43
4.2	Computable Type and the Hilbert Cube	44
4.3	Strong Computable Type	46
4.3.1	Definition	46
4.3.2	A First Characterization	47
4.3.3	A Characterization using Invariants	49
4.4	Strong Computable Type: Further Properties	52
4.4.1	Product and Cone of Pairs	52
4.4.2	A Topological Necessary Condition	53
4.4.3	The ϵ -Surjection Property	54
4.4.4	Uniformity	56
4.4.5	Discussion: Vietoris vs Upper Vietoris Topology	57
4.5	Failing to have Computable Type	58
4.5.1	Computable Witnesses	58
	Comparing Computability in Three Topologies	58

	Application to Computable Type	59
4.5.2	Simple copies	61
4.5.3	An Example	63
4.6	Conclusion	64
5	Descriptive Complexity of Topological Invariants	65
5.1	Introduction	66
5.2	Computability-Theoretic Properties of ANRs	67
5.2.1	Absolute Neighborhood Retracts (ANRs)	67
5.2.2	Homotopy Classes	67
5.2.3	Families of Σ_2^0 Invariants	69
	1) Extension of Functions	69
	2) Null-Homotopy of Functions	70
5.3	Detailed study of some Σ_2^0 Invariants	70
5.3.1	Properties of $E(Y)$	70
	Converging Sequences	71
5.3.2	The Invariant E_n	72
	Relationship with Dimension	73
5.3.3	The Invariant H_n	73
	Relationship with Dimension	75
5.3.4	Connections with Homology and Cohomology	77
	1) Partial Characterization of E_n	77
	2) Partial Characterization of H_n	77
5.4	Application to Strong Computable Type	78
5.4.1	Examples of E_n -Minimal Pairs	78
	1) Chainable Continuum Between Two Points	78
	2) Pseudo n -Cubes	79
	3) A New Example	80
5.4.2	Compact n -Manifolds are H_n -Minimal	81
5.4.3	Circularly Chainable Continuum Which Are Not Chainable	82
5.4.4	A space that properly contains copies of itself	83
5.5	Π_1^0 Invariants	84
5.5.1	Approximations	85
5.6	Σ_2^0 Invariants	87
5.6.1	Strong Approximation	87
	The Closed Topologist's Sine Curve and the Line Segment	88
5.6.2	Cylinder	89
5.6.3	Wedge Sum	89
5.7	Separating Finite Topological Graphs	90
5.7.1	Modulus of Local Connectedness	90
5.7.2	Effective vs Non-Effective Classes	91
5.7.3	Separating Graphs	93
	Proof of the Main Theorem	94
5.8	Conclusion	97
6	The Surjection Property and Computable Type	99
6.1	Introduction	100
6.2	Euclidean Points and Regular Cells	100
6.3	The (ϵ) -Surjection Property	101
6.3.1	The (ϵ) -Surjection Property for Cone Pairs	103

6.3.2	The (ϵ -)Surjection Property and Unions	104
6.4	Finitely Conical Spaces	105
6.4.1	Definition and First Properties	105
6.4.2	The ϵ -Surjection Property for Finitely Conical Pairs	106
6.5	The Surjection Property for Cone Pairs	107
6.5.1	Quotients to Spheres	108
6.5.2	Retractions to Spheres	111
6.5.3	Cycles	112
	1) Simplicial Complexes	113
	2) Cycles vs the Surjection Property	113
6.6	Counter-examples	116
6.6.1	A Family of Spaces	116
6.6.2	Cycles vs the Surjection Property	116
6.6.3	Product	118
	Iteration of the Suspension	119
6.7	Applications to Computable Type	120
6.7.1	A Characterization for Finite Simplicial Complexes	120
6.7.2	Finite 2-Dimensional Simplicial Complexes	123
	1) The Dunce Hat	124
	2) Bing's House, or the House With Two Rooms	125
6.7.3	Boundaries and the Odd Subcomplex	126
	The Odd Subcomplex	127
6.7.4	Computable Type and the Product	128
6.7.5	Cones of Manifolds	128
6.8	Conclusion	129
	Perspectives	131
	Open Questions about Strong Computable Type	131
	Open Questions about the Descriptive Complexity of Topological Invariants	131
	List of Figures	133
	Index	134
	Index of Symbols	136
	Bibliography	139
A	Compact n -Manifolds are H_n -Minimal	145
A.1	Background	145
A.2	Proof of Theorem 5.4.1	145
B	Coefficients	147

How to read this thesis

To effectively navigate through the thesis, follow these guidelines:

- **Introduction** (5 pages): For a concise summary of the thesis, read the Introduction in English. It provides an overview of the research and its key points.
- **Overview** (Chapter 1, 12 pages): If you require a formal summary of the main notions and results, refer to Chapter Overview. This section presents a comprehensive overview in a structured manner.
- **Preliminaries** (Part I, 25 pages): To gain the necessary background knowledge to understand the results, delve into Part Preliminaries. This section provides the foundational concepts and context required for comprehension.
- **Main contributions** (Part II): It contains the detailed results and proofs.

Introduction in French

L'ANALYSE calculable fournit des notions de calculabilité pour divers objets mathématiques tels que les nombres réels, les ensembles, les fonctions, etc. Nous nous concentrons en particulier sur les sous-ensembles compacts des espaces euclidiens et des espaces topologiques plus généraux, pour lesquels les deux notions d'ensembles compacts calculables et ensembles compacts semi-calculables sont définies. En substance, un sous-ensemble du plan euclidien est considéré comme **calculable** s'il est possible de concevoir un programme capable de représenter l'ensemble sur un écran avec une résolution arbitraire. D'autre part, un sous-ensemble est considéré comme **semi-calculable** s'il existe un programme capable de rejeter les points se trouvant en-dehors de l'ensemble. Une illustration bien connue de ces concepts est l'ensemble de Mandelbrot, qui peut être facilement reconnu comme semi-calculable sur la base de sa définition. Cependant, déterminer sa calculabilité reste un problème ouvert, lié à une conjecture en dynamique complexe [33].

Les travaux pionniers de Miller [48] ont révélé que, pour certains ensembles, la semi-calculabilité et la calculabilité sont, étonnamment, équivalentes. Il a prouvé que les sphères de dimension finie plongées dans les espaces euclidiens exhibent cette propriété remarquable. Par la suite, Iljazović a développé une exploration systématique de cette propriété en se concentrant sur les sphères plongées dans les espaces métriques calculables [38], sur les variétés compactes [39], et sur divers autres ensembles, comme en témoigne une série d'articles écrits en collaboration avec plusieurs chercheurs [37, 38, 39, 18, 42, 23, 34, 40, 21, 20].

Ces travaux ont conduit à la définition du type calculable : un espace métrisable compact X est de **type calculable** si toutes les copies semi-calculables de cet espace dans le cube de Hilbert sont calculables (le cube de Hilbert étant un produit cartésien infini dénombrable d'intervalles fermés $[0, 1]$). Une paire compacte (X, A) compacts avec $A \subset X$ est dite de **type calculable** si, pour toute copie (Y, B) de cette paire, si Y et B sont tout les deux semi-calculables, alors Y est calculable. Ainsi, le segment $[0, 1]$ n'est pas de type calculable, mais la paire $([0, 1], \{0, 1\})$ est de type calculable.

Cette propriété constitue le thème central de cette thèse. Notre objectif est d'entreprendre une investigation théorique complète de la notion de type calculable, dans le but d'améliorer notre compréhension de ce concept et de fournir une boîte à outils pour prouver ou réfuter cette propriété. Nous avons remarqué que les techniques existantes dans la littérature sont généralement très spécifiques et pourraient bénéficier de l'intégration d'arguments plus unifiés, ce qui nous mène à explorer de nouvelles approches.

Ce projet interdisciplinaire englobe l'analyse calculable, la théorie descriptive des ensembles et la topologie générale et algébrique. L'étude de la propriété de calculabilité en question interagit de manière complexe avec la topologie, ce qui rend essentielle son incorporation dans notre recherche.

Dans cette introduction, nous donnerons un aperçu succinct et informel des résultats que nous avons obtenus dans diverses directions. Une élaboration plus détaillée sera présentée dans les parties suivantes.

La notion de type calculable. Principalement, deux notions de type calculable ont été introduites dans la littérature, qui considèrent des copies de l'espace plongées dans différentes classes d'espaces topologiques, à savoir les espaces métriques calculables et les espaces de Hausdorff calculables. Plusieurs résultats ont été établis sur les espaces métriques calculables d'abord [37, 39], puis étendus aux espaces de Hausdorff calculables [23, 42]. Nous montrons d'abord que ces deux notions sont en réalité équivalentes, et qu'il suffit de considérer des copies dans le cube de Hilbert (voir le théorème 4.2.1).

La notion de type calculable fort. Il n'est pas possible d'obtenir des caractérisations générales complètes de la propriété de type calculable, car la plupart des espaces sont trivialement de type calculable en raison de l'absence de copies semi-calculables. Pour surmonter cette limitation, nous introduisons une notion plus souple que nous appelons **type calculable fort**, qui correspond à un type calculable relatif à un oracle quelconque (voir la définition 4.3.1).

Avec la notion de type calculable fort, nous sommes en mesure d'obtenir de nombreuses caractérisations et résultats topologiques (voir les théorèmes 4.3.1 et 4.3.3). De plus, cela révèle des liens étroits avec d'autres notions qui motivent une exploration indépendante et un développement ultérieur (voir le corollaire 4.4.3). Dans les deux paragraphes qui suivent, nous donnons quelques détails sur ces résultats.

Type calculable fort et minimalité. Notre première caractérisation est qu'un espace est de type calculable fort si et seulement s'il satisfait une propriété de faible complexité descriptive, et qu'il est minimal au sens où aucun sous-espace propre ne satisfait cette propriété (théorèmes 4.3.1 et 4.3.3). En particulier, tout espace minimal satisfaisant un invariant Σ_2^0 est de type calculable fort (théorème 4.3.2). Cela sert de motivation pour rechercher des invariants Σ_2^0 , ce qui permet de revisiter les résultats précédents et d'en obtenir de nouveaux. Cette découverte élargit considérablement notre compréhension et fournit un modèle commun pour unifier les preuves de la propriété de type calculable fort.

Nous identifions des classes d'invariants Σ_2^0 impliquant des fonctions continues vers des sphères et, plus généralement, des compacts *Absolute Neighborhood Retracts (ANRs)*, voir la section 5.2.3. Lorsque Y est un ANR compact fixé et X un espace compact variable, nous montrons comment l'ensemble $[X; Y]$ des fonctions continues de X vers Y , modulo l'homotopie, peut être calculé à partir de X , sans supposer la calculabilité de Y (théorème 5.2.1). Un cas particulièrement intéressant est lorsque Y est la sphère n -dimensionnelle S_n . Cette analyse induit immédiatement des invariants topologiques de faible complexité descriptive, qui sont très classiques en topologie. Nous définissons les invariants E_n et H_n qui capturent l'extensibilité et la trivialité homotopique des fonctions continues vers la sphère n -dimensionnelle S_n (voir les définitions 5.3.2 et 5.3.3).

Nous étudions en détail ces invariants topologiques et revisitions plusieurs résultats de la littérature sur le type calculable en identifiant un invariant Σ_2^0 approprié pour lequel l'espace ou la paire est minimale (voir la section 5.4). Ces résultats montrent que la théorie s'applique effectivement et renforcent les résultats précédents car ils fournissent plus d'informations et peuvent être utilisés pour dériver de nouveaux résultats. Par exemple,

- La paire (\mathbb{B}_{n+1}, S_n) est minimale par rapport à E_n (proposition 5.3.6).
- Toute variété fermée de dimension n est minimale par rapport à H_n (théorème 5.4.1).
- La paire constituée de la "soucoupe de Varsovie" et de son bord circulaire est minimale par rapport à E_1 et est donc de type calculable fort (proposition 5.4.3), voir figure 1.

Notre cadre de travail permet souvent d'obtenir des preuves plus simples des résultats en divisant l'argument en deux parties : une composante liée à la théorie de la calculabilité (démontrant qu'un invariant topologique est Σ_2^0) et une composante purement topologique (établissant qu'un espace est minimal par rapport à cet invariant). Les deux parties reposent largement sur des théorèmes topologiques classiques.

Il est instructif de comparer la preuve originale d'un résultat préexistant avec l'argument déployé à partir de notre cadre. Il est intéressant de constater que, dans certains cas, les arguments sous-jacents sont essentiellement les mêmes, comme dans le cas des ensembles chainables et des pseudo-cubes. Cependant, dans d'autres cas, les arguments sous-jacents diffèrent considérablement, comme dans le cas des variétés compactes. Dans ce scénario, le nouvel argument fournit des informations supplémentaires, notamment une mesure précise de la non-uniformité du calcul (voir le

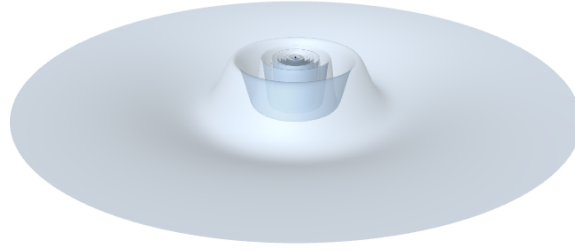

(a) La soucoupe de Varsovie

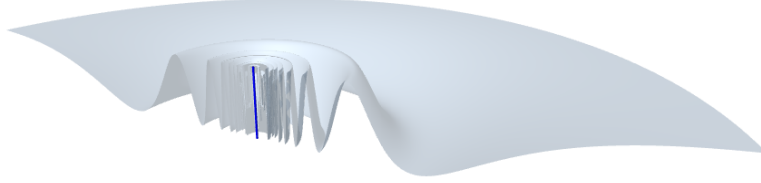

(b) Une demi-coupe de la soucoupe de Varsovie

Figure 1: La soucoupe de Varsovie et une demi-coupe de celui-ci

théorème 4.4.2). De plus, il implique un résultat supplémentaire : les cônes de variétés sont de type calculable (fort), voir corollaire 5.4.1. Il est important de noter que cela se fait au prix d'une forte dépendance à l'égard des résultats de la topologie algébrique concernant l'homologie et la cohomologie des variétés, alors que la preuve présentée dans [39] est locale et utilise principalement les propriétés des boules et des sphères, notamment une forme du théorème du point fixe de Brouwer.

La propriété de (ϵ -)surjection. Nous établissons une condition nécessaire purement topologique pour le type calculable fort, qui est également suffisante pour certains espaces. Cette condition est appelée propriété de ϵ -surjection. Plus précisément, une paire (X, A) satisfait la propriété de ϵ -surjection si toute fonction continue qui est l'identité sur A et est ϵ -proche de l'identité sur X est surjective. Nous démontrons que satisfaire la propriété de ϵ -surjection pour un certain $\epsilon > 0$ est une condition nécessaire pour être de type calculable fort (corollaire 4.4.1). Pour certains espaces, tels que les complexes simpliciaux finis, c'est également suffisant (corollaire 6.7.1).

Il s'avère que la propriété de ϵ -surjection est liée à ce que nous appelons la propriété de surjection. Une paire (X, A) satisfait la propriété de surjection si toute fonction continue qui est l'identité sur A est surjective. Nous étudions cette notion en détail en utilisant la théorie de l'homologie.

Remarquons que dans un complexe simplicial, chaque sommet a un voisinage qui est un cône, avec l'apex au sommet. Nous démontrons que la propriété de ϵ -surjection de l'espace est équivalente à la propriété de surjection pour chaque tel cône (voir corollaire 6.7.1). Iljazović et al. ont déjà observé que le type calculable était une propriété locale, voir par exemple [42]. Nous démontrons que pour les complexes simpliciaux finis, le type calculable fort est équivalent au type calculable (voir encore une fois le corollaire 6.7.1).

Nous relierons la notion de cycle en homologie à la propriété de surjection pour les cônes, cette notion fournit plusieurs caractérisations (voir la section 6.5.3).

Comme application, nous démontrons que pour les paires simpliciales finies (X, A) telles que X est pure ou de dimension au plus 4, la question de savoir si (X, A) est de type calculable est décidable (voir le corollaire 6.7.3).

Grâce à ces résultats, il devient très facile d'établir si un complexe simplicial de dimension 2 est de type calculable (fort), en examinant certains graphes apparaissant dans le complexe (les liens des sommets) et en déterminant si dans ces graphes, chaque arête appartient à un cycle. Comme application, nous démontrons par exemple que la maison de Bing est de type calculable (fort)

(proposition 6.7.2), voir la Figure 2.

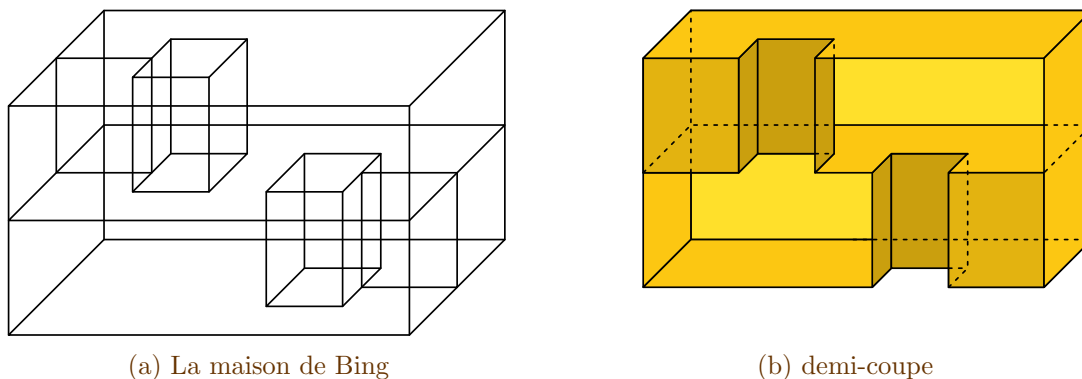

Figure 2: La maison à deux pièces de Bing, ainsi qu'une demi-coupe

Tandis que le bonnet d'âne ou un disque attaché à un tore pincé ne sont pas de type calculable (proposition 6.7.1 et exemple 4.5.1), voir les Figures 3 et 4.

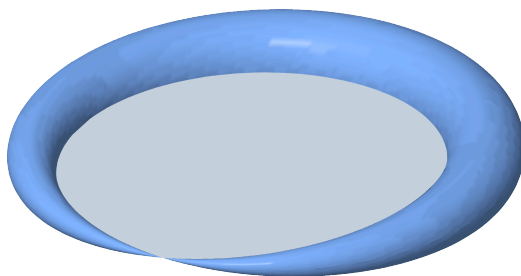

Figure 3: Un disque attaché à un tore pincé n'est pas de type calculable

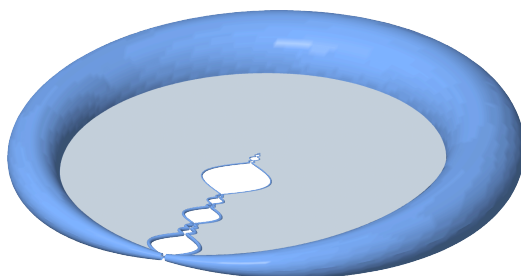

Figure 4: Une copie semi-calculable d'un disque attaché à un tore pincé qui n'est pas calculable

En outre, nous montrons que la propriété de type calculable n'est pas préservée par les produits (théorème 6.6.2). Cela résout une question de Čelar et Iljazović et est dû au comportement sophistiqué de l'homomorphisme de suspension entre les groupes d'homotopie des sphères. Ainsi, il semble que la résolution de cette question aurait été impossible sans une étude topologique approfondie de la propriété de type calculable.

Complexité descriptive des invariants topologiques. Les résultats mentionnés ci-dessus nous incitent à étudier indépendamment la complexité descriptive des invariants topologiques, notamment les invariants de complexité Σ_2^0 .

La théorie descriptive des ensembles est une branche des mathématiques qui étudie la structure et la classification des sous-ensembles d'espaces topologiques en termes de leur définissabilité et

de leur complexité. Nous mesurons la complexité descriptive d'un invariant comme la complexité descriptive de la collection des sous-ensembles compacts du cube de Hilbert satisfaisant cet invariant.

Nous donnons une caractérisation complète des invariants de complexité \mathbb{I}_1^0 (théorème 5.5.1), montrant qu'ils ne peuvent exprimer que des propriétés de connexité de l'espace. De plus, la classe non effective des invariants \mathbb{I}_1^0 et la classe effective des invariants Π_1^0 coïncident.

Nous menons une étude approfondie de la classe des invariants Σ_2^0 . Nous obtenons une caractérisation indiquant quand un espace peut être séparé d'un autre par un invariant Σ_2^0 (théorème 5.6.1). Nous appliquons ce résultat pour montrer que le segment de droite et la courbe sinus fermée du topologue ne peuvent pas être séparés par des invariants Σ_2^0 (proposition 5.6.2), et nous présentons d'autres applications (théorèmes 5.6.2 et 5.6.3).

Nous explorons le pouvoir expressif des invariants Σ_2^0 en identifiant les espaces qu'ils peuvent séparer. Les invariants traditionnels ont tendance à présenter une complexité élevée, ce qui nécessite le développement de nouveaux invariants. Pour cela, nous partons des espaces que nous souhaitons distinguer et construisons des invariants de faible complexité adaptés. Nous appliquons cette stratégie à la famille des graphes topologiques finis, caractérisons les couples de graphes pouvant être séparés par un invariant Σ_2^0 , et en déduisons que toute paire de graphes peut être séparée dans un sens ou dans l'autre par de tels invariants (théorèmes 5.7.2 et 5.7.3).

Orientations futures. Notre étude a révélé plusieurs questions intrigantes qui constituent des directions de recherche prometteuses, dont certaines sont mises en évidence dans la section *Perspectives*.

Par exemple, nos résultats soulèvent la question suivante : si un complexe simplicial fini est de type calculable (fort), est-il minimal par rapport à un invariant topologique Σ_2^0 ?

Nos résultats sur la complexité descriptive de séparation des graphes finis font émerger un problème plus général : pour chaque entier n , quel niveau de complexité descriptive des invariants topologiques permet de séparer toute paire de complexes simpliciaux finis de dimension n ? Dans le cas des graphes à une dimension, existe-t-il une classe "naturelle" d'invariants Σ_2^0 capable de distinguer les graphes topologiques finis?

De plus, nous réfléchissons à la complexité descriptive impliquée dans la reconnaissance d'espaces fondamentaux tels que les cercles ou les disques. Cette question s'étend à tout espace compact, ce qui nous pousse à étudier la complexité descriptive requise pour leur reconnaissance.

L'exploration de ces questions ouvertes présente de grandes promesses pour faire progresser notre compréhension du sujet et stimuler de nouvelles recherches dans le domaine.

Structure de la thèse Présentons l'organisation de la thèse en donnant le contenu de chaque chapitre.

Dans le chapitre 1, nous donnons un aperçu de nos principales contributions. Dans le chapitre 2, nous présentons les concepts standards de calculabilité sur les espaces topologiques et rappelons la définition du type calculable. Nous proposons un récapitulatif concis des concepts clés et des résultats requis de topologie générale et algébrique dans le chapitre 3. Dans le chapitre 4, nous étudions en détail la notion de type calculable fort. Dans le chapitre 5, nous étudions la complexité descriptive des invariants topologiques. Dans le chapitre 6, nous étudions en détail la propriété de surjection et l'appliquons aux complexes simpliciaux finis.

Dans la section *Perspectives*, nous dressons une liste succincte des questions ouvertes. Dans les annexes A et B, nous présentons certaines démonstrations que nous n'avons pas trouvées dans la littérature.

Introduction in English

COMPUTABLE analysis provides notions of computability for various mathematical objects, such as real numbers, sets, functions, etc. We focus in particular on compact subsets of Euclidean spaces and more general topological spaces, for which the two significant notions of computable compact sets and semicomputable compact sets are defined. In essence, a subset of the Euclidean plane is considered **computable** if it is possible to devise a program capable of rendering the set on a screen with arbitrary resolution. On the other hand, a subset is deemed **semicomputable** if there exists a program that can reject points lying outside the set. A well-known illustration of these concepts is the Mandelbrot set, which can be easily recognized as semicomputable based on its definition. However, determining its computability remains an open problem, tied to a conjecture in complex dynamics [33].

Miller's pioneer work [48] revealed that for certain sets, semicomputability and computability are, astonishingly, equivalent. He proved that finite-dimensional spheres embedded in Euclidean spaces exhibit this remarkable property. Subsequently, Iljazović delved into a systematic exploration of this computability-theoretic attribute, focusing on spheres embedded in computable metric spaces [38], on compact manifolds [39], and on various other sets, as evidenced by a series of articles co-authored with several researchers [37, 38, 39, 18, 42, 23, 34, 40, 21, 20].

These works have led to the definition of **computable type**: a compact metrizable space X has computable type if all semicomputable copies of it in the Hilbert cube are computable (the Hilbert cube being an infinite countable Cartesian product of closed intervals $[0, 1]$). A compact pair (X, A) compact with $A \subset X$ is said to have **computable type** if, for any copy (Y, B) of it, if both Y and B are semicomputable, then Y is computable. Thus, the interval $[0, 1]$ is not computable, but the pair $([0, 1], \{0, 1\})$ is computable.

This property serves as the central focus of investigation within this thesis. Our objective is to undertake a comprehensive theoretical investigation of the computable type notion, aiming to enhance our understanding of this concept and provide a toolkit for proving or disproving this property. We have noticed that the existing techniques in the literature are usually very specific and could benefit from incorporating more unifying arguments, which could be addressed by exploring a fresh approach.

This interdisciplinary project encompasses computable analysis, descriptive set theory, and general and algebraic topology. The examination of the computability property in question intricately intersects with topology, making it essential to incorporate into our investigation.

In this introduction, we will provide a brief and informal overview of the results we have obtained in various directions. Further elaboration and details will be presented in subsequent parts.

The notion of computable type. Mainly two notions of computable type have been introduced in the literature, that consider copies of the space embedded in different classes of topological spaces, namely computable metric spaces and computably Hausdorff spaces. Several results have been established on computable metric spaces first [37, 39] and then extended to computably Hausdorff spaces [23, 42]. We first show that these two notions are actually equivalent, and it is sufficient to consider copies in the Hilbert cube (see Theorem 4.2.1).

The notion of strong computable type. Obtaining comprehensive general characterizations of the computable type property is not possible since most spaces trivially have computable type by lacking semicomputable copies. To overcome this limitation we introduce a more flexible notion that we call **strong computable type** which is having computable type relative to any oracle (see Definition 4.3.1).

With the notion of strong computable type we are able to obtain many topological characterizations and results (see Theorems 4.3.1 and 4.3.3). Furthermore, it reveals close connections to other notions that motivate independent exploration and further development (see Corollary 4.4.3). In the next two paragraphs we give some details about these results.

Strong computable type and minimality. Our first characterization is that a space has strong computable type if and only if it satisfies a property of low descriptive complexity, and is minimal in the sense that no proper subspace satisfies this property (Theorems 4.3.1 and 4.3.3). In particular, every space which is minimal satisfying some Σ_2^0 invariant has strong computable type (Theorem 4.3.2). It serves as a motivation to search for Σ_2^0 invariants, allowing to revisit previous results and obtain new ones. This finding significantly expands our understanding and provides a common template for unifying all the proofs of the strong computable type property.

We identify classes of Σ_2^0 invariants involving continuous functions to spheres, and more generally compact absolute neighborhood retracts (ANRs), see Section 5.2.3. When Y is a fixed compact ANR and X is a varying compact space, we show how the set $[X; Y]$ of continuous functions from X to Y quotiented by homotopy can be computed from X , with no computability assumptions about Y (Theorem 5.2.1). A particularly interesting case is when Y is the n -dimensional sphere \mathbb{S}_n . This analysis immediately induces topological invariants of low descriptive complexity, which are very classical in topology. We define the invariants E_n and H_n that capture the extensibility and null-homotopy of continuous functions to the n -sphere \mathbb{S}_n (see Definitions 5.3.2 and 5.3.3).

We thoroughly study these topological invariants and revisit several results of the literature about computable type by identifying a suitable Σ_2^0 invariant for which the space or the pair is minimal (see Section 5.4). These results show that the theory indeed applies, and they strengthen the previous results because they give more information and can be used to derive new results. For instance,

- The pair $(\mathbb{B}_{n+1}, \mathbb{S}_n)$ is E_n -minimal (Proposition 5.3.6),
- Every closed n -manifold is H_n -minimal (Theorem 5.4.1),
- The pair consisting of the Warsaw saucer with its bounding circle is E_1 -minimal and hence has strong computable type (Proposition 5.4.3), see Figure 5.

Our framework often yields simpler proofs of results by splitting the argument into two parts: a computability-theoretic component (demonstrating that a topological invariant is Σ_2^0) and a purely topological component (establishing that a space is minimal with respect to that invariant). Both parts heavily rely on classical topological theorems.

It is instructive to compare the original proof of a previous result with the unfolded argument derived from our framework. Interestingly, we find that in some cases, the underlying arguments are essentially the same, such as in the case of chainable sets and pseudo-cubes. However, for other cases, the underlying arguments differ significantly, as seen in the case of compact manifolds. In this scenario, the new argument provides additional information, including a precise measure of the non-uniformity of the computation (see Theorem 4.4.2). Moreover, it implies an additional result: cones of manifolds have (strong) computable type (Corollary 5.4.1). It is important to note that this comes at the cost of relying heavily on algebraic topology results concerning the homology and cohomology of manifolds, whereas the proof presented in [39] is local and primarily utilizes properties of balls and spheres, notably a form of Brouwer’s fixed-point theorem.

The (ϵ -)surjection property. We establish a purely topological necessary condition for strong computable type, which is also sufficient for some spaces. This condition is called the ϵ -surjection property. Namely, a pair (X, A) satisfies the ϵ -surjection property if every continuous function

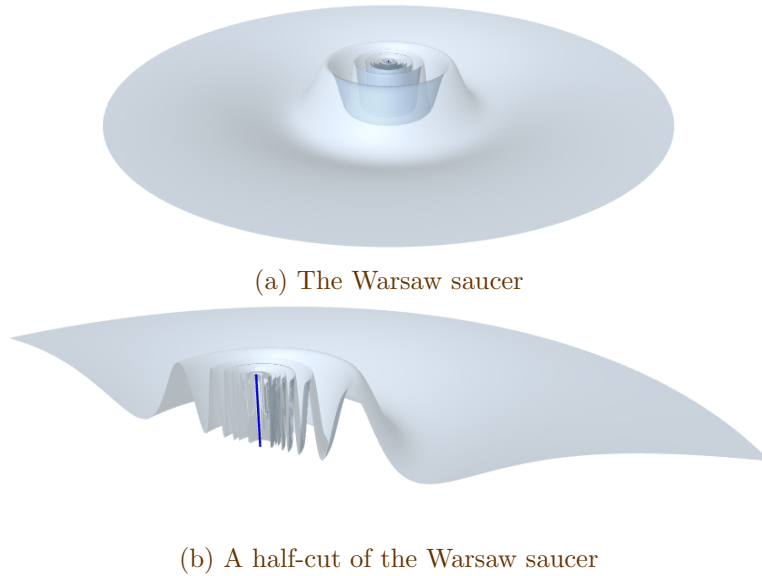

Figure 5: The Warsaw saucer and a half-cut of it

which is the identity on A and is ϵ -close to the identity on X is surjective. We prove that satisfying the ϵ -surjection property for some $\epsilon > 0$ is a necessary condition to have strong computable type (Corollary 4.4.1). For certain spaces, such as finite simplicial complexes, it is also sufficient (Corollary 6.7.1).

It turns out that ϵ -surjection property is related to what we call the surjection property. A pair (X, A) satisfies the surjection property if every continuous function which is the identity on A is surjective. We study this notion in details using homology theory.

Note that in a simplicial complex, each vertex has a neighborhood which is a cone, with the tip at the vertex. We prove that the ϵ -surjection property is equivalent to the surjection property for each such cone (see Corollary 6.7.1). Iljazović et al. already observed that computable type was a local property see for instance [42]. We prove that for finite simplicial complexes, strong computable type is equivalent to computable type (again see Corollary 6.7.1).

We relate the notion of cycle from homology to the surjection property for cone pairs., this notion provide several characterizations (see Section 6.5.3).

As an application, we prove that for finite simplicial pairs (X, A) such that X is pure or has dimension at most 4, whether (X, A) has computable type is decidable (see Corollary 6.7.3).

With these results, it becomes very easy to establish whether a 2-dimensional simplicial complex has (strong) computable type, by inspecting certain graphs appearing in the complex (the links of the vertices), and determining whether in these graphs, each edge belongs to a cycle. As an application we prove for instance that Bing's house has (strong) computable type (Proposition 6.7.2), see Figure 6.

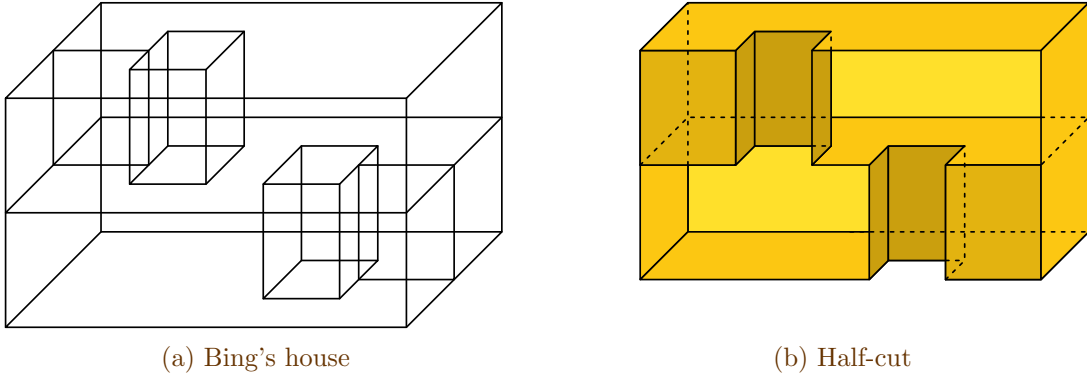

Figure 6: Bing's house with two rooms and a half-cut of it

While the dunce hat or a disk attached to a pinched torus, do not have computable type (Proposition 6.7.1 and Example 4.5.1), see Figures 7 and 8.

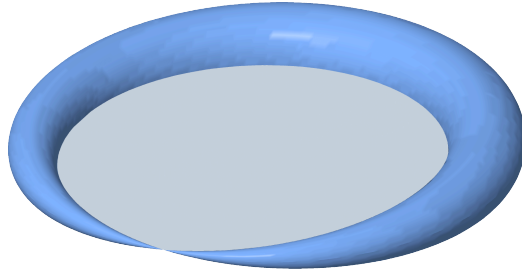

Figure 7: A disk attached to a pinched torus does not have computable type

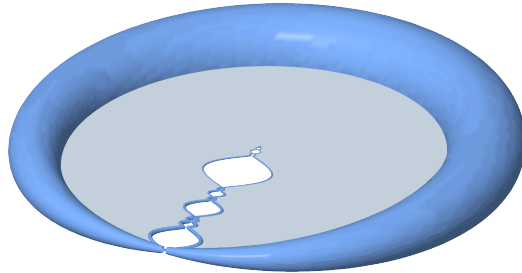

Figure 8: A semicomputable copy of a disk attached to a pinched torus which is not computable

Furthermore, we show that the computable type property is not preserved by products (Theorem 6.6.2). This solves a question by Čelar and Iljazović and is due to the sophisticated behavior of the suspension homomorphism between the homotopy groups of spheres. Thus, it appears that the resolution of this question would have been impossible without a thorough topological study of the computable type property.

Descriptive complexity of topological invariants. The above mentioned results motivate to study independently the descriptive complexity of topological invariants, notably the invariants of complexity Σ_2^0 .

Descriptive Set Theory is a branch of mathematics that investigates the structure and classification of subsets of topological spaces in terms of their definability and complexity. We measure the descriptive complexity of an invariant as the descriptive complexity of the collection of compact subsets of the Hilbert cube satisfying this invariant.

We give a complete characterization of the invariants of complexity $\underline{\Pi}_1^0$ (Theorem 5.5.1), showing that they can only express connectedness properties of the space. Moreover, the non-effective class of $\underline{\Pi}_1^0$ invariants and the effective class of Π_1^0 invariants coincide.

We carry out a thorough study of the class of $\underline{\Sigma}_2^0$ invariants. We obtain a characterization of when a space can be separated from another by some $\underline{\Sigma}_2^0$ invariant (Theorem 5.6.1). We apply this result to show that the line segment and the closed topologist's sine curve cannot be separated by $\underline{\Sigma}_2^0$ invariants (Proposition 5.6.2), and give other applications (Theorems 5.6.2 and 5.6.3).

We explore the expressive power of Σ_2^0 invariants by identifying which spaces they can separate. Traditional invariants tend to exhibit high complexity, necessitating the development of novel invariants. To achieve this, we initiate the process by considering the spaces we aim to distinguish and we construct suitable low complexity invariants. We apply this strategy to the family of finite topological graphs, characterize pairs of graphs that can be separated by a Σ_2^0 invariant, and deduce that any pair of graphs can be separated in one way or another by such invariants (Theorems 5.7.2 and 5.7.3).

Future directions. Our study has unveiled several intriguing questions that serve as promising research directions, some of which are highlighted in Section [Perspectives](#).

For instance, our results raise the following question: if a finite simplicial complex has (strong) computable type, is it minimal with respect to a Σ_2^0 topological invariant?

Our results on the descriptive complexity of separating finite graphs highlight a broader problem: for each integer n , what level of descriptive complexity of topological invariants allows us to separate any pair of finite simplicial complexes of dimension n ? In the case of 1-dimensional graphs, is there a "natural" class of Σ_2^0 invariants capable of discerning finite topological graphs?

Additionally, we ponder over the descriptive complexity involved in recognizing fundamental spaces such as circles or disks. This question extends to any compact space, prompting us to investigate the descriptive complexity required for their recognition.

The exploration of these open questions holds great promise for advancing our understanding of the subject matter and stimulating further research in the field.

Thesis Structure. Let us show how the thesis is organized by giving the content of each chapter.

In Chapter 1 we give an overview of our main contributions. In Chapter 2, we present the standard concepts of computability over topological spaces and recall the definition of computable type. A concise recapitulation of the key concepts and necessary results from general and algebraic topology is provided in Chapter 3. In Chapter 4, we study in details the notion of strong computable type. In Chapter 5, we study the descriptive complexity of topological invariants. In Chapter 6, we study in details the surjection property and apply to finite simplicial complexes.

In Section [Perspectives](#), we give a brief list of open questions. In Appendixes [A](#) and [B](#) we give some proofs that we did not find in the literature.

List of Papers

Published

- **Strong Computable Type**, *Computability*, 2023, with Mathieu Hoyrup, see [8].
- **Comparing Computability in two topologies**, *Journal of Symbolic Logic*, 2023, with Mathieu Hoyrup, see [6],
- **Computability of Finite Simplicial Complexes**, *Leibniz International Proceedings in Informatics (LIPIcs) 49th International Colloquium on Automata, Languages, and Programming (ICALP 2022)*, with Mathieu Hoyrup, see [4].

Submitted

- **Descriptive Complexity of Topological Invariants**, 2023, with Mathieu Hoyrup, see [7].
- **The Surjection Property and Computable Type**, 2023, with Mathieu Hoyrup, see [9].

Chapter 1

Overview

In this chapter, we present a summary of our main contributions, focusing on those that can be easily expressed.

The contributions encompass the introduction of new notions, the development of characterizations, the formulation of theorems and the provision of (counter)examples.

By highlighting these key elements, we aim to provide a concise overview of the significant outcomes and areas of inquiry within our research.

The reader is invited to read the introduction before reading this overview.

Contents

1.1	General Results about (Strong) Computable Type	2
1.1.1	Computable Type and the Hilbert Cube	2
1.1.2	Strong Computable Type	2
	Relative Strong Computable Type	2
1.1.3	Computable Type vs Topological Invariants	3
	1) Σ_2^0 Invariants and Strong Computable Type	3
	2) The invariants E_n and H_n	3
	3) Some Applications	4
	4) Uniformity	4
1.1.4	The ϵ -Surjection Property	5
	A Necessary Condition to have Strong Computable Type	5
1.1.5	Failing to have Computable Type	5
	1) Computable Witnesses	5
	2) Spaces without proper copies of themselves	6
1.2	Descriptive Complexity of Topological Invariants	6
1.2.1	Characterization of the Π_1^0 Topological Invariants	6
1.2.2	The Σ_2^0 Invariants	6
	1) Strong Approximation and Σ_2^0 Invariants	6
	2) Some Applications	7
1.2.3	Separating Finite Topological Graphs	7
1.3	The Surjection Property	8
1.3.1	The (ϵ -)Surjection Property and Unions	8
1.3.2	Finitely Conical Spaces	9
1.3.3	The Surjection Property for Cone Pairs	9
	1) Quotients and Retractions to Spheres	9
	2) Cycles	9

1.3.4	Applications to Computable Type	11
1)	A Characterization for Finite Simplicial Complexes	11
2)	Finite 2-Dimensional Simplicial Complexes	11
3)	Boundaries and the Odd Subcomplex	11
4)	Computable Type is Not Preserved by Products	12

1.1 General Results about (Strong) Computable Type

1.1.1 Computable Type and the Hilbert Cube

Two notions of computable type have been introduced in the literature, we prove that they are equivalent.

Let $Q = [0, 1]^{\mathbb{N}}$ be the Hilbert cube endowed with the product topology, induced by the complete metric $d_Q(x, y) = \sum_i 2^{-i} |x_i - y_i|$ where $x = (x_0, x_1, \dots)$ and $y = (y_0, y_1, \dots)$.

Theorem. (Theorem 4.2.1) Computable type can be equivalently defined on the Hilbert cube, on computable metric spaces and on computably Hausdorff spaces.

The proof is based on Schröder’s effective metrization theorem [53] which implies that compact Hausdorff spaces are metrizable in an effective way.

1.1.2 Strong Computable Type

We introduce a more flexible notion relativizing the notion of computable type.

Let us give some central definitions. A **compact pair** (X, A) consists of a compact metrizable space X and a compact subset $A \subseteq X$. A **copy** of a pair (X, A) in a topological space Z is a pair (Y, B) such that $Y \subseteq Z$ is homeomorphic to X and the image of A by the homeomorphism is B .

Definition. (Definition 4.3.1) A compact pair (X, A) has **strong computable type** if for every oracle O and every copy (Y, B) of (X, A) in Q , if (Y, B) is semicomputable relative to O , then Y is computable relative to O .

We study in details this notion in Chapter 4 and Section 5.4.

Relative Strong Computable Type

We prove that the relativization of strong computable type is captured by a purely topological property which involves ϵ -deformations.

Let d_H be the induced Hausdorff distance on the set of non-empty compact subsets of Q .

Definition. (Definition 4.3.4) Let $X \subseteq Q$ and $\epsilon > 0$. An **ϵ -function** is a continuous function $f : X \rightarrow Q$ such that $d(f(x), x) < \epsilon$ for all $x \in X$. An **ϵ -deformation of X** is the image of X under an ϵ -function.

Corollary. (Corollary 4.4.2) For a compact pair (X, A) , the following statements are equivalent:

1. (X, A) has relative strong computable type (see Definition 4.4.2),
2. There exists $\epsilon > 0$ such that no sequence of ϵ -deformations of (X, A) converges to a proper compact subpair of (X, A) in the Hausdorff distance.

In particular, if a compact pair (X, A) has strong computable type then it satisfies 2. (see Corollary 4.4.1).

1.1.3 Computable Type vs Topological Invariants

Let $\mathcal{K}(Q)$ be the hyperspace of Q , we fix a topology on $\mathcal{K}(Q)$, which is either the Vietoris or the upper Vietoris topology. The descriptive complexity of a property $\mathcal{P} \subseteq \mathcal{K}(Q)$ in that topology is defined as follows. It is Σ_1^0 if it is open, it is Π_1^0 if it is closed, it is Σ_2^0 if it is a countable union of differences of Π_1^0 sets (equivalently, a countable union of Π_1^0 sets when $\mathcal{K}(Q)$ is endowed with the Vietoris topology).

Effective complexity classes Π_1^0 and Σ_2^0 can be defined by requiring that the corresponding description of the set can be produced by a program.

1) Σ_2^0 Invariants and Strong Computable Type

The next result gives a relatively simple recipe to prove that a space (or pair) has strong computable type.

Theorem. (Theorem 4.3.2) If a compact pair (X, A) is minimal satisfying some Σ_2^0 topological invariant (in Vietoris or upper Vietoris topology), then (X, A) has strong computable type.

Note that this theorem is not an equivalence (see Section 5.4.4 for a counter-example). Being minimal for some Σ_2^0 invariant is therefore a distinguished way of having strong computable type, from which particular consequences can be derived, for instance about the level of uniformity of the computation that is involved in strong computable type (see Section 4) below).

2) The invariants E_n and H_n

We define two families of Σ_2^0 invariants E_n and H_n which play a key role in our study of strong computable type. Namely, for every $n \in \mathbb{N}$, we define the invariants E_n and H_n . Let \mathbb{S}_n be the n -dimensional sphere.

Definition. (Definition 5.3.2) For $n \in \mathbb{N}$, a compact pair (X, A) is in E_n if there exists a continuous function $f : A \rightarrow \mathbb{S}_n$ that has no continuous extension $F : X \rightarrow \mathbb{S}_n$.

Definition. (Definition 5.3.3) A compact pair (X, A) is in H_n if there exists a continuous function of pairs $f : (X, A) \rightarrow (\mathbb{S}_n, p)$ which is not null-homotopic relative to A (i.e. the homotopy is constant on A).

These invariants are studied in Sections 5.2, 5.3 and 5.4. They have low descriptive complexity.

Theorem. (Corollaries 5.2.1 and 5.3.3) The topological invariants E_n and H_n are Σ_2^0 in the upper Vietoris topology.

3) Some Applications

We apply this theory by revisiting the previous results and obtain new ones.

Example. (Theorem 5.4.1) Every connected compact n -manifold M is H_n -minimal. Every connected compact n -manifold with boundary $(M, \partial M)$ is H_n -minimal. It gives an alternative proof that they have strong computable type [37, 23, 34].

Example. (Propositions 5.4.1 and 5.4.2) If X is compact connected and is chainable from a to b , then the pair $(X, \{a, b\})$ is E_0 -minimal.

Every pseudo- n -cube is E_{n-1} -minimal.

It gives an alternative proof that they have strong computable type [42].

Furthermore, we are able to obtain new results effortlessly or at no additional cost, thanks to our findings.

Example. (Corollary 5.4.1) If M is a compact connected n -manifold with possibly empty boundary ∂M , then the pair

$$C(M, \partial M) = (C(M), M \cup C(\partial M))$$

is E_n -minimal hence has strong computable type.

Example. (Proposition 5.4.3) The pair consisting of the Warsaw saucer with its bounding circle is E_1 -minimal and hence has strong computable type (see Figure 5).

4) Uniformity

Typically, in cases where a pair has computable type, there is a lack of a uniform method for transforming semicomputability into computability. We focus on examining the non-uniformity of computation by employing Weihrauch degrees.

Definition. (Definition 4.4.4) For a compact pair (X, A) , let $\text{SCT}_{(X,A)}$ be the function taking a copy (Y, B) of (X, A) in τ_{upV}^2 and outputting Y in τ_V^2 .

Definition. (Definition 4.4.5) **Closed choice** over \mathbb{N} is the problem $C_{\mathbb{N}}$ of finding an element in a non-empty set A of natural numbers, given any enumeration of the complement of A .

Strong Weihrauch reducibility relative to some oracle is usually denoted by \leq_{sW}^t (where t stands for *topological*).

The first result holds for every compact pair (which may or may not have strong computable type).

Theorem. (Theorem 4.4.1) Let (X, A) be a compact pair such that X is not a singleton. One has $C_{\mathbb{N}} \leq_{sW}^t \text{SCT}_{(X,A)}$. If (X, A) has a semicomputable copy then $C_{\mathbb{N}} \leq_{sW} \text{SCT}_{(X,A)}$.

If the pair is minimal for some Σ_2^0 invariant, then the non-uniformity level of the computation is precisely what is called non-deterministic computability, captured by the Weihrauch degree of choice over \mathbb{N} (Theorem 4.4.2).

Theorem. (Theorem 4.4.2) Let \mathcal{P} be a Σ_2^0 invariant. If a compact pair (X, A) is \mathcal{P} -minimal then $\text{SCT}_{(X,A)} \leq_W \mathbb{C}_{\mathbb{N}}$.

1.1.4 The ϵ -Surjection Property

We introduce a necessary condition for strong computable type, which is sufficient for certain classes of spaces.

Definition. (Definition 4.4.3) Let $\epsilon > 0$. A pair $(X, A) \subseteq Q$ satisfies the **ϵ -surjection property** if every continuous function $f : X \rightarrow X$ satisfying $d_X(f, \text{id}_X) < \epsilon$ and $f|_A = \text{id}_A$ is surjective.

The pair satisfies the **surjection property** if every continuous function $f : X \rightarrow X$ such that $f|_A = \text{id}_A$ is surjective.

It turns out that the (ϵ -)surjection property is very related to the notion of strong computable type. We study it in details in Chapter 6 and a bit in Section 4.4.

A Necessary Condition to have Strong Computable Type

We prove that the ϵ -surjection property is necessary to have strong computable type.

Corollary. (Corollary 4.4.3) If $(X, A) \subseteq Q$ has strong computable type, then it satisfies the ϵ -surjection property for some $\epsilon > 0$.

Example. (Proposition 4.4.3) If X contains infinitely many isolated points, then X does not have strong computable type.

1.1.5 Failing to have Computable Type

1) Computable Witnesses

We have seen that if a compact pair does not satisfy the ϵ -surjection property for any $\epsilon > 0$, then it does not have strong computable type (Corollary 1.1.4).

We introduce an effective version of "not satisfying the ϵ -surjection property for any $\epsilon > 0$ " and prove that it implies that the pair does not have computable type (what we prove is slightly stronger, because we consider a stronger version of the ϵ -surjection property). We study it in Section 4.5.1.

Definition. (Definition 4.5.4) Let (X, A) be a compact pair in Q . For $\epsilon > 0$, say that $\delta > 0$ is an **ϵ -witness** if there exists a continuous function $f : X \rightarrow X$ satisfying $f(A) \subseteq A$ and $d_X(f, \text{id}_X) < \epsilon$, such that $d_H(X, f(X)) > \delta$.

Say that (X, A) has **computable witnesses** if there exists a computable function sending each rational $\epsilon > 0$ to a rational ϵ -witness $\delta > 0$.

Theorem. (Theorem 4.5.2) Let $(X, A) \subseteq Q$ be a pair of semicomputable compact sets. If it has computable witnesses, then (X, A) does not have computable type, i.e. there exists a semicomputable copy of (X, A) such that the copy of X is not computable.

2) Spaces without proper copies of themselves

We explain why for some spaces it is difficult to produce a semicomputable copy which is not computable (Theorem 4.5.3), contrasting with obvious examples such as the line segment or the n -dimensional ball.

Example. (Theorem 4.5.3) If X is computable and does not properly contain a copy of itself, then there is no geometrical transformation (scaling, rotation, translation) yielding a semicomputable copy of X which is not computable, and more generally there is no bilipschitz transformation yielding such a copy.

1.2 Descriptive Complexity of Topological Invariants

The insightful connection between strong computable type and topological invariants serves as a compelling motivation to conduct an independent study on the descriptive complexity of these invariants.

One approach to establishing strong computable type involves identifying a Σ_2^0 invariant for which the space/pair is minimal. Consequently, a crucial endeavor arises: the search for an extensive collection of Σ_2^0 invariants. This pursuit leads us to the overarching challenge of determining the range of invariants expressible within a given limit of complexity. To embark on this exploration, we initially focus on Π_1^0 invariants as a starting point.

1.2.1 Characterization of the Π_1^0 Topological Invariants

We define a class of Π_1^0 topological invariants.

Definition. (Definition 5.5.1) Let $0 \leq p \leq n$ be natural numbers. The topological invariant $C_{n,p}$ is defined by: $X \in C_{n,p}$ iff X has at most n connected components, among which at most p non-trivial ones.

In particular, $X \in C_{n,n}$ iff X has at most n connected components; $X \in C_{n,0}$ iff X contains at most n points.

In Section 5.5 we show how these invariants generate all Π_1^0 invariants.

Theorem. (Theorem 5.5.1) Let \mathcal{P} be a non-trivial topological invariant. The following statements are equivalent:

1. $\mathcal{P} \in \underline{\Pi}_1^0$,
2. $\mathcal{P} \in \Pi_1^0$,
3. \mathcal{P} is a finite union of $C_{n,p}$'s.

1.2.2 The Σ_2^0 Invariants

1) Strong Approximation and Σ_2^0 Invariants

A way to investigate the expressive power of Σ_2^0 invariants is to understand which spaces can be separated by such invariants. We first give a characterization of the separability of two spaces.

We say that a compact space X strongly approximates a compact space Y if there is a copy $X_0 \subseteq Q$ of X such that for every $\epsilon > 0$, one can continuously deform X_0 to converge to a copy of Y , in such a way that every point of X_0 is moved by at most ϵ .

Definition. (Definition 5.6.1) Let X, Y be compact spaces. We say that X **strongly approximates** Y , written $X \preceq Y$, if there exists a copy $X_0 \subseteq Q$ of X such that for every $\epsilon > 0$, some copy of Y is a limit in the Hausdorff distance (Vietoris topology) of ϵ -deformations of X_0 .

Note that if X strongly approximates Y , then the condition actually holds for *every* copy $X_0 \subseteq Q$ of X (see Remark 5.6.1).

This notion and its relation with $\underline{\Sigma}_2^0$ and Σ_2^0 invariants is studied in Section 5.6. We obtain the following characterization.

Theorem. (Theorem 5.6.1) Let X, Y be compact spaces. The following statements are equivalent:

- X strongly approximates Y ,
- Every $\underline{\Sigma}_2^0$ invariant satisfied by X is satisfied by Y .

2) Some Applications

Example. (Proposition 5.6.2) The closed topologist's sine curve $S = \{(x, \sin(1/x)) : x \in (0, 1]\} \cup \{(0, y) : y \in [-1, 1]\}$ and the line segment cannot be distinguished by $\underline{\Sigma}_2^0$ invariants.

Example. (Example 5.7.1) Every Σ_2^0 invariant satisfied by the line segment is satisfied by the graphs that have a bridge, i.e. an edge whose removal disconnects the graph. Every Σ_2^0 invariant satisfied by the circle is satisfied by the graphs that have a cycle. Moreover, the line segment and the circle can be separated by some Σ_2^0 invariant, in both directions.

1.2.3 Separating Finite Topological Graphs

We study the relation between strong approximation and graphs (see Section 5.7).

We show that for finite topological graphs, the non-effective class $\underline{\Sigma}_2^0$ is no more expressive than the effective class Σ_2^0 .

Theorem. (Theorem 5.7.1) Let X be a finite topological graph and Y a compact space. If there exists a $\underline{\Sigma}_2^0$ invariant satisfied by X but not by Y , then there exists a Σ_2^0 such invariant.

We show that the Σ_2^0 invariants are expressive enough to separate non-homeomorphic graphs.

Theorem. (Theorem 5.7.3) The following are equivalent

- G, H are non-homeomorphic finite topological graphs,
- Some Σ_2^0 invariant is satisfied by G but not by H , or vice-versa.

Note that there is a dissymmetry: it can happen that every Σ_2^0 invariant satisfied by G is also satisfied by H (but not vice-versa).

Let G and H be finite topological graphs, we give a characterization of the following relation: every Σ_2^0 invariant is satisfied by G but not by H .

We say that H can be contracted to G if there is a sequence of edge contractions from H to G ; an edge contraction consists in removing an edge and merging its two endpoints (we actually consider multigraphs with loops).

Theorem. (Theorem 5.7.2) The following statements are equivalent for finite connected graphs G, H :

- Every Σ_2^0 invariant satisfied by G is satisfied by H ,
- Some subdivision of H can be contracted to G .

1.3 The Surjection Property

In this section we study more in details the (ϵ -)surjection property (see Definition 1.1.4) and its relation with (strong) computable type.

The ϵ -surjection property does not depend on the choice of a compatible metric on X (see Proposition 6.3.1)

We use the notion of cones and cone pairs.

Definition. (Definitions 3.2.2 and 3.2.3) Let X be a topological space. The **cone** of X is the quotient of $X \times [0, 1]$ under the equivalence relation $(x, 0) \sim (x', 0)$. Let (X, A) be a pair. Its **cone pair** is the pair $\mathbf{C}(X, A) = (\mathbf{C}(X), X \cup \mathbf{C}(A))$.

Note that for a compact pair (X, A) , the cone pair $\mathbf{C}(X, A)$ has the ϵ -surjection property for some $\epsilon > 0$ iff it has the surjection property (Proposition 6.3.3).

Let X be a topological space and $n \in \mathbb{N}$, $n \geq 1$. A point $x \in X$ is n -Euclidean if it has an open neighborhood that is homeomorphic to \mathbb{R}^n . A point is Euclidean if it is n -Euclidean for some n . We introduce the following class of spaces.

Definition. (Definitions 6.2.1 and 6.2.2)

A space is **almost Euclidean** if the set of Euclidean points is dense. A space is **almost n -Euclidean** if the set of n -Euclidean points is dense. A pair (X, A) is almost Euclidean (resp. almost n -Euclidean) if $X \setminus A$ is almost Euclidean (resp. almost n -Euclidean).

A set $C \subseteq X$ is a **regular n -cell** if there is a homeomorphism $f : \mathbb{B}_n \rightarrow C$ such that $f(\mathbb{B}_n \setminus \mathbb{S}_{n-1})$ is an open subset of X . A **regular cell** is a regular n -cell for some $n \geq 1$.

1.3.1 The (ϵ -)Surjection Property and Unions

We reduce the (ϵ -)surjection property for a pair to the (ϵ -)surjection property for subpairs covering it.

Theorem. (Theorem 6.3.1) Let (X, A) and $(X_i, A_i)_{i \in \mathbb{N}}$ be compact pairs such that $X = \bigcup_{i \in \mathbb{N}} X_i$ and $A = \bigcup_{i \in \mathbb{N}} A_i$. Assume that (X, A) is almost Euclidean. If every pair $\mathbf{C}(X_i, A_i)$ has the surjection property, then $\mathbf{C}(X, A)$ has the surjection property.

Theorem. (Theorem 6.3.2) Let (X, A) and $(X_i, A_i)_{i \leq n}$ be compact pairs such that $X = \bigcup_{i \leq n} X_i$ and $A = \bigcup_{i \leq n} A_i$. Assume that each topological boundary ∂X_i is a neighborhood retract in X .

If every pair (X_i, A_i) has the ϵ -surjection property for some $\epsilon > 0$, then (X, A) has the δ -surjection property for some $\delta > 0$.

1.3.2 Finitely Conical Spaces

For the next class of spaces we prove that the ϵ -surjection property is actually a local property.

Definition. (Definition 6.4.1) A topological space X is **finitely conical** if there exists a finite sequence of compact metrizable spaces $(L_i)_{i \leq n}$ and a finite covering of X by open sets $U_i \subseteq X$, $i \leq n$, where U_i is homeomorphic to $\text{OC}(L_i)$.

A pair (X, A) is **finitely conical** if X is finitely conical and for every i , the homeomorphism $f_i : U_i \rightarrow \text{OC}(L_i)$ satisfies $f_i(U_i \cap A) = \text{OC}(N_i)$ for some compact $N_i \subseteq L_i$.

Note that finitely conical pairs are closed under finite products and the cone operator (see Proposition 6.4.1).

Theorem. (Theorem 6.4.1) Let (X, A) be a finitely conical compact pair coming with $(L_i, N_i)_{i \leq n}$, where each L_i is an ANR. The following statements are equivalent:

1. (X, A) has the ϵ -surjection property for some $\epsilon > 0$,
2. All the cone pairs $\text{C}(L_i, N_i)$ have the surjection property.

1.3.3 The Surjection Property for Cone Pairs

1) Quotients and Retractions to Spheres

The surjection property for cone pairs is intimately related to quotients and retractions to spheres.

Theorem. (Theorem 6.5.1) Let (X, A) be an almost Euclidean compact pair. The following statements are equivalent:

1. $\text{C}(X, A)$ has the surjection property,
2. For every $n \geq 1$ and every regular n -cell $C \subseteq X \setminus A$, the quotient map $q_C : (X, A) \rightarrow (\mathbb{S}_n, s)$ is not null-homotopic.

Corollary. (Corollary 6.5.1) Let (X, A) be an almost Euclidean compact pair. The pair $\text{C}(X, A)$ has the surjection property if and only if $\text{C}(X/A, \emptyset) = (\text{C}(X/A), X/A)$ has the surjection property.

Theorem. (Theorem 6.5.2) Let (X, A) be a compact pair and $C \subseteq X \setminus A$ be a regular n -cell. If there exists a retraction $r : X \setminus \text{op}(C) \rightarrow \text{bd}(C)$ which is constant on A , then the quotient map $q : (X, A) \rightarrow (\mathbb{S}_n, s)$ is null-homotopic, hence $\text{C}(X, A)$ does not have the surjection property.

We prove that condition that $r|_A$ is constant can be replaced by being null-homotopic (Proposition 6.5.2).

2) Cycles

Let $\mathbb{T} = \mathbb{R}/\mathbb{Z}$ is the circle group.

Definition. (Definition 6.5.1) Let (X, A) be a compact pair and $n \geq 1$. A regular n -cell $C \subseteq X \setminus A$ **belongs to a relative cycle** if the canonical homomorphism

$$H_n(X, A; \mathbb{T}) \rightarrow H_n(X, X \setminus \text{op}(C); \mathbb{T})$$

is non-trivial.

For ANRs, this notion can equivalently be reformulated using cohomology (see Remark 6.5.1). For finite simplicial complexes, it can be reformulated using maximal simplices (see Proposition 6.5.3).

Note that $H_n(X, X \setminus \text{op}(C); \mathbb{T}) \cong \mathbb{T}$, that is why we obtain the following.

Corollary. (Corollary 6.5.3) Let (X, A) be an almost Euclidean compact pair. If every regular cell $C \subseteq X \setminus A$ belongs to a relative cycle, then $C(X, A)$ has the surjection property.

Conditions on the dimension give us some characterizations.

Corollary. (Corollary 6.5.4) Let $n \geq 1$. Let (X, A) be an almost n -Euclidean compact pair, where X and A are ANRs and $\dim(X) = n$. The following statements are equivalent:

- The pair $C(X, A)$ has the surjection property,
- Every regular cell $C \subseteq X \setminus A$ belongs to a relative cycle.

Corollary. (Corollary 6.5.5) Let (X, A) be a compact pair, where X and A are ANRs and $\dim(X) = n \geq 1$. For a regular n -cell $C \subseteq X \setminus A$, the following statements are equivalent:

- C does not belong to a relative cycle,
- There exists a retraction $r : X \setminus \text{op}(C) \rightarrow \text{bd}(C)$ which is constant on A .

The equivalence holds if $n = 1$ or 2 , without any dimension assumption about X .

Corollary. (Corollary 6.5.6) Let (X, A) be an almost Euclidean compact pair, where X and A are ANRs and $\dim(X) \leq 3$. The following statements are equivalent:

- The pair $C(X, A)$ has the surjection property,
- Every regular cell $C \subseteq X \setminus A$ belongs to a relative cycle.

We also obtain a relationship between cycles and the ϵ -surjection property for ANRs.

Theorem. (Theorem 6.5.3) Let (X, A) be an almost Euclidean compact pair, where X is an ANR. If every regular cell $C \subseteq X \setminus A$ belongs to a relative cycle, then (X, A) has the ϵ -surjection property for some $\epsilon > 0$.

The product of two pairs (X_1, A_1) and (X_2, A_2) is the pair $(X_1 \times X_2, (X_1 \times A_2) \cup (A_1 \times X_2))$. For a finite simplicial pair, if the product satisfies the ϵ -surjection property for some $\epsilon > 0$, then both (X_1, A_1) and (X_2, A_2) satisfy the δ -surjection property for some $\delta > 0$ (Proposition 6.3.2).

As an application of our results about cycles, we prove surprisingly that the converse does not hold, see Theorem 6.6.2.

1.3.4 Applications to Computable Type

1) A Characterization for Finite Simplicial Complexes

Putting all the results together, we obtain the following characterization for finite simplicial pairs.

Corollary 1.3.1. (Corollary 6.7.1) For a finite simplicial pair (X, A) such that A has empty interior in X , the following statements are equivalent:

1. (X, A) has (strong) computable type,
2. (X, A) satisfies the ϵ -surjection property for some $\epsilon > 0$,
3. For every vertex, the cone pair corresponding to its star has the surjection property (see Section 3.5).

A finite simplicial pair which is a cone, has (strong) computable type iff it satisfies the surjection property.

Using our previous results we obtain the following.

Corollary. (Corollary 6.7.2) Let (X, A) be a finite simplicial pair and $(X_i, A_i)_{i \leq n}$ be pairs of subcomplexes such that $X = \bigcup_{i \leq n} X_i$ and $A = \bigcup_{i \leq n} A_i$. If every pair (X_i, A_i) has computable type, then (X, A) has computable type.

Corollary. (Corollary 6.7.3) For finite simplicial pairs (X, A) such that X is pure or has dimension at most 4, whether (X, A) has computable type is decidable.

2) Finite 2-Dimensional Simplicial Complexes

In particular, we obtain a visual way to prove that a finite 2-dimensional simplicial complex has computable type since it is locally a cone of a finite graph.

Corollary. (Corollary 6.7.4) Let (L, N) be a pair such that L is a finite graph and N is a subset of its vertices. The following statements are equivalent:

1. $C(L, N)$ has the surjection property,
2. Every edge is in a cycle or a path starting and ending in N ,
3. $C(L, N)$ has computable type.

We apply this to prove that Bing's house has computable type whereas the dunce hat does not, see Propositions 6.7.2 and 6.7.1, refer to the introduction for to see their figures.

3) Boundaries and the Odd Subcomplex

Let

- $\partial_1 X$ be the union of simplices that are contained in *exactly* one simplex of the next dimension, i.e. $\partial_1 X$ is the union of the free simplices of X ,
- $\partial_+ X$ be the union of simplices that are contained in *at least* one simplex of the next dimension,

- $\partial_{\text{odd}}X$ be the union of simplices that are contained in *an odd number* of maximal simplices of the next dimension.

The following observations can be made:

- Although $(X, \partial_1 X)$ has computable type when X is a 1-dimensional complex (i.e., a graph), it is no more true for 2-dimensional complexes.
- While $(X, \partial_+ X)$ always has computable type by Proposition 6.7.3, $\partial_+ X$ is far from optimal.
- $(X, \partial_{\text{odd}} X)$ always has computable type but $\partial_{\text{odd}} X$ is in general not optimal.

4) Computable Type is Not Preserved by Products

This is a negative answer of an open question, raised by Čelar and Iljazović in [21]. Note that $(\mathbb{B}_1, \mathbb{S}_0)$ has computable type.

Corollary 1.3.2. (Corollary 6.7.5) There exists a finite simplicial pair (X, A) that has computable type, but such that the product $(X, A) \times (\mathbb{B}_1, \mathbb{S}_0)$ does not.

Part I

Preliminaries

Chapter 2

Background on Computable Topology

Contents

2.1	Effective countably-based T_0-spaces	16
2.1.1	Classes of Computable T_0 -spaces	18
2.1.2	The Hilbert Cube	19
2.2	Computable Type	20
2.2.1	State of the Art	21
2.3	Vietoris Topology, Topological Invariant and Descriptive Complexity	22
2.3.1	State of the Art	24
2.4	Weihrauch reducibility	24

WE give some background about computable aspects of topological spaces, most of which can be found in [64, 54, 41, 44], namely: effective countably-based T_0 -spaces, computable separation axioms, computability of subsets, the Hilbert cube as a universal computable metric space, computable type and descriptive complexity.

First of all, let us recall enumeration reducibility, which enables one to define a notion of computable reduction between points of countably-based topological spaces.

We will mainly use the following notion from computability theory: a set $A \subseteq \mathbb{N}$ is **computably enumerable (c.e.)** if there exists a Turing machine that, on input $n \in \mathbb{N}$, halts if and only if $n \in A$. An **enumeration** of A is any function $f : \mathbb{N} \rightarrow \mathbb{N}$ such that $A = \{n \in \mathbb{N} : \exists p \in \mathbb{N}, f(p) = n + 1\}$. A set is c.e. if and only if it has a computable enumeration. This notion immediately extends to subsets of countable sets, whose elements can be encoded by natural numbers such as the set of rational numbers, or the set \mathbb{N}^* of finite sequences of natural numbers.

The halting set $H \subseteq \mathbb{N}$, which is the set of indices of Turing machines that halt, is a famous example of a c.e. set that is not computable, discovered by Turing in his seminal article [59].

As we will see soon, a point of a countably-based topological space can be identified with a set of natural numbers, namely the set of indices of its basic neighborhoods. Therefore, relative computability between points will be conveniently expressed using enumeration reducibility, which we recall now.

Let $\langle x, D \rangle$ denote the encoding of the pair of finite objects x and D into a natural number.

Definition 2.0.1. (Enumeration reducibility) Let $A, B \subseteq \mathbb{N}$. We say that A is **enumeration reducible** to B , written $A \leq_e B$, if one of the following equivalent statements holds:

1. There is an effective procedure producing an enumeration of A from any enumeration of B ,
2. There exists a c.e. set $W \subseteq \mathbb{N}$ such that, for all $x \in \mathbb{N}$,

$$x \in A \iff \text{there exists a finite set } D \subseteq B \text{ such that } \langle x, D \rangle \in W,$$

3. For every oracle $O \subseteq \mathbb{N}$, if B is c.e. relative to O then A is c.e. relative to O .

The equivalence between 2. and 3. is due to Selman [57].

Now, we start our preliminaries about computable analysis.

2.1 Effective countably-based T_0 -spaces

Definition 2.1.1. An **effective countably-based T_0 -space** is a tuple $(X, \tau, (B_i)_{i \in \mathbb{N}})$ where (X, τ) is a countably-based T_0 topological space and $(B_i)_{i \in \mathbb{N}}$ is a numbered basis of τ such that there exists a c.e. set $\mathcal{E} \subseteq \mathbb{N}^3$ such that for every $i, j \in \mathbb{N}$, $B_i \cap B_j = \bigcup_{k: (i,j,k) \in \mathcal{E}} B_k$. We will say that a point $x \in X$ is **τ -computable** if the set $\{i : x \in B_i\}$ is c.e..

We will often denote an effective countably-based T_0 -space by (X, τ) , the numbered basis being implicit. When several topological spaces are involved, we write B_i^X for the basis of the space X . A subset Y of an effective countably-based T_0 -space (X, τ) is also an effective countably-based T_0 -space, by taking the subspace topology and the numbered basis $B_i^Y = Y \cap B_i^X$. The product of two effective countably-based T_0 -spaces is naturally an effective countably-based T_0 -space.

Example 2.1.1

\mathbb{R} equipped with the topology consisting of all rational open intervals is an effective countably-based T_0 -space.

In an effective countably-based T_0 -space (X, τ) , a point can be identified with the set of its basic neighborhoods, therefore the computability properties of a point of such a space is entirely captured by the enumeration degree of its neighborhood basis. This idea is explored in depth by Kihara and Pauly in [45]. In particular, a computable reduction between points can be defined using enumeration reducibility as follows.

Definition 2.1.2. Let (X, τ_X) and (Y, τ_Y) be an effective countably-based T_0 -spaces. A point x in (X, τ_X) is **computable relative** to a point y in (Y, τ_Y) if

$$\{i \in \mathbb{N} : x \in B_i^X\} \leq_e \{i \in \mathbb{N} : y \in B_i^Y\}.$$

A function $f : X \rightarrow Y$ between effective countably-based T_0 -spaces is **computable** if and only if for every $x \in X$, $f(x)$ is computable relative to x in a uniform way, i.e. using the same machine in the reduction. Equivalently, $f : X \rightarrow Y$ is computable if the sets $f^{-1}(B_i^Y)$ are effectively open, uniformly in i .

Let us recall some notions of computability of sets.

Definition 2.1.3. A set A in an effective countably-based T_0 -space $(X, \tau, (B_i)_{i \in \mathbb{N}})$ is:

1. **Effectively compact**, or **semicomputable**, if it is compact and the set

$$\{(i_1, \dots, i_n) \in \mathbb{N}^* : A \subseteq B_{i_1} \cup \dots \cup B_{i_n}\}$$

is c.e.,

2. **Computably overt** if it is closed and the set $\{i \in \mathbb{N} : A \cap B_i \neq \emptyset\}$ is c.e.,
3. **Computable** if it is effectively compact and computably overt,
4. **Effectively open** or Σ_1^0 if there exists a c.e. set $E \subseteq \mathbb{N}$ such that $A = \bigcup_{i \in E} B_i$,
5. **Effectively closed** or Π_1^0 if its complement is effectively open.

We will often use the word *semicomputable* when talking about a subset of a space, and *effectively compact* when talking about the space itself.

A compact set is computable iff it is semicomputable and contains a dense computable sequence.

The image of a (semi)computable compact set under a computable function is a (semi)computable compact set.

Example 2.1.2

The Mandelbrot set is a semicomputable compact set, it is an open question whether it is computable (see [33]).

The next result is simple but very powerful and central in many arguments: closed sets are preserved by taking existential quantification over a compact set, and it holds effectively. Equivalently, open sets are preserved by taking universal quantification over a compact set, effectively so. It is a standard folklore result in computable analysis that can drastically simplify many arguments. It can be found in [51] for instance, but we include a proof for completeness.

Proposition 2.1.1

Let X, Y be effective countably-based T_0 -spaces such that Y is effectively compact.

- If $R \subseteq X \times Y$ is effectively closed, then its existential quantification

$$R^\exists := \{x \in X : \exists y \in Y, (x, y) \in R\}$$

is effectively closed as well,

- If $R \subseteq X \times Y$ is effectively open, then its universal quantification

$$R^\forall := \{x \in X : \forall y \in Y, (x, y) \in R\}$$

is effectively open as well.

Of course the two items are equivalent by taking complements, but we make both of them explicit as they are equally useful.

Proof. We prove the second item, the first one is obtained by taking complements. As R is effectively

open, there exists a c.e. set $E \subseteq \mathbb{N}^2$ such that $R = \bigcup_{(i,j) \in E} B_i^X \times B_j^Y$. One has

$$x \in R^\vee \iff \{x\} \times Y \subseteq R \quad (2.1)$$

$$\iff \exists \text{ finite set } L \subseteq E, \{x\} \times Y \subseteq \bigcup_{(i,j) \in L} B_i^X \times B_j^Y \quad (2.2)$$

because $\{x\} \times Y$ is compact. Let \mathcal{F} be the collection of (indices of) finite sets $L \subseteq E$ such that $Y \subseteq \bigcup_{(i,j) \in L} B_j^Y$. As Y is effectively compact, \mathcal{F} is a c.e. set. For each $L \in \mathcal{F}$, let $U_L = \bigcap_{(i,j) \in L} B_i^X$. The equivalence (2.2) implies that $R^\vee = \bigcup_{L \in \mathcal{F}} U_L$, which is an effective open set. \square

Descriptive set theory and its effective version provide notions of complexity for subsets of topological spaces ([49]). We have already seen the classes Σ_1^0 and Π_1^0 in Definition 2.1.3, we will also need another class.

Definition 2.1.4. A set A in an effective countably-based T_0 -space $(X, \tau, (B_i)_{i \in \mathbb{N}})$ is Σ_2^0 if it can be expressed as

$$A = \bigcup_{n \in \mathbb{N}} A_n \setminus B_n$$

where A_n, B_n are uniformly effective closed sets (i.e. Π_1^0).

Observe that one can equivalently require A_n, B_n to be effectively *open*, as $A_n \setminus B_n = (X \setminus B_n) \setminus (X \setminus A_n)$. This class is traditionally defined on computable metric spaces (those spaces are defined in Section 2.1.1 below), where it is equivalently defined without the sets B_n . The definition given here was proposed for non-Hausdorff spaces by Scott [55] and Selivanov [56], to make sure that the classes Σ_1^0 and Π_1^0 are contained in the class Σ_2^0 .

Note that the non-effective classes are defined in Section 2.3.

2.1.1 Classes of Computable T_0 -spaces

Each topological separation axiom has a computable version, we recall some of them. These definitions can be found in [53] for instance.

Definition 2.1.5. 1. A **computable metric space** is a tuple (X, d, α) , where (X, d) is a metric space and $\alpha : \mathbb{N} \rightarrow X$ is a dense sequence in (X, d) such that the real numbers $d(\alpha_i, \alpha_j)$ are uniformly computable (i.e. the function $(i, j) \mapsto d(\alpha_i, \alpha_j)$ is computable). A **computable Polish space** is a computable metric space whose metric is complete.

2. An effective countably-based T_0 -space $(X, \tau, (B_i)_{i \in \mathbb{N}})$ is **computably Hausdorff** if the diagonal $\Delta = \{(x, x) : x \in X\}$ is an effectively closed subset of $X \times X$, i.e. if there exists some c.e. set $\mathcal{D} \subseteq \mathbb{N}^2$ satisfying

$$(X \times X) \setminus \Delta = \{(x, y) \in X \times X : x \neq y\} = \bigcup_{(i,j) \in \mathcal{D}} B_i \times B_j.$$

Recall that if (X, d) is a metric space, $x \in X$ and $r > 0$, then we consider the open ball $B(x, r) = \{y \in X : d(x, y) < r\}$ and the closed ball $\overline{B}(x, r) = \{y \in X : d(x, y) \leq r\}$.

Example 2.1.3

Let $n \in \mathbb{N}^*$. \mathbb{R}^n equipped with the topology consisting of all rational open balls is a computable metric space.

Remark 2.1.1

The following facts are standard and can be found in [51] for instance:

- A computable metric space is an effective countably-based T_0 -space, by taking as basis the metric open balls $B_d(\alpha_i, q)$ with $q > 0$ a rational number; these balls are called the **rational balls**,
- A computable metric space is computably Hausdorff,
- In a computably Hausdorff space which is effectively compact, a set is semicomputable (i.e., effectively compact) if and only if it is effectively closed.

The next fact is another powerful feature of effective compactness: in certain situations, if a computable function is injective, then its inverse is automatically computable.

Proposition 2.1.2

Let X be an effective countably-based T_0 -space, Y a computably Hausdorff space and $K \subseteq X$ a semicomputable compact set. If $f : K \rightarrow Y$ is a computable injective function, then its inverse $f^{-1} : f(K) \rightarrow K$ is computable.

Proof. It is a folklore result but we include a proof for completeness. We need to show that for a basic open set B_i of X , its preimage under f^{-1} is effectively open in $f(K)$, uniformly in i . The preimage is precisely $f(B_i \cap K)$. As f is injective, $f(B_i \cap K) = f(K) \setminus f(K \setminus B_i)$. As $K \setminus B_i$ is semicomputable, its image $f(K \setminus B_i)$ is semicomputable as well. As Y is computably Hausdorff, $f(K \setminus B_i)$ is effectively closed, so its complement is effectively open, as wanted. \square

2.1.2 The Hilbert Cube

The Hilbert cube will play a central role in the next chapters, because every computable metric space computably embeds into it, so one can work in this space without loss of generality.

Definition 2.1.6. The **Hilbert cube** is the space $Q = [0, 1]^{\mathbb{N}}$ endowed with the product topology, induced by the complete metric

$$d_Q(x, y) = \sum_i 2^{-i} |x_i - y_i|$$

where $x = (x_0, x_1, \dots)$ and $y = (y_0, y_1, \dots)$. A point $x \in Q$ is **rational** if its coordinates are rational and it has finitely many non-zero coordinates. The set of rational points is dense in Q .

Here are some important facts about the Hilbert cube.

Fact 2.1.1

The Hilbert cube Q satisfies the following properties:

1. Let $(\alpha_i)_{i \in \mathbb{N}}$ be a computable enumeration of the points of Q having rational coordinates, finitely many of them being non-zero. It makes (Q, d_Q, α) a computable metric space and even a computable Polish space,
2. The Hilbert cube is effectively compact,
3. Therefore, a set $X \subseteq Q$ is semicomputable iff it is effectively closed,
4. Every computable metric space embeds effectively into the Hilbert cube. More precisely, for every computable metric space (X, d, α) there exists a computable embedding $f : X \rightarrow Q$ such that f^{-1} is computable, defined as $f(x) = (1/(1 + d(x, \alpha_i)))_{i \in \mathbb{N}}$,
5. The points of Q can be multiplied by factors in $[0, 1]$, and convex combinations can be performed in Q .

In particular, the fourth item implies that the semicomputable compact subsets of arbitrary computable metric spaces are no more general than the semicomputable compact subsets of Q .

The space of continuous functions from Q to itself

Definition 2.1.7. Let $\mathcal{C}(Q)$ be the space of continuous functions from Q to itself endowed with the complete separable metric

$$d(f, g) = \max_{x \in Q} d_Q(f(x), g(x)).$$

If functions f, g are defined on a compact subset $X \subseteq Q$ only, then we also define

$$d_X(f, g) = \max_{x \in X} d_Q(f(x), g(x)).$$

To simplify the notation, we may write $d(f, g)$ rather than $d_X(f, g)$.

Remark 2.1.2

We will often use the following inequalities:

$$d(f \circ h, g \circ h) \leq d(f, g), \tag{2.3}$$

$$d(f \circ g, \text{id}_Q) \leq d(f, \text{id}_Q) + d(g, \text{id}_Q). \tag{2.4}$$

The second inequality holds because $d(f \circ g, \text{id}_Q) \leq d(f \circ g, g) + d(g, \text{id}_Q) \leq d(f, \text{id}_Q) + d(g, \text{id}_Q)$.

2.2 Computable Type

The notion of computable type takes its origins in an article by Miller [48], was studied by Iljazović et al. in [37, 38, 39, 18, 42, 23, 34, 40, 21, 20] and by us in [4, 6, 8, 9]. The first formal definition as given in [42].

Let us present the language needed to formulate the definition of computable type.

2. Background on Computable Topology

In this thesis, all the topological spaces are compact metrizable spaces, which we may implicitly assume. A copy of such a space X in some space Z is a subset of Z that is homeomorphic to X . We will often consider copies in Q .

We recall the definition of compact pairs, which is central in this thesis.

Definition 2.2.1. A **compact pair** (X, A) consists of a compact metrizable space X and a compact subset $A \subseteq X$. A **copy** of a pair (X, A) in a topological space Z is a pair (Y, B) such that $Y \subseteq Z$ is homeomorphic to X and the image of A by the homeomorphism is B . A compact pair (Y, B) is **semicomputable** if Y and B are semicomputable.

Now, we recall the Definition of computable type introduced by Iljazović.

Definition 2.2.2. A compact metrizable space X has **computable type** if for every copy Y of X in the Hilbert cube, if Y is semicomputable then Y is computable. A compact pair (X, A) has **computable type** if for every copy (Y, B) of (X, A) in the Hilbert cube, if (Y, B) is semicomputable then Y is computable.

Note that the notion for pairs subsumes the notion for single sets, clearly by considering the pair (X, \emptyset) .

Example 2.2.1

The first example of a space which has computable type is n -spheres proved by Miller in [48], more examples are given in Section 2.2.1 below.

Originally, two notions of computable type were studied in [37] and [23] respectively, using other spaces than the Hilbert cube. Precisely,

- A compact pair (X, A) has **computable type on computable metric spaces** if for every copy (Y, B) of the pair in any computable metric space Z , if (Y, B) is semicomputable then Y is computable,
- A compact pair (X, A) has **computable type on computably Hausdorff spaces** if for every copy (Y, B) of the pair in any computably Hausdorff space Z , if (Y, B) is semicomputable then Y is computable.

Remark 2.2.1

It is important to note that our approach to study computable type focuses exclusively on compact spaces, in contrast to certain existing results in the literature that establish a computable type property for non-compact spaces (e.g., [18] or [40]). The assumption of compactness is pivotal, and extending the theory beyond compact spaces remains uncertain. Previous studies have introduced slight variations in the notion of computable type, such as employing effective closedness rather than effective compactness, as seen in [38]. However, these variations necessitate additional assumptions on the ambient space, such as effective local compactness. In our thesis, we utilize the notion of effective compactness, which exhibits smoother behavior.

2.2.1 State of the Art

We summarize the main results in the literature in the following fact.

Fact 2.2.1

The following spaces/pairs have computable type:

1. Spheres, balls with their bounding spheres [48] and compact manifolds with or without boundary [38, 39, 18, 42, 20],
2. Graphs with their endpoints [40],
3. Chainable continua between two points [37, 23],
4. Circularly chainable continua which are not chainable [37, 23],
5. Pseudo n -cubes [34],
6. Products of chainable continua [21].

2.3 Vietoris Topology, Topological Invariant and Descriptive Complexity

In this discussion, we will explore an intriguing area of mathematics that involves the study of topological spaces and their relationship to topological invariants. Specifically, we will be interested in the concept of the Descriptive Set Theory (DST) of topological invariants, where we consider placing topologies on the hyperspace of the Hilbert cube and examine compact metric spaces as elements of this space.

Now, let us delve into the detailed definitions.

Vietoris Topology

Definition 2.3.1. Let $\mathcal{K}(Q)$ be the **hyperspace** of Q , i.e. the space of non-empty compact subsets of Q . It can be equipped with:

1. The **upper Vietoris** topology $\tau_{up\mathcal{V}}$ generated by the sets of the form

$$\{K \in \mathcal{K}(Q) : K \subseteq U\},$$

where U ranges over the open subsets of Q ,

2. The **lower Vietoris** topology $\tau_{low\mathcal{V}}$ generated by the sets of the form

$$\{K \in \mathcal{K}(Q) : K \cap U \neq \emptyset\},$$

where U ranges over the open subsets of Q ,

3. The **Vietoris** topology $\tau_{\mathcal{V}}$ generated by $\tau_{up\mathcal{V}}$ and $\tau_{low\mathcal{V}}$.

Note that the upper and lower Vietoris topologies are incomparable.

These three topological spaces are effective countably-based T_0 -spaces. A countable basis $(B_i^{\tau_{up\mathcal{V}}})_{i \in \mathbb{N}}$ of $\tau_{up\mathcal{V}}$ is obtained by taking U among the finite unions of rational balls of Q . A countable sub-basis $(B_i^{\tau_{low\mathcal{V}}})_{i \in \mathbb{N}}$ of $\tau_{low\mathcal{V}}$ is obtained by taking U among the rational balls of Q , and adding $\mathcal{K}(Q)$ to the subbasis. A countable basis for the Vietoris topology is obtained by taking finite intersections of these sets (the basis of $\tau_{up\mathcal{V}}$ and the sub-basis of $\tau_{low\mathcal{V}}$). Using the basis $(B_i)_{i \in \mathbb{N}}$

2. Background on Computable Topology

of Q , the elements of the sub-basis of $(\mathcal{K}(Q), \tau_V)$ are of the form

$$\left\{ K : K \subseteq \bigcup_{k \in \{1, \dots, n\}} B_{i_k}, K \cap B_j \neq \emptyset \right\}$$

for some i_k s, j and n .

The Vietoris topology is also induced by the Hausdorff distance between non-empty compact sets in the Hilbert cube defined as follows.

Definition 2.3.2. Let $A, B \subseteq Q$ be two non-empty compact sets, the **Hausdorff distance** between A and B is defined by:

$$d_H(A, B) = \max \left(\max_{a \in A} \min_{b \in B} d_Q(a, b), \max_{b \in B} \min_{a \in A} d_Q(a, b) \right).$$

The space $(\mathcal{K}(Q), \tau_V)$ is a computable Polish space, by taking the Hausdorff metric, and the dense sequence of finite sets of rational points of Q . Moreover, these three spaces are effectively compact (see Section 5 in [41] for instance; it is sufficient to prove it for the stronger topology τ_V).

Each computability notion of compact set can then be seen as the notion of computable point in one of these topologies. In particular, for a compact set $K \subseteq Q$,

$$\begin{aligned} K \text{ is semicomputable} &\iff K \text{ is a computable element of } (\mathcal{K}(Q), \tau_{upV}), \\ K \text{ is computably overt} &\iff K \text{ is a computable element of } (\mathcal{K}(Q), \tau_{lowV}), \\ K \text{ is computable} &\iff K \text{ is a computable element of } (\mathcal{K}(Q), \tau_V). \end{aligned}$$

It is easy to get confused with the many different uses of the word “computable”, but we will always make it clear what meaning is used.

We use the Vietoris topology rather than the Hausdorff metric because when measuring the descriptive complexity of some property (see Section 2.3), the Vietoris open sets appear more naturally (for instance, being disconnected is about open sets that cover and intersect the set).

Topological Invariant and Property of Pairs

Definition 2.3.3. A **topological invariant**, or shortly an **invariant**, is a property $\mathcal{P} \subseteq \mathcal{K}(Q)$ such that for $X, Y \in \mathcal{K}(Q)$, if $X \in \mathcal{P}$ and Y is homeomorphic to X , then $Y \in \mathcal{P}$.

This easily extends to pairs as follows.

Definition 2.3.4. A **property of compact pairs** is a subset \mathcal{P} of $\mathcal{K}(Q) \times \mathcal{K}(Q)$. It is a **topological invariant**, if for every $(X, A) \in \mathcal{P}$, every copy (Y, B) of (X, A) is in \mathcal{P} .

Example 2.3.1

The set of copies of a space or a pair is a topological invariant.

Descriptive Complexity

Let us briefly clarify how the descriptive complexity of topological invariants is measured.

Every compact metrizable space embeds in the Hilbert cube $Q = [0, 1]^{\mathbb{N}}$. Therefore, such a space can be described as a compact subset of Q .

We fix a topology on $\mathcal{K}(Q)$, which is either the Vietoris or the upper Vietoris topology. The descriptive complexity of a property of compact sets $\mathcal{P} \subseteq \mathcal{K}(Q)$ in that topology is defined as follows. It is Σ_1^0 if it is open, it is Π_1^0 if it is closed, it is Σ_2^0 if it is a countable union of differences of Π_1^0 sets (equivalently, a countable union of $\underline{\Pi}_1^0$ sets when $\mathcal{K}(Q)$ is endowed with the Vietoris topology).

Effective complexity classes Π_1^0 and Σ_2^0 can be defined by requiring that the corresponding description of the set can be produced by a program (see Definitions 2.1.3 and 2.1.4 above). Specifically, $\mathcal{P} \subseteq \mathcal{K}(Q)$ is Σ_1^0 if there exists a program enumerating an infinite list of basic open sets (encoded in the obvious way) whose union is \mathcal{P} ; it is Π_1^0 if its complement is Σ_1^0 . A property \mathcal{P} is Σ_2^0 in the Vietoris topology if $\mathcal{P} = \bigcup_n \mathcal{P}_n$ where each \mathcal{P}_n is Π_1^0 , uniformly in n (i.e. there is a single program describing \mathcal{P}_n on input n); it is Σ_2^0 in the upper Vietoris topology if it is a countable union of differences which can be enumerated by a program of Π_1^0 properties.

We use the same notation for complexity classes in the Vietoris and upper Vietoris topologies and in the sequel we make it explicit which topology is used.

Example 2.3.2

It is not difficult to see that being disconnected is a Σ_2^0 invariant in the upper Vietoris topology.

2.3.1 State of the Art

Let us mention previous works on the descriptive complexity of topological invariants. Ajtai and Becker proved that path-connectedness is Π_2^1 -complete. Becker proved that for compact subsets of \mathbb{R}^2 , simply-connectedness is Π_1^1 -complete ([10, 44]). Debs and Saint-Raymond proved that connectedness is Π_1^0 , local connectedness is Π_3^0 , and gave another, independent proof that path-connectedness is Π_2^1 [25]. Lupini, Melnikov and Nies [46] and Downey, Melnikov [26] showed that the Čech cohomology groups are computable; in particular, whether the n th Čech cohomology group $\check{H}^n(X)$ is non-trivial is Σ_2^0 . The general theory of the descriptive complexity of invariants was studied by Vaught [62].

When more information on the space is available, for instance if the space is given by a finite triangulation, many topological invariants become decidable (however, note that the fundamental group of a simplicial complex is computably presentable, but its non-triviality is undecidable), and the appropriate notion of complexity is their *computational* complexity, typically their time complexity. For instance, the complexity of combinatorial invariants associated to 3-manifolds represented by triangulations was studied in [19]. For simplicial complexes, the problem of deciding whether a homology group is non-trivial was proved to be NP-hard in [1]. The complexity of certain invariants associated to simply-connected spaces represented in an algebraic way was studied in [3].

2.4 Weihrauch reducibility

The goal of this section is to recall the definition of (strong) Weihrauch reducibility, to that end, we need some definitions (see [15]).

Definition 2.4.1. Let $f, g : \subseteq X \rightrightarrows Y$ be multi-valued functions. We say that f is a **strengthening** of g and we write $f \sqsubseteq g$ if $\text{dom}(g) \subseteq \text{dom}(f)$ and for every $x \in \text{dom}(g)$, $f(x) \subseteq g(x)$.

A **represented space** (X, δ) is a set X together with a surjective partial function $\delta : \subseteq \mathbb{N}^{\mathbb{N}} \rightarrow X$.

A **problem** is a partial multi-valued function $f : \subseteq X \rightrightarrows Y$ on represented spaces X and Y . Given represented spaces (X, δ_X) , (Y, δ_Y) , a problem $f : \subseteq X \rightrightarrows Y$ and a function $F : \subseteq \mathbb{N}^{\mathbb{N}} \rightarrow \mathbb{N}^{\mathbb{N}}$. We say that F is a **realizer** of f and we write $F \vdash f$ if $\delta_Y F \sqsubseteq f \delta_X$.

Now, we give the definition of (strong) Weihrauch reducibility.

Definition 2.4.2. (Weihrauch reducibility) Let f and g be problems.

- f is **Weihrauch reducible to g** , denoted $f \leq_W g$, if there exist computable functions $K : \subseteq \mathbb{N}^{\mathbb{N}} \rightarrow \mathbb{N}^{\mathbb{N}}$ and $H : \subseteq \mathbb{N}^{\mathbb{N}} \times \mathbb{N}^{\mathbb{N}} \rightarrow \mathbb{N}^{\mathbb{N}}$ such that for every $G \vdash g$,

$$H \circ (\text{id}, G \circ K) \vdash f,$$

where $(\text{id}, G \circ K) : \mathbb{N}^{\mathbb{N}} \rightarrow \mathbb{N}^{\mathbb{N}} \times \mathbb{N}^{\mathbb{N}}$ is defined as $(\text{id}, G \circ K)(p) = (p, G(K(p)))$.

- f is **strongly Weihrauch reducible to g** , denoted $f \leq_{sW} g$, if there exist computable functions $H, K : \subseteq \mathbb{N}^{\mathbb{N}} \rightarrow \mathbb{N}^{\mathbb{N}}$ such that for every $G \vdash g$, $H \circ G \circ K \vdash f$.

Clearly strong Weihrauch reducibility implies Weihrauch reducibility.

Note that \leq_W and \leq_{sW} are preorders, i.e. they are reflexive and transitive. The corresponding equivalences are denoted by \equiv_W and \equiv_{sW} respectively and the symbols $<_W$ and $<_{sW}$ are used for strict reducibilities, respectively.

Strong Weihrauch reducibility relative to some oracle is usually denoted by \leq_{sW}^t (where t stands for *topological*).

Example 2.4.1

Let $\mathbf{1}$ denotes the Weihrauch degree of the identity $\text{id} : \mathbb{N}^{\mathbb{N}} \rightarrow \mathbb{N}^{\mathbb{N}}$. If a problem f is computable then $f \leq_W \mathbf{1}$ (it is in fact an equivalence, see [15]).

Chapter 3

Background on General and Algebraic Topology

Contents

3.1	Point-Set Topology	28
3.2	Cone and join	29
3.2.1	Cone and Cone Pair	30
	Special Symbol	30
3.2.2	Join	31
	Join of pairs	32
3.3	Homotopy and Absolute Neighborhood Retracts (ANRs)	33
3.3.1	Homotopy	33
3.3.2	Homotopy extension property	33
3.3.3	Absolute Neighborhood Retracts (ANRs)	34
3.3.4	ANRs and Homotopy	34
3.3.5	Pair vs quotient	35
3.4	Homology and Cohomology	36
3.4.1	Hopf's extension and classification theorems	37
3.5	Simplicial Complexes	38

IT turns out that the notion of computable type is very related to some notions in algebraic topology, this firstly appeared in the work of Miller (see [48]), where he proved that n -spheres have computable type using classical results about homology of the complement of n -spheres, and Iljazović's utilization of some form of Brouwer's fixed-point theorem in [38, 39]. Many of our results use different notions in algebraic topology such as homotopy and homology, that is why we need to provide a brief background about algebraic topology.

This chapter provides an overview of the foundational concepts and results in general and algebraic topology that we use, drawing upon influential textbooks in the field. "Algebraic Topology" by Allen Hatcher [30] offers a comprehensive introduction, covering homotopy theory, fundamental groups, and homology and cohomology theories. James Munkres' "Topology" provides a solid foundation in general topology, which is essential for studying algebraic topology [50]. "Topology and Geometry" by Glen E. Bredon [16] offers a comprehensive resource on algebraic topology, encompassing topics such as homotopy theory and cohomology. These textbooks serve as valuable references, equipping readers with the necessary tools to comprehend the subsequent analyses and investigations presented in the thesis.

In addition to some basics in point-set topology in Section 3.1, we include in this preliminary statements and proofs of results that are classical or folklore, but which are stated slightly differently in the literature or for which we found no reference, and therefore deserve some explanations. Section 3.2 is about the cone and join of spaces, Section 3.3 contains results about homotopy of functions Section 3.4 contains Hopf's extension and classification theorems. Finally, in Section 3.5 we recall the notion of simplicial complexes.

3.1 Point-Set Topology

In this section we recall some classical definitions in point-set topology.

Notation. Here are some notations.

- Let (X, τ) be a topological space and $A \subseteq X$ be a subset. Let $\text{cl}_\tau(A)$ be the closure of A in (X, τ) and $\text{int}_X(A)$ the interior of A in X .
- If two topological spaces X and Y are homeomorphic, we write $X \cong Y$.
- If (X, d) is a metric space, $A \subseteq X$ and $r > 0$, let $\mathcal{N}(A, r) = \mathcal{N}_r(A) = \{x \in X : d(x, A) < r\}$.

Connectedness and Dimension

Definition 3.1.1. In a topological space X , a subset A is **connected** if there is no disjoint open sets $U, V \subseteq X$ both intersecting A and such that $A \subseteq U \cup V$. A **connected component** of X is a maximal connected subset. We say that it is trivial if it is a singleton.

A topological space X has **dimension** at most n if for every open cover $(U_i)_{i \in \mathbb{N}}$ of X , there exists an open cover $(V_i)_{i \in \mathbb{N}}$ of X such that each V_i is contained in some U_j and at most $n + 1$ sets V_i 's have non-empty intersection.

Example 3.1.1

The n -dimensional sphere has dimension n .

Pointed Space, Wedge Sum and Disjoint Union

Definition 3.1.2. A **pointed topological space** is a pair (X, x_0) where X is a topological space and $x_0 \in X$ is a distinguished point.

If (X, x_0) and (Y, y_0) are pointed spaces, then their **wedge sum** is the space $X \vee Y$ obtained by attaching X and Y at their distinguished points, which are identified.

If X, Y are topological spaces, then their **disjoint union** is $X \sqcup Y$. The disjoint union topology on $X \sqcup Y$ is defined as the finest topology on $X \sqcup Y$ for which the canonical injections $X \hookrightarrow X \sqcup Y$ and $Y \hookrightarrow X \sqcup Y$ are continuous.

Note that in the case where X and Y are embedded in Q , to build disjoint copies of X and Y for instance, one can take $\{0\} \times X$ and $\{1\} \times Y$ (which are still contained in $[0, 1] \times Q \cong Q$).

Example 3.1.2

The Wedge sum of two segments which have their distinguished points in their endpoints is again a segment.

(Proper) Subpair and Function between Pairs

If (X, A) and (Y, B) are two pairs embedded in a topological space Z , then we say that (X, A) is a **subpair** of (Y, B) , or is **contained** in (Y, B) if $X \subseteq Y$ and $A \subseteq B$. We then write $(X, A) \subseteq (Y, B)$. We say that (X, A) is **strictly contained** in (Y, B) , or is a **proper subpair** of (Y, B) , if in addition $X \neq Y$ (note that A may equal B), and we write $(X, A) \subsetneq (Y, B)$.

Definition 3.1.3. If (X, A) and (Y, B) are two pairs, then a **function between pairs** $f : (X, A) \rightarrow (Y, B)$ is a function $f : X \rightarrow Y$ such that $f(A) \subseteq B$.

Example 3.1.3

Let (X, A) be a pair, every function $f : X \rightarrow X$ which is the identity on A is a function of pairs $f : (X, A) \rightarrow (X, A)$.

Quotient Space

Definition 3.1.4. Let X be a topological space, and let \sim be an equivalence relation on X . The quotient X/\sim is the set of equivalence classes of elements of X . The equivalence class of $x \in X$ is denoted $[x]$. The canonical **quotient map** is the surjection $q : x \in X \mapsto [x]$. The **quotient space** is X/\sim equipped with the quotient topology, whose open sets are the subsets $O \subseteq X/\sim$ such that $q^{-1}(O)$ is open in X . Let A be a subspace of X . The quotient space of X by A , denoted X/A , is X/\sim_A where for every $x, y \in X$, $x \sim_A y$ iff $x = y$ or $x, y \in A$.

Example 3.1.4

The quotient of the n -ball by its bounding $(n - 1)$ -sphere is the n -sphere.

Manifolds

We first recall the definition of a manifold.

Definition 3.1.5. A **manifold** of dimension n , or more concisely an n -**manifold**, is a Hausdorff space M in which each point has an open neighborhood homeomorphic to \mathbb{R}^n . An n -**manifold with boundary** is a Hausdorff space M in which each point has an open neighborhood homeomorphic either to \mathbb{R}^n or to the half-space $\mathbb{R}_+^n = \{(x_1, \dots, x_n) \in \mathbb{R}^n : x_n \geq 0\}$. The set of points which have an open neighborhood homeomorphic to the half-space is called the **boundary** of M and is denoted by ∂M .

Example 3.1.5

$(\mathbb{B}_{n+1}, \mathbb{S}_n)$ is a compact manifold with its boundary, \mathbb{S}_n , the torus and Klien bottle are closed manifolds without boundary.

3.2 Cone and join

The cone of a space and the join of two spaces are classical constructs in topology. We present their counterparts for pairs.

Definition 3.2.1. Let X be a topological space, its **cylinder** is the space $\text{Cyl}(X) = X \times [0, 1]$ endowed with the product topology.

Example 3.2.1

The cylinder of the line segment is the disk.

3.2.1 Cone and Cone Pair

Definition 3.2.2. (Cone) Let X be a topological space. The **cone** of X is the quotient of $X \times [0, 1]$ under the equivalence relation $(x, 0) \sim (x', 0)$. The **open cone** of X is the space $\text{OC}(X) = \text{C}(X) \setminus X$, where X is embedded in $\text{C}(X)$ as $X \times \{1\}$.

The equivalence class of $X \times \{0\}$ is called the **tip** of the cone. If X is embedded in Q , then a realization of $\text{C}(X)$ in $Q \cong [0, 1] \times Q$ is given by

$$\text{C}(X) \cong \{(t, tx) : t \in [0, 1], x \in X\}.$$

Definition 3.2.3. (Cone pair) Let (X, A) be a pair. Its **cone pair** is the pair $\text{C}(X, A) = (\text{C}(X), X \cup \text{C}(A))$. Its **open cone pair** is the pair $\text{OC}(X, A) = (\text{OC}(X), \text{OC}(A))$.

In particular,

$$\begin{aligned} \text{C}(L, \emptyset) &= (\text{C}(L), L) \\ \text{OC}(L, \emptyset) &= (\text{OC}(L), \emptyset). \end{aligned}$$

Special Symbol

We introduce a symbol \odot , which will be treated as a space but is purely formal. It enables to consider a singleton as a cone and is a unit for the join (see Section 3.2.2). It can be thought as the boundary of the singleton, as in the definition of reduced homology. It is analogous to the empty simplicial complex $\{\emptyset\}$, which behaves differently from the void complex \emptyset .

Definition 3.2.4. We define

$$\text{C}(\odot) = \text{OC}(\odot) = \{0\} \tag{3.1}$$

where the point 0 is thought as the tip of a degenerate cone. We take the convention that $\mathbb{S}_{-1} = \odot$.

Example 3.2.2

Let $n \in \mathbb{N}$. One has

$$\begin{aligned} \text{C}(\mathbb{S}_n, \emptyset) &\cong (\mathbb{B}_{n+1}, \mathbb{S}_n), \\ \text{C}(\mathbb{B}_n, \mathbb{S}_{n-1}) &\cong (\mathbb{B}_{n+1}, \mathbb{S}_n), \end{aligned}$$

with the tip at the center of \mathbb{B}_{n+1} and in \mathbb{S}_n respectively. Note that the particular case $n = 0$ is consistent with the convention $\mathbb{S}_{-1} = \odot$.

3.2.2 Join

Definition 3.2.5. If X, Y are topological spaces, then their **join** $X * Y$ is the quotient of $X \times Y \times [0, 1]$ under the equivalence relation $(x, y, 0) \sim (x, y', 0)$ and $(x, y, 1) \sim (x', y, 1)$.

Example 3.2.3

The join of two disjoint points is an interval. The join of a point and an interval is a triangle.

Remark 3.2.1

In the literature, a convention is to let \emptyset be a unit for the join, i.e. to define $X * \emptyset$ as X . Definition 3.2.5 rather makes \emptyset an absorbing element, the unit element will be \odot :

$$\begin{aligned} X * \emptyset &= \emptyset * X = \emptyset, \\ X * \odot &= \odot * X = X. \end{aligned}$$

If X and Y are embedded in Q , then $X * Y$ can be realized as

$$X * Y \cong \{(t, (1-t)x, ty) : t \in [0, 1], x \in X, y \in Y\}.$$

We also realize $X * \odot \cong \{(0, x, 0) : x \in X\}$ and $\odot * Y \cong \{(1, 0, y) : y \in Y\}$.

The cone and join constructs are intimately related: $C(X) = X * \{0\}$. It is proved in Brown [17] (Corollary 5.7.4, §5.7, p. 196) that a product of cones is a cone. More precisely, let X, Y be compact metrizable spaces. There is a homeomorphism

$$C(X * Y) \rightarrow C(X) \times C(Y)$$

which restricts to a homeomorphism

$$X * Y \rightarrow (C(X) \times Y) \cup (X \times C(Y)).$$

We will use the following consequences:

Proposition 3.2.1

Let X, Y be compact metrizable spaces, or \odot . One has

$$\begin{aligned} C(X) \times C(Y) &\cong C(X * Y) \\ OC(X) \times OC(Y) &\cong OC(X * Y). \end{aligned}$$

Proof. The first equality is Corollary 5.7.4 in [17] for the general case. We need to check the particular cases when Y is \emptyset or \odot . One has $C(X) \times C(\emptyset) = \emptyset = C(X * \emptyset)$ and $C(X) \times C(\odot) = C(X) \times \{0\} = C(X * \odot)$, and the symmetric cases are similar. The second equality can be proved as follows for $X, Y \neq \odot$,

$$\begin{aligned} OC(X) \times OC(Y) &= (C(X) \setminus X) \times (C(Y) \setminus Y) \\ &= (C(X) \times C(Y)) \setminus ((C(X) \times Y) \cup (X \times C(Y))) \\ &\cong C(X * Y) \setminus (X * Y) \\ &= OC(X * Y), \end{aligned}$$

and when $Y = \odot$, $OC(X) \times OC(\odot) \cong OC(X) = OC(X * \odot)$. □

Join of pairs

The previous result extends to cone pairs. Note that in all the pairs (X, A) and (Y, B) that we consider, X and Y are never \emptyset or \odot .

Definition 3.2.6. The **join** of two pairs (X, A) and (Y, B) is

$$(X, A) * (Y, B) = (X * Y, X * B \cup A * Y).$$

Example 3.2.4

Let (I, p) be a segment and one of its endpoints, one has $(I, p) * (I, p) = (I * I, I * p \cup p * I)$ which is topologically a tetrahedron with its base.

The cone pair is a particular case of the join of pairs:

$$\begin{aligned} (X, A) * (\{0\}, \odot) &= (\mathbf{C}(X), X \cup \mathbf{C}(A)) \\ &= \mathbf{C}(X, A), \\ (X, \emptyset) * (\{0\}, \odot) &= (\mathbf{C}(X), X) \\ &= \mathbf{C}(X, \emptyset). \end{aligned}$$

Proposition 3.2.2

A product of (open) cone pairs is a (open) cone pair:

$$\begin{aligned} \mathbf{C}(X, A) \times \mathbf{C}(Y, B) &\cong \mathbf{C}((X, A) * (Y, B)) \\ \mathbf{OC}(X, A) \times \mathbf{OC}(Y, B) &\cong \mathbf{OC}((X, A) * (Y, B)). \end{aligned}$$

Proof. The first component of $\mathbf{C}(X, A) \times \mathbf{C}(Y, B)$ is $\mathbf{C}(X) \times \mathbf{C}(Y) = \mathbf{C}(X * Y)$ by Proposition 3.2.1. Its second component is

$$\begin{aligned} &(\mathbf{C}(X) \times (Y \cup \mathbf{C}(B))) \cup ((X \cup \mathbf{C}(A)) \times \mathbf{C}(Y)) \\ &= (\mathbf{C}(X) \times Y) \cup (X \times \mathbf{C}(Y)) \cup (\mathbf{C}(X) \times \mathbf{C}(B)) \cup (\mathbf{C}(A) \times \mathbf{C}(Y)) \\ &\cong (X * Y) \cup \mathbf{C}(X * B) \cup \mathbf{C}(A * Y) \\ &\cong (X * Y) \cup \mathbf{C}(X * B \cup A * Y). \end{aligned}$$

The first component of $\mathbf{OC}(X, A) \times \mathbf{OC}(Y, B)$ is $\mathbf{OC}(X) \times \mathbf{OC}(Y) \cong \mathbf{OC}(L)$ by Proposition 3.2.1. Its second component is

$$\begin{aligned} &(\mathbf{OC}(X) \times \mathbf{OC}(B)) \cup (\mathbf{OC}(A) \times \mathbf{OC}(Y)) \cong \mathbf{OC}(X * B) \cup \mathbf{OC}(A * Y) \\ &\cong \mathbf{OC}(X * B \cup A * Y). \end{aligned}$$

□

3.3 Homotopy and Absolute Neighborhood Retracts (ANRs)

3.3.1 Homotopy

Definition 3.3.1. A **homotopy** between two continuous functions $f, g : X \rightarrow Y$ is a continuous function $H : [0, 1] \times X \rightarrow Y$ such that $H(0, x) = f(x)$ and $H(1, x) = g(x)$ for all $x \in X$. Two functions are **homotopic** if there exist a homotopy between them. A function is **null-homotopic** if it is homotopic to a constant function.

A homotopy $H : [0, 1] \times X \rightarrow Y$ can be seen as a family of continuous functions $h_t : X \rightarrow Y$ where $t \in [0, 1]$ and $(t, x) \mapsto h_t(x)$ is continuous, by taking $h_t(x) = H(t, x)$.

Example 3.3.1

The identity from a ball to itself is null-homotopic.

A function $f : Y \rightarrow Z$ is null-homotopic if and only if it can be extended to a continuous function $\tilde{f} : C(Y) \rightarrow Z$, where Y is embedded in $C(Y)$ as $Y \times \{1\}$.

Homotopy between functions is an equivalence relation, if X, Y are topological spaces and $f : X \rightarrow Y$ is continuous, then we denote by $[f]$ the **homotopy class** of f . Let $[X; Y]$ be the set of homotopy classes of continuous functions from X to Y .

3.3.2 Homotopy extension property

Let us recall an important property of pairs.

Definition 3.3.2. A pair (X, A) has the **homotopy extension property** if for every topological space Y , for every continuous function $f : X \rightarrow Y$ and every homotopy $h_t : A \rightarrow Y$ such that $h_0 = f|_A$, there exists a homotopy $H_t : X \rightarrow Y$ such that $H_0 = f$ and $H_t|_A = h_t$.

Example 3.3.2

For every $n \in \mathbb{N}$, the pair $(\mathbb{B}_{n+1}, \mathbb{S}_n)$ has the homotopy extension property.

Definition 3.3.3. Let (X, A) be a pair. A **retraction** $r : X \rightarrow A$ is a continuous function such that $r|_A = \text{id}_A$. If a retraction exists, then we say that A is a **retract** of X .

It is well-known that a pair (X, A) has the homotopy extension property if and only if $X \times [0, 1]$ retracts to $(X \times \{0\}) \cup (A \times [0, 1])$ (see Hatcher [30], Proposition A.18, p. 533). If (X, A) is a CW pair, then it has the homotopy extension property (see Hatcher [30], Proposition 0.16, p. 15).

Definition 3.3.4. Let X be a topological space and (Y, d) a metric space. For $\epsilon > 0$, an **ϵ -homotopy** is a homotopy function $h_t : X \rightarrow Y$ such that $d(h_t(x), h_0(x)) < \epsilon$ for all x, t .

The homotopy extension property actually implies a controlled version.

Lemma 3.3.1

Let (X, A) be a pair satisfying the homotopy extension property. If (Y, d) is a metric space, $f : X \rightarrow Y$ is continuous, $h_t : A \rightarrow Y$ is an ϵ -homotopy such that $h_0 = f|_A$, then there exists an ϵ -homotopy $H_t : X \rightarrow Y$ such that $H_0 = f$ and $H_t|_A = h_t$.

A similar result with a similar proof holds for arbitrary compact pairs (X, A) when Y is an ANR (Theorem 4.1.3, p. 265 in [61]).

Proof. As (X, A) has the homotopy extension property, there exists a retraction $r : X \times [0, 1] \rightarrow (X \times \{0\}) \cup (A \times [0, 1])$ and a homotopy $H_t : X \rightarrow Y$ extending H_0 and h_t . We define a retraction $r' : X \times [0, 1] \rightarrow (X \times \{0\}) \cup (A \times [0, 1])$ so that $H'_t(x) = H \circ r'(x, t)$ is an ϵ -homotopy.

Let $U = \{x \in X : \forall t \in [0, 1], d(H_t(x), H_0(x)) < \epsilon\}$. As $[0, 1]$ is compact, U is an open set. Moreover, U contains A . Let $\delta : X \rightarrow [0, 1]$ be a continuous function such that $\delta(x) = 1$ for $x \in A$ and $\delta(x) = 0$ for $x \in X \setminus U$. We define r' as follows:

$$r'(x, t) = r(x, t\delta(x)).$$

First, r' is a retraction: $r'(x, 0) = r(x, 0) = (x, 0)$ and for $x \in A$, $r'(x, t) = r(x, t) = (x, t)$. Therefore, H' is a homotopy extending H_0 and h_t . We claim that H' is an ϵ -homotopy, which means that $d(H'_t(x), H_0(x)) < \epsilon$. If $x \notin U$, then $H \circ r'(x, t) = H \circ r(x, 0) = H(x, 0) = H_0(x)$. If $x \in U$, then $H \circ r'(x, t) = H \circ r(x, t\delta(x))$ is ϵ -close to $H_0(x)$. \square

3.3.3 Absolute Neighborhood Retracts (ANRs)

We recall the definition of Absolute Neighborhood Retracts (ANRs).

This important notion was introduced by Borsuk [13] and plays an eminent role in algebraic topology. They have many interesting properties that we will use in our proofs. Moreover, it has very useful computability-theoretic consequences, which we will take advantage of.

Definition 3.3.5. Let X be a Hausdorff compact space.

1. X is an **absolute retract (AR)** if every copy of X in Q is a retract of Q ,
2. X is an **absolute neighborhood retract (ANR)** if every (equivalently, some) copy X' of X in Q is a retract of a neighborhood of X' .

Fact 3.3.1

We recall some classical facts (see [29] and [61]).

1. The n -dimensional ball is an AR,
2. The n -dimensional sphere is an ANR,
3. If Y is an AR and (X, A) is a pair, then every continuous function $f : A \rightarrow Y$ has a continuous extension $F : X \rightarrow Y$,
4. If Y is an ANR and (X, A) is a pair, then every continuous function $f : A \rightarrow Y$ has a continuous extension $F : U \rightarrow Y$ where $U \subseteq X$ is a neighborhood of A .

The topologist's sine curve, or the set $\{0\} \cup \{1/n : n \in \mathbb{N}\}$ are examples of spaces that are not ANRs.

3.3.4 ANRs and Homotopy

ANRs interact nicely with the notion of homotopy.

If two functions to a compact ANR are close to each other, then they are homotopic (Theorem 4.1.1 in [60]).

Lemma 3.3.2

Let $Y \subseteq Q$ be a compact ANR. There exists $\alpha > 0$ such that for every space X , if $f, g : X \rightarrow Y$

are continuous and $d_X(f, g) < \alpha$, then f, g are homotopic.

Whether a function to an ANR has a continuous extension only depends on the homotopy class of the function. This is Borsuk's homotopy extension theorem (Theorem 1.4.2 in [60] or Theorem V.3.1 in [14]).

Theorem 3.3.1. (Borsuk's homotopy extension theorem) Let Y be an ANR and (X, A) be a pair. If $f, g : A \rightarrow Y$ are continuous and f has a continuous extension $F : X \rightarrow Y$, then every homotopy between f and g can be extended to a homotopy between F and some continuous extension $G : X \rightarrow Y$ of g .

The next lemma is an application of Borsuk's homotopy extension theorem (see Exercise 4.1.5 in [60]).

Lemma 3.3.3

Let Y be a compact metric ANR. For every $\epsilon > 0$ there exists $\delta > 0$ such that for all pairs (X, A) and all continuous functions $f, g : A \rightarrow Y$ with $d_A(f, g) < \delta$, if f has a continuous extension $F : X \rightarrow Y$ then g has a continuous extension $G : X \rightarrow Y$ such that $d_X(F, G) < \epsilon$.

The following result is Theorem 4.1.1 in [61].

Lemma 3.3.4

Let Y be a compact metric ANR. For every $\epsilon > 0$ there exists $\delta > 0$ such that for all spaces X , all continuous functions $f, g : X \rightarrow Y$ satisfying $d_X(f, g) < \delta$ are ϵ -homotopic.

The next theorem is a direct consequence of the main result in [67].

Theorem 3.3.2. If X and $A \subseteq X$ are compact ANRs, then (X, A) has the homotopy extension property and X/A is an ANR.

3.3.5 Pair vs quotient

In many cases, a pair (X, A) can be equivalently replaced by the quotient space X/A . The following proposition is an instance of this fact, and is a combination of Proposition 4A.2 and Example 4A.3 in [30].

Let (X, A) be a pair. There is a one-to-one correspondence between the continuous functions $f : X \rightarrow \mathbb{S}_n$ that are constant on A and the continuous functions $g : X/A \rightarrow \mathbb{S}_n$. If $f : X \rightarrow \mathbb{S}_n$ is constant on A then we denote by $\tilde{f} : X/A \rightarrow \mathbb{S}_n$ the function satisfying $f = \tilde{f} \circ q$, where $q : X \rightarrow X/A$ is the quotient map.

Proposition 3.3.1

Let $n \geq 1$ and let s be a distinguished point of \mathbb{S}_n . A function of pairs $f : (X, A) \rightarrow (\mathbb{S}_n, s)$ is null-homotopic if and only if $\tilde{f} : X/A \rightarrow \mathbb{S}_n$ is null-homotopic.

Proof. Let p be the equivalence class of A in X/A . Note that \tilde{f} can also be seen as a function of pairs $\tilde{f}_2 : (X/A, p) \rightarrow (\mathbb{S}_n, s)$, which we denote differently to avoid confusions. The null-homotopy of f is easily equivalent to the null-homotopy of \tilde{f}_2 , inducing a null-homotopy of \tilde{f} . We need to show that a null-homotopy of \tilde{f} (a function between sets) implies a null-homotopy of \tilde{f}_2 (a function between pairs).

Let $h_t : X/A \rightarrow \mathbb{S}_n$ be a homotopy from $h_0 = \tilde{f}$ to a constant function h_1 . We use a different argument for $n = 1$ and for $n \neq 1$.

Assume that $n = 1$. The circle \mathbb{S}_1 can be seen as the additive group \mathbb{R}/\mathbb{Z} with s as the 0 element. Let $g_t : (X/A, p) \rightarrow (\mathbb{S}_1, s)$ be defined by $g_t(x) = h_t(x) - h_t(p) + h_0(p)$. One easily checks that $g_0 = h_0 = \tilde{f}$, $g_t(p) = h_0(p) = s$ for all t and $g_1(x) = s$ for all x , so g_t is a null-homotopy of \tilde{f}_2 .

Assume that $n \neq 1$. Let $Y = [0, 1] \times (X/A)$ and $B = (\{0, 1\} \times X/A) \cup ([0, 1] \times \{p\}) \subseteq Y$. The null-homotopy h_t is a function $h : Y \rightarrow \mathbb{S}_n$. Let $g : B \rightarrow \mathbb{S}_n$ be the continuous function defined by

$$g(t, x) = \begin{cases} \tilde{f}(x) & \text{if } t = 0, \\ s & \text{otherwise.} \end{cases}$$

A null-homotopy of \tilde{f}_2 is a continuous extension $G : Y \rightarrow \mathbb{S}_n$ of g . In order to show that such an extension exists, it is sufficient to show that g is homotopic to the restriction of h to B , by applying Borsuk's homotopy extension theorem (Theorem 1.4.2, p. 38 in [61]) and the fact that \mathbb{S}_n is an ANR.

So let us define a homotopy $k_t : B \rightarrow \mathbb{S}_n$ from $k_0 = g$ to $k_1 = h|_B$. We decompose B as $B_0 \cup B_1$, where $B_0 = \{0, 1\} \times X/A$ and $B_1 = [0, 1] \times \{p\}$. On B_0 , g and h coincide, and we define $k_t(z) = g(z) = h(z)$ for all t and all $z \in B_0$. On B_1 , g has constant value s and the restriction of h to B_1 is a loop from s to itself. As \mathbb{S}_n is simply connected, that loop is contractible, i.e. there exists a homotopy from $g|_{B_1}$ to $h|_{B_1}$, and we define $k_t|_{B_1}$ as this homotopy.

The homotopy $k_t : B \rightarrow \mathbb{S}_n$ is well-defined because it is consistent on $B_0 \cap B_1 = \{0, 1\} \times \{p\}$, where $k_t(0, p) = k_t(1, p) = s$. Therefore, k_t is continuous and is a homotopy from g to $h|_B$. It can be extended to a homotopy from some extension of g to h , because \mathbb{S}_n is an ANR. The extension of g is a null-homotopy of \tilde{f}_2 . \square

3.4 Homology and Cohomology

We do not define homology and cohomology groups, but just recall the notations and some classical results. We refer to standard textbooks on algebraic topology for complete expositions of the concepts [36, 16, 30]. This section is not essential and may be skipped by the reader who is unfamiliar with algebraic topology.

If X is a topological space, G an abelian group and $n \in \mathbb{N}$, one can define the **homology groups** $H_n(X; G)$ and the **cohomology groups** $H^n(X; G)$, which are abelian groups. They are topological invariants that, informally, detect the n -dimensional holes of the space X .

Example 3.4.1

When X is the m -dimensional sphere \mathbb{S}_m , one has

$$H_n(\mathbb{S}_m; G) \cong H^n(\mathbb{S}_m; G) \cong \begin{cases} G & \text{if } n = m \text{ or } n = 0, \\ 0 & \text{otherwise,} \end{cases}$$

where 0 is the trivial group with one element.

These groups are also called the **singular** homology and cohomology groups, to distinguish them from the groups from other homology and cohomology theories, such as the **Čech** homology and cohomology groups, denoted by $\check{H}_n(X; G)$ and $\check{H}^n(X; G)$ respectively. However, these different theories are equivalent for ANRs (Theorem 1 in [47]).

Theorem 3.4.1. If X is an ANR, then for all G and n ,

$$\begin{aligned} H_n(X; G) &\cong \check{H}_n(X; G), \\ H^n(X; G) &\cong \check{H}^n(X; G). \end{aligned}$$

The result applies to compact manifolds with and without boundary, which are ANRs (Corollary A.9 in [30]).

3.4.1 Hopf's extension and classification theorems

We recall two classical results: Hopf's extension and classification theorem. They are usually expressed in terms of cohomology. The following statements using homology can be found in Hurewicz-Wallman [36]. They are stated in terms of Čech homology for compact spaces in [36]. We state them for compact ANRs using singular homology, which is equivalent to Čech homology for these spaces.

Hopf's extension theorem is Theorem VIII.1' in [36] (§VIII.6, p. 147). Let $\mathbb{T} = \mathbb{R}/\mathbb{Z}$ be the circle group.

Theorem 3.4.2. Let $n \in \mathbb{N}$. Let (X, A) be a compact pair, where X and A are ANRs and $\dim(X) \leq n + 1$. For a continuous function $f : A \rightarrow \mathbb{S}_n$, the following statements are equivalent:

- f has a continuous extension $F : X \rightarrow \mathbb{S}_n$,
- $\ker i_* \subseteq \ker f_*$,

where $i : A \rightarrow X$ is the inclusion map and

$$\begin{aligned} i_* &: H_n(A; \mathbb{T}) \rightarrow H_n(X; \mathbb{T}) \\ f_* &: H_n(A; \mathbb{T}) \rightarrow H_n(\mathbb{S}_n; \mathbb{T}) \end{aligned}$$

are the homomorphisms induced by i and f .

The equivalence holds for $n = 0$ or 1 , without any dimension assumption about X .

For $n = 0$, Theorem 3.4.2 also holds when considering homomorphisms between *reduced* homology groups $\tilde{H}_0(\cdot; \mathbb{T})$.

We present the argument for the particular case $n = 0$ or 1 , which is not stated in [36] but follows from the proof.

Proof. Assume that $n \leq 1$. We only need to prove the result for CW-pairs (X, A) , because a pair of compact ANRs is homotopy equivalent to a CW-pair. We assume that $\ker i_* \subseteq \ker f_*$ and prove that f has an extension. From Hopf's extension theorem for spaces of dimension at most $n + 1$, f has an extension to the $n + 1$ -skeleton of X . For $k \geq n + 1$, every function from \mathbb{S}_k to \mathbb{S}_n is null-homotopic (because $n = 0$ or 1), so f can be inductively extended to every cell of X . \square

Theorem 3.4.3. Let $n \in \mathbb{N}$. Let (X, A) be a compact pair, where X and A are ANRs and $\dim(X) \leq n$. For a continuous function $f : (X, A) \rightarrow (\mathbb{S}_n, s)$, the following statements are equivalent:

- f is null-homotopic (as a function of pairs),
- $f_* : \tilde{H}_n(X, A; \mathbb{T}) \rightarrow \tilde{H}_n(\mathbb{S}_n, s; \mathbb{T})$ is trivial.

The equivalence holds for $n \leq 1$, without any dimension assumption about X .

When $n = 0$ and $A = \emptyset$, and only in that case, one indeed needs to consider the homomorphism between reduced homology groups.

Proof. This result is usually stated in terms of cohomology, and for single spaces rather than pairs (for instance, Theorem VIII.2, §VIII.6, p. 149 in [36]). It can be derived from Theorem 3.4.2 as follows. Let $g : X \cup C(A) \rightarrow \mathbb{S}_n$ be defined as $g = f$ on X and $g = s$ on $C(A)$. A null-homotopy of f is a function $G : C(X) \rightarrow \mathbb{S}_n$ extending g . The pair $(C(X), X \cup C(A))$ satisfies all the conditions of Hopf's extension theorem, so g has extension if and only if $\ker i_* \subseteq \ker g_*$. As $C(X)$ is contractible, its reduced homology groups are trivial so $\ker i_*$ is the whole group $\tilde{H}_n(X \cup C(A); \mathbb{T})$; therefore, g has an extension iff $g_* : \tilde{H}_n(X \cup C(A); \mathbb{T}) \rightarrow \tilde{H}_n(\mathbb{S}_n; \mathbb{T})$ is trivial. Up to natural isomorphisms, f_* is g_* . \square

3.5 Simplicial Complexes

Definition 3.5.1. Let $V = \{0, \dots, n\}$ and $P_+(V)$ be the set of non-empty subsets of V . An **abstract finite simplicial complex** is a set $S \subseteq P_+(V)$ such that if $\sigma \in S$ and $\emptyset \neq \sigma' \subset \sigma$, then $\sigma' \in S$. Its elements $\sigma \in S$ are called the **simplices** of S . If $\sigma \in S$ has $n + 1$ elements, then σ is an **n -simplex**. The **vertices** of S are the singletons $\{i\} \in S$. $\sigma \in S$ is **free** if there exists exactly one $\sigma' \in S$ with $\sigma \subsetneq \sigma'$. A **subcomplex** of S is an abstract simplicial complex contained in S .

The **support** of a vector $x = (x_0, \dots, x_n) \in [0, 1]^{n+1}$ is $\text{supp}(x) = \{i : x_i \neq 0\}$. The **standard realization** of an abstract simplicial complex S is the set

$$|S| = \left\{ x = (x_0, \dots, x_n) \in [0, 1]^{n+1} : \sum_i x_i = 1, \text{supp}(x) \in S \right\}.$$

We say that a simplex σ in S is **maximal** if it is not contained in a higher-dimensional simplex of S .

Definition 3.5.2. Any space homeomorphic to the standard realization of an abstract finite simplicial complex is called a **finite simplicial complex**. We often identify an abstract simplicial complex and its standard realization.

A **finite simplicial pair** (X, A) consists of a finite simplicial complex X and a subcomplex A .

Example 3.5.1

For every $n \in \mathbb{N}$, $(\mathbb{B}_{n+1}, \mathbb{S}_n)$ is a finite simplicial pair.

In a finite simplicial complex, each vertex has a neighborhood which is usually called a star and is topologically a cone.

3. Background on General and Algebraic Topology

Indeed, let (X, A) be the standard realization of a finite simplicial pair and $v_i = (0, \dots, 0, 1, 0, \dots, 0)$ be a vertex. A topological cone which is a neighborhood of v_i can be of the form (K_i, M_i) such that:

$$\begin{aligned}K_i &= \{x \in X : x_i \geq 1/2\}, \\M_i &= \{x \in X : x_i = 1/2\} \cup (K_i \cap A),\end{aligned}$$

note that the coefficient $1/2$ is arbitrary and could be replaced by any number in $(0, 1)$. K is a topological cone: let $L_i = \{x \in X : x_i = 1/2\}$, K_i is a copy of the cone of L_i , obtained from $L_i \times [0, 1]$ by identifying all the points $(l, 0)$ together. The point obtained by this identification is the tip of the cone and corresponds to the vertex v_i . If $N_i = \{x \in A : x_i = 1/2\}$, then M_i is the union of L_i and of the cone of N_i .

In the language of simplicial complexes, K_i corresponds to the *star* of v_i and L_i to the *link* of v_i . K_i is homeomorphic to the union of simplices containing v_i . Each such simplex has a face that does not contain v_i , and L_i is the union of these faces.

Part II

Main contributions

Chapter 4

Strong Computable Type

Contents

4.1	Introduction	43
4.2	Computable Type and the Hilbert Cube	44
4.3	Strong Computable Type	46
4.3.1	Definition	46
4.3.2	A First Characterization	47
4.3.3	A Characterization using Invariants	49
4.4	Strong Computable Type: Further Properties	52
4.4.1	Product and Cone of Pairs	52
4.4.2	A Topological Necessary Condition	53
4.4.3	The ϵ -Surjection Property	54
4.4.4	Uniformity	56
4.4.5	Discussion: Vietoris vs Upper Vietoris Topology	57
4.5	Failing to have Computable Type	58
4.5.1	Computable Witnesses	58
	Comparing Computability in Three Topologies	58
	Application to Computable Type	59
4.5.2	Simple copies	61
4.5.3	An Example	63
4.6	Conclusion	64

The results stated in this chapter can be found in [8, 6].

4.1 Introduction

THE objective of this chapter is to establish a structural understanding of the notion of computable type (and not to present new examples), with several goals in mind. Given the technical and challenging nature of establishing whether a space has computable type, there is a need for unified and simplified arguments for previous results, as well as general tools that can be applied to establish new results more effortlessly.

Our overarching aim is to emphasize the interplay between topology and computability that underlies the concept of computable type. The definition of computable type combines ideas from both topology and computability theory, and the arguments employed draw inspiration from these

two fields. It would be illuminating to break down the arguments into two parts: a purely topological component and a computability-theoretic component.

Since computable type is inherently a topological invariant, it is crucial to explore its precise relationship with other topological invariants. A clearer connection with topology would allow for leveraging the extensive field of topology, particularly algebraic topology, in the investigation of computability-theoretic problems. Notably, the main results concerning computable type rely on classical topological results, such as Miller’s utilization of the homology of the complement of the sphere in [48], and Iljazović’s utilization of some form of Brouwer’s fixed-point theorem in [38, 39].

A deeper theoretical understanding of computable type has far-reaching consequences. It can provide additional insights into previous results, facilitate the derivation of new results with minimal effort, and shed light on the role of specific assumptions in the outcomes.

The chapter is organized as follows. In Section 4.2 we prove that some of the variations of computable type introduced in the literature are actually equivalent. In Section 4.3 we introduce the notion of strong computable type and develop the theory. We obtain characterizations using descriptive set theory on the hyperspace of compact subsets of the Hilbert cube. In Section 4.4 we exploit these characterizations and obtain several results that improve our understanding of strong computable type. In Section 4.5, we finish by studying how some spaces fail to have computable type.

4.2 Computable Type and the Hilbert Cube

In this section, we establish that the distinction between computable type on computable metric spaces and computably Hausdorff spaces is unnecessary, as these two notions are actually equivalent. Furthermore, we demonstrate that it suffices to consider the Hilbert cube alone, as defined in Definition 2.2.2. As a result, there is no longer a need to differentiate between these definitions, and the results pertaining to computable type on computable metric spaces seamlessly extend to computably Hausdorff spaces. For instance, the findings in [37, 39] readily imply the results presented in [23, 42]).

Theorem 4.2.1. For a compact pair (X, A) , the following statements are equivalent:

1. (X, A) has computable type (on the Hilbert cube),
2. (X, A) has computable type on computable metric spaces,
3. (X, A) has computable type on computably Hausdorff spaces.

We now proceed with the proof of Theorem 4.2.1. The implications $3. \Rightarrow 2. \Rightarrow 1.$ are straightforward, we only need to prove $1. \Rightarrow 3.$ The idea is that a compact subspace of a Hausdorff space is metrizable, so embedding a compact set in a Hausdorff space implicitly induces an embedding in a metric space. We need to make this argument effective. We will use Schröder’s effective version of Urysohn metrization theorem [53], so we need to introduce the computable version of regular spaces.

Definition 4.2.1. An effective countably-based T_0 -space (X, τ) is **computably regular** if there is a computable procedure associating to each basic open set B_n a sequence of effective open sets $(U_k)_{k \in \mathbb{N}}$ and a sequence of effective closed sets $(F_k)_{k \in \mathbb{N}}$ such that $U_k \subseteq F_k \subseteq B_n$ and $B_n = \bigcup_k U_k$.

Proposition 4.2.1

Let (X, τ) be an effective countably-based T_0 -space. If (X, τ) is effectively compact and computably Hausdorff, then it is computably regular.

Proof. Let $\mathcal{D} \subseteq \mathbb{N}^2$ witness that the space is computably Hausdorff. Let $n \in \mathbb{N}$. The set $K = X \setminus B_n$ is effectively compact, so one can compute an enumeration $(L_k)_{k \in \mathbb{N}}$ of all the finite sets $L \subseteq \mathcal{D}$ such that $K \subseteq \bigcup_{(i,j) \in L} B_j$. To each such L_k associate the pair (U_k, F_k) defined by

$$U_k = \bigcap_{(i,j) \in L_k} B_i$$

$$F_k = X \setminus \bigcup_{(i,j) \in L_k} B_j.$$

By construction, U_k and F_k are uniformly effectively open and closed respectively.

Next, U_k is contained in F_k because B_i is disjoint from B_j for all $(i, j) \in L_k \subseteq \mathcal{D}$. As $X \setminus B_n \subseteq \bigcup_{(i,j) \in L_k} B_j$, one has $F_k = X \setminus \bigcup_{(i,j) \in L_k} B_j \subseteq B_n$.

Finally, we show that $B_n = \bigcup_k U_k$. Let $x \in B_n$. As $x \notin K$, the compact set $\{x\} \times K$ is contained in $\bigcup_{(i,j) \in \mathcal{D}} B_i \times B_j$, so there exists a finite set $L \subseteq \mathcal{D}$ such that $\{x\} \times K \subseteq \bigcup_{(i,j) \in L} B_i \times B_j$. This inclusion is still satisfied if one removes from L the pairs (i, j) such that $x \notin B_i$. Let $L' \subseteq L$ be the result of this operation. There exists k such that $L' = L_k$, and $x \in U_k$. \square

Schröder proved the following effective Urysohn metrization theorem (Theorem 6.1 in [53]): every computably regular space X admits a computable metric, i.e. a computable function $d : X \times X \rightarrow \mathbb{R}$ which is a metric that induces the topology of the space (note that it does not mean that X is a computable metric space, because it may not contain a dense computable sequence). The proof of that result implies the next lemma.

Lemma 4.2.1

If (X, τ) is a computably regular space, then there exists a computable injection $h : X \rightarrow Q$.

Proof. The proof of Theorem 6.1 in [53] consists in building a computable sequence of functions $g_i : X \rightarrow [0, 1]$ that separates points, i.e. such that for all $x, y \in X$ with $x \neq y$, $g_i(x) \neq g_i(y)$ for some $i \in \mathbb{N}$. The metric d is then defined as $d(x, y) = \sum_i 2^{-i} |g_i(x) - g_i(y)|$. In our case, we simply define $h(x) = (g_i(x))_{i \in \mathbb{N}}$. \square

Corollary 4.2.1. If K is a semicomputable compact set in a computably Hausdorff space (X, τ) , then there exists a computable embedding $h : K \rightarrow Q$. Its inverse is necessarily computable by Proposition 2.1.2.

Proof. Consider the subspace (K, τ_K) with the induced topology $\tau_K = \{U \cap K : U \in \tau\}$. Because it is a subspace of a computably Hausdorff space, it is computably Hausdorff as well. As K is semicomputable, as a set, it is effectively compact as a space. Therefore, Proposition 4.2.1 implies that (K, τ_K) is computably regular. By Lemma 4.2.1, there exists a computable injection $h : K \rightarrow Q$. \square

Now, we prove our theorem.

Proof of Theorem 4.2.1. We prove 1. \Rightarrow 3. If (K, L) is a compact pair that has computable type (on the Hilbert cube), (X, τ) is a computably Hausdorff space and $f : K \rightarrow X$ is an embedding such that $f(K)$ and $f(L)$ are semicomputable compact sets, then by Corollary 4.2.1, there exists a computable embedding $h : f(K) \rightarrow Q$ such that h^{-1} is computable. Hence, $h \circ f : K \rightarrow Q$ is an embedding such that $h \circ f(K)$ and $h \circ f(L)$ are semicomputable compact sets. As (K, L) has

computable type, the compact set $h \circ f(K)$ is computable. The compact set $f(K)$ is the image of the computable compact set $h \circ f(K)$ by the computable function h^{-1} , so $f(K)$ is a computable compact set. As a result, (K, L) has computable type on computably Hausdorff spaces. \square

4.3 Strong Computable Type

The notion of computable type encounters a significant limitation: if a compact metrizable space does not possess a semicomputable copy within the Hilbert cube, it automatically has computable type without any substantial justification. Since there are only countably many semicomputable sets, the majority of compact metrizable spaces have computable type in a rather trivial manner. Consequently, the prospect of deriving meaningful characterizations for this notion becomes dim.

To overcome this issue, we introduce a more robust and powerful concept: computable type relative to any oracle. This refined definition resolves the aforementioned drawback and offers the advantage of facilitating topological analysis, particularly concerning the topologies applied to the hyperspace $\mathcal{K}(Q)$ comprising compact subsets of Q . These topological considerations enable us to attain valuable characterizations from a topological perspective.

4.3.1 Definition

We first define the notion of strong computable type, which is a simple relativization of Definition 2.2.2.

Definition 4.3.1. A compact metrizable space X has **strong computable type** if for every oracle O and every copy Y of X in the Hilbert cube, if Y is semicomputable relative to O , then Y is computable relative to O .

A compact pair (X, A) has **strong computable type** if for every oracle O and every copy (Y, B) of (X, A) in Q , if (Y, B) is semicomputable relative to O , then Y is computable relative to O .

Remark 4.3.1

All the spaces which were proved to have computable type in the literature [48, 37, 38, 39, 18, 42, 23, 34, 40, 21, 20, 4] (see Fact 2.2.1) actually have strong computable type because the proofs hold relative to any oracle.

Note that the proof that the definition of computable type reduces to the Hilbert cube (Theorem 4.2.1) also extends to strong computable type, so defining strong computable type on computable metric spaces or computably Hausdorff spaces would yield equivalent notions.

We will see in Section 6.7.1 that for finite simplicial complexes, strong computable type is equivalent to computable type (Corollary 6.7.1). More generally, we expect that for natural spaces, the notion of strong computable type is actually no stronger than the notion of computable type.

Intuitively, a compact pair has strong computable type iff for every copy (Y, B) in the Hilbert cube, the set Y can be fully computed if we are only given the compact information about Y and B . We make it precise by seeing Y and B as points of the hyperspace of compact subsets of the Hilbert cube with suitable topologies.

The property of having strong computable type can then be rephrased as relative computability between elements of $\mathcal{K}(Q)$ with various topologies, using the notion of relative computability given by Definition 2.1.2. As relative computability is expressed in terms of enumeration reducibility, Definition 2.0.1 then provides equivalent formulations of this notion, which we will implicitly use in the rest of the thesis. Let us state such a formulation for clarity.

Proposition 4.3.1

For a compact pair (X, A) , the following statements are equivalent:

1. (X, A) has strong computable type,
2. For every copy (Y, B) of (X, A) in Q , the element Y of the space $(\mathcal{K}(Q), \tau_\nu)$ is computable relative to the element (Y, B) of the product space $(\mathcal{K}^2(Q), \tau_{up\nu}^2)$.

Proof. The second statement is about relative computability, which is defined as enumeration reducibility between neighborhood bases of Y and (Y, B) . The definition of strong computable type is precisely formulation (3) of enumeration reducibility (Definition 2.0.1). \square

This formulation will imply useful consequences, because it enables one to use topology and descriptive set theory on $\mathcal{K}(Q)$ to analyze a computability-theoretic property.

4.3.2 A First Characterization

We give a first characterization of strong computable type. This result is related to the characterization obtained by Jeandel in [43] of the sets $A \subseteq \mathbb{N}$ that are *total*, i.e. whose complement $\mathbb{N} \setminus A$ is enumeration reducible to A .

We recall that (Y, B) is a proper subpair of (X, A) , written $(Y, B) \subsetneq (X, A)$, if $Y \subsetneq X$ and $B \subseteq A$.

Definition 4.3.2. Let \mathcal{P} be a property of compact pairs. A pair $(X, A) \subseteq Q$ is **\mathcal{P} -minimal** if $(X, A) \in \mathcal{P}$ and for every proper compact subpair $(Y, B) \subsetneq (X, A)$, one has $(Y, B) \notin \mathcal{P}$.

We can now state our first characterization of strong computable type.

Theorem 4.3.1. For a compact pair (X, A) , the following statements are equivalent:

1. (X, A) has strong computable type,
2. For every copy (Y, B) of (X, A) in Q , there exists a property \mathcal{P} of compact pairs which is Π_1^0 in the topology $\tau_{up\nu}^2$ and such that (Y, B) is \mathcal{P} -minimal.

Proof. We fix an arbitrary copy of (X, A) in Q (that we still call (X, A)) and prove that the following equivalence holds for that copy: the set of basic τ_ν neighborhoods of X is enumeration reducible to the set of basic $\tau_{up\nu}^2$ neighborhoods of (X, A) iff there exists a Π_1^0 property \mathcal{P} such that (X, A) is \mathcal{P} -minimal.

2. \Rightarrow 1. Assume that \mathcal{P} is Π_1^0 in $\tau_{up\nu}^2$ and that (X, A) is \mathcal{P} -minimal. Given the $\tau_{up\nu}^2$ neighborhoods of (X, A) , we need to enumerate the rational balls U intersecting X . Note that U intersects X iff $X \setminus U$ is a proper subset of X ; as (X, A) is \mathcal{P} -minimal, it is equivalent to $(X \setminus U, A \setminus U) \notin \mathcal{P}$. Given (X, A) in the topology $\tau_{up\nu}^2$, one can compute $(X \setminus U, A \setminus U)$ in the topology $\tau_{up\nu}^2$ (indeed, $X \setminus U \subseteq V \iff X \subseteq U \cup V$, and similarly for $A \setminus U$) so one can semi-decide whether $(X \setminus U, A \setminus U) \notin \mathcal{P}$, i.e. whether U intersects X .

1. \Rightarrow 2. Consider a machine M which takes any enumeration of the basic $\tau_{up\nu}^2$ -neighborhoods of (X, A) and enumerates the open balls intersecting X . Let \mathcal{U} be the set of compact pairs (X', A') on which M fails in the following sense: after reading a finite sequence of $\tau_{up\nu}^2$ neighborhoods of the pair (X', A') , the machine enumerates an open ball U such that $X' \cap \bar{U} = \emptyset$, where \bar{U} is the corresponding closed ball. Let \mathcal{P} be the complement of \mathcal{U} . Note that $(X, A) \in \mathcal{P}$ because the machine does not fail on (X, A) .

We first show that \mathcal{U} is effectively open in $\tau_{up\mathcal{V}}^2$. If $\sigma = \sigma_0 \dots \sigma_k$ is a finite sequence of basic $\tau_{up\mathcal{V}}^2$ -open sets and U is a basic open subset of Q , then let

$$\mathcal{U}_{(\sigma,U)} = \{(X', A') : \forall i \leq k, (X', A') \in \sigma_i \text{ and } X' \subseteq Q \setminus \overline{U}\}.$$

It is an effective $\tau_{up\mathcal{V}}^2$ -open set, and \mathcal{U} is the union of all the $\mathcal{U}_{(\sigma,U)}$ such that M outputs U after reading σ , so it is a c.e. union. Therefore \mathcal{U} is an effective $\tau_{up\mathcal{V}}^2$ -open set and \mathcal{P} is Π_1^0 in $\tau_{up\mathcal{V}}^2$.

We now show that (X, A) is \mathcal{P} -minimal. If (X', A') is a proper compact subpair of (X, A) , then there exists a ball U intersecting X such that \overline{U} is disjoint from X' . On an arbitrary enumeration of the $\tau_{up\mathcal{V}}^2$ -neighborhoods of (X, A) , the machine eventually outputs U after reading a finite sequence σ . As $(X', A') \subseteq (X, A)$, the $\tau_{up\mathcal{V}}^2$ -neighborhoods of (X, A) are also $\tau_{up\mathcal{V}}^2$ -neighborhoods of (X', A') so the machine fails on (X', A') . Therefore, $(X', A') \in \mathcal{U}$, i.e. $(X', A') \notin \mathcal{P}$. We have shown that (X, A) is \mathcal{P} -minimal. \square

In particular, this characterization immediately implies a simple sufficient condition for having strong computable type.

Theorem 4.3.2. Let \mathcal{P} be a topological invariant which is Σ_2^0 in $\tau_{up\mathcal{V}}^2$. Every minimal element of \mathcal{P} has strong computable type.

Proof. Let $\mathcal{P} = \bigcup_n \mathcal{P}_n \setminus \mathcal{Q}_n$ where each $\mathcal{P}_n, \mathcal{Q}_n$ is Π_1^0 in $\tau_{up\mathcal{V}}^2$. Assume that (X, A) is \mathcal{P} -minimal and let (Y, B) be a copy of (X, A) in Q . This copy belongs to some $\mathcal{P}_n \setminus \mathcal{Q}_n$. Let us show that (Y, B) must be \mathcal{P}_n -minimal. Let (Y', B') be a proper compact subpair of (Y, B) . The set \mathcal{Q}_n is Π_1^0 in $\tau_{up\mathcal{V}}^2$ so it is an upper set. As $(Y, B) \notin \mathcal{Q}_n$, $(Y', B') \notin \mathcal{Q}_n$ as well. As (Y, B) is \mathcal{P} -minimal, $(Y', B') \notin \mathcal{P}$, so $(Y', B') \notin \mathcal{P}_n$. Therefore, (Y, B) is \mathcal{P}_n -minimal.

We have shown that each copy (Y, B) of (X, A) is \mathcal{P}_n -minimal for some n , so we can apply Theorem 4.3.1, implying that (X, A) has strong computable type. \square

We will see applications of this result in the sequel. Theorem 4.3.2 is only an implication and we will see later that the converse implication does not hold in general (see Section 5.4.4). However, in the next section we obtain a characterization of strong computable type using Σ_2^0 invariants and a weak form of minimality.

Discussion about Minimality

When applying Theorem 4.3.1 and Theorem 4.3.2 to prove that a pair has strong computable type, one needs to show that a pair (X, A) is \mathcal{P} -minimal for some \mathcal{P} . The definition of minimality involves all the proper compact subpairs $(Y, B) \subsetneq (X, A)$. However, because \mathcal{P} is Π_1^0 in $\tau_{up\mathcal{V}}^2$, it is not necessary to consider all of them.

The reason is that the lower and upper Vietoris topologies interact nicely with the inclusion ordering on compact sets:

- If a set $\mathcal{P} \subseteq \mathcal{K}(Q)$ is closed in $\tau_{up\mathcal{V}}$ or open in $\tau_{low\mathcal{V}}$, then it is an **upper set**: if $K \subseteq K' \subseteq Q$ and $K \in \mathcal{P}$, then $K' \in \mathcal{P}$.
- Dually, if \mathcal{P} is open in the topology $\tau_{up\mathcal{V}}$ or closed in the topology $\tau_{low\mathcal{V}}$, then it is a **lower set**: if $K \subseteq K' \subseteq Q$ and $K' \in \mathcal{P}$, then $K \in \mathcal{P}$.

It gives a shortcut to prove that a pair (X, A) is \mathcal{P} -minimal, when \mathcal{P} is an upper set, for instance when \mathcal{P} is Π_1^0 or more generally closed in the topology $\tau_{up\mathcal{V}}^2$.

Definition 4.3.3. Let (X, A) be a compact pair and \mathcal{F} a family of proper compact subpairs of (X, A) . We say that \mathcal{F} is **cofinal** if every proper compact subpair of (X, A) is contained in some pair in \mathcal{F} .

The next result is elementary but very useful.

Lemma 4.3.1

Let \mathcal{P} be a property of compact pairs which is an upper set. Let $(X, A) \in \mathcal{P}$ and \mathcal{F} be cofinal for (X, A) . If no pair of \mathcal{F} is in \mathcal{P} then (X, A) is \mathcal{P} -minimal.

Proof. If $(Y, B) \subsetneq (X, A)$, then $(Y, B) \subseteq (Z, C) \subsetneq (X, A)$ for some $(Z, C) \in \mathcal{F}$, by cofinality. As $(Z, C) \notin \mathcal{P}$ by assumption and \mathcal{P} is an upper set, $(Y, B) \notin \mathcal{P}$. \square

We will implicitly apply this observation, notably with the following families:

- The family $\{(Y, Y \cap A) : Y \subsetneq X\}$ is cofinal,
- If \mathcal{B} is a basis of the topology of X consisting of open sets, then the family $\{(X \setminus B, A \setminus B) : B \in \mathcal{B}, B \cap X \neq \emptyset\}$ is cofinal,
- If A has empty interior in X , then the family $\{(Y, A) : A \subseteq Y \subsetneq X\}$ is cofinal.

4.3.3 A Characterization using Invariants

In order to prove that a compact pair has strong computable type using Theorem 4.3.1, one needs to find a Π_1^0 property for each copy. In this section we improve the result by making the property less dependent on the copy. It is possible because there are countably many Π_1^0 properties, but uncountably many copies of a pair, so some property must work for “many” copies. The word “many” can be made precise using Baire category on the space of continuous functions of the Hilbert cube to itself.

Theorem 4.3.3. For a compact pair (X, A) , the following statements are equivalent:

1. (X, A) has strong computable type,
2. There exists a Σ_2^0 invariant $\bigcup_{n \in \mathbb{N}} \mathcal{P}_n$, where the sets \mathcal{P}_n are uniformly Π_1^0 in $\tau_{up\mathcal{V}}^2$, such that every copy of (X, A) in Q is \mathcal{P}_n -minimal for some n .

Note that the invariant is more than a Σ_2^0 property, because it is a union of closed sets rather than a union of *differences* of closed sets. The rest of the section is devoted to the proof of this result.

The idea of the proof is that one of the Π_1^0 properties from Theorem 4.3.1 works for “many” copies of (X, A) , in the sense of Baire category. We then transform this Π_1^0 property into a Σ_2^0 invariant. This transformation is an instance of Vaught’s transform [62]. Let us briefly explain this transform. There are several ways of defining an invariant out of a property \mathcal{P} . For instance, the set of compact pairs having at least one copy in \mathcal{P} is an invariant; the set of compact pairs whose copies are all in \mathcal{P} is another invariant. However, these two invariants can have very high descriptive complexities (typically Σ_1^1 and Π_1^1 respectively). Vaught’s transform is an intermediate way of converting a property into an invariant which almost preserves the descriptive complexity: the invariant is the set of compact pairs having “many” copies in \mathcal{P} , where “many” is expressed using Baire category. We now give the details.

Note that we can make $(\mathcal{C}(Q), d)$ a computable metric space (see Definition 2.1.7).

Lemma 4.3.2

There exists a computable sequence of injective continuous functions $\phi_i : Q \rightarrow Q$ that is dense in the metric d .

Proof. We first build a dense computable sequence of functions $f_i : Q \rightarrow Q$ that are not necessarily injective. Say that an element $x \in Q$ is *dyadic of order n* if it has the form $x =$

$(x_0, \dots, x_{n-1}, 0, 0, 0, \dots)$ where each x_i is a multiple of 2^{-n} . For each $n \in \mathbb{N}$, the finite set of dyadic elements of order n forms a regular grid. One can then define a piecewise affine map by assigning a dyadic element to each dyadic element of order n and interpolating affinely in between. All the possible such assignments provide a dense computable sequence of functions from Q to itself.

Every continuous function $f : Q \rightarrow Q$ can be approximated by injective continuous functions $g_n : Q \rightarrow Q$ defined as follows: let $g_n(x)$ be the sequence starting with the first n terms of $f(x)$, appended with x . If f is computable then the functions g_n are computable, uniformly. Therefore injective approximations of the functions f_i give a computable dense sequence of injective functions. \square

Definition 4.3.4. Let $\epsilon > 0$. An ϵ -function is a continuous function $f : Q \rightarrow Q$ satisfying $d(f, \text{id}_Q) < \epsilon$. An ϵ -deformation of a pair $(X, A) \subseteq Q$ is the image $f(X, A) := (f(X), f(A))$ of (X, A) under an ϵ -function f .

Note that if f is an ϵ -function and g is a δ -function, then $f \circ g$ is an $(\epsilon + \delta)$ -function. Therefore, an ϵ -deformation of a δ -deformation of (X, A) is a $(\epsilon + \delta)$ -deformation of (X, A) .

Remark 4.3.2

The notion of ϵ -function can be defined for partial functions $f : X \rightarrow Q$, where $X \subseteq Q$, by requiring $d_X(f, \text{id}_X) < \epsilon$. The notion of ϵ -deformation of (X, A) does not change if we consider ϵ -functions define on Q or on X only, so we will freely use this flexibility in the sequel.

Indeed, if $f : X \rightarrow Q$ is an ϵ -function, then f has a continuous extension $\tilde{f} : Q \rightarrow Q$ which is an ϵ -function. The function \tilde{f} can be defined as follows: let $f_0 : Q \rightarrow Q$ be a continuous extension of f obtained by the Tietze extension theorem; let $\delta > 0$ and $\tilde{f}(x) = (1 - \lambda_x)f_0(x) + \lambda_x x$, where $\lambda_x = \min(1, d_Q(x, X)/\delta)$ (note that Q indeed allows convex combinations). \tilde{f} is a continuous extension of f and if δ is sufficiently small, then $d(\tilde{f}, \text{id}_Q) < \epsilon$.

If a homeomorphism $f : X \rightarrow Y$ is an ϵ -function, then its inverse $f^{-1} : Y \rightarrow X$ is an ϵ -function as well.

Definition 4.3.5. Let \mathcal{P} be a property of compact pairs. We define an invariant \mathcal{P}^* as follows: $(X, A) \in \mathcal{P}^*$ iff there exists a copy (X', A') of (X, A) and an $\epsilon > 0$ such that every ϵ -deformation of (X', A') is in \mathcal{P} .

The key observation about \mathcal{P}^* is that its descriptive complexity is not too high, compared to the descriptive complexity of \mathcal{P} : if \mathcal{P} is Π_1^0 , then \mathcal{P}^* is Σ_2^0 .

Remark 4.3.3

When \mathcal{P} is Π_1^0 (more generally closed) in $\tau_{\mathcal{V}}^2$, \mathcal{P}^* could be equivalently defined by considering injective ϵ -functions only, in which case ϵ -deformations of (X', A') would all be copies of (X', A') . Indeed, the injective continuous functions are dense in $\mathcal{C}(Q)$, so every ϵ -deformation of (X', A') is a limit, in the Vietoris topology, of ϵ -deformations by injective ϵ -functions; if the latter are all in \mathcal{P} , then every ϵ -deformation is also in \mathcal{P} as \mathcal{P} is closed in $\tau_{\mathcal{V}}^2$.

Proof of Theorem 4.3.3. For a rational $\epsilon > 0$, we define

$$\mathcal{P}_\epsilon = \{(X, A) \subseteq Q : \text{every } \epsilon\text{-deformation of } (X, A) \text{ is in } \mathcal{P}\}.$$

One has $\mathcal{P}^* = \{(X, A) \subseteq Q : \exists \epsilon > 0, (X, A) \text{ has a copy in } \mathcal{P}_\epsilon\}$.

4. Strong Computable Type

Claim 4.3.1

Let τ be either τ_V^2 or τ_{upV} . If \mathcal{P} is Π_1^0 in τ then \mathcal{P}_ϵ is Π_1^0 in τ .

Proof. The function $f \in \mathcal{C}(Q) \mapsto f(X, A) \in (\mathcal{K}^2(Q), \tau)$ is continuous, \mathcal{P} is closed in τ and the functions ϕ_k are dense in $\mathcal{C}(Q)$. Therefore, the quantification over the ϵ -functions can be replaced by a quantification over the k 's such that ϕ_k is an ϵ -function: $(X, A) \in \mathcal{P}_\epsilon$ iff $\forall k \in \mathbb{N}$, $d(\phi_k, \text{id}_Q) < \epsilon$ implies $\phi_k(X, A) \in \mathcal{P}$. It is a Π_1^0 predicate. \square

Say that two pairs (X, A) and (Y, B) in Q are ϵ -homeomorphic if there exists a homeomorphism $f : (X, A) \rightarrow (Y, B)$ which is an ϵ -function (note that this relation is symmetric, because in this case f^{-1} is an ϵ -function as well).

Claim 4.3.2

If $(X_0, A_0) \subseteq Q$ and $(X_1, A_1) \subseteq Q$ are homeomorphic, then for every $\epsilon > 0$ there exists i such that $\phi_i(X_0, A_0)$ and (X_1, A_1) are ϵ -homeomorphic.

Proof. Let $f : (X_0, A_0) \rightarrow (X_1, A_1)$ be a homeomorphism and let i be such that $d_{X_0}(\phi_i, f) < \epsilon$. Let $\psi = \phi_i \circ f^{-1}$. One has $\phi_i(X_0, A_0) = \psi(X_1, A_1)$ and $d_{X_1}(\psi, \text{id}_Q) = d_{X_0}(\phi_i, f) < \epsilon$. \square

Claim 4.3.3

Let τ be either τ_V^2 or τ_{upV} . If \mathcal{P} is Π_1^0 in τ then \mathcal{P}_* is Σ_2^0 in τ .

Proof. Again, the idea is that we can replace the quantification over the copies, i.e. over the injective continuous functions, by a quantification over the ϕ_i 's. Precisely, let

$$\mathcal{P}_{i,\epsilon} = \{(X, A) \subseteq Q : \phi_i(X, A) \in \mathcal{P}_\epsilon\}.$$

We show that $\mathcal{P}_* = \bigcup_{i,\epsilon} \mathcal{P}_{i,\epsilon}$, which is Σ_2^0 .

If (X, A) has a copy (X', A') in \mathcal{P}_ϵ , then there exists i such that $\phi_i(X, A) \in \mathcal{P}_{\epsilon/2}$. Indeed, let i be such that $\phi_i(X, A)$ is $\epsilon/2$ -homeomorphic to (X', A') by the previous claim. Every $\epsilon/2$ -deformation of $\phi_i(X, A)$ is an ϵ -deformation of (X', A') , so it belongs to \mathcal{P} . Therefore $\phi_i(X, A) \in \mathcal{P}_{\epsilon/2}$, hence $(X, A) \in \mathcal{P}_{i,\epsilon/2}$. \square

Claim 4.3.4

Assume that (X, A) is \mathcal{P} -minimal and that $(X, A) \in \mathcal{P}_\epsilon$. For every copy (X', A') of (X, A) , there exists i such that (X', A') is $\mathcal{P}_{i,\epsilon/2}$ -minimal.

Proof. Let (X', A') be a copy of (X, A) . Let i be such that $\phi_i(X', A')$ is $\epsilon/2$ -homeomorphic to (X, A) . As in the previous claim, $(X', A') \in \mathcal{P}_{i,\epsilon/2}$, and we show that (X', A') is $\mathcal{P}_{i,\epsilon/2}$ -minimal.

If (X'', A'') is a proper compact subpair of (X', A') , then $\phi_i(X'', A'')$ is $\epsilon/2$ -homeomorphic to a proper compact subpair of (X, A) . The latter is not in \mathcal{P} as (X, A) was \mathcal{P} -minimal, and is an $\epsilon/2$ -deformation of $\phi_i(X'', A'')$, so $\phi_i(X'', A'') \notin \mathcal{P}_{\epsilon/2}$. In other words. $(X'', A'') \notin \mathcal{P}_{i,\epsilon/2}$. As a result, (X', A') is $\mathcal{P}_{i,\epsilon/2}$ -minimal. \square

Claim 4.3.5

If a compact pair (X, A) has strong computable type, then there exists a Π_1^0 property \mathcal{P} , a copy $(X_0, A_0) \subseteq Q$ and an $\epsilon > 0$ such that (X_0, A_0) is \mathcal{P} -minimal and $(X_0, A_0) \in \mathcal{P}_\epsilon$.

Proof. Assume that $(X, A) \subseteq Q$ has strong computable type. Let $\mathcal{I}(Q) \subseteq \mathcal{C}(Q)$ be the subspace of injective continuous functions $f : Q \rightarrow Q$. It is a G_δ -set: $\mathcal{I}(Q) = \bigcap_{n \in \mathbb{N}} \mathcal{I}_n(Q)$ where

$$\mathcal{I}_n(Q) = \{f \in \mathcal{C}(Q) : \forall x, y \in Q, d(x, y) \geq 2^{-n} \implies f(x) \neq f(y)\}$$

is open by Proposition 2.1.1, because it is obtained as a universal quantification of an open predicate over the compact space $Q \times Q$ (see Lemma 1.3.10 in [61] for a more detailed proof). Being a G_δ -subset of the Polish space $\mathcal{C}(Q)$, the space $\mathcal{I}(Q)$ is therefore Polish (Theorem 3.11 in [44]).

Theorem 4.3.1 implies that for each $f \in \mathcal{I}(Q)$ there exists a Π_1^0 property \mathcal{P} (in τ_{upV}^2) such that $f(X, A)$ is \mathcal{P} -minimal. There are countably many Π_1^0 properties, so by Baire category on $\mathcal{I}(Q)$ there exists a Π_1^0 -property \mathcal{P} , an $f_0 \in \mathcal{I}(Q)$ and an $\epsilon > 0$ such that for “almost every” $f \in B(f_0, \epsilon)$, $f(X, A)$ is \mathcal{P} -minimal. By “almost every”, we mean for a dense set of functions $f \in B(f_0, \epsilon)$. It actually implies that for *every* continuous $f \in B(f_0, \epsilon)$ the pair $f(X, A)$ is in \mathcal{P} because \mathcal{P} is closed and the injective functions are dense in the continuous ones by Lemma 4.3.2. The copy $f_0(X, A)$ belongs to \mathcal{P}_ϵ but may not be \mathcal{P} -minimal. But, we can replace f_0 by any $f_1 \in B(f_0, \epsilon/2)$ such that $f_1(X, A)$ is \mathcal{P} -minimal, and ϵ by $\epsilon/2$. We then let $(X_0, A_0) = f_1(X, A)$. \square

Finally, we put everything together. Let (X_0, A_0) , \mathcal{P} and ϵ be given by Claim 4.3.5. The Σ_2^0 invariant we are looking for is $\mathcal{P}_* = \bigcup_{i, \epsilon} \mathcal{P}_{i, \epsilon}$. Claim 6.7.2 implies that every copy of (X, A) is $\mathcal{P}_{i, \epsilon}$ -minimal for some i, ϵ . \square

4.4 Strong Computable Type: Further Properties

In this section, we leverage the analysis conducted thus far to achieve a deeper comprehension of strong computable type from a structural perspective.

4.4.1 Product and Cone of Pairs

We give a relationship between pairs, their products and their cones, w.r.t. strong computable type.

The Product of Two Pairs

Definition 4.4.1. The **product** of two pairs (X_1, A_1) and (X_2, A_2) is the pair

$$(X_1, A_1) \times (X_2, A_2) = (X_1 \times X_2, (X_1 \times A_2) \cup (A_1 \times X_2)).$$

Proposition 4.4.1

If $(X_1, A_1) \times (X_2, A_2)$ has (strong) computable type and (X_2, A_2) has a semicomputable copy in Q , then (X_1, A_1) has (strong) computable type.

Proof. Assume that (X_1, A_1) and (X_2, A_2) are embedded in Q as semicomputable compact pairs, let us prove that X_1 is computable. The product $(X, A) = (X_1, A_1) \times (X_2, A_2) \subset Q \times Q$ is semicomputable because each pair is. Therefore X is computable by assumption, so its first projection X_1 is computable. It shows that (X_1, A_1) has computable type. The proof relativizes, so (X_1, A_1) has strong computable type. \square

The Cone of a Pair

Proposition 4.4.2

Let (X, A) be a compact pair. If $C(X, A)$ has (strong) computable type, then (X, A) has (strong) computable type.

4. Strong Computable Type

Proof. We prove it for computable type and the proof relativizes. Suppose $(Y, B) = C(X, A)$ has computable type and that (X_0, A_0) is a semicomputable copy of (X, A) in Q . Let us prove that X_0 is computable.

Let

$$Y_0 = \{(\lambda, \lambda x) : \lambda \in [0, 1], x \in X_0\},$$

$$B_0 = \{(\lambda, \lambda x) : \lambda \in [0, 1], x \in A_0\} \cup (\{1\} \times X_0).$$

The pair (Y_0, B_0) is a semicomputable realization of $C(X_0, A_0)$ in Q (because the pair (X_0, A_0) is semicomputable and the function $f : x \mapsto \{(\lambda, \lambda x) : \lambda \in [0, 1]\}$ and $f(X_0) = Y_0$ and $f(A_0) = B_0$) so Y_0 is computable by assumption. The intersection Z_0 of Y_0 with $[1/2, 1] \times Q$ is computable as well (an open set B intersects Z_0 iff the open set $B \cap ((1/2, 1] \times Q)$ intersects Y_0 , which is semidecidable). The image of Z_0 under the computable function $(\lambda, y) \mapsto y/\lambda$ is X_0 , which is therefore computable. \square

Remark 4.4.1

The other implication of Proposition 4.4.2 is false. Let L be the graph consisting of two circles joined by a line segment, and $N = \emptyset$ (see Figure 4.1). The pair (L, N) has strong computable type but $C(L, N)$ does not, as shown in Proposition 6.7.1, because the graph L has an edge which belongs to no cycle.

Here is another example. Let L be the so-called house with two rooms, or Bing's house (see Figure 4.2), and $N = \emptyset$. L is contractible and we proved in Proposition 6.7.2 that it has (strong) computable type. However, the results of Section 6.5.3 imply that as L is contractible, the pair $(C(L), L)$ does not have strong computable type.

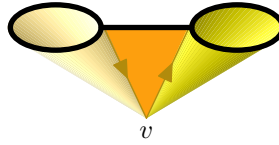

Figure 4.1: Cone of two circles joined by a segment

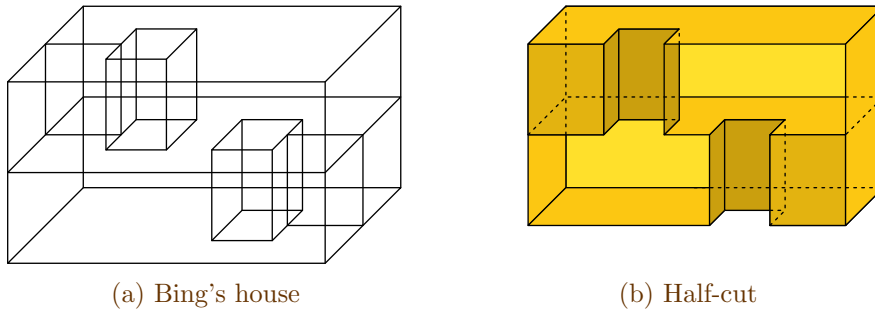

Figure 4.2: Bing's house with two rooms and a half-cut of it

4.4.2 A Topological Necessary Condition

We establish a purely topological understanding of the concept of strong computable type through the identification of a necessary condition from a topological standpoint.

Corollary 4.4.1. (Necessary condition) If a compact pair $(X, A) \subseteq Q$ has strong computable type, then there exists $\epsilon > 0$ such that no sequence of ϵ -deformations of (X, A) converges to a proper compact subpair of (X, A) in the topology $\tau_{up\mathcal{V}}^2$.

Note that if A is empty one should not confuse between this necessary condition and the notion of strong approximation (see Definition 5.6.1).

Proof. From Theorem 4.3.1 and the proof of Theorem 4.3.3, (X, A) has strong computable type iff there exist a property of compact pairs \mathcal{P} which is Π_1^0 in $\tau_{up\mathcal{V}}^2$, a copy (Y, B) of (X, A) in Q which is \mathcal{P} -minimal, and an $\epsilon > 0$ such that every ϵ -deformation of (Y, B) is in \mathcal{P} .

As \mathcal{P} is closed in $\tau_{up\mathcal{V}}^2$, every limit of ϵ -deformations of (Y, B) in that topology also belongs to \mathcal{P} . As (Y, B) is \mathcal{P} -minimal, no such limit is a proper compact subpair of (Y, B) . The same result can be transferred to (X, A) by using a homeomorphism $\phi : (X, A) \rightarrow (Y, B)$. Indeed, ϕ sends proper compact subpairs of (X, A) to proper compact subpairs of (Y, B) and if $\delta > 0$ is sufficiently small, then ϕ sends δ -deformations of (X, A) to ϵ -deformations of (Y, B) . \square

This necessary condition almost suffices and encapsulates the purely topological aspects of strong computable type. In fact, it is equivalent to the following relativization of strong computable type.

Definition 4.4.2. A compact pair (X, A) has **strong computable type relative to some oracle** or **relative strong computable type** if there exists an oracle O such that for every copy (Y, B) of (X, A) in Q one can compute Y in $(\mathcal{K}(Q), \tau_{\mathcal{V}})$ from (Y, B) as an element of $(\mathcal{K}^2(Q), \tau_{up\mathcal{V}}^2)$ using O .

Corollary 4.4.2. For a compact pair (X, A) , the following statements are equivalent:

1. (X, A) has strong computable type relative to some oracle,
2. There exists $\epsilon > 0$ such that no sequence of ϵ -deformations of (X, A) converges to a proper compact subpair of (X, A) in the topology $\tau_{up\mathcal{V}}^2$.

Proof. The proof of Corollary 4.4.1 holds relative to any oracle, which shows (1) \Rightarrow (2). Now assume condition (2). Let \mathcal{P} be the closure, in $\tau_{up\mathcal{V}}^2$, of the set of ϵ -deformations of (X, A) . Let O be an oracle relative to which \mathcal{P} is Π_1^0 in $\tau_{up\mathcal{V}}^2$. By definition, \mathcal{P} contains all the ϵ -deformations of (X, A) and (X, A) is \mathcal{P} -minimal by assumption. Therefore, we can apply the argument in the proof of Theorem 4.3.1, showing that (X, A) has strong computable type relative to O . \square

The contra-position of Corollary 4.4.1 gives a sufficient condition implying that a pair does not have strong computable type. In Section 4.5.1, we prove an effective version which even shows that the pair does not have computable type.

4.4.3 The ϵ -Surjection Property

We define three notions that characterize pairs. Namely, the generalized ϵ -surjection property, the ϵ -surjection property and the surjection property, we study them in details in Chapter 6.

Definition 4.4.3. Let $\epsilon > 0$. A pair $(X, A) \subseteq Q$ satisfies the **generalized ϵ -surjection property** if every continuous function of pairs $f : (X, A) \rightarrow (X, A)$ satisfying $d_X(f, \text{id}_X) < \epsilon$ is surjective.

The pair $(X, A) \subseteq Q$ satisfies the **ϵ -surjection property** if every continuous function $f : X \rightarrow X$ satisfying $d_X(f, \text{id}_X) < \epsilon$ and $f|_A = \text{id}_A$ is surjective. X has the ϵ -surjection property if the pair (X, \emptyset) does.

The pair has the **surjection property** if every continuous function $f : X \rightarrow X$ such that $f|_A = \text{id}_A$ is surjective.

The following special case of Corollary 4.4.1 has a particularly simple formulation.

Corollary 4.4.3. If $(X, A) \subseteq Q$ has strong computable type, then it satisfies the generalized ϵ -surjection property for some $\epsilon > 0$.

Proof. Take ϵ from Corollary 4.4.1. If $f : (X, A) \rightarrow (X, A)$ is an ϵ -function, then $f(X, A)$ is an ϵ -deformation of (X, A) which is a compact subpair of (X, A) . By Corollary 4.4.1 it cannot be a proper compact subpair, which means that f must be surjective. \square

We do not know whether the converse of Corollary 4.4.3 holds, although we do not expect so. As we discuss now, it holds for particular pairs.

Example 4.4.1

As already mentioned, we do not know whether the converse of Corollary 4.4.3 holds. However, there is a simple example showing that the ϵ -surjection property does not imply computable type in general. Consider the pair (X, A) in \mathbb{R}^2 defined as follows: $X = \bigcup_{i \in \mathbb{N}} X_i$ where $X_0 = [0, 1] \times \{0\}$ and for $i \geq 1$, $X_i = \{2^{-i}\} \times [0, 2^{-i}]$ and $A = \{(2^{-i}, 2^{-i}) : i \geq 1\} \cup \{(0, 0)\}$ (see Figure 4.3).

Every continuous function $f : X \rightarrow X$ such that $f|_A = \text{id}_A$ must be surjective, so (X, A) satisfies the surjection property, hence the ϵ -surjection property for every ϵ . However it does not have computable type: if $E \subseteq \mathbb{N}$ is a non-computable c.e. set, then the pair (Y, B) defined by $Y = X_0 \cup \bigcup_{i \notin E} X_i$ and $B = \{(2^{-i}, 2^{-i}) : i \geq 1, i \notin E\} \cup \{(0, 0)\}$ is a semicomputable copy of (X, A) but Y is not computable.

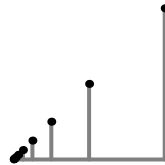

Figure 4.3: A compact pair having the surjection property but not computable type

It is an open question whether there is a compact space with infinitely many connected components having strong computable type. The previous results give partial answers to this question. Essentially, such a space cannot have arbitrarily small connected components.

Proposition 4.4.3

Let X be a compact metric space.

If for every $\epsilon > 0$ there exists a connected component of X of diameter $< \epsilon$ which is not a singleton, then X does not have strong computable type.

If $X \setminus A$ contains infinitely many isolated points in (X, τ_X) , then (X, A) does not have strong computable type.

Proof. We show that in both situations one can build for each $\epsilon > 0$ a non-surjective continuous ϵ -function, implying that X does not have strong computable type by Corollary 4.4.3.

Let $A \subseteq X$ be a connected component of diameter $< \epsilon$, which is not a singleton. A is the intersection of a decreasing sequence of clopen sets, so by compactness it is contained in a clopen set C_ϵ of diameter $< \epsilon$. The function $f : X \rightarrow X$ defined as the identity on $X \setminus C_\epsilon$ and sending all C_ϵ to some point $x \in C_\epsilon$ is a continuous ϵ -function, which is not surjective because C_ϵ is not a singleton.

If $X \setminus A$ contains infinitely many isolated points then by compactness, they have an accumulation point $x \in X$. Given $\epsilon > 0$, let $f : (X, A) \rightarrow (X, A)$ send some isolated point $y \in (X \setminus A) \cap B(x, \epsilon)$ to x and be the identity on $X \setminus \{y\}$. f is a non-surjective continuous ϵ -function. \square

The first result in Proposition 4.4.3 may be generalized to pairs. However, the proof would not use the ϵ -surjection property because there exists pairs which have this property and do not have strong computable type.

For instance, take X to be a countable union of disjoint disks converging to set S disjoint from them and let A be the bounding spheres of the disks in addition to S . There exists a semicomputable copy of (X, A) relative to some oracle O which is not computable relative to it.

Indeed, enumerate each disk X_i in X and let A_i be its bounding sphere, take an oracle O which makes (X, A) semicomputable. If $E \subseteq \mathbb{N}$ is a non-computable c.e. set, then the pair (Y, B) defined by $Y = S \cup \bigcup_{i \notin E} X_i$ and $B = S \cup \bigcup_{i \notin E} A_i$ is a semicomputable copy of (X, A) relative to O but Y is not computable relative to it.

4.4.4 Uniformity

Given a compact pair (X, A) which has strong computable type, a natural question one may ask is whether it is possible to have a single effective procedure that takes any copy (Y, B) given in the topology $\tau_{up\mathcal{V}}^2$ and computes Y in the topology $\tau_{\mathcal{V}}$. It turns out that the answer is almost always negative: uniformity is only possible when X is a singleton (for a singleton $X = \{p\}$ semicomputability is equivalent to computability because a ball B_i contains p iff it intersects it, so there is a single effective procedure which will just output the semicomputability information since it equals the computability information), see Theorem 4.4.1. Therefore, the natural problem is to measure the degree of non-uniformity of this problem, using Weihrauch degrees. It was studied by Pauly [52] in the case of the circle embedded in \mathbb{R}^2 . We give here more results about this question.

Definition 4.4.4. For a compact pair (X, A) , let $\text{SCT}_{(X,A)}$ be the function taking a copy (Y, B) of (X, A) in $\tau_{up\mathcal{V}}^2$ and outputting Y in $\tau_{\mathcal{V}}^2$.

The first result holds for every compact pair (which may or may not have strong computable type).

Definition 4.4.5. Closed choice over \mathbb{N} is the problem $\text{C}_{\mathbb{N}}$ of finding an element in a non-empty set A of natural numbers, given any enumeration of the complement of A .

Theorem 4.4.1. Let (X, A) be a compact pair such that X is not a singleton. One has $\text{C}_{\mathbb{N}} \leq_{sW}^t \text{SCT}_{(X,A)}$. If (X, A) has a semicomputable copy then $\text{C}_{\mathbb{N}} \leq_{sW} \text{SCT}_{(X,A)}$.

Proof. Instead of $\text{C}_{\mathbb{N}}$, we use the strongly Weihrauch equivalent problem Max which sends a non-empty finite subset of \mathbb{N} , represented by its characteristic function, to its maximal element (Theorem 7.13 in [15]). We prove the result when (X, A) has a semicomputable copy, the general case is obtained by relativizing the argument to an oracle which semicomputes some copy.

Assume that (X, A) is already embedded as a semicomputable compact pair in Q . We can assume that $1/2 < \text{diam}(X) < 1$, rescaling X if needed (and using the assumption that X is not a singleton).

Given a non-empty finite set $E \subseteq \mathbb{N}$, let $m = \max E$. We show how to produce a semicomputable copy (X_E, A_E) of (X, A) such that $2^{-m-1} < \text{diam}(X_E) < 2^{-m}$. Given an access to X_E in the topology $\tau_{\mathcal{V}}$, one can compute its diameter so one can compute m , showing that Max is strongly Weihrauch reducible to $\text{SCT}_{(X,A)}$.

We now define (X_E, A_E) . It is obtained from (X, A) by a translation and a scaling by a factor 2^{-m} . Given E , one can compute the sequence $m_i = \max(E \cap [0, i])$ converging to m . The idea is that at stage i , we produce a copy of (X, A) that is translated and scaled by 2^{-m_i} . If at stage $i+1$, one has $m_{i+1} = m_i$ then we keep that copy. If $m_{i+1} > m_i$, then we move to another copy. The new scaling factor is $2^{-m_{i+1}}$ and we choose the translation so that the new copy is contained in the current $\tau_{\text{up}\mathcal{V}}^2$ neighborhood of the previous copy. It is possible because we can assume that at stage i , the $\tau_{\text{up}\mathcal{V}}^2$ neighborhood contains a ball of diameter 2^{-i} , and $2^{m_{i+1}} = 2^{i-1}$. \square

In the other direction, we can prove that $\text{SCT}_{(X,A)} \leq_W \mathbf{C}_{\mathbb{N}}$ holds when (X, A) has strong computable type in a particular way. A strong Weihrauch reduction is impossible, because $\mathbf{C}_{\mathbb{N}}$ has countably many possible outputs while $\text{SCT}_{(X,A)}$ has uncountably many.

Theorem 4.4.2. Let \mathcal{P} be a Σ_2^0 invariant in $\tau_{\text{up}\mathcal{V}}^2$. If a compact pair (X, A) is \mathcal{P} -minimal then $\text{SCT}_{(X,A)} \leq_W \mathbf{C}_{\mathbb{N}}$.

Proof. As $\mathcal{K}(Q)$ is a metric space, \mathcal{P} is of the form $\mathcal{P} = \bigcup_n \mathcal{P}_n$ where \mathcal{P}_n are uniformly Π_1^0 -sets in $\tau_{\text{up}\mathcal{V}}^2$. Given a copy (Y, B) , let $E = \{n : (Y, B) \in \mathcal{P}_n\}$. From (Y, B) in $\tau_{\text{up}\mathcal{V}}^2$ one can enumerate the complement of E , and given any $n \in E$, one can compute Y by using the fact that (Y, B) is \mathcal{P}_n -minimal as in the proof of Theorem 4.3.1. \square

We do not know whether $\text{SCT}_{(X,A)}$ is always Weihrauch reducible to $\mathbf{C}_{\mathbb{N}}$ when (X, A) has strong computable type. It is left as an open question (Question 6.8.2).

4.4.5 Discussion: Vietoris vs Upper Vietoris Topology

We now relate the descriptive complexity of properties of compact pairs in the Vietoris topology $\tau_{\mathcal{V}}^2$ and upper Vietoris topology $\tau_{\text{up}\mathcal{V}}^2$. As $\tau_{\text{up}\mathcal{V}}^2$ is weaker than $\tau_{\mathcal{V}}^2$, the descriptive complexity of a property in $\tau_{\text{up}\mathcal{V}}^2$ is always an upper bound on its complexity in $\tau_{\mathcal{V}}^2$. Although the properties of a given complexity level are not the same in the topologies $\tau_{\mathcal{V}}^2$ and $\tau_{\text{up}\mathcal{V}}^2$, we show that they actually induce the same class of minimal elements.

Notation. For a property of compact pairs \mathcal{P} let

$$\uparrow\mathcal{P} = \{(X, A) \subseteq Q : \exists(X', A') \subseteq (X, A), (X', A') \in \mathcal{P}\}.$$

Proposition 4.4.4

Let \mathcal{P} be a property of compact pairs. The set $\uparrow\mathcal{P}$ has the same minimal elements as \mathcal{P} and

1. If \mathcal{P} is Π_1^0 in $\tau_{\mathcal{V}}^2$, then $\uparrow\mathcal{P}$ is Π_1^0 in $\tau_{\text{up}\mathcal{V}}^2$,
2. If \mathcal{P} is Σ_2^0 in $\tau_{\mathcal{V}}^2$, then $\uparrow\mathcal{P}$ is Σ_2^0 in $\tau_{\text{up}\mathcal{V}}^2$; moreover, $\uparrow\mathcal{P} = \bigcup_n \mathcal{P}_n$ where \mathcal{P}_n are uniformly Π_1^0 in $\tau_{\text{up}\mathcal{V}}^2$.

Therefore, whether a compact pair (X, A) is minimal for some Π_1^0 or Σ_2^0 property does not depend on the topology (among $\tau_{\mathcal{V}}^2$ and $\tau_{\text{up}\mathcal{V}}^2$) in which the complexity is measured.

In order to prove Proposition 4.4.4, we need the next result.

Lemma 4.4.1

The relation \subseteq , which is the set $\{(X, X') \in \mathcal{K}^2(Q) : X \subseteq X'\}$, is Π_1^0 in the topology $\tau_{low\mathcal{V}} \times \tau_{up\mathcal{V}}$.

Proof. One has $X \not\subseteq X'$ iff there exists a rational ball B intersecting X and such that X' is contained in $Q \setminus \overline{B}$. This condition on the pair (X, X') is an effective open set in the topology $\tau_{low\mathcal{V}} \times \tau_{up\mathcal{V}}$. In other words, inclusion is Π_1^0 in that topology. \square

Proof of Proposition 4.4.4. It is easy to see that \mathcal{P} and $\uparrow\mathcal{P}$ have the same minimal elements. Now assume that \mathcal{P} is Π_1^0 in $\tau_{\mathcal{V}}^2$ and let us show that $\uparrow\mathcal{P}$ is Π_1^0 in $\tau_{up\mathcal{V}}^2$. One has

$$(X, A) \in \uparrow\mathcal{P} \iff \exists(X', A') \in \mathcal{K}^2(Q), (X', A') \subseteq (X, A) \text{ and } (X', A') \in \mathcal{P}.$$

Using Lemma 4.4.1 and the assumption that \mathcal{P} is Π_1^0 in $\tau_{\mathcal{V}}^2$, the relation $R := \{(X, A, X', A') : (X', A') \subseteq (X, A) \text{ and } (X', A') \in \mathcal{P}\}$ is Π_1^0 in the topology $\tau_{up\mathcal{V}}^2 \times \tau_{\mathcal{V}}^2$. The space $(\mathcal{K}^2(Q), \tau_{\mathcal{V}}^2)$ is effectively compact, so the projection of R on its first two components, which is $\uparrow\mathcal{P}$, is Π_1^0 in the topology $\tau_{up\mathcal{V}}^2$ by Proposition 2.1.1.

The second item is now easy to prove. If \mathcal{P} is Σ_2^0 in $\tau_{\mathcal{V}}^2$, then $\mathcal{P} = \bigcup_n \mathcal{P}_n$ where \mathcal{P}_n are uniformly Π_1^0 in $\tau_{\mathcal{V}}^2$. Therefore, $\uparrow\mathcal{P} = \bigcup_n \uparrow\mathcal{P}_n$ and $\uparrow\mathcal{P}_n$ are uniformly Π_1^0 in $\tau_{up\mathcal{V}}^2$ by the first statement, so $\uparrow\mathcal{P}$ is Σ_2^0 in $\tau_{up\mathcal{V}}^2$. \square

4.5 Failing to have Computable Type

It is easy to prove that the line segment does not have computable type.

Indeed, the line segment $I = [0, 1]$, embedded in the simplest way as $[0, 1] \times \{q\} \subseteq Q$ where $q = (0, 0, \dots)$, is computable. However, if $A \subseteq \mathbb{N}$ is the halting set (a non-computable c.e. set) and $x_A = \sum_{n \in A} 2^{-n-1}$, then $[x_A, 1] \times \{q\}$ is a copy of I which is semicomputable but not computable.

Similar constructions can be made with disks, and more generally n -dimensional balls. For other spaces, it may not be easy to create a semicomputable copy which is not computable, in this section we obtain some results about this.

4.5.1 Computable Witnesses

The findings presented in [6] shed light on the connection between topology and computability, offering valuable insights that can be employed to distinguish various notions of computability in specific scenarios. The study delved into situations where two topologies imposed on the same space result in distinct sets of computable points. As a concrete application, we provide a means to construct a semicomputable yet non-computable copy of a given compact set, a task that would be arduous to accomplish directly (Theorem 4.5.2).

Comparing Computability in Three Topologies

Definition 4.5.1. On a space X endowed with two effective countably-based topologies τ_1, τ_2 , we say that τ_1 is **effectively weaker** than τ_2 if the basic τ_1 -open sets are effective τ_2 -open sets, uniformly.

If C is a subset of X , then a topology on X induces a topology on C , obtained by intersecting the open sets with C . We say that τ and τ' **agree** on C if they induce the same topology on C .

4. Strong Computable Type

Let (X, τ) be a computable Polish space and τ_1, τ_2 be effective countably-based topologies such that τ_1 is effectively weaker than τ_2 and τ_2 is effectively weaker than τ . We want to build a τ_1 -computable point that is not τ_2 -computable.

Recall the definition of a generically weaker topology (Definition 3.8 in [6]).

Definition 4.5.2. We say that τ_1 is **τ -generically weaker** than τ_2 if every set $C \subseteq X$ on which τ_1 and τ_2 agree is τ -meager.

“meager” can be equivalently replaced by “nowhere dense” (see Remark 3.2 in [6]). An effective version of being generically τ -weaker was introduced in [6] which led to Theorem 4.5.1 stated below.

Definition 4.5.3. Say that τ_1 is **effectively τ -generically weaker** than τ_2 if given $B \in \tau$, one can compute non-empty $B', B'' \in \tau$ and $U \in \tau_2$ such that:

- $B' \subseteq B \cap U$,
- $B'' \subseteq B \setminus U$,
- $B' \subseteq \text{cl}_{\tau_1}(B'')$, i.e., every τ_1 -open set intersecting B' intersects B'' .

Here, B, B' and U are basic open sets represented by indices, but B'' may be a general effective open set. It is an effective version of Definition 4.5.2, i.e. τ_1 is τ -generically weaker than τ_2 if and only if it is effectively so, relative to some oracle see Section 3.4 in [6]. We recall the following result (Theorem 3.5 in [6]), which is easily proved thanks to an effective Baire category theorem (see Theorem 2.1 in [6]).

Theorem 4.5.1. If τ_1 is effectively τ -generically weaker than τ_2 , then there exists $x \in X$ that is τ_1 -computable but not τ_2 -computable. Moreover, such a point can be found in any τ -dense $\Pi_2^0(\tau)$ -set.

Note that the proof utilizes the priority method with finite injury. However, thanks to the effective Baire category theorem (refer to Theorem 2.1 in [6]), the proof is significantly streamlined. Essentially, one needs to provide a strategy to counteract a Turing machine’s attempt to τ_2 -compute x , and the effective Baire category theorem seamlessly handles the interplay between these strategies.

Application to Computable Type

In this section, we give an application of Theorem 4.5.1 to give a clear and complete proof of Theorem 4.5.2. Let us first introduce the relevant notions.

In a more intuitive manner, the following definition signifies that the pair does not effectively fulfill the generalized ϵ -surjection property for every $\epsilon > 0$.

Definition 4.5.4. Let (X, A) be a compact pair in Q . For $\epsilon > 0$, say that $\delta > 0$ is an **ϵ -witness** if there exists a continuous function $f : (X, A) \rightarrow (X, A)$ such that $d_X(f, \text{id}_X) < \epsilon$ and $d_H(X, f(X)) > \delta$.

Say that (X, A) has **computable witnesses** if there exists a computable function sending each rational $\epsilon > 0$ to a rational ϵ -witness $\delta > 0$.

Theorem 4.5.2. Let $(X, A) \subseteq Q$ be a pair of semicomputable compact sets. If it has computable witnesses, then (X, A) does not have computable type, i.e. there exists a semicomputable copy of (X, A) such that the copy of X is not computable.

It is possible to prove more generally an effective contra-position of Corollary 4.4.1: if we assume that $(X, A) \subseteq Q$ is semicomputable and that given $\epsilon > 0$ one can compute $\delta > 0$ such that ϵ -deformations of (X, A) converge to a proper compact subpair $(Y, B) \subsetneq (X, A)$ with $d_H(Y, X) > \delta$, then (X, A) does not have computable type. Note that neither the ϵ -deformations nor the limit Y are required to be computable. The computability assumption is only about the function sending ϵ to δ .

This result therefore identifies a general situation when computable type is equivalent to strong computable type.

Remark 4.5.1

The statement given in Theorem 4.5.2 appearing in [6] is slightly stronger than the statement appearing in [4]. Indeed, in [4] the pair (X, A) is assumed to be computable. Moreover, the notion of witness defined here (and in [6]) is weaker than the one in [4] (where f should be the identity on A). We have realized that this stronger result holds because the proof presented here is simpler and identifies more clearly the needed assumptions.

We now give a proof by applying Theorem 4.5.1.

We assume that (X, A) is embedded as a semicomputable compact pair in Q which has computable witnesses. First, if X is not computable then (X, A) does not have computable type and the result is proved. Therefore, we can assume for the rest of the proof that X is computable (however, A may not be computable). Consider the space $\mathcal{C}(X, Q)$ of continuous functions from X to Q . It is endowed with a complete computable metric $d(f, g) = \max_{x \in Q} d_Q(f(x), g(x))$, inducing a topology τ . The subspace $\mathcal{I}(X, Q)$ of injective continuous functions from X to Q is a dense Π_2^0 subset (complement of a Σ_2^0 set), in particular it contains a dense computable sequence. We consider two weaker topologies τ_1 and τ_2 on $\mathcal{C}(X, Q)$.

For each pair (U, V) of finite unions of basic open subsets of Q , let

$$\mathcal{V}_{U,V} = \{f \in \mathcal{C}(X, Q) : f(X) \subseteq U, f(A) \subseteq V\}$$

and let τ_1 be the topology generated by the sets $\mathcal{V}_{U,V}$ as a subbasis.

For each basic open subset B of Q , let

$$\mathcal{U}_B = \{f \in \mathcal{C}(X, Q) : f(X) \cap B \neq \emptyset\}$$

and let τ_2 be the topology generated by the sets \mathcal{U}_B and $\mathcal{V}_{U,V}$ as a subbasis.

Our goal is to build an injective continuous function $f \in \mathcal{C}(X, Q)$ such that $f(X)$ and $f(A)$ are semicomputable but $f(X)$ is not computable; in other words, we want f to be τ_1 -computable but not τ_2 -computable.

We will apply Theorem 4.5.1, so we need to show that τ_1 is τ -generically weaker than τ_2 .

Lemma 4.5.1

Let $X \subseteq Q$ be a computable compact set and A be a semicomputable compact subset of X . If the pair (X, A) has computable witnesses, then the topology τ_1 is effectively generically τ -weaker than τ_2 .

Proof. We can assume that the centers of the basic metric balls in $(\mathcal{C}(X, Q), d)$ are injective functions. Given a metric ball $B = B_d(g_0, \epsilon)$ in $\mathcal{C}(X, Q)$ (where g_0 and ϵ are computable and g_0 is injective), we need to compute B', B'', U as in Definition 4.5.3. We are going to compute some suitable positive $\epsilon' < \epsilon$ and define:

- $B' = B_d(g_0, \epsilon')$,
- $B'' = \{g \in \mathcal{C}(X, Q) : d(g, g_0) < \epsilon \text{ and } d_H(g(X), g_0(X)) > \epsilon'\}$,

- $U = \{g \in \mathcal{C}(X, Q) : d_H(g(X), g_0(X)) < \epsilon'\}$.

These sets are clearly effective open sets in the respective topologies. Note that $B' \subseteq B \cap U$ and $B'' \subseteq B \setminus U$. We now explain how to choose ϵ' so that B' is contained in $\text{cl}_{\tau_1}(B'')$.

Compute $\delta < \epsilon/2$ such that $d_Q(x, y) < \delta$ implies $d_Q(g_0(x), g_0(y)) < \epsilon/2$. It implies that for all continuous functions $g, h : Q \rightarrow Q$,

$$\text{If } d(h, g_0) < \delta \text{ and } d(g, \text{id}_X) < \delta, \text{ then } d(h \circ g, g_0) < \epsilon. \quad (4.1)$$

Indeed, $d(h \circ g, g_0) \leq d(h \circ g, g_0 \circ g) + d(g_0 \circ g, g_0) < \delta + \epsilon/2 \leq \epsilon$.

Compute β , a δ -witness for (X, A) . Compute $\epsilon' \leq \delta$ such that for all $x, y \in X$, $d_Q(g_0(x), g_0(y)) \leq 2\epsilon'$ implies $d_Q(x, y) \leq \beta$. It implies that for all non-empty compact sets $Y, Z \subseteq X$,

$$\text{If } d_H(Y, Z) > \beta, \text{ then } d_H(g_0(Y), g_0(Z)) > 2\epsilon'. \quad (4.2)$$

We now check that B' is contained in $\text{cl}_{\tau_1}(B'')$. Let $h \in B' = B_d(g_0, \epsilon')$. As β is an δ -witness, there exists $g : X \rightarrow X$ such that $g(A) \subseteq A$, $d(g, \text{id}_X) < \delta$ and $d_H(X, g(X)) > \beta$. We define $g_1 = h \circ g$ and show that $g_1 \in B''$. One has $d(g_1, g_0) < \epsilon$ by (4.1), and

$$\begin{aligned} d_H(g_1(X), g_0(X)) &\geq d_H(g_0(X), g_0 \circ g(X)) - d_H(g_0 \circ g(X), h \circ g(X)) \\ &> 2\epsilon' - d(g_0, h) > \epsilon' \quad \text{by (4.2),} \end{aligned}$$

so $g_1 \in B''$. Moreover, $g_1(X) = h(g(X))$ is contained in $h(X)$ and $g_1(A) = h(g(A)) \subseteq h(A)$, so h belongs to $\text{cl}_{\tau_1}(\{g_1\}) \subseteq \text{cl}_{\tau_1}(B'')$. We have proved that $B' \subseteq \text{cl}_{\tau_1}(B'')$. \square

Proof of Theorem 4.5.2. The subset of injective continuous functions from X to Q is a τ -dense $\Pi_2^0(\tau)$ -subset of $\mathcal{C}(X, Q)$. Therefore, applying Theorem 4.5.1, there exists an injective continuous function $f : X \rightarrow Q$ that is τ_1 -computable but not τ_2 -computable. In other words, the pair $(f(X), f(A))$ is semicomputable, but $f(X)$ is not computable. \square

It may seem that using the effective Baire category theorem (see Theorem 2.1 in [6]) and Theorem 4.5.1 in [6] is a rather convoluted path to proving Theorem 4.5.2. A more direct proof is indeed possible (see [5]), but at the cost of readability, because there are many ingredients to take care of and to put together. These theorems isolate the appropriate concepts that make the construction possible, separating the specific properties of the application (Lemma 4.5.1) from the general construction the effective Baire category theorem (see Theorem 2.1 in [6]) and Theorem 4.5.1 in [6].

4.5.2 Simple copies

When a set or a pair lacks computable type, the task of constructing a semicomputable copy that is not computable can vary in terms of difficulty. For instance, it is straightforward to show that the line segment I does not have computable type (as a single set, i.e. without its boundary): if $r > 0$ is a non-computable right-c.e. real number, then $[0, r]$ is a semicomputable copy of I which is not computable.

However, for other sets such as the dunce hat (see Definiton 6.7.1) or the set shown in Figure 4.4a below, there is no such obvious construction. We can formulate a precise statement expressing this idea, by using the results obtained so far, notably Theorem 4.3.1.

Definition 4.5.5. Let X, Y be compact metric spaces and $f : X \rightarrow Y$ be continuous. A **modulus of uniform continuity** for f is a function $\mu : \mathbb{N} \rightarrow \mathbb{N}$ such that if $d(x, x') < 2^{-\mu(n)}$ then $d(f(x), f(x')) \leq 2^{-n}$.

The choice of strict and non-strict inequalities is not important, but is convenient as it makes the set of functions having modulus μ a closed subset of the space $\mathcal{C}(X, Y)$ of continuous functions from X to Y .

For instance, a Lipschitz function with Lipschitz constant L has a modulus of uniform continuity $\mu(n) = n + \lceil \log_2(L) \rceil$.

Definition 4.5.6. Let $X \subseteq Q$. A copy Y of X in Q is a **simple copy** of X if there exists a homeomorphism $f : X \rightarrow Y$ such that both f and f^{-1} have a computable modulus of uniform continuity.

Theorem 4.5.3. (Computability of simple copies) Let $X \subseteq Q$ be a computable compact set that does not properly contain a copy of itself. Let Y be a simple copy of X . If Y is semicomputable then Y is computable.

In particular, if X is computable and does not properly contain a copy of itself, then there is no geometrical transformation (scaling, rotation, translation) yielding a semicomputable copy of X which is not computable, and more generally there is no bilipschitz transformation yielding such a copy.

We need the following result which is folklore, but does not seem to appear in the literature.

Lemma 4.5.2

Let $X \subseteq Q$ be a computable compact set and let $\mu : \mathbb{N} \rightarrow \mathbb{N}$ be computable. The set

$$\mathcal{K}_\mu := \{f \in \mathcal{C}(X, Q) : \mu \text{ is a modulus of uniform continuity of } f\}$$

is effectively compact.

Proof. Let $(x_i)_{i \in \mathbb{N}}$ be a dense computable sequence in X . If μ is a computable modulus of continuity of f , then an access to a name of $f \in \mathcal{K}_\mu$ is computably equivalent to an access to the values of f on this dense sequence, because using those values and the modulus of continuity, one can computably evaluate f at any point. In other words, the set \mathcal{K}_μ is computably homeomorphic to the set

$$\mathcal{L}_\mu := \{(z_i)_{i \in \mathbb{N}} \in Q^{\mathbb{N}} : \forall i, j, n \in \mathbb{N}, d(x_i, x_j) < 2^{-\mu(n)} \implies d(z_i, z_j) \leq 2^{-n}\}$$

via the map sending $f \in \mathcal{K}_\mu$ to the sequence $(f(x_i))_{i \in \mathbb{N}}$. The space $Q^{\mathbb{N}}$ is effectively compact and \mathcal{L}_μ is a Π_1^0 -subset of $Q^{\mathbb{N}}$, therefore \mathcal{L}_μ is effectively compact, and so is \mathcal{K}_μ . \square

We now prove the result.

Proof of Theorem 4.5.3. Let $\mu : \mathbb{N} \rightarrow \mathbb{N}$ be a computable function. The set \mathcal{J}_μ of injective continuous functions $f : X \rightarrow Q$ such that μ is a modulus of uniform continuity for both f and f^{-1} is an effectively compact subset of $\mathcal{C}(X, Q)$. Indeed, \mathcal{J}_μ is the intersection of \mathcal{K}_μ from Lemma 4.5.2 with

$$\{f \in \mathcal{C}(X, Q) : \forall x, x' \in X, d_Q(f(x), f(x')) < 2^{-\mu(n)} \implies d_Q(x, x') \leq 2^{-n}\},$$

as the latter set is Π_1^0 , its intersection with \mathcal{K}_μ is effectively compact.

Let $\mathcal{P}_\mu = \{f(X) : f \in \mathcal{J}_\mu\}$. As X is computable, the function $\phi : \mathcal{C}(X, Q) \rightarrow (\mathcal{K}(Q), \tau_\gamma)$ sending f to $f(X)$ is computable. As \mathcal{J}_μ is effectively compact, its image \mathcal{P}_μ by ϕ is effectively compact as well, so \mathcal{P}_μ is a Π_1^0 -subset of $\mathcal{K}(Q)$ in the topology τ_γ . As X does not properly contain a copy of itself, any copy of X in \mathcal{P}_μ is \mathcal{P}_μ -minimal. Therefore, any semicomputable copy of X in \mathcal{P}_μ is computable, by the same argument as in the proof of Theorem 4.3.1. \square

4.5.3 An Example

Figure 4.4: A disk attached to a pinched torus and its ϵ -deformations

Figure 4.5: A semicomputable copy of a disk attached to a pinched torus which is not computable

Example 4.5.1

The set X shown in Figure 4.4a, consisting of a disk attached to a pinched torus, does not have computable type.

It can be proved using the results in Section 6.7.1 and Section 4.5.1. Indeed, the neighborhood of the pinched point is the cone of a graph consisting of two circles attached by a line segment (see Proposition 6.7.1); the line segment is not part of a cycle in the graph, implying that the set does not have computable type. Another way to prove that it does not have computable type is to use the fact that for every $\epsilon > 0$, there is a sequence of ϵ -deformations of X converging to a proper subset of X (see Figure 4.4b). Therefore, it does not have strong computable type by Corollary 4.4.1 (and in fact, it does not have computable type as it is a finite simplicial complex (Corollary 6.7.1).

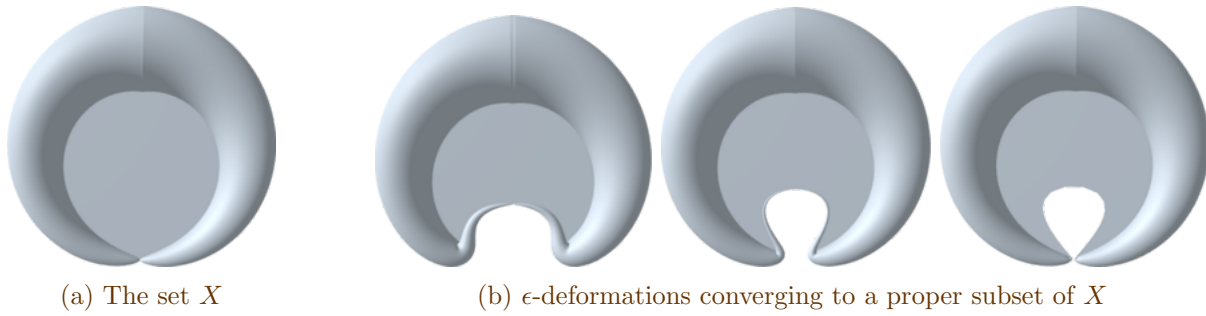
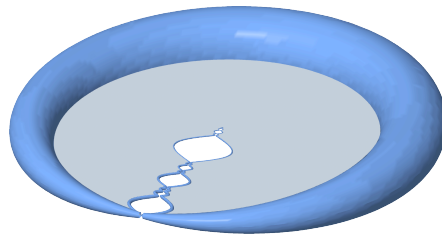
As X does not contain a copy of itself, it has no simple copy which is semicomputable but not computable. It explains why the proof, given in [4, 6], that such sets do not have computable type is not straightforward.

A semicomputable copy of X which is not computable is illustrated in Figure 4.5. It could be obtained more directly by encoding the halting set: if $(n_i)_{i \in \mathbb{N}}$ is a computable one-to-one enumeration of the halting set, then the holes appearing in the disk have sizes $2^{-n_0}, 2^{-n_1}, \dots$ etc.

4.6 Conclusion

IN this chapter, we reduced the notion of computable type to the Hilbert cube and introduced the notion of strong computable type which is more flexible. We obtained characterizations of spaces which have strong computable type. In addition, we proved that being minimal satisfying some Σ_2^0 invariant is sufficient for a compact space to have strong computable type whereas satisfying the ϵ -surjection property is necessary. Furthermore, we studied the measure of the non-uniformity of the computation. Finally, we investigated how some spaces fail to have computable type.

Chapter 5

Descriptive Complexity of Topological Invariants

Contents

5.1	Introduction	66
5.2	Computability-Theoretic Properties of ANRs	67
5.2.1	Absolute Neighborhood Retracts (ANRs)	67
5.2.2	Homotopy Classes	67
5.2.3	Families of Σ_2^0 Invariants	69
1)	Extension of Functions	69
2)	Null-Homotopy of Functions	70
5.3	Detailed study of some Σ_2^0 Invariants	70
5.3.1	Properties of $E(Y)$	70
	Converging Sequences	71
5.3.2	The Invariant E_n	72
	Relationship with Dimension	73
5.3.3	The Invariant H_n	73
	Relationship with Dimension	75
5.3.4	Connections with Homology and Cohomology	77
1)	Partial Characterization of E_n	77
2)	Partial Characterization of H_n	77
5.4	Application to Strong Computable Type	78
5.4.1	Examples of E_n -Minimal Pairs	78
1)	Chainable Continuum Between Two Points	78
2)	Pseudo n -Cubes	79
3)	A New Example	80
5.4.2	Compact n -Manifolds are H_n -Minimal	81
5.4.3	Circularly Chainable Continuum Which Are Not Chainable	82
5.4.4	A space that properly contains copies of itself	83
5.5	Π_1^0 Invariants	84
5.5.1	Approximations	85
5.6	Σ_2^0 Invariants	87
5.6.1	Strong Approximation	87
	The Closed Topologist's Sine Curve and the Line Segment	88

5.6.2	Cylinder	89
5.6.3	Wedge Sum	89
5.7	Separating Finite Topological Graphs	90
5.7.1	Modulus of Local Connectedness	90
5.7.2	Effective vs Non-Effective Classes	91
5.7.3	Separating Graphs	93
	Proof of the Main Theorem	94
5.8	Conclusion	97

The results stated in this chapter can be found in [8] and [7].

5.1 Introduction

WHEN analyzing the topology of a subset of the plane or a Euclidean space, several fundamental questions arise: How challenging is it to understand the topological properties of the set? Can we determine if it is homeomorphic to a specific space? How difficult is it to distinguish between two different spaces? More generally, what is the complexity involved in testing whether the set satisfies a particular topological invariant?

These questions can be approached in various ways, depending on the class of allowed spaces, the method of description, and the notion of complexity used to measure the difficulty of topological invariants.

In this chapter, our focus is on compact subsets of Euclidean spaces, and more generally compact subsets of the Hilbert cube $[0, 1]^{\mathbb{N}}$. Descriptions of such subsets essentially convey information about which voxels or rational balls intersect with them. However, these descriptions are limited in the sense that they do not provide structural or combinatorial details. For example, if the space is a topological graph, the description does not offer direct access to its combinatorial representation. As a result, no topological invariant can be determined in finite time. Therefore, the relevant measure of complexity is descriptive complexity, which quantifies the difficulty of expressing a property in terms of simpler properties. In its effective form, descriptive complexity measures the difficulty of expressing the property using a logical formula or a program.

The primary purpose of topological invariants is to distinguish between different topological spaces and demonstrate their non-homeomorphism. An invariant is considered interesting if it can effectively differentiate between spaces and contributes to a rich theoretical framework. From a logical or computational standpoint, an invariant is also valuable if it is straightforward to test.

In this chapter, our overarching goal is to understand which topological invariants can be tested or described using a limited level of complexity. We tackle the following specific problems:

- Characterize, to the extent possible, the topological invariants corresponding to a given level of complexity.
- For a restricted class of spaces, particularly for pairs of spaces, determine the minimum level of complexity required to distinguish all the spaces in that class.
- Given a specific space, ascertain the complexity involved in recognizing that space.

The study of descriptive complexity in topological invariants is particularly intriguing as it lies at the intersection of two branches of topology: point-set topology and algebraic topology. Descriptive complexity is part of point-set topology as it focuses on expressing sets of points in terms of open sets. Algebraic topology, on the other hand, offers topological invariants with low descriptive complexity.

While descriptive complexity of topological invariants has been explored in previous studies, our approach differs. Rather than determining the descriptive complexity of invariants provided by

topology, we choose a complexity level and search for expressive invariants that possess that level of complexity. We investigate which spaces can be distinguished using invariants of that complexity level. Our particular emphasis is on invariants of low complexity, specifically \mathbb{I}_1^0 and \mathbb{S}_2^0 invariants. We are motivated to study \mathbb{S}_2^0 invariants because they play a crucial role in the study of the computability properties of topological spaces such as strong computable type (see Chapter 4).

In Section 5.2, we show how the classical notion of Absolute Neighborhood Retract (ANR) behaves well in terms of computability, and allows to define topological invariants of low descriptive complexity, expressing extensibility and null-homotopy of continuous functions to ANRs. In Section 5.3 we study these invariants in more details. We apply the theory in Section 5.4 to revisit many previous results about computable type. In Section 5.5, we study \mathbb{I}_1^0 invariants. In Section 5.6 we study \mathbb{S}_2^0 invariants. In Section 5.7, we show how to separate finite topological graphs.

5.2 Computability-Theoretic Properties of ANRs

Theorem 4.3.2 gives a simple way to prove that a compact pair (X, A) has strong computable type by identifying a Σ_2^0 topological invariant for which (X, A) is minimal. In order to apply this result, we need to find suitable Σ_2^0 invariants. In this section, we develop results of independent interest that will be applied to define Σ_2^0 invariants, expressed in terms of extensions of continuous functions.

At the heart of our framework lies the concept of an Absolute Neighborhood Retract (ANR), which holds significant importance in topology. Interestingly, ANRs possess valuable properties from a computability-theoretic perspective, and we will leverage these properties to define Σ_2^0 invariants. The general idea is that the space of functions from a space X to a space Y cannot be handled in a computable way if Y is arbitrary; it can if Y is an ANR.

We explore the computable aspects of ANRs. The results will be applied in the next section.

5.2.1 Absolute Neighborhood Retracts (ANRs)

We point out that computability-theoretic aspects of compact ANRs have been studied by Collins in [24], although we do not use these results.

The results we give here have important computability-theoretic consequences, because arbitrary functions can be replaced by computable functions that are close enough to the original ones so that they are homotopic.

5.2.2 Homotopy Classes

Let Y be a fixed compact ANR. Given a compact set $X \subseteq Q$ in the upper Vietoris topology, we show that the set $[X; Y]$ can be computed in some way. Note that this question has been addressed, for instance in [63], when X and Y are simplicial complexes presented as combinatorial objects. In our case, the information available about X and Y is much more elusive, therefore one might expect that very little can be computed. Note that computable aspects of ANRs have been investigated by Collins [24], where a compact ANR Y is presented together with a neighborhood and a computable retraction. In our case, we do not have access to a retraction.

In order to state the results, let us discuss the consequences of Borsuk's homotopy extension theorem (Theorem 3.3.1). Let (X, A) be a compact pair. Whether a continuous function $f : A \rightarrow Y$ has a continuous extension $F : X \rightarrow Y$ depends on its equivalence class in $[A; Y]$. We denote this class by $[f]_A$ to make it clear that f is defined on A and that we consider homotopies defined on A (rather than X). If $f : A \rightarrow Y$ and $F : X \rightarrow Y$ are continuous functions, then we say that $[F]_X$ **extends** $[f]_A$ if F is homotopic to an extension of f . This relation is well-defined, i.e. does not depend on the representatives of the equivalence classes, because if F extends f , $[g]_A = [f]_A$

and $[G]_X = [F]_X$, then G is homotopic to an extension of g by Borsuk's homotopy extension theorem. In particular, $[F]_X$ extends $[f]_A$ if and only if $[F|_A]_A = [f]_A$.

A **numbering** of a set S is a surjective partial function $\nu_S : \subseteq \mathbb{N} \rightarrow S$.

Theorem 5.2.1. Let Y be a fixed compact ANR. To any compact set $X \subseteq Q$ we can associate a numbering $\nu_{[X;Y]}$ of $[X;Y]$ such that:

1. $\text{dom}(\nu_{[X;Y]})$ is c.e. relative to X ,
2. Equality $\{(i, j) \in \text{dom}(\nu_{[X;Y]})^2 : \nu_{[X;Y]}(i) = \nu_{[X;Y]}(j)\}$ is c.e. relative to X ,
3. For any compact pair (X, A) , the extension relation

$$\{(i, j) \in \text{dom}(\nu_{[X;Y]}) \times \text{dom}(\nu_{[A;Y]}) : \nu_{[X;Y]}(i) \text{ extends } \nu_{[A;Y]}(j)\}$$

is c.e. relative to X and A ,

4. For any compact pair (X, A) , the extensibility predicate

$$\{i \in \text{dom}(\nu_{[A;Y]}) : \nu_{[A;Y]}(i) \text{ has a continuous extension to } X\}$$

is c.e. relative to X and A ,

where X and A are given as elements of $(\mathcal{K}(Q), \tau_{up\nu})$.

Note that the result holds with no computability assumption about Y . We now proceed with the proof of this result.

Lemma 5.2.1

If $Y \subseteq Q$ is a compact ANR, then there exist an effective open set U containing Y , a retraction $r : U \rightarrow Y$ and $\mu, \alpha > 0$ such that:

1. *Functions to Y that are α -close are homotopic,*
2. *For $x \in U$, $d_Q(r(x), x) < \mu$,*
3. *For $x, y \in U$, $d_Q(x, y) < \mu$ implies $d_Q(r(x), r(y)) < \alpha$.*

Proof. The number α exists by Lemma 3.3.2. As Y is an ANR, there exists an open set W containing Y and a retraction $r : W \rightarrow Y$. Let V be an open set such that $Y \subseteq V \subseteq \bar{V} \subseteq W$. As \bar{V} is compact, r is uniformly continuous on \bar{V} so there exists $\mu > 0$ satisfying (iii) for $x, y \in \bar{V}$. As $r|_Y = \text{id}_Y$ and Y is compact, if x is sufficiently close to Y , $d_Q(r(x), x) < \mu$. Therefore we can choose $U \subseteq V$ satisfying 2. and by compactness of Y , U can be replaced by a finite union of rational balls. \square

Proof of Theorem 5.2.1. Let $(f_i)_{i \in \mathbb{N}}$ be a dense computable sequence of functions $f_i : Q \rightarrow Q$. Let $Y \subseteq Q$ be a compact ANR and let U, r, α, μ be provided by Lemma 5.2.1. For $X \subseteq Q$, we define a numbering $\nu_{[X;Y]}$ of $[X;Y]$ and prove (1), (4), (2) and (3) in this order. Its domain is

$$\text{dom}(\nu_{[X;Y]}) = \{i \in \mathbb{N} : f_i(X) \subseteq U\},$$

which is clearly c.e. relative to X , showing (1). For $i \in \text{dom}(\nu_{[X;Y]})$, we then define $\nu_{[X;Y]}(i)$ as the equivalence class of $r \circ f_i|_X : X \rightarrow Y$.

We first show that $\nu_{[X;Y]}$ is surjective. For a continuous function $f : X \rightarrow Y$, let $\tilde{f} : Q \rightarrow Q$ be a continuous extension of f . If f_i is sufficiently close to \tilde{f} , then $f_i(X) \subseteq U$ (hence $i \in \text{dom}(\nu_{[X;Y]})$) and $r \circ f_i|_X$ is α -close to f . Therefore, $r \circ f_i|_X$ is homotopic to f and $\nu_{[X;Y]}(i) = [f]$.

Let now (X, A) be a compact pair in Q and let $\nu_{[X;Y]}$ and $\nu_{[A;Y]}$ be the corresponding numberings. We show condition (4).

Claim 5.2.1

The set

$$\{i \in \text{dom}(\nu_{[X;Y]}) : \nu_{[A;Y]}(i) \text{ has a continuous extension to } X\}$$

is c.e. relative to X and A .

Proof of the claim. We show that $r \circ f_i|_A : A \rightarrow Y$ has a continuous extension to X iff there exists $j \in \text{dom}(\nu_{[X;Y]})$ such that $d_A(f_j, f_i) < \mu$. It will imply the result as this condition is c.e. relative to X and A .

If there exists such a j , then $d_A(r \circ f_j, r \circ f_i) < \alpha$ by Lemma 5.2.1 (iii) so $r \circ f_j|_A$ and $r \circ f_i|_A$ are homotopic by Lemma 5.2.1 (i). As $r \circ f_j|_A$ obviously has an extension $r \circ f_j|_X$, so does $r \circ f_i|_A$ by Borsuk's homotopy extension theorem (see Theorem 3.3.1).

Conversely, assume that $r \circ f_i|_A$ has an extension $f : X \rightarrow Y$. One has $d_A(f, f_i) = d_A(r \circ f_i, f_i) < \mu$ by Lemma 5.2.1 (ii) so if f_j is sufficiently close to f on X , then $f_j(X) \subseteq U$ and $d_A(f_j, f_i) < \mu$. \square

We now show (2), i.e. that equality is c.e. Let $\text{Cyl}(X) = [0, 1] \times X \subseteq Q$ be the cylinder of X and $\partial\text{Cyl}(X) = \{0, 1\} \times X$ its boundary. These sets are semicomputable relative to X . A pair (f, g) of functions from X to Y is nothing else than a function $h : \partial\text{Cyl}(X) \rightarrow Y$, defined as $h(x, 0) = f(x)$ and $h(x, 1) = g(x)$. This correspondence is moreover effective, in the sense that there exists a computable function $\varphi : \text{dom}(\nu_{[X;Y]}) \rightarrow \text{dom}(\nu_{[\partial\text{Cyl}(X);Y]})$ such that if i, j are indices of the homotopy classes of f and g respectively, then $\varphi(i, j)$ is an index of the homotopy class of h . Note that f, g are homotopic iff h has a continuous extension to $\text{Cyl}(X)$. Therefore, for $i, j \in \text{dom}(\nu_{[X;Y]})$, one has $\nu_{[X;Y]}(i) = \nu_{[X;Y]}(j)$ iff $\nu_{[\partial\text{Cyl}(X);Y]}(\varphi(i, j))$ has an extension to $\text{Cyl}(X)$, which is c.e. relative to X by Claim 5.2.1 applied to the pair $(\text{Cyl}(X), \partial\text{Cyl}(X))$.

We finally show (3), i.e. the extension relation is c.e. Note that $\text{dom}(\nu_{[X;Y]}) \subseteq \text{dom}(\nu_{[A;Y]})$ and for $i \in \text{dom}(\nu_{[X;Y]})$, $\nu_{[A;Y]}(i)$ is the equivalence class of the restrictions to A of functions in $\nu_{[X;Y]}(i)$. For $i \in \text{dom}(\nu_{[X;Y]})$ and $j \in \text{dom}(\nu_{[A;Y]})$, $\nu_{[X;Y]}(i)$ extends $\nu_{[A;Y]}(j)$ iff $\nu_{[A;Y]}(i) = \nu_{[A;Y]}(j)$, which is c.e. \square

5.2.3 Families of Σ_2^0 Invariants

The previous results enable us to define families of Σ_2^0 invariants. We will study their properties and use particular instances in the next sections.

1) Extension of Functions

To each compact ANR Y we associate a topological invariant $E(Y)$. Ultimately, we will focus on $Y = S_n$, the n -dimensional sphere.

Definition 5.2.1. (The invariant $E(Y)$) Let Y be a topological space. A compact pair (X, A) belongs to $E(Y)$ if there exists a continuous function $f : A \rightarrow Y$ that cannot be extended to a continuous function $g : X \rightarrow Y$.

Note that this definition is only interesting when A is non-empty, otherwise it is never satisfied.

From this definition, the obvious upper bound on the descriptive complexity of $E(Y)$ is Σ_2^1 . However when Y is a compact ANR, we show that the complexity drops down to Σ_2^0 , which is much lower and is an effective class, even if there is no computability assumption on Y .

Corollary 5.2.1. If Y is a compact ANR, then $E(Y)$ is a Σ_2^0 invariant in $\tau_{up\nu}^2$.

Proof. It is a simple application of Theorem 5.2.1. Indeed,

$$\begin{aligned} (X, A) \in E(Y) &\iff \exists f : A \rightarrow Y \text{ having no extension to } X, \\ &\iff \exists i \in \text{dom}(\nu_{[A;Y]}), \forall j \in \text{dom}(\nu_{[X;Y]}), \nu_{[X;Y]}(j) \text{ does not extend } \nu_{[A;Y]}(i) \end{aligned}$$

which is a Σ_2^0 condition. □

Note that although $E(Y)$ is a countable union of differences of closed sets, it is never a countable union of closed sets in $\tau_{up\nu}^2$ unless it is empty. Indeed, if $E(Y)$ is non-empty then it is not an upper set: take $(X, A) \in E(Y)$, and observe that $(X, X) \notin E(Y)$.

2) Null-Homotopy of Functions

The previous results provide another family of Σ_2^0 invariants.

Definition 5.2.2. (The invariant $H(Y)$) Let Y be a topological space. A space X belongs to $H(Y)$ if there exists a continuous function $f : X \rightarrow Y$ which is not null-homotopic, i.e. not homotopic to a constant function.

Corollary 5.2.2. If Y is a compact ANR, then $H(Y)$ is a Σ_2^0 invariant in $\tau_{up\nu}^2$.

Proof. One has $X \in H(Y)$ iff $[X; Y]$ is non-trivial iff $\exists i, j \in \text{dom}(\nu_{[X;Y]}), \nu_{[X;Y]}(i) \neq \nu_{[X;Y]}(j)$, which is a Σ_2^0 condition. Slightly differently, we fix some i_0 such that $f_{i_0} : Q \rightarrow Q$ is constant with value in U (implying $i_0 \in \text{dom}(\nu_{[X;Y]})$ for any X), so that $[X; Y]$ is non-trivial iff $\exists i \in \text{dom}(\nu_{[X;Y]}), \nu_{[X;Y]}(i) \neq \nu_{[X;Y]}(i_0)$. □

Again, $H(Y)$ is not a countable union of closed sets in $\tau_{up\nu}$ unless it is empty, because it is not an upper set in that case: the maximal set Q is not in $H(Y)$ because it is contractible.

The invariant $H(Y)$ only applies to single sets. We will define a version for compact pairs, with $Y = \mathbb{S}_n$.

5.3 Detailed study of some Σ_2^0 Invariants

We now study in details the Σ_2^0 invariants defined in the previous section.

5.3.1 Properties of $E(Y)$

We study the invariant $E(Y)$ from Definition 5.2.1, and develop a few techniques to establish whether a compact pair satisfies this invariant.

First, if A is a retract of X , then $(X, A) \notin E(Y)$. Indeed, every $f : A \rightarrow Y$ has an extension $f \circ r : X \rightarrow Y$, where $r : X \rightarrow A$ is a retraction.

The next result identifies a relation between compact pairs that preserves the invariant $E(Y)$.

Proposition 5.3.1

Let $\phi : (X', A') \rightarrow (X, A)$ such that $\phi|_{A'} : A' \rightarrow A$ is a homeomorphism. If $(X', A') \in \mathbf{E}(Y)$ then $(X, A) \in \mathbf{E}(Y)$.

Proof. We assume that $(X, A) \notin \mathbf{E}(Y)$ and show that $(X', A') \notin \mathbf{E}(Y)$. Let $f : A' \rightarrow Y$. The function $g = f \circ (\phi|_{A'})^{-1} : A \rightarrow Y$ has a continuous extension $G : X \rightarrow Y$. The continuous function $F = G \circ \phi : X' \rightarrow Y$ then extends f . Indeed, $F|_{A'} = G \circ \phi|_{A'} = g \circ \phi|_{A'} = f \circ (\phi|_{A'})^{-1} \circ \phi|_{A'} = f$. \square

Converging Sequences

Now we give results showing how $\mathbf{E}(Y)$ behaves w.r.t. converging sequences. First, if a sequence of compact pairs (X_i, A_i) converges to a compact pair (X, A) in the Vietoris topology (i.e., if X_i converges to X and A_i converges to A), then whether all (X_i, A_i) are (resp. are not) in $\mathbf{E}(Y)$ does not imply that (X, A) is (resp. is not) in $\mathbf{E}(Y)$. In other words, $\mathbf{E}(Y)$ is neither closed nor open in the Vietoris topology.

Therefore in order to obtain results, we need more complicated assumptions on the way a sequence of compact pairs converges to a compact pair.

The first result can be used to prove that a compact pair is not in $\mathbf{E}(Y)$ by approximating it with compact pairs that are not in $\mathbf{E}(Y)$ in some way. It is taken from the definition of pseudo-cubes in [34].

Proposition 5.3.2

Let (X, A) be a compact pair and $(X_i, A_i)_{i \in \mathbb{N}}$ be a sequence of compact pairs contained in X such that

1. For every i , $X_i \setminus A_i$ is open in X and is contained in $(X \setminus A)$,
2. For every $\epsilon > 0$, there exists i such that $X \setminus (X_i \setminus A_i) \subseteq \mathcal{N}_\epsilon(A)$.

If $(X_i, A_i) \notin \mathbf{E}(Y)$ for all i , then $(X, A) \notin \mathbf{E}(Y)$.

Proof. We assume that $(X_i, A_i) \notin \mathbf{E}(Y)$ for all i and show that $(X, A) \notin \mathbf{E}(Y)$.

Let $f : A \rightarrow Y$ be continuous. Y is an ANR, so there exists some continuous extension \tilde{f} of f to $\mathcal{N}_\epsilon(A)$, for some $\epsilon > 0$ by Fact 3.3.1. Let i be such that $X \setminus (X_i \setminus A_i) \subseteq \mathcal{N}_\epsilon(A)$ by (2), so $\tilde{f}|_{A_i}$ can be defined and has a continuous extension $F_i : X_i \rightarrow Y$ by assumption.

We define a continuous extension $F : X \rightarrow Y$ of f , by defining $F = F_i$ on X_i and $F = \tilde{f}$ on $X \setminus (X_i \setminus A_i)$. Note that X_i and $X \setminus (X_i \setminus A_i)$ are closed and their intersection is A_i , where these two functions agree. Therefore, F is well-defined and continuous and extends f . As f was arbitrary, we have proved that $(X, A) \notin \mathbf{E}(Y)$. \square

The second result can be used to prove that a compact pair is in $\mathbf{E}(Y)$ by approximating it with compact pairs that are in $\mathbf{E}(Y)$, in a particular way.

Definition 5.3.1. Let Y be an ANR and X_i converge to X in the upper Vietoris topology. We say that functions $f_i : X_i \rightarrow Y$ are **asymptotically homotopic** to $f : X \rightarrow Y$ if for some extension $\tilde{f} : U \rightarrow Y$ of f to a neighborhood U of X , f_i is homotopic to $\tilde{f}|_{X_i}$ for sufficiently large i .

There are usually many ways of extending f to a neighborhood of X . However, any two of them are homotopic on a smaller neighborhood, which implies that the definition does not depend on the choice of an extension of f , and is intrinsic to the functions f_i, f .

Proposition 5.3.3

Whether $f_i : X_i \rightarrow Y$ are asymptotically homotopic to $f : X \rightarrow Y$ does not depend on the choice of a neighborhood U of X and an extension $\tilde{f} : U \rightarrow Y$.

Proof. Assume that for some U and $\tilde{f} : U \rightarrow Y$ and sufficiently large i , f_i is homotopic to $\tilde{f}|_{X_i}$. Let V be a neighborhood of X and $g : V \rightarrow Y$ a continuous extension of f . As \tilde{f} and g coincide on X , there exists $\epsilon > 0$ such that their restrictions $\tilde{f}|_{\mathcal{N}_\epsilon(X)}$ and $g|_{\mathcal{N}_\epsilon(X)}$ are as close as needed so that they are homotopic. For sufficiently large i , f_i is homotopic to $\tilde{f}|_{X_i}$ by assumption and X_i is contained in $\mathcal{N}_\epsilon(X)$, so $\tilde{f}|_{X_i}$ is homotopic to $g|_{X_i}$. Therefore, f_i is homotopic to $g|_{X_i}$. \square

Now, we prove that asymptotic homotopy preserves continuous extensibility.

Proposition 5.3.4

Let Y be an ANR, let $(X_i, A_i)_{i \in \mathbb{N}}$ and (X, A) be compact pairs in Q such that (X_i, A_i) converge to (X, A) in the upper Vietoris topology. Assume that $f_i : A_i \rightarrow Y$ are asymptotically homotopic to $f : A \rightarrow Y$. If f has a continuous extension on X , then for sufficiently large i , f_i has a continuous extension on X_i .

Proof. Let $F : X \rightarrow Y$ be a continuous extension of f . It has a continuous extension $\tilde{F} : U \rightarrow Y$ for some neighborhood U of X . Note that U is a neighborhood of A and \tilde{F} is an extension of f . As f_i is asymptotically homotopic to f , f_i is homotopic to $\tilde{F}|_{A_i}$ for large i . The function $\tilde{F}|_{A_i}$ has a continuous extension to X_i , namely $\tilde{F}|_{X_i}$, so f_i also has a continuous extension as well. \square

In particular, when all the involved pairs have the same second component, we obtain the following simple result.

Corollary 5.3.1. Let Y be an ANR. Let $(X_i, A_i)_{i \in \mathbb{N}}$ and (X, A) be compact pairs in Q such that $A_i = A$ for all i and X_i converge to X in the upper Vietoris topology. If $f : A \rightarrow Y$ has no continuous extension to X_i for any $i \in \mathbb{N}$, then f has no continuous extension to X .

5.3.2 The Invariant E_n

For $n \in \mathbb{N}$, the n -dimensional sphere \mathbb{S}_n is an ANR. We define $E_n = E(\mathbb{S}_n)$. This invariant will be used to cover several examples.

Definition 5.3.2. (The invariant E_n) For $n \in \mathbb{N}$, a compact pair (X, A) is in E_n if there exists a continuous function $f : A \rightarrow \mathbb{S}_n$ that has no continuous extension $F : X \rightarrow \mathbb{S}_n$.

Corollary 5.2.1 implies that E_n is a Σ_2^0 invariant, therefore every E_n -minimal compact pair has strong computable type, by applying Theorem 4.3.2.

The simplest example of a compact pair which is E_n -minimal is given by the $n + 1$ -ball and its bounding n -sphere. We first explain why it is in E_n . More generally, whether a pair $(\mathbb{B}_{m+1}, \mathbb{S}_m)$ satisfies E_n depends on the m th homotopy group of the n -sphere.

Proposition 5.3.5

The pair $(\mathbb{B}_{m+1}, \mathbb{S}_m)$ is in E_n if and only if the homotopy group $\pi_m(\mathbb{S}_n)$ is non-trivial. In particular, $(\mathbb{B}_{n+1}, \mathbb{S}_n)$ is in E_n and $(\mathbb{B}_{m+1}, \mathbb{S}_m)$ is not in E_n for $m < n$.

Proof. As \mathbb{B}_{m+1} is the cone of \mathbb{S}_m , a continuous extension of $f : \mathbb{S}_m \rightarrow \mathbb{S}_n$ to \mathbb{B}_{m+1} is nothing else than a null-homotopy of f . \square

Relationship with Dimension

The dimension of a space has a strong impact on the possibility of extending functions to a sphere. First, if X has dimension at most n , then any continuous function from a closed subset to \mathbb{S}_n extends continuously to X (see Theorem 3.6.3 in [60]).

Theorem 5.3.1. Let $n \in \mathbb{N}$. If (X, A) is a compact pair with $\dim(X \setminus A) \leq n$, then $(X, A) \notin E_n$.

In particular, if $\dim(X) \leq n$ then $(X, A) \notin E_n$.

In some cases, if a compact pair is not in E_n then no compact subpair is in E_n .

Lemma 5.3.1

Let (X, A) be a compact pair with $\dim(A) \leq n$. If $(X, A) \notin E_n$, then for every $(Y, B) \subseteq (X, A)$ one has $(Y, B) \notin E_n$.

Proof. As $\dim(A) \leq n$, one has $(A, B) \notin E_n$. Therefore, $(X, A) \notin E_n$ implies $(Y, B) \notin E_n$: every function f on B has an extension to A and then to X , whose restriction to Y is an extension of f . \square

This result gives a simple way to prove E_n -minimality in certain circumstances.

Corollary 5.3.2. Let (X, A) be a pair in E_n , where A has empty interior and $\dim(A) \leq n$. If for every $A \subseteq Y \subsetneq X$ one has $(Y, A) \notin E_n$, then (X, A) is E_n -minimal.

Proof. Let (Y, B) be a proper compact subpair of (X, A) . As A has empty interior, $Y \cup A$ is a proper subset of X , so $(Y \cup A, A) \notin E_n$ by assumption. Therefore, $(Y, B) \notin E_n$ by Lemma 5.3.1. \square

The statement is reminiscent of the discussion about minimality at the end of Section 4.3.2. However, E_n is not an upper set (indeed, $(\mathbb{B}_{n+1}, \mathbb{S}_n) \in E_n$ but $(\mathbb{B}_{n+1}, \mathbb{B}_{n+1}) \notin E_n$) so Lemma 4.3.1 does not apply. Indeed, the dimension assumption cannot be dropped in general. The pair $(\mathbb{B}_4, \mathbb{S}_3)$ is in E_2 as witnessed by the Hopf map, but it is not E_2 -minimal, as $(\mathbb{B}_3, \mathbb{S}_2) \subsetneq (\mathbb{B}_4, \mathbb{S}_3)$ is also in E_2 . However, if $\mathbb{S}_3 \subseteq Y \subsetneq \mathbb{B}_4$ then \mathbb{S}_3 is a retract of Y so $(Y, \mathbb{S}_3) \notin E_2$.

We now apply this technique.

Proposition 5.3.6

For every $n \in \mathbb{N}$, the pair $(\mathbb{B}_{n+1}, \mathbb{S}_n)$ is E_n -minimal.

Proof. By Proposition 5.3.5, $(\mathbb{B}_{n+1}, \mathbb{S}_n)$ is in E_n . If $\mathbb{S}_n \subseteq Y \subsetneq \mathbb{B}_{n+1}$, then Y retracts to \mathbb{S}_n so $(Y, \mathbb{S}_n) \notin E_n$. Therefore by Corollary 5.3.2, no proper compact subpair (Y, B) of $(\mathbb{B}_{n+1}, \mathbb{S}_n)$ is in E_n . As a result, $(\mathbb{B}_{n+1}, \mathbb{S}_n)$ is E_n -minimal. \square

Therefore, our results give an alternative proof that the pair $(\mathbb{B}_{n+1}, \mathbb{S}_n)$ has (strong) computable type, which was shown by Miller [48]. We will give more examples of E_n -minimal pairs in the next sections.

5.3.3 The Invariant H_n

It was shown in [39, 42] that closed manifolds and compact manifolds with boundary have computable type. In this section, we identify a Σ_2^0 invariant for which manifolds are minimal.

Let $p \in \mathbb{S}_n$ be an arbitrary point in the n -sphere. We recall that two continuous functions of pairs $f, g : (X, A) \rightarrow (\mathbb{S}_n, p)$ are **homotopic relative to A** if there exists a homotopy between f and g that is constant on A , i.e. a continuous function $H : [0, 1] \times X \rightarrow \mathbb{S}_n$ such that $H(0, x) = f(x)$, $H(1, x) = g(x)$ for all $x \in X$, and $H(t, a) = p$ for all $t \in [0, 1]$ and $a \in A$. A continuous

function $f : (X, A) \rightarrow (\mathbb{S}_n, p)$ is **null-homotopic relative to A** if f is homotopic, relative to A , to the constant function p .

Definition 5.3.3. (The invariant H_n) A compact pair (X, A) is in H_n if there exists a continuous function of pairs $f : (X, A) \rightarrow (\mathbb{S}_n, p)$ which is not null-homotopic relative to A . A space X is in H_n if the pair (X, \emptyset) is in H_n , i.e. if there exists a continuous function $f : X \rightarrow \mathbb{S}_n$ which is not null-homotopic.

Now that for single spaces, H_n is precisely $H(\mathbb{S}_n)$ from Definition 5.2.2.

We first prove that H_n is a Σ_2^0 invariant, by reducing it to E_n .

Proposition 5.3.7

For a compact pair (X, A) , one has

$$(X, A) \in H_n \iff C(X, A) \in E_n.$$

Moreover, if $C(X, A)$ is E_n -minimal, then (X, A) is H_n -minimal.

Proof. Let $(C, D) = C(X, A) = (C(X), X \cup C(A))$. A continuous function $f : (X, A) \rightarrow (\mathbb{S}_n, p)$ has a canonical extension $F : D \rightarrow \mathbb{S}_n$ with constant value p on $C(A)$. Moreover, a null-homotopy of f relative to A is nothing else than a continuous extension of F to C .

Assume that $(X, A) \in H_n$ and let $f : (X, A) \rightarrow (\mathbb{S}_n, p)$ be a continuous function which is not null-homotopic relative to A . By the previous observation, the function $F : D \rightarrow \mathbb{S}_n$ has no continuous extension to C , therefore $C(X, A) \in E_n$.

Conversely, assume that $C(X, A) \in E_n$ and let $G : D \rightarrow \mathbb{S}_n$ have no continuous extension to C . We cannot directly apply the preliminary observation to G because it is not necessarily constant on $C(A)$. However, G is homotopic to a function $F : D \rightarrow \mathbb{S}_n$ which is constant on $C(A)$. Indeed, $C(A)$ is contractible so the restriction of G to $C(A)$ is null-homotopic. As \mathbb{S}_n is an ANR, the homotopy on $C(A)$ can be extended to a homotopy between $G : D \rightarrow \mathbb{S}_n$ and a function $F : D \rightarrow \mathbb{S}_n$ which is constant on $C(A)$ (Theorem 3.3.1). Let p be the constant value. As G has no extension to C , neither does F . We can now apply the preliminary observation: the restriction $f : X \rightarrow \mathbb{S}_n$ of F to X is not null-homotopic relative to A , therefore $(X, A) \in H_n$.

Assume that $C(X, A)$ is E_n -minimal. If (X', A') is a proper compact subpair of (X, A) , then the pair $C(X', A')$ is a proper compact subpair of $C(X, A)$ so it does not satisfy E_n , therefore $(X', A') \notin H_n$. \square

We will see below (Proposition 5.3.9) that under additional assumptions, the implication about minimality can be turned into an equivalence.

This characterization allows one to derive results about H_n from results about E_n . We start with the descriptive complexity of H_n .

Corollary 5.3.3. H_n is a Σ_2^0 invariant in $\tau_{up\nu}^2$.

Proof. Given a compact pair $(X, A) \subseteq Q$, a copy (C, D) of $C(X, A)$ can be defined as follows:

$$\begin{aligned} C &= \{(t, tx) : t \in [0, 1], x \in X\}, \\ D &= \{(1, x) : x \in X\} \cup \{(t, tx) : t \in [0, 1], x \in A\}. \end{aligned}$$

The map ϕ sending $(X, A) \in (\mathcal{K}^2(Q), \tau_{up\nu}^2)$ to $(C, D) \in (\mathcal{K}^2(Q), \tau_{up\nu}^2)$ is easily computable, and H_n is the preimage of E_n by ϕ by Proposition 5.3.7. As E_n is Σ_2^0 , so is H_n . \square

Relationship with Dimension

As H_n can be expressed using E_n , the relations between E_n and the dimension of the space can be similarly formulated for H_n . Theorem 5.3.1 and Lemma 5.3.1 have the following consequences.

Proposition 5.3.8

Let (X, A) be a compact pair with $\dim(X) \leq n - 1$. One has $(X, A) \notin H_n$.

Proof. One has $\dim(C(X)) \leq n$ so $C(X, A) \notin E_n$ by Theorem 5.3.1, therefore $(X, A) \notin H_n$. \square

Lemma 5.3.2

Let (X, A) be a compact pair satisfying $\dim(X) \leq n$ and $\dim(A) \leq n - 1$. If $(X, A) \notin H_n$, then for every compact pair $(Y, B) \subseteq (X, A)$ one has $(Y, B) \notin H_n$.

Proof. We apply Lemma 5.3.1 to the pairs $(C, D) = C(X, A)$ and $(E, F) = C(Y, B)$. Note that $D = X \cup C(A)$ so $\dim(D) \leq n$. Therefore, if $(C, D) \notin E_n$, then $(E, F) \notin E_n$. \square

Under the same assumptions, we can improve Proposition 5.3.7 to obtain an equivalence.

Proposition 5.3.9

Let (X, A) be a compact pair where A has empty interior, $\dim(X) \leq n$ and $\dim(A) \leq n - 1$. One has

$$(X, A) \text{ is } H_n\text{-minimal} \iff C(X, A) \text{ is } E_n\text{-minimal}.$$

Before proving this result, we need to reformulate Borsuk's homotopy extension theorem (Theorem 3.3.1). The cylinder of a space X is $\text{Cyl}(X) = X \times [0, 1]$. A homotopy $H : [0, 1] \times X \rightarrow Y$ is nothing else than a function from $\text{Cyl}(X)$ to Y , and a null-homotopy is a function from $C(X)$ to Y . Therefore, Borsuk's homotopy extension theorem can be reformulated as follows.

Lemma 5.3.3

Let (X, A) be a compact pair and Y an ANR. Every continuous function $f : X \cup \text{Cyl}(A) \rightarrow Y$ has a continuous extension to $\text{Cyl}(X)$. Every continuous function $g : C(A) \rightarrow Y$ has a continuous extension to $C(X)$.

Proof. The first statement is Borsuk's homotopy extension theorem. The second one is a particular case for functions that are constant on X . More precisely, $C(A)$ is the quotient of $X \cup \text{Cyl}(A)$ by identifying all the points of X . A function $g : C(A) \rightarrow Y$ induces a function $f : X \cup \text{Cyl}(A) \rightarrow Y$ which is constant on X , by composing g with the quotient map. f has a continuous extension $F : \text{Cyl}(X) \rightarrow Y$, which is constant on X , and therefore induces a continuous function $G : C(X) \rightarrow Y$ extending g . \square

Proof of Proposition 5.3.9. Assume that (X, A) is H_n -minimal. We need to show that no proper compact subpair (Y, B) of $C(X, A)$ is in E_n . Using Corollary 5.3.2, it is sufficient to show the result when $B = X \cup C(A)$. Let then Y be a proper subset of $C(X)$ containing $X \cup C(A)$. There exists a non-empty open set $U \subseteq X \setminus A$ and an interval $J = (a, b) \subseteq [0, 1]$ such that $U \times J$ is disjoint from Y (we think of $U \times J$ as embedded in $C(X)$ in the obvious way). Let $f : X \cup C(A) \rightarrow \mathbb{S}_n$. We show how to extend f to $C(X) \setminus (J \times U)$, giving an extension of f to Y by restriction. Figure 5.1 may help visualize the argument.

As (X, A) is H_n -minimal by assumption, $(X \setminus U, A) \notin H_n$ so $C(X \setminus U, A) \notin E_n$. Therefore, the restriction of f to $(X \setminus U) \cup C(A)$ has a continuous extension to $C(X \setminus U)$. So f has a continuous extension $g : X \cup C(X \setminus U) \rightarrow \mathbb{S}_n$.

Applying Lemma 5.3.3, we can extend g to the quotient of $X \times [0, a]$ which is homeomorphic to $C(X)$ and to $\text{Cyl}(X) := X \times [b, 1]$. So we obtain a continuous extension h of f to the union of $C(X \setminus U)$ with the quotient of $X \times ([0, a] \cup [b, 1])$. That union is precisely $C(X) \setminus (J \times U)$.

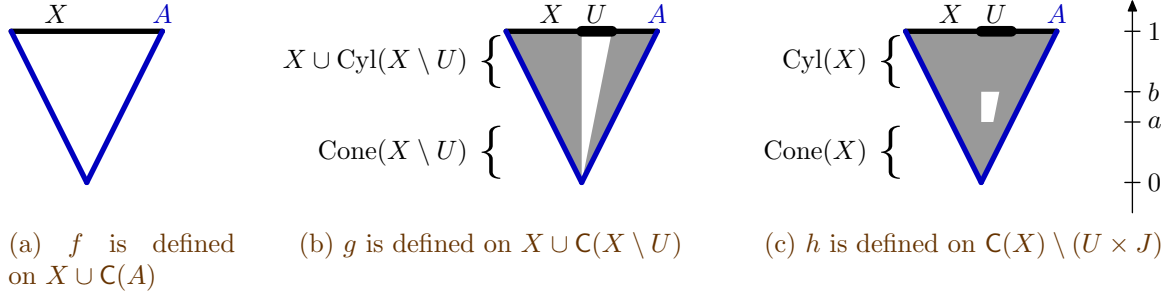

Figure 5.1: Consecutive extensions of f

□

Finally, from the point of view of H_n , a compact pair (X, A) can be replaced by the single set X/A .

Proposition 5.3.10

For every pair (X, A) , $(X, A) \in H_n \iff X/A \in H_n$.

Proof. Let $p_A \in X/A$ be the equivalence class of A . First observe that (X, A) can equivalently be replaced by $(X/A, p_A)$, i.e. $(X, A) \in H_n \iff (X/A, p_A) \in H_n$. Indeed, there is a one-to-one correspondence between continuous functions $f : (X, A) \rightarrow (\mathbb{S}_n, p)$ and continuous functions $g : (X/A, p_A) \rightarrow (\mathbb{S}_n, p)$, and a one-to-one correspondence between null-homotopies of f relative to A and null-homotopies of g relative to p_A .

Now, for a pair (Y, q) , where q is a point of Y , we show that a function $g : (Y, q) \rightarrow (\mathbb{S}_n, p)$ is null-homotopic if and only if it is null-homotopic relative to q . Assume that g is null-homotopic, i.e. homotopic to a constant function. We can assume w.l.o.g. that the constant function is p , because all constant functions are homotopic (indeed, the sphere is path-connected). Let H_t be a homotopy from $H_0 = g$ to $H_1 = p$. Our goal is to define another such homotopy H' which is constantly p on q .

We give a different argument for $n = 1$ and $n \geq 2$.

Let $n = 1$. There exists a continuous function $\phi : \mathbb{S}_1 \times \mathbb{S}_1 \rightarrow \mathbb{S}_1$ such that $\phi(x, p) = x$ and $\phi(x, x) = p$ for all $x \in \mathbb{S}_1$. Indeed, identifying \mathbb{S}_1 with \mathbb{R}/\mathbb{Z} and p with the equivalence class of 0, let $\phi(x, y) = x - y \pmod{1}$. We can then define $H'_t(y) = \phi(H_t(y), H_t(q))$, it is easy to check that it satisfies the required assumptions.

Let now $n \geq 2$ (we do not know whether a similar map $\phi : \mathbb{S}_n \times \mathbb{S}_n \rightarrow \mathbb{S}_n$ can be defined but we provide another argument, which cannot be applied to $n = 1$). We want to define a continuous function $H' : [0, 1] \times Y \rightarrow \mathbb{S}_n$ extending a certain function $h' : ([0, 1] \times \{q\}) \cup (\{0, 1\} \times Y) \rightarrow \mathbb{S}_n$. Let h be the restriction of H to that set. We show that h' is homotopic to h . As h has a continuous extension, it will imply that h' has a continuous extension, because \mathbb{S}_n is an ANR.

On $[0, 1] \times \{q\}$, h and h' define two loops on \mathbb{S}_n (h' defines the constant loop). As \mathbb{S}_n is simply-connected (indeed, $n \geq 2$), these two loops are homotopic relative to $\{0, 1\} \times \{q\}$. As h and h' coincide on $\{0, 1\} \times Y$, they are homotopic. □

We conclude this section with two simple examples of compact pairs and sets that are H_n -minimal.

Proposition 5.3.11

The pair $(\mathbb{B}_n, \mathbb{S}_{n-1})$ and the space \mathbb{S}_n are H_n -minimal.

Proof. It is a direct application of Proposition 5.3.7: one has $C(\mathbb{B}_n, \mathbb{S}_{n-1}) = C(\mathbb{S}_n, \emptyset) = (\mathbb{B}_{n+1}, \mathbb{S}_n)$ which is \mathbf{E}_n -minimal by Proposition 5.3.6. \square

We will see in the Section 5.4.2 that, more generally, compact n -dimensional manifolds with or without boundary are all \mathbf{H}_n -minimal.

5.3.4 Connections with Homology and Cohomology

Concluding this section, we present a partial characterization of \mathbf{E}_n and \mathbf{H}_n in terms of homology and cohomology groups for specific spaces. While our aim is not to provide a comprehensive exposition, we want to emphasize the close connections with algebraic topology that can be utilized in the study of strong computable type, particularly in the context of manifolds.

1) Partial Characterization of \mathbf{E}_n

For compact spaces of dimension at most $n + 1$, \mathbf{E}_n can be characterized in terms of Čech homology and cohomology (Corollaries VIII.2 and VIII.3 (p. 149) in [36]). For a pair (X, A) , let $i : A \rightarrow X$ be the inclusion map. Like any continuous map, it induces natural homomorphisms on the homology and cohomology groups, written $i_* : \check{H}_n(A; G) \rightarrow \check{H}_n(X; G)$ and $i^* : \check{H}^n(X; G) \rightarrow \check{H}^n(A; G)$. It uses the abelian groups $(\mathbb{Z}, +)$ and $(\mathbb{R}/\mathbb{Z}, +)$.

Theorem 5.3.2. Let (X, A) be a compact pair with $\dim(X) \leq n + 1$. One has

$$\begin{aligned} (X, A) \in \mathbf{E}_n &\iff i_* : \check{H}_n(A; \mathbb{R}/\mathbb{Z}) \rightarrow \check{H}_n(X; \mathbb{R}/\mathbb{Z}) \text{ is not injective} \\ &\iff i^* : \check{H}^n(X; \mathbb{Z}) \rightarrow \check{H}^n(A; \mathbb{Z}) \text{ is not surjective.} \end{aligned}$$

The equivalence does not hold in general. For instance, Hopf's fibration is a continuous function $f : \mathbb{S}_3 \rightarrow \mathbb{S}_2$ which is not null-homotopic, hence does not extend to \mathbb{B}_4 , implying that $(\mathbb{B}_4, \mathbb{S}_3) \in \mathbf{E}_2$. However, the second homology and cohomology groups of both \mathbb{B}_4 and \mathbb{S}_3 are trivial, so the only homomorphism between them is bijective.

2) Partial Characterization of \mathbf{H}_n

The invariant \mathbf{H}_n also admits a characterization in terms of Čech homology and cohomology, for compact spaces of dimension at most n (Corollary 4 (p. 150) in [36]).

Theorem 5.3.3. Let X be a compact space with $\dim(X) \leq n$. One has

$$\begin{aligned} X \in \mathbf{H}_n &\iff \check{H}_n(X; \mathbb{R}/\mathbb{Z}) \neq 0 \\ &\iff \check{H}^n(X; \mathbb{Z}) \neq 0. \end{aligned}$$

Again, the equivalence does not hold in general. Hopf's fibration implies that $\mathbb{S}_3 \in \mathbf{H}_2$, but $\check{H}_2(\mathbb{S}_3; \mathbb{R}/\mathbb{Z}) \cong \check{H}^2(\mathbb{S}_3; \mathbb{Z}) \cong 0$.

Lupini, Melnikov and Nies [46], and Melnikov and Downey [26] with a different proof, proved that if $X \subseteq Q$ is given in the Vietoris topology $\tau_{\mathcal{V}}$, then its Čech cohomology groups $\check{H}^n(X; \mathbb{Z})$ can be computably presented (relative to X and uniformly): one can enumerate a list of generators and the words, i.e. finite combinations of generators and their inverses, that are equal to the 0 element of the group. Their result implies that the non-triviality of a group $\check{H}^n(X; \mathbb{Z})$ is a Σ_2^0 invariant in the topology $\tau_{\mathcal{V}}$: the group is non-trivial iff there exists a word which does not equal 0, which is a Σ_2^0 formula. It seems that their proof even shows that it is a Σ_2^0 invariant in the topology $\tau_{up\mathcal{V}}$.

However Proposition 4.4.4 implies that being Σ_2^0 in τ_V is enough for the purpose of proving strong computable type. More precisely,

Corollary 5.3.4. Let X be a compact space. If X is minimal such that $\check{H}^n(X; \mathbb{Z}) \not\cong 0$, then X has strong computable type.

Proof. The invariant $l_n = \{X \in \mathcal{K}(Q) : \check{H}^n(X; \mathbb{Z}) \not\cong 0\}$ is Σ_2^0 in the topology τ_V by [46] and [26]. Therefore, $\uparrow l_n$ is Σ_2^0 in the topology τ_{upV} and has the same minimal elements as l_n (Proposition 4.4.4), so we can apply Theorem 4.3.2. \square

We also mention a stronger connection between maps to the sphere and cohomology. Theorem 5.3.3 is actually a particular case of Hopf's classification theorem, which states that for a compact space of dimension at most n , there is a one-to-one correspondence between homotopy classes of maps to the n -sphere and elements of the n th Čech cohomology group. It can be found as Theorem 2.2 (p. 17) in [2], reformulated in [35].

Theorem 5.3.4. (Hopf classification theorem) Let X be a compact space of dimension $\leq n$. There is a bijection between $[X; \mathbb{S}_n]$ and $\check{H}^n(X; \mathbb{Z})$.

5.4 Application to Strong Computable Type

In this section, we provide a demonstration of our framework by revisiting previous results that establish the computable type property for pairs. We demonstrate that these results can be explained by the minimality of the pairs with respect to a specific Σ_2^0 invariant. By employing a single Σ_2^0 invariant, we can encompass a wide range of sets or pairs, thereby unifying the computability-theoretic aspect of the argument. This allows us to focus on a purely topological analysis for each specific set or pair, benefiting from the well-established field of topology. Consequently, our study of (strong) computable type becomes more explicitly connected to topology.

Remarkably, most of the arguments presented in this section are primarily topological in nature.

5.4.1 Examples of E_n -Minimal Pairs

In this section we show how E_n -minimality covers many of the known examples of pairs having computable type. We also give a new example to illustrate its scope.

1) Chainable Continuum Between Two Points

Iljazović proved in [37] that if X is a continuum (a connected compact metric space) that is chainable from a point $a \in X$ to a point $b \in X$, then the pair $(X, \{a, b\})$ has computable type. This result and its proof can be reformulated as the E_0 -minimality of the pair.

We recall some definitions from [37].

Definition 5.4.1. Let X be a metric space. A finite sequence \mathcal{C} of nonempty open subsets C_0, \dots, C_m of X is said to be a **chain** if $C_i \cap C_j \neq \emptyset \Leftrightarrow |i - j| \leq 1, \forall i, j \in \{0, \dots, m\}$. A chain $\mathcal{C} = \{C_0, \dots, C_m\}$ **covers** X if $X \subseteq \bigcup_i C_i$; for $\epsilon > 0$, it is an **ϵ -chain** if $\max_i(\text{diam}(C_i)) < \epsilon$.

For $a, b \in X$, X is **chainable from a to b** if for every $\epsilon > 0$, there exists an ϵ -chain $\mathcal{C} = \{C_0, \dots, C_m\}$ in X which covers X and such that $a \in C_0$ and $b \in C_m$.

Iljazović proved in [37] that if X is chainable from a to b , then the pair $(X, \{a, b\})$ has computable type. This result can be obtained using the invariant E_0 .

Proposition 5.4.1

If X is compact connected and is chainable from a to b , then the pair $(X, \{a, b\})$ is E_0 -minimal.

Proof. Take $\mathbb{S}_0 = \{a, b\}$ and $f = \text{id}_{\mathbb{S}_0}$. As X is connected, the function f has no continuous extension $g : X \rightarrow \mathbb{S}_0$, because $g^{-1}(a)$ and $g^{-1}(b)$ would disconnect X . Hence, $(X, \{a, b\})$ is in E_0 .

Let $x \in X \setminus \{a, b\}$ and $\epsilon > 0$ be such that $B(x, \epsilon) \subseteq X \setminus \{a, b\}$. Let $f : \{a, b\} \rightarrow \mathbb{S}_0$. The points a, b must be disconnected in $X \setminus B(x, \epsilon)$. Indeed, let $\mathcal{C} = \{C_0, \dots, C_m\}$ be an ϵ -chain covering X with $a \in C_0$ and $b \in C_m$. Let k be such that $x \in C_k$. As $\text{diam}(C_k) < \epsilon$, $a \notin C_k, b \notin C_k$ and $C_k \subseteq B(x, \epsilon)$. Therefore $X \setminus B(x, \epsilon)$ is covered by the two disjoint open sets $U_a := \bigcup_{i < k} C_i$ and $U_b := \bigcup_{i > k} C_i$, containing a and b respectively.

The disconnection can be turned into a continuous extension $g : X \setminus B(x, \epsilon) \rightarrow \mathbb{S}_0$, sending U_a to $f(a)$ and U_b to $f(b)$. Therefore, $(X \setminus B(x, \epsilon), \{a, b\}) \notin E_0$. It implies that $(X, \{a, b\})$ is E_0 -minimal because any proper subset of X is contained in such a $X \setminus B(x, \epsilon)$. \square

We will cover other examples from [37] in Section 5.4.3, using another Σ_2^0 invariant.

2) Pseudo n -Cubes

In [34], the authors introduce the notion of a pseudo- n -cube, which is a compact pair (X, A) which can somehow be approximated by n -dimensional cubes and their boundaries. They prove that pseudo- n -cubes have computable type.

We show how the result can be proved using the invariant E_{n-1} , by showing how the E_{n-1} -minimality of the n -dimensional cube implies the E_{n-1} -minimality of pseudo- n -cubes.

We first recall the definition of pseudo- n -cubes from [34]. Let $n \in \mathbb{N}^*$ and let S_1^0, \dots, S_n^0 and S_1^1, \dots, S_n^1 be the faces of the n -cube I^n defined by

$$\begin{aligned} S_i^0 &= \{(x_1, \dots, x_n) \in I^n : x_i = 0\}, \\ S_i^1 &= \{(x_1, \dots, x_n) \in I^n : x_i = 1\}, \end{aligned}$$

where $i \in \{1, \dots, n\}$. Let $S = \bigcup_i S_i^0 \cup S_i^1$ be the boundary of I^n .

Definition 5.4.2. A compact pair (X, A) in \mathbb{R}^n is called a **pseudo- n -cube** with respect to some finite sequence of compact subsets A_i^0 and A_i^1 , $1 \leq i \leq n$, if $A = \bigcup_i A_i^0 \cup A_i^1$, $A_i^0 \cap A_i^1 = \emptyset$ and for each $\epsilon > 0$ there exists a continuous injection $f : I^n \rightarrow \mathbb{R}^n$ such that

1. $f(I^n) \subseteq X$,
2. $f(\text{int}_{\mathbb{R}^n}(I^n)) \cap A = \emptyset$,
3. $X \setminus f(\text{int}_{\mathbb{R}^n}(I^n)) \subseteq \mathcal{N}_\epsilon(f(S))$,
4. $d_H(f(S_i^0), A_i^0) < \epsilon$ and $d_H(f(S_i^1), A_i^1) < \epsilon$.

We now show how the proof that pseudo- n -cubes have computable type can be simplified by showing that they are E_{n-1} -minimal.

Proposition 5.4.2

Every pseudo- n -cube is E_{n-1} -minimal.

Proof. A pseudo-cube is approximated by cubes. We use Propositions 5.3.4 and 5.3.2 to derive E_{n-1} -minimality of pseudo- n -cubes from E_{n-1} -minimality of n -cubes (Proposition 5.3.6).

We recall that the pair $(I^n, S) \cong (\mathbb{B}_n, \mathbb{S}_{n-1})$ is in E_{n-1} because the identity on S has no continuous extension to I^n . A similar function $h : A \rightarrow S$ can be defined that has no extension to X .

The function h satisfies $h(A_i^0) \subseteq S_i^0$ and $h(A_i^1) \subseteq S_i^1$ and is built as follows. On an intersection $A_1^{b_1} \cap \dots \cap A_n^{b_n}$ (where $b_i \in \{0, 1\}$), h sends every point to the vertex (b_1, \dots, b_n) of I^n . We then progressively extend h , sending intersections of $n - 1$ sets to segments, intersections of $n - 2$ sets to squares, then cubes, etc. and finally sending single sets A_i^0 and A_i^1 to the $n - 1$ -cubes which are the faces S_i^0 and S_i^1 of I^n . All the extensions can be done using the Tietze extension theorem.

Once $h : A \rightarrow S$ is defined, it has a continuous extension \tilde{h} to a neighborhood of A because S is an ANR. For sufficiently small ϵ and a cube (I^n, S) embedded in X as in the definition, \tilde{h} is defined on S and sends S_i^b close to S_i^b , in particular disjoint from S_i^{1-b} . Thus, $\tilde{h}|_S : S \rightarrow S$ is homotopic to id_S . In other words, the functions id_S on the copies of (I^n, S) are asymptotically homotopic to $h : A \rightarrow S$. As id_S has no continuous extension to I^n , h has no continuous extension to X by Proposition 5.3.4. As a result, $(X, A) \in \mathbf{E}_{n-1}$.

We now prove minimality. By definition of pseudo- n -cubes, for each ϵ there exists a copy (X_i, A_i) of the n -cube in X satisfying the conditions of Proposition 5.3.2:

- $X_i \setminus A_i$ is open in X (indeed, it is the image by a continuous injection map of an open subset of \mathbb{R}^n in $X \subseteq \mathbb{R}^n$, so it is open by invariance of domain) and contained in $X \setminus A$,
- $X \setminus (X_i \setminus A_i) \subseteq \mathcal{N}_\epsilon(A)$.

If $U \subseteq X \setminus A$ is an open set intersecting X , then the same conditions are satisfied by the pairs $(X_i \setminus U, A_i \setminus U)$ and $(X \setminus U, A)$. For sufficiently large i , U intersects X_i so $(X_i \setminus U, A_i \setminus U) \notin \mathbf{E}_{n-1}$ by \mathbf{E}_{n-1} -minimality of (X_i, A_i) . We can apply Proposition 5.3.2, which implies that $(X \setminus U, A) \notin \mathbf{E}_{n-1}$. Therefore, (X, A) is \mathbf{E}_{n-1} -minimal (we again use Corollary 5.3.2 which can be applied, as $A \subseteq \mathbb{R}^n$ has empty interior, therefore has dimension at most $n - 1$ by Theorem 3.7.1 in [60]). \square

3) A New Example

In this section, we showcase the application of \mathbf{E}_n -minimality in generating new instances of spaces with the computable type property, requiring minimal effort. We present a specific example to illustrate this approach, although numerous variations can be explored.

Definition 5.4.3. The **topologist's sine curve** T , or **Warsaw sine curve**, is defined by

$$T = \left\{ \left(x, \sin \frac{1}{x} \right) : 0 < x \leq 1 \right\} \cup \{ (0, y) : -1 \leq y \leq 1 \}.$$

We define the **Warsaw saucer** S by

$$S = \left\{ (x, y, z) \in \mathbb{R}^3 : 0 < x^2 + y^2 \leq 1 \text{ and } z = \sin \frac{1}{\sqrt{x^2 + y^2}} \right\} \cup \{ (0, 0, z) : -1 \leq z \leq 1 \}.$$

We define its boundary ∂S as its bounding circle

$$\partial S = \{ (x, y, \sin(1)) \in \mathbb{R}^3 : x^2 + y^2 = 1 \} \cong \mathbb{S}_1.$$

The Warsaw saucer is obtained from the closed topologist's sine curve, making it rotate around the vertical segment, see Figure 5.2.

The set S is compact and connected but neither locally connected nor path-connected. It is neither a manifold, nor a simplicial complex, nor a pseudo- n -cube so none of the previous results applies to $(S, \partial S)$. However, it can easily be proved to have strong computable type, because it is closely related to the pair $(\mathbb{B}_2, \mathbb{S}_1)$ and is therefore \mathbf{E}_1 -minimal.

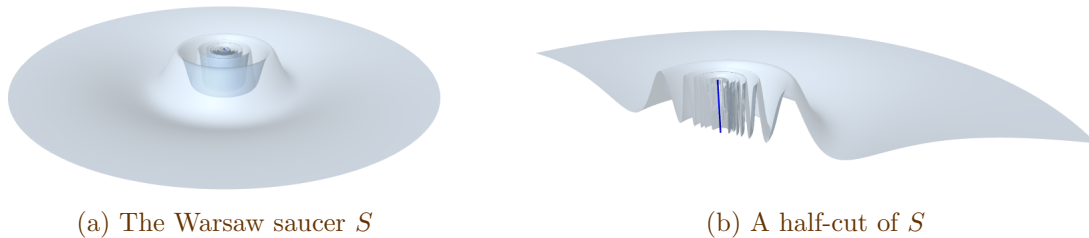

Figure 5.2: The Warsaw saucer and a half-cut of it

Proposition 5.4.3

The pair $(S, \partial S)$ is \mathbf{E}_1 -minimal and hence has strong computable type.

Proof. We show the \mathbf{E}_1 -minimality of $(\mathbb{B}_2, \mathbb{S}_1)$ implies the \mathbf{E}_1 -minimality of $(S, \partial S)$.

The surface S can be approximated by copies of the disk \mathbb{B}_2 that share the same boundary \mathbb{S}_1 . Indeed, let

$$X_i = \left\{ (x, y, z) : \frac{1}{i\pi} \leq \sqrt{x^2 + y^2} \leq 1 \text{ and } z = \sin \frac{1}{\sqrt{x^2 + y^2}} \right\} \cup \left\{ (x, y, 0) : \sqrt{x^2 + y^2} \leq \frac{1}{i\pi} \right\}.$$

The sets X_i converge to S , and they all have the same boundary \mathbb{S}_1 . We know that $(X_i, \mathbb{S}_1) = (\mathbb{B}_2, \mathbb{S}_1) \in \mathbf{E}_1$, moreover the same function, which is the identity $\text{id} : \mathbb{S}_1 \rightarrow \mathbb{S}_1$, has no continuous extension to X_i . Therefore, this function has no continuous extension to S by Corollary 5.3.1.

We now prove \mathbf{E}_1 -minimality. The projection π on the horizontal plane sends S to \mathbb{B}_2 and is the identity on $\partial S = \mathbb{S}_1$. If X is a proper compact subset of S containing ∂S , then $\pi(X)$ is a proper compact subset of \mathbb{B}_2 . As $(\mathbb{B}_2, \mathbb{S}_1)$ is \mathbf{E}_1 -minimal, $(\pi(X), \mathbb{S}_1) \notin \mathbf{E}_1$ so $(X, \partial S) \notin \mathbf{E}_1$ by Proposition 5.3.1 (more directly, every $f : \mathbb{S}_1 \rightarrow \mathbb{S}_1$ has a continuous extension $F : \pi(X) \rightarrow \mathbb{S}_1$, inducing a continuous extension $F' = F \circ \pi : X \rightarrow \partial S$ of f to X). As a result, $(S, \partial S)$ is \mathbf{E}_1 -minimal. \square

5.4.2 Compact n -Manifolds are \mathbf{H}_n -Minimal

It was proved in [39] and [42] that compact manifolds with or without boundary have computable type, as pairs and single spaces respectively. In this section, we show how this result can be derived from classical results in algebraic topology implying that n -dimensional manifolds are \mathbf{H}_n -minimal, and applying Theorem 4.3.2.

The next result seems to be folklore but is not stated in any standard textbook on algebraic topology. However, it can be derived from classical results about homology of manifolds.

Theorem 5.4.1. Every connected compact n -manifold M is \mathbf{H}_n -minimal. Every connected compact n -manifold with boundary $(M, \partial M)$ is \mathbf{H}_n -minimal.

We give here the proof for manifolds without boundary, and put the proof for manifolds with boundary in the appendix (it is similar but requires more technical results about pairs).

Proof. The result is a consequence of Theorem 5.3.3, which reduces \mathbf{H}_n to homology groups, and of classical results about homology groups of manifolds.

Let us use the abelian group $G = \mathbb{R}/\mathbb{Z}$. As it contains an element of order 2, namely $1/2$, Corollary 7.12 in [16] implies that if M is a connected n -manifold, then $H_n(M; G) \neq 0$ if and only if M is compact. Therefore, if M is a compact connected n -manifold and $x \in M$, then

$$\begin{aligned} H_n(M; G) &\not\cong 0, \\ H_n(M \setminus \{x\}; G) &\cong 0, \end{aligned}$$

because $M \setminus \{x\}$ is a non-compact connected manifold.

If $x \in M$ and B is an open Euclidean ball around x , then $M \setminus \{x\}$ deformation retracts to $M \setminus B$, which means that there is a retraction $r : M \setminus \{x\} \rightarrow M \setminus B$ such that if $i : M \setminus B \rightarrow M \setminus \{x\}$ is the inclusion map, then $i \circ r$ is homotopic to $\text{id}_{M \setminus \{x\}}$. It is a classical result that deformation retractions preserve homology groups, so $H_n(M \setminus B) \cong H_n(M \setminus \{x\}) \cong 0$.

Therefore, Theorem 5.3.3 implies that $M \in \mathbf{H}_n$ and $M \setminus B \notin \mathbf{H}_n$. It implies that M is \mathbf{H}_n -minimal by Lemma 5.3.2: if X is a proper subset of M , then $X \subseteq M \setminus B$ for some B , so $X \notin \mathbf{H}_n$. \square

Theorem 5.4.1 implies the result in [39] that compact manifolds with or without boundary have (strong) computable type (because a disconnected compact manifold is a finite union of connected compact manifolds, although they are not \mathbf{H}_n -minimal). However the proof is inherently different and has new implications. For instance, it implies that $\text{SCT}_{M, \partial M} \leq_W \mathbf{C}_{\mathbb{N}}$ by Theorem 4.4.2. Moreover, it immediately implies that other pairs have strong computable type, as follows.

Corollary 5.4.1. If M is a compact connected n -manifold with possibly empty boundary ∂M , then the pair

$$\mathbf{C}(M, \partial M) = (\mathbf{C}(M), M \cup \mathbf{C}(\partial M))$$

is \mathbf{E}_n -minimal hence has strong computable type.

Proof. All the assumptions of Proposition 5.3.9 are met: ∂M has empty interior in M , $\dim(M) = n$ and $\dim(\partial M) = n - 1$. As $(M, \partial M)$ is \mathbf{H}_n -minimal by Theorem 5.4.1, $\mathbf{C}(M, \partial M)$ is \mathbf{E}_n -minimal. \square

The cone of a manifold M is a manifold only when M is a sphere or a ball, so this result is indeed new.

We give another proof of this result in Section 6.7 using cycles, see Corollary 6.7.6.

5.4.3 Circularly Chainable Continuum Which Are Not Chainable

In [37], it is proved that every compact metrizable space which is circularly chainable but not chainable has computable type. The simplest examples of such sets are given by the circle and the Warsaw circle. We briefly show how the proof of this result can be reformulated in our framework by finding a suitable Σ_2^0 invariant.

We already saw the notion of chain in Definition 5.4.1. We recall other related notions, taken from [37]. Let (X, d) be a metric space. A finite sequence $C = (C_0, \dots, C_n)$ of non-empty open subsets of X is called:

- A **chain** if for all $i, j \in \{0, \dots, n\}$, $C_i \cap C_j \neq \emptyset \iff |i - j| \leq 1$,
- A **circular chain** if for all $i, j \in \{0, \dots, n\}$, $C_i \cap C_j \neq \emptyset \iff (|i - j| \leq 1 \text{ or } \{i, j\} = \{0, n\})$.
- A **quasi-chain** if for all $i, j \in \{0, \dots, n\}$, $|i - j| > 1 \implies C_i \cap C_j = \emptyset$.

Its mesh is defined by $\text{mesh}(C) = \max_{0 \leq i \leq n} (\text{diam}(C_i))$. It covers a set $S \subseteq X$ if $S \subseteq \bigcup_i C_i$.

A set $S \subseteq X$ is **chainable** (resp. **circularly chainable**, **quasi-chainable**) if for every $\epsilon > 0$ there exists a chain (resp. circular chain, quasi-chain) of mesh $< \epsilon$ covering S .

If S is connected, then S is chainable if and only if S is quasi-chainable (Lemma 30 in [37]).

Proposition 5.4.4

Not being quasi-chainable is a Σ_2^0 invariant in τ_{upv} . If a compact space is circularly chainable but not chainable, then it is minimal satisfying this invariant and hence it has strong computable type.

Proof. If $U \subseteq Q$ is a finite union of rational open balls, then we write \bar{U} for the corresponding union of closed balls. By a standard compactness argument, a compact set $S \subseteq Q$ is quasi-chainable if for every rational $\epsilon > 0$ there exists a quasi-chain $C = (C_0, \dots, C_n)$ of mesh $< \epsilon$ covering S , with the following additional properties: $\bar{C}_i \cap \bar{C}_j = \emptyset$ for $|i - j| > 1$, and $\text{diam}(\bar{C}_i) < \epsilon$. Finite unions of rational closed balls are effectively compact, so these additional properties are c.e., and whether C covers S is effectively open in the upper Vietoris topology. Therefore, being quasi-chainable is a Π_2^0 invariant.

If S is not chainable then S is not quasi-chainable. If in addition S is circularly chainable, then every proper compact subset of S is quasi-chainable. Indeed, let $T \subsetneq S$ be compact, $x \in S \setminus T$ and $\epsilon < d_Q(x, T)$, and let $C = (C_0, \dots, C_n)$ be a circular chain of mesh $< \epsilon$ covering S . We can assume that $x \in C_n$, applying a circular permutation if needed. As $\text{diam}(C_n) < \epsilon < d_Q(x, T)$, the set C_n is disjoint from T . As a result, (C_0, \dots, C_{n-1}) is a quasi-chain covering T . \square

It can be shown that if a compact space is in H_1 , then it is not quasi-chainable. We do not know whether the converse implication holds, in particular whether spaces that are circularly chainable but not chainable are H_1 -minimal.

5.4.4 A space that properly contains copies of itself

Theorem 4.3.2 states in particular that if a compact space X is minimal for some Σ_2^0 topological invariant then X has strong computable type. We show here that the converse implication does not hold. We actually prove more: we build a compact space X that has strong computable type and contains a proper subset X' that is homeomorphic to X . It implies that X cannot be minimal for *any* topological invariant, because any invariant satisfied by X is also satisfied by X' . Moreover, the space X is to our knowledge the first example of an infinite-dimensional space having strong computable type. The space X is built as follows. Let $f : \mathbb{S}_1 \rightarrow Q$ be a so-called “space-filling curve”, i.e. a surjective continuous function (such a function from $[0, 1]$ to Q exists by the Hahn-Mazurkiewicz theorem, see Theorem 6.3.14 in [27], and can be extended to the circle by joining the two endpoints). Let $X = Q \cup_f \mathbb{B}_2$ be the adjunction space, which is the quotient of the disjoint union $Q \sqcup \mathbb{B}_2$ by the equivalence relation generated by $x \sim f(x)$ for $x \in \mathbb{S}_1 = \partial\mathbb{B}_2$. Note that X contains a proper subset which is homeomorphic to X : indeed, X properly contains Q , which contains a copy of X .

Proposition 5.4.5

If $f : \mathbb{S}_1 \rightarrow Q$ is surjective continuous, then the space $Q \cup_f \mathbb{B}_2$ has strong computable type.

Proof. Although X cannot be H_2 -minimal, we show that there is a continuous function $q : X \rightarrow \mathbb{S}_2$ which is not null-homotopic (i.e. $X \in H_2$) and such that for any compact subset $Y \subsetneq X$, the restriction $q|_Y : Y \rightarrow \mathbb{S}_2$ is null-homotopic. The condition that f is surjective implies that Q has empty interior in X : every $y \in Q$ is the image by f of some $x \in \partial\mathbb{B}_2$, which is a limit of a sequence $x_n \in \mathbb{B}_2 \setminus \partial\mathbb{B}_2$; therefore in X , y is the limit of $x_n \in X \setminus Q$. The quotient space X/Q is homeomorphic to $\mathbb{B}_2/\partial\mathbb{S}_2$, which is homeomorphic to \mathbb{S}_2 , so we can type the quotient map $q : X \rightarrow X/Q$ as $q : X \rightarrow \mathbb{S}_2$. Proposition 0.17 in [30] states that if a pair (X, A) satisfies the homotopy extension property and A is contractible, then the quotient map $q : X \rightarrow X/A$ is a homotopy equivalence. The pair (X, Q) satisfies the homotopy extension property because X is obtained by attaching a disk to Q along its boundary (see the proof of Proposition 0.16 in [30]). The space Q is contractible, so the quotient map $q : X \rightarrow X/Q \cong \mathbb{S}_2$ is a homotopy equivalence, i.e. there exists a function $p : \mathbb{S}_2 \rightarrow X$ such that $p \circ q$ is homotopic to id_X and $q \circ p$ is homotopic to $\text{id}_{\mathbb{S}_2}$. It implies that q is not null-homotopic: otherwise the function $\text{id}_{\mathbb{S}_2}$, which is homotopic to $q \circ p$, would be null-homotopic as well, i.e. \mathbb{S}_2 would be contractible. We now show that if Y is a compact proper subset of X , then the restriction $q|_Y : Y \rightarrow \mathbb{S}_2$ is null-homotopic. As Q has empty interior in X , the interior of \mathbb{B}_2 is dense in X so it contains a point $x \in X \setminus Y$. The space $X \setminus \{x\}$ is contractible,

because it deformation retracts to Q which is contractible. Therefore, the restriction of q to $X \setminus \{x\}$ is null-homotopic, so its restriction to $Y \subseteq X \setminus \{x\}$ is null-homotopic, by restriction of the homotopy. As a result, for a compact set $Y \subseteq X$, one has $Y \neq X$ if and only if the restriction of q to Y is null-homotopic. We now prove that X has computable type. Let $X_0 \subseteq Q$ be a semicomputable copy of X , and $\phi : X_0 \rightarrow X$ a homeomorphism. The previous discussion implies that for an open set $U \subseteq Q$, U intersects X_0 if and only if the restriction of $q \circ \phi$ to $X_0 \setminus U$ is null-homotopic. We now use the properties of the numberings $\nu_{[X;Y]}$ from Theorem 5.2.1. Let i_0 be an index of a constant computable function $f_{i_0} : Q \rightarrow \mathbb{S}_2$. Note that $i_0 \in \text{dom}(\nu_{[Z;\mathbb{S}_2]})$ for all $Z \subseteq Q$. Let i_1 be such that $\nu_{[X_0;\mathbb{S}_2]}(i_1)$ is the homotopy class of $q \circ \phi$. The definition of $\nu_{[X;Y]}$ implies that for any open set $U \subseteq Q$, $i_1 \in \text{dom}(\nu_{[X_0 \setminus U;\mathbb{S}_2]})$ and $\nu_{[X_0 \setminus U;\mathbb{S}_2]}(i_1)$ is the homotopy class of the restriction of q to $X_0 \setminus U$. We saw that a basic open set $U \subseteq Q$ intersects X_0 if and only if $q|_{X_0 \setminus U}$ is null-homotopic, which is equivalent to $\nu_{[X_0 \setminus U;\mathbb{S}_2]}(i_1) = \nu_{[X_0 \setminus U;\mathbb{S}_2]}(i_0)$. As X_0 is semicomputable, so is $X_0 \setminus U$, therefore this predicate is c.e. and X_0 is computable, which shows that X_0 has computable type. The argument holds relative to any oracle, i.e. if X_0 is semicomputable relative to an oracle O , then X_0 is computable relative to O . Therefore, X has strong computable type. \square

5.5 Π_1^0 Invariants

In this section, we give a complete characterization of the topological invariants in the lowest descriptive complexity class, namely Π_1^0 . We show that this level of complexity can only detect connectedness properties of the space.

Definition 5.5.1. Let $0 \leq p \leq n$ be natural numbers. The topological invariant $C_{n,p}$ is defined by: $X \in C_{n,p}$ iff X has at most n connected components, among which at most p non-trivial ones.

As particular cases,

- $X \in C_{n,n} \iff X$ has at most n connected components,
- $X \in C_{n,0} \iff X$ contains at most n points.

These invariants are examples of Π_1^0 invariants.

Proposition 5.5.1

Let $0 \leq p \leq n$. The invariant $C_{n,p}$ is Π_1^0 .

Proof. We show that $X \notin C_{n,p}$ iff there exists $n + 1$ disjoint open sets covering X , each one intersecting X , or $p + 1$ disjoint open sets covering X , each one intersecting X in at least $n - p + 1$ distinct points. This property is Σ_1^0 .

Of course, if $X \notin C_{n,p}$ then one of these coverings exists: either X has at least $n + 1$ connected components, or X has at least $p + 1$ non-trivial connected components, which then contain as many points as needed. Conversely, if the first type of covering exists, then X has more than n components so $X \notin C_{n,p}$. Now assume that the second type of covering exists. If X has more than p non-trivial components, then $X \notin C_{n,p}$. If X has at most p non-trivial components, then one of the open sets does not contain an infinite component, so it contains at least $n - p + 1$ singletons. In total, X contains at least $p + (n - p + 1) = n + 1$ components, so $X \notin C_{n,p}$. \square

Moreover, these invariants generate all the Π_1^0 invariants.

Theorem 5.5.1. Let \mathcal{P} be a non-trivial topological invariant. The following statements are equivalent:

1. $\mathcal{P} \in \underline{\Pi}_1^0$,
2. $\mathcal{P} \in \Pi_1^0$,
3. \mathcal{P} is a finite union of $C_{n,p}$'s.

Observe that 3. \Rightarrow 2. follows from Proposition 5.5.1 and 2. \Rightarrow 1. is obvious. The next section is devoted to the proof of 1. \Rightarrow 3.

5.5.1 Approximations

We introduce the notion of approximation, which is the key ingredient underlying the proof.

Definition 5.5.2. A compact space X **approximates** Y if some copy $Y_0 \subseteq Q$ of Y is a limit of copies of X (in the Vietoris topology, or equivalently the Hausdorff metric).

Proposition 5.5.2

Let X, Y be compact spaces. The following statements are equivalent:

- X approximates Y ,
- Every $\underline{\Pi}_1^0$ invariant satisfied by X is satisfied by Y .

Proof. If X approximates Y and X satisfies a $\underline{\Pi}_1^0$ invariant \mathcal{I} , then all the copies of X belong to \mathcal{I} and so do their limits.

Conversely, assume that every $\underline{\Pi}_1^0$ invariant satisfied by X is satisfied by Y . Let \mathcal{I} be the set of limits of copies of X . By definition, \mathcal{I} is closed, i.e. $\underline{\Pi}_1^0$. \mathcal{I} is a topological invariant: if $K \subseteq Q$ is a limit of copies X_n of X and $K' \subseteq Q$ is homeomorphic to K , then K' is a limit of copies of X , because the homeomorphism $f : K \rightarrow K'$ can be extended to a homeomorphism $F : Q \rightarrow Q$ (Theorem 5.2.4 in [61]), and the copies $F(X_n)$ of X converge to $F(K) = K'$. Strictly speaking, Theorem 5.2.4 in [61] can be applied only if $K, K' \subseteq (0, 1)^{\mathbb{N}}$. If it is not the case, we apply the argument to copies of K, K' scaled down so that they fit in $(0, 1)^{\mathbb{N}}$, and observe that K' is a limit of such copies, taking scaling factors arbitrarily close to 1, which are limits of copies of X .

Finally, \mathcal{I} is satisfied by X hence by Y , i.e. some (actually, every) copy of Y is a limit of copies of X . \square

The proof also shows that in the definition of approximation, one could equivalently replace “some copy” by “every copy”.

The next result gives a particularly simple criterion to establish that a space approximates another space.

Proposition 5.5.3

Let X, Y be compact spaces. If there exists a continuous surjective function $f : X \rightarrow Y$, then X approximates Y .

Proof. We assume that X, Y are embedded in Q . The function $f : X \rightarrow Y$ is a limit of injective continuous functions $f_n : X \rightarrow Q$, defined as follows. $f_n(x)$ consists of the first n coordinates of $f(x)$, followed by x (note that x and $f(x)$, which are points of Q , are sequences of real numbers, therefore it makes sense to insert the first n terms of $f(x)$ at the beginning of x). f_n is injective,

continuous, and is closer and closer to f as n grows. Therefore, Y is the limit of the sets $f_n(X)$, which are copies of X . \square

Here are some properties of approximation related with the disjoint union (see Definition 3.1.2) and connectedness.

Proposition 5.5.4

1. The approximation relation is a pre-order, i.e. it is reflexive and transitive,
2. If X_i approximates Y_i for $i \in \{0, 1\}$, then $X_0 \sqcup X_1$ approximates $Y_0 \sqcup Y_1$,
3. If $X \neq \emptyset$, then $X \sqcup Y$ approximates X ,
4. If X, Y are connected and X is non-trivial, then X approximates Y .

Proof. (1) It follows from Proposition 5.5.2.

(2) Given two sets $A_0, A_1 \subseteq Q$, their disjoint union $A \sqcup B$ can be realized as $(\{0\} \times A_0) \cup (\{1\} \times A_1) \subseteq Q$. Let $Y_0, Y_1 \subseteq Q$ be limits of copies X_0^n, X_1^n of X_0, X_1 respectively. The realization of $Y_0 \sqcup Y_1$ is the limit of the realizations of $X_0^n \sqcup X_1^n$, which are copies of $X_0 \sqcup X_1$.

(3) Let $x_0 \in X$. X is the image of $X \sqcup Y$ under a continuous function $f : X \sqcup Y \rightarrow X$, defined by $f(x) = x$ for $x \in X$ and $f(y) = x_0$ for $y \in Y$.

(4) As X is non-trivial, it contains two distinct points, which differ in at least one coordinate. The projection along that coordinate is a continuous function sending X to a line segment, so X approximates the line segment. The line segment approximates every finite connected graph, because a such a graph is a continuous image of the line segment (a path visiting all the edges, possibly with repetitions, is nothing else than a continuous surjective function from the line segment to the graph). It remains to show that every connected compact space Y is a limit of finite connected graphs.

Given $\epsilon > 0$, let $V \subseteq Y$ be a finite set such that every point of Y is ϵ -close to a point of V . Consider the graph G with vertex set V , with an edge between u and v if $d(u, v) < 2\epsilon$. G is naturally embedded in Q , and each point of an edge is ϵ -close to one of the endpoints, so $d_H(G, Y) < \epsilon$. G must be connected: if there is a non-trivial partition $V = V_1 \sqcup V_2$ with no edge between V_1 and V_2 , then the open ϵ -neighborhoods of V_1 and V_2 cover Y and do not intersect, so they disconnect Y , giving a contradiction. \square

We now have all the ingredients to prove the main result of this section.

Proof of Theorem 5.5.1. Let \mathcal{P} be a non-trivial $\underline{\mathbf{II}}_1^0$ invariant. We first show that there is an upper bound on the number of connected components of spaces in \mathcal{P} . We assume the contrary and show that every space belongs to \mathcal{P} , contradicting the non-triviality of \mathcal{P} . First, a space X with at least n components approximates the finite set F with n points, because there is a continuous surjective function $f : X \rightarrow F$. As the finite sets are dense in $\mathcal{K}(Q)$, if the closed set \mathcal{P} contains every finite set, it contains every compact set. Therefore, \mathcal{P} is trivial, giving the desired contradiction.

Let $X \in \mathcal{P}$ have n connected components, p of them being non-trivial. X approximates every set $Y \in \mathcal{C}_{n,p}$: to each connected component Y_i of Y one can associate a connected component X_i of X in an injective way, such that if Y_i is non-trivial then X_i is non-trivial. Each Y_i is approximated by X_i by Proposition 5.5.4, item 4., so X approximates Y by Proposition 5.5.4, items 2. and 3.. \square

5.6 Σ_2^0 Invariants

Our goal is to analyze the separation power of Σ_2^0 invariants. A natural invariant of that complexity is given by the topological dimension.

Proposition 5.6.1

Having dimension at least n is a Σ_2^0 invariant in the Vietoris topology.

Proof. Let X be a compact subset of Q . Using standard compactness arguments, one can show that $\dim(X) \geq n \iff$ there exists a finite sequence U_0, \dots, U_k of finite union of rational balls of Q covering X such that there is no finite sequence V_0, \dots, V_l of finite unions of rational balls covering X , such that each closure \bar{V}_i is contained in some U_j and each intersection of $n + 2$ sets \bar{V}_i 's is empty.

We now use the fact that Q is *effectively compact*, i.e. given a Σ_1^0 subset U of Q , one can semi-decide whether $U = Q$ (see [41] for instance); in other words, given a Π_1^0 subset of Q , one can semi-decide whether it is empty. Therefore, whether a closed ball is contained in an open set, and whether a closed set is empty are semi-decidable or Σ_1^0 conditions, so the whole formula is Σ_2^0 . \square

We first introduce a refinement of the notion of approximation and prove an analog to Proposition 5.5.2.

5.6.1 Strong Approximation

Definition 5.6.1. Let X, Y be compact spaces. We say that X **strongly approximates** Y , written $X \preceq Y$, if there exists a copy $X_0 \subseteq Q$ of X such that for every $\epsilon > 0$, some copy of Y is a limit of ϵ -deformations of X_0 .

Note that the definition would be equivalent if one requires the ϵ -deformations of X_0 to be images of X_0 under *injective* ϵ -functions. Indeed, as in Proposition 5.5.3, an ϵ -function is a limit of injective ϵ -functions.

Remark 5.6.1

As for the notion of approximation, if X strongly approximates Y , then the condition actually holds for every copy $X_0 \subseteq Q$ of X .

Indeed, let $\epsilon > 0$ and let $h : Q \rightarrow Q$ be a homeomorphism sending X_0 to X'_0 . By uniform continuity take $\delta > 0$ such that $d_Q(y_1, y_2) < \delta$ implies $d_Q(h(y_1), h(y_2)) < \epsilon/2$ and suppose $Y = \lim_{n \rightarrow \infty} f_n(X_0)$ where f_n s are δ -functions. We have $Y = \lim_{n \rightarrow \infty} f_n \circ h^{-1}(X'_0)$ hence $h(Y) = \lim_{n \rightarrow \infty} h \circ f_n \circ h^{-1}(X'_0)$ as h is continuous. In addition, $d_{X'_0}(h \circ f_n \circ h^{-1}, \text{id}_{X'_0}) < \epsilon$: let $x \in X'_0$ and $y = h^{-1}(x)$, we have

$$\begin{aligned} d_Q(h \circ f_n \circ h^{-1}(x), x) &= d_Q(h(f_n(h^{-1}(x))), h(h^{-1}(x))) \\ &= d_Q(h(f_n(y)), h(y)), \end{aligned}$$

but $d_Q(f_n(y), h(y)) < \delta$ so $d_Q(h(f_n(y)), h(y)) < \epsilon/2$. Hence, the condition actually holds for the arbitrarily copy $X'_0 \subseteq Q$ of X .

Theorem 5.6.1. Let X, Y be compact spaces. The following statements are equivalent:

- X strongly approximates Y ,
- Every Σ_2^0 invariant satisfied by X is satisfied by Y .

Proof. Assume that every Σ_2^0 invariant satisfied by X is satisfied by Y . Let $X_0 \subseteq Q$ be a copy of X and let $\epsilon > 0$. Consider the following topological invariant \mathcal{P} : $Y \in \mathcal{P}$ iff there exists $\delta < \epsilon$ and a copy Y_0 of Y which is a limit of δ -deformations of X_0 . We show that it is Σ_2^0 . Let \mathcal{P}_δ be the set of limits of δ -deformations of X_0 . It is closed, i.e. Π_1^0 . Let $f_i : Q \rightarrow Q$ be a dense sequence of computable injective functions. It is not difficult to see that $Y \in \mathcal{P}$ iff there exists $\delta < \epsilon$ and i such that $f_i(Y) \in \mathcal{P}_\delta$, which is a Σ_2^0 condition. Now, X obviously satisfies \mathcal{P} , so Y satisfies \mathcal{P} as well by assumption. As it is true for every $\epsilon > 0$, X strongly approximates Y .

Now assume that X strongly approximates Y and let \mathcal{P} be a Σ_2^0 invariant satisfied by X . One has $\mathcal{P} = \bigcup_{n \in \mathbb{N}} \mathcal{P}_n$ where each \mathcal{P}_n is Π_1^0 . For every homeomorphism $f : Q \rightarrow Q$, $f(X) \in \mathcal{P}$ so $f(X) \in \mathcal{P}_n$ for some n . Therefore, there exists $n \in \mathbb{N}$ such that for “many” f , $f(X) \in \mathcal{P}_n$. It can be made precise by using Baire category on the Polish space of homeomorphisms from Q to itself. It implies that there exists $n \in \mathbb{N}$, $f : Q \rightarrow Q$ and $\epsilon > 0$ such that for every $g : Q \rightarrow Q$ satisfying $d(f, g) < \epsilon$, $g(X) \in \mathcal{P}_n$. As a result, every ϵ -deformation of $f(X)$ belongs to \mathcal{P}_n . As \mathcal{P}_n is closed, every limit of ϵ -deformation of X belongs to \mathcal{P}_n , so some copy of Y is in $\mathcal{P}_n \subseteq \mathcal{P}$. Therefore, Y satisfies \mathcal{P} . \square

Theorem 5.6.1 gives a very effective way of proving that there is no Σ_2^0 invariant separating X from Y , i.e. satisfied by X but not by Y : one simply needs to design ϵ -deformations of X converging to a copy of Y , for every ϵ .

The Closed Topologist’s Sine Curve and the Line Segment

We illustrate this technique by showing that the line segment and the closed topologist’s sine curve cannot be separated by Σ_2^0 invariants.

Definition 5.6.2. The closed topologist’s sine curve is the set

$$S = \{(x, \sin(1/x)) : x \in (0, 1]\} \cup \{(0, y) : y \in [-1, 1]\}.$$

Proposition 5.6.2

The closed topologist’s sine curve and the line segment cannot be distinguished by Σ_2^0 invariants.

Proof. Using Theorem 5.6.1, we simply have to show that S and $I = \{(x, 0) : x \in [0, 1]\}$ strongly approximate each other. We work in the plane \mathbb{R}^2 , which embeds in Q .

Let $\epsilon > 0$, we define continuous functions $f_n : I \rightarrow \mathbb{R}^2$ as follows:

$$f_n(x, 0) = \begin{cases} (x, \epsilon \sin(\frac{1}{x})) & \text{if } x \geq \frac{1}{n\pi}, \\ (x, 0) & \text{if } x \leq \frac{1}{n\pi}. \end{cases}$$

Each f_n is an ϵ -function, and the sets $f_n(I)$ converge to a copy of S , vertically scaled by ϵ . Therefore, I strongly approximates S .

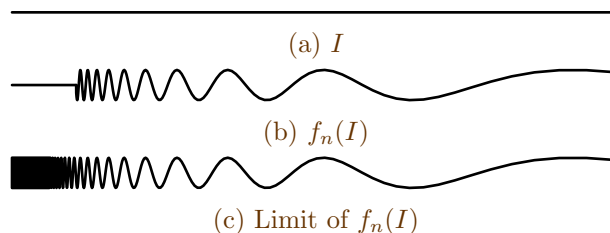

Figure 5.3: ϵ -deformations of I converging to a copy of S

5. Descriptive Complexity of Topological Invariants

We now prove that $S \preceq I$. Let $\epsilon > 0$. We build a continuous function $f : S \rightarrow \mathbb{R}^2$ such that $d(f, \text{id}) < \epsilon$. Let $k \in \mathbb{N}$ be large so that $a_k := \frac{1}{\pi/2 + 2k\pi} < \epsilon$. Note that $\sin(\frac{1}{a_k}) = 1$. We define $f : S \rightarrow \mathbb{R}^2$ by

$$f(x, y) = \begin{cases} (0, y) & \text{if } 0 \leq x \leq a_k, \\ (x - a_k, y) & \text{if } a_k \leq x. \end{cases}$$

The function f satisfies $d(f, \text{id}) \leq a_k < \epsilon$ and $f(S)$ is homeomorphic to I , so $S \preceq I$. \square

5.6.2 Cylinder

We show another application of Theorem 5.6.1.

Theorem 5.6.2. If X is compact connected and not a singleton, then $X \preceq X \times [0, 1]$.

Proof. The argument is illustrated in Figure 5.4.

We first build a sequence of continuous functions $f_n : X \rightarrow [0, 1]$ such that for every n and every $x \in X$, $f_n(\overline{B}(x, 1/n)) = [0, 1]$. As X is compact, there exists a finite set $F_n \subseteq X$ such that for every $x \in X$, there exists $y \in F_n$ with $d(x, y) < 1/2n$. Let $\delta < 1/2n$ be such that $d(y, y') \geq 2\delta$ for all distinct $y, y' \in F_n$. The function $f_n(x) = \min(d(x, F_n)/\delta, 1)$ satisfies the sought condition (for every x , $\{0, 1\}$ have preimages by f_n in $\overline{B}(x, 1/n)$ so by connectedness $f_n(\overline{B}(x, 1/n)) = [0, 1]$).

We assume that X is already embedded in $(0, 1)^\mathbb{N}$ and consider its copy $X_0 = \{0\} \times X$. For $\epsilon > 0$, we then define $g_n : X_0 \rightarrow Q$ as $g_n(0, x) = (\epsilon f_n(x), x)$. The sets $g_n(X_0)$ are ϵ -deformations of X_0 , converging to $[0, \epsilon] \times X$, which is a copy of $[0, 1] \times X$. \square

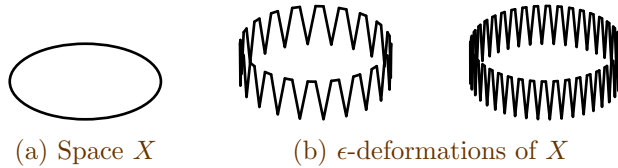

Figure 5.4: Illustration of the proof of Theorem 5.6.2

For instance, every Σ_2^0 invariant satisfied by the circle is also satisfied by the (geometric) cylinder, and every Σ_2^0 invariant satisfied by the line segment is satisfied by the filled square.

However, the cylinder and the filled square satisfy the Σ_2^0 invariant “having dimension at least 2” (Proposition 5.6.1), which is not satisfied by the circle and the line segment.

5.6.3 Wedge Sum

We give another application of Theorem 5.6.1, showing that Σ_2^0 invariants cannot separate certain spaces, at least in one direction.

Theorem 5.6.3. Let (X, x_0) and (Y, y_0) be pointed compact spaces. If Y is connected and x_0 is not isolated in X , then $X \preceq X \vee Y$.

Proof. The idea of the proof is that for any $\epsilon > 0$, one can deform a small neighborhood of x_0 and make it converge to a small copy of Y of size ϵ . Let us give the detailed argument.

First observe that when embedding a pointed space (Z, z_0) in Q , one can always send z_0 to $0 \in Q$ because Q is homogeneous, i.e. every point of Q can be sent to any other point by some homeomorphism (Theorem 1.6.6 in [61]).

Let $Q_0 = \{x \in Q : \forall i, x_{2i} = 0\}$ and $Q_1 = \{x \in Q : \forall i, x_{2i+1} = 0\}$. These subspaces of Q are homeomorphic to Q . By the previous observation, we can embed X in Q_0 and Y in Q_1 , so that $x_0 = y_0 = 0$.

As $x_0 = 0$ is not isolated in X , the function $d(x, 0)$ takes infinitely many values in $\overline{B}(0, 1/n) \cap X$ for any n . Therefore, the set

$$P_n := \{1 - nd(x, 0) : x \in \overline{B}(0, 1/n) \cap X\}$$

is infinite, so some copy Y_n of Y is a limit of copies of P_n . In other words, there exist continuous functions $h_n : P_n \rightarrow Q_1$ such that $h_n(P_n)$ converge to some copy Y' of Y . We can moreover assume that $h_n(0) = 0$.

Let $\epsilon > 0$. We define $g_n : X \rightarrow Q$ as follows:

$$g_n(x) = \begin{cases} x & \text{if } 2/n \leq d(x, 0), \\ (nd(x, 0) - 1)x & \text{if } 1/n \leq d(x, 0) \leq 2/n, \\ \epsilon h_n(1 - nd(x, 0)) & \text{if } d(x, 0) \leq 1/n. \end{cases}$$

If n is sufficiently large, then one has $d(g_n(x), x) \leq 2\epsilon$ for all $x \in Q$. When $n \rightarrow \infty$, $g_n(X)$ converges to $X \vee Y'$. \square

5.7 Separating Finite Topological Graphs

In order to understand which spaces can be separated by $\underline{\Sigma}_2^0$ invariants, we focus on a restricted class of spaces, namely the finite topological graphs. We obtain a characterization of when a graph strongly approximates another graph. As a consequence, we show that $\underline{\Sigma}_2^0$ invariants can separate any two graphs that are not homeomorphic. However, the result is not symmetric: for instance, for each $n \geq 2$ there is a $\underline{\Sigma}_2^0$ invariant satisfied by the star with $n + 1$ branches but not by the star with n branches, but not vice-versa.

5.7.1 Modulus of Local Connectedness

Proving that a space X can be separated from a space Y by some $\underline{\Sigma}_2^0$ invariant is not always easy, because only few classical invariants are $\underline{\Sigma}_2^0$, and we often need to design specific ones. Theorem 5.6.1 gives an alternative strategy, by showing that X does not strongly approximate Y . The proof of the theorem implicitly defines a $\underline{\Sigma}_2^0$ invariant (namely, having a copy which is a limit of ϵ -deformations of X). However this approach has two limitations:

- It may not be simple to show that X does not strongly approximate Y ,
- The argument is not *effective*: it yields a $\underline{\Sigma}_2^0$ (boldface) invariant, but not a Σ_2^0 (lightface) one.

In this section, we introduce a quantitative measure of local connectedness of the space, which can be used to separate many spaces and is effective, i.e. computable in some weak sense. We will see in the next section that it induces a complete invariant for the class of finite connected graphs.

Definition 5.7.1. Let (X, d) be a compact connected metric space. Its **modulus of local connectedness** is a function $\eta_X : (0, +\infty) \rightarrow [0, +\infty)$ defined by

$$\eta_X(r) = \min\{s \in [0, +\infty) : \forall x \in X, B(x, r) \text{ is contained in} \\ \text{a connected component of } \overline{B}(x, s)\}.$$

A compact subset of Q inherits the metric from Q . Let $\mathcal{K}_{\text{conn}}(Q)$ be the space of connected compact subsets of Q .

Proposition 5.7.1

Let X be compact connected. The function η_X is well-defined and non-decreasing. Moreover, the set $\{(X, r, s) : \eta_X(r) > s\}$ is Σ_1^0 in the product space $\mathcal{K}_{\text{conn}}(Q) \times \mathbb{R} \times \mathbb{R}$.

Proof. The set $C_X := \{(r, s, x) : B(x, r) \text{ is contained in a connected component of } \overline{B}(x, s)\}$ is Π_1^0 relative to X . Indeed, $(r, s, x) \notin C_X$ iff there exist disjoint open sets U, V both intersecting $B(x, r)$ and such that $\overline{B}(x, s) \subseteq U \cup V$. By compactness of X , the equivalence still holds if one additionally requires U, V to be finite unions of rational open balls and their corresponding unions of *closed* balls are disjoint. The existence of such open sets can then be effectively tested, showing that the complement of C_X is Σ_1^0 .

For connected X with diameter d , the set defining $\eta_X(r)$ contains d . As this set is closed and lower bounded by 0, it has a minimum, showing that $\eta_X(r)$ is well-defined. It is obviously non-decreasing.

One has $\eta_X(r) > s$ iff $\exists x \in X, (r, s, x) \notin C_X$ which is Σ_1^0 as C_X is Π_1^0 and one can semidecide whether X intersects a Σ_1^0 set. \square

Observe that X is locally connected if and only if $\inf_{r>0} \eta_X(r) = 0$. It implies that being locally connected is Π_3^0 , as proved in [25].

The key property of the modulus of local connectedness is that it does not increase under ϵ -deformations.

Proposition 5.7.2

If Y is a limit of ϵ -deformations of X , then

$$\eta_Y(r) \leq \eta_X(r + 2\epsilon) + \epsilon.$$

Proof. We first show the inequality when Y is an ϵ -deformation of X . Let $f : X \rightarrow Y$ be a surjective ϵ -function. Let $r > 0$ and $s < \eta_Y(r)$. There exists $x, y \in Y$ such that $d(x, y) < r$ and x, y are not in the same connected component of $\overline{B}(x, s) \cap Y$. Let $x' = f^{-1}(x)$ and $y' = f^{-1}(y)$. One has $d(x', y') < r + 2\epsilon$, and x', y' are not in the same connected component of $\overline{B}(x', s - \epsilon) \cap X$. Indeed, if $C \subseteq \overline{B}(x', s - \epsilon) \cap X$ is connected and contains x', y' , then $f(C) \subseteq \overline{B}(x, s) \cap Y$ is connected and contains x, y , giving a contradiction. As a result, $\eta_X(r + 2\epsilon) > s - \epsilon$. As this inequality holds for any $s < \eta_Y(r)$, we obtain the result.

As the function $Y \mapsto \eta_Y(r)$ is lower semicontinuous, the inequality is preserved by taking limits, so it holds for any Y which is a limit of ϵ -deformations of X . \square

5.7.2 Effective vs Non-Effective Classes

We now show that if X is a finite topological graph, then the Σ_2^0 invariants are no more expressive than the Σ_2^0 for separating X from other spaces. We use the modulus of local connectedness to

define a family of Σ_2^0 invariants, which are as powerful as arbitrary $\underline{\Sigma}_2^0$ invariants to separate X from other spaces.

Theorem 5.7.1. Let X be a connected finite topological graph and Y a compact space. If there exists a $\underline{\Sigma}_2^0$ invariant satisfied by X and not Y , then there exists a Σ_2^0 such invariant.

Proof. If Y is disconnected, then “being connected” is a Π_1^0 invariant satisfied by X but not by Y . Now assume that Y is connected.

We fix a copy X_0 of X in Q . For rational $\alpha > 0$, we define an invariant \mathcal{P}_α as follows.

$Y \in \mathcal{P}_\alpha \iff$ there exists $\beta < \alpha$ and a copy Y_0 of Y such
that $d_H(X_0, Y_0) < \beta$ and $\eta_{Y_0}(r) \leq \eta_{X_0}(r + 2\beta) + \beta$ for all $r > 0$.

Claim 5.7.1

If α is rational, then \mathcal{P}_α is a Σ_2^0 invariant.

Proof of the claim. We just give an outline of the argument. There exists a computable sequence $(f_i)_{i \in \mathbb{N}}$ of injective functions $f_i : Q \rightarrow Q$, which is dense in the space of injective continuous functions from Q to Q . The definition of \mathcal{P}_α would be equivalent if one replaces arbitrary copies Y_0 with copies $f_i(Y)$. Therefore, the quantification over Y_0 can be replaced by a quantification over $i \in \mathbb{N}$. The rest of the formula is made of Σ_1^0 and Π_1^0 statements, so the whole expression is Σ_2^0 . \square

Note that $X \in \mathcal{P}_\alpha$ for every $\alpha > 0$. We assume that $Y \in \mathcal{P}_\alpha$ for every $\alpha > 0$, and prove that X strongly approximates Y , implying that every $\underline{\Sigma}_2^0$ invariant satisfied by X is satisfied by Y , by Theorem 5.6.1.

Let $\epsilon > 0$. We show that some copy of Y is a limit of ϵ -deformations of X_0 . The idea is that we can cut X into small line segments, and that each line segment ϵ -approximates a small connected subset of (a copy of) Y . Putting all the pieces together, X ϵ -approximates that copy of Y . Let us now give the details.

Let $\delta > 0$ be small (more precisely, we want $\delta < \epsilon/3$ and $\eta_{X_0}(3\delta) < \epsilon/12$). We subdivide each edge of X by adding new vertices, so that the new edges have diameters $< \delta$. Let V and E be the new sets of vertices and edges respectively. Let $\alpha > 0$ be such that for each edge $e \in E$, its open α -neighborhood U_e has diameter $< \delta$ (we also need $\alpha < \delta$ and $\alpha < \epsilon/12$). Let Y_0 be a copy of Y witnessing that $Y \in \mathcal{P}_\alpha$. As $d_H(X_0, Y_0) < \alpha$, Y_0 is covered by the U_e 's.

One has $\eta_{Y_0}(\delta) \leq \eta_{X_0}(\delta + 2\alpha) + \alpha \leq \eta_{X_0}(3\delta) + \alpha < \epsilon/6$. Each $Y_0 \cap U_e$ has diameter $< \delta$, so it is contained in a connected set $C_e \subseteq Y_0$ of diameter $\epsilon/3$. As the U_e 's cover Y , one has $Y_0 = \bigcup_e C_e$.

For each vertex $v \in V$, we choose a point $y_v \in Y_0$ such that $d(v, y_v) < \alpha$. For each edge e that is incident to v , one has $y_v \in Y_0 \cap U_e \subseteq C_e$.

For each edge e , C_e is connected so it is approximated by the segment e . In other words, there exist continuous functions $f_n^e : e \rightarrow Q$ such that $f_n^e(e)$ converge to C_e when n grows. Moreover, we can make sure that if v is an endpoint of e , then $f_n^e(v) = y_v$. Therefore, for each n , the functions f_n^e can be concatenated into one continuous function $f_n : X \rightarrow Q$, sending each v to y_v . The sets $f_n(X)$ converge to Y when n grows.

We finally show that for sufficiently large n , f_n is an ϵ -function. Let e be an edge and v one of its endpoints. One has $\text{diam}(e) < \delta$ and $\text{diam}(C_e) \leq \epsilon/3$, so for $x \in e$ and $y \in C_e$,

$$\begin{aligned} d(x, y) &\leq d(x, v) + d(v, y_v) + d(y_v, y) \\ &< \delta + \alpha + \epsilon/3 < \epsilon. \end{aligned}$$

If n is sufficiently large, then $f_n^e(x)$ is close to C_e , so $d(x, f_n^e(x)) < \epsilon$. \square

The Σ_2^0 invariants defined in the proof are rather *ad hoc* and not intuitive that is why finding a more natural family of Σ_2^0 invariants achieving the same effect would be appreciated.

5.7.3 Separating Graphs

In this section, we prove that two non-homeomorphic finite graphs can be separated by some Σ_2^0 invariant. First, we show that a graph G can be separated from another graph H precisely when H cannot be contracted to G , even after subdivision.

We allow graphs with multiple edges and loops. Topologically, it makes no difference because subdividing such a graph results in simple graph which is topologically the same. However, edge contractions can create multiple edges and loops.

In a graph, an edge contraction consists in removing an edge and identifying its two endpoints. A contraction is a sequence of edge contractions. A subdivision consists in adding new vertices inside the edges, and splitting the edges accordingly (it does not change the topology of the graph). We refer to [32] for details on contractions.

Theorem 5.7.2. Let G, H be finite connected graphs that are not singletons. The following statements are equivalent:

- There is a Σ_2^0 invariant satisfied by G but not H ,
- No subdivision of H can be contracted to G .

Note that the same result holds for Σ_2^0 invariants, by Theorem 5.7.1. The proof of this result is presented in the end of the section 5.7.3.

Example 5.7.1

For instance, every Σ_2^0 invariant satisfied by the line segment is satisfied by the graphs that have a bridge, i.e. an edge whose removal disconnects the graph. Every Σ_2^0 invariant satisfied by the circle is satisfied by the graphs that have a cycle. Moreover, the line segment and the circle can be separated by some Σ_2^0 invariant, in both directions.

A consequence of this result is that non-homeomorphic graphs can be separated by some Σ_2^0 invariant, because they cannot be contracted to each other, even after subdivisions.

Theorem 5.7.3. If G, H are non-homeomorphic finite connected graphs, then there exists a Σ_2^0 invariant satisfied by one of them but not the other.

Proof. In order to apply Theorem 5.7.2, we need to show that G and H cannot be contracted to each other, even after subdivisions. We assume that some subdivision of G contracts to H and some subdivision of H contracts to G , and prove that G and H must be homeomorphic. It results from the following simple observations, left to the reader:

- In a graph $G = (V, E)$, the sum $S = \sum_{v \in V: \deg(v) \geq 3} \deg(v)$ does not change when subdividing and does not increase when contracting an edge. Indeed, if the endpoints of the contracted edge have degrees a, b , then the new vertex has degree $a + b - 2$, and a simple case analysis ($a, b = 1, 2$ or ≥ 3) shows that S cannot increase; in addition, the sum S is a topological invariant, i.e. does not change under subdivisions. Therefore, S must be the same in G, H and all the intermediate graphs of the contractions,
- If an edge contraction does not change S , then the resulting graph is homeomorphic to the original graph. If at least one of the endpoints of the edge has degree 2, then the graphs are homeomorphic. If one of the endpoints has degree 1 and the other has degree $d \geq 3$, then

they are replaced with a vertex of degree $d - 1$, so S decreases by 1 or d . If both endpoints have degrees $a, b \geq 3$, then they are replaced with a vertex of degree $a + b - 2$, so S decreases by 2. If both vertices have degree 1, then one of the graphs is an edge, the other is a vertex, but a point cannot be contracted to any other graph.

□

Remark 5.7.1

One may suggest to extend Theorem 5.7.3 to larger families of spaces. A natural such family is given by the finite simplicial complexes, which are higher-dimensional generalizations of graphs. However, the analog statement fails. For instance, if X is the disk and Y is the wedge of two disks, then these spaces are 2-dimensional simplicial complexes that are not homeomorphic, however they cannot be separated by Σ_2^0 invariants (it is not difficult to show that they strongly approximate each other). It raises the following question: what is the level of complexity needed to separate 2-dimensional finite simplicial complexes? what about the n -dimensional ones?

Proof of Theorem 5.7.2

We present the proof of Theorem 5.7.2, which can be reformulated this way: if G, H are finite topological graphs, then one has $G \preceq H$ iff some subdivision of H can be contracted to G .

We use the following characterization of contractibility from [32].

Lemma 5.7.1

G is a contraction of H iff there exists a surjective map $\varphi : V_H \rightarrow V_G$ such that:

- Each $\varphi^{-1}(s)$ is connected in G ,
- For every pair of distinct vertices s, t of G , (s, t) is an edge of G iff there exists an edge $e = (u, v)$ of H such that $\varphi(u) = s$ and $\varphi(v) = t$.

Proof of Theorem 5.7.2. One implication is easy: if G is obtained from H by an edge contraction, then we show that G strongly approximates H .

Let e be the edge of H that is contracted and w be the vertex of G replacing e . Consider a small neighborhood of w , which is a star. For any $\epsilon > 0$, one can ϵ -deform this star, so that the endpoints are fixed and a small region around w is collapsed to an edge. The result of this ϵ -deformation is a graph in which w has been replaced by an edge; in other words, it is a copy of H . Therefore, G strongly approximates H .

We now prove the other direction, which is much more involved. Let us first discuss why subdividing H cannot be avoided. Consider the following example: H is just two vertices joined by an edge, and G is the subdivision of H obtained by adding a vertex in the middle. In that case, G and H are topologically the same, however H cannot be contracted to G , because it has less vertices. The best we can hope is that some subdivision of H can be contracted to G .

The strategy is as follows:

- We fix a copy of G , a sufficiently small $\epsilon > 0$ and a copy of H which is a limit of ϵ -deformations of G ,
- We subdivide H so that each edge of H is entirely contained in the ϵ -neighborhood of some edge of G ,
- On each edge e of G , we choose a point a_e which is far from the vertices of both G and H ,

- We show that a_e is close to exactly one edge of H ,
- When removing the points a_e from G , one is left with a disjoint union of stars centered at the vertices of G ,
- We show that H can be contracted to G , by sending each vertex v of H to the center of the star that is closest to v (and using Lemma 5.7.1).

We fix a copy of G and assume that the edges are straight and the distances between two distinct vertices is at least 1. One has $\eta_G(r) \leq r$. Let n be the number of vertices of H .

Let e be an edge of G . There must be a point a in the middle third of e which is far from every vertex of H . Take $n + 1$ points regularly distributed on the middle third of e . They are all at distance at least $\frac{1}{3n}$ from each other. A vertex of H can be $\frac{1}{6n}$ -close to at most one of these points, so by the pigeonhole principle, some of these points is $\frac{1}{6n}$ -far from V_H . We choose such a point for each edge e of G and call it a_e .

Let $\delta \leq \frac{1}{6n}$ and $\epsilon < \delta/6$. Let G_n be $\epsilon/2$ -deformations of G converging to a copy of H . We call this copy H for simplicity.

We now subdivide H , so that every edge of H is entirely close to an edge of G .

Claim 5.7.2

We can subdivide H so that each edge of H is entirely contained in the ϵ -neighborhood of some edge of G .

Proof. The ϵ -neighborhoods of the edges of G form an open cover of the compact set H . Let μ be a Lebesgue number of the cover. We subdivide each edge of H so that the new edges have diameters smaller than μ , and are therefore contained in the ϵ -neighborhood of some edge of G . \square

From now on, we assume that H has been subdivided.

Claim 5.7.3

For every $a \in G$, if $d(a, V_H) > \delta$ then $B(a, \epsilon)$ intersects H in exactly one edge of H .

Proof. First, $B(a, \epsilon)$ intersects H , because the Hausdorff distance between G and H is less than ϵ , and $a \in G$.

As H is a limit of ϵ -deformations of G , one has $\eta_H(r) \leq \eta_G(r + 2\epsilon) + \epsilon = r + 3\epsilon$, so $\eta_H(2\epsilon) \leq 5\epsilon$.

If x and y are two points of $B(a, \epsilon) \cap H$, then $d(x, y) < 2\epsilon$ so x and y are connected in $\overline{B}(x, 5\epsilon) \cap H \subseteq B(a, \delta) \cap H$. This set is disjoint from V_H , so the only way for x and y to be connected in that set is that they belong to the same edge of H . \square

In particular, for each edge e of G , $B(a_e, \epsilon)$ intersects exactly one edge f_e of H . Conversely,

Claim 5.7.4

Each edge f of H can intersect at most one ball $B(a_e, \epsilon)$. In particular, the map $e \mapsto f_e$ is injective.

Proof of the claim. If $e' \neq e$, then $d(a_{e'}, e) \geq 1/3$, so $B(a_{e'}, \epsilon) \cap N_e(e) = \emptyset$ (assuming $\epsilon \leq 1/6$). Because of the preliminary subdivision of H , each edge f of H is contained in $N_e(e)$ for some edge e of G , therefore it does not intersect $B(a_{e'}, \epsilon)$ for $e' \neq e$, so it can only intersect $B(a_e, \epsilon)$.

It follows that the map $e \mapsto f_e$ is injective. Let $e' \neq e$. As $f_{e'}$ intersects $B(a_{e'}, \epsilon)$, it cannot intersect $B(a_e, \epsilon)$. As f_e intersects this ball, one has $f_{e'} \neq f_e$. \square

Let e be an edge of G . As e is convex, the function $r : Q \rightarrow e$ sending a point x to the closest point on e is continuous. Its restriction to f_e is a continuous function $h : f_e \rightarrow e$. The edge e is a

copy of the unit interval $[0, 1]$ and therefore inherits its natural ordering \leq (there are two possible orientations, we choose an arbitrary one).

Let u, v be the endpoints of f_e .

Claim 5.7.5

On the edge e , a is between $h(u)$ and $h(v)$.

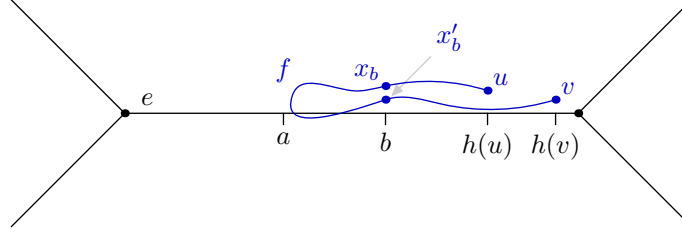

Figure 5.5: An impossible case: x_b and x'_b are close, but not closely connected

Proof of the claim. We assume that $a < h(u) \leq h(v)$ and derive a contradiction. The other cases where $h(u)$ and $h(v)$ are on the same side of a are symmetric, and the same argument applies.

As $f_e \subseteq N_{\epsilon/2}(e)$, one has $d(h(x), x) \leq \epsilon/2$ for all $x \in f_e$.

Let $x_a \in f_e$ be such that $d(x_a, a) \leq \epsilon/2$, implying that $d(h(x_a), a) \leq \epsilon$.

Let $b \in e$ be the middle point between a and $h(u)$. One has $d(a, h(u)) \geq d(a, u) - d(u, h(u)) > \delta - \epsilon/2$ so $d(a, b), d(b, h(u)) > \delta/2 - \epsilon/4$.

As $a < b < h(u) \leq h(v)$, there exist x_b, x'_b such that $u < x_b < x_a < x'_b < v$ such that $h(x_b) = h(x'_b) = b$. One has $d(x_b, x'_b) \leq \epsilon$, so x_b and x'_b must be connected in $H \cap \overline{B}(x_b, 5\epsilon)$. In H , the only paths that connect x_b and x'_b cross x_a or u . Therefore, this ball must contain x_a or u . However, $d(x_b, x_a) \geq d(b, a) - \epsilon$ and $d(x_b, u) \geq d(b, h(u)) - \epsilon$. They are both larger than 5ϵ if ϵ is sufficiently small, $\epsilon < \delta/14$. \square

Let $A = \{a_e : e \in E_G\}$. The set $G \setminus A$ is a disjoint union of stars centered at the vertices of G . Each vertex v of H is ϵ -close to some point y_v of G , which belongs to one of these stars (indeed, $y_v \notin A$ because $d(v, A) > \delta > \epsilon$).

We use Lemma 5.7.1 and define a map $\varphi : V_H \rightarrow V_G$ sending $v \in H$ to the center of the star of y_v .

Let $f = (u, v)$ be an edge of H such that $\varphi(u) \neq \varphi(v)$. f is ϵ -close to an edge $e = (s, t)$ of G . e is $1/3$ -far from every star centered at a vertex other than s and t , so f is $(1/3 - \epsilon)$ -far from these stars. As u and v are ϵ -close to the stars of $\varphi(u)$ and $\varphi(v)$ respectively, one must have $\varphi(u) = s$ and $\varphi(v) = t$ (or the symmetric case). As a result, $(\varphi(u), \varphi(v))$ is the arc e of G .

If $e = (s, t)$ is an edge of G , then $f_e = (u, v)$ satisfies $\varphi(u) = s$ and $\varphi(v) = t$ because u, v stand on opposite sides of a_e .

Claim 5.7.6

Each $\varphi^{-1}(s)$ is connected.

Proof of the claim. Let $u, v \in \varphi^{-1}(s)$. y_u and y_v belong to the star S_s centered at s . The star is connected, so there exists a sequence of points $y_0, y_1, \dots, y_k \in S_s$ with $y_0 = y_u, y_k = y_v$ and $d(y_i, y_{i+1}) < \epsilon$. As G and H are $\epsilon/2$ -close in the Hausdorff metric, there exist $x_0, \dots, x_k \in H$ such that $d(x_i, y_i) \leq \epsilon/2$. One has $d(x_i, x_{i+1}) < 2\epsilon$, so x_i and x_{i+1} are connected in $\overline{B}(x_i, 5\epsilon) \cap H$. Therefore, u and v are connected in $N_{5\epsilon}(S_s) \cap H$, i.e. there is a path from u to v in H contained in $N_{5\epsilon}(S_s)$. All the vertices of this path are close to S_s , so they belong to $\varphi^{-1}(s)$. As a result, u and v are connected in $\varphi^{-1}(s)$. \square

\square

5.8 Conclusion

THE findings regarding strong computable type presented in the preceding chapter serve as a catalyst for delving into the descriptive complexity of topological invariants, a subject that this chapter explores in depth. Namely, we proved that ANRs allow us to define invariants of low effective descriptive complexity; using this result, we defined two Σ_2^0 invariants thanks to which we revisited several results about computable type from the literature and obtained new ones. In addition, we characterized the Π_1^0 invariants using connectedness. We studied the expressive power of Σ_2^0 invariants and proved that the effective versions (Σ_2^0 invariants) can separate between finite topological graphs.

Chapter 6

The Surjection Property and Computable Type

Contents

6.1	Introduction	100
6.2	Euclidean Points and Regular Cells	100
6.3	The (ϵ-)Surjection Property	101
6.3.1	The (ϵ -)Surjection Property for Cone Pairs	103
6.3.2	The (ϵ -)Surjection Property and Unions	104
6.4	Finitely Conical Spaces	105
6.4.1	Definition and First Properties	105
6.4.2	The ϵ -Surjection Property for Finitely Conical Pairs	106
6.5	The Surjection Property for Cone Pairs	107
6.5.1	Quotients to Spheres	108
6.5.2	Retractions to Spheres	111
6.5.3	Cycles	112
	1) Simplicial Complexes	113
	2) Cycles vs the Surjection Property	113
6.6	Counter-examples	116
6.6.1	A Family of Spaces	116
6.6.2	Cycles vs the Surjection Property	116
6.6.3	Product	118
	Iteration of the Suspension	119
6.7	Applications to Computable Type	120
6.7.1	A Characterization for Finite Simplicial Complexes	120
6.7.2	Finite 2-Dimensional Simplicial Complexes	123
	1) The Dunce Hat	124
	2) Bing's House, or the House With Two Rooms	125
6.7.3	Boundaries and the Odd Subcomplex	126
	The Odd Subcomplex	127
6.7.4	Computable Type and the Product	128
6.7.5	Cones of Manifolds	128
6.8	Conclusion	129

Some of the results stated in this chapter can be found in [8, 4, 9].

6.1 Introduction

THE ϵ -surjection property is a topological property of spaces and pairs of spaces, introduced in Section 4.4.3 as a mean to establish a prerequisite for having strong computable type (see Definition 4.4.3 and Corollary 4.4.3). The surjection property is stronger since it does not depend on ϵ .

The objective of this chapter is to examine the surjection and ϵ -surjection properties, offering methods to confirm or disprove them, particularly through the utilization of homotopy and homology theories. Additionally, this chapter aims to present various applications of these techniques. The obtained results are applicable to finite simplicial complexes, as well as slightly broader classes of compact metrizable spaces and pairs.

One of the key implications of our findings is that the ϵ -surjection property holds when the space is a union of homology cycles.

Our findings have further practical implications, one of which is that a finite simplicial complex X has computable type if and only if it satisfies the ϵ -surjection property for some $\epsilon > 0$. Recall that this property says that every continuous function $f : X \rightarrow X$ which is ϵ -close to the identity must be surjective.

We establish that this property holds true if and only if every star, which takes the form of a cone $C(L)$, satisfies the surjection property, namely every continuous function $f : C(L) \rightarrow C(L)$ which is the identity on L is surjective.

In addition, we prove that the computable type property does not remain invariant under products, providing an answer to a query posed by Čelar and Iljazović in [21]. Specifically, we have discovered the existence of a finite simplicial complex X , which has computable type, but its product with the circle, $X \times S_1$ does not. This intriguing result hinges on the intricate characteristics of the suspension homomorphism between homotopy groups of spheres.

By utilizing the reduction to homology, we can deduce that the computable type property can be effectively determined for finite simplicial complexes with dimension up to 4.

Furthermore, it implies that in a simplicial complex K , if every n -simplex belongs to an even number of maximal $(n + 1)$ -simplices, then K has computable type.

The chapter is organized as follows. In Section 6.2, we introduce the notion of almost Euclidean spaces and pairs. In Section 6.3, we investigate general aspects of the (ϵ -)surjection property, such as their preservation under countable unions. In Section 6.4, we show that for spaces that are finite unions of cones, the ϵ -surjection property is equivalent to the surjection property of each cone. In Section 6.5, we investigate the surjection property of cones and obtain precise relationships with homotopy and homology theories. In Section 6.6, we apply these results to a family of spaces which is a source of counter-examples. In Section 6.7, we give applications to the computable type property, the main of which is a characterization for finite simplicial complexes. We end with a conclusion in Section 6.8. Section B in the appendix discusses the choice of the coefficients in homology groups.

6.2 Euclidean Points and Regular Cells

We introduce a class of spaces for which most points have a Euclidean neighborhood. Most of the results will apply to these spaces.

Definition 6.2.1. Let X be a topological space and $n \in \mathbb{N}$, $n \geq 1$. A point $x \in X$ is **n -Euclidean** if it has an open neighborhood that is homeomorphic to \mathbb{R}^n . A point is **Euclidean** if it is n -Euclidean for some n .

A space is **almost Euclidean** if the set of Euclidean points is dense. A space is **almost n -Euclidean** if the set of n -Euclidean points is dense. A pair (X, A) is almost Euclidean (resp. almost n -Euclidean) if $X \setminus A$ is almost Euclidean (resp. almost n -Euclidean).

Every CW-complex without isolated point is almost Euclidean and every n -manifold is almost n -Euclidean.

Definition 6.2.2. Let X be a topological space and $n \geq 1$. A set $C \subseteq X$ is a **regular n -cell** if there is a homeomorphism $f : \mathbb{B}_n \rightarrow C$ such that $f(\mathbb{B}_n \setminus \mathbb{S}_{n-1})$ is an open subset of X . The set $f(\mathbb{S}_{n-1})$ is the **border** of the cell and is denoted by $\text{bd}(C)$. The set $f(\mathbb{B}_n \setminus \mathbb{S}_{n-1})$ is the corresponding **open cell** and is denoted by $\text{op}(C)$. A **regular cell** is a regular n -cell for some $n \geq 1$.

Note that $\text{bd}(C)$ and $\text{op}(C)$ always contain the topology boundary and the interior of C respectively, but do not always coincide with them. For instance, in a simplicial complex, a free face of a simplex is contained in its border but not in its boundary.

A point $x \in X$ is n -Euclidean if and only if x belongs to $\text{op}(C)$ for some n -cell $C \subseteq X$.

Note that we work with compact metrizable spaces only.

6.3 The (ϵ -)Surjection Property

The surjection property and the ϵ -surjection property were defined in Chapter 4. We recall their definitions and develop techniques to prove or disprove these properties.

Definition 6.3.1. A pair (X, A) satisfies the **surjection property**, if every continuous function $f : X \rightarrow X$ such that $f|_A = \text{id}_A$ is surjective.

Let (X, d) be a metric space and $A \subseteq X$ a closed set. For $\epsilon > 0$, (X, A) satisfies the **ϵ -surjection property** if every continuous function $f : X \rightarrow X$ such that $f|_A = \text{id}_A$ and $d(f, \text{id}_X) < \epsilon$ is surjective. The space X has the ϵ -surjection property if the pair (X, \emptyset) does.

It satisfies the **generalized ϵ -surjection property** if every continuous function of pairs $f : (X, A) \rightarrow (X, A)$ satisfying $d_X(f, \text{id}_X) < \epsilon$ is surjective.

Of course, the surjection property implies the ϵ -surjection property for any $\epsilon > 0$.

Example 6.3.1

For every $n \in \mathbb{N}$, the $(n + 1)$ -dimensional ball and its bounding n -dimensional sphere form a pair $(\mathbb{B}_{n+1}, \mathbb{S}_n)$ that has the surjection property. It is a consequence of an equivalent formulation of Brouwer's fixed-point theorem (Corollary 2.15 in [31]) that \mathbb{S}_n is not a retract of \mathbb{B}_{n+1} , but is a retract of any proper subset of \mathbb{B}_{n+1} containing \mathbb{S}_n .

Example 6.3.2

Let $n \in \mathbb{N}$ and let d be a compatible metric on \mathbb{S}_n . If ϵ is smaller than half the distance between every pair of antipodal points, then \mathbb{S}_n has the ϵ -surjection property. It is a consequence of Borsuk-Ulam's theorem.

Example 6.3.3

If $A \subsetneq X$ is a retract of X , then the pair (X, A) does not have the surjection property, as witnessed by the retraction.

Although the ϵ -surjection property depends on the metric of the particular copy of a pair (X, A) , quantifying over ϵ yields a topological invariant, i.e. a property of the pair that is satisfied either by all copies or by none of them.

Proposition 6.3.1

Let (X, A) be a compact pair. Whether there exists $\epsilon > 0$ such that (X, A) has the ϵ -surjection property does not depend on the choice of a compatible metric on X .

Proof. By universality of Q , it is sufficient to prove that the ϵ -surjection property does not depend on the copy of (X, A) in Q . If (Y, B) is a copy of (X, A) , then let $\phi : X \rightarrow Y$ be a homeomorphism such that $\phi(A) = B$. By compactness of X , ϕ is uniformly continuous so given $\epsilon > 0$, there exists $\delta > 0$ such that if $d(x, x') < \delta$ then $d(\phi(x), \phi(x')) < \epsilon$. If (Y, B) has the ϵ -surjection property, then we show that (X, A) has the δ -surjection property. Let $f : X \rightarrow X$ be continuous, satisfying $f|_A = \text{id}_A$ and $d_X(f, \text{id}_X) < \delta$. Define $g = \phi \circ f \circ \phi^{-1} : Y \rightarrow Y$: one has $g|_B = \text{id}_B$ and $d_Y(g, \text{id}_Y) < \epsilon$ by choice of δ so g is surjective, hence f is surjective. \square

When the pair is well-behaved, the condition $f|_A = \text{id}_A$ can be replaced by the weaker condition $f(A) \subseteq A$.

Lemma 6.3.1

Let (X, A) be a compact pair satisfying the homotopy extension property and assume that A is an ANR whose interior is empty. The following statements are equivalent:

1. There exists $\epsilon > 0$ such that (X, A) has the ϵ -surjection property,
2. There exists $\epsilon > 0$ such that (X, A) has the generalized ϵ -surjection property.

When A has non-empty interior, the result still holds if one replaces the surjectivity of f by $X \setminus A \subseteq \text{im}(f)$ in condition 2.

Proof. Of course 2. implies 1., we prove the other direction. We assume that 2. does not hold and prove that 1. does not hold. Let $\epsilon > 0$. Let $\delta < \epsilon/2$ be such that functions to A that are δ -close are $\epsilon/2$ -homotopic (Lemma 3.3.4). Let $f : (X, A) \rightarrow (X, A)$ be a non-surjective function satisfying $d(f, \text{id}_X) < \delta$. There is an $\epsilon/2$ -homotopy $h_t : A \rightarrow A$ from $h_0 = f|_A$ to $h_1 = \text{id}_A$. We then apply Lemma 3.3.1, which implies that there is an $\epsilon/2$ -homotopy $H_t : X \rightarrow A \cup \text{im}(f)$ extending h_t , from f to some $g : X \rightarrow A \cup \text{im}(f)$. As A has empty interior, X is compact and f is not surjective, $A \cup \text{im}(f)$ is a proper subset of X so g is a non-surjective function to X . One has $g|_A = h_1 = \text{id}_A$ and $d(g, \text{id}_X) \leq d(g, f) + d(f, \text{id}_X) < \epsilon$, so (X, A) does not satisfy the ϵ -surjection property. \square

The product of two pairs is $(X, A) \times (Y, B) = (X \times Y, X \times B \cup A \times Y)$. For well-behaved pairs, the ϵ -surjection property of the product implies the δ -surjection property of the two pairs for some δ .

Proposition 6.3.2

Let X, Y and $A \subsetneq X, B \subsetneq Y$ be compact ANRs.

If $(X, A) \times (Y, B)$ has the ϵ -surjection property, then (X, A) and (Y, B) satisfy the δ -surjection for some $\delta > 0$.

Proof. Let $(Z, C) = (X, A) \times (Y, B) = (X \times Y, X \times B \cup A \times Y)$. Note that C is a compact ANR: indeed, the product of ANRs is an ANR (Theorem IV.7.1 in [14]), so $X \times B, A \times Y$ and their

intersection $A \times B$ are ANRs, therefore their union is an ANR (Theorem IV.6.1 in [14]). We can assume w.l.o.g. that the metric on the product space is the maximum of the metrics on X and Y .

We assume that (X, A) does not satisfy the ϵ -surjection property for any $\epsilon > 0$, and show that the same holds for (Z, C) . Let $\epsilon > 0$ and $f : X \rightarrow X$ be a non-surjective function such that $f|_A = \text{id}_A$ and $d(f, \text{id}_X) < \epsilon$. We naturally define $g : (Z, C) \rightarrow (Z, C)$ by $g(x, y) = (f(x), y)$. One easily checks that $g(C) \subseteq C$. As $d(f, \text{id}_X) < \epsilon$, one has $d(g, \text{id}_Z) < \epsilon$. The image of g does not contain $Z \setminus C$: if $x_0 \in X \setminus \text{im}(f)$ and $y_0 \in Y \setminus B$, then $(x_0, y_0) \notin \text{im}(g)$. Therefore, we can apply Lemma 6.3.1, implying that (Z, C) does not satisfy the ϵ -surjection property for any $\epsilon > 0$. \square

6.3.1 The (ϵ -)Surjection Property for Cone Pairs

Cones have the particular property that they contain arbitrarily small copies of themselves, implying that for any $\epsilon > 0$, the ϵ -surjection is equivalent to the surjection property. Cones and cone pairs are defined in Section 3.2.1.

Proposition 6.3.3

Let (X, A) be a compact pair and $\epsilon > 0$. The cone pair $\mathbf{C}(X, A)$ has the ϵ -surjection property iff it has the surjection property.

Proof. Assume that X is embedded in Q and let $\mathbf{C}(X) = \{(t, tx) : t \in [0, 1], x \in X\}$. Assume that there is a non-surjective continuous function $f : \mathbf{C}(X) \rightarrow \mathbf{C}(X)$ which is the identity on $X \cup \mathbf{C}(A)$. For any $\epsilon > 0$, one can define such a function g which is ϵ -close to the identity. We decompose $\mathbf{C}(X)$ as $\mathbf{C}(X) = C \cup D$ where

$$C = \{(t, tx) : t \in [0, \delta], x \in X\}$$

$$D = \{(t, tx) : t \in [\delta, 1], x \in X\}.$$

Note that C is homeomorphic to $\mathbf{C}(X)$. We define g as the identity on D and as a rescaled version of f on C , namely $g(\delta t, \delta tx) = \delta f(t, tx)$ for $t \in [0, 1]$ and $x \in X$. g is non-surjective, is the identity on $X \cup \mathbf{C}(A)$, and if δ is sufficiently small, then g is ϵ -close to the identity.

In Section 3.2.1, we introduce the symbol \odot and define $\mathbf{C}(\odot) = \{0\}$. Note that the proof works when $A = \odot$ and $\mathbf{C}(X, \odot) = (\mathbf{C}(X), X \cup \{0\})$ (where 0 is the tip of $\mathbf{C}(X)$). \square

The only case when we need to consider $A = \odot$ is when X is a singleton.

Proposition 6.3.4

If X is not a singleton, then $\mathbf{C}(X, \odot)$ has the surjection property if and only if $\mathbf{C}(X, \emptyset)$ has the surjection property.

Proof. Assume that $\mathbf{C}(X, \emptyset)$ does not have the surjection property, and let $f : \mathbf{C}(X) \rightarrow \mathbf{C}(X)$ be a non-surjective continuous function which is the identity on X . We build a non-surjective continuous function $g : \mathbf{C}(X) \rightarrow \mathbf{C}(X)$ which is the identity on $X \cup \{0\}$.

We are going to define a proper subspace $Y \subsetneq \mathbf{C}(X)$ that contains $\text{im}(f) \cup \{0\}$ and contains a path from 0 to $f(0)$. Let then $i : X \cup \{0\} \rightarrow Y$ be the inclusion and $j : X \cup \{0\} \rightarrow Y$ be the identity on X and send 0 to $f(0)$. The path from 0 to $f(0)$ in Y induces a homotopy from i to j . As the pair $(\mathbf{C}(X), X \cup \{0\})$ has the homotopy extension property, it implies that the inclusion has a continuous extension $g : \mathbf{C}(X) \rightarrow Y$, which is non-surjective when typed as $g : \mathbf{C}(X) \rightarrow \mathbf{C}(X)$, which completes the proof.

We now define the space Y . There are two cases.

First assume that $0 \in \text{im}(f)$. In that case, we simply take $Y = \text{im}(f)$. Let $x \in \mathbf{C}(X)$ be such that $f(x) = 0$. The image by f of the ray from 0 to x in $\mathbf{C}(X)$ is a path from $f(0)$ to 0, contained in Y .

Now assume $0 \notin \text{im}(f)$. Let Y be the union of $\text{im}(f)$ and the ray from 0 to $f(0)$. We need to show that Y is a proper subset of $\mathbb{C}(X)$. Let a, b be two distinct points of X . As $\text{im}(f)$ is closed and does not contain 0, the rays from 0 to a and b are not contained in $\text{im}(f)$. $f(0)$ belongs to at most one of them, so the other ray is still not contained in Y . Therefore, Y is a proper subset of $\mathbb{C}(X)$. \square

6.3.2 The (ϵ -)Surjection Property and Unions

In certain cases, the (ϵ -)surjection property for a pair (X, A) can be established by proving the (ϵ -)surjection property for subpairs covering (X, A) .

The first result holds for cone pairs and countable unions.

Theorem 6.3.1. Let (X, A) and $(X_i, A_i)_{i \in \mathbb{N}}$ be compact pairs such that $X = \bigcup_{i \in \mathbb{N}} X_i$ and $A = \bigcup_{i \in \mathbb{N}} A_i$. Assume that (X, A) is almost Euclidean. If every pair $\mathbb{C}(X_i, A_i)$ has the surjection property, then $\mathbb{C}(X, A)$ has the surjection property.

Proof. Assume that $\mathbb{C}(X, A)$ does not have the surjection property. There exist $n \in \mathbb{N}$ and a regular n -cell $C \subseteq X \setminus A$ such that the corresponding quotient map $q_C : (X, A) \rightarrow (\mathbb{S}_n, s)$ is null-homotopic.

For each i , the topological boundary ∂X_i of X_i is nowhere dense in X , so $\bigcup_{i \in \mathbb{N}} \partial X_i$ is meager. By the Baire category theorem, its complement is dense, in particular it intersects $\text{op}(C)$. Let x belong to the intersection and let i be such that $x \in X_i$. As $x \notin \partial X_i$, x belongs to the interior of X_i so x is n -Euclidean in X_i . Note that $x \notin A_i$, because C is disjoint from A .

Let $C' \subseteq C \cap X_i \setminus A_i$ be a regular n -cell. The quotient map $q_{C'} : (X, A) \rightarrow (\mathbb{S}_n, s)$ is homotopic to q_C so it is null-homotopic. Therefore, its restriction to (X_i, A_i) is null-homotopic, implying that $\mathbb{C}(X_i, A_i)$ does not have the surjection property. \square

Under certain conditions, the ϵ -surjection property is preserved by taking finite unions.

Theorem 6.3.2. Let (X, A) and $(X_i, A_i)_{i \leq n}$ be compact pairs such that $X = \bigcup_{i \leq n} X_i$ and $A = \bigcup_{i \leq n} A_i$. Assume that each topological boundary ∂X_i is a neighborhood retract in X . If every pair (X_i, A_i) has the ϵ -surjection property for some $\epsilon > 0$, then (X, A) has the δ -surjection property for some $\delta > 0$.

Proof. For each i , there is a neighborhood U_i of X_i and a retraction $r_i : U_i \rightarrow X_i$ such that the only preimage of each $x \in \text{int}_X(X_i)$ is x .

Indeed, let $V_i \subseteq X$ be a neighborhood of ∂X_i and $\rho_i : V_i \rightarrow \partial X_i$ be a retraction. Let $U_i = X_i \cup V_i = \text{int}_X(X_i) \cup V_i$ and define $r_i : U_i \rightarrow X_i$ as the identity on X_i and as ρ_i on $V_i \setminus \text{int}_X(X_i)$. The definition is consistent because the intersection of X_i and $V_i \setminus \text{int}_X(X_i)$ is ∂X_i , on which ρ_i coincides with the identity. Therefore, r_i is well-defined and continuous, and is indeed a retraction.

Let $\epsilon > 0$ be such that each (X_i, A_i) has the ϵ -surjection property. Let $\delta > 0$ be such that for each $i \leq n$, $\mathcal{N}(X_i, \delta) \subseteq U_i$ and for $x, y \in U_i$, $d(x, y) < \delta$ implies $d(r_i(x), r_i(y)) < \epsilon$.

Assume the existence of a non-surjective continuous function $f : X \rightarrow X$ such that $f|_A = \text{id}_A$ and $d(f, \text{id}_X) < \delta$. There exists $i \leq n$ and $x_0 \in \text{int}_X(X_i)$ which is not in the image of f . Let $f_i = r_i \circ f|_{X_i} : X_i \rightarrow X_i$. It is well-defined, because $f(X_i) \subseteq \mathcal{N}(X_i, \delta) \subseteq U_i$. Both f and r_i are the identity on A , so f_i is the identity on A . By choice of δ , $d(f_i, \text{id}_{X_i}) < \epsilon$. Finally, f_i is not surjective, because x_0 is not in its image: the only preimage of $x_0 \in \text{int}_X(X_i)$ by r_i is x_0 , which is not in the image of f . \square

6.4 Finitely Conical Spaces

We show that for a class of spaces containing finite simplicial complexes and compact manifolds, the ϵ -surjection property is actually a local property.

6.4.1 Definition and First Properties

Definition 6.4.1. A topological space X is **finitely conical** if there exists a finite sequence of compact metrizable spaces $(L_i)_{i \leq n}$ and a finite covering of X by open sets $U_i \subseteq X$, $i \leq n$, where U_i is homeomorphic to $\text{OC}(L_i)$.

A pair (X, A) is **finitely conical** if X is finitely conical and for every i , the homeomorphism $f_i : U_i \rightarrow \text{OC}(L_i)$ satisfies $f_i(U_i \cap A) = \text{OC}(N_i)$ for some compact $N_i \subseteq L_i$ (or $N_i = \odot$).

We will say that the sequence $(L_i)_{i \leq n}$ or $(L_i, N_i)_{i \leq n}$ witnesses the fact that X or (X, A) is finitely conical.

For simplicity of notation, we will identify U_i with $\text{OC}(L_i)$, so the condition for pairs can be written as $\text{OC}(L_i) \cap A = \text{OC}(N_i)$.

Remark 6.4.1

We allow the pair $(L_i, N_i) = (\{0\}, \odot)$, giving the open cone pair $\text{OC}(\{0\}, \odot) = ([0, 1], \{0\})$.

Example 6.4.1

Let X be a finite topological graph and A be the set vertices of degree 1. The pair (X, A) is finitely conical. An open cone consists of a vertex v together with the open edges starting at v . The open cone pair centered at v is $\text{OC}(L, N)$, where L is the set of vertices that are neighbors of v and $N = \odot$ if v has degree 1, and $N = \emptyset$ otherwise.

Example 6.4.2

More generally, every pair (X, A) consisting of a finite simplicial complex X and a subcomplex A is finitely conical, witnessed by the open stars of the vertices.

Example 6.4.3

Every compact manifold of dimension $n \in \mathbb{N}^*$ with possibly empty boundary ∂M is finitely conical. The pairs (L_i, N_i) are $(\mathbb{S}_{n-1}, \emptyset)$, as well as $(\mathbb{B}_{n-1}, \mathbb{S}_{n-2})$ when $\partial M \neq \emptyset$. A point $x \in M \setminus \partial M$ is the tip of $\text{OC}(\mathbb{S}_{n-1})$, a point $x \in \partial M$ is the tip of $\text{OC}(\mathbb{B}_{n-1})$. Note that for $n = 1$, one has $(\mathbb{B}_0, \mathbb{S}_{-1}) = (\{0\}, \odot)$ (see Section 3.2.1).

The class of finitely conical spaces or pairs is preserved by many constructs.

Proposition 6.4.1

Finitely conical pairs are closed under finite products and the cone operator.

Proof. Let (X_1, A_1) and (X_2, A_2) be finitely conical, and let $(L_i^1, N_i^1)_{i \leq m}$ and $(L_j^2, N_j^2)_{j \leq n}$ be respective witnesses. It is not difficult to see that the $(X, A) = (X_1, A_1) \times (X_2, A_2)$ is finitely conical, witnessed by the pairs

$$(L_{i,j}, N_{i,j}) = (L_i^1, N_i^1) * (L_j^2, N_j^2),$$

where the join $*$ of pairs is defined in Section 3.2.2.

Indeed, one has

$$X = X_1 \times X_2 = \bigcup_i \text{OC}(L_i^1) \times \bigcup_j \text{OC}(L_j^2) = \bigcup_{i,j} \text{OC}(L_i^1) \times \text{OC}(L_j^2) = \bigcup_{i,j} \text{OC}(L_{i,j}),$$

by Proposition 3.2.1. Note that each $\text{OC}(L_{i,j})$ is open in X . Moreover,

$$\begin{aligned}
 \text{OC}(L_{i,j}) \cap A &= (\text{OC}(L_i^1) \times \text{OC}(L_j^2)) \cap ((A_1 \times X_2) \cup (X_1 \times A_2)) \\
 &= ((\text{OC}(L_i^1) \cap A_1) \times \text{OC}(L_j^2)) \cup (\text{OC}(L_i^1) \times (\text{OC}(L_j^2) \cap A_2)) \\
 &= (\text{OC}(N_i^1) \times \text{OC}(L_j^2)) \cup (\text{OC}(L_i^1) \times \text{OC}(N_j^2)) \\
 &= \text{OC}(N_i^1 * L_j^2 \cup L_i^1 * N_j^2) \\
 &= \text{OC}(N_{i,j}),
 \end{aligned}$$

where the last equality holds by Proposition 3.2.2. We have proved that (X, A) is finitely conical.

We now show that if (X, A) is finitely conical, coming with $(L_i, N_i)_{i \leq n}$, then $\text{C}(X, A)$ is finitely conical, witnessed by the pairs $\text{C}(L_i, N_i)$ together with the pair (X, A) .

The first component of the pair $\text{C}(X, A)$ is the cone $\text{C}(X)$, which is covered by two open sets $\text{OC}(X)$ and $X \times (0, 1]$. Its second component is $X \cup \text{C}(A)$, which is covered by the two open sets $\text{OC}(A)$ and $X \cup (A \times (0, 1])$. All in all, we have $\text{C}(X, A) = \text{OC}(X, A) \cup ((X, A) \times ((0, 1], \{1\}))$.

The first pair $\text{OC}(X, A)$ is finitely conical, because it consists of one open cone pair.

The second pair $(X, A) \times ((0, 1], \{1\}) = (X, A) \times \text{OC}(\{0\}, \odot)$ is a product of two finitely conical pairs, so it is finitely conical by the first statement. It is witnessed by the pairs $(L_i, N_i) * (\{0\}, \odot) = \text{C}(L_i, N_i)$. Therefore, $\text{C}(X, A)$ is the union of two open subspaces which are both finitely conical, so it is finitely conical. \square

Remark 6.4.2

*By similar arguments, it can be proved that if the pairs (X_1, A_1) and (X_2, A_2) are finitely conical, witnessed by $(L_i^1, N_i^1)_{i \leq m}$ and $(L_j^2, N_j^2)_{j \leq n}$ respectively, then their join $(X, A) * (Y, B)$ is finitely conical, witnessed by the pairs*

$$\text{C}((L_i^1, N_i^1) * (L_j^2, N_j^2)),$$

*which means that $(X, A) * (Y, B)$ is covered by the open cones of these pairs. We will not use this result.*

6.4.2 The ϵ -Surjection Property for Finitely Conical Pairs

We show that the ϵ -surjection property of a finitely conical pair reduces to the surjection property of each local cone pair, assuming that the L_i 's are ANRs. This result is particularly useful because it enables one to check a global property by inspecting the local cones independently of each other.

Theorem 6.4.1. Let (X, A) be a finitely conical compact pair coming with $(L_i, N_i)_{i \leq n}$, where each L_i is an ANR. The following statements are equivalent:

1. (X, A) has the ϵ -surjection property for some $\epsilon > 0$,
2. All the cone pairs $\text{C}(L_i, N_i)$ have the surjection property.

The implication 2. \Rightarrow 1. does not follow from Theorem 6.3.2, because in a finitely conical pair (X, A) , one has $A = \bigcup_i \text{C}(N_i)$ while applying Theorem 6.3.2 would require $A = \bigcup_i L_i \cup \text{C}(N_i)$. *Proof.* 1. \Rightarrow 2. Assume that some $\text{C}(L_i, N_i)$ does not have the surjection property and let $\epsilon > 0$. $\text{C}(L_i, N_i)$ does not have the ϵ -surjection property by Proposition 6.3.3, which is witnessed by a non-surjective continuous function $f : \text{C}(L_i) \rightarrow \text{C}(L_i)$. We assume that $\text{C}(L_i)$ is embedded in X in such a way that its topological boundary in X is L_i . We then extend f as the identity outside $\text{C}(L_i)$, showing that (X, A) does not have the ϵ -surjection property. Note that the extension of f is indeed continuous because f is the identity on the boundary of $\text{C}(L_i)$.

2. \Rightarrow 1. We assume that for every $\epsilon > 0$, (X, A) does not have the ϵ -surjection property, and we prove that some cone pair $\mathbf{C}(L_i, N_i)$ does not have the surjection property.

As X is compact and is covered by finitely many open cones $\mathbf{OC}(L_i)$, X is covered by slightly smaller closed cones $\mathbf{C}(L_i)$ contained in these open cones. Let $(K_i, M_i) = \mathbf{C}(L_i, N_i)$ be these closed cones, contained in X . L_i can be seen as a subset of the Hilbert cube Q , and there is a homeomorphism

$$g_i : \{(t, tx) : t \in [0, 1], x \in L_i\} \rightarrow K_i.$$

sending $\{(1, x) : x \in L_i\} \cup \{(t, tx) : t \in [0, 1], x \in N_i\}$ to M_i (if $N_i = \odot$, then the latter set is $\{(1, x) : x \in L_i\} \cup \{(0, 0)\}$).

For any $t \in (0, 1)$, define the smaller copy $(K_i(t), M_i(t))$ of (K_i, M_i) as follows:

$$\begin{aligned} K_i(t) &= g_i(\{(s, sx) : s \in [0, t], x \in L_i\}), \\ M_i(t) &= (K_i(t) \cap A) \cup g_i(\{(t, tx) : x \in L_i\}). \end{aligned}$$

Let $t_0 < 1$ be such that the sets $K_i(t_0)$ cover X , which exists as X is compact. Pick two other real numbers $t_0 < t_1 < t_2 < 1$. Let $\epsilon > 0$ be such that for all i ,

$$\mathcal{N}(K_i(t_0), \epsilon) \subseteq K_i(t_1), \tag{6.1}$$

$$\mathcal{N}(K_i(t_1), \epsilon) \subseteq K_i(t_2). \tag{6.2}$$

Let $\delta < \epsilon$ be smaller than the values provided by Lemma 3.3.3 applied to all the compact ANRs $K_i(t_2)$ and ϵ . By assumption, (X, A) does not have the δ -surjection property, i.e. there exists a non-surjective continuous function $h : X \rightarrow X$ such that $h|_A = \text{id}_A$ and $d_X(h, \text{id}_X) < \delta < \epsilon$. As $X = \bigcup_i K_i(t_0)$ and h is not surjective, there exists i such that

$$K_i(t_0) \not\subseteq h(X). \tag{6.3}$$

Let $(K, M) = (K_i(t_2), M_i(t_2)) \cong \mathbf{C}(L_i, N_i)$. We define a non-surjective continuous function $G : K \rightarrow K$ such that $G|_M = \text{id}_M$, showing that $\mathbf{C}(L_i, N_i)$ does not have the surjection property.

First observe that $h(K_i(t_1))$ is contained in $K = K_i(t_2)$, because h is ϵ -close to the identity, so $h(K_i(t_1)) \subseteq \mathcal{N}(K_i(t_1), \epsilon) \subseteq K$ by (6.2).

We define $g : K_i(t_1) \cup M \rightarrow K$ by

$$g|_{K_i(t_1)} = h|_{K_i(t_1)} \text{ and } g|_M = \text{id}_M.$$

The function g is well-defined and continuous because h coincides with the identity on the intersection $K_i(t_1) \cap M \subseteq A$.

We now define a continuous extension $G : K \rightarrow K$ of g . Note that g is δ -close to the inclusion $f : K_i(t_1) \cup M \rightarrow K$ and f has a continuous extension $F := \text{id}_K : K \rightarrow K$, so using Lemma 3.3.3, g has a continuous extension $G : K \rightarrow K$ satisfying $d_K(G, \text{id}_K) < \epsilon$. As G extends g , $G|_M = \text{id}_M$. It remains to show that G is not surjective. Indeed, $K_i(t_0)$ is not contained in $G(K)$:

- $G(K_i(t_1)) = h(K_i(t_1))$ which does not contain $K_i(t_0)$ by (6.3),
- $G(K \setminus K_i(t_1)) \subseteq \mathcal{N}(K \setminus K_i(t_1), \epsilon)$ which is disjoint from $K_i(t_0)$ by (6.1).

□

6.5 The Surjection Property for Cone Pairs

Theorem 6.4.1 reduces the ϵ -surjection property to the surjection property for cone pairs. The purpose of this section is to develop techniques to establish whether a cone pair has the surjection property. We will only work with cones of almost Euclidean spaces.

6.5.1 Quotients to Spheres

The first characterization of the surjection property for cone pairs involves quotient maps to spheres associated to regular cells.

Let (X, A) be a compact pair and $C \subseteq X \setminus A$ a regular n -cell. The quotient of X by $X \setminus \text{op}(C)$ is homeomorphic to \mathbb{S}_n . We let

$$q_C : (X, A) \rightarrow (\mathbb{S}_n, s) \quad (6.4)$$

be the quotient map, where $s \in \mathbb{S}_n$ is the image of $X \setminus \text{op}(C)$ by q_C .

Theorem 6.5.1. Let (X, A) be an almost Euclidean compact pair. The following statements are equivalent:

1. $\mathbf{C}(X, A)$ has the surjection property,
2. For every $n \geq 1$ and every regular n -cell $C \subseteq X \setminus A$, the quotient map $q_C : (X, A) \rightarrow (\mathbb{S}_n, s)$ is not null-homotopic.

Actually, the implication 1. \Rightarrow 2. holds without assuming that (X, A) is almost Euclidean. In order to prove the theorem, we first give a reformulation of the surjection property for cone pairs.

Lemma 6.5.1

Let (X, A) be an almost Euclidean compact pair. The following statements are equivalent:

1. $\mathbf{C}(X, A)$ does not have the surjection property,
2. There exists a regular cell $C \subseteq X \setminus A$ and a continuous function $f : \mathbf{C}(X) \rightarrow X \cup \mathbf{C}(D)$, where $D = X \setminus \text{op}(C)$, which is the identity on $X \cup \mathbf{C}(A)$.

Proof. 1. \Rightarrow 2. Let $f : \mathbf{C}(X) \rightarrow \mathbf{C}(X)$ be a non-surjective continuous function which is the identity on $X \cup \mathbf{C}(A)$. The union of regular cells $C \subseteq X \setminus A$ is dense in $X \setminus A$, so the union of their cones is dense in $\mathbf{C}(X \setminus A)$. Therefore, there exists a regular cell $C \subseteq X \setminus A$ such that $\mathbf{C}(C)$ is not contained in the image of f . $\mathbf{C}(C)$ is a regular cell in $\mathbf{C}(X)$, its intersection with $X \cup \mathbf{C}(A)$ is contained in its border.

Let x belong to the interior of $\mathbf{C}(C)$ but not to the image of f . There exists a retraction $r_0 : \mathbf{C}(C) \setminus \{x\} \rightarrow \text{bd}(\mathbf{C}(C))$, which extends to a retraction $r : \mathbf{C}(X) \setminus \{x\} \rightarrow X \cup \mathbf{C}(D)$. The composition $r \circ f : \mathbf{C}(X) \rightarrow X \cup \mathbf{C}(D)$ is well-defined, continuous and is the identity on $X \cup \mathbf{C}(A)$.

2. \Rightarrow 1. Such a function f is a non-surjective continuous satisfying $f|_{\mathbf{C}(A) \cup X} = \text{id}_{\mathbf{C}(A) \cup X}$. \square

The existence of a continuous function $f : \mathbf{C}(X) \rightarrow X \cup \mathbf{C}(D)$ which is the identity on X is nothing else than a null-homotopy of the inclusion map $i : X \rightarrow X \cup \mathbf{C}(D)$. If the pair (X, D) has the homotopy extension property, then $X \cup \mathbf{C}(D)$ is homotopy equivalent to X/D (Proposition 0.17 in [30]), which implies that the inclusion map i is null-homotopic if and only if the quotient map $q : X \rightarrow X/D$ is null-homotopic.

We prove a similar equivalence applicable to pairs (X, A) . Essentially, we need to be careful about how the homotopy equivalence between $X \cup \mathbf{C}(D)$ and X/D is defined on A .

Proposition 6.5.1

Let (X, D) be a compact pair satisfying the homotopy extension property and A a compact subset of D . The following statements are equivalent

1. There exists a continuous function $f : C(X) \rightarrow X \cup C(D)$ which is the identity on $X \cup C(A)$,
2. The quotient map $q : (X, A) \rightarrow (X/D, p)$ is null-homotopic (p being the equivalence class of D).

Proof. 1. \Rightarrow 2. The function f is a null-homotopy for pairs of the inclusion map $i_X : (X, A) \rightarrow (X \cup C(D), C(A))$. Consider the quotient map $p : X \cup C(D) \rightarrow (X \cup C(D))/C(D)$ and observe that $(X \cup C(D))/C(D)$ can be identified with X/D . The function $p \circ i_X : (X, A) \rightarrow (X/D, p)$ is precisely q , and the null-homotopy of i_X composed with p is a null-homotopy of q .

2. \Rightarrow 1. Now assume that q is null-homotopic.

First, we show that the inclusion $i_X : X \rightarrow X \cup C(D)$ is null-homotopic. The obvious null-homotopy of the inclusion $i_D : D \rightarrow X \cup C(D)$ can be extended to a homotopy

$$F_t : X \rightarrow X \cup C(D)$$

from $F_0 = i_X$ to some F_1 which is constant on D . Let

$$\widetilde{F}_1 : X/D \rightarrow X \cup C(D)$$

be the continuous map induced by F_1 , i.e. satisfying $F_1 = \widetilde{F}_1 \circ q$. Let

$$H_t : (X, A) \rightarrow (X/D, p)$$

be a homotopy between $H_0 = q$ and the constant map $H_1 = p$. Observe that $\widetilde{F}_1 \circ H_t : X \rightarrow X \cup C(D)$ is a homotopy from $\widetilde{F}_1 \circ q = F_1$ to $\widetilde{F}_1 \circ H_1$ which is constant. Therefore, the inclusion $i_X : X \rightarrow X \cup C(D)$ is homotopic to F_1 which is null-homotopic, so i_X is null-homotopic. The null-homotopy of i_X is given by $K_t = F_{2t}$ for $0 \leq t \leq 1/2$ and $K_t = \widetilde{F}_1 \circ H_{2t-1}$ for $1/2 \leq t \leq 1$.

The null-homotopy K_t can be seen as a function $g : C(X) \rightarrow X \cup C(D)$ which is the identity on X . However, g is not the identity on $C(A)$, but we show how to modify g .

We use the following notation: $C(X)$ is the quotient of $[0, 1] \times X$ obtained by identifying all the points $(1, x)$, so we can express any point of $C(X)$ as the equivalence class of a pair $(t, x) \in [0, 1] \times X$, denoted $[t, x]$. Note that $[1, x] = [1, x']$ for all $x, x' \in X$.

With this notation, we can see how g is defined on $C(A)$. Let τ be the tip of $C(D)$. For $x \in A$ and $t \in [0, 1]$, one has

$$g([t, x]) = \begin{cases} K_t(x) = F_{2t}(x) = [2t, x] & \text{if } 0 \leq t \leq 1/2, \\ K_t(x) = \tau & \text{if } 1/2 \leq t \leq 1. \end{cases}$$

Observe that g is constant on the segment $S = \{[t, x] : t \in [1/2, 1], x \in A\}$, and the idea is to contract S to a point as follows.

Let $D > \max_{x \in X} d(x, A)$ and $h : C(X) \rightarrow C(X)$ be the continuous function defined by

$$h([t, x]) = \begin{cases} [(2 - d(x, A)/D)t, x] & \text{if } 0 \leq t \leq 1/2, \\ [1 + (d(x, A)/D)(t - 1), x] & \text{if } 1/2 \leq t \leq 1, \end{cases}$$

and represented on Figure 6.1.

First, h is surjective because for each $x \in X$, h sends the segment $\{[t, x] : t \in [0, 1]\}$ to itself and fixes its endpoints, so h sends the segment onto itself. As $C(X)$ is compact Hausdorff, h is a quotient map.

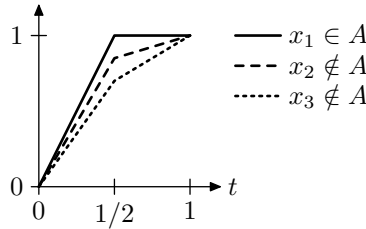

Figure 6.1: Graph of $t \mapsto h_1(t, x)$, where $h(t, x) = [h_1(t, x), h_2(t, x)]$, for different x 's

We claim that the function $f : \mathbf{C}(X) \rightarrow X \cup \mathbf{C}(D)$ satisfying $g = f \circ h$ is well-defined. Indeed, if $h(u) = h(v)$, then $u = v$ or $u, v \in S$, therefore $g(u) = g(v)$. As h is a quotient map and g is continuous, f is continuous as well.

The restriction of f to X (identified with $\{[0, x] : x \in X\}$) is the identity, because $h|_X = g|_X = \text{id}_X$. The function h sends $\mathbf{C}(A)$ onto $\mathbf{C}(A)$, and coincides with g on $\mathbf{C}(A)$, so the restriction of f to $\mathbf{C}(A)$ is the identity. \square

Proof of Theorem 6.5.1. We combine Lemma 6.5.1 and Proposition 6.5.1, which is possible because the pair $(X, X \setminus \text{op}(C))$ has the homotopy extension property. \square

An interesting consequence is that it is always possible to replace a pair (X, A) by the single space X/A .

Corollary 6.5.1. (Pair vs quotient) Let (X, A) be an almost Euclidean compact pair. The pair $\mathbf{C}(X, A)$ has the surjection property if and only if $\mathbf{C}(X/A, \emptyset) = (\mathbf{C}(X/A), X/A)$ has the surjection property.

Proof. Note that X/A is almost Euclidean, so we can apply Theorem 6.5.1 to both (X, A) and $(Y, B) = (X/A, \emptyset)$. For each regular cell $C \subseteq X \setminus A$, the corresponding quotient map $q : (X, A) \rightarrow (\mathbb{S}_n, s)$ is null-homotopic if and only if the quotient map $q' : X/A \rightarrow \mathbb{S}_n$ is null-homotopic, applying Proposition 3.3.1. Therefore, Theorem 6.5.1 applied to (X, A) and (Y, B) gives the equivalence. \square

Another consequence is that in Proposition 6.5.1, the condition that $f : \mathbf{C}(X) \rightarrow \mathbf{C}(X)$ is the identity on $X \cup \mathbf{C}(A)$ can be equivalently replaced by an apparently weaker condition.

Corollary 6.5.2. Let (X, D) satisfy the homotopy extension property and A a compact subset of D . The following statements are equivalent:

- There exists a continuous function $f : \mathbf{C}(X) \rightarrow X \cup \mathbf{C}(D)$ which is the identity on $X \cup \mathbf{C}(A)$,
- There exists a continuous function $f : \mathbf{C}(X) \rightarrow X \cup \mathbf{C}(D)$ which is the identity on X and satisfies $f(\mathbf{C}(A)) \subseteq \mathbf{C}(D)$.

Proof. The second condition precisely means that the inclusion map

$$i : (X, A) \rightarrow (X \cup \mathbf{C}(D), \mathbf{C}(D))$$

is null-homotopic. It implies that the quotient map $q : (X, A) \rightarrow (X/D, p)$ is null-homotopic, which in turn implies the first condition by Proposition 6.5.1. \square

6.5.2 Retractions to Spheres

We give a simple sufficient condition implying that $C(X, A)$ does not have the surjection property. We will later show that this condition is also necessary under certain assumptions.

Theorem 6.5.2. Let (X, A) be a compact pair and $C \subseteq X \setminus A$ be a regular n -cell. If there exists a retraction $r : X \setminus \text{op}(C) \rightarrow \text{bd}(C)$ which is constant on A , then the quotient map $q : (X, A) \rightarrow (\mathbb{S}_n, s)$ is null-homotopic, hence $C(X, A)$ does not have the surjection property.

Note that a retraction $r : X \setminus \text{op}(C) \rightarrow \text{bd}(C)$ is the same thing as a retraction $r' : X \rightarrow C$ which sends $X \setminus \text{op}(C)$ to $\text{bd}(C)$ (indeed, r' can be obtained from r by extending it as the identity on C , and r can be obtained from r' by restriction to $X \setminus \text{op}(C)$).

Proof. Let $D = X \setminus \text{op}(C)$ and $r_0 : D \rightarrow \text{bd}(C)$ be a retraction with constant value p on A . Let $r : X \rightarrow C$ be the retraction extending r_0 , defined as the identity on C . As a function of pairs, $r : (X, A) \rightarrow (C, p)$ is null-homotopic. Indeed, there is a contraction of $C \cong \mathbb{B}_n$ that fixes p , i.e. the identity $\text{id}_C : (C, p) \rightarrow (C, p)$ is null-homotopic, so $r = \text{id}_C \circ r$ is null-homotopic.

The quotient of (X, A) by D is (\mathbb{S}_n, s) , and the quotient of (C, p) by $\text{bd}(C)$ is (\mathbb{S}_n, s) . Let $q_C : (X, A) \rightarrow (\mathbb{S}_n, s)$ and $q'_C : (C, p) \rightarrow (\mathbb{S}_n, s)$ be the quotient maps. As r is the identity on C , one has $q_C = q'_C \circ r$. Therefore, the null-homotopy of r induces a null-homotopy of q_C . Theorem 6.5.1 implies that $C(X, A)$ does not have the surjection property. \square

Example 6.5.1

Let X be a topological graph and C be an edge. If C is neither contained in a cycle nor in a path from a point of A to another point of A (see an example on Figure 6.2), then $C(X, A)$ does not have the surjection property because there is a retraction of $X \setminus \text{op}(C)$ to $\text{bd}(C)$, as we now explain. We will see with Corollary 6.5.4 that these conditions are tight.

As C does not belong to a cycle, its two endpoints a, b belong to two distinct connected components of $X \setminus \text{op}(C)$. As there is no path from A to A through C , the connected component of a or b , say a , is disjoint from A . Let $r : X \setminus \text{op}(C) \rightarrow \text{bd}(C)$ send that component to a and all the rest to the other endpoint b . It is a retraction which is constant on A .

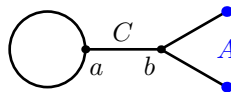

Figure 6.2: A pair (X, A) whose cone pair $C(X, A)$ does not satisfy the surjection property

Example 6.5.2

Let $X = \mathbb{S}_1 \times \mathbb{S}_1$ be the torus with a disk attached along one of the two circles, and $A = \emptyset$. The disk is a regular cell, and the torus retracts to the boundary of the disk, so $C(X, A) = (C(X), X)$ does not have the surjection property.

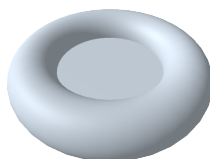

Figure 6.3: A space X whose cone pair $(C(X), X)$ does not satisfy the surjection property

The next result shows that the assumptions in Theorem 6.5.2 can be weakened.

Proposition 6.5.2

Let (X, A) be a compact pair and $C \subseteq X$ be a regular cell which is not contained in A . If there exists a retraction $r : X \setminus \text{op}(C) \rightarrow \text{bd}(C)$ whose restriction $r|_A : A \rightarrow \text{bd}(C)$ is null-homotopic, then $\mathcal{C}(X, A)$ does not have the surjection property.

Proof. We show that there is a regular cell $C' \subseteq C \setminus A$ and a retraction $r' : X \setminus \text{op}(C') \rightarrow \text{bd}(C')$ which is constant on A , and then apply Theorem 6.5.2.

As $C \not\subseteq A$ and A is closed, there exists a regular cell $C' \subseteq \text{op}(C) \setminus A$. The retraction $r : X \setminus \text{op}(C) \rightarrow \text{bd}(C)$ can be extended as the identity on $C \setminus \text{op}(C')$, giving a retraction $r_1 : X \setminus \text{op}(C') \rightarrow C \setminus \text{op}(C')$. There is a retraction $r_2 : C \setminus \text{op}(C') \rightarrow \text{bd}(C')$, because $C \setminus \text{op}(C')$ is a thickened sphere and $\text{bd}(C')$ is its inner sphere.

Let $f = r_2 \circ r_1 : X \setminus \text{op}(C') \rightarrow \text{bd}(C')$. The restriction of f to $A \cup \text{bd}(C')$ is homotopic to a function $h : A \cup \text{bd}(C') \rightarrow \text{bd}(C')$ which is constant on A and is the identity on $\text{bd}(C')$ (extend the null-homotopy of $r|_A$ as the identity on $\text{bd}(C')$, which is disjoint from A). As $\text{bd}(C')$ is an ANR (it is indeed a sphere), Borsuk's homotopy extension theorem implies that f is homotopic to an extension of h . Such an extension is a retraction $r' : X \setminus \text{op}(C') \rightarrow \text{bd}(C')$ which is constant on A . \square

6.5.3 Cycles

Let (X, A) be a pair consisting of a topological finite graph X and a subset A of vertices. As a particular case of Corollary 6.5.4 proved below, $\mathcal{C}(X, A)$ has the surjection property if and only if every edge belongs to a cycle or a path between two points of A . It is assumed that cycles and paths visit each edge at most once. The result should be compared with Example 6.5.1.

More generally, we prove a higher-dimensional version for spaces like finite simplicial complexes, and even almost Euclidean spaces. The higher-dimensional notions of cycles and paths between points of A are the homology cycles and cycles relative to A , i.e. the elements of $H_n(X, A)$. We need to express the idea that a cell “belongs” to a relative cycle.

Recall that $\mathbb{T} = \mathbb{R}/\mathbb{Z}$ is the circle group.

Definition 6.5.1. Let (X, A) be a compact pair and $n \geq 1$. A regular n -cell $C \subseteq X \setminus A$ **belongs to a relative cycle** if the canonical homomorphism

$$H_n(X, A; \mathbb{T}) \rightarrow H_n(X, X \setminus \text{op}(C); \mathbb{T})$$

is non-trivial.

Let us explain why this definition is meaningful. First, we use the coefficient group \mathbb{T} because it subsumes the more usual coefficients groups \mathbb{Z} and $\mathbb{Z}/k\mathbb{Z}$ (see Proposition B.0.1). The canonical homomorphism is non-trivial if there exists a relative cycle in (X, A) which is not cancelled when quotienting by the part of the space which is not in C , so the cycle should “visit” C . An alternative way of seeing this is to consider the exact sequence (with coefficients in \mathbb{T})

$$H_n(X \setminus \text{op}(C), A) \rightarrow H_n(X, A) \rightarrow H_n(X, X \setminus \text{op}(C)).$$

The second homomorphism is non-trivial if and only if the first one is non-surjective, which means that there is a relative cycle in (X, A) which is not contained in $X \setminus \text{op}(C)$.

Remark 6.5.1

Here is an equivalent formulation of Definition 6.5.1, at least for pairs (X, A) where X and A are ANRs. C belongs to a relative cycle if and only if the canonical homomorphism on cohomology groups with coefficients in \mathbb{Z}

$$H^n(X, X \setminus \text{op}(C)) \rightarrow H^n(X, A)$$

is non-trivial. Indeed, $H_n(X, A; \mathbb{T})$ is the Pontryagin dual of $H^n(X, A)$ and the homomorphisms between homology and cohomology groups are dual to each other (Proposition G, §VIII.4, p. 137 and Proposition F, §VIII.5, p. 141 in [36]).

1) Simplicial Complexes

Let us illustrate Definition 6.5.1 in the case of finite simplicial complexes.

A finite simplicial complex is almost Euclidean, each maximal simplex being a regular cell. For simplicial complexes, singular homology is isomorphic to simplicial homology. Whether a simplex belongs to a relative cycle in the sense of Definition 6.5.1 can be reformulated in a much more explicit way using the concept of n -chains (for a comprehensive understanding of chains, you may refer to Section 2.1 in [30]).

Proposition 6.5.3

Let (X, A) be a finite simplicial pair and C a maximal simplex, of dimension n . C belongs to a relative cycle if and only if there exists an n -chain with coefficients in \mathbb{T} (equivalently, either in \mathbb{Z} or $\mathbb{Z}/k\mathbb{Z}$ for some $k \geq 2$) whose boundary is contained in A , assigning a non-zero coefficient to C .

Proof. Let $(\Delta_i)_{i \leq m}$ be the n -simplices in X , and assume w.l.o.g. that Δ_0 is C . Let D be the subcomplex obtained by removing C from X (but keeping its faces). The homomorphism

$$H_n(X, A; \mathbb{T}) \rightarrow H_n(X, D; \mathbb{T})$$

is realized, at the level of n -chains, by sending $\sum \alpha_i \Delta_i$ to $\alpha_0 \Delta_0$. As Δ_0 is maximal, Δ_0 is not a boundary. Therefore, the homomorphism is non-trivial if and only if there exists a relative cycle assigning a non-zero coefficient α_0 to Δ_0 . \square

2) Cycles vs the Surjection Property

Let (X, A) be a compact pair and $C \subseteq X \setminus A$ be a regular n -cell ($n \geq 1$). One has natural isomorphisms

$$\begin{aligned} H_n(X, X \setminus \text{op}(C); \mathbb{T}) &\cong H_n(C, \text{bd}(C); \mathbb{T}) && \text{(by excision)} \\ &\cong H_n(C/\text{bd}(C), s; \mathbb{T}) \\ &\cong H_n(\mathbb{S}_n, s; \mathbb{T}) \\ &\cong \mathbb{T}. \end{aligned}$$

Therefore, up to isomorphism, the canonical homomorphism from Definition 6.5.1

$$H_n(X, A; \mathbb{T}) \rightarrow H_n(X, X \setminus \text{op}(C); \mathbb{T})$$

is nothing else than the homomorphism induced by the quotient map $q_C : (X, A) \rightarrow (\mathbb{S}_n, s)$ on homology groups. It has the following immediate consequences:

- If C belongs to a relative cycle, then $q_C : (X, A) \rightarrow (\mathbb{S}_n, s)$ is not null-homotopic,
- When $\dim(X) = n$ and X, A are ANRs, C belongs to a relative cycle if and only if $q_C : (X, A) \rightarrow (\mathbb{S}_n, s)$ is not null-homotopic, by Hopf's classification theorem (Theorem 3.4.3).

Therefore, we obtain partial generalizations of the claimed result for graphs in the beginning of the section to higher-dimensional spaces. The first one is only an implication.

Corollary 6.5.3. (Cycles vs surjection property, implication) Let (X, A) be an almost Euclidean compact pair. If every regular cell $C \subseteq X \setminus A$ belongs to a relative cycle, then $C(X, A)$ has the surjection property.

This result becomes an equivalence when the space “has the same dimension everywhere”, giving a first extension from graphs to *pure* simplicial complexes, i.e. simplicial complexes X whose maximal simplices all have the same dimension.

Corollary 6.5.4. (Cycles vs surjection property, equivalence) Let $n \geq 1$. Let (X, A) be an almost n -Euclidean compact pair, where X and A are ANRs and $\dim(X) = n$. The following statements are equivalent:

- The pair $C(X, A)$ has the surjection property,
- Every regular cell $C \subseteq X \setminus A$ belongs to a relative cycle.

Theorem 6.5.2 also becomes an equivalence when the dimension of the space matches the dimension of the cell, or the cell has dimension at most 2.

Corollary 6.5.5. (Cycles vs retraction) Let (X, A) be a compact pair, where X and A are ANRs and $\dim(X) = n \geq 1$. For a regular n -cell $C \subseteq X \setminus A$, the following statements are equivalent:

- C does not belong to a relative cycle,
- There exists a retraction $r : X \setminus \text{op}(C) \rightarrow \text{bd}(C)$ which is constant on A .

The equivalence holds if $n = 1$ or 2 , without any dimension assumption about X .

Proof. We assume that C does not belong to a relative cycle and build a retraction (the other implication is Theorem 6.5.2). Let $Y = X/A$. The existence of a retraction which is constant on A is equivalent to the existence of a retraction $r : Y \rightarrow \text{bd}(C)$. Let $f : \text{bd}(C) \rightarrow \text{bd}(C)$ be the identity and $i : \text{bd}(C) \rightarrow Y \setminus \text{op}(C)$ be the inclusion map. Note that $\text{bd}(C) \cong \mathbb{S}_{n-1}$ and let f_*, i_* be the induced homomorphisms on reduced homology groups $\tilde{H}_{n-1}(\cdot; \mathbb{T})$. We want to find a retraction, i.e. an extension of f . As $\dim(X) = n$, we can apply Hopf's extension theorem (Theorem 3.4.2): f has an extension if and only if $\ker i_* \subseteq \ker f_*$. As f_* is injective, f has an extension if and only if i_* is injective.

In the exact sequence (with the coefficient group \mathbb{T})

$$H_n(Y) \rightarrow H_n(Y, Y \setminus \text{op}(C)) \rightarrow \tilde{H}_{n-1}(Y \setminus \text{op}(C)) \quad (6.5)$$

the first homomorphism is trivial by assumption (note that $H_n(X/A) \cong H_n(X, A)$ as $n \geq 1$), so the second homomorphism is injective. The latter is i_* up to isomorphism, because one has natural isomorphisms

$$H_n(Y, Y \setminus \text{op}(C)) \cong H_n(C, \text{bd}(C)) \cong \tilde{H}_{n-1}(\text{bd}(C)).$$

6. The Surjection Property and Computable Type

As a result, i_* is injective. It implies that f has an extension, which is the sought retraction.

The particular case $n = 1$ or 2 corresponds to the particular case in Hopf's extension theorem. \square

It also implies that one can extend from graphs to simplicial complexes of dimension at most 3 that are not necessarily pure.

Corollary 6.5.6. Let (X, A) be an almost Euclidean compact pair, where X and A are ANRs and $\dim(X) \leq 3$. The following statements are equivalent:

- The pair $C(X, A)$ has the surjection property,
- Every regular cell $C \subseteq X \setminus A$ belongs to a relative cycle.

Proof. For every regular n -cell C , one has $n = \dim(X)$ or $n = 1$ or $n = 2$ so we can apply Corollary 6.5.5. If C does not belong to a relative cycle, then there exists a retraction $r : X \setminus \text{op}(C) \rightarrow \text{bd}(C)$, so the quotient map $q_C : (X, A) \rightarrow (\mathbb{S}_n, s)$ is null-homotopic (Theorem 6.5.2). \square

We will see in Section 6.6 that the dimension assumption in Corollaries 6.5.4, 6.5.5 and 6.5.6 cannot be dropped.

We also obtain a relationship between cycles and the ϵ -surjection property for ANRs.

Theorem 6.5.3. Let (X, A) be an almost Euclidean compact pair, where X is an ANR. If every regular cell $C \subseteq X \setminus A$ belongs to a relative cycle, then (X, A) has the ϵ -surjection property for some $\epsilon > 0$.

Proof. As X is a compact ANR, if ϵ is sufficiently small, then every function $f : X \rightarrow X$ satisfying $f|_A = \text{id}_A$ and $d(f, \text{id}_X) < \epsilon$ is homotopic to id_X , via a homotopy $h_t : X \rightarrow X$ such that $h_t|_A = \text{id}_A$. We claim that (X, A) has the ϵ -surjection property. Assume otherwise, let $f : X \rightarrow X$ be non-surjective continuous, satisfy $f|_A = \text{id}_A$ and $d(f, \text{id}_X) < \epsilon$. f is homotopic to $\text{id}_X : (X, A) \rightarrow (X, A)$.

Let $C \subseteq X \setminus A$ be a regular n -cell which is disjoint from $\text{im } f$, $i : (X \setminus \text{op}(C), A) \rightarrow (X, A)$ the inclusion map and let $\tilde{f} : (X, A) \rightarrow (X \setminus \text{op}(C), A)$ be such that $f = i \circ \tilde{f}$.

As $f = i \circ \tilde{f}$ is homotopic to id_X , $i_* \circ \tilde{f}_*$ is an isomorphism on homology groups of (X, A) , so $i_* : H_n(X \setminus \text{op}(C), A) \rightarrow H_n(X, A)$ is surjective (coefficients are implicitly in \mathbb{T}). In the exact sequence

$$H_n(X \setminus \text{op}(C), A) \xrightarrow{i_*} H_n(X, A) \longrightarrow H_n(X, X \setminus \text{op}(C))$$

the second homomorphism is therefore trivial, contradicting the assumption that C belongs to a relative cycle. Therefore, there is no such function f , so (X, A) has the ϵ -surjection property. \square

The converse implication in Theorem 6.5.3 does not hold, even under dimension assumptions, as the next example shows.

Example 6.5.3

Let X be Bing's house (see Figure 6.10), or the house with two rooms, which is a pure 2-dimensional simplicial complex, and $A = \emptyset$. We prove in Proposition 6.7.2 that it has the ϵ -surjection property, by using the fact that the star of each vertex in X is the cone of a graph which consists of a union of cycles. However, X is contractible, so no 2-cell belongs to a cycle.

6.6 Counter-examples

We consider a family of spaces which enables us to find counter-examples, and show that certain assumptions in the previous results cannot be dropped.

6.6.1 A Family of Spaces

Let m, n be two natural numbers and let $f : \mathbb{S}_m \rightarrow \mathbb{S}_n$ be continuous. One can attach \mathbb{B}_{m+1} to \mathbb{B}_{n+1} along their boundaries using f . We obtain the space $X_f = \mathbb{B}_{n+1} \cup_f \mathbb{B}_{m+1}$, which is the quotient of $\mathbb{B}_{m+1} \sqcup \mathbb{B}_{n+1}$ obtained by identifying $x \in \mathbb{S}_{m+1} = \partial\mathbb{B}_{m+1}$ to $f(x) \in \mathbb{S}_n = \partial\mathbb{B}_n$. It is illustrated in Figure 6.4.

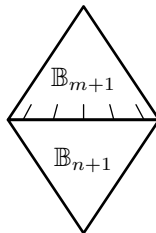

Figure 6.4: The space X_f . The ball \mathbb{B}_{n+1} is visualized as the cone $C(\mathbb{S}_n)$, the center of the ball is the tip of the cone.

We will see that the properties of X_f we are interested in only depend on the homotopy class of f . Therefore, by the Simplicial Approximation Theorem (Theorem 2C.1 in [30]), we can always assume that f is a simplicial map, implying that X_f is a finite simplicial complex.

We will need to consider the suspension construct. We recall that the **suspension** of a space X is $SX = X * \mathbb{S}_0$. One has $S\mathbb{S}_n = \mathbb{S}_{n+1}$. To a map $f : X \rightarrow Y$ is associated its suspension $Sf : SX \rightarrow SY$, which is naturally defined from f . Note that for $f : \mathbb{S}_m \rightarrow \mathbb{S}_n$, one has $Sf : \mathbb{S}_{m+1} \rightarrow \mathbb{S}_{n+1}$.

6.6.2 Cycles vs the Surjection Property

We show that the equivalences stated in Corollaries 6.5.4 and 6.5.5 are no more valid when the assumptions about the dimension of the space and the dimension of the regular cells are dropped. For clarity, let us summarize what we have so far.

For any compact pair (X, A) , if $C \subseteq X \setminus A$ is a regular n -cell, then we have the following implications 1. \Rightarrow 2. \Rightarrow 3.:

1. There is a retraction $r : X \setminus \text{op}(C) \rightarrow \text{bd}(C)$ which is constant on A ,
2. The quotient map $q_C : (X, A) \rightarrow (\mathbb{S}_n, s)$ is null-homotopic,
3. C does not belong to a relative cycle.

When (X, A) is a finite simplicial pair and $\dim(X) = n$, all these conditions are equivalent by Corollaries 6.5.4 and 6.5.5. However we show that if $\dim(X) > n$, then both implications 2. \Rightarrow 1. and 3. \Rightarrow 2. fail in general (still assuming that (X, A) is a finite simplicial pair).

Note that \mathbb{B}_{n+1} is a regular $(n+1)$ -cell in X_f . We relate the conditions 1., 2. and 3. for the space X_f and the regular $(n+1)$ -cell $C = \mathbb{B}_{n+1}$ in terms of the properties of f .

Theorem 6.6.1. Let $m, n \in \mathbb{N}$ and $f : \mathbb{S}_m \rightarrow \mathbb{S}_n$ be continuous. The space $X_f = \mathbb{B}_{n+1} \cup_f \mathbb{B}_{m+1}$ enjoys the following properties:

- a) There exists a retraction $r : \mathbb{S}_n \cup_f \mathbb{B}_{m+1} \rightarrow \mathbb{S}_n$ iff f is null-homotopic,
- b) The quotient map $q : X_f \rightarrow \mathbb{S}_{n+1}$ is null-homotopic iff $\mathbb{S}f$ is null-homotopic,
- c) If $m \neq n$, then \mathbb{B}_{n+1} does not belong to a cycle in X_f .

Moreover, $(C(X_f), X_f)$ has the surjection property iff $\mathbb{S}f$ is not null-homotopic.

Proof. (a) Note that $\mathbb{S}_n \cup_f \mathbb{B}_{m+1}$ is the quotient of \mathbb{B}_{m+1} by the equivalence relation $x \sim y$ iff $x = y$, or $x, y \in \mathbb{S}_m$ and $f(x) = f(y)$. Therefore, there is a one-to-one correspondence between the continuous functions $r : \mathbb{S}_n \cup_f \mathbb{B}_{m+1} \rightarrow \mathbb{S}_n$ and the continuous functions $F : \mathbb{B}_{m+1} \rightarrow \mathbb{S}_n$ that respect \sim . A function $r : \mathbb{S}_n \cup_f \mathbb{B}_{m+1} \rightarrow \mathbb{S}_n$ is a retraction iff the corresponding function $F : \mathbb{B}_{m+1} \rightarrow \mathbb{S}_n$ is an extension of f , i.e. is a null-homotopy of f .

(b) As \mathbb{B}_{n+1} is contractible, the quotient map $p : X_f \rightarrow X_f/\mathbb{B}_{n+1} \cong \mathbb{S}_{m+1}$ is a homotopy equivalence. We show that the homotopy class of $q : X_f \rightarrow \mathbb{S}_{n+1}$ is sent to the homotopy class of $\mathbb{S}f : \mathbb{S}_{m+1} \rightarrow \mathbb{S}_{n+1}$ under the equivalence, which implies that q is null-homotopic if and only if $\mathbb{S}f$ is. More precisely, we show that $q \sim \mathbb{S}f \circ p$ (these two maps are illustrated on Figures 6.5a and 6.5b).

The sphere \mathbb{S}_{n+1} is a union of two balls \mathbb{B}_{n+1} , called the lower and upper hemispheres, joined at the equator. Let $j : \mathbb{B}_{n+1} \sqcup \mathbb{B}_{m+1} \rightarrow \mathbb{S}_{n+1}$ send \mathbb{B}_{n+1} homeomorphically to the lower hemisphere of \mathbb{S}_{n+1} , and send \mathbb{B}_{m+1} to the upper hemisphere of \mathbb{S}_{n+1} by applying the map $C(f) : C(\mathbb{S}_m) \rightarrow C(\mathbb{S}_n)$, i.e. $C(f) : \mathbb{B}_{m+1} \rightarrow \mathbb{B}_{n+1}$. The space X_f is a quotient of $\mathbb{B}_{m+1} \sqcup \mathbb{B}_{n+1}$ and the map j respects that quotient: if $x, y \in \mathbb{S}_m = \partial\mathbb{B}_{m+1}$ and $z \in \mathbb{S}_n = \partial\mathbb{B}_{n+1}$ are such that $f(x) = f(y) = z$, then $j(x) = j(y) = j(z)$ is z , seen as a point of the equator of \mathbb{S}_{n+1} .

Therefore, j induces a continuous function $k : X_f \rightarrow \mathbb{S}_{n+1}$, illustrated on Figure 6.5c. The functions q and $\mathbb{S}f \circ p$ can be factored using k as follows. Let U and L be the upper and lower halves of \mathbb{S}_{n+1} . The quotient of \mathbb{S}_{n+1} by U or L is again \mathbb{S}_{n+1} . Let $q_U, q_L : \mathbb{S}_{n+1} \rightarrow \mathbb{S}_{n+1}$ be the corresponding quotient maps. One has $q = q_U \circ k$ and $\mathbb{S}f \circ p = q_L \circ k$. One easily sees that $q_U \sim q_L$, so $q \sim \mathbb{S}f \circ p$.

(c) As \mathbb{B}_{n+1} is contractible, X_f is homotopy equivalent to X_f/\mathbb{B}_{n+1} , which is homeomorphic to \mathbb{S}_{m+1} . Therefore, $H_{n+1}(X_f; G) \cong H_{n+1}(\mathbb{S}_{m+1}; G)$ which is trivial as $m \neq n$. As a result, any homomorphism defined on $H_{n+1}(X_f; G)$ is trivial.

We prove the last assertion. For a regular $(m+1)$ -cell $C \subseteq X_f$, the corresponding quotient map $q_C : X_f \rightarrow \mathbb{S}_{m+1}$ is never null-homotopic, because it is a homotopy equivalence. Therefore, $(C(X_f), X_f)$ enjoys the surjection property if and only if $\mathbb{S}f$ is not null-homotopic. \square

The first application is that in Corollary 6.5.4, one cannot drop the assumption that all the cells have the same dimension as the space.

Example 6.6.1

Let $h : \mathbb{S}_3 \rightarrow \mathbb{S}_2$ be the Hopf map. It is known that h and $\mathbb{S}h$ are not null-homotopic (Corollary 4J.4 in [30]). Therefore, in X_h the quotient map is not null-homotopic and $(C(X_h), X_h)$ enjoys the surjection property although no regular cell belongs to a cycle, so the implication 3. \Rightarrow 2. fails for X_h .

A second application is that the dimension assumption in Corollary 6.5.5 is needed.

Example 6.6.2

Let again $h : \mathbb{S}_3 \rightarrow \mathbb{S}_2$ be the Hopf map. The function $2h$ (which is the concatenation of h

(a) The map $q : X_f \rightarrow \mathbb{S}_{n+1}$ (b) The map $Sf \circ p : X_f \rightarrow \mathbb{S}_{n+1}$ (c) The map $k : X_f \rightarrow \mathbb{S}_{n+1}$

Figure 6.5: Illustration of the proof of (b) in Theorem 6.6.1

with itself using the homotopy group operation) is not null-homotopic, however its suspension $S2h$ is (again by Corollary 4J.4 in [30]). Therefore, in X_{2h} the quotient is null-homotopic and $(C(X_{2h}), X_{2h})$ does not satisfy the surjection property, but there is no retraction, so the implication $2. \Rightarrow 1.$ fails for X_{2h} .

6.6.3 Product

We have shown with Proposition 6.3.2 that for finite simplicial pairs, if $(X, A) \times (Y, B)$ satisfies the ϵ -surjection property for some $\epsilon > 0$, then both (X, A) and (Y, B) satisfy the δ -surjection property for some $\delta > 0$.

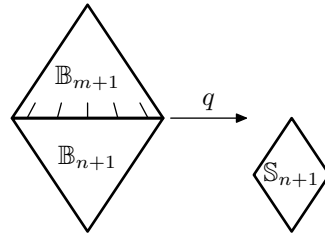
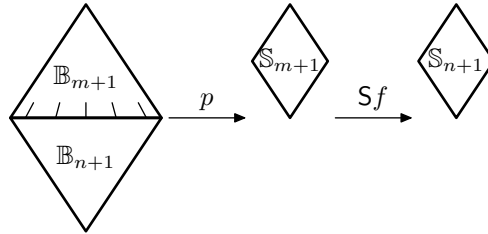
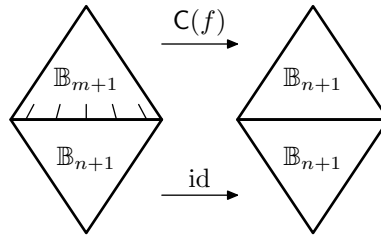
We prove that the converse implication does not hold.

Theorem 6.6.2. There exists a finite simplicial pair (X, A) that has the surjection property, but the product $(X, A) \times (\mathbb{B}_1, \mathbb{S}_0)$ does not have the ϵ -surjection property for any $\epsilon > 0$. There exists a finite simplicial complex Y that has the ϵ -surjection property for some $\epsilon > 0$, but the product $Y \times \mathbb{S}_1$ does not have the δ -surjection property for any $\delta > 0$.

Proof. We choose $m, n \in \mathbb{N}$ and $f : \mathbb{S}_m \rightarrow \mathbb{S}_n$ so that Sf is not-null-homotopic but S^2f is (we will give detailed references in the next section below on the existence of such functions). We then

let $(X, A) = (C(X_f), X_f)$ and $Y = SX_f$. □

Lemma 6.6.1

SX_f is homeomorphic to X_{Sf} .

Proof. Both spaces are the quotients of $(\mathbb{B}_{n+1} \sqcup \mathbb{B}_{m+1}) \times [0, 1]$ by the equivalence relation generated by:

$$(y, t) \sim (f(y), t) \text{ for } y \in \mathbb{S}_m, \tag{6.6}$$

$$(x, 0) \sim (x', 0) \text{ and } (x, 1) \sim (x', 1) \text{ for } x, x' \in \mathbb{B}_{n+1}, \tag{6.7}$$

$$(y, 0) \sim (y', 0) \text{ and } (y, 1) \sim (y', 1) \text{ for } y, y' \in \mathbb{B}_{m+1}. \tag{6.8}$$

Proof. Taking the quotient by (6.6) first yields $X_f \times [0, 1]$, and then the quotient by (6.7), (6.8) yields SX_f . Taking the quotient by (6.7), (6.8) first yields $S\mathbb{B}_{n+1} \sqcup S\mathbb{B}_{m+1}$ and then the quotient by (6.6) yields X_{Sf} . □

Therefore,

$$\begin{aligned} (C(X_f), X_f) \times (C(\mathbb{S}_0), \mathbb{S}_0) &\cong (C(X_f * \mathbb{S}_0), X_f * \mathbb{S}_0) \\ &\cong (C(SX_f), SX_f) \\ &\cong (C(X_{Sf}), X_{Sf}). \end{aligned}$$

If Sf is not null-homotopic but S^2f is, then $(C(X_f), X_f)$ enjoys the surjection property whereas $(C(X_{Sf}), X_{Sf})$ does not. For cone pairs, the surjection property is equivalent to the ϵ -surjection property for any $\epsilon > 0$ by Proposition 6.3.3.

The space $Y = SX_f$ is finitely conical with two open cones $OC(X_f)$, so Y has the ϵ -surjection property for some $\epsilon > 0$. The product $Y \times \mathbb{S}_1 = SX_f \times S\mathbb{S}_0$ is finitely conical with four open cones $OC(X_{Sf})$, so $Y \times \mathbb{S}_1$ does not satisfy the ϵ -surjection property for any $\epsilon > 0$. In both case we use Theorem 6.4.1. □

Iteration of the Suspension

The existence of the function f in the proof of Theorem 6.6.2 can be extracted from the literature on homotopy groups of spheres and the suspension homomorphism, as we explain now.

Theorem 6.6.3. For $(m, n) = (7, 3)$ or $(8, 4)$, there exists $f : \mathbb{S}_m \rightarrow \mathbb{S}_n$ such that Sf is not null-homotopic but S^2f is.

The results in the literature are usually expressed in terms of the **reduced suspension** Σ rather than the suspension S (we use the notation Σ as in [30], while the other references use the notation E). We recall that ΣX is defined as the quotient of $SX = X * \mathbb{S}_0$ by the segment $\{x_0\} * \mathbb{S}_0$ for some $x_0 \in X$. However, for a CW-complex X , ΣX and SX are homotopy equivalent (Example 0.10 in [30]) and if X, Y are CW-complexes and $f : X \rightarrow Y$ is continuous, then Σf is null-homotopic if and only if SX is. More precisely, the quotient map $\varphi_X : SX \rightarrow \Sigma X$ is a homotopy equivalence and one has $\Sigma f \circ \varphi_X = \varphi_Y \circ Sf$.

We use the following homotopy groups of spheres, that can be found in Hatcher [30] (§4.1, p. 339):

$$\pi_7(\mathbb{S}_3) \cong \mathbb{Z}_2 \quad \pi_8(\mathbb{S}_4) \cong \mathbb{Z}_2^2 \quad \pi_9(\mathbb{S}_5) \cong \mathbb{Z}_2 \quad \pi_{10}(\mathbb{S}_6) \cong 0$$

Whitehead Product. The Whitehead product is a way of combining an element $f \in \pi_p(\mathbb{S}_n)$ with an element $g \in \pi_q(\mathbb{S}_n)$ into their product $[f, g] \in \pi_{p+q-1}(\mathbb{S}_n)$. The suspension of a Whitehead product is always null-homotopic (see Whitehead [65], Theorem 3.11, p. 470).

Theorem 6.6.4. If $f \in \pi_p(\mathbb{S}_n)$ and $g \in \pi_q(\mathbb{S}_n)$, then one has $\Sigma[f, g] = 0$.

The next result was proved by Toda [58] (§5.ii, p. 79).

Lemma 6.6.2

There exists $f : \mathbb{S}_7 \rightarrow \mathbb{S}_3$ such that Σf is not null-homotopic but $\Sigma^2 f$ is.

Proof. Let $i_4 : \mathbb{S}_4 \rightarrow \mathbb{S}_4$ be the identity. Let $h_2 : \mathbb{S}_3 \rightarrow \mathbb{S}_2$ be the Hopf map and $\nu_4 = \Sigma^2 h_2 : \mathbb{S}_5 \rightarrow \mathbb{S}_4$. It is proved in [58], §5.ii that there exists $f : \mathbb{S}_7 \rightarrow \mathbb{S}_3$ such that $\Sigma f = [\nu_4, i_4] \neq 0$, implying that $\Sigma^2 f = 0$. (It is defined as $f = a_3 \circ \nu_6$ for some particular $a_3 : \mathbb{S}_6 \rightarrow \mathbb{S}_3$.) \square

Suspension Homomorphism. We will use the fact that the suspension homomorphism $\Sigma : \pi_8(\mathbb{S}_4) \rightarrow \pi_9(\mathbb{S}_5)$ is surjective, which follows from the famous Freudenthal suspension theorem (see Whitehead [65] p. 468 for the statement). The next theorem can be found in [28].

Theorem 6.6.5. The suspension homomorphism

$$\Sigma : \pi_{n+k}(\mathbb{S}_n) \rightarrow \pi_{n+k+1}(\mathbb{S}_{n+1})$$

is an isomorphism if $k < n - 1$, and is surjective if $k = n - 1$ or $k = n$ is even.

Lemma 6.6.3

There exists $f : \mathbb{S}_8 \rightarrow \mathbb{S}_4$ such that Σf is not null-homotopic but $\Sigma^2 f$ is.

Proof. As $\pi_9(\mathbb{S}_5) \cong \mathbb{Z}_2$ is non-trivial, let $g \in \pi_9(\mathbb{S}_5)$ be non-zero. As $\Sigma : \pi_8(\mathbb{S}_4) \rightarrow \pi_9(\mathbb{S}_5)$ is surjective, let $f \in \pi_8(\mathbb{S}_4)$ be such that $\Sigma f = g$. As $\pi_{10}(\mathbb{S}_6)$ is trivial, $\Sigma^2 f = 0$.

Alternatively, Whitehead [66] (§9, p. 234) shows that there exists $\gamma \in \pi_8(\mathbb{S}_4)$ such that $\Sigma \gamma = \pm[i_5, i_5] \neq 0$, where $i_5 : \mathbb{S}_5 \rightarrow \mathbb{S}_5$ is the identity, therefore $\Sigma^2 \gamma = 0$. (It is defined as $\gamma = J(\gamma_3)$ for some γ_3 in [66]). \square

6.7 Applications to Computable Type

The results obtained in the present chapter have immediate applications to the computable type property.

6.7.1 A Characterization for Finite Simplicial Complexes

Iljazović has demonstrated that every finite (topological) graph (G, V_1) , where V_1 represents the set of vertices of degree 1, has computable type [40].

In this section, our objective is to extend the study of computable type to the broader class of finite simplicial complexes. We achieve this by topologically characterizing the pairs that exhibit computable type, utilizing the (ϵ -)surjection property and unifying our findings from this chapter.

Finite simplicial complexes serve as the higher-dimensional counterparts to finite graphs, constructed by connecting simplices along their faces. This class encompasses a wide range of compact

topological spaces, including common compact manifolds and geometric models in computer graphics. Moreover, finite simplicial complexes can be effectively described using finite combinatorial information, enabling us to potentially achieve a comprehensive characterization of their computable type.

We focus solely on finite simplicial complexes, as infinite simplicial complexes, under the usual topologies, become non-compact.

We establish two topological characterizations for simplicial pairs (X, A) that have computable type. One characterization operates on a global level (the ϵ -surjection property), while the other offers a local perspective (the surjection property).

The local characterization simplifies the process of determining whether a simplicial pair (X, A) has computable type, as it involves inspecting the neighborhoods of each vertex individually (see Figure 6.6).

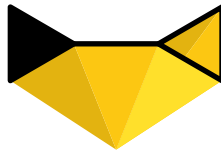

Figure 6.6: A cone at a vertex in a finite simplicial complex

Previous techniques found in the literature were too specialized to be applied to these sets. Our techniques not only accommodate any simplicial complex but also provide a straightforward and visual approach to addressing the computable type question for numerous sets.

By combining all the results, we arrive at the following comprehensive characterization for finite simplicial pairs.

Corollary 6.7.1. For a finite simplicial pair (X, A) such that A has empty interior in X , the following statements are equivalent:

1. (X, A) has strong computable type,
2. (X, A) has computable type,
3. (X, A) satisfies the generalized ϵ -surjection property for some $\epsilon > 0$,
4. (X, A) satisfies the ϵ -surjection property for some $\epsilon > 0$,
5. For every vertex, the cone pair corresponding to its star has the surjection property (see Section 3.5).

Proof. The following implications hold for any compact pair: $(1) \Rightarrow (2)$ and $(3) \Rightarrow (4)$.

$(1) \Rightarrow (3)$ is Corollary 4.4.3. $(4) \Leftrightarrow (5)$ is Theorem 6.4.1. It remains to prove that $(2) \Rightarrow (4)$ and $(4) \Rightarrow (1)$ to obtain all the equivalences.

Let us prove that $(2) \Rightarrow (4)$ by contra-position.

Note that the standard realization of (X, A) is computable. We show that if it does not have the ϵ -surjection property for any $\epsilon > 0$, then it has *computable* witnesses, which together with Theorem 4.5.2 concludes the proof of $(2) \Rightarrow (4)$.

Claim 6.7.1

If a simplicial pair (X, A) does not have the ϵ -surjection property for any $\epsilon > 0$, then its standard realization has computable witnesses.

Proof of Claim 6.7.1. By (2) \Rightarrow (1) in Theorem 6.4.1, there exists a cone pair $(K_i, M_i) = \mathbf{C}(L_i, N_i)$ which does not have the surjection property, so there exists a non-surjective function $f_0 : K_i \rightarrow K_i$ such that $f_0|_{M_i} = \text{id}_{M_i}$. One can assume w.l.o.g. that $d_X(f_0, \text{id}_X) < 1$. Let $\delta_0 > 0$ be such that $d_H(f_0(X), X) > \delta_0$. Given $\epsilon > 0$, the number $\delta = \delta_0\epsilon$ can be computed from ϵ and is an ϵ -witness. Indeed, the function f obtained by applying f_0 to a version of K_i scaled by a factor ϵ and extended as the identity elsewhere satisfies all the conditions. \square

Let us prove that (4) \Rightarrow (1).

We now prove the announced implication. Assume that (X, A) is embedded as a semicomputable pair in Q and has the ϵ -surjection property for some $\epsilon > 0$. X can be subdivided so that each simplex has diameter less than $\epsilon/4$ (for instance by barycentric subdivision, see [31]). Let $(M_i)_{1 \leq i \leq n}$ be the maximal simplices of X and ∂M_i the union of the proper faces of M_i . Let $Y_i = (X \setminus M_i) \cup \partial M_i$. One has $A \subseteq Y_i$ and Y_i is an ANR because it is a finite simplicial complex.

Let $\alpha_i > 0$ be provided by Lemma 3.3.3 applied to Y_i and $\frac{\epsilon}{4}$, and let $\alpha = \min_i(\alpha_i)$. Using Lemma 5.2.1, for every i , let $V_i \supseteq Y_i$ be a finite union of rational balls and $r_i : V_i \rightarrow Y_i$ a retraction such that $d_{V_i}(r_i, \text{id}_{V_i}) < \min(\epsilon/4, \alpha/2)$. Let $(f_j)_{j \in \mathbb{N}}$ be a dense computable sequence of functions from Q to itself provided by Lemma 4.3.2. Now, let $U \subseteq Q$ be an open set and $Z = (X \setminus U) \cup A$.

Claim 6.7.2

The following are equivalent:

1. U intersects X ,
2. There exist $i \leq n$ and a continuous function $g : Z \rightarrow Y_i$ such that $g|_A = \text{id}_A$ and $d_Z(g, \text{id}_Z) < \epsilon/4$,
3. There exist $i \leq n$ and j such that $f_j(Z) \subseteq V_i$, $d_A(f_j, \text{id}_A) < \frac{\alpha}{2}$ and $d_Z(f_j, \text{id}_Z) < \epsilon/2$.

Proof of Claim 6.7.2.

1 \Rightarrow 2: Let $i \leq n$ be such that $M_i \cap U \neq \emptyset$. Take $x \in U \cap M_i \setminus \partial M_i$ and a retraction $r : X \setminus \{x\} \rightarrow Y_i$. Let g be the restriction of r to Z . g satisfies the conditions because $A \subseteq Y_i$ and the diameter of M_i is less than $\epsilon/4$.

2 \Rightarrow 3: Note that the conditions that f_j should satisfy are satisfied by g and by any function that is sufficiently close to g . As the sequence $(f_j)_{j \in \mathbb{N}}$ is dense, one can take f_j arbitrarily close to g , so that f_j satisfies the required conditions.

3 \Rightarrow 1: Suppose that U is disjoint from X , i.e. $Z = X$. Let $F = r_i \circ f_j : X \rightarrow Y_i$. One has $d_A(F, \text{id}_A) = d_A(r_i \circ f_j, \text{id}_A) \leq d_A(r_i \circ f_j, f_j) + d_A(f_j, \text{id}_A) < \alpha/2 + \alpha/2 = \alpha$. Therefore using Lemma 3.3.3 there exists a continuous extension $G : X \rightarrow Y_i$ of id_A such that $d_X(G, F) < \epsilon/4$. One has $d_X(G, \text{id}_X) \leq d_X(G, r_i \circ f_j) + d_X(r_i \circ f_j, f_j) + d_X(f_j, \text{id}_X) < \epsilon/4 + \epsilon/4 + \epsilon/2 = \epsilon$, which contradicts the ϵ -surjection property of (X, A) . \square

If U is a rational ball in Q , then 3. is semidecidable. As 3. is equivalent to 1., one can semidecide which rational balls U intersect X , therefore X is computable. \square

Remark 6.7.1

For a finite simplicial pair that is itself homeomorphic to a cone pair i.e. $(X, A) = \mathbf{C}(L, N)$, we obtain a further equivalence, since the surjection and ϵ -surjection properties are equivalent for cone pairs.

Remark 6.7.2

¹ The equivalence between the ϵ -surjection property and strong computable type can be done

more generally for compact ANRs that are covered by finitely many regular cells. However, the proof does not use the existence of computable retractions, since such spaces need not to have a computable copy; one needs to generalize our proof of implication 2. \Rightarrow 1. of Theorem 3.4 in [4] to these spaces to obtain the result.

Remark 6.7.3

A single topological space X has many different simplicial decompositions, i.e. many abstract simplicial complexes whose realizations are homeomorphic to X . For instance, a triangle can be decomposed into many smaller triangles. At first sight, the fifth condition in Corollary 6.7.1 depends on the choice of the decomposition, because the local cone pairs are taken at the vertices of the decomposition. However, the theorem implies that the choice of the simplicial decomposition is irrelevant, because the other conditions do not depend on the decomposition: if all the cone pairs in a simplicial decomposition have the surjection property, then it is still true for all other simplicial decompositions of the space.

The next Corollary is a direct consequence of Corollary 6.7.1 and Theorem 6.3.2.

Corollary 6.7.2. Let (X, A) be a finite simplicial pair and $(X_i, A_i)_{i \leq n}$ be pairs of subcomplexes such that $X = \bigcup_{i \leq n} X_i$ and $A = \bigcup_{i \leq n} A_i$. If every pair (X_i, A_i) has computable type, then (X, A) has computable type.

For instance, if a finite simplicial complex X is a finite union of subcomplexes that are homeomorphic to spheres, then X has computable type. More generally, if a finite simplicial pair (X, A) is a finite union of pairs of subcomplexes (X_i, A_i) that are homeomorphic to pairs $(\mathbb{S}_n, \emptyset)$ or $(\mathbb{B}_{n+1}, \mathbb{S}_n)$, then (X, A) has computable type.

Corollary 6.7.3. For finite simplicial pairs (X, A) such that X is pure or has dimension at most 4, whether (X, A) has computable type is decidable.

Proof. Such a pair (X, A) is finitely conical and has computable type if and only if each cone pair $\mathbb{C}(L_i, N_i)$ has the surjection property. If X is pure or has dimension at most 4, then each L_i is pure or has dimension at most 3, so the surjection property for $\mathbb{C}(L_i, N_i)$ is equivalent to the fact that each maximal simplex of L_i belongs to a relative cycle in (L_i, N_i) by Corollaries 6.5.4 and 6.5.6. As homology groups of finite simplicial complexes can be computed, this property is therefore decidable. \square

6.7.2 Finite 2-Dimensional Simplicial Complexes

We present a comprehensive characterization of 2-dimensional simplicial pairs with computable type (note that they are locally cones of finite graphs). This characterization is achieved by leveraging the surjection property of local cone pairs and reducing it to a simple graph property (Corollary 6.7.4), which comes from Corollaries 6.5.4 and Remark 6.7.1.. Consequently, we provide a visual tool that effectively demonstrates the computable type of finite 2-dimensional simplicial complexes. To further emphasize the strength of our findings, we showcase non-trivial applications through the examination of two famous sets: the dunce hat (Figure 6.9a) and Bing's house (Figure 6.10).

Corollary 6.7.4. Let (L, N) be a pair such that L is a finite graph and N is a subset of its vertices. The following statements are equivalent:

1. $C(L, N)$ has the surjection property,
2. Every edge is in a cycle or a path starting and ending in N ,
3. $C(L, N)$ has computable type.

We follow the usual convention that in a graph, a path and a cycle do not visit a vertex twice, i.e. they are topologically a line segment and a circle respectively. In particular, a path connects two different points.

Example 6.7.1

Fix some $n \geq 1$ and let X be the star with n branches and A be the n endpoints of these branches (see Figure 6.7), with a special case for $n = 1$: $C(\{v\}, \odot) = (\mathbb{B}_1, \xi_0)$. The pair (X, A) is precisely $C(A, \emptyset)$. As A has no edge, it satisfies the conditions of Theorem 6.7.4, therefore (X, A) has the surjection property. One can then obtain Iljazović's result that every finite graph has computable type [40], because the local cones of a finite graph are stars, which have the surjection property.

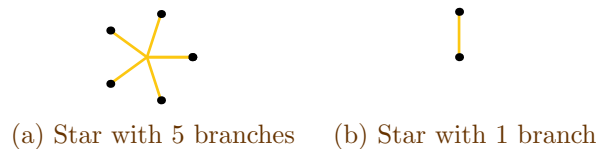

Figure 6.7: The star pairs (X, A) have the surjection property (Example 6.7.1) (X in yellow, A in black)

Example 6.7.2

Fix some $n \geq 2$ and let X be the union of n squares which all meet in one common edge and A be the union of all the other edges (see Figure 6.8). The pair (X, A) has the surjection property. Indeed, $(X, A) = C(A, \emptyset)$ and A is a graph which is a union of circles (each circle is the boundary of the union of two squares). Therefore, $C(A, \emptyset)$ has the surjection property and computable type by Corollary 6.7.4

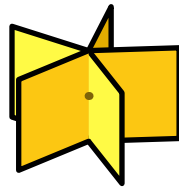

Figure 6.8: A union of 5 squares is the cone of a graph; the tip is at the center, the graph is in black (Example 6.7.2).

1) The Dunce Hat

Definition 6.7.1. The **dunce hat** D is the space obtained from a solid triangle by gluing its three sides together, with the orientation of one side reversed (see Figure 6.9a).

It is a classical example, introduced by Zeeman [68], of a space that is contractible but not intuitively so. It is a 2-dimensional simplicial complex with no free edge, i.e. no edge that belongs to one triangle only.

Proposition 6.7.1

The dunce hat does not have computable type.

Proof. First, it is possible to turn the dunce hat into a simplicial complex, so we can apply our results. The vertices of the triangle are identified to a point v , and we show that the cone pair at that point does not have the surjection property. Indeed, in Figure 6.9c one can see that the cone pair at v is $C(L, \emptyset) = (C(L), L)$ where L is the graph consisting of two circles joined by a line segment.

We apply Corollary 6.7.4: L is a finite graph containing an edge which is neither in a cycle nor in a path from N to N (N is empty), therefore $C(L, N)$ does not have the surjection property and hence the dunce hat does not have computable type. \square

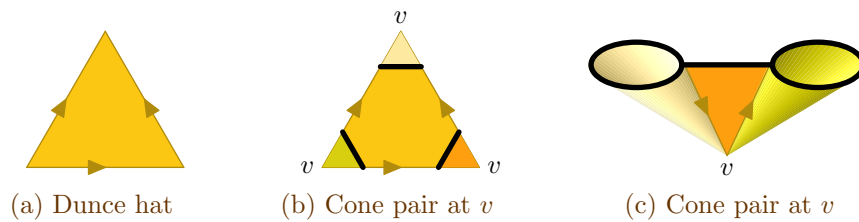

Figure 6.9: (a) The dunce hat is obtained by gluing the edges with the indicated orientations; (b) and (c) a cone pair $(C(L), L) = C(L, \emptyset)$ with tip at v , with L in black.

If A is the identified edges of the triangle, then it can be proved, by analyzing its local cone pairs, that the pair (D, A) has computable type. In particular, the cone pair at v is $C(L, N)$ where N consists of the two endpoints of the middle interval, so L is the union of two circles and a line segment between two points of N , hence $C(L, N)$ has the surjection property by Corollary 6.7.4.

Remark 6.7.4

It is proved in [22] that for any compact pair (X, A) where A has empty interior, if the quotient space X/A has computable type then the pair (X, A) has computable type. It is also proved that the converse implication fails, the counter-example is given by the circle X and a subset A consisting of a converging sequence together with its limit. The pair (X, A) has computable type, simply because X itself has computable type. However, X/A is homeomorphic to the Hawaiian earring which does not have computable type. This quotient is not a finite simplicial complex.

We give another counter-example of a quotient space which is a finite simplicial complex. Let $L = C_1 \vee I \vee C_2$, X be the cylinder of L and A the two bases of the cylinder. Inspecting the local cones one can show that (X, A) has computable type but X/A does not.

2) Bing’s House, or the House With Two Rooms

All the known examples of sets having computable type are non-contractible (note that we are not considering pairs, but single sets), and one might conjecture that no contractible set has computable type. We give a counter-example, which is a famous space that was defined as a counter-example for other properties. It was invented by Bing [12] and is now called **Bing’s house**, or the house with two rooms. The set is depicted in Figure 6.10, together with a half-cut to help visualizing it. It is an example of a space which is contractible but not intuitively so. It can be endowed with a simplicial

complex structure (by triangulating each flat surface). It is then a 2-dimensional simplicial complex with no free edge, which means that every edge belongs to at least two triangles.

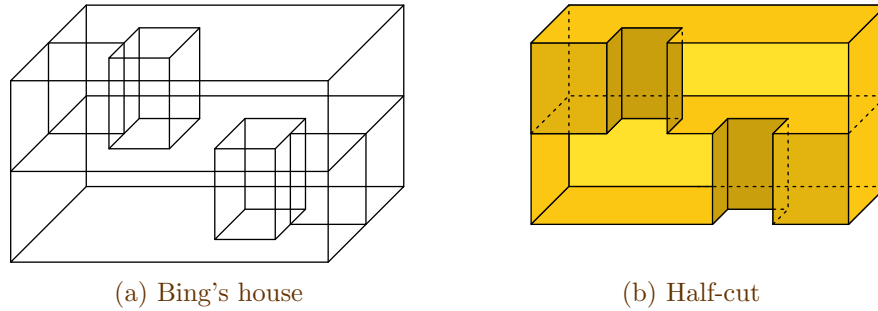

Figure 6.10: Bing's house with two rooms and a half-cut of it (the full house is obtained by adding the symmetric reflection of the half-cut through the front vertical plane). It consists of two rooms, each of which can be accessed from outside through a tunnel crossing the other room. Each tunnel is linked by an internal wall to a side wall.

Using our results we easily show that this set has computable type as a single set, i.e. without adjoining a boundary to it.

Proposition 6.7.2

Bing's house has computable type.

It is worth noticing that thanks to our results, it can be proved by looking at pictures only, although the argument can be formalized.

Proof. Using Corollary 6.7.1, it is sufficient to inspect the possible local cones. One easily sees that there are three types of possible cones, depicted in Figure 6.11. The basis of each cone is a graph which is a union of 1, 2 or 3 cycles, so by Corollary 6.7.4 each cone pair has the surjection property, therefore Bing's house has computable type by Corollary 6.7.1.

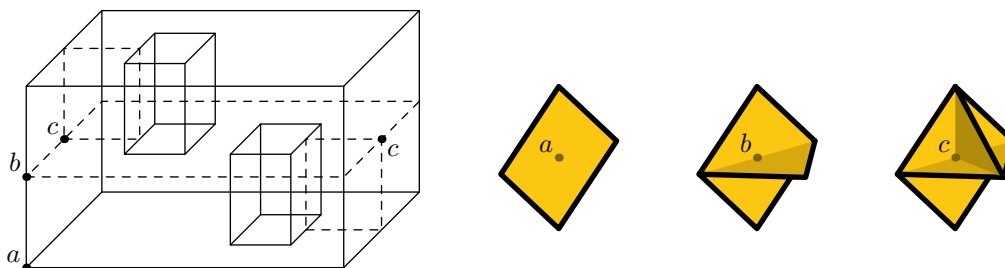

Figure 6.11: The local cones in Bing's house: their bases (in black) are graphs that are unions of cycles. Each point of Bing's house is the tip of one of these three cones: two points are tips of the third cone, all the other points on the dashed lines are tips of the second cone, all the other points are tips of the first cone.

□

6.7.3 Boundaries and the Odd Subcomplex

Given a simplicial complex X , a natural problem is to understand whether there is a minimal notion of boundary ∂X such that the pair $(X, \partial X)$ has computable type. We make a few observations about three possible candidates. Let

6. The Surjection Property and Computable Type

- $\partial_1 X$ be the union of simplices that are contained in *exactly* one simplex of the next dimension, i.e. $\partial_1 X$ is the union of the free simplices of X ,
- $\partial_+ X$ be the union of simplices that are contained in *at least* one simplex of the next dimension,
- $\partial_{\text{odd}} X$ be the union of simplices that are contained in *an odd number* of maximal simplices of the next dimension.

Proposition 6.7.3

Every simplicial pair $(X, \partial_+ X)$ has computable type.

Proof. Let $(M_i)_{i \leq n}$ be an enumeration of the maximal simplices of X . M_i is a ball, let ∂M_i be its bounding sphere, which is a subcomplex of M_i . One has $X = \bigcup_{i \leq n} M_i$ and $\partial_+ X = \bigcup_{i \leq n} \partial M_i$. Each pair $(M_i, \partial M_i)$ has the surjection property (Example 6.3.1), so $(X, \partial_+ X)$ has the ϵ -surjection property for some ϵ by Theorem 6.3.2. As a result, $(X, \partial_+ X)$ has computable type by Corollary 6.7.1. \square

Proposition 6.7.4

Let X be a finite simplicial complex and A a subcomplex. If (X, A) has computable type, then A contains $\partial_1 X$.

Proof. Assume that some simplex Δ belongs to $\partial_1 X$ but not to A . We show that for every $\epsilon > 0$, (X, A) does not have the ϵ -surjection property, implying that (X, A) does not have computable type by Corollary 6.7.1. Let $\epsilon > 0$. Let Δ' be the unique maximal simplex having Δ as a face (Δ' has one more vertex than Δ). There is a non-surjective function $f : \Delta' \rightarrow \Delta'$ which is ϵ -close to the identity and is the identity on the other faces of Δ' : f slightly pushes points of Δ' away from Δ . We extend f as the identity on the rest of X , which gives a continuous function because Δ is free. As Δ is not in A , f is the identity on A . \square

The Odd Subcomplex

If K is a finite simplicial complex, then there is a natural subcomplex A of K such that the pair (K, A) has the ϵ -surjection property for some $\epsilon > 0$. This subcomplex is the *odd subcomplex* of K .

Definition 6.7.2. Let K be a finite simplicial complex of dimension m . For $0 \leq n < m$, the **odd n -subcomplex** $\partial_{\text{odd}}^n(K)$ of K is the collection of all n -simplices of K that are contained in an odd number of maximal $(n+1)$ -simplices in K . The **odd subcomplex** $\partial_{\text{odd}}(K)$ of K is the union $\bigcup_{0 \leq n < m} \partial_{\text{odd}}^n(K)$.

Clearly, for every finite simplicial complex K , $\partial_{\text{odd}}(K)$ has empty interior because it contains no maximal simplex of K .

Theorem 6.7.1. For every finite simplicial complex K , the pair $(K, \partial_{\text{odd}}(K))$ has the ϵ -surjection property for some $\epsilon > 0$, hence has computable type.

Proof. Any finite simplicial complex is an ANR, so the pair $(K, \partial_{\text{odd}}(K))$ has the assumption of Theorem 6.5.3, therefore it is sufficient to show that every maximal simplex in K belongs to a relative cycle. We use the formulation of this latter property provided by Proposition 6.5.3.

Let S be a maximal n -simplex of K . Let c be the formal sum of the maximal n -simplices of K , seen as an n -chain with coefficients in $\mathbb{Z}/2\mathbb{Z}$. The boundary of c is the sum of the $(n-1)$ -simplices

that are contained in an odd number of maximal n -simplices. Therefore, ∂c is a chain of $\partial_{\text{odd}}(K)$ so c is a relative cycle in $(K, \partial_{\text{odd}}(K))$. As S is itself a maximal n -simplex, its coefficient in c is 1, so S belongs to a relative cycle and the proof is complete. \square

The following observations can be made:

- Although $(X, \partial_1 X)$ has computable type when X is a 1-dimensional complex (i.e., a graph), it is no more true for 2-dimensional complexes. For the dunce hat D , one has $\partial_1 D = \emptyset$ but we saw in Proposition 6.7.1 that (D, \emptyset) does not have computable type.
- While $(X, \partial_+ X)$ always has computable type by Proposition 6.7.3, $\partial_+ X$ is far from optimal. For instance, it is always non-empty (unless X is a single point), but for any sphere \mathbb{S}_n , the pair $(\mathbb{S}_n, \emptyset)$ already has computable type.
- $(X, \partial_{\text{odd}} X)$ always has computable type. Observe that $\partial_{\text{odd}} X$ is in general not optimal, as the example of graphs shows: $(X, \partial_1 X)$ has computable type and $\partial_1 X$ is usually smaller than $\partial_{\text{odd}} X$, which contains all the vertices of odd degrees.

6.7.4 Computable Type and the Product

Whether the computable type property is preserved by taking products was an open question, raised by Čelar and Iljazović in [21]. Theorem 6.6.2 enables us to give a negative answer to this question. Note that $(\mathbb{B}_1, \mathbb{S}_0)$ and \mathbb{S}_1 both have computable type.

Corollary 6.7.5. There exists a finite simplicial pair (X, A) that has computable type, but such that the product $(X, A) \times (\mathbb{B}_1, \mathbb{S}_0)$ does not.
There exists a finite simplicial complex Y that has computable type, but such that the product $Y \times \mathbb{S}_1$ does not.

Proof. For simplicial spaces and pairs, computable type is equivalent to the ϵ -surjection property for some ϵ , so we can simply apply Theorem 6.6.2. \square

Note however that the converse direction holds: we proved that if $(X, A) \times (Y, B)$ has computable type, then both (X, A) and (Y, B) have computable type (assuming that they both have a semicomputable copy, which is the case for finite simplicial pairs), see Proposition 4.4.1. This implication is consistent with Proposition 6.3.2, which shows that the ϵ -surjection property behaves similarly.

6.7.5 Cones of Manifolds

Let $(M, \partial M)$ be a compact n -manifold with (possibly empty) boundary. It is almost n -Euclidean, because every point of $M \setminus \partial M$ is n -Euclidean.

One has $H_n(M, \partial M; \mathbb{Z}/2\mathbb{Z}) \cong \mathbb{Z}/2\mathbb{Z}$ and the fundamental homology class intuitively contains every point of $M \setminus \partial M$. More formally, every regular n -cell $C \subseteq M \setminus \partial M$ belongs to a relative cycle with coefficients in $\mathbb{Z}/2\mathbb{Z}$ (therefore in \mathbb{T}), in the sense of Definition 6.5.1. Indeed, $M \setminus \partial M$ is $\mathbb{Z}/2\mathbb{Z}$ -orientable so the homomorphism

$$H_n(M, \partial M; \mathbb{Z}/2\mathbb{Z}) \rightarrow H_n(M, M \setminus \text{op}(C); \mathbb{Z}/2\mathbb{Z}) \cong \mathbb{Z}/2\mathbb{Z}$$

is an isomorphism, sending the fundamental class to the generator of $\mathbb{Z}/2\mathbb{Z}$ (see [30] for instance).

Therefore, we can apply Corollary 6.5.3 and Remark 6.7.2, giving the next result.

Corollary 6.7.6. If $(M, \partial M)$ is a compact manifold with possibly empty boundary, then the pair $\mathbb{C}(M, \partial M)$ has the surjection property, and hence it has computable type.

Recall that this result is proved differently in Section 5.4, see Corollary 5.4.1.

6.8 Conclusion

THE ϵ -surjection property was proved in Section 4.4.3 to be a necessary condition to have strong computable type. For cones, it reduces to the surjection property. In this chapter, we have developed several techniques to establish or refute these properties, applicable to classes of spaces including finite simplicial complexes and compact manifolds.

We have established precise relationships between the (ϵ -)surjection property and the homotopy of certain quotient maps to spheres, which enables us to take advantage of results from homology and homotopy theory. We have given applications of these techniques. The first one is that the cone of a compact manifold has computable type. The second one is that any finite simplicial complex together with its odd boundary has computable type. The third and most important application is an answer to a question raised in [21], showing that the computable type property is not preserved by taking products.

We give a characterization of finite simplicial pairs which have computable type. Namely, we prove that a finite simplicial complex has (strong) computable type iff it satisfies the ϵ -surjection property iff the star at each vertex satisfies the surjection property. This gives a visual tool to prove computable type for 2-dimensional finite simplicial complexes. As a concrete application, we prove that Bing's house has computable type whereas the dunce hat does not.

The reduction to homology implies that whether a finite simplicial complex which has dimension at most 4 has computable type is decidable.

Perspectives

Open questions could be considered as future directions, our study leaves many of them, we give here some examples.

Open Questions about Strong Computable Type

The example from Section 5.4.4 is a space that has strong computable type and properly contains copies of itself. The argument strongly relies on the fact that it contains the Hilbert cube, which is infinite-dimensional.

Question 6.8.1. Is there a finite-dimensional space which has strong computable type and contains a proper copy of itself?

Question 6.8.2. Theorem 4.4.2 assumes that the pair is minimal for some Σ_2^0 invariant. Can this assumption be dropped? Is it always true that if (X, A) has strong computable type, then $\text{SCT}_{(X,A)} \leq_W^t \mathbb{C}_\mathbb{N}$?

Question 6.8.3. Is there a compact space having (strong) computable type and infinitely many connected components?

We have revisited several results from the literature on computable type, identifying a Σ_2^0 invariant for which the space or the pair is minimal, we do not know whether the results on finite simplicial complexes (Corollary 6.7.1) can be restudied in a similar way.

Question 6.8.4. If a finite simplicial pair (X, A) has strong computable type, is it minimal satisfying some Σ_2^0 topological invariant? Is there a canonical notion of boundary ∂X for a simplicial complex X , such that $(X, \partial X)$ always has computable type, and ∂X is minimal in some sense?

Open Questions about the Descriptive Complexity of Topological Invariants

To any compact space X is associated the problem of recognizing X :

Input. A compact space Y ,

Output. Is Y homeomorphic to X ?

Note that each particular space X induces a topological invariant, which is “being homeomorphic to X ”. The obvious descriptive complexity of this invariant is Σ_1^1 , because it is formulated using

an existential quantifier over continuously many objects: Y is homeomorphic to X iff there exists a homeomorphism $f : Q \rightarrow Q$ such that $f(Y) = X$.

However, a classical theorem from Descriptive Set Theory, due to Miller ([44], Theorem 15.14) and Ryll-Nardzewski ([11], Theorem 2.3.4) implies that the complexity of recognizing a particular space is always Borel. For the interested reader, this result states that when a Polish group continuously acts on a Polish space, each orbit is Borel. In our context, the Polish group of homeomorphisms from Q to itself continuously acts on the Polish space of compact subsets of Q , and the set of copies of a space is an orbit of the group action, and is therefore Borel by this theorem.

This result opens up the following research program: for each concrete space X , what is the exact complexity of recognizing X ?

The results presented in this chapter are the first steps of a much broader research program. We list a few important problems left for future investigations.

We have built *ad hoc* Σ_2^0 invariants separating finite topological graphs.

Question 6.8.5. Is there a “natural” class of Σ_2^0 invariants separating finite topological graphs?

The family of finite graphs is very restricted. The finite simplicial complexes, which are generalizations of graphs to higher-dimensions, provide a rich family of spaces.

Question 6.8.6. For each $n \in \mathbb{N}$, what is the minimal level of complexity of topological invariants that can separate any pair of n -dimensional finite simplicial complexes? In the 1-dimensional case of graphs, we saw that it is Σ_2^0 .

Question 6.8.7. What is the descriptive complexity of recognizing the circle? the disk? The same question can be raised for any particular compact space.

List of Figures

1	La soucoupe de Varsovie et une demi-coupe de celui-ci	xvii
2	La maison à deux pièces de Bing, ainsi qu’une demi-coupe	xviii
3	Un disque attaché à un tore pincé n’est pas de type calculable	xviii
4	Une copie semi-calculable d’un disque attaché à un tore pincé qui n’est pas calculable	xviii
5	The Warsaw saucer and a half-cut of it	xxiii
6	Bing’s house with two rooms and a half-cut of it	xxiv
7	A disk attached to a pinched torus does not have computable type	xxiv
8	A semicomputable copy of a disk attached to a pinched torus which is not computable	xxiv
4.1	Cone of two circles joined by a segment	53
4.2	Bing’s house with two rooms and a half-cut of it	53
4.3	A compact pair having the surjection property but not computable type	55
4.4	A disk attached to a pinched torus and its ϵ -deformations	63
4.5	A semicomputable copy of a disk attached to a pinched torus which is not computable	63
5.1	Extensions of f in the proof of Lemma 5.3.3	76
5.2	The Warsaw saucer and a half-cut of it	81
5.3	A segment converging to the closed topologist’s sine curve	88
5.4	Illustration of the proof of Theorem 5.6.2	89
5.5	Illustration of the proof of Theorem 5.7.2	96
6.1	A graph explaining how h is defined in the proof of Proposition 6.5.1	110
6.2	A pair (X, A) whose cone pair $C(X, A)$ does not satisfy the surjection property . . .	111
6.3	A space X whose cone pair $(C(X), X)$ does not satisfy the surjection property . . .	111
6.4	The space X_f	116
6.5	Illustration of the proof of (b) in Theorem 6.6.1	118
6.6	A cone at a vertex in a finite simplicial complex	121
6.7	The star pairs have the surjection property	124
6.8	A union of 5 squares is the cone of a graph	124
6.9	The dunce hat	125
6.10	Bing’s house with two rooms and a half-cut of it	126
6.11	The local cones in Bing’s house	126

Index

- absolute neighborhood retract, 34
- absolute retract, 34
- abstract finite simplicial complex, 38
- agree, 58
- almost Euclidean, 8, 101
- almost n -Euclidean, 8, 101
- ANR, 34
- approximates, 85
- AR, 34
- asymptotically homotopic, 71

- belongs to a relative cycle, 10, 112
- Bing's house, 125
- border, 101
- boundary, 29

- c.e., 15
- Cech, 36
- chain, 78, 82
- chainable, 82
- chainable from a to b , 78
- circular chain, 82
- circularly chainable, 82
- closed choice, 4, 56
- closed topologist's sine curve, 7, 88
- cofinal, 48
- cohomology group, 36
- compact pair, 2, 21
- computable, xxi, 17
- computable function, 16
- computable metric space, 18
- computable Polish space, 18
- computable relative, 16
- computable type, xxi, 21
- computable witnesses, 5, 59
- computably enumerable, 15
- computably Hausdorff, 18
- computably overt, 17
- computably regular, 44
- cone, 8, 30
- cone pair, 8, 30

- connected, 28
- connected component, 28
- copy, 2, 21
- covers, 78
- cylinder, 30

- dimension, 28
- disjoint union, 28
- dunce hat, 124

- effective countably-based T_0 -space, 16
- effectively closed, 17
- effectively compact, 17
- effectively open, 17
- effectively weaker, 58
- effectively τ -generically weaker, 59
- enumeration, 15
- enumeration reducible, 16
- ϵ -chain, 78
- ϵ -deformation, 2, 50
- ϵ -function, 2, 50
- ϵ -homotopy, 33
- ϵ -surjection property, 5, 55, 101
- ϵ -witness, 5, 59
- Euclidean, 101
- extends, 67

- finite simplicial complex, 38
- finite simplicial pair, 38
- finitely conical pair, 9, 105
- finitely conical space, 9, 105
- free, 38
- function between pairs, 29

- generalized ϵ -surjection property, 55, 101

- Hausdorff distance, 23
- Hilbert cube, 19
- homology group, 36, 143
- homotopic, 33
- homotopic relative to, 73
- homotopy, 33

- homotopy class, 33
- homotopy extension property, 33
- House With Two Rooms, 125
- hyperspace, 22

- invariant, 23

- join, 31
- join of two pairs, 32

- lower set, 48
- lower Vietoris topology, 22

- manifold, 29
- maximal simplex, 38
- minimal, 47
- modulus of local connectedness, 91
- modulus of uniform continuity, 61

- n -Euclidean, 101
- n -manifold, 29
- n -manifold with boundary, 29
- n -simplex, 38
- null-homotopic, 33
- null-homotopic relative to, 74
- numbering, 68

- odd subcomplex, 127
- odd n -subcomplex, 127
- open cell, 101
- open cone, 30
- open cone pair, 30

- \mathcal{P} -minimal, 47
- pair contained in, 29
- pair strictly contained in, 29
- pointed topological space, 28
- problem, 24
- product of two pairs, 52
- proper subpair, 29
- property of compact pairs, 23
- pseudo- n -cube, 79

- quasi-chain, 82
- quasi-chainable, 82
- quotient map, 29
- quotient space, 29

- rational balls, 19
- rational point in Q , 19
- realizer, 24
- reduced suspension, 119

- regular cell, 8, 101
- regular n -cell, 8, 101
- relative strong computable type, 54
- represented space, 24
- retract, 33
- retraction, 33

- semicomputable, xxi, 17
- semicomputable compact pair, 21
- simple copy, 62
- simplices, 38
- singular, 36
- special symbol, 30
- standard realization, 38
- strengthening, 24
- strong computable type, xxi, 2, 46
- strongly approximates, 7, 87
- strongly Weihrauch reducible to, 25
- subcomplex, 38
- subpair, 29
- support, 38
- surjection property, 5, 55, 101
- suspension, 116

- τ -computable, 16
- τ -generically weaker, 59
- tip, 30
- topological invariant, 23
- topologist sine curve, 80

- upper set, 48
- upper Vietoris topology, 22

- vertices, 38
- Vietoris topology, 22

- Warsaw saucer, 80
- Warsaw sine curve, 80
- wedge sum, 28
- Weihrauch reducible to, 25

Index of Symbols

- $A \leq_e B$, 2.0.1 on page 16
 Σ_1^0 , 2.1.3 on page 17
 Π_1^0 , 2.1.3 on page 17
 Σ_2^0 , 2.1.4 on page 18
 Q , 2.1.6 on page 19
 d_Q , 2.1.6 on page 19
 $\mathcal{C}(Q)$, 2.1.7 on page 20
 $d_X(f, g)$, 2.1.7 on page 20
 $\mathcal{K}(Q)$, 2.3.1 on page 22
 $\tau_{up\nu}$, 2.3.1 on page 22
 $\tau_{low\nu}$, 2.3.1 on page 22
 τ_ν , 2.3.1 on page 22
 d_H , 2.3.2 on page 23
 $\underline{\Sigma}_1^0$, 2.3 on page 24
 $\underline{\Pi}_1^0$, 2.3 on page 24
 \leq_W , 2.4.2 on page 25
 \leq_{sW} , 2.4.2 on page 25
 \leq_{sW}^t , 2.4.2 on page 25
 $\mathcal{N}(A, r)$, $\mathcal{N}_r(A)$, 3.1 on page 28
 $X \vee Y$, 3.1.2 on page 28
 $X \sqcup Y$, 3.1.2 on page 28
 $\text{Cyl}(X)$, 3.2.1 on page 30
 $\mathcal{C}(X)$, 3.2.2 on page 30
 $\text{OC}(X)$, 3.2.2 on page 30
 $\mathcal{C}(X, A)$, 3.2.3 on page 30
 $\text{OC}(X, A)$, 3.2.3 on page 30
 \odot , 3.2.4 on page 30
 $X * Y$, 3.2.5 on page 31
 $(X, A) * (Y, B)$, 3.2.6 on page 32
 $H_n(X; G)$, 3.4 on page 36
 $H^n(X; G)$, 3.4 on page 36
 \mathbb{T} , 3.4.1 on page 37
 \mathcal{P}^* , 4.3.5 on page 50
 $(X_1, A_1) \times (X_2, A_2)$, 4.4.1 on page 52
 $\text{SCT}_{(X,A)}$, 4.4.4 on page 56
 $\mathbb{C}_{\mathbb{N}}$, 4.4.5 on page 56
 $\uparrow\mathcal{P}$, 4.4.5 on page 57
 $[X; Y]$, 5.2.2 on page 67
 $[f]_A$, 5.2.2 on page 67
 $\nu_{[X;Y]}$, 5.2.2 on page 67
 $\mathbb{E}(Y)$, 5.2.1 on page 69
 $\mathbb{H}(Y)$, 5.2.2 on page 70
 \mathbb{E}_n , 5.3.2 on page 72
 \mathbb{H}_n , 5.3.3 on page 74
 \mathcal{C} , 5.4.1 on page 78
 $Q \cup_f \mathbb{B}_2$, 5.4.4 on page 83

$C_{n,p}$, 5.5.1 on page 84

$X \preceq Y$, 5.6.1 on page 87

$\eta_X(r)$, 5.7.1 on page 91

$\text{bd}(C)$, 6.2.2 on page 101

$\text{op}(C)$, 6.2.2 on page 101

q_C , 6.5.1 on page 108

X_f , 6.6.1 on page 116

SX , 6.6.1 on page 116

Sf , 6.6.1 on page 116

$\partial_1 X$, 6.7.3 on page 126

$\partial_+ X$, 6.7.3 on page 126

$\partial_{\text{odd}}(K)$, 6.7.2 on page 127

$\partial_{\text{odd}}^n(K)$, 6.7.2 on page 127

Bibliography

- [1] Michal Adamaszek and Juraj Stacho. Complexity of simplicial homology and independence complexes of chordal graphs. *Computational Geometry*, 57:8–18, 2016. [2.3.1](#)
- [2] Pavel Alexandroff. On the dimension of normal spaces. *Proceedings of the Royal Society of London. Series A. Mathematical and Physical Sciences*, 189(1016):11–39, 1947. [2](#)
- [3] Manuel Amann. Computational complexity of topological invariants. *Proceedings of the Edinburgh Mathematical Society*, 58(1):27–32, 2015. [2.3.1](#)
- [4] Djamel Eddine Amir and Mathieu Hoyrup. Computability of finite simplicial complexes. In Mikolaj Bojanczyk, Emanuela Merelli, and David P. Woodruff, editors, *49th International Colloquium on Automata, Languages, and Programming, ICALP 2022, July 4-8, 2022, Paris, France*, volume 229 of *LIPICs*, pages 111:1–111:16. Schloss Dagstuhl - Leibniz-Zentrum für Informatik, 2022. ([document](#)), [2.2](#), [4.3.1](#), [4.5.1](#), [4.5.1](#), [4.5.1](#), [4.5.1](#), [6](#), [6.7.2](#)
- [5] Djamel Eddine Amir and Mathieu Hoyrup. Computability of finite simplicial complexes. preprint, 2022. [4.5.1](#)
- [6] Djamel Eddine Amir and Mathieu Hoyrup. Comparing computability in two topologies. *The Journal of Symbolic Logic*, pages 1–19, 2023. ([document](#)), [2.2](#), [4](#), [4.5.1](#), [4.5.1](#), [4.5.1](#), [4.5.1](#), [4.5.1](#), [4.5.1](#), [4.5.1](#), [4.5.1](#)
- [7] Djamel Eddine Amir and Mathieu Hoyrup. Descriptive complexity of topological invariants. working paper or preprint, September 2023. ([document](#)), [5](#)
- [8] Djamel Eddine Amir and Mathieu Hoyrup. Strong computable type. *Computability*, pages 227–269, January 1 2023. ([document](#)), [2.2](#), [4](#), [5](#), [6](#)
- [9] Djamel Eddine Amir and Mathieu Hoyrup. The surjection property and computable type, 2023. ([document](#)), [2.2](#), [6](#)
- [10] Howard Becker. Descriptive set theoretic phenomena in analysis and topology. In Haim Judah, Winfried Just, and Hugh Woodin, editors, *Set Theory of the Continuum*, pages 1–25, New York, NY, 1992. Springer US. [2.3.1](#)
- [11] Howard Becker and Alexander S. Kechris. *The Descriptive Set Theory of Polish Group Actions*. London Mathematical Society Lecture Note Series. Cambridge University Press, 1996. [6.8](#)
- [12] RH Bing. Some aspects of the topology of 3-manifolds related to the poincaré conjecture. *Lectures on modern mathematics*, 2:93–128, 1964. [2](#)
- [13] Karol Borsuk. Über eine Klasse von lokal zusammenhängende Räumen. *Fundamenta Mathematicae*, 19:220–242, 1932. [3.3.3](#)

-
- [14] Karol Borsuk. *Theory of retracts*. Monografie Matematyczne, Tom 44. Państwowe Wydawnictwo Naukowe, Warsaw, 1967. [3.3.4](#), [6.3](#)
- [15] Vasco Brattka, Guido Gherardi, and Arno Pauly. Weihrauch complexity in computable analysis. In Vasco Brattka and Peter Hertling, editors, *Handbook of Computability and Complexity in Analysis*, Theory and Applications of Computability, pages 367–417. Springer, Cham, 2021. [2.4](#), [2.4.1](#), [4.4.4](#)
- [16] G.E. Bredon. *Topology and Geometry*. Graduate Texts in Mathematics. Springer, 1993. [3](#), [3.4](#), [5.4.2](#), [A.1](#), [A.1](#), [A.2](#)
- [17] R. Brown. *Topology and Groupoids*. www.groupoids.org, 2006. [3.2.2](#), [3.2.2](#)
- [18] Konrad Burnik and Zvonko Iljazović. Computability of 1-manifolds. *Logical Methods in Computer Science*, 10(2), 2014. ([document](#)), [2.2](#), [2.2.1](#), [1](#), [4.3.1](#)
- [19] Benjamin A. Burton, Clément Maria, and Jonathan Spreer. Algorithms and complexity for turaev-viro invariants. In Magnús M. Halldórsson, Kazuo Iwama, Naoki Kobayashi, and Bettina Speckmann, editors, *Automata, Languages, and Programming*, pages 281–293, Berlin, Heidelberg, 2015. Springer Berlin Heidelberg. [2.3.1](#)
- [20] Matea Čelar and Zvonko Iljazović. Computability of glued manifolds. *Journal of Logic and Computation*, 32(1):65–97, 10 2021. ([document](#)), [2.2](#), [1](#), [4.3.1](#)
- [21] Matea Čelar and Zvonko Iljazović. Computability of products of chainable continua. *Theory Comput. Syst.*, 65(2):410–427, 2021. ([document](#)), [4](#)), [2.2](#), [6](#), [4.3.1](#), [6.1](#), [6.7.4](#), [6.8](#)
- [22] Matea Čelar and Zvonko Iljazović. Computable type of an unglued space, 2021. Talk at Computability and Complexity in Analysis (CCA). [6.7.4](#)
- [23] Eugen Čičković, Zvonko Iljazović, and Lucija Validžić. Chainable and circularly chainable semicomputable sets in computable topological spaces. *Arch. Math. Log.*, 58(7-8):885–897, 2019. ([document](#)), [3](#)), [2.2](#), [2.2](#), [3](#), [4](#), [4.2](#), [4.3.1](#)
- [24] Pieter Collins. Computability of homology for compact absolute neighbourhood retracts. In Andrej Bauer, Peter Hertling, and Ker-I Ko, editors, *Sixth International Conference on Computability and Complexity in Analysis, CCA 2009, August 18-22, 2009, Ljubljana, Slovenia*, volume 11 of *OASICS*. Schloss Dagstuhl - Leibniz-Zentrum fuer Informatik, Germany, 2009. [5.2.1](#), [5.2.2](#)
- [25] Gabriel Debs and Jean Saint Raymond. The descriptive complexity of connectedness in Polish spaces. *Fundamenta Mathematicae*, 249(3):261–286, 2020. [2.3.1](#), [5.7.1](#)
- [26] Rod Downey and Alexander Melnikov. Effectively compact spaces, 2022. Preprint. [2.3.1](#), [2](#)), [2](#))
- [27] Ryszard Engelking. *General topology. Rev. and compl. ed.*, volume 6. Berlin: Heldermann Verlag, rev. and compl. ed. edition, 1989. [5.4.4](#)
- [28] Hans Freudenthal. Über die Klassen der Sphärenabbildungen. I. Große Dimensionen. *Compos. Math.*, 5:299–314, 1937. [6.6.3](#)
- [29] Olof Hanner. Some theorems on absolute neighborhood retracts. *Arkiv for Matematik*, 1(5):389–408, 1951. [3.3.1](#)

- [30] Allen Hatcher. *Algebraic Topology*. Algebraic Topology. Cambridge University Press, 2002. [3](#), [3.3.2](#), [3.3.5](#), [3.4](#), [3.4](#), [5.4.4](#), [6.5.1](#), [1](#)), [6.6.1](#), [6.6.1](#), [6.6.2](#), [6.6.3](#), [6.7.5](#), [A.1](#), [A.2](#)
- [31] Allen Hatcher. *Algebraic Topology*. Algebraic Topology. Cambridge University Press, 2002. [6.3.1](#), [6.7.1](#)
- [32] Pinar Heggernes, Pim van't Hof, Benjamin Lévêque, Daniel Lokshtanov, and Christophe Paul. Contracting graphs to paths and trees. *Algorithmica*, 68(1):109–132, 2014. [5.7.3](#), [5.7.3](#)
- [33] Peter Hertling. Is the Mandelbrot set computable? *Math. Log. Q.*, 51(1):5–18, 2005. ([document](#)), [2.1.2](#)
- [34] Marko Horvat, Zvonko Iljazović, and Bojan Pažek. Computability of pseudo-cubes. *Annals of Pure and Applied Logic*, 171(8):102823, 2020. ([document](#)), [3](#)), [2.2](#), [5](#), [4.3.1](#), [5.3.1](#), [2](#)
- [35] Sze-Tsen Hu. Mappings of a normal space into an absolute neighborhood retract. *Transactions of the American Mathematical Society*, 64(2):336–358, 1948. [2](#)
- [36] Witold Hurewicz and Henry Wallman. *Dimension Theory (PMS-4)*. Princeton University Press, 1941. [3.4](#), [3.4.1](#), [3.4.1](#), [3.4.1](#), [1](#)), [2](#)), [6.5.1](#)
- [37] Zvonko Iljazović. Chainable and circularly chainable co-r.e. sets in computable metric spaces. *Journal of Universal Computer Science*, 15(6):1206–1235, 2009. ([document](#)), [3](#)), [2.2](#), [2.2](#), [3](#), [4](#), [4.2](#), [4.3.1](#), [1](#)), [1](#)), [1](#)), [5.4.3](#)
- [38] Zvonko Iljazović. Co-c.e. spheres and cells in computable metric spaces. *Logical Methods in Computer Science*, 7(3), 2011. ([document](#)), [2.2](#), [2.2.1](#), [1](#), [3](#), [4.1](#), [4.3.1](#)
- [39] Zvonko Iljazovic. Compact manifolds with computable boundaries. *Log. Methods Comput. Sci.*, 9(4), 2013. ([document](#)), [2.2](#), [1](#), [3](#), [4.1](#), [4.2](#), [4.3.1](#), [5.3.3](#), [5.4.2](#), [5.4.2](#)
- [40] Zvonko Iljazović. Computability of graphs. *Mathematical Logic Quarterly*, 66(1):51–64, 2020. ([document](#)), [2.2](#), [2.2.1](#), [2](#), [4.3.1](#), [6.7.1](#), [6.7.1](#)
- [41] Zvonko Iljazović and Takayuki Kihara. Computability of subsets of metric spaces. In Vasco Brattka and Peter Hertling, editors, *Handbook of Computability and Complexity in Analysis*. Springer, 2021. [2](#), [2.3](#), [5.6](#)
- [42] Zvonko Iljazović and Igor Sušić. Semicomputable manifolds in computable topological spaces. *Journal of Complexity*, 45:83–114, 2018. ([document](#)), [3](#)), [2.2](#), [1](#), [4.2](#), [4.3.1](#), [5.3.3](#), [5.4.2](#)
- [43] Emmanuel Jeandel. Enumeration reducibility in closure spaces with applications to logic and algebra. In *32nd Annual ACM/IEEE Symposium on Logic in Computer Science, LICS 2017, Reykjavik, Iceland, June 20-23, 2017*, pages 1–11. IEEE Computer Society, 2017. [4.3.2](#)
- [44] Alexander S. Kechris. *Classical Descriptive Set Theory*. Springer, January 1995. [2](#), [2.3.1](#), [4.3.3](#), [6.8](#)
- [45] Takayuki Kihara and Arno Pauly. Point degree spectra of represented spaces. *CoRR*, abs/1405.6866, 2014. [2.1](#)
- [46] Martino Lupini, Alexander Melnikov, and Andre Nies. Computable topological abelian groups, 2021. [2.3.1](#), [2](#)), [2](#)
- [47] Sibe Mardešić. Equivalence of singular and čech homology for anr-s. application to unicoherence. *Fundamenta Mathematicae*, 46:29–45, 1958. [3.4](#)

-
- [48] Joseph S. Miller. Effectiveness for embedded spheres and balls. *Electronic Notes in Theoretical Computer Science*, 66(1):127 – 138, 2002. CCA 2002, Computability and Complexity in Analysis (ICALP 2002 Satellite Workshop). (document), 2.2, 2.2.1, 1, 3, 4.1, 4.3.1, 5.3.2
- [49] Y.N. Moschovakis. *Descriptive Set Theory*. Mathematical Surveys and Monographs. American Mathematical Society, 2009. (Second edition). 2.1
- [50] J.R. Munkres. *Topology*. Featured Titles for Topology. Prentice Hall, Incorporated, 2000. 3
- [51] Arno Pauly. On the topological aspects of the theory of represented spaces. *Computability*, 5(2):159–180, 2016. 2.1, 2.1.1
- [52] Arno Pauly. Weihrauch degrees of problems related to topological circles, 2021. Continuity, Computability, Constructivity (CCC). 4.4.4
- [53] Matthias Schröder. Effective metrization of regular spaces. In Ker-I Ko, Anil Nerode, Marian B. Pour-El, Klaus Weihrauch, and Jiří Wiedermann, editors, *Computability and Complexity in Analysis*, volume 235, pages 63–80. Informatik Berichte, FernUniversität Hagen, 1998. 1.1.1, 2.1.1, 4.2, 4.2, 4.2
- [54] Matthias Schröder. Admissibly represented spaces and Qcb-spaces. In Vasco Brattka and Peter Hertling, editors, *Handbook of Computability and Complexity in Analysis*. Springer, 2021. 2
- [55] Dana Scott. Data types as lattices. *SIAM Journal on Computing*, 5(3):522–587, 1976. 2.1
- [56] Victor L. Selivanov. Towards a descriptive set theory for domain-like structures. *Theoretical Computer Science*, 365(3):258–282, 2006. Spatial Representation: Discrete vs. Continuous Computational Models. 2.1
- [57] Alan L. Selman. Arithmetical reducibilities I. *Mathematical Logic Quarterly*, 17(1):335–350, 1971. 2
- [58] Hirosi Toda. Some relations in homotopy groups of spheres. *Journal of the Institute of Polytechnics, Osaka City University. Series A: Mathematics*, 2(2):71 – 80, 1952. 6.6.3, 6.6.3
- [59] Alan Turing. On computable numbers, with an application to the entscheidungsproblem. *Proceedings of the London Mathematical Society*, 2, 42:230–265, 1936. 2
- [60] Jan van Mill. *Infinite-dimensional topology - prerequisites and introduction*, volume 43 of *North-Holland mathematical library*. North-Holland, 1989. 3.3.4, 3.3.4, 3.3.4, 5.3.2, 2)
- [61] Jan van Mill. *The Infinite-Dimensional Topology of Function Spaces*. North-Holland Mathematical Library. Elsevier Science, 2001. 3.3.2, 3.3.1, 3.3.4, 3.3.5, 4.3.3, 5.5.1, 5.6.3
- [62] Robert Vaught. Invariant sets in topology and logic. *Fundamenta Mathematicae*, 82(3):269–294, 1974. 2.3.1, 4.3.3
- [63] Martin Čadek, Marek Krčál, Jiří Matoušek, Francis Sergeraert, Lukáš Vokřínek, and Uli Wagner. Computing all maps into a sphere. *Journal of the ACM*, 61(3), jun 2014. 5.2.2
- [64] Klaus Weihrauch. *Computable Analysis*. Springer, Berlin, 2000. 2
- [65] George W. Whitehead. On products in homotopy groups. *Annals of Mathematics*, 47(3):460–475, 1946. 6.6.3, 6.6.3
- [66] George W. Whitehead. A generalization of the Hopf invariant. *Annals of Mathematics*, 51:192, 1950. 6.6.3

BIBLIOGRAPHY

- [67] J. H. C. Whitehead. Note on a theorem due to Borsuk. *Bulletin of the American Mathematical Society*, 54(12):1125 – 1132, 1948. 3.3.4
- [68] E.C. Zeeman. On the dunce hat. *Topology*, 2(4):341–358, 1963. 1)

Appendix A

Compact n -Manifolds are H_n -Minimal

A.1 Background

We gather some results from Bredon [16] and Hatcher [30]. We do not recall the definitions of homology groups, but recall results from algebraic topology and then show how they imply Theorem 5.4.1.

If X is a topological space, $A \subseteq X$ is a subset and G is an abelian group, then for each $n \in \mathbb{N}$ one can define the n th **homology group** $H_n(X, A; G)$, which is an abelian group. When $A = \emptyset$, we write $H_n(X; G)$ for $H_n(X, A; G)$. When $G = \mathbb{Z}$, one denotes $H_n(X, A; \mathbb{Z})$ by $H_n(X, A)$.

Homology of manifolds is very well understood. We will mainly use the fact that homology can detect compactness of manifolds (Corollary VI.7.12 (p. 346) in [16]), as follows.

Theorem A.1.1. Let M be a connected n -manifold and assume that G contains an element of order 2. One has

$$H_n(M) \neq 0 \iff M \text{ is compact.}$$

The next result is a generalization to pairs (Corollary VI.7.11 (p. 346) in [16]).

Theorem A.1.2. Let M be an n -manifold and assume that G contains an element of order 2. If $A \subseteq M$ is closed and connected, then

$$H_n(M, M \setminus A; G) \neq 0 \iff A \text{ is compact.}$$

Note that Theorem A.1.1 is just a particular case of Theorem A.1.2, with $A = M$.

A.2 Proof of Theorem 5.4.1

These results imply that if $(M, \partial M)$ is a compact connected n -manifold with (possibly empty) boundary, then removing a point makes the n th homology group trivial, because compactness is lost. The argument is very classical but we did not find this particular statement in any reference textbook, so we include a proof. For $x \in M$, we write $M_x = M \setminus \{x\}$.

Theorem A.2.1. Let $(M, \partial M)$ be a compact connected n -manifold with (possibly empty) boundary. If G contains an element of order 2, then $H_n(M, \partial M; G) \neq 0$. For any $x \in M \setminus \partial M$ one has $H_n(M_x, \partial M; G) \cong 0$.

Proof. If ∂M is empty, then it is a direct consequence of Theorem A.1.1, because M_x is a non-compact connected n -manifold. Let us now consider the case when ∂M is non-empty.

In M , ∂M has a *collar neighborhood*, i.e. an open neighborhood that is homeomorphic to $\partial M \times [0, 1)$, in which ∂M is identified with $\partial M \times \{0\}$ (Proposition 3.42 in [30]). Moreover we can assume that this collar neighborhood does not contain x (otherwise take the subset that is sent to $\partial M \times [0, \epsilon)$ by the homeomorphism, for sufficiently small $\epsilon > 0$). For simplicity of notation, we identify the collar neighborhood with $\partial M \times [0, 1)$. As the collar neighborhood deformation retracts to ∂M , one has for any abelian group G ,

$$\begin{aligned} H_n(M_x, \partial M; G) &\cong H_n(M_x, \partial M \times [0, 1); G) \\ &\cong H_n(M_x \setminus \partial M, \partial M \times (0, 1); G) \end{aligned}$$

where the last isomorphism exists by excision (it is a classical derivation that can be found for instance in [16], at the beginning of section VI.9). Similarly, $H_n(M, \partial M; G) \cong H_n(M \setminus \partial M, \partial M \times (0, 1); G)$. We apply Theorem A.1.2 to the manifolds $N = M \setminus \partial M$ and $N_x = M_x \setminus \partial M$ and their subsets $A = N \setminus (\partial M \times (0, 1))$ and $A_x = N_x \setminus (\partial M \times (0, 1))$. A is compact but A_x is not because x has been removed, so by Theorem A.1.2,

$$\begin{aligned} H_n(M \setminus \partial M, \partial M \times (0, 1); G) &= H_n(N, N \setminus A) \neq 0. \\ H_n(M_x \setminus \partial M, \partial M \times (0, 1); G) &= H_n(N_x, N_x \setminus A_x) \cong 0. \end{aligned}$$

As a result, $H_n(M, \partial M; G) \neq 0$ and $H_n(M_x, \partial M; G) \cong 0$. □

We can now prove that compact connected n -manifolds with boundary are H_n -minimal, using the same argument as for manifolds without boundary.

If $x \in M \setminus \partial M$ and $B \subseteq M \setminus \partial M$ is an open Euclidean ball around x , then M_x deformation retracts to $M \setminus B$, which means that there is a retraction $r : M_x \rightarrow M \setminus B$ such that if $i : M \setminus B \rightarrow M_x$ is the inclusion map, then $r \circ i$ is homotopic to $\text{id}_{M \setminus B}$, and the homotopy is constant on $M \setminus B$. It is a classical result that deformation retractions preserve homology groups (Proposition 2.19 in [30]), so $H_n(M \setminus B, \partial M; G) \cong H_n(M_x, \partial M; G) \cong 0$.

Theorem 5.3.3 relates H_n with homology groups, but is only for single sets. However, pairs can be reduced to single sets as follows. On the one hand, relative homology groups of pairs satisfying the homotopy extension property are isomorphic to homology groups of their quotients, so:

$$\begin{aligned} H_n(M/\partial M; G) &\cong H_n(M, \partial M; G) \neq 0, \\ H_n(M_x/\partial M; G) &\cong H_n(M_x, \partial M; G) \cong 0. \end{aligned}$$

On the other hand, a pair (X, A) is in H_n iff X/A is in H_n (Proposition 5.3.10).

Therefore, Theorem 5.3.3 implies that $(M, \partial M) \in H_n$ and $(M \setminus B, \partial M) \notin H_n$. It implies that $(M, \partial M)$ is H_n -minimal by Lemma 5.3.2: if (X, A) is a proper compact subpair of M , then $(X, A) \subseteq (M \setminus B, \partial M)$ for some $B \subseteq M \setminus \partial M$, so $(X, A) \notin H_n$.

Appendix B

Coefficients

In Definition 6.5.1 we used the coefficient group \mathbb{T} to detect relative cycles. One could equivalently use the groups $\mathbb{Z}_k = \mathbb{Z}/k\mathbb{Z}$ (with $k \geq 2$). The group \mathbb{Z} can also give information. Although the next result is probably folklore, we did not find a suitable reference and include a proof for completeness.

Proposition B.0.1

Let (X, A) be a compact pair and $x \in X \setminus A$ be n -Euclidean. The following statements are equivalent:

- The homomorphism $H_n(X, A; \mathbb{T}) \rightarrow H_n(X, X \setminus \{x\}; \mathbb{T})$ is non-trivial,
- The homomorphism $H_n(X, A; \mathbb{Z}_k) \rightarrow H_n(X, X \setminus \{x\}; \mathbb{Z}_k)$ is non-trivial for some $k \geq 2$,

and they hold if the homomorphism $H_n(X, A) \rightarrow H_n(X, X \setminus \{x\})$ is non-trivial.

Proof. We use the universal coefficient theorem for homology, and the fact that it is functorial in the space and in the coefficient group. For any abelian group G , one has the following commuting diagram:

$$\begin{array}{ccccccc}
 0 & \longrightarrow & H_n(X, A) \otimes G & \xrightarrow{g_1} & H_n(X, A; G) & \xrightarrow{g_2} & \text{Tor}(H_{n-1}(X, A), G) \longrightarrow 0 \\
 & & \downarrow f_1 & & \downarrow f_2 & & \downarrow f_3 \\
 0 & \longrightarrow & \underbrace{H_n(\mathbb{S}_n, s) \otimes G}_G & \xrightarrow{h_1} & \underbrace{H_n(\mathbb{S}_n, s; G)}_G & \xrightarrow{h_2} & \underbrace{\text{Tor}(H_{n-1}(\mathbb{S}_n, s), G)}_0 \longrightarrow 0
 \end{array} \tag{B.1}$$

We will write f_1^k for $G = \mathbb{Z}_k$ and f_1' for $G = \mathbb{T}$, and similarly for the other homomorphisms.

We first assume that $f : H_n(X, A) \rightarrow H_n(\mathbb{S}_n, s) \cong \mathbb{Z}$ is non-trivial and show that f_2^k is non-trivial for some $k \geq 2$. Let $q \in H_n(\mathbb{S}_n, s)$ be a non-zero element of the image of f . Let $k \geq 2$ be an integer that does not divide q , and take $G = \mathbb{Z}_k$ in B.1, so that $(q, 1)$ is not zero in $H_n(\mathbb{S}_n, s) \otimes G$. As $(q, 1)$ belongs to the image of f_1^k , f_1^k is non-trivial. As h_1^k is injective, $h_1^k \circ f_1^k = f_2^k \circ g_1^k$ is non-trivial, so f_2^k must be non-trivial.

We now assume that f_2^k is non-trivial for some $k \geq 2$ and show that f_2' is non-trivial. The inclusion $\mathbb{Z}_k \rightarrow \mathbb{T}$ sending $[p]$ to $[p/k]$ induces homomorphisms from $H_n(Y, B; \mathbb{Z}_k)$ to $H_n(Y, B; \mathbb{T})$ which make the following diagram commute:

$$\begin{array}{ccc}
 H_n(X, A; \mathbb{Z}_k) & \xrightarrow{i_2} & H_n(X, A; \mathbb{T}) \\
 \downarrow f_2^k & & \downarrow f_2' \\
 H_n(\mathbb{S}_n, s; \mathbb{Z}_k) & \xrightarrow{j_2} & H_n(\mathbb{S}_n, s; \mathbb{T})
 \end{array} \tag{B.2}$$

Note that $j_2 : \mathbb{Z}_k \rightarrow \mathbb{T}$ is the inclusion so it is injective. Therefore, the non-triviality of f_2^k implies the non-triviality of f'_2 .

Finally, we assume that f'_2 is non-trivial and show that f_2^k is non-trivial for some $k \geq 2$. Again, the inclusion $\mathbb{Z}_k \rightarrow \mathbb{T}$ sending $[m]$ to $[m/k]$ induces the following commuting diagram:

$$\begin{array}{ccccccc}
0 & \longrightarrow & H_n(X, A) \otimes \mathbb{Z}_k & \xrightarrow{g_1^k} & H_n(X, A; \mathbb{Z}_k) & \xrightarrow{g_2^k} & \text{Tor}(H_{n-1}(X, A), \mathbb{Z}_k) \longrightarrow 0 \\
& & \downarrow i_1 & & \downarrow i_2 & & \downarrow i_3 \\
0 & \longrightarrow & H_n(X, A) \otimes \mathbb{T} & \xrightarrow{g'_1} & H_n(X, A; \mathbb{T}) & \xrightarrow{g'_2} & \text{Tor}(H_{n-1}(X, A), \mathbb{T}) \longrightarrow 0
\end{array} \tag{B.3}$$

Claim B.0.1

For every $c \in H_n(X, A; \mathbb{T})$, there exist $k \geq 2$, $d \in H_n(X, A) \otimes \mathbb{T}$ and $e \in H_n(X, A; \mathbb{Z}_k)$ such that $c = g'_1(d) + i_2(e)$.

Proof. Note that $\text{Tor}(H_{n-1}(X, A), \mathbb{T})$ is the torsion subgroup of $H_{n-1}(X, A)$. Therefore, $g'_2(c)$ is a torsion element of $H_{n-1}(X, A)$, so there exists $k \geq 2$ such that $g'_2(c) \in \text{im}(i_3)$. As g_2^k is surjective, $g'_2(c) = i_3 \circ g_2^k(e)$ for some $e \in H_n(X, A; \mathbb{Z}_k)$. One has $g'_2 \circ i_2(e) = i_3 \circ g_2^k(e) = g'_2(c)$, so $c - i_2(e) \in \ker(g'_2) = \text{im}(g'_1)$, therefore there exists $d \in H_n(X, A) \otimes \mathbb{T}$ such that $c - i_2(e) = g'_1(d)$. \square

Now assume that f'_2 is non-trivial, and let $c \in H_n(X, A; \mathbb{T})$ have a non-zero image under f'_2 . One has $c = g'_1(d) + i_2(e)$ as in Claim B.0.1, so $f'_2 \circ g'_1(d) \neq 0$ or $f'_2 \circ i_2(e) \neq 0$. If $f'_2 \circ g'_1(d) \neq 0$, then f'_1 is non-trivial by B.1 so f is non-trivial and we can apply the first argument of the proof, implying that f_2^r is non-trivial for some $r \geq 2$. If $f'_2 \circ i_2(e) \neq 0$, then f_2^k is non-trivial by B.2. \square

It can happen that the homomorphism is trivial with the coefficient group \mathbb{Z} but not with some \mathbb{Z}_k . It happens for instance if X is an n -manifold that is not orientable, with $k = 2$.