



HAL
open science

Long-term Memory of pain in Humans: a pain conditioning study in immersive Virtual Reality

Argitxu Caldichoury

► **To cite this version:**

Argitxu Caldichoury. Long-term Memory of pain in Humans: a pain conditioning study in immersive Virtual Reality. Neuroscience. Université Claude Bernard - Lyon I, 2022. English. NNT: 2022LYO10192 . tel-04341624

HAL Id: tel-04341624

<https://theses.hal.science/tel-04341624>

Submitted on 13 Dec 2023

HAL is a multi-disciplinary open access archive for the deposit and dissemination of scientific research documents, whether they are published or not. The documents may come from teaching and research institutions in France or abroad, or from public or private research centers.

L'archive ouverte pluridisciplinaire **HAL**, est destinée au dépôt et à la diffusion de documents scientifiques de niveau recherche, publiés ou non, émanant des établissements d'enseignement et de recherche français ou étrangers, des laboratoires publics ou privés.



**THESE de DOCTORAT DE
L'UNIVERSITE CLAUDE BERNARD LYON 1**

**Ecole Doctorale N° 476
Ecole Doctorale Neurosciences et Cognition**

Discipline : Neurosciences

Soutenue publiquement le 09/12/2022, par :
Argitxu CALDICHOURY

**Mémoire à long-terme de la douleur chez
l'Homme - étude sur le conditionnement
douloureux en Réalité Virtuelle Immersive**

Devant le jury composé de :

RAVEL Nadine: DR/CNRS Lyon/ UMR5292 - CRNL
JACKSON: Philip PU/ Université Laval, Québec/CIRRIS
POISBEAU: Pierrick PU/Université de Strasbourg/ UPR3212-EURIDOL
KROLAK Pierre : PUPH/ Université Lyon 1/ UMR5292-CRNL
BAUDIC Sophie : Neuropsych. HDR/CETD Hôpital Ambroise Paré/INSERM U987
GAGNEPAIN Pierre : CR/ INSERM Caen/U1077-NIMH

Présidente
Rapporteur
Rapporteur
Examinateur
Examinatrice
Invité

FROT Maud – CR/INSERM Lyon/ U1028-CRNL

Directrice de thèse

Remerciements

Mes remerciements vont à Philip Jackson et Pierrick Poisbeau d'avoir accepté d'être rapporteurs de cette thèse, puis à Nadine Ravel, Sophie Baudic et Pierre Krolak d'avoir accepté d'être membre du jury. Merci également à Pierre Gagnepain et Gaën Plancher pour avoir encadré mon Comité de Suivi de Thèse et pour vos précieux conseils.

Je souhaite remercier chaleureusement toutes les personnes qui m'ont accompagné durant ces années de thèse, sans qui ce travail n'aurait pu être réalisé.

Je remercie l'ensemble de l'équipe NEUROPAIN, en particulier sa qualité d'entraide et de soutien. L'ambiance chaleureuse qui règne au sein de l'équipe m'a permis de traverser les périodes les plus laborieuses de ces dernières années, autant sur le plan professionnel que personnel.

Je remercie tout d'abord Maud Frot, ma directrice de thèse, d'avoir eu confiance en moi et en mes capacités pour m'accorder ce projet de recherche. Merci de m'avoir encadré, conseillé et soutenu tout le long de cette thèse, malgré les périodes difficiles. Grâce à ta rigueur intellectuelle, ton enseignement et ta bienveillance, j'ai pu mener ce travail le plus loin possible.

Je remercie Luis Garcia-Larrea, directeur du laboratoire, qui a suivi l'avancée de mon travail tout le long de ces années. Merci pour ta disponibilité, ton enthousiasme et la qualité de tes réflexions et précieux conseils que tu m'as accordé.

Je remercie Caroline Perchet, pour ta bienveillance, ton écoute, tes conseils, ta disponibilité, ton humour et surtout pour ton soutien chaleureux qui m'a été indispensable durant ces années de thèse.

Merci à Juliette Gélebart et Siloé Corvin, aussi connues sous le nom de *brigade de la rédaction*. Merci pour ces moments partagés, ces fous rires, ces discussions dans notre petit bureau, mais aussi votre soutien professionnel et personnel, tout aussi précieux.

Merci à Hélène Bastuji, Isabelle Faillenot et Amandine Rey pour votre aide et remarques constructives.

Je souhaite également remercier Kasia Pisanski, du laboratoire ENES à Saint-Etienne, et Amandine Rey qui m'ont grandement aidé lors de la mise en place de mon protocole.

Un grand merci à celles et ceux qui ont participé à mon expérience, sans qui il n'y aurait pas de recherche.

Enfin, je souhaiterais sincèrement remercier ma famille et mes amis, pour leur soutien chaleureux ainsi que leurs encouragements permanents. On ne peut réussir que si on est bien entouré. Je remercie du fond du cœur Erick, qui m'a soutenu, redressé et même parfois supporté durant ces trois dernières années malgré des

moments compliqués, des humeurs parfois indescriptibles et des plaintes sans remède. Sans toi, je ne serais pas allée jusqu'au bout. *Danke – Milesker- an meine Eltern, die mich während meines Studiums unterstützt und begleitet haben und versucht haben, einige Entscheidungen zu verstehen.* Merci à mes frères et sœurs , Kattalin – pour avoir été un soutien indispensable- puis Gaxuxa, Iñaki et Ramuntxo de tout simplement être qui vous êtes.

Long-term Memory of pain in Humans- a pain conditioning study in immersive Virtual Reality

NEUROPAIN Lab.

Central integration of pain in Humans

Neuroscience Research Center of Lyon (U1028, CRNL)

Hospital of Neurology - Pierre Wertheimer

59 Boulevard Pinel,

69500 BRON

Abstract

The experience of pain, most often lived as a traumatic incidence, can be memorized as such, thus favour potential chronicity of pain and influence the way future pain is perceived. In line with how a traumatic experience is memorized in association with its related environmental and emotional context, similar mechanisms may well appear in the case of pain. However, few studies focus on understanding the underlying mechanisms of long-term memorization (LTM) of pain.

The first preliminary study of this PhD serves as introduction to investigate *explicit memorization* of pain, by focusing on short-term memory (STM) mechanisms using high-density electroencephalography (EEG). STM of a nociceptive stimulus was characterized by a focal alpha-activity enhancement, which progressed from bilateral occipital regions (cuneus and mid-occipital gyri) toward the right-superior and right mid-temporal gyri during the memorization phase. These results suggest that alpha oscillations, while indicating local inhibitory processes, can also indirectly reveal active stimulus-handling, including maintenance in short-term memory buffers, by objectivizing the filtering out of irrelevant and potentially disrupting inputs in brain regions engaged in internally-driven operations.

The second and main study focuses on *implicit memorization* of pain: it aims to investigate how a contextually induced aversive stimulus (painful and non-painful) can modulate both the perception and the implicit content-memorization of its associated environment. A contextual aversive conditioning protocol was created by means of an “ecological” environment modelled in immersive Virtual Reality. The environment was a three-room apartment (kitchen, living-room, bathroom) each associated to a specific stimulus: either painful, an electrical tonic stimulation induced on the left-hand; non-painful, a set of aversive noises; or no stimulation, serving as control. Fifty-nine healthy volunteers have undergone the conditioning protocol: immersed subjects entered ten times each room in random order, during which the different stimuli were induced in their attributed context. Assessment of the environment’s perception was focused on valence attribution to each room using the self-assessment manikin scale. Implicit content-memorization was evaluated using a blurred picture paradigm (object-identification reaction time). Both evaluations were conducted at four time-points: pre-conditioning (valence only), post-conditioning, the next day and two weeks after. Behavioural results revealed that both aversive conditionings resulted in a valence decrease, in particular for the pain-conditioning-environment, which remained significant at long-term. Reaction time analysis showed a gender effect at every time-point: women identified pain-related-objects significantly faster than men, which translated in a quicker identification of the latter compared to non-painful- and control- associated objects exclusively for women. This suggests that overall aversiveness, specifically physical pain, can modulate at long-term the remembered perception of the context in which it was induced as well as the implicit memory of said context’s content.

Key words: implicit long-term memory, pain, aversive contextual conditioning, short-term memorization, context perception, valence, immersive Virtual Reality, high-density EEG

Résumé

La douleur, pouvant être vécue et mémorisée comme un événement traumatique, peut influencer les douleurs futures ainsi que favoriser le développement d'une douleur chronique. Au même titre qu'il existe dans la mémorisation d'un événement traumatique des associations fortes avec la mémorisation du contexte et les émotions associées à l'évènement, des mécanismes similaires sont susceptibles de survenir pour la douleur. Pourtant, peu d'études se focalisent sur la compréhension des mécanismes sous-tendant la mémorisation à long-terme de la douleur.

La première étude préliminaire de ce projet de thèse vise à introduire la *mémorisation explicite* de la douleur, en se focalisant sur les processus de la mémoire à court-terme de la douleur par le biais d'électroencéphalographie (EEG) à haute densité. La mémoire à court-terme d'un stimulus nociceptif est associée à une augmentation focale des oscillations alpha, qui progressent de régions bilatérales occipitales (cuneus et gyrus occipital médian) vers les gyri supérieur droit et temporal médian pendant la phase de mémorisation. Ces résultats suggèrent que les oscillations alpha, bien qu'indicatrices de processus inhibiteurs, peuvent également refléter indirectement un traitement actif du stimulus, tel que le maintien temporaire des informations en mémoire, tout en filtrant celles qui sont non-pertinentes ou perturbatrices des régions cérébrales engagées dans des processus internes.

La seconde et principale étude de cette thèse se concentre sur la *mémoire implicite* associée à la douleur : elle vise à étudier comment un conditionnement contextuel aversif (douloureux et non-douloureux) peut moduler la perception de l'environnement conditionné ainsi que la mémoire implicite de son contenu. Un protocole de conditionnement contextuel aversif a été réalisé avec un environnement « écologique » modélisé en Réalité Virtuelle immersive. L'environnement est un appartement à 3 pièces (cuisine, salle-de-bain et salon), chacune étant associée à un stimulus spécifique : (i) douloureux, une stimulation électrique et tonique induite sur la main gauche ; (ii) non-douloureuse, des sons aversifs ; ou (iii) pas de stimulation, servant de contrôle. Cinquante-neuf sujets sains ont participé au protocole de conditionnement : les sujets immergés devaient entrer dix fois dans chacune des pièces, durant lesquels les différentes stimulations étaient délivrées en fonction de leur pièce attribuée. L'évaluation de la perception de l'environnement a été focalisée sur la valence attribuée à chaque pièce (mesurée avec l'échelle du *Self-Assessment Manikin*). La mémoire implicite du contenu de l'environnement a été mesurée avec un paradigme d'images floutées (temps de réaction d'identification d'objets). Ces mesures ont été faites à plusieurs instants : pré-conditionnement (valence uniquement), post-conditionnement, le jour-suivant et deux semaines plus tard. Les résultats comportementaux ont montré que les deux types de conditionnement aversif ont provoqué une diminution de la valence de la pièce associée, en particulier pour la condition douleur, jusqu'à deux semaines post-conditionnement. L'analyse des temps de réaction a révélé un effet genre à chaque instant de mesure : les femmes ont identifié plus rapidement les objets de la pièce douleur comparées aux hommes, ce qui s'est traduit en un temps de réaction significativement plus bas pour les objets de la pièce douleur comparé à celui des objets des pièces non-douleur et contrôle

exclusivement chez les femmes. Ces résultats suggèrent que l'aversion, en particulier la douleur, peut moduler à long-terme la perception du contexte associé ainsi que la mémoire implicite de son contenu.

Mots-clefs: mémoire implicite à long-terme, douleur, conditionnement contextuel aversif, mémoire à court-terme, perception du contexte, valence, réalité virtuelle immersive, EEG à haute-densité.

Content

THEORETICAL PART

❖ THE PAIN EXPERIENCE

1. NEUROPHYSIOLOGY OF PAIN	
1.1. Ascending pathways	17
1.2. Cortical integration of pain	20
2. CONTEXT AND MEMORY IN PAIN	
2.1. Pain and the context	22
2.2. Pain and memory	23
2.3. Implications for Chronic Pain	25

❖ CONDITIONING MECHANISMS

1. CLASSICAL CONDITIONING	
1.1. Definitions	27
1.2. Conditioning Procedure	27
1.3. Main concepts of fear conditioning	30
1.4. Clinical Implications	39
2. PAIN CONDITIONING	
2.1. Pain-related fear conditioning in Chronic Pain	40
2.2. Experimental models	41
2.3. Neural mechanisms	44
2.4. The importance of context	45

❖ PHD PROJECT

EXPERIMENTAL PART

❖ STUDY I

SHORT-TERM MEMORIZATION OF PAIN *Submitted paper*

1. Introduction	50
2. Methods	52
3. Results	58
4. Discussion	64

❖ STUDY II

CHAPTER 1: Building a contextual aversive conditioning protocol in iVR

Part A: Conception of a 3-roomed apartment in iVR

1. Introduction	72
2. Methods	74
3. iVR testing	93
4. Summary	95

Part B: Contextual aversive conditioning protocol design in Humans

1. Introduction	98
2. Methods	100
3. Summary	110

CHAPTER 2: Behavioral and physiological analysis of contextual aversive conditioning	
Part A: Validation of the contextual conditioning protocol in iVR.	
1. Introduction	114
2. Data analysis	116
3. Results	125
4. Summary and discussion	131
Part B: Behavioral mnemonic mechanisms underlying aversive contextual conditioning	
1. Introduction	134
2. Data analysis	136
3. Results	139
4. Discussion	154
GENERAL CONCLUSION	162
REFERENCES	165
APPENDI	188

Figures and Tables Index

THEORETICAL PART

❖ THE PAIN EXPERIENCE

Figure 1 Pain Fibers (*Huether 2019*)

Figure 2 Functional organization of nociceptive pathways (*adapted from Peyron 2007*)

Figure 3 A. The pain matrix (*adapted from Xiong et al. 2022*)

B. Onset activation latencies (*Bastuji et al. 2016*)

Figure 4 A model regarding brain circuitry involved in the transition from acute to chronic pain (*Apkarian et al. 2010*).

❖ CONDITIONING MECHANISMS

Figure 1 Pavlov's classical conditioning experiment

Figure 2 Acquisition of conditioned response

Figure 3 Basic fear conditioning circuitry (*adapted from Cushman 2010*)

Figure 4 Extinction of conditioned response

Figure 5 Neural circuits mediating Pavlovian fear conditioning, extinction retrieval, and renewal (*adapted from Bouton et al. 2021*)

Figure 6 Generalization of conditioned response

Figure 7 The continuous pain learning circuit in chronic pain.

Figure 8 From Fear avoidance model of chronic pain (*Meulders 2020*)

EXPERIMENTAL PART

❖ STUDY I

Figure 1 Experimental protocol:

Figure 2 Temporal segments analysis

Figure 3 A. Average ratings of low (1) and high (2) intensities

B. Number of subjects per interval of correct answer percentages

C. Percentage of correct answers

Figure 4 Mean alpha power (μV^2) for the painful (SP) and the non-painful (SNP) conditions

Figure 5 A. Spectral graphs between 0 and 25 Hz for the painful (SP) and the non-painful (SNP) conditions

B. Observational analysis per electrode

C. Mean alpha power (μV^2)

Figure 6 Current density increase in the lower alpha frequency band during memorization of a painful stimulus vs. during control task.

Table 1 ROIs defined by selection of electrode clusters

Table 2 MNI coordinates of each cluster's most significant voxel

❖ STUDY II

CHAPTER 1:

Part A:

Figure 1 Virtual environment

Figure 2 Working tool windows in Unity

Figure 3 Real vs Virtual positioning on

Figure 4 Programmed timeline of the avatar's movement

Figure 5 Illustration of the Search task

Figure 6 Main Menu interface

Figure 7 Immersion evaluation mean scores

Table 1 List of furniture
Table 3 List of 153 objects modeled in Blender ®
Table 3 Mean BOSS norms

Part B:

Figure 1 Electro-stimulation glove,
Figure 2 Self-Assessment Manikin
Figure 3 Sound parameters correlations
Figure 4 Example of subject installation
Figure 5 Behavioral testing sequence
Figure 6 Experimental protocol timeline

Table 1 Mixed soundtracks parameters

CHAPTER 2:

Part A:

Figure 1 Event log representation and data segmenting
Figure 2 Example of Data segmentation and exportation
Figure 3 Example of Baseline segments creation.
Figure 4 Example of averaged SSR segment division
Figure 5 Mean unpleasantness ratings
Figure 6 Environment perception
Figure 7 Example of one subject's mean SSR
Figure 8 Mean SSR peak-to-peak amplitude (Max-Min) (μV)
Figure 9 SSR peak-to-peak amplitude (μV) during the extinction phase

Table 1 Coding scheme- The Observer
Table 2 Detailed results of Post-hoc tests

Part B:

Figure 1 A. Pain intensity ratings
Figure 2 Pain ratings positive correlations
Figure 3 Valence perception at various time-points:
Figure 4 Valence perception at various time-points A
Figure 5 Emotional Impact assessment
Figure 6 A. Global performance and B. Identification Reaction Time
Figure 7 Mean object Identification time for

Table 1 Measurement Timepoints for Behavioral tests
Table 2 Mean Anxiety levels (IASTA, State Y-1 and Trait Y-2).
Table 3 Statistical results of post-hoc t-test
Table 4 Statistical results of post-hoc t-test

THEORETICAL PART

General Introduction

Pain – while preferably avoided - is a vital process serving as personal alarm for when something goes wrong in our bodies. The most recent definition of pain established by the International Association of the Study of Pain (IASP) implies that pain is “*an unpleasant sensory and emotional experience associated with, or resembling that associated with, actual or potential tissue damage,*”. Hence the pain experience comprises both a physiological (sensory) and a subjective (affective and psychological) component. Importantly, the context in which pain is experienced (e.g. emotional, environmental and socio-cultural) plays an important role in both the perception of pain and its long-term inscription into conscious and unconscious memory. Specifically, pain is a highly salient and emotional stimulus that facilitates unconscious associative learning, that is, learning that specific stimulations can lead to body harm or injury. This feature of pain is essential for survival purposes and avoidance of danger; as the saying “*one only burns their finger once*” is quite accurate (Apkarian et al. 2009).

❖ *But what happens when the alarm never goes off?*



In the case of a negative or traumatic context, memorization of a painful experience in association with a specific context can alter future pain perceptions and facilitate chronic pain (CP) development. CP is defined as pain that persists for more than 12 weeks over normal healing time (Treede et al. 2019). As pain is consistently present, continuous aversive associations are made with daily contextual events. The latter results into behavioral and physiological conditioned fear responses towards pain – called **pain-related fear conditioning**. Excessive learning of fear leads to maladaptive behaviors such as avoidance and increased anxiety which

consequently decreases the individual’s daily activities and overall quality of life. Thus, investigating the relationship between pain, context and memory along with associated mechanisms is essential to better understand processes underlying chronic pain.

The following introduction to the PhD project will be divided into two main sections: 1. The pain experience: this part will briefly describe the neurophysiology of pain followed by the importance of context and memory in the perception of pain. 2. Conditioning mechanisms: including classical fear conditioning mechanisms and pain conditioning research standpoint.

The Pain experience

1. Neurophysiology of pain

Nociception is defined as the mechanisms by which a noxious stimulus-signal is transmitted from the location of injury to the brain. Ascending pathways and cortical integration of nociception will be briefly described here on.

1.1. Ascending pathways of nociception

From injury to nociceptors: The painful experience starts at the peripheral terminals of primary afferent fibers, where pain receptors, also called nociceptors, are located (Basbaum and Jessell 2000). Nociceptors, present throughout the body except for brain tissue, selectively respond to different chemical, mechanical and thermal stimuli, by inducing action potentials in neurons, for which cellular substance is found in the spinal ganglion located in the dorsal root of the spinal cord. In other words, the first step, called transduction, refers to when the initial chemical signal of an injury is transformed into an electric signal to be further transmitted. Types of nociceptors include: (i) receptors of mechanical noxious stimuli only, (ii) receptors of both mechanical and thermal noxious stimuli (above $\sim 45^{\circ}\text{C}$, under $\sim 15^{\circ}\text{C}$), (iii) polymodal receptors, responding to variety of noxious stimuli modalities and (iv) silent receptors, only responding to onset of inflammation.

From nociceptors to the spinal cord: Action potentials of mechanical only- and mechanical/thermal- stimuli responding nociceptors are generated in afferent nerve fibers called $A\delta$ fibers. These fibers transmit “fast” nociceptive signals to the spinal cord (slightly myelinated, conduction velocity: 5 to 30m/s). Activation of $A\delta$ fibers results in acute and localized pain (e.g. *brief stinging sensation caused by a drop of boiling water*), e.g. primary ‘rapid pain’. Action potentials of polymodal and silent nociceptors are generated in C nerve fibers. These fibers transmit “slow” nociceptive signals (unmyelinated, conduction velocity: 0.5 to 2.0 m/s) (Peyron 2007). Activation of C fibers results in delayed perception of pain, diffused and longer-lasting (e.g. *lasting burning sensation*), e.g. secondary ‘slow pain’. $A\delta$ and C fibers primary afferent signals reach the spinal cord through Rexed laminae I, II and V of the dorsal horn (Figure 1) (Dinikar and Stillman 2016, Basbaum et al. 2009) and translate the nociceptive information to relay nociceptive cells. Relay cells of the spinal cord are either (i) nociception-specific, mainly located in the laminae I and activated only in the case of noxious mechanical and thermal stimuli or (ii) non-nociception specific, mainly located in the laminae V, and activated for both noxious and non-noxious mechanical and thermal stimuli, called wide dynamic range (WDR) neurons. From here, these cells communicate the nociceptive input to higher centers in the brain through various ascending pathways.

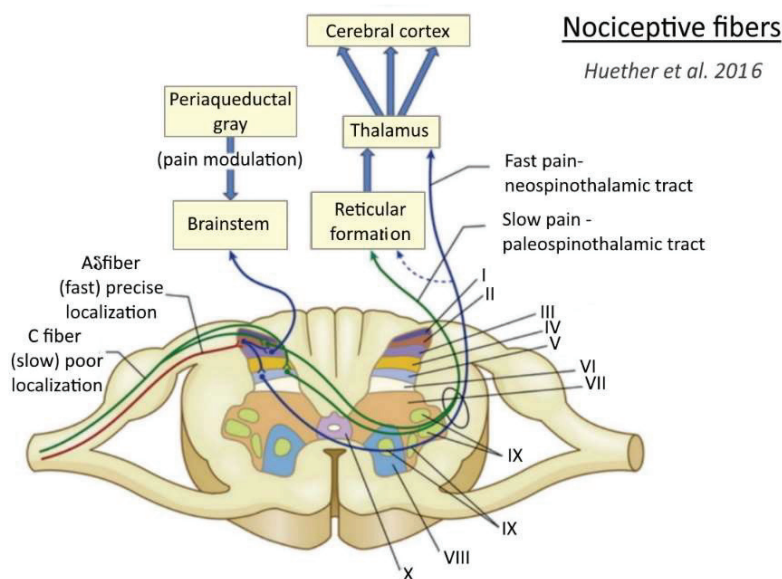

Figure 1 Pain Fibers that terminate primarily in laminae II and V of the dorsal horn. The myelinated A δ fibers (fast localized pain) synapse on a second set of neurons that carry the signal to the thalamus via the neospinothalamic tracts. The C fibers (slow pain) synapse on laminae II and V interneurons that connect with neurons in laminae II, IV, and V and carry the pain signal to the reticular formation and midbrain via the paleospinothalamic tract. The axons of the spinothalamic tracts cross over the spinal cord to ascend in the anterior and lateral spinal cord white matter. (figure and title from : Huether et al., 2016)

From the dorsal horn to the thalamus: There are three main nociceptive pathways from the spinal cord to the brain (Millan 1999) (Figure 2):

1. The spino-thalamic tract comprises axons from both nociceptive-specific and WDR neurons from laminae I, IV and VIII. These axons take the anterolateral path of the spinal cord to reach the ventrolateral section of the medulla-white substance, and finally project onto either the lateral or median thalamic nucleus. This tract conducts somatotopic information and is involved in sensory-discriminative and emotional aspects of pain.
2. The spino-reticulo-thalamic tract comprises primarily axons from nociceptive-specific neurons from laminae VII and VIII which project onto the reticular formation and the median thalamus. Spino-reticular projections are non-somatotopic and serve as nociception signal alert to the central nervous system.
3. The spino-mesencephalic tract comprises axons from neurons of laminae I and V and projects onto the mesencephalic reticular substance and periaqueductal gray (PAG). This relay is said to play a role in the affective component of pain. (Peyron 2007).

Median System

Frontal Cortex
Cingulate Cortex
Insula
Limbic Cortex
Striatum
LC, MC and
intralaminar nucleus
(Paleo)-Spino-reticular-
thalamic and paleo-
spino-thalamic pathway

Slow conduction
Dull pain
Poor systemization
Non-discriminative
Affective and emotional
component
Awake and defense
Opiate receptors +++

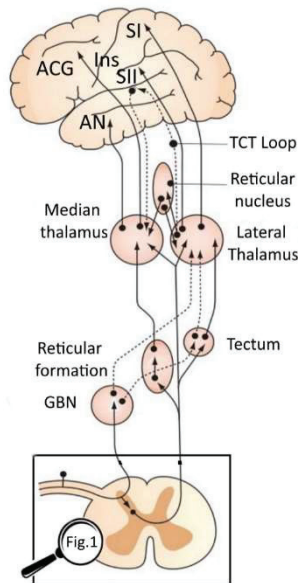

Lateral System

Parietal Cortex (SI, SII)
Insula
VPL
Neo-spino-thalamic pathway

Rapid conductor
Acute pain
Discriminative
Qualitative analysis of
noxious stimulus
(topographie, duration
nature)
Opiate receptors +

Nociceptive pathways

Peyron 2007

Figure 2 Functional organization of nociceptive pathways (adapted and translated from Peyron 2007). The nociceptive system can be divided into two parallel systems, lateral and median. The lateral system, which has a discriminative function, projects onto the primary and secondary somatosensory cortex (SI, SII), and onto the Insula (Ins), whereas the median system establishes projections onto the anterior cingulate cortex (ACG) and the amygdala (AN: Amygdala nucleus)

From the thalamus to the cortex: The thalamus serves as gate between nociceptive pathways and the cortex (Figure 1B). The **median thalamic** nucleus (comprised of the centrolateral nucleus and intralaminar complex) integrates information of the spinothalamic and spinoreticular tracts. Median thalamic neurons relay the nociceptive input onto various cortical regions that process the information, including: precentral, cingulate and prefrontal cortex, cerebellum, striatum, hypothalamus and the limbic system (Peyron 2007). These projections are not sensory-discriminative, rather serve to **encode motivational and affective aspects of pain** as well as defensive motor-responses and awake-related attention (review Apkarian and Hodge 1989).

The **lateral thalamic** nucleus (comprised of the ventral posterolateral (VPL) nucleus, ventral posteromedian (VPM) nucleus and ventral posteroinferior (VPI) nucleus, anterior pulvinar (PuA) and supragenulate (Sg) nucleus) receives information of the spino-thalamic pathway. Associated neurons receptors are primarily limited to transfer localization, type and intensity information of the nociceptive input. Further projections onto the cortex include: the primary and secondary somato-sensory cortex (S1 and S2) and the posterior insula (PI)-areas involved in processing **specific sensory-discriminative features** of the noxious stimulus (Craig 2014)-and the ventromedial posterior nucleus (VPMo) which projects onto the posterior insula (PI) - specific for the discriminatory analysis of cold sensations, including noxious cold (Craig 1995).

In sum, two parallel nociceptive pathways to the thalamus are identifiable: the median system – involved in the sensory-discriminative aspect of pain- and the lateral system – involved in the affective, motivational and cognitive aspects of pain. The nociceptive information transferred from the spinothalamic tracts onto numerous cortical and sub-cortical areas leads to an orchestra of coordinated cortical-activations, eventually resulting in pain (Garcia-Larrea and Peyron 2013).

1.2. Cortical integration of pain

Cortical integration of pain is spread across a wide ensemble of regions called the *pain matrix* (Figure 3) (Garcia-Larrea and Peyron 2013).

First order matrix: The spino-thalamic projections target a primary set of cortical regions including the posterior insula (PI) (~40%), medial parietal operculum (~30%) and mid-cingulate cortex (MCC) (~24%) (Figure 2A) (Dum et al. 2009). The PI and inner operculum are exclusive regions for which stimulation generates acute pain (Mazzola et al. 2012). These regions constitute *the nociceptive matrix* and receive early nociceptive information no later than 120 ms after noxious stimulus (Figure 3B; Bastuji et al. 2016). Parallel motor (SMA) and limbic (amygdala) regions are simultaneously activated. Activation of this ensemble has been shown to persist in coma state or sleep (Bastuji et al. 2012) and prior motor reactions, thus highlighting a preconscious network serving as gateway for further processing. Though the nociceptive matrix is essential to induce physiological pain, further cortical networks are needed to integrate the fully conscious experience of pain along with its cognitive and attentional modulation impact.

Second order matrix: A second set of cortical regions are generally activated around 140 ms after noxious stimuli (Figure 3B; Bastuji et al. 2016). These include the anterior insula (AI), the anterior cingulate cortex (ACC), the dorsolateral prefrontal cortex (dlPFC), the orbitofrontal cortex, the precuneus and frontal operculum. Multimodal integration of the nociceptive input to this network allows conscious access to pain (Bastuji et al. 2016, Frot et al. 2003, Peyron et al. 2000). This ensemble does not receive direct projections from the thalamic tracts, rather their input to the pain matrix depends on the context in which the stimulus is induced. Regions of this network are non-specific to noxious input. For instance, the AI has been reported as associated with cardiovascular functions and respiration (Henderson et al. 2002), touch (Lindgren et al. 2012), disgust (Calder et al. 2007), interoceptive awareness and general emotional processing (Zaki et al. 2012). Its contribution to the second-order pain matrix is (i) first to integrate output of the PI (nociceptive information) (Frot et al. 2014) ,(ii) secondly to moderate vegetative responses to nociception (e.g. heart rate, respiration and skin conductance) and, along with prefrontal and posterior parietal areas, sustain attentional and evaluative processes of anticipation, learning and cognitive control (Apkarian et al. 2005). The AI and ACC conjointly activate in a salience network for behaviorally-relevant stimuli (non-noxious specific), hence participate in perceptual decision making (Wiech et al. 2010). Altogether, this second network is labeled as *the perceptive-attentional matrix*, and enables conscious perception and emotional processing of pain.

Third order matrix: The pain awareness originated from the nociceptive and perceptive-attentional matrices can be modulated by a third group of cortical areas that integrate one's inner state, expectancies and emotions (Wiech 2016, Wager and Atlas 2015, Godinho et al. 2012). This third network of regions mostly activated between 150 and 180ms post-noxious stimulus comprises higher order polymodal areas including: anterolateral prefrontal and orbitofrontal areas, the perigenual cingulate, as well as limbic areas (e.g. hippocampus) (Figure 3B, Bastuji et al. 2016). Several areas of this network (e.g. perigenual cingulate and orbitofrontal cortices) are

strongly connected with subcortical regions of descending pathways of pain control (e.g. the periaqueductal gray, PAG), possibly indicating a monitoring loop with ascending nociceptive pathways, and consequently ascending cortical input (Garcia-Larrea and Peyron 2013). Altogether, this third order network, called *the reappraisal matrix*, enables reappraisal of pain according to its associated context and emotional implication.

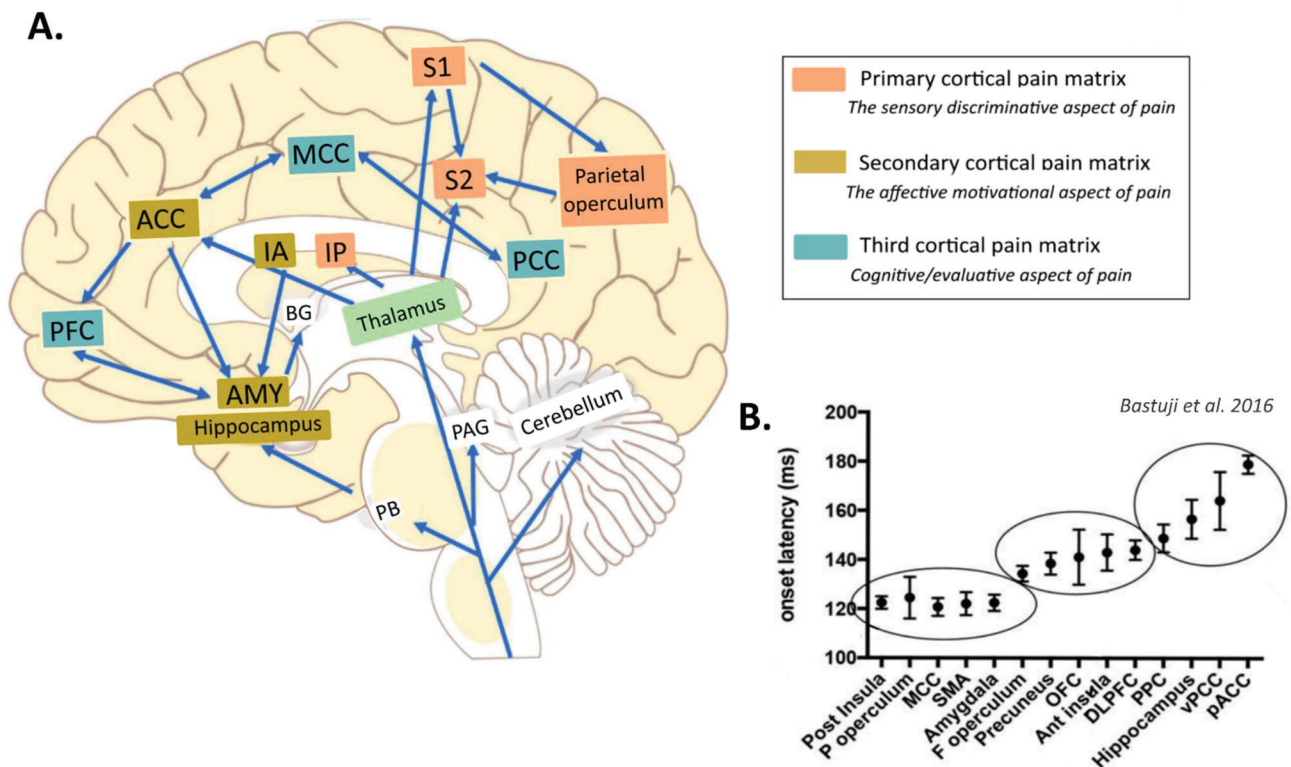

Figure 3 A. The pain matrix. ACC: anterior cingulate cortex; PFC: prefrontal cortex; AMY: amygdala; PAG: periaqueductal gray; IA anterior insula; IP: posterior insula S1/S2: primary and secondary somatosensory cortex; MCC: medial cingulate cortex; PCC: posterior cingulate cortex; PB: parabrachial nucleus (adapted from Xiong et al. 2022) **B. Onset activation latencies** of regions of the pain matrix. SMA: Supplementary Motor Area, OFC: Orbito-Frontal cortex, PPC: Posterior parietal cortex (Bastuji et al. 2016).

The pain experience: In conclusion, the pain experience (e.g. *the experience to be remembered*) is the interaction of 3 cortical networks -labeled as nociceptive, perceptive-attentional and reappraisal-emotional (Garcia-Larrea and Peyron 2013)-, progressively guiding nociception from an objective sensory experience to a further emotional- and inner-state dependent subjective process (Craig 2009). Reappraisal of pain regulates instant perception, moderated to either built up or play down according to the current inner **emotional status** and **past experiences of pain**, leading up to a personal pain experience logged in long-term memory (Garcia-Larrea and Peyron 2013). In this next part, the role of the pain-associated **context** and **memory** on pain modulation will be shortly discussed.

2. Importance of context and memory in pain

2.1. Pain and context

Clinical and non-clinical research has disclosed that altogether sensory, cognitive and emotional processes possibly acting on pain awareness, appraisal and interpretation derive from the immediate environmental and emotional context of the painful experience (Di Blasi et al. 2001, Carlino et al. 2014). Contextual factors including healthcare settings, but also personal meaning attributed to psychosocial context are known to influence pain perception (Rossetini et al. 2018, Coan and Schaefer 2006). These can either induce a *placebo* effect- positive context- (Benedetti 2008, Benedetti et al. 2013) or a *nocebo* effect - negative context (Wells and Kaptchuk 2012, Holloway et al. 2013, Karos et al. 2015). For instance, it has been posited that the placebo response observed in therapeutic settings relies on several sensory and social stimuli, including patient-doctor interactions, treatment facilities (e.g. the hospital) and letting the patient believe that treatment has been performed. The placebo effect is said to rely on two parallel processes: (i) a conscious process of optimistic expectation, where positive contextual elements that predict improvement can reduce anxiety levels and even activate reward-systems; and (ii) an unconscious process that relies on classical conditioning mechanisms or associative learning (*for more insight click on [Conditioning mechanisms](#)*) – for instance, learning that ingesting a treatment pill induces pain relief can lead to conditioned learning that any resembling pill (regardless of its content) results in pain-relief, e.g. conditioned placebo response (Benedetti 2008, Benedetti et al. 2013). Inversely, negative diagnoses and prognoses have shown to magnify pain intensity, and deteriorate patients' emotional state (Wells and Kaptchuk 2012). Interestingly, neuroimaging research has highlighted brain activity increases correlated with negative expectations of pain, including the PFC, ACC and insula- paralleled with exacerbated perception of pain (Sawamoto et al. 2000, Porro et al. 2002, Kong et al. 2008). Along these lines, a study on healthy subjects highlighted the effect of a negative context on pain-related fear: Karos and colleagues (2015) manipulated the social context during a pain-related fear conditioning paradigm, using pictures of angry (e.g. threatening) versus happy (e.g. safe) faces presented concurrently with a painful electric stimulus. Results revealed that a threatening context enhanced pain expectancy and pain-related behavioral and physiological fear compared to the safe condition.

Importantly, not only does the context impact current pain perception, but it is also suggested that the context in which pain is memorized influences future pain perception and its potential chronicity development (Apkarian et al. 2009). Remembering pain implies remembering its associated emotional and environmental context, thus pain intensity recollection depends strongly on the affective attribute of the context (Christiansen et al. 2002, Babel et al. 2018, McNeil et al. 2011) , see Study II- Chp 2- Part B- [Introduction](#).

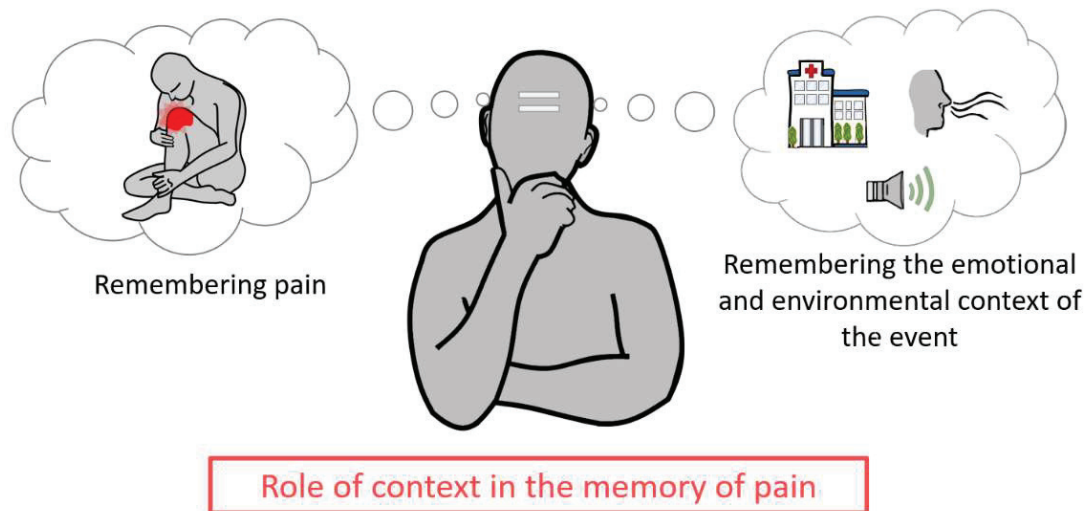

Illustration of the role of context in the memory of pain.

Altogether these findings stress the importance of the affective and environmental context of the pain experience, both for its instant perception and memory. In the following section the interaction between pain and memory will be presented.

2.2. Pain and memory

There is extensive evidence of neuroanatomic and mechanical overlap between pain and memory. For instance, the amygdala, hippocampus, prefrontal and anterior cortex are essential for mnemonic encoding and consolidation, including emotional aspects, as well as involved in the cortical network of experiential pain. Anatomical and mechanical similarities promote the hypothesis that pain and memory do not exist in isolation but rather thoroughly interact on several levels (McCarberg and Peppin 2019).

2.2.1. Definitions

In brief, the mnemonic system is defined as a sequential storing process essential for information flow from the environment into a short-term memory (STM) buffer, that later builds into a long-term memory (LTM) (Baddeley 2010, Khera and Rangasamy 2021). Encoding of environmental cues is a crucial step to gate memory formation, as initial attention towards an event -partially regulated by the prefrontal lobe and thalamus - intensifies neuron firing (Nadel 2011, Jin and Maren 2015). Attention is enhanced through emotional significance of the experience, and processed automatically in the amygdala, which is also considered a central hub for synaptic plasticity associated with fear learning (Blair et al. 2000). Multimodal sensory input is then translated in various cortical areas set to bind in the hippocampus. The amygdala and hippocampus coherently

interact to create long-term memories of emotional events (Richter-Levin 2004, 2000). As pain is defined as a highly salient and emotional stimulus, it is capable of strong inscription into long-term memory. Explicit and implicit memories are defined in the context of pain:

Explicit memory of pain: Explicit memory or declarative memory, is the conscious recollection of factual or learned information (e.g. semantic memory, acquired knowledge) as well as past life-events (e.g. episodic memory) (McCarberg and Peppin, 2019). It comprises both short-term and long-term explicit memory (Khoshnejad et al. 2017, Upadhyay et al. 2016).

STM of pain and underlying mechanisms are yet poorly understood. It is characterized by a rapid decline in performance, and it lasts around 4 to 14 seconds-long post painful stimulus delivery (Rainville et al. 2005). Several studies in functional imagery have shown that STM of pain neural activations involve regions required for cortical integration of pain (see part 1.1.2.), including the anterior insula, primary somato-sensory cortex and prefrontal cortex (Fairhurst et al. 2012, Khoshnejad et al. 2017). A scalp EEG study further revealed oscillatory activity in the parietal lobe during STM of pain (Wang et al. 2016). Although understanding STM processes is key to further access to LTM mechanisms of pain, experimental studies on this topic are scarce.

The first study of this PhD project (*click for access:* [STUDY I](#)) serves as introductory research on explicit memory of pain, exploring oscillatory neural correlates of short-term memorization of pain – using high density EEG.

For explicit LTM of pain, accuracy of the experience recollection is quite variable upon research studies (review, Erskine 1990), as it greatly depends on several factors: (i) the emotional context (Babel 2017) (see Study II- Chp 2- Part B- [Introduction](#)), (ii) an individual's mood and personality trait (Rocha et al. 2009) and (iii) previous experiences with pain (Salovey and Smith, 1997). For instance, CP patients frequently show signs of psychological comorbidities and mood disturbances, known to influence pain memory: high emotional distress, symptoms of depression and perseverance of negative affective-state can induce overestimation of recalled pain in individuals suffering from various CP conditions (Lefebvre and Keefe 2013, Bryant 1993). In regards to the influence of pain experiences, several studies presume that singular acute and novel pain correlates with greater accurateness of pain intensity recollection in contrast to chronic pain, for which repeated painful episodes lead to memory distortion (Roche and Gijbers 1986, Salovey and Smith 1997). In keeping with Brewer (1988) research on autobiographical memory, events comprising strong 'cue distinctiveness' -including newness- are the best predictors of later memory.

Implicit memory of pain: Implicit memory, non-declarative, refers to unconscious and unintentional memories that occur automatically (e.g. associative and non-associative learning, Orsini and Maren 2012). It is well-known that long-term memorization of pain can be both explicit and implicit as research has evidenced that individuals having no conscious recollection of painful experiences nevertheless presented life-long behavioral and physiological alterations in regards to pain (Grunau et al. 2006, Knaepen et al. 2012). Implicit memory for pain is highly reflected through autonomic associative learning, that is learning that a specific stimulus can lead to pain. The phrase *"one only burns the finger once"* perfectly illustrates that pain can trigger instantaneous learning which promotes life-long survival adaptations (Apkarian et al. 2009). Associative learning of pain is reflected through **classical conditioning mechanisms**, presented in the following section (*click for access: [Conditioning mechanisms](#)*).

The second and main study of this PhD project focuses on understanding behavioral mechanisms of contextual aversive (painful and non-painful) conditioning using immersive Virtual Reality (*click for access: [STUDY II](#)*).

2.3. Implications for Chronic pain

Clinical research has widely highlighted morphological and functional brain alterations in various types of chronic pain (CP) -e.g. low back pain, irritable bowel syndrome (IBS), fibromyalgia, complex regional pain syndrome (CRPS), knee osteoarthritis, migraine (Huang et al. 2019, Blankstein et al. 2010, Barroso et al. 2020, Parks et al. 2011, Kim et al. 2008) including in regions involved in memory processes. The role of the emotional limbic system in the transition from nociception to pain and from acute to chronic pain has been increasingly supported. The meso-corticolimbic circuit – primarily involving the prefrontal cortex, nucleus accumbens, amygdala and hippocampus- is suggested to be involved in the development, strengthening and persistence of chronic pain along with its affective component (Figure 4) (Neugebauer et al. 2003, 2009, Neugebauer 2015, Baliki et al. 2010, Apkarian 2004, Mutso et al. 2012). For instance, preclinical studies have demonstrated that increased neuronal activity and lack of inhibitory control in the amygdala contributes to the abnormal persistence of emotional states in CP (Apkarian et al. 2013, 2010). Chronic pain has also been characterized by a grey matter volume decrease in the medial prefrontal cortex (mPFC)(Kang et al. 2019), which has been correlated with increased anxiety-like behaviors in rodents (Seminowicz et al. 2009), along with a possible contribution to the inhibitory control deficiency observed in the amygdala (Neugebauer 2015). The role of the hippocampus in CP has yet to be thoroughly qualified, though studies in humans have found that hippocampal activity is related to (i) exceeding anticipation of pain, (ii) predicting pain, (iii) evaluating future pain sensations, and (iv) pain exacerbation after inducing a negative affective mood (Berna et al. 2010). In the context of CP, reorganization of hippocampal functional connectivity and upregulation of hippocampal neurogenesis has been documented in the transition from acute to chronic back pain and maintenance of CP (Mutso et al. 2014,

Neugebauer 2015), behaviorally manifested by an exaggeration of pain recollection in patients (Berger et al. 2018) (see Barroso et al. 2021 for review).

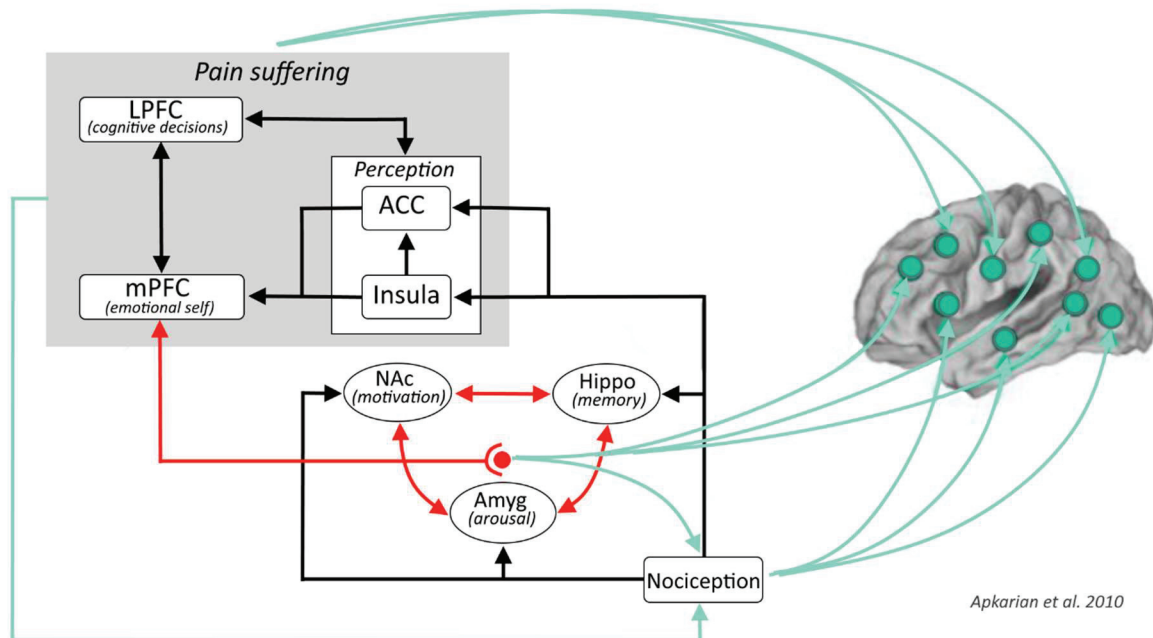

Apkarian et al. 2010

Figure 4 (Apkarian et al. 2010) A model regarding brain circuitry involved in the transition from acute to chronic pain. Nociceptive information, perhaps distorted by peripheral and spinal cord sensitization processes, impinges on limbic circuitry (Hippo, hippocampus; NAc, nucleus accumbens; and Amyg, amygdala). The interaction of limbic circuitry with prefrontal processes determines the level at which a certain pain condition transitions to a more emotional state. The limbic circuitry also provides learning/modulation signals to the rest of the cortex inducing functional and anatomical distortions that reflect the suffering and coping strategies of specific chronic pain conditions. Nociceptive signals also provide the brain with modulatory signals, and are in turn controlled by the state of suffering of the individual as well as limbic changes in arousal and motivation, through descending modulatory pathways.

Conditioning mechanisms

1. Classical Conditioning

1.1. Definitions

Discovered by the physiologist Ivan Pavlov in the early 20th century, **classical conditioning** is defined as a form of unconscious or automatic learning that uses stimulus associations to elicit new responses to previously neutral stimuli. To understand classical conditioning, the following concepts must be defined:

Unconditioned Stimulus (US): An unconditioned stimulus is a trigger that elicits an automatic response. For example: *during springtime, inhaling pollen causes you to sneeze*. Inhaling pollen is the US.

Unconditioned Response (UR): An unconditioned response is the automatic or unconscious response generated by the unconditioned stimulus. In the previous example, *sneezing* is the UR.

Neutral Stimulus (NS): A neutral stimulus is a stimulus that initially triggers no response on its own. For example: *during springtime, hearing birds chirping doesn't necessarily cause any response*. In this case, hearing birds chirping is the NS.

Conditioned Stimulus (CS): A conditioned stimulus is a stimulus that was initially a NS, but now generates a response. For example: *if you initially used to ignore birds, but later got beaked by one, resulting in fear every time you encounter a bird, then birds now elicit an automatic response*. Birds are the CS.

Conditioned Response (CR): A conditioned response is a learned response that is created by a CS. In the previous example, *the fear* elicited by birds (CS) is a CR.

Contingency awareness: Contingency awareness is the conscious knowing of the US-CS association. The CS becomes a predictor of the US.

1.2. Conditioning procedure

1.2.1. Example of Pavlov's experiment

Classical conditioning consists in learning a new association between a US and an initially NS. The informational relationship created between the US and the CS is said to be the key factor of classical conditioning (Rescorla 1968). There are three fundamental steps that will be illustrated via the Pavlov dog-conditioning experiment (Pavlov 1927) (Figure 1):

Step I. Before conditioning: The first step of classical conditioning is to select an effective US that elicits an automatic response (UR) - in the Pavlov dog experiment for example, the dog is presented with food (US) which elicits the dog to salivate (UR). In parallel, a NS must be chosen, here a bell ring was used, which, prior conditioning, triggers no response in the dog (no salivation).

Step II. During conditioning: The conditioning phase is the learning phase of the US and NS association. During conditioning, the dog is repeatedly exposed to the neutral stimulus-bell ring- paired with dog food (US), all while the latter triggers the salivating automatic response (UR). This repeated pairing results into a learned association between the previously neutral stimulus and the US - between the bell ring and food.

Step III. After conditioning: At this point, the previously neutral bell ring has become a conditioned stimulus (CS), which after learned association with the US, appears to elicit the unconditioned response-salivation- when presented alone. This response is thus called the conditioned response (CR).

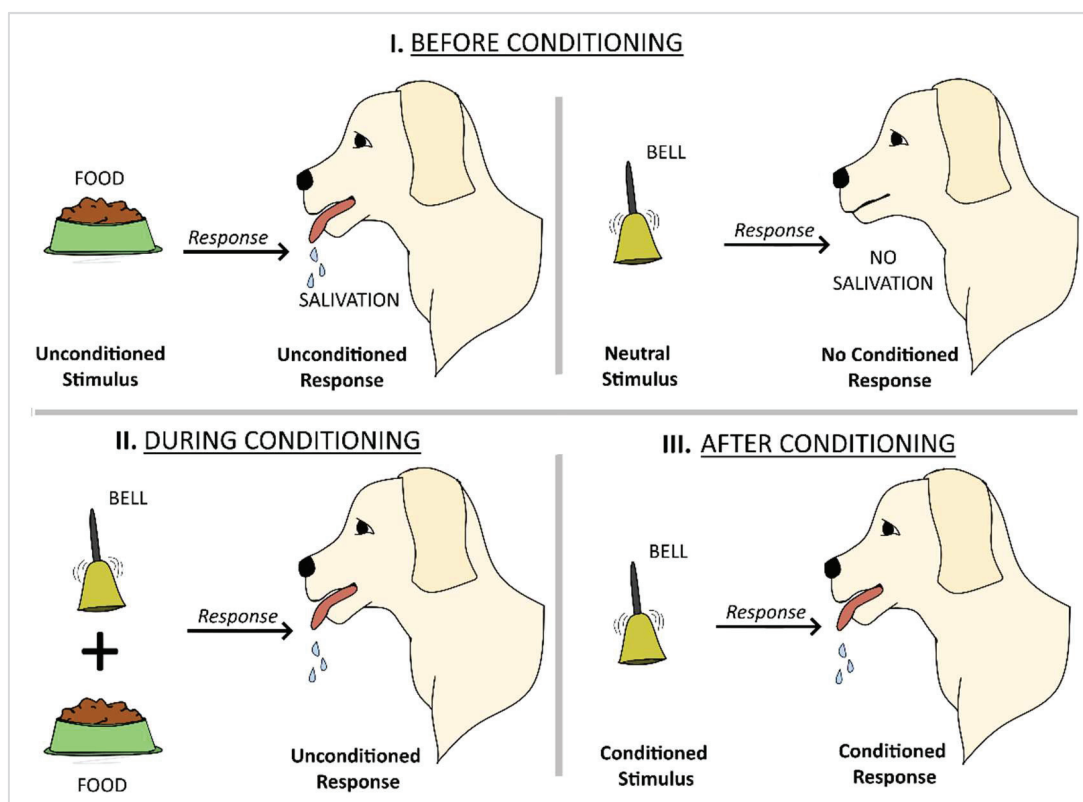

Figure 1 Pavlov’s classical conditioning experiment – Salivating dog. I. Before conditioning, the unconditioned stimulus- US (food) triggers an unconditioned response- UR (salivation). In parallel a neutral stimulus- NS (bell ring), elicits no response (no salivation). II. During conditioning, the US(food) and NS(bell ring) a repeatedly paired so to alter the initially neutral bell ring into a conditioned stimulus (CS) III. After condition, the presentation of the CS (bell ring) alone elicits the UR (salivation). The latter is called a conditioned response (CR)

The following additional definitions describe different types of conditioning procedures:

Discrete cue conditioning: Cue conditioning refers to a type of conditioning where the CS is a single item. Cues can be of auditory, olfactory, visual or somatosensory modality. For example: *a neutral tone, a colored light, a visual shape presented on a screen, a mild stroke, a specific smell etc.*

Context conditioning: Context conditioning refers to a type of conditioning where the CS is the subject's surrounding. For example: *in animals, it can be the cage in which it is placed; for humans, the laboratory room or a virtual environment set up.*

Delay conditioning: Delay conditioning refers to a type of conditioning where the US is simultaneously presented or immediately proceeds the CS. For example: *in the Pavlov experiment, the food is simultaneously presented with the ringing bell.*

Trace conditioning: Trace conditioning refers to a type of conditioning where the CS and US are separated by a time interval (generally between 100ms and 60s), called *trace* interval. For example: *in the Pavlov experiment, the food is presented a few seconds after the bell rings.*

Instrumental conditioning: Instrumental conditioning refers to a type of conditioning where the CS is an active behavior of the subject rather than an external cue or context. For example: *considering Pavlov's dog, if every time the dog gave the paw, it was rewarded with food, then eventually "giving the paw" would become a CS.*

1.2.2. Fear conditioning- Example of Watson's 'Little Albert':

The 'Little Albert' experiment was conducted by the behaviorist John Watson and his associated student Rosalie Rayner. Together they used Pavlov's research to show that a classical conditioning, in particular a fear-evoking conditioning, could be induced on humans (Watson and Rayner 1920). The participant to the study was a 9-month old child called "Albert B." and later known as Little Albert. The principle of the experiment was the same as described above:

Little Albert was shown a series of items including a white rat (NS). The boy exhibited no fear reaction to any of these stimuli. Later, when Albert was playing with the white rat, the experimenter made a loud frightening banging noise by striking a metal pipe with a hammer (US). Automatically, Albert began to cry (UR) hearing that noise. That procedure was repeated a certain amount (US-CS association) until Albert showed signs of noise expectation whenever he saw the white rat (CS). Finally, the boy started crying whenever he saw the animal (CR).

This experiment not only enabled to prove that classical conditioning could be induced in humans but also that it could elicit a **conditioned emotional response**: fear. This paradigm has since been extensively used in research to better understand different aspects of fear learning, in both animal and human studies.

1.3. Main concepts of fear conditioning

As described in the ‘Little Albert’ experiment, fear or threat conditioning relies on associating a neutral stimulus to a fear-evoking stimulus thus leading to a conditioned fear response. Current investigation on fear conditioning relies on the belief that fear is a “*defensive motivational system that evolved to improve survival in the face of environmental threats*” (Cushman and Fanselow 2010). Activation of the fear system triggers highly expectable alterations in behavior and physiology that are proportionate to the level of fear itself. In this part, the key principles of fear conditioning and their associated neural and behavioral mechanisms will be elucidated.

1.3.1. Acquisition

Definition: In fear conditioning, acquisition is defined as the first stage of associative fear learning, that is, the period for which the conditioned stimulus (CS) comes to evoke the conditioned response (CR). In other words, acquisition refers to the **conditioning phase** explained [above](#). There are, to date, an extensive amount of experimental fear conditioning protocols, in particular in animals.

Example: See Figure 2 for illustration of acquisition phase in experimental paradigm - Fear conditioning paradigms in rodents commonly use a mild electric foot shock as unconditioned fear-evoking stimulus (US) paired with an auditory or visual cue stimulus (in this example: a specific tone – *in red color*) as CS (Kim and Jung 2006). This specific stimulus is referred as the CS+. A second similar cue stimulus is also presented (for example: a different tone – *in green color*), but never paired with the US. This specific CS is referred as the CS- and serves as control or safety cue. Acquisition is measured through number of trials (repeated US-CS+ pairing) and increase in conditioned response (for example: freezing time) .

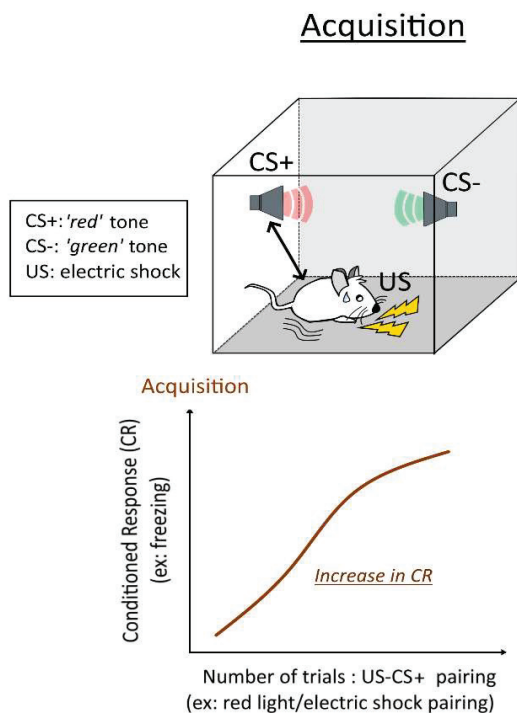

Figure 2 Acquisition of conditioned response (CR) phase in a fear conditioning paradigm in rodents. Pairing of the Unconditioned stimulus (US) – mild electric foot shock- with the Conditioned stimulus (CS+)- red tone. The control or safety cue is referred as the CS- - green tone- and is never paired with the US. Acquisition is measured through the increase in CR (e.g. freezing time) with the increasing number of trials (US-CS+ pairing).

Fear acquisition neural correlates: The neural circuit of fear learning acquisition has been well established **in animals** (Kim and Jung 2006, Flor 2001, LeDoux 2000, Davis 1992, 1997, Marek et al. 2013). Two key brain regions have been identified to contribute to fear acquisition : the amygdala, and the hippocampus (Marek et al. 2013).

Role of the Amygdala: The primary neural system underlying fear learning resides in the amygdala – a region comprised of a group of nuclei located deep within the temporal lobe. It is well-known that the amygdala is an essential area implicated in emotional processing, long-ago evidenced in monkey studies (Kluver and Bucy 1937): Kluver and Bucy (1937) demonstrated that bilateral medial temporal lobectomy in rhesus monkeys resulted in an absence of emotional fear behavior and loss of aggression. Since then, the amygdala has been further proved to be a key structure in the acquisition and expression of fear conditioning (Cushman and Fanselow 2010, Orsini and Maren 2012, Robinson 1963).

The amygdala is divided into various subregions: the lateral (LA) and basolateral nucleus of the amygdala (BLA) and the central nucleus of the amygdala (CeA) (Maren 2003). The LA and BLA are anatomically connected to receive sensory input from various brain regions (e.g. thalamus, neocortex, olfactory and auditory cortex, hippocampus), hence including both US and CS inputs (figure 3). In particular, neurons of the LA are able to respond to both nociceptive and acoustic stimuli (Luchkina and Bolshakov 2018, Pitkänen et al. 1997). Somato-sensory information is then transmitted into the central amygdala (CeA) which projects towards autonomic and somato-motor structures said to moderate specific behavioral and physiological responses (e.g. periaqueductal gray matter (PAG) for freezing or activity burst, lateral hypothalamus (LH) for heart rate changes, pontine reticular formation (Pontine RF) for potentiation of startle response and the bed nucleus of stria terminalis(bNST) for release of stress hormones) (Maren and Quirk 2004, LeDoux 1996). Acquisition of conditioned fear and associated response seemingly relies on the amygdala neurons' capacity of associative synaptic plasticity when US and CS inputs are received simultaneously in the LA and BLA (Maren and Quirk 2004, Cushman and Fanselow 2010). On one hand, the US can by its own strongly activate the LA/BLA, thus triggering the CeA activation which results in an unconditioned response, such as an activity burst. On the other hand, the CS is initially too weak to induce CeA activation. However, through repeated US-CS pairing, the CS input pathway towards the amygdala progressively strengthens until the CS alone is capable of activating the CeA (Figure 3).

Role of the Hippocampus: The hippocampus is another important structure to be taken into consideration, specifically in contextual conditioning. Indeed, animal studies in rats have shown that a lesion to the hippocampus during conditioning erased traces of contextual fear learning but not tone cue learning (Maren et al. 1997, Kim and Jung 2006). Synaptic plasticity in various subregions of the hippocampus are said to be essential for the formation of contextual representation (Maren 2001). Previous research using electrophysiological recordings in awake-animals has demonstrated that hippocampal neurons activation (referred as *place cells*) correlated with specific locations of the animal within a given environment. The

exclusive activation pattern emerging from these *place cells* was described as code for the environment and as indicator of spatial location for the animal (Sanders et al. 2003, O’Keefe 1976). Ultimately, the hippocampus enables encoding and association of vastly processed sensory input from across the cortex, and thus serves to create a cohesive representation of the sensory and physical environment. Further hippocampal projections towards the BLA may therefore indicate context-US association, e.g. contextual fear learning (Cushman and Fanselow 2010, Orsini and Maren 2012) (Figure 3).

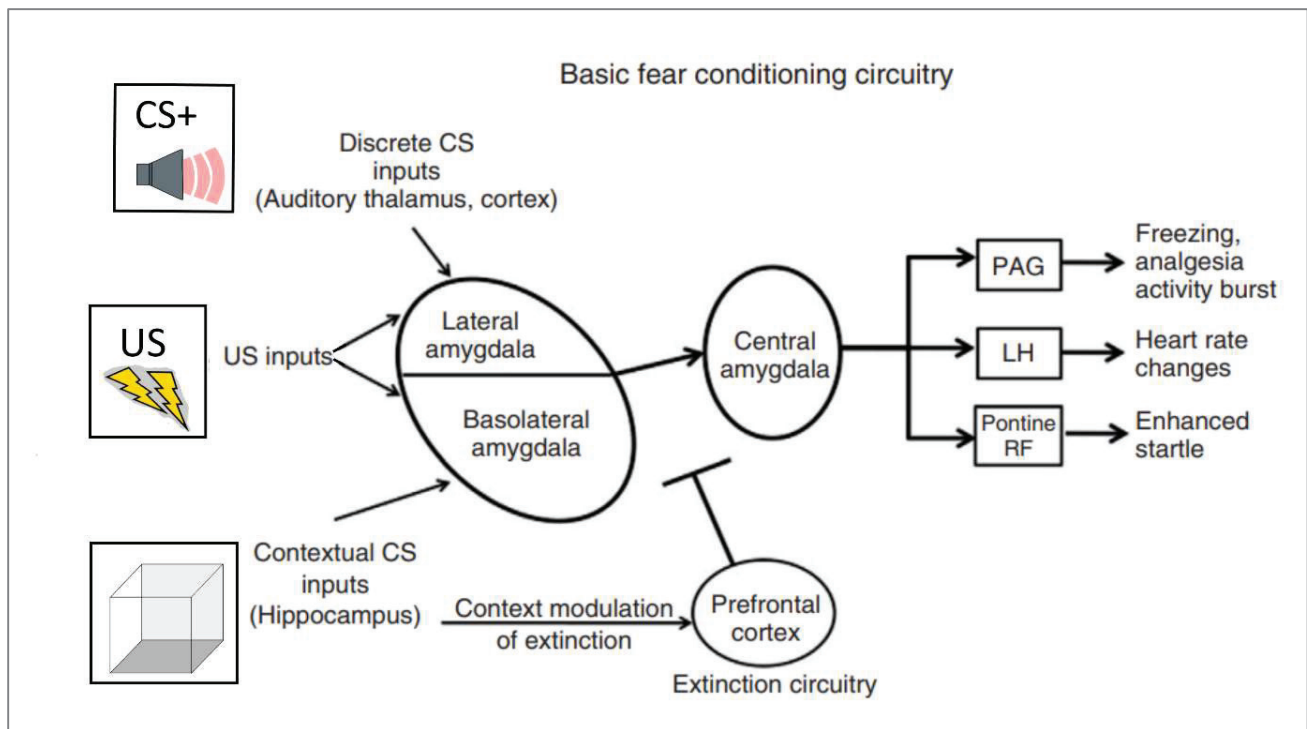

Figure 3 Adapted from Cushman and Fanselow 2010 **Basic fear conditioning circuitry**. This diagram outlines a simplified view of the most important neuroanatomical pathways in fear conditioning. CS and US information converges in the amygdala. During training, co-activation of CS and US inputs strengthen the weak CS input such that after training the CS can activate the amygdala on its own. This drives activity in the central amygdala, which subsequently drives activity in downstream fear output regions such as the periaqueductal gray (PAG), lateral hypothalamus (LH), and pontine reticular formation (pontine RF) to produce conditional fear responses. During extinction, where the CS is presented in the absence of the US, prefrontal circuitry comes to inhibit the activity of neurons in the amygdala. This is a form of new learning that is under complex regulation by contextual information provided by the hippocampus. For more insight on extinction [see part 1.3.2](#).

Human studies using functional imagery have attested that neural mechanisms of fear learning are somewhat conserved between rodents and humans (Büchel and Dolan 2000, Marek and Sah 2018). Both the amygdala and the hippocampus play a key role in human fear conditioning. In 1995, Bechara et al. observed fear conditioning behaviors in patients with either bilateral damage to the amygdala or the hippocampus (Bechara et al. 1995). Amygdala injured patients were found to be incapable of attaining conditional autonomic fear responses all the while being aware of the CS-US contingency (the CS predicted the upcoming shock). Hippocampus damaged patients however, were capable of eliciting a fear-CR, yet were unaware of the US-

predictive role of the CS. A further study comparing trace vs. delay conditioning mechanisms noted that contingency awareness of the CS-US association mediated through the hippocampus was crucial for trace conditioning but not for delay conditioning (Clark and Squire 1998). In other words, the amygdala appears to be essential for autonomic/unconscious fear learning and behavioral response, whereas the hippocampus mediates the conscious awareness of US-CS contingency, presumably through episodic recollection of the conditioning trials (Cushman and Fanselow 2010).

Indeed, fMRI studies have observed the role of the hippocampus in context conditioning protocols (Lang et al. 2009, Maren 2013, Alvarez et al. 2008). Marschner et al. (2008) used different visual cues - geometric shapes- that could be either paired or unpaired with an electric-pulse shock (US) according to the given background (a specific room image as screen background). Meaning the specific background was the conditioned contextual stimulus (CTX+). Interestingly they found that the hippocampus BOLD response increased only with the CTX+ in the unpaired condition, whereas the amygdala activated in both paired and unpaired conditions of the CTX+. These results imply that the amygdala has a comprehensive role in aversive conditioning and that context conditioning specifically requires added hippocampal activation (Marschner et al. 2008).

Additional brain areas have also been observed to activate during fear acquisition such as: the anterior cingulate cortex (ACC) and the medial prefrontal cortex (mPFC)- involved in expression of fear, pain processing, and evaluation of emotionally salient stimuli (Etkin et al. 2011); the inferior parietal cortex and lateral orbital cortex- regions commonly implicated in anticipatory anxiety (Wager et al. 2004, Ploghaus et al. 1999) ; and the insula, reported to activate when the US is a painful stimulus (Büchel and Dolan 2000).

Behavioral and physiological fear responses: Behavioral and physiological conditioned fear response in rodents include (i) increase in muscle reflex (potential startle) (Davis 1997), (ii) freezing (movement halt) (LeDoux 1986) or active crouching (avoidance) (Gruene et al 2015, Blanchard and Blanchard 1969), (iii) decrease in pain sensitivity (Helmstetter 1992) and (iv) changes in the autonomic nervous system (increase in heart rate, blood pressure and respiration rate) (Stiedl and Speiss 1997).

Behavioral and physiological conditioned fear response in humans include (i) higher reported CS-related fear or anxiety (Troger et al. 2012, Glotzbach-Schoon et al. 2013, Andreatta et al. 2015) (ii) higher reported arousal and negative valence of the CS (Kroes et al. 2017, Andreatta et al. 2015) (iii) increase in skin conductance response and heart rate (Troger et al. 2012) (iv) fear potentiated startle and avoidance behavior (Glotzbach 2012, Kroes et al. 2017) (v) US expectancy (Huff et al. 2011).

1.3.2. Extinction

Definition: In fear conditioning, extinction is referred to the progressive weakening of the conditioned response (CR) resulting in a decrease or disappearance of the conditioned fear-evoked behavior and/or physiological response. Extinction consists in repeated exposition to the CS alone, meaning without the US. Gradually, the CS returns to its initial neutral status. In experimental studies, the conditioning or acquisition phase is commonly followed by an extinction phase.

Example: Considering the previous example, extinction would consist in delivering both CSs (CS+/CS-) to the conditioned rodent. The 'red' tone initially elicits the CR (freezing), but this effect slowly decreases in time with the number of 'red' tone presentations without the previously associated electric foot-shock, until freezing behavior completely disappears (figure 4).

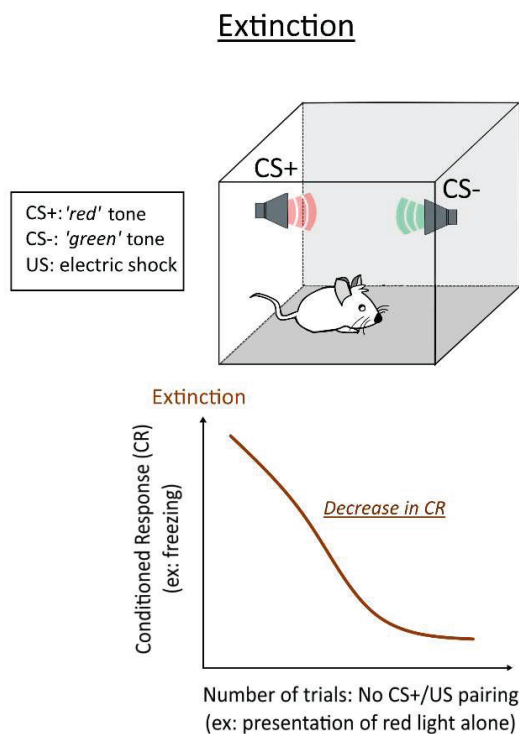

Figure 4 Extinction of conditioned response (CR) (right) phase in a fear conditioning paradigm in rodents. Presentation of the conditioned stimulus (CS+) – 'red' tone - alone (without the unconditioned stimulus (US) - electric foot-shock). The control or safety cue is referred as the CS- - green tone- and was never paired with the US. Extinction is measured through the decrease in CR (e.g. freezing time) with the increasing number of trials (CS+ alone).

Recovery of fear expression: Recovery or relapse is the re-appearance of the CS-associated fear memory and its associated CRs after extinction training. Among recovery effects the most fundamental one is *renewal* (Bouton et al. 2021). Renewal corresponds to the recovery of extinguished behavior when extinction of CS is performed in a second context of that of conditioning (ABA renewal). That is, US-CS association is performed in context A, extinction of CS in context B, and renewal occurs when the subject is reinstated in context A in the presence of the CS (Alvarez et al. 2008). Other forms of recovery include *spontaneous recovery* – the initial conditioned fear returns after a certain time post-extinction- and *reacquisition* – a single US-CS pairing post-

extinction recovers conditioned fear response (Rescorla et al. 2004). From this phenomenon emerged the hypothesis that extinction does not necessarily imply **erasing of the initial fear acquisition memory but rather creating a new behavior learning** along with the creation of a ‘safe’ memory (Bouton et al. 2021, Myers and Davis 2007).

N.B.: Recovery mechanisms will not be detailed, though mentioning was important to understand the opening hypothesis for extinction mechanisms.

Fear extinction neural mechanisms: In line with the observation that extinction does not erase the initial US-CS associative memory, it was suggested that neural correlated of extinction do not simply imply deactivation of the CS-amygdala pathway. Instead, it is proposed that a new learning is formed within and outside of the amygdala, meaning that fear memory is somewhat inhibited through further neuronal and synaptic processes situated elsewhere in the brain (Singewald et al. 2015). Thus, fear extinction circuit is said to rely on three main brain structures: the amygdala, the medial prefrontal cortex (mPFC), and the hippocampus.

Interaction between the amygdala and the mPFC: Primary suggestion of the amygdala’s role in extinction learning came from electrophysiological work on animals, showing that extinction (or decline in conditioned response) came with a decrease in CS-evoked neuronal activity in the BLA (McEchron et al. 1995). Davis et al. (1992) later confirmed the latter by inhibiting amygdala NMDA receptors during extinction in a fear-potentiated startle paradigm, which resulted in impaired extinction learning. Importantly, this effect was observed when BLA receptors were inhibited, but not CeA’s. Although the BLA is proposed to mediate acquisition of extinction, neither BLA activity nor NMDA receptors activation have been proven necessary for extinction memory consolidation. Rather, pharmacological studies suggested that the mPFC neuronal and synaptic activity is required for consolidation (Laurent and Westbrook, 2008).

Extensive evidence in animal studies has shown that medial prefrontal cortex (mPFC) projections towards the amygdala are essential for inhibition of conditioned fear. Enhanced activity of mPFC neurons, specifically in the infralimbic section (IL), has been shown to suppress the signal flow in the amygdala and in turn inhibit the fear response in extinguished animals (Milad et al. 2004, Milad and Quirk 2002). Indeed, enhanced neuronal firing in the IL was found to be negatively correlated with freezing levels and relapse probabilities (Milad and Quirk 2002). The mPFC has strong projections towards both local inhibitory interneurons of the BLA but also intercalated cells (ITC)- located between the BLA and CeA- resulting in suppression of outflow from the BLA to the CeA after extinction (Likhtik et al 2008). In sum, the mPFC may act through multiple mechanisms to suppress conditioned fear response after extinction (example of auditory cue extinction Figure 5, Bouton et al. 2021).

Interaction between the hippocampus and the mPFC: In line with the role of the hippocampus in fear learning, it is also implicated in the representation of contextual extinction learning. The mPFC has no direct projections to the hippocampus, however it is indirectly connected through the nucleus reuniens (RE), belonging to the ventral midline thalamic nucleus. The RE is known to coordinate mPFC and hippocampal oscillatory

activity and thereby is essential for memory and learning processes that require both these regions (Jin and Maren 2015, Dolleman-van der Weel et al. 2019). In particular RE inhibition can degrade spatial working memory (Griffin 2015) and contextual fear memory (Ramanathan et al. 2018). Importantly, studies in humans have suggested that the hippocampus/mPFC interaction leads to suppression of context-inaccurate or unsolicited memories (Gagnepain et al. 2017), a mechanism called retrieval suppression. In line with this interpretation, it is considered that extinction represents not only inhibition of CS-US association memory encoded in the amygdala, but also the contextual (or episodic) memory of the conditioning experience encoded in the hippocampus (Ehrlich et al. 2009, Lacagnina et al. 2019) (figure 5).

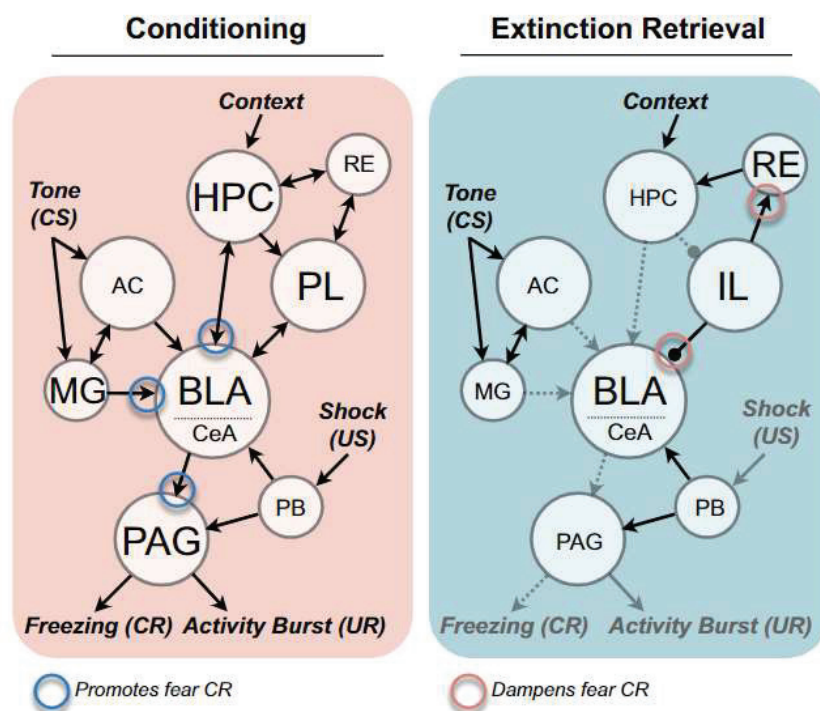

Figure 5 (adapted from Bouton et al. 2021) **Neural circuits mediating Pavlovian fear conditioning, extinction retrieval, and renewal.** **Left:** auditory conditioned stimuli (CS) are processed by the thalamic medial geniculate nucleus (MG) and auditory cortex (AC) projected to the basolateral nucleus of the amygdala (BLA). This information is associated with the foot-shock unconditioned stimulus (US), which is conveyed by the parabrachial (PB) nucleus and other relays, in the amygdala. Contextual information is processed in the hippocampus (HPC) and medial prefrontal cortex (prelimbic (PL) and infralimbic (IL) cortex), which are interconnected by the nucleus reuniens (RE). HPC projections and MG nucleus projections to the BLA are involved in the expression of fear conditioned responses (CRs) to auditory and contextual stimuli, respectively. Projections from the central nucleus of the amygdala (CeA) to the ventrolateral midbrain periaqueductal gray (PAG) are involved in the freezing CR. The dorsolateral PAG mediates activity burst unconditioned responses (UR) to the shock US. **Right:** the retrieval of extinction memories is associated with infralimbic (IL) cortical inhibition of BLA neurons involved in CR production to auditory and contextual stimuli. IL projections to the RE may suppress retrieval of contextual fear memories.

1.3.3. Generalization

Definition: In fear conditioning, generalization refers to the acquired conditional fear that spread across all stimuli somewhat perceptually-related or contextually-related to the initial CS. Fear generalization mechanism are considered to be either adaptive or maladaptive: if generalized responses to fear encourage survival of an organism, it is considered as adaptive; inversely, if generalization exceeds this function, meaning it opposes the directive of self-preservation then it is considered maladaptive (Lissek et al. 2010). For example, in the ‘Little Albert’ experiment, generalization effect was observed as after fear conditioning of the white rat, the boy starting showing fear towards similar white objects and even other furred items (Watson and Raynor 1920). In experimental settings, this effect is commonly observed through instauration of a novel stimuli that resembles the CS+ (general stimuli: GS). Generalization is measured through CR levels elicited by both the CS+ (paired with the US during conditioning) and the GS (never paired with the US but resembling the CS+).

Example: In our example (Figure 6), generalization would be observed if the animal presented a CR (freezing) towards both the ‘red’ tone (CS+), and towards a novel general stimuli (GS) resembling the CS+. For example, the GS could be a ‘red+green’ tone resembling somewhat equally the CS+ and CS-. Although this example refers to discrete cue generalization, this effect has also been observed in context conditioning, where a first context (for example a ‘red’ cage) serves as CS (CTX+) and a second context (for example a ‘green cage’) is never paired with the US (CTX-). Likewise, generalization is observed when the animal exhibits CRs in both context stimuli.

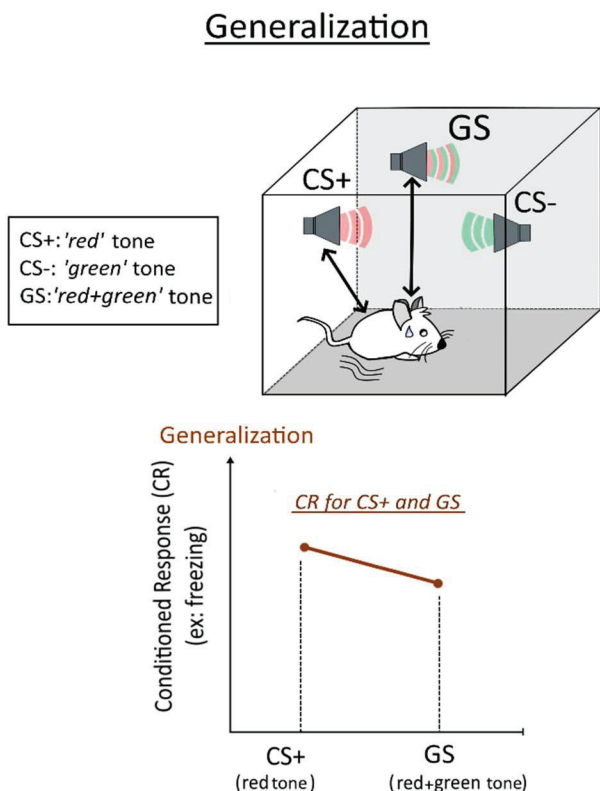

Figure 6 Generalization of conditioned response (CR) in a fear conditioning paradigm in rodents. Presentation of a novel generalized stimuli (GS) – ‘red+green’ tone, perceptually resembling the CS+ - ‘red’ tone - and CS- -‘green’ tone-. The GS elicits a degree of CR similarly to the CS+ though never paired with the unconditioned stimuli (US- electric foot-shock). Generalization is measured through the CR elicited by the CS+ and GS (freezing). Generalization effect can even extend to the CS.

Generalization neural mechanism: Generalization neural mechanisms is currently an intense field of investigation and further research is needed to understand the underlying processes. Explanation of associated neural processes will be described briefly.

In the case of cue conditioning, recordings in the lateral amygdala (LA) in a discrete cue-discrimination task has revealed distinct neuronal subpopulations that either responded to generalized or cue-specific associations (Ghosh and Chattarji 2015). Ghosh and Chattarji evidenced that increasing US intensity was followed by increased fear generalization which was reflected by a cell proportion alteration in the LA (proportion of generalized/cue-specific neurons). Pharmacological studies in rats supported these findings by showing that LA activity was higher when a novel stimulus resembling the threatening CS was presented, and inversely lower when the novel stimulus was undoubtedly different from the CS (Grosso et al. 2018). Specifically, in the case of novel cues nor too similar, nor too different from the CS, evidence of two opposite neuronal subdivisions in the LA was revealed when discrimination of such ambiguity was needed. Recruitment of the LA neuronal ensemble thus enables discrimination processes and failure of the latter, or generalization, appears when activation proportions of these cells are out of balance (Grosso et al. 2018).

In the case of contextual conditioning, generalization is said to rely on hippocampal and prefrontal mechanisms. Specifically, hippocampal processes of pattern separation and completion are said to contribute to contextual fear generalization (Huckleberry et al. 2016). The dentate gyrus (DG), temporal sub-part of the hippocampus (CA3 sub-field), comprises a large amount of scattered active cells which are believed to contribute to pattern separation processes, supposedly limiting context generalization by creating unique neural codes for varying contexts. Along these lines, disrupting the DG function may impair context discrimination and enhance contextual fear generalization (McHugh et al. 2007). Research has also highlighted the implication of the mPFC in fear generalization, via the nucleus reuniens (RE) circuit between the mPFC and the hippocampus CA1 subfield. Xu and Südhof (2013) demonstrated that silencing prefrontal outflow to the RE or RE input to the CA1 increased contextual fear generalization, and inversely activation of this circuitry during acquisition reduced generalization effects. Overall, generalization neural processes seem to rely within the amygdala, prefrontal cortex and hippocampus.

1.4. Clinical implications

Extensive research has focused on understanding fear conditioning in anxiety disorders (AD), for example post-traumatic stress disorder (PTSD). Indeed, PTSD is a fear-based disorder that is primarily induced by a traumatic event, e.g. life-threatening accidents, war or assaults. These traumatic fear-learning episodes can lead to maladaptive coping mechanisms which can induce behavioral and physiological alterations (see review Huether 1996). According to the Diagnostic and Statistical Manual of Mental Disorders (DSM-V), these alterations include: (i) re-experiencing symptoms of the aversive experience (e.g. through intrusive memories) (ii) avoidance of event-related reminders (places, thoughts and even people) and (iii) hyperarousal symptoms correlated with physiological responses, such as irritability, hypervigilance, concentration deficits, enhanced startle and anger responses.

Research models investigating underlying mechanisms of PTSD have mainly focused on learning and memory processes, specifically **fear associative learning** (e.g. conditioning) (Bodemeier-Loayza-Careaga et al. 2016). Indeed, discrete and contextual stimuli present in the environment at the occurrence of the trauma, (e.g. objects, place features, loud noises) are automatically associated with the aversive event. Hence, fear conditioning has been suggested to reflect memory features of PTSD, that possibly explain further fear-responses such as avoidance symptoms and re-experiencing negative emotions (Yehuda and LeDoux 2007). A wealth of experimental evidence indicates that individuals with anxiety and trauma-related disorders show greater fear reactivity to safety cues (CS-) than healthy subjects, possibly indicating either impaired inhibition of fear responses or increased fear generalization to safety cues. Additionally, AD patients also exhibited lesser extinction learning of conditioned response in contrast to control individuals (Lissek et al. 2010, Michael et al. 2007, Duits et al. 2015). Neuroimaging studies have identified alterations in key regions of fear and extinction learning mentioned previously, including hyperactivation in the amygdala in PTSD and social anxiety, as well as hypoactivation in the ventromedial prefrontal cortex and anterior cingulate cortex - indicators of increased fear learning and decreased extinction learning (Etkin and Wager 2007). Reduced bilateral hippocampal volumes was also found in PTSD patients compared to healthy individuals (Kitayama et al. 2005) – possibly signaling a facilitated generalization process.

What about Chronic Pain? Analogously to PTSD, a painful experience can be perceived as a traumatic event and thus be memorized as such. In parallel to how fear conditioning mechanisms are disturbed in patients suffering from PTSD, it is considerable that chronic pain patients may exhibit maladaptive pain-related fear conditioning responses. This next part will focus on understanding pain conditioning in chronic pain and current experimental research standpoint.

2. Pain Conditioning

As a hard-wired indicator for physical harm, pain is recognized as a strong motivator for associative learning. As Meulders stated (2020) :“*pain induces a motivational state triggering defensive responses in order to reduce further damage*”(Wall 1979). Particularly, the highly prominent nature of pain combined with the harm-signaling function promotes *predictive learning*. In other words, the learning of events or cues preceding a painful experience enables to activate protective behaviors and avoid or limit the consequences of pain. Thus, pain or nociceptive stimuli are often used as USs in animal fear conditioning (electric foot-shock), as it enables robust and rapid pain-related fear learning (Kim and Jung 2005). In human fear conditioning studies however, the US is mostly limited to an unpleasantness but not painful stimulus (example Kroes et al. 2017).

2.1. Pain-related fear conditioning in Chronic Pain

Chronic pain can be described as a state of persistent learning in which the continuous presence of pain generates constant aversive associations with daily events (Apkarian et al. 2009, Mazza et al. 2018, Harvie et al. 2017) resulting in pain or pain-related fear conditioning. As a result, the inability to extinguish the continuous pain conditioning leads to the maintenance of chronic pain (figure 7).

The theory of classical conditioning as a model for chronic pain was first proposed in 1977 by Gentry and Bernal: the model is based on the observation that high-intensity or acute pain acts as an unconditioned stimulus (US) that triggers various unconditioned responses (UR), such as muscular strain and fear. Accordingly, the model implies that common daily stimulations (e.g. movement) repeatedly paired with pain become conditioned stimuli (CS), that progressively elicit the CRs on their own (Gentry and Bernal 1977, Linton et al. 1984). This interpretation was further utilized in current conditioning models, such as the Fear Avoidance Model (FAM; Vlaeyen and Linton 2000, 2012), which suggests that the fear response elicited by pain or **rather pain-related fear conditioning** drives towards avoidance behavior, which in turn triggers distress, disability and overall decrease in quality of life in chronic pain patients.

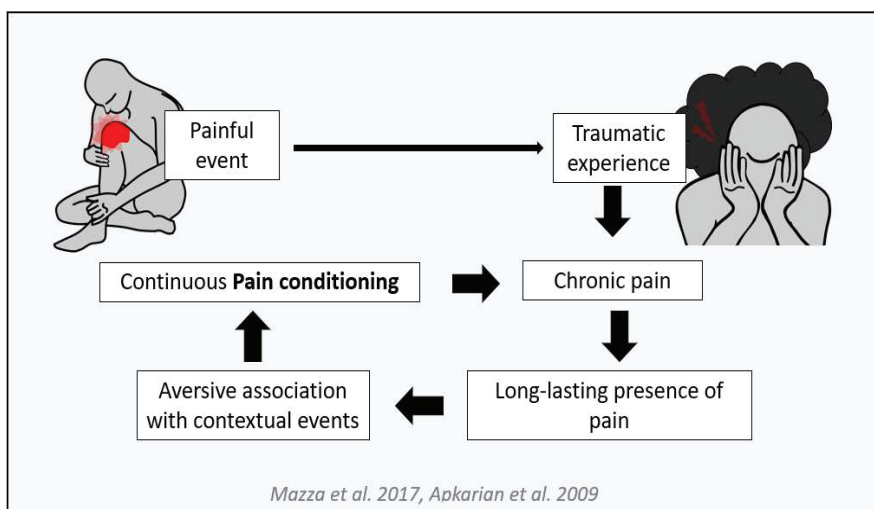

Figure 7: The continuous pain learning circuit in chronic pain. A painful event can be lived and memorized as a traumatic experience, which facilitates chronic pain induction (see *The pain experience- part 2*). Chronic pain is a state of long-lasting persistent pain during which frequent aversive associations are made with daily contextual events. These associations are translated into continuous pain conditioning. The inability to erase the mnemonic trace of that conditioning leads to the maintenance of chronic pain.

2.2. Experimental models for pain-related fear conditioning

The Fear-avoidance model (FAM) has been well established as a theory explaining the transition from acute to chronic pain, pain-related fear and avoidance behaviors, resulting in extinction-based treatments implemented in clinical settings (Vlaeyen et al. 2012). According to the FAM model, acute pain can transition in opposite directions according to coping mechanisms (adaptive or maladaptive): (i) individuals who tend to appraise pain as threatening will tend to prioritize pain control (e.g. over-predict pain), and consequently adopt conditioned behaviors such as avoidance and pain-related fear. The persistent avoidance behaviors result in restricted physical movement and daily activities subsequently leading to disuse, negative affect and eventually chronic pain induction; (ii) inversely, people who perceive pain as non-threatening tend to favor confronting their pain, and focus on other valued life-goals which enables to assess and adapt daily pain expectations, eventually leading to recovery (see Figure 8).

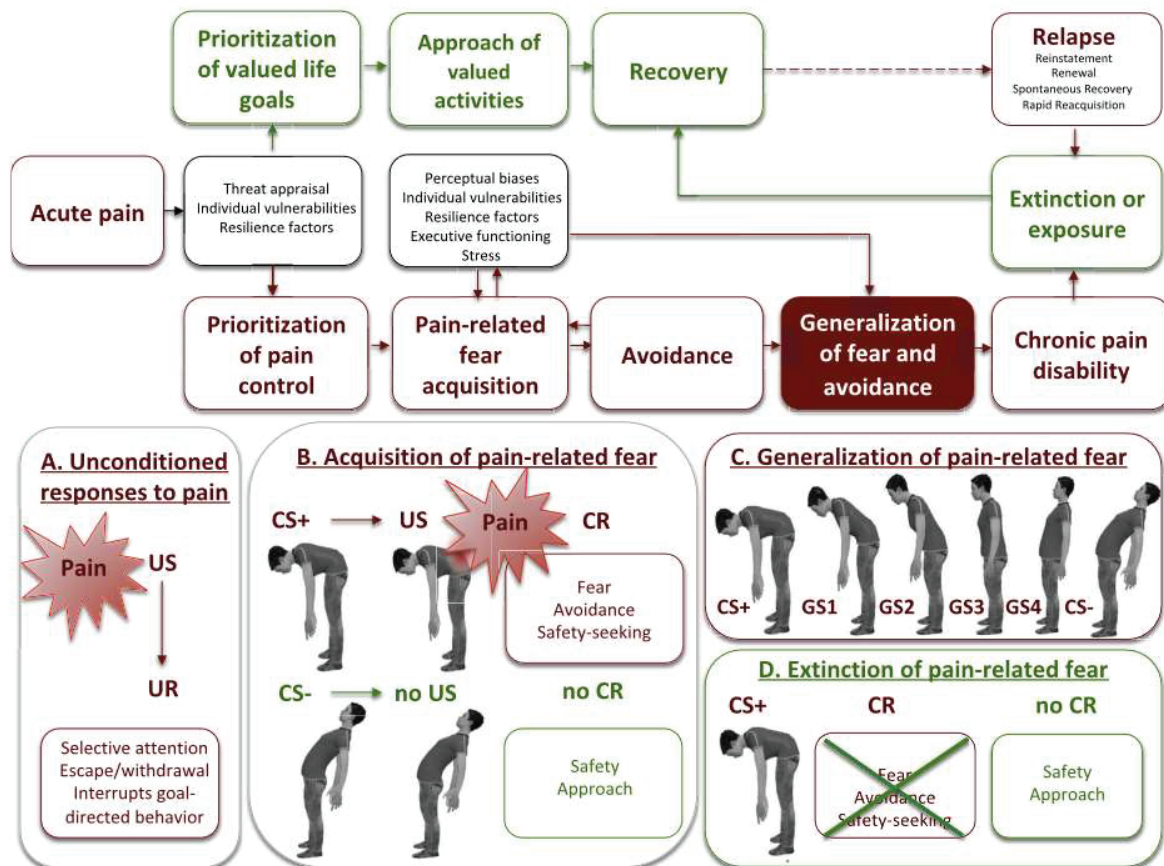

Figure 8 (From Meulders 2020) Fear avoidance model of chronic pain: fear of movement-related pain in chronic low back pain as an example. **A.** Unconditioned pain responses: US = unconditioned response; UR = unconditioned response. **B.** Acquisition of pain-related fear: the CS+ (i.e. bending forward) = conditioned stimulus that is followed by the pain-US, triggering CR = conditioned responses; the CS- (leaning backward) is not followed by the pain-US and triggers no CRs. **C.** Generalization of pain-related fear: GSs = generalization stimuli (i.e. novel intermediate movements between the CS+ and CS-) closer to the CS+ (e.g., GS1) are also able to trigger CRs. In chronic pain patients, GSs closer to the CS- (e.g., GS3) also trigger CRs = “overgeneralization” or excessive fear generalization. **D.** Extinction of pain-related fear: Exposure to the CS+ in absence of the pain-US/feared catastrophe (e.g. snapping of the nerves in the back) leads to a decrease in CRs and installation of a new behavioral pattern to the CS+.

However, there is still very much lacking experimental research to understand the fundamental mechanisms of pain-related fear conditioning. As mentioned before, classical fear conditioning paradigms in humans often use unpleasant but non-painful aversive stimuli to induce fear learning. Only in the last decade has research started to focus on pain as the specific US, with experimental work emphasizing on precise pain disorders such as visceral pain, musculoskeletal pain, genital pain and complex regional pain Syndrome (CRPS) (Meulders 2020). Among pain-related fear types, the following have been investigated : fear of movement (Vlaeyen 2015), fear of touch (Biggs et al. 2020), fear of penetration (Thomten and Linton 2013) and fear of visceral sensations (Drossman and Hasler 2016). Experimental example of *pain-related fear of movement* acquisition, generalization and extinction will be elucidated in the following paragraphs.

2.2.1. Acquisition



Extract of Figure 8B (Meulders et al. 2020)

Pain-related fear of movement is primarily used for musculoskeletal pain disorder models where proprioceptive information (e.g. movement, body posture) are highly salient stimuli allowing to **predict** harm-risk situations. For instance, an initially neutral movement such as bending forward can easily become a CS if it is paired with a painful US, (e.g. back pain) (Figure 8B). In turn, pain can be predicted in CS-related movements resulting in avoidance and safety-seeking conditioned response (CR).

An example of pain-related fear paradigm is the Voluntary Joystick Movement Paradigm (VJMP) developed by Meulders and colleagues (Meulders et al. 2011). The experiment consisted in simulating musculoskeletal pain disorder by using joystick manipulations as CSs (movement the right, left, upwards and downwards) and a painful 2ms-lasting electro-stimulation as US. In the US-predictable condition, the joystick movement to the right was systematically followed by the US (CS+) whereas movement to the left was never followed by the US (CS-). In the US-unpredictable condition, joystick movements upwards or downwards were never contingent to the US, rather it was presented in an intertrial interval (ITI), defined as the overall testing context. Successful pain-related fear conditioning was acquired as indicated by enhanced startle amplitudes in the CS+ condition vs. CS-. Interestingly, none of the unpredictable CSs (upward and downward movement) elicited any CR, however the ITI did, evidence of contextual pain-related fear learning.

2.2.2. Generalization



Extract of Figure 8C (Meulders et al. 2020)

As previously mentioned, generalization processes are to some extent necessary for survival purposes. However, overgeneralization occurs when pain-related fear is prolonged to initially safe stimuli. For example, if “bending forward” is the initial pain-evoking stimulus (CS+), then over-generalization can affect an entire range of movement resembling “bending forward” (represented as GS 1 to 4 in Figure 8C), consequently limiting non-

painful movements. The physical restrictions induced by generalized fear can promote sustained anxiety and avoidance behaviors and eventually translate into disability (Meulders 2019).

In the VJMP protocol, fear of movement generalization was observed in healthy participants. Pain-related fear was reported in novel stimuli (GS) resembling the initial CS+ (e.g. joystick movement to the right) but not the CS- (e.g. movement to the left). Specifically, the more the GS resembled the CS+ (GS+: moving to the upper-right, lower-right) the greater the evoked fear, in contrast to lesser similar GSs (GS-: upper-left, lower left joystick movement) (Meulders and Vlaeyen 2013).

2.2.3. Extinction and renewal of pain-related fear

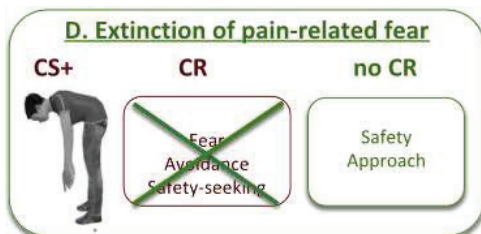

Extract of Figure 8D (Meulders et al. 2020)

Extinction or exposure treatment has been proven successful to diminish pain-related fear levels, disabilities, and even pain evaluation in highly conditioned patients suffering from musculoskeletal pain (Den Hollander et al. 2010). Extinction involves patients to be exposed to activities commonly feared without the dreaded consequences (pain or fear of new injury), such as adopting *safety behaviors* (e.g. ‘bending forward to pick something up with a straight back’), proven to

successfully extinguish fear responses. Contrarily to acquisition of pain-related fear, which can easily be installed following a single harmful event (e.g. learning that bending forward induces shooting back pain), extinction is much harder to implement. As previously explained, extinction consists in a new learning where the CS no longer predicts the US therefore leads to inhibition of fear responses. However, extinction learning treatment is often context-specific (e.g. practiced in specific medical settings) (Goubert et al. 2005), which makes the initial US-CS association learning vulnerable to relapse in other environments (e.g. spontaneous recovery, reinstatement, renewal; den Hollander et al. 2010). Indeed, as chronic pain patients exhibit over-generalized fear of pain, possibly acquired in a variety of contexts, it is very hard to pinpoint a specific US-CS association for exposure therapy.

In the VJMP experiment, Meulders and Vlaeyen (2012) performed an extinction phase after acquisition of predictable (CS+/CS-) and unpredictable (ITI) conditionings, where both the CS+ (joystick moving to the right) and ITI (intertrial interval, between upward and downward joystick movements) were no longer followed by the painful electrostimulation (US). Extinction was successfully indicated through disappearance of fear response towards the CS+. Likewise, eliminating the unpredictable-US during ITI resulted in contextual pain-related fear extinction.

2.3. Neural mechanisms of pain-related fear conditioning

Neural circuitry of pain-related fear learning has been studied in models of chronic abdominal pain disorders such as irritable bowel syndromes (IBS) (Icenhour et al. 2015, Kattoor et al. 2013, Gramsch et al. 2014). In an fMRI study comparing IBS patients with healthy subjects, they used rectal distention to induce painful visceral sensations (US) and visual cues (e.g. geometric shapes) as CSs to assess neural correlates of pain-related fear acquisition and extinction (Icenhour et al. 2015). Results indicated enhanced activity in the ventro-lateral prefrontal cortex (vlPFC) and posterior cingulate cortex (PCC) during early acquisition and enhanced activity in the amygdala during late acquisition of pain-related fear in contrast to control subjects. The PCC is said to integrate multi-modal information and involved in attentional processes and memory creation (Icenhour et al. 2015). It has also been suggested that this region is implicated in assessing the valence of potential threatening items (Maddock et al. 2003). The vlPFC is suggested to be involved in attention, anticipation of nociceptive input and higher cognitive appraisal of a painful experience (Wiech et al. 2008). Therefore, greater activation in these areas may suggest hypervigilance and greater anticipation of pain-related threat in chronic IBS patients compared to healthy individuals. Likewise, enhanced activity in the amygdala may reflect higher emotional fear learning, and greater pain-related fear conditioning in IBS individuals (Buchel and Dolan, 2000). Re-instatement analysis (memory reactivation post-extinction learning) revealed stronger hippocampal activation in IBS subjects compared to controls suggesting enhanced processing of pain-related contextual memories. A similar study in healthy participants also found anticipatory activation of the anterior cingulate cortex (ACC), the somatosensory cortex and precuneus during pain learning acquisition– regions implicated in pain processing– as well as enhanced activity in the amygdala (Kattoor et al. 2013). During extinction, participants exhibited strong activity in the dorsolateral prefrontal cortex– in keeping with research on extinction of fear learning neural correlates– and reinstatement triggered hippocampal activation– possibly indicating reactivation of the old pain-related fear memory trace.

Overall, although these studies only address a certain type of pain, it seems as the neural mechanisms underlying pain-related fear learning, extinction and reinstatement are correlated with fear learning mechanisms mentioned in [part 1](#).

2.4. The importance of context in pain-related fear

Though pain-related fear conditioning can in some cases be cue-specific, where patients report knowledge of pain outbreaks in the presence of specific stimuli (Johnson et al. 2006), non-cue specific pain occurrences can lead to contextual pain-related fear conditioning (Meulder 2020). As highlighted by the VJMP protocol of Meulders and Vlaeyen (2012), an unpredictable painful unconditioned stimulus (US) induced in the absence of distinguishable cues causes the context in which it is delivered to be perceived as a potential hazard and leads to continuous anticipation of threat (Meulders et al. 2011, Fonteyne et al. 2010, Vansteenwegen et al. 2008). Correspondingly to how context information contributes to the development, maintenance and treatment of anxiety and trauma-related disorders (Bouton et al. 2006), **contextual pain-related fear** has been reported to play a key role in the persistence of chronic pain (CP) (Harvie et al. 2017, Meulders 2020; Mazza et al. 2018). Several studies have found significant deficits in precise threat-signals identification in CP patients (Schneider et al. 2004). This failure of effective learning, recognizing and responding to discrete predictors of pain promotes contextual associations with threat, eventually resulting in **contextual pain-related fear conditioning** (Harvie et al. 2017). Contrarily to discrete cues, contexts are uncertain and complex stimuli, for which prediction of harm is much more difficult. Hence, associating a context with pain may lead to hypervigilance and emotional distress, reported to induce diffused pain-related fear and greater avoidance behaviors (Meulders et al. 2012). A conceivable and ecological approach to pain-related fear conditioning in CP patients would be to consider that the continuous learning of associations between pain and daily events involves several and multimodal sensory stimuli rather than single cues, which would translate into a unique representation of the aversive experience, e.g. a specific pain-associated context.

Along with a need for further research on pain-related fear conditioning, experimental models for contextual pain conditioning and associated learning processes are still poorly understood.

PhD Project

The PhD project is divided into two parallel studies:

1. [STUDY I](#) is a preliminary study on **explicit memory** of pain, by means of introductory research exploring oscillatory neural activity correlated with short-term memorization of pain, known to be critical for understanding long-term memory mechanisms. The article is currently under review at *the European Journal of Neuroscience*.
2. [STUDYII](#) is the main research conducted during this PhD and focuses on pain conditioning mechanisms and associated **implicit memory processes**. The study comprises two chapters: (i) chapter 1 consists in explaining the construction of an aversive (painful and non-painful) conditioning protocol using immersive Virtual Reality (iVR), and chapter 2 consists in validating that protocol and analyzing physiological and behavioral mechanisms associated with contextual pain conditioning. The methodological part of this study will soon be submitted to *Behavior Research Methods*.

EXPERIMENTAL PART

STUDY 1: Short-term memorization of pain : a high-density EEG study with source localization

This work resulted in a manuscript currently under review at the *European Journal of Neuroscience* :
*Caldichoury A., Garcia-Larrea L., Frot M. Focal changes in alpha oscillations during short-term
memorization of pain: a high-density EEG study with source localization.*

Focal changes in alpha oscillations during short-term memorization of pain: a high-density EEG study with source localization

Argitxu Caldichoury¹, Luis Garcia-Larrea^{1,2}, Maud Frot¹

¹Central Integration of Pain (NeuroPain) Lab-Lyon Neuroscience Research Center, INSERM U1028, CNRS, UMR5292, Université Claude Bernard, Bron, France

²Centre d'Evaluation et de Traitement de la Douleur, Hôpital Neurologique, Lyon, France

Short Title: Alpha power enhancement during short-term memorization of pain

ABSTRACT

Memories of painful events constitute the basis for assessing patients' pain. This study explores temporal and spatial aspects of brain activity during short-term memorization of a nociceptive stimulus. High-density EEG activity (128-electrodes) was recorded in 13 healthy subjects during a match-to-sample sensory discrimination task, whereby participants compared the intensity of a thumb-located electric shock (S2) with a prior-stimulus to the same location (S1) delivered 8-10sec earlier. Stimuli were above or below the individual nociceptive-threshold. EEG activity with intracortical-source-localization via LORETA source reconstruction was analyzed during the inter-stimuli period, and contrasted with a non-memory-related control task.

The inter-stimulus memorization phase was characterized by a focal alpha-activity enhancement, significant during the nociceptive condition only, which progressed from bilateral occipital regions (cuneus and mid-occipital gyri) during the first encoding - memorization phase toward the right-superior and right mid-temporal gyri during the 2-4 sec immediately preceding S2. Initial alpha enhancement in occipital areas/cuneus is consistent with rapid non-specific inhibition of task-irrelevant visual processing during initial stimulus encoding. Its transfer to the right-temporal regions was concomitant to the temporary upholding of the stimulus perceptual representation, previous to receiving S2, and suggest an active and local blockade of external interferences while these regions actively maintain internal information. These results add to a growing field indicating that alpha oscillations, while indicating local inhibitory processes, can also indirectly reveal active stimulus-handling, including maintenance in short-term memory buffers, by objectivizing the filtering out of irrelevant and potentially disrupting inputs in brain regions engaged in internally-driven operations.

1. Introduction

The recollection of previously endured painful events constitutes the basis for assessing pain in patients, and the way a specific pain is memorized can influence the perception of future pain events (Apkarian et al. 2009). Memory-related mechanisms of synaptic plasticity, such as long-term potentiation and central sensitization, can support the long-lasting imprint of acute pain in the central nervous system and contribute to the transition of acute pain to chronicity (Kissin et al. 2006, Apkarian et al. 2009, Kissiwaa and Bagley 2018, Mazza et al. 2018). Since every painful experience is built both from the perceived sensation and the comparison made with previously undergone pain, the subjective assessment of pain often appeals to long-term memory (LTM) of painful events. However, investigation of the encoding, storing and recalling mechanisms of noxious stimulation is hampered by the impossibility of re-enacting, voluntarily or experimentally, a full painful sensation, except in very exceptional cases (e.g. Lenz et al. 1995).

Nonetheless, certain specific aspects relative to the experience of pain, such as its intensity or duration, can be experimentally assessed via short-term memory (STM) experiments. The mechanisms underlying STM, including working memory (WM), are thought to be highly relevant for understanding the LTM of pain: the quality of early WM processes may condition the establishment of LTM (Bergmann et al. 2013), and memory impairments in clinical pain patients have been shown to be reflected in WM for sensory stimuli (Oosterman et al. 2011; Munoz and Esteve 2005). Clinical studies have demonstrated STM deficits in diseases implying chronic pain symptoms (Moriarty et al. 2011), and a significant decline in performance during WM tasks has been repeatedly found both in patients suffering from chronic pain (Berryman et al. 2013) and in animal models of neuropathic pain (Cardoso-Cruz et al 2018). Therefore, investigating the process of short-term memorization of nociceptive stimuli can give us access to better understanding how maladaptive mnemonic processes of pain retention influence centralized chronic pain induction.

Few previous studies have gathered data on STM for pain. The temporal capacity of short-term memorization of pain stimuli in a sensory discriminatory task was found to have a very rapid decay, between 4 and 14 seconds after stimulus presentation (Rainville et al. 2005). fMRI studies have suggested that regions implicated in the initial integration of a nociceptive signal, such as the somatosensory and posterior parietal cortices and the anterior insula, are reactivated during the memorization phase of the intensity of a painful stimulus (Albanese et al. 2007, Khoshnejad et al. 2017), while memorization of the stimulus duration also activated the inferior frontal gyrus, striatum and middle temporal gyri (Khoshnejad et al. 2017). Electrophysiological studies in humans have shown a power increase in the alpha frequency band over the parietal scalp during a WM task (Wang et al. 2016), and both alpha and beta oscillations appeared to correlate with WM capacity for phasic nociceptive stimuli (Valentini et al. 2017). However, although electrophysiological approaches provided unique temporal resolution inaccessible to functional imaging, previous EEG data were based on scalp distribution from relatively limited electrode density (25-60 electrodes), did not provide localization of the recorded activity in terms of brain generators, and did not consider possible carry-over effects between each memorization block (Rainville et al. 2005, Wang et al. 2016, Khoshnejad et al.

2017). Carry over effects have been shown to interfere with pre-acquired input in short-term memory task, both with verbal stimuli (Jonides and Nee 2006, D'Esposito et al. 1999) and auditory (Ruusuvirta et al. 2006, Visscher et al. 2009), which results in disruption of task performance.

In this study we aimed to tackle both the temporal and spatial aspects of brain activity during the short-term memorization of a nociceptive stimulus using high-density scalp electroencephalographic recordings (128-channel EEG) together with source reconstruction of brain generators in healthy subjects, and controlling possible memory residual effects by introducing a non-memory sensory task between each pain discrimination block.

2. Methods

2.1. Participants

This study was approved by the Regional Ethics Committee (Comité de Protection de Personnes CPP Sud-Est III, n°2014-A01280-47) and sponsored by the French National Scientific Research Council (CNRS). Participants were recruited through university announcements, and were remunerated for their participation. Inclusion criteria required healthy subjects aged 18 – 50 years, affiliated to a social security regimen, and having given their written consent. Were excluded subjects suffering from neurological disorders, chronic pain, under drug treatment with analgesics or drugs that can alter memory performances; and subjects with abnormal short-term mnemonic capacities (tested at the beginning of the experience with the Wechsler Memory Scale, Third Edition (WMS-III: Wechsler, 1997), with an admission score between 7 to 13 points on the numerical test). Of 15 initial participants 2 were discarded due to insufficient WM scores to ensure a good performance during the full test; hence, 13 healthy volunteers participated to the final recordings (21.7 ± 2.2 y.o; 7 women). Based on previous reports under similar WM versus control condition and reporting an effect size of 0.73 (Wang et al. 2016), we estimated that a sample size $n=13$ subjects allows to disclose a difference in power spectral analysis between the memory and the control condition with a power of 79.8% and error $\alpha=0.05$ (Gpower 3.1.9.2).

2.2. Stimulations

Two types of electrical somatosensory stimuli delivered to the hand, nociceptive and non-nociceptive, were used for the experiment.

Somatosensory electrical stimuli were delivered on the right thumb of each subject through a Micromed (ENERGY ©) stimulator. Nociceptive and non-nociceptive stimuli were delivered in different sessions, respectively through a concentric planar electrode (Walter Graphtek GmbH, Lübeck, Germany) and through ring electrodes. As the concentric planar electrode does not enable to deliver non-painful stimuli above perception threshold, ring electrodes had to be used for the non-nociceptive stimulations. The two types of stimuli consisted of monophasic constant current pulses of 100 μ s duration delivered at sub-nociceptive or supra-nociceptive intensities.

For each type of stimulus, two different intensities were used, labeled ‘low’ and ‘high’. Both levels of stimulation were tailored for each subject to ensure that they were identified without errors. For non-nociceptive electrical stimuli, the ‘low’ intensity corresponded to the lowest intensity for which the subject could feel 3 out of 3 consecutive stimuli. For nociceptive stimuli, the ‘low’ intensity corresponded to the lowest intensity for which one given subject evaluated the sensation as ‘painful but tolerable’ in 3 out of 3 stimuli, using the method of limits. Then, ‘high intensity’ stimuli were determined for each subject in the two modalities, at 1.5 times the threshold intensities. If such intensity was not enough to allow distinguishing the two stimulus levels, the ‘high intensity’ stimuli was progressively increased until it allowed 100% discrimination. It was ensured previous to the main experiment that the two intensities were such that (a) each participant could distinguish easily between

them, and (b) they were rated clearly as painful for the nociceptive modality and clearly as non-painful for the non-nociceptive one. Once determined in a given subject, the two intensities in each modality were kept stable during the whole experiment.

2.3. Experimental procedure

Participants were comfortably seated in front of a computer screen. The main experiment consisted in a match-to-sample memory task in two conditions presented in random order: (i) somatosensory painful (SP); (ii) somatosensory non-painful (SNP). Each of the two memory tasks was contrasted with a corresponding control task of same modality, devoid of memory effort (Figure 1). Overall, the experimental phase lasted around 40 minutes.

2.3.1 Memory Task:

The memory session was composed of 32 trials, each formed of two sensory stimuli to be compared (S1 and S2) separated by an inter-stimulus interval (ISI) of 8-10 sec (mean: 9.0 ± 0.6 sec) and followed by a response period. The two stimulations (S1-S2) were always of the same modality (i.e. two nociceptive, or two non-nociceptive). Subjects were asked to indicate if the second stimulus was of higher, equal, or lower intensity than the first one by pointing on the computer screen. Further, they also indicated the subjective certainty of their response by clicking on a VAS, ranging from “not sure” to “completely sure”. To avoid possible residual memory traces between blocks, a visual task was introduced between each block whereby the subject had to detect modifications of a visual stimulus (a square, a circle...) presented on a screen for 2 sec followed by a response time where subjects indicated whether the shape had changed color, form, both or none (Figure 1.A).

2.3.2 Control Task:

Control sessions consisted of 20 consecutive stimuli of same modality (10 ‘high’ and, 10 ‘low’ intensity as described above) presented randomly with an ISI of 8-10 sec (mean: 9.0 ± 0.6 sec). For the nociceptive modality, the subjects had to rate the intensity of each stimulus on a VAS ranging from 0 (no pain) to 100 (maximal pain). For the non-nociceptive modality, the subjects had to rate the intensity of each stimulus on a VAS ranging from 0 (no sensation) to 100 (strong but non-painful sensation). Each modality had its own VAS scale to prevent subjects from rating too closely the ‘high’ and ‘low’ intensities of the non-nociceptive stimulus. To prevent any tendency to memorize the stimuli received, the same visual task as described above was introduced in between each stimulus. This procedure prevented any effort to memorize the somatic stimulus, and allowed comparing the brain activity during the interval between two consecutive stimuli with or without a memory encoding task (Figure 1.B).

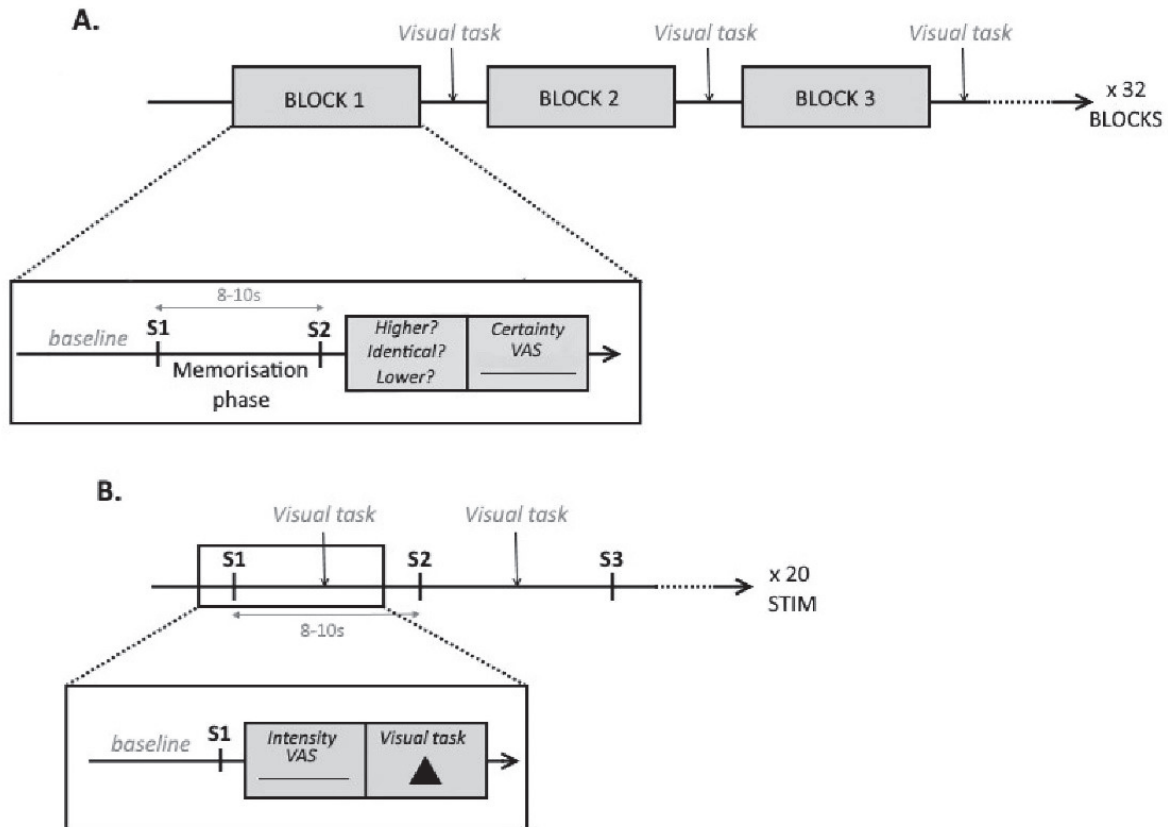

Figure 1 Experimental protocol: A. Memory Task. Thirty-two blocks separated each by a visual task. Each block contains: a baseline period (3s); two painful or non-painful stimulations (S1, S2) with an ISI of 8 to 10s corresponding to the memorization phase; a response period composed of an S1-S2 comparison and a certainty scale (VAS). **B. Control task.** Twenty blocks of 8 to 10s containing each: a baseline period (3s); a painful or non-painful stimulation (S); a response period during which the intensity of the stimulation (S) was to be rated on a VAS; a visual task (4s).

2.4. Behavioral data

For each subject and type of stimulation, ‘high’ versus ‘low’ intensity ratings were compared using Student’s T-test to ensure that the two intensity levels were correctly distinguished. A Student T-test was also used to compare certainty rates between each condition (SP, SNP).

Subjects’ performances on the visual and memory tasks were assessed as the *proportion of correct answers* for each condition (SP, SNP) specifically for the memory task to ensure that performance was different of chance rate of 33% (3 possible answers: *higher, lower and identical*). A Student T-test was used to compare performances across conditions.

Cochran Q test was used to assess possible changes of performance with time. This binary test identifies correct answers as 1 and incorrect answers as 0, hence enabling to assess the difficulty of each question according to the number of 1 and 0 associated. The test was used to ensure that each trial was evaluated equally and that performance did not decline throughout the session.

2.5. EEG recordings and analyses

EEG was continuously recorded during all experimental sessions (control and memory). The recordings were obtained using an electrode cap (Waveguard Cap, ANT) and the Advanced Source Analysis system (ASA™-ANT Software, Netherlands), with 128 electrodes referenced to the nose. Ground was placed on the mid-forehead. An electro-conducting gel was inserted in each electrode to decrease the skin impedance below 5k Ω . Blinks and saccades were recorded on Fp1/Fp2 and F7/F8 electrodes. The EEG signal was continuously sampled at 512Hz, amplified x50.000 and written to hard disk to be averaged and processed offline.

EEG pre-processing, spectral and scalp topographical analyses were performed on BrainVision Analyzer 2.1© (BrainProducts GmbH, Germany). ICA ocular correction was done to clean the raw EEG data. A band-pass filter was applied to the raw EEG between 1 and 100Hz (-3 dB; slope 48 dB/oct and 12 dB/oct respectively) plus a Notch filter at 50 Hz. The signal was segmented into time windows of 2750 ms duration each. In the memory task, three consecutive time-windows of equivalent duration formed one block: (i) a pre-stimulus baseline from -3000 ms to -250 ms before S1 (BL_{MEM}) (ii) an early memorization period (MEM1) ranging from 1000 ms to 3750 ms after S1 thus excluding the event-related potential triggered by the stimulus, and (iii) a late memorization period (MEM2) from 3750 ms to 6500 ms after S1, thus excluding the anticipation activity occurring in the 1500ms before S2 (Figure 2.A). Defining an early and a late stage allowed us to assess the dynamics of the memorization phase. In the control task, only two EEG segments of same duration (2750ms) were used: (i) a pre-stimulus baseline ranging from -3000 ms to -250 ms before S1 (BL_{CONT}) and (ii) one post-stimulus during the control task (CONT) from 3000 ms to 5750 ms after S1 (Figure 2.B) which avoids both the motor response to the post-stimulus VAS (3000ms after S1) and the motor response to the visual task (2750 ms before S2). Segments containing artefacts (blinks, eye movements, muscle artefacts, electrode artefacts) were excluded from the analysis.

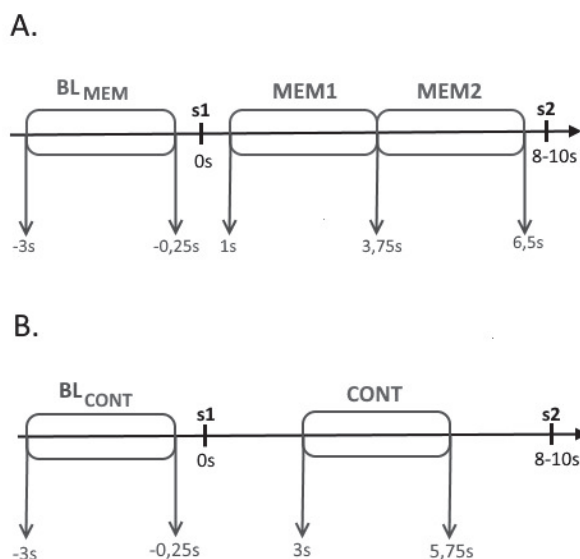

Figure 2 Temporal segments analysis for: A. the memory task (MEM): a baseline (BL_{MEM}) and two periods during memorization of the stimulation intensity (MEM1 and MEM2) and **B.** the control task (CONT): a baseline (BL_{CONT}) and a period during the visual task during which the subject does not memorize (CONT)

A Fast Fourier Transform (FFT) was applied to every segment, dividing their spectral composition into 5 frequency bands: delta [1.0- 4.0 Hz], theta [4.5 -7.5Hz], alpha [8.0-13 Hz], beta [13.5–30 Hz], and gamma [30–45 Hz]. The spectral power of the different segments described above was then averaged according to their position, across all trials, so as to obtain 5 averaged segments per subject, one for each condition: BL_{MEM}, MEM1, MEM2, and BL_{CONT}, CONT. To eliminate non-specific effects, each baseline was subtracted to the corresponding condition: MEM1-BL_{MEM}; MEM2- BL_{MEM}; CONT- BL_{CONT}. To alleviate writing, these subtractions will be referred as MEM1, MEM2 and CONT from here on. The same procedure was done by selecting only correct answer-segments to the memorization task (TRUE) on one hand and incorrect answer-segments (FALSE) on the other: MEM1_{TRUE}, MEM2_{TRUE}, MEM1_{FALSE}, MEM2_{FALSE}, CONT.

For both modalities (non-nociceptive-SNP and nociceptive-SP) and each frequency band, we calculated the standard deviation of the control condition’s spectral power for each electrode: SD_{CONT}. This enabled to perform an observational analysis per electrode by comparing averages and selecting electrode clusters where the spectral power during the memory conditions (MEM1, MEM2) either exceeded the control condition power by at least 1 standard deviation or inversely, was below the control condition data minus 1 standard deviation. These clusters were then defined as regions of interest (ROI), where statistical assessment was applied (table 1). For both conditions (SP, SNP,) and for every frequency bands (delta, theta, alpha, beta, gamma), repeated measures ANOVA were performed on the defined ROI with periods (MEM1 vs. MEM2 vs. CONT) as a within subject factor. The same analysis was performed on correct answer periods (MEM1_{TRUE} vs. MEM2_{TRUE} vs. CONT) and incorrect answer periods (MEM1_{FALSE} vs. MEM2_{FALSE} vs. CONT).

	ROI 1	ROI 2	ROI 3	ROI 4
SP	FFC1h	Cz	TPP9h	TPP10h
	FC&	C2	TPP7h	TPP8h
	FCz	C4	P7	CPP6h
	FCC3h	CCP2h	P5	TP8
	FCC1h	CP2	P3	P8
	C1	CP4	P9	P6
	Cz	CPP2h	PPO9h	P4
	CCP3h	CPP4h	PO7	PPO2
	CP1	P2	PPO5h	PPO6h
	CPP3h	Pz	PO5	PO4
	CPP1h		PO3	PO6
	P1		PPO1	PO8
	Pz		POO3h	PPO10h
			PO9	PO10
			POO9h	POO4h
			O1	O2
			O11h	POO10h
		I1	I2	
			O12h	
SNP	PO6	Cz		
	PPO6h	CPP1h		
	P6	CPz		
	P8	CP1		
	TPP8h	CPP1h		
	PPO10h	Pz		
	PO8	P1		
	O2	CPP3h		
	POO10h	P3		
	POO4h	PPO5h		
	PPO2	PO5		
	P4	PO3		
CPP6h				
P2				

Table 1 ROIs defined by selection of electrode clusters for which the spectral power during memory conditions (MEM1, MEM2) exceeded by at least 1 standard deviation the data during the control condition for painful (SP) and non-painflu (SNP) stimulation.

2.6. Brain source reconstruction

Brain source reconstruction was performed using Low Resolution Brain Electromagnetic Tomography Analysis (sLORETA-Version 20081104). Source localization of spectral differences was performed by applying sLORETA analysis to each 2750ms-EEG segment (Pascual-Marqui 2008). sLORETA estimates the standard current density in 6239 voxels of 5mm³, for each frequency band. These voxels cover the cortical grey matter and the hippocampus, but exclude the thalamus, basal ganglia and brainstem. For the brain model and electrodes positions, sLORETA uses the Montreal Neurological Institute average MRI brain map (MNI-152), corrected in Talairach coordinates, allowing to link brain regions to Brodmann areas.

As the software is unable to import signals in spectral form, the Fast Fourier Transformation was replicated on each EEG taking account of the 8 pre-defined bands of sLORETA, the alpha and beta bands being divided in two and three sub-bands respectively (alpha 1, alpha 2 and beta1, beta2, beta3). The sLORETA was performed in the frequency domain to localize neural oscillators on the average referenced EEG.

Voxel-by-voxel paired post-hoc t-tests on log-transformed sLORETA data were performed to compare CONT and MEM periods. A non-parametric randomized correction (5000 permutations) was applied to limit type I errors (Pascual-Marqui, 2002). This correction procedure is based on a permutation test. Permutation tests, analog to a type of resampling, serve to quantify p-values of a statistical test by analyzing effects under different rearrangements of data points. In other words, as the null hypothesis is based on arbitrary labelling of observations, statistical significance of an experiment can be leveled by comparing distribution of values obtained when labels are permuted (see Nichols T.E and Holmes AP, 2002 for more details).

Signal to noise ratio was bettered by subtracting the baseline to each corresponding condition. The significance threshold was fixed at $p < 0.05$ after correction for multiple comparisons. Only regions for which at least 7 contiguous voxels appeared to have a significant effect were considered as results. Color-coded statistical results were projected onto 3D MRI images (MNI) using sLORETA.

All statistical analyses except sLORETA were performed with JASP® software with significance level set at $p < 0.05$, and Greenhouse-Geisser correction applied to repeated-measures ANOVA when needed. Bonferroni post-hoc corrections were used when necessary. In all the figures, data are presented as mean \pm S

3. Results

3.1. Behavior

3.1.1. Intensity perception

For all types of stimuli, the differences between high and low stimulus intensities were correctly discriminated during the control task by every subject before initiating the memory task. Ratings for ‘low’ and ‘high’ painful pulses were respectively 44.5 ± 11.3 and 64.7 ± 13.4 ($t(12) = 5.82$, $p = 8.3 \cdot 10^{-6}$) on a 0-100 scale where 0 was defined as non-painful and 100 as maximal pain. Ratings for ‘low’ and ‘high’ non-painful stimuli were respectively 27.9 ± 10.9 and 68.9 ± 12.2 ($t(12) = 7.46$, $p = 7.7 \cdot 10^{-6}$) on a 0-100 scale where 0 was defined as non-felt and 100 as non-painful but perfectly felt (Figure 3A).

3.1.2. Performances on the visual task

The visual task was introduced between memory blocks to erase possible residual memory traces between blocks in the memory condition, and to prevent unwanted recollections in the control task (see methods). For every type of stimulation and for both conditions (control and memory), a high score of correct answers was obtained in the visual discrimination task ($>97\%$ correct responses in each condition), with no significant difference between conditions and sessions.

Results of the Cochran Q test showed no significant difference in the distribution of correct and incorrect responses to the memorization task throughout the stimulations for every condition ($Q(45) = 25.6$, $p = 0.79$; $Q(45) = 26.6$, $p = 0.78$ for SP and SNP conditions respectively), indicating that there were no significant changes in performance over time.

3.1.3. Performances on the Memory Task

Overall, the rate of correct answers was well above the chance rate of 33% for both SP and SNP conditions ($48.01 \pm 9.31\%$, $58.24 \pm 14.7\%$, respectively) with 11 out of 13 subjects being above 40% rate of correct answers for the SP condition and 10 out of 13 above 50% for the SNP condition (Figures 3B and 3C). The number of correct answers was higher when subjects compared non-painful relative to painful stimuli, but the difference was barely significant ($t(12) = 2.12$, $p = 0.045$) (Figure 3C).

The certainty rate (estimating the confidence subjects had in their responses accuracy) was also high for all conditions (SP, SNP) ($74.13 \pm 12.31\%$, $69.99 \pm 11.96\%$ respectively). No significant differences in certainty rates were revealed neither between conditions (SP, SNP) nor between correct and incorrect answers within a type of stimulation. No correlation was found between certainty rate and number of correct responses.

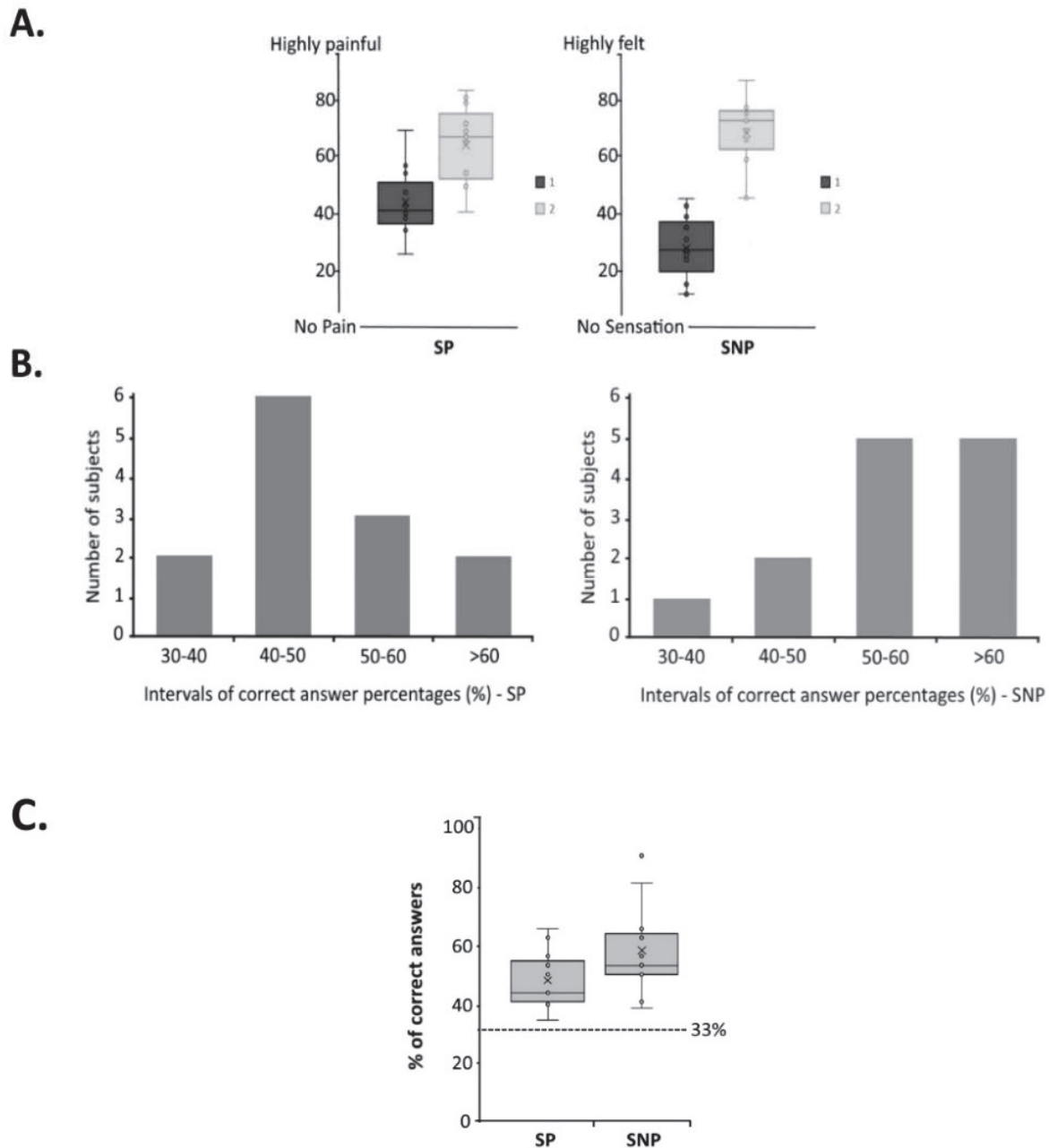

Figure 3 A. Average ratings of low (1) and high (2) intensities for the SP stimuli with a scale rating from “non-pain” to ‘highly painful” and the SNP stimuli with a scale rating from “no sensation” to “highly felt”. B. Number of subjects per interval of correct answer percentages for SP and SNP stimuli. The highest number of subjects was in the 40 to 50% of correct answers percentages for SP stimuli and above 50 % of correct answers percentages for SNP stimuli. C. Percentage of correct answers for SP and SNP conditions above chance rate (33%). * $p < 0.05$; * $p < 0.001$; SP: somatosensory painful; SNP: somatosensory non-painful**

3.2. EEG Recordings

3.2.1. SP and SNP conditions compared to the control period

Visual analysis indicated a prominent effect in the alpha band in both the SP and the SNP condition, with a power increase during the memorization period (MEM1, MEM2) relative to the control period (CONT) (Figure 4,5A). The alpha power appeared to progressively intensify from period CONT to MEM 1 to MEM2, and also from condition SNP to SP (Figure 4). Single electrode analysis in each frequency band confirmed that the spectral power in the alpha band was the only EEG band that exceeded 1*SD of the control period in both conditions (SP and SNP), and this during both the MEM1 and MEM2 periods (Figure 5B). No electrodes had a spectral power below the control period minus 1*SD. No other effect was apparent in the other frequency bands.

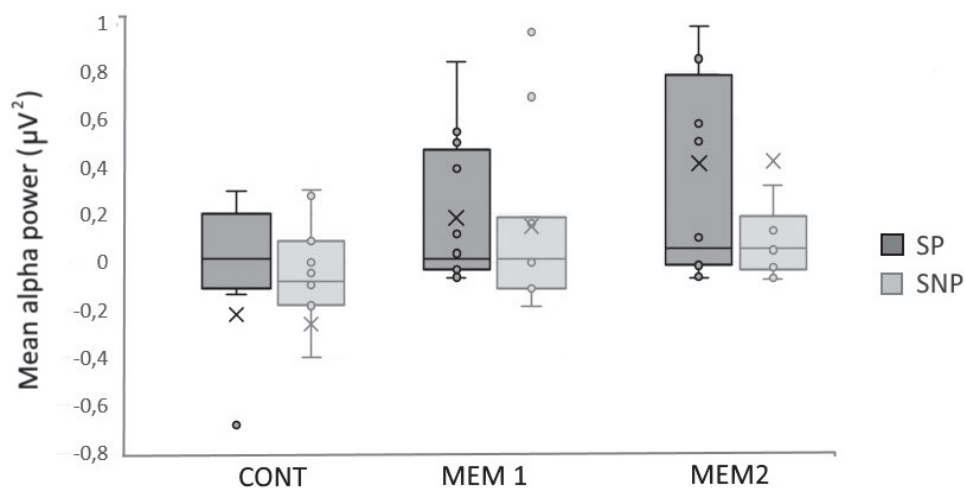

Figure 4 Mean alpha power (μV^2) for the painful (SP) and the non-painful (SNP) conditions during the control period (CONT) and in the memorization periods (MEM1 and MEM2). For each period and condition, the Standard error of means is represented (SEM)

For the pain (SP) condition, memorizing a nociceptive stimulus came with an alpha increase in bilateral parieto-occipital regions during the first memory period MEM1, which then expanded to centro-parietal and right parieto-temporal regions during the late period MEM2 (Figure 5B), thus defining four ROIs detailed in table 1. Results of the repeated-measures ANOVA on these ROIs showed a significant effect of analysis window (MEM1 vs. MEM2 vs. CONT) with a significant increase in the left parieto-occipital region (ROI 3: $F(3,12) = 9.718$; $p = 0.009$) during MEM1 compared to CONT ($t(12) = -3.029$; $p = 0.034$) and even more so during MEM2 compared to CONT ($t(12) = -3.252$; $p = 0.023$) which also appears in the right parieto-temporal and occipital region (ROI 4: $F(3,12) = 8.094$; $p = 0.015$) specifically during MEM2 ($t(12) = -2.931$; $p = 0.041$). Analysis on TRUE segments revealed a significant increase during MEM 1_{TRUE} compared to CONT in the right-parieto-temporal and occipital region (ROI 4: $t(12) = 2.701$; $p = 0.037$) which does not appear for FALSE segments (Figure 5C).

For the non-painful (SNP) condition, MEM1 alpha power also exceeded 1SD of CONT alpha power in the right parieto-occipital region, which slightly expanded to centro-parietal and left parietal regions in MEM2 (Figure 5B) thus defining two ROIs detailed in table 1. However, repeated-measures -ANOVA on these ROIs revealed no significant effect of the period. Although spectral changes during the memory tasks were significant in the pain (SP) condition but not in the SNP, direct spectral composition comparison between the two conditions showed no significant differences in any frequency band.

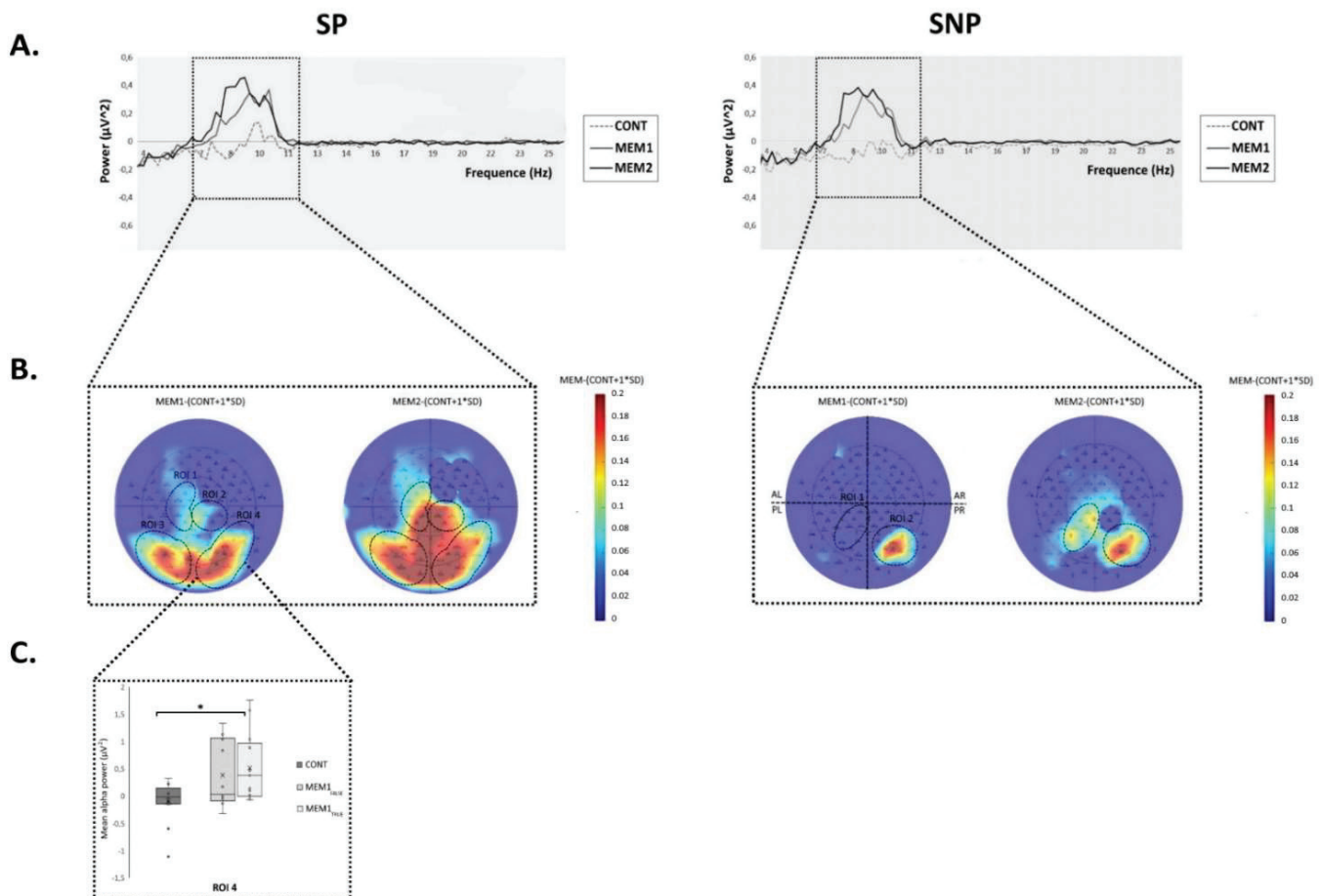

Figure 5 A. Spectral graphs between 0 and 25 Hz for the painful (SP) and the non-painful (SNP) conditions during the first phase of memorization (MEM1- grey line), the second phase of memorization (MEM2- black line) and the control task (CONT-dashed grey line). Note that since temporal segments (MEM1, MEM2, CONT) last 2750 ms only, the delta band was excluded from analyses as frequencies under 4Hz complete one cycle or less under such time length. The rectangle in black dotted line shows the frequency bands for which the power values appeared different for the memory periods (MEM1 and MEM2) compared to the control period (CONT). **B. Observational analysis per electrode:** comparison of averages for which the spectral power during the memory conditions (MEM1, MEM2) exceeded by at least 1 standard deviation the data during the control condition for non-painful stimuli (SNP) and painful stimuli (SP). The color scale represents the difference between the memory condition (MEM1, MEM2) and the control condition + 1SD (CONT+1SD) with zero corresponding to no difference between the two conditions. **ROI: Region of interest.** AL: Anterior-Left; AR: Anterior-Right; PL: Posterior-Left; PR: Posterior-Right. **C. Mean alpha power (μV^2) for the painful (SP) condition in ROI4 during the control period (CONT) and the first memorization period for TRUE segments (MEM1_{TRUE}) and FALSE segments (MEM1_{FALSE}). * $p < 0.05$**

3.2.2 Brain source reconstruction

A significant current density increase was observed in the low alpha frequency band during memorization of the nociceptive stimulus intensity only, and this during the two memorization periods (MEM1 and MEM2) (Figure 6). During MEM1, this effect was significant in both occipital lobes (cuneus and middle occipital gyri) and the right temporal lobe - middle and superior temporal gyri - ($t(12) = 5.714$; $p < 0.05$). During MEM2, the current density increase was significant in the right temporal lobe - middle temporal gyri and supramarginal gyri - ($t(12) = 5.813$ $p < 0.05$), and even more so in the right superior temporal gyri ($t(12) = 7.232$; $p < 0.01$). Coordinates of the most significant voxels are shown in table 2. No further difference was found when separating TRUE segments and FALSE segments for the nociceptive condition.

No significant effects were observed during the SNP condition.

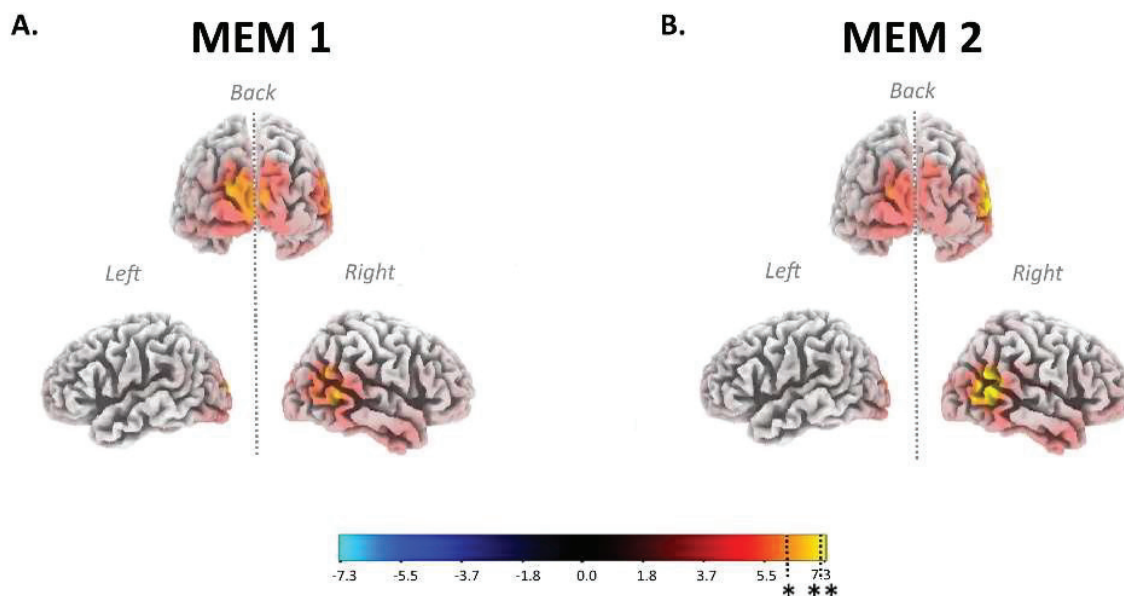

Figure 6 Current density increase in the lower alpha frequency band during memorization of a painful stimulus vs. during control task. For each memorization period (MEM 1 and MEM2), 3 views are represented: first row: back; second row: left, right. **A.** First period of memorization (MEM1), significant effect in 61 voxels of the occipital lobe (bilateral cuneus and bilateral middle occipital gyri) and 26 voxels of the right temporal lobe (superior and middle temporal gyri). Threshold $t = 5.714$ for $p < 0.05$. **B.** Second period of memorization (MEM2), significant to highly significant effect in 57 voxels of the right temporal lobe (superior and middle temporal gyri, supramarginal gyri). Threshold $t = 5.813$ for $p < 0.05$, $t = 7.232$ for $p < 0.01$.
* $p < 0.05$ ** $p < 0.01$

	Frequency bands Range (Hz)	Brain Region (Brodmann area B)			Local maximum			
		Left	Bilateral	Right	Brain Area	X	Y	Z
MEM 1	Alpha 1 8.5-10.0		Cuneus (B17) Middle occipital gyri (B19)	Middle temporal gyri (B21) Superior temporal gyri (B22)	Middle temporal gyri Cuneus	65 -5	-50 -90	5 5
MEM 2				Middle temporal gyri (B21) Superior temporal gyri (B22)	Superior temporal gyri	65	-50	10

Table 2 MNI coordinates of each cluster's most significant voxel for the alpha frequency band during memorization of a painful stimulation

4. Discussion

The goal of this study was to analyze, in healthy subjects, the brain oscillatory activity during the short-term memorization of the intensity of a somatic stimulus, nociceptive or non-nociceptive, both delivered to the same distal body region. Focal activity in the alpha band was enhanced during both memorization conditions relative to the control task, but such effect was statistically significant exclusively during the nociceptive condition. Spectral differences between the memory and the control conditions were localized by source analysis in parieto-occipital and temporal brain regions, with a right-hemisphere predominance.

Parieto-occipital oscillatory activity in the alpha band during short-term memorization is commonly interpreted as reflecting the inhibition of brain areas irrelevant to the memorization task at hand (e.g. Klimesch et al. 2006, Dipoppa et al. 2016, Lozano-Soldevilla 2018). However, a number of studies have challenged the all-inhibitory role of alpha, and suggested a direct implication of the processes underlying alpha oscillations in selective attention and the maintenance of relevant information in memory stores (Piantoni et al. 2017; Schroeder et al. 2018; Palva et al. 2007). . Here we posit that the two views are complementary rather than contradictory: while alpha activity may indeed reflect inhibition of external input, it does not reveal a non-specific ‘idle state’ of the cortex, nor it merely represents the inhibition of task-irrelevant regions, “thus routing information to task-relevant regions” (Jensen and Masaheri 2010). While such re-routing may be true in some cases (see below), alpha enhancement can also be essential to the performance of *task-relevant* regions as well, especially when the task involves internally-generated information, as is the case during the maintenance of perceptual representations. By allowing networks to work without perturbation, the blockade of external inputs to an active brain region may be essential to the stabilization of percepts. This is consistent with our present results, and also with recent reports of visual alpha enhancement associated with stable perceptual representations during the alternate experiences of a bi-stable Necker cube (Piantoni et al. 2017).

Short-term memorization of a sensory stimulus needs to activate systems that both ensure stabilization of the information to be retained, and suppression of alternative unrelated activity. It has been posited that working memory (WM) is made of non-discrete phases characterized by two main neural processes: an ‘early’ stage establishing an internal perceptual image of the stimulus and a ‘late’ stage that maintains the mental image in memory (Bergmann et al. 2013, 2015). In the same vein, Khoshnejad et al. (2013) described the process of pain memorization as consisting firstly in transforming the nociceptive signal into a mental representation of pain, and then storing the latter as an implicit memory. In both of these models, the initial WM phase requires active processes for (i) establishing an internal perceptual model and (ii) suppress the handling of non-relevant concomitant sensory input. Alpha enhancement during this early phase was localized in visual regions, and may correspond to a non-specific inhibition of visual input during the formation of an internal representation of the

nociceptive stimulus. Indeed, this early phase is particularly vulnerable to incoming task-unrelated material and competing perceptions (Bergmann et al. 2013; Piantoni et al. 2017), and the alpha enhancement observed in occipital visual areas has been suggested to reflect such inhibition of distracting input (ElShafei et al 2018, Sghirripa et al 2021). In parallel, the concomitant oscillatory enhancement that we observed in the cuneus, known to play a crucial role in the conscious perception of one's own body (e.g. Whitlock, 2017), might echo its contribution in the development of a perceptual image of pain.

In addition to the early alpha enhancement in occipital areas and cuneus, a significant later increase in alpha current density occurred in the right temporal gyri, which started in MEM1, but greatly strengthened during MEM2, just before the presentation of the second stimulus. In the framework of the two-stage models of WM, this late phase should involve processes contributing to the maintenance of the 'mental image' of the first stimulus in memory previous to establishing a comparison with the second stimulus of the pair (Bergmann et al. 2013, 2015; Khoshnejad et al. 2013). Although the right superior temporal gyrus is commonly associated to visuo-spatial processing (Karnath et al. 2001, Shah-Basak et al 2018) it is also thought to play a role in multimodal alertness (Thiel and Fink 2007), and more recently in the memory maintenance of both auditory (Fritz et al 2016) and pain stimuli (Houdé et al 2020). It is therefore tempting to consider that the enhanced right temporal alpha current density was associated with some processes involved in the maintenance of the neural configuration corresponding to the perceptual representation (MEM2). As stated above, such an interpretation of alpha activity is not necessarily contradictory with its inhibitory role, since blocking external inputs may be essential to safeguard the processing of internal (vs. external) information in active brain regions. In support of this view, Lim et al (2015) reported a direct association between enhanced alpha power in the superior and middle right temporal gyri and representational precision, and a stronger alpha increase in right parieto-temporal regions paralleled in our subjects a well-performed task. We can speculate that the inhibitory role of alpha oscillations may be 'heterotopic' and non-specific when it occurs in regions *different* from those receiving and processing external stimuli, or on the contrary 'homotopic' and specific when it arises in regions directly involved in the processing of internal information.

Behavioral analysis showed a decay in performances when it came to memorize nociceptive stimulations compared to non-nociceptive input. A possible explanation may be that the intensity of the second nociceptive stimulus is poorly evaluated due to pain anticipation, thus biasing its comparison to the first one. Pain anticipation may lead to a 'nocebo' effect creating an expected hyperalgesia, as is suggested by the pre-activation of pain- and emotion-related areas, when subjects expect the arrival of a nociceptive stimulus (review in Palermo et al. 2015). One could also consider that the encoding of the first stimulation was erroneous; however, during the non-memorization control task, subjects correctly

evaluated and discriminated the different intensities of the stimulation, suggesting that the first stimulation was probably well encoded.

Limitations of the study:

The most important limitation of this study is the relatively small subjects' sample that could be investigated. Two of the initial subjects had to be discarded because of insufficient performances in memory tasks, and changes in the lab's technical settings precluded adding more participants to the sample. The behavioral and electrophysiological results were however reliable and in general highly significant, and our settings allowed for a power of ~ 0.8 with the number of subjects analyzed; we are therefore confident on the reliability of the results, which should be seen as exploratory. Lack of analysis of possible changes in the gamma band can also be considered as a limitation, since gamma activity has been considered as a direct reflect of both external and internal local information processing (Strube et al. 2021, Yang et al. 2020, Balconi et al 2008, Kaiser and Lutzenberger 2005). The gamma oscillatory activity is however highly sensitive to contamination from high-frequency artifacts, mostly muscle activity whose spectral content largely overlaps with it (Nunez and Srinivasan 2010) and was shown to preclude gamma analysis during pain experiments (Chouchou et al 2021). Intracranial EEG recordings in patients implanted with intracerebral electrodes might be in the future the best option to explore alpha-gamma coupled activity in pain memorizing experiments.

Although previous data have revealed a collateral effect of posterior alpha enhancement on a somatosensory attentional task performance (Haegens et al. 2012), the behavioral consequence of alpha increase has scarcely been described, and our results remain too faint to conclude any direct causality.

Conclusion:

Overall, this study suggests that part of the operations underlying short-term memorization of pain intensity are reflected by activity increase in the alpha band. The initial phase of encoding (MEM1) was associated with by a bilateral parieto-occipital alpha current density increase interpreted as a non-specific-gating and suppression of potentially disrupting input processing. This was followed by a right temporal enhancement of alpha current density which increased and stabilized during the late memorization phase, and could play a role in blocking external input to regions actively maintaining internally generated representations. Such differences between 'heterotopic' and 'homotopic' changes in alpha activity deserve further investigation, probably using intracerebral recordings to allow precise localization and comparison with changes in higher (gamma) EEG spectral changes.

REFERENCES

References are added at the end of the Thesis manuscript.

Author Note:

This work was supported by a grant from Rhône-Alpes region (ARC-2 Qualité de vie et vieillissement), and the Labex CORTEX (ANR11-LABX-0042; ANR-11-IDEX-0007).

The authors declare no competing interests.

STUDY 2: Contextual pain conditioning in healthy subjects: a study using immersive Virtual Reality.

This study is presented in two chapters:

- ❖ **Chapter I** details the conception of a contextual conditioning protocol in immersive virtual reality (iVR) by (i) firstly, presenting the programming of a virtual apartment using 3D modeling software (**Part A**) and (ii) secondly, explaining the use of that virtual apartment as context in an aversive (painful and non-painful) conditioning protocol (**Part B**).
- ❖ **Chapter II** presents behavioral and physiological data obtained on 60 healthy participants to the conditioning experiment, their analyses and interpretation.

CHAPTER I: Methods - Building a contextual aversive conditioning protocol in immersive Virtual Reality

Since the beginning of Pavlov's conditioning paradigm, many experiments have issued since in the field of fear or threat conditioning, in animal and human studies. The benefit of animal studies is the convenience in creating paradigms where the animal's entire surroundings serve as stimulus to be conditioned, thus simulating **contextual fear conditioning**. The inability to reproduce such ecological settings in human studies has led researchers to turn to Virtual Reality (VR) as a working tool. Indeed, to compromise between laboratory dispositions/experience requirements and real-life situations, VR, specifically immersive VR (iVR), offers a new dimension to contextual conditioning protocols in human studies. In the last ten years, iVR technology has been used to investigate various characteristics of contextual fear conditioning – such as avoidance behavior, gaze behavior, extinction effects and physiological responses (Kroes et al. 2017, Houtekamer et al. 2020, Reichenberger et al. 2020, Binder and Spoormarker 2020, Huff NC et al. 2010). In line with this ascent, our goal was to combine our interest in pain conditioning and iVR technology to investigate both painful and non-painful aversive contextual conditioning in healthy subjects. This chapter details how the contextual aversive conditioning protocol was built in iVR.

The chapter is composed of two parts: **Part A** focuses on the development of the context for the conditioning protocol: an ecological virtual environment created using game motor and 3D modelling software later used. This part also converses the uprising of VR as a working tool in behavioral research and our contribution to the later, as well as discuss how our environment can be improved for future studies; **Part B** focuses on the making of a contextual aversive conditioning protocol in healthy subjects by the means of iVR and arguments the use of this technology to optimize contextual stimuli in human studies and overall conditioning paradigms.

Part A: Conception of a 3-roomed apartment in immersive Virtual Reality – a novel tool for behavioral experiments

1. Introduction

The concept of Virtual Reality (VR) has first been introduced in the 1960's by Ivan Sutherland as a *kinesthetic display* that stimulates various senses simultaneously (Sutherland, 1965), which subsequently evolved into a 3-ingredient formula including: immersion, sense of presence in the virtual reality and interaction with that reality (Andersen and Thorpe 2009, Slater 2009, Sundar et al. 2010). Specifically, immersion is characterized by the number of sensory modalities involved, the level of synergy with the virtual environment (VE) and its resemblance to reality that relies on the operated technological devices' assets (Slater et al. 2009). Immersive systems commonly conjoin multiple sensory outputs including head mounted displays (HDMs) which offer a 360° field of vision coordinated with the user's head movements, often accompanied by audio and haptic devices (Cipresso et al. 2018). VR expertise purposely creates worlds that increasingly reflect reality though only occurring in computer memory (Botella et al. 2017). The virtual experience entails the illusion of presence expressed as the combination of physical and emotional belonging to the virtual world in which our actions have repercussions (Botella et al. 1998, Lombard and Ditton, 1997, Riva et al. 2015).

This singularity of immersive VR (iVR) systems has in the last 10 years attracted numerous researches in various fields, such as neuroscience, psychology and education among others, that recourse to VR devices as a work-related tool (Cipresso et al. 2018), extending from experimental investigation to clinical practice (see Botella et al. 2017 for extensive review). The purpose of adopting VR techniques in a laboratory-framework is to construct ecological settings that allow to present and control concurrent stimuli within a dynamic and malleable environment, combined with reliable behavioral and physiological measurements (Rizzo et al. 2012), thus offering an enhanced generalizability of results (Baños et al. 1999). Indeed, VR use in pain management has been proven as an efficient distraction tool to minimize experimental and clinical pain (Keefe et al. 2012, Honzel et al. 2019, see for review: Garrett et al. 2014, Morris et al. 2009, Triberti et al. 2014) including in chronic pain patients (Morales Tejera et al. 2020, Garcia-Palacios 2015). This technology has also been widely used in stress-related disorders for which imaginal exposure therapy, limited by patients' ability to reconstruct and reengage with traumatic event, has been substituted for VEs replicating real life settings, that offer a more flexible and adaptable work environment, which long-term benefits have been certified (Botella et al 2015, Motraghi et al. 2014) specifically in extinction training i.e. exposure therapy for post-traumatic stress disorders (see review Maples-Keller et al. 2017). Out of several research applications, we noted a growing appeal of iVR systems in conditioning paradigms (Kroes et al. 2017, Houtekamer et al. 2020, Reichenberger et al. 2020, Binder and Spoormarker 2020, Huff NC et al. 2010), focusing on various behavioral and physiological aspects of fear or threat conditioning. In particular, these studies used iVR to optimize contextual stimuli, thus sourcing our interest in using this innovative technology.

However, we noted that laboratory means often resort to pre-fabricated items or even entire environments available cost-free on the cross-game platform engine Unity (Unity Technologies, www.unity3d.com) typically used to establish VEs. Although very efficient, these elements remain visually basic which enhances their cleavage with the outside real world and possibly deteriorates the quality of immersion. Indeed, the quality of VR experience relies on the correspondence between the visual stimuli and the level of expectation of the user (Baños et al. 2000): the higher is the similarity between the virtual stimulus and real-life stimulus, the closer to reality is the outcome of the user's behavior. Considering most studies focus on behavioral measurements, tackling this issue could contribute to better iVR systems as a profit for experimental research.

As VR systems continue to carve their way into experimental tools, our project serves to contribute to that uprising by offering a virtual apartment fabricated from the ground up, for which every single item was modeled so to ally realism, practicality and immersion quality in experimental settings. Initially created for the purpose of conditioning paradigm type experiments, our immersive 3-room apartment is intended as a benefit for future behavioral experiments. In this part, the methodological genesis of the virtual environment, its end-result quality of use and an example of integrated cognitive task are presented.

2. Methods

2.1. iVR Equipment

iVR system : The iVR system used was the HTC VIVE technology which comprises VR headset, cameras called base stations and a set of controllers. VR headset display offers a 360° field of vision (120° horizontal, in a stable position), with a refreshing framerate at 120Hz, which translates into a smooth display of movement. Pixel resolution goes up to 2448x2448 pixels per eye-screen. HTC VIVE headset and controllers are compatible with SteamVR® 1.0 and 2.0 base stations which detect the headset position (user's position) and configurate the field of movement available. Cameras are placed in all corners of the room to define the movement space range: 10m x10m range of movement with four base stations and 5mx5m range with two stations (see details on product: <https://www.vive.com/fr/product/vive-pro2-full-kit/specs/>).

Computer settings : Robust computer requirements are needed for correct iVR functioning. The processor used was an Intel® Core™ i7-7700K CPU at 4.20GHz with the NVIDIA GeForce GTX 1060 6GB graphic card under Windows® 10 exploiting system.

2.2. VR software

The environment context was created in VR. Two software were used to model and build the environment: Blender2.92 ® and Unity 2018.2.16f1 ®.

Blender ® is a free and open software offering a wide range of tools for 3D creations in particular the following used to create the elements of our environment: modeling, rigging, rendering, compositing and texture painting.

Unity ® is a free and open game engine platform developed by Unity Technologies, www.unity3D.com. This software is easy to use for beginners and provides a full-range of tutorials to learn proper usage. It is mainly used for 2D and 3D video-game development. For our protocol, the 2018 Unity version number 2.16 was used to construct the virtual environment with the modeled elements in Blender as well as program movement, effects and over-all time line of the experiment. Coding is done in C# on the Visual Studio platform which is directly plugged in Unity.

Visual Studio is a developing platform software which comprises a set of tools that uses different coding languages such as Visual Basic, Visual C++ and Visual C#. Every coding language share the same *integrated development environment* (IDE) which is a set of tools and database that enables to enhance coding productivity for software-creating programmers by automating events and simplifying processes.

Within the framework of Unity, we use C# coding and appeal to various database such as: *System.Collections*, *System.collections.Generic* and *UnityEngine*.

For our virtual environment, we mainly scripted *classes of objects*. In Visual Studio an object is a combination of code and data that are handled as a single item. Every object is defined by a class. A class

describes variables, properties, procedures and events of an object. Objects are instances of a class. Once a class is defined, as many objects as needed can arise from this class.

HTC Vive plugin Unity® : To implement Immersive VR in Unity, the need to plugin Virtual glasses into the Unity project is essential to project the game screen as a 3-dimensional scene with a 360° overview. Unity asset store provides the VIVE Input Utility (VIU), which is a toolkit that enables developing immersive VR practices specifically with the HTC VIVE/VIVE Pro glasses. For more information on the package content check the [asset store website](#).

2.3. Virtual environment:

The virtual environment is a three-roomed apartment composed of a kitchen, a living-room, a bathroom all separated by a central round-shaped hallway (figure 1).

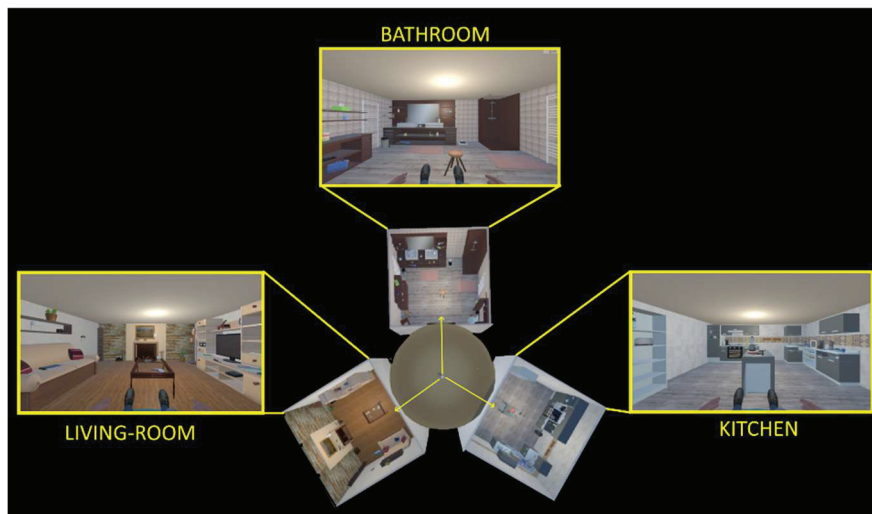

Figure 1: Virtual environment modeled in Blender® and Unity®, comprised of a central hallway, a kitchen, a living-room and a bathroom.

2.3.1. Apartment conception:

To build the main shape of the apartment, simple 3D polygons were glued together in Blender®: a hollow cylinder long enough to create a rounded wall and two flattened cylinders for the ceiling and ground of the hallway; six flattened cubes to create the walls, ceiling and ground floor of the three different rooms. Once every polygon is placed correctly in Blender so to create the core frame of the apartment, the latter is uploaded in Unity® as one single object: from Blender the file is exported and named as a ‘. fbx’ file named ‘Core shape’ that is saved directly in the Unity Project’s **Assets folder** (figure 2C). The file is then introduced in the main **Scene** of Unity (figure 2B) (space in which environments are set up) attached to an empty *GameObject* named ‘APPARTEMENT’ in the **Hierarchy** section (figure 2A).

GameObjects in Unity are fundamental items that embody scenery, props and characters. When created, these items are empty as they merely serve as vessels for components which instrument their functionality. Here,

by attaching the apartment polygon to a *GameObject* we can manipulate the latter as an object. The concept of *GameObject* allows to define a hierarchy between components in Unity (figure 2A). For example, if we define the core of the apartment as a higher order vessel, then every sub-item attached to the latter follow the same guidelines attributes to the apartment shape. Every *GameObject* and its sub-items can be modified via the **Inspector** section (figure 2D), in which transformations (position, rotation and scale), rendering, scripts, texture and physics attributes are defined.

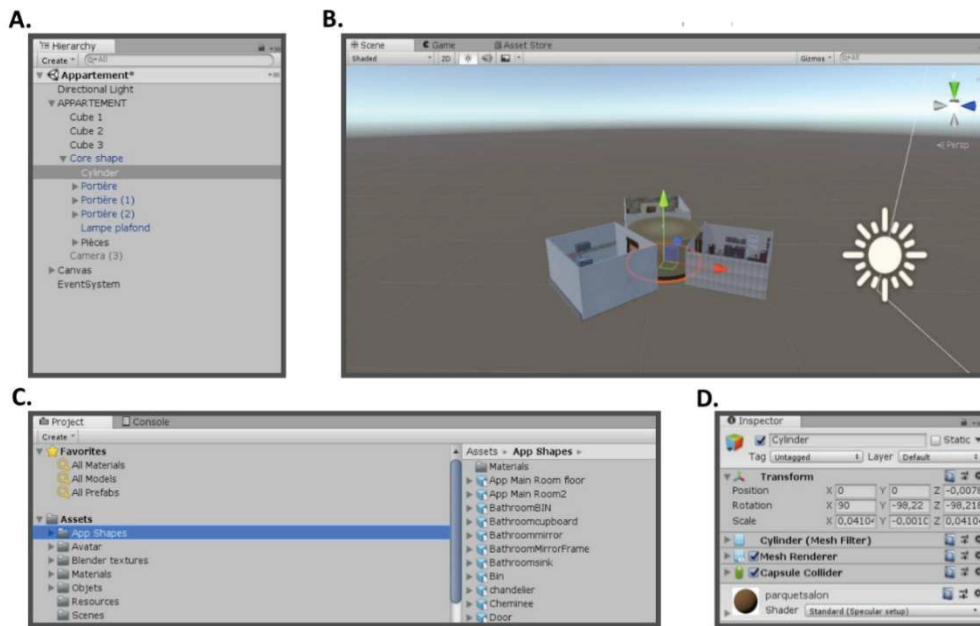

Figure 2 : Working tool windows in Unity. **A.** Hierarchy section, this section defines *GameObjects* and sub-items hierarchy of the environment placed in the main workspace: Main Scene **B.** Main Scene: this section enables to construct the scenery of the environment by introducing and positioning the different items selected from the Assets folder **C.** Asset's folder: this folder contains every file needed for the environment (blender imported files, textures, materials, scripts, plug-ins, packages) which are modified in the Inspector section **D.** Inspector section: this section enables to read and/or transform, define and edit every item imported into the asset's folder.

Each room except for the hallway is composed of a numerous amount of furniture allowing to recognize its function (table 1). The furniture is created in Blender® and imported into Unity® by following the same procedure described here above.

Living Room	Bathroom	Kitchen
Chandelier	Cupboard	Bin
Chimenea	Door	Center island
CD Cupboard	Mirror/Frame	Cupboards
Cushion	Laundry-bin	Chair
Door	Plug	Door
Glass-Table	Sink	Hanger
Frame	Shower wall	Induction hob
Lamp	Shower glass doors	Kitchen cabinet
Shelves	Shower column	Kitchen counter
Sofa	Stool	Microwave
Side table	Switch	Oven
Painting	Toilet	Oven clock
Television	Toilet paper	Shelves
Television cabinet	Toilet paper holder	Sink
Under glass table	Towel hanger	Wall cupboards
Wood-cage	Rug	Wall paper

Table 1 List of furniture modeled in Blender® for each room: living-room, bathroom and kitchen. Each furniture item is imported in Unity® as a *GameObject*.

2.3.2. Object fabrication:

A total of 153 objects were modeled in Blender® (51 objects per-room). Although pre-fabricated objects can be found directly in the asset store of Unity, the latter does not offer this amount of variety in the repertoire of room specific objects, nor are all items cost-free. The goal here was to not only create our own personalized objects but also optimize their realism and identification. The list of objects is given in table 3

LIVING-ROOM	BATHROOM	KITCHEN
Aloe Vera	Alcohol disinfectant	Aluminium foil
Ashtray	Cleaning brush	Baking mold
Book	Cleaning bucket	Baking whip
Box cutter	Cleaning glove	Blender
Cactus	Comb	Bread knife
Calculator	Cotton bud	Bottle opener
Calendar	Cotton face cleanser	Bowl
Camera	Deodorant	Can opener
Candle	Disinfectant spray	Casserole
Candle igniter	Drug box	Cheese
Card deck	Electric razor	Chopper
CD Box	Eye drops	Cutting board
Cellphone	Face cream	Coffee machine
Chessboard	First aid bag	Coffee filter machine
Coaster	Hair brush	Dish-holder
Compass	Hair clipper	Dish-washing liquid
DVD Player	Hair dryer	Electric whip
Eraser	Hair gel	Fruit basket
Firefighter truck toy	Hair straightener	Funnel
Fireplace equipment	Hair scissors	Glass
Fireplace wood basket	Lipstick	Graper
Glass statuette	Mascara	Hand blender
Glu	Mirror	Jug
Headphones	Nail clipper	Kitchen rug
Home phone	Nail file	Matches
Keys	Nail polish dissolvent	Meat fork
Knitting needles	Nail polish	Meat tenderdizer
Knitting thread	Nail scissors	Mug
Laptop	Perfume	Multi Graper
Legos	Razing blade	Pan
Lighter	Razor	Paper wipe
Magazine	Shampoo bottle	Pepper grinder
Measure tape	Shaving creme	Peeler
Metal statuette	Shower brush	Plate
Notebook	Soap pump	Rolling pin
Pen	Solid soap	Shower
Picture frame	Sun screen	Spatula
Piano	Tissue paper box	Sponge
Plant	Thermometer	Table fork
Post-its	Toilet paper	Table knife
Radio	Toilet brush	Table spoon
Remote control	Toilet bag	Teapot
Speakers	Toilet glove	Toaster
Stapler	Toilet plug	Tupperware
Stereo	Toothbrush	Waffle iron
Sunglasses	Toothpase	Water bottle
Table clock	Tooth thread	Water heater
Vase	Tweezers	Wine glass
Wifi box	Towel	Wooden spoon

Table 3 List of 153 objects modeled in Blender @ 51 objects per room (living-room, kitchen and bathroom)

Objects were selected following the Bank of Standardized Stimuli (BOSS, Brodeur et al. 2014). The BOSS normative databank classifies visual stimuli of objects according to their percentile of *no-recognition*,

called *Don't Know Object* percentile (*DKNO%*) (number of no recognition/number of input) and percentile of *no-naming*, called *Don't know Name* percentile (*DKN%*) (number of no name given/number of input).

We based our selection primarily on *DKO%* as recognition of objects was our priority. Objects for which *DKO%* was less than 20 percent were chosen for our environment out of which 68.6% percent have a *DKO%* equal to 0 i.e. systematically identified objects (82% of kitchen-objects, 75% of living-room objects, 49% of bathroom-objects) (table 4). Overall, mean *DKO%* was inferior to 3% for each room. However, out of the 51 objects created per room, some did not appear in the BOSS normative databank: 3 of the kitchen objects, 7 of the living-room objects and 12 of the bathroom objects. To verify correct identification of these objects, the latter were tested during pilot phase of the study (see “iVR testing” below). Details of Objects BOSS norms are given in supplementary data.

ROOM	Nb of input	DKO%	DKN%	Nb DKO%=0	Nb DKO%<10	Nb DKO%<20	Nb Missing
Kitchen	39	1.8	7.2	42	2	4	3
Living-room	39	1.6	3.7	38	2	4	7
Bathroom	35	3.0	4.3	25	9	5	12

Table 4 Mean BOSS norms for selected objects for each room of the apartment (kitchen, living-room, bathroom). Don't Know Objects percentages (*DKO%*) are of 1.8%, 1.6% and 3% for the kitchen, living-room and bathroom respectively. *DKN%*: Don't know Name percentile

2.3.3. Avatar movement:

An avatar was created to set a reference for the subject's camera view. This avatar was elaborated via the software Makehuman[®] – a plugin for Blender[®], which main use is to model Avatars with the following creation pipeline: modelling (age, sex, race, body proportions), topology, materials, animation and rendering. The folder is then exported as a “.mfx” file to Blender which offers further modelling tools. In blender, the avatar's position, clothes, bone placement, texture and animation can be modified.

In the said blender file, a long-blue lounge chair was modeled to match as identically as possible the real one where users lay on during immersion (figure 3). The avatar is modeled as seating on the chair by bending its bones' appointment. The idea is to recreate entirely the position of the user so to better immersion in the environment.

Once the avatar and its chair were finalized, the file was exported and imported into Unity as a sub-item of the main Camera in Unity (first person focal view). The avatar/chair montage was placed in the center of the hallway as an initial neutral position.

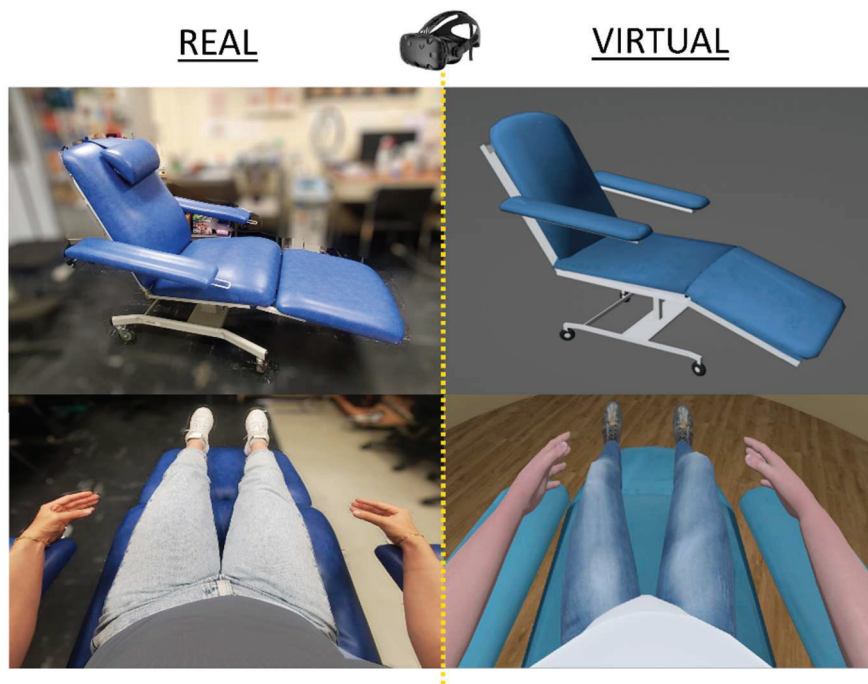

Figure 3 Real vs Virtual positioning on lower-left user's position on the blue chair (upper-left) vs. on lower-right, virtual avatar's position on the modeled blue chair (upper right) in the apartment central hallway.

In Unity, a set of scripts were written in C# to code the movement of the avatar in each room of the apartment. Scripts are available on Open Source: <https://github.com/argitxuCaldichoury/VEProtocol.git> and in Appendix 1.

- **'MovementManager' class:** This script defines the movement class type. It describes the characteristics of each basic shift such as moving forwards, moving backwards, turning right, turning left and stop moving/rotating. Note that every class is composed of a *start* instruction (condition for which the class is activated) and an *update* instruction (update called per frame, with a resolution of 30 fps).

- **'Cameraa' script:** This class serves to link the functions created in 'MovementManager' to a GameObject in unity. In our case, we named it 'Cameraa' as it will be set on the Camera GameObject. To do so, we initiate the function with the instruction to call the component of the MovementManager Class. In the Update section, we defined precisely the different existing shift voids that activate an Object: *MoveForward*, *MoveBackward*, *StopMove*, *TurnLeft*, *TurnRight*, *StopRotation*.

- **'InputManager' script:** This class describes the trajectory of the avatar in the environment. As the avatar/chair montage is a sub-item of the main camera, this script is affected to the latter and not the avatar itself. *Note that this script does not necessarily use every function defined in the two previous classes.*

Instruction of frame-per-frame update describe one circuit of the avatar in the apartment. Note that, in this example of circuit, nor the preprogrammed rotation functions (*TurnRight*, *TurnLeft*) neither the random rotation (*randturn*) were used for the purpose of the aimed protocol. Instead were used precisely defined instant rotations, called *local rotation transformation*, in terms of both direction and amplitude, which the user sees as a jump from one point of view to another. The update function first sets the time countdown: *timeleft -= Time.deltaTime* decreases the *timeleft* variable of one frame per past frame. The different phases of the circuit are then based on its value.

The avatar is first positioned in the hallway center facing the first door to be crossed. The starting time is *timeleft=225s* and stop time *timeleft=-2.5s*, meaning a duration of *227.5s (3.8min)* for one round around the entire apartment. The following steps describe one circuit in one room (figure 4):

1. The avatar starts moving forward towards the door for 3.5s and stops for 1.5s. In that stop time, the door opens (see door opening script described below).
2. The avatar moves forward for 5.0s to enter the first room and stops again for 4.0s.
3. The avatar then rotates instantly around the z-axis (called as Vector3.up) in the right direction at a 45-degree angle using the *local rotation transformation*.
4. The avatar moves forward for 3.0s and stops for 4.0s.
5. The avatar rotates again in the left direction at a 45-degree angle, moves forward for 6.0s and stops for 4.0s.
6. The avatar rotates instantly in the left direction at a 90-degree angle, moves for 5.0s and stops for 4.0s.
7. The avatar rotates instantly in the left direction at a 90-degree angle, moves for 5.0s and stops for 4.0s.
8. The avatar is instantly translated to a position in front of the door with a *position transformation* function and stops for 1.0s. In that stop time, the door opens (see door opening script described below).
9. The avatar Moves forward for 10.5s until reaching the center of the hallway again and stops for 10.0s.
10. The avatar rotates instantly so to face the next door.

That procedure is repeated 3 times so to travel once in each room of the apartment.

The entire circuit is a total of ten rounds around the apartment thus lasting 2275s (around 38 minutes) in total.

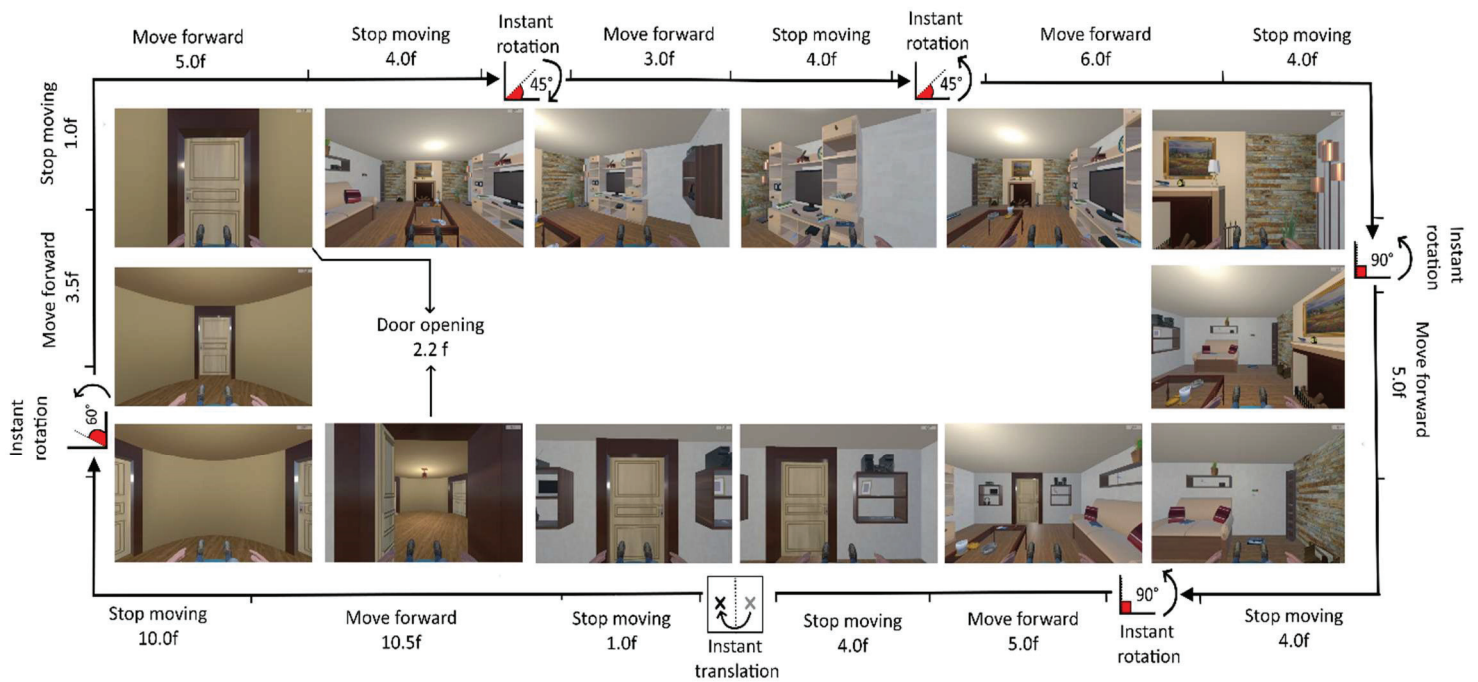

Figure 4 Programmed timeline of the avatar's movement around each room of the apartment (illustrated here in the living-room). Time count is based on number of seconds ($f = \text{float number}$) and types of movement include: move forward, stop moving, instant rotation and instant translation.

2.3.4. Environment movement:

Scripts are available on Open Source: <https://github.com/argitxuCaldichoury/VEProtocol.git> and in Appendix 1.

-**'DoorOpening' class:** Doors were programmed to open and close according to the time lap of the avatar's circuit. The script was based on the same time frame set up ($\text{timeleft} = 225.0s$) as the *InputManager* script (time frame of one round across the apartment). To open the doors, a simple rotation around the z axis was instructed in the correct time points .

-**'GlobalAppMovement' class:** The apartment shape was conceived such as the user can not locate himself in the hallway. This enables to randomize the circuit in order to prevent early anticipation/expectation of each room. This way, the subject only realizes in which room the avatar will enter once the front door is opened. To do so, we programmed the rotation of every room around the hallway cylinder. The script *GlobalAppMovement* is based on a time countdown $\text{timeleft} = 2275.0f$, entire duration of the avatar' circuit (ten rounds in each room in total).

2.3.5. Example of cognitive task development:

An example of a cognitive task that can be used in this environment is a visual search task. Here we used simple geometric shapes that we placed on random objects. Seven different kinds of shapes were created (square, rectangle, triangle, star, hexagon, circle, diamond) all of color green. Subjects are instructed to carefully observe every object of each room so to find these shapes that can appear on any object. Each time the subject enters once again in a room, the task is reset.

To create this task, seven specifically shaped polygons were modelled in Blender® and introduced into Unity® as sub-items of seven randomly selected objects per-room. An added script to these objects enabled to make shapes appear/ disappear as desired according to the user's circuit. To do so, the function 'SetActive' was used (function available in the database). This function is either set on *True* or *False* to activate or deactivate the appearance of a shape on the associated object. In the Appendix 1 is the script associated to the shapes of the kitchen objects called *SearchTaskKitchen*.



Figure 5 Illustration of the Search task in the kitchen (left) and the living-room (right). Green shapes include: square, rectangle, triangle, star, hexagon, circle, diamond

2.3.6. Launching interface

Scripts are available on Open Source: <https://github.com/argitxuCaldichoury/VEProtocol.git> and in Appendix 1.

Main menu : A main menu interface was created composed of two buttons: *play* and *quit* buttons. The 'MainMenu' script uses Unity's *SceneManager* toolbox which enables to load and close scenes created in the Unity project folder. The play button loads the main apartment scene with the *PlayGame* function and the quit button associated to a *QuitGame* function closes the application (see Application for running below).

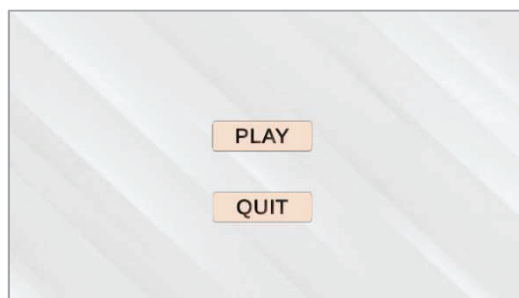

Figure 6 Main Menu interface

Quit button : A simple quit button was added in the apartment scene, enabling to stop the application while environment is running.

Application for running : Once the entire modeling project is complete in Unity, the software enables to generate an application for simple launching of the environment. To do so, application building settings allow selection of scenes to be built (MainMenu and Apartment scenes) and configures the support system in which the application will run (target platform - Windows, architecture -x86_64, compression method - default).

3. iVR testing:

3.1. Participants

The conception of the apartment was tested in the framework of a project studying pain conditioning mechanism in humans. Pilot subjects were thus recruited according to the requirements for this project. The latter was approved by a National Ethics Committee (Comité de Protection de Personnes CPP Nord-Ouest IV n° 2019-A01816-51, ClinicalTrials.gov ID: NCT04189965) and declared at the Liberties and Informatic National Commission (CNIL). Participants were recruited through the same procedure as main experiment participants via announcements at the Neuroscience Research Center (CRNL) and universities of Lyon, and were remunerated for their participation. **Nine volunteers** participated to the pilot study.

3.2. Pilot studies

Pilot experiments were extensively needed to test and better the contextual conditioning protocol. Tested parameters included : iVR tolerance, head-mounted-display calibration, and avatar/real-body placement synchronization, as well as room function identification, objects' visibility and object recognition.

Among primary tested parameters was the tolerance and comfort of immersive VR. At the beginning of the pilot experiment, subjects were seated on the blue lounge chair with a similar position to that modelled in the virtual avatar and instructed to stay still during the entire experiment. Subjects were told to imagine that someone was pushing their chair around the apartment, thus explaining why they would move involuntarily.

Pilot trials revealed that a programmed travel-movement used to guide subjects' 3D view in the virtual environment lacking any static reference point triggered immediate nausea in volunteers. This crucial issue was

tackled by adding an avatar which body was positioned on a blue long-chair modelled to fit identically the real one subjects were asked to lay on (see paragraph 2.3.3.). Another nausea causing element was time-real rotation throughout the coded movement particularly when subjects moved their heads in one direction while the camera angle rotated towards the opposite way. The latter was thus replaced by an instant right-angled rotation (see above) to which participants adapted easily. Once subjects were able to tolerate five minutes in the environment, they tolerated the entire duration needed for the main protocol (thirty-five minutes).

To optimize avatar/real-body placement synchrony, the VR calibration parameters had the following correspondences: the HMD was set in 'static position mode' (no movement from the initial position is required), the center of the room was defined as the chair in which subjects were seated and finally, ground level was measured by positioning the HTC Vive glasses on the floor and setting the parameters at 0 cm. Adjustments of the camera settings in Unity were needed to better the user's first position view and set realistic sight distance to the avatar's body: (i) projection type is set to perspective and (iii) field of view is set to 74.6, indicating the height of the camera's view angle measured in degrees vertically or along the Y-axis. Other parameters are left at default settings.

Room functions and all objects were correctly identified for every subject. However, 5 objects had to be resized to better fit realistic parameters: blender, disinfectant spray, keys and compass.

Video of the environment with integrated search task: *Supplementary data*

3.3.. Immersion evaluation

For immersion quality testing, participants were required to evaluate their iVR experience in terms of location and presence in the environment ((ii) and (iv)) and body ownership ((i) and (iii)) . Subjects were asked to indicate whether or not they agreed with the following affirmations: (i) "My (real) body started to embody the posture or form of the virtual avatar" (Posture) (ii)" My (real) body could be affected by the environment" (Possibly affected) (iii) "The avatar's body was my own" and (iv)" My (real) body was placed in the same location as the avatar's body". Seven available answers were given: 1. Never 2. Rarely 3. Occasionally 4. Half of the time 5. Often 6. Almost always 7. Always. Theses answers were then translated into a 6 point-scale, 0-points being "Never" and 6-points being "Always". Descriptive analysis of immersion quality was done by averaging numerical answers across all subjects for each affirmation.

Results: Mean score to the *location* affirmation (4.48 out of 6) and to the *possibly affected* affirmation (4.31 out of 6)-between "often" and "almost always"- revealed that the subjects' and the avatar's location concurred correctly for 75 % of immersion time and that subjects frequently felt potentially influenced by their surroundings (72% of immersion duration). However, lower mean scores to both the *posture* and the *belonging* affirmations (2.63 and 2.03 out of 6 respectively) -between "occasionally" and "half of the time"- revealed that bodily immersion sensations in terms of real-body/avatar merging and complete body ownership were only felt during 39% and 34% of immersion (Figure 7).

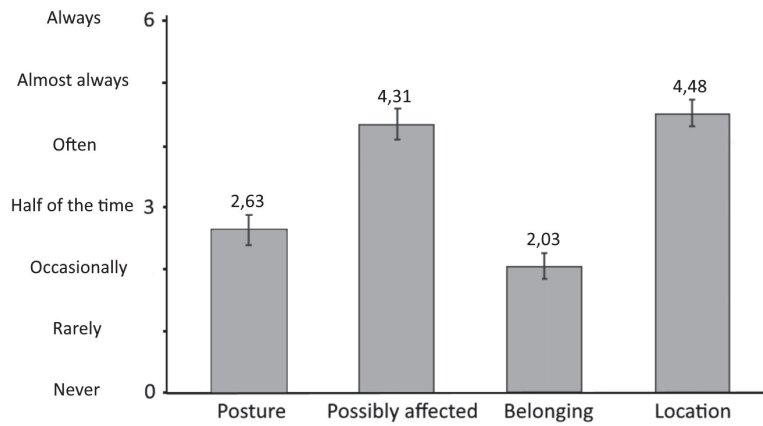

Figure 7 Immersion evaluation mean scores for *Posture*, *Possibly affected*, *Belonging* and *Location* affirmations on a 6 point-scale, 0-points =“Never” and 6-points =“Always”. Highest scores are obtained for *Possibly affected* and *Location* with a mean score of 4,31 and 4,48 respectively.

4. Summary

This part demonstrated the construction of a 3D-virtual environment designed for research experimenting in immersive Virtual Reality. The environment is a three-room apartment composed of a kitchen, a living-room and a bathroom, all rooms being connected via a central hallway. A total of forty-eight furniture items (sixteen per room) and one-hundred and fifty-three objects (fifty-one per room) were modelled and integrated into the apartment. A virtual body and its associated seating were fabricated serving as main camera focus, so to fit user’s positioning and first-person point of view. To move the avatar, a timed circuit around each room was scripted with a passage in the hallway in between each, corresponding to one round around the apartment. Entrance doors of each room were scripted to open and close after each circuit. The entire travelling duration was programmed for ten rounds. In between each round, rooms of the apartment were programmed to rotate around the hallway so to randomize the order of room presentation. Finally, a simple visual search task was written to run the entire travelling duration.

Pilot studies enabled to adjust camera settings and positioning, HMD calibration, visual parameters of the environment and movement programming so to optimize comfort and tolerance for long-lasting immersion. Overall, immersion was well tolerated and the apartment content well identified. Integration of the environment in a conditioning protocol is presented in Part B.

Immersion quality :

Results of immersion evaluation showed that surface level immersion parameters were mostly respected (synchronized location with the avatar and sense of possible affection by the environment), subjects did not attain complete sense of body ownership towards the avatar (posture merging and belonging), possibly reflecting a weaker sense of immersion.

Among essential parameters of immersive Virtual reality, 3D visual settings represent the basis of any iVR environment, and immersion quality has been initially reported to depend on visual stimuli realism (Hendrix & Barfield, 1996, Slater et al. 1995). Studies have shown that enhancing graphic detailing (Hvass et al. 2017, Hendrix & Barfield 1996) and visual dynamic parameters- such as ray-tracing, shadow casting and reflection effect- (Khanna et al. 2006, Slater et al. 2009, Mania and Robinson 2004) result in both improved self-reported sense of presence and stronger physiological fear responses (Hvass et al. 2017, Slater et al. 2009).

However, as iVR technology evolves into a more interactive platform, where users embody active avatars, the likelihood that a stronger immersion quality would rely only on visual rendering is arguable (Steed et al. 2018). Steed et al. describe immersion as a combination of four possible illusions, each classified as degrees of immersion (Steed et al. 2018): *place illusion*, *plausibility illusion*, *body ownership* and *agency*. Place illusion and plausibility illusion constitute the mere sense of presence and translate respectively the perceptual impression of being in the virtual environment and the illusion that what occurs in the later is real (Slater 2009). In our case, high scores found for *location* and *possibly affected* questions would translate the first two degrees of illusion thus assuring a strong sense of presence. Though participants had very little movement range, the correspondence between what was expected (i.e. the explanation and instructions given at the beginning) and what truly occurred was close enough to create the feeling of presence in the apartment. Body ownership and agency however rely on more robust immersion criteria including control of one's virtual body and sense of impact and control over its surrounding environment (Kim et al. 2020). In our case, The lack of body ownership is to be expected due to the lack of stimuli input/output needed to create these impressions. Though for our experiment setting specifically these elements could have hardly been added- *due to multiple measuring and stimulation equipment - physiological measurements (skin conductance, EKG), electroencephalogram recordings and electrostimulation -*, they are important to consider for future protocols allowing extended freedom of movement and agency in the virtual apartment to expand immersion and, along these lines, improve ecological quality.

Part B: Contextual aversive conditioning protocol design in Humans – a combination of behavioral and EEG measurements using immersive Virtual Reality

1. Introduction

The learning of pain in association with a specific event is suggested to facilitate induction and maintenance of chronic pain through classical conditioning (Faasse and Johnson 2008, Madden et al. 2016, Moseley and Vlaeyen, 2015, Vlaeyen, 2015, Koenig et al. 2021). Chronic pain can be described as a state of persistent learning in which the continuous presence of pain generates constant aversive associations with daily events (Apkarian et al. 2009, Mazza et al. 2018, Harvie et al. 2017) resulting in pain or pain-related fear conditioning. Though pain-related fear conditioning can in some cases be cue-specific, where patients report knowledge of pain outbreaks in the presence of specific stimuli (Johnson et al. 2006), non-cue specific pain occurrences can lead to contextual pain-related fear conditioning (Meulder 2020, Meulders et al. 2011, 2013). Indeed, research has shown that an unpredictable painful unconditioned stimulus (US) induced in the absence of distinguishable cues causes the context in which it is delivered to be perceived as a potential hazard and leads to continuous anticipation of threat (Meulders et al. 2011; Fonteyne et al. 2010; Vansteenwegen et al. 2008). Although contextual pain-related fear has been reported to play a key role in the persistence of chronic pain (Keefe et al. 2004; Meulders 2020; Mazza et al. 2018), we noted a lack of research concerning experimental models for better understanding its mechanisms.

In parallel, a comprehensive literature of contextual fear conditioning is available, specifically in animal studies (Yu et al. 2021, Schroyens et al. 2019, Kenney et al. 2017, Curzon et al. 2009) for which context stimuli are easily constructed and modelled under experimental requirements by simply modifying the environment's properties (e.g. different spaces with change of color, texture or odor) or changing the animal's location. In comparison, contextual fear conditioning studies in humans struggle to meet such criteria, as it would analogically require subjects to physically move from one location to another, i.e. require settings that are unavailable in experimental laboratories. In recent years, we noted an increasing number of studies aiming to bridge the gap between animal and human research by using an innovative and ecological working-tool: immersive Virtual Reality (iVR) (Kroes et al. 2017, Houtemaker et al. 2020, Reichenberger et al. 2020, Binder and Spoormarker 2020). Immersive Virtual Reality has been shown to optimize context stimuli and enhance emotional implication during contextual learning (Kim et al. 2014, Kroes et al. 2017) as it offers an effective sense of presence where users report the illusion of *being* in a virtual environment in which occurrences truly happen (Sanchez-Vives et al. 2005).

In 2010, the Duke University virtual environment (DiVE) system initially introduced immersive context at the profit of contextual fear conditioning based on a projected virtual reality "CAVE" design (Cruz-Neira et al. 1993) described as a fully enclosed 30 feet cube-shaped room in which the virtual environment is projected

on all 4 walls, ceiling and floor (Huff NC et al. 2010). Nowadays, iVR contexts are widely displayed through immersive Head Mounted Displays (HMDs) (Kroes et al. 2017). Kroes and colleagues (2017) offer a commercially accessible iVR environment comprised of a 2-separate-room area connected by a hallway which, combined with an unpleasant stimulus (electric shocks), resulted in an effective threat conditioning protocol. This system was further used as a context tool for threat conditioning studies, investigating the effect of a reminder prior to extinction on contextual mnemonic performance, physiological reactivity (skin conductance, eye blink, heart rate) and behavioral measures (context perception, stimulus rating) (Houtekamer et al. 2020), as well as other similar tool systems investigating specifically conditioning-related avoidance behaviors (Reichenberger et al. 2020, Binder and Spoormarker 2020).

In line with these studies, our goal is to contribute to filling the gap in contextual pain conditioning research in humans by using immersive Virtual Reality technology.

To better understand pain conditioning and its specificities, a complex contextual conditioning protocol was elaborated using an ecological environment modelled in iVR, eliciting both a painful and a non-painful aversive conditioning in healthy subjects. This protocol aims to offer a comprehensive view of conditioning processes as it combines both behavioral and electrophysiological measurements throughout the experiment. In this part, we focus on the construction of a protocol specifically designed to study implicit mnemonic mechanisms of contextual aversive conditioning and brain activity mechanisms using high-density EEG.

Behavioral results obtained with the recorded data are elucidated in chapter 2. EEG data was not analyzed during this PhD.

2. Methods

2.1. Participants

This study was approved by a National Ethics Committee (Comité de Protection de Personnes CPP Nord-Ouest IV n° 2019-A01816-51, ClinicalTrials.gov ID: NCT04189965) and declared at the Liberties and Informatic National Commission (CNIL). Participants were recruited through announcements at the Neuroscience Research Center (CRNL) and universities of Lyon, signed informed consent, and were remunerated for their participation. Were excluded subjects suffering from any type of chronic pain or under drug treatment with analgesics, subjects suffering from any psychiatric disorder and subjects with heart abnormalities and/or abnormal long-term mnemonic capacities (tested at the beginning of the experience with The Doors and People memory Test (D&P; Baddeley et al., 1994). 60 subjects participated to the final version of the experiment, out of which 3 were discarded due to technical issues (misfunctioning of stimuli), 2 were discarded due to very low performance on behavioral testing and 1 due to an exclusion criterion revealed at the end of the experiment ; hence, n=54 healthy volunteers participated to the final study (25.77 ± 5.5 y.o; 26 women). No subjects were excluded for iVR intolerance nor aversive stimuli intolerance.

Anxiety level assessment: Participants' anxiety level was tested prior the main experience. State anxiety and Anxiety trait were measured using the STAY -Y-A and STAI- Y-B (State Trait Anxiety Inventory, Spielberger et al. 1977) questionnaires respectively, French version (IASTA, Gauthier and Bouchard 1993). State anxiety reflects the current emotional state of the participant, that is the day of the experiment. Anxiety trait reflects regular anxiety level. Questionnaires are available in annex documents.

2.2. Stimulations

2.2.1. Nociceptive stimulation

The nociceptive stimulation was an electric stimulus induced homogeneously on the left-hand's surface creating a feeling of paresthesia mainly on the palm of the hand. It was induced by the means of an Electrostimulation Glove (Axion®, France) and a 5*5-centimeter plane electrode placed on the wrist, and delivered by a Micromed stimulator (Micromed®, France) with the following parameters' calibration: 20 Hz; 1000ms; 800 μ ; trig OUT (figure 1). The stimulus lasted 40 seconds and its intensity was determined for each subject at the beginning of the experiment by using a scale rated from 0 to 10 where 0 was defined as 'non-painful', 10 as 'Extremely painful' and 4 being the nociceptive threshold. After calibration, the final chosen stimulus intensity had to match a 5 on the rating scale, which means a stimulation felt as painful but tolerable. The current intensity varied between 12mA to 28mA throughout all participants: for women, the average current intensity was 15 ± 4.8 mA; for men 17 ± 4.8 mA. During the experiment, participants systematically rated the painful stimulation, allowing to adjust the current intensity in case of habituation (ratings below 5 out of 10 on the rating scale) or sensitization (ratings above 5 out of 10). Adjustments varied around ± 4 mA around the initial calibration. The benefit of using an electro-stimulation glove is the wider surface of stimulation it offers compared to simple electrodes, which allows better modelling of pain described in clinical settings (Peyron et al. 1998)



Figure 1 Electro-stimulation glove, plane electrode placed on the wrist and Micromed® stimulator set on 20 Hz; 1000ms; 800 μ ; trig OUT, with variable intensity (mA) according to each subject's individual calibration

2.2.2. Non-nociceptive aversive stimulation:

The non-nociceptive aversive stimulation was an auditory stimulation delivered through Bluetooth headphone (Sonic.), with a volume set on 67dB. The volume allowed clear but painless hearing of aversive sounds. The stimulus was a set of seven mixed soundtracks each composed of three aversive sounds.

Aversive sounds were selected and recorded with the help of Kasia Pisanski, a postdoctoral researcher working for the ENES (*Equipe de Neuro-Ethologie Sensorielle*) team of the Neuroscience Research Center of Lyon (CRNL). Seven different categories of sounds were used (knife rubbing against glass bottle, bike brakes, street drill, chalk against board squeaking, door squeaking, fork rubbing on plate, nail scratching), each recorded in various exemplars giving a total of 60 sound samples of 6 to 10 second duration. The samples were assessed via a questionnaire uploaded online to evaluate the following features: 1) averseness, 2) valence and emotional impact and 3) relation to pain.

- 1) Averseness was rated on a 10-point Scale, 1 corresponding to 'Not aversive' rating and 10 to 'Extremely Aversive'.

2) Valence and Emotional Impact were evaluated using the Self-Assessment Manikin (figure 2, Bradley &Lang, 1994). The SAM scale is widely used to evaluate stimuli perception and translates into a 9-point scale. Valence is represented via the expression from discontent (left) to high contentment (right) of the Manikin (above scale): 1 point corresponds to *negative*, 5 to *neutral* and 9 to *positive* assessment of the stimulus. Emotional impact is represented via an increasing spiked spot at the center of the manikin (lower scale): 1 equals a *low* impact, 5 equals average and 9 equals a high emotional impact.

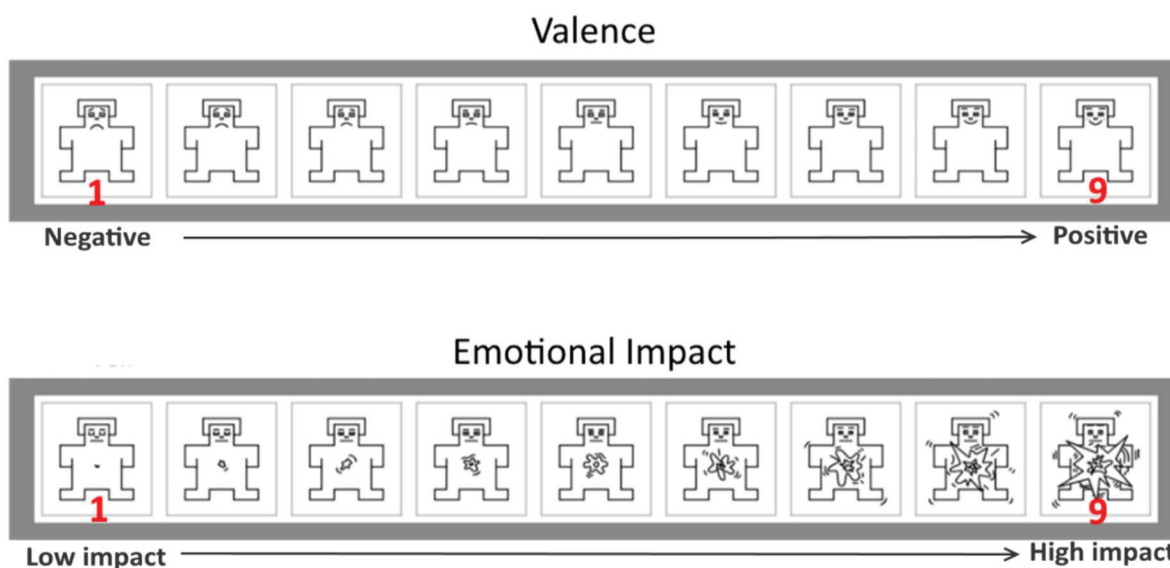

Figure 2 Self-Assessment Manikin (Bradley & Lang 1994). Valence: 9-point scale- 1 corresponding to a negative valence, 9 to positive. Emotional Impact: 9-point scale – 1 corresponding to a low impact, 9 to a high impact.

3) Relation to pain was evaluated with a Choice-answer question “How much does this sound remind you of physical pain?”. Possible answers included: “not at all”, “slightly”, “moderately”, “a lot”, “extremely”. Answers were translated into numerical values going from 1 to 5 points. This scale was required as our goal was to have an aversive stimulation completely separated from pain or any pain-associations.

Sixty-one volunteers answered the questionnaire (37.42 ± 16.4 y.o; 31 women). Results revealed strong positive correlation between rated aversion and emotional impact (correlation coefficient $r^2= 0,65$) as well as negative correlations between aversion and valence ratings (the more aversive the sound, the more negative its valence rating) and between emotional impact and valence (the more negative the sound valence is, the higher the induced emotional impact) (correlation coefficients $r^2= 0,85$ and $r^2= 0,61$ respectively) (figure 3). No sex-related differences were found. This lead to use the same sounds for all participants.

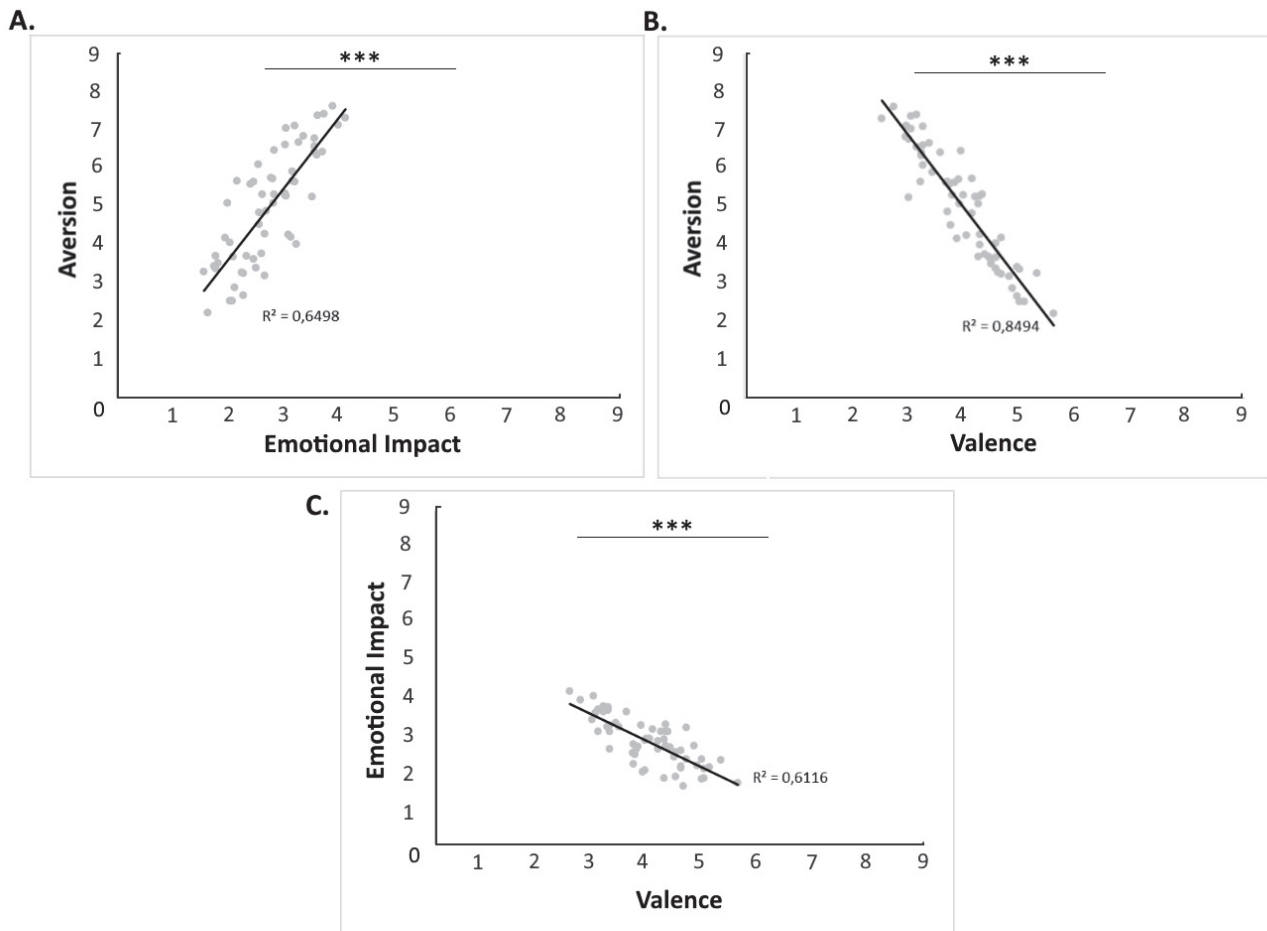

Figure 3 Sound parameters correlations between **A.** Rated aversion and emotional impact ($r^2= 0,65$) **B.** Rated aversion and valence ($r^2= 0,85$) and **C.** Rated emotional Impact and valence ($r^2=0,61$). *** $p<.001$

To create mixed soundtracks, a selection of sounds was made according to the following criteria: a minimum mean score of 5 out of 10 on the aversion scale, and below 2 out of 5 on its relation to pain. Twenty-one sounds were by means included and divided in seven groups composed of 3 sounds with equivalent mean aversion ($5,8\pm 0,06$), mean valence ($3,7\pm 0,15$), mean emotional impact ($3,0\pm 0,26$) and mean association to pain ($1,6\pm 0,04$). Resulting soundtracks are shown in table 1.

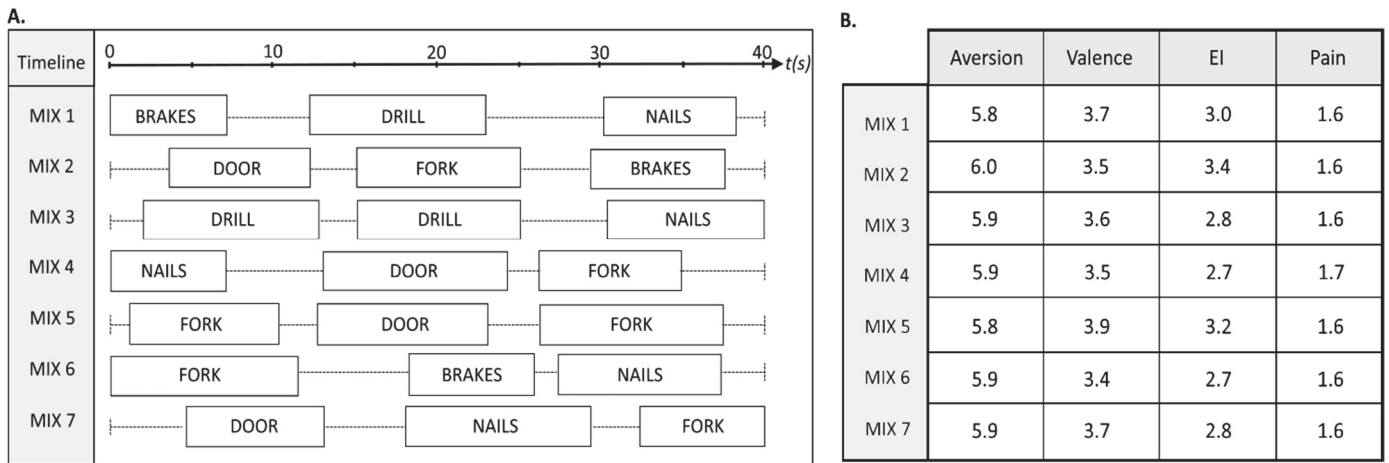

Table 1 Mixed soundtracks parameters. A. Seven mixed soundtracks timeline composed of three aversive sounds each for a total duration of 40s. Included aversive sounds are: Brakes=bike brakes, Drill= street drill noises, Door= door squeaking, Fork=fork rubbing on plate, Nails=nail scratching. **B.** Mean Aversion, Valence, Emotional Impact (EI) and Pain association (Pain) for each mixed soundtrack.

2.2.3. Context stimulation

Refer to Part A. To summarize, the context stimuli is a 3D-apartment modelled in immersive Virtual Reality composed of a kitchen, a living-room and a bathroom. The three-roomed architecture was chosen to create three neutral contextual stimuli, each to be associated with one specific condition: painful aversive condition (PA), non-painful aversive condition (NPA) and control condition (CONT). The protocol procedure will be detailed in [Section 1.5-Experimental Procedure](#).

2.3. Electrophysiological recordings

EEG recordings: High-density electroencephalogram data was recorded via a 128-electrode cap (Waveguard Cap, ANT) and acquisition system ASA (ANT Software, The Netherlands). Sixty-four electrodes were activated with a reference electrode placed on the left mastoid (electrode M1) and a ground electrode integrated into the cap between electrodes AFz and Fz. Electrodes impedance was lessened by introducing a conducting gel (ElectroCap) in every targeted electrode. Sampling rate was set at 512 Hz.

ECG and skin conductance recordings: Electrocardiogram and skin conductance were recorded continuously using the same acquisition system ASA (ANT Software, The Netherlands). For ECG, an electrode was placed on the skin surface of each forearm of the participant. As for skin conductance, one electrode was placed on the palm of the right hand and another on the opposite side as reference-electrode.



Figure 4 Example of subject installation – EEG recording cap, ECG and skin conductance electrodes; electro-stimulation glove; HTC Vive iVR glasses.

2.4. Behavioral Tests

Behavioral measurements were programmed on PsychoPy®. This open source software uses python scripting to design behavioral experiments in both psychology and neuroscience research fields. For our protocol, we programmed two experiments comprising all behavioral measurements : environment evaluation and stimulation evaluation for one and implicit memory testing for another (figure 4).

Environment evaluation: To assess subject’s perception of the different rooms of the apartment, the Self-Assessment Manikin Scale (Bradley & Lang, 1994) was used. See explanation of the scale in part 2.2. Psychopy explanation part.

Stimulation evaluation: Painful and non-painful aversive stimuli were assessed with Visual Analog Scales (VAS). For the painful stimulation, subjects rated both the level of unpleasantness and the pain intensity of the electro-stimulus: the VAS for the level of unpleasantness ranged from “Not unpleasant” to “Extremely unpleasant”; the VAS for pain intensity ratings ranged from “Not painful” to “Extremely painful”. As for aversive sounds, subjects evaluated the level of unpleasantness only (same VAS described above).

Implicit memory test: Implicit memory, specifically perceptual priming was assessed using a blurred picture paradigm (Bargh & Chartrand, 2000). The paradigm was created using pictures of objects of each room of the apartment (kitchen, living-room and bathroom associated objects). Subjects were presented pictures of objects one by one in random order. The latter first appeared completely blurred then progressively became clearer in a time interval of 6 seconds. To create this effect, a total of 16 pictures of increasing blurring caliber were created for all 132 objects. These pictures were assembled in a single 6-seconds long video to create a progressive deblurring using the WonderShare® video editor software.

Subjects were asked to identify each object as quickly as possible before complete clearing of the picture for which reaction time was recorded via key press. After each key press, subjects had to type in the name of the object, enabling to validate their answer.

Environment and stimulation assessment, as well as identification reaction time and response data were collected at the end of the experiment in two separated excel files created by PsychoPy® software.

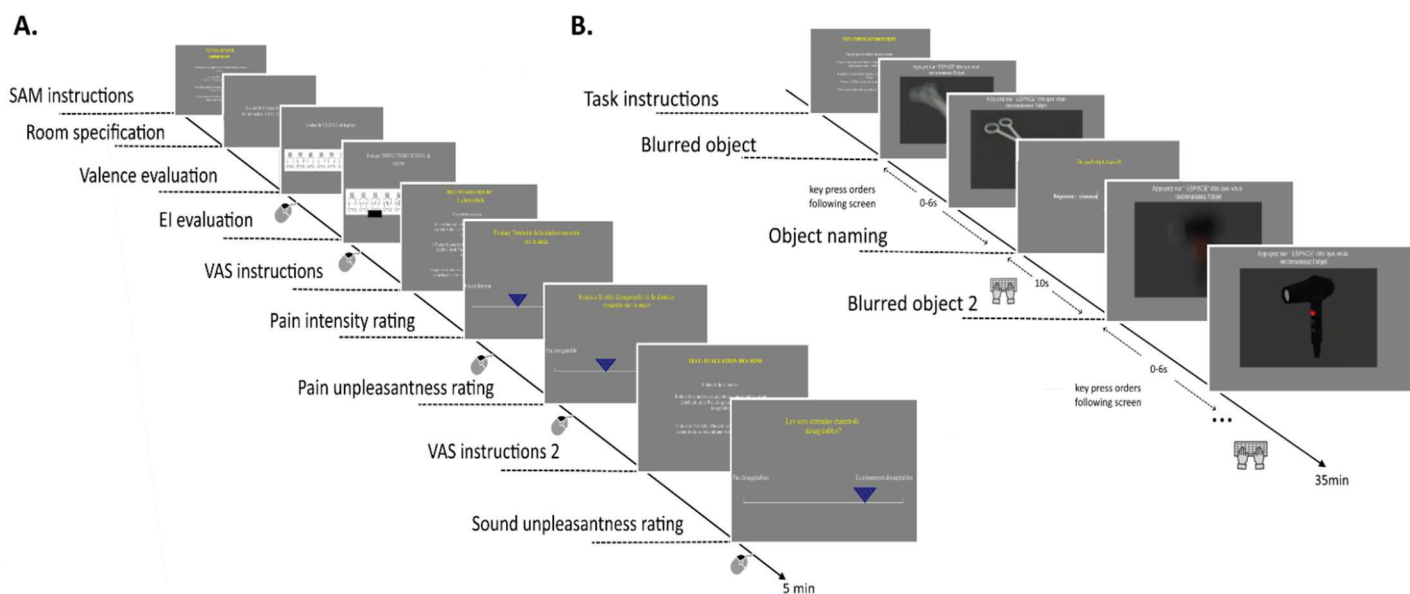

Figure 5 Behavioral testing sequence A. Valence and Emotional Impact (EI) evaluation (SAM scale) for each room (kitchen, living-room; bathroom) followed by Pain intensity and Pain unpleasantness ratings (VAS) and Sound unpleasantness rating (VAS). **B.** Implicit memory testing with a blurred picture paradigm: random sequence of progressively deblurring 6-second-long videos of objects followed by a response time of 10 seconds.

2.5. Experimental Procedure

The experiment comprised three sessions in total at different time points: day one (main session), next day and two weeks after (figure 5).

Session 1: Participants were comfortably seated in a lounge chair either in front of a screen during testing or wearing the Head Mounted Display HTC Vive ® during immersion. This session comprised three main periods : familiarization, conditioning and extinction period.

- **Familiarization:** Participants had to first and foremost adjust with iVR. Familiarization consisted in immersing the participant in the virtual apartment for one single round around each room, thus lasting less than 4 minutes in total. As the subject would later on be connected to EEG, ECG and skin conductance wiring, he/she was instructed to stay still on the chair and move the head only slightly from right to left, up and down, and avoid any brusque rapid movement. This procedure enabled both: (i) to validate the participant's tolerance towards immersion and confirm their ability to proceed with the rest of the experiment and (ii) for the subject to discover all three rooms prior any type of conditioning, as neutral stimulations. Note that during this phase, all rooms were presented empty, with none of the objects later used for memory testing. After familiarization, subjects were asked to evaluate their perception of the environment, i.e. measure the valence and emotional impact of each room pre-conditioning.
- **Conditioning:** The conditioning phase consisting in creating two types of aversive conditioning (PA and NPA) to be compared to a control condition (CONT). To do so, each room (kitchen, living room, bathroom) was randomly attributed to a specific condition (painful aversive (PA), non-painful aversive (NPA) or control (CONT)), thus varying from subject to subject.

Participants were immersed for 35 minutes in the virtual apartment, during which they proceeded to complete ten rounds in each room. Participants stayed between 45 to 50 seconds in each room with a 30 second stay in the hallway in between each room visit. According to the room they entered, the experimenter either induced the electro-stimulation (PA condition), the aversive sounds (NPA condition), or no stimulation at all (CONT condition). Stimulations were delivered between 1 to 5 seconds during room entrance. In the aversive rooms, for three rounds out of ten, no stimulations were delivered, these being randomly distributed across all ten rounds for each condition (the electro-stimulation free rounds and sound-free rounds not being necessarily simultaneous). This enabled to monitor the development of both conditionings throughout the entire phase.

During conditioning, subjects were asked to complete a visual search task, also known as incidental encoding task : subjects were instructed to carefully observe every object of each room so to find simple geometric green-colored shapes (square, rectangle, triangle, diamond, star, hexagon) that could appear on any object to subject's knowledge; in reality, shapes appeared only on 7 pre-defined objects (reference to cognitive task development in part A-section [2.2.3 Example of cognitive task](#)

development), which were later discarded from implicit memory testing. Each time the subject entered the next room, the task was reset. The incidental encoding task allowed to make sure that subjects would observe objects without however explicitly memorizing them. Each time subjects exited the PA-room (where the electro-stimulation is delivered), subjects were asked to rate the pain intensity and unpleasantness of the stimulus they had just felt.

After conditioning, subjects were asked to evaluate the valence and emotional impact of each room post-conditioning, rate the average pain intensity and pain unpleasantness of all seven electro-stimulations received and rate the mean unpleasantness of all seven aversive sound stimuli (figure 4 A). Following up, subjects passed the implicit memory test on all objects present in the environment except the 21 objects reserved for the visual search task (7 per room) (figure 4B).

- Extinction: Three groups of subjects were defined for extinction: (i) a **Total-extinction** group: both aversive conditionings were extinguished, the procedure was exactly the same as in conditioning phase with no stimulation delivered, (ii) a **PA-extinction** group: only the painful aversive conditioning was extinguished, aversive sounds were again delivered and (iii) an **NPA-extinction** group: only the non-painful aversive conditioning was extinguished, electro-stimulations were again delivered. These different groups of extinction allowed to analyze the long-term effects of extinction particularly on behavioral measurements, i.e. environment perception, stimulation evaluation and implicit memory of the environment's content.

Session 2: The second session took place **the day after** session 1. The subject was asked to recall the previous day and reevaluate the valence and emotional impact of each room, as well as rate the remembered pain intensity, pain unpleasantness and sound unpleasantness.

Session 3: The third session took place **two weeks after** session 1. The subject was asked to recall the first session and reevaluate the valence and emotional impact of each room, as well as rate the remembered pain intensity, pain unpleasantness and sound unpleasantness. At the end of session 3, the subject was asked to answer a final question: "In which room did you receive the different stimuli? (i) Pain associated room(s), (ii) Sound associated room(s) and (iii) No stimulus associated room(s)." Three answers were collected in total, one for each type of stimulation.

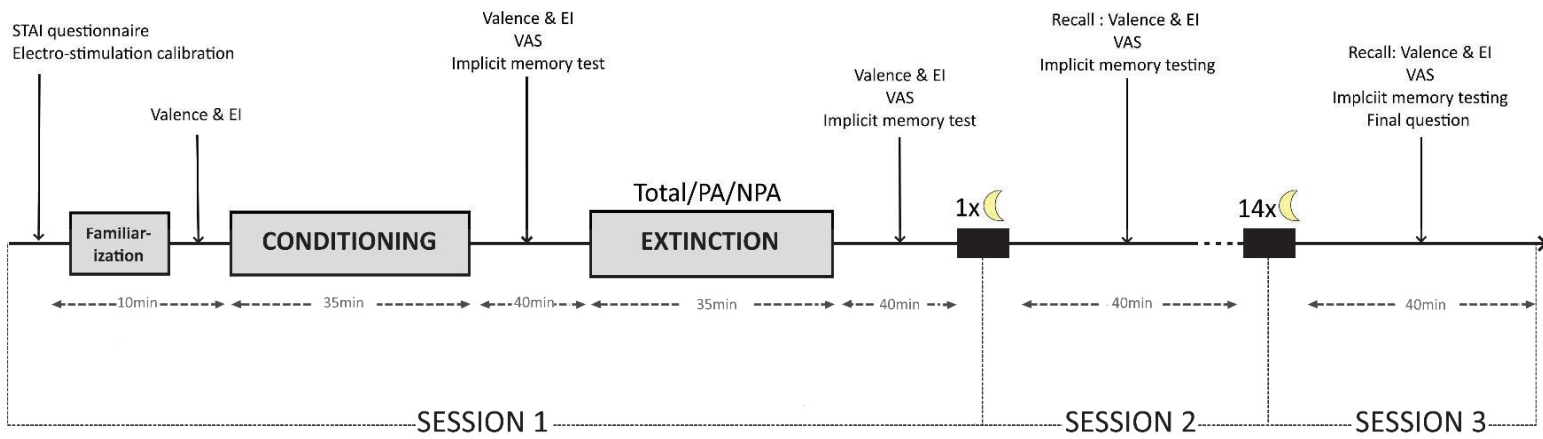

Figure 6 Experimental protocol timeline: session 1 (day 0) – familiarization, conditioning and extinction session with behavioral measurements (Valence and EI, VAS, Implicit memory testing) in between each phase; session 2 (next day) – reiteration of behavioral measurements and session 3 (two weeks after)- reiteration of behavioral measurements with additional final question. STAI : State and Trait Anxiety Inventory ; EI : Emotional Impact ; VAS : Visual Analog Scale ; PA : Painful Aversive ; NPA : Non-Painful Aversive.

3. Summary

This part details the construction of a contextual aversive (painful and non-painful) conditioning protocol by means of an “ecological” environment modelled in immersive Virtual Reality. The environment is a three-room apartment (kitchen, living-room, bathroom) each associated to a specific stimulus: either painful, an electrical tonic stimulation induced on the left-hand; non-painful, a set of aversive noises; or no stimulation, serving as control. Fifty-four healthy volunteers have undergone the conditioning protocol: immersed subjects entered ten times each room in random order, during which the different stimuli were induced in their attributed context. The conditioning phase was followed by an extinction protocol for which three groups of subjects were defined: (i) a total extinction group – both aversive conditionings were extinguished, (ii) a PA extinction group – only the painful aversive conditioning was extinguished and (iii) an NPA extinction group – only the non-painful aversive conditioning was extinguished. Electrophysiological data (SSR, ECG, EEG) were recorded throughout the entire conditioning and extinction phases.

Behavioral measurements (stimulation evaluation, environment’s perception, implicit memory) were recorded in five different time points: pre-conditioning (environment’s perception only), post-conditioning, post-extinction, the next day and two weeks after.

Results validating the conditioning protocol are presented in chapter 2, part A. Behavioral results are presented in chapter 2- part B. EEG data were not analyzed during this PhD.

CHAPTER II: Analysis of aversive (painful and non-painful) contextual conditioning mechanisms – a behavioral and physiological study in healthy subjects.

The experience of pain, most often lived as a traumatic incidence, can be memorized as such, thus favour potential chronicity of pain and influence the way future pain is perceived (Apkarian et al. 2009). In line with how a traumatic experience is memorized in association with its related environmental and emotional context, similar mechanisms may well appear in the case of pain. However, few studies focus on understanding the underlying mechanisms of long-term memorization of pain.

Our main hypothesis is that **pain, a sensory and emotional traumatic event, can be memorised in association with a specific context**, even more so when the painful stimulation is repeated. In line with mnemonic processes discovered in post-traumatic stress disorder, we suppose that re-evoking that context can consolidate its memory and that of its associated pain by potentially distorting it, thus supporting chronic pain induction. We also hypothesis that the mnemonic impregnation of a pain-associated context is stronger and/or different than that of less aversive contexts. This study aims to investigate behavioral and physiological markers of long-term pain/context memorization through contextual pain conditioning processes compared to a non-painful aversive conditioning by using the previously described protocol elaborated in iVR.

This chapter is composed of two parts: **Part A** focuses on certifying the protocol by validating behavioral and physiological markers of contextual conditioning in humans. **Part B** focuses on analyzing behavioral mnemonic processes associated with both painful and non-painful aversive conditioning, specifically to investigate how a contextually induced aversive stimulus (painful and non-painful) can modulate both the perception and the implicit content memorization of its associated environment .

Part A: Validation of the contextual conditioning protocol in immersive Virtual Reality.

1. Introduction

This first part focuses on validating the contextual conditioning protocol in iVR by verifying known markers of aversive conditioning in humans including context perception modulation (Valence and Emotional impact measurements) and physiological data (sympathetic skin response , SSR).

Several studies in humans have observed context perception modulation in fear learning and fear extinction (Andreatta et al. 2020, Alvarez et al. 2008, Baas et al. 2004, Hermann et al. 2016, Huff et al. 2010, Kalisch et al. 2006, Muhlberger et al. 2014, Sjouwerman et al. 2015). As previously described (*chp. 1- partB- introduction*), the context, defined as the physical environment (i.e. external and internal conditions of an event) (Maren et al. 2013), plays a critical role in associative threat learning, as it structures the perception of an event and ultimately serves as retrieval cues that shape conditioned behavior (Sjourwerman et al. 2015). For our study, monitoring how the perception of the different condition-associated rooms change throughout the different steps of the protocol may signal an effective contextual conditioning.

The SSR response has extensively been used as an indicator for variations occurring in the autonomic nervous system during the establishment of a conditioned response (Bräsher and Witthöft 2019, Faghieh et al. 2015, Esteves et al. 1994, Sjourwerman et al. 2015) and as proof of extinction (Faghieh et al. 2015, Vervleit et al. 2004, Sjourwerman et al. 2015). In short, pain or fear related activation of cutaneous nerves issues in increased secretion of the palmar and plantar sweat glands, resulting in enhanced electrical conductivity (skin conductance response) in these areas. In fear conditioning paradigms, studies have extensively shown that presenting the conditioned stimulus (CS+) triggered greater SSC response compared to the neutral stimulus (CS-) in the absence of the initial threat (Di Giacinto et al. 2018, Ney et al . 2018, Tzovara et al. 2018). In our case, keeping track of that response can therefore serve as an index of stress-related activation (for both the painful electro-stimulation and the aversive sounds), but also anticipation-related stress when facing the associated conditioned rooms alone (Painful Aversive (PA) and Non-Painful Aversive (NPA) rooms) compared to control (CONT room). Though traditional skin conductance measurements record the absolute skin conductance in response to a cue stimulus, we recorded SSR continuously for the duration of each room (40 seconds). Thus, SSR was analyzed in terms of variation, defined as the peak-to-peak amplitude in a specific time-interval.

This part aims to test whether our contextual aversive conditioning protocol in immersive Virtual Reality is effective, specified by (i) modulation of the perception of the environment, comparing conditioned rooms with the control room (ii) skin conductance response modulation and (iii) immersion quality testing. Data from Session 1 only were included (see chapter 1-part B -2.5)

2. Data analyses

All statistical analyses were performed with JASP® software with significance level set at $p < 0.05$, and Greenhouse-Geisser correction applied to repeated-measures ANOVA when needed. Holm post-hoc corrections were used when necessary. In all the figures, data are presented as mean \pm SEM.

2.1. Behavioral data

Stimulations perception: Unpleasantness ratings were measured on a Visual Analog Scale (extremities “not unpleasant” to “extremely unpleasant”) post-conditioning for the painful electro-stimulation (Pain), and for the non-painful aversive sounds (Sound). A Student-t test was used to compare unpleasantness ratings between stimulations (Pain and sound).

Environment perception: Valence and Emotional Impact (EI) of each room (measured with the Self-Assessment Manikin Scale, see explanation of scale chapter 1- part 2.2.2) were assessed at three different time-points for every subject: after familiarization (Pre-COND), after conditioning (Post-COND), and after extinction (Post-EXT).

For Valence, a repeated - measures ANOVA was done using time point (PreCOND, PostCOND, PostEXT) and room (PA, NPA, CONT) as within factors and extinction type (total, NPA extinction, PA extinction) as inter-subject factor.

For Emotional Impact (EI), Pre-COND EI value was used as baseline*. For each room (PA, NPA, CONT) Post-COND EI and Post-EXT EI were baseline corrected using the following subtractions: Post-COND EI – Pre-COND EI; Post-EXT EI - Pre-COND EI. To alleviate writing, the latter will be referred as Post-COND EI and Post-EXT EI. A repeated - measures ANOVA was done using time point (PostCOND, PostEXT) and room (PA, NPA, CONT) as within factors and extinction type (total, NPA extinction, PA extinction) as inter-subject factor.

**The need for a baseline was due to random EI values at Pre-COND, specifically an unexpected higher EI value for the PA room compared to the NPA and CONT room, which biased further analysis.*

2.2. Physiological data

2.2.1. Data pre-processing:

Physiological data recordings (EEG, EKG, SSR) were pre-processed on The Observer XT © software (Noldus - Wageningen, the Netherlands). This behavioural research tool software enables to synchronize and analyse multiple inputs (e.g. video, audio, physiological signals, etc.) of an experiment. In our case, it was used to synchronize the timeline of the experiment using a recorded video of the virtual environment conditioning circuit and the recorded physiological data. This allowed to extract specific segments of the recorded data (for example, extraction of all segments corresponding to periods in the PA condition room) to be further analysed. In brief, pre-processing on The Observer enabled to extract segments from the continuously recorded physiological data according to the subject's location (hallway and PA, NPA, CONT rooms), entrance in each type of room (PA, NPA, CONT), and stimulation delivered (pain or sound) (see Figure 1). The different steps of pre-proceeding in The Observer XT © software are the following:

1. Project settings: The first step consists in creating a project file with fixed parameters and containing a number of *Observations*. *Observations* are defined as a set of multitype data all issued from a single experiment. In our case, an *Observation* represents one subject's experimenting phase (conditioning and extinction phase) containing both the circuit timeline (video) and physiological data (EEG, SSR, EKG). Project parameters were set at 'offline' (meaning the recorded data is imported into the software post-experimenting), 'continuous sampling' and 'open-ended duration' observation.
2. Coding scheme definition: To delimit the different occurrences happening throughout both the conditioning and extinction phase, an experimental template called *Coding scheme* had to be established first.

A coding scheme allows to define *Behaviors* – corresponding to the various instances, for example the subject's location (living-room, bathroom kitchen or hallway)– and *Modifiers*- corresponding to the different conditions within a *Behavior*, for example to specify if a stimulation (painful electro-stimulation or non-painful aversive sounds) is **on** or **off** during that *Behavior*.

For our experiment, three behaviours were created: 1. Location (hallway, kitchen, living-room, bathroom) 2. Room entry (Kitchen entry, Living-room entry, Bathroom entry) and 3. Stimulation (electro-stimulation, sound stimulation). For ‘Room Entry’ and ‘Location’ (except hallway) *Behaviors*, four *Modifiers* were created : PAIN ON, PAIN OFF, SOUND ON and SOUND OFF. Details of the Coding Scheme are given in table 1.

BEHAVIORS	KeyCode	MODIFIERS
<u>Location :</u>		<u>Stimulation ON/OFF :</u>
Hallway		X
Kitchen	K/k	PAIN ON
		PAIN OFF
		SOUND ON
		SOUND OFF
Living-room	L/l	PAIN ON
		PAIN OFF
		SOUND ON
		SOUND OFF
Bathroom	B/b	PAIN ON
		PAIN OFF
		SOUND ON
		SOUND OFF
<u>Room Entry :</u>		<u>Stimulation ON/OFF :</u>
Kitchen entry	C /c	PAIN ON
		PAIN OFF
		SOUND ON
		SOUND OFF
Living-room entry	S/s	PAIN ON
		PAIN OFF
		SOUND ON
		SOUND OFF
Bathroom entry	D/d	PAIN ON
		PAIN OFF
		SOUND ON
		SOUND OFF
<u>Stimulation :</u>		
Electro-stimulation	P/p	X
Auditive stimulation	A/a	X

Table 1 Coding scheme- The Observer: categories of *Behaviors* and *Modifiers* defined to code the different events occurring during both the conditioning and the extinction phase

3. Observation creation: For each subject, two *Observations* were created : one for the conditioning phase, one for the extinction phase. For each observation, the video of the circuit around the apartment was imported serving as timeline to code each *Behavior* and *Modifier*. Electro-physiological data (EEG, EKG and SSR) was imported to its corresponding observation (conditioning or extinction phase).

After each *Observation* folder was complete, electrophysiological data had to be synchronized with the circuit video. The Observer XT enables to add a temporal offset either manually (mouse sliding of the data/video) or numerically (specific numerical time offset insertion) to any data in the *Observation* folder.

As no specific triggers were marked on the data, synchronization was based on the electro-stimulation artefact created on EKG signals (see figure 1). This artefact matches exactly the 40-second-long painful stimulation, and thus allowed to adjust the data's offset by coordinating the artefact with the corresponding location in the PA condition room. Synchronization was valid when all 7 stimulation artefacts corresponded to the correct room location.

4. Start observation : event log: For each *Observation*, an *Event log* was created. An *Event log* refers to the description of the *Observation's* events, that is, the coding of the different *Behaviors* and *Modifiers* happening throughout the experiment. As all subjects undergo the same circuit around the apartment (room appearance order, time spent in each room and hallway), with only room/condition (NPA, PA and CONT) associations varying across subjects, and round numbers for which stimulations were not delivered (PAIN ON/PAIN OFF, SOUND ON/SOUND OFF), a core *Event log* was defined coding non-varying *Behaviors* such as location and room entry.

Once the core *Event log* was imported into each *Observation*, specific *Modifiers* (PAIN ON, PAIN OFF, SOUND ON, SOUND OFF) and stimulation *Behaviors* (Auditive stimulation, electro-stimulation) were added according to the corresponding subject's experimental scheme (figure 1).

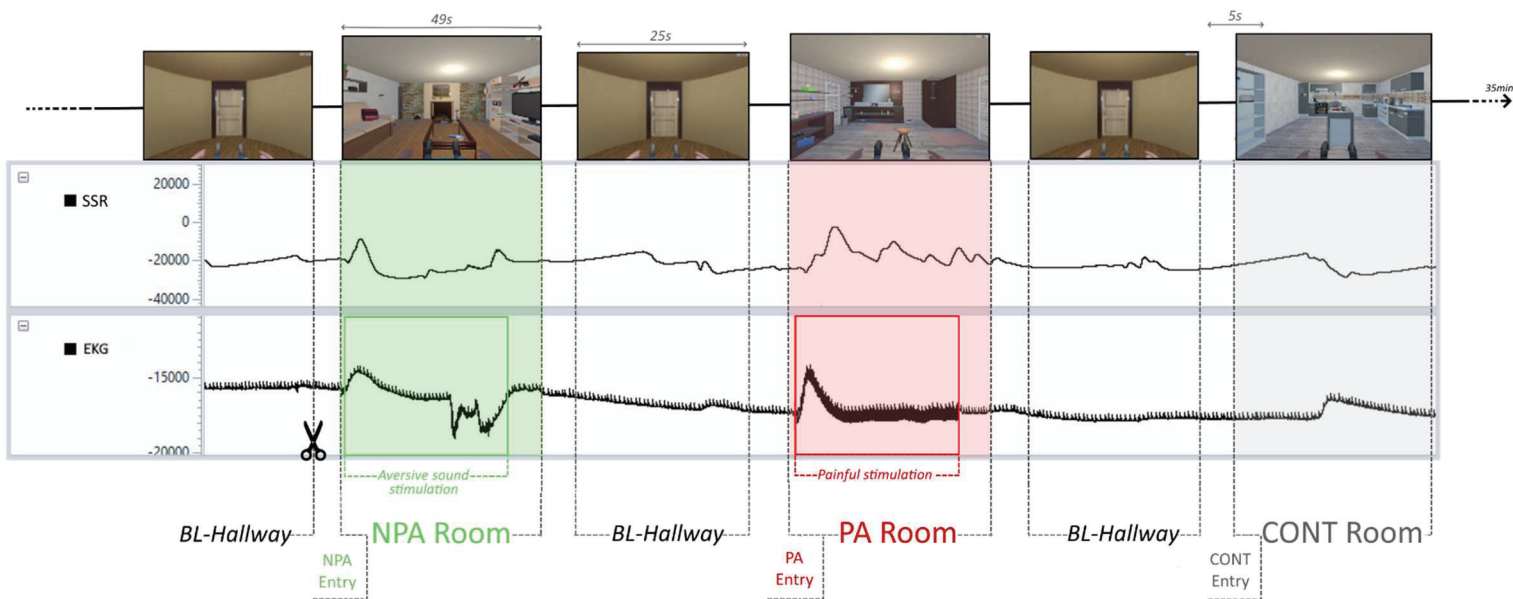

Figure 1 Event log representation and data segmenting using the programmed coding scheme, according to the circuit time-line. Example of room cut-off (PA: Painful Aversive, NPA: Non-Painful Aversive and CONT: control rooms), entries (PA, NPA and CONT entry) and stimulations (Painful and aversive sounds). A single room segment lasts 49s ; a single hallway segment lasts on average 25s ; an entry segment lasts 5s.

5. Data segments export: After coding Event logs for each observation (all subjects, for both conditioning and extinction phases), The Observer automatically recognises different segments of the imported data (EEG, SSR, EKG) according to the associated *Behaviors* and *Modifiers*. For example, it can, for one

observation, isolate all segments corresponding to a specific location (Bathroom, living-room, kitchen, hallway) and a specific stimulation status (PAIN ON/PAIN OFF, SOUND ON/SOUND OFF).

To extract and export specific segments of an *Observation*, a *Data profile* was created. The *Data profile* section allows to select specific data segments by filtering the data according to *Observation* names, *Behavior* intervals and *Modifiers* (see figure 2 for example). The end resulting data can then be exported from the Observer as an Excel file containing all segments of one specific event.

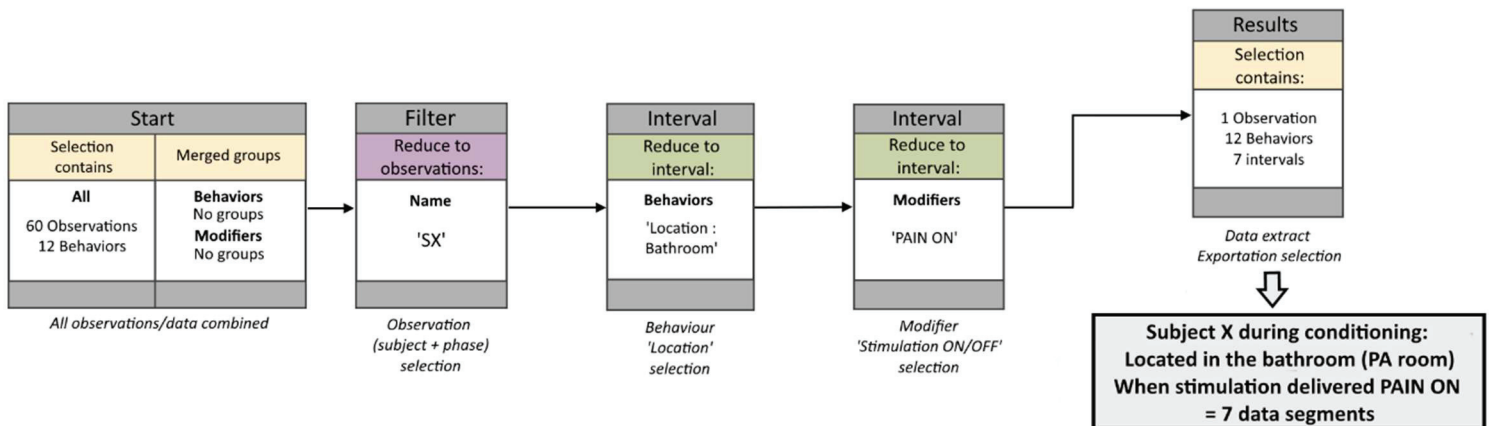

Figure 2 Example of Data segmentation and exportation using a *Data Profile* created in The Observer: Selection of *Observation* 'SX', filtered with both a *Behavior* interval 'Location: Bathroom' and a *Modifier* interval 'PAIN ON', resulting in 7 data segments corresponding to when the subject is in the PA room all while the Electro-stimulation is delivered.

To alleviate further writing, the PA condition-associated room location will be referred as PA-ON (when the electrostimulation is ON), PA-OFF (for when it is OFF); the NPA condition associated room location will be referred as NPA-ON (when the sound stimulation is ON), NPA-OFF (for when it is OFF); the control condition associated room location will be referred as CONT; the hallway location serving as baseline will be referred as BL. The same code will be used for room entries (Entry PA-ON, Entry PA-OFF, Entry NPA-ON, Entry NPA-OFF, Entry CONT). Stimulations will be referred as PA-STIM for the painful electro stimulation and NPA-STIM for the aversive sound stimulation.

EEG, SSR and EKG data were exported for each subject in each phase (conditioning and extinction).

For the conditioning phase: the following segments were exported for each subject: (i) 7 segments PA-ON , 7 segments NPA-ON, 3 segments PA-OFF , 3 segments NPA-OFF, 10 segments CONT – all 49 seconds long each (duration of the subject's presence in a specific room) (ii) 7 segments Entry-PA-ON, 7 segments Entry NPA-ON, 3 segments Entry-PA-OFF, 3 segments Entry NPA-OFF, 10 segments Entry-CONT – 5 seconds long each (duration of entrance into a room) (iii) 7 segments PA-STIM , 7 segments NPA-STIM – 40 seconds long each (stimulation duration) and (iv) 30 segments BL of average 25 seconds each (duration of the subject's presence in the hallway). Note that stimulations (electro-stimulation and sound stimulation) were both delivered in the 5s Entry-PA-ON and Entry-NPA-ON time windows respectively.

For the extinction phase: the number of ON/OFF segments varied across subjects according to their specific extinction-group-belonging (Total extinction, NPA extinction, PA extinction).

For the total extinction groups: (i) 10 segments PA OFF, 10 segments NPA OFF (ii) 10 segments Entry PA OFF, 10 segments Entry NPA OFF.

For the NPA extinction groups: (i) 7 segments PA ON, 3 segments PA OFF, 10 segments NPA OFF (ii) 7 segments Entry-PA-ON, 3 segments Entry PA OFF, 10 segments Entry NPA OFF.

For the PA extinction groups: (i) 7 segments NPA ON, 3 segments NPA OFF, 10 segments PA OFF (ii) 7 segments Entry-NPA-ON, 3 segments Entry NPA-OFF, 10 segments Entry PA OFF.

Note: Further analyses concern SSR data and location specific segments only: SSR_{PA-ON} , SSR_{NPA-ON} , SSR_{PA-OFF} , $SSR_{NPA-OFF}$, SSR_{CONT} , SSR_{BL} .

2.2.2. Sympathetic skin response:

All segments of every condition (PA-ON, PA-OFF, NPA-ON, NPA-OFF and CONT) and baseline segments were rectified before further processing.

For **conditioning phase** segments, an artificial baseline of 49 seconds was created for baseline correction of each condition. To do so, 15 **artificial segments** of 49 seconds were created out of the initial 25 seconds long SSR_{BL} segments (see example Figure 3). Baseline segments were then averaged to create a single 49 seconds long SSR_{BL} segment for each subject.

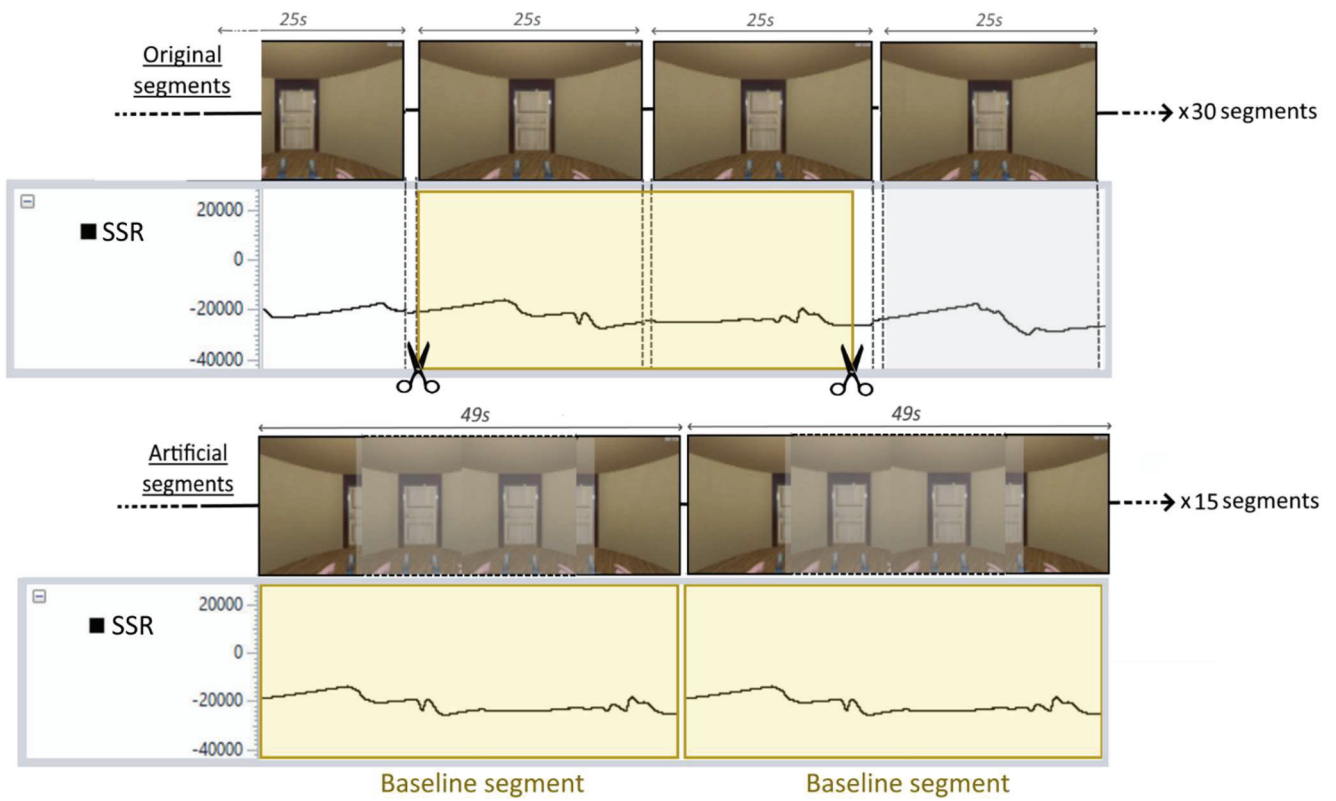

Figure 3 Example of Baseline segments creation. Out of the thirty 25-seconds long initial Hallway segments (upper row), a total of fifteen new baseline (BL) segments were created artificially lasting 49-seconds long (lower row) to match condition segments (PA-ON/PA-OFF: PA-room when the painful stimulus is on and off respectively ; NPA-ON/NPA-OFF: NPA-room when the sound stimulus is on and off respectively; CONT: the control room).

All 7 SSR_{PA-ON} segments , 7 SSR_{NPA-ON} segments, 3 SSR_{PA-OFF} segments, 3 $SSR_{NPA-OFF}$ segments and 10 SSR_{CONT} segments were averaged within their condition so to finally obtain six averaged segments in total for each subject: SSR_{PA-ON} , SSR_{NPA-ON} , SSR_{PA-OFF} , $SSR_{NPA-OFF}$, SSR_{CONT} , SSR_{BL} . To eliminate non-specific effects, the baseline was subtracted to each condition: $SSR_{PA-ON} - SSR_{BL}$, $SSR_{NPA-ON} - SSR_{BL}$, $SSR_{PA-OFF} - SSR_{BL}$, $SSR_{NPA-OFF} - SSR_{BL}$, $SSR_{CONT} - SSR_{BL}$. To alleviate writing these will be further referred as : SSR_{PA-ON} , SSR_{NPA-ON} , SSR_{PA-OFF} , $SSR_{NPA-OFF}$, SSR_{CONT} .

Averaged segments were divided into four 10 seconds-long intervals starting at 3s after event onset to avoid any contaminations (e.g. the shock of the corresponding stimulation or associated startle probe), intervals will be referred as: 0-10 s, 10-20s, 20-30s, 30-40s). This allowed to investigate the evolution of SSR throughout the entire duration of a specific room (PA-ON, PA-OFF, NPA-ON, NPA-OFF and CONT) (see example Figure 4).

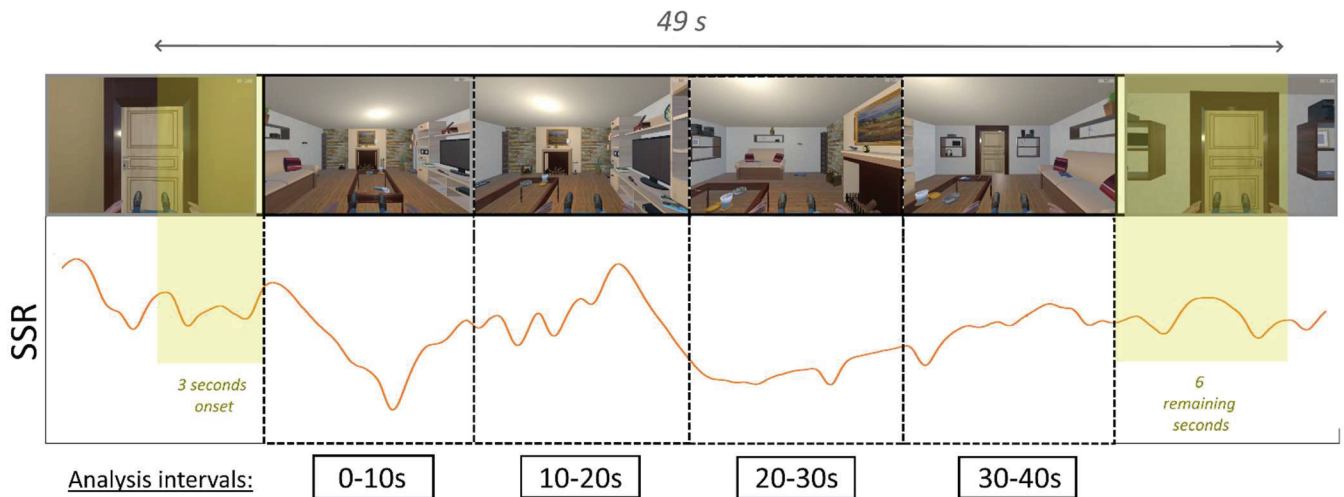

Figure 4 Example of averaged SSR segment division into four equal time-intervals (0-10s, 10-20s, 20-30s, 30-40s). with 3-seconds long onset (to avoid stimulation contamination) and 6 remaining seconds.

SSR amplitude: For each interval of each segment, amplitude of the SSR was measured peak-to-peak of the largest deflection of the corresponding interval, in keeping with previous studies (Chapon et al. 2019, Kroes et al. 2017).

Statistical analysis: A two-way repeated measures ANOVA was performed with rooms (PA-ON, PA-OFF, NPA-ON, NPA-OFF and CONT) and time intervals (0-10 s, 10-20 s, 20-30s, 30-40s) as inner-subject factors, with Greenhouse-Geisser correction. Holm-corrected post-hoc t-tests were added when needed.

Extinction phase: segments were baseline corrected following the same procedure described above. Extinction SSR analysis was focused on the first 10 seconds of room-location (interval 0-10s). For each group of subjects, only extinguished conditions were used for analysis: (i) Total extinction group subjects resulted in three type of segments : 10 segments SSR_{PA-OFF} , 10 segments $SSR_{NPA-OFF}$, 10 segments SSR_{CONT} (ii) NPA extinction group subjects resulted in two types of segments: 10 segments $SSR_{NPA-OFF}$, 10 segments SSR_{CONT} and (iii) PA extinction group subjects resulted in two types of segments: 10 segments SSR_{PA-OFF} , SSR_{CONT} . For each subject and all 10 rounds, SSR amplitude was measured peak-to-peak-, between the minima and maxima of the corresponding interval.

For each subject, SSR amplitudes of round 1 to round 5 were averaged defining a first period of extinction called EARLY stage; amplitudes of round 6 to round 10 were averaged defining a second period of extinction called LATE stage to evaluate the extinction progress throughout the extinction phase.

Statistical analysis: Painful stimulation extinction (including Total extinction and PA extinction groups subjects) and non-painful aversive stimulation extinction (including Total extinction and NPA extinction group subjects) were analysed separately. These will further be referred simply as PA extinction and NPA extinction. For both extinctions, a two-way repeated measures ANOVA was performed with rooms (PA-OFF, CONT and NPA-OFF, CONT rooms respectively) and period (EARLY, LATE) as inner-subject factors, for the 0-10s interval. Holm-corrected post-hoc t-tests were added when needed.

2.2.3. EKG Analyses

These analyses will be performed after manuscript deposition

3. Results

3.2. Behavioral results

Stimulation unpleasantness: Results of Student-t test revealed that subject evaluated the painful electro-stimulation (mean rating: 63.2 +/-18.5) as more unpleasant than the non-painful aversive sounds (mean rating: 57.3 +/- 19.0) ($t(58)=2.142$ $p=0.036$) (Figure 5).

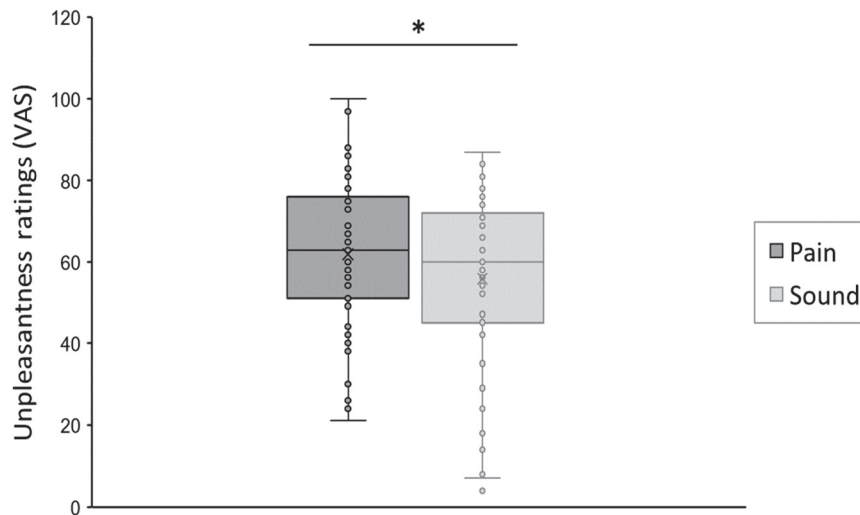

Figure 5 : Mean unpleasantness ratings for the painful stimulation (dark grey) and the aversive sound stimulation (light grey) post-conditioning. Individual ratings are represented in dots. * $p<0.05$

Valence: Repeated measure ANOVA revealed both a significant room effect ($F(2,58)=5.49$; $p=0.007$), and timepoint effect ($F(2,58)=20.2$, $p<.001$) with a significant room/timepoint interaction ($F(4,58)=5.36$ $p<.001$). Post-hoc t-tests showed that both the PA and NPA rooms valence was significantly different from that of the CONT room ($t(58)=2.72$ $p= 0.015$; $t(58)=2.99$ $p=0.010$ respectively) though no difference was revealed within aversive conditions. All rooms confounded, pre-conditioning valence was revealed to be significantly higher than post-conditioning valence ($t(58)=6.21$ $p<.001$) and post-extinction valence ($t(58)=4.26$ $p<.001$) measurements. Pre-conditioning, no difference in valence assessment was found between rooms (PA, NPA and CONT). Post-conditioning, a significant decrease in valence assessment was found for the NPA room ($t(58)=3.99$ $p=0.002$) and even more so for the PA room ($t(58)=4.6$ $p<.001$) compared to the control room. No difference was found between PA and NPA rooms. Post-extinction, PA and NPA valence assessment increased approaching CONT room valence, hence difference between rooms disappeared (Figure 6A).

Repeated measures ANOVA also revealed an extinction group effect ($F(2,58)= 3.76$ $p=0.029$) with a significant difference in valence assessment between the Total extinction group and the NPA extinction group ($t(58)=-2.68$ $p=0.029$) (figure 6B). Though the difference seems to rely on the PA room valence – the NPA

extinction group evaluated increasingly lower valence at Post-EXT compared to the total extinction group (to be expected due to repeated painful stimulation in the PA room), further analysis did not show specific statistical significance.

Emotional Impact: Repeated-measured ANOVA revealed a significant room effect ($F(2,58)=3.90$ $p=0.025$) and phase effect ($F(2,58)=9.28$ $p<0.003$) with a significantly higher EI attributed to the NPA room compared to the PA room ($t(58)=2.53$, $p=0.039$) and the CONT room ($t(58)=2.29$, $p=0.047$) with an overall significant decrease in Emotional impact Post-EXT compared to Post-COND, though further post-hoc t-test revealed this decrease to be significant for the NPA room only ($t(58)=3.30$, $p=0.015$) (Figure 6C).

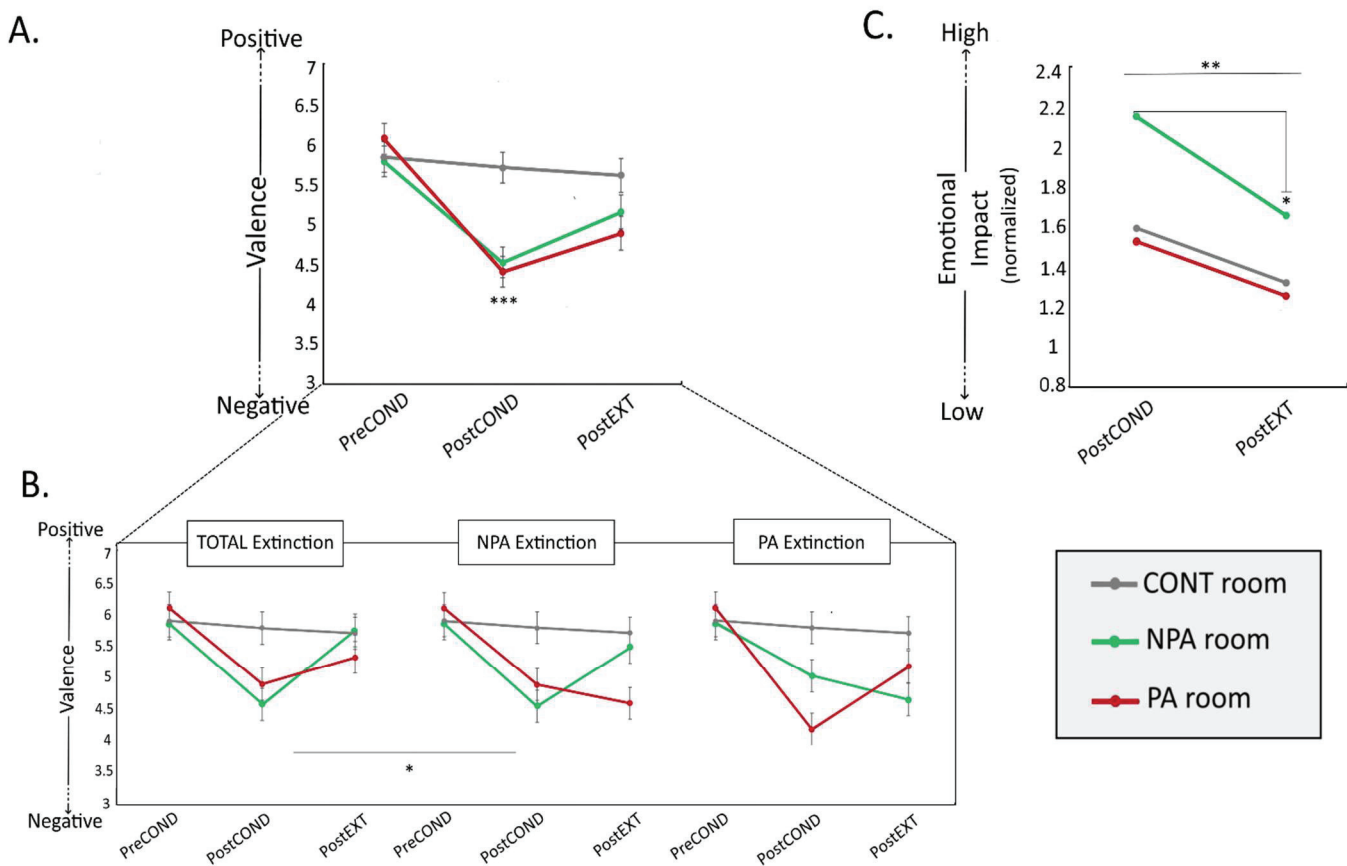

Figure 6 Environment perception **A.** Global valence assessment for each room (PA, NPA and CONT) and each time-point (PreCOND, PostCOND, PostEXT) **B.** Valence for each extinction group (Total, NPA and PA extinction) and **C.** Emotional Impact for each room (PA, NPA and CONT) and time-point (PostCOND, and PostExt) * $p<0.05$ ** $p<0.01$ *** $p<0.001$.

3.3. Physiological results

Conditioning phase: Example of mean SSR for each condition (PA ON, PA OFF, NPA ON, NPA OFF, CONT) as a function of time is given in Figure 7.

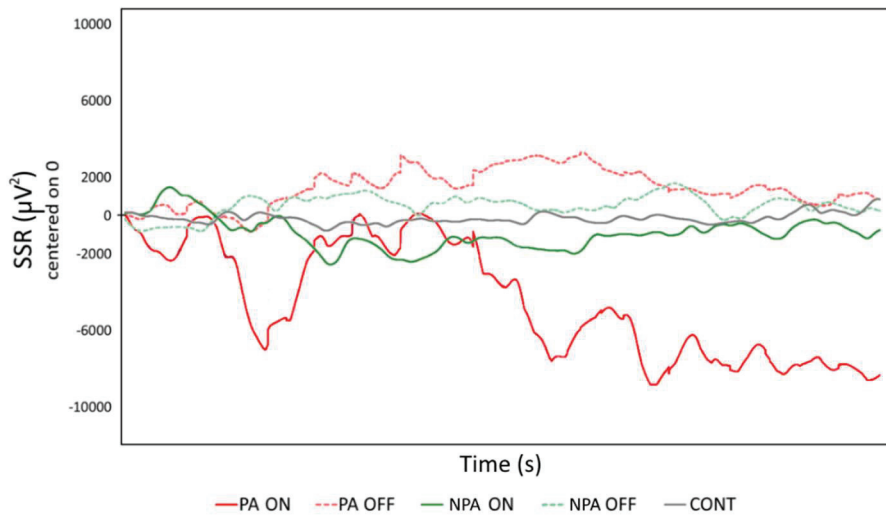

Figure 7 Example of one subject's mean SSR across conditions (PA ON, PA OFF, NPA ON, NPA OFF, CONT) throughout the entire duration of a room circuit (49 seconds long). Mean SSRs are baseline corrected and centered at 0 for visualization facilitation.

Repeated measures ANOVA revealed that SSR amplitude depended on the condition associated room ($F(4.58)=42.8$ $p<.001$) with SSR amplitude of the PA ON room appearing considerably greater compared to all the other rooms (CONT: $t(58)=11.6$ $p<.001$; PA OFF $t(58)=8.71$ $p<.001$; NPA ON: $t(58)=9.71$ $p<.001$; NPA OFF: $t(58)=10.4$ $p<.001$); as well as a greater SSR amplitude in the PA OFF room compared to CONT ($t=2.84$ $p=0.03$) (Figure 8A). Time-interval was also a contributing factor ($F=10.9$ $p<.001$) as SSR amplitude during the first ten seconds of room circuits (0-10s) appeared significantly different than SSR amplitude during the remaining 30 seconds (10-20s: $t=3.78$ $p<.001$; 20-30s: $t=4.88$ $p<.001$; 30-40s: $t=4.99$ $p<.001$) with a significant room/time-interval interaction ($F=6.63$ $p<.001$). Indeed, PA OFF room-SSR amplitude was significantly larger compared to control during the first ten seconds of room circuit only ($t=4.09$ $p=0.007$) (Figure 8B), with a slight tendency remaining in the second time-interval (10-20s) ($t=3.46$ $p=0.075$) before decreasing to control level at 20s past room entry. SSR amplitude during the PA ON room was overall significantly larger compared to all

other rooms (PA OFF, NPA ON, NPA OFF, CONT) in all time-intervals (0-10s, 10-20s, 20-30s and 30-40s) (see table 2).

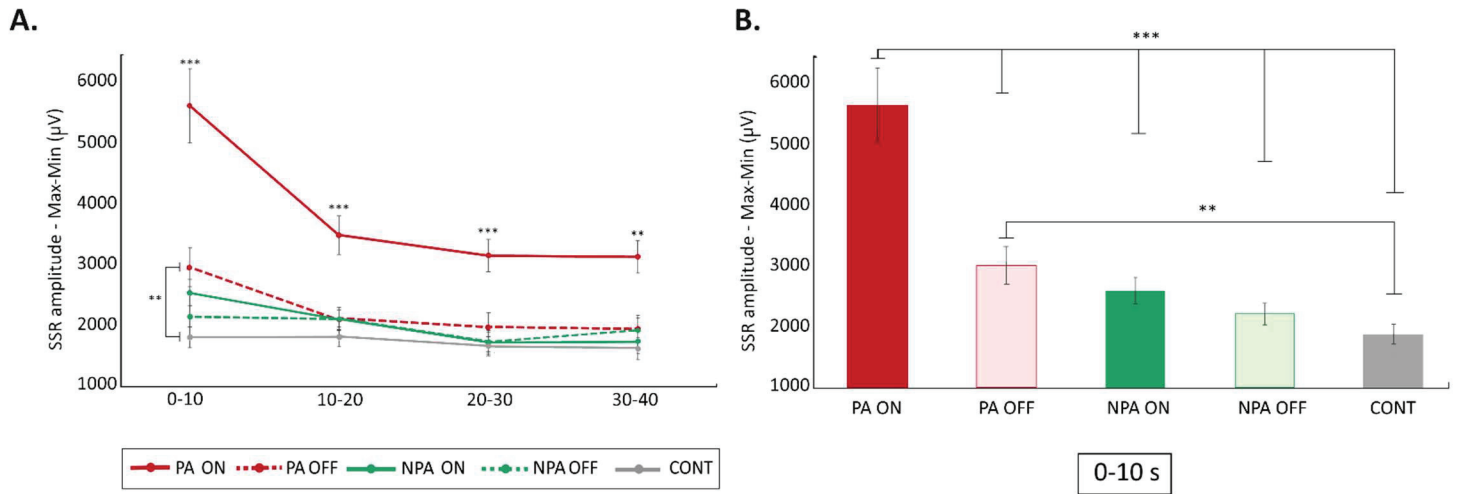

Figure 8 Mean SSR peak-to-peak amplitude (Max-Min) (µV) **A.** For each room (PA ON, PA OFF, NPA ON, NPA OFF, CONT) at each time-interval (0-10s, 10-20s, 20-30s, 30-40s) and **B.** During the first 10 seconds of room-circuit (0-10s interval) for each room (PA ON, PA OFF, NPA ON, NPA OFF, CONT) **p<0.01 ***p<0.001.

	PA ON	PA OFF	NPA ON	NPA OFF	CONT
0-10s					
PA ON		t=9.31 p<.001	t=10.4 p<.001	t=12.2 p<.001	t= 13.4 p<.001
PA OFF			t=1.13 p=1.0	t=2.86 p=0.5	t=4.09 p=0.007
10-20s					
PA ON		t=4.77 p<.001	t=4.53 p=0.001	t=4.99 p<.001	t=5.64 p<.001
PA OFF			t= 0.24 p=1.0	t= 2.22 p=1.0	t=3.46 p=0.075
20-30s					
PA ON		t=4.04 p=0.009	t=4.84 p<.001	t=5.03 p<.001	t=5.21 p<.001
PA OFF			t=0.87 p=1.0	t=0.99 p=1.0	t=1.18 p=1.0
30-40s					
PA ON		t=3.83 p=0.019	t= 4.62 p<.001	t=3.93 p=0.013	t= 4.86 p<.001
PA OFF			t=0.82 p=1.0	t=0.099 p=1.0	t=1.02 p=1.0

Table 2 Detailed results of Post-hoc tests (Holm corrected) for SSR peak-to-peak amplitude of the PA ON and PA OFF rooms compared to all other rooms (PA ON, PA OFF, NPA ON, NPA OFF, CONT) at all time-intervals (0-10s,10-20s,20-30s,30-40s)

Note: SSR amplitude of the PA room overshadows what happens in the NPA room. Isolating NPA ON, NPA OFF and CONT, similar results were exposed with an overall room effect ($F(2,58) = 6.61$ $p=0.004$), post-hoc t -tests revealing a significant difference between NPA OFF and CONT ($t=2.30$ $p=0.047$) and even more so between NPA ON and CONT ($t(58) = 3.58$ $p=0.002$)

Extinction phase: *For the PA extinction subjects (including Total extinction and PA extinction groups), observational analysis of SSR amplitude during the first ten seconds of a room circuit revealed a progressive decline throughout all ten rounds for both the PA room (mean slope at -181.0 from round 2 to 9) and CONT room (mean slope at -167.8 from round 2 to round 9) (Figure 9A). Results of the repeated measures ANOVA indicated a period effect ($F=7.65$ $p=0.010$) with overall SSC amplitudes being significantly larger at the EARLY period of extinction (from round 1 to 5) compared to the LATE period (round 5 to 10), all rooms confounded (PA OFF, CONT) (Figure 9B). No statistical difference was found between rooms.*

*For the NPA extinction subjects (including total extinction and NPA extinction groups) observational analysis during the first ten seconds of room-location revealed a progressive decline in SSC amplitude throughout all ten rounds mainly for the CONT room (mean slope at -224.3 from round 2 to 9) whereas decrease in SSR amplitude is less obvious for the NPA room (mean slope at -110.6 from round 2 to 9) (Figure 9A). Results of the repeated measures ANOVA indicated a period effect ($F=7.11$ $p=0.013$) with overall SSR amplitudes being significantly larger at the EARLY period of extinction (from round 1 to 5) compared to the LATE period (round 5 to 10), all rooms confounded (NPA OFF, CONT) (Figure 9B). No statistical difference was found between rooms nor any room*period interaction.*

A.

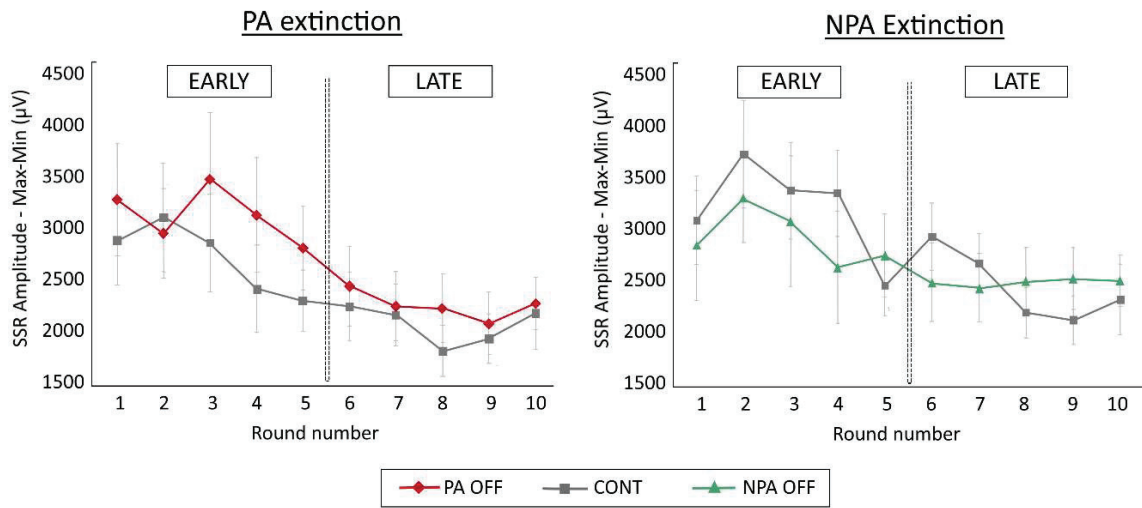

B.

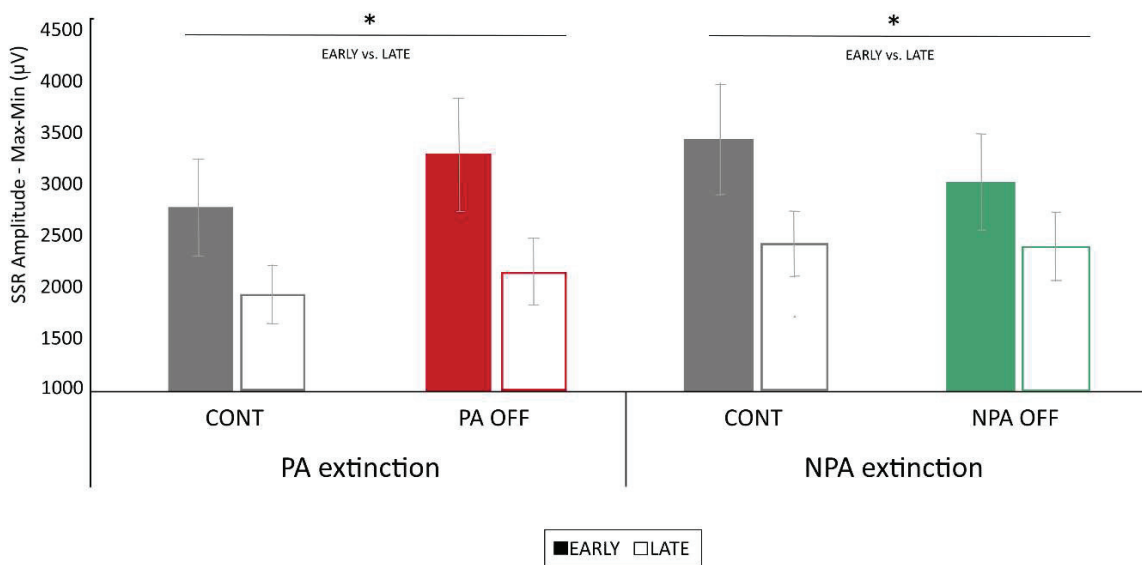

Figure 9 SSR peak-to-peak amplitude (µV) during the extinction phase A. On the left- Mean SSR amplitude for all ten rounds of the extinction phase for the PA stimulation extinction subjects (Total and PA extinction groups) for both PA OFF and CONT rooms; On the right- Mean SSR amplitude for all ten rounds of the extinction phase for NPA stimulation extinction subjects (Total and NPA extinction groups) for both NPA OFF and CONT rooms **B.** Mean SSR amplitude at EARLY and LATE periods of extinction for PA stimulation extinction subjects (PA OFF, CONT) and NPA stimulation extinction subjects (NPA OFF, CONT). * $p < 0.05$.

4. Summary and discussion

Results confirmed a successful context perception modulation indicated by a strong decline in valence assessment for both aversive conditioned rooms (PA and NPA), compared to the control room (CONT), in keeping with previous studies showing discriminative perceptions of conditioned stimulus (CS+), judged as more negative than neutral conditioned stimulus (CS-) (Andreatta et al. 2020, Neueder et al. 2019, Hermann et al. 2016, Alvarez et al. 2008, Huff et al. 2010, Muhlberger et al. 2014). Coherently with results showing that the painful stimulation was perceived as more unpleasant than aversive sounds, a slightly stronger decline was observed for the PA room vs. the NPA room in contrast with control. Extinction partially canceled this effect with both aversive room valence recovering back to near CONT level. NPA conditioning only generated a high emotional impact rating of the NPA room compared to CONT and PA rooms, with a significant decrease post-extinction, though initial bias of pre-conditioning high emotional impact ratings for the PA room renders conclusion on this outcome unstated.

Evidence of an effective conditioning was also revealed on a physiological level, as SSR peak-to-peak amplitude appeared undoubtedly larger for the PA room when the painful stimulation was delivered (PA ON) compared to the NPA room (NPA ON, NPA OFF) and the CONT room, but also in the absence of the painful stimulus (PA OFF) compared to control, thus manifesting signs of increased pain-related-stress and pain-contextual-related anticipation (Andreatta et al. 2015a, 2017, Neueder et al. 2019, Genheimer et al. 2017, Baas et al. 2004). The latter primarily occurred in the first 10 seconds of entering a specific room, only to disappear for the remaining 30 seconds, presumably coordinated with subjects' awareness of stimulus absence. Skin conductance (SC) responses, such as variability and SC levels, have been positively correlated to experimental and clinical pain (Sugiminie et al. 2020, Syrjala et al. 2019, Günther et al. 2016, 2013) as well as emotional stress (Günther et al. 2013); however, strong SC responses to painful stimulations compared to non-painful sympathetic stimuli (Sugiminie et al. 2020) as well as negatively connotated sound and emotionally induced stress (Günther et al. 2016) suggested a discriminator role of SC response, differentiating physical pain from non-painful sensory and emotional stimuli. In our case, PA conditioning clearly outweighed NPA conditioning in terms of SSR amplitude, evidenced by greater pain-specific and pain-specific-anticipation responses, even though isolating NPA ON, NPA OFF and CONT rooms revealed similar but weaker outcomes, as sound-related and sound-anticipation-related SSR amplitude appeared higher compared to control.

PA Extinction was expressed by a progressive decrease in SSR amplitude from round 1 to round 10 for both the PA OFF room and the CONT room, which was characterized by an overall significantly lower SSR amplitude during the LATE phase of extinction compared to the EARLY phase. NPA extinction however was expressed by a similar decline in SSR amplitude primarily for the CONT room, and only slightly for the NPA OFF room, which nonetheless translated into an overall significant difference in SSR amplitude between EARLY and LATE periods of extinction. Both extinctions (PA and NPA) appear to be context-independent, possibly reflecting contextual generalization mechanisms. The lack of context-specificity in SSR extinction processes has been observed in studies using generalization stimulus (Vervliet et al. 2004). Vervliet et al. highlighted the

capacity to extinguished conditioned response when confronting an extinction stimulus fairly similar but perceptually different from the conditioned stimulus – even though further confrontations with the initial conditioned stimulus revealed that extinction of generalized stimulus was not effective as indicated by return of fear responses. Regardless of the latter, in the present study, subjects confronted all three rooms (CONT, NPA, PA) during extinction for which main features were similar- including shape, size, trajectory and initial visualization (door opening and entrance)- it is tempting to consider that although room-contents were different, they all generated equal SSR extinction responses due to generalization processes. This affirmation remains speculative, as both PA and NPA extinctions include subjects for whom aversive sounds or electro-stimulations respectively were still induced in non-extinguished rooms, which could have disturbed extinction processes.

Conclusion:

The goal of this methodologic study was to develop an effective ecological contextual aversive (painful and non-painful) conditioning paradigm in healthy subjects, using immersive Virtual Reality. Results show that aversive conditioning was successfully acquired via contextual perception modulation (negative perception of conditioned contexts) and sympathetic skin conductance responses to aversive stimulations and to stimulation anticipation when entering associated contexts (specifically the painful electro-stimulation and pain anticipation). The innovative aspect of our protocol was the use of long-period induced stimulations, enabling not only to near real-life conditions such as in chronic pain, but also avoided any cue conditioning processes with specific items of the environment, rather than general context conditioning. High rates of iVR tolerance supports the use of this innovative tool as context stimulation, and contributes to the evolving substance of literature using VR to investigate contextual conditioning mechanisms. The outcome of this study encourages to investigate further use of iVR environments to focus on different research interrogations, still mainly addressed in cue conditioning paradigms, such as explicit memory mechanisms (Dunsmoor and Kroes 2018, Ähs et al. 2015, Connor and Gould 2016), attentional biases (Klein et al. 2021, Oehlberg and Mineka 2011, Koenig et al. 2021), gaze and avoidance behavior (Armstrong et al. 2022, Michalska et al. 2017) and extinction and renewal of threat responses (Andreatta et al. 2020, 2017, Hermann et al. 2016, Milad et al. 2005, Bouton et al. 2004).

Part B: Behavioral mnemonic mechanisms underlying aversive contextual conditioning in healthy subjects.

1. Introduction

The event of pain constitutes a complex emotional and sensory experience for which underlying long-term mnemonic mechanisms are still poorly understood. Current knowledge offers extensive evidence that pain memorization can be both explicit and implicit: explicit memory comprises short- and long-term episodic recollection of painful events, whereas implicit memory includes non-declarative immediate sensory reaction to pain (habituation/ sensitization) as well as sensitivity alterations regarding painful incidents (Upadhyay et al. 2016, Khoshnejad et al. 2017). Studies have uncovered this effect through investigation of neonates repeatedly exposed to harmful events who later on displayed life-long behavioral and physiological maladaptive changes regarding not only painful procedures but also contextually-associated routine handling (Knaepen et al. 2012, Grunau et al. 2006), which, in some cases, leads to heightened generalized stress or even chronic pain in infants (Grunau et al. 2006, Holsti et al. 2005, Von Baeyer et al. 2004).

In contrast to how pain influences the perception of its associated environment, the context in which a painful event is memorized appears to impact future pain perception and its potential chronicity development (Apkarian et al. 2009). In fact, depending on the valence attributed to the pain-associated context, its recollection can respectively either shift to a decreased assessment of pain, for example in women's remembering labor associated pain (Christiansen et al. 2002, Waldenström & Schytt 2008, Niven & Murphy-Black 2000) and in memory of pain associated with physical exercise (Babel et al. 2018, Babel 2016), or increased assessment, such as in chronic pain (Apkarian et al. 2009, McCarberg & Peppin 2019) or in traumatic painful experiences (Gedney & Logan 2004, McNeil et al. 2011).

It is indeed comprehensible to consider that pain constitutes a traumatic aggression and thus be memorized as such. As strong associations are made between the memory of a traumatic event and that of its associated context, equivalent processes might occur regarding pain. Several studies focused on the role of implicit learning in context/stimulus associations: using blurred-picture paradigms it was discovered that post-traumatic stress disorder (PTSD) patients presented perceptual priming for specific trauma-related sensory cues compared to neutral cues (Kleim et al. 2012). Generalized perceptual facilitation for negatively connotated stimulus was also observed in patients suffering from PTSD (Mazza et al. 2012, Hayes et al. 2012), but also in healthy subjects (Ehlers et al. 2006, Michael et al 2007, Gregoire et al. 2021). Specific cues capable of triggering trauma-associated adverse emotions, observed in fear conditioning responses (i.e. enhanced physiological reactivity and avoidance behavior to fear related context), may well verify the reality of a strong implicit mnemonic trace of an initial traumatic event.

As fear conditioning and extinction paradigms are widely used as experimental models for fear memory in PTSD, pain conditioning protocols in humans aiming to investigate behavioral mnemonic mechanisms of pain

and fear of pain are only slowly developing, even though essential to better understand the role played in the maintenance of chronic pain (Meulders et al. 2020). Indeed, –chronic pain is described as a state of persistent learning in which the continuous presence of pain generates constant aversive associations with daily events (Apkarian et al. 2009, Mazza et al. 2018; Harvie et al. 2017) resulting in pain or pain-related fear conditioning. (see Chapter 1- Introduction)–

Our goal is to study long-term mnemonic mechanisms of pain conditioning in humans, by investigating long-term memory of multiple aspects of pain (intensity and unpleasantness) as well as how a contextually induced painful stimulus can modulate both the perception and the implicit content memorization of its associated environment, compared to a non-painful aversive conditioning.

1. Data analysis

Stimulation perception: Pain intensity, pain unpleasantness and sound unpleasantness were assessed at several time points (see table 1). The NPA extinction group was the only group for which we had two measures of pain intensity and pain unpleasantness on day 0 after the conditioning phase. Indeed, we measured these two parameters both just after conditioning ($D0_{\text{PostCOND}}$) and after extinction ($D0_{\text{PostEXT}}$) since, for this group, only the sound stimulation was extinguished. In order to have a single value of pain intensity and unpleasantness for all groups for the period after conditioning on day 0, we performed an average of these two values for the NPA group. This average value was further referenced as $D0_{\text{PostCOND}}$ in order to homogenize the different groups. Likewise, for the PA extinction group, for which two measures of sound unpleasantness were performed after the conditioning phase, $D0_{\text{PostCOND}}$ and $D0_{\text{PostEXT}}$ sound unpleasantness ratings were averaged to obtain a single $D0_{\text{PostCOND}}$ rating.

For pain intensity ratings, a repeated measures ANOVA was done using time point ($D0_{\text{-COND}}$, $D0_{\text{PostCOND}}$, D1, D14) as within factor and gender as inter-subject factor. Subjects were later categorized into two groups: 1. Subjects who increased their pain intensity ratings from $D0_{\text{PostCOND}}$ to D14 (referred as PAIN+), and 2. Subjects who decreased their pain intensity ratings (referred as PAIN-). This enabled further observational analysis of mean anxiety levels (see [Anxiety level assessment](#) below).

For unpleasantness ratings, a repeated measures ANOVA was done using time point ($D0_{\text{PostCOND}}$, D1, D14) and type of stimulation (pain, sound) as within factors and gender as inter-subject factor.

		Time Points					
		Day 0				Day 1 (next day)	Day 14 (two weeks after)
		Pre-conditioning $D0_{\text{-PreCOND}}$	During conditioning $D0_{\text{COND}}$	Post-conditioning $D0_{\text{PostCOND}}$	Post-extinction $D0_{\text{-PostEXT}}$	D1	D14
Stimulation Perception	Pain Intensity		X	X	X - NPA extinction group *	X	X
	Pain Unpleasantness		X	X	X - NPA extinction group *	X	X
	Sound Unpleasantness			X	X - PA extinction group **	X	X
Environment Perception	Valence	X		X	X	X	X
	Emotional Impact	X		X	X	X	X
Contingency awareness	Final question						X
Implicit memory	Object Identification (performance + RT)				X	X	X

Table 1 Measurement Timepoints for Behavioral tests : (i) Stimulation perception : Pain intensity, pain unpleasantness and sound unpleasantness ratings; * pain intensity and pain unpleasantness ratings at $D0_{\text{PostEXT}}$ concern the NPA extinction group only; ** sound unpleasantness ratings at $D0_{\text{PostEXT}}$ concern the PA extinction group only, (ii) Environment perception : Valence and EI of each room – PA, NPA, CONT, (iii) Contingency awareness : recollection of room-condition associations, (iv) Implicit memory : object identification - performance and RT.

Environment perception: Valence and Emotional Impact of each room were assessed at five different time-points for every subject as illustrated in Table 1.

For Valence, a repeated measures ANOVA was done using time point (D0-PreCOND, D0-PostCOND, D0-PostEXT, D1, D14) and room (PA, NPA, CONT) as within factors and gender as inter-subject factor.

For Emotional Impact (EI), D0-PreCOND- EI value was used as baseline* (**see explanation part A- section 2.1**). A repeated - measures ANOVA was done using time point (D0-PostCOND, D0-PostEXT, D1, D14) and room (PA, NPA, CONT) as within factors and gender as inter-subject factor.

Contingency awareness: At the end of the experiment, meaning at 14 days or more after conditioning, the following question was asked: “*In which room did you receive the following stimuli? (i) Painful stimulation, (ii) Sound stimulation, (iii) No stimulation*”. Subjects were categorized into two groups: either CORRECT group (CT), corresponding to subjects with all rooms correctly identified, and INCORRECT group (ICT), corresponding to at least one error out of the three answers.

Statistical analysis of Valence and EI was repeated adding **contingency awareness (CT, ICT)** as inter-subject factor.

Note: Contingency awareness question was added in the course of the experimental period, resulting in 47 answers out of the 59 participants (23 women) : 21 subjects answered at the end of D14, 26 subjects answered around 3 months post-experimenting and 12 subjects did not respond to late solicitation.

Implicit memory: Out of the 59 healthy volunteers (25.77 ± 5.5 y.o; 29 women) (see chapter 1-Part A-Participants section), 2 subjects had to be excluded from implicit memory analyses due to very low performance on testing (number of error $> \text{Mean} + 2 * \text{SD}$) and 2 due to out of norm reaction time (RT) values ($\text{RT} < \text{Mean} - 2 * \text{SD}$), thus, $n=55$ (26.41 ± 6.0 y.o; 26 women) participants were included in the analysis of implicit memory. Implicit memory of room-associated objects was measured using a blurred picture paradigm: blurred pictures of each objects had to be identified within a 6s time window corresponding to the duration of progressive deblurring until clear (see explanation of test Chapter 1- Part B- section 2.4) in four different time-points: at the end of D0 (D0), the next day (D1) and two weeks after (D14) (Table 1).

Identification of 132 objects was tested, out of which 90 objects were effectively in the apartment during conditioning and extinction phase (30 objects per room)- further referred as **present objects**, and 42 new objects were added during testing (14 objects per room, i.e. semantically associated to a specific room)- further **referred as non-present objects**. Identification reaction times (RTs) and corresponding answers (see below) were collected. **The following analyses were performed separately for present and non-present objects.**

Performance: Performance to object identification testing was defined in terms of *number of correct identifications* - corresponding to correct identifications given within the time interval of 6s (see explanation of test [Chapter 1- Part B- section 2.4](#)) for each type of object (PA, NPA or CONT room associated). Other types of answers were grouped in three categories: (i) *number of missed correct identifications* (corresponding to correct

identifications given after the time limit of 6s), (ii) *number of incorrect* identifications (corresponding to incorrect identifications given within the time interval of 6s) and (iii) *number of missed* (no answer given) for each type of object. For each type of answer, a repeated measures ANOVA was performed with condition (PA, NPA and CONT) and time point (D0, D1, D14) as within factors, and gender as inter-subject factor. Holm-corrected post-hoc tests were performed when needed.

Reaction time (RT): For each subject, RTs were ordered to their associated room (PA, NPA, CONT). RTs were rectified for each subject and each timepoint by removing values over Mean RT \pm 2 SD to eliminate any inattention effect or early reflex key press. For each subject, identification RTs were averaged for each room (PA, NPA, CONT) and each assessment time point (D0, D1, D14).

For present objects, a repeated measures ANOVA was performed on mean identification RTs with room (PA, NPA and CONT) and time point (D0, D1, D14) as within factors, and gender as inter-subject factor. Holm-corrected post-hoc tests were performed when needed. The same procedure was done on non-present objects.

Anxiety level assessment: State and Trait- anxiety levels were measured (*see chapter 1- part B- section 2.4*). Mean State and Trait-Anxiety levels will be compared between (i) men and women, (ii) PAIN + (subjects who increased pain intensity ratings from D0 to D14) and PAIN- (subjects who decreased pain intensity ratings from D0 to D14) groups , and (iii) CT (subjects who remembered correctly room-stimuli associations) and ICT (subjects who did not remember room-stimuli associations) groups.

2. Results

2.1. PA and NPA stimulations perception

Pain Intensity: Repeated measures ANOVA showed a significant time-point effect ($F(3.58) = 7.13$ $p < .001$) and time-point*gender interaction ($F(6.58) = 3.22$ $p = 0.036$). In particular, post-hoc tests revealed that although men and women's intensity ratings were equivalent during COND ($t(58) = 0.33$, $p = 1.0$; 44.4 ± 10.2 ; 44.9 ± 10.0 respectively), women exclusively appeared to increase their pain intensity assessment in all post-conditioning recall time-points ($D0_{\text{PostCOND}}$: 55.6 ± 17.2 ; $D1$: 57.9 ± 18.3 ; $D14$: 58.42 ± 18.9) compared to ratings during COND ($t(58) = 3.74$ $p = 0.007$; $t(58) = 4.60$ $p < .001$; $t(58) = 4.79$ $p < .001$ respectively), whereas no difference was revealed for men ($D0_{\text{PostCOND}}$: 47.1 ± 14.1 ; $D1$: 47.3 ± 16.2 ; $D14$: 46.4 ± 19.2). This outcome was highlighted by an overall significant gender effect ($F = 5.58$, $p = 0.022$) (Figure 1A.).

Note: Mean electrostimulation intensity used to induce a sensation above the pain threshold was slightly higher for men (17.2 ± 4.8 mA) compared to women (15.1 ± 4.6 mA).

Stimulation Unpleasantness: Results of the repeated measures ANOVA showed that the painful aversive stimulation was rated significantly more unpleasantness than the aversive sounds all time points confounded (on average: 62.2 ± 20.2 ; 53.6 ± 21.3) ($F = 10.7$ $p = 0.002$). Post-hoc tests specified that this difference appeared at $D1$ ($t = 3.17$, $p = 0.025$) and even more so at $D14$ ($t = 3.61$ $p = 0.007$). No difference was found between pain unpleasantness ratings during conditioning ($D0_{\text{COND}}$, 62.9 ± 14.6) and post-conditioning ratings ($D0_{\text{PostCOND}}$, $D1$ and $D14$) (Figure 1B), insinuating that subjects' recall of pain unpleasantness stays intact throughout the experiment. Though no direct analysis could be made for aversive sounds as unpleasantness ratings were not recorded during conditioning, a somewhat comparison can be made with previous average ratings collected from the initial sound data bank used to create soundtracks (see chapter 1 – Part B – Non-painful aversive stimulation), which mean rating (58.7 ± 6.7) is closer to ratings of pain unpleasantness during conditioning (62.9 ± 14.6) (Figure 1B).

Inversely to pain, aversive sound ratings seem to decrease throughout time: 58.7 ± 6.7 sound bank compared to $D0_{\text{PostCOND}}$ ratings (55.9 ± 20.8), $D1$ (53.6 ± 21.1) and $D14$ (51.4 ± 22.2). A quick analysis was added to investigate this effect using a repeated measures ANOVA performed on sound unpleasantness ratings only with time-point as factor ($D0$, $D1$, $D14$): results revealed a time-point effect ($F = 3.98$ $p = 0.022$) and post-hoc tests confirmed a significant difference between $D0_{\text{PostCOND}}$ ratings and $D14$ ratings ($t = 2.79$ $p = 0.018$) (Figure 1B).

No gender effect was found for overall unpleasantness ratings.

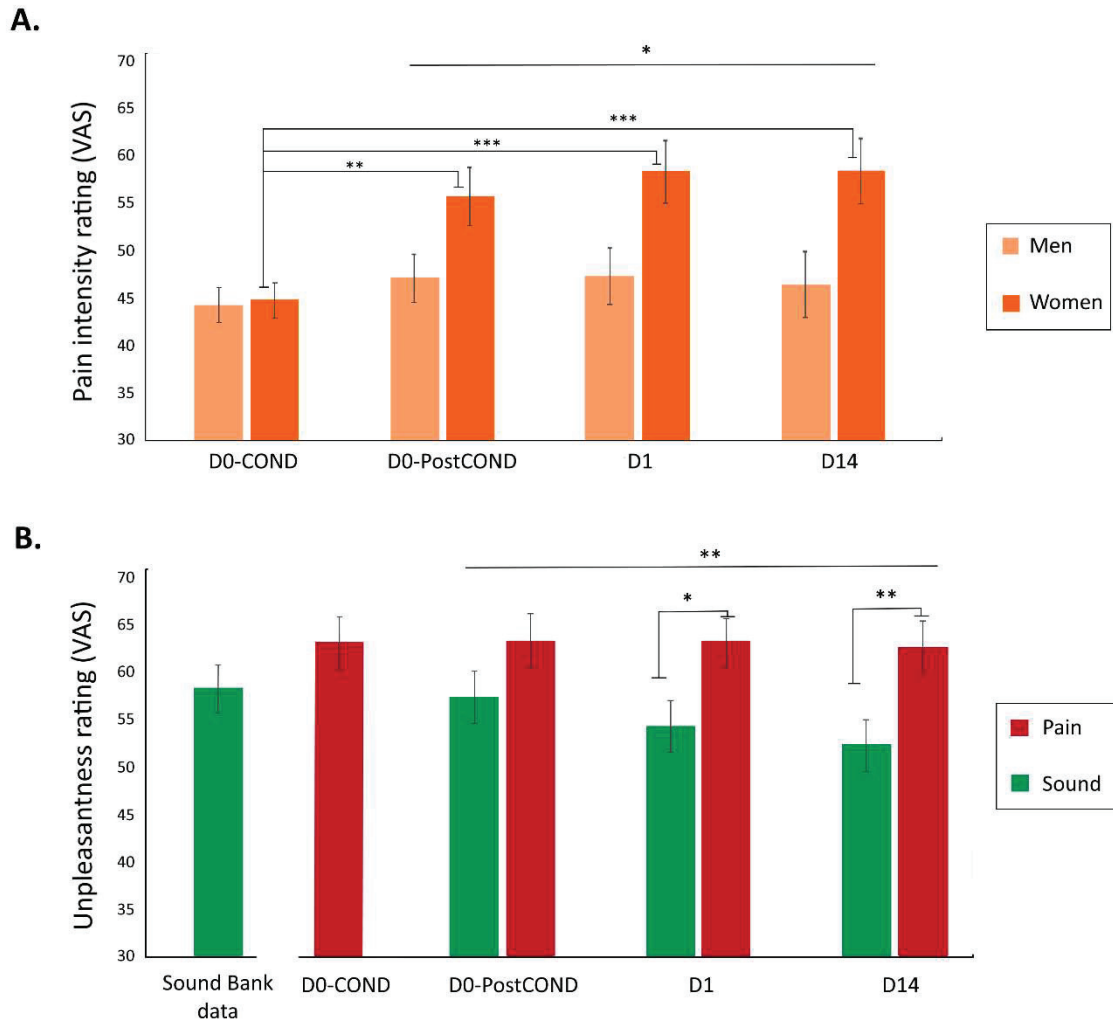

Figure 1 A. Pain intensity ratings at 4 different time-points (D0-COND, D0-PostCOND, D1 and D14) for men (light orange) and women (dark orange) and **B. Stimulation unpleasantness ratings** measured at 3 different time-points (D0-PostCOND, D1 and D14) for sound (green) and pain (red) as well as pain unpleasantness ratings at D0-COND and sound unpleasantness ratings from previous sound Bank (chap 1-PartB-2.2.2). * $p < 0.05$, ** $p < 0.01$, *** $p < 0.001$

Significant positive correlations were found between pain intensity ratings and pain unpleasantness ratings at D0-PostCOND ($r^2=0.53$, $p < .001$), D1 ($r^2=0.61$ $p < .001$) and D14 ($r^2=0.54$ $p < .001$). No correlation was found during conditioning (D0-COND) (Figure 2).

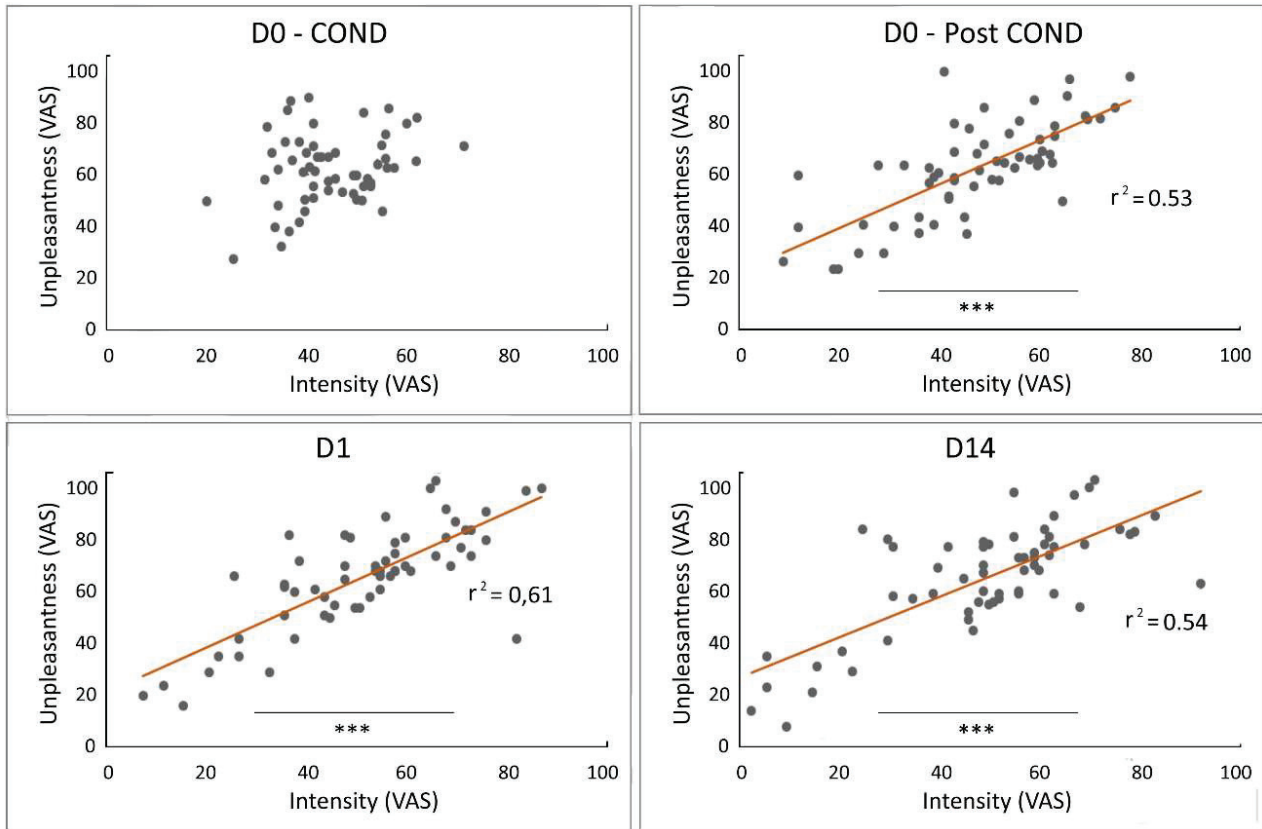

Figure 2 Pain ratings positive correlations: pain unpleasantness ratings according to intensity ratings at D0. COND (no correlation), D0-PostCOND ($r^2=0.53$), D1($r^2=0.61$) and D14($r^2 =0.54$). *** $p<0.001$

Relationship between anxiety level and pain intensity/unpleasantness ratings. State and Trait- anxiety levels were averaged for PAIN+ and PAIN- groups: we noted that subjects for whom pain intensity ratings increased from D0 to D14 (PAIN +) had overall higher Trait Anxiety levels compared to subjects who decreased their ratings (PAIN -) (44.4 +/- 10.1 vs. 36.9 +/- 8.30); for both men (39.5 +/- 9.13 vs. 33.8 +/- 6.83) and women (48.4 +/- 9.32 vs. 41.2 +/- 8.51). No noteworthy difference in anxiety levels were found for subjects who increased vs. decreased unpleasantness ratings (for both painful and aversive sounds stimulations) (Table 2).

	Number	State	SD	Trait	SD
Global	59	30,9	5,4	41,3	9,8
Men	28	29,6	5,3	36,8	8
Women	29	32,2	5,3	45,7	9,6
PAIN +	33	30,8	6,11	44,4	10,1
Men PAIN +	15	29,2	6,07	39,5	9,13
Women PAIN +	18	32,2	5,68	48,4	9,32
PAIN -	26	31	5,18	36,9	8,3
Men PAIN -	15	30,1	5,96	33,8	6,83
Women PAIN-	11	32,2	4,4	41,2	8,5
Contingency awareness	47	30,6	5,4	39,9	8,6
Men CT	11	25,8	4,4	31,4	6,3
Men ICT	13	30,6	4,9	36,3	6,3
Women CT	14	32,1	5	45,5	8,3
Women ICT	9	32,3	6,5	44,3	9,6

Table 2 Mean Anxiety levels (IASTA, State Y-1 and Trait Y-2). Global: all subjects; PAIN+: subjects for whom pain intensity ratings increased from D0 to D14; PAIN - : subjects for whom pain intensity ratings decreased from D0 to D14; CT: subjects who correctly remembered at D14 or later in which rooms they received each type of stimuli and which room was the control room. ICT: subjects who did not remember these parameters. Values in **bold** highlight noteworthy differences : in Trait anxiety PAIN + vs. PAIN – (general, men and women); Trait and State anxiety Men ICT vs .Men CT

2.2. Environment perception

Valence: Repeated-measures ANOVA revealed that conditioning came with significant alteration in room-valence evaluation ($F(2,58)=8.24$ $p<.001$) with overall significantly lower valence for aversive rooms (PA and NPA) than control (CONT) ($t(58)=-3.35$ $p=0.003$; $t(58)=-3.45$ $p=0.003$ respectively); as well as a significant time point-effect ($F(4,58)= 21.8$ $p<.001$). The room*time-point interaction ($F(8,58)=3.96$ $p<.001$) revealed that initial valence prior conditioning was equivalent for all rooms, then, from $D0_{\text{PostCOND}}$, the valence decreased for the aversive rooms compared to the control room, with a valence decay even more marked for the PA than for the NPA room (PA vs CONT: $t(58)=4.62$ $p<.001$; NPA vs CONT: $t(58)=4.04$ $p=0.005$). This effect disappeared post-extinction ($D0_{\text{PostEXT}}$) only to reappear exclusively for the PA room at D1 ($t(58)=3.98$ $p=0.006$) and slightly still at D14 ($t(58)=3.48$ $p=0.042$) (Figure 3).

For the PA room, valence declined significantly after conditioning compared to pre-conditioning ($D0_{\text{PreCOND}}$ vs. $D0_{\text{PostCOND}}$), and remained distinctly negative post-extinction until two weeks after ($D0_{\text{PreCOND}}$ vs. $D0_{\text{PostEXT}}$, D1, D14) (Figure 3). For the NPA room, valence declined significantly after conditioning compared to

pre-conditioning ($D0_{PreCOND}$ vs. $D0_{PostCOND}$), slightly increased post-extinction, only to drop again at D1 and D14 ($D0_{PreCOND}$ vs. D1, D14). See table 3 for Post-hoc details.

For both the NPA and the PA rooms, no difference in post-conditioning timepoints valence was found. No difference between timepoint valence was found for the CONT room.

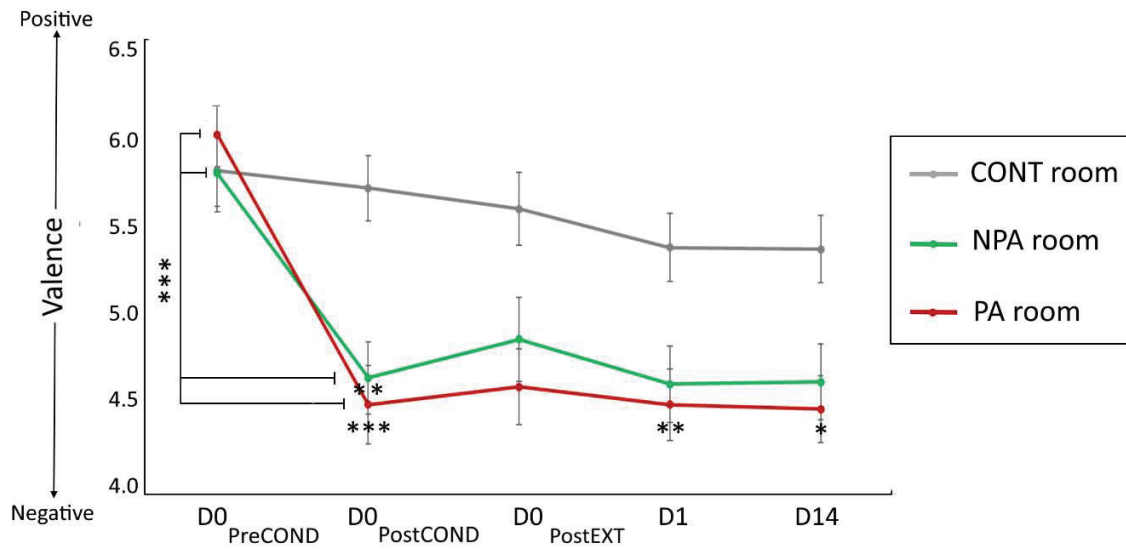

Figure 3 Valence perception at various time-points: Global Valence assessment of each room (PA, NPA, CONT) at 5 time-points ($D0_{PreCOND}$, $D0_{PostCOND}$, $D0_{PostEXT}$, D1, D14) – significant decrease in valence for both aversive rooms compared to CONT

		GLOBAL (n=59 t(58))				
		PA				
		D0 PreCOND	D0 PostCOND	D0 PostEXT	D1	D14
PA	D0 PreCOND					
	D0 PostCOND	t=7.14 p<.001				
	D0 PostEXT	t=5.03 p<.001	t=-2.11 p=1.0			
	D1	t=6.62 p<.001	t=-0.33 p=1.0	t=1.78 p=1.0		
	D14	t=7.38 p<.001	t=0.24 p=1.0	t=2.53 p=1.0	t=0.57 p=1.0	
		NPA				
		D0 PreCOND	D0 PostCOND	D0 PostEXT	D1	D14
NPA	D0 PreCOND					
	D0 PostCOND	t=5.68 p<.001				
	D0 PostEXT	t=3.41 p=0.049	t=-2.27 p=1.0			
	D1	t=4.70 p<.001	t=-0.97 p=1.0	t=1.30 p=1.0		
	D14	t=5.84 p<.001	t=0.16 p=1.0	t=2.43 p=0.82	t=1.14 p=1.0	

Table 3: Statistical results of post-hoc t-test- Holm corrected- for Valence of the Painful-Aversive (PA) room and for the Non-Painful Aversive (NPA) room at all timepoints ((D0-PreCOND, D0-PostCOND, D0-PostEXT, D1, D14). Significant results are evidenced in bold.

Contingency awareness and Valence: Out of the forty-seven subjects who answered the contingency awareness question, 51% of which did not remember correctly in which room they received the different stimuli (Incorrect group, ICT), in particular men (58 %) compared to women (39%).

Observing separately Valence evaluation patterns for subjects who remembered room-condition associations (CT) and subjects who did not (ICT), we noted that the global effect in valence decrease of PA and NPA room compared to CONT (see above) remained true for the CT subjects whereas the ICT subjects appeared to evaluate all three rooms somewhat equally, in particular the CONT room valence seemed reduced to an aversive (PA, NPA) room valence (Figure 4A.).

Results of the repeated measures ANOVA with integrated contingency awareness (CT, ICT) as inter-subject factor confirmed that observation: a room*contingency awareness interaction appeared significant ($F(2,58)=5.98$ $p=0.005$); and post-hoc tests revealed that ICT subjects rated overall significantly lower valence compared to CT subjects **exclusively for the CONT room** ($t(58)=-2.94$, $p=0.04$) (Figure 4B).

Separating CT and ICT groups, the following results of repeated measures ANOVA were found (Figure 4A):

For CT group: Results of the repeated measures ANOVA revealed a room effect ($F(2,24)=8.87$ $p=0.001$), a time-point effect ($F(4,24)=11.5$ $p<.001$) and room*time-point interaction ($F(8,24)=3.83$ $p=0.004$). Post-hoc tests confirmed that both aversive rooms were perceived more negatively than the CONT room (NPA vs. CONT: $t(24)=-3.13$ $p=0.006$; PA vs. CONT: $t(24)=-4.01$ $p<.001$).

For the PA room, valence at post-conditioning was significantly more negative than the control room (CONT). This effect remained until D14. Within the PA room, the decrease in valence was significant from post-conditioning until D14.

For the NPA room no difference was found in comparison to the CONT room. Within the NPA room, decrease in valence was significant post-conditioning, however this effect disappeared post-extinction only to reappear at D14. *See table 4 for Post-hoc details.*

For ICT group: Results of repeated measures ANOVA showed a significant time-point effect ($F(4,21)$ $p=0.002$) though no room effect ($F(2,21)$ $p=0.53$). For all rooms, a significant valence decrease was revealed at post-conditioning compared to pre-conditioning valence. This effect disappeared post-extinction only to reappear the next day, and even more so two weeks after. *See table 4 for Post-hoc details.*

A.

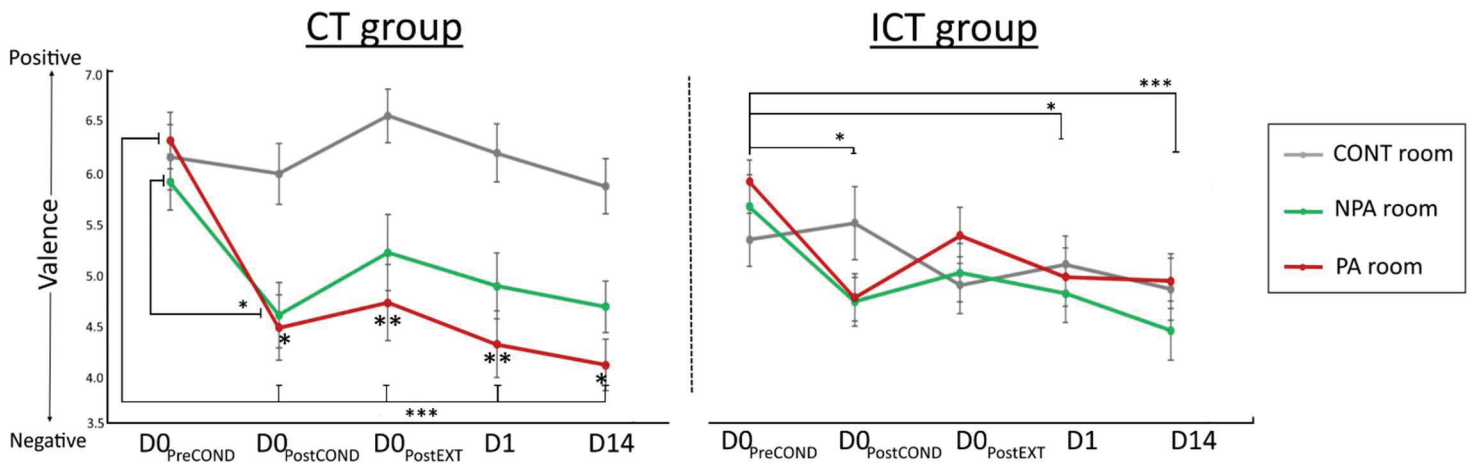

B.

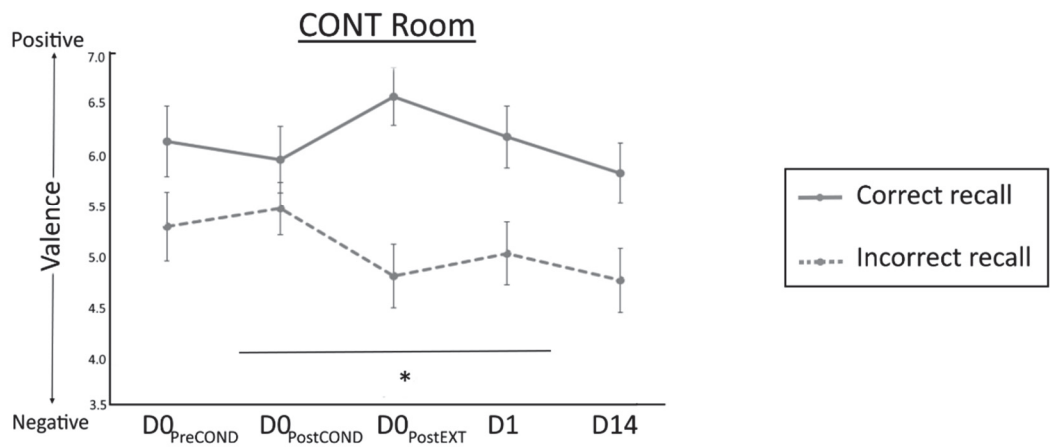

Figure 4 Valence perception at various time-points **A.** Valence assessment at all time-points for each *contingency awareness* subject groups (left- CT group; right – ICT group) and **B.** Difference in valence assessment for the CONT room at all time-points between CT group and ICT group of subjects. * $p < 0.05$ ** $p < 0.01$ *** $p < 0.001$

		CT GROUP (n=25 t(24))				
		PA				
		D0 PreCOND	D0 PostCOND	D0 PostEXT	D1	D14
PA	D0 PreCOND					
	D0 PostCOND	t=5,39 p<,001				
	D0 PostEXT	t=4,67 p<,001	t=-0,72 p=1,0			
	D1	t=5,87 p<,001	t=0,48 p=1,0	t= 1,20 p=1,0		
	D14	t=6,47 p<,001	t=1,08 p=1,0	t=1,79 p=1,0	t=0,59 p=1,0	
CONT	D0 PreCOND	t=0,37 p=1,0	t=0,73 p=1,0	t=-0,55 p=1,0	t=-0,27 p=1,0	t=-0,99 p=1,0
	D0 PostCOND	t=-3,72 p=0,024	t=-3,42 p=,064	t=-4,63 p<,001	t=-3,81 p=0,018	t=-3,09 p=0,17
	D0 PostEXT	t=-3,18 p=0,13	t=-2,81 p=0,35	t=-4,16 p=0,005	t=-3,29 p=0,10	t=-2,54 p=0,70
	D1	t=-4,09 p=0,007	t=-3,72 p=0,024	t=-4,99 p<,001	t=-4,25 p=,004	t=-3,45 p=0,058
	D14	t=-4,54 p=0,001	t=-4,18 p=0,005	t=-5,44 p<,001	t=-4,63 p<,001	t=-3,97 p=0,01
		NPA				
		D0 PreCOND	D0 PostCOND	D0 PostEXT	D1	D14
NPA	D0 PreCOND					
	D0 PostCOND	t=3,83 p=0,014				
	D0 PostEXT	t=2,04 p=1,0	t=-1,80 p=1,0			
	D1	t=2,99 p=0,19	t=-0,84 p=1,0	t=-0,36 p=1,0		
	D14	t=3,59 p=0,032	t=-0,24 p=1,0	t=0,091 p=1,0	t=0,59 p=1,0	
		ICT GROUP (n=22 t(21))				
		ALL ROOMS				
		D0 PreCOND	D0 PostCOND	D0 PostEXT	D1	D14
ALL ROOMS	D0 PreCOND					
	D0 PostCOND	t=3.14 p=0.018				
	D0 PostEXT	t=2.67 p=0.063	t=-0.48 p=1.0			
	D1	t=3.33 p=0.011	t=0.20 p=1.0	t=0.67 p=1.0		
	D14	t=4.41 p<,001	t=1.27 p=1.0	t=1.74 p=0.52	t=1.07 p=1.0	

Table 4: Statistical results of post-hoc t-test- Holm corrected- for (i) the CT group (upper table)- subjects who remembered in which room they received the different stimuli. Painful-Aversive condition (PA) room valence comparison between timepoints (D0_{PreCOND}, D0_{PostCOND}, D0_{PostEXT}, D1, D14) . PA room valence comparison with the control room (CONT) at all timepoints. Non-Painful Aversive condition (NPA) room valence comparison between timepoints ; (ii) the ICT group (lower table)- subjects who did not remember these parameters- comparison of all rooms' valence (PA, NPA and CONT confounded) between timepoints . Significant results are evidenced in **bold.**

Relationship between anxiety level and contingency awareness: Anxiety levels of each groups was verified: men from the ICT group appeared to have higher State-anxiety levels (30.6 +/- 4.9) compared to those of the CT group (25.8 +/- 4.4) as well as higher Trait anxiety levels (36.3+/-6.3 vs. 31.4+/-6.3). No difference in anxiety levels was observed for women (see table 2 above).

Emotional Impact (EI): As mentioned in the Methods section, EI analysis was biased due to different ratings at the D0_{PreCOND} stage. Nonetheless, repeated measures ANOVA showed a significant room effect (F(2,58)=8.40 p=0.026), the NPA room triggering higher emotional impact than both the PA (t(58)=2.45 p=0.047) and the CONT room (t(58)=2.35 p=0.047). The ANOVA also showed a time-point effect (F(3,58)=5.46 p=0.005) as overall D0_{PostEXT} EI ratings significantly decreased from D0_{PostCOND} ratings (t(58)=4.03 p<.001), though this difference disappears at D1 and D14 (Figure 5).

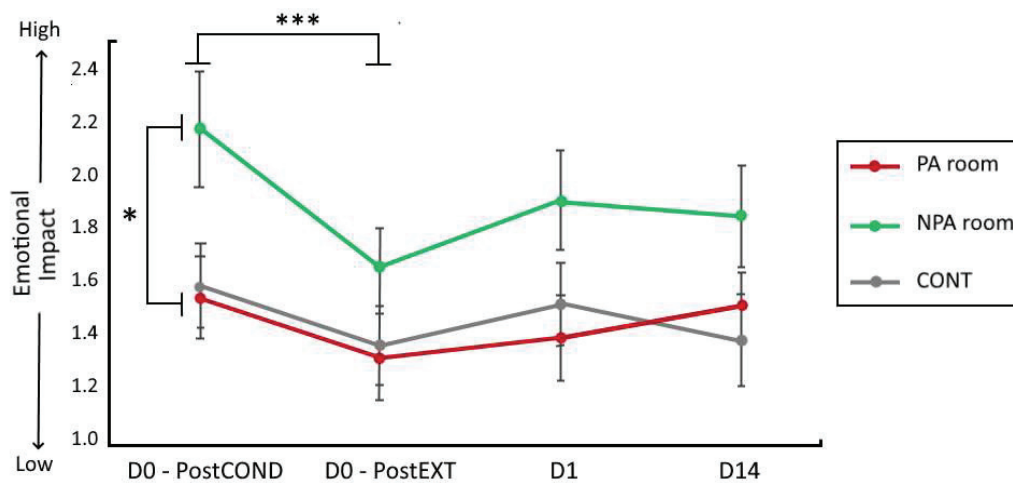

Figure 5 Emotional Impact assessment for each room (PA, NPA, CONT) and each time-point (D0_{PostCOND}, D0_{PostEXT}, D1 and D14)

Contingency awareness and EI: Results of repeated measures ANOVA with integrated contingency awareness as inter-subject factor (ICT, CT) revealed no significant effect in EI evaluation.

2.3. Implicit memory – identification reaction time

Performance and objects-identification RT for present objects: Analysis of performance on the blurred object identification paradigm revealed a significant time-point effect ($F(2,54)=34.3$ $p<.001$) with *number of correct identifications* being significantly higher at D1 and D14 compared to D0 ($t(54)=6.23$ $p<.001$; $t(54)=7.85$ $p<.001$ respectively) all rooms confounded (PA, NPA and CONT). No difference in performance was found between rooms.

In line with increasing performance, overall identification RT strongly decreased in time for all rooms ($F(2,54)=72.0$ $p<.001$), significantly so from D0 to D1 ($t(54)=11.7$ $p<.001$) and from D0 to D14 ($t(54)=8.17$ $p<.001$), though RTs increased from D1 to D14 ($t(54)=-3.53$ $p<.001$) (Figure 6).

As subjects repeat the test a number of 4 times between D0 and D14, this learning effect with increased performance and decreased identification RT was to be expected.

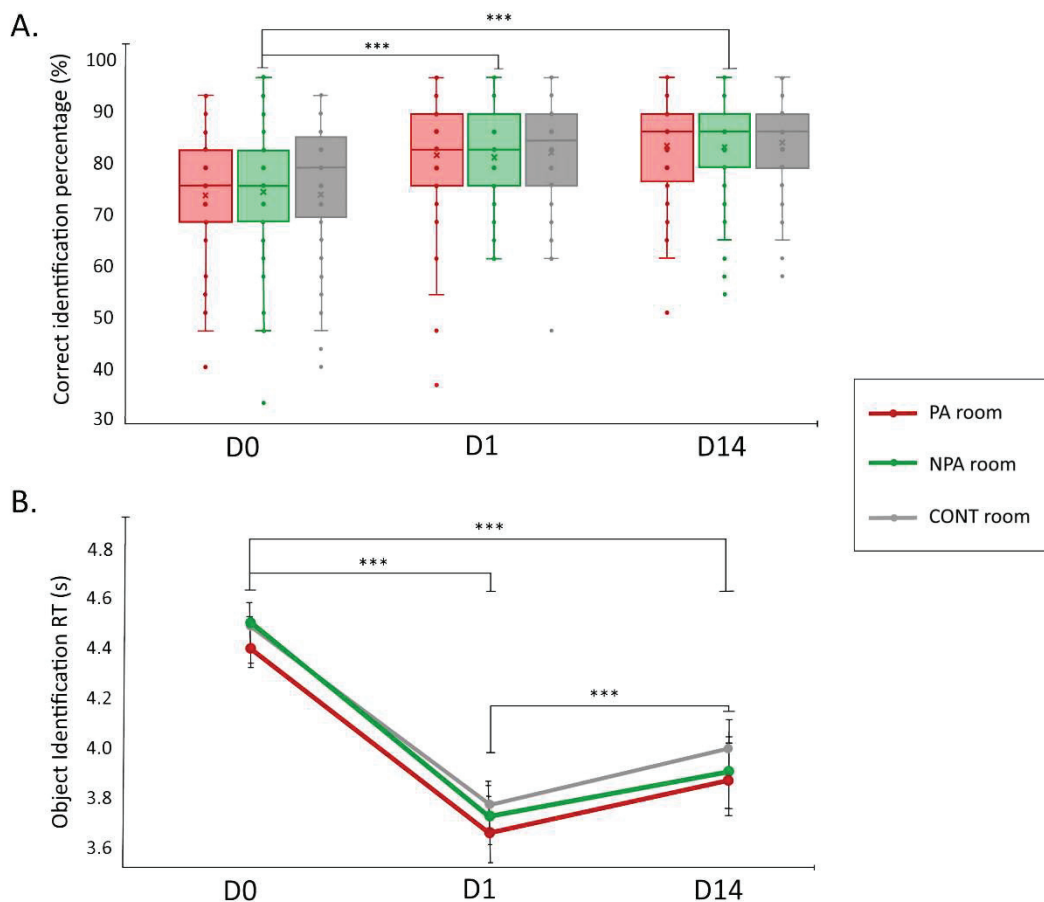

Figure 6 A. Global performance and B. Identification Reaction Time to the implicit memory test for every room (PA, NPA and CONT) at all time-points (D0, D1, D14). Performance is represented as correct identification percentage. *** $p<.001$

Results of the repeated measures ANOVA on RTs also exposed a room*gender interaction ($F(6.54)=7.93$ $p<.001$), specifically in the PA room for which women identified significantly faster the associated objects than men, all time-points confounded ($t(54)=-3.14$ $p=0.034$) (Figure 7A). On the one hand, this effect translated into an overall room effect exclusively for women ($F(2.25)=5.53$ $p=0.007$). Post-hoc tests revealed that women identified significantly faster objects belonging to the PA room compared to objects of the NPA ($t(25)=-2.89$ $p=0.017$) and CONT rooms ($t(25)=-2.87$ $p=0.017$). On the other hand, men's identification RT did not differ in between rooms (Figure 7B).

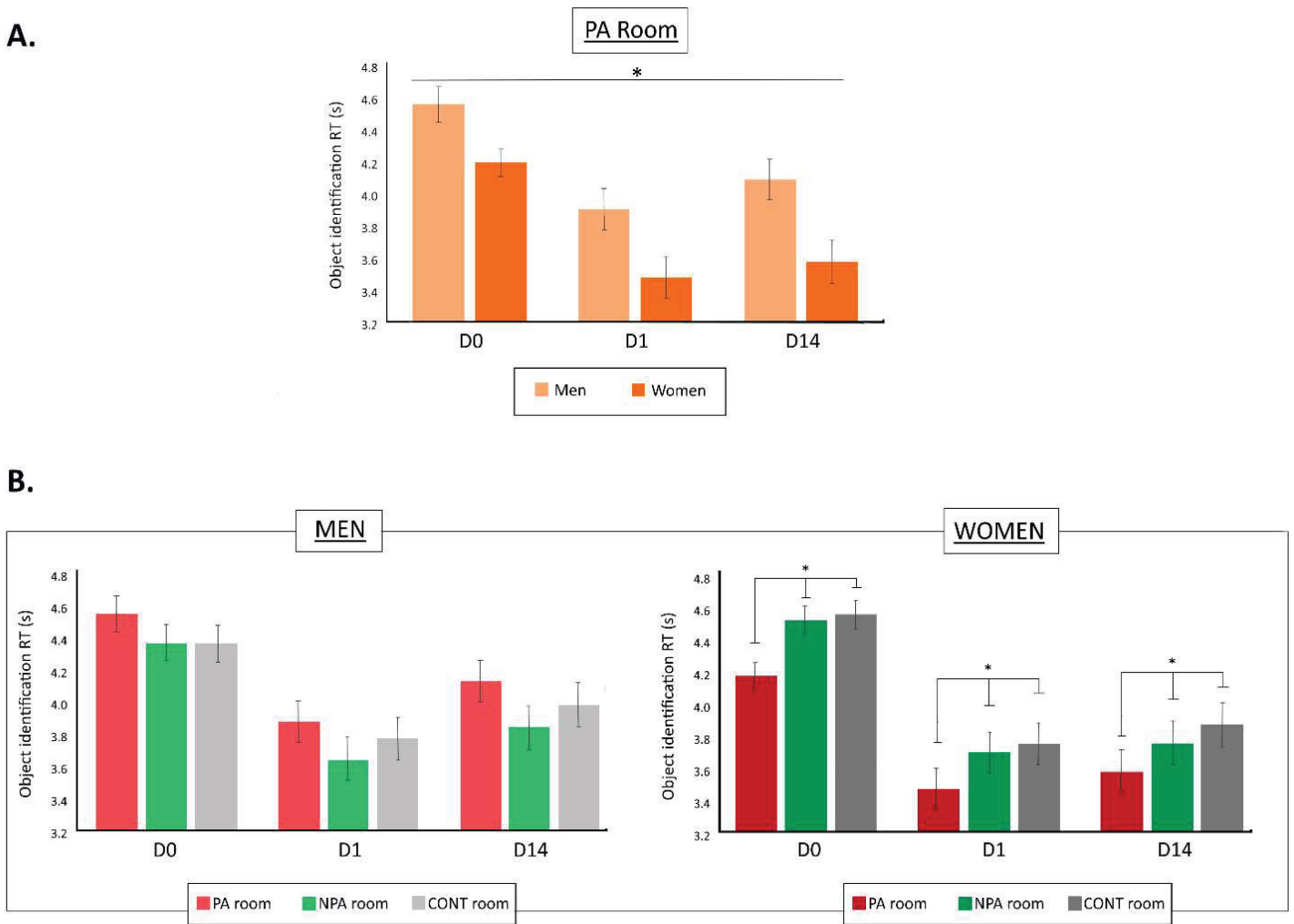

Figure 7 Mean object Identification time for A. PA room associated objects, for men (light orange) and women (dark orange) at all time-points (D0, D1 and D14) B. Global RT for all rooms (PA, NPA and NPA) for men (left) and women (right) at every time-point (D0, D1 and D14) * $p<.05$

Performance and objects identification RT for non-present objects: Results of the repeated measures ANOVA showed a significant time-point effect on Performance (number of correct identification) for non-present objects (time-point $F(2,54)=5.45$ $p=0.006$), with a significant increase in performance from D0 to D14 ($t(54)=3.29$ $p=0.004$).

Results of the repeated measures ANOVA showed an equivalent learning effect for identification RTs (time-point $F(2,54)= 68.6$ $p<.001$) with a significant decline in RT from D0 to D1 ($t(54)= -11.4$ $p<.001$) as from D0 to D14 ($t(54)=-8.10$ $p<.001$), along a slight increase from D1 to D14 ($t(54) =-3.31$ $p=0.001$). Only a slight room*gender interaction tendency came through ($F(2,54)=3.06$ $p=0.052$). No further statistical results were found.

Results summary:

- ❖ Post-conditioning, the painful stimulation was evaluated as significantly more unpleasant than non-painful aversive sounds for both men and women. This effect persisted at long-term, up to 14 days post-conditioning.
- ❖ Although pain intensity ratings were equivalent for men and women during conditioning, only women's assessments significantly increased post-conditioning, which lasted until 14 days later. This translated into an overall significant gender effect, with women rating higher pain intensity compared to men at post-conditioning, the next day and two-weeks after.
- ❖ Pre-conditioning, all rooms (CONT, NPA, PA) were evaluated at similar valence levels. Post-conditioning, both aversive rooms (PA and NPA) assessment meaningfully deteriorated as valence decreased significantly compared to CONT room valence; this decline persevering at long-term for the PA room only.
- ❖ Contingency awareness testing revealed that subjects who remembered correctly in which room they received the different stimuli (CT) appeared to have the same pattern described above in terms of valence assessment, whereas subjects who did not remember room-condition associations (ICT) tended to decrease all room valence regardless of their condition, with the CONT room valence being reduced to that of the PA and NPA rooms.
- ❖ Performance to the Object identification test (blurred picture paradigm) increased from D0 to D14 (learning effect), and was equivalent for all types of objects (associated to either the CONT, the NPA or the PA room). No difference was found between men and women's performance.
- ❖ The overall learning effect translated into a significant decrease in identification RT from D0 to D14 for all types of objects (PA, NPA, CONT room). Women appeared to identify significantly faster objects from the PA room compared to men, which rendered into significant decrease in identification RT for PA-room objects compared to NPA and CONT room objects exclusively for women.

Additional analyses and observations not mentioned in the above results chapters:

- When isolating women for which pain unpleasantness rating was higher than sound unpleasantness rating at $D0_{\text{-PostCOND}}$, the effect on identification RT was enhanced, comparing PA room associated objects to NPA ($t=-3.33$ $p=0.007$) and CONT room associated objects ($t=-3.15$ $p=0.008$). In brief, the more the women found the pain stimulus unpleasant as compared to the sound, the more they identify faster the objects associated to the PA room in comparison to the other rooms. Observing RTs for women belonging to the ICT group (meaning they did not remember correctly in which room they received the different stimuli), the same pattern appeared, although no statistical significance was found as sampling size came down to 7 subjects.
- No difference between men and women was found on a physiological level (SSR amplitude in response to pain/sound and anticipation of pain/sound) (see part A) nor between CT and ICT group subjects.
- In term of performance to object identification: No difference was found between rooms for the following types of answers: number of missed correct identifications (corresponding to correct identifications given after the time limit of 6s), number of incorrect identifications (corresponding to incorrect identifications given within the time interval of 6s) and number of missed.
- No correlations were found between anxiety levels and different types of stimulus ratings, neither with the environment's perception, nor with SSR amplitudes.

3. Discussion

Context perception modulation:

Contextual aversive conditioning lead to a modulation of the environment's perception, as both aversive (pain and non-painful) rooms' valence deteriorated post-conditioning -appearing significantly more negative compared to the control room- and even more so for the pain associated context. Although slight post-extinction recovery of valence was observed for both aversive contexts, the pain -associated room-valence decline resumed the next day and persisted up to 14 days post-conditioning.

The impact of threat conditioning on context valence decay has been observed in iVR human studies (Kroes et al. 2017, Troger et al. 2012, Glotzbach et al. 2012, Andreatta et al. 2015), with similar outcomes to our results; however very few directly compare different types of contextual aversive conditioning, in particular painful vs. non-painful. In a recent cue-conditioning study, researchers investigated behavioral correspondence of negative expectations comparing different threat across sensory modalities - including visceral pain *versus* aversive sounds as unconditioned stimuli (US) (Koenen et al. 2021). They demonstrated that conditioned negative valence attributed to the conditioned cue stimuli (CS) was consistently correlated with USs emotional valence (unpleasantness rating) for which visceral pain's was enhanced compared to aversive sounds. In keeping with subjects' higher pain unpleasantness ratings compared to aversive sounds, associated contexts valence evaluation seems to reflect the degree of aversiveness attributed to each stimulation. This correlates with physiological differences found in regards to stimulus-related and stimulus-anticipation-related SSR amplitudes (see part A), as pain manifestly triggered greater physiological arousal than non-painful aversive sounds. Indeed, pain represents an emotionally salient-threat- or stressor (see review Timmers et al. 2019), and in particular pain has the capacity of generating single incident learning, for which memory formation can last a life-time (Apkarian et al. 2009). Accordingly, Shafe et al. highlighted the effectiveness of pain on associative learning and memory in a classical Pavlovian paradigm, as they noted that the more painful the US, the less trials were needed to establish a long-term aversive negative emotion towards the initially neutral CS (Shafe et al. 2001). Although direct comparison of aversive conditionings had no outcome, our results suggest that the pain conditioning specifically seemed to elicit not only stronger but also longer-lasting perception modulation of the related context. In the Koenen et al. (2021) study, extinction was performed immediately after acquisition- as was in our protocol- and it was found that the visceral pain associated CS remained negatively evaluated post-extinction contrarily to the sound associated CS, suggesting that the former association was more resistant to extinction. Although they did not measure long-term evaluation of valence, it is tempting to consider a similar effect in our case, as the painful electro-stimulation elicited stronger context-conditioning acquisition, immediate extinction presumably had less long-term impact on reestablishing the pain context to control levels.

Contrarily to most studies, no US-CS association explicit contingency awareness measurements was done during or immediately after conditioning. In our study, subjects were tested at the end of the experiment, i.e. 14 days or more after conditioning. Out of the 49 subjects who responded, 47% did not recall in which room they received the different stimuli (Incorrect : ICT group / Correct: CT group). Observing context modulation for CT

and ICT groups, we noted that CT group followed the same pattern of context perception modulation described [above](#), whereas the ICT group lacked valence discrimination. For ICT group, subjects rated equivalent negative valence for all rooms regardless of their condition (PA, NPA, CONT), precisely the control room valence was reduced to aversive room levels, from post-extinction until two weeks after. This effect was confirmed via significantly lower valence rating for ICT subjects compared to CT, exclusively for the CONT room.

These results suggest that poor contingency awareness possibly translated a generalization of negative affect upon the entire conditioning environment. Fear or pain-related fear generalization is described to a certain extent as an adaptive neurobiological and behavioral process promoting resilience towards fluctuating environments, which in turn can become mal-adaptive when generalization exceeds survival needs (Jovanic et al. 2010, Meulders et al. 2017, Cooper and Blumstein 2015, Cooper and Dunsmoor 2021), such as in anxiety disorders (Cooper et al. 2022, Lis et al. 2020, Thome et al. 2018, Dymond et al. 2015) or in chronic pain (Meulders 2020, Meulders and Bennett 2018). In experimental studies, pain related fear generalization is mostly studied in terms of generalized fear of movement (Meulders et al. 2011), which consists in developing fear to novel movements perceptually resembling initial pain-triggering actions. Humans are also capable of conceptualizing contextual details of a learning event, which in turn can generalize conditioning behavioral consequences between perceptually dissimilar stimuli that are on some level semantically related. This effect, called *category-or semantic-based* fear conditioning (Dunsmoor & Murphy 2015), can easily be illustrated: for example, if an individual has a frightening experience with a French Poodle, all other races of dogs consequently become a source of fear through category-based association. The category ‘dog’ becomes the negative stimulus. In our case, we can presume that subjects generalized the specific pain associated room (for example, the living-room) to the semantically associated category (e.g., a room of the apartment), consequently resulting in negative valence ratings for the entire apartment. Hence ICT subjects possibly failed to discriminate perceptual details between the aversive conditioned contexts and the neutral context, and thus generalized context perception modulation onto the entire environment. Processes causing generalization likely imply a combination of the following: (i) An active inhibitory weakening of US-CS associations through extinction training (Spence 1936, Yang et al. 2011, Radulovic and Tronson 2010)- which was possibly physiologically reflected in SSR amplitude extinction generalization processes discussed in part A, (ii) Failure to form strong associations between the conditioned context and its associated aversive stimuli (pain or sound) (Asok et al. 2019, Rudy and O’Reilly 1999, Rescorla and Wagner 1972)- for example due to important attentional distractions such as the cognitive task at hand or even the virtual environment itself and/or (iii) Forgetting/or failure to retrieve explicit memory of the conditioning phase (Bouton et al. 1999)- which is facilitated when retrieval is performed at remote timepoints of initial acquisition (Wiltgen and Silva, 2007, Wiltgen et al. 2010).

Interestingly, anxiety trait levels have been suggested to modulate contextual conditioning (Neueder et al. 2019, Glotzbach-Schoon et al. 2013c, Davis-Caulfield et al. 2021), specifically high anxiety disorders such as PTSD have been shown to correlate with less distinction between safe and threat context in contingency awareness in contrast to healthy controls (Steiger et al. 2015, Cooper et al. 2022), which coherently goes along with higher trait-anxiety average for ICT men compared to CT men. However, following this interpretation, we

might have expected more conditioned generalization in women, having on average higher state and trait-anxiety levels than men.

The primary reason for “late” contingency awareness measurements in our study was to avoid any conscious recollection of the environment in between sessions, disabling interferences with implicit memory testing discussed further on. Thus, no confident conclusions can be drawn on subjects’ strategies when trying to recall the stimulus/context association at 14 days or more after conditioning [evaluating the different contexts valence]. Nonetheless, according to Grisart et al. (2007), we can hypothesize that two types of stimulus-recollection processes occurred in long-term memory of the different contexts: *remembering and knowing* (Gardiner 1988). As Mazza et al. described in 2018: “*Remembering is a controlled process involving the conscious recollection of having personally experienced something in the past. In contrast knowing is an automatic process of familiarity without conscious recollection.*”. In line with this definition, it is possible to consider that subjects adopted either one of these processes during context evaluation. In the *remembering* approach, the subject would have evaluated each room according to the specific episodic remembering of the conditioning phase, meaning according to explicit room/condition associations recollection. In the *knowing* approach, the subject would have relied on unconscious perception of the environment without explicitly considering room/condition associations, which would reflect an implicit trace of the conditioning phase. Interestingly, associative learning has been suggested to be expressed in two parallel mnemonic processes: implicit and explicit. In a human fear conditioning study, Shultz et al. (2013) found that subjects displayed skin conductance response to the CS (implicit learning) prior conscious awareness of US-CS association (explicit learning). Temporal disparities in implicit and explicit learning processes were suggested to reflect a dual mnemonic processing of associative learning articulated in patterns of unconscious conditioned responses prior to explicit recollection of US-CS association (Shultz et al. 2013). In keeping with the latter, we found no difference in amplitudes of SSR recorded in aversive rooms between ICT and CT groups, suggesting that implicit learning of US-CS associations was equivalent for both groups during conditioning. Thus, the ICT and CT group divergence in room/condition association recall might somewhat reflect parallel implicit/explicit processes of aversive conditioning.

Though the contingency awareness/context perception modulation issue raises interesting questions, it requires more thorough integration into our protocol for advanced analysis, as the recollection question was added during the course of the experimental period, which in consequence lead to a part of subjects answering at 14 days post-conditioning, another at 3 months post-conditioning while a remaining sample did not respond at all.

Pain intensity memory:

During pain conditioning, ratings of pain intensity and unpleasantness were equivalent for men and women. However, post-conditioning evaluations revealed that women exclusively overestimated the experienced pain intensity, thus generating a gender difference in ratings which remained significant until two weeks after conditioning. Pain unpleasantness was correctly remembered for both genders at all time-points following conditioning.

In line with extensive evidence showing that women have higher pain sensitivity than men in both experimental and clinical settings (Mogil 2012, Frot et al. 2004, Sullivan et al. 2000, Berkley 1997), a slightly higher electro-current intensity was needed (+2mA) for men compared to women to exceed pain threshold and equal average pain ratings (intensity and unpleasantness) during conditioning, although SDs of +/-5 mA minimizes this current-intensity disparity. Nonetheless, conditioning ratings suggest that men and women experienced similar pain intensities, which can be supported by physiological data analyzed in Part A– for which no gender difference was found in SSR to the electro-stimulation, nor regarding pain anticipation. Men and women thus seem to diverge essentially when it comes to remembering the experienced pain.

Gender effect on pain memory has been observed in clinical framework, for example, in a study observing periodontal surgical pain recollection, women were found to remember significantly higher post-operative pain intensity in contrast to men (Eli et al. 2000) although, contradictory results have also been revealed (Sisk et al. 1991). A possible explanation for women's over-estimation of pain in post-conditioning ratings may be due to higher state- and even more so trait- anxiety levels compared to men, both said to play a role in the memory of pain (Eli et al. 2000, Gedney et al. 2003; Hovasapian and Levine 2015, Rocha et al. 2009). Hovasapian and Levine (2015) investigated the influence of anxiety sensitivity (AS)- defined as the predisposition to be fearful of anxiety-related body sensations and positively correlated with trait anxiety (Reiss et al. 1986)- on memory biases of pain in a cold-pressor test experiment. They showed that individuals with above medium level AS, mainly women, were inclined to remember greater experimental pain than initially reported in contrast to individuals with lower AS. A conceivable cause is that when individuals remember pain, they have limited access to episodic memory of its physical component, thus rather rely on the current thoughts and appraisal of the experience (Hovasapian and Levine 2015, Levine and Safer 2002). As AS involves global negative appraisal, such as the propensity to read body sensations as threatening (Richards et al. 2001), higher AS individuals would therefore have a tendency of over-estimating past pain. Our findings support this idea as we showed that both women and men who increased their pain intensity ratings from post-conditioning to D14 had higher mean trait anxiety than those who did not.

Prior conditioning subjects were told that, during experimenting, the electro-stimulation had to be painful but tolerated for the entire phase. In other words, current intensity would be controlled to stay in a tolerable intensity interval. Thus, though it is conceivable that women tended to increase their remembered pain, we cannot discard the hypothesis that men could have also been less willing to report high intensity during conditioning (possibly explaining the +2mA current intensity difference) and subsequently lower their ratings on the VASs. Indeed,

psychosocial factors might have also influenced the gender-related divergence in reported pain intensity; which has been observed in both clinical (Eli et al. 2000) and experimental settings (Wise et al. 2002). In clinical pain for example, men have been found to be more self-conscious of their pain than women, and socio-cultural factors- i.e. the perceived and expected societal status of men and women- may cause minimization of pain assessment in men, unless higher-order needs are at stake (quality of life, increased severity) (see review Unruh 1996). In an experiment examining sex-related stereotypic ascriptions of pain sensitivity, endurance and willingness to report pain using the Gender-Role Expectantly of Pain questionnaire (GREP), it was shown that men stated to be less incline to report pain than women (Robinson et al. 2001), which was later confirmed in actual pain-related experimental settings (Alabas et al. 2013, Wise et al. 2002). Male subjects might have therefore been more cautious of rating high intensities on post-conditioning Visual Analog Scales than women.

Implicit memory:

Analysis of the Object Identification task exposed an increase in Performance (number of correct identification) and decrease in Identification Reaction Time (RT) from D0 to D1 and D14 for each type of room-associated objects (PA, NPA, CONT), revealing an overall learning effect throughout repeated testing. Results further showed a significant room specific gender-related difference in Identification RTs: women identified faster objects from the PA room than men at all timepoints (D0,D1,D14); which in turn deciphered into significantly lower RTs for PA-associated objects compared to than NPA- and CONT- associated objects, exclusively for women.

Perceptual priming for pain associated items in women may translate enhanced implicit learning of pain associated context content. Several studies have evidenced perceptual facilitation in humans for negatively connotated stimuli, both on a neurophysiological (Leblanc-Sirois et al. 2021) and behavioral levels (Michael et al. 2007, Ehlers et al. 2006). For example, Ehlers et al. (2006) experiment consisted in showing a set of “traumatic” or “neutral” picture stories to healthy participants, for which central objects were tested in a blurred picture paradigm: likewise, objects of the “traumatic” context were more effectively primed in contrast to “neutral” context objects. Interestingly, their results were further correlated with enhanced re-experiencing symptom of the traumatic story (Intrusive Memories Questionnaire) measured at 3 months-post experimenting; a noteworthy observation that was paralleled with clinical understandings indicating that intrusive memories of traumatic events seem to be prompted by perceptual cues that somewhat resemble items of the initial event (Ehlers and Clark 2000). A recent study by Leblanc-Sirois et al. (2021) supported these results via analysis of event-related potentials (ERP), in particular P1 amplitude, to trauma-related stimuli: they revealed a brain activity response as early as 100ms after stimuli presentation over posterior brain areas (in particular, P1 is generated in the extrastriate visual cortex) exclusively for items associated with a previously viewed traumatic film (vs. neutral film items). This was referred as an increase in baseline visual perceptual processing for stimuli related to recent possibly traumatic events in healthy subjects, as was previously observed in PTSD patients (Gregoire et al. 2018). Although these studies concur with our findings, they did not reveal nor mention gender disparities in perceptual priming of negatively affected stimuli.

Literature on experimental evidence of gender-related differences in perceptual priming of negative information is quite scarce, with a few studies suggesting contrary results to ours, such as evidence of women's perceptual priming for positively affected stimuli rather than negative in comparison to men, for whom priming effects were stronger in negative conditions (Gohier et al. 2013, Donges et al. 2012) as well as enhanced attentional bias towards safety cues instead of threat cues in women, and inversely so in men (Labrenz et al. 2020). However, none of these studies investigated specifically the effect of *pain* on perceptual priming, yet sex-differences in pain processing have been extensively highlighted (Osborne and Davis, 2022). In fact, although contradictory to our findings, these studies initially hypothesized that women would show facilitation of perceptual processing for negative affected stimuli, in line with the prevalence of women observed in post-traumatic stress disorder (PTSD) (Breslau et al. 1997, Itoh et al. 2019) and Chronic Pain (CP) (Umeda and Kim 2019, Fillingim et al. 2009, Unruh 1996). As pain is a fundamentally fear-triggering stimulus, it attracts strong attentional responses leading to increased sensitivity for negative information and aberrant attentional orienting toward threat (Van Ryckeghem et al. 2013, Schoth et al. 2012), both processes said to contribute to chronic pain induction and maintenance. Particularly, women exhibit stronger sensitivity to negative events and negative emotions associated with physical threat, reflected through behavioral and physiological sex-related disparities (Rhudy and Williams 2005). For example, Bradley et al. (2001) experiment consisted in showing visual stimuli of varied pain-related menace (e.g. contamination, mutilation, animal attack, human attack), and revealed greater unpleasantness, arousal and startle levels in women compared to men, for whom only highest levels of threat enhanced responses. It is thus coherent to suggest that women may be pre-disposed to exhibit *cognitive vulnerability* for pain - defined as the automatic processing bias for negative information (Scher et al. 2005). Additionally, CP patients have been reported to show signs of facilitated encoding and retrieval for negative emotional material processing (Mazza et al. 2018), as they displayed stronger memory performance for pain-related words than healthy controls (Busch et al. 2006, Karimi et al. 2016). Reasoning behind this effect is that CP individuals exhibit a *mood-congruity effect*- referred to as a facilitated tendency to recall content with the same emotional value that of the intrinsic emotional state (Drace 2013). Although in our protocol no aversive stimulation is delivered during implicit memory testing, prior measurements (including recall of pain intensity and unpleasantness and room evaluation – Valence and EI) may have reactivated the memory of the initial experimental conditioning phase, possibly re-evoking aversive emotions towards the past-experience and altering subjects current mood state. It is possible to consider that this hypothetical effect was more prominent for women. In keeping with Rhudy and Williams (2005) comprehensive review of gender-related differences in emotional pain processing - suggesting that the system associated with negative affect is more attuned to threatening stimuli in women than in men- it may, in our case, be reflected by a facilitated re-experiencing of aversive emotions of the conditioning phase exclusively in women. Also, recall bias in CP is said to be enhanced when pain intensity ratings are higher (Koutantji et al. 2000), which reasonably agrees with results exhibiting higher pain intensity ratings in women compared to men. Findings of enhanced perceptual priming for PA -room associated objects suggests that women may be disposed to display facilitated perceptual processing towards highly physical-threat-evoking stimulus like pain, which might contribute to explaining prevalence of women in developing CP.

Additional observations of gender-related mnemonic processes differences:

Findings from the neuroimaging literature have highlighted the role of sex in pain-related fear conditioning mnemonic processes, with general observations of enhanced fear memory traces in women compared to men (Keiser et al. 2017, Benson et al. 2014, Lebron-Milad et al. 2012, Kennedy et al. 2012, Merz et al. 2010). Based on known regions implicated in fear conditioning, such as the amygdala, hippocampus, medial prefrontal cortex (mPFC) and brain-stem subregions (also known as sexually dimorphic regions (Kogler et al. 2016, Goldstein et al. 2001), Lebron-Milad et al. (2012) analyzed the BOLD signal changes to investigate sex differences in associative fear learning. Their results showed that women had greater activation in the right amygdala, the dorsal anterior cingulate cortex (dACC) and the mPFC compared to men, possibly indicating different learning degrees. Indeed, the mPFC and dACC are involved in pain processing, expression of fear and evaluation of emotionally salient stimuli (Kim et al. 2021, Etkin et al. 2011, Linnman 2011), and the amygdala is known to intermediate emotional learning (Davis and Whalen 2001) and processing of the emotional component of pain (Neugebauer 2015). Enhanced activation of these areas may reflect stronger fear conditioning. In an animal study, Keiser et al. (2017) demonstrated that male and female mice had differential neural correlates in retrieval of context-associated memory, where male mice showed greater hippocampus-dependent activation whereas female mice exhibited greater basal-amygdala dependent retrieval process. Considering these findings, along with results of the Leblanc-Sirois (2021) study mentioned above -showing that perceptual priming of trauma-related items is correlated with early evoked potential P1-may lead us to a possible interpretation of sex-related differences found in implicit memory testing. Leblanc-Sirois research demonstrated that P1 evoked potential to trauma-related items generated in the extrastriate visual cortex signals the influence of affective context on neuronal activity in this region, which may derive from connections between the amygdala to the striate and extrastriate cortex (Kravitz et al. 2013). Consistent with the two-pathway model of affective visual input processing, a rapid pathway and a slow pathway (Rudrauf et al. 2008), it is suggested that information from the retina can rapidly provide affective information to the amygdala, which in consequence can modulate early valence assessment of visual processing. In line with a preferential amygdala-based retrieval processing in women, enhanced activation of this area may possibly contribute to understand early or rapid processing of pain-associated items, reflected in our study by shorter identification RTs. Though our study did not include EEG recordings during priming testing, we will hopefully contribute to better understand neural processes during conditioning.

GENERAL CONCLUSION

Contextual aversive (painful and non-painful) conditioning revealed a modulation of the perception of the environment, with an overall long-term decrease in valence for aversive rooms in contrast to control, even more so for the pain-associated room, coherently reflected by higher unpleasantness ratings for pain compared to aversive sounds. Remote contingency awareness measurements revealed that the sample of subjects who did not-remember room-stimuli associations generalized a negative valence affect upon the entire environment. Sex differences appeared first in pain intensity ratings, as women remembered experiencing higher intensity during conditioning compared to men, possibly correlated to higher Trait-anxiety levels. Along these lines, implicit memory of each condition associated context-content seemed to be affected exclusively for women, as perceptual priming was significantly enhanced for the pain-room associated objects compared to both sound- and control-room objects. No effect in perceptual priming was found in men.

This study offers insight to better understanding behavioral long-term mnemonic mechanisms of contextual aversive conditioning, and further analysis of EEG recordings will be absolutely crucial to aim for a comprehensive understanding of pain conditioning processes; for instance, if gender-related disparities are reflected in brain activity. The validated iVR protocol offers a wide range of perspective studies, for example, to investigate explicit mnemonic processes or attentional processes during aversive conditioning using eye-tracking technology (Hopkins et al. 2015, Ojala and Bach, 2020). The latter is particularly worthy of investigation closely related to our findings, as studies have suggested that eye-movements can index attentional and memory processes occurring without awareness. Eye-tracking could therefore give us insight to implicit processing of surroundings occurring during aversive learning.

REFERENCES

A

- Åhs, F., Dunsmoor, J.E., Zielinski, D., LaBar, K.S., 2015. Spatial proximity amplifies valence in emotional memory and defensive approach-avoidance. *Neuropsychologia* 70, 476–485. <https://doi.org/10.1016/j.neuropsychologia.2014.12.018>
- Alabas, O. a., Tashani, O. a., Johnson, M. i., 2013. Effects of ethnicity and gender role expectations of pain on experimental pain: A cross-cultural study. *European Journal of Pain* 17, 776–786. <https://doi.org/10.1002/j.1532-2149.2012.00229.x>
- Albanese MC, Duerden EG, Rainville P, Duncan GH. Memory Traces of Pain in Human Cortex. *The Journal of Neuroscience*. *J Neurosci*. 27 (17), 4612-4620, 2007; DOI: <https://doi.org/10.1523/jneurosci.0695-07.2007>
- Alvarez, R.P., Biggs, A., Chen, G., Pine, D.S., Grillon, C., 2008. Contextual fear conditioning in humans: cortical-hippocampal and amygdala contributions. *J Neurosci* 28, 6211–6219. <https://doi.org/10.1523/JNEUROSCI.1246-08.2008>
- Andersen, S., Thorpe, J., 2009. An IF–THEN theory of personality: Significant others and the relational self. *Journal of Research in Personality* 43, 163–170. <https://doi.org/10.1016/j.jrp.2008.12.040>
- Andreatta, M., Leombruni, E., Glotzbach-Schoon, E., Pauli, P., Mühlberger, A., 2015. Generalization of Contextual Fear in Humans. *Behavior Therapy* 46. <https://doi.org/10.1016/j.beth.2014.12.008>
- Andreatta, M., Neueder, D., Glotzbach-Schoon, E., Mühlberger, A., Pauli, P., 2017. Effects of context preexposure and delay until anxiety retrieval on generalization of contextual anxiety. *Learn. Mem.* 24, 43–54. <https://doi.org/10.1101/lm.044073.116>
- Andreatta, M., Genheimer, H., Wieser, M.J., Pauli, P., 2020. Context-dependent generalization of conditioned responses to threat and safety signals. *Int J Psychophysiol* 155, 140–151. <https://doi.org/10.1016/j.ijpsycho.2020.06.006>
- Apkarian, A.V., Baliki, M.N., Farmer, M.A., 2013. Predicting transition to chronic pain. *Curr Opin Neurol* 26, 360–367. <https://doi.org/10.1097/WCO.0b013e32836336ad>
- Apkarian, V.A., Hashmi, J.A., Baliki, M.N., 2011. Pain and the brain: specificity and plasticity of the brain in clinical chronic pain. *Pain* 152, S49–S64. <https://doi.org/10.1016/j.pain.2010.11.010>
- Apkarian, A.V., Baliki, M.N., Geha, P.Y., 2009. Towards a theory of chronic pain. *Prog Neurobiol* 87, 81–97. <https://doi.org/10.1016/j.pneurobio.2008.09.018>
- Apkarian, A.V., Bushnell, M.C., Treede, R.-D., Zubieta, J.-K., 2005. Human brain mechanisms of pain perception and regulation in health and disease. *Eur J Pain* 9, 463–484. <https://doi.org/10.1016/j.ejpain.2004.11.001>
- Apkarian, A.V., Sosa, Y., Sonty, S., Levy, R.M., Harden, R.N., Parrish, T.B., Gitelman, D.R., 2004. Chronic back pain is associated with decreased prefrontal and thalamic gray matter density. *J Neurosci* 24, 10410–10415. <https://doi.org/10.1523/JNEUROSCI.2541-04.2004>
- Apkarian, A.V., Hodge, C.J., 1989. Primate spinothalamic pathways: III. Thalamic terminations of the dorsolateral and ventral spinothalamic pathways. *J Comp Neurol* 288, 493–511. <https://doi.org/10.1002/cne.902880309>
- Asok, A., Kandel, E.R., Rayman, J.B., 2019. The Neurobiology of Fear Generalization. *Frontiers in Behavioral Neuroscience* 12. <https://doi.org/10.3389/fnbeh.2018.00329>
- Asok, A., Hijazi, J., Harvey, L.R., Kosmidis, S., Kandel, E.R., Rayman, J.B., 2019a. Sex Differences in Remote Contextual Fear Generalization in Mice. *Frontiers in Behavioral Neuroscience* 13. <https://doi.org/10.3389/fnbeh.2019.00056>
- Armstrong, T., Sarawgi, S., Olatunji, B.O., 2012. Attentional bias towards threat in contamination fear: Overt components and behavioral correlates. *J Abnorm Psychol* 121, 232–237. <https://doi.org/10.1037/a0024453>

B

- Baas, J.M., Nugent, M., Lissek, S., Pine, D.S., Grillon, C., 2004. Fear conditioning in virtual reality contexts: a new tool for the study of anxiety. *Biological Psychiatry* 55, 1056–1060. <https://doi.org/10.1016/j.biopsych.2004.02.024>
- Bąbel, P., 2017. Memory of pain induced by physical exercise. *Memory* 24, 548–559. <https://doi.org/10.1080/09658211.2015.1023809>
- Bąbel, P., Bajcar, E.A., Śmieja, M., Adamczyk, W., Świder, K., Kicman, P., Lisińska, N., 2018. Pain begets pain. When marathon runners are not in pain anymore, they underestimate their memory of marathon pain—A mediation analysis. *European Journal of Pain* 22, 800–809. <https://doi.org/10.1002/ejp.1166>
- Baddeley, A., 2010. Working memory. *Current Biology* 20, R136–R140. <https://doi.org/10.1016/j.cub.2009.12.014>

- Baddeley, A. D., Emslie, H., & Nimmo-Smith, I., 1994. *The Doors and People Test: A test of visual and verbal recall and recognition*. Bury-St-Edmunds, UK: Thames Valley Test Company
- Balconi M, Lucchiarì C. Consciousness and arousal effects on emotional face processing as revealed by brain oscillations, 2008. A gamma band analysis. *Int. J. Psychophysiol.* 67(1):41–6. <https://doi.org/10.1016/j.ijpsycho.2007.10.002>.
- Baliki, M.N., Geha, P.Y., Fields, H.L., Apkarian, A.V., 2010. Predicting value of pain and analgesia: nucleus accumbens response to noxious stimuli changes in the presence of chronic pain. *Neuron* 66, 149–160. <https://doi.org/10.1016/j.neuron.2010.03.002>
- Baños, R., Botella, C., García-Palacios, A., Villa, H., Perpiñá, C., Gallardo, M., 1999. Psychological variables and reality judgment in virtual environments: the roles of absorption and dissociation. *Cyberpsychol Behav* 2, 143–148. <https://doi.org/10.1089/cpb.1999.2.143>
- Baños, R., Botella, C., Garcia-Palacios, A., Martin, H., Perpiñá, C., Alcañiz Raya, M., 2000. Presence and Reality Judgment in Virtual Environments: A Unitary Construct? *CyberPsychology & Behavior* 3. <https://doi.org/10.1089/10949310050078760>
- Barroso, J., Vigotsky, A.D., Branco, P., Reis, A.M., Reis, A.M., Schnitzer, T.J., Galhardo, V., Apkarian, A.V., 2020. Brain gray matter abnormalities in osteoarthritis pain: a cross-sectional evaluation. *Pain* 161, 2167–2178. <https://doi.org/10.1097/j.pain.0000000000001904>
- Barroso, J., Branco, P., Apkarian, A.V., 2021. Brain mechanisms of chronic pain: critical role of translational approach. *Transl Res* 238, 76–89. <https://doi.org/10.1016/j.trsl.2021.06.004>
- Basbaum A., Jessell T., 2000. The perception of pain. In ER Kandel, JH Schwartz, TM Jessell (Ed.) *Principles of neural science*, 4th edn., McGraw-Hill, New-York, 472–491.
- Basbaum, A.I., Bautista, D.M., Scherrer, G., Julius, D., 2009. Cellular and Molecular Mechanisms of Pain. *Cell* 139, 267–284. <https://doi.org/10.1016/j.cell.2009.09.028>
- Bastuji, H., Mazza, S., Perchet, C., Frot, M., Mauguière, F., Magnin, M., Garcia-Larrea, L., 2012. Filtering the reality: functional dissociation of lateral and medial pain systems during sleep in humans. *Hum Brain Mapp* 33, 2638–2649. <https://doi.org/10.1002/hbm.21390>
- Bastuji, H., Frot, M., Perchet, C., Magnin, M., Garcia-Larrea, L., 2016. Pain networks from the inside: Spatiotemporal analysis of brain responses leading from nociception to conscious perception. *Hum Brain Mapp* 37, 4301–4315. <https://doi.org/10.1002/hbm.23310>
- von Baeyer, C.L., Marche, T.A., Rocha, E.M., Salmon, K., 2004. Children’s memory for pain: overview and implications for practice. *J Pain* 5, 241–249. <https://doi.org/10.1016/j.jpain.2004.05.001>
- Benson, S., Kattoor, J., Kullmann, J.S., Hofmann, S., Engler, H., Forsting, M., Gizewski, E.R., Elsenbruch, S., 2014. Towards understanding sex differences in visceral pain: Enhanced reactivation of classically-conditioned fear in healthy women. *Neurobiology of Learning and Memory* 109, 113–121. <https://doi.org/10.1016/j.nlm.2013.12.014>
- Berkley, K.J., 1997. Sex differences in pain. *Behavioral and Brain Sciences* 20, 371–380. <https://doi.org/10.1017/S0140525X97221485>
- Bergmann HC, Kiemeneij A, Fernández G, Kessels RP, 2013. Early and late stages of working-memory maintenance contribute differentially to long-term memory formation. *Acta Psychologica*, 143(2):181-90. <https://doi.org/10.1016/j.actpsy.2013.02.009>
- Bergmann HC, Daselaar SM, Beul SF, Rijpkema M, Fernández G, Kessels RP, 2015. Brain activation during associative short-term memory maintenance is not predictive for subsequent retrieval. *Front Hum Neurosci.* 2; 9:479. <https://doi.org/10.3389/fnhum.2015.00479>
- Berryman C, Stanton TR, Jane Bowering K, Tabor A, McFarlane A, Lorimer MoSELEY, 2013. Evidence for working memory deficits in chronic pain: A systematic review and meta-analysis. *Pain*, 154(8), 1181-1196 <https://doi.org/10.1016/j.pain.2013.03.002>
- Bechara, A., Tranel, D., Damasio, H., Adolphs, R., Rockland, C., Damasio, A.R., 1995. Double dissociation of conditioning and declarative knowledge relative to the amygdala and hippocampus in humans. *Science* 269, 1115–1118. <https://doi.org/10.1126/science.7652558>
- Benedetti, F., 2008. Mechanisms of placebo and placebo-related effects across diseases and treatments. *Annu Rev Pharmacol Toxicol* 48, 33–60. <https://doi.org/10.1146/annurev.pharmtox.48.113006.094711>

- Benedetti, F., Amanzio, M., 2013. Mechanisms of the placebo response. *Pulm Pharmacol Ther* 26, 520–523. <https://doi.org/10.1016/j.pupt.2013.01.006>
- Berger, S.E., Vachon-Preseu, É., Abdullah, T.B., Baria, A.T., Schnitzer, T.J., Apkarian, A.V., 2018. Hippocampal morphology mediates biased memories of chronic pain. *Neuroimage* 166, 86–98. <https://doi.org/10.1016/j.neuroimage.2017.10.030>
- Berna, C., Leknes, S., Holmes, E.A., Edwards, R.R., Goodwin, G.M., Tracey, I., 2010. Induction of depressed mood disrupts emotion regulation neurocircuitry and enhances pain unpleasantness. *Biol Psychiatry* 67, 1083–1090. <https://doi.org/10.1016/j.biopsych.2010.01.014>
- Biggs, E.E., Meulders, A., Kaas, A.L., Goebel, R., Vlaeyen, J.W.S., 2020. The acquisition and generalization of fear of touch. *Scand J Pain* 20, 809–819. <https://doi.org/10.1515/sjpain-2019-0177>
- Binder, F.P., Spoormaker, V.I., 2020. Quantifying Human Avoidance Behavior in Immersive Virtual Reality. *Frontiers in Behavioral Neuroscience* 14
- Blair, H.T., Schafe, G.E., Bauer, E.P., Rodrigues, S.M., LeDoux, J.E., 2001. Synaptic plasticity in the lateral amygdala: a cellular hypothesis of fear conditioning. *Learn Mem* 8, 229–242. <https://doi.org/10.1101/lm.30901>
- Blanchard, R.J., Blanchard, D.C., 1969. Crouching as an index of fear. *Journal of Comparative and Physiological Psychology* 67, 370–375. <https://doi.org/10.1037/h0026779>
- Blankstein, U., Chen, J., Diamant, N.E., Davis, K.D., 2010. Altered brain structure in irritable bowel syndrome: potential contributions of pre-existing and disease-driven factors. *Gastroenterology* 138, 1783–1789. <https://doi.org/10.1053/j.gastro.2009.12.043>
- Bonnefond M., Jensen O. The role of gamma and alpha oscillations for blocking out distractions, 2013. *Communicative and Integrative Biology* 6:1, e22702. <https://doi.org/10.4161/cib.22702>
- Botella, C., Serrano, B., Baños, R.M., Garcia-Palacios, A., 2015. Virtual reality exposure-based therapy for the treatment of post-traumatic stress disorder: a review of its efficacy, the adequacy of the treatment protocol, and its acceptability. *Neuropsychiatr Dis Treat* 11, 2533–2545. <https://doi.org/10.2147/NDT.S89542>
- Botella, C., Quero, S., Perpiñá, C., Baños, R., Alcañiz Raya, M., Lozano, J., Rey, A., 1998. Virtual Environments for the Treatment of Claustrophobia. *The International journal of Virtual Reality* 3. <https://doi.org/10.20870/IJVR.1998.3.3.2626>
- Botella, C., Fernández-Álvarez, J., Guillén, V., García-Palacios, A., Baños, R., 2017. Recent Progress in Virtual Reality Exposure Therapy for Phobias: A Systematic Review. *Curr Psychiatry Rep* 19, 42. <https://doi.org/10.1007/s11920-017-0788-4>
- Bouchard, S., Gauthier, J., 1993. Adaptation canadienne-française de la forme révisée du State-Trait Anxiety Inventory de Spielberger. *Canadian Journal of Behavioural Science / Revue canadienne des sciences du comportement*. <https://doi.org/10.1037/h0078881>
- Bouton, M., 2004. Bouton ME. Context and behavioral processes in extinction. *Learn Mem* 11: 485-494. *Learning & memory* (Cold Spring Harbor, N.Y.) 11, 485–94. <https://doi.org/10.1101/lm.78804>
- Bouton, M.E., Maren, S., McNally, G.P., 2021. Behavioral and neurobiological mechanisms of Pavlovian and instrumental extinction learning. *Physiol Rev* 101, 611–681. <https://doi.org/10.1152/physrev.00016.2020>
- Bouton, M.E., Nelson, J.B., Rosas, J.M., 1999. Stimulus generalization, context change, and forgetting. *Psychological Bulletin* 125, 171–186. <https://doi.org/10.1037/0033-2909.125.2.171>
- Bradley, M.M., Codispoti, M., Sabatinelli, D., Lang, P.J., 2001. Emotion and motivation II: sex differences in picture processing. *Emotion* 1, 300–319.
- Bradley, M.M., Lang, P.J., 1994. Measuring emotion: The self-assessment manikin and the semantic differential. *Journal of Behavior Therapy and Experimental Psychiatry* 25, 49–59. [https://doi.org/10.1016/0005-7916\(94\)90063-9](https://doi.org/10.1016/0005-7916(94)90063-9)
- Bräscher, A.-K., Witthöft, M., 2019. Behavioral and electrodermal data on implicit nocebo conditioning using supraliminally presented visual stimuli. *Data in Brief* 27, 104705. <https://doi.org/10.1016/j.dib.2019.104705>
- Breslau, N., Davis, G.C., Andreski, P., Peterson, E.L., Schultz, L.R., 1997. Sex differences in posttraumatic stress disorder. *Arch Gen Psychiatry* 54, 1044–1048. <https://doi.org/10.1001/archpsyc.1997.01830230082012>
- Bryant, R.A., 1993. Memory for pain and affect in chronic pain patients. *Pain* 54, 347–351. [https://doi.org/10.1016/0304-3959\(93\)90036-O](https://doi.org/10.1016/0304-3959(93)90036-O)

Busch, H., Montgomery, W., Melin, B., Lundberg, U., 2006. Visuospatial and Verbal Memory in Chronic Pain Patients: An Explorative Study. *Pain Practice* 6, 179–185. <https://doi.org/10.1111/j.1533-2500.2006.00083.x>

Büchel, C., Dolan, R.J., 2000. Classical fear conditioning in functional neuroimaging. *Current Opinion in Neurobiology* 10, 219–223. [https://doi.org/10.1016/S0959-4388\(00\)00078-7](https://doi.org/10.1016/S0959-4388(00)00078-7)

C

Calder, A.J., Beaver, J.D., Davis, M.H., van Ditzhuijzen, J., Keane, J., Lawrence, A.D., 2007. Disgust sensitivity predicts the insula and pallidal response to pictures of disgusting foods. *Eur J Neurosci* 25, 3422–3428. <https://doi.org/10.1111/j.1460-9568.2007.05604.x>

Carlino, E., Frisaldi, E., Benedetti, F., 2014. Pain and the context. *Nat Rev Rheumatol* 10, 348–355. <https://doi.org/10.1038/nrrheum.2014.17>

Careaga, M.B.L., Girardi, C.E.N., Suchecki, D., 2016. Understanding posttraumatic stress disorder through fear conditioning, extinction and reconsolidation. *Neurosci Biobehav Rev* 71, 48–57. <https://doi.org/10.1016/j.neubiorev.2016.08.023>

Cardoso-Cruz H, Dourado M, Monteiro C, Galhardo V, Blockade of dopamine D2 receptors disrupts intrahippocampal connectivity and enhances pain-related working memory deficits in neuropathic pain rats. *Eur J Pain*; 22(5) :1002-1015. <https://doi.org/10.1002/ejp.1186>

Caulfield, M.D., Vogel, A.L., Coutinho, M.R., Kan, I.P., 2021. Mnemonic discrimination is associated with individual differences in anxiety vulnerability. *Behavioural Brain Research* 401, 113056. <https://doi.org/10.1016/j.bbr.2020.113056>

Chapon, A., Perchet, C., Garcia-Larrea, L., Frot, M., 2019. Hyperalgesia when observing pain-related images is a genuine bias in perception and enhances autonomic responses. *Sci Rep* 9, 15266. <https://doi.org/10.1038/s41598-019-51743-3>

Chouchou, F., Perchet, C., Garcia-Larrea, L., 2021. EEG changes reflecting pain: is alpha suppression better than gamma enhancement? *Neurophysiologie Clinique* 51, 209–218. <https://doi.org/10.1016/j.neucli.2021.03.001>

Christiansen, P., Klostergaard, K.M., Terp, M.R., Poulsen, C., Agger, A.O., Rasmussen, K.L., 2002. [Long-memory of labor pain]. *Ugeskr Laeger* 164, 4927–4929.

Cipresso, P., Giglioli, I.A.C., Raya, M.A., Riva, G., 2018. The Past, Present, and Future of Virtual and Augmented Reality Research: A Network and Cluster Analysis of the Literature. *Frontiers in Psychology* 9.

Clark, R.E., Squire, L.R., 1998. Classical conditioning and brain systems: The role of awareness. *Science* 280, 77–81. <https://doi.org/10.1126/science.280.5360.77>

Coan, J.A., Schaefer, H.S., Davidson, R.J., 2006. Lending a Hand: Social Regulation of the Neural Response to Threat. *Psychol Sci* 17, 1032–1039. <https://doi.org/10.1111/j.1467-9280.2006.01832.x>

Connor, D.A., Gould, T.J., 2016. The role of working memory and declarative memory in trace conditioning. *Neurobiology of Learning and Memory* 134, 193–209. <https://doi.org/10.1016/j.nlm.2016.07.009>

Cooper, W. E., and Blumstein, D. T. (2015). *Escaping From Predators: An Integrative View of Escape Decisions*. Cambridge: Cambridge University Press

Cooper NR, Croft RJ, Dominey SJJ, Burgess AP, Gruzelier JH, 2003. Paradox lost? Exploring the role of alpha oscillations during externally vs. internally directed attention and the implications for idling and inhibition hypotheses. *Int J of Psychophysiol.* 47: 65-74. [https://doi.org/10.1016/s0167-8760\(02\)00107-1](https://doi.org/10.1016/s0167-8760(02)00107-1)

Cooper, S.E., Dunsmoor, J.E., 2021. Fear conditioning and extinction in obsessive-compulsive disorder: A systematic review. *Neurosci Biobehav Rev* 129, 75–94. <https://doi.org/10.1016/j.neubiorev.2021.07.026>

Cooper, S.E., van Dis, E.A.M., Hagenaars, M.A., Kryptos, A.-M., Nemeroff, C.B., Lissek, S., Engelhard, I.M., Dunsmoor, J.E., 2022. A meta-analysis of conditioned fear generalization in anxiety-related disorders. *Neuropsychopharmacology* 47, 1652–1661. <https://doi.org/10.1038/s41386-022-01332-2>

Craig, AD (1995). Supraspinal projections of lamina I neurons. In: Besson JM, Guilbaud G, Ollat H, editors. *Forebrain areas involved in pain processing*. Paris: John Libbey. p. 13-26.

Craig, AD. (2014). Topographically organized projection to posterior insular cortex from the posterior portion of the ventral medial nucleus in the long-tailed macaque monkey: VMpo input to posterior insula. *J Comp Neurol* 522, 36–63.

- Craig, A.D.B., 2014. Topographically organized projection to posterior insular cortex from the posterior portion of the ventral medial nucleus in the long-tailed macaque monkey. *J Comp Neurol* 522, 36–63. <https://doi.org/10.1002/cne.23425>
- Craig, A.D.B., 2009. How do you feel--now? The anterior insula and human awareness. *Nat Rev Neurosci* 10, 59–70. <https://doi.org/10.1038/nrn2555>
- Curzon, P., Rustay, N.R., Browman, K.E., 2009. Cued and Contextual Fear Conditioning for Rodents, in: Buccafusco, J.J. (Ed.), *Methods of Behavior Analysis in Neuroscience, Frontiers in Neuroscience*. CRC Press/Taylor & Francis, Boca Raton (FL).
- Cruz-Neira, C., Sandin, D., DeFanti, T., 1993. Surround-Screen Projection-Based Virtual Reality: The Design and Implementation of the CAVE. Presented at the ACM SIGGRAPH, pp. 135–142. <https://doi.org/10.1145/166117.166134>
- Cushman, J. D., Fanselow, M.S., 2010. Fear Conditioning, in: Koob, G.F., Moal, M.L., Thompson, R.F. (Eds.), *Encyclopedia of Behavioral Neuroscience*. Academic Press, Oxford, pp. 524–531. <https://doi.org/10.1016/B978-0-08-045396-5.00136-6>

D

- Davis, M., 1997. Neurobiology of fear responses: The role of the amygdala. *The Journal of Neuropsychiatry and Clinical Neurosciences* 9, 382–402. <https://doi.org/10.1176/jnp.9.3.382>
- Davis, M., 1992a. The role of the amygdala in conditioned fear, in: *The Amygdala: Neurobiological Aspects of Emotion, Memory, and Mental Dysfunction*. Wiley-Liss, New York, NY, US, pp. 255–306.
- Davis, M., 1992b. The role of the amygdala in conditioned fear, in: *The Amygdala: Neurobiological Aspects of Emotion, Memory, and Mental Dysfunction*. Wiley-Liss, New York, NY, US, pp. 255–306.
- Davis, M., Whalen, P., 2001. The amygdala: vigilance and emotion. *Mol Psychiatr* 6: 13-34. *Molecular psychiatry* 6, 13–34. <https://doi.org/10.1038/sj.mp.4000812>
- D'Esposito M., Postle B., Jonides J., Smith E, 1999². The neural substrate and temporal dynamics of interference effects in working memory as revealed by event-related functional MRI. *Proc Natl Acad Sci USA*. 96(13): 7514-9. <https://doi.org/10.1073/pnas.96.13.7514>
- Dippoppa M, Szwed M, Gutkin BS. Controlling Working Memory Operations by Selective Gatong: The roles of Oscillations and Synchrony. *Adv Cogn Psychol* 12(4): 209-232, 2016; DOI: <https://doi.org/10.5709/acp-0199-x>
- Di Blasi, Z., Harkness, E., Ernst, E., Georgiou, A., Kleijnen, J., 2001. Influence of context effects on health outcomes: a systematic review. *Lancet* 357, 757–762. [https://doi.org/10.1016/s0140-6736\(00\)04169-6](https://doi.org/10.1016/s0140-6736(00)04169-6)
- Dinakar, P., Stillman, A.M., 2016. Pathogenesis of Pain. *Semin Pediatr Neurol* 23, 201–208. <https://doi.org/10.1016/j.spen.2016.10.003>
- Di Giacinto, A., Brunetti, M., Sepede, G., Ferretti, A., Merla, A., 2014. Thermal signature of fear conditioning in mild post-traumatic stress disorder. *Neuroscience* 266, 216–223. <https://doi.org/10.1016/j.neuroscience.2014.02.009>
- Dolleman-van der Weel, M.J., Griffin, A.L., Ito, H.T., Shapiro, M.L., Witter, M.P., Vertes, R.P., Allen, T.A., 2019. The nucleus reuniens of the thalamus sits at the nexus of a hippocampus and medial prefrontal cortex circuit enabling memory and behavior. *Learn Mem* 26, 191–205. <https://doi.org/10.1101/lm.048389.118>
- Donges, U.-S., Kersting, A., Suslow, T., 2012. Women's greater ability to perceive happy facial emotion automatically: Gender differences in affective priming. *PLoS ONE* 7. <https://doi.org/10.1371/journal.pone.0041745>
- Drace, S., 2013. Evidence for the role of affect in mood congruent recall of autobiographic memories. *Motivation and Emotion* 37, 623–628. <https://doi.org/10.1007/s11031-012-9322-5>
- Drossman, D.A., Hasler, W.L., 2016. Rome IV-Functional GI Disorders: Disorders of Gut-Brain Interaction. *Gastroenterology* 150, 1257–1261. <https://doi.org/10.1053/j.gastro.2016.03.035>
- Duits, P., Cath, D.C., Lissek, S., Hox, J.J., Hamm, A.O., Engelhard, I.M., van den Hout, M.A., Baas, J.M.P., 2015. Updated meta-analysis of classical fear conditioning in the anxiety disorders. *Depress Anxiety* 32, 239–253. <https://doi.org/10.1002/da.22353>
- Dum, R.P., Levinthal, D.J., Strick, P.L., 2009. The Spinothalamic System Targets Motor and Sensory Areas in the Cerebral Cortex of Monkeys. *J. Neurosci.* 29, 14223–14235. <https://doi.org/10.1523/JNEUROSCI.3398-09.2009>
- Dunsmoor, J.E., Murphy, G.L., 2015. Categories, concepts, and conditioning: how humans generalize fear. *Trends Cogn Sci* 19, 73–77. <https://doi.org/10.1016/j.tics.2014.12.003>

- Dunsmoor, J.E., Kroes, M.C.W., 2019. Episodic memory and Pavlovian conditioning: ships passing in the night. *Curr Opin Behav Sci* 26, 32–39. <https://doi.org/10.1016/j.cobeha.2018.09.019>
- Dymond, S., Dunsmoor, J.E., Vervliet, B., Roche, B., Hermans, D., 2015. Fear Generalization in Humans: Systematic Review and Implications for Anxiety Disorder Research. *Behav Ther* 46, 561–582. <https://doi.org/10.1016/j.beth.2014.10.001>
- E**
- Ehlers, A., Clark, D., 2000. A cognitive model of posttraumatic stress disorder. *Behaviour Research and Therapy* 15, 249–275. <https://doi.org/10.1016/S0005-7967%2899%2900123-0>
- Ehlers, A., Michael, T., Chen, Y.P., Payne, E., Shan, S., 2006. Enhanced perceptual priming for neutral stimuli in a traumatic context: A pathway to intrusive memories? *Memory* 14, 316–328. <https://doi.org/10.1080/09658210500305876>
- Ehrlich, I., Humeau, Y., Grenier, F., Ciochi, S., Herry, C., Lüthi, A., 2009. Amygdala inhibitory circuits and the control of fear memory. *Neuron* 62, 757–771. <https://doi.org/10.1016/j.neuron.2009.05.026>
- ElShafei HA, Bouet R, Bertrand O, Bidet-Caulet A. Two sides of the same coin: distinct sub-bands in the α rhythm reflect facilitation and suppression mechanisms during auditory anticipatory attention. *eNeuro* 17;5(4): ENEURO.0141-18, 2018; DOI: <https://doi.org/10.1523/ENEURO.0141-18.2018>.
- Eli, I., Baht, R., Kozlovsky, A., Simon, H., 2000. Effect of gender on acute pain prediction and memory in periodontal surgery. *Eur J Oral Sci* 108, 99–103. <https://doi.org/10.1034/j.1600-0722.2000.00777.x>
- Erskine, A., Morley, S., Pearce, S., 1990. Memory for pain: a review. *Pain* 41, 255–265. [https://doi.org/10.1016/0304-3959\(90\)90002-U](https://doi.org/10.1016/0304-3959(90)90002-U)
- Esteves, F., Dimberg, U., Öhman, A., 1994. Automatically elicited fear: Conditioned skin conductance responses to masked facial expressions. *Cognition and Emotion* 8, 393–413. <https://doi.org/10.1080/02699939408408949>
- Etkin, A., Egner, T., Kalisch, R., 2011. Emotional processing in anterior cingulate and medial prefrontal cortex. *Trends Cogn Sci* 15, 85–93. <https://doi.org/10.1016/j.tics.2010.11.004>
- Etkin, A., Wager, T.D., 2007. Functional neuroimaging of anxiety: a meta-analysis of emotional processing in PTSD, social anxiety disorder, and specific phobia. *Am J Psychiatry* 164, 1476–1488. <https://doi.org/10.1176/appi.ajp.2007.07030504>
- F**
- Faasse, K., Johnson, M., 2008. The role of associative learning and pain. *Ngau Mamae Quarterly Publication of the New Zealand Pain Society* 8, 12–19.
- Faghieh, R.T., Stokes, P.A., Marin, M.-F., Zsido, R.G., Zorowitz, S., Rosenbaum, B.L., Song, H., Milad, M.R., Dougherty, D.D., Eskandar, E.N., Widge, A.S., Brown, E.N., Barbieri, R., 2015. Characterization of fear conditioning and fear extinction by analysis of electrodermal activity, in: 2015 37th Annual International Conference of the IEEE Engineering in Medicine and Biology Society (EMBC), pp. 7814–7818. <https://doi.org/10.1109/EMBC.2015.7320204>
- Fairhurst, M., Fairhurst, K., Berna, C., Tracey, I., 2012. An fMRI Study Exploring the Overlap and Differences between Neural Representations of Physical and Recalled Pain. *PLOS ONE* 7, e48711. <https://doi.org/10.1371/journal.pone.0048711>
- Flor, H., Birbaumer, N., 2001. Fear Conditioning, in: Smelser, N.J., Baltes, P.B. (Eds.), *International Encyclopedia of the Social & Behavioral Sciences*. Pergamon, Oxford, pp. 5422–5425. <https://doi.org/10.1016/B0-08-043076-7/03643-3>
- Fillingim, R.B., King, C.D., Ribeiro-Dasilva, M.C., Rahim-Williams, B., Riley, J.L., 2009. Sex, Gender, and Pain: A Review of Recent Clinical and Experimental Findings. *The Journal of Pain* 10, 447–485. <https://doi.org/10.1016/j.jpain.2008.12.001>
- Fonteyne, R., Vervliet, B., Hermans, D., Baeyens, F., Vansteenwegen, D., 2010. Exposure to the context and removing the unpredictability of the US: Two methods to reduce contextual anxiety compared. *Biological Psychology* 85, 361–369. <https://doi.org/10.1016/j.biopsycho.2010.08.007>
- Fritz JB, Malloy M, Mishkin M, Saunders RC, 2016. Monkey's short-term auditory memory nearly abolished by combined removal of the rostral superior temporal gyrus and rhinal cortices. *Brain Res.* 1640 (PtB) :289-98. <https://doi.org/10.1016/j.brainres.2015.12.012>.
- Frot, M., Faillenot, I., Mauguière, F., 2014. Processing of Nociceptive Input From Posterior to Anterior Insula in Humans. *Human brain mapping* 35. <https://doi.org/10.1002/hbm.22565>
- Frot, M., Mauguière, F., 2003. Dual representation of pain in the operculo-insular cortex in humans. *Brain* 126, 438–450. <https://doi.org/10.1093/brain/awg032>

Frot, M., Feine, J.S., Bushnell, M.C., 2004. Sex differences in pain perception and anxiety. A psychophysical study with topical capsaicin. *Pain* 108, 230–236. <https://doi.org/10.1016/j.pain.2003.11.017>

G

Gagnepain, P., Hulbert, J., Anderson, M.C., 2017. Parallel Regulation of Memory and Emotion Supports the Suppression of Intrusive Memories. *J Neurosci* 37, 6423–6441. <https://doi.org/10.1523/JNEUROSCI.2732-16.2017>

Garcia-Palacios, A., Herrero, R., Vizcaíno, Y., Belmonte, M.A., Castilla, D., Molinari, G., Baños, R.M., Botella, C., 2015. Integrating virtual reality with activity management for the treatment of fibromyalgia: acceptability and preliminary efficacy. *Clin J Pain* 31, 564–572. <https://doi.org/10.1097/AJP.0000000000000196>

Gardiner, J.M., 1988. Functional aspects of recollective experience. *Memory & Cognition* 16, 309–313. <https://doi.org/10.3758/BF03197041>

Garcia-Larrea, L., Peyron, R., 2013. Pain matrices and neuropathic pain matrices: a review. *Pain* 154 Suppl 1, S29–S43. <https://doi.org/10.1016/j.pain.2013.09.001>

Garrett, B., Taverner, T., Masinde, W., Gromala, D., Shaw, C., Negraeff, M., 2014. A rapid evidence assessment of immersive virtual reality as an adjunct therapy in acute pain management in clinical practice. *Clin J Pain* 30, 1089–1098. <https://doi.org/10.1097/AJP.0000000000000064>

Gedney, J.J., Logan, H., 2004. Memory for stress-associated acute pain. *J Pain* 5, 83–91. <https://doi.org/10.1016/j.jpain.2003.11.005>

Gedney, J.J., Logan, H., Baron, R.S., 2003. Predictors of short-term and long-term memory of sensory and affective dimensions of pain. *The Journal of Pain* 4, 47–55. <https://doi.org/10.1054/jpai.2003.3>

Gentry, W. D., & Bernal, G. A. A. (1977). Chronic pain. In R. Williams & W. D. Gentry (Eds.), *Behavioral approaches to medical treatment* (pp. 173–182). Cambridge: Ballinger.

Genheimer, H., Andreatta, M., Asan, E., Pauli, P., 2017. Reinstatement of contextual conditioned anxiety in virtual reality and the effects of transcutaneous vagus nerve stimulation in humans. *Sci Rep* 7, 17886. <https://doi.org/10.1038/s41598-017-18183-3>

Ghosh, S., Chattarji, S., 2015. Neuronal encoding of the switch from specific to generalized fear. *Nat Neurosci* 18, 112–120. <https://doi.org/10.1038/nn.3888>

Glottzbach, E., Ewald, H., Andreatta, M., Pauli, P., Mühlberger, A., 2012. Contextual fear conditioning predicts subsequent avoidance behaviour in a virtual reality environment. *Cogn Emot* 26, 1256–1272. <https://doi.org/10.1080/02699931.2012.656581>

Glottzbach-Schoon, E., Andreatta, M., Reif, A., Ewald, H., Tröger, C., Baumann, C., Deckert, J., Mühlberger, A., Pauli, P., 2013. Contextual fear conditioning in virtual reality is affected by 5HTTLPR and NPSR1 polymorphisms: effects on fear-potentiated startle. *Front Behav Neurosci* 7, 31. <https://doi.org/10.3389/fnbeh.2013.00031>

Godinho, F., Faillenot, I., Perchet, C., Frot, M., Magnin, M., Garcia-Larrea, L., 2012. How the pain of others enhances our pain: Searching the cerebral correlates of ‘compassional hyperalgesia.’ *European Journal of Pain* 16, 748–759. <https://doi.org/10.1002/j.1532-2149.2011.00039.x>

Gohier, B., Senior, C., Brittain, P.J., Lounes, N., El-Hage, W., Law, V., Phillips, M.L., Surguladze, S.A., 2013. Gender differences in the sensitivity to negative stimuli: cross-modal affective priming study. *Eur Psychiatry* 28, 74–80. <https://doi.org/10.1016/j.eurpsy.2011.06.007>

Goldstein, J.M., Seidman, L.J., Horton, N.J., Makris, N., Kennedy, D.N., Caviness, V.S., Faraone, S.V., Tsuang, M.T., 2001. Normal sexual dimorphism of the adult human brain assessed by in vivo magnetic resonance imaging. *Cereb Cortex* 11, 490–497. <https://doi.org/10.1093/cercor/11.6.490>

Goubert, L., Craig, K.D., Vervoort, T., Morley, S., Sullivan, M.J.L., Williams, de C.A.C., Cano, A., Crombez, G., 2005. Facing others in pain: the effects of empathy. *Pain* 118, 285–288. <https://doi.org/10.1016/j.pain.2005.10.025>

Gramsch, C., Kattoor, J., Icenhour, A., Forsting, M., Schedlowski, M., Gizewski, E.R., Elsenbruch, S., 2014. Learning pain-related fear: Neural mechanisms mediating rapid differential conditioning, extinction and reinstatement processes in human visceral pain. *Neurobiology of Learning and Memory* 116, 36–45. <https://doi.org/10.1016/j.nlm.2014.08.003>

Grégoire, L., Landry, L., Gustafsson, E., Blanchette, I., 2021. Alteration of early attentional processing after analogue trauma exposure: evidence from event-related potentials. *Exp Brain Res* 239, 3671–3686. <https://doi.org/10.1007/s00221-021-06234-1>

- Grégoire, L., Caparos, S., Leblanc, C.-A., Brisson, B., Blanchette, I., 2018. Sexual Abuse Exposure Alters Early Processing of Emotional Words: Evidence from Event-Related Potentials. *Frontiers in Human Neuroscience* 11.
- Grisart, J., Van der Linden, M., Bastin, C., 2007. The contribution of recollection and familiarity to recognition memory performance in chronic pain patients. *Behaviour Research and Therapy* 45, 1077–1084. <https://doi.org/10.1016/j.brat.2006.05.002>
- Griffin, A.L., 2015. Role of the thalamic nucleus reuniens in mediating interactions between the hippocampus and medial prefrontal cortex during spatial working memory. *Front Syst Neurosci* 9, 29. <https://doi.org/10.3389/fnsys.2015.00029>
- Grosso, A., Santoni, G., Manassero, E., Renna, A., Sacchetti, B., 2018. A neuronal basis for fear discrimination in the lateral amygdala. *Nat Commun* 9, 1214. <https://doi.org/10.1038/s41467-018-03682-2>
- Gruene, T.M., Flick, K., Stefano, A., Shea, S.D., Shansky, R.M., 2015. Sexually divergent expression of active and passive conditioned fear responses in rats. *Elife* 4, e11352. <https://doi.org/10.7554/eLife.11352>
- Grunau, R.E., Holsti, L., Peters, J.W.B., 2006. Long-term consequences of pain in human neonates. *Semin Fetal Neonatal Med* 11, 268–275. <https://doi.org/10.1016/j.siny.2006.02.007>
- Günther, A.C., Schandl, A.R., Berhardsson, J., Bjärtå, A., Wällgren, M., Sundin, Ö., Alvarsson, J., Bottai, M., Martling, C.-R., Sackey, P.V., 2016. Pain rather than induced emotions and ICU sound increases skin conductance variability in healthy volunteers. *Acta Anaesthesiol Scand* 60, 1111–1120. <https://doi.org/10.1111/aas.12751>
- Günther, A.C., Bottai, M., Schandl, A.R., Storm, H., Rossi, P., Sackey, P.V., 2013. Palmar skin conductance variability and the relation to stimulation, pain and the motor activity assessment scale in intensive care unit patients. *Critical Care* 17, R51. <https://doi.org/10.1186/cc12571>
- H**
- Harvie, D.S., Moseley, G.L., Hillier, S.L., Meulders, A., 2017. Classical Conditioning Differences Associated With Chronic Pain: A Systematic Review. *J Pain* 18, 889–898. <https://doi.org/10.1016/j.jpain.2017.02.430/>
- Haegens S, Luther L, Jensen O, 2012. Somatosensory Anticipatory Alpha Activity Increases to Suppress Distracting Input. *J Cogn Neurosci*. 24(3):677-85. https://doi.org/10.1162/jocn_a_00164
- Händel BF, Haarmeier T, Jensen O, 2011. Alpha oscillations correlate with the successful inhibition of unattended stimuli. *J Cogn Neurosci*; 23:2494502. <https://doi.org/10.1162/jocn.2010.21557>
- Harvie, D.S., Moseley, G.L., Hillier, S.L., Meulders, A., 2017. Classical Conditioning Differences Associated With Chronic Pain: A Systematic Review. *J Pain* 18, 889–898. <https://doi.org/10.1016/j.jpain.2017.02.430>
- Hayes, J.P., VanElzakker, M.B., Shin, L.M., 2012. Emotion and cognition interactions in PTSD: a review of neurocognitive and neuroimaging studies. *Front Integr Neurosci* 6, 89. <https://doi.org/10.3389/fnint.2012.00089>
- Hendrix, C., Barfield, W., 1996. Presence within Virtual Environments as a Function of Visual Display Parameters. *Presence: Teleoperators & Virtual Environments* 5, 274–289. <https://doi.org/10.1162/pres.1996.5.3.274>
- Hermann, A., Stark, R., Milad, M.R., Merz, C.J., 2016. Renewal of conditioned fear in a novel context is associated with hippocampal activation and connectivity. *Soc Cogn Affect Neurosci* 11, 1411–1421. <https://doi.org/10.1093/scan/nsw047>
- Helmstetter, F.J., 1992. The amygdala is essential for the expression of conditional hypoalgesia. *Behav Neurosci* 106, 518–528. <https://doi.org/10.1037//0735-7044.106.3.518>
- Henderson, L.A., Macey, P.M., Macey, K.E., Frysinger, R.C., Woo, M.A., Harper, R.K., Alger, J.R., Yan-Go, F.L., Harper, R.M., 2002. Brain Responses Associated With the Valsalva Maneuver Revealed by Functional Magnetic Resonance Imaging. *Journal of Neurophysiology* 88, 3477–3486. <https://doi.org/10.1152/jn.00107.2002>
- Holloway, R.G., Gramling, R., Kelly, A.G., 2013. Estimating and communicating prognosis in advanced neurologic disease. *Neurology* 80, 764–772. <https://doi.org/10.1212/WNL.0b013e318282509c>
- Holsti, L., Grunau, R.E., Oberlander, T.F., Whitfield, M.F., 2005. Prior pain induces heightened motor responses during clustered care in preterm infants in the NICU. *Early Hum Dev* 81, 293–302. <https://doi.org/10.1016/j.earlhumdev.2004.08.002>

Honzel, E., Murthi, S., Brawn-Cinani, B., Colloca, G., Kier, C., Varshney, A., Colloca, L., 2019. Virtual reality, music, and pain: developing the premise for an interdisciplinary approach to pain management. *Pain* 160, 1909–1919. <https://doi.org/10.1097/j.pain.0000000000001539>

Hopkins, L.S., Schultz, D.H., Hannula, D.E., Helmstetter, F.J., 2015. Eye Movements Index Implicit Memory Expression in Fear Conditioning. *PLOS ONE* 10, e0141949. <https://doi.org/10.1371/journal.pone.0141949>

Hovasapian, A., Levine, L.J., 2016. Reappraisal mitigates overestimation of remembered pain in anxious individuals. *Cogn Emot* 30, 1222–1231. <https://doi.org/10.1080/02699931.2015.1049937>

Houde F, Martel M, Coulombe-Lévêque A, Harvey MP, Auclair V, Mathieu D, Whittingstall K, Goffaux P, Léonard G. Perturbing the activity of the superior temporal gyrus during pain encoding prevents the exaggeration of pain memories: A virtual lesion study using single-pulse transcranial magnetic stimulation. *Neurobiol Learn Mem.* 169:107174, 2020. DOI: <https://doi.org/10.1016/j.nlm.2020.107174>.

Houtekamer, M.C., Henckens, M.J.A.G., Mackey, W.E., Dunsmoor, J.E., Homberg, J.R., Kroes, M.C.W., 2020. Investigating the efficacy of the reminder-extinction procedure to disrupt contextual threat memories in humans using immersive Virtual Reality. *Sci Rep* 10, 16991. <https://doi.org/10.1038/s41598-020-73139-4>

Huang, J., Gadotti, V.M., Chen, L., Souza, I.A., Huang, S., Wang, D., Ramakrishnan, C., Deisseroth, K., Zhang, Z., Zamponi, G.W., 2019. A neuronal circuit for activating descending modulation of neuropathic pain. *Nat Neurosci* 22, 1659–1668. <https://doi.org/10.1038/s41593-019-0481-5>

Huckleberry, K.A., Ferguson, L.B., Drew, M.R., 2016. Behavioral mechanisms of context fear generalization in mice. *Learn Mem* 23, 703–709. <https://doi.org/10.1101/lm.042374.116>

Huether, G., 1996. The central adaptation syndrome: Psychosocial stress as a trigger for adaptive modifications of brain structure and brain function. *Progress in Neurobiology* 48, 569–612. [https://doi.org/10.1016/0301-0082\(96\)00003-2](https://doi.org/10.1016/0301-0082(96)00003-2)

Huether SE, Rodway G, Defriez C, 2016. Pain, Temperature Regulation, Sleep, and Sensory Function. *Basic medical Key.* <https://basicmedicalkey.com/pain-temperature-regulation-sleep-and-sensory-function/>

Huff, N.C., Zeilinski, D.J., Fecteau, M.E., Brady, R., LaBar, K.S., 2010. Human fear conditioning conducted in full immersion 3-dimensional virtual reality. *J Vis Exp* 1993. <https://doi.org/10.3791/1993>

Hvass, J., Larsen, O., Vendelbo, K., Nilsson, N., Nordahl, R., Serafin, S., 2017. Visual realism and presence in a virtual reality game, in: 2017 3DTV Conference: The True Vision - Capture, Transmission and Display of 3D Video (3DTV-CON). pp. 1–4. <https://doi.org/10.1109/3DTV.2017.8280421>

I

Itoh, M., Hori, H., Lin, M., Niwa, M., Ino, K., Imai, R., Ogawa, S., Matsui, M., Kamo, T., Kim, Y., 2019. Memory bias and its association with memory function in women with posttraumatic stress disorder. *Journal of Affective Disorders* 245, 461–467. <https://doi.org/10.1016/j.jad.2018.10.365>

Icenhour, A., Kattoor, J., Benson, S., Boekstegers, A., Schlamann, M., Merz, C.J., Forsting, M., Elsenbruch, S., 2015. Neural circuitry underlying effects of context on human pain-related fear extinction in a renewal paradigm. *Hum Brain Mapp* 36, 3179–3193. <https://doi.org/10.1002/hbm.22837>

J

Jensen O, Gelfand J, Kounios J, Lisman JE, 2002. Oscillations in the alpha band (9–12 Hz) increase with memory load during retention in a short-term memory task. *Cereb Cortex* 12:877– 882. <https://doi.org/10.1093/cercor/12.8.877>

Jensen O, Mazaheri A, 2010. Shaping functional architecture by oscillatory alpha activity: gating by inhibition. *Front Hum Neurosci.* 4:186. <https://doi.org/10.3389/fnhum.2010.00186>

Jin, J., Maren, S., 2015. Prefrontal-Hippocampal Interactions in Memory and Emotion. *Front Syst Neurosci* 9, 170. <https://doi.org/10.3389/fnsys.2015.00170>

Johnson, L.M., Zautra, A.J., Davis, M.C., 2006. The role of illness uncertainty on coping with fibromyalgia symptoms. *Health Psychology* 25, 696–703. <https://doi.org/10.1037/0278-6133.25.6.696>

- Jonides J., Nee DE. Brain mechanisms of proactive interference in working memory. *Neuroscience*, 139(1):181-93, 2006. DOI : <https://doi.org/10.1016/j.neuroscience.2005.06.042>
- Jovanovic, T., Norrholm, S.D., Blanding, N.Q., Davis, M., Duncan, E., Bradley, B., Ressler, K.J., 2010. Impaired fear inhibition is a biomarker of PTSD but not depression. *Depression and Anxiety* 27, 244–251. <https://doi.org/10.1002/da.20663>
- ## K
- Kaiser J, Lutzenberger W. Human gamma-band activity: a window to cognitive processing. *Neuroreport*. 16(3):207-11, 2005. DOI: <https://doi.org/10.1097/00001756-200502280-00001>
- Kalisch, R., Korenfeld, E., Stephan, K.E., Weiskopf, N., Seymour, B., Dolan, R.J., 2006. Context-dependent human extinction memory is mediated by a ventromedial prefrontal and hippocampal network. *J Neurosci* 26, 9503–9511. <https://doi.org/10.1523/JNEUROSCI.2021-06.2006>
- Karimi, Z., Pilenko, A., Held, S.M., Hasenbring, M.I., 2016. Recall Bias in Patients with Chronic Low Back Pain: Individual Pain Response Patterns Are More Important Than Pain Itself! *Int J Behav Med* 23, 12–20. <https://doi.org/10.1007/s12529-015-9499-6>
- Karnath HO, Ferber S, Himmelbach M, 2001. Spatial awareness is a function of the temporal not the posterior parietal lobe. *Nature*. 411(6840):950-3. <https://doi.org/10.1038/35082075>.
- Karnath HO, 2001. New insights into the functions of the superior temporal cortex. *Nat Rev Neurosci*. 2(8):568-76,10.1038/35086057.
- Karos, K., Meulders, A., Vlaeyen, J.W.S., 2015. Threatening social context facilitates pain-related fear learning. *J Pain* 16, 214–225. <https://doi.org/10.1016/j.jpain.2014.11.014>
- Kattoor, J., Gizewski, E.R., Kotsis, V., Benson, S., Gramsch, C., Theysohn, N., Maderwald, S., Forsting, M., Schedlowski, M., Elsenbruch, S., 2013. Fear Conditioning in an Abdominal Pain Model: Neural Responses during Associative Learning and Extinction in Healthy Subjects. *PLoS One* 8, e51149. <https://doi.org/10.1371/journal.pone.0051149>
- Keefe, F.J., Rumble, M.E., Scipio, C.D., Giordano, L.A., Perri, L.M., 2004. Psychological aspects of persistent pain: current state of the science. *J Pain* 5, 195–211. <https://doi.org/10.1016/j.jpain.2004.02.576>
- Keefe, F.J., Huling, D.A., Coggins, M.J., Keefe, D.F., Rosenthal, M.Z., Herr, N.R., Hoffman, H.G., 2012. Virtual Reality for Persistent Pain: A New Direction for Behavioral Pain Management. *Pain* 153, 2163–2166. <https://doi.org/10.1016/j.pain.2012.05.030>
- Kenney, J.W., Scott, I.C., Josselyn, S.A., Frankland, P.W., 2017. Contextual fear conditioning in zebrafish. *Learn Mem* 24, 516–523. <https://doi.org/10.1101/lm.045690.117>
- Keiser, A.A., Turnbull, L.M., Darian, M.A., Feldman, D.E., Song, I., Tronson, N.C., 2017. Sex Differences in Context Fear Generalization and Recruitment of Hippocampus and Amygdala during Retrieval. *Neuropsychopharmacology* 42, 397–407. <https://doi.org/10.1038/npp.2016.174>
- Kennedy, P.J., Clarke, G., Quigley, E.M.M., Groeger, J.A., Dinan, T.G., Cryan, J.F., 2012. Gut memories: towards a cognitive neurobiology of irritable bowel syndrome. *Neurosci Biobehav Rev* 36, 310–340. <https://doi.org/10.1016/j.neubiorev.2011.07.001>
- Keogh, E., Holdcroft, A., 2002. Sex differences in pain: Evolutionary links to facial pain expression. *Behavioral and Brain Sciences* 25, 465–465. <https://doi.org/10.1017/S0140525X02320089>
- Khanna, P., Yu, I., Mortensen, J., Slater, M., 2006. Presence in response to dynamic visual realism: A preliminary report of an experiment study. Presented at the Paper Presented at the 13th ACM Symposium Virtual Reality Software and Technology, VRST'06, pp. 364–367. <https://doi.org/10.1145/1180495.1180569>
- Khera, T., Rangasamy, V., 2021. Cognition and Pain: A Review. *Front Psychol* 12, 673962. <https://doi.org/10.3389/fpsyg.2021.673962>
- Khoshejad M, Roy M, Martinu M, Chen JI, Cohen-Adad J, Grondin S, Rainville P. Brain processing of the temporal dimension of acute pain in short-term memory. *Pain* 158(10):2001-2011, 2017; DOI: <https://doi.org/10.1097/j.pain.0000000000001003>
- Khoshejad M, Fortin MC, Rohani F, Duncan GH, Rainville P, 2013. Remembering the dynamic changes in pain intensity and unpleasantness: A psychophysical study. *Pain*. 155 (3), 581-590. <https://doi.org/10.1016/j.pain.2013.12.015>

- Kim, J.J., Jung, M.W., 2006. Neural circuits and mechanisms involved in Pavlovian fear conditioning: A critical review.
- Kim, J.H., Suh, S.-I., Seol, H.Y., Oh, K., Seo, W.-K., Yu, S.-W., Park, K.-W., Koh, S.-B., 2008. Regional grey matter changes in patients with migraine: a voxel-based morphometry study. *Cephalalgia* 28, 598–604. <https://doi.org/10.1111/j.1468-2982.2008.01550.x>
- Kim, K., Rosenthal, M.Z., Zielinski, D.J., Brady, R., 2014. Effects of virtual environment platforms on emotional responses. *Computer Methods and Programs in Biomedicine* 113, 882–893. <https://doi.org/10.1016/j.cmpb.2013.12.024>
- Kim, H., Nanavaty, N., Ahmed, H., Mathur, V.A., Anderson, B.A., 2021. Motivational Salience Guides Attention to Valuable and Threatening Stimuli: Evidence from Behavior and Functional Magnetic Resonance Imaging. *Journal of Cognitive Neuroscience* 33, 2440–2460. https://doi.org/10.1162/jocn_a_01769
- Kim, S.-Y., Park, H., Jung, M., Kim, K.K., 2020. Impact of Body Size Match to an Avatar on the Body Ownership Illusion and User's Subjective Experience. *Cyberpsychol Behav Soc Netw* 23, 234–241. <https://doi.org/10.1089/cyber.2019.0136>
- Kissin I, Freitas CF, Bradley Jr EL. Memory of pain: the effect of perineural resiniferatoxin. *Anesth Analg.* 103(3):721-8, 2006; DOI: <https://doi.org/10.1213/01.ane.0000230604.00934.a1>
- Kissiwaa SA, Bagley EE. Central sensitization of the spino-parabrachial-amygdala pathway that outlasts a brief nociceptive stimulus. *J Physiol.* 596(18):4457-4473, 2018; DOI: <https://doi.org/10.1113/JP273976>
- Kitayama, N., Vaccarino, V., Kutner, M., Weiss, P., Bremner, J.D., 2005. Magnetic resonance imaging (MRI) measurement of hippocampal volume in posttraumatic stress disorder: a meta-analysis. *J Affect Disord* 88, 79–86. <https://doi.org/10.1016/j.jad.2005.05.014>
- Kleim, B., Ehring, T., Ehlers, A., 2012. Perceptual processing advantages for trauma-related visual cues in post-traumatic stress disorder. *Psychol Med* 42, 173–181. <https://doi.org/10.1017/S0033291711001048>
- Klein, Z., Ginat-Frolich, R., Barry, T., Shechner, T., 2021. Effects of increased attention allocation to threat and safety stimuli on fear extinction and its recall. *Journal of Behavior Therapy and Experimental Psychiatry* 72, 101640. <https://doi.org/10.1016/j.jbtep.2021.101640>
- Klimesch W, Doppelmayr M, Hanslmayr S. Upper alpha ERD and absolute power: their meaning for memory performance. *Prog Brain Res.* 159:151-65, 2006; DOI: [https://doi.org/10.1016/S0079-6123\(06\)59010-7](https://doi.org/10.1016/S0079-6123(06)59010-7)
- Klüver, H., Bucy, P.C., 1937. “Psychic blindness” and other symptoms following bilateral temporal lobectomy in Rhesus monkeys. *American Journal of Physiology* 119, 352–353.
- Knaepen, L., Patijn, J., van Kleef, M., Mulder, M., Tibboel, D., Joosten, E.A.J., 2013. Neonatal repetitive needle pricking: plasticity of the spinal nociceptive circuit and extended postoperative pain in later life. *Dev Neurobiol* 73, 85–97. <https://doi.org/10.1002/dneu.22047>
- Koenig, S., Körfer, K., Lachnit, H., Glombiewski, J.A., 2021. An attentional perspective on differential fear conditioning in chronic pain: The informational value of safety cues. *Behaviour Research and Therapy* 144, 103917. <https://doi.org/10.1016/j.brat.2021.103917>
- Koenen, L.R., Pawlik, R.J., Icenhour, A., Petrakova, L., Forkmann, K., Theysohn, N., Engler, H., Elsenbruch, S., 2021. Associative learning and extinction of conditioned threat predictors across sensory modalities. *Commun Biol* 4, 1–17. <https://doi.org/10.1038/s42003-021-02008-1>
- Kogler, L., Müller, V.I., Seidel, E.-M., Boubela, R., Kalcher, K., Moser, E., Habel, U., Gur, R.C., Eickhoff, S.B., Derntl, B., 2016. Sex differences in the functional connectivity of the amygdalae in association with cortisol. *Neuroimage* 134, 410–423. <https://doi.org/10.1016/j.neuroimage.2016.03.064>
- Koenig, S., Körfer, K., Lachnit, H., Glombiewski, J.A., 2021. An attentional perspective on differential fear conditioning in chronic pain: The informational value of safety cues. *Behav Res Ther* 144, 103917. <https://doi.org/10.1016/j.brat.2021.103917>
- Koutantji M, Pearce SA, Oakley DA., 2000. Cognitive processes of pain-related cords and psychological adjustment in high and low pain frequency participants. *British Journal of Health Psychology*, Vol 5 Issue 3, p275-288. <https://doi.org/10.1348/135910700168919>
- Kong, J., Kaptachuk, T.J., Polich, G., Kirsch, I.V., Vangel, M., Zyloney, C., Rosen, B., Gollub, R., 2009. An fMRI study on the interaction and dissociation between expectation of pain relief and acupuncture treatment. *Neuroimage* 47, 1066–1076. <https://doi.org/10.1016/j.neuroimage.2009.05.087>

Kravitz DJ, Saleem KS, Baker C, Ungerleider LG, Mishkin M., 2013. The ventral visual pathway: an expanded neural framework for the processing of object quality. *Trends in cognitive sciences* 17. <https://doi.org/10.1016/j.tics.2012.10.011>

Kroes, M.C.W., Dunsmoor, J.E., Mackey, W.E., McClay, M., Phelps, E.A., 2017. Context conditioning in humans using commercially available immersive Virtual Reality. *Sci Rep* 7, 8640. <https://doi.org/10.1038/s41598-017-08184-7>

L

Labrenz, F., Knuf-Rtveliashvili, S., Elsenbruch, S., 2020. Sex Differences Linking Pain-Related Fear and Interoceptive Hypervigilance: Attentional Biases to Conditioned Threat and Safety Signals in a Visceral Pain Model. *Frontiers in Psychiatry* 11.

Lacagnina, A.F., Brockway, E.T., Crovetti, C.R., Shue, F., McCarty, M.J., Sattler, K.P., Lim, S.C., Santos, S.L., Denny, C.A., Drew, M.R., 2019. Distinct hippocampal engrams control extinction and relapse of fear memory. *Nat Neurosci* 22, 753–761. <https://doi.org/10.1038/s41593-019-0361-z>

Lang, S., Kroll, A., Lipinski, S.J., Wessa, M., Ridder, S., Christmann, C., Schad, L.R., Flor, H., 2009. Context conditioning and extinction in humans: differential contribution of the hippocampus, amygdala and prefrontal cortex. *Eur J Neurosci* 29, 823–832. <https://doi.org/10.1111/j.1460-9568.2009.06624.x>

Laurent, V., Westbrook, R.F., 2008. Distinct contributions of the basolateral amygdala and the medial prefrontal cortex to learning and relearning extinction of context conditioned fear. *Learn Mem* 15, 657–666. <https://doi.org/10.1101/lm.1080108>

Lenz FA, Gracely RH, Romanoski AJ, Hope EJ, Rowland LH, Dougherty PM. Stimulation in the human somatosensory thalamus can reproduce both the affective and sensory dimensions of previously experienced pain. *Nat Med.* 1(9):910-3, 1995; DOI: <https://doi.org/10.1038/nm0995-910>

LeDoux, J.E., 2000. Emotion circuits in the brain. *Annu Rev Neurosci* 23, 155–184. <https://doi.org/10.1146/annurev.neuro.23.1.155>

LeDoux, J.E., 1996. The emotional brain: The mysterious underpinnings of emotional life, *The emotional brain: The mysterious underpinnings of emotional life.* Simon & Schuster, New York, NY, US.

LeDoux, J.E., 1986. Sensory systems and emotion: A model of affective processing. *Integrative Psychiatry* 4, 237–243.

Lefebvre, J.C., Keefe, F.J., 2013. The effect of neuroticism on the recall of persistent low-back pain and perceived activity interference. *J Pain* 14, 948–956. <https://doi.org/10.1016/j.jpain.2013.03.006>

Leblanc-Sirois, Y., Chouinard-Gaouette, L., Grégoire, L., Blanchette, I., 2021. Perceptual processing of stimuli related to an analogue traumatic event: An ERP study. *Brain Cogn* 153, 105774. <https://doi.org/10.1016/j.bandc.2021.105774>

Lebron-Milad, K., Milad, M.R., 2012. Sex differences, gonadal hormones and the fear extinction network: implications for anxiety disorders. *Biol Mood Anxiety Disord* 2, 3. <https://doi.org/10.1186/2045-5380-2-3>

Levine, L.J., Safer, M.A., 2002. Sources of Bias in Memory for Emotions. *Curr Dir Psychol Sci* 11, 169–173. <https://doi.org/10.1111/1467-8721.00193>

Lim SJ, Wöstmann M, Obleser J. Selective Attention to auditory memory neutrally enhances perceptual precision. *J Neurosci.* 35(49):16094-16104, 2015; DOI: <https://doi.org/10.1523/JNEUROSCI.2674-15.2015>

Linnman, C., Rougemont-Bücking, A., Beucke, J.C., Zeffiro, T.A., Milad, M.R., 2011. Unconditioned responses and functional fear networks in human classical conditioning. *Behav Brain Res* 221, 237–245. <https://doi.org/10.1016/j.bbr.2011.02.045>

Lis, S., Thome, J., Kleindienst, N., Mueller-Engelmann, M., Steil, R., Priebe, K., Schmahl, C., Hermans, D., Bohus, M., 2020. Generalization of fear in post-traumatic stress disorder. *Psychophysiology* 57, e13422. <https://doi.org/10.1111/psyp.13422>

Likhtik, E., Popa, D., Apergis-Schoute, J., Fidacaro, G.A., Paré, D., 2008. Amygdala intercalated neurons are required for expression of fear extinction. *Nature* 454, 642–645. <https://doi.org/10.1038/nature07167>

Lindgren, L., Westling, G., Brulin, C., Lehtipalo, S., Andersson, M., Nyberg, L., 2012. Pleasant human touch is represented in pregenual anterior cingulate cortex. *Neuroimage* 59, 3427–3432. <https://doi.org/10.1016/j.neuroimage.2011.11.013>

Linton, S.J., Melin, L., Götestam, K.G., 1984. Behavioral Analysis of Chronic Pain and Its Management, in: Hersen, M., Eisler, R.M., Miller, P.M. (Eds.), *Progress in Behavior Modification.* Elsevier, pp. 1–42. <https://doi.org/10.1016/B978-0-12-535618-3.50005-7>

Lissek, S., Rabin, S., Heller, R.E., Lukenbaugh, D., Geraci, M., Pine, D.S., Grillon, C., 2010. Overgeneralization of Conditioned Fear as a Pathogenic Marker of Panic Disorder. *AJP* 167, 47–55. <https://doi.org/10.1176/appi.ajp.2009.09030410>

Lombard, M., Ditton, T., 1997. At the Heart of It All: The Concept of Presence. *Journal of Computer-Mediated Communication* 3, 0–0. <https://doi.org/10.1111/j.1083-6101.1997.tb00072.x>

Lozano-Soldevilla D. On the Physiological Modulation and Potential Mechanisms Underlying Parieto-Occipital Alpha Oscillations. *Front Comput Neurosci.* 12:23, 2018; DOI: <https://doi.org/10.3389/fncom.2018.00023>

Luchkina, N.V., Bolshakov, V.Y., 2019. Mechanisms of Fear Learning and Extinction: Synaptic Plasticity — Fear Memory Connection. *Psychopharmacology (Berl)* 236, 163–182. <https://doi.org/10.1007/s00213-018-5104-4>

M

Madden, V.J., Bellan, V., Russek, L.N., Camfferman, D., Vlaeyen, J.W.S., Moseley, G.L., 2016. Pain by Association? Experimental Modulation of Human Pain Thresholds Using Classical Conditioning. *J Pain* 17, 1105–1115. <https://doi.org/10.1016/j.jpain.2016.06.012>

Maddock, R.J., Garrett, A.S., Buonocore, M.H., 2002. Posterior cingulate cortex activation by emotional words: fMRI evidence from a valence decision task. *Hum Brain Mapp* 18, 30–41. <https://doi.org/10.1002/hbm.10075>

Maples-Keller, J.L., Yasinski, C., Manjin, N., Rothbaum, B.O., 2017. Virtual Reality-Enhanced Extinction of Phobias and Post-Traumatic Stress. *Neurotherapeutics* 14, 554–563. <https://doi.org/10.1007/s13311-017-0534-y>

Mania, K., Robinson, A., 2004. The effect of quality of rendering on user lighting impressions and presence in virtual environments. pp. 200–205. <https://doi.org/10.1145/1044588.1044629>

Marek, R., Sah, P., 2018. Neural Circuits Mediating Fear Learning and Extinction. *Adv Neurobiol* 21, 35–48. https://doi.org/10.1007/978-3-319-94593-4_2

Marek, R., Strobel, C., Bredy, T.W., Sah, P., 2013. The amygdala and medial prefrontal cortex: partners in the fear circuit. *J Physiol* 591, 2381–2391. <https://doi.org/10.1113/jphysiol.2012.248575>

Maren, S., 2005. Central and basolateral amygdala neurons crash the aversive conditioning party: Theoretical comment on Rorick-Kehn and Steinmetz (2005). *Behavioral Neuroscience* 119, 1406–1410. <https://doi.org/10.1037/0735-7044.119.5.1406>

Maren, S., 2003. The amygdala, synaptic plasticity, and fear memory. *Ann N Y Acad Sci* 985, 106–113. <https://doi.org/10.1111/j.1749-6632.2003.tb07075.x>

Maren, S., 2001. Neurobiology of Pavlovian fear conditioning. *Annu Rev Neurosci* 24, 897–931. <https://doi.org/10.1146/annurev.neuro.24.1.897>

Maren, S., Aharonov, G., Fanselow, M.S., 1997. Neurotoxic lesions of the dorsal hippocampus and Pavlovian fear conditioning in rats. *Behav Brain Res* 88, 261–274. [https://doi.org/10.1016/s0166-4328\(97\)00088-0](https://doi.org/10.1016/s0166-4328(97)00088-0)

Maren, S., Phan, K.L., Liberzon, I., 2013. The contextual brain: Implications for fear conditioning, extinction and psychopathology. *Nature reviews. Neuroscience* 14, 417–428. <https://doi.org/10.1038/nrn3492>

Maren, S., Quirk, G.J., 2004. Neuronal signalling of fear memory. *Nat Rev Neurosci* 5, 844–852. <https://doi.org/10.1038/nrn1535>

Marschner, A., Kalisch, R., Vervliet, B., Vansteenwegen, D., Büchel, C., 2008. Dissociable Roles for the Hippocampus and the Amygdala in Human Cued versus Context Fear Conditioning. *J. Neurosci.* 28, 9030–9036. <https://doi.org/10.1523/JNEUROSCI.1651-08.2008>

Mazza, S., Frot, M., Rey, A.E., 2018. A comprehensive literature review of chronic pain and memory. *Prog Neuropsychopharmacol Biol Psychiatry* 87, 183–192. <https://doi.org/10.1016/j.pnpbp.2017.08.006>

Mazza, M., Catalucci, A., Mariano, M., Pino, M.C., Tripaldi, S., Roncone, R., Gallucci, M., 2012. Neural correlates of automatic perceptual sensitivity to facial affect in posttraumatic stress disorder subjects who survived L’Aquila earthquake of April 6, 2009. *Brain Imaging and Behavior* 6, 374–386. <https://doi.org/10.1007/s11682-012-9151-x>

Mazzola, L., Faillenot, I., Barral, F.-G., Mauguière, F., Peyron, R., 2012. Spatial segregation of somato-sensory and pain activations in the human operculo-insular cortex. *Neuroimage* 60, 409–418. <https://doi.org/10.1016/j.neuroimage.2011.12.072>

- McCarberg, B., Peppin, J., 2019a. Pain Pathways and Nervous System Plasticity: Learning and Memory in Pain. *Pain Med* 20, 2421–2437. <https://doi.org/10.1093/pm/pnz017>
- McEchron, M.D., McCabe, P.M., Green, E.J., Llabre, M.M., Schneiderman, N., 1995. Simultaneous single unit recording in the medial nucleus of the medial geniculate nucleus and amygdaloid central nucleus throughout habituation, acquisition, and extinction of the rabbit's classically conditioned heart rate. *Brain Res* 682, 157–166. [https://doi.org/10.1016/0006-8993\(95\)00331-j](https://doi.org/10.1016/0006-8993(95)00331-j)
- McHugh, T.J., Jones, M.W., Quinn, J.J., Balthasar, N., Coppari, R., Elmquist, J.K., Lowell, B.B., Fanselow, M.S., Wilson, M.A., Tonegawa, S., 2007. Dentate gyrus NMDA receptors mediate rapid pattern separation in the hippocampal network. *Science* 317, 94–99. <https://doi.org/10.1126/science.1140263>
- McNeil, D.W., Helfer, A.J., Weaver, B.D., Graves, R.W., Kyle, B.N., Davis, A.M., 2011. Memory of pain and anxiety associated with tooth extraction. *J Dent Res* 90, 220–224. <https://doi.org/10.1177/0022034510385689>
- Merz, C.J., Tabbert, K., Schweckendiek, J., Klucken, T., Vaitl, D., Stark, R., Wolf, O.T., 2010. Investigating the impact of sex and cortisol on implicit fear conditioning with fMRI. *Psychoneuroendocrinology* 35, 33–46. <https://doi.org/10.1016/j.psyneuen.2009.07.009>
- Merz, C.J., Wolf, O.T., Schweckendiek, J., Klucken, T., Vaitl, D., Stark, R., 2013. Stress differentially affects fear conditioning in men and women. *Psychoneuroendocrinology* 38, 2529–2541. <https://doi.org/10.1016/j.psyneuen.2013.05.015>
- Meulders, A., Vansteenwegen, D., Vlaeyen, J.W.S., 2011. The acquisition of fear of movement-related pain and associative learning: a novel pain-relevant human fear conditioning paradigm. *Pain* 152, 2460–2469. <https://doi.org/10.1016/j.pain.2011.05.015>
- Meulders, A., Vlaeyen, J.W.S., 2013. Mere intention to perform painful movements elicits fear of movement-related pain: an experimental study on fear acquisition beyond actual movements. *J Pain* 14, 412–423. <https://doi.org/10.1016/j.jpain.2012.12.014>
- Meulders, A., Vlaeyen, J.W.S., 2012. Reduction of fear of movement-related pain and pain-related anxiety: An associative learning approach using a voluntary movement paradigm. *Pain* 153, 1504–1513. <https://doi.org/10.1016/j.pain.2012.04.013>
- Meulders, A., Vandael, K., Vlaeyen, J.W.S., 2017. Generalization of Pain-Related Fear Based on Conceptual Knowledge. *Behavior Therapy* 48, 295–310. <https://doi.org/10.1016/j.beth.2016.11.014>
- Meulders, A., 2020. Fear in the context of pain: Lessons learned from 100 years of fear conditioning research. *Behaviour Research and Therapy* 131, 103635. <https://doi.org/10.1016/j.brat.2020.103635>
- Meulders, A., Bennett, M.P., 2018. The Concept of Contexts in Pain: Generalization of Contextual Pain-Related Fear Within a de Novo Category of Unique Contexts. *J Pain* 19, 76–87. <https://doi.org/10.1016/j.jpain.2017.09.003>
- Meulders, A., Meulders, M., Stouten, I., De Bie, J., Vlaeyen, J.W.S., 2017. Extinction of Fear Generalization: A Comparison Between Fibromyalgia Patients and Healthy Control Participants. *J Pain* 18, 79–95. <https://doi.org/10.1016/j.jpain.2016.10.004>
- Michalska, K.J., Machlin, L., Moroney, E., Lowet, D.S., Hettema, J.M., Roberson-Nay, R., Averbach, B.B., Brotman, M.A., Nelson, E.E., Leibenluft, E., Pine, D.S., 2017. Anxiety symptoms and children's eye gaze during fear learning. *J Child Psychol Psychiatry* 58, 1276–1286. <https://doi.org/10.1111/jcpp.12749>
- Michael, T., Halligan, S.L., Clark, D.M., Ehlers, A., 2007. Rumination in posttraumatic stress disorder. *Depress. Anxiety* 24, 307–317. <https://doi.org/10.1002/da.20228>
- Milad, M.R., Quirk, G.J., 2002. Neurons in medial prefrontal cortex signal memory for fear extinction. *Nature* 420, 70–74. <https://doi.org/10.1038/nature01138>
- Milad, M., Orr, S., Roger, P., Rauch, S., 2005. Context modulation of memory for fear extinction in humans. *Psychophysiology* 42, 456–64. <https://doi.org/10.1111/j.1469-8986.2005.00302.x>
- Millan, M.J., 1999. The induction of pain: an integrative review. *Prog Neurobiol* 57, 1–164. [https://doi.org/10.1016/s0301-0082\(98\)00048-3](https://doi.org/10.1016/s0301-0082(98)00048-3)
- Michael, T., Ehlers, A., 2007. Enhanced perceptual priming for neutral stimuli occurring in a traumatic context: Two experimental investigations. *Behaviour Research and Therapy* 45, 341–358. <https://doi.org/10.1016/j.brat.2006.03.012>

- Mogil, J.S., 2012. Sex differences in pain and pain inhibition: multiple explanations of a controversial phenomenon. *Nat Rev Neurosci* 13, 859–866. <https://doi.org/10.1038/nrn3360>
- Motraghi, T.E., Seim, R.W., Meyer, E.C., Morissette, S.B., 2014. Virtual reality exposure therapy for the treatment of posttraumatic stress disorder: a methodological review using CONSORT guidelines. *J Clin Psychol* 70, 197–208. <https://doi.org/10.1002/jclp.22051>
- Moriarty O, McGuire BE, Finn DP. The effect of pain on cognitive function: A review of clinical and preclinical research. *Progress in Neurobiology*, 93(3), 385-404, 2011; DOI: <https://doi.org/10.1016/j.pneurobio.2011.01.002>
- Morris, L.D., Louw, Q.A., Grimmer-Somers, K., 2009. The effectiveness of virtual reality on reducing pain and anxiety in burn injury patients: a systematic review. *Clin J Pain* 25, 815–826. <https://doi.org/10.1097/AJP.0b013e3181aaa909>
- Moseley, G.L., Vlaeyen, J.W.S., 2015. Beyond nociception: the imprecision hypothesis of chronic pain. *Pain* 156, 35–38. <https://doi.org/10.1016/j.pain.0000000000000014>
- Munoz M, Esteve R. Reports of memory functioning by patients with chronic pain. *Clinical Journal of Pain*, 21(4), 287-291, 2005; DOI: <https://doi.org/10.1097/01.ajp.0000173993.53733.2e>
- Mühlberger, A., Andreatta, M., Ewald, H., Glotzbach-Schoon, E., Tröger, C., Baumann, C., Reif, A., Deckert, J., Pauli, P., 2014. The BDNF Val66Met Polymorphism Modulates the Generalization of Cued Fear Responses to a Novel Context. *Neuropsychopharmacol* 39, 1187–1195. <https://doi.org/10.1038/npp.2013.320>
- Mutso, A.A., Radzicki, D., Baliki, M.N., Huang, L., Banisadr, G., Centeno, M.V., Radulovic, J., Martina, M., Miller, R.J., Apkarian, A.V., 2012. Abnormalities in hippocampal functioning with persistent pain. *J Neurosci* 32, 5747–5756. <https://doi.org/10.1523/JNEUROSCI.0587-12.2012>
- Mutso, A.A., Petre, B., Huang, L., Baliki, M.N., Torbey, S., Herrmann, K.M., Schnitzer, T.J., Apkarian, A.V., 2014. Reorganization of hippocampal functional connectivity with transition to chronic back pain. *J Neurophysiol* 111, 1065–1076. <https://doi.org/10.1152/jn.00611.2013>
- Myers, K.M., Davis, M., 2007. Mechanisms of fear extinction. *Mol Psychiatry* 12, 120–150. <https://doi.org/10.1038/sj.mp.4001939>
- N**
- Nadel, L., Hardt, O., 2011. Update on memory systems and processes. *Neuropsychopharmacology* 36, 251–273. <https://doi.org/10.1038/npp.2010.169>
- Neueder, D., Andreatta, M., Pauli, P., 2019. Contextual Fear Conditioning and Fear Generalization in Individuals With Panic Attacks. *Frontiers in Behavioral Neuroscience* 13.
- Neugebauer, V., 2015. Amygdala Pain Mechanisms, in: Schaible, H.-G. (Ed.), *Pain Control, Handbook of Experimental Pharmacology*. Springer, Berlin, Heidelberg, pp. 261–284. https://doi.org/10.1007/978-3-662-46450-2_13
- Neugebauer, V., Li, W., Bird, G.C., Bhave, G., Gereau, R.W., 2003. Synaptic Plasticity in the Amygdala in a Model of Arthritic Pain: Differential Roles of Metabotropic Glutamate Receptors 1 and 5. *J. Neurosci.* 23, 52–63. <https://doi.org/10.1523/JNEUROSCI.23-01-00052.2003>
- Neugebauer, V., Galhardo, V., Maione, S., Mackey, S.C., 2009. Forebrain Pain Mechanisms. *Brain Res Rev* 60, 226–242. <https://doi.org/10.1016/j.brainresrev.2008.12.014>
- Ney, L.J., Wade, M., Reynolds, A., Zuj, D.V., Dymond, S., Matthews, A., Felmingham, K.L., 2018. Critical evaluation of current data analysis strategies for psychophysiological measures of fear conditioning and extinction in humans. *Int J Psychophysiol* 134, 95–107. <https://doi.org/10.1016/j.ijpsycho.2018.10.010>
- Nichols TE, Holmes AP. Nonparametric permutation tests for functional neuroimaging: A primer with examples. *Human Brain Mapping*, 15(1):1-25,2002; DOI: <https://doi.org/10.1002/hbm.1058>
- Niven, C.A., Murphy-Black, T., 2000. Memory for Labor Pain: A Review of the Literature. *Birth* 27, 244–253. <https://doi.org/10.1046/j.1523-536x.2000.00244.x>
- Nunez PL, Srinivasan R. Scale and frequency chauvinism in brain dynamics: too much emphasis on γ band oscillations. *Brain Struct Funct*. 215(2):67-71,2010 DOI: <https://doi.org/10.1007/s00429-010-0277-6>.

O

Oehlberg, K., Mineka, S., 2011. Fear Conditioning and Attention to Threat: An Integrative Approach to Understanding the Etiology of Anxiety Disorders. *Associative Learning and Conditioning Theory: Human and Non-human Applications* 44–78. <https://doi.org/10.1093/acprof:oso/9780199735969.003.0020>

Ojala, K.E., Bach, D.R., 2020. Measuring learning in human classical threat conditioning: Translational, cognitive and methodological considerations. *Neuroscience and Biobehavioral Reviews* 114, 96–112. <https://doi.org/10.1016/j.neubiorev.2020.04.019>

O'Keefe, J., 1976. Place units in the hippocampus of the freely moving rat. *Exp Neurol* 51, 78–109. [https://doi.org/10.1016/0014-4886\(76\)90055-8](https://doi.org/10.1016/0014-4886(76)90055-8)

Oosterman JM, Derksen LC, van Wijck AJ, Veldhuijzen DS, Kessels RP. Memory functions in chronic pain: examining contributions of attention and age to test performance. *Clinical Journal of Pain*, 27(1), 70-75, 2011; DOI: <https://doi.org/10.1097/AJP.0b013e3181f15cf5>

Orsini, C.A., Maren, S., 2012. Neural and cellular mechanisms of fear and extinction memory formation. *Neurosci Biobehav Rev* 36, 1773–1802. <https://doi.org/10.1016/j.neubiorev.2011.12.014>

Osborne, N.R., Davis, K.D., 2022. Chapter Eight - Sex and gender differences in pain, in: Moro, E., Arabia, G., Tartaglia, M.C., Ferretti, M.T. (Eds.), *International Review of Neurobiology, Sex and Gender Differences in Neurological Disease*. Academic Press, pp. 277–307. <https://doi.org/10.1016/bs.irn.2022.06.013>

P

Palva S, Palva JM. New vistas for alpha-frequency band oscillations. *Trends Neurosci*. 30(4):150-8, 2007; DOI: <https://doi.org/10.1016/j.tins.2007.02.001>

Palermo S, Benedetti F, Costa T, Amanzio M. Pain anticipation: an activation likelihood estimation meta-analysis of brain imaging studies. *Hum Brain Mapp*. 36(5):1648-61, 2015; DOI: <https://doi.org/10.1002/hbm.22727>

Park H, Lee DS, Kang E, Kang H, Hahn J, Kim JS, Chung CK, Jensen O. Blocking of irrelevant memories by posterior alpha activity boosts memory encoding. *Hum Brain Mapp*. 35(8):3972-87, 2014; DOI: <https://doi.org/10.1002/hbm.22452>

Pavlov, I.P., 1927. *Conditioned reflexes: an investigation of the physiological activity of the cerebral cortex*. Oxford Univ. Press, Oxford, England.

Peyron, R., Laurent, B., García-Larrea, L., 2000. Functional imaging of brain responses to pain. A review and meta-analysis (2000). *Neurophysiol Clin* 30, 263–288. [https://doi.org/10.1016/s0987-7053\(00\)00227-6](https://doi.org/10.1016/s0987-7053(00)00227-6)

Peyron, R. (2007). *Physiologie de la douleur*. EMC Neurol 17–003.

Peyron R, García-Larrea L, Grégoire MC, Convers P, Lavenne F, Veyre L, et al. Allodynia after lateral -medullary (Wallenberg) infarct. A PET study. *Brain* 1998; 121: 345–56.

Piantoni G, Romejin N, Gomez-Herrero G, Van Der Werf YD, Van Someren EJW. Alpha power predicts persistence of bistable perception. *Sci. Rep* 7(1):5208, 2017; DOI: <https://doi.org/10.1038/s41598-017-05610-8>

Pitkänen, A., Savander, V., LeDoux, J.E., 1997. Organization of intra-amygdaloid circuitries in the rat: an emerging framework for understanding functions of the amygdala. *Trends Neurosci* 20, 517–523. [https://doi.org/10.1016/s0166-2236\(97\)01125-9](https://doi.org/10.1016/s0166-2236(97)01125-9)

Ploghaus, A., Tracey, I., Gati, J.S., Clare, S., Menon, R.S., Matthews, P.M., Rawlins, J.N., 1999. Dissociating pain from its anticipation in the human brain. *Science* 284, 1979–1981. <https://doi.org/10.1126/science.284.5422.1979>

Porro, C.A., Baraldi, P., Pagnoni, G., Serafini, M., Facchin, P., Maieron, M., Nichelli, P., 2002. Does anticipation of pain affect cortical nociceptive systems? *J Neurosci* 22, 3206–3214. <https://doi.org/20026310>

Q

R

Radulovic, J., Tronson, N.C., 2010. Molecular specificity of multiple hippocampal processes governing fear extinction. *Reviews in the Neurosciences* 21, 1–17. <https://doi.org/10.1515/REVNEURO.2010.21.1.1>

- Ramanathan, K.R., Jin, J., Giustino, T.F., Payne, M.R., Maren, S., 2018. Prefrontal projections to the thalamic nucleus reuniens mediate fear extinction. *Nat Commun* 9, 4527. <https://doi.org/10.1038/s41467-018-06970-z>
- Rainville P, Doucet JC, Fortin MC, Duncan GH. Rapid deterioration of pain sensory discriminative information in short-term memory. *Pain* 110 (3), 605-615, 2005; DOI: <https://doi.org/10.1016/j.pain.2004.04.024>
- Reiss, S., Peterson, R.A., Gursky, D.M., McNally, R.J., 1986. Anxiety sensitivity, anxiety frequency and the prediction of fearfulness. *Behav Res Ther* 24, 1–8. [https://doi.org/10.1016/0005-7967\(86\)90143-9](https://doi.org/10.1016/0005-7967(86)90143-9)
- Reichenberger, J., Pfaller, M., Mühlberger, A., 2020. Gaze Behavior in Social Fear Conditioning: An Eye-Tracking Study in Virtual Reality. *Frontiers in Psychology* 11.
- Rescorla, R., Wagner, A., 1972. A theory of Pavlovian conditioning: The effectiveness of reinforcement and non-reinforcement. *Classical Conditioning: Current Research and Theory*.
- Rescorla, R.A., 2004. Spontaneous recovery. *Learning & Memory* 11, 501–509. <https://doi.org/10.1101/lm.77504>
- Rescorla, R.A., 1968. Probability of shock in the presence and absence of cs in fear conditioning. *Journal of Comparative and Physiological Psychology* 66, 1–5. <https://doi.org/10.1037/h0025984>
- Rhudy, J.L., Williams, A.E., 2005. Gender differences in pain: Do emotions play a role? *Gender Medicine* 2, 208–226. [https://doi.org/10.1016/S1550-8579\(05\)80051-8](https://doi.org/10.1016/S1550-8579(05)80051-8)
- Richards, J.C., Austin, D.W., Alvarenga, M.E., 2001. Interpretation of Ambiguous Interoceptive Stimuli in Panic Disorder and Nonclinical Panic. *Cognitive Therapy and Research* 25, 235–246. <https://doi.org/10.1023/A:1010783427196>
- Richter-Levin, G., 2004. The amygdala, the hippocampus, and emotional modulation of memory. *Neuroscientist* 10, 31–39. <https://doi.org/10.1177/1073858403259955>
- Richter-Levin, G., Akirav, I., 2000. Amygdala-hippocampus dynamic interaction in relation to memory. *Mol Neurobiol* 22, 11–20. <https://doi.org/10.1385/MN:22:1-3:011>
- Riva, G., 2005. Virtual reality in psychotherapy: review. *Cyberpsychol Behav* 8, 220–230; discussion 231-240. <https://doi.org/10.1089/cpb.2005.8.220>
- Rizzo, A., Buckwalter, J.G., John, B., Newman, B., Parsons, T., Kenny, P., Williams, J., 2012. STRIVE: Stress Resilience In Virtual Environments: a pre-deployment VR system for training emotional coping skills and assessing chronic and acute stress responses. *Stud Health Technol Inform* 173, 379–385.
- Robinson, E., 1963. EFFECT OF AMYGDALECTOMY ON FEAR-MOTIVATED BEHAVIOR IN RATS. *J Comp Physiol Psychol* 56, 814–820. <https://doi.org/10.1037/h0045711>
- Robinson, M.E., Riley, J.L., Myers, C.D., Papas, R.K., Wise, E.A., Waxenberg, L.B., Fillingim, R.B., 2001. Gender role expectations of pain: relationship to sex differences in pain. *J Pain* 2, 251–257. <https://doi.org/10.1054/jpai.2001.24551>
- Rocha, E.M., Marche, T.A., von Baeyer, C.L., 2009. Anxiety influences children’s memory for procedural pain. *Pain Research & Management* 14, 233–237. <https://doi.org/10.1155/2009/535941>
- Roche, P.A., Gijsbers, K., 1986. A comparison of memory for induced ischaemic pain and chronic rheumatoid pain. *Pain* 25, 337–343. [https://doi.org/10.1016/0304-3959\(86\)90237-X](https://doi.org/10.1016/0304-3959(86)90237-X)
- Rossettini, G., Carlino, E., Testa, M., 2018. Clinical relevance of contextual factors as triggers of placebo and nocebo effects in musculoskeletal pain. *BMC Musculoskelet Disord* 19, 27. <https://doi.org/10.1186/s12891-018-1943-8>
- Rudrauf, D., David, O., Lachaux, J.-P., Kovach, C.K., Martinerie, J., Renault, B., Damasio, A., 2008. Rapid interactions between the ventral visual stream and emotion-related structures rely on a two-pathway architecture. *J Neurosci* 28, 2793–2803. <https://doi.org/10.1523/JNEUROSCI.3476-07.2008>
- Rudy, J.W., O’Reilly, R.C., 1999. Contextual fear conditioning, conjunctive representations, pattern completion, and the hippocampus. *Behavioral Neuroscience* 113, 867–880. <https://doi.org/10.1037/0735-7044.113.5.867>
- Ruusuvirta T., Wikgren J., Astikainen, P. Proactive interference in a two-tone pitch-comparison task without additional interfering tones. *Psychol Res.*, 72(1):74 -8, 2006. DOI: <https://doi.org/10.1007/s00426-006-0094-y>

S

- Salovey, P., Smith, A.F., 1997. Memory for the Experience of Physical Pain, in: Memory for Everyday and Emotional Events. Routledge.
- Sanchez-Vives, M.V., Slater, M., 2005. From presence to consciousness through virtual reality. *Nat Rev Neurosci* 6, 332–339. <https://doi.org/10.1038/nrn1651>
- Sanders, H., Rennó-Costa, C., Idiart, M., Lisman, J., 2015. Grid Cells and Place Cells: An Integrated View of their Navigational and Memory Function. *Trends Neurosci* 38, 763–775. <https://doi.org/10.1016/j.tins.2015.10.004>
- Sanders, M.J., Wiltgen, B.J., Fanselow, M.S., 2003. The place of the hippocampus in fear conditioning. *Eur J Pharmacol* 463, 217–223. [https://doi.org/10.1016/s0014-2999\(03\)01283-4](https://doi.org/10.1016/s0014-2999(03)01283-4)
- Sawamoto, N., Honda, M., Okada, T., Hanakawa, T., Kanda, M., Fukuyama, H., Konishi, J., Shibasaki, H., 2000. Expectation of pain enhances responses to nonpainful somatosensory stimulation in the anterior cingulate cortex and parietal operculum/posterior insula: an event-related functional magnetic resonance imaging study. *J Neurosci* 20, 7438–7445.
- Schafe, G.E., Nader, K., Blair, H.T., LeDoux, J.E., 2001. Memory consolidation of Pavlovian fear conditioning: a cellular and molecular perspective. *Trends Neurosci* 24, 540–546. [https://doi.org/10.1016/s0166-2236\(00\)01969-x](https://doi.org/10.1016/s0166-2236(00)01969-x)
- Scher, C.D., Ingram, R.E., Segal, Z.V., 2005. Cognitive reactivity and vulnerability: Empirical evaluation of construct activation and cognitive diatheses in unipolar depression. *Clinical Psychology Review* 25, 487–510. <https://doi.org/10.1016/j.cpr.2005.01.005>
- Schroeder SCY, Ball F, Busch NA. The role of alpha oscillations in distractor inhibition during memory retention. *Eur J Neurosci*. 48(7):2516-2526, 2018; DOI: <https://doi.org/10.1111/ejn.13852>
- Schoth, D.E., Nunes, V.D., Liossi, C., 2012. Attentional bias towards pain-related information in chronic pain; a meta-analysis of visual-probe investigations. *Clin Psychol Rev* 32, 13–25. <https://doi.org/10.1016/j.cpr.2011.09.004>
- Schroyens, N., Sigwald, E.L., Van Den Noortgate, W., Beckers, T., Luyten, L., 2021. Reactivation-Dependent Amnesia for Contextual Fear Memories: Evidence for Publication Bias. *eNeuro* 8, ENEURO.0108-20.2020. <https://doi.org/10.1523/ENEURO.0108-20.2020>
- Schultz, D.H., Balderston, N.L., Geiger, J.A., Helmstetter, F.J., 2013. Dissociation between implicit and explicit responses in postconditioning UCS revaluation after fear conditioning in humans. *Behav Neurosci* 127, 357–368. <https://doi.org/10.1037/a0032742>
- Seth, A., Suzuki, K., Critchley, H., 2012. An Interoceptive Predictive Coding Model of Conscious Presence. *Frontiers in Psychology* 2.
- Sghirripa S, Graetz L, Merkin A, Rogasch NC, Ridding MC, Semmler JG, Goldsworthy MR. The role of alpha power in the suppression of anticipated distractors during verbal working memory. *Brain Topogr*. 34(1): 102-109, 2021; DOI: <https://doi.org/10.1007/s10548-020-00810-4>.
- Shah-Basak PP, Chen P, Caulfield K, Medina J, Hamilton RH. The role of the right superior temporal gyrus in stimulus-centered spatial processing. *Neuropsychologia*, 113:6-13, 2018; DOI: <https://doi.org/10.1016/j.neuropsychologia.2018.03.027>
- Singewald, N., Schmuckermair, C., Whittle, N., Holmes, A., Ressler, K.J., 2015. Pharmacology of cognitive enhancers for exposure-based therapy of fear, anxiety and trauma-related disorders. *Pharmacol Ther* 149, 150–190. <https://doi.org/10.1016/j.pharmthera.2014.12.004>
- Sisk, A.L., Grover, B., Steflik, D.E., 1991. Long-term memory of acute postsurgical pain. *J Oral Maxillofac Surg* 49, 353–358; discussion 358-359. [https://doi.org/10.1016/0278-2391\(91\)90369-w](https://doi.org/10.1016/0278-2391(91)90369-w)
- Sjouwerman, R., Niehaus, J., Lonsdorf, T.B., 2015. Contextual Change After Fear Acquisition Affects Conditioned Responding and the Time Course of Extinction Learning—Implications for Renewal Research. *Frontiers in Behavioral Neuroscience* 9.
- Slater, M., 2009. Place illusion and plausibility can lead to realistic behaviour in immersive virtual environments. *Philos Trans R Soc Lond B Biol Sci* 364, 3549–3557. <https://doi.org/10.1098/rstb.2009.0138>
- Slater, M., Khanna, P., Mortensen, J., Yu, I., 2009. Visual Realism Enhances Realistic Response in an Immersive Virtual Environment. *IEEE computer graphics and applications* 29, 76–84. <https://doi.org/10.1109/MCG.2009.55>

- Slater, M., Usoh, M., Steed, A., 1995. Taking steps: The influence of a walking technique on presence in virtual reality. *ACM Transactions on Computer-Human Interaction (TOCHI)* 2, 201–219. <https://doi.org/10.1145/210079.210084>
- Spence, K.W., 1936. The nature of discrimination learning in animals. *Psychological Review* 43, 427–449. <https://doi.org/10.1037/h0056975>
- Spielberger, C. D., Gorsuch, R. L., Lushene, R., Vagg, P. R., & Jacobs, G. A. (1983). *Manual for the State-Trait Anxiety Inventory*. Palo Alto, CA: Consulting Psychologists Press.
- Steed, A., Pan, Y., Watson, Z., Slater, M., 2018. “We Wait”—The Impact of Character Responsiveness and Self Embodiment on Presence and Interest in an Immersive News Experience. *Frontiers in Robotics and AI* 5.
- Stiedl, O., Spiess, J., 1997. Effect of tone-dependent fear conditioning on heart rate and behavior of C57BL/6N mice. *Behav Neurosci* 111, 703–711. <https://doi.org/10.1037//0735-7044.111.4.703>
- Steiger, F., Nees, F., Wicking, M., Lang, S., Flor, H., 2015. Behavioral and central correlates of contextual fear learning and contextual modulation of cued fear in posttraumatic stress disorder. *International Journal of Psychophysiology, Fear Learning, Fear Memory and Psychopathology* 98, 584–593. <https://doi.org/10.1016/j.ijpsycho.2015.06.009>
- Strube A, Rose M, Fazeli S, Büchel C, 2021. Alpha-to-beta- and gamma-band activity reflect predictive coding in affective visual processing. *Sci Rep*. 11(1):23492. <http://doi.org/10.1038/s41598-021-02939-z>
- Sullivan, M., Tripp, D., Santor, D., 2000. Gender Differences in Pain and Pain Behavior: The Role of Catastrophizing. *Cognitive Therapy and Research* 24. <https://doi.org/10.1023/A:1005459110063>
- Sundar, S.S., Xu, Q., Bellur, S., 2010. Designing interactivity in media interfaces: A communications perspective. Presented at the Proceedings of the Conference on Human Factors in Computing Systems, pp. 2247–2256. <https://doi.org/10.1145/1753326.1753666>
- Sutherland, 1965. *The Ultimate Display. Multimedia: From Wagner to Virtual Reality*. New York, NY: Norton
- Sugimine, S., Saito, S., Takazawa, T., 2020. Normalized skin conductance level could differentiate physical pain stimuli from other sympathetic stimuli. *Sci Rep* 10, 10950. <https://doi.org/10.1038/s41598-020-67936-0>
- Syrjala, E., Jiang, M., Pahikkala, T., Salanterä, S., Liljeberg, P., 2019. Skin Conductance Response to Gradual-Increasing Experimental Pain. *Annu Int Conf IEEE Eng Med Biol Soc* 2019, 3482–3485. <https://doi.org/10.1109/EMBC.2019.8857776>
- ## T
- Tejera, D.M., Beltran-Alacreu, H., Cano-de-la-Cuerda, R., Leon Hernández, J.V., Martín-Pintado-Zugasti, A., Calvo-Lobo, C., Gil-Martínez, A., Fernández-Carnero, J., 2020. Effects of Virtual Reality versus Exercise on Pain, Functional, Somatosensory and Psychosocial Outcomes in Patients with Non-specific Chronic Neck Pain: A Randomized Clinical Trial. *Int J Environ Res Public Health* 17, E5950. <https://doi.org/10.3390/ijerph17165950>
- Thiel CM, Fink GR. Visual and auditory alertness: modality-specific and supramodal neural mechanisms and their modulation by nicotine. *J Neurophysiol*. 97(4):2758-68, 2007; DOI: <https://doi.org/10.1152/jn.00017>.
- Thome, J., Hauschild, S., Koppe, G., Liebke, L., Rausch, S., Herzog, J.I., Müller-Engelmann, M., Steil, R., Priebe, K., Hermans, D., Schmahl, C., Bohus, M., Lis, S., 2018. Generalisation of fear in PTSD related to prolonged childhood maltreatment: an experimental study. *Psychological Medicine* 48, 2223–2234. <https://doi.org/10.1017/S0033291717003713>
- Thomtén, J., Lundahl, R., Stigenberg, K., Linton, S., 2014. Fear Avoidance and Pain Catastrophizing among Women with Sexual Pain. *Womens Health (Lond Engl)* 10, 571–581. <https://doi.org/10.2217/WHE.14.51>
- Timmers, I., Quaedflieg, C.W.E.M., Hsu, C., Heathcote, L.C., Rovnaghi, C.R., Simons, L.E., 2019. The interaction between stress and chronic pain through the lens of threat learning. *Neurosci Biobehav Rev* 107, 641–655. <https://doi.org/10.1016/j.neubiorev.2019.10.007>
- Treede, R.-D., Rief, W., Barke, A., Aziz, Q., Bennett, M.I., Benoliel, R., Cohen, M., Evers, S., Finnerup, N.B., First, M.B., Giamberardino, M.A., Kaasa, S., Korwisi, B., Kosek, E., Lavand’homme, P., Nicholas, M., Perrot, S., Scholz, J., Schug, S., Smith, B.H., Svensson, P., Vlaeyen, J.W.S., Wang, S.-J., 2019. Chronic pain as a symptom or a disease: the IASP Classification of Chronic Pain for the International Classification of Diseases (ICD-11). *Pain* 160, 19–27. <https://doi.org/10.1097/j.pain.0000000000001384>
- Triberti, S., Repetto, C., Riva, G., 2014. Psychological factors influencing the effectiveness of virtual reality-based analgesia: a systematic review. *Cyberpsychol Behav Soc Netw* 17, 335–345. <https://doi.org/10.1089/cyber.2014.0054>

Tröger, C., Ewald, H., Glotzbach, E., Pauli, P., Mühlberger, A., 2012. Does pre-exposure inhibit fear context conditioning? A Virtual Reality Study. *J Neural Transm* 119, 709–719. <https://doi.org/10.1007/s00702-011-0757-8>

Tuladhar AM., Huurne N., Schoffelen JM., Maris E., Oostenveld R., and Jensen O. Parieto-Occipital Sources Account for the Increase in Alpha activity with working memory load. *Hum Brain Mapp.* 28 :785-78, 2007 ; DOI : <https://doi.org/10.1002/hbm.20306>

Tzovara, A., Korn, C.W., Bach, D.R., 2018. Human Pavlovian fear conditioning conforms to probabilistic learning. *PLOS Computational Biology* 14, e1006243. <https://doi.org/10.1371/journal.pcbi.1006243>

U

Umeda, M., Kim, Y., 2019. Gender Differences in the Prevalence of Chronic Pain and Leisure Time Physical Activity Among US Adults: A NHANES Study. *International Journal of Environmental Research and Public Health* 16, 988. <https://doi.org/10.3390/ijerph16060988>

Unruh, A.M., 1996a. Gender variations in clinical pain experience. *Pain* 65, 123–167. [https://doi.org/10.1016/0304-3959\(95\)00214-6](https://doi.org/10.1016/0304-3959(95)00214-6)

Upadhyay, J., Granitzka, J., Bauermann, T., Baumgärtner, U., Breimhorst, M., Treede, R.-D., Birklein, F., 2016. Detection of central circuits implicated in the formation of novel pain memories. *J Pain Res* 9, 671–681. <https://doi.org/10.2147/JPR.S113436>

V

Van Ryckeghem, D.M.L., Crombez, G., Goubert, L., De Houwer, J., Onraedt, T., Van Damme, S., 2013. The predictive value of attentional bias towards pain-related information in chronic pain patients: a diary study. *Pain* 154, 468–475. <https://doi.org/10.1016/j.pain.2012.12.008>

Vansteenwegen, D., Iberico, C., Vervliet, B., Marescau, V., Hermans, D., 2008. Contextual fear induced by unpredictability in a human fear conditioning preparation is related to the chronic expectation of a threatening US. *Biological Psychology* 77, 39–46. <https://doi.org/10.1016/j.biopsycho.2007.08.012>

Valentini E, Nicolardi V, Aglioti SM. Painful engrams: Oscillatory correlates of working memory for phasic nociceptive laser stimuli. *Brain Cogn.* 115:21-32, 2017; DOI: <https://doi.org/10.1016/j.bandc.2017.03.009>

Vervliet, B., Vansteenwegen, D., Eelen, P., 2004. Generalization of Extinguished Skin Conductance Responding in Human Fear Conditioning. *Learn. Mem.* 11, 555–558. <https://doi.org/10.1101/lm.77404>

Visscher KM, Kahana MJ, Sekuler R., 2009. Trial-to-trial Carryover in Auditory Short-term Memory. *J Exp Psychol Learn Mem Cogn* 35(1):46-56. <https://doi.org/10.1037/a0013412>.

Vlaeyen, J.W.S., 2015. Learning to predict and control harmful events: chronic pain and conditioning. *Pain* 156, S86–S93. <https://doi.org/10.1097/j.pain.000000000000107>

Vlaeyen, J.W.S., Linton, S.J., 2012. Fear-avoidance model of chronic musculoskeletal pain: 12 years on. *Pain* 153, 1144–1147. <https://doi.org/10.1016/j.pain.2011.12.009>

Vlaeyen, J.W.S., Morley, S., Linton, S.J., Boersma, K., de Jong, J., 2012. Pain-related fear: Exposure-based treatment of chronic pain. IASP Press, Seattle, WA, US.

Vlaeyen, J.W.S., Linton, S.J., 2000. Fear-avoidance and its consequences in chronic musculoskeletal pain: a state of the art. *Pain* 85, 317–332. [https://doi.org/10.1016/S0304-3959\(99\)00242-0](https://doi.org/10.1016/S0304-3959(99)00242-0)

W

Wager, T.D., Atlas, L.Y., 2015. The neuroscience of placebo effects: connecting context, learning and health. *Nat Rev Neurosci* 16, 403–418. <https://doi.org/10.1038/nrn3976>

Wager, T.D., Rilling, J.K., Smith, E.E., Sokolik, A., Casey, K.L., Davidson, R.J., Kosslyn, S.M., Rose, R.M., Cohen, J.D., 2004. Placebo-induced changes in FMRI in the anticipation and experience of pain. *Science* 303, 1162–1167. <https://doi.org/10.1126/science.1093065>

Waldenström, U., Schytt, E., 2009. A longitudinal study of women's memory of labour pain--from 2 months to 5 years after the birth. *BJOG* 116, 577–583. <https://doi.org/10.1111/j.1471-0528.2008.02020.x>

- Wall, P.D., 1979. On the relation of injury to pain. The John J. Bonica lecture. *Pain* 6, 253–264. [https://doi.org/10.1016/0304-3959\(79\)90047-2](https://doi.org/10.1016/0304-3959(79)90047-2)
- Wang L, Gui P, Li L, Ku Y, Bodner M, Fan G, Zhou YD, Dong XW. Neural Correlates of HeatEvoked Pain Memory in Humans. *J Neurophysiol.* 115(3), 1596-1604, 2016; DOI: <https://doi.org/10.1152/jn.00126.2015>
- Watson JB & Rayner R, 1920. Conditioned emotional reactions. *Journal of Experimental Psychology*, 3(1), 1-14.
- Waldenström, U., Schytt, E., 2009. A longitudinal study of women’s memory of labour pain—from 2 months to 5 years after the birth. *BJOG: An International Journal of Obstetrics & Gynaecology* 116, 577–583. <https://doi.org/10.1111/j.1471-0528.2008.02020.x>
- Wells, R.E., Kaptchuk, T.J., 2012. To Tell the Truth, the Whole Truth, May Do Patients Harm: The Problem of the Nocebo Effect for Informed Consent. *The American Journal of Bioethics* 12, 22–29. <https://doi.org/10.1080/15265161.2011.652798>
- Whitlock JR. Posterior parietal cortex. *Curr Biol*, 27(14): R691-R69, 2017; DOI: <https://doi.org/10.1016/j.cub.2017.06.007>
- Wianda E, Ross B. The roles of alpha oscillation in working memory retention. *Brain Behav.* 9(4): e01263, 2019. DOI: <https://doi.org/10.1002/brb3.1263>.
- Wiech, K., 2016. Deconstructing the sensation of pain: The influence of cognitive processes on pain perception. *Science* 354, 584–587. <https://doi.org/10.1126/science.aaf8934>
- Wiech, K., Lin, C., Brodersen, K.H., Bingel, U., Ploner, M., Tracey, I., 2010. Anterior insula integrates information about salience into perceptual decisions about pain. *J Neurosci* 30, 16324–16331. <https://doi.org/10.1523/JNEUROSCI.2087-10.2010>
- Wiech, K., Ploner, M., Tracey, I., 2008. Neurocognitive aspects of pain perception. *Trends Cogn Sci* 12, 306–313. <https://doi.org/10.1016/j.tics.2008.05.005>
- Wiltgen, B.J., Silva, A.J., 2007. Memory for context becomes less specific with time. *Learn. Mem.* 14, 313–317. <https://doi.org/10.1101/lm.430907>
- Wiltgen, B.J., Zhou, M., Cai, Y., Balaji, J., Karlsson, M.G., Parivash, S.N., Li, W., Silva, A.J., 2010. The Hippocampus Plays a Selective Role in the Retrieval of Detailed Contextual Memories. *Current Biology* 20, 1336–1344. <https://doi.org/10.1016/j.cub.2010.06.068>
- Wise, E.A., Price, D.D., Myers, C.D., Heft, M.W., Robinson, M.E., 2002. Gender role expectations of pain: relationship to experimental pain perception. *Pain* 96, 335–342. [https://doi.org/10.1016/S0304-3959\(01\)00473-0](https://doi.org/10.1016/S0304-3959(01)00473-0)
- X**
- Xiong, H.-Y., Zheng, J.-J., Wang, X.-Q., 2022. Non-invasive Brain Stimulation for Chronic Pain: State of the Art and Future Directions. *Frontiers in Molecular Neuroscience* 15.
- Xu, W., Südhof, T.C., 2013. A neural circuit for memory specificity and generalization. *Science* 339, 1290–1295. <https://doi.org/10.1126/science.1229534>
- Y**
- Yang K, Tong L, Shu J, Zhuang N, Yan B, Zeng Y., 2020. High Gamma Band EEG Closely related to Emotion: evidence from functional network. *Front Hum Neurosci.* 14:89. <https://doi.org/10.3389/fnhum.2020.00089>
- Yang, chih-hao, Huang, C.-C., Hsu, K.-S., 2011. Generalization of Fear Inhibition by Disrupting Hippocampal Protein Synthesis-Dependent Reconsolidation Process. *Neuropsychopharmacology* : official publication of the American College of Neuropsychopharmacology 36, 1992–2008. <https://doi.org/10.1038/npp.2011.87>
- Yehuda, R., LeDoux, J., 2007. Response Variation following Trauma: A Translational Neuroscience Approach to Understanding PTSD. *Neuron* 56, 19–32. <https://doi.org/10.1016/j.neuron.2007.09.006>
- Yu, J., Naoi, T., Sakaguchi, M., 2021. Fear generalization immediately after contextual fear memory consolidation in mice. *Biochemical and Biophysical Research Communications* 558, 102–106. <https://doi.org/10.1016/j.bbrc.2021.04.072>
- Z**
- Zaki, J., Davis, J.I., Ochsner, K.N., 2012. Overlapping activity in anterior insula during interoception and emotional experience. *Neuroimage* 62, 493–<https://doi.org/10.1016/j.neuroimage.2012.05>.

APPENDIX

Appendix 1: C# scripts coded in Visual Studio

Movement Manager script

```
using UnityEngine;

public class MovementManager:MonoBehaviour {

    public float speed = 5f;
    public float speedRotation= 100;

    private Rigidbody;
    private bool isMoving;
    private bool isMovingBack;
    private float directionOfTurn;// -1 or +1 // Use this for
initializatio

    void Start () {
        rigidBody = GetComponent<Rigidbody> ();
    }

    // Update is called once per frame
    void Update () {
        Move();
        Turn ();
        MoveBack();
    }

    void Move(){
        if (isMoving) {
            this.transform.Translate( Vector3.forward * Time.deltaTime * speed);
        }
    }

    void Turn(){
        float turn = directionOfTurn * speedRotation * Time.deltaTime; //
speedRotation*Time.deltaTime= speed per frame
        this.transform.Rotate(new Vector3(0, turn, 0));
    }
    void MoveBack()
    {
        if (isMovingBack)
        {
            this.transform.Translate(Vector3.forward*-1 * Time.deltaTime * speed);
        }
    }
    public void SetIsMoving(bool b){
        isMoving = b;
    }

    public void SetIsMovingBack(bool b)
    {
        isMovingBack = b;
    }

    public void TurnInLeftDirection(){
        directionOfTurn = -1;
    }

    public void TurnInRightDirection(){
        directionOfTurn = 1;
    }

    public void StopRotation()
    {
        directionOfTurn = 0;
    }
}
```

Cameraa script

```
using UnityEngine;

public class Cameraa : MonoBehaviour {

    private MovementManager movementManager;

    // Use this for initialization
    void Start () {
        movementManager = GetComponent<MovementManager> ();
    }

    // Update is called once per frame
    void Update () {

    }

    public void MoveForward(){
        print ("MoveForward");
        movementManager.SetIsMoving (true);
    }

    public void MoveBackward()
    {
        print("MoveBack");
        movementManager.SetIsMovingBack(true);
    }

    public void StopMove(){
        print ("StopMove");
        movementManager.SetIsMoving (false);
        movementManager.SetIsMovingBack(false);
    }

    public void TurnLeft(){
        movementManager.TurnInLeftDirection ();
    }

    public void TurnRight(){
        movementManager.TurnInRightDirection ();
    }

    public void StopRotation(){
        movementManager.StopRotation ();
    }

}
```

Input Manager script

```
using System.Collections;
using System.Collections.Generic;
using UnityEngine;

public class InputManager3 : MonoBehaviour {

    public Camera cube;
    private MovementManager;
    public float timeleft = 225.0f;
    public GameObject Cube1;
    public GameObject Cube2;
    public GameObject Cube3;
    public GameObject Main;
    public Vector3 initialposition;
    private float[] values;
    private int randomValue;
    private float randturn;
    public int count;

    // Use this for initialization
    void Start()
    {
        Cube1 = GameObject.Find("Cube 1");
        Cube2 = GameObject.Find("Cube 2");
        Cube3 = GameObject.Find("Cube 3");
        Main = GameObject.Find("[CameraRig]");

        initialposition = Main.transform.position;

        movementManager =
GetComponent<MovementManager>();
        values = new float[2];
        randomValue = Random.Range(0, 2);
        values[1] = -1.0f;
        values[0] = 1.0f;
        randturn = values[randomValue];

        count = 0;

    // Update is called once per frame
    public void Update()
    {
        timeleft -= Time.deltaTime;

        if (timeleft < 224)
        {
            if (timeleft > 220.5)
            {
                cube.MoveForward();
            }
            else cube.StopMove();
        }

        if (timeleft < 219)
        {
            if (timeleft > 214)
            {
                cube.MoveForward();
            }
            else cube.StopMove();
        }
    }
}
```

```
if (timeleft < 210)
{
    if (timeleft > 209)
    {
        this.transform.localRotation =
Quaternion.AngleAxis(-35, Vector3.up);
    }
    else cube.StopRotation();
}

if (timeleft < 209)
{
    if (timeleft > 206)
    {
        cube.MoveForward();
    }
    else cube.StopMove();
}

if (timeleft < 202)
{
    if (timeleft > 201)
    {
        this.transform.localRotation =
Quaternion.AngleAxis(-100, Vector3.up);
    }
    else cube.StopRotation();
}

if (timeleft < 201)
{
    if (timeleft > 195)
    {
        cube.MoveForward();
    }
    else cube.StopMove();
}

if (timeleft < 191)
{
    if (timeleft > 190)
    {
        this.transform.localRotation =
Quaternion.AngleAxis(-190, Vector3.up);
    }
    else cube.StopRotation();
}

if (timeleft < 190)
{
    if (timeleft > 185)
    {
        cube.MoveForward();
    }
    else cube.StopMove();
}
}
```

```

if (timeleft < 181)
{
    if (timeleft > 180)
    {
        transform.localRotation =
Quaternion.AngleAxis(-280, Vector3.up);
    }
    else cube.StopRotation();
}

if (timeleft < 180)
{
    if (timeleft > 175)
    {
        cube.MoveForward();
    }
    else cube.StopMove();
}

if (timeleft < 171)
{
    if (timeleft > 170)
    {
        transform.position =
Cube1.transform.position;
transform.localRotation =
Quaternion.AngleAxis(-280, Vector3.up);
    }
    else cube.StopRotation();
}

if (timeleft < 169)
{
    if (timeleft > 158.5)
    {
        cube.MoveForward();
    }
    else cube.StopMove();
}

if (timeleft <148.5)

    if (timeleft > 147.5)
    {
        transform.localRotation =
Quaternion.AngleAxis(-343, Vector3.up);
    }
    else cube.StopRotation();

if (timeleft < 146.5)
{
    if (timeleft > 143)
    {
        cube.MoveForward();
    }
    else cube.StopMove();
}

if (timeleft < 141.5)
{
    if (timeleft > 136.5)
    {
        cube.MoveForward();
    }
    else cube.StopMove();
}
}

```

```

if (timeleft <132.5)
{
    if (timeleft > 131.5)
    {
        this.transform.localRotation =
Quaternion.AngleAxis(-285, Vector3.up);
    }
    else cube.StopRotation();
}

if (timeleft < 131.5)
{
    if (timeleft > 128.5)
    {
        cube.MoveForward();
    }
    else cube.StopMove();
}

if (timeleft <124.5)
{
    if (timeleft > 123.5)
    {
        this.transform.localRotation =
Quaternion.AngleAxis(-342, Vector3.up);
    }
    else cube.StopRotation();
}

if (timeleft < 123.5)
{
    if (timeleft > 118.5)
    {
        cube.MoveForward();
    }
    else cube.StopMove();
}

if (timeleft < 114.5)
{
    if (timeleft >113.5)
    {
        this.transform.localRotation =
Quaternion.AngleAxis(-430, Vector3.up);
    }
    else cube.StopRotation();
}

if (timeleft <113.5)
{
    if (timeleft > 108.5)
    {
        cube.MoveForward();
    }
    else cube.StopMove();
}

if (timeleft < 104.5)
{
    if (timeleft > 103.5)
    {
        transform.localRotation =
Quaternion.AngleAxis(-520, Vector3.up);
    }
    else cube.StopRotation();
}
}

```

```

if (timeleft < 103.5)
{
    if (timeleft > 98.5)
    {
        cube.MoveForward();
    }
    else cube.StopMove();
}
if (timeleft < 94.5)
{
    if (timeleft > 93.5)
    {
        transform.position =
Cube2.transform.position;
        transform.localRotation =
Quaternion.AngleAxis(-520, Vector3.up);
    }
    else cube.StopRotation();
}
if (timeleft < 92.5)
{
    if (timeleft > 82)
    {
        cube.MoveForward();
    }
    else cube.StopMove();
}

if (timeleft < 72)
    if (timeleft > 71)
    {
        transform.localRotation =
Quaternion.AngleAxis(-583, Vector3.up);
    }
    else cube.StopRotation();

if (timeleft < 71)
{
    if (timeleft > 68.5)
    {
        cube.MoveForward();
    }
    else cube.StopMove();
}

if (timeleft < 65.5)
{
    if (timeleft > 60.5)
    {
        cube.MoveForward();
    }
    else cube.StopMove();
}

if (timeleft < 56.5)
{
    if (timeleft > 55.5)
    {
        this.transform.localRotation =
Quaternion.AngleAxis(-527, Vector3.up);
    }
    else cube.StopRotation();
}

if (timeleft < 55.5)
{
    if (timeleft > 52.5)
    {
        cube.MoveForward();
    }
    else cube.StopMove();
}

```

```

if (timeleft < 48.5)
{
    if (timeleft > 47.5)
    {
        this.transform.localRotation =
Quaternion.AngleAxis(-580, Vector3.up);
    }
    else cube.StopRotation();
}
if (timeleft < 47.5)
{
    if (timeleft > 41.5)
    {
        cube.MoveForward();
    }
    else cube.StopMove();
}
if (timeleft < 37.5)
{
    if (timeleft > 36.5)
    {
        this.transform.localRotation =
Quaternion.AngleAxis(-670, Vector3.up);
    }
    else cube.StopRotation();
}

if (timeleft < 36.5)
{
    if (timeleft > 31.5)
    {
        cube.MoveForward();
    }
    else cube.StopMove();
}

if (timeleft < 27.5)
{
    if (timeleft > 26.5)
    {
        transform.localRotation =
Quaternion.AngleAxis(-760, Vector3.up);
    }
    else cube.StopRotation();
}

if (timeleft < 26.5)
{
    if (timeleft > 22.5)
    {
        cube.MoveForward();
    }
    else cube.StopMove();
}

if (timeleft < 21.5)
{
    if (timeleft > 20.5)
    {
        transform.position =
Cube3.transform.position;
        transform.localRotation =
Quaternion.AngleAxis(-760, Vector3.up);
    }
    else cube.StopRotation();
}

```

```

        if (timeleft < 20.5)
        {
            if (timeleft > 10.5)
            {
                cube.MoveForward();
            }
            else cube.StopMove();
        }

if (timeleft < 20.5)
{
    if (timeleft > 10.5)
    {
        cube.MoveForward();
    }
    else cube.StopMove();
}

if (timeleft < 0.5)
{
    if (timeleft > -2.5)
    {
        transform.localRotation =
Quaternion.AngleAxis(-820, Vector3.up);
    }
    else
        if (count < 10)
        {
            Reset();
        }
        if (count > 9)
        { cube.StopMove();
          cube.StopRotation();
        }
    }
}

}

void Reset()
{
    values = new float[2];
    randomValue = Random.Range(0, 2);
    values[1] = -1.0f;
    values[0] = 1.0f;
    randturn = values[randomValue];
    timeleft = 225.0f;

    count = count + 1;
}
}

```

Global apartment Script

```
using System.Collections;
using System.Collections.Generic;
using UnityEngine;

public class GlobalAppMovement : MonoBehaviour{

    public float timeleft = 2275.0f;
    public GameObject Pièces;

    // Use this for initialization
    void Start()
    {
        Pièces = GameObject.Find("Pièces");
    }

    // Update is called once per frame
    void Update()
    {
        timeleft -= Time.deltaTime;

        if (timeleft < 2050)
        {
            if (timeleft > 2047)
            {
                this.transform.Rotate(new Vector3(0,
40* Time.deltaTime, 0));
            }
        }

        if (timeleft < 1823)
        {
            if (timeleft > 1820)
            {
                this.transform.Rotate(new Vector3(0,
40*Time.deltaTime, 0));
            }
        }

        if (timeleft < 1593)
        {
            if (timeleft > 1592.8)
            {
                this.transform.Rotate(new Vector3(0,
80 * Time.deltaTime, 0));
            }
        }

        if (timeleft < 1366)
        {
            if (timeleft > 1363)
            {
                this.transform.Rotate(new Vector3(0,
0, 0));
            }
        }
    }
}
```

```
if (timeleft < 1140)
{
    if (timeleft > 1137)
    {
        this.transform.Rotate(new Vector3(0, 40
* Time.deltaTime, 0));
    }
}

if (timeleft < 911)
{
    if (timeleft > 910.8)
    {
        this.transform.Rotate(new Vector3(0, 40
* Time.deltaTime, 0));
    }
}

if (timeleft < 686)
{
    if (timeleft > 683)
    {
        this.transform.Rotate(new Vector3(0,40
*Time.deltaTime, 0));
    }
}

if (timeleft < 458)
{
    if (timeleft > 455)
    {
        this.transform.Rotate(new Vector3(0, 40
* Time.deltaTime, 0));
    }
}

if (timeleft < 230)
{
    if (timeleft > 227)
    {
        this.transform.Rotate(new Vector3(0,0,
0));
    }
}
}
```

Search Task (Kitchen) script

```
using System.Collections;
using System.Collections.Generic;
using UnityEngine;

public class SearchTaskKitchen : MonoBehaviour {

    public float timeleft = 2275.0f;

    public GameObject RectanglePelle;
    public GameObject CerclePelle;
    public GameObject CarréPelle;
    public GameObject EtoilePelle;

    public GameObject CarréBol;
    public GameObject CercleBol;
    public GameObject EtoileBol;
    public GameObject TriangleBol;

    public GameObject EtoilePoivre;
    public GameObject TrianglePoivre;
    public GameObject LosangePoivre;
    public GameObject CerclePoivre;

    public GameObject CercleThé;
    public GameObject EtoileThé;
    public GameObject RectangleThé;

    public GameObject HexagoneTorchon;
    public GameObject LosangeTorchon;
    public GameObject RectangleTorchon;
    public GameObject TriangleTorchon;

    public GameObject CercleRouleau;
    public GameObject TriangleRouleau;

    public GameObject HexagonePoele;
    public GameObject CerclePoele;
    public GameObject TrianglePoele;
    public GameObject LosangePoele;
```

```
// Use this for initialization
void Start () {

    RectanglePelle.SetActive(false);
    CerclePelle.SetActive(false);
    CarréPelle.SetActive(false);
    EtoilePelle.SetActive(false);

    CarréBol.SetActive(false);
    CercleBol.SetActive(false);
    EtoileBol.SetActive(false);
    TriangleBol.SetActive(false);

    EtoilePoivre.SetActive(false);
    TrianglePoivre.SetActive(false);
    LosangePoivre.SetActive(false);
    CerclePoivre.SetActive(false);

    CercleThé.SetActive(false);
    EtoileThé.SetActive(false);
    RectangleThé.SetActive(false);

    HexagoneTorchon.SetActive(false);
    LosangeTorchon.SetActive(false);
    RectangleTorchon.SetActive(false);
    TriangleTorchon.SetActive(false);

    CercleRouleau.SetActive(false);
    TriangleRouleau.SetActive(false);

    HexagonePoele.SetActive(false);
    CerclePoele.SetActive(false);
    TrianglePoele.SetActive(false);
    LosangePoele.SetActive(false);
}
```

```

// Update is called once per frame
void Update()
{
    timeleft -= Time.deltaTime;

    if (timeleft < 2275)
    {
        if (timeleft > 2047.5)
        {
            CarréPelle.SetActive(true);
            CarréBol.SetActive(true);
            EtoilePoivre.SetActive(true);
        }
    }
    if (timeleft < 2047.5)
    {
        if (timeleft > 1820)
        {
            TrianglePoivre.SetActive(true);
            CercleThé.SetActive(true);

            CarréPelle.SetActive(false);
            CarréBol.SetActive(false);
            EtoilePoivre.SetActive(false);
        }
    }
    if (timeleft < 1820)
    {
        if (timeleft > 1592.5)
        {
            CercleBol.SetActive(true);
            CercleRouleau.SetActive(true);
            HexagoneTorchon.SetActive(true);

            TrianglePoivre.SetActive(false);
            CercleThé.SetActive(false);
        }
    }
    if (timeleft < 1592.5)
    {
        if (timeleft > 1365)
        {
            HexagoneTorchon.SetActive(true);

            CercleBol.SetActive(false);
            CercleRouleau.SetActive(false);
        }
    }
    if (timeleft < 1365)
    {
        if (timeleft > 1137.5)
        {
            HexagoneTorchon.SetActive(false);

            LosangeTorchon.SetActive(true);
            RectangleTorchon.SetActive(true);
            RectanglePelle.SetActive(true);
            EtoilePelle.SetActive(true);
            HexagonePoele.SetActive(true);
            CarréBol.SetActive(true);
        }
    }
    if (timeleft < 1137.5)
    {
        if (timeleft > 910)
        {
            LosangeTorchon.SetActive(false);
            RectangleTorchon.SetActive(false);
            RectanglePelle.SetActive(false);
            EtoilePelle.SetActive(false);
            HexagonePoele.SetActive(false);
            CarréBol.SetActive(false);

```

```

            CerclePoele.SetActive(true);
            TrianglePoele.SetActive(true);
            TriangleRouleau.SetActive(true);
            LosangePoivre.SetActive(true);
        }
    }
    if (timeleft < 910)
    {
        if (timeleft > 682.5)
        {
            CerclePoele.SetActive(false);
            TrianglePoele.SetActive(false);
            TriangleRouleau.SetActive(false);

            LosangePoivre.SetActive(false);
            EtoileBol.SetActive(true);
            CerclePelle.SetActive(true);
        }
    }
    if (timeleft < 682.5)
    {
        if (timeleft > 455)
        {
            CercleRouleau.SetActive(true);

            EtoileBol.SetActive(false);
            CerclePelle.SetActive(false);
        }
    }
    if (timeleft < 455)
    {
        if (timeleft > 227.5)
        {
            CercleRouleau.SetActive(false);

            EtoilePelle.SetActive(true);
            TriangleTorchon.SetActive(true);
            CerclePoivre.SetActive(true);
            CercleBol.SetActive(true);
            TriangleBol.SetActive(true);
            CercleThé.SetActive(true);
            LosangePoele.SetActive(true);
        }
    }
    if (timeleft < 227.5)
    {
        if (timeleft > 0)
        {
            RectangleThé.SetActive(true);
            HexagoneTorchon.SetActive(true);

            EtoilePelle.SetActive(false);
            TriangleTorchon.SetActive(false);
            CerclePoivre.SetActive(false);
            CercleBol.SetActive(false);
            TriangleBol.SetActive(false);
            CercleThé.SetActive(false);
            LosangePoele.SetActive(false);
        }
    }
}
}

```

Main menu and Quit button script

```
using System.Collections;
using System.Collections.Generic;
using UnityEngine;
using UnityEngine.SceneManagement;

public class MainMenu : MonoBehaviour
{
    public void PlayGame()
    {
        SceneManager.LoadScene(SceneManager.GetActiveScene().buildIndex + 1);
    }

    public void QuitGame ()
    {
        Debug.Log("QUIT");
        Application.Quit();
    }
}
```

```
using System.Collections;
using System.Collections.Generic;
using UnityEngine;
using UnityEngine.SceneManagement;

public class QuitButton : MonoBehaviour {

    public void QuitGamebis()
    {
        Debug.Log("QUIT");
        Application.Quit();
    }
}
```

Appendix 2: Online testing of aversive sounds:

Consigne

Lors de ce test il vous sera demandé d'écouter attentivement 20 bandes sonores d'une durée de quelques secondes chacune. A la fin de chaque son, vous devrez répondre aux quatre questions suivantes :

1- A quel point ce son est-il désagréable pour vous ?

Pour répondre à cette question, vous devrez cliquer sur une ligne continue allant de "pas du tout désagréable" à "extrêmement désagréable" :

Pas du tout désagréable 1 2 3 4 5 6 7 8 9 10 Extrêmement désagréable

2- Quelle valence attribuez-vous à ce son ?

Il s'agit d'indiquer ici si le son vous évoque quelque chose de positif ou de négatif. Vous devrez répondre en cliquant sur le petit personnage qui correspond le mieux à votre ressenti :

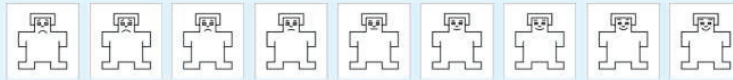

3- A quel point ce son vous impacte-t-il émotionnellement ?

Il s'agit cette fois d'indiquer à quel point le son vous touche. Il n'y a pas ici de notion de positif ou de négatif. La bande sonore peut vous toucher de façon positive ou négative. Vous devrez répondre en cliquant sur le petit personnage qui correspond le mieux à votre ressenti :



4- Est-ce que ce son vous évoque une douleur physique ?

Vous devrez ici évaluer à quel point ce son évoque pour vous une douleur physique en cliquant sur l'item correspondant :

Pas du tout Un peu Moyennement Beaucoup Fortement

Appendix 3: Details of mean aversion, valence, emotional impact and link to pain ratings for each sound:

	Brakes_2	Brakes_3	Brakes_4	Door_1	Door_2	Door_5	Door_6
Aversion	5,09	5,58	6,47	5,63	5,63	5,29	5,33
Valence	4,22	3,68	3,89	3,79	3,63	4,24	4,29
EI	2,83	2,42	2,84	3,21	2,47	3,05	3,05
Pain	1,57	1,63	1,68	1,37	1,58	1,33	1,33
	Drill_10	Drill_4	Fork_10	Fork_11	Fork_4	Fork_7	Fork_9
Aversion	5,09	5,32	7,30	6,61	5,74	6,43	6,09
Valence	3,87	3,95	2,48	3,22	4,11	3,19	3,22
EI	2,00	2,84	4,13	3,04	2,79	3,71	2,57
Pain	1,26	1,53	1,74	1,78	1,68	1,81	1,57
	Fork_8	Nails_1	Nails_10	Nails_7	Nails_8	Nails_9	Drill_3
Aversion	6,67	5,32	5,91	5,67	5,65	6,78	5,71
Valence	3,33	3,74	3,39	3,17	3,65	2,96	3,86
EI	3,29	2,63	3,17	3,17	2,17	3,57	2,81
Pain	2,00	1,63	1,52	1,54	1,57	1,70	1,95

Appendix 4 : Immersion quality questionnaire :

Questionnaire d'Immersion en Réalité Virtuelle

Veillez sélectionner votre niveau d'accord avec les affirmations suivantes :

« Pendant l'expérience par moment j'ai ressenti que ... »

Q1. J'étais hors de mon corps »

Jamais *Presque jamais* *Rarement* *La moitié du temps* *Souvent* *La plupart de temps* *Toujours*

Q2. Mon (vrai) corps dérivait vers le corps virtuel ou que le corps virtuel dérivait vers mon (vrai) corps »

Jamais *Presque jamais* *Rarement* *La moitié du temps* *Souvent* *La plupart de temps* *Toujours*

Q3. Les mouvements du corps virtuel influençaient mes propres mouvements »

Jamais *Presque jamais* *Rarement* *La moitié du temps* *Souvent* *La plupart de temps* *Toujours*

Q4. Mon (vrai) corps se transformait en un corps d'avatar »

Jamais *Presque jamais* *Rarement* *La moitié du temps* *Souvent* *La plupart de temps* *Toujours*

Q5. Mon (vrai) corps commençait à prendre la posture ou la forme du corps virtuel que je voyais »

Jamais *Presque jamais* *Rarement* *La moitié du temps* *Souvent* *La plupart de temps* *Toujours*

Q6. Je portais des vêtements différents de ceux que j'avais en arrivant au laboratoire »

Jamais *Presque jamais* *Rarement* *La moitié du temps* *Souvent* *La plupart de temps* *Toujours*

Q7. Mon corps avait changé »

Jamais *Presque jamais* *Rarement* *La moitié du temps* *Souvent* *La plupart de temps* *Toujours*

Q8. Une sensation de _____ dans mon corps lorsque j'ai vu _____ »

Jamais *Presque jamais* *Rarement* *La moitié du temps* *Souvent* *La plupart de temps* *Toujours*

Q9. Mon (vrai) corps pouvait être affecté par _____ »

Jamais *Presque jamais* *Rarement* *La moitié du temps* *Souvent* *La plupart de temps* *Toujours*

Q10. Le corps de l'avatar virtuel était le mien »

Jamais *Presque jamais* *Rarement* *La moitié du temps* *Souvent* *La plupart de temps* *Toujours*

Q11. Le corps virtuel ressemblait à mon (vrai) corps en termes de forme, couleur de peau ou autres caractéristiques »

Jamais *Presque jamais* *Rarement* *La moitié du temps* *Souvent* *La plupart de temps* *Toujours*

Q12. Mon (vrai) corps était situé au même endroit que le corps virtuel »

Jamais *Presque jamais* *Rarement* *La moitié du temps* *Souvent* *La plupart de temps* *Toujours*

Q13. Je pouvais contrôler le corps de l'avatar comme si c'était mon (vrai) corps »

Jamais *Presque jamais* *Rarement* *La moitié du temps* *Souvent* *La plupart de temps* *Toujours*

Appendix 5 : BOSS norms (%DKNO) per object:

Salle de Bain	% DKO	Cuisine	% DKO	Salon	% DKO
Savon (solide)	0,00	cuillère	0,00	plantes	0,00
Pompe à savon	0,00	assiette	0,00	ordinateur	0,00
déodorant	0,00	bol	0,00	jeux d'echecs	0,00
crème visage		tasse	0,00	cadre photos	0,03
coton-tiges	0,00	verre	0,00	enceinte	0,00
PQ	0,10	pichet	0,00	lecteur DVD	0,33
produit désinfectant	0,00	cuillère en bois	0,00	télécommande	0,00
brosse WC	0,00	cafetière	0,00	vase	0,03
mouchoirs	0,00	théière	0,00	livre	0,00
serviette	0,00	casserole	0,00	cd	0,00
mousse à raser	0,17	poele	0,00	calendrier	0,00
miroir	0,14	tupperware	0,00	appareil photo	0,00
dentifrice	0,03	torchon	0,00	panier à bûche	0,00
brosse à dents	0,00	sopalin	0,00	magazines	
shampooing		planche	0,13	stylos	0,00
trousse de toilette		panier à fruit	0,00	cahier à notes	0,00
mascara	0,00	liqui vaisselle	0,00	lampe de chevet	0,00
rouge à lèvres	0,03	éponge	0,00	cendrier	0,00
gant de toilette		balayette	0,00	post-it	0,12
parfum	0,00	passoire	0,00	téléphone fixe	0,00
ventouse WC		fouet	0,00	gomme	
disque-coton	0,07	papier alu	0,00	boîte wifi	
crème solaire		saladier	0,00	calculatrice	0,00
trousse 1er secours	0,00	allumette	0,00	horloge de table	0,00
fil dentaire	0,00	porte-vaisselle	0,24	portable	0,00
balance	0,00	moulin à poivre	0,03	lunettes	0,00
pansements	0,08	bouteille eau	0,00	colle	0,04
bête médicaments	0,00	rouleau à pate	0,00	radio	0,00
vernis à ongle	0,03	entonnoir	0,00	fil à coudre	0,00
seau	0,00	(grill) appareil à gauf	0,14	metre	0,00
brosse cheveux		plat à cake	0,00	piano (taille jouet)	0,00
gel		machine à café	0,00	dessous de verre	0,13
sérum physio.	0,13	éplucheur	0,00	cartes	0,00
gants nettoyage	0,00	couteau	0,00	casque audio	0,00
brosse douche		fourchette	0,00	chaîne-hifi	0,00
brosse nettoyage	0,05	couteau pain	0,00	jouet camion pompier	0,00
rasoir elec	0,00	hachoir		agrapheuse	0,00
ciseaux-ongle	0,00	spatule	0,00	equerre	0,00
pince à épiler	0,00	mixeur	0,00	statuette en métal	0,00
lame de rasoir		blendeur	0,00	aloe vera	0,00
rasoir	0,03	bouilloire	0,00	cactus	0,00
peigne	0,00	attendrisseur		aiguilles à couture	
sèche-cheveux	0,00	fourchette fondue	0,00	bougies	0,00
fer à lisser	0,02	couteau à fromage	0,26	déco de table	
ciseaux-cheveux	0,00	grille-pain	0,00	allume-bougie	
coupe-ongle	0,00	grattoir		serviteur cheminée	
lime à ongle	0,21	rape à fromage	0,00	statuette en verre	0,00
alcool désinfectant		ouvre-boîte	0,00	clefs	0,00
pince à cheveux	0,08	tir-bouchon	0,00	couteau carton	0,00
dissolvant		mixeur-plongeur	0,07	briquet	0,00
thermometre	0,00	verre de vin	0,00	légos	