



HAL
open science

1950-2022: A History of Nanotechnology into Physical and Mathematical Relationship

Andrea Durlo

► **To cite this version:**

Andrea Durlo. 1950-2022: A History of Nanotechnology into Physical and Mathematical Relationship. Micro and nanotechnologies/Microelectronics. Université de Lille, 2023. English. NNT: 2023ULILN016 . tel-04353583

HAL Id: tel-04353583

<https://theses.hal.science/tel-04353583>

Submitted on 19 Dec 2023

HAL is a multi-disciplinary open access archive for the deposit and dissemination of scientific research documents, whether they are published or not. The documents may come from teaching and research institutions in France or abroad, or from public or private research centers.

L'archive ouverte pluridisciplinaire **HAL**, est destinée au dépôt et à la diffusion de documents scientifiques de niveau recherche, publiés ou non, émanant des établissements d'enseignement et de recherche français ou étrangers, des laboratoires publics ou privés.



1950-2022: A History of Nanotechnology into Physical and Mathematical Relationship

Graduate School

Engineering and Systems Sciences (ENGSYS ED 632), Lille University, France

Mr. Andrea DURLO

Presented & Discussed for Ph.D. Defence in a Public Exam, 2023, 16th of June

Mr. Full Prof. Dr. Vladik KREINOVICH Dir. of the Computer Science Centre, University of Texas at El Paso, USA	<i>Rapporteur</i>
Mrs Full Prof. Dr. Maria Sabrina SARTO Dir. of the Department of Astronautics, Electrical and Energetics Engineering, University of Rome La Sapienza, Italy	<i>Rapporteur</i>
Mr. Full Prof. HDR, Fabrizio CLERI IEMN, Dir. Physics Group, Lille University–CNRS, France	<i>Examiner</i> <i>Pres. Of Jury</i>
Mrs Associate Prof. HDR, Pascale DIENER IEMN, Lille University–CNRS, France	<i>Examiner</i>
Mr. DR, HDR, Stefano GIORDANO IEMN, Lille University–CNRS, France	<i>Examiner</i>
Mrs Full Prof. Dr. Flavia MARCACCI Dir. of IRAFS, Pontifical Lateran University, Vatican State	<i>Examiner</i>
Mrs Full Prof. Dr. Manisha SHARAN Science Program Director, Baker College of Royal Oak, Baker Business University in Michigan, USA	<i>Examiner</i>
Mr. Full Prof. HDR, Raffaele PISANO IEMN, Dir. HOPAST, Lille University–CNRS, France	<i>Supervisor</i>
Mr. DR HDR, Christophe DELERUE IEMN, Lille University–CNRS, France	<i>Invited</i>

Academic Year 2022 – 2023

1950-2022: Histoire des Nanotechnologies entre une Relation Physique et Mathématique

École doctorale

Engineering and Systems Sciences (ENGSYS ED 632), Lille University, France

Mr. Andrea DURLO

Présentation et discussion pour la défense du doctorat lors d'un examen public, 16 juin 2023

M. Prof. Dr. Vladik KREINOVICH

Rapporteur

Directeur du Centre des Sciences Informatiques, Université du Texas à El Paso, États-Unis

M.me Prof. Dr. Maria Sabrina SARTO

Rapporteur

Directeur du Département d'Astronautique, d'Ingénierie électrique et énergétique, Université de Rome La Sapienza, Italie

M. Prof. HDR, Fabrizio CLERI

Examineur

IEMN, Directeur du groupe de physique, Université de Lille-CNRS, France

Pres. du Jury

M.me Prof. HDR, Pascale DIENER

Examineur

IEMN, Université de Lille-CNRS, France

Mr. DR, HDR, Stefano GIORDANO

Examineur

IEMN, Université de Lille-CNRS, France

M.me Prof. Dr. Flavia MARCACCI

Examineur

Directeur de l'IRAFS, Université pontificale du Latran, État du Vatican

M.me Prof. Dr. Manisha SHARAN

Examineur

Directeur du programme scientifique, Baker College of Royal Oak, Baker Business University dans le Michigan, États-Unis

M. Prof. HDR, Raffaele PISANO

Superviseur

IEMN, Directeur de HOPAST, Université de Lille-CNRS, France

M. DR HDR, Christophe DELERUE

Invité

IEMN, Université de Lille-CNRS, France

1950-2022: A History of Nanotechnology into Physical and Mathematical Relationship

Andrea Durlò

Acknowledgements

My first thought of gratitude goes to my supervisor, Prof. Raffaele Pisano, who took on the task of supervising me; I have never lacked his teaching, his severity, his encouragement, all of which are fundamental to taking care of work at the highest level in an international context. I am deeply indebted to him.

My second thought goes to Prof. Christophe Delerue, of the IEMN in Lille, for the material he gave me on the occasion of the Institute's 30th anniversary celebrations and for the exchanges of ideas and opinions we had on the occasion of the IEMN day in Enneveline in 2022.

I am grateful to all the members of the Jury with whom I discussed this work.

I am grateful to all those who allowed me to use their material. I would like to dedicate a special thought to Christopher Toumey, “the evil anti-Feynman” as he was called by some, with whom I had engaged in a fruitful exchange of ideas, and who died suddenly at the beginning of 2022.

Heartfelt thanks also go to Jun Taniguchi, of the Tokyo University of Science, who recommended some very interesting texts to me and was privileged to have been a pupil of Engineer Norio Taniguchi, who first defined and used the word “nanotechnology”.

I am indebted to Buryak, Editor-in-Chief of the Russian Journal of Chemistry A, for all the concessions made on the use of the 1952 article by Radushkevich and Lukyanovich, which I analysed in my thesis. To Belenkina and Alexander (he never mentioned his surname to me), also from the Russian Journal of Chemistry A, I am indebted for Nesterenko's 1982 article.

I would also like to thank Cornelia Keck (Institut für Pharmazeutische Technologie und Biopharmazie of the Philipps-Universität Marburg, Germany), Kourouski (Texas A&M University, USA), Thamwattana (University of Newcastle, Australia), Di Sia (University of Padua, Italy), Texas Instruments in the person of Wyner, Dasgupta (Bhabha Atomic Research Centre, Mumbai, India), the Taylor&Francis Group, Springer Nature, Peter Strickland of the IUCr Journal, and Chen (Surfaces and Interfaces at the Nanoscale, Aalto University, Espoo, Finland) for advice and permission to cite their work.

My heartfelt thanks also go to Anne Duchene, of the IEMN, Service Editions, Communication et Multimédias, who prepared the large banner that was displayed at the celebrations for the 30 years of the IEMN, and for the exchanges of ideas that enabled us to supplement and enrich this work. Thanks to her active collaboration, my supervisor and I prepared and displayed poster material for several events, not least the one for the celebration of the 30th anniversary of the IEMN.

Again, special thanks go to Julie Robarts, University of Melbourne, for her meticulous proofreading of the manuscript, articles and posters that were prepared out of this thesis.

Remarks for the Reader

This document contains the description of my doctoral thesis and includes its purpose, as a PhD thesis, and the most complete and comprehensive collection of facts and names, as long as it is possible. It contains the methodology, the state-of-the-art, a literature review and *ad hoc* description of my international participations. The reader will find both the general and specific objectives of this paper, and a brief History of Nanoscience and Nanotechnology to design the framework this research is conducted within. Also, I propose a classification of the different sub-divisions of Nanotechnology. I studied/read and archived copies of the original/fundamental documents, more than 750, translating into English the ones in different foreign languages, regarding the subject of my thesis.

The idea behind my research work is to apply the historiographical method to construct a large-scale course on the history of nanoscience and nanotechnology. This area of research is fundamental because it represents at the same time the past, the present, and the future of a large part of research. We speak of the past, because it was in the past decades that a strong impetus was observed in the development of ideas and instruments that made it possible to intervene in matter, as well as the achievement of the first major successes, such as the realisation of new materials. It is possible, at the same time, to speak of the present of research, as nanotechnology is now one of the leading sectors in many respects. Ideas are exchanged, large amounts of funds are moved, and intra- and inter-national relationships are forged. Nanoscience and nanotechnology are also the future of research, because only the limits of imagination seem to be the obstacles, so to speak, to new and more exciting discoveries. Nanotechnology has turned out to be an area of research with almost unlimited cross-disciplinary potential, and this has resulted in a proliferation of publications devoted to individual discoveries.

To describe the progress made over the decades, I have relied as much as possible on the original articles. The search for some of them was quite complex, because they were publications that were hampered by language or political barriers. With the advent of new media, the dissemination of information in all fields, and particularly in science, has become increasingly rapid and effective. While the ever-increasing number of articles and texts has proved to be a very wide range of choice for my work, it has also made the choice of topics to describe somewhat more complex.

However, this gives my research an additional value: it can serve as a starting point for future research and in-depth studies, both of the points I have considered and those that have not.

Each of the Chapter is introduced by a brief Prologue that depicts the contents the reader will find, and will be concluded by a short Epilogue that recalls the topics described, before the list of the references used. The structure of this work is divided into Part I–Introduction, containing the chapter One The Nanophysics, Part II–Experimental Nanophysics & Mathematical Modelling, containing the chapter Two Lab Instrumentation and Mathematical Applications, Part III–A History of Nanotechnology Research, that groups the chapters Three 1950–1970, Four 1971–1990, Five 1991–2020, and Six about the IEMN and its 30 years of history, Part IV–A History of Nanotechnology & Science in Society,

including chapter Seven, where Nanotechnology is described as an Applied Science in Society and Part V–Concluding Remarks where the reader will find the chapter Conclusions.

The reader will see that chapter One acts as an introduction when chapter Two is the most technical one, containing information that should be known to physicist–readers. The historical part is recollected in chapters from Three to Six, and chapter Seven contains concepts on Ethics and Nanotechnology. The Appendix at the end of the thesis contains the permissions to use contents and/or from other authors and the list of my participations, including the slides and the posters presented in the different events. At the very end, the reader will find the complete list of the references used for this thesis: this includes the ones separately reported at the end of each chapter, references which are specifically dedicated to the contents of the chapters.

The referencing style follows the *Springer Basic Style* both as a recall in the running text, at the end of each chapter and in the dedicated section at the end of this document. Under the heading Primary sources I decided to group all the main sources that I have used to retrieve information directly from researchers, both about scientific discoveries and about the invention of brand new/improvement of the already known research tools. These are the first observations, from a temporal point of view, of new materials, structures, investigation devices. As primary sources I used the original articles and books (if original works on a new topic, not recollecting or abridging other sources, see for example Kuhn 1962) and when appropriate, I deepened through other writings of the same authors, such as the Nobel Lectures. Under the heading Secondary sources I have reported the books and manuals – which constitute indirect sources of information – that I have consulted and which group information/articles/essays by other authors.

To give a complete view on the state of the art of research in the field of Nanosciences and Nanotechnologies, I thought it appropriate to report a section of the bibliography relating to the research that is conducted at the IEMN, to give further evidence to the work environment in which I am inserted. Here I chose also to report some of the most recent works published from IEMN researchers. This section also includes the publications – together with the scientific ones, even the historical and epistemological ones appear – of my thesis supervisor, prof. Raffaele Pisano.

When it was possible to go visit International Institutions in which to conduct my doctoral research, I obtained information that is reported under the heading *in situ* in the bibliography. As the last item in the bibliography, I have also reported other sources, taken from the articles consulted or from the websites, which expand and deepen the various points of my thesis but which, for reasons of different nature, are not quoted in the different parts of the thesis.

In the running text, I adopted the rule to quote all the names of the article writers/contributors as long as their number is not larger than four, as several articles are written by more than four researchers, the reader will find the citation (Surname *et al.* YYYY). All the contributors' names are listed in the References.

This large Reference section represents a source of value within my doctoral thesis, particularly for History of Science and Historiographical and Epistemological research. In order to collect the documents required, I consulted different sources. The most frequently used sources are listed in the following table.

Type of Reference & Sources

- ✓ Primary and Secondary sources
- ✓ Online sources
- ✓ Academia
- ✓ AAPT – American Association of Physics Teachers
- ✓ AIP publishing
- ✓ American Scientist
- ✓ Archive.org
- ✓ ArXiv.org
- ✓ Britannica
- ✓ Elsevier
- ✓ Gallica.BNF – Bibliothèque Nationale de France
- ✓ Library of Congress
- ✓ NASA – National Aeronautics and Space Administration
- ✓ Nature
- ✓ NewScientist
- ✓ Researchgate.net
- ✓ Science magazine
- ✓ Science Publishing Group
- ✓ Springer
- ✓ Various University Press
- ✓ Wiley Online Library

Additionally, I asked for and obtained the permission to use copyrighted materials from the respective authors/publishers. When I prepared myself some images to better describe the arguments, the reader will find the note “Source: AD (Andrea Durlò), designed with XX” and the name of the software I adopted to obtain the image

When encountering non-English historical texts in the document, a translation in English is always provided in the running text, while the original text will be found in a footnote. The used versions are the trusted English translations, preferentially and when possible. Otherwise, the note “Translation by AD” will indicate that the translation is my work.

Finally, a native English speaker (English mother tongue), Prof. Julie Robarts of the University of Melbourne – to whom goes my gratitude – proofread this thesis.

Summary of the PhD Thesis

My Ph.D thesis brings together the highlights of the History of Nanotechnology (1950-2022) to the present day. As this time-span is well documented, I based my three-year long research on the original articles and the most representative texts, according to the historiographic method, aiming of highlighting the steps taken over time that have led to Nanotechnology as we know it today. The thesis, consisting 850+ pages, is then a wide-ranging work divided into five parts over eight chapters. It includes also a long Introduction, an Appendix, four historical chapters as the Main Matter, a large comprehensive Bibliography and Indexes of Names and Subjects. The results I achieved are:

- 1) the preparation of a large reference-volume recollecting chronologically the most important discoveries in NNT, something that has not been prepared yet, to the best of my knowledge;
- 2) the analysis of historical articles from the Russian literature usually not examined;
- 3) setting the basis for further and larger research on the subject;
- 4) the presentation of parts of my research to national and international events;
- 5) providing material for publication.

In the Introduction, the fundamental concepts and definitions, Nanotechnology within the relationship Physics–Mathematics, the state of the art of Nanoscience and Nanotechnology (NNT) with a description of the fundamental role of the IEMN and an analysis of the research around the world, are reported and analysed.

The first chapter deals with the techniques used to create nanostructures and nanomaterials, the figures of researchers who have played a fundamental role in the history of Nanoscience, and the main fields of research into which Nanotechnology is divided.

The second chapter is devoted to the electron microscopy techniques that have made it possible to investigate and manipulate matter, focusing on the technology and the physical principles behind it. The progress made by mathematics to describe nanostructures in the form of the models used is also presented.

The third chapter opens the specifically historical part of the thesis within the relationship Physics–Mathematics, analysing the two decades between 1950 and 1970. Here I emphasize the first laboratory observation of elongated hollow structures - the future so-called carbon nanotubes - and the increasingly stringent perception of the need to design smaller and more efficient electronic components.

The fourth chapter covers the decades between 1970 and 1990, when the term Nanotechnology was born and tunnel effect and atomic force microscopes saw the light of day. During this period, Nobel Prizes were awarded in the field of NNT.

The fifth chapter runs from 1990 to 2022 and describes the latest advances in NNT up to the present day. These are the years when graphene and carbon nanotubes were discovered, and when NNT developed on several fronts.

The sixth chapter is specific to the IEMN, the research centre where I carried out this thesis, and its first thirty years of history. In this chapter I presented the most important articles published by the Institute, comparing them with the most significant moments in the history of NNT, to prove the quality of the research conducted and how many times the results proved to be real premieres in the scientific landscape.

The seventh chapter addresses the impact that NNT have on the environment and what regulations have been established over time to contain the inevitable effects on humans and the environment of a new science.

The final chapter eight is dedicated to bringing together the conclusions and perspectives indicated by this thesis work.

A large bibliographical chapter of studied references is included. This thesis can be considered as a source-book that will be of particular interest for physicists, historians of science, mathematicians and applied science & technology researchers.

Résumé de la Thèse

Ma thèse de doctorat porte sur l'histoire des nanosciences et des nanotechnologies - NNT - (1950-2022). Cette période étant bien documentée, j'ai basé ma recherche (3 ans) sur les articles originaux et les livres les plus représentatifs, selon la méthode historique scientifique/historiographique, dans le but de mettre en évidence les étapes et les fondamentaux qui ont conduit aux nanotechnologies telles que nous les connaissons aujourd'hui. La thèse (850+ pp.) est donc un ouvrage de grande envergure divisé en cinq parties et huit chapitres. Elle comprend également une précise introduction, un appendice, quatre chapitres historiques en guise de corps principal, une bibliographie et l'index des noms et des sujets. Les résultats obtenus sont les suivants:

- 1) Une véritable analyse et chronologie précise des résultats les plus importants dans le domaine des NNT;
- 2) Une originelle analyse historique des articles/littérature russe qui n'ont pas été examinés habituellement ;
- 3) La création d'une base pour des recherches plus approfondies sur le sujet ;
- 4) La présentation de certaines parties de mes recherches lors d'événements nationaux et internationaux ;
- 5) Matériel pour des publications.

L'introduction analyse les concepts et les définitions fondamentaux des nanotechnologies dans le contexte de la relation physique-mathématique, l'état de l'art des NNT avec une description du rôle fondamental de l'IEMN et une analyse de la recherche mondiale.

Le premier chapitre traite des techniques utilisées pour créer des nanostructures/nanomatériaux, des figures de chercheurs dans l'histoire des nanosciences et des principaux domaines de recherche dans lesquels se répartissent les nanotechnologies.

Le deuxième est consacré aux techniques de microscopie électronique qui ont rendu possible l'étude et la manipulation de la matière, en mettant l'accent sur la technologie et les principes physiques qui les caractérisent. Il est également question des progrès réalisés par les mathématiques pour décrire les nanostructures sous la forme de modèles utilisés.

Le troisième ouvre la partie spécifiquement historique de la thèse dans le cadre de la relation Physique-Mathématiques, en analysant les deux décennies entre 1950 et 1970. Je souligne ici la première observation en laboratoire de structures creuses allongées - ou nanotubes de carbone - et la perception croissante de la nécessité de concevoir des composants électroniques plus petits et efficaces.

Le quatrième chapitre couvre les décennies entre 1970 et 1990, période où le terme de nanotechnologie est né et où les microscopes à effet tunnel et à force atomique ont vu le jour. Au cours de cette période, des prix Nobel ont été décernés.

Le cinquième s'étend de 1990 à 2022 et décrit les dernières avancées des NNT. C'est au cours de ces années que le graphène et les nanotubes de carbone ont été découverts et que les NNT se sont développés sur plusieurs fronts.

Le sixième est consacré à l'IEMN et à ses trente premières années d'histoire. Dans ce chapitre, j'ai présenté les articles les plus importants publiés par l'institut, en les comparant aux moments les plus significatifs de l'histoire des NNT, afin de démontrer la qualité de la recherche effectuée et la fréquence à laquelle les résultats se sont avérés être de véritables innovations dans le paysage scientifique.

Le septième chapitre traite de l'impact des NNT sur l'environnement et des réglementations mises en place pour contenir les effets inévitables d'une nouvelle science sur l'homme et l'environnement.

Le dernier chapitre est consacré à la synthèse des conclusions et des perspectives indiquées par ce travail de thèse.

Un chapitre bibliographique exhaustif de références étudiées est également inclus. Cette thèse peut être considérée comme un ouvrage de référence particulièrement intéressant pour les physiciens, les historiens des sciences, les mathématiciens et les chercheurs en sciences et en technologies appliquées

TABLE OF CONTENTS

1950–2022: A History of Nanotechnology into Physical and Mathematical Relationship

Acknowledgements	iii
Remarks for Reader	v
Summary of the PhD Thesis	ix
Résumé de la Thèse	xi
Introduction	3
I. General Introduction	4
I.1 Preliminary Concepts	4
I.1.1 The Nano Revolution and its Concept of Paradigm	9
I.1.2 Nature and Nanotechnology	10
I.1.3 Fields of Application: a Short Description	16
I.1.3.1 Nanomaterials	16
I.1.3.2 Nanoelectronics	18
I.1.3.3 Nanomechanics	19
I.1.3.4 Nanometrology	21
I.1.3.5 Nanorobotics	22
I.1.3.6 Nanophotonics	24
I.1.3.7 Nanomedicine	24
I.1.3.8 Nanohealth	25
I.1.3.9 Nanotoxicology	26
I.1.3.10 Nanotechnology and Safety	27
I.1.3.11 Molecular Nanotechnology	27
I.2 Specific Introduction to my Ph.D. Thesis	28
I.2.1 The Purposes	28
I.2.2 General Objectives	29
I.2.3 Specific Objectives	30
I.3 Nanoscience and Nanotechnology: the State-of-the-Art	35
I.3.1 Methods and Data	35
I.3.2 The IEMN: its Role in Nanotechnology in France	37
I.3.3 Nanoscience & Nanotechnology: the Worldwide Research	42
I.3.4 On the History of Nanoscience and Nanotechnology	130
I.3.4.1 Preliminary Consideration	131
I.3.4.2 An Early History	132
II. Expected Impact	153
III. The Originality	154
IV. An Overview of the Thesis Project	156
References	160

PART I
INTRODUCTION

Chapter I

The World of Nano	173
An Outline	173
Prologue I	174
1.1 Nanoscience and Nanotechnology	175
1.1.1 Definitions	176
1.1.2 How Old is Nano	177
1.1.3 What Nanomaterials do we know?	181
1.1.3.1 Natural Nanomaterials	184
1.1.3.2 Industrial and Engineered Nanomaterials	195
1.1.4 Manufacturing Nanomaterials Techniques	198
1.1.4.1 Soft lithography	201
1.1.4.2 Physical Vapour Deposition	203
1.1.4.3 Chemical Vapour Deposition	204
1.1.4.4 Etching	205
1.1.4.5 Electron Beam (E-Beam) Lithography	204
1.1.4.6 Focused Ion Beam	207
1.1.4.7 Photolithography	208
1.1.5 Pioneers in Nanotechnology	209
1.1.5.1 Richard Feynman, Eric Drexler and a Possible Debate	207
1.1.5.2 Norio Taniguchi	225
1.2 Subdivisions of Nanotechnology	227
1.2.1 Nanomechanics	227
1.2.2 Nanoelectronics	228
1.2.3 Nanotribology	228
1.2.4 Nanophotonics	228
1.2.5 Nanomaterials	229
1.2.6 Nanochemistry	229
1.2.7 Nanophysics	229
1.2.8 Nanomedicine	232
1.2.9 Nanotoxicology	232
Epilogue I	233
References	234

PART II
EXPERIMENTAL NANOPHYSICS & MATHEMATICAL MODELLING

Chapter II

Lab Instrumentation and Mathematical Applications	247
An Outline	247
Prologue II	248
2.1 The Instruments of Nanophysics	250
2.1.1 Electronic Microscopy	252
2.1.1.1 Scanning Electron Microscope	254
2.1.1.2 Transmission Electron Microscope	263
2.1.2 Scanning Tunneling Microscopy	269
2.1.3 Atomic Force Microscopy	272
2.1.4 Nano-Chemical Imaging and Spectroscopy	277

2.2 Mathematics for Physics at the Nanoscale: Examples	283
2.2.1 Mathematical Modelling	283
2.2.1.1 Thermal Conductivity	285
2.2.1.2 Electrorheological Fluids	289
2.2.1.3 Mechanics for Carbon Nanotubes	292
2.2.2 The Drude–Lorentz Model	297
2.2.2.1 The Drude Model	298
2.2.2.2 Model Description	299
2.2.2.3 The most common Drude–Lorentz–like Models	297
2.2.2.4 The Smith Model	302
2.2.2.5 A New Point of View	303
2.2.2.6 Key Functions	306
2.2.2.7 About Complex Conductivity	307
2.2.2.8 DS Model: Quantum and Relativistic Versions	306
2.2.3 Enhanced Flow in Carbon Nanotubes	315
2.2.4 Nanoparticle Melting	317
2.2.5 Another Perspective on Thermal Conductivity	319
Epilogue II	327
References	328

PART III
A HISTORY OF NANOTECHNOLOGY RESEARCH

Chapter III	
1950–1970	339
An Outline	339
Prologue III	336
3.1 The Beginning of a New Era	342
3.1.1 1951: The Field Ion Microscope: a New Instrument	338
3.1.2 1952: The first Image of a Nanotube	343
3.1.3 1956: Molecular Engineering	355
3.1.4 1958: The First Integrated Circuit	358
3.1.5 1959: “There’s Plenty of Room at the Bottom”	356
3.1.6 1960: MOSFET and Carbon Friction Nanotubes	376
3.1.7 1962: A Junction Transistor Nanolayer–Based	380
3.1.8 1965: Moore’s Law and Chip Sizes	382
3.1.9 1966: Nanoworld in Sci–Fi Literature	387
3.1.10 1968: Layer–by–Layer Growth of Materials	389
3.1.11 1970: QSE, the Quantum Size Effect	391
Epilogue III	399
References	400

Chapter IV	
1971–1990	405
Prologue IV	406
4.1 New Instruments and Discoveries	409
4.1.1 1974: Nanotechnology: New Word for a New World	405
4.1.2 1976: Nanometric Scaled Carbon Fibres	409
4.1.3 1977: Molecular Technology, a new Concept	414
4.1.4 1980: Quantum Dots and QSE on Nanoparticles	418
4.1.5 1981: The Scanning Tunneling Microscope STM	425

4.1.6 1982: USSR Observation of Carbon Structures	433
4.1.7 1985: The C60 Fullerene	437
4.1.8 1986: AFM and “Engines of Creation”	445
4.1.9 1987: Applications of AFM	455
4.1.10 1989: Manipulating Atoms at Nanoscale	458
4.1.11 1990: Nanotechnology Press	468
Epilogue IV	477
References	478
Chapter V	
1991–2022	483
Prologue V	484
5.1 The Most Recent Applications	485
5.1.1 1991: New Discoveries on Nanotubes	485
5.1.2 1992: Mesoporous Silica	493
5.1.3 1993: CdE Semiconductor Nanocrystallites	498
5.1.4 1994: Molecular Machines	504
5.1.5 1995: Electron Emission from Nanotubes	511
5.1.6 1996: Gold Colloids	520
5.1.7 1997: Helicity of Carbon Nanotubes	520
5.1.8 1998: Carbon Nanotube Transistors	530
5.1.9 1999: Dip–Pen Nanolithography	539
5.1.10 2000: Quantum Mirages	544
5.1.11 2002: Characterization of Nanoferrites	548
5.1.12 2003: Gold Nanoshells	572
5.1.13 2004: Birth and Rise of Graphene	577
5.1.14 2006: Development of Polymeric Nanoparticles	580
5.1.15 2009: Nanotechnology and Drug Delivery	586
5.1.16 2011: Introducing FinFET Technologies	596
5.1.17 2015: Nanocrystals and Nano–Optics	607
5.1.18 2022: Recent Atom Manipulation	611
Epilogue V	619
References	620
Chapter VI	
From 1992 to 2022: A History of the Nanotechnologies at IEMN	633
An Outline	633
Prologue VI	634
6.1 Introduction: Birth of the IEMN Laboratory	636
6.2 IEMN: A History of Success in Science and Nanotechnology	641
6.3 IEMN Publications and History of Nanotechnology	647
6.4 IEMN Premieres	656
Epilogue VI	678
References	682

PART IV
NANOTECHNOLOGY & SCIENCE IN SOCIETY

Chapter VII	
Nanoparticles and Society	701
An Outline	701
Prologue VII	702
7.1 Nanoparticles and Society	703
7.1.1 Introduction	701
7.1.2 Nanotechnology: a Concept Difficult to Define?	703
7.1.3 A Review on Classification of Nanomaterials	706
7.1.4 Nanoparticles and Life	707
7.1.4.1 Interactions with the Human Body	709
7.1.4.2 Nanoparticles in Medicine	712
7.1.4.3 Nanoparticles and Environment	715
7.2 Regulations	718
7.2.1 A Brief Overview	719
7.2.2 Some Remarks about Dimensions	720
7.2.3 Some Concerns on Ethical Issues	720
7.2.4 Risks of Nano and Emerging Techniques	721
Epilogue VII	725
References	726

PART V
CONCLUDING REMARKS

Chapter VIII	
Conclusions	735
8.1 Conclusions	735
8.1.1 General Conclusions	735
8.1.2 Specific Conclusions	735

Appendix	741
Appendix 1 – Copyright Permissions	741
Appendix 2 – National and International Events	757
Appendix 3 – My Outcomes	785

Bibliography	791
---------------------	-----

Analytical Index – Names & Subjects	863
--	-----

Introduction

In this Thesis, I want to present the History of Nanoscience and the most relevant results achieved by its application, called Nanotechnology, from 1950 to 2022. Nanotechnology is one of the most important research fields in Science since it continuously brings new remarkable results in different fields, from Engineering to Medicine, to Biology. In detail, this new science has spread to encompass Nanobiotechnology, Nanomedicine and Nanobiology, Nanomanufacturing and Nanomaterials, Nanoengineering and Nanofabrication, Nanometrology, Nanotribology and Characterisation at Nanoscale. New sectors have taken hold and opened new paths for increasingly specific and advanced research such as Nanophotonics, Nanotoxicology, Nanohealth. New names for new disciplines have been created, new instruments are being designed, new laws are being written to define the legitimate uses of nanoproducts and their ethical impact on the Society. Today, it appears that the History of Nanoscience and Nanotechnology is not structured in a single issue as, sometimes, it is just briefly described in short paragraphs or abridged chapters in current literature; so far it appears that as book recollecting the most important facts of this branch of Physics is not yet existing.

My is why this Ph.D. thesis is conceived, to present such a succession of events and people under scientific, historical and epistemological points of view, in the most complete way possible, reviewing the evolution of thought and means – mathematical and physical ones, particularly – that made this revolution possible.

I. General Introduction

The twentieth century was characterised by the development of Science in the direction of the microscopic world, in a much more marked way than was observed during the previous centuries. Yet, the second half of the twentieth century saw the birth and formalization of a science that pushed even further towards an even smaller world: the nano world. The research, in this direction, has led to absolutely innovative and sometimes sensational discoveries. Virtually no field of scientific research has been left out of the Nanotechnology revolution.

The word *revolution* is not accidental, the enormous development we have been witnessing for decades in Nanotechnologies amply justifies it, especially if we consider the vastness of the fields of action of these disciplines. As I shall discuss in detail in a following chapter, a revision of the research paradigms is necessary, in terms of approach to the study, practical methodologies, hypotheses and descriptive models.

The worlds of Nanoscience and Nanotechnology have opened the doors to a new conception of the ethics of science, entirely new problems relating to the use of the products of this new technology, and to the legitimacy of certain uses.

The 21st century aims to be like that of the complete development of Nanotechnologies, from the point of view of research and epistemological approach.

In the following paragraphs of this Introduction, the reader will find the scientific definition of “nano”, the most recent definitions of Nanoscience and Nanotechnology, and the way I differentiate the branches of Nanoscience into Nanotechnology, also making comparisons with the information available. I also report there a brief history of Nanoscience and Nanotechnology, the natural observation of nanostructures and the description of the branches of Nanotechnology, before studying the subject in detail in the central chapters. To give a more complete description of the state of the art in the studies of this discipline I also review the most important Universities and Research Centres where Nano is the main area of research and development, briefly describing the IEMN – Institut d’Electronique, de Microélectronique et de Nanotechnologie – and its departments.

I.1. Preliminary Concepts

Nanoscience and Nanotechnology are becoming more and more important in almost every field of Science; in our era Nanotechnology has changed our lives and made them somehow easier and healthier since there are many applications that make use of it. Many of these have entered into our daily life even without us noticing their presence. Both Nanoscience and Nanotechnology represent a fertile research area which is involving structures, devices, systems and researchers. Nanotechnology deals with the control and manipulation of matter at nanometric dimensions. *What does nano mean?* This prefix is derived from the Greek word “nanos” – νᾶνος – meaning “dwarf”. In the world of Science this means that the measure we are taking is to be multiplied by the factor 10^{-9} ; for example, a nanometer is one billionth of a meter (10^{-9} m). It has been used since it was admitted to the International System of Units of Measures, in 1960. The following table (Table I.1) groups all the well-known prefixes as they have been stated by the International System of Units of Measures. In the last column I report the year of adoption, to give the reader an historical point of view and the possibility to understand when new definitions became necessary, because of the progress of Science.

Table I.1 The 20 prefixes for the International System of Units. According to the History of Science, prefixes adopted before 1960 existed before the International System.

Prefix		Base 10	Adoption
Name	Symbol		
Yotta	Y	10^{24}	1991
Zetta	Z	10^{21}	1991
Exa	E	10^{18}	1975
Peta	P	10^{15}	1975
Tera	T	10^{12}	1960
Giga	G	10^9	1960
Mega	M	10^6	1873
Kilo	K	10^3	1795
hecto	H	10^2	1795
deca	Da	10^1	1795
		10^0	----
deci	D	10^{-1}	1795
centi	C	10^{-2}	1795
milli	M	10^{-3}	1795
micro	μ	10^{-6}	1873
nano	n	10^{-9}	1960
pico	p	10^{-12}	1960
femto	f	10^{-15}	1964
Atto	a	10^{-18}	1964
zepto	z	10^{-21}	1991
yocto	y	10^{-24}	1991

It is important to distinguish at the very start between *Nanoscience*, which is the study of phenomena at the very small scale, and *Nanotechnology*, which implies to achieve a result that is in some way useful. Thus, the words Nanoscience and Nanotechnology do not regard the same concept.

In 1994, the *Royal Society/Royal Academy for Engineering Working Group* on the subject adopted the following definitions:

-Nanoscience is the study of phenomena and manipulation of materials at atomic, molecular and macromolecular scales, where properties differ significantly from those at larger scale.

-Nanotechnologies are the design, characterization, production and application of structures, devices and systems by controlling shape and size at nanometre scale. (Whatmore 2006).

According to other more recent definitions, Nanoscience is the study of structures and molecules on the scales of nanometers, ranging between 1nm and 100nm, while the technology that uses Nanoscience in practical applications such as electronic devices, medical applications and so on, is called Nanotechnology (Mansoori 2017).

Nanotechnology is indeed one of the most promising research fields of the 21st century. It is the skill to convert the Nanoscience theories to useful applications through observations, measurements, assembling, controlling and manufacturing matter for dedicated purposes at the nanometric scale.

The *National Nanotechnology Initiative* (NNI), in the United States, defines Nanotechnology as:

A science, engineering and technology conducted at the nanoscale (1 to 100nm) where unique phenomena enable novel applications in a wide range of fields, from chemistry, physics and biology, to medicine, engineering and electronics. In other words, Nanotechnology is the understanding and

control of matter at the nanoscale [...]. Encompassing nanoscale science, engineering, and technology, Nanotechnology involves imaging, measuring, modelling, and manipulating matter at this length scale (National Nanotechnology Initiative 2020. Retrieved via: <https://www.nano.gov>).

Both these definitions suggest that three conditions have to be kept well in mind when we are talking about Nanotechnology.

The first is a matter of scale: Nanotechnology is concerned with matter whose structures possess a size at nanometric scale.

The second issue has to do with novelty: Nanotechnology *must* deal with small things taking advantage of brand–new properties because of the nanoscale; these properties do not appear in the bulk material.

The last one, but not least, is about the interdisciplinarity of this subject since, as we shall see briefly later, almost every field of science nowadays has its debt to this new technology at small scale.

It is important to always make this distinction between Nanoscience and Nanotechnology. Nanoscience merges physics, chemistry, material science and biology manipulating materials at molecular and atomic scales, while Nanotechnology is the ability to manipulate – whatever this means, measure, assemble, manufacture, control – materials at a nanometric scale (cfr. Bayda *et al.* 2020).

What fields are embraced in Nanotechnology? Since the very first use of the word Nanotechnology, by Norio Taniguchi (1912–1999) in 1974 (Taniguchi 1974), this discipline has spread throughout almost all the disciplines available in Science. The following picture (Fig. I.1) illustrates briefly the fields with an interest in Nanotechnology; it is to be noted that both Nanophysics and Nanochemistry (where new materials are designed and new instruments studied to investigate matter at the nanoscale) can be imagined as two bridges connecting the world of Healthcare, where we can include Nature, Environment, Medicine, Biology, to the world of Engineering.

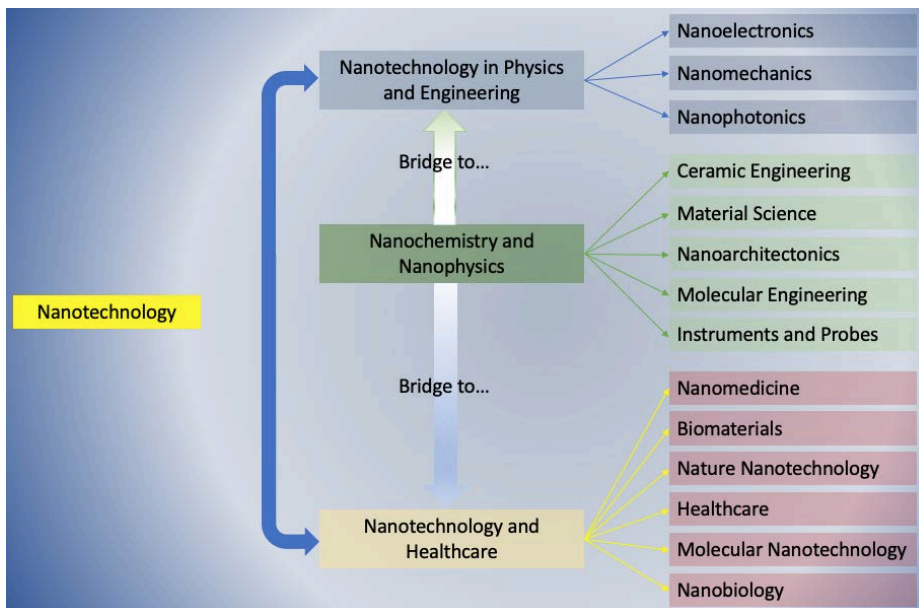

Fig. I.1 Interpretation of the interdisciplinarity of Nanotechnology. Source: AD

I set up a classification of Nanotechnology in this way, considering the fact that Chemistry (as regards the manipulation of atoms and molecules) and Physics (as regards the characterization, observation, determination of certain properties of materials), may be considered as its basis, as Chemistry and Physics are the disciplines that can be imagined to be the essential starting points for the development of these new sciences. Nanochemistry and Nanophysics, the declinations in the world at 10^{-9} m of these two sciences, are linked on one hand to engineering applications, and on the other hand to human health and the environment. As such, Physics and Chemistry of the nanoworld can be considered directly in relation with the Science of Materials and their characterization. These can be the same materials that then find application in the fields mentioned above.

Edilson Gomes de Lima (de Lima 2017) stated that the first step when organizing a subject is to sort precisely, and then clearly draw up a list of topics. By doing so, it is possible to arrive at a different classification of technological complexity, and we can therefore conclude that after having organized what is complex, we have an effective and practical simplicity. As the reader can see from the figure I showed above, there are many articulations in which Nanotechnology is developed and a systematization procedure could prove to be an endless job, as this new science is always developing towards new fields. For this purpose, it is necessary to provide for a procedure that allows to correctly place the disciplines in which Nanotechnology is articulated. Succeeding in this challenge is important, as the matter is large and being able to separate the fields of action is fundamental. The classification operation that I adopted here aims to organize and locate the specific areas of Nanoscience and Nanotechnology. These two sciences bring together multiple disciplines, and a classification is of extreme importance.

Separating each area of Nanotechnology from another is very difficult, because sometimes they are intertwined in an inextricable way and there is not only one field involved in research.

Consequently, thinking of Chemistry as the Science that tells us *how things happen* and of Physics as the Science that tells us *why things happen*, I have chosen these two disciplines as the starting point, in the context of the nanoworld, with the name of Nanochemistry and Nanophysics, respectively. Then I decided to connect the part relating to Physics to the Engineering field, as the affinities that bind these two fields are many, starting with the equations that are used for setting up and solving problems, for example. Physics and Engineering deal, among others, with problems relating to the transport or diffusion of matter, equilibrium, statics, dynamics of rigid or variable mass bodies. Chemistry, Medicine and, consequently, health, deal with how substances interact first with each other and then with the organisms into which they are introduced or come into contact with and the beneficial or harmful consequences they bring. The division, however, cannot stop at this level because the description would still appear too general. In fact, there are very different fields in which nanochemistry and nanophysics can be articulated. Thinking, in particular, of the technological aspects of Nanoengineering and Nanophysics, I have combined fields such as Nanoelectronics, Nanomechanics and Nanophotonics with these disciplines. On the other hand, I have naturally combined Nanochemistry with Biomaterials, Nanomedicine, Nanobiology, Molecular Nanotechnology and so on. Although it is not possible to think of each of these areas as circumscribed and independent disciplines, as the influences of each are continuous, I have identified Materials Science, Ceramic Engineering, Molecular Engineering as the subjects in which the presence of Chemistry and Physics is more markedly in the same proportion. These areas constitute a region between the two that I have previously described.

Making a diagram of this type regarding Nanotechnology, from a practical point of view, is a challenging and long-term task that, once completed, is going to allow the disciplines that concern the nanoworld to be quickly framed.

The diagram I propose is only one of the different choices possible. In fact, in 2008, the *Australian Bureau of Statistics* published a possible alternative known as the *Australian and New Zealand Standard Research Classification* (ANZSRC). The following are included in the group that covers Nanotechnology:

- Molecular and Organic Electronics;
- Nanobiotechnology;
- Nanomedicine;
- Nanoscale Characterisation;
- Health and Safety aspects of Nanotechnology and Nanotoxicology.

Also, this group can be divided into more detailed sub categories like:

- Environmental Nanotechnology;
- Molecular and Organic Electronics;
- Nanobiotechnology;
- Nanoelectromechanical Systems;
- Nanoelectronics;
- Nanofabrication, Growth and Self Assembly;
- Nanomanufacturing;
- Nanomaterials;
- Nanomedicine;
- Nanometrology;
- Nanophotonics;
- Nanoscale Characterization;
- Nanotoxicology, Health and Safety;
- Nanotechnology not elsewhere classified.

It is interesting to note also that a new vocabulary is flourishing, following the new fields that come to light because of the continuous spread of Nanotechnology. Here I present a list (Table I.2), which will continue to be updated, of what I consider to be the “Nano” words.

Table I.2 These 84 “nano” words hardly cover all the fields of Nanotechnology and new words are expected to arrive as the research explores new paths and new discoveries are made. Adapted by Ewards 2006.

Nanoage	Nanocrystalline	Nanomanufacturing	Nanorobotics
Nanoarray	Nanocube	Nanomaterial	Nanorod
Nanoassembly	Nanodevice	Nanomechanics	Nanoscale
Nanobacteria	Nanodivide	Nanomedicine	Nanoscience
Nanobiologist	Nanodomain	Nanomembrane	Nanoscope
Nanobiology	Nanodot	Nanometer	Nanosecond
Nanobiomedicine	Nanodrug	Nanomicelle	Nanoshell
Nanobiotechnology	Nanoelectromechanical	Nanomotor	Nanostructured
Nanobot	Nanoelectronics	Nanoparticle	Nanostructures
Nanocapsule	Nanoencapsulation	Nanoparticulate	Nanoswarm
Nanocar	Nanofabrication	Nanophase	Nanosystem
Nanocassette	Nanofibers	Nanophotonics	Nanotechnology
Nanocatalyst	Nanofilter	Nanophysics	Nanotool
Nanochemistry	Nanofluidics	Nanoplatelates	Nanotoxicology

Nanoclay	Nanohealth	Nanoporous	Nanotransistor
Nanocoating	Nanolayer	Nanopowder	Nanotribology
Nanocomponent	Nanoliter	Nanoproduct	Nanotube
Nanocomposite	Nanolithography	Nanoreactor	Nanotweezers
Nanocconnection	Nanomachine	Nanoreplicator	Nanowire
Nanocosm	Nanomagnetic	Nanoribbon	Nanoworks
Nanocrystal	Nanomanipulator	Nanorobot	Nanoworld

This a list is waiting for new words and does not take into account the companies whose name contains the prefix “nano”. Certainly, the proliferation of a science full of promise will lead to the enrichment of the vocabulary with new nano terms to come.

1.1.1. The nano Revolution and its Concept of Paradigm

The advent of nanoscience and its consequent applications in nanotechnologies have led to a real revolution in the scientific world, a revolution that, on one hand, has led to extraordinary and unexpected results, as it is not possible to imagine the same results with bulk materials, on the other hand, indeed, it has profoundly changed the direction of research, having proposed itself as extremely transversal. The image of the “dwarf” world has entered daily life through the products that are offered to the users with ever greater accessibility. I believe that it is possible to say that, if in the years 1950 to 2000 the foundations and the first structures of this scientific revolution were laid, from 2000 to 2020 we witnessed the full flourishing of the nanoworld. This is witnessed by the discoveries, progress, availability of results, the number of publications which, at various levels – from the strictly technical, in the various fields, to the more simply popular – multiply with a trend that well conveys the idea of how much this science has established itself, and is consolidated today. If, from 1950 to 2000, we can speak of nanoscience as a scientific revolution which has dragged solid state physics even more towards the quantum world, thanks to the quantum behaviour of the particles involved, precisely by virtue of their size, from 2000 on we can affirm that we are in the midst of the post–revolutionary development.

This concept of revolution perfectly fits one of the hypotheses that Thomas Kuhn posed in his 1962 essay *The Structure of Scientific Revolutions* (Kuhn 1962):

[...] If I am right that each scientific revolution alters the historical perspective of the community that experiences it, then that change of perspective should affect the structure of postrevolutionary textbooks and research publications.

Based on what was established by Kuhn, regarding the value and historical collocation of a new theory characterized by special connotations – and nanoscience enters by right into a similar definition –, when the theory itself appears on the scientific landscape, it rarely constitutes a simple addition to the amount of knowledge already consolidated. The assimilation of the new concepts involves, according to Kuhn, a reconstruction and rethinking of what is known through a slow process, that certainly cannot be accomplished by a single person, or in an extremely short period of time. Again, the paradigms of science, as they were previously known, change by definition and meaning. It is known that, in Kuhn’s words, it is possible to speak of a paradigm when an acquired knowledge system possesses two fundamental characteristics. First, it is innovative and unprecedented enough

to attract significant groups of researchers, also it must be open-ended, so that it can leave a number of unsolved problems available to scientists.

Nanoscience and nanotechnology fully meet these requirements as they answer a series of unsolvable problems in the macro world and, at the same time, they are opening many doors of a research field that seems to be unstoppable, and gradually moves its limits further, to the point of almost having none, apparently.

In nanotechnology, the founding and iconic paradigm is linked to the affirmation that the properties of materials that allow their most innovative applications emerge thanks to their nanometric size. This fits in with the parameters set by Kuhn, as it possesses the qualities of innovation and extraordinary interest together with the ability to open new horizons in research. Not only that, but the declination of nanoscience in all branches of the nanoworld has made it possible to coin new paradigms within each of the fields of application of nanotechnologies. I am going to discuss this point in detail within the historical chapters, as new discoveries and applications in the different articulations of nanoscience are described.

1.1.2. Nature and Nanotechnology

Since the most ancient times, man has been inspired by Nature to create materials and devices that have allowed him to go beyond his own limits. Even in the case of Nanosciences and Nanotechnologies, Nature has constituted for scientists the fundamental model from which to draw inspiration to engineer the products that are used today, thanks to the properties that they exhibit at the nanometer size.

The history of the universe began, according to the Big Bang model, about 14 billion years ago while the Solar System seems to have formed around 4.6 billion years ago, when the universe was about 65% of its current size. Soon after, according to the dates that are accepted today, the formation of the Earth took place. Today, nanoparticles have been observed in Nature, so it is logical to assume that while the universe itself was, and still is, expanding the nanoparticles have been, and are still, well present within it. Since it is known that the properties of nanoparticles that make them so important manifest themselves precisely because of the particle size, it can be hypothesized that Nature itself continues to design structures of this type, as they could prove to be fundamental in the continuation of the evolution of life or in the formation of new worlds.

Here I will describe some of the most notable examples found in Nature, such as the feet of the gecko lizard, the spider webs and the water-repellent leaves of the lotus.

The gecko is a small reptile that lives in coastal or sub-coastal areas where winters are generally mild, and is known for its extraordinary ability to adhere to the smoothest surfaces. To date, only PolyTetraFluoroethylene (PTFE) – named Teflon, or Syncolon – appears to be the only material to which this animal cannot adhere. The gecko adheres to the surfaces without resorting to adhesive secretions on the legs but, rather, through a series of setae placed on the lower part of the legs themselves. Studies on the adhesive capacity of these structures have shown that they are Van der Waals interactions that allow the animal to climb on and remain attached to almost any surface, however it is oriented, thanks to the extreme subdivision of the *setae* themselves (Fig. I.2).

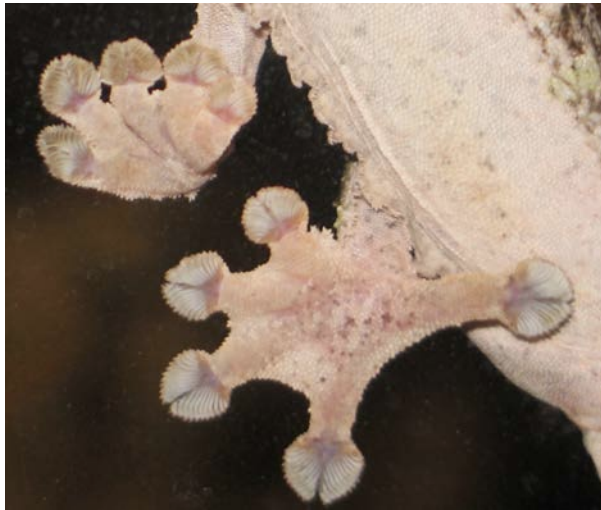

Fig. I.2 Image of the *setae* under the feet of a gecko attached on a glass panel. <https://upload.wikimedia.org/wikipedia/commons/d/d6/Setae.png>. Source: unknown author, Public Domain

There is a definite hierarchy in the structures that make up the gecko's legs. The macro-, meso-, micro- and nano-sized structures of the paws have been studied in detail: each of the five toes carries about 20 rows of sticky and very tight *lamellae*, each *lamella* is organized in "setal" arrays consisting of thousands of *setae* for a total of about 200,000 *setae* for each toe, each *seta* carrying hundreds to 1000 *spatulae* at the ends. The following pictures, taken with the help of the electron microscopy show the fascinating complexity of the structures Nature gave to this lizards (Fig. I.3).

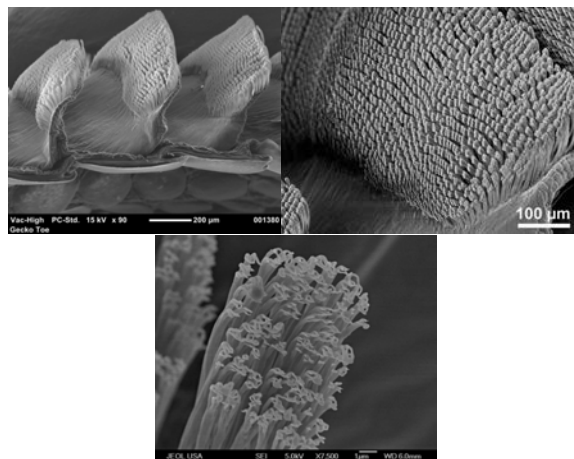

Fig. I.3 From left to right: the *lamellae* under each toe of a gecko's paw, the array of *setae*, the *spatulae* at the end of each *seta*. Images available at <https://geckskin.umass.edu/images> for educational and non-commercial use only

The study of the hierarchical structure present on the legs of the gecko has allowed the creation of extremely interesting materials, including the so-called gecko tape, an experimental material the surface of which is covered with nanostructures, in order to maximize the contact area with other interfaces. Deepening the study of how this lizard can remain attached to the smoothest surfaces, and how it is able to move thanks to the natural nanostructures it is equipped with, are challenges that sometimes lead not to solutions, but to further rather complex problems. For example, the friction force F_L (which we can indicate as lateral force) and the adhesion force F_N (which we consider a normal force) must obviously be added vectorially on each of the *spatulae* to obtain the total force acting on the gecko. But the body, the legs, the fingers, can point in different directions, if we observe an animal attached to a wall, and therefore the sum:

$$F(\theta) = [F_N \sin \theta + F_L \cos \theta] \quad (I.1)$$

on the right side of the equation is what proves that adhesion and frictional forces together allow the calculation of the net force, over all the angles θ is not an easy task to perform, so the calculation of both F_L and F_N is not easy since both these components depend on the angle too (Tian *et.al* 2006).

Able to withstand tearing or winds whose speed is equal to or greater than that of a hurricane, the natural fibres the spider webs are woven with, are a marvel that hardly leaves you indifferent. The web is made up of nanofibers that can be stretched two to four times their original length, and which are also light and insoluble in water. As it regards their specific strength, they are even stronger than steel: they are five times stronger than a steel rod of the same diameter. The Darwin's bark spider is said to produce a fibre that is stronger than Kevlar (fig. I.4).



Fig. I.4 Observing a spider's web not only allows us to observe its incredible aesthetic appearance, but also lets us appreciate what a marvel it is from a biological point of view, as the fibres were the most resistant known, until the advent of carbon nanotubes. <https://commons.wikimedia.org/wiki/File:SpiderWeb.jpg> Source: Michael Hartl. Public Domain

In the oriental tradition, one of the few flowers that have a fundamental importance is the lotus flower. In Indian symbolism, for example, the Lotus (*nelumbo nucifera*) is a sign of purity because the plant is able to remain intact under the action of water and mud. From

the scientific point of view, the lotus leaf is classified as a super-hydrophobic material. It is known that a surface is hydrophobic when a drop of water placed on its surface forms a contact angle greater than 90° . If the contact angle is greater than 150° , the surface is said to be super-hydrophobic. The following picture (Fig. I.5) shows briefly the situations possible, when a water droplet lies on a surface.

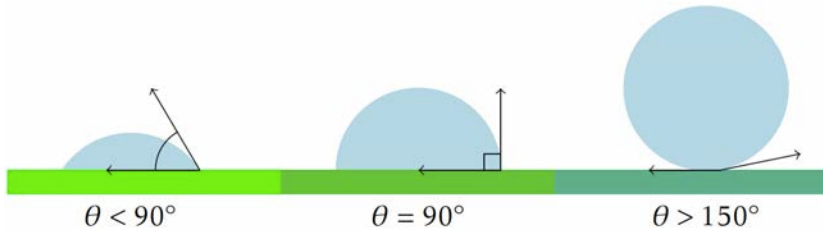

Fig. I.5 On the left, a non-hydrophobic situation, with a contact angle lesser than 90° ; in the centre the limit situation, above which we speak of a water-repellent (hydrophobic) surface; on the right, the super-hydrophobic surface situation. In the latter case, the drop of water is practically supported, almost entirely, by the surface. Source: AD

Such a situation of super-hydrophobic surface can be observed in the case of the Lotus leaves. As the following pictures show (Fig. I.6), these leaves behave to repel water droplets.



Fig. I.6 On the left, the behaviour of water on a Lotus leaf. Detail of a picture available at <https://commons.wikimedia.org/wiki/File:LotusEffect1.jpg>. Source: Ralf Pfeifer, CC BY-SA 3.0 License
On the right, a computer rendering of a lotus leaf surface.
https://en.wikipedia.org/wiki/Lotus_effect#/media/File:Lotus3.jpg. Source: William Thielicke, CC BY-SA 4.0

When a drop of water falls on a super-hydrophobic leaf, the high surface tension of the water makes it take on a practically spherical shape, this is because, from simple geometry considerations, the sphere is the solid that minimizes the lateral surface and by doing so, the energy at the solid-liquid interface is minimal. The nanostructures on the surface are responsible for the super-hydrophobic behaviour of the leaf: since the adhesion forces between the drop and the leaf are extremely low, what we can observe is a capacity of the Lotus leaf to be self-cleaning. Water repellence facilitates the removal of particulate

depositions, like dust or spores, and results in the plant surfaces' purification via rain, fog or dew. (Neinhuis and Barthlott 1997).

More specifically, the lotus leaf shows superior properties, compared to those of other plants, thanks to the combination of micro and nanostructures, the geometry of which is optimized, as well as a waxing of the cuticular surface of unique chemical composition. The upper part of the leaf is structured in *papillae* of different height and unique in shape, their apical end is not spherical, but rather ogival in shape. The density of the lotus *papillae* is the greatest, measured in comparison to other aquatic plants, but the diameters of the *papillae* themselves are much smaller in order to minimize the area of contact with the water droplets. The following SEM pictures (Fig. I.7) depict examples of the structures coating some leaves, to appreciate the difference among a lotus leaf and the others.

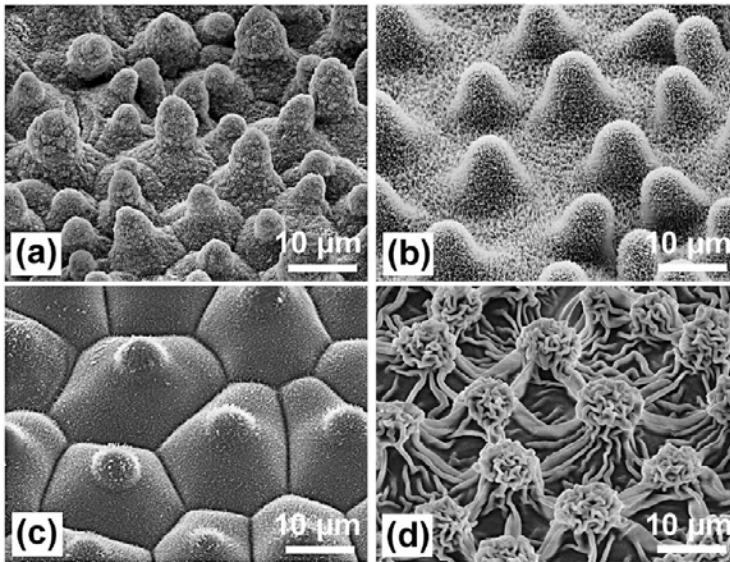

Fig. I.7 SEM images of the *papillae* on the surface of *Nelumbo nucifera* (Lotus) (a), *Euphorbia myrsinites* (b), *Colocasia esculenta* (c) and *Alocasia macrorrhiza* (d). The highest density of *papillae* belongs to lotus. The image allows us to appreciate the difference in height. Source: Ensikat, Ditsche-Kuru, Neinhuis, Barthlott 2011, Open Access article. Unrestricted use: <http://creativecommons.org/licenses/by/2.0>

Due to the surface tension that limits the deformation of the water droplets, these only touch the highest *papillae* when they are in contact with the leaf and at rest, i.e. they are sliding away. This is easily understood, as the pressure exerted on the leaf is solely due to the weight of the water. However, if the pressure exerted were to be greater, think of a drop of water falling due to the rain, part of the water itself wedges itself more into the interstices of the structures, forming a meniscus at the superhydrophobic wax tubules coating. A repellent force is caused because of the deformation of the non-wetting droplet surface due to surface tension. As the droplet water retracts the contact areas decrease in number and the contacts between the water surface and the *papillae* are released one by one. Before losing contact between the droplet and the leaf, only few of the *papillae* will still be in an adhesive state.

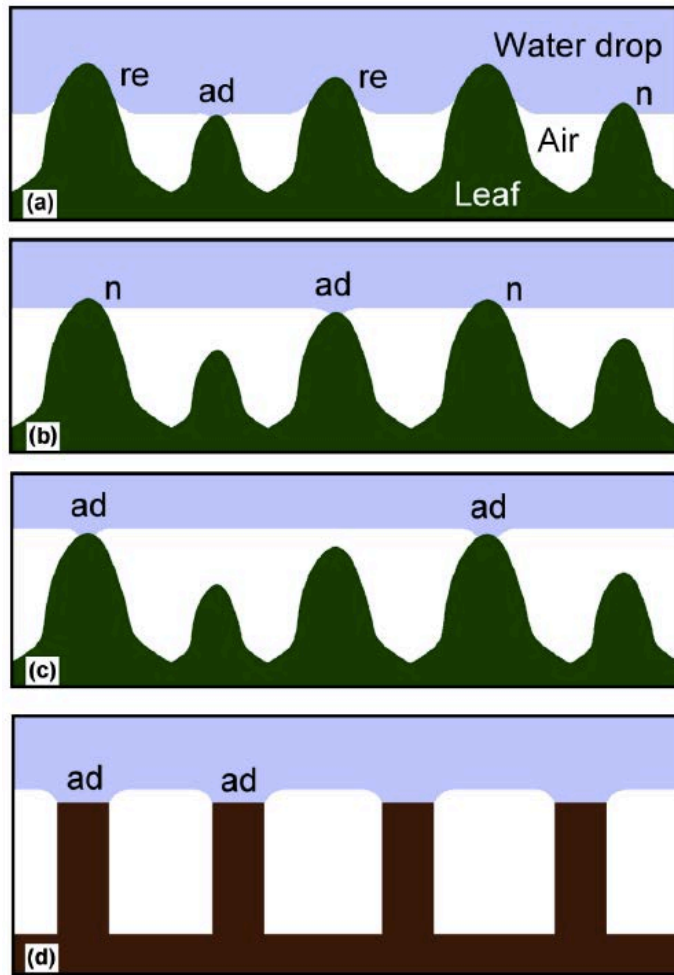

Fig. 1.8 The interpretation of the contact phenomenon between a water drop (blue) and the surface of lotus leaves (green). With the action of a moderate pressure, water can wedge between the structures but leaving a layer of air – in white in the picture – between the droplet and the epidermis. (a) The super-hydrophobic surface exerts a repellent force (“re”). When the water recedes, there is a progressive loss of contact (b and c). When the meniscus is flat the force is neutral (“n”). Just before the separation, an adhesive force – the almost horizontal *papilla* tip – due to the small surface involved, this can be considered horizontal –. The last situation shows what happens in case of artificial super-hydrophobic structures. Source: Ensikat, Ditsche-Kuru, Neinhuis, Barthlott 2011, Open Access article. Unrestricted use: <http://creativecommons.org/licenses/by/2.0>

If we try to mimic Nature engineering an artificial super-hydrophobic we achieve a result as the one shown in Fig.1.8 (d). There are structures of the same height, something that does not occur in nature, and more adhesive forces appear all at the same time before the detachment of the droplet, giving a global stronger adhesion effect than the natural one (Ensikat, Ditsche-Kuru, Neinhuis and Barthlott 2011).

1.1.3. Fields of Application: a Short Description

In the following sections I want to briefly describe the most important subjects in research about the nanoworld, to give the reader some insights about the different fields where Nanotechnology is applied. The historical details that led to the development of these fields are the subject of the core chapters of this thesis.

1.1.3.1. Nanomaterials

According to ISO/TS 80004–1:2015 (ISO/TS 2015), the document setting the standards on Nanotechnologies¹, we call a *nanomaterial* a “material with any external dimension in the nanoscale or having internal structure or surface structure in the nanoscale”. Again, we call *nanoscale* the length range from 1nm to 100nm. A given nanomaterial may belong to two different categories. The first category is the one grouping *nano-objects*, i.e. discrete pieces of materials, while the second groups the so-called *nanostuctured materials*, whose internal or surface structure is on the nanoscale.

Earlier, on October the 18th 2011, the European Commission (EC) adopted a different definition of nanomaterial. This is:

A natural, incidental or manufactured material containing particles, in an unbound state or as an aggregate or as an agglomerate and for 50% or more of the particles in the number size distribution, one or more external dimensions is in the range 1nm – 100nm. In specific cases and where warranted by concerns for the environment, health, safety or competitiveness the number size distribution threshold of 50% may be replaced by a threshold between 1% to 50% (Rauscher *et al.* 2019).

There are three ways of making so-called nanomaterials: they can be imagined, designed and then artificially manufactured to have certain properties and to have at least one dimension below 100nm (NIOSH² 2013), or they may appear randomly, or they already exist in Nature.

Today there are different methods to obtain engineered nanomaterials, each method is distinguished from the others because of operative conditions to get the desired shape, sizes, chemical composition. According to the *Health and Safety Executive* (HSE), a British association whose mission is to reduce work-related death, injury and ill health, there are six large manufacturing categories regarding artificial nanomaterials (NIOSH 2013).

- Gas phase processes, including flame pyrolysis, high-temperature evaporation and plasma synthesis;
- Chemical Vapor Deposition (CVD);
- Colloidal or liquid phase methods;
- Mechanical processes including grinding, milling, and alloying;
- Atomic and Molecular Beam Epitaxy;
- Dip-pen lithography.

The reader interested in the details of these processes can find a more detailed description of the methods in the Appendix of this thesis.

¹ According to the website <https://www.iso.org/standard/68058.html>, retrieved October 30, 2020, the standard was reviewed and confirmed in 2019 so the current version available still stands.

² Acronym for National Institute for Occupational Safety and Health.

Artificial and engineered nanomaterials are some fullerenes, quantum dots, nanowires, nanorods, carbon nanotubes, graphene.

Some other nanomaterials may be produced incidentally as side products of industrial processes or mechanical processing. Randomly appearing nanomaterials include vehicle engine incomplete combustion exhausts, welding smoke, solid fuel combustion products, cooking and heating. Ultrafine particles are those nanomaterials that incidentally appear in the atmosphere and are unintentionally produced during intentional processes. They are accounted as air pollution.

Nature has been producing nanomaterials since ancient times. The structure of foraminifera and viruses, the wax crystals that cover a lotus leaf, spider–mite silk, the blue hue of tarantulas, the gecko feet, some butterfly wing scales, natural colloids, paper, cotton, corals are examples of natural organic nanomaterials.

There also are natural inorganic nanomaterials. We can observe them as crystals growing under different conditions from the Earth's crust. Clays display complex nanostructures due to anisotropy – nanoclays – and volcanic activity can give rise to opals that behave like photonic crystals, due to their nanoscaled structure (Fig. I.9). Fires, volcanic ash, ocean spray may be sources for natural inorganic nanomaterials.

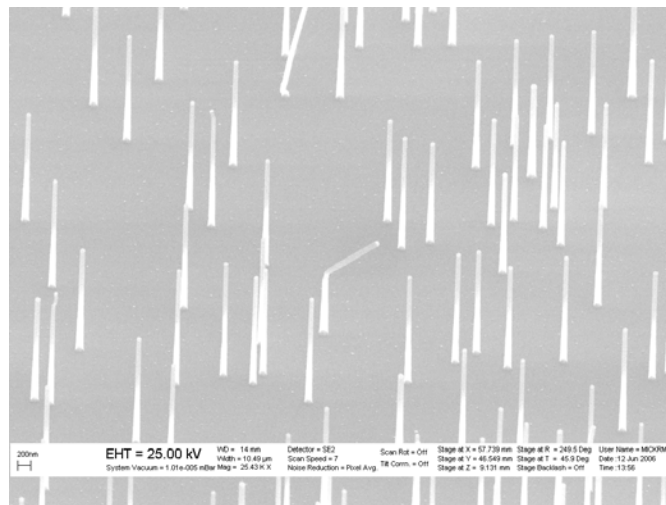

Fig. I.9 A SEM–acquired picture of Epitaxial Nanowire Heterostructures, Image by Christian Mølhave, <https://commons.wikimedia.org/w/index.php?curid=1386053>. Public Domain, CC BY 2.5 License

In any case, Nanomaterials are not something brand new. They have been prepared and used by mankind for ages. It is the comprehension, the understanding of certain materials as nanostructured ones that is relatively recent and it has been made possible by the invention/improvement of laboratory tools that can give information at the nanoscale.

As I shall discuss in detail later, some remarkable examples of Nanomaterials used in history are the following.

- The ruby red colour in some ancient glass is due to gold and silver nanoparticles in the glass matrix.

- Some medieval pottery is covered with a decorative glaze or a metallic film, called “luster”, this film contains spherical metal nanoparticles that give rise to particular optical properties (Fig. I.10).



Fig. I.10 “Coppa a rilievo con la Maddalena”, Italian maiolica dish 1530–1540. Source: Sailko (nickname) <https://en.wikipedia.org/wiki/Lustreware>, Public Domain, CC BY 3.0 License

- Carbon black is used in tires to increase their useful life and as a pigment to give them the black appearance.
- The “wootz” steel prepared in India about 1500 years ago was used to manufacture strong and long-lasting sharp swords. Nowadays electron microscopy shows that carbon nanotubes are included inside the blade matrix.

1.1.3.2. Nanoelectronics

Nanoelectronics is the use of Nanotechnology in electronics, covering different devices and materials. All of these possess the common feature that they are so small that interatomic interactions and quantum mechanical properties cannot be neglected and must be seriously taken into account.

The nano world entered the field of electronics sixty years ago. In 1960, the Egyptian engineer Mohamed Atalla (1924–2009) and his Korean colleague Dawon Kahng (1931–1992) at the Bell Laboratories fabricated the first Metal–Oxide–Semiconductor Field–Effect Transistor (MOSFET) with a gate oxide thickness of 10nm and a gate length of 2 μ m (Sze 2002). Two years later, again Atalla and Kahng realized a nanolayer–base metal semiconductor junction transistor with gold (Au) thin films 10nm thick (Pasa 2010).

In 1987 the Iranian engineer Bijan Davari and his team from IBM obtained the first MOSFET with a 10nm gate oxide thickness, through wolfram–gate technology (Davari *et*

al. 1987). The Fin Field–Effect Transistor, or FinFET, was the first to enable scaling multi–gate MOSFETs below 20nm gate length, it being a three–dimensional and non–planar double–gate MOSFET (Colinge 2008). Technology evolved rapidly, and in 1999 the limits of what can be called the principles of MOSFET were tested using a CMOS, Complementary Metal–Oxide Semiconductor, with a diameter of 18nm (roughly 70 atoms placed side by side) developed in Grenoble, France, at the Laboratory for Electronics and Information Technology. CMOS was first developed by Chih–Tang Sah and Frank Wanlass (1933–2010) at Fairchild Semiconductor, the results were published in 1963 (Sah and Wanlass 1963).

Since the 1970s CMOS logic has been widely applied in watches and calculators (Semiconductor History Museum of Japan 2019). The French work, in 1999, was not just a research experiment to move forward CMOS technology, but a proof of how this technology was now working and how close technology was to working on a molecular scale (Gilder 1990). In 2006, a 3nm MOSFET was successfully developed by researchers from the Korea Advanced Institute of Science and Technology, KAIST, and the National Nano Fab Center, it was based on Gate–All–Around, GAA, FinFET technology (Lee *et al.* 2006). Recently, in the 2010s, the commercial production of nanoelectronic semiconductor devices started (Fig. I.11). The Taiwan Semiconductor Manufacturing Company, TSMC, began a production of a 16nm FinFET process (Kuhn 2018). In 2017, TSMC announced new plans for the commercial production of a 3nm process by 2022 (Armasu 2019. Retrieved via: www.tomshardware.com).

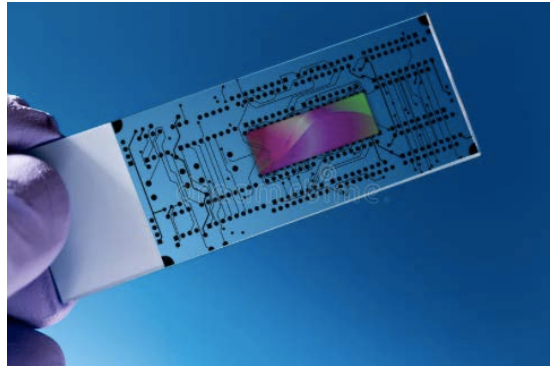

Fig. I.11 The new way to integrate the full functions of a laboratory on a nano chip: it is called a Lab–On–Chip. <https://www.dreamstime.com/stock-photo-lab-chip-loc-device-integrates-laboratory-functions-nano-image44548622>. Public Domain, Creative Commons Zero (CC0) License

I.1.3.3. Nanomechanics

Nanomechanics focuses on the mechanical properties of engineered nanostructures and nanosystems such as the ones containing nanoscale components of importance. Such devices may be nanomachines, nanoparticles, nanopowders, nanowires, nanorods, nanoribbons, nanotubes and carbon nanotubes as well and boron nitride nanotubes, nanoshells and nanomembranes, nanocoatings and nanocomposite or nanostructured materials, nanomotors... (see Fig. I.12) Nanomechanics is based on general principles and specific ones. The first general principle of mechanics that must be taken into account is the

principle of conservation of total energy, which is valid when the system is subject to forces derived from potentials that depend solely on the position. The second general principle deals with conservation of linear momentum (if the total force is zero then linear momentum is conserved) and angular momentum (if the total torque is zero then the angular momentum is conserved). Also, the integral Hamilton's principle for monogenic principles applies, as a general principle. Last but not least, as general principles, symmetry principles of Physics must be considered.

As nanoparticles are quite small, nanomechanics must take into account a series of other effects. First the discreteness of the object whose size is comparable to the atomic distances, then the degrees of freedom in the object, then the thermal fluctuations. Also, entropic effects and quantum effects are to be considered.

Novel properties of nanoscaled objects appear because of the dimensions of the particles and are not present in the macroscale objects or bulk materials. The smallness of particles gives rise to several surface effects due to the high surface–area–to–volume ratio, so affecting properties like the melting point, heat capacitance and so on. Discreteness serves for the dispersion of mechanical waves in solids and some special behaviour of basic elastomechanics solutions at small scales.

Degrees of freedom are the reasons for thermal tunnelling of nanoparticles through potential barriers, such as the cross diffusion of liquids and solids. The Brownian motion of nanoparticles is due to the smallness and the thermal fluctuations. Thermal fluctuations and entropy at the nanoscale give rise to phenomena like super elasticity, entropic elasticity or other exotic kinds of elasticity. Quantum effects determine novel electrical, optical and chemical properties of nanostructures and are of great importance for areas of Nanotechnology such as nanoelectronics and advanced energy systems.

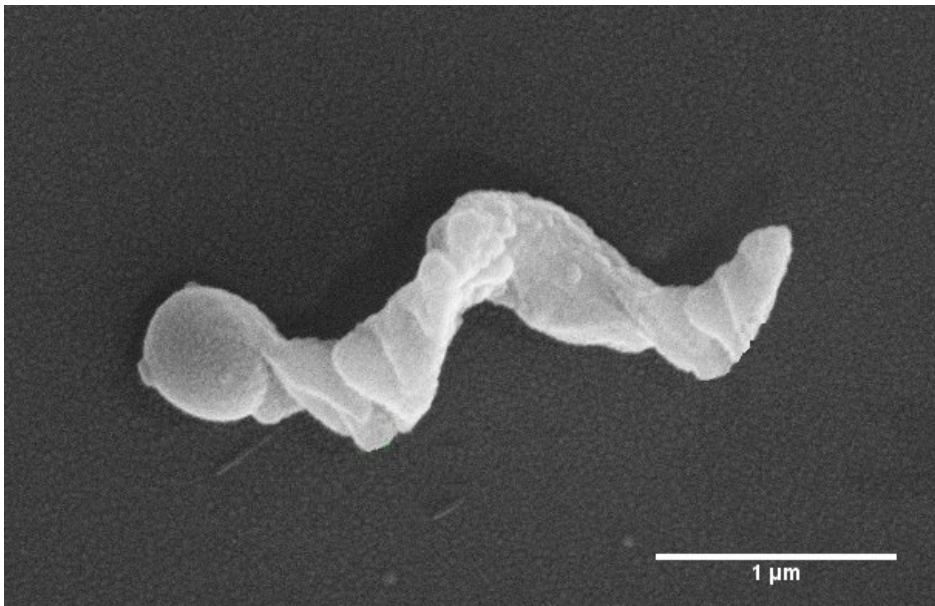

Fig. I.12 SEM image of a helical nanomotor. Image by “Xortical”.

https://en.wikipedia.org/wiki/Nanomotor#/media/File:Helical_nanomotor.jpg. Public Domain CC BY–SA 4.0 License

1.1.3.4. Nanometrology

According to the Nanotechnology–Nanoscience Glossary, Nanometrology is “the science of measurement at the nanoscale level” . As Nanotechnology is continuously developing, Nanometrology is fundamental as it allows the analysis of nanomaterials and nanosized devices to check their accuracy and reliability. There are several fields where Nanometrology is important. Measurements of length and size are the first ones involved – and it must be kept in mind that uncertainty is below 1nm when measuring dimensions in the nanometric size –, including chemical composition, nanoparticle concentration, force, mass electrical properties and so forth.

As Nanotechnology is developing at a very fast rate, Nanometrology being a very large industrial sector, there is no reason to doubt it will also continue rapid growth, because of the need for accurate and precise control of the dimensions of nanoobjects. In fact, dimensions play a decisive role in the properties of nanomaterials. Some of these properties are the following.

- The phenomenon of atomic diffusion becomes a very efficient mechanism of mass transfer when we are operating at the nanoscale.
- A crystal size smaller than the free mean path of electrons reduces conductivity and the temperature coefficient through grain boundary scatter.
- Nanosurfaces and nanoparticles modify the phonon spectra.
- Band gap changes cause blueshifts in luminescence signals of nanosized semiconductor particles.
- Tribological properties are absolutely different when the interacting materials are nanosized and this reduces friction and wear in microelectromechanical systems (MEMS).

The following table I.3 summarizes the properties of nanomaterials and the correlated applications.

Table. I.3 Properties of nanomaterials and their applications.

Property	Applications
High surface-to-volume ratio	Catalysis, solar veils and gas sensors
Low percolation threshold	Conductive materials and sensors
Increasing hardness/wear resistance with decreasing grain size	Hard coatings and protective layers
Improved resistivity with decreasing grain size	Electronics, passive components and sensors
Improved atomic transport kinetics	Batteries and hydrogen storage
Low melting and sintering temperature	Materials processing and low-temperature sintering materials
Improved reliability and fatigue resistance	Electronic components and MEMS

In real life systems, nano-objects usually show characteristic size distribution, like grain size in polycrystalline materials and particle size in particulate matter (Fig. I.13). The size distribution may result in serious problems when the properties of nanosized particles are investigated. All the properties that appear when a bulk material is reduced down to nanoscale may disappear if the particle dimensions are not correct, i.e. if they are bigger than what is required for the particular application. Thus, it is important to control the

dimensions with the maximum accuracy and check the grain size distribution when manufacturing the nanomaterials (Herrera–Basurto and Simonet 2013).

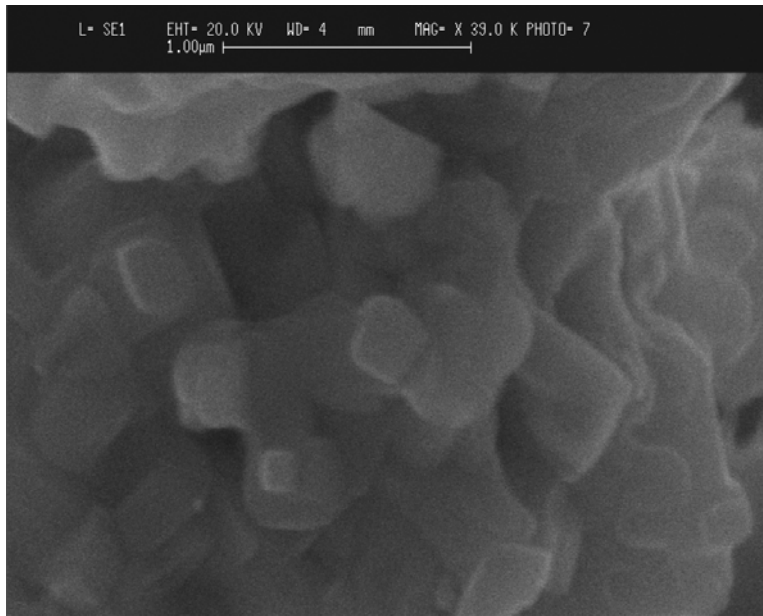

Fig. I.13 SEM image of nickel oxide with legenda. Source: AD, Master Thesis in Physics, University of Ferrara, Italy

1.1.3.5. Nanorobotics

One of the most challenging and exciting goals of Nanotechnology is Nanorobotics, i.e. creating robots or machines whose dimensions are at or close to a nanometre (Sierra, Weir and Jones 2005). Nanorobotics thus concerns the engineering of designing and building nanorobots (Ignatyev 2010). Nanorobotics carries different definitions throughout the literature.

These machines/robots allow precise interactions with objects at nanoscales, or manipulate things at nanoscale resolutions. Microscopy or scanning probe microscopy already work down to a scale of 10^{-9} m, so Atomic Force Microscopy could be considered as a nanorobotic instrument that performs nanomanipulations. From this point of view, macroscale machineries like robots or microrobots can be considered to belong to nanorobotics if they can move objects that are nanosized.

Usually, the field of nanorobotics can be divided into two main areas.

The first area deals with the design, simulation, control and coordination of robots with nanoscale dimensions. Nanomachines/nanorobots are objects with dimensions at or below a micrometre, i.e. 10^{-6} m, and made of assembled nanoscaled components. According to the definition, the dimension of the parts range between 1nm and 100nm. The model to start from is nature, because biological nanorobotic systems exist and provide evidence that such systems are possible (Requicha 2003).

The second area deals with the manipulation and/or assembly of nanoscale components with macroscale instruments or robots.

The use of nano-object manufacturing techniques such as photolithography, combined with nanoelectronics and the development of new biological materials, allows for the creation of nanorobots for medical purposes, the area of greatest interest for these new devices. The possibility to functionalize nanomaterials, in order to release the active ingredients of medicines in a localized and specific way, is the main feature that makes Nanotechnology and nanorobots of great medical interest. The diagnosis of diseases and the intervention on patients in a non-invasive and absolutely punctual way can be the next step towards a new medicine: the doctor/surgeon no longer physically intervenes on the body but remotely controls the device. This is a desire that is often mentioned, a very strong idea, not impossible to realize, but which today remains in the future. Therefore, it will be one of the most popular research fields in Nanotechnology in the coming years. Another idea involves the use of nanorobots as surgeons, injected into patients and who carry out their functions independently at the cellular level. Obviously, such a type of device will have to be engineered so as not to self-replicate, as such a feature increases the complexity of the nanorobot itself. Other useful functions that can be implemented include tissue repair, such as supporting white blood cells.

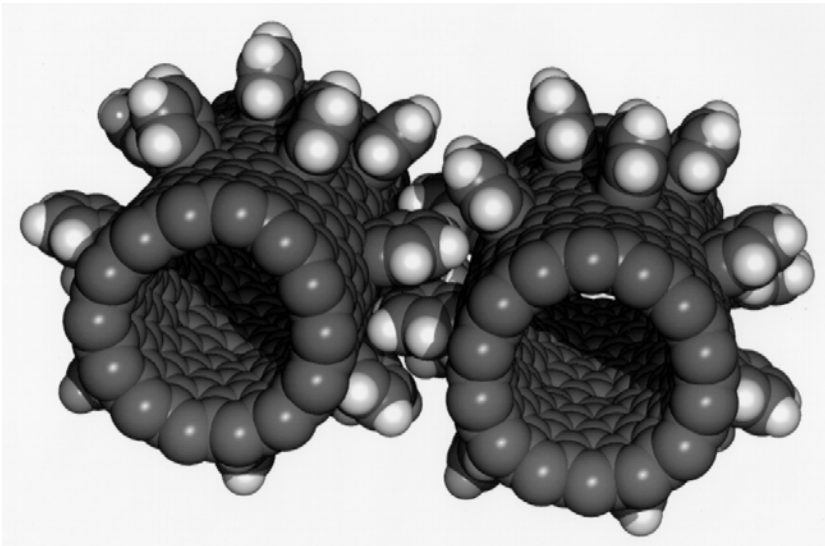

Fig. I.14 Two “Fullerenes Nano-gears” with multiple teeth. Nasa Images, <https://archive.org/details/GPN-2000-001535>. Source: Public Domain

In people’s imaginations, the idea that a nanorobot is an object that, independently or controlled from the outside, moves inside the human body, to perform certain functions, may not be uncommon. Actually, the fields of application of nanorobotics (Fig. I.14) are many and not necessarily linked to futuristic or science fiction ideas. In addition to what was previously mentioned, in fact, there is evidence of applications of nanorobots, for example, in geology. Nanorobots that move in subsurface rock formations to determine their geological and geophysical characteristics are in fact the subject of a patent filed in 2009,

for instance. Underground rocks and hydrocarbon formations are the subject of research by these modern nano geologists (Kamal, Sanni and Kanj 2010).

1.1.3.6. Nanophotonics

The study of light behaviour at the nanoscale or the analysis of the interaction between light and nanometrically sized structures is the subject of Nanophotonics. Sometimes, this discipline is also called nano-optics because it regards situations involving ultraviolet, visible and near-infrared wavelengths.

There are two major issues that have to do with Nanophotonics. The first concerns the interaction of light with nanoparticles, objects which therefore have a dimension smaller than the wavelength, and the control of the flow of light when the scale is nanometric.

Spectroscopy and coherent control of single quantum dots are areas where Nanophotonics research is particularly active. Semiconductors made with InAs nanostructures are manufactured in such a way as to confine both the hole and the electron, thus creating extremely intense optical dipole moments that give rise to strong interactions with light. Such a phenomenon allows to operate using coherent light, produced – let us say – on a chip, to control electronic interaction on the same chip.

Nanoparticles doped with ions of elements belonging to the rare earth group (scandium, yttrium and the series of lanthanides) have recently been used to obtain new optical solids, such as transparent ceramic materials that are now used in the field of high-power lasers at the 100kW level.

A further area of research concerns plasmonics when nanoparticles and their complexes are engineered to create optical structures with absolutely new properties.

1.1.3.7. Nanomedicine

Nanomedicine is the medical application of Nanotechnology (Cassano, Pocoví-Martínez and Voliani 2018). As nanomaterials exhibit completely new properties due to their extremely small scale, when these same properties are compared with the bulk material, strong possibilities for their interactions with biological systems appear. Biological systems possess components whose dimensions are nano scaled (such as proteins, membranes, nucleic acids and so on). Therefore, nanomaterials can be applied to both in vitro and in vivo biomedical research and applications.

Scientists can add different functionalities to nanomaterials to get diagnostic devices, contrast agents, analytical tools and applications to physical therapies or drug transport systems. This fact opens new doors to research as synergies among nanosystems and biological components may improve health and quality of life, on one hand; on the other hand, ethical implications arise about the legitimate use of such new discoveries and the awareness of their side effects.

The possibility of delivering the active ingredients precisely to the designated site of pathology is one of the major, and perhaps the most important, feature that Nanotechnology provides to nanodrugs (Ranganathan *et al.* 2012). This is fundamental, as it regards the opportunity of significantly reduce side effects on the organism, and therefore on the patient. Also, a smaller dose of the ingredients will result in reduced expenses, a lower cost of the medicine, and wider availability. Molecular targeting by devices that are nanoengineered

could be the way to achieve such results (LaVan, McGuire and Langer 2003; Cavalcanti, Shirinzadeh, Freitas and Hogg 2003).

The efficacy of drug delivery through nanomedicine (Fig. I.15) is based upon different factors such as an efficient coating of the active ingredients, a successful delivery of the drug to the exact point of action inside the body and an effective release of the ingredient (Santi *et al.* 2020).

Advances in medicine have been very significant, especially in recent decades. Yet many surgeries are still performed by cutting and opening patients' bodies. It is true that certain orthodontic interventions are today so advanced that they can be performed without anesthesia, but such a thing is not yet imaginable for complex surgery that still intervenes on the human body. Using nano dimensioned devices could result into less invasive interventions on the patient and might open the door to the possibility to implant the "surgeon" or the "chemist" inside the body, leaving the patient with no sensation of it, unlike an external prostheses, for example. Remotely monitoring the situation, an external doctor could intervene in case of necessity without "physically touching" the body. This, on the other hand, opens a serious debate on the Ethics of Nanomedicine: would anybody accept being remote-controlled by somebody? Would people be aware of the fact that the drug is being administered and is acting at one moment, rather than another? Careful attention must be given to such a delicate field as that concerning human health.



Fig. I.15 Metal nanoparticles in colloidal suspensions. These products are all registered medical devices under CE certification. From left to right: Copper, Silver, Gold, Zinc, Iron, Silicon. Source: AD taken/reproduced under permission by Living Source®

I.1.3.8. Nanohealth

Healthcare has to do with maintaining or recovering an individual's optimal physical and psychological condition. All this can be achieved through prevention, rapid and early

diagnosis, treatment of more or less serious illnesses, wounds and injuries, be they physical or mental. The development of Nanotechnology has made it possible to create devices that are able to help in the prevention and monitoring of any pathologies on which to intervene, if necessary, also with innovative nanosurgery techniques.

Today, many devices are available for athletes, or amateurs, or ordinary people to monitor their health status – checking medical parameters like systolic and diastolic blood pressure, heart rate, body temperature and so on, or more simple data like the number of steps in a walk and how many calories we burned along the way, the average speed we maintained –. It is not difficult to download apps, purchase bracelets, watches, wristbands... to get those data. Nanomaterials can open new perspectives when manufacturing such devices. One of the best candidates to improve the existing technology could be graphene, as this material is ultra-flexible and high-conductive.

Sports is not the only field where such a material may be applied. Hospital wards can be an environment where nano-scale health monitoring devices find application.

We can imagine patients wearing control devices, based on nanomaterials, capable of transferring biomedical data to a memory accessible by doctors at any time. In this way, patient care could be facilitated and prompt action could be taken in the event of an unfortunate change in the monitored parameters. Not only that, but such a device, easily worn by the patient, could reduce hospitalization times and allow medical checks even from home. The monitoring of the state of health of elderly patients could easily be made possible by the application of nanodevices that collect data and send them to processing centres. Their rapid control can allow targeted interventions and an improvement in the quality of life of older people.

If, on the one hand, the control of biological parameters is important, on the other hand the prevention of diseases is fundamental and their diagnosis must be made as soon as possible. The use of nanometric devices could allow the intervention, in this direction, at the cellular level, through sensors and imaging techniques that allow the observation of any critical factors in the patient's health.

1.1.3.9. Nanotoxicology

The study of toxicity of nanoparticles is called nanotoxicology (Buzea, Pacheco and Robbie 2007). Features like quantum size effects or their large surface to volume ratio may affect the toxicity of the nanoparticles. Serious side effects such as inflammation, fibrosis or carcinogenicity are possible hazards of inhalation exposure of some nanoparticles. Skin contact and ingestion exposure are to be seriously considered.

Nanotechnology can be considered a relatively recent development in science and its effects on health, despite the studies conducted so far, are yet to be deeply understood. It is fundamental to know how exposures to these agents may affect the health and safety of workers and users, or what level of exposure will be acceptable. As health must be protected, over all it is important to take precautions to minimize hazardous exposure and side effects (NIOSH 2013. Retrieved via: <https://www.cdc.gov>).

We can say that nanotoxicology is a new sub-speciality of particle toxicology. As the properties of nanoparticles differ from the bulk-dimension ones, due to their nanometric sizes, their toxicity appears to be different for the same reason: dimension. For example, a metal like gold, which is known to be inert at macroscopic dimensions becomes very active at nanometric dimension. This is one of the reasons why a discipline such as nanotoxicology

is becoming more and more important, trying to establish if and to what extent these properties may become hazardous to human health and the environment (Mahmoudi, Hofmann, Rothen–Rutishauer and Petri–Fink 2012).

It is not correct to believe that nanoparticles are only man–engineered artificial structures, like carbon nanotubes for instance. In fact, it is possible to find them in Nature as combustion–derived nanoparticles, like in diesel soot, or as naturally occurring nanoparticles from volcanic eruptions, or atmospheric chemistry. So, the hypothetical threat comes from different sides, not one of them to be neglected. Once they have entered the body, through inhalation, swallowing or skin absorption, because of their small size, the particles can migrate inside the body and affect distant sites such as brain and other organs, conveyed by the cardiovascular apparatus.

1.1.3.10. Nanotechnology and Safety

The rapid development of Nanotechnology has brought to the fore several ethical issues in relation to the possible effects of nano–sized products on people’s health and on the Environment in general. The proliferation of new nanomaterials raises the problem of identifying what their health effects may be, not only, but also the question of what to look for that may prove harmful in the short or long term. At the same time, finding a harmful agent allows the establishment of rules relating to the use – or total disposal – of the material that carries it.

The question of researching what dangerous nanoscale agents may be, at any level, is also a prelude to the development of laboratory tools and operational protocols to identify the agents in question. The search for risk factors is not always easy, due to the rapid and continuous introduction on the market of new products, and it is not always possible to evaluate which are the actual parameters that determine the degree of threat posed by the materials.

It is therefore necessary for the researcher to ask himself some questions, faced with such a sudden development of this new science, and that the same ethical and operational paradigms must be rethought in function of the protection of the individual and the environment in which he lives.

There is, in fact, the need to evaluate new approaches to the concepts of toxicity, or hazard, associated with nanomaterials, to the control modality of new products and to parameter testing.

1.1.3.11. Molecular Nanotechnology

Designing and testing molecular properties, their behaviour and interactions to obtain better engineered materials, systems, and processes for specific functions are some of the most important fields in Nanotechnology called molecular engineering. As Nanotechnology is interdisciplinary, so is Molecular Nanotechnology. Under this name many aspects of chemical engineering, material science, bioengineering, electrical engineering, physics, chemistry and mechanical engineering are gathered.

In 1956, Arthur von Hippel (1898–2003) first mentioned molecular engineering, defining it as “a new mode of thinking about engineering problems. Instead of taking prefabricated materials and trying to devise engineering applications consistent with their

macroscopic properties, one builds materials from their atoms, and molecules for the purpose at hand” (von Hippel 1956).

Richard Feynman (1918–1988) echoed these concepts in his famous talk at Caltech in 1959, *There's Plenty of Room at the Bottom* (POR), which is regarded by the classical historiography as the founding document of some of the most important concepts of Nanotechnology (Feynman 1960).

It was Eric Drexler who amplified the ideas and made them grow in popular consciousness by publishing his famous book *Engines of Creation: The Coming Era of Nanotechnology* (Drexler 1986).

In 1977, Alan Heeger discovered electrically–conductive properties in polyacetylene, thereby opening the field of organic electronics, a discipline that proved to be fundamental for many molecular engineering studies. Designing and optimizing these materials has led to several innovations, including organic light–emitting diodes and flexible solar cells (Chiang *et al.* 1977).

I.2. Specific Introduction to My Ph.D. Thesis

My Ph.D. research thesis field is the History of Physics (and its relationship with Mathematics). The subject is the *History of Nanoscience–Nanotechnology* (hereafter HNN) from 1950 to the 2020s. It concerns both a history of theoretical/experimental aspects of HNN and a history of discoveries and its impact in the Society. For, having a strong pioneering interdisciplinary character, I will systematically confront several disciplines and their technological applications.

My research revolves around the discoveries, scientists, thinkers who have contributed significantly to the birth and growth of this new science. In fact, it has established itself as an absolute novelty in many research fields, as I have already pointed out, changing the paradigm of scientific observation regarding the dimensions of matter and its properties which are completely different, to nanometric dimensions.

HNN is not only interested in science and technology, but has also benefited from the mathematical tools of physics and materials science. Investigation from this direction also proved useful to discover the uses of known mathematical relationships, or in which areas new equations were needed to understand and predict the behaviour of nanomaterials and their engineering.

This thesis is a first step in the realization of a historical and scientific path that embraces the multiple fields involved in Nanoscience, and that leaves the doors open for further historical and epistemological studies and developments.

I.2.1. The Purposes

I pursued and completed multiple objectives.

First, I analysed the historical context from which to develop the work in the field of Nanoscience and Nanotechnology. Since a work that collects the most important events of this science in an extended form does not yet seem to be available, considering the scientific, historical and epistemological aspects, I started from the sources to frame the historical context, in terms of authors and works. So, I have retrieved the most important documents, functional to my research, in the form of articles, essays and books. By analysing the most

recent texts, I was able to realise what the state of the art of historical research is in this respect. The comparison between the texts and this thesis has shown me that, as far as I am aware, the structure of my work constitutes a novelty in the field of nanotechnology history.

Collecting and categorizing the works I have read made me organize a dedicated library on Nanotechnology, understanding what the role played by each work and its impact on this field. Together with this work of systematic documentation, I had to consider not only the simple historical succession of the events, but also the different disciplines. There have been discoveries and advancements made first in Physics, for example, due to new instruments made to explore such a small world, and in Mathematics, through a new use of already known concepts, like the Finite Elements Method. The search for the original documents led me to find articles of which I had to personally supervise the translation from foreign languages other than English.

Secondly, I had to organize the succession of events. The chronological sequence immediately appeared to be the most logical and linear choice, applying the Historical Method. This allowed the sequence of historical events to be followed together with the scientific discoveries. The flow of events in chronological succession has actually created, in the historical chapters of this thesis, a chronicle of the most relevant facts and discoveries in the HNN.

Consequently, I had to compare my results with other researchers and historians to evaluate the formal correctness of my work from several points of view. Although the chronological order is easy enough to pursue, as a researcher I had to be very careful when considering the scientific event and the historical context where the scientific event itself took place. The environment, the condition, the historical context, all deeply influence the situation where and when scientific research is made and its purposes.

A careful analysis of the sources – articles mainly, since in books History of Nanotechnology is not described broadly – is necessary to evaluate their impact, and the influence they had on researchers. One remarkable case of a different possible interpretation on There's Plenty of Room at the Bottom emerged, and brought a new interesting light on this paper, maybe one of the most famous in History of Science and History of Physics, in particular.

Therefore, it was necessary to consider the historical and epistemological aspect in the concatenation of the facts, their interpretation and their conceptualization. The question concerning the history of science and the history of Nanotechnology, precisely because this science investigates a world beyond the microscopic, in a myriad of aspects, also involves science in society.

These aspects must be investigated and deepened because the discipline is, in itself, profoundly transversal, and no researcher can be considered exempt from considering what consequences and repercussions the discoveries in this field will have.

In addition to considering the technical and historical aspects, specifically, I also focused on those of epistemological and ethical nature, which invest the role of the researcher as such.

1.2.2. General Objectives

The scope of this thesis is to provide researchers a volume in which to find information regarding research and discoveries on Nanotechnology from 1950 to 2022. I have organised the information on the history of nanotechnology based on the chronological sequence of

events. Whenever possible, I have reported the discoveries year by year. The concluding work proved to be extensive, and provides a starting point for developing in-depth articles from the topics covered. Similarly, it can be seen as a starting point for even more research, going into even greater detail on the individual topics and expanding on the results reported here. The topics dealt with in this thesis are in fact not limited to the history of nanotechnology, but also concern the technical development of the instrumentation, the mathematics used for modelling, and the implications that the development of new materials brings to society, from the point of view of ethics and the impact on the environment and those living in it.

I examined the existing literature first, to understand how deep in the History of Nanotechnology other authors have gone in their works.

So far, there is no evidence of a comprehensive book about a chronological and detailed History of Nanotechnology so, after research on the publications available, I concentrated on collecting articles, according to the contents chronologically ordered.

The purpose of the collection of articles is to get as close as possible to the original sources relating to the discoveries in the field of Nanotechnology or to the development of the tools that made the discoveries possible. For this purpose, the Nobel Lectures are particularly significant because on the one hand they present the achievement of a result in the words of its discoverers, and on the other hand they confirm the importance of the discovery, which is rewarded with such a significant mention.

The research in the articles also opens up a further problem, concerning the significance of the writings themselves and their impact on the scientific community.

Nanotechnology has affected so many fields of research and so many publications have been written, that the differentiation of the different sectors makes it almost impossible to be aware of all the discoveries. It is important to understand which information can be of effective influence and which, even with their contribution to the scientific community, should be considered of not so fundamental importance.

1.2.3. Specific Objectives

In Part One the early History of what will be later called Nanoscience and Nanotechnology is described, including the role of Nature as the very first nano manufacturer in our history. Also, concepts about what Nanoscience and Nanotechnology are, according to the definitions that changed in time, and what fields are interested by these subjects will be discussed. We will also talk about the difference between artifact and natural nanomaterials. It will be proved how Nature has been the first manufacturer.

The pioneers of this brand new branch of physics will be introduced along with the debate about the real/ideal influence of their works on subsequent researchers. This argument will be discussed according both the historical and epistemological points of view. The figures and authoritative careers of these researchers will absolutely not be criticized.

The possibility of investigating matter on such a small scale and with such great effectiveness has given to the technological human being the power to create, assemble and work with structures and mechanisms so small that they can intervene on materials on a practically atomic scale. This aspect will be discussed in Part One.

The impact of scientists like Richard Feynman will be discussed regarding one of his most famous works. This is the case of the conference that has entered history under the name of *There's Plenty of Room at the Bottom. An Invitation to Enter a New Field of Physics*

in which this curious scientist poses a whole series of questions related to an extremely small physical world.

Cited in seminars, translated and rendered available in papers and online, the paper regarding this conference was and still is presented as the founding document of Nanoscience. Yet, many scientists whose contribution has been nothing short of essential in the development of the nanoworld, contributions that in some cases led to the Nobel Prize, were not even aware of POR. In other cases, they stated that the influence of this work was absolutely marginal to their research. Hence here arises the importance of demystifying some interpretations and relocating, on the basis of the theory of knowledge, in a correct light some scientific works whose validity is not in any way questioned.

In Part Two both the Physics needed, and the Mathematical instruments applied to the nanoworld will be examined. We will talk about the progress and the instruments of electron microscopy that made the observation and manipulation of very little things, down to atom size, possible in less than one hundred years. The mathematics necessary to describe the nanoparticles and their behaviour into nanostructures will be approached.

A short review of theory and applications of Quantum Mechanics, Continuum mechanics and Finite Elements Methods will be presented in an accurate form.

This is relevant and necessary here, because it is historically important to underline that new fields of science often need new tools, whose development goes hand in hand with the experimental needs that have to be addressed.

Nanosciences are no exception and, although the first observations were made through electron microscopy for example – the same microscopy that Feynman indicated in his talk as still not adequate to go down to the bottom, in POR, for the proper intervention of the researcher on a nanometric scale –, the progress of these tools has made discoveries and achievements possible that were unthinkable a century ago.

Scanning Electron Microscopy, Transmission Electron Microscopy and Microanalysis are techniques that have been improved over time and flanked by other devices such as the STEM microscope (Scanning Transmission Electron Microscope), a hybrid device between SEM (Scanning Electron Microscope) and TEM (Transmission Electron Microscope), or the Environmental Transmission Electron Microscopy (ETEM) microscope for the analysis of samples in controlled gaseous atmospheres.

It is essential that nanoscale materials are characterized with the highest accuracy possible. For this reason, investigation techniques such as Electron Energy Loss Spectroscopy (EELS) are used to allow a quantitative analysis of the chemical characteristics of the sample.

The History of Science has awarded with the Nobel Prize the invention of the microscope STM (Scanning Tunneling Microscope); the Atomic Force Microscope AFM (Atomic Force Microscope) and the variants of the STM microscope today allow surfaces and structures to be effectively probed and visualized on nanometric scales. The manipulation of objects and the tools developed for such a manipulation are central aspects in the development of a society who wants to be considered advanced; the SPL (Scanning Probe Lithography) technique allows the manipulation of atoms on a material on a nanometric scale. Although constrained by the diffraction limit, optical microscopy has also proved to be an effective tool for Nanoscience investigation.

We could also define Confocal Microscopy (CM) and Scanning Nearfield Optical Microscopy (SNOM) as improvements to a pre-existing technique, the optical microscopy of the beginning of the XX century, to study atoms and molecules in this new, rapidly growing field of Physics.

Ion-based investigation devices are important in Nanotechnologies. Two of them are Focused Ion Beam-based Lithography (FIBL) and Secondary Ion Mass Spectrometry (SIMS).

Rooted in the *Annus mirabilis* by Albert Einstein (1879–1955) and, in particular, in the photoelectric effect, although the term photoelectric is to be traced to the Italian scientist Augusto Righi (1850–1920) who observed the phenomenon and described it in an article dated back to 1888, is the Photoelectron Spectroscopy (PE), which is based on Einstein's equation of the photoelectric effect:

$$h\nu = KE + \phi \quad (I.2)$$

where $h\nu$ is the energy of the light quanta – as Einstein would have said – coming out of the metal material, ϕ the work function and KE the kinetic energy of the photoemitted electron.

Finally, the technique of investigation that allows, in an almost univocal way, an unknown material to be characterized based on the shape of the diffractograms is X-Ray Diffraction; single crystal diffractometry is used for the study of molecular structures while diffraction from dust is used for the analysis of different phases, although the latter is also able to provide information on a molecular scale. However, even X-Ray Diffraction is not a technique of recent application – Bragg's Law dates back to 1912, for example – but it proves that important results in the field of Nanoscience have been acquired through new investigations conducted with old tools.

A similar discussion can be made for the indispensable mathematical instrument. Thinking of conducting technologically innovative observations without the help of mathematics seems decidedly improbable.

In the study of Nanotechnologies it seems that–what we have already said about the new use of old instruments in the field of physics–is particularly true, since modelling the behaviour of structures and particles of such a small size has made use of a mathematics already known, and which is borrowed from engineering. In the specific case, this is achieved by reference to continuous mechanics and finite element calculation.

Carbon nanostructures have been the focus of researchers since they appeared on the laboratory scene; in particular, their electrical and mechanical properties have been extensively investigated in recent decades precisely because of their extremely interesting behaviour. Strength and brittleness of nanostructures and nanomaterials, for example, proved to be greater than the same measured properties in steel.

Today, the analysis of properties such as those mentioned above on nanostructures is based mainly on the principles of molecular mechanics, molecular dynamics, continuum mechanics, finite element calculus and laboratory experiments. For these materials it is important to determine the value of the Young's modulus (Hooke's law constant), related to longitudinal elasticity and often determined through the stress–deformation diagram in the section where the response of the material to the voltage applied is linear, by the formula:

$$E = \frac{\sigma}{\varepsilon} = \frac{\sigma}{\lambda-1} \quad (I.3)$$

where σ is the uniaxial stress, ε the strain and λ the stretch factor (defined as the ratio of the final length to the initial length of the sample).

These two characteristics of the material are essential, but their numerical value is yet to be determined.

It is also very important to consider computational time in nanostructure modelling as it is a real challenge. To meet this challenge, atomic-scale finite element calculation (Atomic-scale Finite Element Method – AFEM) has been developed and applied, for example, for multi-scale analysis of carbon nanotubes. It is based on the measurement of interatomic potential energy that describes the interactions of one atom with others surrounding it in terms of local or non-local bounding forces. Ultimately, the choice of the atom and the arrangement of its close neighbours on the lattice will determine the specific atomic finite element. In principle, the method can be applied to all atomic systems that can be described by an interatomic potential energy. We will then see how the equation system of the AFEM method can be written in the following condensed form:

$$[K(u)]\{u\}=\{P\} \quad (I.4)$$

where $[K(u)]$ is the non-linear stiffness matrix, $\{u\}$ the displacement increment vector and $\{P\}$ the non-equilibrium load vector.

In the Third Part, the history of the nanoworld will be explored in chronological order, for easier reference. This is the real core of the text, the longest and most section. Where possible, year by year the most important events will be treated, connecting the dots between 1950 and 2022. It appears obvious that 2022 will not be considered as the definitive end of this historiography but just a “resting point” to start over from, for further research and analysis.

Original papers on discoveries, Noble lectures will play a very important role in this section of this work.

Archives, public (and private) libraries, bibliography, internet, newspapers, magazines, films, photographs, testimonies are the necessary sources to draw up a document whose most important part is historical. The chronological order of the events is the most natural and allows parallels to be established between the most varied disciplines that have found themselves involved in the explosion of the nanoworld, whose characteristics are modified time after time within the different fields. Alongside this, the epistemological value of research in the nanoworld – understood as structure, methodology and logic of science – will also have to be investigated, to see how thought has changed over the last decades in relation to a research field that has expanded beyond imagination.

The Fourth Part will consider the impact of Nanoscience and Nanotechnology in Society and it is a very important part of discussion since many products we are using in everyday life are based upon nanoproducts. The awareness of ordinary people about the presence of nanoproducts will be examined together with the national and international rules and regulations on the subject. The focus of this chapter then will be on Health, Institutions and Nano.

New research conducted at such microscopic dimensions could not fail to arise from the need to go further in the exploration of the world, the acquired knowledge of which being insufficient to satisfy the curiosity of researchers. Every historical period has been marked by precise cultural directions that have become representative of the epoch itself and the nanoworld is no exception. Indeed, its impact on everyday reality is so significant – even if perhaps not perceived in its entirety – that we could well say we are living in the Age of Nanotechnologies, where there are still no changes in higher organisms, but where probably

“the higher organism” par excellence is manipulating nature in order to modify it and then modify himself.

Therefore, it is essential to understand the full extent of people’s perceptions of this revolutionary science, –and what the consequences may be. This research is revealing day by day a world at the limits of the impossible straddling two physics – Classical Physics and Quantum Physics –, a hyper–technological world. Nowadays changes occur at such a rate that they almost do not allow people to assimilate them into society. Are individuals to be necessarily informed of every mutation of nature obtained in the nanoworld? Should their interest in such research be encouraged or are the results to be introduced into the world deliberately without direct perception by the unaware end–users?

Will this be a form of hidden control?

It will probably be a long time before these questions can have a definite and indisputable answer, if there will ever be one. However, all these questions can only reflect the contradictions of the contemporary world, where the human being is subjugated to the technology created by other human beings. Many are enthusiastic about the innovations that have changed everyone’s life in a span of less than fifty years, and yet unaware of how this technology works. Sometimes they are uninterested in the consequences, focused only on the benefits, sometimes only apparent, and more quickly usable.

The transformation of a science such as physics and, in particular, the physics of the nanoworld necessarily implies a transformation of society. This did not immediately happen, for example, with the advent of quantum mechanics as the phenomena of everyday life can be effectively traced back to the paradigms of classical mechanics. But today we cannot ignore the technological nano revolution and, as a consequence, quantum mechanics because the devices we are using daily depend on it.

The biomedical field, for example, has benefited from many nanotechnological research results; could the full application of these definitively transform man into something bio–nano–technological, literally extrapolating him from his place in nature? Is the human being ready for this? Above all, is he aware of this? We are returning, as we can easily understand, to the problem of the dissemination of information and the effects of research.

Moreover, it seems that this field of research on nanostructures and their applications is giving rise to some modification, even if sectorial, of the very meaning of “scientific culture”. From the old canon, according to which the so–called pure scientist has nothing to say outside his field of expertise, we necessarily move towards an interdisciplinary science, because nanotechnological research involves multiple disciplines such as physics, chemistry, maths, medicine, biology, engineering and social sciences. This is why the concept of interdisciplinarity is linked to the scientist who, although having his roots and experience in his specific field, is able to dialogue with colleagues operating in other theoretically distant sectors.

From this perspective, the rapid renewal of the concept of scientist requires the protagonist of the research to mediate effectively between his specialist investigation and those that will give rise to an organic conception of the nanoworld and Nanotechnologies.

What today is a mosaic of scientific disciplines merges under the umbrella of Nanoscience and all together must be subjected to a methodological criticism, for the results nowadays achieved through research show us a different conception of the world. However, it is important to express this new concept clearly, and to analyse all the evidence in favour and the philosophical difficulties with the rigour required and, above all, for the consequences also to be made clear and known.

The Fifth Part of the thesis will include the conclusions, leaving further research and epistemological questions open, for other further developments to come. I am aware that

some observations may be raised in this work, especially in relation to the choice I made regarding the succession of discoveries that I have chosen to include in the historical chapters. The choices I made were dictated by the need to identify the salient moments in the HNN, to give a first complete meaning to this thesis. Nothing prevents us from conducting further investigations that lead to a subsequent rearrangement of the historical sequence, to give rise, at a later stage, to a broader rewriting that also takes into consideration new documents and discoveries.

I.3. Nanoscience and Nanotechnology: the State-of-the-Art

In the following subsections I describe the method I applied to collect the information and the data needed to complete the task of writing this thesis. I also describe the state-of-the-art of the research at Lille University and the different departments of the IEMN Research Centre. I also report here the most prominent centres whose main research topic is Nanotechnology, detailing what the main fields are and what opportunities can be offered there.

I also include an abridged history of Nanotechnology, sketching the arguments that I am going to describe in detail in the dedicated chapters of my work.

I.3.1. Methods and Data

As a first step of my thesis, I proceeded to draft what would later become the table of contents of the final text. This made it possible to always keep in view the progress of the writing.

After that, the first part of my doctoral research was devoted to the collection of texts and articles that refer to the various aspects of HNN that I investigated. I have collected historical, mathematical, epistemological articles on HNN and books on Nanotechnology, which I have consulted, to understand to what extent the historical question has been deepened. Most of the documents are, obviously, in English, but there are also articles written in other languages, such as Russian, or German, or Japanese, for example, which describe important technical discoveries or progress in thinking about the Nanoworld and, thus, represent fundamental moments in the development of Nanotechnologies. To give the reader an idea of how the number of publications has evolved, over the time span that I have taken into consideration to conduct my research, and how broad and challenging this work has been, I have carried out a survey among the articles, texts, patents and citations that, in the title, contain the following keywords.

- Nanoscience
- Nanotechnology
- Nanomaterials
- Nanoelectronics
- Nanomechanics
- Nanometrology
- Nanorobotics
- Nanophotonics
- Nanomedicine
- Nanohealth

- Nanotoxicology

For ease of reading, I grouped the number of publications in the following table I.4, considering the years two by two, with the exception of 1974, the year when Taniguchi made the first use of the term Nanotechnology in history, in order to summarize the data and highlight the trend, from which I extracted the graph then reported.

Table. I.4 The growth of the number of publications on Nanoscience and Nanotechnology since 1974. Data retrieved via Google Scholar. Source: AD

Year	No. of issues	Year	No. of issues	Year	No. of issues
1974	1	1989/90	50	2005/06	6110
1975/76	2	1991/92	139	2007/08	7840
1977/78	3	1993/94	129	2009/10	8940
1979/80	1	1995/96	273	2011/12	10250
1981/82	1	1997/98	350	2013/14	10660
1983/84	3	1999/00	824	2015/16	10930
1985/86	23	2001/02	1779	2017/18	12230
1987/88	25	2003/04	4090	2019/20	15530

The plotted data from the table gives the following graph (Fig. I.16).

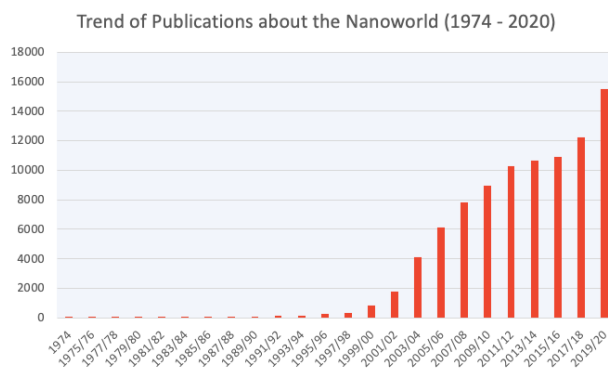

Fig. I.16 The growth of the number of publications on Nanoscience and Nanotechnology since 1974. Data retrieved via Google Scholar. Source: AD

This trend clearly demonstrates that the 2000s are the years in which there was a more than significant increase in the study of the different fields on nanotechnologies, and the sudden growth of the number of publications released on the subject.

The first text I took into consideration is the *Springer Handbook of Nanotechnology*, a huge manual edited by prof. Bharat Bhushan in 2004 for Springer, Berlin. This book, however, dedicates few pages to HNN, only five, for a brief historical description, while it must be noticed that the other chapters are a meticulous description of the techniques that are applied to Nanotechnologies.

Another book I came across is *Nano: the Essentials. Understanding Nanoscience and Nanotechnology* (Pradeep 2008). This volume is actually a manual for by students, with theory and exercises. The first chapter is dedicated to HNN, but this is done from a very general point of view, embracing from ancient times to modernity. There are no historically specific details because all the other chapters are dedicated to specific parts of Nanoscience.

A very recent publication is the book *History of Nanotechnology. From Prehistoric to Modern Times*, edited by Madhuri Sharon (Sharon 2019). This book concerns the History of Nanotechnology mostly in the ancient times. The chapters are dedicated to Nanotechnology from the Prehistoric Era to ancient Indians and the Maya, from the Roman Empire to the Medieval period, from Faraday to Maxwell. The final chapter is dedicated to contemporary Nanotechnology, reviewing the most famous steps only. A large part of this book is dedicated, because of the origin of the author, to Nanotechnology in Ancient India. There is an interesting chronological succession of events at the end of the book, covering the most recent discoveries in the field.

In the same year *Size Really Does Matter* was published, by Colm Durkan (Durkan 2019). In this book, History of Nanotechnology is described in short paragraphs in chapters 1 and 2. This book is more a reader-friendly issue than a technical manual, and a systematic succession of the events is not included. The emphasis is on the importance of the nano dimensions and several applications are described, especially as regards the medical field.

The importance of the mathematical tool in Nanotechnology is well described in *Mathematics and Physics for Nanotechnology* by Paolo Di Sia (Di Sia 2019). Here, HNN is virtually absent, just a few notes about nanoelectronics are mentioned in the first chapter. Problems are proposed at the end of most of the chapters. This is a very specific manual proposing theory and exercises about several topics of Mathematics and Physics. Most of the arguments are at university level, though some might be also proposed to upper intermediate and highly motivated students.

A text I found interesting for its contribution to the description of the so-called pioneers of Nanotechnology is *The Nanotech Pioneers* by Steve A. Edwards (Edwards 2006). In this book the main accent is on the people who made the history of Nanotechnology and their backgrounds, more than on the techniques applied in the nanoworld – although a description of the instruments is present –.

Particular attention was paid to the articles that can be considered as foundations of Nanoscience and Nanotechnology. Some of them are particularly famous and are repeatedly cited as essential cornerstones such as, for example, *There's Plenty of Room at the Bottom* by Richard Feynman.

1.3.2. The IEMN: its Role in Nanotechnology in France

I was able to write this thesis also thanks to the affiliation to an important research centre such as the *Institute d'Electronique, de Microélectronique et Nanotechnologie* – IEMN – in Lille, a centre of European and world relevance that actually associates several institutions such as the *Centre National de la Recherche Scientifique* – CNRS –, the *Université de Lille*, the *Université Polytechnique Hauts-de-France*, the *Central University of Lille*, the *Ecole d'ingénieurs des Hautes Technologies et du Numérique* ISEN YNCREA.

The cooperation between such diverse and prestigious partners allows the development of extensive research that is divided into different areas of interest, such as the physics of materials and nanostructures, advanced systems on telecommunications, microwaves and

acoustics. In particular, nanostructures, microelectronics and nanoelectronics, the study of microwaves and microsystems are the areas in which IEMN mainly focuses its interests, in particular, to achieve the most innovative goals and discoveries.

One of the founding characteristics of the IEMN is the know-how to wisely combine research on multiple areas, while maintaining a balance between the Academic world and the external world of Research and Development for industry. To do this, 22 research groups are divided into 5 main departments.

The first department, *Matériaux, Nanostructures et Composants*, deals with the study of materials, nanostructures and components, as part of the most important research that is carried out within the IEMN. Departmental research is oriented towards the study of thin films, heterostructures and periodic structures (0D, 1D, 2D), optics and acoustics, optoelectronics and Nanotechnologies, organic electronics and models inspired by biology. The groups *EPItaxy and heterostructures PHYSics – EPIPHY –*, *Nanostructures nanoComposants et Molécules – NCM –*, *Physique, SimuLation PHYSique de Dispositifs Electroniques et optoélectroniques – SILPHYDE –* and *Dispositifs Opto et MicroElectroniques – DOME –*, cooperate together in the most advanced research.

The second department, *Micro et Nano-Systèmes*, over time has built and consolidated a solid and internationally recognized experience in the study and development of micro- and nano-systems. Its research work is highly interdisciplinary and concerns materials, microfabrication processes of devices such as sensors and actuators, microfluidics and microelectronics, chemistry and biology. Particular attention is paid to the social impact that these areas have on everyday life. The IEMN design, first construction, testing and production facilities, including a clean room of impressive size (1600m²), are exploited to achieve the objectives of the structure.

The third department, *Micro Nano Opto Electronique*, has made its mission-research that overcomes today's limits of micro and optoelectronic components through the implementation of new materials, developed through completely new technologies that go beyond the traditional canons of research. The improvement of the characteristics of new microelectronic components, in terms of background noise, power and working frequency, is the leading principle on whose basis the improvements are increasingly moving the state-of-the-art of these devices forward, devices that will find application in the fields of analog and digital electronics, depending on their characteristics. The development of the most innovative components of sensors and telecommunications is carried out through the study of the interactions between microwaves and waves in the visible field, with the instruments of optoelectronics and very high magnetic fields.

The *Circuits et Systèmes de Télécommunication* is the fourth department, and it mainly deals with the development of innovative systems dedicated to telecommunications and the development of instrumentation and was the pioneer of 60GHz operating systems. The fundamental objectives of this group are high speed and/or high mobility communications, together with very low power communications. Circuit design, the problem of energy recovery, energy storage and its management, heterogeneous integration, signal processing, cooperative communications for sensor networks are the challenges the department faces through the balance of several sectors, such as the conception, design, experimental verification and practical realization of the devices.

The fifth department, *Acoustic*, deals with the design, characterization and production of electronic components and systems, thanks to the acquired, developed and continuously updated knowledge of active materials, acoustic meta-materials, unusual properties observed during propagation of acoustic waves, and acoustic microsystems. The components for telecommunications, instrumentation and biology are implemented through

the study of sensor networks, while acoustic imaging is one of the non-destructive techniques through which materials are investigated and which is studied in depth in this department.

Within the research area called *Physique, the History of Physics And Science Technology* – HOPAST – working group, headed by Prof. Raffaele Pisano HDR, my thesis supervisor, has been activated, and is supported by Fabrizio Cleri. The main purpose of this research group is to develop new historical–scientific approaches to science research, understood as including natural sciences but also human sciences, through a continuous dialogue between its members and European and extra–European scientific institutions. For this reason, the area of the group’s discussions, be they regarding the historical, cultural, social, epistemological aspects of physics in the first place, without neglecting the other sciences, is of a very high level of quality. Furthermore, HOPAST organizes prestigious Lectures and Meetings, Master Classes, Summer Schools, Workshops and other events that aim to involve young and established researchers within a stimulating work environment to allow comparison and the exchange of ideas. In–depth study of the study topics is encouraged through the evaluation of doctorates and candidates for the HDR qualification – Habilitation à Diriger des Recherches – which allows access to the position of full professor and supervisor of doctoral theses.

The research Prof. Pisano leads individually and in collaboration with other colleagues embraces, particularly, the fields of History and Epistemology of Sciences (Physics–Mathematics), Historical Epistemology of Sciences, Philosophy of Sciences (Physics–Mathematics) Nature of Science Teaching, Intellectual History of Sciences, Foundations of Sciences. In one of his most recent works, for example, (Pisano, et al. 2020), Prof. Pisano and his associates explored the figure of James Prescott Joule, as described on the occasion of a symposium organized in London in 2018, on the occasion of the bicentenary of birth of the English physicist. The work is presented as relevant in several respects. Firstly, because it deals with the Energy Conservation Law itself, then because it addresses the problem of the concepts of energy and work from the point of view of the didactic proposal on textbooks and in classes. Finally, the possibility of teaching/learning science through the History of Science is examined. Again, in 2020, Prof. Pisano published an article in which he examined a fundamental character in the Italian History of Mathematics, Niccolò Fontana, known as *Tartaglia*, author, among other things, of the translation of Euclid’s Elements in the Italian language of his time (Pisano 2020). The subject of the article is Tartaglia’s work of 1546, *Quesiti et Inventioni Diverse*, and the sixth chapter – *Libro sexto* (or *Libro sesto* as it appears in the header of some pages) – is studied in detail together with an addition that follows with the name of *La Gionta del Sesto Libro*. The text contains considerations about mathematics and geometry applied to the design of fortifications – also following the rules of Euclidean geometry – and the use of artillery together with the study of projectile trajectories. The professor here asked himself questions about the role and temporal placement of *La Gionta del Sesto Libro*, in order to understand its actual placement – is it a complement to the chapter or a text in its own right? – and the role played by the Venice publisher Curzio Troiano Navò in editing Tartaglia’s manuscripts. In 2020 as well, Prof. Pisano was co–author (Pisano and Sozzo 2020) of an interesting and profound article, absolutely not trivial neither about the contents nor about the exposure, in which the quantum formalism of Hilbert’s space theory is applied to cognitive domains, in order to evaluate errors of judgment and decision making processes. Judgments on the action to be taken and decisions are described as non–deterministic processes where the interaction of two subjects is expressed, the conceptual identity and the surrounding cognitive context. A quantum point of view, from which a phenomenon is considered, is introduced with

observables, states and properties governed by the formalism of the typical mathematics of quantum mechanics.

Still generally speaking, the IEMN is an international research centre whose studies embrace a very wide range of scientific disciplines, in collaboration with other French, European and non-European Institutions. The broad scope of the research conducted and the ability of the IEMN staff to open up to collaborations with other subjects are well evidenced by the number of publications made individually by the various researchers, or in teams with French and non-French colleagues. The continuous exchange of ideas and cooperation ensures a continuous improvement in the quality of the results achieved and the opening of new research opportunities, both in the academic field and in the field of industrial research and development. Significant results have been obtained, over the years, in Solid State Physics, Thermodynamics, Biology and Genetics, just to mention a few areas researchers deal with, as it is underlined by the numerous publications available online, in various databases.

In 2020, for example, the working group that includes Cleri and Giordano undertook the study of a stochastic model applicable to the physical concept of force, to study the transition from ballistic to diffusive modality of heat conduction in solids and nanomaterials. They chose, as the simplest predictive model for conducting heat, that of a harmonic chain made up of N masses. To obtain the results then published (Cleri, Giordano *et al.* 2020), the chain, in contact with two Langevin thermal baths at different temperatures, was subjected to a stochastic force field. The interactions between the dimensions of the system and the properties of the thermal bath were analysed. Then, the interactions between the dimensions of the system in question and the properties of the thermal bath were analysed afterwards. A stochastic force field has proved to be the ideal tool, because it is simple enough to guarantee the Principle of Conservation of Energy for each of the particles making up the chain, but it also possesses those random properties that allow the transition from the ballistic regime to the diffusive one for the chain, when its conductive characteristics are studied. If the force field is not present, the ballistic behaviour proved to be strongly dependent on the collision frequency, characteristic of the thermal baths, whatever the size of the system. Once the stochastic force field is applied, a diffusive behaviour is established and, within the thermodynamic limit, the effect of the thermal field is removed. The results obtained also showed that the transition between the ballistic and the diffusive regime is observed when the size of the system increases; the authors found that – through a rigorous mathematical model – the so-called Matthiessen rule is able to describe the investigated process very effectively. The results obtained can be applied to thermal problems at the nanoscale, where an attempt is made to optimize the thermal conductivity of nanosystems between two thermal baths, when the number of particles N is finite and small. For the sake of completeness, the Matthiessen rule, to which the authors refer, is an experimental one summarized in the formula:

$$\kappa = \kappa_{\infty} \cdot \frac{N}{c+N} \quad W \cdot (\text{m} \cdot \text{K})^{-1} \quad (\text{I.5})$$

The researchers' ability to cooperate in teams and the strong international vocation of the IEMN both appear clear in a 2019 work on the local density of states (Franchina Vergel *et al.* 2019), through Scanning Tunneling Microscopy (STM) topography, to study quantum semiconductive structures. The working group of Franchina Vergel, Tadjine, Delereue and other researchers of the IEMN, together with scholars belonging to different international

institutes, investigated the behaviour of the quantum holes of $\text{In}_{0.53}\text{Ga}_{0.47}\text{As}$ grown on p-doped InP (110), so as to be able to describe the local density of the states in the hole, through the STM survey technique. The $\text{In}_{0.53}\text{Ga}_{0.47}\text{As}$, in particular, is a ternary compound whose lattice is matched to the InP and used as a channel for high frequency MOSFETs devices. The topography of this ternary compound, observed with STM microscopy, shows structures whose width is of the order of 40nm and whose height measures approximately 0.29nm.

Another international work published the same year (Jazi *et al.* 2019) studied quantum dot solids of colloidal nanocrystals (NCs), as they are interesting both for their optoelectronic properties, that reflect single nanocrystalline quantum dots, and for dipolar and electronic couplings that are established between them. Solid NCs are very versatile materials that can be configured very effectively through a chemical action on their surface. For these materials, the working group studied the phenomenon of electron transport on single sheets of PbSe having a geometric honeycomb structure. These structures, in fact, can be effectively incorporated in a transistor device, and their electron density and electron transport characteristics can be measured, the mobility of which is limited, because of the very accentuated scattering due to lattice imperfections.

In 2018, the working group lead by Cleri addressed the study of thermal behaviour in nanomaterials, through the relaxation of the thermal lattice in multilayer materials characterized by thermal resistances at the interface (Cleri *et al.* 2018). The research group has considered possible non-diffusive effects at the nanoscale of materials, through a non-local formulation of the heat equation, applying a similar experimental approach to the measurable thermal resistance at the grain boundary of silicon. A study of this type constitutes a non-trivial challenge, which is why the team applied different techniques. First, Raman thermometry, 3ω method, time domain thermo-reflectance or Scanning Thermal Microscopy were used. However, these methods work in the radiative spectrum of the optical wavelengths, which is why the spatial resolution is necessarily limited. The light-induced transient grating – LITG – technique, on the other hand, proves to be a non-invasive approach, also ensuring high accuracy and reproducibility of the results. The thermal response of the sample is a function of the wavelength of the transient grating and allows direct detection of non-local effects, confirming other results obtained in this direction, related to the nanometric thickness of the structure. The correct description of the non-diffusive effects for nanoscale transport was obtained through the introduction of a homogeneous non-local bulk conductivity, in the heat diffusive equation, in order to derive the scale-dependent model of the thermal behaviour of the bulk.

Thinking about the properties of matter at the solid state, in 2017 Cleri and his co-workers investigated the thermal conductivity of silicon nanowires (Cleri *et al.* 2017). Generally, this subject is studied through atomistic simulations that mark it as dependent both on the length and on the diameter of the wire itself. This equilibrium-approach methodology works very well for bulk material, and has been applied to wires up to 1.2 μm long and whose diameter ranges from 1nm to 14nm. The researchers also demonstrated that the temperature profile, along the axis of the analysed wire, and its temporal evolution satisfy the heat equation. Furthermore, it has been proved that the thermal conductivity proves to be length dependent, as a consequence of the fact that the cumulative distribution of the free mean paths of the phonons grows slowly. By reducing the mean free path of phonons in nanowires to a few hundred nanometers, the simulations allowed the observation of, unlike the bulk material, the infinity-limit saturation value of conductivity.

In 2015, Viero, Copie, Guérin, Krzeminski, Vuillaume, Lenfant and Cleri published a study on functionalized and self-assembling nanoparticles, a research field that sees

applications, for example, in molecular-scale electronic devices (Viero *et al.* 2015). Their research focused on the self-assembly of 10nm-sized gold particles, functionalized by a dense layer of azobenzene-bithiophene (AzBT) molecules to create a light-controllable device, characterized by on/off memristive properties. For this purpose, planar nanodevices were prepared, consisting of a network of self-assembled nanoparticles. Simulations of the molecular dynamics of the structures and of the interface between the chemo adsorbed monolayers on the nanoparticles were carried out. This way it was possible to prove that the action of light of a very specific wavelength had an effect on the molecules in terms of switching between the cis and trans isomers of the AzBT molecules; the switching between the two isomers is reversible and can be obtained, in fact, through irradiation with a precise sequence of wavelengths.

It is not only Solid State Physics, in terms of the structure of matter or the thermodynamic behaviour of materials, that is treated within the IEMN labs, but also biochemistry, in terms of the analysis of the DNA structure. In 2013, Singh, Blossy and Cleri studied the structure and mechanical properties of *i*-motif (intercalated motif) DNA nanowires, a non-standard structure of DNA discovered in 1993 by Maurice Guéron, at l'École Polytechnique in Palaiseau, France, through computer simulations of molecular dynamics (Singh, Blossy and Cleri 2013). Wires with a length of up to 230 nanometers in length were prepared, based on a repeating sequence of TC5, from which it was possible to calculate both the Young's modulus and the bending modulus; from the realized models it was also possible to estimate the tensile strength, demonstrating that the DNA *i*-motif nanowires are analogous, from the point of view of tensile stiffness, to structural proteins, but are more similar to nucleic acids and flexible proteins, in terms of what concerns the bending stiffness. Indeed, thanks to the thin cross section, the tensile strength is comparable to that of a metal. Thanks to their particular mechanical properties, they represent very good candidates for biomimetic nanoscale templates.

1.3.3. Nanoscience & Nanotechnology: the Worldwide Research

Since Nanoscience and Nanotechnology are disciplines of worldwide interest, I think it appropriate to indicate which, according to the statistics, are the best places to study these subjects in depth. As the following table is the result of statistical surveys, it cannot be considered as containing absolute results, but a snapshot of the situation as of today, a situation which is obviously susceptible to changes. The following table I.5 recollects the first 50 “top” places in which to study Nanoscience and Nanotechnology, and is an excerpt of 250 names, compiled from the website <https://www.usnews.com/education/best-global-universities/Nanoscience-Nanotechnology>³ where the data are collected and where it is also possible to learn more about which parameters have been considered and through which algorithms the numbers that are reported as Subject score and Global score have been calculated.

³ Retrieved December the 2nd 2020.

Tab. 1.5 The top 50 worldwide Institutions for Nanoscience and Nanotechnology, <https://www.usnews.com/education/best-global-universities/Nanoscience-Nanotechnology>.

Country	Institution	Subject score	Global score	Enrollment
Singapore	Nanyang Technological University	100	76,6	23.902
China	Tsinghua University	92,2	78,5	37.484
United States of America	Georgia Institute for Nanoscience and Nanotechnology	90,1	73,3	24.695
China	Soochow University	89,6	55,5	49.098
China	University of Chinese Academy of Science	89,3	62,6	N/A
United States	Stanford University	89,2	95,3	16.223
China	Peking University	88,9	74,9	38.583
China	University of Science and Technology of China	88,3	68,0	16.434
United States of America	Massachusetts Institute of Technology	85,4	97,9	11.276
China	Zhejiang University	85,0	66,9	36.825
China	Wuhan University of Technology	84,8	52,4	52.910
United States of America	University of California - Berkeley	84,2	89,8	39.918
United States of America	Harvard University	82,9	100,0	21.261
Singapore	National University of Singapore	82,7	77,5	30.943
China	Huazong University of Science and Technology	81,6	62,2	56.941
United States of America	University of California – Los Angeles	79,4	84,3	42.509
China	Tianjin University	78,6	55,6	N/A
China	Xi'an Jiaotong University	78,5	57,8	36.551
Saudi Arabia	King Abdullah University of Science & Techology	77,5	68,3	N/A
China	South China University of Technology	77,5	58,2	40.581
United Kingdom	University of Cambridge	77,5	85,8	19.580
China	Fudan University	77,2	65,5	32.597
United States	Rice University	77,2	67,6	6.805
China	Shanghai Jiao Tong University	77,2	68,2	38.556
Switzerland	École Polytechnique Federale of Lausanne	76,8	74,4	10.942
United States of America	University of Washington – Seattle	76,5	86,0	46.258
China	Jilin University	76,1	51,7	71.593

Saudi Arabia	King Abdulaziz University	76,1	76,0	31.869
China	Nanjing University	75,9	66,0	37.457
China	Nankai University	75,9	55,9	29.500
Australia	University of Wollongong	75,5	61,8	19.703
China	Beihang University	75,1	57,7	30.172
Hong Kong	City University Hong Kong	75,1	65,3	9.513
Hong Kong	University of Science and Technology	75,0	69,1	9.976
China	Harbin Institute of Technology	74,5	61,8	31.513
United Kingdom	University of Oxford	73,6	87,0	N/A
United States	University of Texas – Austin	73,6	76,6	N/A
China	Sun Yat-sen University	73,4	64,0	53.734
China	Xiamen University	72,3	57,9	41.546
China	Beijing Institute of Technology	72,1	52,7	31.964
China	Nanjing University of Technology	71,2	44,9	34.424
United States of America	Northwestern University	70,9	80,4	N/A
United States of America	Drexel University	70,7	54,4	N/A
China	University of Science & Technology Beijing	70,4	50,5	N/A
South Korea	Ulsan National Institute of Science & Technology	70,1	54,1	N/A
China	University of Electronic Science and Technology of China	69,9	55,9	32.932
China	Shenzhen University	69,8	53,2	35.396
China	Nanjing University of Science & Tech.	69,4	47,6	33.452
South Korea	Seoul National University	69,3	67,5	N/A
Switzerland	Swiss Federal Institute of Technology Zurich	69,3	79,5	19.043

As part of my research, I also found it important to investigate where studies on Nanoscience and Nanotechnology are being conducted in various countries at different levels. For this reason, in the following table, I have reported the places – universities or study centres – that deal with these topics, concentrating the research on institutions in the “western” area. In order to retrieve the information, I used the website www.nanowerk.com⁴ which collects, in a very comprehensive way, the most important information on the nanoworld (Table I.6).

⁴ Retrieved December the 2nd 2020.

Table. I.6 Some of the research centres where Nanoscience and Nanotechnology are the most important subjects with a short description of what is organised.

Country	Institution	Research Areas
Austria	Technical University Vienna – Centre for Micro- and Nanostructures (ZMNS)	The centre provides a state-of-the art environment for teaching the fundamental techniques used to fabricate new semiconductor devices. The main goal of the research and development activities is the transfer of innovative ideas from basic science to device concepts.
Austria	Technical University Vienna – Solid State Electronics Institute	Supramolecular chemistry involving: Nanoglycobiology, Nano-Biotechnology, Nanostructures
Austria	University of Graz – Optical Nanotechnology/Nano-Optics	The group's research program is devoted to the investigation of the physical concepts of a subwavelength light technology (Nano-Optics), mainly based on surface plasmon excitations in metal nanostructures.
Austria	University of Graz – Single Molecule Chemistry	The group's research is focused on the characterization and manipulation of nanostructures, single atoms and functionalized molecules on surfaces. By using Scanning Tunneling Microscope (STM) and Atomic Force Microscope (AFM) at different temperatures, imaging of nanostructures is obtained with atomic and sub-molecular resolution while spectroscopy provides information on their electronic structure.
Austria	University of Vienna – Quantum Nanophysics and Molecular Quantum Optics	Research interests are focused on quantum nanophysics with large molecules and nanoparticles: Matter-wave coherence, interference and decoherence; Quantum-enhanced molecule & cluster metrology; New trapping and cooling schemes; New molecular beam and detection methods.
Austria	University of Vienna – Solid-state spectroscopy	Solid State Spectroscopy research group at the University of Vienna.

Belgium	Erasmus Mundus Master Nanoscience and Nanotechnology	Four leading research and educational institutions in Europe propose a joint Erasmus Mundus Master Course entitled “Nanoscience and Nanotechnology”. The objective of this course is to provide top quality multidisciplinary education in Nanoscience and Nanotechnology.
Belgium	Katholieke Universiteit Leuven – Master of Nanoscience and Nanotechnology	The objective of the programme Master of Nanoscience and Nanotechnology is to provide top-quality University multidisciplinary education in nano-science as well as in the use of nano-technologies for systems and sensors at the macro-scale. Ethical and societal aspects with respect to the use of nano-science and nano-materials are also part of this curriculum. Courses are taught in English.
Belgium	Université Catholique de Louvain – Institute of Condensed Matter and Nanosciences	The institute of Condensed Matter and Nanosciences (IMCN) conducts multidisciplinary research at the intersection fields of materials (starting from the atomic and molecular levels), electronics and biology. The institute studies new chemistry and physics, exploiting novel principles in nanostructured devices with new functionalities. The research deals with the synthesis, design, handling, modelling and implementation of (bio)molecules, (bio)surfaces and solid materials. The functions, properties or reactivity of these novel (nano)structures are investigated and characterized by advanced techniques, or predicted by numerical simulations.

Belgium	University of Antwerp – Master of Nanophysics	The Master of Nanophysics programme is not organised every year, but a number of English courses remain available to foreign students (e.g. within Erasmus program). Additionally, foreign students are welcome for internships and their M.Sc. thesis work at University of Antwerp. Provided that more than 40 ECTS are collected and recognized by his/her home university, the student can obtain a bi-diploma.
Belgium	University of Antwerp – NanoLab Centre of Excellence	The NanoLab centre of excellence consists of six research groups (EMAT, CMT, PLASMANT, AXES, DuEL, ENM) with complementary expertise in the field of Nanoscience and nanomaterials. The research focuses around the themes of structural and chemical characterization by means of electron microscopy, computer simulations of the growth of nano structures formed in plasmas or by laser interaction, theoretical modulation of nano structures and the study of their optical, magnetic and superconducting properties.
Belgium	University of Mons–Hainaut – Laboratory for Chemistry of Novel Materials	The research activities of the group deal with the structural, electronic, and optical properties of novel organic materials, such as functional nanostructures, with promising characteristics in the field of electronics, photonics, and information technology.
Belgium	University of Mons–Hainaut – Laboratory of Polymeric and Composite Materials	Synthesis, characterization, transformation, processing, and applications of polymeric and composite (nano)materials.

Belgium	University of Namur – Laboratoire Interdisciplinaire de Spectroscopie Electronique (LISE)	The Laboratoire Interdisciplinaire de Spectroscopie Electronique (LISE) is an interdisciplinary research and teaching unit at the University of Namur. Experimental, condensed, matter physics and chemistry. Focus is on synthesis and analysis of nanomaterials.
Canada	Carleton University – BSc Chemistry with a concentration in Nanotechnology	Students study atoms and molecules used to create computer chips and other devices that are the size of a few nanometres – thousands of times smaller than current technology permits. Such discoveries will be applied in a number of fields, including aerospace, medicine, and electronics.
Canada	Carleton University – BSc Nanoscience	At Carleton, Nanoscience through the disciplines of physical chemistry and electrical engineering to understand the physical, chemical and electronic characteristics of matter in this size regime is examined. The combination of these two areas of study allows to fully understand Nanoscience in photonic, electronic, energy and communication technologies. The focus of the program is on materials – their use in electronic devices, their scalability and control of their properties.
Canada	McGill University – Bachelor of Engineering, Minor Nanotechnology	Through courses already offered in the Faculties of Science, Engineering, and Medicine, depending on the courses completed, undergraduate students acquire knowledge in areas related to Nanotechnology.
Canada	McGill University – Nano Electronic Devices and Materials	Investigation of semiconductors and devices for optoelectronic applications including photovoltaic energy conversion and optical communications. Development of thin film transistors for electronic displays and imaging systems.

Canada	McGill University – Nanobioengineering	The group's research in micro- and nano-bioengineering is focused on miniaturizing biological experimentation to microscopic scales and progresses along two axes: Firstly, create tools and use them for precisely controlling and varying the cellular microenvironment, which will allow studying the response of cells and groups of cells to external cues and <i>stimuli</i> applied to single cells. Secondly, the large scale parallelization of the biological experiments for both protein analysis and cell biological experiments.
Canada	McGill University – Nanoscience & Scanning Probe Microscopy Group	The focus of the research program is to apply the recently developed tools, techniques and materials to the emerging field of Nanoelectronics.
Canada	McMaster University – Microscopy of Nanoscale Materials	The group's research focuses on the application and development of advanced microscopy techniques to study the structure of materials at very high spatial resolution. The core area of research is based on Transmission Electron Microscopy methods but they also use scanning probe techniques and other characterization techniques to provide information on how the structure of materials affects the properties these materials exhibit.

Canada	NanoQAM	The Research centre NanoQAM is a grouping of five laboratories in Nanotechnologies of the Université du Québec à Montréal each offering their knowledge and expertise in nanomanufacturing using polymers, development of high-energy nanomaterials, renewable energies, nanoimaging, green chemistry as well as the development of biological membranes, biomaterials and biosensors. NanoQAM allows access to its infrastructures and scientific equipment, either for industries and other academic institutions.
Canada	Nanorobotics Laboratory at the École Polytechnique Montréal	The main research focus of the Laboratory is to pioneer in the development of new instrumented platforms and techniques through nanorobotics by exploiting the unique properties of molecular scale entities. The main areas of applications are in medicine and bioengineering, including supporting new robotic platforms for nanomanufacturing or high-throughput automatic operations at the nanoscale.
Canada	Northern Alberta Institute of Technology – Nanotechnology Systems Diploma Program	The two year program will provide graduates with the skills to operate systems and equipment associated with Canada's emerging Nanotechnology industry and lead to a Diploma in Nanotechnology Systems.
Canada	Université de Sherbrooke CRN2 (Centre de Recherche en NanoFabrication et en Nanocaractérisation)	The CRN2 is active in fundamental and applied research in microelectronics, nanoelectronics, and optoelectronics.

Canada	University of Alberta – BSc Computer Engineering with Nanoscale System Design Option	This option provides an introduction to the processes involved in the fabrication of nanoscale integrated circuits and to the computer aided design (CAD) tools necessary for the engineering of large scale system on a chip. By selecting this option, students learn about fault tolerance in nanoscale systems and gain an understanding of quantum phenomena in systems design.
Canada	University of Alberta – BSc Electrical Engineering with Nanoengineering Option	This option provides an introduction to the principles of electronics, electromagnetics and photonics as they apply at the nanoscale level. By selecting this option, students learn about the process involved in the fabrication of nanoscale structures and become familiar with the computer aided design (CAD) tools necessary for analysing phenomena at these very high levels of miniaturization.
Canada	University of Alberta – BSc Engineering Physics with Nanoengineering Option	The Nanoengineering Option provides broad skills suitable for entry to the Nanotechnology professions, combining core Electrical Engineering and Physics courses with additional instruction in biochemistry and chemistry, and specialized instruction in nanoelectronics, nano-bioengineering, and nanofabrication.
Canada	University of Alberta – BSc Materials Engineering with Nano and Functional Materials Option	Subject areas covered include electronic, optical and magnetic materials, nanomaterials and their applications, nanostructured molecular sieves, nano and functional materials processing and fabrication. Employment opportunities exist in several sectors of Canadian industry, such as microelectronic/optoelectronic device fabrication, MEMS processing and fuel cell development.

Canada	University of Alberta – Buriak Research Group	Subject areas cover nanomaterials, materials for energy, silicon surface chemistry, block copolymer self-assembly and cooperation with industries
Canada	University of Alberta – Centre for Surface Engineering and Science	Specializing in surface characterization and modification, ACSES provides sample analysis capabilities for a wide range of material and process applications. With a focus on elucidating the composition and structure of thin films, the equipment set available to academic and industrial users is unmatched within an academic environment. Coupled with a dedicated staff of 3, ACSES provides all necessary onsite expertise for training and data analysis.
Canada	University of Alberta – Nano Interfaces and Molecular Engineering	The focus of the group's research is to understand the fundamental process of nanoscale interfaces and use that information to develop novel instrumentation and tools which will enhance our quality of life and protect the environment. Their focus areas are nanoscale interface and molecular engineering with an emphasis on oilsands, nanobiology, and energy harvesting.
Canada	University of Alberta – NanoFab	The nanoFAB is an open access micro and nano fabrication research facility. With approximately \$30,000,000 worth of micro and nano fabrication equipment and infrastructure, their instruments allow for optical mask generation, electron beam lithography, PVD, LPCVD and PECVD deposition of thin films, deep Si etch processes and micro and nano embossing. Along with a dedicated staff of 10 for training and on-site technical assistance for process development, this is an unparalleled Canadian academic facility for micro and nano fabrication research and development.

Canada	University of Alberta – Office of Environmental NanoSafety	The Office of Environmental NanoSafety website serves several purposes and audiences: 1) This site serves as a resource to industry to inform them of the Nanotechnology research capacity in Canada. 2) It contains an index of nano-companies and research groups involved in environmental health and safety research in Canada. 3) It acts as a non-governmental sources of information on environmental nanotoxicology/nanosafety issues in Canada for both interested media and the public.
Canada	University of British Columbia – Advanced Materials and Process Engineering Laboratory (AMPEL)	A multi-disciplinary research centre with Nanoscience and Nanotechnology research.
Canada	University of British Columbia – Microsystems and Nanotechnology Group (MiNa)	The group is engaged in many areas of microsystems and Nanotechnology, with a particular focus on devices and systems, experimentation and fabrication. Applications of MiNa research span over many areas, including biomedical devices, nano-computing, nano-devices, communication, energy, sensors and actuators.
Canada	University of British Columbia – Single Molecule AFM Laboratory	The research program is in the area of single molecule biophysical chemistry and interested in the mechanical properties and conformational dynamics of elastic proteins.
Canada	University of Calgary – B.Sc. Concentration in Nanoscience	Courses offered are a B.Sc. Minor in Nanoscience and a B.Sc. Concentration in Nanoscience.
Canada	University of Calgary – B.Sc. Minor in Nanoscience	Courses offered are a B.Sc. Minor in Nanoscience and a B.Sc. Concentration in Nanoscience.

Canada	University of Calgary nanoGroup	The University of Calgary nanoGroup is a student-led organization founded in 2013 with one central focus: to cultivate and support the Nanotechnology community at the University of Calgary Campus.
Canada	University of Guelph – BioNano Laboratory	The Suresh lab at the School of Engineering is focused on studying the nanoscale aspects of biosystems through bio-instrumentation and bio-imaging. The group fosters interdisciplinary approach to research in studies covering diverse topics of food, biological and agricultural systems.
Canada	University of Guelph – Nanoscience B.Sc. Program	At Guelph we have created a unique approach to Nanoscience studies. Fundamental science courses are combined with specially designed courses in Nanoscience covering material that would previously only be found in graduate programs.
Canada	University of Toronto – Advanced Micro and Nanosystems Laboratory	The Advanced Micro and Nanosystems Laboratory's research has a strong focus on bio-oriented micro and nanosystems. The actively pursued areas are micro-nano device design and fabrication (MEMS sensors and actuators, bioMEMS, and NEMS); microbotic biomanipulation; microstructure controls; cellular mechanobiology; nanorobotic manipulation of nanomaterials.
Canada	University of Toronto – BAsC in Engineering Science (Nanoengineering Option) https://www.nanowork.com/nanotechnology-labs.php?url2=University_of_Toronto_BAsC_in_Engineering_Science_Nanoengineering_Option.php	This option transcends the traditional boundaries between physics, chemistry, and biology. Starting with a foundation in materials engineering and augmented by research from the leading-edge of nanoengineering, students receive an education that is at the forefront of this constantly evolving area.

Canada	University of Toronto - Centre for Advanced Nanotechnology (ECAN)	ECAN's mission is to provide visionary leadership in creating a solid, dynamic, multidisciplinary research and development infrastructure for Canada.
Canada	University of Toronto – Electronic-Photonic Materials Group (EPMG)	EPMG is a research group dedicated to the training of highly-qualified personnel in understanding the science and engineering of electronic materials suitable for advancing the performance of future generations of electronic and photonic devices.
Canada	University of Toronto – Integrated Nanotechnology & Biomedical Sciences Laboratory	The Chan research group aims to elucidate the cell's molecular dynamics by using recent developments in Nanotechnology, microtechnology, and molecular engineering.
Canada	University of Toronto – Ozin Group	The Ozin research group at the University of Toronto.
Canada	University of Toronto – Sargent Group	The Sargent Group at the University of Toronto applies discoveries in Nanoscience towards applications relevant to our health, environment, security, and connectedness. The team unites chemistry, physics, and engineering within six experimental laboratories at the University of Toronto.
Canada	University of Victoria Centre for Advanced Materials and Related Technology (CAMTEC)	CAMTEC is a research centre committed to interdisciplinary work on advanced materials and technology.

Canada	University of Waterloo – Bachelor of Applied Science Nanotechnology Engineering	The Nanotechnology Engineering honours degree program is designed to provide a practical education in key areas of Nanotechnology, including the fundamental chemistry, physics, and engineering of nanostructures or nanosystems, as well as the theories and techniques used to model, design, fabricate, or characterize them. Great emphasis is placed on training with modern instrumentation techniques as used in the research and development of these emerging technologies.
Canada	University of Waterloo – Master of Applied Science Nanotechnology	The interdisciplinary research programs, jointly offered by three departments in the Faculty of Science and four in the Faculty of Engineering, provide students with a stimulating educational environment that spans from basic research through to application. The goal of the collaborative programs is to allow students to gain perspectives on Nanotechnology from a wide community of scholars within and outside their disciplines in both course and thesis work. The MASc and MSc degree collaborative programs provide a strong foundation in the emerging areas of nano-science or nano-engineering in preparation for the workforce or for further graduate study and research leading to a doctoral degree.

Canada	University of Waterloo – Master of Science Nanotechnology	The interdisciplinary research programs, jointly offered by three departments in the Faculty of Science and four in the Faculty of Engineering, provide students with a stimulating educational environment that spans from basic research through to application. The goal of the collaborative programs is to allow students to gain perspectives on Nanotechnology from a wide community of scholars within and outside their disciplines in both course and thesis work. The MASc and MSc degree collaborative programs provide a strong foundation in the emerging areas of nano-science or nano-engineering in preparation for the workforce or for further graduate study and research leading to a doctoral degree.
Canada	University of Waterloo – Ph.D. Program in Nanotechnology	The objective of the Ph.D. program is to prepare students for careers in academia, industrial Research & Development and government research labs. Students from Science and Engineering will work side-by-side in world class laboratory facilities namely, the Giga-to-Nano Electronics Lab (G2N), Waterloo Advanced Technology Lab (WatLAB) and the new 225,000 gross sq. ft. Quantum-Nano Center.
Canada	University of Waterloo – Quantum-Nano Centre (QNC)	The Quantum-Nano Centre (QNC) will be a technology incubator for the 21st Century. From Nano Structures to Quantum Information Processing, the focus of the QNC will be to develop new and practical devices that exploit the laws of quantum mechanics with applications that include computation, information, metrology and material science.

Canada	University of Waterloo – Waterloo Institute for Nanotechnology	The Waterloo Institute for Nanotechnology (WIN) is a world-class research centre, located at the University of Waterloo (UW) in Ontario, Canada. The campus is home to world-class researchers, flagship research facilities and Canada's largest Nanotechnology undergraduate engineering program with over 450 students. The overall objective is to establish WIN as a global centre of excellence for Nanotechnology and its applications.
Canada	University of Waterloo Nanotechnology Engineering	Offers the only undergraduate program specialized in Nanotechnology engineering in Canada.
China	Beihang University – Bioinspired Functional Nanocomposites	Inspired by the natural biological materials, such as the spider silk, lotus root silk, shells, the group is focused on bioinspired polymer nanocomposites, including assembly, design and physical properties investigation. Different nanomaterials, such as montmorillonite, carbon nanotubes and graphene oxide, are utilized as building blocks for constructing polymer nanocomposites.
China	CAS Technical Institute of Physics and Chemistry – Laboratory of Controlled Preparation and Application of Nanomaterials	The lab's research is focused on: Nanomedicine, Quantum dots, Biosensor, Textile, Controllable synthesis, Electronic paper.
China	City University of Hong Kong – Center of Super-Diamond and Advanced Films (COSDAF)	COSDAF works in the areas of nanomaterials & Nanotechnology, organic light-emitting devices (OLED), nanodiamond and super-hard thin films.
China	Hong Kong University – Nano and Advanced Materials Institute (NAMI)	In partnership with local industries, NAMI will conduct market-driven, demand-led development of Nanotechnology and advanced materials.

China	Hong Kong University of Science and Technology – M.Phil. Nano Science and Technology	At the Hong Kong University of Science and Technology (HKUST), the School of Science and the School of Engineering jointly offer Nano Science and Nano Technology Postgraduate Programs that integrate different disciplines in both science and engineering. The School of Science offers MPhil and Ph.D. Program in Nano Science and Technology (NSNT) and the School of Engineering offers Nanotechnology Concentration.
China	Hong Kong University of Science and Technology – Ph.D. Nano Science and Technology	At the Hong Kong University of Science and Technology (HKUST), the School of Science and the School of Engineering jointly offer Nano Science and Nano Technology Postgraduate Programs that integrate different disciplines in both science and engineering. The School of Science offers MPhil and Ph.D. Program in Nano Science and Technology (NSNT) and the School of Engineering offers Nanotechnology Concentration.
China	Hong Kong University of Science and Technology – Smart Materials Lab	Main research interests include soft condensed matter physics, electrorheological and magnetorheological fluids, field-induced pattern and structure transitions, micro- and nano-fluidic controlling, microsphere and nanoparticle fabrications, thin film physics, band gap materials, metamaterials and nonlinear optical materials.
China	Hong Kong University of Science and Technology – William Mong Institute of Nano Science and Technology (INST)	The mission of the INST is to pursue world-class fundamental research in the area of nanostructured materials.
China	Jinan University – Institute of Nanophotonics	The institute conducts research in all areas of nanoscale optics and photonics.

China	Southeast University – Advanced Photonics Center	The centre is focused on the areas of advanced photonics, including Fundamental Photonics, Information Photonics, Nanophotonics and Biophotonics.
China	Tianjin University – Micro and Nano Manufacturing and Measuring Technology Engineering Center	The centre is supported by school of precision instrument and optoelectronics engineering, national key laboratory of precision measurement technology and instrument, research institute of micro and nano measurement and equipment and it mainly specializes in industrialized work like micro electromechanical system, Ultra-precision micro-nano processing as well as micro and nano measurement and equipment.
China	University of Science and Technology of China – Deng Research Group	Research in this group is highly interdisciplinary, covering analytical chemistry, bio-Nanotechnology, and electrochemistry. The group is working on constructing electrochemistry-based sensors for high sensitivity and easy detection of biomolecules (DNA and proteins, in particular). They are also interested in using bio-inspired processes and electrochemical approaches for the development of new tools towards nanotechnological applications.
Denmark	Aarhus University – Center for DNA Nanotechnology (CDNA)	The vision of CDNA is exploring fundamental aspects of DNA as a programmable tool for directing the assembly of molecules and materials into nanoarchitectures and functional structures.

Denmark	Aarhus University – Interdisciplinary Nanoscience Center (iNANO)	iNANO commands a variety of facilities for the synthesis of nanostructured/nanopatterned 0D (i.e. nanoparticle), 1D, 2D and 3D materials. These include: equipment for electrospinning, photo- and electron beam-lithography, nanoparticle synthesis (supercritical synthesis), solid-phase peptide synthesis, DNA modification, bioreactors for large-scale protein expression, isotope labelling, and procedures for synthesis of functionalized nanoparticles for targeted drug delivery and bioimaging, aptamers, etc.
Denmark	DTU Nanotech – MSc Physics and Nanotechnology	The MSc programme in Physics and Nanotechnology covers a wide range of technological, theoretical, and experimental techniques in modern physics. The applications include various topics, such as the development of nanostructured materials with tailor-made electrical, magnetic, optical, mechanical and chemical properties, manufacturing and integration of nano- and micro-components in systems design, modelling of complex biological systems, optical data processing and transfer, and the development of technologies for sourcing, storing, and converting sustainable energy – e.g. fuel cells and hydrogen technology.

Denmark	DTU Nanotech – Ph.D. Program	The Department of Micro- and Nanotechnology – DTU Nanotech – is a highly esteemed research institution within the field of micro- and Nanotechnology. Applied science, innovation strategies and state-of-the-art technology form the core identity as a scientific institution. Technology transfer and technology development are encouraged through industry collaboration, and industrial Ph.D. students are an integrated part of the Ph.D. programme.
Denmark	iNANOschool	iNANOschool is a graduate school in Nanoscience and Nanotechnology at the University of Aarhus and Aalborg University.
Denmark	Technical University of Denmark – Center for Electron Nanoscopy (CEN)	CEN houses 7 new microscopes built by FEI ranging from a standard SEM instrument to two highly specialized Titan TEMs. The new unit represents an exciting opportunity that will allow DTU and Denmark to be at the forefront of research utilizing all forms of electron microscopy and will be available for use by both in-house and external users.
Denmark	Technical University of Denmark – Center for Individual Nanoparticle Functionality (CINF)	The main objective of the Danish National Research Foundation Center for Individual Nanoparticle Functionality (CINF) at DTU is to explore and understand the fundamental relations between surface morphology and reactivity on the nanometer scale.
Denmark	Technical University of Denmark – Center for Nanotechnology (Nano DTU)	Nano DTU covers the full spectrum from basic research to applications. Nano DTU is organized in nine research themes, spanning from nano bio-technology to energy technology.
Denmark	Technical University of Denmark – DANCHIP National Cleanroom Facility for Micro- and Nanotechnology	DANCHIP is a national facility for producing components based on micro- and nanostructured materials for the use in research and industrial products.

Denmark	Technical University of Denmark – Department of Micro and Nanotechnology (MIC)	MIC is the department for micro- and Nanotechnology at the Technical University of Denmark. MIC's mission is to: educate scientists and engineers, conduct research and development in micro and Nanotechnology, and transfer new technologies to Danish industry, through joint programmes.
Denmark	University of Aalborg – Institute of Physics and Nanotechnology	Recent work has focused on Linear and nonlinear optical nanoscopy; Photoemission and nonlinear optical spectroscopy of metallic quantum wells; Quantum mechanical and statistical modelling of organic and inorganic nanomaterials; Advanced spectroscopic and STM studies of surface structures and reactions.
Denmark	University of Aarhus – Bachelor's Program in Nanoscience	During the first three years, students receive basic interdisciplinary training in physics, chemistry, biology, molecular biology, mathematics, and computer science. Many of the courses are followed along with students from these core disciplines. In addition, a number of courses address issues specific to the nano-area.
Denmark	University of Aarhus – Doctorate Degree in Nanoscience	In addition to the undergraduate programs, iNANO hosts a Doctorate school in Nanoscience, iNANO school. Here, students can be admitted with a Master's degree in a traditional (5+3) year model, but at this Faculty, studies are more often carried out following a (4+4) year model where the students are admitted after four years of study and the Master's project becomes an integrated part of the Doctorate which then lasts four years. A special (3+5) year honours program has recently been introduced where very talented students can be admitted to graduate school with a Bachelor's degree.

Denmark	University of Aarhus – Interdisciplinary Nanoscience Center (iNANO)	The members of iNANO and their respective research groups have complementary research programs in the analysis and synthesis of nanomaterials. The framework of iNANO, however, fosters and strengthens interdisciplinary activities, promotes the development of new non-traditional programs, and provides unique facilities for competitive research.
Denmark	University of Aarhus – Master’s Program in Nanoscience	During their Master’s degree students are required to specialize in one of three different disciplines: nanophysics, nanochemistry or nanomolecular biology.
Denmark	University of Copenhagen – Bachelor in Nanoscience	The university’s Nanoscience bachelor (in Danish).
Denmark	University of Copenhagen – Bachelor in Nanoscience – QD research	The Center for Quantum Devices research: How to create, control, measure, and protect quantum coherence and entanglement in solid-state electronic devices are the main themes of QDev.
Denmark	University of Copenhagen – MSc Nanoscience	On the master’s degree program in Nanoscience you will specialise yourself within your field of Nanoscience and Nanotechnology. There is a great amount of freedom to choose between the different topics and courses, and to a wide extent it will be possible for you to draw up your own education. You will also have the chance to participate in conferences in Denmark and abroad.
Denmark	University of Southern Denmark – MSc in Nanobioscience	Nanobioscience is a scientific discipline where techniques on a nano-scale are used to understand and utilise the construction of nature and the molecular principles and structures which are the cornerstones of all biology. The purpose of Nanobioscience is, for instance, to use biological molecules for constructing functional nanomaterials with a long list of groundbreaking uses.

Denmark	University of Southern Denmark – Nano Site	The Nano site serves all activities around Nanoscience, Nanotechnology and nanobusiness at the University of Southern Denmark. It is separated into two platforms: NanoBIC for activities related to nanobioscience and Nanotek related to Nanotechnology.
Denmark	University of Southern Denmark – NanoSYD	The mission of NanoSYD is to establish Nanotechnology in the region of Southern Denmark around new and existing focus areas and niche competences and to bridge basic science and technology along micro- and Nanotechnologies.
Denmark	University of Southern Denmark – Biomolecular Nanoscale Engineering Center (BioNEC)	The vision of BioNEC is to revolutionize bottom-up nanoscale engineering by integrating state-of-the-art lipid-, peptide- and carbohydrate chemistry with nucleic acid based self-assembly. The group will design and synthesize building blocks for controlled assembly of unique and functional nanostructures in solution and on surfaces. Within BioNEC, the assembled nanostructures will be explored to solve concrete scientific challenges relating to synthetic chemistry and biological recognition processes.

France	Ecole Polytechnique – NanoMaDe Group	Created in 2003 the NanoMaDe team (NanoMATERIALS & DEVICES) is involved in the field of Nanotechnology and Nanoscience, particularly on topics related to the carbon nanotubes, graphene and semiconductor nanowires synthesis, as well as their collective organization, deposition on various substrates, in deep characterization and integration into advanced electronic devices (field effect transistors, gas or biological sensors, NEMS, field emission micro-cathodes and other applications).
France	Grenoble Institute of Technology – Nanotech Master Program	A 2-year international course born of the collaboration between three European engineering institutes: Institut national polytechnique de Grenoble (France), école polytechnique fédérale de Lausanne (Switzerland) and Politecnico di Torino (Italy).
France	Lyon Institute of Nanotechnology – Master of Nanoscale Engineering	The Master of Nanoscale Engineering offers you the opportunity to explore this challenging field in a stimulating scientific and cultural environment. The program is dedicated to a multidisciplinary and international approach and it is suited equally well for students planning an academic or an industrial career. The two-year curriculum provides both the theoretical basis and the practical expertise in all fields related to the fabrication, the characterization and the design of nanoscale structures and systems.
France	Université de Bourgogne – Département Nanosciences	Research areas include nanomaterials and nanosensors.
France	Université de Bourgogne – Master mixte Nanotechnologies et nanobiosciences	A Master degree program in Nanotechnologies and nanobiosciences.

France	Université de Lyon – Master of Nanoscale Engineering	The Master of Nanoscale Engineering offers you the opportunity to explore this challenging field in a stimulating scientific and cultural environment. The program is dedicated to a multidisciplinary and international approach and it is suited equally well for students planning an academic or an industrial career. The two-year curriculum provides both the theoretical basis and the practical expertise in all fields related to the fabrication, the characterization and the design of nanoscale structures and systems.
France	Université de Technologie de Troyes – Doctorat Spécialité Optique et Nanotechnologies	The specialty “Optics and Nanotechnologies” relies mainly on one of the research teams of the ICD, the laboratory of Nanotechnologies and Optical Instrumentation. The training is mainly in the field of microscopies and optical spectroscopies with local probe and familiarization with other microscopies. The main research themes addressed are focused on Nanosciences ⁵ .
France	Université de Technologie de Troyes – Master Sciences Optique et Nanotechnologies	The Optics and Nanotechnologies (ONT) specialty of the Sciences, Technologies and Health Master offers training mainly in the field of optical microscopies and spectroscopies with local probe and familiarization with other microscopies (AFM, STM) ⁶ .

⁵ La spécialité ‘Optique et Nanotechnologies’ s’appuie principalement sur une des équipes de recherche de l’ICD, le laboratoire de Nanotechnologies et d’Instrumentation Optique. La formation se situe essentiellement dans le domaine des microscopies et spectroscopies optiques à sonde locale et une familiarisation aux autres microscopies. Les principaux thèmes de recherche abordés sont tournés vers les Nanosciences.

⁶ La spécialité Optique et Nanotechnologies (ONT) de la Master Sciences, Technologies et Santé propose une formation principalement dans le domaine des microscopies et spectroscopies optiques à sonde locale et une familiarisation aux autres microscopies (AFM, STM).

France	Université de Technologie Troyes – Laboratory of Nanotechnology, Instrumentation and Optics (LNIO)	The Laboratory of Nanotechnology, Instrumentation and Optics (LNIO) is tasked with the development of nano-optics, which addresses a number of technological, scientific and socio-economic challenges. Researchers at LNIO are working on new concepts and approaches, developing both innovative instrumentation and nanocharacterization and nanomanufacturing methods.
France	Université Joseph Fourier Grenoble – Master Nanosciences/Nano technology	This interdisciplinary master programme in physics, chemistry and biology, equips students with in-depths knowledge in their field of study while they are being immersed in an exceptional research environment: the international scientific community of Grenoble which includes the UJF laboratories, the Grenoble INP, the CEA Grenoble, the CNRS and major research centres such as the synchrotron (ESRF) and the Institut Laue-Langevin (ILL).
France	Université Lille 1 – Master Micro & Nanotechnologies	The Micro & Nanotechnology specialty trains professionals and researchers with a good knowledge of industrial applications of microsystems and Nanosciences: characterization, manufacturing & integration.
France	Université Paris Sud – Silicon Photonics	The main promising applications are forecast in the fields of optical interconnects in CMOS integrated circuits and optical communications, where silicon can provide low cost solutions. Strong potential also exists in the development of silicon nanostructures for biophotonics. Studies in this field have been performed for many years in this group (MINAPHOT). They mainly work on the design, the fabrication of test devices in our cleanroom and the characterization.

France	University of Strasbourg – Banhart Group	Banhart's group at the University of Strasbourg focusses on carbon nanostructures and irradiation effects.
Germany	Chemnitz University of Technology – Masters programme in Micro and Nano Systems	The Faculty of Electrical Engineering and Information Technology at Chemnitz University of Technology offers a new, 4-semester international master's programme in Micro and Nano Systems. The programme provides world-class, future-oriented education in design, manufacturing, characterization and integration of miniaturized components into engineering systems.
Germany	Leibniz University Hannover – Master of Science in Nanotechnology	The interdisciplinary degree courses in Nanotechnology at Leibniz Universität Hannover provide extensive training in the field of Nanotechnology. The Faculties of Electrical Engineering and Computer Science, Mechanical Engineering, Mathematics and Physics, and Natural Sciences have combined forces to offer this joint programme.
Germany	Munich University of Applied Sciences – MSc Micro- and Nanotechnology	This internationally recognized Master of Science (M. Sc.) course of study offers students of the natural sciences an advanced degree coupled with practical experience. The Course of Study may be completed in three semesters of full-time study or over a longer period of time for students whose professions only permit part-time study.
Germany	Ohm University of Applied Sciences Nuremberg – Master of Engineering Nano- and Production Technologies	The course imparts knowledge and skills in the manufacture, testing, processing and use of materials, e.g. of metals, plastics, non-metallic-inorganic materials and materials of composite and Nanotechnology ⁷ .

⁷ Der Studiengang vermittelt Kenntnisse und Fähigkeiten in der Herstellung, Prüfung, Verarbeitung und Verwendung von Werkstoffen, z.B. von Metallen, Kunststoffen, Nichtmetallisch-Anorganischen Werkstoffen und Werkstoffen der Verbund- und Nanotechnologie.

Germany	Saarland University – MSc Microtechnology and Nanostructures	The interdisciplinary course in microtechnology and nanostructures combines the basics of physics with engineering with a focus on miniaturization. Special importance is attached to the interdisciplinary system concept ⁸ .
Germany	Technical University Ilmenau – Master in Micro- and Nanotechnologies	The aim of the course is to impart the scientific and technological basics for the production of micro and nanostructures and to enable the students within the field of study to advance future developments in micro and Nanotechnologies as well as nanotechnical systems ⁹ .
Germany	Technical University of Dresden – Master of Science (MSc) Molecular Bioengineering	The program Molecular Bioengineering aims to teach students the fundamentals in biomedicine and bio-Nanotechnology combining biology and technology, which are linked in two ways: On the one hand, biological knowledge on cells is applied to develop the notion of molecular factories; on the other hand, Nanotechnology and bioinformatics are enabling technologies applicable to engineer biomaterials for medical applications.
Germany	Technical University of Dresden – Master of Science (MSc) Nanobiophysics	The 2-year master program aims to teach students the fundamentals in biophysics and bio-Nanotechnology with a twofold aim: to use nanotechnological approaches to better characterize and understand complex molecular machines such as biomolecules, but also to harness these molecules in technological systems or use them as templates or model systems for a bottom-up Nanotechnology.

⁸ Der interdisziplinäre Studiengang Mikrotechnologie und Nanostrukturen kombiniert Grundlagen der Physik mit den Ingenieurwissenschaften mit dem thematischen Schwerpunkt Miniaturisierung. Dem fächerübergreifenden Systemgedanken wird dabei besondere Bedeutung beigemessen.

⁹ Ziel des Studiengangs ist es, die naturwissenschaftlichen und technologischen Grundlagen für die Erzeugung von Mikro- und Nanostrukturen zu vermitteln und die Studenten innerhalb der Studienrichtung zu befähigen, zukünftige Entwicklungen zu Mikro- und Nanotechnologien sowie nanotechnischen Systemen voranzutreiben.

Germany	Technical University of Dresden – Master Program Organic and Molecular Engineering	The Master's Program in Organic and Molecular Electronics is designed to provide students with professional skills needed to advance a successful international career in the cutting edge field of organic electronics. It offers an interdisciplinary study program comprising physics, chemistry, electrical engineering and materials science. The close collaboration with industry partners enables a highly practice-oriented education. Moreover, we strongly focus on developing soft skills required in an everyday professional lives of our future graduates, such as project management, patent law, and much more.
Germany	University Duisburg Essen – Master of Science (M.Sc.) NanoEngineering	The master's degree consists of two specializations, nano-process technology and nano (opto) electronics. Both directions have some events in common, in which, above all, extended basics are developed ¹⁰ .
Germany	University Erlangen-Nürnberg – Master of Science Nanotechnology	This new range of courses complements the previous options for students in the natural sciences and technology with an important field. Nanoscience & Technology is a course that is located between the natural sciences and the engineering sciences, i.e. a good basic education in natural science subjects is necessary in order to be able to develop new technological applications ¹¹ .

¹⁰ Der Master-Studiengang besteht aus zwei Vertiefungsrichtungen, Nanoproszesstechnologie und Nano(opto)elektronik. Beiden Richtungen sind einige Veranstaltungen gemeinsam, in denen vor allem erweiterte Grundlagen erarbeitet werden.

¹¹ Dieses neue Studienangebot ergänzt die bisherigen Möglichkeiten für Studierende im Bereich Naturwissenschaft und Technik um ein wichtiges Feld. Nanoscience & Technology ist ein Studiengang der zwischen den Naturwissenschaften und den Ingenieurwissenschaften angesiedelt ist, d.h. es ist eine gute Grundausbildung in naturwissenschaftlichen Fächern notwendig, um neue technologische Anwendungen erschliessen zu können.

Germany	University of Bielefeld – Master of Science (MSc) Nanosciences	The concentration of research in the field of Nanosciences was already taken into account in teaching in the bachelor phase. The range of courses should be supplemented by an in-depth offering in an independent master's course in Nanosciences, research-oriented, but with a strong application focus ¹² .
Germany	University of Kassel – MSc Nanostrukturwissenschaften	The Master of Science in nanostructural science started in 2012/2013 after the first Bachelor graduated in nanostructural science ¹³ .
Germany	University of Würzburg – FOKUS Physik Masterstudiengang (M.Sc. hon.) Nanostrukturtechnik	As a research-oriented and time-compressed course of the Faculty of Physics and Astronomy of the Julius Maximilians University of Würzburg, the FOKUS Physics-Nanostructural Technology course is offered as part of the Elite Network Bavaria (ENB) with a Master of Science with Honours degree. The Master of Science course prepares students for scientific activities in research and development in the field of Nanosciences ¹⁴ .

¹² Der Konzentration der Forschung im Bereich Nanowissenschaften wurde in der Lehre bereits in der Bachelorphase Rechnung getragen. Das Lehrangebot soll durch ein vertiefendes Angebot in einem eigenständigen Masterstudiengang Nanowissenschaften forschungsorientiert, jedoch mit starkem Anwendungsbezug, ergänzt werden.

¹³ Der Master of Science in Nanostrukturwissenschaften begann 2012/2013 nach dem ersten Bachelor in Nanostrukturwissenschaften.

¹⁴ Als forschungsorientierter und zeitlich komprimierter Studiengang der Fakultät für Physik und Astronomie der Julius-Maximilians-Universität Würzburg wird der Studiengang FOKUS Physik-Nanostrukturtechnik im Rahmen des Elitenetzwerks Bayern (ENB) mit dem Abschluss Master of Science with Honors angeboten. Das Studium zum Master of Science bereitet auf die wissenschaftlichen Tätigkeiten in Forschung und Entwicklung im Fachgebiet Nanowissenschaften vor.

Germany	University of Würzburg – M.Sc. Nanostrukturtechnik	The Master of Science degree prepares students for scientific work in the field of nanostructure technology. It also prepares for a doctorate to become a Dr. rer. nat. or Dr. – Ing. in front. The aim of the training is to provide students with in-depth knowledge of scientific work in research and application of the Nanosciences and its fundamental principles ¹⁵ .
Hungary	Bay Zoltan Institute For Materials Science And Technology	The mission of the Institute is to play a dominant role in the materials science and technology innovation chain, first of all in the field of laser technology, metal technology and simulation, polymer technology and Nanotechnology.
Hungary	Hungarian Academy of Sciences – Biological Soft Matter Platform	The primary task of the Department of Biological Nanochemistry is the preparation and characterisation of nanosized systems for medical applications
Hungary	Hungarian Academy of Sciences – Institute of Materials and Environmental Chemistry	The Institute of Materials and Environmental Chemistry studies functional and structural materials, micro- and nanosized surface layers and solid/liquid interfaces in order to reveal correlations among their chemical composition, structure, properties and methods of preparation. The institute is involved in research aimed at developing new procedures and methods decreasing environmental impact of technologies.

¹⁵ Das Studium zum Master of Science bereitet auf wissenschaftliche Tätigkeiten im Fachgebiet Nanostrukturtechnik vor. Es bereitet auch auf eine Promotion zum Dr. rer. nat. oder Dr.–Ing. vor. Das Ziel der Ausbildung ist es, den Studierenden vertiefte Kenntnis des wissenschaftlichen Arbeitens in der Forschung und Anwendung der Nanowissenschaften und seiner inhaltlichen Grundlagen zu vermitteln.

Hungary	Hungarian Academy of Sciences – Institute of Technical Physics and Materials Science	The mission of the Institute of Technical Physics and Materials Science is to conduct multidisciplinary research on complex functional materials and nanometer-scale structures targeting the exploration of physical, chemical and biological principles, and their exploitation in integrated micro- and nanosystems.
Hungary	MTA MFA Budapest – Nanostructures Laboratory	Nanotechnology at the Hungarian Academy of Sciences
Ireland – EIRE	Dublin Institute of Technology – BSc Science with Nanotechnology	Nanoscience and Nanotechnology are built upon chemistry and physics. This degree is a solid science degree (physics and chemistry) but with a unique focus on Nanoscience and Nanotechnology. In the Years 3 and 4 of the degree the student chooses to major in either physics or chemistry, but all students do the Nanotechnology modules.
Ireland – EIRE	National University of Ireland – National Centre for Biomedical Engineering Science	The Centre’s research is focused on innovative therapeutic solutions to current medical challenges and deals with various nanoscale applications and materials.
Ireland – EIRE	Trinity College Dublin – Nanomechanics Team	This laboratory is focuses on the dynamics and kinetics of interacting biomolecules, the mechanics of protein imported to mitochondria membranes, the kinetics of molecular motors under external strain and the nanomechanical action at ribosomal complexes during translation.

Ireland EIRE	–	Trinity College Dublin – Nanoscience, Physics and Chemistry of Advanced Materials (N-PCAM)	This is a four-year degree programme, run jointly by the Schools of Chemistry and Physics at Trinity College Dublin. Students will gain a deep and lasting understanding of the science of advanced materials that underpins the nano revolution. Some laboratory training is provided in CRANN, the leading institute for Nanoscience in Ireland.
Ireland EIRE	–	University College Dublin – Centre for Bionano Interactions	The Centre for BioNano Interactions (CBNI) is a multi-disciplinary platform for Nanotoxicology and NanoMedicine. CBNI is Ireland's National Platform for BioNanoInteraction science, and draws together specialists from its Universities, Institutes and companies. They are one of the world's leading Centres of knowledge for bio-nano-interactions applied to the fields of nano-safety, nanobiology and nanomedicine, and we are pioneering many of the new techniques and approaches in the arena.
Ireland EIRE	–	University College Dublin – Masters Programme in NanoBioScience	Current MSc projects include molecular modelling, molecular motors, imaging and analysis, Atomic Force Microscopy, light scattering in tissues, and organic solar cells. Future career options include biomedical technologies, pharmaceutical industry and drug development, sustainable energy, academic and industrial research, and students are taught innovation as part of the programme.
Ireland EIRE	–	University of Dublin – Centre for Research on Adaptive Nanostructures and Nanodevices (CRANN)	CRANN is Ireland's first purpose-built Research Institute with a mission to advance the frontiers of Nanoscience. The three major research areas are Nano-Biology of Cell Surface Interactions, Bottom-Up Fabrication and Testing of Nanoscale Integrated Devices and Magnetic Nano-Structures and Devices.

Ireland – EIRE	University of Limerick – Nanotechnology Research Group	The group research Interests are in Semiconductor Nanocrystals and Nanowires with emphasis on Synthesis, Assembly and Device Applications in Energy Storage and Energy Conversion Applications. The group also studies nucleation and growth in both hard (metal, semiconductor) and soft (pharmaceutical) nanocrystal materials with emphasis on size, shape and crystal phase control.
Italy	Politecnico di Milano – Master of Science Materials Engineering and Nanotechnology	This Master of Science programme is taught entirely in English to stimulate the student in acquiring greater familiarity with the terminology used internationally. The objective of the programme is to prepare a professional figure expert in materials and in the design of processes and manufactured goods. Within the scope of the study plan a number of specific specialisations are foreseen: Surface Treatments Engineering; Polymer and Composite Engineering; Nanotechnologies; Materials Design.
Italy	Politecnico di Torino – Materials and Processes for Micro & Nano Technologies	The Group has a well-established experience in growth, characterization and processing of semiconductors and insulating materials.
Italy	Università degli Studi di Modena e Reggio Emilia (UNIMORE) – Ph.D. in Nanosciences and Nanotechnologies	This is a strongly multidisciplinary course open to students with different background (physics, chemistry, biology, engineering, etc...). Students will learn about fundamental phenomena that are relevant at the nanoscale, approaches to the fabrication and the analysis of nanostructures, as well as advanced Nanotechnology applications.

Italy	Università degli Studi di Modena e Reggio Emilia (UNIMORE) – Physics and Nanosciences	The School focuses on development and application of advanced experimental and theoretical/computational methods for the study of matter and systems at the micro and nano-scale. The program has a strongly interdisciplinary character: it ranges from physics to chemistry, biology and engineering.
Italy	Università degli Studi di Bologna – Photochemistry and Supramolecular Chemistry Group	The Balzani group's research focuses on molecular engineering and molecular motors.
Italy	Università degli Studi di Brescia – CNR-INFM Sensor Laboratory	Nanomedicine: Artificial Olfactive Systems in-vivo and specific sensors in-vitro for early diagnosis and prevention of severe diseases and for drug screening.
Italy	Università degli Studi di Firenze – Center for Colloid and Surface Science (CSGI)	The main goal of CSGI is the preparation and study of new supramolecular “smart” devices and colloidal systems, and the development of their different industrial applications.
Italy	Università degli Studi di Firenze – European Laboratory for Non-Linear Spectroscopy (LENS)	LENS is presently an active member of the LASERLAB-EUROPE consortium, constituted by 18 large laser infrastructures operating in different European countries providing access to the different laser facilities to external visiting scientists with the financial support of the European Union. The research fields at LENS nowadays cover a wide spectrum of subjects, from atomic physics to photochemistry, biochemistry and biophysics, from material science to photonics, from art restoration and preservation to solid and liquid state physics.
Italy	Università degli Studi di Modena – Theoretical Nanoscience Group	The main emphasis is on fundamental properties of nanoscale structures, particularly low-dimensional quantum systems, and their applications in novel nanodevices.

Italy	Università degli Studi di Padova – Centre for Environmental Law Decisions and Corporate Ethical Certification	CIGA’s mission is to research ethical and social implications of Nanotechnology; analysing the frameworks of legal regulation of new technologies and namely of Nanotechnologies; promoting interdisciplinary exchanges on these topics; improving the public debate on implications of new technologies.
Italy	Università degli Studi di Salerno – Soft Matter Molecular Simulation Group	The group’s research is about understanding the behaviour of materials on the basis of their chemical structure and its effects on large length and timescales. For this reason, they develop and apply simulation methods and theory to study polymeric materials, nanomaterials and more in general soft matter.
Italy	Università degli Studi di Trento – Laboratory of Bio-inspired & Graphene Nanomechanics	The lab of Nicola Pugno, Professor of Solid and Structural Mechanics.
Italy	Università degli Studi di Trento/Bruno Kessler Foundation – Master NanoMicro	The main goal of the Master is to train professionals in the design, fabrication and characterization of nano- and micro- systems for different applications, such as sensors and actuators, photonics, BioMEMS, with high scientific and industrial impact. The Master will offer an educational portfolio that includes four thematic areas: Bio NEMS – MEMS, photonic NEMS-MEMS, NEMS-MEMS for sensors and actuators, NEMS MEMS for the alternative energy sources and environmental monitoring.
Italy	Università degli Studi di Trieste – Carbon Nanotechnology Group	The Prato group at the University of Trieste conducts research on nanostructures such as organic functionalization of fullerenes and carbon nanotubes.
Italy	Università degli Studi Trieste – Laboratory of Nanoparticles	Research on nanoparticles in the Department of Chemical Sciences.

Italy	Università degli Studi di Trieste – Molecular Simulation Engineering (MOSE)	The MOSE laboratory deals with theory, simulation and modelling in three different areas: process simulation, material science (mesoscale modelling and simulation in the field of nano science and Nanotechnology) and life science.
Japan	ERATO Nakamura Functional Carbon Cluster Project	The Nakamura Functional Carbon Cluster project aimed at creating a wide variety of functional materials based on C60 and carbon nanotubes that are given functionality through organic synthesis.
Japan	Hiroshima University – Research Center for Nanodevices and Systems (RCNS)	The RCNS consists of four research divisions: Nanodevice; Nanoprocess; Molecular Assembly and Materials Synthesis; and System Design and Architecture.
Japan	Hokkaido Innovation through Nanotechnology Support (HINTS)	Hokkaido Innovation through Nanotechnology Support (HINTS) is a Nanotechnology support project centered at Hokkaido University (Research Institute for Electronic Science, Catalysis Research Center, Center for Advanced Research of Energy Conversion Materials, and Research Center for Integrated Quantum Electronics) with close cooperation of Chitose Institute of Science and Technology.
Japan	Hokkaido University – Laboratory of Nanobiotechnology	The group studies unsolved biological problems in terms of applied physics toward elucidating the nature of life and developing the state-of-the-art technology.

Japan	Keio University – Laboratory for Precision Machining and Nano Processing (PMNP)	The PMNP Laboratory (Yan research group) is interested in high-accuracy, high-efficiency, resource-saving manufacturing technologies. Through micro/nanometer-scale material removal, deformation, and surface property control, new products with high added value are provided to micromechanical, optical, optoelectronic, and biomechanical applications. Japan The group is exploring multidisciplinary R&D by interfacing with mechanical science, physics, material science and Nanotechnology.
Japan	Kobe University Mesoscopic Materials Lab (MML)	Major research topics are Optical Properties of Mesoscopic Particles; Fabrication and Characterization of Novel Carbonaceous Nano-Materials; Surface Plasmon and Near-Field Optics; and Optical Waveguides and Other Photonic Devices.
Japan	Kyoto University – Kawakami Laboratory	The lab tries to construct and establish a new concept of semiconductor materials research, that is, semiconductor exciton photonics. Research includes growth techniques for low dimensional or nanoscale structures by atomic-scale controlling of surfaces and interfaces together with excitonic and photonic properties.
Japan	Kyoto University – Quantum Optoelectronics Laboratory	Research in the group involves searching for new optoelectrical phenomena in atomic structures, which result from new quantum phenomena as well as the co-existence of light and electrons. Design of new optoelectronics devices.
Japan	Kyushu Institute of Technology – Center for Microelectronics	Research areas include Parallel Processors, Super-Scalar Technology, Nano-Fabrication Technology, High Speed Devices, Smart Sensors, Interconnection Technology and Micromachining.

Japan	Nagoya University – Department of Micro-Nano Systems Engineering (Fukuda Lab)	Nano devices and bio- MEMS.
Japan	Nagoya University – Department of Molecular Design and Engineering	The department offers programs of study and research in the major areas of biofunctional polymer chemistry, applied organic chemistry, organic process and catalyst chemistry, chemical physics of condensed matters, analytical science, materials design chemistry, and function development technology including nanoparticulate systems.
Japan	Nagoya University – Institute of Nano- Life-Systems	The lab aims to develop the bases of future nano- electronics. Their main subjects are novel electron devices and optoelectronic devices using carbon nanotubes, high-power and high-frequency GaN transistors, and resonant- tunneling devices and functional circuits.
Japan	Nagoya University – Quantum Nano- Device Group	Global Research, Education, and Industry Center for Advanced Biosciences and Next-generation Systems Using Integrated Physical and Cyberspace Platform.
Japan	Okinawa Institute of Science and Technology – Micro/Bio/Nanofluidics Unit	The group combines experiments, theory, and modelling to explore the dynamics and properties of flows involving nano- or micro-structures (i.e., DNA, surfactants, lipid vesicles, or bacteria, cells), in which intermolecular/particle forces give rise to time- and length- scale distributions that are important in many biophysical and technological processes.

Japan	Okinawa Institute of Science and Technology – Nanoparticles by Design Unit	This research unit studies the structural, magnetic, electronic, chemical properties and applications of size selected monometallic, bimetallic and core-shell nanoclusters/nanoparticles prepared by magnetron sputter gas aggregation source.
Japan	Osaka Prefecture University – Nanofluidics Lab	The research group is directed toward the integration of “Nano”, “Bio”, and “Chem” at femtoliter, attoliter, and single molecule scales through nanofluidics. They continue to involve the study and development of novel nanofluidic methods and devices for single cell omics, single molecule chemistry, biomaterials, nanomedicine, energy, and process engineering.
Japan	Osaka University – Biophysical Dynamics Laboratories Nano-Biophotonics Group	Ultra-high spatial-resolution and sensitivity for sensing biomolecules and DNA can be achieved by the use of Nanotechnology such as scanning probe techniques and non-linear photonics using ultra short pulsed lasers. The Group is evolving these techniques to create new biological applications, particularly, real-time measurement of the chemical reactions occurring in living cells and tissue.
Japan	Osaka University – Institute for Nanoscience Design	The Institute for Nanoscience Design prepares various kinds of education and training programs such as trans-disciplinary graduate-school minor program, evening course refresher program, short-term international research training program, etc. It offers a series of lectures, some of them in the form of distance education broadcasted live to satellite classrooms located many places in Japan, and tentatively even overseas in English.

Japan	Osaka University – Laboratory for Scientific Instrumentation and Engineering (LaSIE)	LaSIE is doing some of the world's frontier research in photonics, Nanotechnology (nanophotonics, nanofabrication), and bio-related areas.
Japan	Osaka University – Nanoscience and Nanotechnology Center	The Nanoscience and Nanotechnology Center proactively promotes industrial applications of Nanotechnology while carrying out bottom-up and top-down technologies.
Japan	Osaka University – Protonic NanoMachine Group	The Protonic NanoMachine Group aims at the ultimate understanding of the mechanisms of self-assembly and its regulation, conformational switching, force generation, and energy transduction by biological macromolecular complexes.
Japan	Osaka University – Soft Biosystem Group	Research in the group focuses mainly on molecular signalling systems that transmit and convert cell and gene information, in which dynamic organization into the bio-system is deeply related to the function. Techniques including imaging technique of single molecules in 3D and real time are being developed to visualize and manipulate single molecules in bio-systems and the behaviour, structural changes and physical and chemical properties of individual biomolecules acting in biomolecular systems will be monitored in real time and space.
Japan	Ries Hokkaido University – Laboratory of Functional Thin Film Materials	The group's research focuses on the development of functional oxides based thin film devices utilizing photonic, electronic, and magnetic properties; the fabrication of conducting oxide based superstructure and their potential investigation as thermoelectric materials; the development of special epitaxial growth method; and the development of novel oxide spintronics devices.

Japan	Ries Hokkaido University – Laboratory of Molecular Photonics	The group explores advanced molecular photonics based on semiconducting quantum dots, photofunctional organic molecules, and laser manipulation techniques.
Japan	Ries Hokkaido University – Laboratory of Nanomaterials and Nanoscopy	The group's research focuses on plasmonics for photochemistry and photophysics, including following sub-topics: Plasmonic Waveguiding; Single Molecule Studies; Plasmon Associated Energy Harvesting; Drug Delivery System based on Plasmonics.
Japan	Ries Hokkaido University – Laboratory of Nanostructure Physics	Researchers in the lab are involved in a variety of research aimed at integrating and combining top-down and bottom-up phenomena.
Japan	Ries Hokkaido University – Laboratory of Nanostructured Functional Materials	The lab is researching inorganic optical material with its robust frame structure, and are conducting research on the expression of optical functions through formation of nanostructures on the surface.
Japan	RIKEN Nanophotonics Laboratory	Research includes: Three-dimensional multi-layered tera byte optical storage with gold nano-particles; Chiral nanophotonics; Near-field Vibrational Nanophotonics; Plasmonic Band Gap Devices; Plasmonic Metamaterials; Metallic Nanolens.
Japan	Ritsumeikan University Micro Nanoscience Integrated Systems	Research target is establishment of new evaluation technique for MEMS / NEMS material properties. Research of silicon nanolithography technique and development of MEMS/NEMS devices are also performed.

Japan	Shinshu University – Research Center for Exotic NanoCarbons	This project is about the ultimate nanocarbons “exotic nanocarbons”, which are expected to make innovations possible in a wide number of fields ranging from the environment, energy, resources and ICT to biotechnology and medicine. Four distinguished researchers with differing backgrounds in Nanotechnology were invited to participate in this project and they, together with Shinshu University and participating companies, are conducting joint research on a wide range of topics with the goal of making various advanced innovations.
Japan	Tohoku University – Laboratory for Nano– Photoelectronics	The lab’s main interest lies in the studies of physical and chemical phenomena that take place in nanometer–scale regions as well as the applications of such phenomena in photo–electronic devices.
Japan	Tohoku University – Laboratory for Nanoelectronics and Spintronics	Research activities at the Ohno Lab cover the areas of preparation, characterization and application of compound semiconductor quantum structures for high speed devices.
Japan	Tohoku University – Laboratory of Strength and Reliability of Nano and Micro Scale Structures	The group has been developing the methods for explicating the determinant factors of physical properties of nano–particles, thin film materials, and materials used for micro structures.
Japan	Tohoku University – Micro/Nanomachini ng Research and Education Center	The centre consists of several individual research groups and labs that deal with nano–related research.
Japan	Tohoku University Institute of Fluid Science – Intelligent Nano-Process Lab	The Samukawa Lab conducts research on ways to generate charged particles (positive and negative ions, electrons) and neutral particles (atoms/molecules) and associated acceleration technologies (including beam technologies), as well as research on particle flow and the latest bio–nano processes.

Japan	Tokai University – Micro/Nano Technology Center	MNTC encompasses all fields from molecular level mechanism analysis to medical application. Specifically, MNTC’s research focuses on functional ultra-thin polymer films (films with thickness of under 100 nm). The cooperative medical, physics, and engineering organization utilizes the features unique to the “structure of the plane” created when polymers are formed into ultra-thin films, and applies these to medical technologies.
Japan	University of Tokyo – Aida Laboratory	The laboratory for supramolecular and macromolecular chemistries and materials sciences.
Japan	University of Tokyo – Nakamura Lab	Among other areas, research in the Nakamura lab deals with the Nanoscience of tailor-made cluster molecules in biology.
Japan	University of Tokyo – Nanoelectronics Collaborative Research Center (NCRC)	NCRC was established at University of Tokyo for the purpose of realizing core technologies for the development of the ubiquitous information devices based on Nanotechnologies, and is aiming at becoming one of the Center of Excellence (COE) in the world of advanced nano-photonics and electronics.
Japan	University of Tokyo – Theory and Construction of Molecular Computers	Project group dealing with molecular computing.
Japan	Waseda University – Department of Nanoscience and Nanoengineering	Backed by the establishment of Center of Excellence as a hub research centre and the enhancement of research facilities, the Department of Nanoscience and Nanoengineering has created an environment that provides powerful support for Nanoscience and nanoengineering, alongside industry-academy partnerships.

Japan	Yokohama City University – Kojima & Tachibana Laboratory Lab	The research of the lab interfaces with condensed matter physics, materials science, and biophysics. Current research projects involve the development of synthesis and crystal growth of novel carbon materials such as carbon nanotubes and fullerenes.
Netherlands, The	Casimir Research School	The Casimir Research School is a graduate school for interdisciplinary physics with a strong emphasis on the various Nanosciences.
Netherlands, The	Delft University of Technology – BioNanoscience	The department focuses on the functioning of single cells in all their complexity down to the molecular level. Understanding the mechanisms operating inside a cell is very useful for practical applications in, for example, improved health care, molecularly targeted medicine, and development of new energy sources. The department of BioNanoscience is part of the university's successful Kavli Institute of Nanoscience.
Netherlands, The	Delft University of Technology – Else Kooi Lab	The Else Kooi Laboratory and its staff aim to provide micro fabrication capabilities that facilitate excellence in (sub)micro-fabrication oriented Research & Science, enable customers to test out concepts that may lead to business successes (up to and including small scale production) and build a bridge between Academics and Industrial Innovation.

Netherlands, The	Delft University of Technology – MSc Nanobiology	The Nanobiology programme of TU Delft and Erasmus MC builds on extensive existing bottom up research collaborations and cooperative mission organizations like Medical Delta. The molecular building blocks of living organisms are the focus and current advances in the Nanotechnology toolkit enable the precise visualization, study and control of these biological molecules. Developments in biomedicine, such as studies on human genome variation and the control of stem cells, increasingly require analysis and quantitative description at the fundamental level.
Netherlands, The	Delft University of Technology – Quantum Nanoscience	The department studies quantum phenomena in a wide variety of nanometer scale devices and materials, exploring new physics and novel applications of quantum effects. The department consists of a number of active scientists working on both experimental and theoretical aspects of Quantum Nanoscience.
Netherlands, The	Delft University of Technology – Kavli Institute of Nanoscience	The Kavli Institute of Nanoscience at Delft University of Technology consists of six research groups and a nanofabrication cleanroom facility.
Netherlands, The	Eindhoven University of Technology – Advanced Nanomaterials & Devices	The group exploits the properties of new nanomaterials; their unusual structural, optical, thermal, and electronic properties for future applications. Research in the group centres around nanowires since these offer an unprecedented level of flexibility and control. The versatility of their material composition allows envisioning new applications in chemistry, physics, engineering science and bioscience.

Netherlands, The	Eindhoven University of Technology – Master Track Bio/Nanoscience and Technology (BIONANO)	Bio/Nanoscience and Technology (BIONANO) focuses on the control of materials at the nanometer scale. It involves emerging technologies that enable scientists to address and position individual atoms and molecules. There is also the possibility to gain the “Theoretical Physics for Technology” certificate intended for students with extra interest in the more theoretical and fundamental aspects of the chosen specialization.
Netherlands, The	Eindhoven University of Technology – Master Track Chemical Biology, Materials and Nanomedicine	This track approaches biomedical problems from a molecular perspective. Researchers simulate extant biological systems, so as to build upon them and for example develop new materials with new functions or properties. Another category of research involves decoding the molecular mechanisms behind diseases such as Alzheimer’s disease and Creutzfeldt–Jakob.
Netherlands, The	Eindhoven University of Technology – Molecular Materials and Nanosystems Group	The group brings together researchers from these two fields and aims at establishing a coherent research program on the physics and chemistry of nanostructured materials and nano-sized organic and inorganic molecular systems.
Netherlands, The	Eindhoven University of Technology – The Physics of Nanostructures Group	Current research projects in the areas nanomagnetism, spintronics, and ultra-fast spin dynamics.
Netherlands, The	Leiden Institute of Physics	The Kamerlingh Onnes Laboratory has 6 research groups that deal with Atomic and Molecular Conductors, Interface Physics, Magnetic and Superconducting Materials, Quantum Physics of Nanostructured Materials, Quantum Physics and Applications at Ultra Low Temperatures, Granular & Disordered Media, and Physics of Surfaces and Materials.

Netherlands, The	Radboud University Institute for Molecules and Materials	The aim of IMM is to conduct research in the field of functional molecular structures and materials. There is an emphasis on understanding and controlling complexity in order to be able to design new functionality in these systems. This research area can roughly be divided into two main themes: bio-inspired systems and nano/mesoscopic structures.
Netherlands, The	Saxion University of Applied Sciences – Master in Applied Nanotechnology	In the course of this master programme, you will acquire fundamental and extensive theoretical and practical knowledge of all disciplines related to design, laboratory and manufacturing techniques. Upon graduation, you will have mastered the skills needed to come up with innovative product-market combinations and production processes. Meanwhile, you will have an entrepreneurial, creative and inquisitive mindset.
Netherlands, The	University of Groningen – Feringa Group	The research program of the Feringa group at the University of Groningen in the Netherlands is focused on synthetic organic chemistry with a major part of the research is directed towards Nanotechnology and novel functional materials, like molecular switches and motors.
Netherlands, The	University of Groningen – Master programme in Nanoscience	The Top Master programme in Nanoscience aims to train the cutting-edge scientists of the future. This is achieved by offering a challenging interdisciplinary programme and by admitting only very talented and motivated students. The courses are taught by top international scientists, and a large part of the programme consists of actually conducting scientific research, alongside world-class scientists, using the state-of-the-art facilities of the Zernike Institute.

Netherlands, The	University of Groningen – NanoLab	Within the NanoLab NL program, the infrastructure in Groningen is designed to function as the Dutch centre for bottom-up (bio)molecular electronics and functional (bio)molecular nanostructures, and for the development of nanostructures based on supramolecular interactions and molecular lithography.
Netherlands, The	University of Groningen – Zernike Institute for Advanced Materials	The classic materials triangle concerns an integrative approach in the three aspects of structure, property and chemical composition. The Zernike Institute for Advanced Materials adds an extra dimension to this traditional view by an unconventional linkage to the field of biomolecular sciences, which includes the design aspects as well.
Netherlands, The	University of Leiden – Molecular Nano-Optics and Spins	For many years, the group's research theme has been the resonant interaction of electromagnetic waves, or photons, with condensed matter, consisting in most cases of organic molecules. Photons can be simply absorbed by matter, they can flip spins in a magnetic field in Electron Paramagnetic Resonance (EPR), or excite the electron cloud in optical absorption experiments. However, many of the effects they look at are more complex, nonlinear. They study, for example, the effect of two frequencies on spin echoes in EPR, the emission of light at wavelengths different from that of the excitation laser (fluorescence), and the effect of spin resonance on this emission (optically detected magnetic resonance, ODMR), or phenomena involving two or more photons, such as spectral hole-burning.

Netherlands, The	University of Twente – Complex Photonic Systems (COPS)	The group investigates photonic band gap crystals, Anderson localization and diffusion of light, random lasers and related phenomena.
Netherlands, The	<u>University of Twente - MESA+ Institute for Nanotechnology</u>	MESA+ institute for Nanotechnology, trains graduate students and Ph.D.– students and conducts research in the fields of Nanotechnology, microsystems, materials science and microelectronics. Unique of MESA+ is its multidisciplinary composition. Many research groups of the faculties Electrical Engineering, Mathematics, Computer Science (EEMCS) and Science and Technology (S&T) participate in the MESA+ institute.
Netherlands, The	University of Twente – MSc Nanotechnology	The MSc Nanotechnology is a 2 year programme for anybody having a BSc degree in any applied science. The educational programme is offering you a multidisciplinary approach to this new emerging field, forming an excellent preparation for a scientific career both at the university or in industry.
Netherlands, The	University of Twente – Ph.D. Program Novel Nanomaterials	The graduate research programmes of the Twente Graduate School are set up as a coherent and integrated master and doctorate course that runs over a period of five to at most six years leading to a Ph.D. degree.

Netherlands, The	University of Twente – Physical Aspects of Nanoelectronics	In order to obtain a deeper insight into the behaviour of nanoscale devices the group of Prof. Zandvliet studies their physical, chemical and especially electronic properties with high spatial resolution techniques. For that purpose they mainly apply Scanning Probe Microscopy (SPM) and Spectroscopy (SPS). Further development of SPM-based probes for electrical characterisation of nanostructures is a key part of their described research area.
Netherlands, The	Wageningen BioNanotechnology Centre for food and health innovations – BioNT	Wageningen BioNT at the University of Wageningen is active in the fundamental science and technology of micro- and nanosystems and their applications in food and health. The centre helps companies to utilize the opportunities of micro- and Nanotechnology to improve our food and prevent health problems.
Norway	Norwegian University of Science and Technology (NTNU) – Master’s Program Nanotechnology	The 5-year programme is supported on a solid foundation of courses within physics, chemistry and mathematics. These are combined with courses in electronics and materials science that are oriented towards technology to give a good grounding for further studies in Nanotechnology. The programme provides the theoretical basis and knowledge of experimental methods and technological applications of Nanotechnology. The social implications of Nanotechnology pertaining to ethical and environmental issues are also addressed. The first two years are common for all students in the programme. In the last three years, students choose their main profile from key areas relating to research, business and industry.

Norway	Norwegian University of Science and Technology (NTNU) – NanoLab	The aim of NTNU NanoLab is to establish a cross-disciplinary research environment for researchers within the fields of physics, chemistry, biology, electrical engineering, materials technology and medical research.
Norway	University of Oslo – Master’s Degree Materials Science and Nanotechnology	This is a multidisciplinary programme at the interface between physics and chemistry. The main focus is on advanced materials, energy, and Nanotechnology, but the programme also provides a solid foundation in physics and chemistry. Even though specific courses in physics, chemistry, mathematics, Nanotechnology, and computer science are compulsory, there is room for a range of optional courses that you can integrate into the degree.
Norway	University of Oslo – Master’s Degree Nanoelectronics and Robotics	The master’s programme Nanoelectronics and Robotics will provide you with the necessary knowledge and skills to develop application specific data and electronic systems from basic building blocks implemented in nanoelectronics, to complex systems consisting of both software and hardware for demanding signal processing and control.
Norway	University of Oslo Center for Materials Science and Nanotechnology	The centre is responsible for the university’s strategic programme on functional materials (FUNMAT), and the activities at the Micro- and Nanotechnology laboratory (MINA-lab).

Portugal	International Iberian Nanotechnology Laboratory (INL)	The INL International Iberian Nanotechnology Laboratory, located in Braga (North of Portugal) was founded by the governments of Portugal and Spain under an international legal framework to perform interdisciplinary research, deploy and articulate Nanotechnology for the benefit of society. INL aims to become the world-wide hub for Nanotechnology addressing society's grand challenges.
Portugal	Universidade da Madeira – Master in Nanochemistry and Nanomaterials	University of Madeira and Centro de Quimica da Madeira, Madeira Island, Portugal, invite applicants with a Bachelor or a Master degree in Chemistry, Biochemistry, Biology, Life Sciences, Materials, Physics or related sciences/engineering courses to apply to our new two years Master Programme in Nanochemistry and Nanomaterials.
Portugal	Universidade de Aveiro – Ph.D. in Nanosciences and Nanotechnology	The University of Aveiro, particularly acknowledged for its research concerning the synthesis, properties and applications of nanomaterials, offers a program of study leading to the Ph.D. degree in Nanosciences and Nanotechnology. In its first stage, students are introduced to contemporary topics in Nanoscience and Nanotechnology, comprising several courses in the field and thus initiating a cross-disciplinary approach to research and learning. Different research units at the University contribute actively to this stage. Students admitted to the second stage of the doctoral program follow to N&N activities leading to the elaboration of a doctorate thesis. The courses are taught in English.

Portugal	University of Porto – Institute of Physics for Advanced Materials, Nanotechnology and Photonics (IFIMUP)	IFIMUP carries out research over a wide range of topics focused on the innovative physical properties of materials at different scales, boosting the development of new technologies in order to contribute to solve today's Grand Challenges.
Romania	IMT Bucharest Center of Nanotechnology	Nanomaterials and nanostructures, with main areas of expertise: silicon nanoelectrode arrays, low-frequency noise in nanostructured materials; porous silicon layers; field emission nanostructures; biofunctional nanostructures and interfaces.
Romania	Romanian Nanomedicine Network (Ro-Nanomed)	The RO-NANOMED project is devoted to the creation and development of an integrated research network in the field of nanobiotechnology for health. This network is targeting integration into the European Technology Platform (ETP) "Nanomedicine" of "a".
Spain	Miguel Hernández University – Masters in Molecular Nanoscience and Nanotechnology	The joint Master's in Molecular Nanoscience and Nanotechnology responds to academic and research profiles through the range of courses it offers in scientific and technological areas of interest today such as molecular electronics, molecular nanomagnetism and spintronics, supramolecular chemistry, surface physics, and molecular materials science.
Spain	Rovira i Virgili University – Chemometrics, Qualimetrics and Nanosensors Group	The activity of the group focuses on two main areas. On the one hand, the Group develops and applies new chemometric techniques related to the validation of analytical methodologies. On the other hand, the second main activity of the Group is the transfer of knowledge and technology.

Spain	Rovira i Virgili University – Master’s Degree in Nanoscience and Nanotechnology	The main aim of the Master’s Degree is to provide students with solid, interdisciplinary training that will make it possible to respond to the challenges of scientific and technological development. Students will learn about new tools for fabricating, nanohandling and characterizing materials, devices and systems of nanometric size that are necessary for undertaking experimental work.
Spain	Rovira i Virgili University – Nanoelectronic and Photonic Systems (NePhoS)	The group works on modelling and design of linear and nonlinear photonic crystals; the development of technologies based on the macroporous ordered silicon and on the nanoporous silicon for the production of 1D and 2D photonic crystals; and the development of physical models for advanced electronic devices: Thin-film transistors, nanometric-sized MOSFETs, silicon-based heterojunction devices.
Spain	Universidad Autónoma de Madrid – Centro de Microanálisis de Materiales (CMAM)	The main purpose of our research centre is to enhance the Ion Beam Analysis (IBA) and Ion Beam Modification of Materials (IBMM) techniques for their use in a broad range of fields, from Materials Science to Archaeometry or Environmental Science, areas of scientific research on which IBA techniques have already proven their power.
Spain	Universidad Complutense de Madrid – Nazario Martin Group	The research developed in Martin’s group is mainly focused to Carbon Nanostructures (Fullerenes and Carbon Nanotubes) as materials for the preparation of Photo- and Electroactive Organic Molecular Systems.

Spain	Universidad Complutense de Madrid – Quantum Nanosystems Group	The group's research focuses on quantum properties of ultra-small semiconductor and organic structures with the aim to investigate theoretically new, unusual and unexpected phenomena. In particular they are interested in structures that operate in the quantum regime where several exciting and still unresolved puzzles await their discovery.
Spain	Universidad Complutense de Madrid – Surface Engineering and Nanostructured Materials	Research activities in the field of Surface engineering for high temperature: Study of corrosion behaviour of protective coatings at high temperature. Within this field the national and international projects that focus in developing new protective coating for the power generation and aerospace industry as well as the study of corrosion behaviour in very aggressive environments.
Spain	Universidad de Alicante – Master en Nanociencia y Nanotecnología Molecular	The Interuniversity Master in Nanosciences and Molecular Nanotechnology does not have precedents nationally since it discusses the aspects placed in the intersection of one science at its peak as it is Nanoscience with the more traditional molecular systems. It influences, therefore, scientific areas of present-day interest like Molecular Electronics, Molecular Magnetism, the Supramolecular Chemistry, Physics at Surfaces, or the Molecular Materials Science.
Spain	Universidad de Malaga – Nanotechnology and Organic Synthesis	A research group in nanochemistry and organic synthesis in the Department of Organic Chemistry.
Spain	Universidad Politécnica de Catalunya – Centre for Research in NanoEngineering	Research, development and innovation in the fields of nanoengineering, Nanotechnology and Nanoscience.

Spain	Universidad Politecnica de Madrid ISOM	The Microsystems and Nanotechnology group deals with Opto- and Electro-mechanical systems, MEMS and MOEMS. Optical detection modulation with piezoelectric devices; Physical, chemical and biological sensors (optical, piezoelectric, electrochemical). Polymer deposition; Nanoparticles, nanostructures and nanodevices; Atomic Force Microscope and Electron Beam Lithography.
Spain	Universitat Autònoma de Barcelona – Master’s Degree in Nanotechnology and Materials Science	The master’s degree in Nanotechnology and Materials Science at UAB enables its students to apply their knowledge in the fields of Nanotechnology and materials science to the analysis, reformulation and generation of new applications and products. Students will also become familiar with the principal methods of preparation, synthesis and analysis of materials and nanomaterials.
Spain	University of Alicante – Master in Nanoscience and Molecular Nanotechnology	By its nature, Nanotechnology is a multidisciplinary and multisectoral area. It is for this reason that collaboration between various centres, with experience in the different aspects of this discipline – physical / chemical, theoretical / experimental, basic / applied–, and with the common denominator of studying molecular systems, is essential to implement a training program like the one proposed. The Master of NNM is unprecedented at the national level as it aims to address the aspects that are at the intersection of Nanoscience with molecular systems ¹⁶ .

¹⁶ Por su naturaleza la nanotecnología es un área multidisciplinar y multisectorial. Es por esta razón que la colaboración entre diversos centros, con experiencia en los diferentes aspectos de esta disciplina – físicos/químicos, teóricos/experimentales, básicos/aplicados–, y con el denominador común de estudiar los sistemas moleculares, es imprescindible para implantar un programa de formación como el que se propone. El Máster de NNM no tiene precedentes a nivel nacional ya que pretende abordar los aspectos que se encuentran en la intersección de la Nanociencia con los sistemas moleculares.

Spain	University of Alicante – Molecular Nanotechnology Lab	Research on energy, nanomaterials, biomimetics and medicine.
Spain	University of Barcelona – Bioelectrochemistry and Nanotechnology	Research in the group includes biomembranes, optical switches, nanoelectrochemistry and molecular self-assembly.
Spain	University of Barcelona – Bioelectronics and Nanobioengineering	Research includes development of nanostructures of biocompatible polymers; study of polymer surfaces in 2D and 3D; Development of biosensors based on membrane receptors with electrochemical and optical detection principles. Development of biosensors based on DNA structures. Application to the development of microfluidic systems for lab-on-chip. Modelling of microfluidic systems.
Spain	University of Barcelona – Official Master Degree in EUROPHOTONICS – European Master in Photonics Engineering, Nanophotonics and Biophotonics	The EUROPHOTONICS–POESII Erasmus Mundus Joint Master Degree (EMJMD) started in 2010 is a two years Master program focusing on advanced research and applied topics that will constitute the near and extended future scientific goals in the field of Photonics Engineering, Nanophotonics, Biophotonics, with interdisciplinary applications.

Spain	University of Barcelona – Official Master in Nanoscience and Nanotechnology	This Master constitutes an ambitious inter university action that involves Lecturers, Professors and Researchers from groups with a significant activity in the fields of Nanoscience and Nanotechnology. This involves four of the main Universities in Catalonia (including two of the main Research and Technological Universities in Spain, located in Barcelona) and research institutes in the areas of Barcelona and Tarragona (including Institutes integrated in the Spanish Superior Research Council (CSIC)), under the coordination of the University of Barcelona.
Spain	University of Barcelona – Self-Organized Complexity & Self-Assembled Materials	The group investigates soft matter and biophysical systems from a physicochemical point of view.
Spain	University of Vigo - Colloid Chemistry Group	The research activity of the Colloid Chemistry Group is focused on the synthesis and formation mechanisms of metal, semiconductor, magnetic and hybrid nanoparticles with controlled composition, size and morphology; the creation of colloidal composites; nanostructured thin films and nanoparticle ordered arrays in two and three dimensions; the optical characterization of nanoparticles and their assemblies; and the use of metal nanoparticles as biosensors. The group is closely linked to the BioNanoPlasmonics Lab at CIC biomaGUNE.
Spain	University of Vigo – Nanoparticles and Nanostructures Group	The group's research is focused on the synthesis, characterization and applications of nanoparticles and assemblies thereof.

Spain	University of Zaragoza – Masters Degree in Nanostructured Materials for Nanotechnology Applications	This official Master from Zaragoza University (Spain) has a duration of 18 months and comprises 75 ECTS credits. The course is suitable for graduates with science, engineering, medicine or related degrees keen to develop careers at the forefront of Nanoscience and Nanotechnology. The course is multidisciplinary and aims to provide students with fundamental knowledge, practical experience, and skills in the fabrication and characterization of nanostructured materials and devices with applications in key areas of nanochemistry, nanophysics, and nanobiomedicine.
Spain	University of Zaragoza – Nanoporous Films and Particles Research Group	The common thread linking the group's research areas is the use of nanoporous interfaces, in a multiplicity of shapes and textures. The group is interested in methods that allow them to develop and control porous structures, and to deploy these structures on a variety of surfaces and environments; they also try to find applications in which nanoporous structures can be employed to modify the performance of different types of devices.
Spain	Valencia Nanophotonics Technology Center (NTC)	The Valencia Nanophotonics Technology Center (NTC) is a research centre whose mission is to exert the leadership in Europe in the micro/nanofabrication of structures on silicon, as a key support for the development of Nanotechnology and Nanoscience, specially towards their applications in photonics: in the areas of optical fibre networks and systems, biophotonics, defence, security, photonic computation, etc.

Sweden	Chalmers University of Technology – Graphene Centre	The Graphene Centre at Chalmers gathers all of our research, education and innovation related to graphene under one common umbrella. Synergies between our multiple graphene projects can be identified, utilised and developed, at same time we create an environment that attracts researchers, students and cooperation partners. The centre is the obvious entry point to the Swedish network of graphene research and development, as well as to the EU's research initiative on graphene – the Graphene Flagship.
Sweden	Chalmers University of Technology – Linnaeus Centre on Engineered Quantum Systems (Linneqs)	The Linneqs environment is coordinated by a supervisor, co-working with four project coordinators for the four different research areas, Qubits, Quantum Transport, Graphene and Enabling Technologies.
Sweden	Chalmers University of Technology – Master's Programme in Nanotechnology	The Master's Programme in Nanotechnology is tailored to students aiming at international careers in the field of Nanoscience and Nanotechnology, both regarding the fundamentals of Nanoscience and how to design and build components on the nanoscale.
Sweden	Chalmers University of Technology – Master's Programme Materials Chemistry and Nanotechnology	The programme is intended for students aiming at a career in the area of materials science, which is a very broad field both scientifically and technologically. Scientists who work in industry or at universities and engineers who work in materials science are active in fields ranging from fundamental materials development to application of materials technology to products and processes.
Sweden	Chalmers University of Technology – Micro- and Nanosystem Fabrication and Integration	The research focuses on carbon based device fabrication, characterization, interconnect and packaging for electronics, microsystem and biomedicine.

Sweden	Chalmers University of Technology – Microtechnology and Nanoscience	Large efforts, experimental as well as theoretical, are directed at materials, devices and subsystems for future micro/nanoelectronics in the fields of microwave electronics, quantum devices, photonics, micro- and nanosystems, superconducting devices and circuits and molecular electronics just to mention a few.
Sweden	Chalmers University of Technology – Nanofabrication Laboratory	The Nanofabrication Laboratory is a world-class university cleanroom for research into and fabrication of micro and nano technology. The laboratory is run by the department of Microtechnology and Nanoscience at Chalmers, but is an open user facility for external as well as internal academic and industrial interests.
Sweden	KTH – Royal Institute of Technology – Master Nanotechnology	The Master's Programme in Nanotechnology provides a solid background in solid state physics, semiconductor devices, materials science and design, microelectronics, materials chemistry and an introduction to biotechnology. It offers a broad range of fundamental courses, e.g., quantum mechanics and solid state physics, but the programme is also experimentally oriented and provides several laboratory exercises as well as practical experience from advanced research tools for materials and device characterization.
Sweden	KTH – Royal Institute of Technology – Stockholm – Materials Platform	Materials science has traditionally been an important research area at KTH with strong ties to the Swedish industry. In addition to the internationally highly competitive research in traditional materials, KTH has strong research in Nanoscience and Nanotechnology, which is used to study and tailor material structures.

Sweden	KTH – Royal Institute of Technology Stockholm – Nanostructure Physics	Research on quantum Josephson circuits, nanostructured proteins and spintronics.
Sweden	Linköping University – Materials Science and Nanotechnology Master	The Material Physics and Nanotechnology master's programme focuses on the physics of new materials and covers a wide range of materials used in for example semiconductor technology, optoelectronics and biotechnical applications.
Sweden	Lund University – Master Program Nanoscience	Are you interested in diving into a different world where classical laws do not hold anymore and quantum mechanics governs? Would you like to take an atomistic view in order to understand how things work? Do you like working in a truly interdisciplinary environment? What about developing new biomedical sensors by applying Nanotechnology or connecting electronics to living cells? In that case: study Engineering Nanoscience at Lund University. This is a 5-year program culminating in a Master of Science degree. Note: The first three years of the program are conducted in Swedish. The final 2 years will be conducted similarly to the Master's program and given mainly in English.
Sweden	Lund University – NanoLund Center for Nanoscience	The Nanometer Structure Consortium is the host to several national and international research programs in the area of Nanoscience.

Switzerland	EMPA – Laboratory for Mechanics of Materials and Nanostructures	The lab investigates mechanical materials properties from the nano to macro-scale using experimental, analytical, and computational techniques. Current cutting edge research within European projects and the ETH competence centre on high temperature materials focuses on micro- and nano-mechanical properties of materials (instrumentation, scale effects related to microstructure and physical dimension).
Switzerland	EPFL Lausanne – Laboratoire de Systemes Robotiques (LSRO)	One of the areas of research deals with nanometric positioning.
Switzerland	EPFL Lausanne – Laboratory of Physics of Complex Matter	Group at the Institute of Physics of Complex Matter.
Switzerland	EPFL Lausanne – Laboratory of Ultrafast Spectroscopy	The activities of the laboratory aim at a detailed description of photo-induced processes in the molecular condensed phase (liquid, solid and proteins) and in metallic and semiconductor nanostructured materials. A central approach of the group is the visualization in “real time” of the processes by means of ultrafast laser spectroscopy.
Switzerland	EPFL Lausanne – Nanoelectronic Devices Group (NANOLAB)	NANOLAB is working on various subjects in the field of silicon micro/nano-electronics with special emphasis on the technology, design and modelling of nanoscale solid-state devices (including Silicon-On-Insulator devices, few-electron devices, hybrid SET/CMOS, single electron memory, nanowires and nanotubes), Radio Frequency MEMS devices for in- and above-IC and integrated optoelectronic devices. The group is interested in exploring new materials, novel fabrication techniques, and novel device concepts for future nanoelectronic systems.

Switzerland	EPFL Lausanne – Nanophotonics and Metrology Laboratory	The Nanophotonics & Metrology Laboratory (NAM) at the Swiss Federal Institute of Technology Lausanne (EPFL) covers a broad spectrum, from nanophotonics to plasmonics, near-field optical microscopy to spectroscopy, from optical signal processing for sensing and telecommunications to speckle and holographic interferometry.
Switzerland	EPFL Lausanne – Nanoscale Electronics and Structures	The group is working on nanoelectronics based on new, two-dimensional materials such as graphene and MoS ₂ . These materials represent the ultimate limit of miniaturization in the vertical dimension and offer substantial advantages over nanotubes or nanowires.
Switzerland	EPFL Lausanne – Nanotechnology for Solar Energy Conversion Group	The group develops and characterizes novel nanostructured materials for solar energy applications. The nanocomposite coatings consist typically of dielectric, semiconductor or metal nanocrystals embedded in a dielectric matrix. Applications include antireflection coatings on solar collector glazing, coloured coatings with high solar transmittance for novel glazing of solar thermal facades, photoluminescent quantum dot solar concentrators for photovoltaic energy conversion, and optical selective absorber coatings for thermal solar collectors and thermoelectric power generation.
Switzerland	EPFL Neuchatel – Samlab	The Sensors, Actuators and Microsystems Laboratory was created in 1982 by professor Nico F. de Rooij. Since then, SAMLAB has increased in size and has reached a staff of about 50 persons, including 15 Ph.D. students.

Switzerland	Fribourg Center for Nanomaterials (FriMat)	FriMat combines a leading fundamental research program on soft condensed matter and solid state physics with an innovative approach to synthesize novel compounds in order to create and study advanced materials. FriMat is determined to not only focus on the creation of novel materials and promote Nanotechnology, but investigates into potential risks associated with nanoparticles, and develops new tools essential in any attempt to sample and characterize nanoparticles in the environment.
Switzerland	Swiss Federal Institute of Technology (ETH Zurich) – EMPA Nanostructures Materials	As the materials research institute in the ETH-domain, Empa is most certainly active in Nanotechnology and is generating new knowledge, new materials and new applications and is transferring this knowhow to potential users.
Switzerland	Swiss Federal Institute of Technology (ETH Zurich) – FIRST Center for Micro- and Nanoscience	FIRST is a technology and cleanroom facility for advanced Micro- and Nanotechnology.
Switzerland	Swiss Federal Institute of Technology (ETH Zurich) – Functional Materials Laboratory	The Functional Materials Laboratory (FML) is exploring the interface between materials and chemistry (catalysis) and biology (cell culture).

Switzerland	Swiss Federal Institute of Technology (ETH Zurich) – Laboratory for Nanoelectronics	The Laboratory for Nanoelectronics investigates the potential of nanoscale materials in electronic devices at each point in the energy life-cycle collection, storage, and usage. Using a combination of experiment and theory, they study the fundamental electronic properties of materials and apply their findings to the rational design of devices that harness the novel form factors and properties provided by nano-sized materials. They focus on the design and fabrication of solid state and electrochemical devices including solar cells, batteries, and efficient LEDs.
Switzerland	Swiss Federal Institute of Technology (ETH Zurich) – Laboratory for Nanometallurgy	The group finds the optimal length scale for diverse materials properties and design materials accordingly.
Switzerland	Swiss Federal Institute of Technology (ETH Zurich) – Laboratory for Surface Science and Technology	The LSST is involved in research and teaching in numerous areas of surface science and technology, with a special focus on the areas of tribology, functional biointerfaces, biomedical interfaces, dynamic biointerfaces, surface functionalization, surface forces, and advanced surface analytical techniques.
Switzerland	Swiss Federal Institute of Technology (ETH Zurich) – Laboratory of Applied Mechanobiology	The Applied Mechanobiology Laboratory exploits Nanotechnology tools to decipher how bacteria, mammalian cells, and micro-tissues take advantage of mechanical forces to recognize and respond to material properties in their native environments.

Switzerland	Swiss Federal Institute of Technology (ETH Zurich) – Materials Research Center	Research in Materials Science and Engineering (MSE) at ETH Zurich is a massive undertaking, involving nearly 300 graduate students, more than 50 professors and eight departments. This involvement in materials goes back to the ETH's beginnings, and has resulted in many outstanding contributions, both in science and in applications.
Switzerland	Swiss Federal Institute of Technology (ETH Zurich) – Nano-Optics Group	Research in the group encompasses all that has to do with the study of the interaction of light and matter at the nanometer scale.
Switzerland	Swiss Federal Institute of Technology (ETH Zurich) – Nanophysics	The group's research focuses on the preparation of ultra-small semiconductor structures with the aim to investigate experimentally new, unusual and unexpected physical systems. In particular they are interested in structures that operate at the crossover between classical physics and quantum physics.
Switzerland	Swiss Federal Institute of Technology (ETH Zurich) – Nanoscience for Energy Technology and Sustainability	The group's interest is in development of nanomanufacturing techniques for bridging Nanoscience and real world applications.
Switzerland	Swiss Federal Institute of Technology (ETH Zurich) – Nanotechnology Group	The group targets manufacturing techniques for the micro and nano-scale that rely on assembly principles observed in living cells. They particularly focus on maskless techniques outside of cleanrooms, at the solid-liquid interface, and suitable for a wide range of materials.
Switzerland	Swiss Federal Institute of Technology (ETH Zurich) – Particle Technology Laboratory	Researching the synthesis and processing of nanoparticles.

Switzerland	Swiss Federal Institute of Technology – Master of Science in Micro and Nanosystems	The interdisciplinary curriculum is centred on mechanical and electrical engineering courses of importance for micro and nanosystems engineers, complemented by courses in physics, chemistry, biology, material science, computational science, business administration and management.
Switzerland	Swiss Universities of Applied Science – Swiss Master of Advanced Studies in Nano and Micro Technology	The Master of Advanced Studies (MAS) is the only title recognized by the confederation for postgraduate studies at the master level in the natural and engineering sciences. The Master of Advanced Studies is euro compatible.
Switzerland	University of Basel – Bachelor of Science (BSc) in Nanosciences	The University of Basel is the first Swiss university to provide a programme in Nanosciences. From the very beginning of studies, the interdisciplinary curriculum in Nanosciences combines the three disciplines of biology, chemistry and physics into the word of nano systems. After three years a BSc with a Major in Nanosciences can be awarded. Three semesters later the degree of an MSc in Nanosciences becomes possible.
Switzerland	University of Basel – Master of Science (MSc) in Nanosciences	The University of Basel is the first Swiss university to provide a programme in Nanosciences. From the very beginning of studies, the interdisciplinary curriculum in Nanosciences combines the three disciplines of biology, chemistry and physics into the word of nano systems. After three years a BSc with a Major in Nanosciences can be awarded. Three semesters later the degree of an MSc in Nanosciences becomes possible.

Switzerland	University of Basel – Nanoelectronics Group	The Experimental Mesoscopic Physics Group explores quantum effects in model structures ranging from lithographically defined devices down to single molecules.
Switzerland	University of Basel – The Swiss National Centre for Nano Scale Science	“Nanoscale Science” as a National Center of Competence in Research (NCCR) is a long-term interdisciplinary research effort focusing on nanoscale structures and aiming to provide new impact and ideas for the life sciences, for the sustainable use of resources, and for information and communications technologies
Switzerland	University of Berne – Calzaferri Research Group	Calzaferri’s research in the Department of Chemistry and Biochemistry deals with Luminescent molecules and quantum-sized particles in the cavities and channels of zeolites. The group develops highly organized dye-zeolite materials for nanosensors and photoelectronic devices.
Switzerland	University of Fribourg – Adolphe Merkle Institute	The Adolphe Merkle Institute (AMI) is an independent competence centre at the University of Fribourg that focuses on research and education in the domain of soft nanomaterials.
Switzerland	University of Fribourg – Advanced Particles (Fink Group)	The Fink Group focuses on the synthesis and characterization of novel multifunctional and/or hybrid particles and materials for a variety of applications, predominately in biology and medicine. The group works on a variety of interdisciplinary research projects ranging from reactor development and nanoengineering to biotechnology and surface chemistry. While addressing fundamental problems, our research efforts are also highly relevant to important societal issues such as environment and sustainability, human health and nanobiotechnology.

Switzerland	Zurich University of Applied Sciences – Center for Functional Materials and Nanotechnology	The focus of the Center of Functional Materials and Nanotechnology are the modification and analysis of surfaces and the development of applications in the following areas of chemistry and biology: Functional- and biomaterials; Nanotechnology; Surface analysis; Filtration technology in industrial chemistry.
Turkey	Bilkent University – Master of Science in Materials Science and Nanotechnology	The Materials Science and Nanotechnology graduate program has started accepting applications. Students from departments of materials science, physics, electronics, chemistry, mechanical engineering, biotechnology, genetics, pharmacy, mechatronics, agriculture and textile can apply.
Turkey	Bilkent University – Nanotechnology Research Center (NANOTAM)	Nanotechnology Research Center at Bilkent University is dedicated to research on theoretical and experimental Nanoscience and Nanotechnology with strong emphasis on education and training.
Turkey	Middle East Technical University – MSc Micro and Nanotechnology	The graduate program in Micro and Nanotechnology is a joint interdisciplinary program of the following Departments: Biological Sciences, Chemistry, Physics, Chemical Engineering, Electrical and Electronics Engineering, Engineering Sciences, Metallurgical and Materials Engineering, Mining Engineering and Mechanical Engineering.
Turkey	Middle East Technical University – Ph.D. Micro and Nanotechnology	The Ph.D. program in Micro and Nanotechnology is a joint interdisciplinary program of the following Departments: Biological Sciences, Chemistry, Physics, Chemical Engineering, Electrical and Electronics Engineering, Engineering Sciences, Metallurgical and Materials Engineering, Mining Engineering and Mechanical Engineering.

Turkey	National Nanotechnology Research Center at Bilkent University	A centre of excellence in Nanoscience and Nanotechnology in Turkey.
Turkey	Sabanci University – Nanotechnology Research and Application Center (SUNUM)	The Center is engaged in highly effective multidisciplinary research programs, bringing together researchers with expertise spanning advanced materials, nano-bio technology, nano-electronics, micro-nano fluidics, micro-nano-electromechanical systems and nano-engineering.
Turkey	Toros University – Nanomaterial Production Laboratory	In the lab of Cagdas Allahverdi, the group is producing II-VI and V-VI group semiconductors whose average sizes are below 100 nm. Their aim is to create applications using these nanomaterials in the future.
Turkey	Yeditepe University – Nanobiotechnology Research Group	Research in the group aims at the development of nature-inspired bio- and nanosensors for the solution of several challenging problems of today's world.
United Kingdom	Bangor University – MSc Nanotechnology and Microfabrication	This course teaches numerate graduates knowledge and skills in the field of Nanotechnology and microfabrication. The course takes an immersive approach to learning both the principles and practices of Nanotechnology and microfabrication with much of the material based around examples and practical exercises. Students completing this course will have a firm grasp of the current practices and directions in this exciting area and will have the knowledge and skills to enable them to design and build microscale devices.
United Kingdom	Glyndwr University – Chemistry with Green Nanotechnology	This degree is for those who have an interest in chemistry and a desire to explore the frontline of science. This programme combines chemistry with green Nanotechnology in order to solve a wide range of issues.

United Kingdom	Heriot-Watt University – Chemistry with Nanotechnology MChem	This programme is attractive to students with an interdisciplinary interest in chemistry, physics and mathematics, and their engineering applications. Chemists have always been nanotechnologists because molecules are about one thousandth–millionth of a metre in size. The programme combines core Chemistry with Nanochemistry, Nanophysics and Microengineering. Nanotechnology finds application (and will expand into new applications) in areas as diverse as Chemical Engineering, Chemistry, Biochemistry, Medicine, Microelectronics, Communications and Aerospace.
United Kingdom	Heriot-Watt University – Nanoscience BSc	This 4-year course is based on physics but includes content from chemistry and biology to give an important appreciation of how all the sciences have new effects to be observed and new applications to be discovered.
United Kingdom	Heriot-Watt University – Nanoscience Master of Physics (MPhys)	This 4/5-year course is based on physics but includes content from chemistry and biology to give an important appreciation of how all the sciences have new effects to be observed and new applications to be discovered.
United Kingdom	Imperial College London – MRes in Nanomaterials	Combining interdisciplinary teaching with cutting edge research, this flagship course will train the next generation of nanotechnologists. The course is associated with the London Centre for Nanotechnology, a joint venture between Imperial College London and UCL, allowing a wider choice of collaborative opportunities.
United Kingdom	Imperial College London – MSc Physics with Nanophotonics	Nanophotonics is a stream within the university's MSc in Physics which is where the science and technology of Nanotechnology and photonics meet, delivering the manipulation and control of light on the nanoscale.

United Kingdom	King's College London – Physics at the Nanoscale MRes	Gain experience of research in the rapidly developing interdisciplinary areas of biophotonics, nanomaterials and nanophotonics, X-ray physics and computational modelling. Consists of taught components plus a research project. Ideal preparation for a higher physics degree or careers in scientific research or the financial sector.
United Kingdom	Lancaster University – Nanoscience Ph.D.	This Ph.D. offers research in Nanoscience and Nanotechnologies which is excelled by the experimentalists in the Quantum Technology Centre and theorists in the Centre for Nanoscale Dynamics at Lancaster.
United Kingdom	Swansea University – BSc Physics with Nanotechnology	B.Sc. Physics with Nanotechnology Degree Scheme.
United Kingdom	<u>Swansea University - MPhil in Nanotechnology</u>	This is a one-year course, normally a first- or second-class honours degree, dependent on the area of research, offered at the university's The Multidisciplinary Nanotechnology Centre.
United Kingdom	Swansea University – MRes Nanoscience to Nanotechnology	The MRes course consists of a 4-month period of intensively taught modules from October to the end of January, followed by an 8-month period of individual research. There are two streams to the MRes course and students may choose to specialise in either structures or fluids. The MSc course consists of an initial 6-month period of taught modules. This provides a good grounding in computer modelling and in the finite element method, in particular. Following the taught component, students undertake a 6-month period of project work.

United Kingdom	Swansea University – MSc by Research in Nanotechnology	The university's Systems and Process Engineering Centre brings together academic expertise from across the University, incorporating state-of-the-art facilities. With their reputation for research in Nanotechnology, Swansea University provides an excellent base for your research as a MSc by Research student in Nanotechnology.
United Kingdom	Swansea University – MSc Nanomedicine	The 1-year, full-time MSc in Nanomedicine involves studying for 120 credits of taught modules.
United Kingdom	Swansea University – MSc Nanoscience to Nanotechnology	This course provides students with the knowledge, motivation, and self-learning skills required for continuous professional development during their future careers and provides valuable experience of working on complex projects both as individuals and as team members. The full-time scheme lasts for 12 months and consists of two taught semesters (Part I), followed by a three-month period of individual research (Part II) during the summer.
United Kingdom	Universities of Leeds and Sheffield – Masters (MSc) Course in BioNanotechnology	Full-time MSc study entails a 12-month programme, split between Leeds and Sheffield campuses. In order to complete the full MSc programme, you must complete the eight lecture modules and a major project.
United Kingdom	Universities of Leeds and Sheffield - Masters (MSc) Course in Nanoscale Science and Technology	Full-time MSc study entails a 12-month programme, split between Leeds and Sheffield campuses. In order to complete the full MSc programme, you must complete the eight lecture modules and a major project.
United Kingdom	University College London – Centre for Doctoral Training in Delivering Quantum Technologies	The CDT provides a 4-year programme. The students will take a broadly based training year before undertaking a Ph.D. research project in one of the centre's research groups.

United Kingdom	University College London – MEng Electronic Engineering with Nanotechnology	The programme provides a solid grounding in Electronic Engineering along with specialisation in Nanotechnology. It makes use of UCL’s pivotal position as hosts of the London Centre for Nanotechnology, to provide access to state-of-the-art laboratory facilities and teaching from experts in the field.
United Kingdom	University College London – MSc in Nanotechnology	The programme introduces students to and provides training in the skills essential for almost all fields of Nanotechnology research, including key laboratory skills and techniques in planning, building devices, analysis, and results comparison. The core lecture programme covers essential topics in physics, electrical and electronic engineering, and biology.
United Kingdom	University College London – MSc in Nanotechnology & Regenerative Medicine	Delivered by a group of world-leading research scientists, lecturers and experts in technology transfer, the MSc in Nanotechnology & Regenerative Medicine has a clinical focus, ensuring it addresses real medical needs. Students have the opportunity to learn about new technologies that are transforming modern medicine: nanomedicine; tissue engineering; stem cell technologies. They will also develop research skills by joining interdisciplinary world leading teams. An in-depth laboratory-based research project is an integral component of the programme (50%). Project topics include: nanoparticle targeted drug delivery, imaging and therapy; trachea, nose, ear, cardiovascular, skin and bone tissue engineering; functionalised scaffolds for directing stem cell differentiation.

United Kingdom	University of Birmingham – MRes Environmental and Biological Nanoscience	This postgraduate programme is designed to provide students with a comprehensive understanding of all aspects of Nanoscience and its potential environmental and human health related risk. The MRes focuses on the fundamental and underpinning science but also discusses applications, synthesis and policy and regulatory responses.
United Kingdom	University of Bristol MSc in Nanoscience & Functional Nanomaterials	The interdisciplinary 1-year MSc programme will equip students with the skills, knowledge and expertise to become practitioners in Nanoscience, whether in industry or academia.
United Kingdom	University of Cambridge – Master in Micro- and Nanotechnology Enterprise	The Master's Programme in Micro- and Nanotechnology Enterprise is an opportunity in which world-leading scientists and successful entrepreneurs are brought together to deliver a one-year Master's degree, which combines an in-depth multidisciplinary scientific programme with a global perspective on the commercial opportunities and business practice necessary for the successful exploitation in the rapidly developing fields of Nanotechnology and microelectromechanical systems (MEMS).
United Kingdom	University of Cambridge – Ph.D. in Nanoscience and Nanotechnology	The Ph.D. programme is based on courses, practical activity and projects in Year 1 before selection of an interdisciplinary Ph.D. topic for research in Years 2–4 in a Nano group within Physics, Chemistry, Engineering, Materials or another department. A significant element will be a Management of Technology Innovation (MoTI) component provided through the Judge Business School.

United Kingdom	University of Glasgow – MSc Nanoscience and Nanotechnology	The Masters in Nanoscience and Nanotechnology teaches you the skills desired by modern industry for scientists and engineers doing research, development and production in Nanoscience and nanofabrication. This multidisciplinary programme will complement your background in electronics, materials science, or physics. Prestigious Scottish Funding Council Awards are available to high calibre applicants for this programme.
United Kingdom	University of Hull – BSc Chemistry with Nanotechnology	The programme provides opportunities for students to develop and demonstrate knowledge, understanding, skills, qualities and other attributes in chemistry with a Nanotechnology focus.
United Kingdom	University of Leeds – BEng Electronics and Nanotechnology	This unique course is focused directly on this interface between the fields of electronics and Nanotechnology. It covers the foundations of electronic engineering, from communications systems through to computer engineering, integrated circuit design and micro/nano fabrication. It enables you to understand the principles of electronics and Nanotechnology, in particular the principles of the fabrication and design of modern microelectronic products.

United Kingdom	University of Leeds – MEng Electronics and Nanotechnology	This unique course is focused directly on this interface between the fields of electronics and Nanotechnology. It covers the foundations of electronic engineering, from communications systems through to computer engineering, integrated circuit design and micro/nano fabrication. It enables also to understand the principles of electronics and Nanotechnology, in particular the principles of the fabrication and design of modern microelectronic products.
United Kingdom	University of Liverpool – MSc (Eng) Micro and Nano Technology	The programme starts in late September each year and is divided into three approximately equal periods. The first and second periods consist of lectures, laboratory classes, seminars and similar material. In the third period, students undertake an individually supervised project on a topic relevant to their special interests.
United Kingdom	University of Manchester – Nanostructured Materials MPhil	The Nanostructured Materials research degrees are part of a large and multidisciplinary activity within the School of Materials. There are strong links with industry and leading research councils.
United Kingdom	University of Manchester – Nanostructured Materials MSc by Research	The Nanostructured Materials research degrees are part of a large and multidisciplinary activity within the School of Materials. We have strong links with industry and leading research councils.
United Kingdom	University of Nottingham – Physics with Nanoscience MSc	This innovative taught, 1–year fulltime higher degree course aims to train a new generation of scientists and engineers in the emerging field of Nanoscience.

United Kingdom	University of Oxford – MSc in Nanotechnology for Medicine and Health Care	This advanced modular course is delivered by leading scientists and experts in this rapidly developing field and has been specifically designed for those who would value a part-time modular learning structure, for example those in full-time employment, both in the UK and overseas. The MSc is designed to be completed part-time, normally over a two- to three-year period, and so provides a path to career development that is flexible and recognised within academia and industry. The programme comprises three online modules exploring the fundamentals of science and materials characterisation at the nanoscale, three intensive five-day face-to-face modules describing the clinical and commercial application of such science, and a piece of original lab-based research leading to the submission of a dissertation.
United Kingdom	University of Sheffield – Masters (MRes) Course in Quantum Photonics and Nanomaterials	Full-time MSc study entails a 12-month programme, split between Leeds and Sheffield campuses. In order to complete the full MSc programme, you must complete the eight lecture modules and a major project.
United Kingdom	University of Sheffield – MSc Nanomaterials and Material Science	The course content reflects the highly interdisciplinary nature of this subject and allows students to specialise via choice of the Major Research Project.
United Kingdom	University of Sheffield – MSc Nanoscale Science and Technology	Full-time MSc study entails a 12-month programme, split between Leeds and Sheffield campuses. In order to complete the full MSc programme, you must complete eight lecture modules and a major project.

United Kingdom	University of Southampton – M.Sc. Nanoelectronics and Nanotechnology	Areas of research include: Nanotechnology and Nanoelectronics, Nanophotonics (photonic crystals and integrated photonics), Quantum Technology and electronic devices, Micro and Nanoelectromechanical Systems (MEMS, microsensors and actuators), Bioelectronics and Lab on a Chip (Microfluidics and Nanofluidics), RF system design (ARTIC).
United Kingdom	University of Southampton – MEng Electronic Engineering with Nanotechnology	This four-year MEng degree course in Electronic Engineering with Nanotechnology focuses on the design and implementation of secure electronic systems. Advanced topics include cyber security, safety-critical systems, automated software verification and cryptography.
United Kingdom	University of Strathclyde – MSc Physics with Nanoscience	Nanoscience is the most diverse division in Physics at Strathclyde. It reflects the broad range of scientific areas in which Nanotechnology (the use of very small objects) will impact upon our future lives.
United Kingdom	University of Surrey – MSc in Nanotechnology and Renewable Energy	The programme's broad theme is the practical implementation of Nanoscience and quantum engineering, nanomaterials and Nanotechnology. The programme covers the fundamentals behind Nanotechnology and moves on to discuss its implementation using nanomaterials – such as graphene – and the use of advanced tools of Nanotechnology which allow us to see at the nanoscale, before discussing future trends and applications for energy generation and storage.
United Kingdom	University of York – BEng Electronic Engineering with Nanotechnology	An undergraduate BEng/MEng course.

United Kingdom	University of York – MSci Natural Sciences specialising in Nanoscience	You will learn how using quantum and statistical mechanics and thermodynamics of the very small, and arranging atoms and molecules in specific ways, leads to new materials or systems with remarkable functions. You will develop laboratory skills in the university's clean room and your final year project could be conducted in, and supervised by, the York–JEOL Nanocentre.
United States of America	City University of New York – M.S. Program in Nanoscience	The M.S. Program in Nanoscience is ideal for students who want to enter the workforce in Nanoscience and its related energy, biomedical, electronics, telecommunications, and materials science fields, as well as for students who wish to expand their knowledge and skills in preparation for doctoral programs in chemistry, physics or materials science.
United States of America	City University of New York – Ph.D. in Nanotechnology & Materials Chemistry	The Graduate School offers a program of study leading to the Ph.D. degree in Chemistry. As one of seven sub-disciplines, students may specialize in Nanotechnology and materials.
United States of America	Joint School of Nanoscience and Nanoengineering – Ph.D. in Nanoengineering	The Joint School of Nanoscience and Nanoengineering has been approved its Ph.D. in Nanoengineering by the UNC–GA. Program details to come.

United States of America	Joint School of Nanoscience and Nanoengineering – Ph.D. in Nanoscience	The Ph.D. in Nanoscience requires a minimum of 60 hours and is designed to prepare students to take positions in industrial, governmental, or academic research settings by providing a solid background in Nanoscience theory and experimental techniques through course work and dissertation research. Advanced elective courses in Nanoscience areas ensure students will have substantial depth of understanding in their area of interest and enable them to effectively carry out advanced Nanoscience research.
United States of America	Louisiana Tech University – Engineering Ph.D. Micro/Nanotechnology Emphasis	The Ph.D. in Engineering is an interdisciplinary degree with a strong research emphasis. The program prepares candidates for both academic and industry careers. The Ph.D. Engineering program offers a Micro/Nanotechnology curriculum.
United States of America	Rice University – Ph. D. in Science and Engineering with Concentration in Nanophotonics	Rice University has established a unique interdisciplinary program in Nanophotonics aimed at providing science and engineering students with the educational and research training to develop new tools for generating, controlling and manipulating light at nanoscale dimensions.

United States of America	Rochester Institute of Technology – Ph.D. Program in Microsystems Engineering	The multidisciplinary program builds on the fundamentals of traditional engineering and science, combined with curriculum and research activities addressing the numerous technical challenges of micro- and nano-systems. These include the manipulation of electrical, photonic, optical, mechanical, chemical, and biological functionality to process, sense, and interface with the world at a nanometer scale. The goal is to provide the foundation to explore future technology through research in nano-engineering, design methods, and technologies for micro- and nano-scaled systems.
United States of America	South Dakota School of Mines and Technology – Nanoscience and Nanoengineering Ph.D.	The Nano Ph.D. program offers a research-intensive degree focused on Nanoscience and Nanotechnology, with an emphasis on nano-scale materials. A multi-disciplinary core curriculum is taken by students from diverse science and engineering backgrounds. These “core” courses are intended to introduce students to contemporary topics in Nanoscience and Nanotechnology, and to initiate a cross-disciplinary approach to research and learning.

United States of America	Stevens Institute of Technology – Doctor of Philosophy with Nanotechnology Concentration	Participation in the Nanotechnology Graduate Program leads to Masters of Science, Masters of Engineering, and Doctor of Philosophy in the respective disciplines with a designated Nanotechnology concentration. To qualify for the Nanotechnology concentration, in addition to satisfying disciplinary core requirements, candidates for Masters' degrees must complete the common core and a minimum of three elective courses and should attend regularly the seminar series in the Nanotechnology Curriculum.
United States of America	SUNY Polytechnic Institute – Ph.D. in Medicine and Nanoscale Science or Engineering	The Nanoscale Engineering program offers an academically rigorous preparation for students intending to pursue scientific, technical, or professional careers in Nanotechnology-enabled fields or graduate studies in nanoscale engineering or nanoscale science, as well as other physical sciences or interdisciplinary sciences such as materials science, physics, biophysics, chemistry or biochemistry.
United States of America	SUNY Polytechnic Institute – Ph.D. in Nanobioscience	The Ph.D. in Nanobioscience program trains students in the principles, practices, and research paradigms of Nanobioscience to prepare them for interdisciplinary careers in research, development, deployment and education at the convergence of medicine and life science with nanoscale science and engineering.
United States of America	University of Albany – MD/Ph.D. in Medicine and Nanoscale Science or Engineering	This first-of-its-kind dual degree program provides pioneering education and training in both medicine and nanoscale science research, preparing a new generation of professionals for exciting 21 st century careers as world-class research physicians in the emerging science and practice of nanomedicine.

United States of America	University of Albany – Nanoscale Engineering tracks for Ph.D. degree	CNSE’s Nanoscale Engineering program provides corresponding skill and expertise in the design, fabrication, and integration of nanoscale devices, structures, and systems for the development and deployment of emerging Nanotechnologies.
United States of America	University of Albany – Nanoscale Science tracks for Ph.D. degree	CNSE’s Nanoscale Science program provides the critical theoretical and experimental skill base and know-how for knowledge creation in the areas of nanoscale materials, structures, and architectures.
United States of America	University of California, San Diego – Ph.D. Nanoengineering	Plans are currently underway to develop graduate curricula leading to the M.S. and Ph.D. degrees in Nanoengineering by 2011. Until Nanoengineering graduate programs are in place, students wishing to pursue nanoengineering as a graduate focus are encouraged to apply to related graduate programs in bioengineering, chemical engineering, and mechanical and aerospace engineering. Transfer to Nanoengineering will be considered upon approval of its degree programs.
United States of America	University of New Mexico – Doctor of Philosophy Nanoscience and Microsystems	This exciting program bridges the distinct properties of the nanoscale to microsystem functionality. The integrated academic and research activities highlight our capabilities and unique breadth in materials synthesis and self-assembly, nanolithography, interrogative platforms, and functional micro/macrosystems.

United States of America	University of North Carolina Charlotte – Nanoscale Science Ph.D. Program	The Ph.D. in Nanoscale Science at UNC Charlotte is an interdisciplinary program that addresses the development, manipulation, and use of materials and devices on the scale of roughly 1–100 nanometers in length, and the study of phenomena that occur on this size scale. The program prepares students to become scholarly, practicing scientists who possess the critical thinking, methodological, and communication skills required to advance and disseminate knowledge of fundamental and applied nanoscale science.
United States of America	University of Texas at Austin – Ph.D. Engineering Nanomaterials Thrust	Students who have a strong background in any of the physical sciences or engineering disciplines are encouraged to apply to the Graduate Program in Materials Science and Engineering. MS&E students that select the Nanomaterials Thrust will take a sequence of courses from basic to advanced designed to train them in the fundamentals of materials science as well as critical skills in processing, characterization and applications of nanomaterials.
United States of America	University of Washington – Dual Degree Program in Nanotechnology	After admission to a participating department, graduate students can apply for our “Option Ph.D. in Nanotechnology” program. Fulfilment of both departmental and Nanotechnology Program requirements will lead to a Ph. D. in Nanotechnology and the chosen discipline.

United States of America	Virginia Commonwealth University – Ph.D. Nanoscience and Nanotechnology	The new program, which was developed by faculty in the VCU Departments of Chemistry and Physics, is designed to cross-train students in the physical sciences of chemistry and physics with particular focus on how the science changes at reduced dimensions. There is a potential for other departments to become more involved as the program develops.
--------------------------	---	--

The long table above gathers many institutions that concentrate their research efforts on the nanoworld, with a very brief but accurate description of their main field of research and the opportunities of each. This list is naturally open to be updated as new institutions become important in Nanoscience.

1.3.4. *On the History of Nanoscience & Nanotechnology*

In the following subsections I describe the most important events in the History of Nanoscience, to give the reader a brief but accurate summary of the subject I am going to describe later in detail. The reader will find information on researchers and the most important discoveries in the history of the nanoworld.

Also, to help the reader to find the information he/she needs out of this thesis, I group the subjects in the following table for quick reference.

Tab. I.7 A brief summary of the thesis and the chapters.

Chapter	Contents
Chapter 1	This chapter groups the definitions of Nanoscience and Nanotechnology and a brief History of Nanotechnology from the ancient times to 1950. The reader will find the difference between natural and artificial nanomaterials and the description of the pioneers in Nanotechnology (Feynman, Drexler, Taniguchi). Also, an interesting historiographic debate is discussed and the articulation of Nanoscience into nanotechnologies is briefly described.
Chapter 2	This chapter is dedicated to the physical devices applied to Nanotechnology and their principles of working. Here, the reader can find information about the mathematical models applied when theoretical solid state nanophysics is the subject of study.
Chapter 3	This chapter describes 20 years, from 1950 to 1970, of the History of Nanotechnology. Here it is possible to find information about researchers such as Radushkevich and Lukyanovic, Moore, Atalla and Kahng, concepts like the Field ion Microscope or the Quantum Size Effect. There is also the necessary quotation of “There’s Plenty of Room at the Bottom” in 1959.

Chapter 4	In this chapter I introduce the figure of Taniguchi and the first definition of the word Nanotechnology, the history of the fullerene, researchers like Rohrer and Binnig and Eigler, together with the description of the Nobel Prizes attained by the researchers in the nanoworld. The chapter will span a timeline from 1971 to 1990.
Chapter 5	From 1991 to 2022, I describe the most recent discoveries and advancements on nanotube technology, colloids, nanolithography, nanomachines, DNA, nanodots and nanorobots, graphene and nanocomputers.
Chapter 6	This chapter is dedicated to IEMN celebrating its 30-years-old history, since its official foundation in 1992. Thanks to the help of prof. C. Delerue and prof. R. Pisano, I received the most important publications of the lab in this time span. Here I present the results, some of them are world premieres, compared to other achievements in HNN.
Chapter 7	This chapter is dedicated to the implications that go together with the applications of the results and the research itself. I am going to discuss here the possible effects of nanoparticles inside the human body and their effects on the environment as it regards toxicity factors.
Chapter 8	In this chapter I gather the concluding remarks and leave many directions open for further research or developments towards new documents, books, articles or researchers willing to deepen the topics I treated here in this Ph.D. thesis.

1.3.4.1. Preliminary Consideration

Two definitions must be set: we will talk about conscious research (the researcher knows he is at work with Nanotechnology) once a definition of Nanoscience/Nanotechnology has been established in time and then research has been directed towards nanoscale materials, their properties and applications on the basis of precise guidelines. We will call unaware research (the researcher works in any case at really small dimensions but outside the definition) that which, although going on to investigate matter and its properties in the order of atomic size, does not refer to the “nanoworld container” as it would be later defined but which nevertheless laid the foundations of today’s research.

As a matter of fact, unaware research temporally preceded conscious research according to the definition given above, while, currently, there is reason to believe that researchers “make Nanotechnology” well aware of the scientific container they are moving within.

A second distinction is to be made with regard to natural and artificial nanomaterials. Natural nanomaterials are formed during erosive processes, volcanic eruptions and forest fires. Ultrafine particles are released into the environment through combustion processes. Amorphous silica, soot and ash are among the main natural nanomaterials.

Synthetic nanomaterials are manufactured specifically or are a by-product of production processes. Major synthetic nanomaterials in quantitative terms include carbon black (industrially manufactured soot), silicon dioxide, calcium carbonate and titanium dioxide.

1.3.4.2. An Early History

Is it possible to establish a date from which to trace the birth of the Nanoworld? According to the evidence from the studies that have been made so far, nanoparticles are commonly found in natural compounds. Virtually every chemical compound in Nature possesses some structure features at the nanometric scale, and several nanogeoscience studies confirm this.

The formation of natural nanoparticles is possible thanks to the work done by atmospheric agents. Such processes are mechanical at first sight, but are in their turn connected to precipitation and dissolution phenomena, the realization of colloidal structures in the water streams, activities related to volcanism such as the rapid cooling of fumes or explosions that throw out amounts of tephra, the set of pyroclastic materials produced during a volcanic eruption (regardless of their composition or size), outside the volcanic building.

We can therefore deduce that nanoparticles are formed in a solid/aeriform phase transition condition due to atmospheric agents, liquid/aeriform erosion in evaporation, for example, of seawater, solid/liquid by atmospheric action on minerals and rocks. From a chemical point of view, these nanoparticles consist of metal oxides and hydroxides or alloys, non-metals and allotropic forms of these such as carbon, copper sulphates and zinc containing pyrite. In addition, natural gold particles have been detected during mining activities both in low temperature conditions and in high temperature conditions.

Geographically speaking, deserts are known to be the largest source of nanoparticles that winds can disperse into the atmosphere.

In the 17th Century, Galileo Galilei (1564–1642) proposed the name of *Aurora borealis* joining the name of the Roman goddess of dawn, Aurora, to the Greek one for the north wind, Borea, for those atmospheric optical phenomena that we now know to be due to the interaction of the solar wind with the nanoparticles of the ionosphere, under the influence of the Earth's magnetic field.

The origin of life on Earth led to the development of nanoparticle structures synthesized by nanometric-sized biosystems and biological organisms, which in turn metabolized them for their life cycle into cellular nano organelles. With a diameter between 20nm and 1mm, *nanobi*, filamentous structures discovered by Uwins in 1996 in sediments and rocks dating back to the Triassic (between 251 and 199 million years ago) and the Jurassic (between 199 and 145 million years ago) are the traces of the smallest life forms that have appeared on our planet. They can be counted in the category of aerobic procellular organisms; lacking DNA or RNA, they are filamentous and non-crystalline structures in which a cell wall encloses a high density phase of electrons (interpretable as the cytoplasm) and a low density electron phase (which could perform the core function, having demonstrated selective reactivity to three organic reagents).

Although there is no fossil evidence of their existence in past geological eras, viruses may be included in nanosized structures – not considered as living organisms as they are incapable of autonomous life –. They may have evolved from complex protein molecules and nucleic acids, according to some hypotheses, even before the appearance of the first cell on Earth. Again, it can be assumed that they formed from important fragments of genetic DNA and became independent. According to a third hypothesis, they have appeared very recently, in the arc of the evolutionary panorama since both the viruses attacking bacteria and viruses attacking man can have a common origin dated several millions of years ago. In any case, they are nanosized entities; parvoviruses, whose size ranges between 18nm and 28nm are the smallest ever isolated viruses and among the most aggressive known examples.

If we look back to the definition the biologists give to viruses, according to which they are *on the margins of life* because they lack a real cellular structure and a metabolism, we could think of them as a nanoparticle that exists on the border between living and non-living entities.

It is not only viruses that occupy a relevant place in the panorama of biology; those that are known by the name of nanobacteria are the smallest cells in which a cell membrane is recognizable and can be described as ultramicrobacteria, hypothetical dormant forms of larger cells (200nm), and mycoplasmas (300nm), the smallest bacteria known to date.

This brief summary leads us to affirm that, just during the process of cooling of the Earth and the consequent establishment of the conditions that allowed the development of life, natural nanoparticles of extremely different compositions appeared. Nanoparticles have become part of both the world of the living and that of the not-living, thanks to their properties related to the nanometric dimension.

As it was plausible to suppose, it was Nature that created the first nanostructures. We will now see how the progress of the human being has benefited from the *more or less aware* use of nanostructures and what steps have, more than others, characterized the technological development of human activity within this context.

If we go through the history of humanity from the point of view of the scientific and technological development of civilizations, we can discover some fundamental points.

Regarding what we can indicate as an *unaware* application, there are many examples of artifacts from the Pharaonic Egyptian era to the Central American Empires, from Ancient Rome to the realms of India that reached our days and raised our attention.

The use of nanoparticles from copper, gold and silver has a long lived history; without knowing how to produce nanoparticles in full effect, potters and master glassmakers used nanoparticles dissolved in the melt material for over 3000 years. They developed techniques to reduce, in the presence of appropriate agents, metallic compounds into fine particles, the same ones we now call nanoparticles. By adding copper nanoparticles to glass siliceous pastes, the first stained glass was realized in Egypt and Mesopotamia.

The *Egyptian blue* (Fig. I.17), a bright blue dye used for the decoration of tomb walls and artifacts, is believed to be the first artificial pigment ever developed by humanity, being datable around 4500 years ago. It can be obtained from a naturally occurring mineral, cuprorivaite, which is – indeed – extremely rare. Therefore, given the poor availability of the natural precursor, it must be admitted that the ancient Egyptians were able to artificially produce this pigment. Not only that, but the extreme complexity and the precision with which whole operation must be conducted gives us good reason to believe that the chemical knowledge in their possession was extremely advanced, at an even extraordinary level.



Fig. I.17 *Ibis-head* statue of Thot, god of the Moon, of wisdom, of mathematics and geometry. Notice the use of Egyptian blue in the details of the figure. Source: Erika Wittlieb, from pixabay.com. Free-to-use image

The amount of material needed to make the pigment, compared to its natural availability, allows us to say that the realization of such a dye had to be part of a job of great prestige.

Similar considerations are also due to the so-called *Maya Blue* pigment, a colour that has survived over time thanks to its almost unique chemical characteristics. It was in use until the sixteenth century, then the technique was lost. Despite the passage of time and exposure to weather and atmospheric agents, the Maya Blue has not faded, indeed it has proved to be strongly resistant to chemical solvents and acids, the latter used not in excessive concentration. According to studies by Doménech, Maya Blue consists of an organic/inorganic hybrid nanostructure prepared by connecting a natural indigo dye to a clayey phyllosilicate.

A lot has been written about the *Lycurgus Cup*, whose glass appears red if observed in transmitted light but green if observed in reflected light (Fig. I.18). Its dichroic glass gives rise to unusual but extremely interesting optical effects; it possesses different properties due to gold and silver in solid solution with the siliceous paste, the gold being responsible for the reddish light observed in transmission, silver for the greenish light in reflection.



Fig. I.18 The Lycurgus Cup in transmitted light (left) and reflected light (right), The Trustees of the British Museum. <https://www.thevintagenews.com/2020/02/15/lycurgus-cup/> CC BY-NC-SA 4.0 license

Finally, mention should be made of swords and blades made of special steel from India. Today we know that wootz steel is a Nanotechnology-based alloy made by ancient Indian craftsmen. This steel was made of an extremely advanced material and possesses properties like high hardness to impact and super plasticity. Such features are due to the presence of iron carbide (Fe_3C) also known as cementite; the carbon nanostructures in wootz steel show cylindrical arrangements.

These few examples document how nanomaterials have been practically part of the history of man ever since, yet their appearance is not attributable to a precise date.

Many other successful results were recorded by medieval scientists although between the 4th century and the 17th century – a considerable span of time – glass staining practices did not develop. In the 1650s Andreas Cassius (1605–1673) discovered the first synthetic purple coloured pigment called *Purple of Cassius*, after him. This colour is due to fine gold particles in the solution. Curiously, bringing that colour to light was credited to his son Andreas Cassius (1645–1700?). Cassius (father) was able to discover the process of purple pigment formation from gold and its use in the staining process of glasses without knowledge of nanoparticles. Later on, at the end of the 19th century the Viennese chemist

Richard Zsigmondy (1865–1929) – inventor of the ultramicroscope for colloid analysis – gave the description of its exact synthesis process (Fig. I.19).

PREPARATION OF THE PURPLE POWDER OF CASSIUS.

M. FIGUIER gives the following as a certain process for preparing the above-named compound:—dissolve 300 grains of gold in five times their weight of aqua regia, prepared from four parts of hydrochloric acid and one part of nitric acid; evaporate the solution almost to dryness; this evaporation is requisite to get rid of the acid. The chloride of gold being redissolved in water and filtered, the solution is to be diluted till it measures 26 ounces; fragments of granulated tin are then to be put into it, which becomes turbid and brown in a few minutes; its tint gradually becomes deeper, and at the end of a quarter of an hour it assumes a fine purple colour, the precipitate is deposited, and it remains only to collect it on a filter.

It sometimes happens, and especially when large quantities are operated on, that the precipitate does not separate, but remains in the liquid, to which it gives a deep purple colour; in this case it is merely requisite to heat the liquid slightly and to add a little common salt; the product then immediately separates.

When the liquid holding the purple powder in suspension is decanted to separate the excess of metallic tin, care must be taken that no particles of tin, which remain at the bottom of the vessel in the state of a black powder, are poured off with it; it is proper to allow the liquor to settle for some time and afterwards to decant it; this operation should be repeated three or four times.—*Ann. de Ch. et de Phys.*, Juillet 1844.

**ON THE OXIDES AND SOME OTHER COMPOUNDS OF GOLD. BY
M. FIGUIER.**

In preceding Numbers we have stated the methods employed by M. Figuiet in preparing the protoxide of gold, and given his account of its properties, we now proceed to the

Auric Acid.—This is prepared by two processes:—1st, by treating

Fig. I.19 How to prepare the Purple of Cassius

After this excursus into the ancient history of Nanosciences, it is now necessary to outline the most significant points of the research that have been made and developed, from 1950 onwards.

As for the path of History of Nanoscience after the Second World War, probably the first step in the direction of the nanoworld was achieved through the realization of the Field Ion Microscope (FIM). The Field Ion Microscope was completed by Erwin Müller (1911–1977) in 1951. It is a type of microscope that can be used to visualize, through light spots, the arrangement of atoms on the surface of a pointed metal tip. It was on October 11, 1955, that Erwin Müller and his doctoral student Kanwar Bahadur of Pennsylvania State University observed single wolfram atoms on the surface of a pointed wolfram tip, after cooling it down to a temperature of 21K, then using helium as the imaging gas. Müller and Bahadur were the first people to observe individual atoms directly.

This first result in the nanoworld, although this expression was yet to come, made it possible to visualize matter as never before and can be considered as one of the milestones in Nanoscience.

It was only a matter of a few years, at the end of the 1950s, that an impulse was given to research in the direction of miniaturization, thanks to a conference by Richard Phillips Feynman.

On December 29, 1959, participants of the American Physical Society listened to the future Nobel Prize winner's talk that would soon be transcribed with the famous title *There's Plenty of Room at the Bottom. An Invitation to Enter a New Field of Physics*. In this conference, Feynman considered some possibilities linked to a more general ability to manipulate matter on an atomic scale. He was particularly interested in the possibilities of making denser electronic circuitry – it should be remembered that it was the historical period in which computers literally occupied rooms –, and microscopes able to visualize objects much smaller than what was possible those days, using the Scanning Electron Microscope.

These ideas were realized years later, through the use of the Scanning Tunneling Microscope (STM), the Atomic Force Microscope (AFM) and other scanning probe microscope models. A storage system such as Millipede, created by IBM researchers, responded to the problem of data storage. Feynman also suggested that, in principle, it should be possible to make nanoscale machines that “arrange atoms the way we want” and make chemical synthesis by mechanical manipulation. In particular, the precise placement of the atoms in predefined positions by the operator would solve the question with which the discussion in POR opens, in effect: Why can't we reproduce all 24 volumes of the Encyclopaedia Britannica on the head of a pin?

Feynman also presented the possibility of *swallowing the doctor*, an idea he credited in the essay to his friend and graduate student Albert Hibbs (1924–2003).

A friend of mine (A.R. Hibbs) suggests a very interesting possibility for relatively small machines. He says that, although it is a very wild idea, it would be interesting in surgery if you could swallow the surgeon. You put the mechanical surgeon inside the blood vessel and it goes into the heart and looks around (of course the information has to be fed out). It finds out which valve is the faulty one and takes a little knife and slices it out. Other small machines might be permanently incorporated in the body to assist some inadequately functioning organ (Feynman 1960).

This concept involved the construction of a small swallowable surgical robot able to operate surgically from within the patient.

It is interesting to observe that – just making a leap forward to our times – that authoritative researchers such as Durkan have found reasons to say that:

Nanotechnology is NOT about making nanorobots which can autonomously go around our bodies repairing damaged cells. [...] However [...] while we cannot make robots that repair cells, we can make nanoparticles that attach to and destroy cancer cells (Durkan 2019).

This slightly dialectically contradicts Hibbs' vision, but also provides scientific evidence of the fact, as we shall see later.

With POR it seems that a date, an inspiring pioneer and a founding document are available to found a new science (Fig. I.20).

There's Plenty of Room at the Bottom

An invitation to enter a new field of physics.

by Richard P. Feynman

I imagine experimental physicists must often look with envy at men like Kamerlingh Onnes, who discovered a field like low temperature, which seems to be bottomless and in which one can go down and down. Such a man is then a leader and has some temporary monopoly in a scientific adventure. Percy Bridgman, in designing a way to obtain higher pressures, opened up another new field and was able to move into it and to lead us all along. The develop-

nothing, that's the most primitive, halting step in the direction I intend to discuss. It is a staggeringly small world that is below. In the year 2000, when they look back at this age, they will wonder why it was not until the year 1960 that anybody began seriously to move in this direction.

Why cannot we write the entire 24 volumes of the Encyclopaedia Britannica on the head of a pin?

Let's see what would be involved. The head of a

Fig. I.20 Was this document responsible for all that happened after? Source: Feynman (1960)

A recent work from Toumey, *Reading Feynman Into Nanotechnology: A Text for a New Science*, provides an interesting series of considerations and, even more interesting, parts of interviews between the author and other *nano luminaries*, as he calls them.

For example, according to Toumey, Heinrich Rohrer (1933–2013), Nobel Prize in 1986 for the STM discovery with Gerd Binnig, stated that he was influenced “not whatsoever” by POR. In his words:

Binnig and I neither heard of Feynman's paper until Scanning Tunneling Microscopy was widely accepted in the scientific community a couple of years after our first publication, nor did any referee of our papers ever refer to it... It might have been even after the Nobel [Prize] (Toumey 2008).

In Toumey we can also read this from Gerd Binnig: “I have not read [Plenty of Room] ... I personally admire Feynman and his work but for other reason than for his work on Nanotechnology”.

A pure necessity for a more precise laboratory device is quoted by Calvin Quate (1923–2019), one of the inventors of the Atomic Force Microscope, again in Toumey:

None of this work derived from the publications of Feynman. I had not read the Feynman article and I don't think Binnig or Rohrer had read it. All they wanted was a better method for examining microdefects in oxides (Toumey 2008).

The debate that emerges from this different opinion and what the tradition says about Plenty of Room is very intriguing and this aspect will deserve a more detailed discussion further on in this work.

Anyway, since 1959 nano research literally flourished, despite the different interpretations that can be given to POR.

Between 1959 and 1960 the contribution of many technicians, researchers, engineers, scientists in time merged into what today is considered the most manufactured electronic device in history, the MOSFET, or Metal–Oxide–Semiconductor Field–Effect Transistor. Mohamed Atalla and Dawon Kahng (Fig. I.21) held in their hands the first MOSFET at Bell Laboratories in 1959 and the device was first presented to the public the next year. The

MOSFET is considered to be the most prominent semiconductor device in analog and digital integrated circuits and the most common power device.



Fig. I.21 Mohamed Atalla (left) and Dawon Kahng (right), the two researchers that invented the MOSFET in 1959. https://en.wikipedia.org/wiki/Mohamed_M._Atalla
https://en.wikipedia.org/wiki/Dawon_Kahng. CC BY-SA 4.0

Basically, it consists of a compact transistor and its progressive miniaturization and mass-production have made it vital for the digital revolution.

The NASA Research Center first discovered a ferrofluid in 1960s, when the Space Race competition was reaching its peak. The initial work of Stephen “Steve” Solomon Papell (1918–2025), working for NASA *Lewis Research Center*, on dilute magnetic dispersion in hydrocarbon was published in 1963. Papell was interested in creating a liquid rocket fuel that could be drawn toward a pump inlet in a weightless environment, by applying a magnetic field. In brief, ferrofluids are liquid colloids in which ferrimagnetic or ferromagnetic nanoparticles are carried by a fluid suspension; Papell had his project patented and publicized in 1965.

The growth of technology needed reductions in the dimensions of devices and active materials. This became dramatically evident in the case of computer technology: the number of transistors used in an integrated circuit has increased in an incredible way so far. In 1965, Gordon Moore, co-founder of Intel observed that the number of transistors per square inch on integrated circuits doubled every year since the integrated circuit was invented and predicted that the trend would continue in a foreseeable future. Actually, by the end of the 1970s and the beginning of the 1980s, the law was modified since it appeared that the number of transistors would double every 24 months. In the following years this pace slowed down and settled around 18 months for doubling the data density. This was the current definition of Moore’s Law which has nowadays slowed down below the predicted pace with a cadence close to two and a half years. The following figure shows the evolution of Moore’s Law from 1970 to 2018 (Fig. I.22).

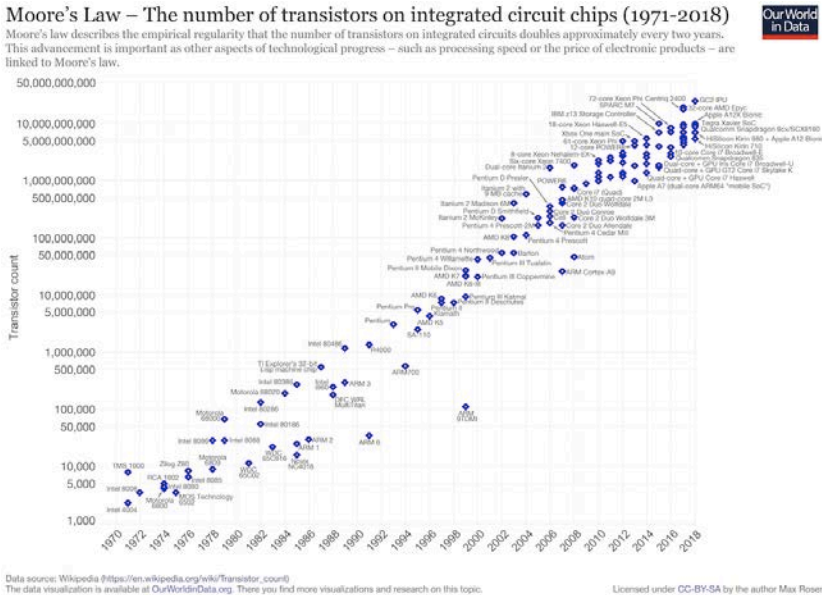

Fig. I.22 Moore’s law from 1971 to 2018. Picture by Max Roser – <https://ourworldindata.org/uploads/2019/05/Transistor-Count-over-time-to-2018.png>. CC BY–SA 4.0

The laws of Classical Mechanics are good to explain most of the phenomena occurring in our macroscopic world. But if we look at smaller things, nanoobjects for example, other effects appear, since those are the dimensions of Quantum Mechanics and confinement of the movements of the electrons is significant. In 1970, Quantum Size Effect (QSE) was observed, i.e. the reduction of the dimensions of the sample, namely a semiconductor, below a certain threshold gives rise to a new electronic structure and new properties are observed. Structures that we will discuss in detail regarding QSE are quantum wells – two-dimensional objects –, nanowires – one-dimensional systems – and quantum dots as zero-dimensional systems.

As we already said before, Norio Taniguchi was, fifteen years after Feynman, the first scientist to use and define the term *Nanotechnology* in 1974. According to Taniguchi, “Nanotechnology mainly consists of the processing of separation, consolidation, and deformation of materials by one atom or one molecule”.

The following years brought innovation in instrumentation.

Curiosity and observation are the keys to making new discoveries and this is especially true about Nanotechnology: when we talk about nano objects, it is impossible to proceed further with the investigation without observing these objects. Observation is made with probes which may consist of photons, electrons, neutrons, atoms, ions or an atomically sharp pin. When investigating nanomaterials, the probing light or particle often possesses varying frequencies ranging from gamma to infrared rays or beyond in the case of photons or hyperthermal (<100eV) to relativistic energies in the case of particles. The information we get can be processed to give images or spectra revealing the physical, geometric, topographic, structural or even chemical details of the material. Several techniques can be applied to characterize matter and study nanostructures in one way or the other.

In 1977 Richard Van Duyne (1945–2019) discovered surface-enhanced Raman spectroscopy, a very promising technique to observe very low concentrations of molecules on nanoparticles and nanostructured surfaces. That technique was the first of the many surface-enhanced spectroscopies now commonly used in several fields such as physics, chemistry or biology. The work of Van Duyne resulted in the transition of new technologies and methodologies – scanning probe microscopy, ultrafast optical spectroscopy, electronic structure calculation or chemical functionalization of nanoparticles – into practical applications.

The year 1981 deserves particular consideration since that year Gerd Binnig and Heinrich Rohrer invented a new type of microscope at IBM *Zurich Research Laboratory*, the Scanning Tunneling Microscope (STM).

The STM uses a sharp tip moving so close to a conductive surface that the electron wave functions of the atoms of the tip overlap with the wave functions of the atoms of the surface (Fig. I.23). When a voltage is applied electrons move from the tip to the surface – or vice versa – because of quantum tunnel effect. In STM the quantum phenomenon of electron tunnelling is applied to obtain an image of the topography of the surface through the principle of vacuum tunnelling. Two surfaces – a tunnelling probe and the surface to be tested – are brought near contact at a small bias voltage. This is why we said that the two wavefunctions can overlap. The developed theory tells us that for the electron wavefunctions at the Fermi level it is possible to calculate a characteristic exponential inverse decay length:

$$K = \sqrt{8m\phi/\hbar} \quad (\text{I.6})$$

where m is the mass of the electron and ϕ the local tunnelling barrier height (or the average work function) of tip and sample. When a small bias voltage V is applied between the tip and the sample, the overlapped electron wavefunction allows the quantum tunnelling effect so that a current I can flow through. It is possible to prove that the tunnelling current decays exponentially in dependence of the distance of separation d between tip and sample according to the formula:

$$I \propto V e^{-2d\sqrt{8m\phi/\hbar}} \quad (\text{I.7})$$

The tunnelling current is a result of the overlap of electronic wavefunctions of the tip and the sample. STM has revolutionized a great number of areas of fundamental science. Among the advantages of STM are its capability to analyse samples down to atomic resolution, to see processes as they are occurring and to perform this when the sample is still in atmospheric conditions. In Nanoscience and Nanotechnology STM has been used in different ways to understand the electronic structure and properties of carbon nanotubes.

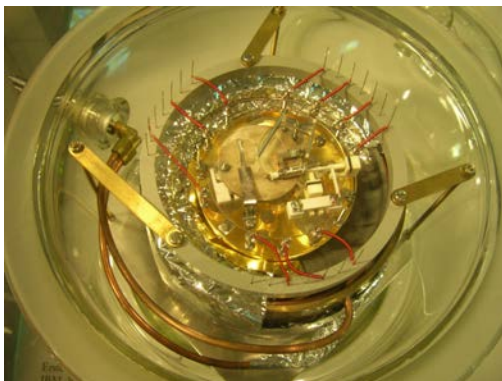

Fig. I.23 The first Scanning Tunneling Microscope, Bonn, Deutsches Museum. Source: J. Brew. <https://www.flickr.com/photos/brewbooks/176058521/in/photostream/> CC BY-SA 2.0

Again in 1981, Alexey Ekimov, a Russian solid-state physicist, discovered semiconductor nanocrystals – as they constitute a sub-class of a broader family of nanoparticles including semiconductor, metal, insulator, organic, ... particles – now known as quantum dots (QDs), particles the size of a few nanometers showing peculiar optical and electronic properties due to quantum effects, different from the same properties of particles of larger size (Fig. I.24). Semiconductor quantum dots are signifying a class of materials in which quantum confinement effects are investigated in greater detail.

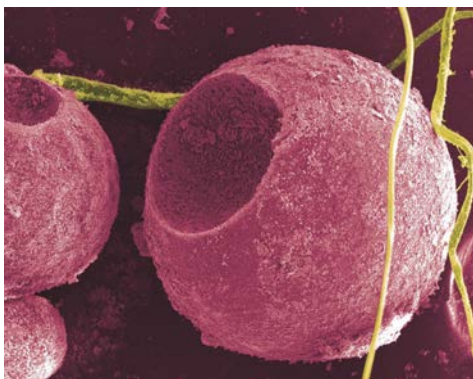

Fig. I.24 Cadmium sulphide quantum dots on cells. Source: Pacific Northwest National Laboratory, US Department of Energy. Public Domain. https://commons.wikimedia.org/wiki/File:Cadmium_sulfide_quantum_dots_on_cells_high_res.jpg

Not least, a scientist of the *Space System Laboratory* at Massachusetts Institute of Technology, K. Eric Drexler published his article *Molecular engineering: An approach to the development of general capabilities for molecular manipulation*. Its abstract is somehow prophetic, especially when Drexler states that:

Development of the ability to design protein molecules will open a path to the fabrication of devices to complex atomic specifications, thus sidestepping obstacles facing conventional microtechnology. This path will involve construction of molecular machinery able to position reactive groups to atomic

precision. It could lead to great advances in computational devices and in the ability to manipulate biological materials. The existence of this path has implications for the present (Drexler 1981).

It had not only implications in his present, but also in our future.

Drexler did not miss the chance to quote himself in 1991 in his Ph.D. thesis *Molecular Machinery and Manufacturing with Applications to Computation*, about another meaning of the word Nanotechnology. In a footnote appearing in the early pages Drexler makes the following considerations.

The term “Nanotechnology” was first introduced into widespread use to refer to what is here termed “molecular Nanotechnology”, but has increasingly been used to refer to the incremental extension of conventional microfabrication techniques into the submicron size range. Accordingly, some recent discussions of the history, status, and prospects of “Nanotechnology” have confused essentially dissimilar concepts, as if “ornithology” were used to describe the study of flying things, thereby stirring birds, balloons and bombers together into a single conceptual muddle (Drexler 1991).

In this quotation it is to be observed that Drexler refers – when mentioning (Drexler 1986) – to his formerly published book *Engines of Creation. The coming Era of Nanotechnology* where he says again:

We can use the terms ‘Nanotechnology’ and ‘molecular technology’ interchangeably to describe the new style of technology. The engineers of the new technology will build both nanocircuits and nanomachines (Drexler 1986).

This paragraph is the one where Drexler uses the word Nanotechnology for the first time in the book.

Robert Curl, Harold Kroto (1939–2016) and Richard Smalley (1943–2005) later discovered a very stable form of carbon with chemical formula C_{60} , that was named buckminsterfullerene – or buckyball (Fig. I.25), it being exactly shaped like an old fashioned white–hexagons and black–pentagons football – after the architect Richard Buckminster Fuller (1895–1983), the first to widely develop geodetic surfaces for structures.

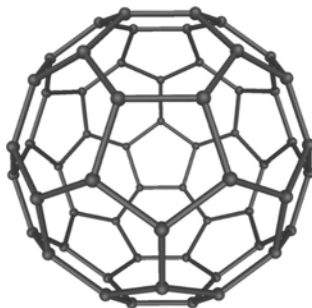

Fig. I.25 Schematic of a C_{60} buckyball–fullerene. Source: Public Domain

The truncated icosahedron – 12 pentagons, 20 hexagons – is the Archimedean solid where carbon atoms are placed, at each vertex, connected one to each other through covalent bonds. The high symmetry of the Archimedean solids is one of the bases of their stability as structures for complex molecules and buckyballs (in our case) pose no exception, for

their stability was mathematically proven working on symmetry only before their discovery and subsequent physical/chemical analysis.

In 1986 Binnig and Rohrer were awarded the Nobel Prize in Physics for their design of the Scanning Tunneling Microscope. In the same year, again Gerd Binnig together with Christoph Gerber and Calvin Quate developed the Atomic Force Microscope (AFM). This new kind of microscopy was a significant improvement, since STM can image conducting or semiconducting surfaces only and AFM can be used on almost every type of surfaces, independently from the conductivity features of the materials, i.e. polymers, ceramics, glass, composites and biological specimens.

In 1990 one of the most famous pictures of the nanoworld was taken, as Donald Eigler and Erhard Schweizer used a STM to manipulate xenon atoms to write the acronym IBM (Fig. I.26). This image of the IBM logo nowadays hangs in a gallery at IBM's Almaden Research centre, where it is titled "The Beginning", quite properly, indeed.

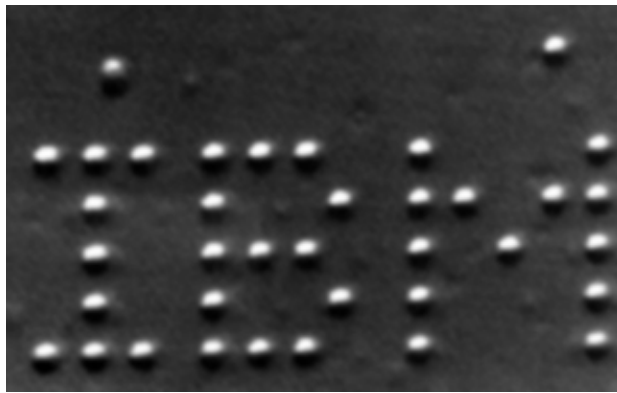

Fig. I.26 Xenon atoms to form IBM logo. Source: IBM Almaden Research Center – Fair use. http://www.foresight.org/UTF/Unbound_LBW/chapt_4.html.

Why have scientists decided to explore matter with electron microscopes, so improving these devices? Was it not possible to do the same with optical instruments? Using electron microscopes means using electrons rather than photons, but optical systems suffer from the so-called diffraction limit. If we try to focus the image of a point with an optical microscope what we get is not the point we are looking for but something that resembles a poorly defined disk at the edges. There is blur in the image, an unwanted effect when we want to observe sharp details of our sample. A healthy human naked eye can commonly resolve two points divided by a distance of one tenth of a millimetre, more or less. Let us suppose that we are observing two points with an optical microscope and the points are far enough apart: any blur will not be important and will not affect the final image as we can see both the points. On the other hand, if both the points are too close and we try to magnify the image it will no longer be possible to tell one point from the other. In 1879, Lord Rayleigh (1842–1919) defined his criterion to resolve two points (actually the minimum separation between two light sources that may be resolved into distinct objects): two point sources are regarded as just resolved when the principal diffraction maximum of one image coincides with the first minimum of the other. If the distance is greater, the two points are well resolved and if it is smaller, they are regarded as not resolved. It is possible to calculate the Airy disk – the

central region of the profile of each diffraction pattern from the peak to the first minimum – using the relation:

$$\theta \approx 1.22 \frac{\lambda}{D} \quad (\text{dimensionless}) \quad (\text{I.8})$$

where θ is the angular radius of the disk, λ the wavelength of light and D the diameter of the aperture.

Diffraction becomes important at the edge of the lenses we are using since the smallest observable distance we can observe on a sample is a distance of the order of a wavelength.

To avoid such optical inconvenience electron microscopy was developed and has been continuously improved to observe much smaller objects zooming in to the nanoworld.

A major breakthrough occurred in 1991, when the Japanese physicist and inventor Sumio Iijima “invented” multi-wall – nested single-wall – carbon nanotubes.

If we imagine stretching a C_{60} buckyball along one axial direction, we can obtain a structure quasi-cylindrical that is called carbon nanotube. The individual carbon nanotube is considered as a tubular and elongated nanostructure which has become a one-dimensional nano object.

Actually, we know that carbon nanotubes had been observed earlier, in 1952, when Radushkevich and Lukyanovic described hollow graphitic fibres approximately 50nm in diameter (Radushkevich and Lukyanovic 1952), but Iijima’s article caused an unprecedented interest in the field of nanotubes and fuelled the research in Nanotechnology. From 1991, almost every year brought an advance in carbon nanotubes research; in 1992 groups of the *Massachusetts Institute of Technology* (MIT), the *U.S. Naval Research Laboratory* (USNRL) and NEC (*Nippon Electric Company, Limited*) Corporation theoretically predicted the properties of these materials. The following year, Donald Bethune and again Sumio Iijima independently discovered how to produce single-wall carbon nanotubes using transition-metal based catalysts.

Single-walled nanotubes are formed by one or more sheets of graphene and, depending on how the graphene sheet/sheets is/are rolled up it is possible to manufacture different structures (see Fig. I.27). Taking some specific words from organic chemistry, the way hexagons are oriented along the main axis define what we call chiral or achiral/non-chiral nanotubes. They will be chiral if they cannot be superposed to their mirror images, achiral/not-chiral on the contrary.

It being a chemical/physical feature, chirality defines the electronic properties of nanotubes, for example some nanotubes can behave as semiconductors due to their chirality. Because of their one-dimensionality, they also exhibit an aspect ratio defined as the ratio between their length and diameter; as the length is way larger than the diameter, directional properties can be measured. Metallic nanotubes prove to possess a very good electrical conductivity.

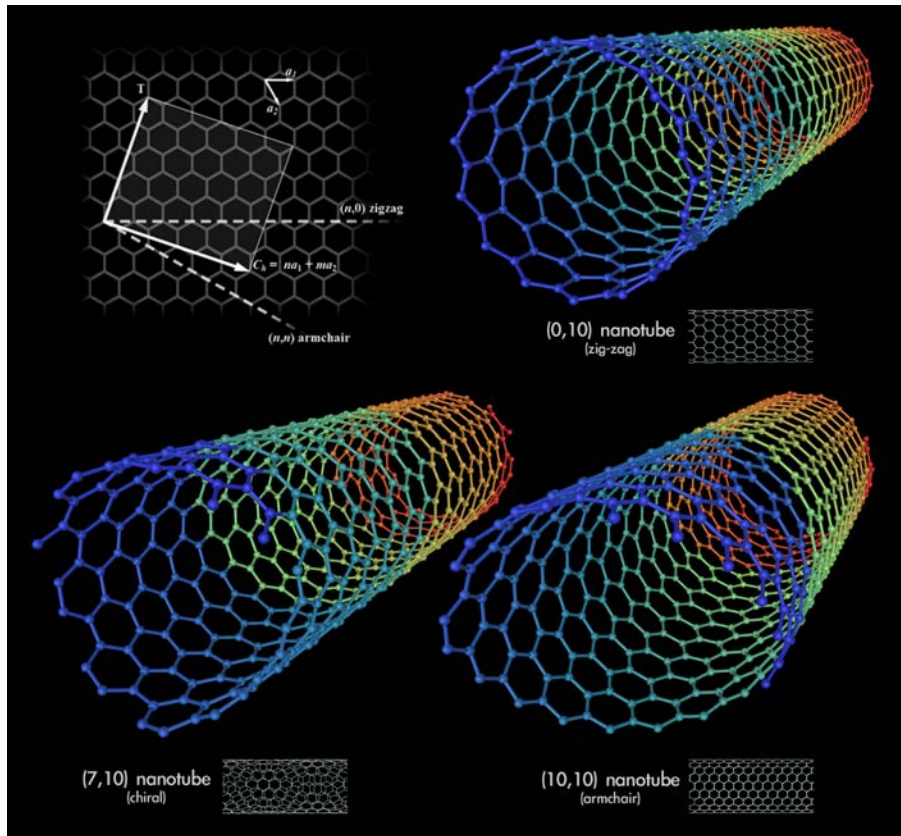

Fig. I.27 Types of Carbon Nanotubes. Source: Michael Stroeck CC BY-SA 3.0

We shall see that carbon nanotubes are nowadays applied to different areas especially in fields like electronics, energy and health.

In 1995 electron emission properties of carbon nanotubes were proved by Swiss researchers. In 1997 low temperature carbon nanotube single-electron transistor existence was proved in *Delft University* and *UC Berkeley*; the same year, January, Robert Crowley patented his idea of realizing optical antennas using carbon nanotubes, the Ultra Black Absorber. It is a fact to be noted that – again in 1997 – *Zyvex*, the first molecular Nanotechnology company – was founded by James Von Ehr II.

The 2000s saw the interest of Politics in Nanoscience as, in the US, president Clinton announced the U.S. National Nanotechnology Initiative, a federal government program for science, engineering and technological research and development for projects at nanoscale, which president Bush signed into law as the *21st Century Nanotechnology Research and Development Act* in 2003. Nanotechnology research became a priority in the USA and the National Nanotechnology Initiative (NNI) was founded afterwards.

In 2004 Andre Geim and Konstantin Novoselov discovered an allotrope form of carbon, the next generation material, graphene (Fig. I.28). For such a discovery both Geim and Novoselov were awarded the Noble Prize in 2010.

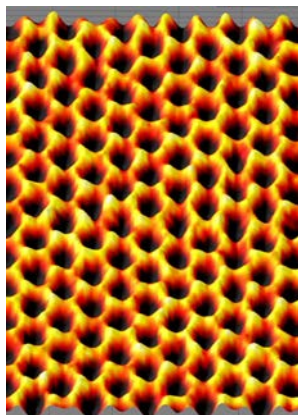

Fig. I.28 Scanning probe microscopy image of graphene. Source: U.S. Army Material Command - <https://www.flickr.com/photos/armymaterielcommand/6795812766>

In 2005 a group headed by Professor James Tour designed a so-called *nanocar* (Fig. I.29) in order to investigate if the wheels, made up with four fullerene balls slide or roll on metal surfaces (actually they roll).

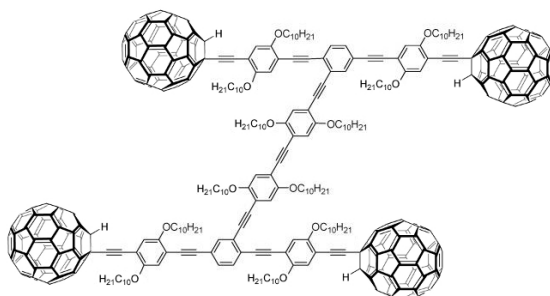

Fig. I.29 The “H-shaped chassis” of a nanocar with four fullerene groups acting as wheels. Source: <https://commons.wikimedia.org/wiki/File:Nanocar2.png#mw-jump-to-license>

In 2009 Nadrian Seeman, the nanotechnologist that in 1982 laid out the conceptual foundations of DNA Nanotechnology achieved the result of making DNA structures fold into 3D rhombohedral crystals. In the 1980s he predicted that “it is possible to generate sequences of oligomeric nucleic acids, which preferentially associate to form migratorially immobile junctions, rather than linear duplexes, as they usually do”.

Design and synthesis of nanomachines granted the Nobel Prize in 2016 to Sauvage, Sir Stoddard and Feringa (Fig. I.30).

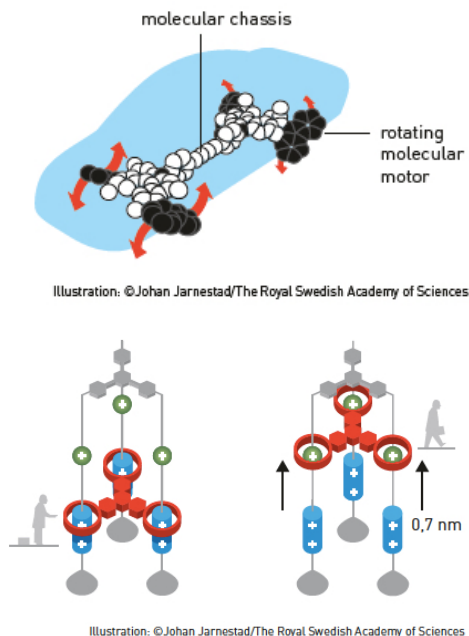

Fig. I.30 Nanocar (left) and Nanoelevator (right). Source: The Royal Swedish Academy of Sciences, <http://www.nobelprize.org/>

In 2018, researchers at the California Institute of Technology decided to literally play at nanoscale; as assistant professor of Bioengineering, Qian, said “We developed a mechanism to program the dynamic interactions between complex DNA nanostructures. Using this mechanism, we created the world's smallest game board for playing tic-tac-toe (Fig. I.31), where every move involves molecular self-reconfiguration for swapping in and out hundreds of DNA strands at once”.

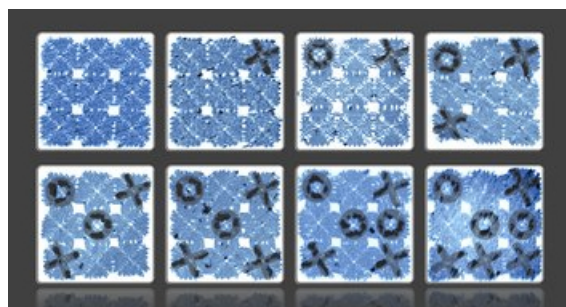

Fig. I.31 The smallest tic-tac-toe ever. Source: Caltech. <https://www.caltech.edu/about/news/researchers-make-worlds-smallest-tic-tac-toe-game-board-dna-84691>

In a few decades nanomaterials and the Nanoscience behind them have become absolutely important and outstanding to industrial applications and medical research. Although the most relevant efforts in Nanoscience appear to be dedicated to biomedicine, cancer treatment and medicine, as nanomedicine seems to offer innovative and non-patient-aggressive alternatives to classic radiotherapy and chemotherapy, recent advances in chemistry, physics and material science have provided new nanomaterials with unique properties.

Today nanomedicines are being developed to have accurate, controllable, reliable, economic and rapid responsive diagnostic and treatment solutions for various kinds of diseases. With advancements in drug discovery processes, stress is on effective drug delivery to the affected organ. It is well known that many therapeutic agents have intracellular compartments as their site of actions. For instance, the nucleus is the centre for anti-cancer intercalating agents whereas cytoplasm is the site of action for a number of steroids. Accordingly, the efficacy of a drug depends on its sustained availability at the targeted point of delivery.

The purpose of biology is to understand how living beings are organized and the way they are *functioning*, if this can be said for live entities. So, why are dimensions important and, in particular, why are tiny dimensions fundamental to understanding a biological phenomenon? There is no single answer since living phenomena are organized on different scales. But among the many ones we can decide to study, protein transport in biological blisters up to 100nm is interesting because it is at the nanoscale and its observation can clarify the situations about the mechanisms.

Biologists say that a cell membrane is nano-organized as we can observe nanoscale dimensioned domains – so called lipid rafts – that can concentrate receptors needed to give the correct biological response to external signals: biology is then to be considered a Nanoscience. Together with the historical description, since Nanotechnology is an interdisciplinary subject, it will be necessary to talk about the mathematical instruments we need to model and study the phenomena at nanometric level. Mathematical and physical notions are important and necessary for theory and applications, and we will see that many results have been achieved applying concepts that are already known such as the equations of Quantum Mechanics or the equations of Continuum Mechanics or particular fields of Finite Element Analysis.

The nanoworld lies on the thin red line dividing the world of classical physics and the world of quantum physics, thus the Schrödinger equation and its applications to Nanotechnology are to be mentioned, especially to quantum dots, as the electron confinement conditions can be considered variable from a 2D quantum well, to a 1D quantum wire to a 0D quantum dot.

Transport processes of carriers in nanostructures are also well described by the Drude-Lorentz model and its variants like the Smith model or the effective medium theories which include the so-called Drude-like models of Maxwell-Garnett and Bruggeman, as we shall see later. These analytical results are of great interest and can be implemented through experimental data retrieved from literature.

Finally, we must consider the interconnections between Nanoscience, Nanotechnology and society in the context of a very fast changing social environment and we cannot look at each of these topics separately. Advances achieved in scientific and technological knowledge lead to changes in social relations and sociological patterns; nowadays the technological changes occur so fast that society can hardly respond immediately to find a new equilibrium. Although scientific discoveries do not necessarily eradicate existing social structures, the applications of Nanoscience and Nanotechnology have been relevant and

proved to have a strong impact on society. Therefore, it is necessary to consider the societal implications of Nanoscience if we want to find – and then understand – the direction in which society is advancing. The potential societal implications of such a scientific and technological innovation need to be explored; both the uniqueness and distinctiveness of Nanoscience and Nanotechnology clearly explain the fact that their impact on almost all the spheres of human life is exceeding those of all other conventional technological innovations.

One of the conceptions that lies at the very heart of modern science concerns science and it being neutral and objective. Historical epistemology teaches us that the criterion of objectivity historically appeared in science at the turn of XIX Century and it is not an intrinsic necessity or a self-evident fact but a real value that was stated and adopted by the scientific community. If we think about neutrality, the idea of a neutral science that never encounters internal moral questions must go together with the concept of the impartial scientist. But is it really so? The basic concept should be *Scientia gratia scientiae*, science for itself, for the good of science starting from impartial points of view with respect to the different interests brought into play in research.

Can objectivity and neutrality be intrinsically logic criteria? Not really. Impartiality and objectivity are values needed for science to operate within society. Too often, though, it is not difficult to spy situations where science is subjugated to economic interests, not caring too much about ethics or the commonwealth.

Is there an ethic of science and is it practiced today? Who makes the most important decisions that will impact on society and the environment?

The first level is occupied by the scientist as such, but it is easy to understand that this cannot be the only decisional stage as, so doing, scientists become the only depositories of knowledge under all the possible points of view.

A further level can be occupied by contractors; as they can fund laboratories and research centres, they can direct scientists from behind the scenes thanks to the power of money they make available. Will they follow an ethical path, or will it just be a matter of business?

Public opinion could intervene in the ethical debate. There are many players on the ground and even more aspects have to be considered because of their impact: effects on customers' health, evident or subtle models proposed to people, the chance to modify a certain vision of the human being.

Today we could state that nobody can think of himself/herself relieved of considering the consequences for the environment, health, human science, politics and social issues of Nanotechnology and its widespread use. This is not only about science in laboratories. All the relevant aspects of anyone's life are implicated by these subjects, and good judgement is not easy since no choice is neutral with respect to science and society.

There are nanoproducts in everyday life, but what is their impact? Should we trust anybody telling us that Nanotechnology is not dangerous, but is it all about advantages, on the contrary, just because they are saying so?

Are they hazardous? Will we be affected in the short or a long term because of exposure to nanosized agents? What if, in the name of health, they are introduced to an organism?

Can they attack, modify, alter our ecosystems?

Some considerations must be made regarding the amounts of money behind this new world. Is Nanotechnology something only for the few that can afford to support research at the highest levels, like big countries or blocks, or is it a chance also for the third/fourth world to emerge? What are the policies regulating the development of Nanoscience, if any?

In 2016 an optimistic forecast was made by Prof. Themis Prodromakis from the University of Southampton. He presented the following assumptions.

The real challenge is using [...] techniques reliably to manufacture working nanoscale devices. The physical properties of matter, such as its melting point, electrical conductivity and chemical reactivity, become very different at the nanoscale, so shrinking a device can affect its performance. If we can master this technology, however, then we have the opportunity to improve not just electronics but all sorts of areas of modern life (Prodromakis 2016. Retrieved via: <https://www.southampton.ac.uk>).

Then he gets back to the idea, formerly premiered by Richard Feynman, of “swallowing the doctor”.

Wearable fitness technology means we can monitor our health by strapping gadgets to ourselves. There are even prototype electronic tattoos that can sense our vital signs. But by scaling down this technology, we could go further by implanting or injecting tiny sensors inside our bodies. This would capture much more detailed information with less hassle to the patient, enabling doctors to personalise their treatment. The possibilities are endless, ranging from monitoring inflammation and post-surgery recovery to more exotic applications whereby electronic devices actually interfere with our body’s signals for controlling organ function. Although these technologies might sound like a thing of the far future, multi-billion healthcare firms [...] are already working on ways to develop so-called “electroceuticals” (*Ibidem*).

Another interesting subject of his is the enthusiastic vision to put sensors almost everywhere.

These sensors rely on newly-invented nanomaterials and manufacturing techniques to make them smaller, more complex and more energy efficient. For example, sensors with very fine features can now be printed in large quantities on flexible rolls of plastic at low cost. This opens up the possibility of placing sensors at lots of points over critical infrastructure to constantly check that everything is running correctly. Bridges, aircraft and even nuclear power plants could benefit (*Ibidem*).

What about people, we could reply? Are they really willing to be under control every moment?

Self-repairing structures are one of the most interesting features mentioned.

If cracks do appear then Nanotechnology could play a further role. Changing the structure of materials at the nanoscale can give them some amazing properties – by giving them a texture that repels water, for example. In the future, Nanotechnology coatings or additives will even have the potential to allow materials to “heal” when damaged or worn. For example, dispersing nanoparticles throughout a material means that they can migrate to fill in any cracks that appear. This could produce self-healing materials for everything from aircraft cockpits to microelectronics, preventing small fractures from turning into large, more problematic cracks (*Ibidem*).

Data storage is one of the most important current problems since the exchange of information is growing up to exabytes. His idea is the following.

All these sensors will produce more information than we’ve ever had to deal with before – so we’ll need the technology to process it and spot the patterns that will alert us to problems. The same will be true if we want to use the “big data” from traffic sensors to help manage congestion and prevent accidents or prevent crime by using statistics to more effectively allocate police resources. Here, Nanotechnology is helping to create ultra-dense memory that will allow us to store this wealth of data. But it’s also providing the inspiration for ultra-efficient algorithms for processing, encrypting and communicating data without compromising its reliability. Nature has several examples of big-data processes efficiently being performed in real-time by tiny structures, such as the parts of the eye and ear that turn external signals into information for the brain. Computer architectures inspired by the brain could also use energy more efficiently and so would struggle less with excess heat – one of the key problems with shrinking electronic devices further (*Ibidem*).

His last consideration is made on environment.

The fight against climate change means we need new ways to generate and use electricity, and Nanotechnology is already playing a role. It has helped create batteries that can store more energy for electric cars and has enabled solar panels to convert more sunlight into electricity. The common trick in both applications is to use nanotexturing or nanomaterials (for example nanowires or carbon nanotubes) that turn a flat surface into a three-dimensional one with a much greater surface area. This means that there is more space for the reactions that enable energy storage or generation to take place, so the devices operate more efficiently in the future. Nanotechnology could also enable objects to harvest energy from their environment. New nano-materials and concepts are currently being developed that show potential for producing energy from movement, light, variations in temperature, glucose and other sources with high conversion efficiency (*Ibidem*).

Nanoscience and its deriving technologies have the potential to improve the state of our world if the applications are designed and tailored to fit the needs at their best. But this must be carefully controlled and always assessed from the perspective of the ethics of research and its applications and will be the final – but not of lesser significance – chapter of this work.

As a conclusion, it is curious today to compare old articles, some dated back to the 1990s with the developments Nanotechnology has achieved today. Once, statements like “only time will tell us if Nanotechnology is something just fashionable, a funny laboratory exercise or if it will grow and how much in our world” were not unusual.

In 2006, Prof. Henry I. Smith shared his idea about the novelties Nanotechnology seems to promise.

Nanotechnology is a field of science and engineering that deals with structures having at least one of their three dimensions less than 100 nanometers (nm). (A nanometer is one billionth of a meter.) We have “living proof” of the importance of nanostructures in that living systems are complex assemblies of nanoscale components: macromolecules, protein complexes, organelles, quasi-inorganic systems (e.g., shells, bones), etc. The marvellous functions performed by living systems (logic, memory, motion, chemical synthesis, energy conversion, even our self-consciousness) are the direct result of nanoscale structural complexity.

The transistors, numbering in the millions, that constitute the chips that drive our computers and cell phones, are clearly nanostructures. Thus, the field of Nanotechnology is extremely broad ranging from molecular biology to electronics and beyond. Although research and development in nanostructures has been going on for decades, and commercial products based on nanostructures have been available for decades, interest in the field has accelerated recently in scientific circles as well as at government agencies and in the investment community.

The growth of interest in nanoscale science and engineering is due to the conjunction of several factors: improved nanofabrication and microscopy techniques; recognition that novel properties become available in synthetic nanostructures; the anticipation that a commercial and societal revolution, similar to that produced by the semiconductor industry, will result from research in Nanotechnology and, finally, increased government funding of nanoscale science and engineering.

History tells us that the fruits of research are impossible to predict. However, history also tells us that certain areas of research can be recognized as highly promising, even at an early stage. This was the case for molecular biology, 30 years ago, and we see that the research efforts begun then are bearing fruit today in improved health care and greater understanding of genetic diseases, to name only 2 impacts.

Similarly, in the early days of computer technology it was clear that investment in computer science research would bear valuable fruit. Yet, none of the early pioneers in computer science anticipated the World-Wide Web. In the early days of research in optical fibres no one anticipated the enormous optical communication network we have today. With the invention of the transistor in 1947 the importance of semiconductor research was widely recognized but no one in their wildest dreams would have envisaged billions of transistors in low-cost personal computers operated by schoolchildren.

So, taking this history of research into account, there is every reason to anticipate that research on Nanotechnology, if intelligently funded and pursued, will bear fruit that fully justifies today's enthusiasm (Smith 2006).

To better understand the number of these problems, and how many discoveries have involved many research fields, I report in the following table I.8 some of the most recent events in the history of Nanotechnology to make the reader understand the scale of the umbrella under which this multidisciplinary branch of science sits.

Table. I.8 Some interesting results year-by-year

1991	New discoveries on Nanotubes
1992	Mesoporous silica
1993	Single-wall Nanotubes and a Nobel Prize
1995	Electron emission from Nanotubes
1996	Gold colloids
1997	The first Nanotech factory and Nanorobots
1998	Carbon Nanotubes transistor
1999	Dip-pen Nanolithography
2000	Quantum mirages
2001	Molecular Nanomachines
2002	Carbon Nanotubes and DNA
2003	Gold Nanoshells
2004	Fluorescent Nanodots
2005	Nanotransistors and Nanocars
2006	DNA origami and medicine
2007	Artificial molecular machines
2008	Memristors and proteins
2009	New Nanorobots
2010	Silicon tips and ultra-fast lithography
2011	New discoveries on polymers
2012	Nanotechnology Signature Initiatives
2013	A Nanotube computer
2016	Molecular machines and another Noble Prize
2018	A DNA tic-tac-toe, shrinking objects to a Nanoscale
2019	The graphene era
2020	Very high concern for carbon nanotubes?
2022	New atom manipulation

II. Expected Impact

As for the impact that I expect from this thesis, I believe several aspects will have to be considered.

From the point of view of physics itself, the reader will find the fundamental concepts of Nanotechnology, together with the basic notions of instrumentation applied in solid state physics. Consequently, I can think that the part most closely related to science may represent a brief summary of the already known concepts on instrumentation and the most used mathematical techniques. The reader will be able to find this information summarized, together with a specific bibliography of the reference texts consulted and others that can be used for further study.

As for the history of physics, I expect this work to be significant for the number of historical events taken into consideration as, at the moment, such a publication does not seem to be available, relative to its size and complexity. Since the history of Nanotechnologies appears very briefly even in the articles dedicated to it, also due to the amount of information that has accumulated in over seventy years, I think that a work that illustrates not only the main events, but also the steps that have connected them over time, can be appreciated. One of the strengths of this thesis lies in the fact that it traces the discoveries and improvements that have characterized this science from its birth to its most recent developments almost year by year. Given information of this magnitude every single discovery cannot be covered, this thesis will certainly be a point of arrival, and at the same time a departure point for further developments in this field. Some topics may be taken up and developed according to the interest of the researcher in the history of Nanotechnology.

When writing a text on the history of science, it is necessary to think that it will not only be addressed to professional scientists or historians, exclusively. There will be several readers in different fields who can be reached in their area of interest. I therefore expect that there will be several areas in which this thesis can be used.

For this reason, I expect it to arouse interest in the field of researchers in the history of science and the history of physics first.

This work does not only concern physics and the history of science, but also deals with the philosophy underlying the concepts of research. For this reason, considering the time interval that is embraced by the historical chapters, I think it will be interesting to follow the evolution of scientific thought itself. It will be of great value to retrace the evolution of the modern philosophy of science linked to this field of research. For this reason, considerations will not be developed solely concerning the progress of the historical process, which starting from good premises leads to valid discoveries, but also on the theory of knowledge.

I expect this work to also have value from the point of view of science teaching. In it ideas addressing different topics and at different levels of study can be found. On one hand, the historical part assumes a relevant importance, and this must not make us forget how fundamental it is to place every single discovery within a precise historical context. It is fundamental to ask ourselves not only how certain results have been achieved, but also the reason for such research. This poses a further problem with regards to research ethics, which is analysed in this thesis. The lawfulness of some aspects of science is a topic that can raise debate and profound considerations, so I expect this thesis to also give rise to further discussions on this topic.

Again, since the history of Nanotechnology is progressing beyond belief, this work certainly is not yet exhaustive, and I expect further insights will branch out from it.

What is the purpose of doing such a substantial work on HNN? Today we know that information, including and above all scientific information, appears online in specialized journals, on websites, in open access publications. These dissemination channels are broadly of two types: those dedicated to specific topics and those that collect publications in a more general way. While acting meritoriously, the former may suffer from the limit of making public only very sectorial articles, the latter (with the aim of publishing new disciplinary developments as quickly as possible) present the events from a purely sequential point of view, and the search for news of interest can be difficult.

Hence the need to systematize historical research in a field whose evolution is extremely rapid, to create a starting point from which to develop other more sectorial paths, in the various fields in which Nanotechnology is articulated. The broad set of fields that make up today's Nanotechnology, as we know it, has taken on a precise historical structure within the thesis that I wanted to write, and such a treatment can only become more and more exhaustive over time, subsequently integrating with those points that will emerge and can be discussed and will make part of further revisions.

Ultimately, I believe that this thesis can serve in the first analysis as a reference text for those who already work in the Nanotechnology field, from the historical point of view. More broadly, it may be of interest to those who look at Nanotechnology from an epistemological, rather than a purely technical, point of view. More broadly still, this work may be useful for those with a general interest in the history of science. Last but not least, those who wish to use it as a text from which to start organizing a historical course, to expand the so-called culture scientifique, will certainly find interesting ideas.

III. The Originality

The originality of this thesis lies in what I believe it is its unicity. So far I haven't found any other work so detailed, almost year by year, on the History of Nanoscience. It has become a real chronicle of the recent history of this not-so-new science, which today, generally speaking, can be considered in its period of greatest flourishing.

As I collected the materials to be studied, I had the chance to read all the chapters or paragraphs dedicated to the history of Nanoscience and Nanotechnology and it clearly appeared that information can be found, at different levels of detail, but nothing specified for every year from 1950 to 2022, or similar shorter timespans.

I believe that one of the most useful tools available, at the outset of a study in History of Science, is the chronological succession of the events analysed in the most accurate detail. This allows the researcher to know who, when, where and why a step was taken to answer to this question: what? As I started working on my subject of research, I looked for something similar already present in literature, but I was able to find only very short summaries of the History of Nanotechnology, and all of them focused on the most common/the same topics that can be abridged the following way (Table I.9).

Table. I.9 The frequency of the most common events in History of Nanotechnology.

Year	Event	Frequency
1960	Publication of “There’s Plenty of Room at the Bottom” from 1959 Feynman’s lecture.	Everywhere
1974	First use of the word “Nanotechnology” by Taniguchi.	Common but not always present
1981	STM microscope.	Everywhere
1985	Discovery of fullerenes by Smalley.	Everywhere
1986	Publication of “Engines of Creation” by Eric Drexler.	Everywhere
1986	AFM microscope	Common
1989	IBM logo with Xenon atoms	Everywhere
1991	First carbon nanotubes by Ijima.	Everywhere
1993	First Nobel Prize for Nanotechnology	Not always present
1993	First “Feynman Prize in Nanotechnology”	Not always present
2000	National Nanotechnology Initiative	Not always present
2007	Graphene characterisation	Not always present

Starting from a rather simple observation of data, such as those that can be recovered in literature, as those collected in the table above, it is easy to realize how a systematic and organized history of Nanoscience is limited to events which, even if extremely significant and fundamental, are presented recursively. They are certainly important, but they cannot be considered exhaustive, if we want to extensively retrace the period that characterized the development of nanotechnologies to the point we know today.

Hence the need to develop a text that contains, within the time allowed for its drafting, a chronologically ordered description of as many events as possible, in order to give the reader the opportunity to retrieve more historical and epistemological information than is possible through all the literature available today.

Another interesting feature is that by the end of the document, I am going to gather the most important moments in HNN, somehow completing the lists I have found so far, merging the information from different sources and including some other topics I evaluated to be remarkable in my discussion. This, because the historical information found in literature is important, but still left to the writer’s choice, so everyone is – obviously – free to include what he/she thinks it is important, also keeping the length of the script in mind. Since this is a work of huge proportions, much space is left for a more complete exposition of the facts.

In the first chapter, for example, I expand those sections of the History of Nanoscience and Nanotechnology that are usually found in the literature, and I deepen the debate on the interpretation of the documents commonly considered founders of the discipline, presenting in this way an element of novelty compared to what is reported in the literature and with respect to the manner in which information is presented.

In the second chapter, again I group together the most important results from a technical and mathematical point of view. Again, such a collection of information in one single text does not yet appear to be available.

The historical chapters collect and supplement what is scattered throughout the literature and present a collection of topics that I have not found in similar publications, such as books or essays.

My research, therefore, is original from this point of view and constitutes a starting point for a further expansion, as it is not yet possible to consider it exhaustive, a characteristic that a historical text can hardly claim to have. This work can be expanded later given further

insights, in new directions, integrating the different chapters with other historiographical ideas and updating the different sections with those innovations in the nanotechnology field that deserve an in–depth evaluation and citation.

The thesis is not only useful to historians, but it is also interesting from a didactic point of view, as it is possible to find food for thought to integrate the explanation of the Nanoworld not only from a strictly technical point of view but also from a historiographical one, involving the reader both in the scientific sphere and in the moment and context in which the discovery was made.

Another interesting point of originality of this thesis comes from the study of the roots of the concepts of Nanoscience and Nanotechnology in the past, before their definitions according to the nowadays known literature, and also from the point of view of Nature of Science perspectives. If the reader is a student, for example, this may provide a different approach to a modern topic in contemporary Physics that helps understanding what is at the basis of the devices that are common today. This work may help the learning–teaching process by bringing together disciplines such as Physics, Mathematics, History and Epistemology, to design a more complete curriculum based upon understanding science. If this thesis is going to be used as a reference text, the logical sequence of teaching will put together the concept and its historical background allowing an advancement in learning for advanced physics classes. Despite the difference of each individual approach to both teaching and learning, such a text will integrate the learning process with different citations and explanations, allowing the reader to find further and complete information needed on this subject.

Today, talking about the history of science is placed within a popular context that is either by one side oriented to a narrative dissemination of ideas, and on the other side dedicated to specific groups of high–level training (such as schools or seminars on History of Physics at an academic level), or it is an approach that remains somewhat relegated to the margins of what we call the higher education. Not only that; the narrative of the history of nanotechnology, as I indicated in the previous table, is based on reporting methodically a limited number of events, according to consolidated interpretations. What I intend to present is a more complete approach that is not only anecdotal, but also based on the possibility of re–reading from different points of view the moments that marked the development of this new science. In my opinion, this thesis can be an opportunity for intellectual enrichment in the history of science and physics, and an opportunity to enrich curricula teaching on the subject.

IV. An Overview of the Thesis Project

Ph.D. Candidate	Dr. Andrea DURLO IEMN, Lille University–CNRS, France
Ph.D. Thesis Title a.y.s 2020/2023	1950–2022: A History of Nanotechnology into Physical and Mathematical Relationship
Ph.D. Advisor	Prof. Dr. Raffaele PISANO, HDR Physicist, Professor of History of Physics, History of Science & Education IEMN, Lille University, France; CPNSS; LSE, UK

Follow-up Ph.D. Committee¹⁷ [Comité de Suivi]	1. Organized by EDSPI, Lille University, France
Ph.D. School	École Doctorale SPI, IEMN, Lille University, France
Area of research	History of Physics, History of Science, History of Nanoscience, History of Nanotechnology, Mathematics, Physics, Epistemology, Science in Society.
Subject	History of Nanoscience and Nanotechnology
Structure	<ol style="list-style-type: none"> 1. The first part – Introduction – concerns the definitions on Nanoscience and Nanotechnology with a short review of the ancient History of Nanotechnology. This introduces the subject to the reader, together with a short description of the works of R.P. Feynman, K.E. Drexler and N. Taniguchi. 2. The second part – Experimental Nanophysics & Mathematical Modelling – describes the instruments used in Nanotechnology and their evolution. The instruments of advanced mathematics are analysed. 3. The third part – A History of Nanotechnology Research – is the most relevant and, in three chapters, it embraces the discoveries made from 1950 to 2022. A chapter on the IEMN is conceived. 4. The fourth part – A History of Nanotechnology & Science in Society – concerns the impact of this science in everyday life and its ethical implications. 5. The fifth part – Concluding Remarks – concludes this discussion, leaving doors open for further interesting research.
Outlines	The study of the History of Nanotechnology in Physics and its implications in History of Science, Epistemology and Science in Society. The investigations of the roots of this discipline and its concepts. My work is about the chronological study of the History of Nanotechnology. The work collects concepts from Physics, Mathematics, History of Science and Epistemology.
General objectives	The overall objective of this work is to study the History of Nanotechnology from 1950 to 2022, from an interdisciplinary point of view (historical, scientific, social, epistemological) and leave a work from which start for further investigations.

¹⁷ The Follow-up Ph.D. Committee is an advisory body whose role is to monitor the progress of the doctoral student's thesis work, including related activities and to detect any scholarly problems or difficulties. In accordance with current French rules and regulations, this committee does not inquire on the content and methodology of the thesis and cannot be part of the final Ph.D. defence jury.

- Specific objectives**
- Order the history of modern Nanotechnology
 - Develop an accurate account on Nanotechnology and its contemporary history, provide a single work where to find, chronologically ordered, the most important events in this Science.
 - Provide a basis of information for further developments.
- Methodology of Research**
- Research and studies based on primary sources and *in situ* when possible.
 Online research, peer-reviewed papers, ...
 Participation in specific meetings and events.
 Discussion with experts.
 Use of the Historical methodology and scientific guidelines
- Expected results**
- Show the importance of History of Science.
 - Recollect the most important facts on the History of Nanotechnology and show the roles of the most important scientists in the field.
 - Evaluate the influence of this discipline in History of Science and Science in Society.
 - Provide a source of information where to start from new research.
 - Recognize of the impact of less-known scientists.
 - Analyse how this multidisciplinary discipline can be presented to non-experts or students at university or high school/secondary school levels.
 - Discuss on the importance and the impact of Nanotechnology on everyday life.
 - Identify the epistemological most important topics and the obstacles that may arise.
- Perspectives**
- Build a synthesis of the events that happened from 1950 to 2022, from the roots of Nanotechnology to the most important actors and discoveries.
 - Identify the theoretical (mathematical and physical), historical and epistemological obstacles in the history of Nanotechnology and how these can be overcome.
 - Evaluate the role of the history of discoveries and its interpretations.
 - Evaluate the interdisciplinarity of this subject and how it is at the core of many discoveries.
 - Publish articles, essays or more important issues.

Type of Reference & Sources

- ✓ Primary and Secondary sources
- ✓ Online sources
- ✓ Academia
- ✓ AAPT – American Association of Physics Teachers
- ✓ AIP publishing
- ✓ American Scientist
- ✓ Archive.org
- ✓ ArXiv.org
- ✓ Britannica
- ✓ Elsevier
- ✓ Gallica.BNF– Bibliothèque Nationale de France
- ✓ Library of Congress
- ✓ NASA – National Aeronautics and Space Administration
- ✓ Nature
- ✓ NewScientist
- ✓ Researchgate.net
- ✓ Science magazine
- ✓ Science Publishing Group
- ✓ Springer
- ✓ Various University Press
- ✓ Wiley Online Library

References

Primary Sources

- Bayda S, Adeel M, Tuccinardi T, Cordani M, Rizzolio F (2020) The History of Nanoscience and Nanotechnology: From Chemical–Physical Applications to Nanomedicine. *Molecules* 25/1:112. doi:10.3390/molecules25010112
- Feynman RP (1960) There’s Plenty of Room at the Bottom. *Engineering and Science* 23/5:22–36
- Radushkevich LV, Lukyanovich VM (1952) The Structure of Carbon Forming in Thermal Decomposition of Carbon Monoxide on an Iron Catalyst. (In Russian) *Russian Journal of Physical Chemistry* 26:88–95.
- Taniguchi N (1974) On the Basic Concept of Nano–Technology. *J–Proceedings of the Japan Society of Precision Engineering, Tokio Science University* 8/2:18–23

Secondary Sources

- Acuna G, Grohmann D, Tinnefeld P (2014) Enhancing Single–Molecule Fluorescence with Nanophotonics. *FEBS Letters* 588/19:3547–3552. Doi:10.1016/j.febslet.2014.06.016
- Armasu L (2019) Samsung Plan Mass Production of 3nm GAAFET Chips in 2021. Saved from: <https://www.tomshardware.com/nesw/samsung-3nm-gaafet-production-2021,38426.html>
- Assefa S, Xia F, Vlasov YA (2010) Reinventing Germanium Avalanche Photodetector for Nanophotonic On–Chip Optical Interconnects. *Nature* 464/7285:80–4. doi:10.1038/nature08813
- AZoNano (2006) Nanoscale Tribology and Lubrication Analysis Using Atomic Force Microscopy. Saved from <https://www.azonano.com/article.aspx?ArticleID=1507>
- Betzig E, Harootunian A, Isaacson M, Kratschmer E (1986) Near Field Scanning Optical Microscopy (NSOM). *Biophysical journal* 49:269–279
- Bhushan B (2001) *Fundamentals of Tribology and Bridging Gap between Macro–and Micro/Nanoscales*. Springer, Dordrecht
- Bussotti P, Pisano R (2013a) On the Conceptual Frames in René Descartes’ Physical Works. *Advances in Historical Studies* 2/3:106–125
- Bussotti P, Pisano R (2014a) Newton’s *Philosophiae Naturalis Principia Mathematica* “Jesuit” Edition: The Tenor of a Huge Work. *Accademia Nazionale Lincei–Rendiconti Matematica e Applicazioni* 25/4:413–444
- Bussotti P, Pisano R (2014b) On the Jesuit Edition of Newton’s *Principia*. *Science and Advanced Researches in the Western Civilization*. In Pisano 2014 3/1:33–55
- Buzea C, Pacheco II, Robbie K (2007) Nanomaterials and nanoparticles: sources and toxicity. *Biointerphases* 2/4:MR17–71. doi:10.1116/1.2815690
- Campbell M (2019) Samsung Plans to Mass Produce of 3nm GAAFET Chips in 2021. Retrieved 26 August 2020 from:
- Carmona ER, García–Rodríguez A, Marcos R (2018) Genotoxicity of Copper and Nickel Nanoparticles in Somati Cells of *Drosophila melanogaster*. *Journal of Toxicology*. Doi:10.1155/2018/7278036
- Cassano D, Poci-Martinez S, Voliani V (2018) Ultrasmall–in–Nano Approach: Enabling the Translation of Metal Nanomaterials to Clinics. *Bioconjugate Chemistry* 29/1:4–16. doi:10.1021/acs.bioconjchem.7b00664
- Cavalcanti A, Shirinzadeh B, Freitas RA, Hogg T (2008) Nanorobot Architecture for Medical Target Identification. *Nanotechnology* 19/1:015103. doi:10.1088/0957–4484/19/01/015103
- Chan WCW (2007) *Bio–Applications of Nanoparticles*. Springer Science, Berlin
- Chiang CK, Fincher CR Jr, Park YW, Heeger AJ, Shirakawa H, Louis EJ, Gau SC, MacDiarmid AG (1977) Electrical Conductivity in Doped Polyacetylene. *Physical Review Letters* 39/17:1098–1101. doi:10.1103/PhysRevLett.39.1098
- Cleri F (2019) Agent–Based Model of Multicellular Tumor Spheroid Evolution Including Cell Metabolism. *The European Physical Journal E* 42/112. doi: 10.1140/epje/i2019–11878–7
- Cleri F, Lampin E, et al. (2017) Thermal Conductivity of Glass GeTe₄ by First–Principles Molecular Dynamics. *Physical Chemistry Chemical Physics* 19:9729–9732. doi:10.1039/C7CP01063J
- Cleri F, et al. (2018) On the Occurrence of Size Effects in the Calculation of Thermal Conductivity by First–Principle Molecular Dynamics: The Case of Glassy GeTe₄. *Journal of Non–Crystalline Solids* 498:190–193. doi: 10.1016/j.jnoncrsol.2018.05.014

- Cleri F, Giordano S, et al. (2020) A Stochastic Force Model for the Ballistic–Diffusive Transition of Heat Conduction. *Physica Scripta* 95/7. doi: 10.1088/1402-4896/ab8d56.
- Cleri F, Lampin E, et al. (2016) Length Dependence of Thermal Conductivity by Approach–to–Equilibrium Molecular Dynamics. *Physical Review B* 94/054303. doi:10.1103/PhysRevB.94.054304
- Cleri F, Lampin E, et al. (2017) Fourier–Like Conduction and Finite One–Dimensional Thermal Conductivity in Long Silicon Nanowires by Approach–to–Equilibrium Molecular Dynamics. *Physical Review B* 95/10:104309. doi:10.1103/PhysRevB.95.104309
- Cleri F, Landuzzi F, Blosser R (2018) Mechanical Evolution of DNA Double–Strand Breaks in the Nucleosome. *PLOS Computational Biology* 14/6:e1006224. doi: 10.1371/journal.pcbi.1006224
- Colinge JP (2008) *FinFETs and Other Multi–Gate Transistors*. Springer Science & Business Media, p.11
- Copie G, Cleri F, Makoudi Y, Krzeminski C, Berthe M, Cherioux F, Palmino F, Grandidier B (2015) Surface–Induced Optimal Packing of Two–Dimensional Molecular Networks. *Physical Review Letters* 114/066101. doi: 10.1103/PhysRevLett.114.066101
- Davari B, Ting CY, Ahn KY, Basavaiah S, Hu CK, Taur Y, Wordeman MR, Aboelfotoh O, Krusin–Elbaum L, Joshi RV, Polcari MR (1987) Submicron Tungsten Gate MOSFET with 10 nm Gate Oxide. 1987 Symposium on VLSI Technology. Digest of Technical Papers
- Delerue C, Lannoo M (2004) *Nanostructures. Theory and Modeling*. Springer, Berlin
- Di Sia P (2019) *Mathematics and Physics for Nanotechnology*. Pan Stanford Publishing, Singapore
- Drexler KE (1986) *Engines of Creation. The Coming Era of Nanotechnology*. Doubleday, New York
- Dufour M, Izquierdo E, Livache C, Martinez B, Silly MG, Pons T, Lhuillier E, Delerue C, Ithurria S (2019) Doping as a Strategy to Tune Color of 2D Colloidal Nanoplatelets. *ACS Applied Materials & Interfaces* 11/10:10128–10134. doi: 10.1021/acsami.8b18650
- Dürig U, Pohl DW, Rohner F (1986) Near–Field Optical Scanning Microscopy. *Journal of Applied Physics* 59/10:3318–3327. doi:10.1063/1.336848
- Durkan C (2019) *Size Really Does Matter – The Nanotechnology Revolution*. World Scientific Publishing Europe Limited., London
- Edwards SA (2006) *The Nanotech Pioneers*. WILEY–VCH Verlag GmbH & Co. KGaA, Weinheim
- Ensikat HJ, Ditsche–Kuru P, Neinhuis C, Barthlott W (2011) Superhydrophobicity in Perfection: the Outstanding Properties of the Lotus Leaf. *Beilstein Journal of Nanotechnology* 2:152–161. doi:10.3762/bjnano.2.19
- Erdely A, Dahm M, Chen BT, Zeidler–Erdely PC, Fernbach JE, Birch ME, Evans DE, Kashon ML, Deddens JA, Hulderman T, Bilgesu SA, Battelli L, Schwegler–Berry D, Leonard HD, McKinney W, Frazer DG, Antonini JM, Porter DW, Castranova V, Schubauer–Berigan MK (2013) Carbon Nanotube Dosimetry: from Workplace Exposure Assessment to Inhalation Toxicology. *Particle and Fibre Toxicology* 10/1:53. doi:10.1186/1743–8977–10–53
- Ferry VE, Munday JN, Atwater HA (2010) Design Considerations for Plasmonic Photovoltaics. *Advanced Materials* 22/43:4794–4808
- Franchina Vergel NA, Post LC, Sciacca D, Berthe M, Vaurette F, Lambert Y, Yarekha D, Troadec D, Coinon C, Fleury G, Patriarche G, Xu T, Desplanque L, Wallart X, Vanmaekelberg D, Delerue C, Grandidier B (2020) Engineering a Robust Flat Band in III–V Semiconductor Heterostructures. *Nano Letters* 12/2020. doi: 10.1021/acs.nanolett.0c04268
- Franchina Vergel NA, Tadjine A, Notot V, Mohr M, Kouassi N’Guissan A, Coinon C, Berthe M, Biadala L, Sossoe KK, Dzagli MM, Girard JC, Rodary G, Desplanque L, Berndt R, Stiévenard D, Wallart X, Delerue C, Grandidier B (2019) Influence of Doping Level and Surface States in Tunneling Spectroscopy of an In_{0.53}Ga_{0.47}As Quantum Well Grown on *p*–type Doped InP(001). *Physical Review Materials* 3/094604. doi:10.1103/PhysRevMaterials.3.094604
- Freitas RA (2005) What is Nanomedicine? 1/1:2–9. doi:10.1016/j.nano.2004.11.003
- Fu Y, Kao WJ (2010) Drug Release Kinetics and Transport Mechanisms of Non–Degradable and Degradable Polymeric Delivery Systems. *Expert Opinion on Drug Delivery* 7/4:429–444. doi:10.1517/17425241003602259
- Geiregat P, Houtepen AJ, Sagar LK, Infante I, Zapata F, Grigel V, Allan G, Delerue C, Van Thourhot D, Hens Z (2018) Continuous–Wave Infrared Optical Gain and Amplified Spontaneous Emission at Ultralow Threshold by Colloidal HgTe Quantum Dots. *Nature Materials* 17:35–42. doi: 10.1038/nmat5000
- Gilder G (1990) *Microcosm: The Quantum Revolution In Economics And Technology*. Simon and Schuster pp.144–5
- Giordano S, Cleri F, Collard D, et al. (2016) Real–time Mechanical Characterization of DNA Degradation Under Therapeutic X–Rays and its Theoretical Modeling. *Microsystems & Nanoengineering* 2/16062. doi:10.1038/micronano.2016.62

- Giordano S, Cleri F, et al. (2012) Theory and Monte Carlo Simulations for the Stretching of Flexible and Semiflexible Single Polymer Chains Under External Fields. *Journal of Chemical Physics* 137/244907. doi:10.1063/1.4772656
- Hall JS (2005) *Nanofuture: What's Next for Nanotechnology*. Prometheus Books, Amherst, New York
- Hasan A, Morshed M, Memic A, Hassan S, Webster TJ, Marei HES (2018) Nanoparticles in Tissue Engineering: Applications, Challenges and Prospects. *International Journal of Nanomedicine* 13:5637–5655. doi:10.2147/IJN.S153758
- Herrera-Basurto R, Simoet BM (2013) Nanometrology. In *Encyclopedia of Analytical Chemistry*. John Wiley and Sons, Ltd New York. doi:10.1002/9780470027318.a9177
- Herrmann IK, Grass RN, Stark WJ (2009) High-Strength Metal Nanomagnets for Diagnostics and Medicine: Carbon Shells allow Long-Term Stability and Reliable Linker Chemistry. *Nanomedicine* 4/7:787–98. doi:10.2217/nmm.09.55
- Herrmann IK, Schlegel A, Graf R, Schumacher CM, Senn N, Hasler M, Gschwind S, Hirt AM, Günther D, Clavien PA, Stark WJ, Beck-Schimmer B (2013a) Nanomagnet-Based Removal of Lead and Digoxin from Living Rats. *Nanoscale* 5/18:8718–23. doi:10.1039/c3nr02468g
- Herrmann IK, Urner M, Graf S, Schumacher CM, Roth-Z'graggen B, Hasler M, Stark WJ, Beck-Schimmer B (2013b) Endotoxin Removal by Magnetic Separation-Based Blood Purification. *Advanced Healthcare Materials* 2/6:829–835. doi:10.1002/adhm.201200358
- Hoet PHM, Brüske-Höfied I, Salata OV (2004) Nanoparticles – Known and Unknown Health Risks. *Journal of Nanobiotechnology* 2/1:12. doi:10.1186/1477-3155-2-12
- Holsapple MP, Farland WH, Landry TD, Monteiro-Riviere NA, Carter JM, Walker NJ, Thomas KV (2005) Research Strategies for Safety Evaluation of Nanomaterials, part II: Toxicological and Safety Evaluation of Nanomaterials, Current Challenges and Data Needs. *Toxicological Sciences* 88/1:12–7. doi:10.1093/toxsci/kfi293
- Hsu SM, Ying CZ (2002) *Nanotribology: Critical Assessment and Research Need*. Kluwer Academic Publishers, Dordrecht.
https://www.overclock3d.net/news/misc_hardware/samsung_plans_to_mass_produce_3nm_gaafet_chips_in_2021/1
- Ignatyev MB (2010) Necessary and Sufficient Conditions of Nanorobot Synthesis. *Doklady Mathematics* 82/1:671–675. doi:10.1134/S1064562410040435
- ISO/TS 80004-1 (2015) *Nanotechnologies – Vocabulary – Part 1: Core Terms*.
<https://www.iso.org/obp/ui/#iso:std:iso:ts:80004:-1:ed-2:v1:en>
- Jaiswal JK, Goldman ER, Mattoussi H, Simon SM (2004) Use of Quantum Dots for Live Cell Imaging. *Nature Methods* 1:73–78. <https://doi.org/10.1038/nmeth1004-73>
- Jazi MA, Kulkarni A, Buhbut Sinai S, Peters JL, Geschiere E, Failla M, Delerue C, Houtepen AJ, Siebels LDA, Vanmaekelbergh D (2019) Room-Temperature Electron Transport in Self-Assembled Sheets of PbSe Nanocrystals with a Honeycomb Nanogeometry. *The Journal of Physical Chemistry* 123:14058–14066. doi:10.1021/acs.jpcc.9b03549
- Juzgado A, Solda A, Ostric A, Criado A, Valenti G, Rapino S (2017) Highly Sensitive Electrochemiluminescence Detection of a Prostate Cancer Biomarker. *Journal of Materials Chemistry B* 5/32:6681–6687. doi:10.1039/c7tb01557g
- Kamal RA, Sanni ML, Kanj MY (2010) System, Method, and Nanorobot to Explore Subterranean Geophysical Formations. United States Patent 9,063,252 B2. Washington DC: USTPO
- Kang JH, Super M, Yung CW, Cooper RM, Domansky K, Graveline AR, Mammoto T, Berthet JB, Tobin H, Cartwright MJ, Watters AL, Rottman M, Waterhouse A, Mammoto A, Gamini N, Rodas MJ, Kole A, Jiang A, Valentin TM, Diaz A, Takahashi K, Ingber DE (2014) An Extracorporeal Blood-Cleansing Device for Sepsis Therapy. *Nature Medicine* 20/10:1211–6. doi:10.1038/nm.3640
- Karlsson S, Albertsson AC (1995) *Degradable Polymers: Principles and Applications*. Chapman & Hall, London
- Kuhn K (2018) CMOS and Beyond CMOS: Scaling Challenges. In *High Mobility Materials for CMOS Applications*. Woodhead Publishing, Sawston
- Kuhn T (1962) *The Structure of Scientific Revolutions, Second Edition, Enlarged*. The University of Chicago Press
- Lalwani G, Henslee AM, Farshid B, Lin L, Kasper FK, Qin YX, Mikos AG, Sitharaman B (2013) Two-Dimensional Nanostructure-Reinforced Biodegradable Polymeric Nanocomposites for Bone Tissue Engineering. *Biomacromolecules* 14/3:900–9. doi:10.1021/bm301995s
- Lalwani G, Henslee AM, Farshid B, Parmar P, Lin L, Qin YX, Kurtis Kasper F, Mikos AG, Sitharaman B (2013) Tungsten Disulphide Nanotubes Reinforced Biodegradable Polymers for Bone Tissue Engineering. *Acta Biomaterialia* 9/9:8365–73. doi:10.1016/j.actbio.2013.05.018

- Lampin E, Cleri F, et al. (2013) Thermal Conductivity from Approach-to-Equilibrium Molecular Dynamics. *Journal of Applied Physics* 114/033525. doi: 10.1063/1.4815945
- Lampin E, Cleri F, et al. (2018) Interface Thermal Behavior in Nanomaterials by Thermal Grating Relaxation. *International Journal of Heat and Mass Transfer*. Retrieved December 15 2020 from <https://arxiv.org/abs/1805.12086>
- Lampin E, Nguyen QH, Francioso PA, Cleri F (2012) Thermal Boundary Resistance at Silicon-Silica Interfaces by Molecular Dynamics Simulations. *Applied Physics Letters* 100/131906. doi:10.1063/1.3698325
- Larese Filon F, Bello D, Cherrie JW, Sleenwenhoek A, Spaan S, Brouwer DH (2016) Occupational Dermal Exposure to Nanoparticles and Nano-Enabled Products: Part I-Factors Affecting Skin Absorption. *International Journal of Hygiene and Environmental Health* 219/6/8:536-544
- LaVan DA, McGuire T, Langer R (2003) Small-Scale Systems for *in vivo* Drug Delivery. *Nature Biotechnology* 21/10:1184-91. doi:10.1038/nbt876
- Lee H, Yu, LE, Ryu SW, Han JW, Jeon K, Jang DY, Kim KH, Lee J, Kim JH, Jeon S, Lee G, Oh J, Park Y, Bae W, Lee H, Yang J, Yoo J, Kim S Choi YK (2006) Sub-5nm All-Around Gate FinFET for Ultimate Scaling. 2006 Symposium on VLSI Technology. 2006 Digest of Technical Papers
- Lee JJ, Jeong KJ, Hashimoto M, Kwon AH, Rwei A, Shankarappa SA, Tsui JH, Kohane DS (2014) Synthetic Ligand-Coated Magnetic Nanoparticles for Microfluidic Bacterial Separation from Blood. *Nano Letters* 14/1:1-5. doi:10.1021/nl3047305
- Lewis DD (1990) *Biodegradable Polymers as Drug Delivery Systems*. Marcel Dekker, New York
- Mahmoudi M, Hofmann H, Rothen-Ruitshauer B, Petri-Fink A (2012) Assessing the *in vitro* and *in vivo* Toxicity of Superparamagnetic Iron Oxide Nanoparticles. *Chemical Reviews* 112/4:2323-38. doi:10.1021/cr2002596
- Mansoori GA (2017) *An Introduction to Nanoscience & Nanotechnology, in Nanoscience and Plant-Soil Systems*. Springer Soil Biology Series, Switzerland. doi:10.1007/978-3-319-46835-8
- Mattoni A, Colombo L, Cleri F (2005) Atomic Scale Origin of Crack Resistance in Brittle Fracture. *Physical Review Letters* 95/115501. doi:10.1103/PhysRevLett.95.115501
- Miller-Keane Encyclopedia and Dictionary of Medicine, Nursing and Allied Health, Seventh Edition 2003. Retrieved August 23 2020 from <https://medical-dictionary.thefreedictionary.com/carcinogenicity>
- National Council on Radiation Protection and Measurements (2017) *Radiation Safety Aspects of Nanotechnology*. <http://www.ncrppublications.org/Reports/176>
- National Nanotechnology Initiative (2020) *What It Is and How It Works*. <https://www.nano.gov/nanotech-101/what> Retrieved 02 April 2020
- Neinhuis C, Barthlott W (1997) Characterization and Distribution of Water-Repellent, Self-Cleaning Plant Surfaces. *Annals of Botany* 79:667-677
- Nel A, Xia T, Mädler L, Li N (2006) Toxic Potential of Materials at the Nanolevel. *Science* 311/5761:622-7. doi:10.1126/science.1114397
- NIOSH (2009) *Managing the Health and Safety Concerns Associated with Engineered Nanomaterials*. 125:11-12. Retrieved August 24 2020 from <https://www.cdc.gov/niosh/docs/2009-125>
- NIOSH (2013) *Current Intelligent Bulletin 65: Occupational Exposure to Carbon Nanotubes and Nanofibers*. pp.v-ix:33-35,63-64
- NIOSH (2013) *Current Strategies for Engineering Controls in Nanomaterial Production and Downstream Handling Process*. Retrieved August 23 2020 from https://en.wikisource.org/wiki/Current_Strategies_for_Engineering_Controls_in_Nanomaterial_Production_and_Downstream_Handling_Processes
- Oberdörster G, Maynard A, Donaldson K, Castranova V, Fitzpatrick J, Ausman K, Carter J, Karn B, Kreyling W (2005) Principles for Characterizing the Potential Human Health Effects from Exposure to Nanomaterials: Elements of a Screening Strategy. *Particle and Fiber Toxicology* 2/8. doi:10.1186/1743-8977-2-8
- Oberdörster G, Oberdörster E, Oberdörster J (2005) Nanotoxicology: an Emerging Discipline Evolving from Studies of Ultrafine Particles. *Environmental Health Perspectives* 113/7:823-39. doi:10.1289/ehp.7339
- Pan L, Park Y, Xiong Y, Ulin-Avila E, Wang Y, Zeng L, Xiong S, Rho J, Sun C, Bogy DB, Zhang X (2011) Maskless Plasmonic Lithography at 22nm Resolution. *Scientific Reports* 1:175. doi:10.1038/srep00175
- Pasa AA (2010) Chapter 13: Metal Nanolayer-Base Transistor. *Handbook of Nanophysics: Nanoelectronics and Nanophotonics*, pp.13-1, 13-4. CRC Press, Boca Raton
- Pisano R (2008) A history of chemistry à la Koyré? Introduction and setting of an epistemological problem. *Khimiya* 2/17:143-161

- Pisano R (2009) On method in Galileo Galilei's mechanics. In Hunger H (ed.), *Proceedings of 3rd Congress of the European Society for the History of Science*. The Austrian Academy of Science, Vienna, pp. 174–186
- Pisano R (2011) Physics–Mathematics Relationship. Historical and Epistemological notes. In Barbin E, Kronfellner M and Tzanakis C (eds.), *Proceedings of the ESU 6 European Summer University History And Epistemology in Mathematics*. Verlag Holzhausen GmbH–Holzhausen Publishing Ltd., Vienna, pp. 457–472
- Pisano R (2013) History Reflections on Physics Mathematics Relationship in Electromagnetic Theory. In Barbin and Pisano 2013, pp. 31–58
- Pisano R (2014) (ed.) *Isaac Newton and his Scientific Heritage: New Studies in the History and Historical Epistemology of Science*. Special Issue. *Advances in Historical Studies* 3/3
- Pisano R (2016a) What kind of Mathematics in Leonardo da Vinci and Luca Pacioli? *Bulletin–British Society for the History of Mathematics* 31:104–111
- Pisano R (2016b) A Development of the Principle of Virtual Laws and its Framework in Lazare Carnot's Mechanics as Manifest Relationship between Physics and Mathematics. *Transversal–International Journal for Historiography of Science*, in press.
- Pisano R (2020) A Tale of Tartaglia's *Libro Sesto* & Gionta in *Quesiti et Inventioni diverse (1546-1554)*. Exploring the Historical and Cultural Foundations. *Foundations of Science (Springer)* 25/2:477–505
- Pisano R, Anakkar A, Pellergrino E, Nagels M (2019) Thermodynamic Foundations of Physical Chemistry. Reversible Processes and Thermal Equilibrium into History. *Foundations of Chemistry (Springer)* 21:297–323. <https://link.springer.com/journal/10698>
- Pisano R, Bussotti P (2012) Galileo and Kepler: On *Theoremata Circa Centrum Gravitatis Solidorum* and *Mysterium Cosmographicum*. *History Research* 2/2:110–145
- Pisano R, Bussotti P (2013) Notes on the Concept of Force in Kepler. In Pisano, Capecchi and Lukešová 2013, pp. 337–344
- Pisano R, Bussotti P (2014a) Galileo in Padua: architecture, fortifications, mathematics and “practical” science. *Lettera Matematica Pristem International* 2/4:209–221
- Pisano R, Bussotti P (2014b). Historical and Philosophical Reflections on the Culture of Machines around the Renaissance. How Science and Technique Work? *Acta Baltica Historiae et Philosophiae Scientiarum* 2/2:20–42
- Pisano R, Bussotti P (2015a) Historical and Philosophical Reflections on the Culture of Machines around the Renaissance: Machines, Machineries and Perpetual Motion. *Acta Baltica Historiae et Philosophiae Scientiarum* 3/1:69–87
- Pisano R, Bussotti P (2015b) Introduction to Exploring Changes in How the Histories of the Exact Sciences from the 18th to through the 20th Century Have Been Written: Interpreting the Dynamics of Change in these Sciences and Interrelations Amongst Them—Past Problems, Future Cures? *Advances in Historical Studies Special Issue* 4/2:65–67
- Pisano R, Bussotti P (2016) A Newtonian Tale Details on Notes and Proofs in Geneva Edition of Newton's *Principia*. *Bulletin–British Society for the History of Mathematics* 32:1–19
- Pisano R, Bussotti P (2020) Historical and Foundational Details on the Method of Infinite Descent: Every Prime Number of the Form $4n+1$ is the Sum of Two Squares. (with Paolo Bussotti, Udine University, Italy). *Foundations of Science (Springer)*, 1:1–32
- Pisano R, Capecchi D (2013) Conceptual and Mathematical Structures of Mechanical Science in the Western Civilization around 18th Century. *Almagest* 4/2:86–121
- Pisano R, Capecchi D (2015) Tartaglia's science weights. *Mechanics in sixteenth century*. Selection from *Quesiti et invention diverse: Books VII–VIII*. Dordrecht, Springer
- Pisano R, Capecchi D, Lukešová A (eds.) (2013) *Physics, Astronomy and Engineering. Critical Problems in the History of Science*. International 32nd Congress for The SISFA–Italian Society of Historians of Physics and Astronomy. The Scientia Socialis UAB & Scientific Methodical Centre Scientia Educologica Press, Šiauliai University, Lithuania
- Pisano R, Fichant M, Bussotti P, Oliveira ARE (2017) (eds.) *Leibniz and the Dialogue between Sciences, Philosophy and Engineering, 1646–2016*. New Historical and Epistemological Insights. The College Publications, London, in press
- Pisano R, Gaudiello I (2009a) Continuity and discontinuity. An epistemological inquiry based on the use of categories in history of science. *Organon* 41:245–265
- Pisano R, Gaudiello I (2009b) On categories and scientific approach in historical discourse. In Hunger H (ed.) *Proceedings of ESHS 3rd conference*. The Austrian Academy of Science, Vienna, pp. 187–197

- Pisano R, et al. (2020) Introduction. Joule's Bicentenary: History of Science, Foundations and Nature of Science. Foundations of Science. Springer, Cham. <https://doi.org/10.1007/s10699-020-09680-2>
- Pisano R, Sozzo S (2020) A Unified Theory of Human Judgements and Decision-making under Uncertainty. *Entropy*. Special Issue. Khrennikov A, Bagarello F (eds). *Quantum Models of Cognition and Decision-Making* 22/7:1–34. <https://www.mdpi.com/1099-4300/22/7/738>
- Pisano R, Dolenc K, Ploj-Vrtič M (2020) Historical Foundations of Physics & Applied Technology as Dynamic Frameworks in Pre-Service STEM. *Foundations of Science*. doi:10.1007/s10699-020-09662-4
- Pohl DW (2000) Near Field Optics Seen as an Antenna Problem. *Near Field Optics: Principles and Applications/The Second Asia-Pacific Workshop on Near Field Optics* pp-9–21 World Scientific, Singapore
- Pohl DW, Denk W, Lanz M (1984) Optical Sthetoscropy: Image Recording with Resolution $\lambda/20$. *Applied Physics Letters* 44/7:651-653. doi: 10.1063/1.94865
- Postma HWC, Teepen T, Yao Z, Grifoni M, Dekker C (2001) Carbon Nanotube Single-Electron Transistors at Room Temperature. *Science* 293/5527:76–79. doi:10.1126/science.1061797
- Powers KW, Brown SC, Krishna VB, Wasdo SC, Moudgil BM, Roberts SM (2006) Research Strategies for Safety Evaluation of Nanomaterials. Part VI. Characterization of Nanoscale Particles for Toxicological Evaluation. *Toxicological Sciences* 90/2:296–303. doi:10.1093/toxsci/kfj099
- Powers KW, Palazuelos M, Moudgil BM, Roberts SM (2007) Characterization of the Size, Shape, and State of Dispersion of Nanoparticles for Toxicological Studies. *Nanotoxicology* 1/1:42–51. doi:10.1080/17435390701314902
- Pradeep T (2008) *Nano: The Essentials. Understanding Nanoscience and Nanotechnology*. The McGraw-Hill Companies, Inc., New York
- Prasher RS, Hu XJ, Chalopin Y, Mingo N, Lofgreen K, Volz S, Cleri F, Keblinski P (2009) Turning Carbon Nanotubes from Exceptional Heat Conductors into Insulators. *Physical Review Letters* 102/105901. doi:10.1103/PhysRevLett.102.105901
- Prodromakis T (2016) Five ways Nanotechnology is Securing your Future. Retrieved July 07 2020 from <https://www.southampton.ac.uk/news/2016/03/themis-Nanotechnology-article.page>
- Ranganathan R, Madanmohan S, Kesavan A, Baskar G, Krishnamoorthy YR, Santosham R, Ponraju D, Rayala SK, Venkatraman G (2012) Nanomedicine: Towards Development of Patient-Friendly Drug-Delivery Systems for Oncological Applications. *International Journal of Nanomedicine* 7:1043–60
- Rauscher H, Mech A, Gibson N, Gilliland D, Held A, Kestens V, Koeber R, Lisinger TPJ, Stefaniak EA (2019) Identification of Nanomaterials through Measurements. Publication Office of the European Union, Luxembourg
- Sah CT, Wanlass F (1963) Nanowatt Logic using Field-Effect Metal-Oxide Semiconductor Triodes. *IEEE International Solid-State Circuits Conference. Digest of Technical Papers*. VI:32–33
- Santi M, Mapanao AK, Cassano D, Vlamidis Y, Cappello V, Voliani V (2020) Endogenously-Activated Ultrasmall-in-Nano Therapeutics: Assessment on 3D Head and Neck Squamous Cell Carcinomas. *Cancers* 12/5:1063. doi:10.3390/cancers12051063
- Scheunert G, Cohen SR, Kullock R, McCarron R, Rechev K, Kaplan-Asnhiri I, Bitton O, Dawson P, Hecht B, Oron D (2017) Grazing-Incidence Optical Magnetic Recording with Super-Resolution. *Beilstein Journal of Nanotechnology* 8:28–37. doi:10.3762/bjnano.8.4
- Schrand AM, Rahman MF, Hussain SM, Schlager JJ, Smith DA, Syed AF (2010) Metal-based Nanoparticles and their Toxicity Assessment. *Wiley Interdisciplinary Reviews: Nanomedicine and Nanobiotechnology* 2/5:544–568. doi:10.1002/wnan.103
- Schumacher CM, Hermann IK, Bubenhofer SB, Gschwind S, Hirt A, Beck-Schimmer B, Günther D, Stark WJ (2013) Quantitative Recovery of Magnetic Nanoparticles from Flowing Blood: Trace Analysis and the Role of Magnetization. *Advanced Functional Materials* 23/39:4888–4896. doi:10.1002/adfm.201300696
- Seabra AB, Durán N (2015) Nanotoxicology of Metal Oxide Nanoparticles. *Metals* 5/2:934–975. doi:10.3390/met5020934
- Semiconductor History Museum of Japan (2019) 1978:Double-Well Fast CMOS SRAM. Version 2019/1/23. Retrieved 27 August 2020
- Sharon M (2019) *History of Nanotechnology. From Prehistoric to Modern Times*. Beverly, Scrivener Publishing, Wiley
- Sherrington I, Rowe WB, Wood RJK (2002) *Total Tribology: Towards an Integrated Approach*. Professional Engineering Publishing Ltd, United Kingdom
- Sierra DP, Weir NA, Jones JF (2005) A Review of Research in the Field of Nanorobotics. U.S. Department of Energy – Office of Scientific and Technical Information Oak Ridge. doi:10.2172/875622

- Singh PR, Blossey R, Cleri F (2013) Structure and Mechanical Characterization of DNA i-Motif Nanowires by Molecular Dynamics Simulation. *Biophysical Journal* 105:2820–2831. doi: 10.1016/j.bpj.2013.10.021
- SK Hynix (2010) History: 2010s. <https://www.skhynix.com/eng/about/history2010.jsp>. Retrieved 28 August 2020
- Smith HI (2006) The Promise of Nanotechnology. In: *NANOTECHNOLOGY. The Industrial Revolution of the 21st Century*. Fundación de la Innovación Bankinter. Madrid. Spain
- Sonin D, Pochaeva E, Zhuravskii S, Postnov V, Korolev D, Vasina L, Kostina D, Mukhametdinova D, Zelinskaya I, Skorik Y, Naumysheva E, Malashicheva A, Somov P, Istomina M, Rubanova N, Aleksandrov I, Vasyutina M, Galagudza M (2020) Biological Safety and Biodistribution of Chitosan Nanoparticles. *Nanomaterials* 10/4/810. doi:10.3390/nano10040810
- Sun Y, Myers BT, Xia Y (2002) Template-Engaged Replacement Reactions: A One-Step Approach to the Large-Scale Synthesis of Metal Nanostructures with Hollow Interiors. *Nano Letters* 2/5:481–485
- Sydney Morning Herald (2003) Power from blood could lead to human batteries. <https://www.smh.com.au/articles/2003/08/03/1059849278131>. Retrieved 29 August 2020
- Sze SS (2002) *Semiconductor Devices: Physics and Technology*. John Wiley & Sons, New York
- Tadias Magazine (2010) Research Discovery By Ethiopian Scientist At IBM. Tadias Magazine. <http://www.tadias.com/index.php?s=research+discovery+by+ethiopian+scientist+at+ibm>. Retrieved 29 August 2020
- Themistoklis Sidiropoulos PH, Röder R, Geburt S, Hess O, Maier SA, Ronning C, Oulton RF (2014) Ultrafast Plasmonic Nanowire Lasers near the Surface Plasmon Frequency. *Nature Physics* 10/11:870–876. doi:10.1038/nphys3103
- Tian B, Zheng X, Kempa TJ, Fang Y, Yu N, Yu G, Huang J, Lieber CM (2007) Coaxial Silicon Nanowires as Solar Cells and Nanoelectronic Power Sources. *Nature* 449/7164:885–889. doi:10.1038/nature06181
- Tian Y, Pesika N, Zeng H, Rosenberg K, Zhao B, McGuiggan P, Autumn K, Israelachvili J (2006) Adhesion and Friction in Gecko Toe Attachment and Detachment. *Proceedings of the National Academy of Science of the United States of America* 103/51:19320–19325. doi:10.1073/pnas.0608841103
- TSMC Taiwan Semiconductor Manufacturing Company Limited (2019) 5nm Technology. https://www.tsmc.com/english/dedicatedFoundry/technology/logic.htm#1_5nm_technology. Retrieved 28 August 2020
- Valenti G, Rampazzo E, Bonacchi S, Petrizza L, Marcaccio M, Montalti M, Prodi L, Paolucci F. (2016) 2+ Core-Shell Silica Nanoparticles. *Journal of the American Chemical Society* 138/49:15935–15942. doi:10.1021/jacs.6b08239
- Viero Y, Copie G, Guérin D, Krzeminski C, Vuillaume D, Lenfant S, Cleri F (2015) High Conductance Ratio in Molecular Optical Switching of Functionalized Nanoparticles Self-Assembled Nanodevices. *Journal of Physical Chemistry C* 119/36:21173–21183. doi: 10.1021/acs.jpcc.5b05839
- Von Hippel AR (1956) Molecular Engineering. *Science* 123/3191:315–317. doi:10.1126/science.123.3191.315
- Wagner V, Dullaart A, Bock AK, Zweck A (2006) The Emerging Nanomedicine Landscape. *Nature Biotechnology* 24/10:1211–7. doi:10.1038/nbt1006-1211
- Whatmore RW (2006) Nanotechnology—What is it? Should we be worried? *Occupational Medicine* 56:295–299. doi:10.1093/occmed/kql050
- Wu P, Yan XP (2013) Doped Quantum Dots for Chemio/Biosensing and Bioimaging. *Chemical Society Reviews* 42/12:5489–521. doi:10.1039/c3cs60017c
- Xiang J, Lu W, Hu Y, Wu Y, Yan H, Lieber CM (2006) Ge/Si Nanowire Heterostructures as High Performance Field-Effect Transistors. *Nature* 441/7092:489–493. doi:10.1038/nature04796
- Yung CW, Fiering J, Mueller AJ, Ingber DE (2009) Micromagnetic-Microfluidic Blood Cleansing Device. *Lab on a Chip* 9/9:1171–7. doi:10.1039/b816986a
- Zaibaq NG, Pollard AC, Collins MJ, Pisaneschi F, Pagel MD, Wilson LJ (2020) Evaluation of the Biodistribution of Serinolamide-Derivatized C₆₀ Fullerene. *Nanomaterials* 10/1/143. doi:10.3390/nano10010143
- Zhang J, Bingqing Y, Cjao H, Yuanyuan H (2020) Urease Immobilized Magnetic Graphene Oxide as Safe and Effective Urea Removal Recyclable Nano-catalyst for Blood Purification. *Industrial & Engineering Chemistry Research* 59/19:8955–8964. doi:10.1021/acs.iecr.0c00302
- Zhang R, Zhang Y, Dong ZC, Jiang S, Zhang C, Chen LG, Zhang L, Liao Y, Aizpurua J, Luo Y, Yang JL, Hou JG (2013) Chemical Mapping of a Single Molecule by Plasmon-Enhanced Raman Scattering. *Nature* 498/7452:82–86. doi:10.1038/nature12151

Zheng G, Patolsky F, Cui Y, Wang WU, Lieber CM (2005) Multiplexed Electrical Detection of Cancer Markers with Nanowire Sensor Arrays. *Nature Biotechnology* 23/10:1294–301. doi:10.1038/nbt1138

Selected Additional References on the Subject Suggested for Further Readings

- Amabilino DB, Stoddard JF, Williams DJ (1994) From Solid-State Structures and Superstructures to Self-Assembly Processes. *Chemistry of Materials* 6:1159–1167
- Amato I (1999) *Nanotechnology: Shaping the World Atom by Atom*. Washington, DC: National Science & Technology Council
- Appenzeller T (1991) The Man Who Dared to Think Small. *Science* 254:1300–01. doi:10.1126/science.254.5036.1300
- Baird D, Shew A (2003) *The Mythology of Nanotechnology: Changing the Epistemology of Science*. Unpublished paper
- Becker RS, Golovchenko JA, Swarzenruber BS (1987) Atomic-scale Surface Modifications Using a Tunneling Microscope. *Nature* 325:419–421. doi:10.1038/325419a0
- Berube D (2004) Denialism: Drexler vs. Roco. *IEEE Technology and Society Magazine* Winter 2004:22–26
- Binnig G (1990) Atomic Force Microscope and Method for Imaging Surfaces with Atomic Resolution. United States Patent RE33,387. Washington DC: USPTO
- Binnig G, Rohrer H, Gerber C, Weibel E (1983) 7X7 Reconstruction on Si(111) Resolved in Real Space. *Physical Review Letters* 50/2:120–123. doi:10.1103/PhysRevLett.50.120
- Binnig G, Gerber C, Rohrer H, Wiebel E (1985) Nano-Aperture. *IBM Technical Disclosure Bulletin* 27/8:4893
- Binnig G, Quate CF, Gerber C (1986) Atomic Force Microscope. *Physical Review Letters* 56/9:930–933. doi:10.1103/PhysRevLett.56.930
- Binnig G, Rohrer H (1982) Scanning Tunneling Microscope. United States Patent 4,343,993. Washington DC: USPTO
- Binnig G, Rohrer H (1984) Scanning Tunneling Microscopy. *Physica* 125B:37–95
- Binnig G, Rohrer H (1985) The Scanning Tunneling Microscope. *Scientific American* August, pp.50–56
- Binnig G, Rohrer H (1986) Scanning Tunneling Microscopy. *IBM Journal of Research & Development* 30/4:355–369
- Binnig G, Rohrer H (1987) Scanning Tunneling Microscopy – From Birth to Adolescence. *Reviews of Modern Physics*, Part 1 59/3:615–625. doi:10.1103/RevModPhys.59.615.
- Brannigan A (1979) The Reification of Mendel. *Social Studies of Science* 9:423–454. doi:10.1177/030631277900900403
- Brown LM (2000) *Selected Papers of Richard Feynman*. Singapore: World Scientific
- Clinton WJ (2000) President Clinton's Remarks at Science and Technology Event. Online: <http://mrs.org/pa/nanotech/clinton.html>
- Coleman RV, Dranke B, Hansma PK, Slough G (1985) Charge-Density Waves Observed with a Tunneling Microscope. *Physical Review Letters* 55/4:394–398
- Crewe AV, Wall J, Langmore J (1970) Visibility of Single Atoms. *Science* 168:1338–1340. doi:10.1126/science.168.3937.1338
- DeGrado WF (1997) *Proteins from Scratch*. *Science* 278:80–81
- Drexler KE (1992) *Nanosystems*. Wiley & Sons, New York
- Drexler KE (2004) Nanotechnology: From Feynman to Funding. *Bulletin of Science, Technology & Society* 24/1:21–27
- Drexler KE, Smalley R (2003) *Nanotechnology*. *Chemical & Engineering News* pp.37–42
- Eigler DM, Schweizer EK (1990) Positioning Single Atoms with a Scanning Tunneling Microscope. *Nature* 344:524–526
- Economist Technology Quarterly*, The (ETQ) (2004) Touching the Atom. *Economist Technology Quarterly* September pp.42–43
- Feynman RP (1960) The Wonders That Await a Micro-Microscope. *Saturday Review* pp.45–47
- Feynman RP (1960) How to Build an Automobile Smaller Than This Dot. *Popular Science* pp.114–ff
- Feynman RP (1984) *Tiny Machines*. Videotape available online <https://www.youtube.com/watch?v=4eRCygdW--c>
- Feynman RP (1986) Quantum Mechanical Computers. *Foundations of Physics* 16:507–521

- Feynman RP (1986) The ORIGINAL Nanotechnology Paper (sic; reprint of “There’s Plenty of Room at the Bottom”). In *Nanotechnology with Feynman Machines*, by Conrad W. Schneiker, unpublished book manuscript of 215 pages, pp. 133–149
- Feynman RP (1993) Infinitesimal Machinery. *Journal of Microelectromechanical Systems* 2/1:4–14
- Feynman RP (2005) *Perfectly Reasonable Deviations from the Beaten Path: The Letters of Richard P. Feynman*, edited by Michelle Feynman. Perseus, Cambridge MA
- Foster JS, Frommer JE, Arnett PC (1988) Molecular Manipulation Using a Tunneling Microscope. *Nature*, 331:324–326
- Freiser MJ, Marcus PM (1969) A Survey of Some Physical Limitations on Computer Elements. *IEEE Transactions on Magnetics* 5/2:82–90
- Gleick J (1992) *Genius: The Life and Times of Richard Feynman*. Pantheon, New York
- Goldstein H (2004) A Beautiful Noise. *IEEE Spectrum* pp.50-52
- Hameroff SR (1987) *Ultimate Computing: Biomolecular Consciousness and Nanotechnology*. North-Holland, Amsterdam
- Hansma PK, Tersoff J (1987) Scanning Tunneling Microscopy. *Journal of Applied Physics*, 61/2:R1–R23
- Henson K, Schneiker CW (1984) The Annual Von Neumann–Feynman Award. Unpublished manuscript of 22 May 1984, 3 pages
- Hessenbruch, A (2004) Nanotechnology and the Negotiation of Novelty. In *Discovering the Nanoscale*, ed. by D. Baird, A. Nordmann & J. Schummer. IOS Press, Amsterdam pp.135–144
- Hey AJG (1999) Feynman and Computation: An Overview. In *Feynman and Computation*, edited by A.J.G. Hey. Westview, Reading, MA pp.ix–xxiii
- Joy B (2000) Why the Future Doesn’t Need Us. *Wired* pp.238–262
- Junk, A. and F. Riess. 2006. “From an Idea to a Vision: There’s Plenty of Room at the Bottom.” *American Journal of Physics*, 74(9):825-830
- Keiper A (2003) The Nanotechnology Revolution. *The New Atlantis* pp.17–34
- Keyes RW (1969) Physical Problems and Limits in Computer Logic. *IEEE Spectrum* 6/5:36–45
- Keyes RW (1975) Physical Limits in Digital Electronics. *Proceedings of the IEEE* 63/5:740–767
- Krieger M (2006) Epilogue. In *Nanotechnology: Science, Innovation, and Opportunity*, edited by L.E. Foster. Prentice Hall, Upper Saddle River NJ pp.243–245
- Krumhansl JA, Pao YH (1979) Microscience: An Overview. *Physics Today* pp.25–32
- Kurzweil R (2005) *The Singularity Is Near: When Humans Transcend Biology*. Penguin, London
- McCray WP (2005) Will Small Be Beautiful? Making Policies for Our Nanotech Future. *History and Technology* 212:177–203
- Mehra J (1994) *The Beat of a Different Drum: The Life and Science of Richard Feynman*. Clarendon, Oxford
- Milburn C (2002) Nanotechnology in the Age of Posthuman Engineering: Science Fiction as Science. *Configurations* 10:261–295
- Moreland J, Alexander S, Cox M, Sonnenfeld R, Hansma PK (1983) Squeezable Electron Tunneling Junctions. *Applied Physics Letters* 43/4:387–388
- Newman TH, Williams KE, Pease RFW (1987) High Resolution Patterning System with a Single Bore Objective Lens. *Journal of Vacuum Science Technology B* 5/1:88–91
- Niemeyer CM (1997) DNA as a Material for Nanotechnology. *Angewandte Chemie – International Edition in English* 36/6:585–587
- Niemeyer CM (1999) Progress in “Engineered Up” Nanotechnology Devices Utilizing DNA as a Construction Material. *Applied Physics A* 68:119–124
- Niemeyer, CM (2000) Self-Assembled Nanostructures Based on DNA: Towards the Development of Nanobiotechnology. *Current Opinion in Chemical Biology* 4/6:609–618
- Niemeyer CM (2001) Bioorganic Applications of Semisynthetic DNA–Protein Conjugates. *Chemistry–A European Journal* 7/15:3189–95
- Niemeyer CM (2001) Nanoparticles, Proteins, and Nucleic Acids: Biotechnology Meets Materials Science. *Angewandte Chemie – International Edition in English* 40/22:585–587
- Niemeyer CM (2002) The Developments of Semisynthetic DNA–Protein Conjugates. *Trends in Biotechnology* 20/9:395–401
- Niemeyer CM, Burger W, Peplies J (1998) Covalent DNA–Streptavidin Conjugates as Building Blocks for Novel Biometallic Nanostructures. *Angewandte Chemie – International Edition in English* 37/16:2265–68
- Niemeyer CM, Adler M, Song G, Lifeng C (2002) Supramolecular DNA–Streptavidin Nanocircles with a Covalently Attached Oligonucleotide Moiety. *Journal of Biomolecular Structure & Dynamics* 20/2:223–230
- Olby R (1979) Mendel No Mendelian? *History of Science* 17:53–72

- Olby R (1989) Rediscovery as an Historical Concept. In *New Trends in the History of Science*, edited by R. Visser, H. Bos, L. Palm & H. Snelders. Rodopi, Amsterdam pp.197–208.
- Pabo C (1983) Designing Proteins and Peptides. *Nature* 301:200
- Philp D, Stoddard JF (1996) Self-Assembly in Natural and Unnatural Systems. *Angewandte Chemie, International Edition in English* 35:1154–1196
- Platt JR (1962) National Laboratories for Biology? *Science* 136:859–861
- Pohl WD, Schneiker C (1991) Distance-controlled Tunneling Transducer. U.S. Patent Number 5,043,577 [see also U.S. patents 5,210,714 and RE36,603]
- Regis E (1995) *Nano: The Emerging Science of Nanotechnology: Remaking the World – Molecule by Molecule*. Little and Brown, Boston
- Regis E (2004) *The Incredible Shrinking Man*. Available online: <https://www.wired.com/2004/10/drexler/> pp.179–181, 204–205
- Rohrer H (undated) There Is Plenty of Room at the Bottom. Undated unpublished comments on Feynman's "Plenty of Room" by H. Rohrer; sent to C. Toumey by email from H. Rohrer in November 2004
- Roukes M (2001) Plenty of Room, Indeed. *Scientific American* pp.42–49
- Schneiker CW (1983) Prospects and Applications for Genesis and Ultra Mass Production of Sub-Millimeter Machines, Devices, and Replicating Systems. Unpublished manuscript of 10 August 1983. 41 pages
- Schneiker CW (1984) Some Research Topics for a New Space Development Programme. *Journal of the British Interplanetary Society*, 37:190–192
- Schneiker CW (1984) Beyond Fifth Generation Machines: Feynman Replicators. Unpublished manuscript of 1 December 1984. 8 pages
- Schneiker CW (1985) The Modified Scanning Tunneling Microscope as a Nanometer Scale Machine Tool and Multimode Interface for Precision Assembly, Manipulation, Analysis and Control of Solid State Atomic Systems. Unpublished manuscript of 26 February 1985. 4 pages
- Schneiker CW (1985) EUREKA! – Atomic Scale Machine Tools. Unpublished manuscript of 4 April 1985. 4 pages
- Schneiker CW (1985) Nanoscience & NanoEngineering: Foundation for a New Renaissance. Unpublished manuscript of 22 April 1985. 4 pages
- Schneiker CW (1985) Nanotechnology. Unpublished manuscript of 31 July 1985. 30 pages
- Schneiker CW (1986) Nanotechnology with STMs, Feynman Machines, and von Neumann Machines. Unpublished paper, 11 July 1986. Feynman Archives at Caltech, Box 27, Folder 11. 7 pages. (Note: this paper was converted into a poster by C. Schneiker, presented by S. Hameroff, at an STM Conference in Santiago de Compostela, Spain, July 14–18 1986.)
- Schneiker CW (1986) Nanotechnology with Feynman Machines. Unpublished book manuscript of 215 pages
- Schneiker CW (1989) Nanotechnology with Feynman Machines: Scanning Tunneling Engineering and Artificial Life. In *Artificial Life, Volume VI: Santa Fe Institute Studies in the Sciences of Complexity* [proceedings of a September 1987 workshop in Los Alamos NM], edited by C. Langton, Addison–Wesley, Reading MA pp.443–500
- Schneiker CW, Hameroff S (1988) Nanotechnology Workstations, Based on Scanning Tunneling/Optical Microscopy: Applications to Molecular Scale Devices. In *Molecular Electronic Devices* [Proceedings of the Third International Symposium on Molecular Electronic Devices, Arlington VA, 6–8 October 1986], edited by F.L. Carter, R.E. Siatkowski & H. Wohltjen, North–Holland, Amsterdam pp.69–90
- Schneiker C, Hameroff S, Voelker M, He J, Dereniak E, McCuskey R (1988) Scanning Tunneling Engineering. *Journal of Microscopy* 152/2:585–596
- Simic–Krstic Y, Kelley M, Schneiker C, Krasovich M, McCuskey R, Koruga D, Hameroff S (1989) Direct Observation of microtubules with the Scanning Tunneling Microscope. *FASEB Journal* 3:2184–2188
- Stent GS (1972) Prematurity and Uniqueness in Scientific Discovery. *Scientific American* pp.84–93
- Stoddard JF (1993) Molecular Recognition and Self–Assembly. *Anales de Quimica* 89/1:51–56.
- Stroscio JA, Eigler DM (1991) Atomic and Molecular Manipulation with the Scanning Tunneling Microscope. *Science* 254:1319–26
- Taniguchi N, Maezawa S (1963) Temperature analysis of electron beam machining. *Proceedings of 5th Annual Electron Beam Symposium*, Boston
- Taniguchi N (1967) Analysis of mechanism of various materials–workings based on the concept of working energy. *Scientific Papers of the Institute of Physical and Chemical Research, Tokio* 61/3
- Taniguchi N (1973) Ion beam sputter–machining of glass. *College International pour la Recherche en Productique (CIRP) Annalen*, Berlin

- Thomas TR (2004) Nanotechnology, Materials and Applications. In *Encyclopedia of Twentieth-Century Technology*, Vol. 1, edited by C. Hempstead & W. Worthington, Routledge, New York pp.521–523
- Thompson ISI (2004) The Journal Selection Process. Online: www.isinet.com/essays/selectonofmaterialforcoverage/199701.html
- Toumey C (2004) Narratives for Nanotech: Anticipating Public Reactions to Nanotechnology. *Techné* 8/2:88–116
- Toumey C (2004) Nano Hyperbole and Lessons from Earlier Technologies. *Nanotechnology Law & Business* 1/4:397–405
- Toumey C (2005) Apostolic Succession: Does Nanotechnology Descend from Richard Feynman’s 1959 Talk? *Engineering & Science* 68/1:16–23
- Toumey C (2005) Feynman Unprocessed. Review of Perfectly Reasonable Deviations from the Beaten Path: the Letters of Richard P. Feynman. *Techné* 8/3:76–86
- Voelker M, He D, Dereniak E, McCuskey R, Schneiker C, Hameroff S (1988) Scanning Tunneling Microscopy (STM) for Biomolecular Imaging and Interactions. *Biophysical Journal* 53/2; Part 2:396a
- Weinstein A (1977) How Unknown was Mendel’s Paper? *Journal of the History of Biology* 10/2:341–364
- Yater JC (1979) Rebuttal to “Comments on ‘Power Conversion of Energy Fluctuations’.” *Physical Review A* 20/2:623–627
- Yater JC (1982) Physical Basis of Power Conversion of Energy Fluctuations. *Physical Review A* 26/1:522–537

PART I

Introduction

Chapter I

The World of Nano

An outline. The First Part, which is entirely made up of the First Chapter, is designed as a container for the fundamental concepts of Nanoscience and Nanotechnology, and is written for those readers who have little knowledge of these topics and their historical progress. For this reason, it contains the definitions of Nanoscience and Nanotechnology according to the most recent standards; brief references to the history of this science from antiquity to the present day appear; and the personalities responsible for the origin of Nanoscience and Nanotechnology as we know them are mentioned. The reader will also find a nod to the inevitable debates that arise when new doors of knowledge are opened. There is also a brief description of natural and biological nanomaterials, along with those produced technologically, with hints at their manufacturing processes. At the end of the chapter, a brief description of some of the main fields of application of nanotechnology is included, to give the reader an idea of how research has evolved in this field, which touches on so many fields, in fact affecting all the Sciences we know.

Prologue I

Great revolutions characterised the world of science in the 1900s. Among these, in the field of Physics, I will mention three. The first is Quantum Mechanics, which imposed a revision of the paradigm of Classical Physics when new phenomena were observed at the level of the structure of matter, such as the ultraviolet catastrophe, the photoelectric effect and the Compton effect, to mention those most often reported in the literature as fundamental moments of this new Physics. The second is Einstein's Theory of Relativity, through which it was necessary to reconsider the concepts of space and time, until then considered as distinct, and linked to a reference system and to well-defined sequences of "before" and "after". The third is Nanoscience, the search for the dimensions of a billionth of a metre, which took off definitively in the second half of the last century, starting in the 1950s, thanks to a succession of inventions, improvements in laboratory equipment, automation processes and even strokes of luck, as sometimes happens. Nanoscience has proved to be one of the most fruitful areas of research in the Physics of Matter, and its results are still opening up new research horizons in many disciplines that are involved across the board, in turn offering opportunities for ever closer collaborations between researchers. The study of the History of Nanoscience and its applications in Nanotechnology allows us to retrace the fundamental steps that have been taken along this path. In this first chapter I will describe the fundamental concepts underlying this History. First, the reader will find the definitions of Nanoscience and Nanotechnology as they have been elaborated by authoritative organisations and research bodies; I have presented them following their evolution over time and the progressive adjustments they have undergone. I then described the categories into which Nanomaterials can be divided. It was necessary to distinguish between Nanomaterials that appear in Nature and those that are engineered and industrially produced. I then described what techniques are used today to make devices at the nanoscale. Starting from Soft Lithography, which uses elastomers to replicate structures, and which had great momentum between 1995 and 2005, I described then both the Physical and Chemical Deposition of Vapours, which allow extremely performing high quality materials to be obtained. After this, the reader will find the Etching technique, applied to make nano-engravings and Electron-Beam Lithography through which it is possible to perform the selective removal of parts of material in order to achieve the required part. Finally, the Focused Ion Beam as a technique of ablation of material and Photolithography is described. The History of Science obviously includes a host of illustrious figures, and Nanoscience and Nanotechnology are no exception. In this first chapter of my research, I have considered three of the best known researchers whose contributions have been fundamental in the course of history, both from the point of view of their fields of research and of their written contributions, their books or articles. The first of these is Richard Feynman, who is often referred to as the founding father of nanotechnology, thanks to a speech he gave in December 1959 at the *American Physical Society at Caltech*, which was transcribed with the famous title *There's Plenty of Room at the Bottom* a few months later. The second name is that of Eric Drexler, the American engineer who is credited with having given a new voice to Feynman's work of more than twenty years earlier and with having allowed readers, even those not in the scientific field, to approach these topics through his text *Engines of Creation. The Coming Era of Nanotechnology*. The third person I have mentioned in this chapter, but he will certainly not be the last, is Norio Taniguchi, the Japanese researcher who is credited with the historical merit of having invented and given full definition to the term Nanotechnology for the first time in the history of science.

In the following chapters, however, I will devote more detailed paragraphs to each of them, when I describe the history of Nanotechnology through its most significant years. This first Chapter concludes with a dutiful subdivision of the world of Nanoscience into its main Nanotechnology categories. The reader will immediately realise how many articulations in basic and advanced research a generic term such as Nanotechnology can contain and, above all, how this is absolutely transversal and can no longer allow individual researchers to proceed in absolute isolation without establishing relations with experts in neighbouring disciplines.

1.1 Nanoscience and Nanotechnology

The Nanoworld deals with objects whose scale is down to 10^{-9} m. The modern Physics of the Nanoworld, the way we know it, began 70 years ago, shortly after the end of the Second World War.

Generally speaking, if we observe the succession of events from a historical point of view, we can see how the Twentieth Century was characterized by three innovations, in the field of physics, which revolutionized the knowledge and direct experience of the world: Quantum Mechanics, the Theory of Relativity and Nanoscience. Quantum Mechanics was developed to overcome the inadequacy of the laws of Classical Mechanics applied to particular electron behaviours, for example. The Theory of Relativity modified the description of space and time known until the early Twentieth Century. Nanoscience has opened, not only virtually, the eyes of scientists on the universe of matter at a size close to atomic dimensions. On this scale, the properties of matter change to the point of giving rise to completely new phenomena, the study and development of which have lasted for decades and the results of which are, for the most part, already applied in everyday life.

Nanoscience is, in fact, a journey into the deep subsoil of matter, discovering what properties it demonstrates when it is investigated and made to interact at very small dimensions, of the order of one billionth of a metre. This journey has been undertaken by researchers in many fields, from Engineering to Medicine, from Physics to Biology, from Mathematics to Chemistry, and its end does not seem to be in sight at all: so many discoveries and opportunities follow one another, that it will not be easy to put an end to a search of this type. The results that are, almost daily, obtained are so many that a final event does not appear predictable in the medium or long term. Nevertheless, Nanoscience, and all its application fields that we shall shortly address as Nanotechnology, is already seventy years old and yet it seems to be at the dawn of its most radiant youth.

In the vast majority of historical writings dealing with this discipline, we read that doing Nanoscience already had a very specific purpose, even before starting in practice or possessing the appropriate tools to proceed: the investigation of the nanoworld was the solution, theoretically, through which an answer would be given to otherwise unsolvable problems. According to Richard Feynman, the inability to transcribe the entire *Encyclopaedia Britannica* on the head of a pin was linked to the absence, at his time, of the tools to do so. Why would such an operation be useful to people? Because it would mean the ability to condense entire libraries and make them transportable and usable practically anywhere, by anyone. In reality, doing Nanotechnology as a practical application of Nanoscience does not originate from a written mission statement. There is no document in which we can read: scientists set these goals and will go as far as this limit. The possibilities of this research seem limitless, its applications go beyond the imaginable. Nanotechnology

is an open, boundless field in which we investigate for the pleasure of research and for economic achievement, for the improvement of the quality of life and for the acquisition of control over matter at any level. Yet, there is no apparently declared purpose for it, but perhaps only the underlying one of wanting to reshape the world, thanks to the properties of nanomaterials, in a different way than it is today, made with the same materials, at the bulk dimension.

However, a question must necessarily be asked and it is inevitable: is it really necessary to do this? The debate is open between the two main opposing factions: the supporters of Nanotechnology seen as a world of self-assembling machines and devices programmed by man for the most diverse purposes, and the detractors of this research, frightened by the fact that nanodevices can autonomously take control and supplant man in everyday life. To all intents and purposes, this seems to be a badly posed problem: it is not Nanoscience or Nanotechnology themselves that brings the connotations of positivity or danger towards man, but rather its use, and this is obviously left to the free will and conscience of those who apply it to the different fields.

As I will describe in the rest of this Thesis, in fact there is no scientific field that can be considered unaffected by the nanoworld. Composite materials, where nanoparticles are immersed in a polymeric matrix, with superior structural and robustness characteristics, transport systems for medicinal active ingredients, possessing the skill to precisely identify the release site, are just two of the fields in which it is expressed daily research in Nanotechnologies.

To begin the discussion on History of Nanoscience and Nanotechnology (HNN), I will give the definition of both Nanoscience and Nanotechnology the way they are accepted today, through a description of how the definitions themselves changed over time, and then I will discuss a question that is often asked, at the beginning, in most of the works regarding the nanoworld: how old is “nano”? I will therefore talk about which nanomaterials are known today, giving the reader a general description of the two major areas, one about natural and the other about artificial nanomaterials, and how these last are manufactured. Next, I will talk about those people who are considered the pioneers and founding fathers of this science, notably Richard Feynman, Eric Drexler, and Norio Taniguchi, through their most significant articles and books. Later, I will highlight, thanks to a paper by Christopher Toumey, how the transcript of the conference *There's Plenty of Room at the Bottom*, by Richard Feynman, which is almost universally indicated as the founding document of Nanotechnology, is the subject of an interesting epistemological debate. I will bring to the attention of the reader both Toumey's interpretations and the opinions of scientists – some of whom were awarded the Nobel Prize for their research in the field – from which it appears that this document does not always seem to have been fundamental for the discoveries. Indeed, in some notable cases, it was even unknown to researchers. I will then proceed to a description of the fields of study of Nanotechnology.

1.1.1 Definitions

It is important to distinguish at the very outset between *Nanoscience*, which is the study of phenomena at the very small scale, and *Nanotechnology*, which implies achieving a result that is in some way useful. According to this brief description, it is clear that Nanoscience and Nanotechnology are words that do not regard the same concept.

In 1994, the Royal Society/Royal Academy for Engineering Working Group on the subject adopted the following definitions:

Nanoscience is the study of phenomena and manipulation of materials at atomic, molecular and macromolecular scales, where properties differ significantly from those at larger scale.

Nanotechnologies are the design, characterization, production and application of structures, devices and systems by controlling shape and size at nanometre scale (Whatmore 2006).

According to other more recent definitions, nanoscience is the study of structures and molecules on the scales of nanometers, ranging between 1nm and 100nm while the technology that uses nanoscience in practical applications such as electronic devices, medical applications and so on, is called Nanotechnology (Mansoori 2017).

Nanotechnology is indeed one of the most promising research fields of the 21st century. It is the skill to convert the nanoscience theories to useful applications through observations, measurements, assembling, controlling and manufacturing matter for dedicated purposes at the nanometric scale.

The National Nanotechnology Initiative, in the United States, defines Nanotechnology as *a science, engineering and technology conducted at the nanoscale (1nm to 100nm) where unique phenomena enable novel applications in a wide range of fields, from chemistry, physics and biology, to medicine, engineering and electronics*. In other words, *Nanotechnology is the understanding and control of matter at the nanoscale [...]. Encompassing nanoscale science, engineering, and technology, Nanotechnology involves imaging, measuring, modeling, and manipulating matter at this length scale* (National Nanotechnology Initiative 2020).

Both these definitions suggest that two conditions must be present when we are talking about Nanotechnology. The first is a matter of scale: Nanotechnology is concerned with matter whose structures possess a size at nanometric scale. The second issue has to do with novelty: Nanotechnology *must* deal with small things taking advantage of brand new properties because of the nanoscale; these properties do not appear in the bulk material.

It is important to always make this distinction between Nanoscience and Nanotechnology. Nanoscience merges Physics, Material Science and Biology manipulating materials at molecular and atomic scales, while Nanotechnology is the ability to manipulate – whatever this word can mean, measure, assemble, manufacture, control – materials at a nanometric scale (Bayda *et al.* 2019).

1.1.2 How Old is Nano

It took a concatenation of events and a convergence of scientific discoveries to bring Nanotechnology into the public domain, from the invention of the Scanning Tunneling Microscope (STM), which saw the light in 1981, to the discovery of fullerenes in 1985 and graphene in 2004. Not only that, Nanotechnology received even more visibility thanks to the awarding of specific Nobel prizes, generally for Physics and Chemistry, to people whose names have remained milestones in the History of Science such as Heinrich Rohrer and Gerd Binnig, awarded in 1986 for the realization of the STM, Harold Kroto, Robert Curl and Richard Smalley in 1996 for the discovery of fullerene, ten years later, Andre Geim and Konstantin Novoselov in 2010 for their research on graphene.

The few events mentioned here were among those that brought to the fore the existence of a new science whose field of investigation belongs to Solid State Physics, where at least

one of the dimensions is of the order of 10^{-9} m. From an historical point of view, it is legitimate to ask whether fullerene and graphene, for example, were the very first nanomaterials observed by researchers or, above all, the first materials produced on such a small scale. What we can say is that Man has always tried to mimic Nature, especially when he has come into possession of increasingly refined tools to investigate it. In this way, he was able to observe its structure, understand its mechanisms and try to artificially replicate what is present in the natural world in order to apply its secrets to as many outcomes as possible, adapting it in the laboratory, improving it for his own needs or even manipulating it, sometimes for his own purposes. Last but not least, Man has learnt a great deal from Nature, although some of the results Nature has achieved so far are still far from being replicated in a laboratory.

It becomes almost a need, therefore, to ask oneself if nanoparticles already exist in Nature and, if so, for how long have they done so. It is also easy to understand how extremely difficult it may be able to answer, at least the second question. The first question obviously has an easy affirmative answer. The presence of nanoparticles in Nature is quite predictable from the beginning, as practically every chemical compound – with the exception of liquid and gaseous compounds – has structures that can be made to fit into the nanometer size.

Starting from about the IV century AD, artisans have used materials in several circumstances which, thanks to their nanometric components, have led to improvements in metallurgy, glass art, ceramics and painting.

The pigment known as Egyptian Blue (Fig. 1.1) has been used for thousands of years in Ancient Egypt. In nature, it can be extracted from a copper–calcium silicate, known as cuprorivaite, or copper–calcium tetrasilicate, whose chemical formula is $\text{CaCuSi}_4\text{O}_{10}$. Since this silicate is extremely rare in nature, it is not plausible that the Egyptians used it from natural sources, but rather that they were able to manufacture it through a complex and very precise process, which gives us reason to believe that their knowledge of chemistry was quite advanced; at the same time, the presence of this pigment in the artefacts identifies them as works of great value and prestige.



Fig. 1.1 Egyptian blue powder. Source: Public Domain

Today we know that this pigment can be obtained by mixing sand with quartz content, a compound based on copper, calcium carbonate and alkaline substances according to the reaction:

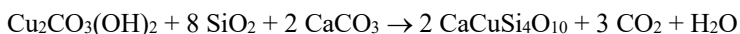

which is performed at around 800°C or 1000°C.

The pigment has properties that make it possible to envisage applications today that go beyond the simple colouring of objects. When irradiated with visible light, Egyptian Blue emits intense near-infrared radiation, which makes it interesting, for example, for applications in microscopy and near-infrared spectroscopy. In medicine, imaging is a key tool for the analysis and prevention of dysfunctions. Typically, light-reactive substances called fluophores are used to mark the structures to be highlighted with a dye. By using reagents based on Aegyptian Blue, it is possible to investigate tissues in greater depth and obtain less distorted images. In 2020, a group of researchers at the University of Göttingen succeeded in obtaining nanosheets 100,000 times thinner than a human hair that give rise to near-infrared fluorescence, which is extremely stable and ideal for imaging (Selvaggio *et al.* 2020).

The brilliant turquoise-blue colour that has survived through the centuries in Central America is known as Maya-Blue, thanks to the pre-Columbian civilisation that created it, and has come down to us, unlike other pigments, because of its almost unique chemical characteristics. Technically, Maya-Blue is obtained when indigo is incorporated into palygorskite, a clay mineral. Indigo is extracted from the leaves of *Indigofera suffruticosa* and combined with a natural clay, palygorskite, a magnesium aluminium phyllosilicate with the formula $(\text{Mg},\text{Al})_2\text{Si}_4\text{O}_{10}(\text{OH})\cdot 4(\text{H}_2\text{O})$, which is typical of clay soils but mysteriously only found in small deposits in southern Mexico and in areas where the Maya civilisation developed.

The chemical composition of Maya-Blue as we know it was determined in the 1950s through powder X-ray diffraction experiments, while a comprehensive study of the pigment has been made through techniques such as infrared spectroscopy, Raman spectroscopy, optical spectroscopy, voltammetry, nuclear magnetic resonance and computer simulation (Del Rio *et al.* 2011). This pigment results in a complex nanostructured organic-inorganic hybrid material of the components we have indicated, in which several positional isomers of indigoid molecules coexist with clay.

One of the most significant artifacts that must be recalled here is what is called the Lycurgus Cup. This is, technically, a *diatretum* cup, that is a glass container, from the Roman era and considered luxury item, which consists of an internal container and an external support cage, which detaches from the body of the cup, to which it remains attached through special supports. The depiction on the glass shows Lycurgus in the act of killing Ambrosia, a follower of Dionysus; however, the latter, transformed into a vine plant, wraps Lycurgus with its shoots, killing him before he achieves his purpose. The scene takes place under the teasing gaze of Dionysus and two of his followers.



Fig. 1.2 One of the most famous artifacts in ancient history of science and art: the Lycurgus Cup. The cup displays its red aspect in transmitted light (left) and the green colour when under reflected light (right). Source: The Trustees of the British Museum.

<https://www.thevintagenews.com/2020/02/15/lycurgus-cup/> CC BY–NC–SA 4.0 license

The glass the cup is made of is a dichroic glass showing different colours, depending on the light position with respect to the cup: if the light is frontal and is therefore reflected, the colour of the cup will be green while, if the light source is placed behind the cup and the light is transmitted through the cup, the glass will appear red (Fig. 1.2). This effect is a direct consequence of the presence of a small quantity of gold and silver nanoparticles, in colloidal form, in the glass paste; gold is responsible for the red colour while green produces the green colour. It is rather unlikely that this effect was deliberately obtained by master glassmakers, precisely because the size of the particles, around 70nm in diameter, and the quantities used are very small. It is more likely to think that the dichroic property of glass is a lucky result of a melting in a crucible in which other materials had been previously worked, and that they left residues in an exact but random quantity such as to produce the glass as we can admire it in the Lycurgus Cup. It must be remembered that the behaviour of glass, in the case of the Lycurgus Cup, depends on an absolutely precise concentration of colloids, on the oxidation state of some chemical elements present, on the diameter of the particles, on the proportions of the components, on the processing time, on the crucible temperature, from atmospheric conditions, probably, during processing. It would have been very difficult to obtain a second product with the same properties that have been described for the Lycurgus Cup. The glass technology that allowed the Romans to obtain these results did not, however, last very long.

A blade so sharp as to be capable of cutting a piece of silk that inadvertently falls on it is the description made of those swords called Damascus Swords. These swords possess characteristics of very high mechanical resistance and such a flexibility that they are said to bend up to an angle of 90°. To understand the reason for the features of these swords, made of a metal that was believed to be legendary, a sample of the steel was dissolved in hydrochloric acid and then the remains were analysed under a high-resolution Transmission Electron Microscope and through Wide Angle X-ray Diffraction (WAXD). From the images, it was possible to highlight the presence of carbon nanotubes and cementite nanowires as residues from the forging process. The artisanal heating and forging process

incorporates organic debris, in different steps, that allow the formation of nanostructures during the steel manufacturing process (Fig. 1.3).



Fig. 1.3 A bladesmith from Damascus, Syria. Source: Studiolum.com, Public Domain, <https://commons.wikimedia.org/w/index.php?curid=14837124>

Damascus steel was, in turn, forged from ingots of a steel originating in southern India, and which is known as Wootz steel. The carbon content in Wootz steel was granted by the preparation itself, that made use of *Cassia auriculata* wood and the leaves of the *Calotropis gigantea* shrub, two plant species characteristic of India and the island of Ceylon, together with minerals extracted in particular mines. Analyses have shown the presence of cementite also in weapons made with Wootz steel. During processing, the steel was repeatedly heated and hammered, in order to obtain a thin and shaped blade, a process that left very characteristic wavy patterns on the surface of the alloy (Fig. 1.4).

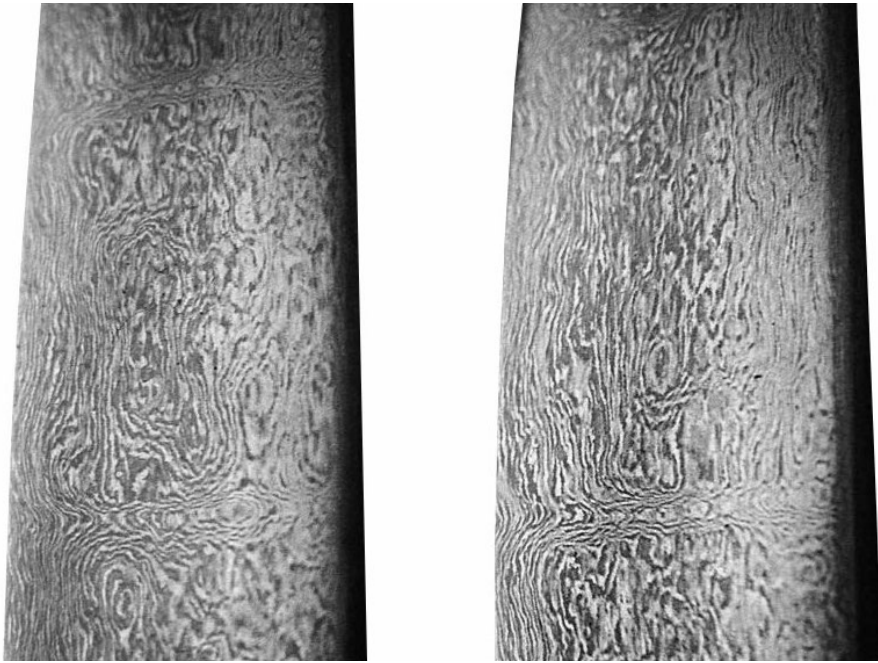

Fig. 1.4 Close view of details of a 13th century Persian–forged Damascus steel sword. Source: image by Rahil Alipour Ata Abadi – Transferred from en.wikipedia to Commons., GFDL, <https://commons.wikimedia.org/w/index.php?curid=50800188>

Although they were extremely skilled, the blacksmiths of ancient India and Damascus could be defined as real “unaware nanotechnologists”, because they were certainly not aware of the fact that they were working on nanometre–sized materials. We might guess that they proceeded by trying and failing, trying again and finally reaching the result without knowing what was actually happening inside the material.

The coloured glasses that adorn the stained glass windows and the rose windows of the cathedrals that arose, especially in Europe, during the Middle Ages are another example of how nanotechnologies can be applied for the realization or, as this is the case, the improvement of materials. The most superb examples of this glazing technique are in the windows of the Notre–Dame of Chartres cathedral (Fig. 1.5), whose construction began in 1194. Exactly as we said before regarding the roman glassmakers, it is logical to assume that the craftsmen were not aware of the physical principles capable of justifying the colouring, rather of the fact that by adding different metals to the melted paste they could obtain extremely particular shades of colour.



Fig. 1.5 Detail of the *Notre-Dame de la Belle-Verrière*, or *Blue Virgin* (1180–1225), perhaps the most famous window at Chartres, Cathedral. Source: Vassil – Own work, Public Domain, <https://commons.wikimedia.org/w/index.php?curid=6080958>

They were able to add auric chloride (Au_2Cl_6) to the glass during processing, which gives rise to the formation of gold nanospheres with a diameter of about 25nm capable of interacting with sunlight in order to produce ruby red reflections. In addition to this colour, characteristic of the gold added in the molten paste, it was possible to obtain a blue or green colour by adding copper, or a green or brown colour by adding iron.

1.1.3 *What Nanomaterials do we know?*

Nowadays nanotechnology, with its applications, is in fact omnipresent and is an integral part of the lifestyle we lead and the products we use, from silver nanoparticles in toothpastes, to particles that improve the release of the active ingredients of medicines, to nano additives that are used to reinforce plastics.

Here I describe the two main categories Nanomaterials can be divided into: Natural Nanomaterials and Industrial and Engineered Nanomaterials. Natural Nanomaterials appear as a consequence of natural or biological phenomena, like volcanic eruptions, to give an example. Industrial Nanomaterials are designed and manufactured, instead, to answer to specific requests in different fields and must possess very precise characteristics.

1.1.3.1 Natural Nanomaterials

When it comes to nanoparticles, it is not always necessarily true that something artificial is being described. Through the research of scientists themselves, we have realised that Nature is an excellent nano-technologist. In fact, it is able to provide us with a wide range of particles, from inorganic ashes to soot, from sulphur nanoparticles to minerals found in wells or in the air, up to those produced by bacteria or yeasts, such as selenium nanoparticles (Fig. 1.6). All these examples refer to nanoparticles which are completely natural and whose observation, not surprisingly, stimulates the interest of research in the development of natural products at the nanoscale, in new fields such as phyto-nanotechnology¹⁸ and phyco-nanotechnology¹⁹. The nanomaterials found in nature, together with those manufactured in laboratory, but which are still inspired by those that can be observed in the surrounding environment, have proved to be promising starting points for research in fields such as Medicine, Nutrition, Agriculture and Cosmetics. This is thanks to their unique chemical and physical properties, and their ability to be activated in biological structures (Griffin *et al.* 2018).

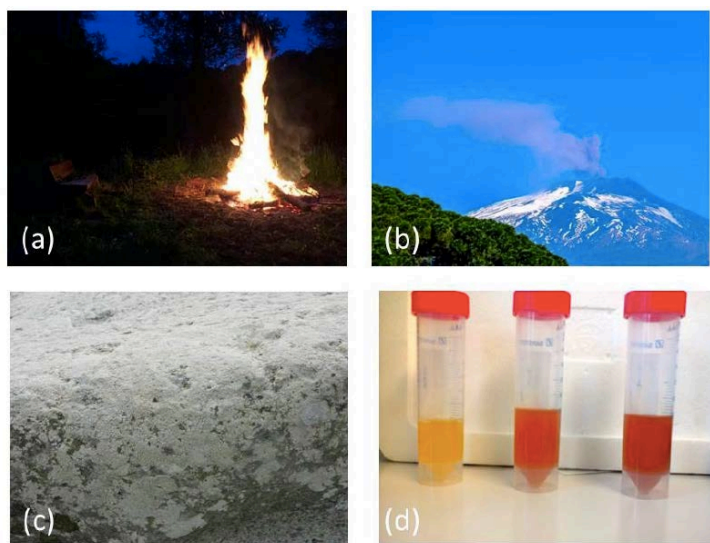

Fig. 1.6 These pictures show where it is possible to find nanoparticles, for example (a) near open fires, (b) as a result of volcanic activity, (c) as chemical precipitates and (d) as bio-reductively formed deposits of elements in bacteria. Source: Courtesy of Cornelia M. Keck

When we talk about “natural” nanomaterials, it is important also to make a distinction between those nanomaterials that are “natural” because they are already present in nature without any human intervention, and those ones that are, at the same time, “natural” and also “bio”, i.e. they exist in nature as a result of biological activities, primarily referring to

¹⁸ Phyto-nanotechnology is a new emerging research field of the nanoworld, where target-specific delivery of nanomaterials to agricultural crops and plants is studied, which may enhance or add plant functions, and achieve environmental monitoring and resistance to pollution as well.

¹⁹ Phyco-nanotechnology can be defined as the study of algae-mediated biosynthesis of nanometals.

biological substances or materials. This is not just a semantic distinction, though. In the following picture (Fig. 1.7) this division is illustrated, providing some interesting examples of natural nanoparticles of particular interest, and nanoparticles from natural products.

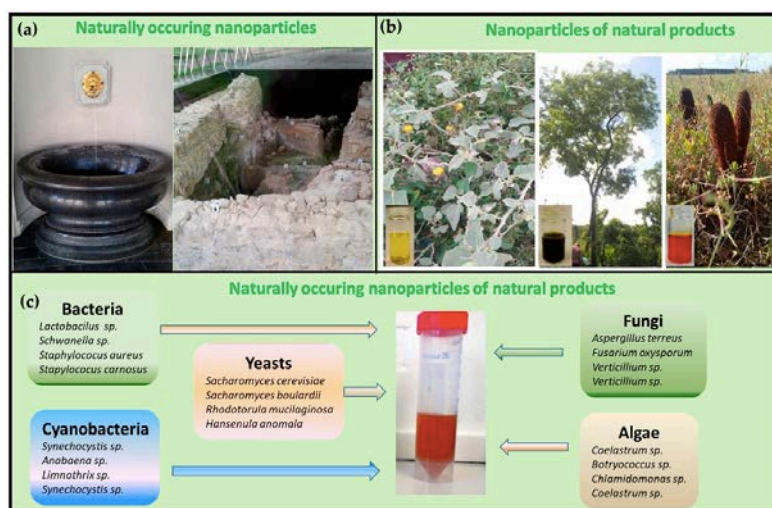

Fig. 1.7 These are some examples of natural and biological materials containing nanoparticles. We can find naturally occurring nanoparticles of elemental sulphur in hydrogen sulphide-rich mineral wells (a) such as at the Elisenbrunnen in Aachen, Germany. Mechanically produced nanomaterials (b) have been evaluated for medical and agricultural applications. Also naturally produced nanomaterials from natural and biological products exist (c) such as nanoparticles of elemental selenium, coated with microbial proteins formed by bio-reductive, or oxidative, metabolism in bacteria and fungi. Source: Courtesy of Cornelia M. Keck

Mother Nature really is a very skilled nano manufacturer. To understand completely where natural nanostructures may have appeared from, we must first refer to the hypothesis proposed by Aleksandr Ivanovič Oparin in 1927, stating that the first step of evolution on Earth involved the chemistry of simple organic substances, within the warm primordial oceans formed after the cooling of the Earth, in its younger stages. Oparin believes this level was inevitable even at a former era, regarding carbon compounds:

However, the Earth was gradually cooling down and the time must have come when combinations of free elements began, the elements mixed together. (Oparin, 1977).

Further on, the author goes into the discussion of the nitrogen and carbon compounds that are recognized as the basis of life.

Eventually, the time came when the temperature of the surface layers of the Earth dropped to 100°C. [...] The first organic substances that had hitherto remained in the atmosphere were now dissolved in the water and fell to the ground with it. What were these substances? [...] They were substances with a large reserve of chemical energy and possessing a great chemical potential. Since they were in the Earth's atmosphere, they had begun to combine with each other, giving rise to very complex compounds. They also combined with oxygen and ammonia to give hydroxy-derivatives and amino-derivatives of hydrocarbons (i.e. compounds of hydrocarbons with oxygen and nitrogen, respectively). When these substances fell from the atmosphere into the primitive ocean, they did not cease to interact one with each other. Specific organic substances brought by the waters met and

combined. Thus, even larger and more complex molecules were formed. We can easily get a fairly accurate picture of this process of aggregation (polymerization) of organic substances on Earth, by studying it in our chemical laboratories. In fact, the conditions, under which organic substances existed at the stage of development of the Earth we are dealing with, can be realized quite easily in our laboratories. If we subject substances such as hydrocarbon radicals to the conditions described above, and leave them to themselves, we must find that the entire chain of reactions described above takes place. The hydrocarbon radicals will be oxidized at the expense of oxygen in the water and air to give the largest variety of derivatives (alcohols, aldehydes, acids, etc ...). This process takes place particularly quickly at high temperatures, and in the presence of iron and other metals (*ibidem*).

In a later paragraph, we can read also that:

In this mixture, we can even find, among other things, compounds of the nature of carbohydrates and proteins. Both of these types of compounds play an important role in the structure of living material. We find them in animals and plants without exception. In combination with other and even more complex substances, they are, so to speak, the basis of life (*ibidem*).

This is the first stage of the chemical evolution.

At a second stage, the structures Oparin predicted combined to form amino acids and other complex structures such as peptides, proteins and so on. The dehydration process allowed the polymerization of small units, so the process could happen, at this level, abiotically.

A third stage involves the interaction of these polymers with each other to give rise to aggregates known as protobionts. These primary aggregates do not possess all the features of a living being, since they cannot reproduce, but at a further stage they acquired the possibility of reproduction and passing of information from one generation to the next.

This kind of genesis of living beings on Earth was no longer possible after the appearance of photosynthetic organisms that filled the atmosphere with oxygen. The presence, in the upper atmosphere, the O₃ allotropic and resonant form of oxygen, and its interaction with the UV frequencies rendered abiogenesis impossible. A new form of evolution was then necessary under a completely new form of atmosphere that transformed in composition and temperature to be the one that nowadays surrounds the planet.

In this changing environment, the organisms that evolved were nanometric in size, or could contain nanometer-sized organelles needed to perform their fundamental functions and ensure survival, and were able to organize themselves into more complex structures of different shapes and sizes. Not only that, they were able to interact with the surrounding environment, with light, water, temperature, the conditions of acidity or basicity around or with other molecules and organisms. Therefore, we must think that nanoparticles were already existing when the evolution of life on Earth began; for example, single particles of nanometric size, and not connected to each other or connected to something else, were found in different fluids of natural origin. Viruses, organelles of living cells, diatom shells incorporated in grains of sand suspended in water or on the seabed of the oceans are no exception. Because of the global conditions described by Oparin, the first organisms to evolve on Earth had to be thermophilic, able to survive in warm environments, and they developed a chemotropic metabolism in order to extract energy from inorganic substances such as sulphur or carbon to ensure their survival.

About 2.5 billion years ago, at the end of the Archean era, the temperature on Earth dropped to 72 degrees Celsius, which has been recognized as the maximum limit for triggering the phenomenon of photosynthesis, and allowing the production of free oxygen in the atmosphere. The cyanobacteria then present improved the photosynthetic process, causing a radical change in the composition of the Earth's atmosphere, and the disappearance of those organisms whose survival depended on an environment rich in

carbon dioxide and methane. Life then evolves to more complex forms, characterized by the presence of nanoparticles such as biopolymers like DNA and RNA, certain types of proteins, cellular organelles such as *mitochondria* for respiration, ribosomes for protein synthesis, chloroplasts for the completion of the photosynthesis process, the nucleus seat of genetic information and so on.

The earliest life forms that appeared on Earth were necessarily very small in size, as higher size structures and higher complexity evidently entailed unmet evolutionary stages. Some of the nano-organisms that then appeared can be grouped into three main categories: nanobi, viruses, and bacteria.

Nanobi are filamentous structures, comparable to actinomycetes, which were dated in the Triassic, between 251 and 199.6 million years ago, and in the Jurassic, between 199.6 and 145.5 million years ago, in sedimentary rock structures and sandstone. We recall that the temporal interval between these two periods was marked by the great mass extinction of the great reptiles. Due to their size, the smallest can measure between 1nm and 20nm in diameter, so it can be assumed that it is the smallest form of life, being up to ten times smaller than the smallest bacteria known so far. Since they were found in rocky sediments, the first interpretation that has been attributed to these living beings is that they simply are crystalline formations, however the presence of DNA, found in nanobi specimens, would prove the opposite. Indeed, nanobi are non-crystalline and show the presence of an outer membrane, which encloses two regions that have been observed.

The first region is densely occupied by electrons, and is usually interpreted as a kind of cytoplasm, the second, centrally located, is less dense and is referred to as the nucleus, as it has shown reactivity to three organic dyes. The first of these dyes is DAPI (Fig. 1.8), or 4',6-diamidino-2-phenylindole, a dye that is highly reactive to regions rich in adenine-thymine blocks, and which can be used for both the analysis of live cells and fixed cells, thanks to its ability to penetrate the cell membrane. In the following figure the molecule of DAPI is represented.

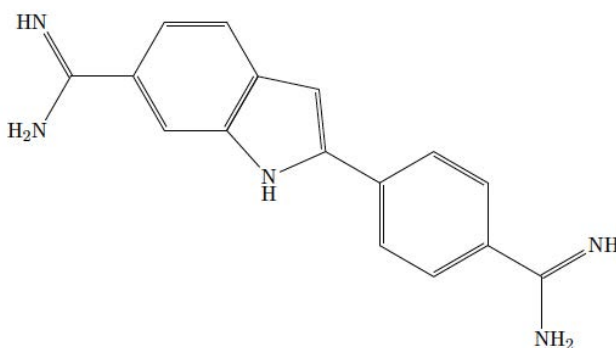

Fig. 1.8 The structure of DAPI molecule. Source: AD, designed with chemfig L^AT_EX package

The second technique involves acridine orange (Fig. 1.9), an aromatic heterocyclic compound that can, in turn, cross cell membranes to interact with DNA or RNA, in the first case by intercalation, in the second case by electrostatic attraction.

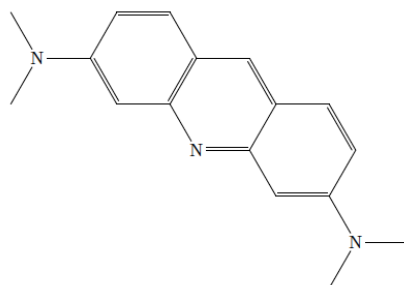

Fig. 1.9 The acridine orange structure. Source: AD, designed with chemfig L^AT_EX package

Finally, it is possible to highlight the nucleus of these nanostructures through the procedure that takes the name of Colouring of Feulgen, from the name of the German physiologist Robert Feulgen (1884–1955), who first perfected it in 1914. With this technique, which involves the use of decolorized hydrochloric acid and fuchsin (the so-called Schiff reagent, see Fig. 1.10), it is possible to colour the DNA, not highlighting, at the same time, also the RNA, thus differentiating the two nucleic acids. Nanobi, which are carbon, nitrogen and oxygen compounds, grow aerobically at room temperature.

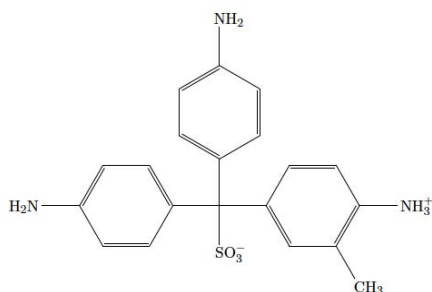

Fig. 1.10 The leucofuchsin molecule structure. Source: AD, designed with chemfig L^AT_EX package

Viruses are not considered as living beings, since they are not able to sustain all the vital functions characteristic of what is defined as autonomous life, such as they cannot reproduce without a host, they cannot metabolize autonomously, they do not possess a cellular structure. To be able to exactly date the appearance of viruses on Earth is not so simple, as there are no fossils that testify their presence in ancient times. One of the most likely hypotheses is that they were subject to some form of evolution, from complex protein molecules and nucleic acid, before the appearance of life on Earth. Other hypotheses, based on the analysis of different virus genes, suggest that they originated from cellular DNA fragments and only later became independent. A third possibility is that these viruses appeared very early in the evolution scale, and part of their DNA remained bound to the genome of some cells. The fact that some viruses are able to infect humans as well as animals, suggests that they may have had a common origin that could be dated to several billion years ago. They are entities of nanometric dimensions. The *Parvoviridae* family includes the smallest known viruses, measuring between 18nm and 28nm. These viruses are

linear, not segmented and consist of a single strand of DNA, the average size of their genome is about 5000 nucleotides and their viral capsule consists of 2 to 4 proteins. Alongside these, *Pandoraviruses* (1000nm) and *Phitoviruses* (1500nm) are, among the isolated viruses, those with the largest size.

Bacteria are the oldest known organisms. Their evolution is approximately between 3.5 billion years ago and 2.7 billion years ago. The almost total absence of competition with eukaryotic organisms and their simplicity of organization have allowed their enormous development in virtually every environment. Pathogenic bacteria, usually referred to as microbes, develop nanoparticles in the environment, through biomineralization processes that allow them to produce inorganic substances such as iron and silicon nanominerals, carbonate and calcium phosphate. Nanobacteria, or nano-size bacteria, are the smallest bacteria in the cell wall, and include ultramicrobacteria as a possible dormant form of larger cells (200nm) and mycoplasmas (300nm) as the smallest known form of bacteria. Organisms belonging to precise subdivisions of the classification system, namely bacteria, fungi, algae and plant cells, have all attempted the biosynthetic production of nanometals and it is no secret that unicellular and pluricellular organisms can synthesize inorganic nanomaterials through intracellular processes, but also through extracellular processes. Bacteria belonging to the genus *Leptothrix* and the genus *Gallionella* are able to oxidize iron to produce the energy necessary for their survival, producing metal nanoparticles of ferrihydrite and iron(III) oxide-hydroxide.

The search for nanoparticles in our environment is also characterised by a number of natural particles that do not belong to the realm of the living such as, for example, ash and soot particles, products of volcanic activities, in whose clouds one can observe microscopic and nanometric particles containing silicates and ferrous compounds, or fires, i.e. different types of combustion. These particles are found in nature, but cannot be traced back to biological processes. Their size, varying between 100nm and 200nm, means that they have a significant impact on health once inhaled, as they can penetrate deep into the respiratory tract, trachea, bronchi and lung alveoli. In the case of combustion of organic substances, such as the wood of particular tree species, it has been possible to measure nanoparticles of a smaller size, whose structure is typical of multi-walled carbon nanotubes, between 15nm and 70nm.

The processes of precipitation, oxidation and reduction, albeit to a minimal extent in the latter case, are responsible for the formation of nanoparticles, transformed from higher structures already present in nature.

Water, examined under the microscope, provides the medium for the suspension of calcium carbonates and sulphates coordinated with iron oxides. The suggested mechanisms for their formation range from slow precipitation to abrasion, which must lead us to think that the nanometer-sized particles that are present in our environment are not as rare as we might think. The nanometric materials generated in nature, through simple chemical processes that are more or less random, are characterised by a rather coarse morphology, far removed from the structures that can be precisely obtained in a laboratory, where conditions are controlled. If, for example, we consider natural sulphur-based nanoparticles, they may have originated from a simple sulphide (HS^-), inorganic polysulphides (HS_x^-) or elemental sulphur (S). These three classes of compounds are highly reactive and can be easily converted into each other in the presence of oxidising agents, mainly air, or chemical reductions. In the laboratory, however, sulphur nanoparticles of appreciable quality, almost uniform size and virtually spherical shape, with a diameter of around 150nm, can be obtained under controlled conditions and reactions similar to those performed by nature. Typically, sulphide and sulphite (SO^{2-}_3) are proportioned through redox.

It is not only processes linked to volcanism or mineral springs that give rise to natural nanoparticles. Living cells can use a variety of reactions to produce such compounds. It is precisely because of their size that cells have to deal with nanotechnology: a DNA strand has a diameter of around 2.5nm for instance, a virus is about 100nm wide, while a typical bacterium is about ten times larger, at around $1\mu\text{m}$ – $3\mu\text{m}$. It should therefore come as no surprise that cells are engaged in nanotechnology. It should be noted, however, that cells do not work in the solid state because any type of deposit, precisely because of the size involved, could lead to the death of the cell itself and must be effectively expelled from it. The expulsion of deposits, which these organic nanolabels achieve in the form of almost spherical particles, is the end of a real mechanism for producing nanoparticles that has been mimicked. These processes can be exploited to produce particles of good quality and yield, even in food products, or for bioremediation or decontamination of soils that have been enriched/polluted with toxic metals or semi-metals. Removing environmental contaminants (heavy metals, pollutants, organic or inorganic) from contaminated sites by means of nanoparticles or nanomaterials derived from plants, fungi or bacteria, what is called nanobioremediation (NBR) is an environmentally friendly and cost-effective alternative to traditional chemical methods. The three main strategies of this modern bioremediation, which aims primarily at removing contaminants, include the use of plants, microbes or isolated enzymes such as laccase or nitrate reductase. The nanoparticles that are generated by these organisms are no longer seen as pollutants but as valuable alternatives of natural origin. One of the most interesting compounds for the development of selenium nanoparticles, whose medical/therapeutic applications are being investigated, is selenite anion, a selenium oxyanion whose formula is SeO_3^{2-} , which can be processed by microorganisms such as *Saccharomyces cerevisiae* and *Staphylococcus carnosus*. Through these microbes, it is possible to obtain rather homogeneous silicon nanoparticles, the diameters of which can be measured between 60nm and 80nm. After being cleaved by the cell, these particles can be recovered for application as food supplement or antimicrobial agents, thanks to the properties they have been shown to possess. Not only that, possibilities have also opened up for their use in agriculture where, at the same time, they can strengthen foodstuffs, provide plants with elements for their natural defences and eradicate pathogens from plants. Other bacteria, such as *Pseudomonas aeruginosa*, *Thiobacillus Serratia* and *Stenotrophomonas* employ a reductive or oxidative detoxification pathway that eventually leads to the formation of elementary particles of sulphur, selenium, silver and gold (Fig. 1.11).

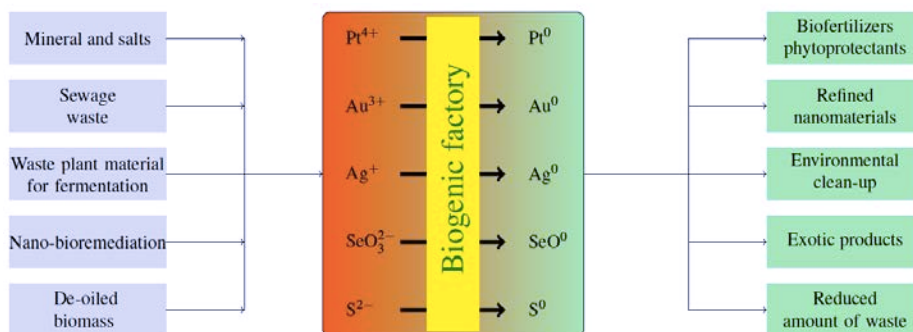

Fig. 1.11 A schematic description of a biogenic factory, i.e. bacteria that can detoxify wastes or dangerous ions into useful compounds and elemental metals. Source: AD, designed with TikZ L^AT_EX package

It must be emphasised that nanoparticles of natural origin are not comparable to materials that are made in the laboratory, as they cannot be chemically pure and contain a natural coating of proteins, a reflection of the organic environment in which they were produced. Eventually, we can imagine a process in which bacteria are grown on contaminated soil and, as they reclaim that soil, produce well-defined nanoparticles that can be harvested and used in medicine, agriculture or other applications. The benefits that could result from such an approach can be substantial and are not far-fetched either, since major contaminants such as heavy metals often also form the basis for the production of particularly interesting nanoparticles.

Nature is a source of inspiration for researchers, who observe the nanometric biological structures that are already present, in order to translate them into synthetic materials of common use, or into technological structures for the most advanced uses. One of the most remarkable examples is the so-called Gecko-Tape, a synthetic tape that aims to reproduce the structures under the legs of the reptile known as the gecko.

The legs of the gecko have attracted attention because they allow this lizard to adhere to a wide variety of surfaces without having to secrete adhesive substances, but rather because of their structure, which allows Van der Waals forces to be exploited. The underside of the legs is covered with microscopic hairs, called *setae* (from the Latin *seta*), consisting of fibrous structural proteins that protrude from the dermis, thinner, on average, than a human hair. On each of these *setae* are thousands of even smaller structures called *spatulae*. The large number of *spatulae* serves to maximise the area of contact between the animal and the surface (Fig. 1.12).

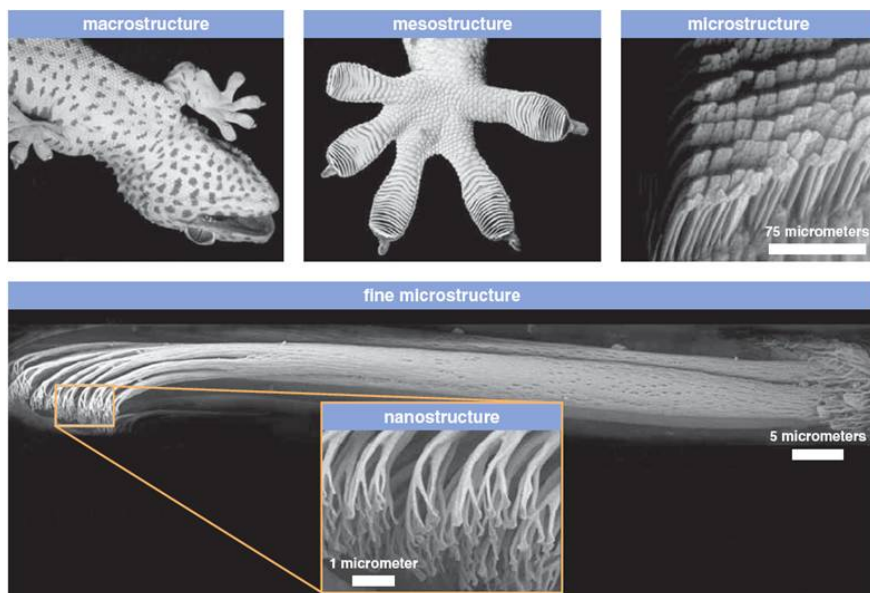

Fig. 1.12 The hierarchical structures on a gecko's foot. Source: Kellar Autumn, CC BY-CA 3.0, https://en.wikipedia.org/wiki/Gecko_feet

Since these structures are the ones in contact with the surface, they are the ones that are studied most carefully in terms of friction and adhesion capacity, considering the forces acting on them.

Kendall's model (Kendall 1975) makes it possible to study how a tape behaves when it is detached from a surface through the interaction of three terms, elastic, potential and surface. The equation, quadratic in F/b , which groups them is as follows.

$$\left(\frac{F}{b}\right)^2 \cdot \frac{1}{2hE} + \frac{F}{b} \cdot (1 - \cos \vartheta) - G = 0 \quad (1.1)$$

Here $F=F(\vartheta)$ is the force needed to detach the tape – the gecko's leg –, b the width of the tape – the *spatula* pads –, h the thickness, E the elastic modulus, ϑ the angle of detachment, and G the breaking energy, which is needed to break a unit area of surface at a detachment angle of 90° . A difference we have to note is that Kendall's model does not include any term referring to friction, which for gecko must be considered.

The two terminal levels in the hierarchy of gecko structures, those dedicated to adhesion on surfaces, are the *setae* and the *spatulae*. Let us see how the study of adhesion and friction mechanisms between a single *spatula* and the substrate is treated in literature.

$$E_x = E_0 \sin(2\pi x/x_0) \quad (1.2)$$

so that the friction force is:

$$F_f = -\frac{dE_x}{dx} = -\frac{2\pi E_0}{x_0} \cdot \cos\left(\frac{2\pi E_0}{x_0}\right) \quad (1.3)$$

where x_0 is a spacing that refers to the atomic lattice, or the size of the asperities on the surface of the *spatula* and the substrate. When $E_x = 0$, then $F_L = F^{max_f}$ and the maximum static frictional force, in the absence of external load, between the two contacting surfaces is obtained. If a force greater than this is applied, the surfaces begin to slip and then slide. If, on the other hand, $F_L \leq F^{max_f}$, the friction force becomes $F_L = F_f$, and the surfaces remain in contact, although some extremely slow microslip cannot be excluded.

The Lennard–Jones model, which includes an attraction energy E_A and a repulsion energy E_R , allows us to calculate the normal potential E_z and the force F_{vdW} between the two surfaces along the z direction.

$$E_z = -E_A \left(\frac{z}{z_0}\right)^{-n} + E_R \left(\frac{z}{z_0}\right)^{-m} \quad (m > n) \quad (1.4)$$

and:

$$F_{vdW} = -\frac{dE_z}{dz} = -nE_A \left(\frac{z}{z_0}\right)^{-(n+1)} + mE_R \left(\frac{z}{z_0}\right)^{-(m+1)} \quad (1.5)$$

when E_z has the minimum value, $F_{vdW} = 0$ with a gap between the surfaces D_0 . When the two surfaces are compressed against each other, $D < D_0$ and the force F_{vdW} is repulsive,

while if it is $D > D_0$ the force is attractive and reaches a maximum value $F_n = F_{vdw}^{max}$, when the surfaces separate spontaneously.

The maximum attractive force calculated per unit area, if $D < D_0$, can be approximated with the relation:

$$P_{vdw}^{max} \approx \frac{A}{6\pi D_0^3} \quad (1.6)$$

where A is the so-called Hamaker constant (1905–1993), a parameter that relates the Van der Waals energy to the distance separating two molecules. If, on the other hand, $D > D_0$ the relation must be corrected in the following:

$$P_{vdw} = \frac{A}{6\pi D^3} \quad (1.7)$$

At steady state there are three forces acting in three precise zones. The first is the contact region, where the Van der Waals force is balanced by the steric repulsive surface forces: here, obviously, the overall force acting on the blade has zero resultant. The second zone is the detachment zone, where the force F_{vdw} of the blade is balanced by the force $F(\vartheta)$ along the axis of the blade itself. The third is where the Van der Waals force is negligible and where the tensile force is $F(\vartheta)$ along the axis. We can write:

$$F(\vartheta) = F_n \sin \vartheta + F_L \cos \vartheta \quad (1.8)$$

The bending force $F_b(\vartheta - 90^\circ)$ can be neglected because the bending inertia of the individual spatula is also negligible. The individual components of (1.8) are:

$$F_n = F_{vdw} = F(\vartheta) \sin \vartheta \quad (1.9)$$

$$F_L = F_f = F(\vartheta) \cos \vartheta \quad (1.10)$$

The following integral allows the calculation of the attractive force in the detaching area.

$$\begin{aligned} F_{vdw} &= \int_0^\vartheta \frac{A}{6\pi D^3} \cdot bR \, d\phi \\ &= \int_0^\vartheta \left\{ \frac{A}{6\pi [D_0 + R(1 - \cos \phi)]^3} \right\} \cdot bR \, d\phi \end{aligned} \quad (1.11)$$

where the denominator expression has been expanded taking into account that the radius R of the *spatula* is related to the critical separation distance from the relationship:

$$R = \frac{D_c}{1 - \cos \vartheta} \quad (1.12)$$

and D_0 represents the distance between the surfaces.

It is possible to evaluate the Van der Waals force from the expression of the force between a plane surface and a cylinder whose radius is half of R :

$$F_{vdw} = \frac{Ab \sqrt{R}}{16\sqrt{2} D^{5/2}} \quad (1.13)$$

Equation (1.6) can be used to give an estimate of the attractive component $F_{c,vdW}$ in the contact region which allows the contribution of the adhesion force to the friction F_t to be calculated. If the values $A = 0.4 \times 10^{-19} J$ and $D_0 = 0.3 \text{ nm}$ are considered as the separation distance of two surfaces, the equation leads to the following value $P_{c,vdW} = 80 \text{ MPa}$. In the contact region, the net attractive force is:

$$F_{c,vdW} = L_c \cdot b \cdot P_{c,vdW} \quad (1.14)$$

where $L_c \cdot b$ is the contact area between the *spatula* and the *substrate*. The maximum friction force, using the result shown in (Urbakh, Klafter, Gourdon and Israelachvili 2004) for the friction coefficient:

$$F_t^{max} = \mu F_{c,vdW} \quad (1.15)$$

where μ is the coefficient of friction. Since this coefficient, for a polymer that is rubbed against a chemically inert surface, or Van der Waals surface, varies on average between 0.2 and 1.0, one can estimate F_t^{max} to be around 900 nN–4500 nN. It has not been possible to directly measure the friction force of a single spatula yet. Instead, a friction test for a single silk was done years ago (Autumn *et al.* 2000) and showed that the maximum friction force of a single silk is around $\approx 200 \mu\text{N}$. If we estimate, for a single silk, a number of *spatulae* varying between 100–1000, then the value of F_t^{max} is around 200 nN–2000 nN, in agreement with the theoretical prediction.

As is well known, one cannot have a high adhesion normal force F_n for small pull angles, if the lateral friction force is high. The total normal force can be written as:

$$\begin{aligned} F_n(\vartheta) &= F(\vartheta) \sin \vartheta \\ &= (F_f \cos \vartheta + F_{vdW} \sin \vartheta) \cdot \sin \vartheta \\ &= 0.5 F_f \sin 2\vartheta + F_{vdW} \sin^2 \vartheta \end{aligned} \quad (1.16)$$

If the value $F_{vdW}(10^\circ) = 70 \text{ nN}$ is applied, it is possible to observe that for high angular values, i.e. for $\vartheta > 60^\circ$, the term F_{vdW} gives the greatest contribution to the value of $F_n(\vartheta)$,

while for small angles, i.e. $\vartheta < 30^\circ$, it is F_f that provides the most significant contribution to the total normal force. The highest adhesion force is obtained for small angles ϑ and this is fundamental to understand how these reptiles manage to exert such a large adhesion force that they can run on ceilings.

The contributions to the total lateral force are:

$$\begin{aligned} F_L(\vartheta) &= F(\vartheta) \cos \vartheta \\ &= (F_f \cos \vartheta + F_{V_{dW}} \sin \vartheta) \cdot \cos \vartheta \\ &= 0.5F_{V_{dW}} \sin 2\vartheta + F_f \cos^2 \vartheta \end{aligned} \quad (1.17)$$

When the angle ϑ becomes small, the friction reaches very high values and justifies why the gecko can hang from the ceilings.

When the *spatulae* are placed on the surface, they form an angle of about 30° with the silk and are practically orthogonal to their support structure so, when they adhere to the substrate, the angle between the spatula support and the latter will be close to 90° , with a low adhesion force, which has been measured at about $8\mu\text{N}$. When the gecko, however, takes hold on the surface, the angle that can be measured between the silk backing and the surface is reduced in a range between 0° and 30° , which is in the range for which the adhesion force has been shown to be maximum. For an angle around 10° , the calculation resulted in a value of $200\mu\text{N}$.

This may be the scientific explanation for the behaviour of the gecko's legs and thus their ability to remain firmly attached to surfaces and run on ceilings.

Finally, in order to evaluate the detachment force applied to a silk, if N is the average number of *spatulae* present on a silk that detach instantaneously, B the length of the total support of the *spatulae*, v the detachment speed and $T = B/v$ the detachment time of a single silk, we have:

$$\begin{aligned} F_{n\text{-seta}} &= \frac{1}{T} \int_{t=0}^{t=T} N F_{V_{dW}} \cdot \frac{(B - vt)}{L} dt \\ &= N F_{V_{dW}} \cdot \frac{B}{2L} \end{aligned} \quad (1.18)$$

where L is the projection of the silk support on the surface (Tian *et al.* 2006).

Another of the best-known examples of the presence of nanostructures in Nature is that of the surface of lotus leaves (*nelumbo nucifera*). In the course of evolution, this plant has perfected itself, developing exceptional water-repellent properties, properties that are now being studied in the laboratory and applied to advanced materials, although it is not yet possible to reproduce Nature's perfection exactly in this case.

The leaf of the lotus, or rather the upper page of the leaf, is the most super-hydrophobic of those that can be found in the plant kingdom, because it is able to develop a contact angle with water of up to 170° and a sliding angle of 5° , a characteristic that allows the leaf to remain clean even in muddy environments, i.e. to quickly remove the raindrops that fall on it during rainy seasons, thus removing, thanks to the watery spheres, any dirt and debris that may be present. This is because the adhesion between water and dust is greater than the adhesion between dust and leaf.

This characteristic of the leaf is known as the “lotus effect”. In 1997, Wilhelm Barthlott and Christoph Neinhuis observed the unique structure of this plant under a scanning electron microscope. The leaf structure is organised in a cuticle and an epicuticular wax coating. This makes it possible for the plant to trap air under the water droplets and give rise to superhydrophobic behaviour.

The way in which a drop of water interacts with a surface allows it to be classified as hydrophilic, hydrophobic and superhydrophobic (Fig. 1.13). This classification is usually related to the angle the droplet forms with the surface; when this angle is less than 90° , the surface is hydrophilic, when the angle is greater than 90° the surface is hydrophobic, and when the angle is greater than 150° the surface is superhydrophobic.

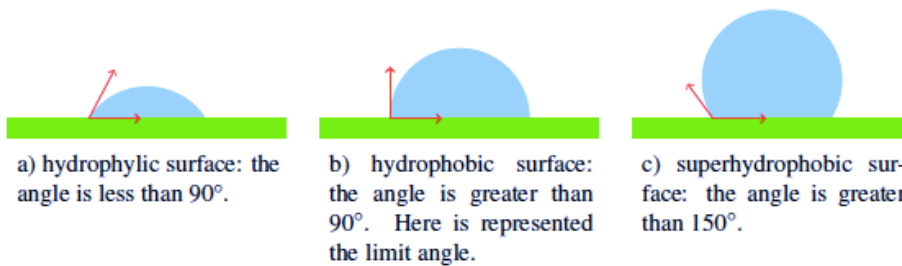

Fig. 1.13 A schematic description of the behaviour of a surface where a waterdrop lies. Source: AD, designed with Tikz L^AT_EX package

In order to understand how the wettability of a surface and its roughness are related, the Wenzel and Cassie–Baxter models have been proposed (Fig. 1.14). They illustrate how a drop of water can occupy the interstices of a rough surface (Wenzel 1936) or rest on the asperities, avoiding interstitial locations (Cassie and Baxter 1945).



Fig. 1.14 A schematic description of the models proposed when a water droplet (blue) lies on a rough surface (in gray). Source: AD, designed with Tikz L^AT_EX package

In the latter case, the asperities allow the air to wedge below the water droplet, which results in the water having a high contact angle with the surface.

Let's see how these models differ, from a mathematical point of view.

According to the Wenzel model, as we have seen, the liquid wets both the roughness and the interstices of surfaces that are chemically inhomogeneous. The apparent contact angle, denoted with ϑ_w , of a droplet on a rough surface is calculated with the equation:

$$\cos \vartheta_w = r_w \cos \vartheta_E \quad (1.19)$$

where r_w is the roughness factor, which is defined as the ratio between the effective area of the rough surface and the geometric projection of the area considered. This factor, as defined, is always greater than unity. In the equation, ϑ_E is the angle of equilibrium of the liquid droplet on a flat surface.

When, on the other hand, we are dealing with a heterogeneous surface, the contact angle predicted by the Cassie–Baxter model, where the droplet is supported by the roughness of the surface, is defined by the Cassie–Baxter equation:

$$\cos \vartheta_{CB} = f \cos \vartheta_E + f - 1 \quad (1.20)$$

where f is the fraction of the surface area of the solid area that is wetted by the liquid (Jia, Lei, Yang and Wang 2016).

1.1.3.2 Industrial and Engineered Nanomaterials

Before talking about industrial and engineered nanomaterials, I believe it is worth talking about one of the most well-known scientists in the History of Physics that, absolutely by chance, found himself with a nanoparticle solution unintentionally obtained, something that is not uncommon in a laboratory.

Among those who gave an impetus to the study of nanomaterials in colloidal suspensions, and among these materials gold, in particular, we should certainly mention Michael Faraday (1791–1867) who, in the mid-1800s, quite by chance realised that he had created a ruby red solution while preparing slides for microscopic observation of thin gold leaves. Faraday's interest in studying the properties of light as well as matter led him to publish his *Bakerian Lecture* (Faraday 1857) in 1857, in which he detailed his study of the experimental relationships between light, gold and other metals, having prepared the first sample of what he called activated gold in the same year. By using phosphorus to reduce a solution of gold chloride, Faraday achieved one of the earliest known examples of colloidal gold, a solution that is still optically active today. Faraday was able to attribute the ruby red colour of the preparation to the very small size of the gold particles in suspension; the light scattering phenomenon observed by Faraday is now known as the Faraday–Tyndall effect. Faraday knew that gold foils could be shrunk to 1/282000th of an inch, approximately 10^{-8} m, and were able to transmit green light, reflect yellow light and absorb a portion of light incident upon it. Faraday actually used foils made of an alloy in the proportion of 12 silver, 6 copper and 462 gold; according to the scientist himself, 2000 such foils weighed about 384 grains, just under 25 grams. One of the 2,000 leaves Faraday is also said to have used, weighing a total of 408 grains, an average of two-tenths of a grain per leaf, gave a yellow–orange reflection of light and a warm green transmitted light. By chemically attacking the leaves with chlorine or potassium cyanide, their thickness could be reduced to the point

where virtually white light could pass through. Part of the process of preparing the leaves for observation involved rinsing the gold to produce a pale red solution. Faraday stored samples in bottles and used them for transmitted light experiments. Faraday is a scientist known not only for his results, but also for the meticulousness of his laboratory notes which he kept for about thirty years, starting in 1832, numbering each paragraph for quick reference, from 1 to 16041. The experiments on ruby fluids can be found here:

March 25 to April 7. 14591–14647, 14651–14654 Ruby fluids and deposits. Heated films: pressure effects with agate. Fluids with particles in suspension: their colours by reflected and transmitted light. Light transmitted by gold leaf (Faraday 1856).

Faraday had also thought to use phosphorus to reduce gold “in an excessively subdivided condition”. He observed that:

If the solution be weak and the phosphorus clean, part of the gold is reduced in exceedingly fine particles, which becoming diffused, produce a beautiful ruby fluid (Faraday 1857, p.159).

This can be considered the first historical realisation of metallic gold colloids, based on nanoparticles randomly obtained from the gold processing.

As I will describe in detail further on, in Chapter 4, the 1970s and 1980s saw the convergence of scientific discoveries in terms of research apparatuses such as STM and AFM microscopes, definitions – such as the very definition of Nanotechnology – and the first results, for example the manipulation of xenon atoms, which proved the effective possibility of directly operating at the nanometric and atomic scales. The invention of the STM microscope, by Gerd Binnig and Heinrich Rohrer, of the IBM Research Laboratory in Zurich, opened up the possibility of intervening on matter at dimensions that had previously been inaccessible. It was in that period, as a matter of fact, that the manipulation of matter began in practice, and exactly according to the definition of Nanotechnology: man was able to intervene on the deepest basis of matter to radically modify it, according to his own purposes. Only a few years later, in 1986, the introduction of the AFM microscope would have removed the operational limitations that had characterized and, in some ways limited, the use of the STM microscope. Not only that, but this instrument would prove to be of fundamental importance in supporting Scanning Electron Microscopy, whose results are excellent in terms of visualization for particles above 5nm, allowing the analysis of a very wide range of samples, from the non-conductive ones, to organic molecules. It is important to understand that, when the creation of ever more sophisticated materials is pursued, being able to observe the structure on such a small scale becomes of fundamental importance. Electron microscopy not only allows to physically see the structure of matter, but also to intervene on it, and this feature led to lab-engineered nanomaterials.

Artificial nanomaterials are those materials designed and made by man, in which more than 50% of the particles that constitute them have, according to the definition, a variable size between 1nm and 100nm. One of the reasons why these materials are made is, for example, that the properties that are observed at the nanometer size are completely new, or virtually undetectable in the bulk material. From a technical point of view, what is important to consider is that the ratio between surface and volume that can be obtained when materials of this type are made. As this ratio increases as the diameter of the particle decreases, we observe the confinement of a greater number of atoms on its outer surface. The smaller number of nearest neighbour atoms that can be counted for the atoms on the surface, compared to those inside it, means that fewer chemical bonds are committed to the cohesion between the atoms placed on the surface, therefore these are characterized by a greater reactivity, a characteristic that is then transferred to the whole particle.

Engineered nanoparticles and nanomaterials are part of that group of innovative products that are primarily intended for commercial application. The main ones include fullerene, carbon nanotubes, graphene, quantum dots and dendrimers.

Fullerene is a molecule whose three-dimensional structure is made up of 60 carbon atoms, organized at the vertices of pentagons and hexagons, and which closely resembles the shape of an old-fashioned soccer ball. This molecule was discovered in 1985 by four scientists from Rice University, Texas, specifically Richard Smalley, Robert Curl, Sean O'Brien and James Heath, and by Harold Kroto, of the University of Sussex. The discovery earned Kroto, Smalley and Curl the Nobel Prize in Physics in 1996. In fact, the first experimental evidence of the presence of such a molecule must be traced back in time, to the previous year, when Exxon researchers had a tangible proof of the existence of a cluster structure of 60 carbon atoms performing mass spectrometry analyses but, being concentrated on searching for new catalysts, they did not immediately grasp the importance of their observation. Again, in 1970 Professor Eiji Osawa (Osawa 1970), professor of computational chemistry, was able to predict the existence of a molecule whose carbon atoms would be bound together in space, just like in fullerenes, but the language barrier constituted by Japanese very much limited the diffusion of the article in which Osawa presented his discovery of this molecule.

The extremely particular structure of fullerene is the reason for its interesting properties. The most immediate property is the shape of the molecule: if we look at it under an electron microscope, the fullerene molecule really looks like a small soccer ball. A similar thing could not be said for the other molecules, whose formulas are reported on paper to visualize atoms and bonds in an abstract way, but which in fact represent models that we hardly actually observe, especially in conditions of resonance of chemical bonds.

In 1991, a Japanese researcher from NEC Corporation, Sumio Iijima, discovered an entirely new class of fullerenes, while trying to make his fullerenes through arc evaporation. This new class of materials consisted of so-called carbon nanotubes. The nanotubes that Iijima discovered are what we can define as multi-walled nanotubes, that is, multiple nanotubes of different diameters, coaxially encased one with each other, such as Russian matryoshka dolls. Actually, the first observation of these structures should be backdated to 1952, when Radushkevich and Lukyanovich first observed similar structures (the reader will find the necessary insights into these topics in chapters III and V), but once again the linguistic barrier, constituted from the Russian, and the historical situation relating to the Cold War, prevented the spread of their writing to Western scientists. We can think of a carbon nanotube as a single molecule entirely made up of carbon, a single sheet of graphene, with its planar structure of hexagonal cells, rolled up on itself to form a cylinder. Although the diameter of these nanotubes is small, the theoretical limit seems to be around 0.4nm, their length can even reach a few centimetres, like DNA which, despite having a diameter of nanometric dimensions, can extend up to half a meter, in the chromosomes of mammals. The mechanical properties measured on the carbon nanotubes proved to be very interesting. They are as resistant as diamond and their thermal conductivity is comparable to that of the diamond itself. Their strength is greater than that of steel, although the density is reduced to one sixth, nanotubes are flexible, elastic and have some shape-memory that causes them to return to their original shape even after being subjected to deformation, be it elongation or even bending around support structures. Carbon nanotubes are used as additives of the polymeric composites to which they confer resistance and in fact have supplanted previous carbon fibres, which while performing the same mechanical function, were characterized by greater weight and rigidity.

Conceptually, graphene is an easily explained material. It is, in fact, a single sheet of graphite. In other words, graphene is a two-dimensional structure of carbon atoms arranged on the vertices of regular hexagons, which tessellate the plane according to the rules of plane geometry (Fig. 1.15).

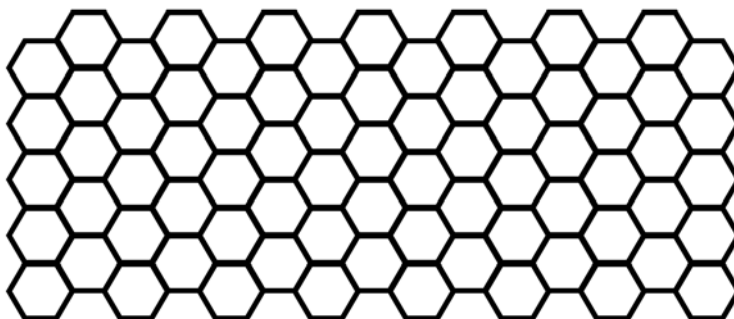

Fig. 1.15 The way we can imagine one single layer of graphene. Source: AD, designed with chemfig L^AT_EX package.

Graphite consists of sp^2 hybridized carbon planes, with σ and π bonds contained within each individual layer; the different planes are held together by weak Van der Waals interactions, which allows graphite to be an effective writing material. When it is dragged onto the paper, the Van der Waals forces are unable to hold together the individual planes, that settle then on the sheet leaving the trace of the writing. It is also possible that individual layers of graphene may be found on that sheet. One of the simplest and most commonly used methods to obtain this material is the so-called scotch-tape method: a graphite crystal is placed on the surface of an adhesive tape. The ribbon is detached from the crystal and then folded back on itself and opened several times in correspondence with the imprint left by the graphite. In this way it is possible to detach the individual layers from each other, and recover portions of graphene that can be easily transferred to a sample holder for subsequent analysis. Although this system, as a result of the intuition of André Geim, the scientist who with Konstantin Novoselov isolated the first atomic layer of graphene in 2004, is easy to implement in the laboratory, it is not difficult to understand that it cannot be applied on a large scale, for large industrial production. Yet, this stratagem solved an age-old problem that tormented researchers since 1947, when the structure of graphene had been theoretically hypothesized, but, at the same time, being able to isolate a single atomic layer of material seemed impossible.

1.1.4 Nanomaterial Manufacturing Techniques

Nanometric objects have existed in nature since time immemorial, and long before mankind became aware of them. However, when they were discovered, and their high technological potential was revealed in all its importance for the most diverse applications, the industrial development of new production techniques became necessary, in order to manufacture these

objects under constant laboratory and technological control. Nanomaterials should not be regarded as a futuristic class of object, but are applied in a variety of products that are available to practically everyone, from nanodevices for electronics to self-cleaning glass, from nanomaterials for medicine to antibacterial fabrics, and the way in which nanometric materials are manufactured depends on their end use.

There are two distinct ways to fabricate engineered nanomaterials.

The first is called the “top-down” approach and starts with a bulk block of material whose size is progressively reduced until the desired size is achieved. The smallest limit to which one can go depends, of course, on the tools available.

The second approach is called “bottom-up” and makes use of building blocks, so to speak, ranging in size from atomic to more complex basic molecules, which are assembled together to create larger objects.

The bottom-up method has been chosen by various organisms, for example, as one of the tools suggested by nature to build complex organic higher systems, while the top-down method has become the standard procedure for microtechnology applied to electronics, for example.

In top-down machining, when starting from a block of bulk material, it is necessary to be able to intervene selectively on the material. In this mode of operation, selective engravings are made on the material using a lithography process. Masks are then placed on the workpiece, through which a precise pattern is reproduced on the substrate.

The top-down methodology for manufacturing nanoscale devices is now widely practised in industry. A number of techniques have been developed using this approach, which is conceptually very simple: it consists of starting with a massive block of material, removing what is superfluous and then working on it, like a sculptor who frees his statue from the inside of a rough block of marble. Top-down processes make it possible to obtain many of the objects that enable our electronic devices to work, such as integrated circuits, which are themselves made up of several billion transistors. Not only transistors but also motion sensors, lab-on-chips used in modern medicine and photonic crystals are examples of nanodevices obtained by this process.

Since the transistor is the key element of modern electronics, I will describe the most established top-down techniques for the realisation of this device, in which the components must be arranged in a very precise order, according to a well-defined geometry. In principle, the construction of a transistor is based on the processing of various materials on a substrate of silicon, a semiconductor material whose properties at room temperature make it the most important material in electronics, being obtainable in extremely pure form, in the form of a single crystal. Silicon serves as a substrate for the deposition of other materials in the form of thin films of the order of a few atomic layers, and the techniques that have been developed over time allow extremely fine processing that is practically contaminant-free, thanks to the conditions in which it can be carried out. The technique to be chosen will depend on the object we want to manufacture and the thicknesses which, depending on the object, must be obtained.

The top-down approach is applied to chemical and physical procedures.

1.1.4.1 Soft lithography

Soft lithography uses a stamp made from an elastomer material, on the surface of which structures are modelled to create nanoimprints ranging in size from 30nm to 100µm. Soft

lithography is an inexpensive and effective methodology for creating nanostructures. The soft lithography technique uses stamps made from polydimethylsiloxane (PDMS), as stamps of this material adhere well to surfaces and can be easily removed from rigid masters (Fig. 1.16).

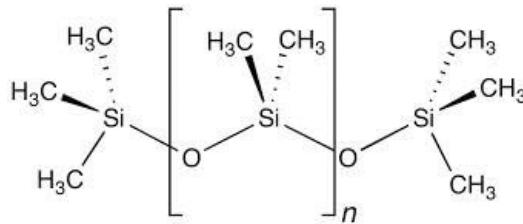

Fig. 1.16 The structure of PDMS. Source: public domain.

To obtain the stamp for further processing, the liquid elastomer is poured into a rigid master on which the patterns to be replicated are made. The mixture is then heated to a high temperature and solidifies in the process. Once hardened, the PDMS is peeled off in the form of a stamp shaped according to the pattern made on the starting rigid master.

Soft lithography is applied in two preferred ways, microcontact printing and capillary microprinting.

With microcontact printing, the pattern is transferred onto the surface of the substrate by means of an inked stamp that is adhered to the substrate. An alcohol-based solution of alkanethiols is the “ink” that is most commonly used in this technique; the traces that are left on the substrate are made from the shaped protrusions on the elastomeric pad, which has been previously modelled (Fig. 1.17).

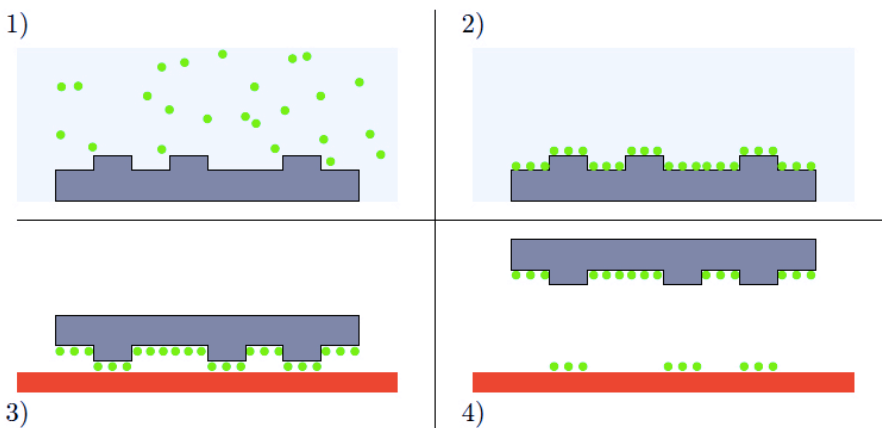

Fig. 1.17 The main phases of the microcontact printing. 1) The ink is deposited on the substrate where 2) it adheres to all the surface. 3) The stamp is put on the substrate and 4) then removed. The ink is transferred from the stamp to substrate. Source: AD, designed with TikZ L^AT_EX package

Through the technique of micromoulding in capillaries (MIMIC), channels are cut into the mould which, once the pad has been placed on the substrate, delimit the track into which the liquid to be polymerised is injected. By capillary action, the liquid fills all available cavities along the track and is then polymerised. Once the mould has been removed, the liquid that has solidified remains on the surface of the substrate, leaving the designed track on the substrate (Fig. 1.18).

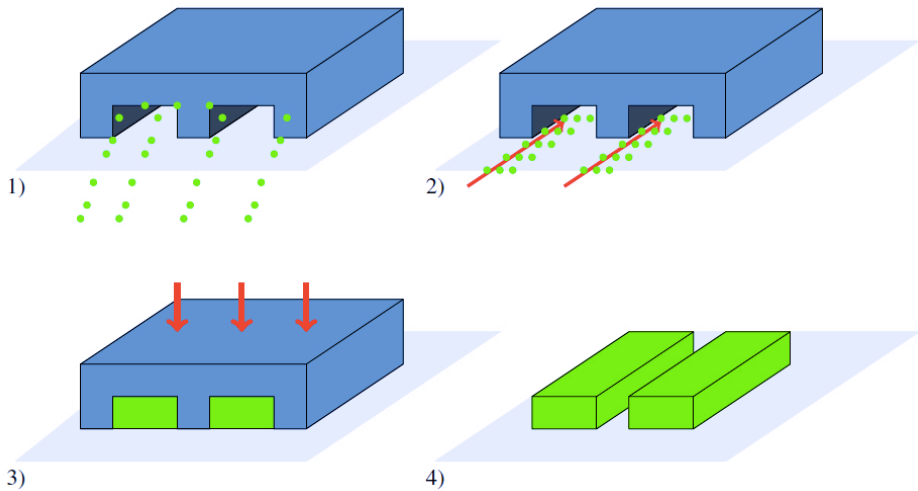

Fig. 1.18 The main phases of the MIMIC. 1) The stamp adheres to the substrate and 2) by capillarity the fluid fills the cavities in the stamp. 3) The stamp is heated to solidify the polymeric fluid and 4) once the stamp is removed, the traces remain on the substrate. Source: AD, designed with TikZ L^AT_EX package

1.1.4.2 Physical Vapour Deposition

In micro- and nanofabrication of devices, and deposition on a metal substrate, the process of thin film deposition is used. Physical Vapour Deposition (PVD) is the technique of depositing material onto a substrate – called a wafer – both contained within the same clean chamber. This process takes place through a series of sequential steps. First, the material to be deposited is converted into vapour; this vapour is then passed through a low-pressure region from the source to the substrate. On the substrate, the vapour condenses to form a thin film. By controlling the condensation phase, it is possible to adjust the thickness of the film from a few nanometres up to thousands of nanometres.

A physical deposition technique is sputtering. A target material is hit with argon atoms, produced in direct current or through a plasma, to eject atoms that are sent towards the substrate where they form a thin film. Through this technique, the deposition of the film is very carefully controlled.

In the sputtering technique, a target material is targeted with argon ions; this action removes atoms from the target and ejects them towards the substrate. Argon ions hitting the target are produced using a direct current (DC) or RF plasma. Sputtering allows better control of the composition of multicomponent films, and greater flexibility in the types of materials deposited

(Fig. 1.19). Plasma-based sputtering is the most common form of sputtering, using positive ions accelerated towards the target, which is held at a negative potential relative to the plasma.

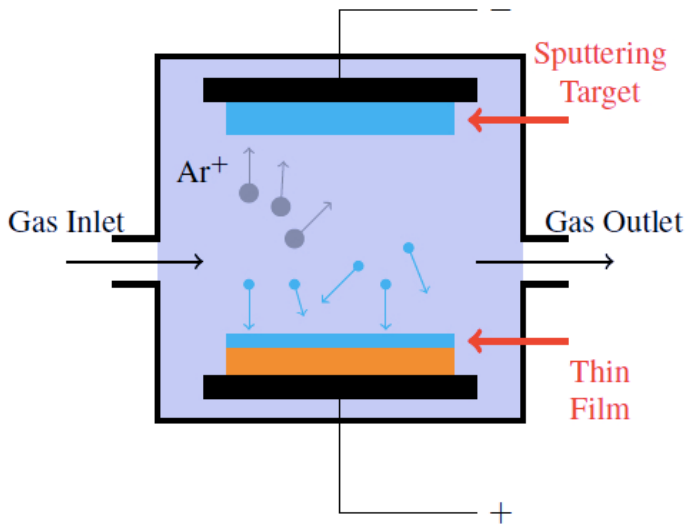

Fig. 1.19 A simplified scheme of the PVD technique. Source: AD, designed with TikZ L^AT_EX package

The technique based on metal evaporation involves the use of a small melting pot in which the metal to be melted is placed and brought to a temperature where it evaporates. Operating in a high vacuum, inside a chamber in which the crucible and substrate are placed, and exploiting the high vapour pressure, the atoms that have evaporated from the liquid are deposited on the substrate.

1.1.4.3 Chemical Vapour Deposition

It is possible to make nanomaterials from precursors that react chemically in the vapour phase and then deposit and give rise to the required end products. This production technique is Chemical Vapour Deposition (CVD). In CVD, the flow of one or more starting gases is conveyed into an oven in which the reheated object, or objects, to be coated are contained. As they flow past the heated substrate, the materials contained in the gas phase undergo decomposition when they react with the surface. The reaction by-products accompanying the process are removed from the oven in the gas stream that did not take part in the reaction. The precursor gas, typically a hydrocarbon, decomposes due to the high temperature or in the presence of a plasma. Catalysts based on transition metals, the d-block elements (mainly iron, nickel, cobalt or molybdenum), help to increase the reaction rate.

CVD processes also include low-pressure CVD (LPCVD) and plasma-enhanced CVD (PECVD). LPCVD is carried out inside low-pressure tubes (kept around 13Pa to 130Pa) heated through electrical systems at temperatures between 550°C and 900°C.

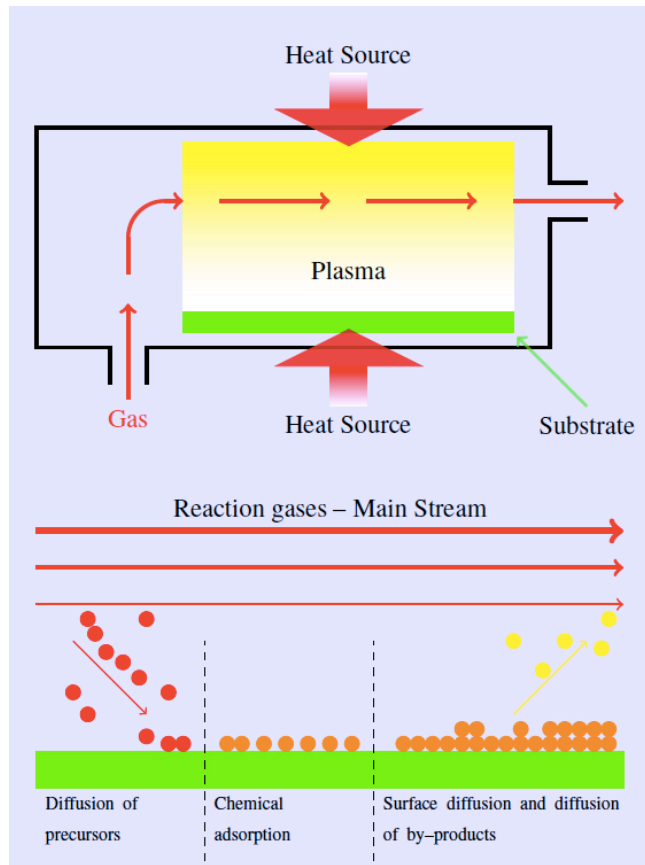

Fig. 1.20 The diagram of CVD process. In the upper part of the picture a simplified apparatus is depicted, while in the lower part I represent a schematic process of what happens on the substrate. Source: AD, designed with TikZ L^AT_EX package

Figure 1.20 shows the main steps of a CVD process. First, the precursor gas is introduced into the furnace and then decomposed through heat or plasma. Then the gas is adsorbed onto the surface of the substrate and reacts there to form the required nanostructures. The reaction sub-pipelines are ejected from the furnace.

Radio frequencies are used in PECVD to create the reactive species within the plasma that will also adhere to the substrate. In this way, the operating temperatures of the chamber are lower, because part of the plasma energy replaces the heat, allowing the precursor to decompose at a lower temperature.

1.1.4.4 Etching

The etching process allows traces to be made on the surface of the material to be processed-. The traces describe the topography of the object to be produced. Surface processing can be carried out by means of physical devices, or through well-defined chemical attacks. The etching technique uses liquids or gases, and the resulting engraving is called isotropic if it is

uniform in all directions, or anisotropic if there is a preferred direction of engraving. In the first case, the walls obtained in the material have a characteristic semi-circular shape and are wider than the opening of the tracing mask. Conversely, if the incision to be made is anisotropic, the dissolution of the material being attacked occurs more quickly in the vertical direction and the incision has almost straight vertical walls.

The etching technique can be carried out dry, so-called dry-etching, or by immersion in liquid solvents, so-called wet-etching.

Wet-etching is based on immersion of the wafer in a reactive solution, from which the solution diffuses over the surface of the material to be processed. At this point, the chemical attack on the oxide and the removal of the reaction by-products takes place. It must be said, however, that the minimum size of the material that can be obtained is limited to 3µm, due to undercutting phenomena, i.e. the presence of areas of material that prove to be inaccessible.

The dry-etching technique allows the oxide to be worked with little undercut and therefore the incisions that are made are sharper and smaller than those obtained through wet-etching. In addition, dry-etching avoids the use of solvents or acids, which can be dangerous for the operator. From a plasma, ions are obtained which are directed towards the wafer to perform the processing. The action of the ions breaks the bonds of the surface atoms, removing them out of position and leaving them free. Since the ions are strongly vertically directed, collisions occur preferentially with the horizontal surface and, as a result, the engraving is characterised by very sharp vertical grooves. The transfer of the pattern from the mask to the wafer is thus very precise and only takes place at the location of the pattern (Fig. 1.21).

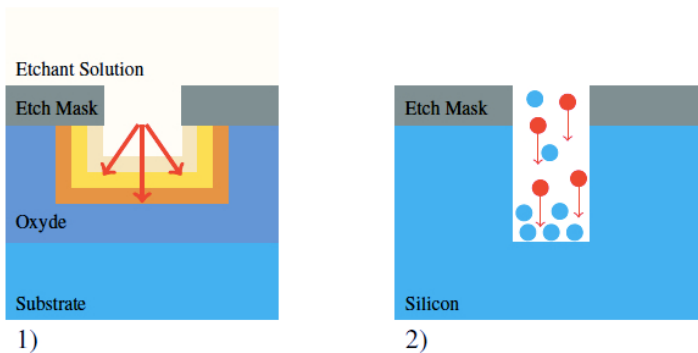

Fig. 1.21 The etching process. 1) wet-etching, 2) dry-etching. It has to be noticed how the dry attack results in a more precise pattern transfer. Source: AD, designed with TikZ L^AT_EX package

1.1.4.5 Electron Beam (E-Beam) Lithography

Integrated circuits, channels for injecting nanofluids and photonic crystals are just some of the devices that are manufactured using a technique known as electron beam lithography. Using an electron beam, it is possible to carry out extremely precise processing between 5 and 7 nanometres.

The operating principle of Electron Beam Lithography is simple: the electron beam is passed through a region of a substrate, which is itself covered with a material called resist, forming the desired pattern. When the resist is exposed to the beam, the chemical bonds of the atoms involved in the passage of electrons change. In particular, it is the solubility of these atoms that

is altered during the process. Once the resist has been traced, the material is subjected to a developing solution which acts either on the areas that have been exposed to the electrons or on those that have not, removing, depending on the solution, the resist that has been exposed or that has not been exposed (Fig. 1.22).

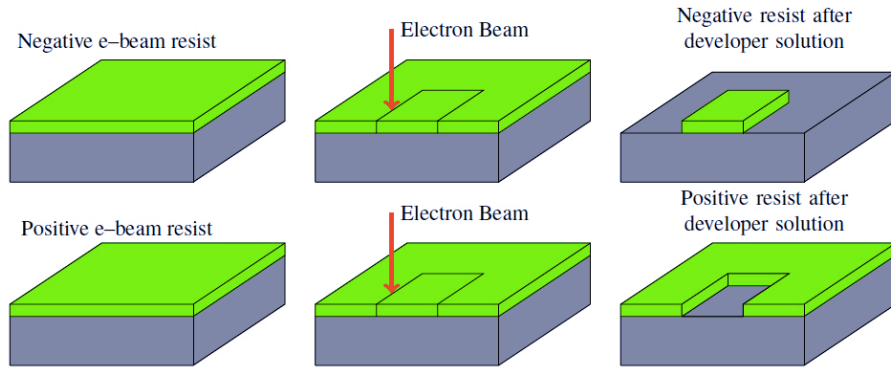

Fig. 1.22 Electron Beam Lithography for negative and positive resist. Source: AD, designed with TikZ L^AT_EX package

Electron beam lithography has many features that are common to scanning electron microscopy (SEM). In fact, it also works with an electron beam that sweeps over a portion of the sample. In this technique, the electrons are obtained from a source that can be thermionic or by using field electron emission sources. The electron beam is collimated with lenses that can be electrostatic or magnetic. It should be noted that magnetic lenses are preferred to electrostatic lenses because the latter suffer from aberration phenomena and do not allow the electron beam to be focused with extreme precision. The system basically consists of an electron source, as described, a chamber housing the sample to be processed, and a column containing the electromagnetic lenses. The column and the sample chamber are kept under high vacuum.

1.1.4.6 Focused Ion Beam

A technique known as Focused Ion Beam (henceforth FIB) has made its way into materials science or the semiconductor industry. With FIB, sites in biological tissue can be precisely analysed, materials can be selectively deposited, or material can be selectively removed from the sample; in fact, this technique is preferably used for milling samples. FIB also has features that make it similar to SEM microscopy, however, the major difference is that whereas an SEM microscope uses an electron beam to scan the sample, FIB uses an ion beam. FIB preferentially uses gallium ions, although it is possible to use gold or iridium sources.

The sensitivity of this technique is very high, as the ion beam that will be collimated by the electronic lens can be narrowed down to 2nm at the source. When the beam strikes the sample, the ions interact with the sample atoms, resulting in collisions that are both elastic and inelastic. Elastic collisions lead to sputtering of atoms, while inelastic collisions produce secondary electron and X-ray emission. The ions and electrons extracted from the sample can be used to create an image of the sample (Pradeep 2007).

1.1.4.7 Photolithography

Increasing the power of electronic devices and simultaneously decreasing their size are two fundamental achievements that have been made possible by the processing of materials using a technique known as photolithography. As the name of this technique suggests, photolithography is a technique based on a photographic process.

Light is projected onto a mask which reproduces the circuit model to be produced. In this way, the light projects, through the mask, the trace to be made onto a wafer covered with a photoresist material, which is sensitive to light. Resolution accuracy is achieved by varying the wavelength of the incident light: shorter wavelengths – and therefore higher radiation energies – correspond to better resolutions.

To prepare the wafer, a technique known as spin coating is used: a small part of the coating material is placed on the centre of the wafer, which has a circular geometry. The wafer is then spun around its own axis in a vacuum chamber. In this way, the coating is spread evenly over the substrate by centrifugal force, without bubbles or other imperfections forming. The vacuum ensures the adhesion of the coating material to the substrate. To print the designed pattern, a photomask is placed on the substrate and irradiated with ultraviolet light to transfer the pattern onto the wafer. The wavelengths used range from near UV (350nm–500nm) to deep ultraviolet (150nm–300nm) or extreme ultraviolet (10nm–14nm). Exposure to light causes a chemical change in the coating, which can be removed by a solution called the developer (Fig. 1.23).

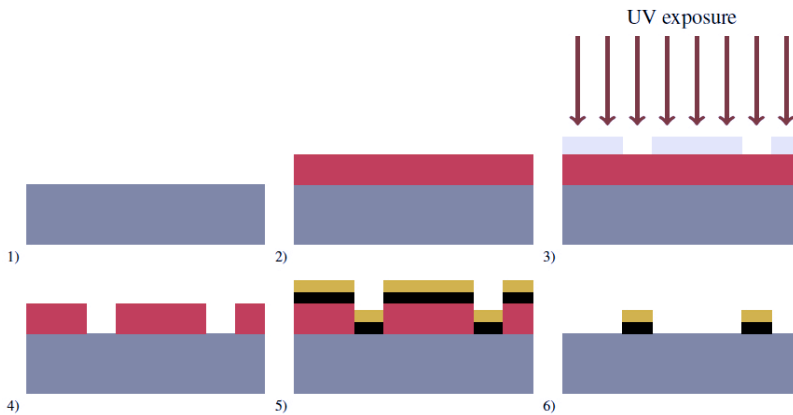

Fig. 1.23 The phases of photolithography. The substrate 1) is covered with the resist 2). After the deposition the mask is applied and the sample is radiated with UV light 3). The exposed substrate is removed 4) (positive resist). 5) Gold is evaporated on the surface and 6) the remaining resist is removed. Source: AD, designed with TikZ L^AT_EX package

The processing of the material depends on the type of resist used, as it can undergo two different transformations under UV light. If the photoresist that is affected by ultraviolet light is positive, the bonds of the atoms in the exposed regions will be attached and will be more soluble in the developing solution. If the photoresist is negative, the atoms will cross-link when exposed to UV radiation and become insoluble in the developing solution, not being removed, unlike the areas not exposed to light.

The production of ever-smaller integrated circuits requires manufacturing techniques that keep pace with electronic progress. For this reason, Extreme Ultraviolet Lithography (henceforth EUV or EUVL) was developed, a technique that differs fundamentally from conventional lithography. Since there are no materials with transparent behaviour for the wavelengths used (around 13.5nm), concave and convex mirrors must be used, each containing alternating layers of molybdenum and silicon, capable of reflecting radiation of 13.5nm wavelength. Machining down to a size of 11nm is possible with this technique. The wavelengths required for the EUVL technique are obtained through plasmas produced by laser devices, when a target is irradiated by a pulsed laser beam.

Compared to the conventional lithography technique, EUVL has a number of advantages. These include:

- construction of structures with maximum detail;
- for the same amount of space, an increase in the number of transistors with a consequent increase in the speed of the devices;
- production of objects of minimum dimensions.

1.1.5 Pioneers in Nanotechnology

The History of Science is made up of dates and characters that have characterized the salient moments. Similarly, the History of Nanoscience and Nanotechnologies is made up of characters and discoveries that, in the last seventy years, have definitively changed the perception of the nanoworld, through results that influence the existence of man, day by day.

In this paragraph we take into consideration those who can be considered the leading figures in the History of Nanotechnology: Richard Feynman, who is considered to be the father of Nanotechnology; Eric Drexler, who took up and expanded the ideas proposed by Feynman and, finally, Norio Taniguchi, who first coined the term Nanotechnology.

1.1.5.1 Richard Feynman, Eric Drexler and Two Debates

Richard Feynman (1918–1988) is very often referred to, in the literature, as the founder of Nanotechnology as it is known today. His name appears in texts, articles, essays, as that of the main inspirer of this new physics.

The reason for this can be found in a famous 1960 article called *There's Plenty of Room at the Bottom* (POR) in which Feynman predicts the wonders of the nanoworld, at a time when the tools that are now part of this science still had to be perfected or made. Actually, this is not an article²⁰ designed for publication in a specialized journal, but a meticulous transcription of a recording, made on December 29, 1959. On that date, Feynman gave a lecture at the Californian Institute of Technology, Caltech, for the American Physical Society Annual Meeting. At that event, an avid attendant of Feynman's lectures taped every word of the future Nobel Prize winner, producing a paper that would be published shortly after, in February 1960, in the Caltech *Engineering and Science* journal. Later in the same

²⁰ Although this script is not technically an article but a transcription, instead, we will refer about it as to an article, from this chapter on, everywhere this work will be quoted in this thesis.

year, *The New Scientist* magazine reported the impressions of the audience attending the lecture.

The Professor literally spun the idea off the top of his mind in an after-dinner talk at an American Physical Society meeting in Pasadena last December. If any news reporters heard it, they betrayed no interest. But the scientific audience was captivated. Those who afterwards asked for copies of the remarks learned that there hadn't even been notes beforehand. Professor Feynman had just talked on a subject considered important. Fortunately, a foresighted admirer had lugged a tape recorder to the session. The transcription was pocked with typical Feynman jokes; after they had been extracted, the Caltech house organ, *Science and Engineering*, published what remained under a corny title, "There Is Plenty of Room at the Bottom" (Lear 1960).

These few words convey very well the effect of Feynman's intervention on the audience. On the other hand, the Professor's ability to entertain the participants to a conference is well known.

It appears that the contents of POR justify the enthusiasm of those who support the figure of Richard Feynman as the inspiring father of modern Nanotechnology. In fact, the characteristics that are sought today within nanostructured materials, as totally new specifications due to the nanometric dimension, compared to the material at the macroscopic scale, seem to have been, in some way, anticipated in 1959. In the first paragraph, Feynman quotes Heike Kamerlingh Onnes (1853–1926), the scientist whose research on helium granted him the Nobel Prize *for his investigations on the properties of matter at low temperatures which led, inter alia, to the production of liquid helium*.

I imagine experimental physicists must often look with envy at men like Kamerlingh Onnes, who discovered a field like low temperature, which seems to be bottomless and in which one can go down and down. Such a man is then a leader and has some temporary monopoly in a scientific adventure. Percy Bridgman, in designing a way to obtain higher pressures, opened up another new field and was able to move into it and to lead us all along. The development of ever higher vacuum was a continuing development of the same kind (Feynman 1960).

Now that we know the entire history of POR, could we ask if Feynman was aware of the impact he expected from the talk, and if he was thinking of obtaining a *temporary monopoly* in this new field of Physics?

The following famous paragraphs give the reader an idea of how revolutionary the concepts that Feynman presented, that evening of December 29, 1959, would have sounded to the ears of the people present.

I would like to describe a field, in which little has been done, but in which an enormous amount can be done in principle. This field is not quite the same as the others in that it will not tell us much of fundamental physics (in the sense of, "What are the strange particles?") but it is more like solid-state physics in the sense that it might tell us much of great interest about the strange phenomena that occur in complex situations. Furthermore, a point that is most important is that it would have an enormous number of technical applications. What I want to talk about is the problem of manipulating and controlling things on a small scale. As soon as I mention this, people tell me about miniaturization, and how far it has progressed today. They tell me about electric motors that are the size of the nail on your small finger. And there is a device on the market, they tell me, by which you can write the Lord's Prayer on the head of a pin. But that's nothing; that's the most primitive, halting step in the direction I intend to discuss. It is a staggeringly small world that is below. In the year 2000, when they look back at this age, they will wonder why it was not until the year 1960 that

anybody began seriously to move in this direction. Why cannot we write the entire 24 volumes of the Encyclopedia Britannica²¹ on the head of a pin? (*ibidem*)

His words are about manipulating and controlling things on a small scale. Feynman's perspective – anyway – was not only about materials and nano chances but on what people in the future might have thought about his times and the discoveries made in the Sixties (or more likely what he would have thought about the research in the Sixties, if he was alive in 2000).

In the year 2000, when they look back at this age, they will wonder why it was not until the year 1960 that anybody began seriously to move in this direction (*ibidem*).

Was it the prophetic ability to see a new science in the future that made Richard Feynman the first visionary of Nanotechnology? This is what is strongly reiterated in many texts, from popular ones to the most authoritative, that deal with the history of Nanoscience and Nanotechnology at various levels, and a point that I shall discuss later.

Richard Feynman's article seemed to find new life when it was rediscovered by an MIT student, Kim Eric Drexler, who, coming from engineering studies, was able to draw a very interesting parallel between the world of mechanics and the world of biology. He did this by combining more or less complex mechanical objects, or parts of them, with biological structures whose function was in some way attributable to engineering objects (Drexler 1981). His imagination was greatly stimulated by Molecular Biology, to the point that he was able to coin, starting from the term "Engineering" and the term "Molecular biology", a new expression: "Molecular engineering". These are the two words that open his 1981 article.

Throughout all his articles, and although already present in the scientific dictionary, Drexler never refers to manipulation of objects to the nanoscale, never using the prefix "nano" or any nano-word. This is already made clear from his abstract.

Development of the ability to design protein molecules will open a path to the fabrication of devices to complex atomic specifications, thus sidestepping obstacles facing conventional microtechnology. This path will involve construction of molecular machinery able to position reactive groups to atomic precision. It could lead to great advances in computational devices and in the ability to manipulate biological materials. The existence of this path has implications for the present (Drexler 1981).

In his description of what molecular engineering could be, Drexler does not proceed through formal demonstrations, such as those of mathematics, but through analogies between the ideas he proposes, what is observable in Nature and what has been possible to achieve with the help of technology. Where the similarities are compatible and strong, according to Drexler, the new devices will be considered feasible. It is also interesting to note how Drexler proposes, as Nature's approach to the fabrication of its systems, what is now called the Bottom-Up process, rather than what is called the Top-Down process. In fact, he observes that biochemical systems are subject to this type of "microtechnology": starting from the molecular level they develop higher systems through a series of "tools" to create "devices" to be copied. From this point on, gene synthesis and recombinant DNA technology could direct ribosomes, for example in bacteria, towards the synthesis of absolutely new proteins that can serve as building blocks for larger molecular structures. Drexler then suggests a comparison between macroscopic and biochemical mechanical components.

²¹ Written with this syntax in the original paper.

Through multiple combinations of structural elements, moving parts, bearings and with the use of a driving force, Drexler expects that mechanical systems characterized by great versatility can be created. The assemblages of atoms in molecules can act as solid structures, occupying a certain region of space and being characterized by a predefined shape. However, while rigid structures can behave as structural elements, they can also act as moving parts. Sigma bonds, which are characterized by a low steric footprint, can act as rotating bearings, capable of withstanding a stress of up to 10^{-9} N. A succession of sigma bonds can instead perform the functions of a hinge. Proteins capable of changing their conformation can serve, in Drexler's idea, as sources of driving force for motion along a linear trajectory. The reversible motor of a bacterium's *flagellum* can serve as a source of driving force to trigger a rotational motion. The existence, in Nature, of this range of components makes it possible to imagine the feasibility of making mechanical systems driven by some motor organ, whose dimensions are measured with a molecular scale. Similarly to macroscopic devices, Drexler provides for molecular machine manipulation devices, capable of handling different instruments, controlled by human operators or macroscopic machines. Molecular-scale tools may also evidently be capable of producing macroscopic signals, indicating the feasibility of feedback control in molecular manipulations. All these arguments, taken together, are a clear indication that it is possible to obtain devices capable of moving molecular objects, positioning them with atomic precision, applying forces to them to effect a change and inspecting them to verify that the change in shape or position imposed by the external operator has actually been carried out.

Drexler then creates the following correspondences (Table 1.1), where he reports the macroscopic and microscopic components, together with the description of their functions, a description that, in his imagination, acts as a bridge between the two worlds.

Table. 1.1 Comparison of macroscopic and microscopic components (Drexler 1981).

Technology	Function	Molecular example(s)
Struts, beams, casings	Transmit force, hold positions	Microtubules, cellulose, mineral structures
Cables	Transmit tension	Collagen
Fasteners, glue	Connect parts	Intermolecular forces
Solenoids, actuators	Move things	Conformation-changing proteins, actin/myosin
Motors	Turn shafts	Flagellar motor
Drive shafts	Transmit torque	Bacterial <i>flagella</i>
Bearings	Support moving parts	σ bonds
Containers	Hold fluids	Vesicles
Pipes	Carry fluids	Various tubular structures
Pumps	Move fluids	<i>Flagella</i> , membrane proteins
Conveyor belts	Move components	RNA moved by fixed ribosome (partial analog)
Clamps	Hold workpieces	Enzymatic binding sites
Tools	Modify workpieces	Metallic complexes, functions groups
Production lines	Construct devices	Enzyme systems, ribosomes

An interesting debate on the epistemological interpretation of POR is supported by an article by Christopher Toumey (1949–2022), of the USC NanoCenter, University of South

Carolina (Toumey 2008). Starting from the essential point of view that the object of discussion is POR and not the figure of Richard Feynman as a scientist and histrionic character, researcher, teacher and Nobel laureate (1965), the author reports direct testimonies of scientists who have made the history of the nanoworld. on their way of thinking, on their results and forecasts of possible developments. Surprisingly, and somehow contradicting the official point of view or the common historical approach, several of the testimonies reported by Toumey do not agree with it. There is evidence of scientists whose results were achieved without the inspiration, albeit visionary and ingenious, of POR.

According to the History of Science and, in particular, the History of Nanotechnology, POR is an essential step without which, most likely, the evolution of Nanoscience and Nanotechnology would have possibly followed very different paths. In his article, instead, Toumey focused on the validity of the paradigm holding POR to be the essential document in the History of Nanotechnology, supporting his reflections with interesting interviews with those scientists who applied their knowledge in the nanoworld for different reasons. The article reports a break in the paradigm, as understood by most. POR was not, at least in several cases, a fundamental document without which the light of research in nanotechnology would probably not have been lit. To first frame the question from a historiographical and epistemological point of view, it is interesting to note how three possible interpretations of POR are presented, which could also be applied to other scientific cases, similar to ours.

The first interpretation is based on the assumption that important scientists and researchers could not have conceived their ideas, or even obtained the results for which they became best known, without POR. This perspective fully reflects the paradigm that we can find in historical textbooks, articles and essays, and which confirms Feynman's work in his fundamental role. The name of *Apostolic Succession* is given to this interpretation, a name that cannot avoid a religious connotation. Richard Feynman is the inspiring prophet, POR the sacred text from which everything originates, the scientists and researchers who succeeded him are the faithful and conscious executors of his vision.

The second interpretation takes the name of *nano-Mendel approach*. There is no doubt that Gregor Mendel is the father of genetics the way we know it, thanks to the results he first obtained and published. However, later in time, other researchers, notably Hugo DeVries (1848–1935), Carl Correns (1864–1933) and Erich von Tschermal (1871–1962) independently re-discovered the same laws established by Mendel, without having been influenced by his previous work, let alone being aware of his figure. This view can be similarly shifted to Feynman's work. He was, without any doubt, one of the most influential scientists of the last century but it is not necessary to attribute the first stirrings of Nanotechnology to his authorship. By doing so, while acknowledging Feynman's greatness, we relieve him of the responsibility of history, of having predicted and described in detail where Nanotechnology should go and what results it would lead to.

The third interpretation is the one that approaches POR via the *Nostradamus-like reading* and gives an interpretation of it, precisely in the style of his famous work *Les Prophéties* (The Prophecies, or the Centuries). According this key, no one immediately understood Feynman in 1959, POR was a visionary and, in some ways, obscure text. It is thanks to the discoveries that have been made over the decades, up to now, that we can give the correct meaning to the words of Feynman, just as today we can correctly interpret the words of Nostradamus, in the light of the facts that have taken place. Actually, what makes the Centuries a "prophetic" text is precisely their ambiguity, a factor that makes them adaptable to different situations on the basis of individual interpretation. In fact, there is nothing prophetic in the words of Nostradamus except the interpretation that is, in fact, left

to the reader. The same approach can be applied to POR. We now understand what Feynman intended seventy years ago, because the scientific events hidden in his words have come true and we can finally understand, to the fullest, his thoughts on Nanotechnology. It is clear that this latter approach could be applied not only to Feynman, in the case we are examining, but to any scientist; in the same way, with this interpretation it is possible to “see” Feynman everywhere, within Nanotechnology. In Toumey’s opinion, this approach is the weakest, and is reduced to a mere attempt to bring back to the present a text published in the past, connecting old words to later events.

Before going into the discussion about the more or less marked influence of POR in the history of Nanotechnology, I will briefly review some salient points of this article, to understand the reasons why it is considered, by historiography, as a seminal document. The paper can be quite simply schematized: it opens with an introduction and develops in ten subparagraphs, before the conclusions. In the introduction it is possible to read very clearly Feynman's mission statement, regarding the lecture.

[...] what I want to talk about is the manipulating and controlling things on a small scale (Feynman 1960).

It is interesting to note, from an epistemological point of view, how Feynman never uses the prefix nano in any of the terms of his talk. In fact, the nano prefix, although first introduced in 1947 at the 14th congress of the *Union Internationale de Chimie* as a thousandth–millionth of a part, was incorporated into the International System of Units in 1960 only. Furthermore, the term nanometre, as a measure of the billionth part of the meter, appeared for the first time in 1963, this measure being formerly known as the millimicrometer. When he needs to measure “at the bottom”, Feynman refers to 10 angstroms, for example. Then, with a rather precise description, Feynman illustrates a process by which letters can be reduced by 25,000 times using an electron microscope. Once the plastic moulds of the text were prepared, it would have been sufficient to reproduce them in silicon to be able to read them, again with the aid of an electron microscope. In the following, Feynman moves the discussion from the strictly practical level to that relating to the compatibility of his statements with what is known, from the scientific point of view.

I will not discuss how we are going to do it, but only what is possible in principle – in other words, what is possible in principle according to the laws of Physics (*ibidem*).

Five times he remarks to his audience that what he proposes is always consistent with the laws of physics. Further on, it is possible to read this line.

I am not inventing anti–gravity, which is possible someday only if the laws are not what we think. I am telling you what could be done if the laws are what we think; we are not doing it simply because we haven’t yet gotten around to it (*ibidem*).

or:

I would like to try and impress upon you, while I am talking about all of these things on a small scale, the importance of improving the electron microscope by a hundred times. It is not impossible; it is not against the laws of diffraction of the electron (*ibidem*).

Yet:

There is nothing that I can see in the physical laws that says the computer elements cannot be made enormously smaller than they are now (*ibidem*).

All these statements indeed appear very prophetic. POR condenses within it some forecasts on what will happen, in effect, “we could arrange atoms one by one the way we want them” with other statements that almost express a desire for a more advanced scientific future “Is there no way to make the electron microscope more powerful?” Feynman expresses his thought always remarking that he cannot know exactly how to achieve certain results, but that these are not impossible, in principle. A first reading of POR, always thinking of the histrionic figure of Richard Feynman, would certainly lead most of the readers to think that they are facing the inspiring vision of a science that in a few decades has revolutionized our world. It is not possible to deny that several ideas are suggested in the writing, and some of them have actually been realized today.

If POR is believed to be the historically inspiring document for Nanotechnology, notable remarks to this point of view are given by well-known researchers such as, for example, Kim Eric Drexler. In his 1981 article *Molecular Engineering*, Drexler immediately makes it clear that he is aware of the contents in POR, from the copy published in the magazine *Miniaturization*, and from this he draws inspiration for his subsequent arguments:

Feynman’s 1959 talk entitled “There’s Plenty of Room at the Bottom” discussed microtechnology as a frontier to be pushed back, like the frontiers of high pressure, low temperature, or high vacuum. He suggested that ordinary machines could build smaller machines that could build still smaller machines, working step by step down toward the molecular level; he also suggested using particle beams to define two-dimensional patterns. Present microtechnology (exemplified by integrated circuits) has realized some of the potential outlined by Feynman by following the same basic approach: working down from the macroscopic level to the microscopic (Drexler 1981).

Later, in his authoritative volume *Engines of Creation*, Drexler again quotes POR as a text in which Feynman’s inspiring ideas, relating to nanomachines capable of controlling and directing chemical syntheses, are reported, although “[Feynman] could foresee neither the time nor the cost of doing so” (Drexler 1986).

Again, in his doctoral thesis, in 1991, Drexler pays tribute to the ability of Feynman and POR to inspire research:

The body of the talk focuses on miniaturization and microtechnology; this section anticipates capabilities like those that are now basic to the microelectronics industry and proposes an alternative approach to miniaturization (using machines to build smaller machines, which build still smaller machines, and so forth) that has not, in fact, been followed (Drexler 1991).

Before going on, considering those witnesses that open the historiographical debate, I find it important to first underline that considering POR as the inspiring document of the ideas that led to Nanotechnology, as we know it today, is not incorrect; this is simply one of the interpretations possible, and which finds its validity in the fact that several of Feynman’s words on this subject have found a realization in the contemporary world. Furthermore, it is essential to keep in mind that the considerations I am carrying out here do not in any way concern the figure of Feynman as a researcher, much less as a scientist or populariser. My description of the facts is based upon the interpretation of POR as the cornerstone of Nanotechnology.

Now, in order to better understand what influence POR had on researchers, Toumey himself interviewed distinguished scholars in Nanosciences/Nanotechnology to discover if Feynman’s paper was (really) of some inspiration or even illuminating. Three researchers were chosen for the interviews, for their close relationship with three of the most important (according to Toumey’s opinion) discoveries in Nanotechnology: the invention of the STM microscope, the invention of the AFM and the first atom

manipulation using a STM microscope. Probably, most people would cite these three events as the most significant ones for Nanotechnology.

Heinrich Rohrer (1933–2013), Nobel Laureate in 1986 for his research in STM together with Gerd Binnig, wrote:

Binnig and I neither heard of Feynman’s paper until Scanning Tunneling Microscopy was widely accepted in the scientific community a couple of years after our first publication, nor did any referee of our papers ever refer to it... It might have been even after the Nobel [Prize] [...] I think it had no influence whatsoever (Toumey 2008).

Gerd Binnig, Nobel Laureate with Rohrer for STM, suggested:

I have not read [“Plenty of Room”]... I personally admire Feynman and his work but for other reasons than for his work on Nanotechnology (which actually does not exist) [Binnig’s brackets]. I believe people who push too much his contribution to this field do harm to his reputation. His contribution to science is certainly not minor and he needs not to be lifted [posthumously] onto the train of Nanotechnology (*ibidem*).

Calvin Quate (1923–2019), who contributed to the development of AFM, wrote that:

None of this work derived from the publications of Feynman. I had not read the Feynman article and I don’t think Binnig or Rohrer had read it. All they wanted was a better method for examining microdefects in oxides (*ibidem*).

Donald Mark “Don” Eigler, the physicist that in 1989 arranged 35 xenon atoms to spell out the letters IBM, a worldwide famous picture also known as “The Beginning”, said that he might have read “Plenty of Room” when he was a graduate student, a long time before manipulating atoms with STM but he also says that:

The technical aspects of my work have not been influenced by Feynman’s paper (*ibidem*).

Toumey’s work appears to be important as it contains several extracts from interviews by the author with the protagonists of the recent history of Nanotechnology. This adds a particular value to a new possible interpretation of a work that has been widely credited as the one and only that indicated the way to go throughout the research.

Submitting such results to public opinion triggers, in an almost inevitable way, heated debates which, however, can be traced back to two fundamental levels of discussion.

The first level is what I have analysed up to this point and collects the ideas of those in favour and against the idea that POR is the document from which it all originated, as regards Nanotechnology. The opinions of the debates, at this level, dwell on the content of the POR and the ideas expressed in it, to establish whether they constituted, to all intents and purposes, the essential starting points for the developments that would come. The testimonies in this sense are discordant, as I have reported through the work of Toumey; indeed, authoritative researchers have had no difficulty in affirming that they were not aware of the publication of POR, or that they did not draw illuminating opinions from it. It should be noted that such a point of view in no way diminishes the historical significance of POR, nor does it prevent other researchers from affirming the exact opposite, and considering it as a milestone in the historiography of science. In fact, our considerations are based on the analysis, in terms of contents, of a scientific article and do not enter into the merits of the historical interpretation of the figure of its author, Richard Feynman. In other words, it is possible to consider POR not to be a “prophetic” text, lifting the figure of Feynman from the paternity of Nanotechnology, without, on the other hand, diminishing the historical significance of Feynman himself as a scientist, Nobel laureate and populariser.

Such a diminishment absolutely does not constitute the goal of those who have distanced themselves from POR, as an inspiring document for their research. On the other hand, it is equally possible to consider POR as a fundamental article, as some of the ideas expressed in it have been realized, and nothing prevents them from being considered as direct inspiration for research.

The second level of discussion arises, as Toumey's direct experience confirms, when the focus of the debate shifts from the objective vision of the speech – whether or not POR is an inspiring document – to a subjective interpretation that completely distorts the object of the matter itself. That is, when the reader no longer considers POR at all, and Richard Feynman becomes the subject of the debate, as if the considerations on POR may be considered a simple prelude to a more decisive attack on Feynman. Toumey summarizes these concepts in a paragraph of his article which he titles *The evil anti-Feynman*. This, in fact, is the interpretation attributed to Toumey, following the publication of his article, by some thinkers whose attention shifted dramatically from POR to its author, a move Toumey never intended, as we read from his own words. The outcry in defence of Feynman allows us to infer how the object of the dispute was completely misrepresented, and how some felt compelled to defend Feynman from accusations which, on closer inspection, are completely absent. By reflecting on this aspect, it is possible to broaden the discussion further. The author and his writing are not one and the same thing. Those who felt compelled to defend Feynman have in fact combined Feynman's words and thought and figure together into one, considering POR to be an absolutely indisputable work. To question not Feynman, not his work but only the possible influence of one of his articles – not even the article itself, at this point – and not in an abstract way, but supporting the ideas with the direct testimonies of those who, while expressing the highest esteem for Feynman himself, confirmed that the ideas of POR did not address their research at all, this constitutes an intellectual scandal for some.

I believe I can consider this fact as breaking the scientific paradigm that has long been accepted: Feynman is the father of Nanotechnology because in POR he foresaw, in some way, some of the results we have achieved today in this subject. This paradigm has been reinforced for decades by all those authors who inaugurated and still open their writings with the words “In 1959 Richard Feynman gave a lecture...”. I do not believe that it is a question of choosing one path rather than the other but rather accepting the plurality of points of view, without thinking of undermining – this is absolutely not the purpose – the figure of Feynman or the validity of POR itself.

A second crucial debate, the one concerning the practical feasibility of the molecular assembly mechanism, an achievement that seems to be the key to the most wonderful results promised by nanotechnology, involved one of its founding fathers, Eric Drexler, and Richard Smalley, a *Rice University* professor and Nobel Prize winner. Drexler argued that it was possible to manufacture molecular-sized objects with extreme accuracy, and this idea, with its developments, was the basis of Smalley's criticism. The publication of the observations and counter-responses at later dates fuelled the discussion between the two scientists.

According to one of the most simplistic interpretations, the basic promise of nanotechnology is to provide mankind with the tools to design a completely new world by allowing, at the limit, the repair of any device, including the human body in its most delicate organs such as the brain, by manipulating elements on an atomic or molecular scale. Kurzweil (Kurzweil 1990) argued that the linear dimension, one of the key features of technology, is shrinking by a factor of 4 every decade and sets 2020 as the year by which most electronic and many mechanical technologies will be considered as nanotechnologies,

with dimensions below 100 nanometres. In reality, electronic achievements are already below this threshold, even if they are not self-assembling structures. The last few years have also been devoted to preparing the conceptual framework within which new ideas and projects in nanotechnology can be developed.

The focus point of the discussion between Drexler and Smalley concerns the realisation of self-assembling devices of molecular dimensions.

To better understand how Drexler developed his idea of the molecular assembler, it is historically interesting to go back to the late 1940s, when information theorist John Von Neumann (1903–1957), inspired by the concepts of construction, universality and evolution, proposed a model of a self-replicating system consisting of a universal constructor combined with a universal computer. In his idea, the purpose of the computer is to execute a program that directs the actions of the constructor, which makes one copy of the computer, one of the self-replicating program and one of the constructor. Interesting as it is, this idea, not one of those for which Von Neumann is remembered, understandably remains very abstract. It is not clear, in fact, how the computer and the constructor are to be made, many solutions are possible, and the materials that can be used are different. Later, he elaborated the concept of the “kinematic builder”, a robot characterised by at least one manipulator, or arm, capable of building a replica of itself from a so-called “sea of parts”.

Eric Drexler is credited with founding the field of modern nanotechnology in the mid-1980s with the draft of his doctoral thesis, which laid the foundations for nanotechnology and provided the road map that is still followed today. In his work, Drexler presents a Von Neumann Kinematic Constructor that works with atoms and fragments of molecules, in turn taking inspiration from the ideas contained in POR. Drexler calls this constructor the “universal assembler”, where the word “universal” refers directly to the device’s ability to operate practically at will in performing its functions. The products of a universal assembler must necessarily follow the laws of physics and chemistry, so only atomically stable structures are feasible. Moreover, any specific assembler is limited to building products from his available “sea of parts”, even though the feasibility of using individual atoms has been repeatedly demonstrated.

In his work, it must be said, Drexler has not provided a detailed blueprint of what he understands as an assembler, and there does not yet appear to be any such blueprint, yet, as indicated above, each of its components can be associated with an object found in nature. A further plausible classification is based on the following points.

- The computer: this is needed to provide what Drexler calls “intelligence”, to control the assembly process; it must be small and simple. Drexler describes an intriguing mechanical computer with molecular “locks” instead of transistors. Each lock requires only 5 cubic nanometres of space and switches 20 billion times per second. This proposal remains more competitive than any known electronic technology, although it could be overtaken by electronic computers built from three-dimensional arrays of carbon nanotubes.
- The architecture of the instructions: Drexler and his colleague Ralph Merkle have proposed a Single Instruction Multiple Data (SIMD) architecture in which a single database records instructions to be transmitted simultaneously to trillions of molecular-sized assemblers (each with its own simple computer). In this way, it is not necessary for each assembler to store the entire program to create the desired product. This “broadcast” architecture makes it possible to deal with a key security problem, namely the threat of self-replication, which can be nipped in the bud by inhibiting the single central database. Drexler, however, points out that a nano-sized assembler need not be self-replicating. The Foresight Institute therefore sets up a series of ethical blocks that contain explicit prohibitions against self-replication, which in the worst-case scenario is unlimited, especially when operating in the natural environment.

- Transmission of instructions: the transmission of instructions from the centralised data archive to each of the many assemblers is carried out electronically, if the computer is electronic, or through mechanical vibrations if a mechanical computer is used, which is also provided for in Drexler's vision.
- The builder robot: the builder is a simple molecular robot with a single arm, similar to Von Neumann's kinematic builder, but on a smaller scale. In later years, Drexler would demonstrate how mechanical organs can be replicated by molecular-based structures.
- The tip of the robotic arm: *Nanosystems: molecular machinery, manufacturing, and computation*, is the 1992 book in which Drexler provided a series of chemicals that could be used for the tip of the robotic arm which would be able to grasp, using appropriate atomic force fields, a molecular fragment, or even a single atom, and then deposit it where required by the program. Having developed a deposition process to make artificial diamonds, it is known that it is possible to remove individual carbon atoms, as well as molecular fragments that include carbon, and then place them in another position through very precisely controlled chemical reactions. The creation of an artificial diamond involves trillions of atoms, but the process behind it has been exploited to design the tip of a robotic arm that can remove hydrogen atoms from a starting material and deposit them in the desired position in a molecular machine under construction. In doing so, the machines are constructed from a diamond-like material (called "diamondoid"). As well as possessing great strength, the material can be doped with impurities, very precisely, to make electronic components such as transistors. Simulations have shown that mechanical elements such as gears, levers, motors and other systems can be built from these carbon matrices. In the following years, several proposals were made, including several innovative designs proposed by Ralph Merkle (Merkle 1996). In recent years, three-dimensional carbon nanotubes, capable of providing both mechanical and electronic functions at the molecular level, made up of hexagonal arrays, have received a great deal of attention.
- The internal environment of the assembler: environmental impurities that interfere with the delicate assembly process must be carefully avoided. Drexler proposes to maintain an almost total vacuum and build the walls of the assembler from the same diamondoid material that the assembler itself is capable of producing.
- The energy required for the assembly process: this can be provided either by electricity or chemical energy. Drexler proposed a chemical process in which the fuel is woven into the raw construction material. More recent proposals use nano-engineered fuel cells incorporating hydrogen and oxygen, or glucose and oxygen.

Many different configurations have been proposed; generally speaking, the typical assembler is described as a desktop unit that can manufacture any physically possible product that can be described in some way by software. The products that can be made can vary in kind: computers, clothes and artwork, even cooked meals. Larger products, such as furniture, cars or even houses, can be built in a modular way, or using larger assemblers. A key point of discussion concerns the fact that an assembler can create copies of itself. The cost of creating any physical product, including the assemblers themselves, would basically be the cost of raw materials. The real cost, of course, would be the value of the information through which each type of product is described, namely the software that controls the assembly process. In this way, everything of value in the world, including physical objects, would be composed essentially of information. We are not so far from this situation today, as the "information content" of products is rapidly reaching 100% of their value.

Once operational, the centralised data repository simultaneously sends commands to all robots dedicated to assembly. Trillions of robots make up an assembler, each executing the same instruction at the same time. The assembler creates these molecular robots by starting with a small number and then using these robots to create others, iteratively, until the required number is reached.

Each local robot has a local data memory that specifies the type of mechanism it is building. This local data storage is used to mask global instructions that are sent from the centralised database, so that some instructions are blocked while only local instructions are executed. In this way, even though all assemblers receive the same sequence of instructions, there is a level of customisation of the part built by each molecular robot. Each robot extracts the raw materials it needs from the source material. These include single carbon atoms and molecular fragments. The required chemical fuel is also included in the source material. All the requirements that go into the design, including the routing of instructions and the source material, have been described in detail in Drexler's two works.

It is Life itself that provides us with the ultimate proof of the feasibility of a molecular assembler. Indeed, as we deepen our understanding of the information base of life processes, we discover specific ideas to address the design requirements of a general molecular assembler. For example, proposals have been made to use a molecular energy source of glucose and ATP similar to that used by biological cells.

Biology is capable of solving each of these assembler design challenges. Ribosomes represent, for example, both the computer and the building robot, as Life does not store data centrally, but provides the entire code to each cell. However, the ability to limit a nanorobot's local data storage to only a small part of the assembly code, particularly in cases of self-replication, is one way in which one can think of designing a nanotechnology with greater safety mechanisms than Nature.

In these years in which nanotechnology has taken hold, the potential is available to replace the genetic information repository of biology in the cell nucleus with a nanosystem capable of storing the genetic code and simulating the actions of RNA, ribosomes and other computer elements in the assembler. Doing this might bring significant advantages. It could eliminate the accumulation of DNA transcription errors, a major source of the ageing process, or introduce DNA modifications to essentially reprogram our genes using gene therapy techniques. The ethical implications of such radical interventions in the human genome and the question of ethics will be discussed in detail in Chapter VI.

With such a system, the recommended transmission architecture could enable us to stop unwanted replication, thereby defeating cancer, autoimmune reactions and other pathological processes. Although most of these disease processes will already have been defeated by genetic engineering, re-engineering the computer of life using nanotechnology could remove any remaining obstacles and create a level of durability and flexibility far beyond the inherent capabilities of biology. If, over time, nano-replicators become more and more sophisticated, more capable of extracting carbon atoms and carbon-based molecular fragments from source materials that are themselves less controlled, and are able to operate outside defined boundaries, as is the case in the world of biology, they will potentially be a serious threat, particularly if we consider on the one hand their resistance, and on the other hand the speed of replication with which they are endowed, a characteristic that we have already pointed out many times to be considerably greater than that of biological systems. This is, of course, the source of the great controversy alluded to in the article regarding the Drexler-Smalley debate and the letters that followed.

In the decade since the publication of *Nanosystems*, every aspect of Drexler's proposed projects on a purely conceptual level has been reinforced by further proposals for design, supercomputer simulations and, above all, the actual construction of molecular machines. Ross Kelly, professor of chemistry at *Boston College*, described in the journal *Nature* his creation of a chemically powered nanomotor consisting of 78 atoms (Kelly, De Silva, Silva

1999). A biomolecular research group led by C. D. Montemagno²² (1956–2018) has, in turn, created a nanomotor powered by ATP (Montemagno, Bachan, Stelick and Bachand 1999). Another molecular-sized motor, powered by solar energy, was created by Ben Feringa, at the *University of Groningen* in the Netherlands and granted him the Noble Prize. Molecular-scale mechanical components such as gears, rotors and levers have been developed extensively, from Drexler's initial ideas to the present day. Systems demonstrating how chemical energy or acoustic energy can be used, exactly as originally described by Drexler, have been designed, simulated and, in many cases, actually built. Substantial progress has been made in the development of various types of electronic components made from molecular-scale devices, particularly in the area of carbon nanotubes, an area pioneered by Smalley.

Under the light of the rapid development of practically every aspect of nanotechnology, from the simplest to the most futuristic, it is interesting to note that the concept of the nano-assembler proposed by Drexler has no defects of its own that have been discovered and then described in the literature. In *Scientific American* (Smalley 2001), Smalley objected strongly to Drexler, but based his ideas on a distorted description of Drexler's proposal, ignoring the numerous results obtained in the last decade. Being rightly counted among the pioneers of nanotechnology for his expertise on carbon nanotubes, Smalley has constantly moved between enthusiasm and scepticism, having written that “nanotechnology holds the answer, insofar as there are answers, to most of our pressing material needs in energy, health, communication, transport, food, water”.

Smalley describes an assembler “according to Drexler” as a device consisting of five to ten “fingers” (or manipulator arms) capable of holding, moving and positioning each atom in the machine being built. Later, he objects that there it would be no room for so many fingers in the confined environment in which a nanobot assembler device is supposed to work. Smalley refers to this situation as to the “fat fingers” problem; these fingers would also have difficulty releasing their atomic load due to the forces of molecular attraction, this is what he called the “sticky fingers” problem. Smalley then describes the “intricate three-dimensional waltz that is performed” by five to fifteen atoms in a typical chemical reaction. In fact, Drexler's idea of assemblers bears no resemblance to Smalley's description and the subject of his criticism. Drexler's idea, as well as most of those that followed from it, is of an assembler possessing only one probe, or “finger”. The History of Science has shown us how similar devices have been made, and reference is made to Scanning Probe Microscopes (SPM) and the more sophisticated Atomic Force Microscope. This puts Smalley's criticism to rest: if it were supported by experience, Life itself would be impossible.

Furthermore, there have been extensive descriptions and analyses of possible fabrication techniques that do not involve picking up and placing atoms as if they were mechanical parts to be deposited in place. For example, the feasibility of moving hydrogen atoms using Drexler's “propynyl hydrogen abstraction” (Drexler 1992) has been widely confirmed in subsequent years. The ability of the scanning probe microscope (SPM), developed at IBM in 1981, and the more sophisticated atomic force microscope to position individual atoms through specific reactions of a tip with a molecular-scale structure provide further evidence of feasibility.

Smalley also objects that despite “frantic work... generating even a tiny amount of a product would require [for a nanobot]... millions of years of work”. Here it must be admitted that reason is on Smalley's side: an assembler consisting of a single nanobot would not be able to produce any appreciable amount of a product. The basic nanotechnological concept

²² In 2003, Dr. Montemagno was awarded the Feynman Prize for Nanotechnology.

is that we will need trillions of nanobots to achieve significant results. Such a large number of nanobots poses significant safety problems. Creating trillions of nanobots at a reasonable cost will require the nanobots to make themselves, this self-replication solves the economic problem on the one hand while introducing serious dangers on the other. Biology has used the same solution to create organisms with trillions of cells, but virtually all diseases result from a biological self-replication process gone wrong.

Previous challenges to the concepts behind nanotechnology have also been addressed and resolved successfully. Critics have pointed out that nanobots would be subject to bombardment by thermal vibrations of nuclei, atoms and molecules. For this reason, conceptual designers of nanotechnology have emphasised the construction of structural components in diamondoids or carbon nanotubes. Increasing the strength or stiffness of a system reduces its susceptibility to thermal effects. Analysis of these designs has shown that they are thousands of times more stable in the presence of thermal effects than biological systems, and can therefore operate over a much wider temperature range (Merkle 2001).

Similar challenges have also been faced with regard to the uncertainty of position resulting from the inevitable quantum effects, based on the nanometric size of the engineered devices. Quantum effects are significant for an electron, but a single nucleus of a carbon atom is more than 20,000 times more massive than an electron. A nanobot will be constructed of anywhere from hundreds of thousands to millions of carbon and other atoms, so a nanobot will be billions of times more massive than an electron. Plugging this ratio into the fundamental quantum equation for positional indeterminacy shows that this is an insignificant factor.

Providing power to the devices presented a further challenge. Drexler's original proposals involved glucose-oxygen fuel cells, which have held up well in feasibility studies. The glucose-oxygen approach has one major advantage: nanomedicine applications can exploit the glucose, oxygen and ATP resources already provided by the human digestive system. A nanoscale engine has been created using helices made of nickel and powered by an ATP-based enzyme (Montemagno, Bachan, Stelick and Bachand 1999).

However, advances in the implementation of hydrogen-oxygen fuel cells at the MEMS and even nanoscale have provided an alternative approach. Hydrogen-oxygen fuel cells, with hydrogen supplied by a safe methanol-based fuel, have advanced in recent years. A small Massachusetts company, Integrated Fuel Cell Technologies, Inc. (Kurzweil 2003) has demonstrated an operational fuel cell based on MEMS. Each device, approximately the size of a postage stamp, contains thousands of microscopic fuel cells and includes power lines and electronic controls. NEC planned to introduce nanotube-based fuel cells in 2004 for laptops and other portable electronic devices. They claimed that their small power sources would power the devices for up to 40 hours before the user needs to change the methanol canister.

Back to the debate, on 16 April 2003, Drexler responded to Smalley's article in *Scientific American* with an open letter. He cited 20 years of his and other scientists' research and specifically responded to the fat-finger objection and the sticky-finger objection. As mentioned above, molecular assemblers have never been described as having actual fingers, but rather a precise location of reactive molecules. Drexler cited biological enzymes and ribosomes as examples of precise molecular assembly in the natural world. Drexler concluded by quoting Smalley's own observation that "when a scientist says something is possible, he is probably underestimating how long it will take. But if scientists say it's impossible, they're probably wrong".

Three more rounds of this debate have published to date. Smalley responded to Drexler's open letter by backtracking on his objections to fat fingers and sticky fingers and

acknowledging that enzymes and ribosomes are indeed engaged in the precise process of molecular assembly that Smalley had previously indicated was impossible. Smalley states that biological enzymes function only in water and that such water-based chemistry is limited to biological structures such as “wood, flesh and bone”. This is incorrect and Drexler stated this assumption. Many enzymes, even those that normally operate in water, can also function in anhydrous organic solvents, and some enzymes can act on substrates in the vapour phase, without the presence of any liquid (Zaks and Klibanov 1984).

Smalley goes on to say (but without making any deductions or quotations) that enzyme-type reactions can only take place with biological enzymes. This is also incorrect. It is easy to see why biological evolution adopted water-based chemistry: it is the most abundant substance on our planet, and also comprises 70 to 90% of our bodies, our food and all organic matter. Most people think of water as something quite simple, but it involves far more complex phenomena than conventional wisdom suggests.

The three-dimensional electrical properties of water, for example, are quite powerful and can break the strong chemical bonds of other compounds. Consider what happens when we put salt in water. Salt is quite stable when it is dry, but it is rapidly broken down into its ionic components when put into water. The negatively charged oxygen side of the water molecules attracts positively charged sodium ions (Na^+), while the positively charged hydrogen side of the water molecules attracts negatively charged chlorine ions (Cl^-). In the dry form of the salt, the sodium and chlorine atoms are tightly bound together, but these bonds are easily broken by the electrical charge of the water molecules. Water is considered the “universal solvent” and is involved in most biochemical pathways in our bodies. So we can consider the chemistry of life on our planet mainly as water chemistry.

However, the primary thrust of our technology has been to develop systems that are not limited by the restrictions of biological evolution, which has adopted only water chemistry and proteins as its basis. Biological systems can fly, but if we want to fly at 30,000 feet and hundreds or thousands of miles per hour, we will use our modern technology, not proteins. Biological systems like human brains can remember things and do calculations, but if we want to do data mining on billions of pieces of information, we would want to use our electronic technology, not unassisted, though efficient, human brains.

Here Smalley is avoiding considering the last decades of research that has investigated alternatives for placing molecular fragments using precisely guided molecular reactions. The synthesis of diamondoid (the diamond-like material formed in precise patterns, as also mentioned before) that can be very finely controlled has been extensively studied, for example, at *Caltech's Materials and Process Simulation Center*; *North Carolina State University's Department of Materials Science and Engineering*; *Institute for Molecular Fabrication, University of Kentucky*; *the U.S. Naval Academy*; and *the Xerox Palo Alto Research Center* (Kurzweil 2003).

Smalley is also ignoring the established scanning probe microscope mentioned above, which uses precisely controlled molecular reactions. Based on these concepts, Ralph Merkle has described reactions, at the microscope tip, that can involve up to four reactants (Merkle 1997). There is an extensive literature on reactions that occur at very precise sites, can be accurately guided, and would be feasible for a molecular assembler. Smalley ignores all this literature when he claims that reactions in water carried out by biological enzymes in water are the only ones possible. Recently, many tools beyond SPMs are emerging that can reliably manipulate molecular atoms and fragments.

On 3 September 2003, Drexler responded to Smalley's reply by once again alluding to the vast body of literature that Smalley was ignoring, citing the analogy of a modern factory, only made at the nanoscale. Drexler also cited analyses of transition state theory, according

to which positional control would be feasible at megahertz frequencies for appropriately selected reactants.

The final step in this debate is a follow-up letter from Smalley. This letter does not abound in scientific specifics and citations, but dabbles in imprecise metaphors that avoid the key issues. He writes, for example, that “just as you can’t make a boy and a girl fall in love simply by pushing them together, you can’t make precise chemistry take place as desired between two molecular objects by a simple mechanical movement... it can’t be done simply by putting two molecular objects together”. Smalley again acknowledges that enzymes do in fact accomplish this, but refuses to acknowledge that such reactions could occur outside of a biological type system: “this is why I led you... to talk about real chemistry with real enzymes... any such system will need a liquid medium. For the enzymes we know, that liquid will have to be water, and the kinds of things that can be synthesized with water around can’t be much broader than the flesh and bones of biology.”

Drexler’s frustration in this debate is understandable because many critics do not bother to read or understand the data and arguments presented to describe future technologies. Smalley’s argument is of the form “we don’t have ‘X’ today, so ‘X’ is impossible”. Simply because some things are not available to us today does not mean that they cannot be available to us in the future. Indeed, some realities that will be manifest in the future may be unavoidable, but the fact that they are not before us today makes them easy to deny. Denying the feasibility of an imminent technological transformation is a short-sighted strategy.

In the early twentieth century, some thinkers saw the flight of heavier-than-air objects as an entirely possible technological advancement, but proponents of what we would now call mainstream thinking were quick to denigrate them by claiming that it had not been demonstrated at all. Today, flying is one of the most common modes of travel and is done by means that are clearly heavier than air. In 1990, Garry Kasparov scoffed at the idea that a computer or artificial intelligence could beat him in a game of chess, yet when he was beaten by the Deep Blue computer in 1997, observers dismissed it as saying that chess was not such a big deal after all.

Those of us who try to project into the future based on well-founded methodologies are at a disadvantage.

Smalley reveals at least part of his motivation at the end of his most recent letter when he writes:

A few weeks ago I gave a lecture on nanotechnology and energy entitled “Be a Scientist, Save the World” to about 700 middle and high school students from Spring Branch ISD, a large public school system here in the Houston area. Before my visit, the students were asked to “write an essay on why I am a Nanogeek”. Hundreds responded, and I had the privilege of reading the top 30 essays, choosing my 5 favorites. Of the essays I read, almost half assumed that self-replicating nanobots were possible, and most were deeply concerned about what would happen in their future when these nanobots spread around the world. I did what I could to allay their fears, but there is no doubt that many of these young people have been told a bedtime story that is deeply disturbing. You and the people around you have frightened our children (Kurzweil 2005).

Smalley should note that previous critics have also expressed scepticism that both global communications networks and the software viruses that spread through them are viable. Today, we have both the benefits and the harms of both these realisations. However, along with the danger of software viruses, a technological immune system has also emerged. Even if it does not protect us completely, few people would advocate eliminating the Internet to eliminate software viruses. We are getting far more benefit than harm from this latest twist of promise and danger.

Smalley's approach of reassuring the public about the potential abuse of this future technology is not the right strategy. Denying the feasibility of both the promise and the danger of molecular assembly will ultimately prove counterproductive and fail to steer research in the necessary constructive direction. Molecular assembly will provide tools to effectively fight poverty, clean up our environment, defeat disease, extend human longevity, and many other useful activities.

Like any other technology humanity has created, it can also be used to amplify and enable us to unleash our destructive side. It is important that we approach the new developments in technology, and nanotechnology in particular, in a conscious way to gain the profound benefits it promises, while avoiding the dangers to which it inevitably exposes us. Drexler and his colleagues at the Foresight Institute have been at the forefront of developing the ethical guidelines and design considerations needed to steer the technology in a safe and constructive direction (Kurzweil 2003).

1.1.5.2 Norio Taniguchi

Professor Norio Taniguchi was born in 1912 and passed away in 1999. He was professor of Tokyo University of Science and, in 1999, just a few months before his death, he was awarded in Bremen the 1st *Lifetime Achievement Award* by the *European Society for Precision Engineering and Nanotechnology (euspen)*²³.

In 1974, he coined the term *nano-technology* to describe semiconductor processes such as thin film deposition and ion beam milling, both processes exhibiting characteristic control on the order of a nanometer. The abstract of his article (Taniguchi 1974) can be undoubtedly considered a milestone in History of Science, and it is worth reading.

Nano-technology is the production technology to get the extra high accuracy and ultrafine dimensions, i.e. the preciseness and fineness of the order of $1nm$ (nanometer), $10^{-9}m$ in length. The name of Nano-technology originates from this nanometer. In the processing of materials, the smallest bit size of stock removal, accretion or flow of materials is probably of one atom or molecule, namely $0.1\sim 0.2nm$ in length. Therefore, the expected limit size of fineness would be of the order of 1 nm . Accordingly, Nano-technology mainly consists of the processing of separation, consolidation and deformation of materials by one atom or one molecule. Needless to say, the measurement and control techniques to assure the preciseness and fineness of 1 nm play very important role in this technology. In the present paper, the basic concept of Nano-technology in materials processing is discussed on the basis of microscopic behaviour of materials and, as a result, the ion sputter-machining is introduced as the most promising process for the technology (*ibidem*).

In his article, Taniguchi focuses his attention on the need of ultra-fine finishing when manufacturing integrated circuits, electronic devices and opto-electronic devices. He points out also that the grade of fineness required must be of $1nm$ in length and such a grade can be achieved operating on one atom or one molecule at the time. Back to his article, we read his ideas.

[...] on the manufacturing of mechanical parts of high precision machineries, for instance, block gauge, injection pump, pneumatic or hydraulic bearing, memory disc or drum of electronic computer,

²³ The Mention on the award reads: "In recognition of his unique and outstanding contributions to research and development in the ultra precision materials processing technologies and in 1974, being the first to formulate and use the term Nanotechnology. Through his vision, writings and example of total dedication to his field of endeavour he has stimulated the development of what will be one of the dominant technologies of the 21st Century".

aspheric lens, precision diamond tools, etc., such a high grade finishing in dimension and surface roughness has also become to be necessary to improve their qualities to the extreme²⁴ limit. From the emergent needs based on these industrial requirements, the system of ultra fine finishing or “Nano–technology” has been introduced. The usual precision finishing technology has aimed to get the preciseness and fineness of $1\mu\text{m}$, i.e. 10^{-6}m in length, hence it says “micro–technology”, not so accurate in meaning. Consequently, in contrast, the finishing technology aimed to get the preciseness and fineness of 1nm would be called “Nano–technology”. Needless to say, the technology includes the systems of materials processing, measurement and control for the preciseness and fineness of 1nm (*ibidem*).

According to his ideas, Taniguchi states that Nano–technology must pursue one objective, i.e. to achieve a process of ultra–fine finishing whose precision and fineness is about 1nm in length.

Taniguchi’s idea is to work on one atom or one molecule at the time, removing it from what he calls the work–piece materials, concentrating the processing energy to the particular atom or molecule we want to take away, this particular energy being at least the molecular bonding energy necessary to remove the atom or the molecule off the surface of the bulk piece.

In the article we can find information about the fact that in 1974 some processes were already developed as reported in the table 1.2 below.

Table. 1.2 The processes on materials capable to intervene on one atom/molecule, according Taniguchi.

	Mechanism	Kinds of processing
(Removing) Separation process	Chemical decomposition	Chemical etching (photo–etching), chemical polishing
	Electro–chemical decomposition	Electrolytic polishing, electro–chemical machining
	Evaporation, dissolution (thermal)	Electron beam machining, laser ray machining, electro discharge machining, dissolution machining
	Sputtering (dynamical)	Ion sputter machining
(Accreting, joining) Consolidation process	Physical and thermal accretion	Vapour deposition, sputter deposition, ionic deposition
	Chemical accretion	Chemical plating or deposition
	Electro–lytic accretion	Electro–plating, electrocasting
	Chemical and electro–chemical composition	Thin film (anodic oxidation, oxidation, nitration; gaseous, liquid)
	Implantation (dynamical)	Ion implantation
	Diffusion (thermal)	Surface treatment, sintering
	Crystal growth (thermal)	Epitaxial, molecular beam
(Flow) Deformation process	Fusion (thermal)	Dip plating, thermal fusion
	Surface flow (thermal)	Flow finishing (gas flame, high frequency, heat ray, electron beam, laser ray)
	Viscous flow and abrasion (dynamical)	Flow finishing (vibration sliding, liquid, gas)

²⁴ This word is written as “extrem” in the original. The historian reader interested not only in the content of the article, but also in the style the article itself is written with, is strongly recommended to read it.

Here it is of historical interest to notice how precisely Taniguchi guides the reader among removing processes, accreting ones and flow processes, also detailing which processes are dynamical or thermal.

The figure of Norio Taniguchi must appear in every text that concerns the History of Nanoscience and Nanotechnology, because the honour of christening a new science must be credited to him, whose aim was then to improve the techniques used to operate on single atoms and molecules, which today has proved to be of maximum impact in mankind's everyday life.

1.2 Subdivisions of Nanotechnology

In a life span of more than seventy years, nanotechnology has affected virtually every field of study, from biology to medicine, from engineering to materials science, crossing the boundaries of pure sciences such as chemistry and physics. One of the main prerogatives of this science is its transversality. It is not possible, and sometimes inappropriate, to confine the fields of research in the nanoworld to rigidly circumscribed areas.

However, while bearing these considerations in mind, it is possible to give definitions of the various fields of application of nanotechnology, specifying the characteristics that distinguish them from one another. Here I report some of the most important fields where the nanoworld is applied.

1.2.1 *Nanomechanics*

Nanomechanics focuses on the mechanical properties of engineered nanostructures and nanosystems and nanosystems such as the ones containing nanoscale components of importance. Such devices may be nanomachines, nanoparticles, nanopowders, nanowires, nanorods, nanoribbons, nanotubes and carbon nanotubes as well and boron nitride nanotubes, nanoshells and nanomembranes, nanocoatings and nanocomposite or nanostructured materials, nanomotors...

Nanomechanics is based on general principles and specific ones. General principles regard mechanics principles including energy and momentum conservation principles, variational Hamilton's principle and symmetry principles. As nanoparticles are quite small, nanomechanics must take in account a series of other effects. First the discreteness of the object whose size is comparable to the atomic distances, then the degrees of freedom in the object, then the thermal fluctuations. Also entropic effects and quantum effects are to be considered. Novel properties of nanoscaled objects appear because of their dimensions and are not present in the macroscale objects or bulk materials. The smallness of particles gives rise to several surface effects due to the high surface–area–to–volume ratio so affecting properties like the melting point, heat capacitance and so on. Discreteness serves for the dispersion of mechanical waves in solids and some special behaviour of basic elastomechanics solutions at small scales. Degrees of freedom are the reasons for thermal tunnelling of nanoparticles through potential barriers and for the cross diffusion of liquids and solids. The Brownian motion of nanoparticles is due to the smallness and the thermal fluctuations. Thermal fluctuations and entropy at the nanoscale give rise to phenomena like super elasticity, entropic elasticity or other exotic kinds of elasticity. Quantum effects determine novel electrical, optical and chemical properties of

nanostructures and they are of great importance for areas of Nanotechnology such as nano-electronics and advanced energy systems.

1.2.2 Nanoelectronics

Nanoelectronics is the use of Nanotechnology in electronics, covering different devices and materials. All of these possess the common feature that they are so small that interatomic interactions and quantum mechanical properties cannot be neglected and must be taken into serious account. When working at the nanoscale, physical phenomena are involved that are completely different from those we experience in the macro world, such as the quantum tunnel effect. Miniaturisation has played a key role in the research and development process in nanoelectronics, as after World War II the first transistors were over a centimetre in size, while today the smallest transistor is 7nm. This leads to billions of transistors integrated on a single chip.

1.2.3 Nanotribology

Nanotribology regards interactions of objects at the nanoscale. Because structures are shrinking in size and information is compressed in space, these interactions become very important. Reducing friction between the interacting surfaces is fundamental in the area of micro and nano devices; in other words, nanotribology deals with macroscopic phenomena like friction but at a molecular level. Interfacial processes during adhesion, friction, wear, nano indentation and thin-film lubrication are investigated.

As for other properties of nanoparticles compared to ones of the bulk dimension, the behaviours studied through nanotribology are quite different from the ones observed at macroscopic levels. Understanding tribological behaviours can help manipulating matter at the nanoscale (Hsu, Ying 2002, Sherrington, Rowe and Wood 2002, Bhushan 2001).

1.2.4 Nanophotonics

With the term Nanophotonics the study of the behaviour of light at 10^{-9} m scale is intended. Also, the interaction of nanometric objects with light will be considered. This is a new interdisciplinary branch of optics that includes optics itself, Nanotechnology, electrical and optical engineering. This discipline deals with metallic components that can transport and focus light through surface plasmon polaritons. Nanophotonics can also be called nanooptics; nanooptics usually has to do with wavelengths from ultraviolet to near-infrared.

It is known that optical microscopy and optical instruments cannot normally focus light to nanometric scales, due to the diffraction limit – Rayleigh criterion –. In certain cases, however, it is possible to bring light down to the nanometric scale using different techniques like surface plasmons, localized surface plasmons around nanoscale metal objects, and the nanoscale doors and sharp tips used in Near-field Scanning Optical Microscopy (Pohl, Denk and Lanz 1984), NSOM (Dürig, Pohl and Rohner 1986, Betzig, Harootunian, Isaacson and Kratschmer 1986) or sometimes referred as SNOM.

1.2.5 Nanomaterials

Materials in which a single unit of size is between 1nm and 100nm are called nanomaterials. ISO/TS 80004–1:2015 describes the standard and the core terms for Nanotechnology and was confirmed in 2019. A nanomaterial is defined as the “material with any external dimension in the nanoscale or having internal structure or surface structure in the nanoscale”, with nanoscale defined as the “length range approximately from 1nm to 100nm”. This includes both nanoobjects, which can be defined as pieces of material at discrete dimensions, and nanostructured materials, whose internal or surface structure on the nanoscale (ISO/TS 80004 2019).

On October 18th, 2011, the European Commission adopted this definition for a nanomaterial: “A natural, incidental or manufactured material containing particles, in an unbound state or as an aggregate or as an agglomerate and for 50% or more of the particles in the number size distribution, one or more external dimensions is in the size range 1nm–100nm. In specific cases and where warranted by concerns for the environment, health, safety or competitiveness the number size distribution threshold of 50% may be replaced by a threshold between 1% to 50%” (European Commission 2011).

1.2.6 Nanochemistry

The combination of inorganic and organic chemistry with Nanotechnology is called Nanochemistry. This discipline deals with synthesis of building blocks where size is strongly under control, together with shape, surface and defect properties. Nanochemistry is at the base of chemical science, of course, materials and physical sciences, as well as of engineering, biological and medical applications.

The synthesis of nanocompounds depends on how surface, size and shape lead to self-assembly of building blocks into the desired structures. Among the materials that show the properties of nanochemistry we can name silica, gold, carbon, cadmium selenide, iron oxide, polydimethylsiloxane. For example, iron oxide, common rust, can be the most effective contrast agent in Magnetic Resonance Imaging (MRI). This oxide has the ability to detect certain cancer cells and eventually kill them if the disease is at an initial stage. Silica – in glass – can be used to bend or stop light paths.

The scope of Nanochemistry is to find a way to arrange atoms, to solve problems, controlling additional degrees of freedom of atoms and particles, beyond the capabilities of traditional Chemistry. This way, it is possible to control the properties and behaviour of the new materials obtained (Cademartiri and Ozin 2009).

1.2.7 Nanophysics

There is a world of dwarves sized a billionth of a metre. It is called the nanoworld and its laws are different from the macroscopic ones we are used to, as the laws of Quantum Mechanics applied to very small structures give rise to new properties, the ones scientists are interested in. The same substance in its bulk form and at the nanoscale may show totally different features.

The electronic properties of these materials, together with its optical properties and surface ones are detected and investigated. This fundamental research needs the continuous

development of imaging and detection, refining the instruments and the tools available, or the realization of new ones. The resolution goes to the nanoscale and the atomic scale.

Observation is fundamental, the key for new exciting discoveries and this appears to be particularly true when nanoscale is the object. The observation of materials at the nanoscale can be performed using electrons, photons, scanning probes, ions, atoms and so on. A wide range of techniques is available in each of these areas and systematic applications of several tools lead to the understanding of the system (Pradeep 2008).

The most common analytical tools to characterize materials are listed here (Table 1.3).

Table. 1.3 Analytical tools for characterization of materials (Pradeep 2008).

AES	Auger Electron Spectroscopy
AFM	Atomic Force Microscope
APECS	Auger Photoelectron Coincidence Spectroscopy
APFIM	Atom Probe Field Ion Microscopy
APS	Appearance Potential Spectroscopy
ARPES	Angle Resolved Photoelectron Spectroscopy
ARUPS	Angle Resolved Ultraviolet Photoelectron Spectroscopy
ATR	Attenuated Total Reflection
BEEM	Ballistic Electron Emission Microscopy
BIS	Bremsstrahlung Isochromat Spectroscopy
CFM	Chemical Force Microscopy
CM	Confocal Microscopy
DRIFTS	Diffuse Reflectance Infra-Red Fourier Transform Spectroscopy
EDX	Energy Dispersive X-ray Analysis
EELS	Electron Energy Loss Spectroscopy
EMS	Electron Momentum Spectroscopy
EPMA	Electron Probe Micro-Analysis
ESCA	Electron Spectroscopy of Chemical Analysis
ESD	Electron Stimulated Desorption
ESDIAD	Electron Stimulated Desorption Ion Angle Distribution
EXAFS	Extended X-ray Absorption Fine Structure
FEM	Field Emission Microscopy
FIM	Field Ion Microscopy
FRET	Fluorescence Resonance Energy Transfer
FTIR	Fourier Transform Infra-red Spectroscopy
FT RA-IR	Fourier Transform Reflectance-Absorption Infra-red
HAS	Helium Atom Scattering
HEIS	High Energy Ion Scattering
HOPG	Highly Oriented Pyrolytic Graphite
HREELS	High Resolution Electron Energy Loss Spectroscopy
IETS	Inelastic Electron Tunneling Spectroscopy
KRIPES	k-Resolved Inverse Photoemission Spectroscopy
ILS	Ionization Loss Spectroscopy
INS	Ion Neutralization Spectroscopy
IPES	Inverse Photoemission Spectroscopy
IRAS	Infra-red Absorption Spectroscopy
ISS	Ion Scattering Spectroscopy
LEED	Low Energy Electron Diffraction
LEEM	Low Energy Electron Microscopy
LEIS	Low Energy Ion Scattering
LFM	Lateral Force Microscopy
MBS	Molecular Beam Scattering
MCXD	Magnetic Circular X-ray Dichroism

MEIS	Medium Energy Ion Scattering
MFM	Magnetic Force Microscopy
MIES	Metastable Impact Electron Spectroscopy
MIR	Multiple Internal Reflection
NEXAFS	Near-Edge X-ray Absorption Fine Structure
NSOM	Near Field Scanning Optical Microscopy
PAES	Positron Annihilation Auger Electron Spectroscopy
PEEM	Photoemission Electron Microscopy
PED	Photoelectron Diffraction
PIXE	Proton Induced X-ray Emission
PSD	Photon Stimulated Desorption
RAIRS	Reflection Absorption Infra-red Spectroscopy
RAS	Reflectance Anisotropy Spectroscopy
RBS	Rutherford Back Scattering
RDS	Reflectance Difference Spectroscopy
REFLEXAFS	Reflection Extended X-ray Absorption Fine Structure
RHEED	Reflection High Energy Electron Diffraction
RiFS	Reflectometric Interference Spectroscopy
SAM	Scanning Auger Microscopy
SCM	Scanning Confocal Microscope
SEM	Scanning Electron Microscopy
SEMPA	Scanning Electron Microscopy with Polarization Analysis
SERS	Surface Enhanced Raman Spectroscopy
SEXAFS	Surface Extended X-ray Absorption Spectroscopy
SFS	Sum Frequency Spectroscopy
SHG	Second Harmonic Generation
SH-MOKE	Second Harmonic Magneto-optic Kerr Effect
SIM	Scanning Ion Microscope
SIMS	Secondary Ion Mass Spectrometry
SKS	Scanning Kinetic Spectroscopy
SLM	Scanning Light Microscope
SMOKE	Surface Magneto-optic Kerr Effect
SNMS	Sputtered Neutral Mass Spectrometry
SNOM	Scanning Near Field Optical Microscopy
SPIPES	Spin Polarized Inverse Photoemission Spectroscopy
SPEELS	Spin Polarized Electron Energy Loss Spectroscopy
SPLEED	Spin Polarized Low Energy Electron Diffraction
SPM	Scanning Probe Microscopy
SPR	Surface Plasmon Resonance
SPUPS	Spin Polarized Ultraviolet Photoelectron Spectroscopy
SPXPS	Spin Polarized X-ray Photoelectron Spectroscopy
STM	Scanning Tunneling Microscopy
SXAPS	Soft X-ray Appearance Potential Spectroscopy
SXRD	Surface X-ray Diffraction
TDS	Thermal Desorption Spectroscopy
TIRF	Total Internal Reflectance Fluorescence
TPD	Temperature Programmed Desorption
TPRS	Temperature Programmed Reaction Spectroscopy
TXRF	Total Reflection X-ray Fluorescence
UPS	Ultraviolet Photoemission Spectroscopy
XANES	X-ray Absorption Near-Edge Structure
XPD	X-ray Photoelectron Diffraction
XPS	X-ray Photoemission Spectroscopy
XRR	X-ray Reflectometry
XSW	X-ray Standing Wave

1.2.8 Nanomedicine

We call the medical application of Nanotechnology Nanomedicine. As nanomaterials exhibit completely new properties due to their extremely small scale, when these same properties are compared with the bulk material, strong chances for their interactions with biological systems appear. Biological systems possess components whose dimensions are nano scaled (such as proteins, membranes, nucleic acids and so on). So, nanomaterials can be applied to both in vitro and in vivo biomedical research and applications.

Scientists can add different functionalities to nanomaterials to get diagnostic devices, contrast agents, analytical tools, applications to physical therapies or drug transport systems.

This fact opens new doors to research as synergies among nanosystems and biological components may improve health and quality of life, from one side; on the other side, ethical implications arise about the legitimate use of such new discoveries and the awareness of their side effects.

1.2.9 Nanotoxicology

The study of toxicity of nanoparticles is called nanotoxicology (Buzea, Pacheco and Robbie 2007). Features like quantum size effects or their large surface to volume ratio may affect the toxicity of the nanoparticles. Serious side effects such as inflammation, fibrosis or carcinogenicity, i.e. the tendency of an active ingredient to produce cancer (O'Toole 2003) are possible hazards of inhalation exposure of some nanoparticles. Skin contact and ingestion exposure are to be seriously considered.

Nanotechnology can be considered a relatively recent development in science and its effects on health, despite the studies conducted so far, are yet to be deeply understood. We could consider Nanotechnology a rather recent scientific development so it is fundamental to know how exposures to these agents may affect the health and safety of workers and users, or what level of exposure will be acceptable. As health is to be protected above all, it is important to take precautions to minimize hazardous exposure and side effects (NIOSH, 2014).

We can say that nanotoxicology is a new sub-speciality of particle toxicology. As the properties of nanoparticles differ from the bulk ones due to their nanometric dimensions, so their toxicity appears to be different due to the same reason: dimension. For example, a metal like gold which is known to be inert at bulk dimensions becomes very active at nanometric dimension. This is why a discipline such as nanotoxicology is becoming more and more important, trying to establish if and to what extent these properties may become hazardous to human health and the environment (Mahmoudi, Hofmann, Rothen-Rutishauser and Petri-Fink 2012).

It is not correct to believe that nanoparticles are man-engineered artificial structures only, like carbon nanotubes for instance. In fact, it is possible to find them in Nature as combustion-derived nanoparticles, like in diesel soot, or as naturally occurring nanoparticles from volcanic eruptions, atmospheric chemistry and so on. So, the hypothetical threat is coming from different sides, none of them to be neglected. Once they have entered the body, through inhalation, swallowing or skin absorption, due to their small size, the particles can migrate inside the body and affect distant sites such as brain and other organs, conveyed by the cardiovascular apparatus.

Epilogue I

This first chapter has been devoted, from an historical point of view, to the beginnings of Nanoscience and Nanotechnology, the research sectors which developed at the end of the last century and which have definitively taken hold in the first twenty years of this new millennium. We have seen how Nature was the first to create nanostructures of a biological or mineral nature, and how many of these nanoproducts are still available today in volcanic ash, soot or combustion products. With nanomaterials whose production process was unknown, ancient civilisations made artefacts and colours that still survive today. In the 19th century, Michael Faraday obtained the first colloidal suspension of gold particles. Subsequently, biological and artificially obtained materials have been described. A science that has invested decisively and across the board has also brought to the forefront the figures of scientists who have risen to the role of founding fathers. Among these, the most important are certainly Richard Feynman, who is credited with the fundamental vision that inspired nanotechnology, Eric Drexler, who amplified Feynman's vision, and Norio Taniguchi, who used the term nanotechnology for the first time. Inevitably, the arrival of new sciences brings with it sometimes heated debates. In this case, we have seen how the hypothesis that POR is not necessarily to be considered as the founding document of nanotechnology has been openly opposed, a hypothesis that has been confirmed by the testimony of Nobel prize winners. In order to explore some of the many fields in which nanotechnology has been developed to date, the main outlets in which this discipline has been applied are listed in a dedicated section at the end of the chapter.

References

Primary Sources

- Bayda S, Adeel M, Tuccinardi T, Cordani M, Rizzolio F (2020) The History of Nanoscience and Nanotechnology: From Chemical–Physical Applications to Nanomedicine. *Molecules* 25/1:112. doi:10.3390/molecules25010112
- Drexler KE (1981) Molecular Engineering: An Approach to the Development of General Capabilities for Molecular Manipulation. *Proceedings of the National Academy of Science USA* 78/9:5275–5278
- Drexler KE (1986) *Engines of Creation. The Coming Era of Nanotechnology*. Doubleday, New York
- Drexler KE, Peterson C, Pergamit G (1991) *Unbounding the Future: the Nanotechnology Revolution*. William Morrow and Company, Inc. New York
- Faraday M (1856) *Faraday’s Diary. Being the Various Philosophical Notes of Experimental Investigations*. G. Bell and Sons, London (1936 printing)
- Faraday M (1857) The Bakerian Lecture: Experimental Relations of Gold (and Other Metals) to Light. *Philosophical Transactions of the Royal Society of London* 147:145–181
- Feynman RP (1960) There’s Plenty of Room at the Bottom. An Invitation to Enter a New Field of Physics. *Engineering and Science* pp.22–36
- Jia Z, Lei W, Yang H, Wang G (2016) Dynamic Wetting Behaviour of Vibrated Droplets on a Micropillared Surface. *Advances in Materials Science and Engineering* 2016. doi:10.1155/2016/8409683
- Griffin S, Masood MI, Nasim MJ, Sarfraz M, Ebokaiwe AP, Schäfer KH, Keck CM, Jacob C (2018) Natural Nanoparticles: A Particular Matter Inspired by Nature. *Antioxidants* 7/1:3. doi:10.3390/antiox7010003
- National Nanotechnology Initiative (2020) What It Is and How It Works. <https://www.nano.gov/nanotech-101/what> Retrieved April 20, 2020
- Oparin AI (1977) L’origine della vita. *Universale scientifica Boringhieri*, Torino
- Taniguchi N (1974) On the Basic Concept of ‘Nano–Technology’. *J–Proceedings of the Japan Society of Precision Engineering*, Tokio Science University
- Tian Y, Pesika N, Zeng H, Rosenberg K, Zhao B, McGuiggan P, Autumn, Israelachvili J. (2006) Adhesion and Friction in Gecko Toe Attachment and Detachment. *Proceedings of the National Academy of Science* 103/51:19320–19325. doi:10.1073/pnas.0608841103

Secondary Sources

- Betzig E, Harootian A, Isaacson M, Kratschmer E (1986) Near Field Scanning Optical Microscopy (NSOM). *Biophysical Journal* 49/1:269–279. doi:10.1016/s0006–3495(86)83640–2
- Bhushan B (2001) *Fundamentals of Tribology and Bridging Gap between Macro– and Micro/Nanoscales*. Kluwer Academic Publishers, Alphen aan der Rijn
- Buzea C, Pacheco II, Robbie K (2007) Nanomaterials and Nanoparticles: Sources and Toxicity. *Biointerphases* 2/4:MR17–71. doi: 10.1116/1.2815690
- Cademartiri L, Ozin G (2009) *Concept of Nanochemistry*. Wiley VCH, Weinheim
- Del Rio MS, Doménech A, Doménech–Carbó MT, Vázquez de Agredo Pascual ML, Suárez M, García–Romero E (2011) The Maya Blue Pigment, in *Developments in Clay Science*, Chapter 18,453–481. Elsevier Amsterdam
- Drexler KE (1992) *Nanosystems: Molecular Machinery, Manufacturing and Computation*. Wiley, New York
- Durkan C (2019) *Size Does Really Matter. The Nanotechnology Revolution*. World Scientific Publishing Europe Ltd., London
- Dürig U, Pohl DW, Rohner F (1986) Near–Field Optical Scanning Microscopy. *Journal of Applied Physics* 59/10:3318–3327. doi:10.1063/1.336848
- Edwards SA (2006) *The Nanotech Pioneers. Where Are They Taking Us?* WILEY–VCH Verlag GmbH & Co. KGaA, Weinheim
- Ensikat HJ, Ditsche–Kuru P, Neinhusi C, Barthlott W (2011) Superhydrophobicity in Perfection the Outstanding Properties of the Lotus Leaf. *Beilstein Journal of Nanotechnology* 2:152–161. doi:10.3762/bjnano.2.19

- Hsu SM, Ying CZ (2002) *Nanotribology: Critical Assessment and Research Need*. Kluwer Academic Publishers, Alphen aan der Rijn
- Kelly TR, De Silva H, Silva RA (1999) Unidirectional Rotary Motion in a Molecular System. *Nature* 401/6749:150–152. doi:10.1038/43639
- Kurzweil R (2005) *The Singularity is Near. When Humans Transcend Biology*. Viking Penguin Books, London
- Latthe SS, Terashima C, Nakata K, Fujishima A (2014) Superhydrophobic Surfaces Developed by Mimicking Hierarchical Surface Morphology of Lotus Leaf. *Molecules* 19:4256–4283. doi:10.3390/molecules19044256
- Mahmoudi M, Hofmann H, Rothen–Rutishauser B, Petri–Fink A (2012) Assessing the In Vitro and in Vivo Toxicity of Superparamagnetic Iron Oxide Nanoparticles. *Chemical Reviews* 112/4:2323–38. doi:10.1021/cr2002596
- Mansoori GA (2017) *An Introduction to Nanoscience & Nanotechnology, in Nanoscience and Plant-Soil Systems*. Springer Soil Biology Series, Switzerland. doi:10.1007/978–3–319–46835–8
- Merkle RC (1996) Design Considerations for an Assembler. *Nanotechnology* 7:210–215
- Merkle RC (1997) A Proposed ‘Metabolism’ for a Hydrocarbon Assembler. *Nanotechnology* 8:149–162
- Montemagno CD, Bachand G, Stelick S, Bachand M (1999) Constructing Biological Motor Powered Nanomechanical Devices. *Nanotechnology* 10:225–231
- Murty BS, Shankar P, Raj Baldev, Rath BB, Murday J (2013) *Textbook of Nanoscience and Nanotechnology*. Universities Press Private Limited, Himayatnagar, Hyderabad
- Neinhuis C, Barthlott W (1997) Characterization and Distribution of Water–repellent, Self–cleaning Plant Surfaces. *Annals of Botany* 79:667–677. doi:10.1063/1.94865
- O’Toole Marie (2003) *Miller–Keane Encyclopedia & Dictionary of Medicine, Nursing and Allied Health*. Saunders Elsevier, Philadelphia
- Pohl DW, Denk W, Lanz M (1984) Optical Stethoscopy: Image Recording with Resolution $\lambda/20$. *Applied Physics Letters* 44/7:651–653
- Pradeep T (2007) *NANO: The Essentials: Understanding Nanoscience and Nanotechnology*. McGraw–Hill, New York
- Sanders WC (2019) *Basic Principles of Nanotechnology*. CRC Press, Taylor & Francis Group, Boca Raton
- Selvaggio G, Chizhik A, Nißler R, Kuhlemann I, Meyer D, Vuong L, Preiß H, Hermann N, Mann FA, Lv Z, Oswald TA, Spreinat A, Erpenbeck L, Großhans J, Janshoff A, Giraldo JP, Kruss S (2020) Exfoliated Near Infrared Fluorescent Silicate Nanosheets for (bio)Photonics. *Nature Communications* 11/1495:1–11. doi:10.1038/s41467–020–15299–5
- Sharon M (2019) *History of Nanotechnology. From Prehistoric to Modern Times*. Scrivener Publishing, Beverly
- Sherrington I, Rowe WB, Wood RJ (2002) *Total Tribology. Towards an Integrated Approach*. Professional Engineering Publishing Ltd., London
- Shong CW, Haur SC, Wee ATS (2010) *Science at the Nanoscale. An Introductory Textbook*. Pan Stanford Publishing Pte. Ltd., Singapore
- Smalley RE (2001) Of Chemistry, Love and Nanobots. *Scientific American Magazine* 285/3:76–77. doi:10.1038/scientificamerican0901–76
- Toumey C (2008) Reading Feynman Into Nanotechnology: A Text for a New Science. *Techné: Research in Philosophy and Technology* 12/3:133–168. doi:10.5840/techne20081231.
- Whatmore RW (2006) Nanotechnology–what is it? Should we be worried? *Occupational Medicine* 56:295–299. doi:10.1093/occmed/kql050
- Zaks A, Klibanov AM (1984) Enzymatic Catalysis in Organic Media at 100 Degree °C. *Science* 224/4654:1249–1251. doi: 10.1126/science.6729453

Web References

- Kurzweil R (2003) *The Drexler–Smalley Debate on Molecular Assembly*. Retrieved February the 21st 2021 via: <https://www.kurzweilai.net/the-drexler-smalley-debate-on-molecular-assembly>
- Merkle RC (2001) *That’s Impossible! How Good Scientists Reach Bad Conclusions*. Retrieved March the 12th 2021 via: <http://www.zyvex.com/nanotech/impossible.html>.

Selected Additional References on the Subjects Suggested for Further Reading

- Aghdam MTB, Mohammadi H, Ghorbanpour M (2015) Effects of Nanoparticulate Anatase Titanium Dioxide on Physiological and Biochemical Performance of *Linum usitatissimum* (Linaceae) under Well-watered and Drought. *Brazilian Journal of Botany*, 23:1–8
- Allho F (2007) On the Autonomy and Justification of Nanoethics. *Nanoethics* 1:185–210
- Amabilino DB, Stoddard JF, Williams DJ (1994) From Solid-State Structures and Superstructures to Self-Assembly Processes. *Chemistry of Materials* 6/8:1159–1167
- Amato I (1999) *Nanotechnology: Shaping the World Atom by Atom*. Washington, DC: National Science & Technology Council
- Anischik VM, Borisenko VE, Zhdanok SA, Tolochko NK, Fedosyuk VM (2008). *Nanomaterials and Nanotechnologies*. Izd. Ben-Gurion University, Negev
- Appenzeller T (1991) The Man Who Dared to Think Small. *Science* 254/5036:1300–01
- Averin DV, Likharev KK (1986) Coulomb Blockade of Single-Electron Tunneling, and Coherent Oscillations in Small Tunnel Junctions. *Journal of Low Temperature Physics* 62:345–373
- Aviram A, Ratner MA (1974) Molecular Rectifiers. *Chemical Physics Letters* 29:277–283. doi:10.1016/0009-2614(74)85031-1
- Baird D, Shew A (2003) *The Mythology of Nanotechnology: Changing the Epistemology of Science*. Unpublished paper
- Baker SN, Baker GA (2010) Luminescent Carbon Nanodots: Emergent Nanolights. *Angewandte Chemie International Edition in English* 49:6726–6744
- Barber DJ, Freestone IC (1990) An Investigation of the Origin of the Colour of the *Lycurgus Cup* by Analytical Transmission Electron Microscopy. *Archaeometry* 32:33–45
- Bayda S, Hadla M, Palazzolo S, Kumar V, Caligiuri I, Ambrosi E, Pontoglio E, Agostini M, Tuccinardi T, Benedetti A, Riello P, Canzonieri V, corona G, Toffoli G, Rizzolio F (2017) Bottom-up Synthesis of Carbon Nanoparticles with Higher Doxorubicin efficacy. *Journal of Controlled Release* 248:144–152
- Beck JS, Vartuli JC, Roth WJ, Leonowicz ME, Kresge CT, Schmitt KD, Chu CTW, Olson DH, Sheppard EW, McCullen SB, Higgins JB, Schlenker JL (1992) A New Family of Mesoporous Molecular Sieves prepared with Liquid Crystal Templates. *Journal of the American Chemical Society* 114/27:10834–10843
- Becker RS, Golovchenko JA, Swarzentruer BS (1987) Atomic-scale Surface Modifications Using a Tunneling Microscope. *Nature* 325:419–421
- Berube D (2004) Denialism: Drexler vs. Roco. *IEEE Technology and Society Magazine Winter 2004*:22–26
- Bethune DS, Klang CH, de Vries MS, Gorman G, Savoy R, Vazquez J, Beyers R (1993) Cobalt-catalysed Growth of Carbon Nanotubes with Single-atomic-layer Walls. *Nature* 363:605–607
- Bhushan B (2008) nanotribology and Nanomechanics in Nano/Biotechnology. *Philosophical Transactions of the Royal Society A* 366:1499–1537
- Binnig G (1990) Atomic Force Microscope and Method for Imaging Surfaces with Atomic Resolution. United States Patent RE33,387. Washington DC: USPTO
- Binnig G, Gerber C, Rohrer H, Wiebel E (1985) Nano-Aperture. *IBM Technical Disclosure Bulletin* 27/8:4893
- Binnig G, Rohrer H (1985) The Scanning Tunneling Microscope. *Scientific American* 253:50–56
- Binnig G, Rohrer H (1986) Scanning Tunneling Microscopy. *IBM Journal of Research & Development* 30/4:355–369
- Binnig G, Rohrer H, Gerber C, Weibel E (1982) Surface Studies by Scanning Tunneling Microscopy. *Physical Review Letters* 49:57–61
- Binnig G, Rohrer H, Gerber C, Weibel E (1982) Tunneling through a controllable vacuum gap. *Applied Physics Letters* 40:178
- Binnig G, Rohrer H, Gerber C, Weibel E (1983) 7x7 Reconstruction on Si(111) Resolved in Real Space. *Physical Review Letters* 50:120–123
- Binnig G, Rohrer H (1987) Scanning Tunneling Microscopy – From Birth to Adolescence. *Reviews of Modern Physics*, Part 1 59/3:615–625
- Brannigan A (1979) The Reification of Mendel. *Social Studies of Science* 9:423–454
- Brown LM (2000) *Selected Papers of Richard Feynman*. Singapore: World Scientific

- Cao L, Wang X, Meziani MJ, Lu F, Wang H, Luo PG, Lin Y, Harru BA, Veca LM, Murray D, Xie SY, SunYP (2007) Carbon Dots for Multiphoton Bioimaging. *Journal of the American Chemical Society* 129:11318–11319
- Carpick RW, Salmeron M (1997) Scratching the Surface: Fundamental Investigations of Tribology with Atomic Force Microscopy. *Chemical Reviews* 97/4:1163–1194
- Clinton WJ (2000) President Clinton's Remarks at Science and Technology Event. Online: <http://mrs.org/pa/nanotech/clinton.html> (accessed 8 Sept. 2004)
- Coleman RV, Dranke B, Hansma PK, Slough G (1985) Charge–Density Waves Observed with a Tunneling Microscope. *Physical Review Letters* 55/4:394–398
- Cordani M, Somoza Á (2019) Targeting Autophagy using Metallic Nanoparticles: A Promising Strategy for Cancer Treatment. *Cellular and Molecular Life Sciences* 76/7:1215–1242
- Crewe AV, Wall J, Langmore J (1970) Visibility of Single Atoms. *Science* 168:1338–1340
- Dahl JE, Liu SG, Carlson RMK (2003) Isolation and Structure of Higher Diamondoids, Nanometer–Sized Diamond Molecules. *Science* 299/5603:96–99
- DeGrado WF (1997) Proteins from Scratch. *Science* 278/5335:80–81
- Dienwiebel M, Pradeep N, Verhoeven GS, Zandbergen HW, Frenken JWM (2005) Model Experiments of Superlubricity of Graphite. *Surface Science* 576:197–211
- Dienwiebel M, Verhoeven GS, Pradeep N, Frenken JWM, Heimberg JA, Zandbergen HW (2004) Superlubricity of Graphite. *Physical Review Letters* 92:126101
- Drexler KE (1992) *Nanosystems*. Wiley & Sons, New York
- Drexler KE (2004) Nanotechnology: From Feynman to Funding. *Bulletin of Science, Technology & Society* 24/1:21–27
- Drexler KE, Smalley R (2003) Nanotechnology. *Chemical & Engineering News* pp.37–42
- Du G, Moulin E, Jouault N, Buhler E, Giuseppone N (2012) Muscle–like Supramolecular Polymers: Integrated Motion from Thousands of Molecular Machines. *Angewandte Chemie* 124:12672–12676
- Ebrahimi N, Mansoori GA (2014) Reliability for Drug Targeting in Cancer Treatment through Nanotechnology. *International Journal of Medical Nano Research* 1/1:ISSN:2378–3664
- Economist Technology Quarterly, The (ETQ) (2004) Touching the Atom. *Economist Technology Quarterly* September pp.42–43
- Eigler DM, Schweizer EK (1990) Positioning single atoms with a scanning tunnelling microscope. *Nature* 344:524–526
- Ekimov A, Onushchenko A (1982) Quantum Size Effect in the Optical–Spectra of Semiconductor Microcrystals. *Soviet Physics. Semiconductors* 16/7:775–778
- Eliassi A, Eikani MH, Mansoori GA (2002) Production of Single–Walled Carbon Nanotubes. *Proceedings of the First Conference on Nanotechnology – The next industrial revolution*, 2, 160, March
- Esaki L (1958) New Phenomenon in Narrow Germanium p–n Junctions. *Physical Reviews* 109:603–604
- Esteves da Silva JCG, Gonçalves HMR (2011) Analytical and Bioanalytical Applications of Carbon Dots. *Trends in Analytical Chemistry* 30:1327–1336
- Faraday M (1857) The Bakerian Lecture: Experimental Relations of Gold (and Other Metals) to Light. *Philosophical Transactions of the Royal Society London* 147:145–181
- Feynman RP (1960) How to Build an Automobile Smaller Than This Dot. *Popular Science* pp.114–ff
- Feynman RP (1960) The Wonders That Await a Micro–Microscope. *Saturday Review* pp.45–47
- Feynman RP (1984) Tiny Machines. Videotape available online <https://www.youtube.com/watch?v=4eRCygdW--c>
- Feynman RP (1986) Quantum Mechanical Computers. *Foundations of Physics* 16:507–521
- Feynman RP (1986) The ORIGINAL Nanotechnology Paper (sic; reprint of “There's Plenty of Room at the Bottom”). In *Nanotechnology with Feynman Machines*, by Conrad W. Schneiker, unpublished book manuscript of 215 pages, pp. 133–149
- Feynman RP (2005) Perfectly Reasonable Deviations from the Beaten Path: The Letters of Richard P. Feynman, edited by Michelle Feynman. Perseus, Cambridge MA.
- Feynman RP (2006) Infinitesimal Machinery. In *Nanotechnology: Science, Innovation, and Opportunity*, edited by L.E. Foster, Prentice Hall, Upper saddle River NJ pp.247–268.
- Foster JS, Frommer JE, Arnett PC (1988) Molecular Manipulation Using a Tunneling Microscope. *Nature*, 331:324–326
- Foster L (2005). *Nanotechnology Science, Innovation and Opportunity*. Prentice Hall, New York
- Freestone I, Meeks N, Sax M, Higgitt C (2007) The Lycurgus Cup—A Roman Nanotechnology. *Gold Bull* 40:270–277
- Freiser MJ, Marcus PM (1969) A Survey of Some Physical Limitations on Computer Elements. *IEEE Transactions on Magnetics* 5/2:82–90

- Ghorbanpour M (2015) Major Essential Oil Constituents, Total Phenolics and Flavonoids Content and Antioxidant Activity of *Salvia Officinalis* Plant in Response to Nano-Titanium Dioxide. *Indian Journal of Plant Physiology* 20/3:249–256
- Ghorbanpour M, Hadian J (2015) Multi-Walled Carbon Nanotubes Stimulate Callus Induction, Secondary Metabolites Biosynthesis and Antioxidant Capacity in Medicinal Plant. *Carbon* 94: 749–759
- Ghorbanpour M, Hatami M (2015) Changes in Growth, Antioxidant Defense System and Major Essential Oils Constituents of *Pelargonium Graveolens* Plant Exposed to Nano-Scale Silver and Thidiazuron. *Indian Journal of Plant Physiology* 20/2:116–123
- Ghorbanpour M, Hatami M, Hatami M (2015) Activating Antioxidant Enzymes, Hyoscyamine and Scopolamine Biosynthesis of *Hyoscyamus Niger* L. Plants with Nano-Sized Titanium Dioxide and Bulk Application. *Acta Agriculturae Slovenica* 105/1:23–32
- Gleick J (1992) *Genius: The Life and Times of Richard Feynman*. Pantheon, New York
- Gnach A, Lipinski T, Bednarkiewicz A, Rybka J, Capobianco JA (2015) Upconverting nanoparticles: Assessing the toxicity. *Chemical Society Reviews* 44:1561–1584
- Goldstein H (2004) *A Beautiful Noise*. *IEEE Spectrum* pp.50–52
- Hameroff SR (1987) *Ultimate Computing: Biomolecular Consciousness and Nanotechnology*. North-Holland, Amsterdam
- Hansma PK, Tersoff J (1987) Scanning Tunneling Microscopy. *Journal of Applied Physics*, 61/2:R1–R23
- Hatami M, Ghorbanpour M (2014) Defense Enzyme Activities and Biochemical Variations of *Pelargonium Zonale* in Response to Nanosilver Application and Dark Storage. *Turkish Journal of Biology* 38/1:130–139
- Hatami M, Ghorbanpour M, Salehiarjomand H (2014) Nano-Anatase TiO₂ Modulates the Germination Behavior and Seedling Vigority of some Commercially Important Medicinal and Aromatic Plants. *Journal of Biological & Environmental Sciences* 8/22:53–59
- Henson K, Schneiker CW (1984) The Annual Von Neumann-Feynman Award. Unpublished manuscript of 22 May 1984, 3 pages
- Hersam MC; Guisinger NP, Lyding JW (2000) Isolating, Imaging, and Electrically Characterizing Individual Organic Molecules on the Si(100) Surface with the Scanning Tunneling Microscope. *Journal of Vacuum Science and Technology A and Vacuum Surface Films* 18:1349
- Hessenbruch, A (2004) *Nanotechnology and the Negotiation of Novelty*. In *Discovering the Nanoscale*, ed. by D. Baird, A. Nordmann & J. Schummer. IOS Press, Amsterdam pp.135–144
- Hey AJG (1999) *Feynman and Computation: An Overview*. In *Feynman and Computation*, edited by A.J.G. Hey. Westview, Reading, MA pp.ix–xxiii
- Hill TL (2001) A Different Approach to Nanothermodynamics. *Nano Letters* 1/5:273–275
- Hirsch LR, Stafford RJ, Bankson JA, Sershen SR, Rivera B, Price RE, Hazle JD, Halas NJ, West JL (2003) Nanoshell-Mediated Near-Infrared Thermal Therapy of Tumors under Magnetic Resonance Guidance. *Proceedings of the National Academy of Science USA* 100/23:13549–13554
- Hulla J, Sahu S, Hayes A (2015) *Nanotechnology. History and Future*. *Human & Experimental Toxicology* 34:1318–1321
- Iqbal P, Preece JA, Mendes PM (2012) *Nanotechnology: The “Top-Down” and “Bottom-Up” Approaches*. In *Supramolecular Chemistry*. JohnWiley & Sons, Ltd. Chichester
- Jeanmaire DL, Van Duyne RP (1977) Surface Raman Spectroelectrochemistry. *Journal of Electroanalytical Chemistry and Interfacial Electrochemistry* 84:1–20
- Joy B (2000) Why the Future Doesn't Need Us. *Wired* pp.238–262
- Junk, A. and F. Riess. 2006. From an Idea to a Vision: There's Plenty of Room at the Bottom. *American Journal of Physics*, 74/9:825–830
- Keiper A (2003) *The Nanotechnology Revolution*. *The New Atlantis* pp.17–34
- Keyes RW (1969) Physical Problems and Limits in Computer Logic. *IEEE Spectrum* 6/5:36–45
- Keyes RW (1975) Physical Limits in Digital Electronics. *Proceedings of the IEEE* 63/5:740–767
- Khataee AR, Mansoori GA (2011) *Nanostructured Titanium Dioxide Materials (Properties, Preparation and Applications)*. World Scientific Publishing Company, Hackensack
- Kinnear C, Moore TL, Rodriguez-Lorenzo L, Rothen-Rutishauser B, Petri-Fink A (2017) Form Follows Function: Nanoparticle Shape and Its Implications for Nanomedicine. *Chemical Reviews* 117/17:11476–11521
- Knoll AW, Pires D, Coulembier O, Dubois P, Hedrick JL, Frommer J, Duerig U (2010) Probe-Based 3-D Nanolithography Using Self-Amplified Depolymerization Polymers. *Advanced Materials* 22:3361–3365
- Knoll M, Ruska E (1932) Beitrag zur Geometrischen Elektronenoptik. I. *Annalen der Physik* 404:607–640

- Kresge CT, Leonowicz ME, Roth WJ, Vartuli JC, Beck JS (1992) Ordered Mesoporous Molecular Sieves Synthesized by a Liquid–Crystal Template Mechanism. *Nature* 359:710–712
- Krieger M (2006) Epilogue. In *Nanotechnology: Science, Innovation, and Opportunity*, edited by L.E. Foster. Prentice Hall, Upper Saddle River NJ pp.243–245
- Krim J (2002) Surface Science and the Atomic–Scale Origins of Friction: What Once was old is New Again. *Surface Science* 500:741–758
- Krumhansl JA, Pao YH (1979) *Microscience: An Overview*. *Physics Today* pp.25–32
- Kumar V, Bayda S, Hadla M, Caligiuri I, Russo Spena C, Palazzolo S, Kempter S, Corona G, Toffoli G, Rizzolio F (2016) Enhanced Chemotherapeutic Behavior of Open–Caged DNA@Doxorubicin Nanostructures for Cancer Cells. *Journal of Cellular Physiology* 231:106–110
- Kumar V, Palazzolo S, Bayda S, Corona G, Toffoli G, Rizzolio F (2016) DNA Nanotechnology for Cancer Therapy. *Theranostics* 6/5:710–725
- Kurzweil R (2005) *The Singularity Is Near: When Humans Transcend Biology*. Penguin, London
- Lafferentz L, Ample F, Yu H, Hecht S, Joachim C, Grill L (2009) Conductance of a Single Conjugated Polymer as a Continuous Function of Its Length. *Science* 323/5918:1193–1197
- Lee PY, Wong KKY (2011) Nanomedicine: A New Frontier in Cancer Therapeutics. *Current Drug Delivery* 8:245–253
- Li Q, Ohulchanskyy TY, Liu R, Koynov K, Wu D, Best A, Kumar R, Bonoiu A, Prasad PN (2010) Photoluminescent Carbon Dots as Biocompatible Nanoprobes for Targeting Cancer Cells in Vitro. *Journal of Physical Chemistry C* 114:12062–12068
- Li Y, Hu Y, Zhao Y, Shi G, Deng L, Hou Y, Qu L (2011) An Electrochemical Avenue to Green–Luminescent Graphene Quantum Dots as Potential Electron–Acceptors for Photovoltaics. *Advanced Materials* 23/6:776–780
- Liu L, Li Y, Zhan L, Liu Y, Huang C (2011) One–step Synthesis of Fluorescent Hydroxyls–coated Carbon Dots with Hydrothermal Reaction and its Application to Optical Sensing of Metal Ions. *Science China Chemistry* 54:1342–1347
- Lok C (2010) Nanotechnology: Small wonders. *Nature* 467/7311:18–21
- Loo C, Lin A, Hirsch L, Lee MH, Barton J, Halas N, West J, Drezek R (2004) Nanoshell–Enabled Photonics–Based Imaging and Therapy of Cancer. *Technology in Cancer Research & Treatment* 3/1:33–40
- Mann AB, Pethica JB (1996) Nanoindentation Studies in a Liquid Environment. *Langmuir* 12/19:4583–4586
- Mann AB, Pethica JB (1996) The Role of Atomic Size Asperities in the Mechanical Deformation of Nanocontacts. *Applied Physics Letters* 69/7:907–909
- Mansoori G, Fauzi Soelaiman T (2005) Nanotechnology—An Introduction for the Standards Community. *Journal of ASTM International* 2:1–22
- Mansoori GA (2002) Organic Nanostructures and Their Phase Transitions. *Proceedings of the first Conference on Nanotechnology - The Next Industrial Revolution* 2, 345
- Mansoori GA (2005) *Principles of Nanotechnology*. World Scientific Publishing Company, Hackensack
- Mansoori GA (2013) Diamondoids – The Molecular Lego of Biomedicine, Materials Science and Nanotechnology. *Journal of Bioanalysis & Biomedicine* 5/2:1–3
- Mansoori GA, Brandenburg KS, Shakeri–Zadeh A (2010) A Comparative Study of Two Folate–Conjugated Gold Nanoparticles for Cancer Nanotechnology Applications. *Cancers* 2/4:1911–1928
- Mansoori GA, de Araujo PLB, de Araujo ES (2012) *Diamondoid Molecules with Applications in Biomedicine, Materials Science, Nanotechnology & Petroleum Science*. World Scientific Publishing Company, Hackensack
- Mansoori GA, Enayati N, Agyarko L (2016) *Energy: Sources, Utilization, Legislation, Sustainability, Illinois as the Model State*. World Scientific Publishing Company, Hackensack
- Mansoori GA, George TF, Assoufid L, Zhang G (Eds) (2007) *Molecular Building Blocks for Nanotechnology: From Diamondoids to Nanoscale Materials and Applications*. *Topics in Applied Physics* 109, Springer, Berlin
- Mansoori GA, Mohazzabi P, McCormack P, Jabbari S (2007) *Nanotechnology in Cancer Prevention, Detection and Treatment: Bright Future Lies Ahead*. *World Review of Science, Technology and Sustainable Development* 4/2,3:226–257
- Mansoori GA, Vakili–Nezhaad GR, Ashrafi AR (2005) Some Mathematical Concepts Applicable in Nanothermodynamics. *International Journal of Pure & Applied Mathematical Sciences* 2/1:58–61
- McCray WP (2005) Will Small Be Beautiful? Making Policies for Our Nanotech Future. *History and Technology* 212:177–203

- Mehra J (1994) *The Beat of a Different Drum: The Life and Science of Richard Feynman*. Clarendon, Oxford
- Mie G (1908) Beiträge zur Optik trüber Medien, speziell Kolloidaler Metallösungen. *Annalen der Physik* 330:377–445
- Milburn C (2002) Nanotechnology in the Age of Posthuman Engineering: Science Fiction as Science. *Configurations* 10/2:261–295
- Mirkin CA, Letsinger RL, Mucic RC, Storho JJ (1996) A DNA-Based Method for Rationally Assembling Nanoparticles into Macroscopic Materials. *Nature* 382:607–609
- Montemagno CD (2001) Nanomachines: A Roadmap for Realizing the Vision. *Journal of Nanoparticle Research* 3:1–3
- Moore GE (1965) Cramming more Components onto Integrated Circuits. *Electronics* 38:114–117
- Moreland J, Alexander S, Cox M, Sonnenfeld R, Hansma PK (1983) Squeezable Electron Tunneling Junctions. *Applied Physics Letters* 43/4:387–388
- Morin JF, Shirai Y, Tour JM (2006) En Route to a Motorized Nanocar. *Organic Letters* 8/8:1713–1716
- Morris JE, Iniewski K (Eds) (2013) *Graphene, Carbon Nanotubes, and Nanostructures: Techniques and Applications (Devices, Circuits, and Systems)*. CRC Press, Boca Raton
- Müller EW (1936) Experimente zur Theorie der Elektronenemission unter dem Einfluß starker Felder. *Physikalische Zeitschrift* 37:838–841
- Müller EW, Bahadur K (1956) Field Ionization of Gases at a Metal Surface and the Resolution of the Field Ion Microscope. *Physical Reviews* 102:624–631
- Nazem A, Mansoori GA (2008) Nanotechnology Solutions for Alzheimer’s Disease: Advances in Research Tools, Diagnostic Methods and Therapeutic Agents. *Journal of Alzheimer’s Disease*, 13/2:199–223
- Nazem A, Mansoori GA (2014) Nanotechnology Building Blocks for Intervention with Alzheimer’s Disease Pathology: Implications in Disease Modifying Strategies. *J Bioanal. & Biomed* 6/2,6:009–014
- Newman TH, Williams KE, Pease RFW (1987) High Resolution Patterning System with a Single Bore Objective Lens. *Journal of Vacuum Science Technology B* 5/1:88–91
- Niemeyer CM (1997) DNA as a Material for Nanotechnology. *Angewandte Chemie – International Edition in English* 36/6:585–587
- Niemeyer CM (1999) Progress in “Engineered Up” Nanotechnology Devices Utilizing DNA as a Construction Material. *Applied Physics A* 68:119–124
- Niemeyer CM (2000) Self-assembled Nanostructures Based on DNA: Towards the Development of Nanobiotechnology. *Current Opinion in Chemical Biology* 4/6:609–618
- Niemeyer CM (2001) Bioorganic Applications of Semisynthetic DNA–Protein Conjugates. *Chemistry–A European Journal* 7/15:3189–95
- Niemeyer CM (2001) Nanoparticles, Proteins, and Nucleic Acids: Biotechnology Meets Materials Science. *Angewandte Chemie – International Edition in English* 40/22:585–587. doi:10.1002/1521-3773(20011119)40:22<4128::AID-ANIE4128>3.0.CO;2-S
- Niemeyer CM (2002) The Developments of Semisynthetic DNA–Protein Conjugates. *Trends in Biotechnology* 20/9:395–401
- Niemeyer CM, Adler M, Song G, Lifeng C (2002) Supramolecular DNA–Streptavidin Nanocircles with a Covalently Attached Oligonucleotide Moiety. *Journal of Biomolecular Structure & Dynamics* 20/2:223–230
- Niemeyer CM, Burger W, Peplies J (1998) Covalent DNA–Streptavidin Conjugates as Building Blocks for Novel Biometallic Nanostructures. *Angewandte Chemie – International Edition in English* 37/16:2265–68. doi:10.1002/(SICI)1521-3773(19980904)37:16<2265::AID-ANIE2265>3.0.CO;2-F
- Novoselov KS, Geim AK, Morozov SV, Jiang D, Zhang Y, Dubonos SV, Grigorieva IV, Firsov AA Electric Field Effect in Atomically Thin Carbon Films. *Science* 306/5696:666–669
- Olby R (1979) Mendel No Mendelian? *History of Science* 17:53–72
- Olby R (1989) Rediscovery as an Historical Concept. In *New Trends in the History of Science*, edited by R. Visser, H. Bos, L. Palm & H. Snelders. Rodopi, Amsterdam pp.197–208
- Oran D, Rodrigues SG, Gao R, Asano S, Skylar-Scott MA, Chen F, Tillberg PW, Marblestone AH, Boyden ES (2018) 3D Nanofabrication by Volumetric Deposition and Controlled Shrinkage of Patterned Scaffolds. *Science* 362/6420:1281–1285
- Osawa E (1970) Superaromaticity. *Kagaku Kyoto* 1970, 25, 854–863
- Pabo C (1983) Designing Proteins and Peptides. *Nature* 301:200

- Palazzolo S, Hadla M, Russo Spena C, Caligiuri I, Rotondo R, Adeel M, Kumar V, Corona G, Canzonieri V, Toffoli G, Rizzolio F (2019) An Effective Multi-Stage Liposomal DNA Origami Nanosystem for In Vivo Cancer Therapy. *Cancers* 11/12:1997
- Palazzolo S, Hadla M, Spena CR, Bayda S, Kumar V, Lo Re F, Adeel M, Caligiuri I, Romano F, Corona G, Canzonieri V, Toffoli G, Rizzolio F (2019) Proof-of-Concept Multistage Biomimetic Liposomal DNA Origami Nanosystem for the Remote Loading of Doxorubicin. *ACS Medical Chemistry Letters* 10/4:517–521
- Papell SS (1965) Low Viscosity Magnetic Fluid Obtained by the Colloidal Suspension of Magnetic Particles. U.S. Patent 3215572A, 2 November 1965
- Petersen P, Tikhomirov G, Qian L Information-Based Autonomous Reconfiguration in Systems of Interacting DNA Nanostructures. *Nature Communications* 9:5362
- Philp D, Stoddard JF (1996) Self-Assembly in Natural and Unnatural Systems. *Angewandte Chemie, International Edition in English* 35:1154–1196
- Piner RD, Zhu J, Xu F, Hong S, Mirkin CA (1999) “Dip-Pen” Nanolithography. *Science* 283/5402:661–663
- Pinheiro AV, Han D, Shih WM, Yan H (2011) Challenges and Opportunities for Structural DNA Nanotechnology. *Nature Nanotechnology* 6/12:763–772
- Plank CJ, Rosinski EJ (1964) Catalytic Cracking of Hydrocarbons with a Crystalline Zeolite Catalyst Composite. U.S. Patent 3140249A, 7 July 1964
- Platt JR (1962) National Laboratories for Biology? *Science* 136/3519:859–861
- Pohl WD, Schneiker C (1991) Distance-controlled Tunneling Transducer. U.S. Patent Number 5,043,577 [see also U.S. patents 5,210,714 and RE36,603]
- Poole C Jr., Owens F (2003). *Introduction to Nanotechnology*. Wiley, Hoboken
- Pradell T, Climent-Font A, Molera J, Zucchiatti A, Ynsa MD, Roura P, Crespo D (2007) Metallic and Nonmetallic Shine in Luster: An Elastic Ion Backscattering Study. *Journal of Applied Physics* 101:103518
- Priyanto S, Mansoori GA, Suwono A (2001) Measurement of Property Relationships of Nanostructure Micelles and Coacervates of Asphaltene in a Pure Solvent. *Chemical Engineering Science* 56/24:6933–6939
- Rafii-Tabar H, Mansoori GA (2004) Interatomic Potential Models for Nanostructures. *Encyclopedia of Nanoscience & Nanotechnology* 4:231–248
- Ramezani H, Mansoori GA (2007) Diamondoids as Molecular Building Blocks for Biotechnology Wet Nanotechnology, Drug Targeting and Gene Delivery. *Topics in Applied Physics* 109:44–71, Springer
- Regis E (1995) *Nano: The Emerging Science of Nanotechnology: Remaking the World – Molecule by Molecule*. Little and Brown, Boston
- Regis E (2004) The Incredible Shrinking Man. Available online: <https://www.wired.com/2004/10/drexler/pp.179–181,204–205>
- Reibold M, Paufler P, Levin AA, Kochmann W, Pätzke N, Meyer DC (2006) Materials: Carbon nanotubes in an ancient Damascus sabre. *Nature* 444:286
- Roco MC, Williams S, Alivisatos P (Ed’s) (1999) *Nanotechnology Research Directions: IWGN Workshop Report – Vision for Nanotechnology R&D in the Next Decade*. WTEC, Loyola College in Maryland
- Rohrer H (undated) There Is Plenty of Room at the Bottom. Undated unpublished comments on Feynman’s “Plenty of Room” by H. Rohrer; sent to C. Toumey by email from H. Rohrer in November 2004
- Roco MC, Williams RS, Alivisatos P, eds. (2000). *Nanotechnology Research Directions: Vision for Nanotechnology in the Next Decade*. Springer, New York
- Rossetti R, Nakahara S, Brus LE (1983) Quantum Size Effects in the Redox Potentials, Resonance Raman Spectra, and Electronic Spectra of CdS Crystallites in Aqueous Solution. *Journal of Chemical Physics* 79:1086
- Rothmund PWK (2006) Folding DNA to Create Nanoscale Shapes and Patterns. *Nature* 440:297–302
- Roukes M (2001) Plenty of Room, Indeed. *Scientific American* pp.42–49
- Sagiv J (1980) Organized Monolayers by Adsorption. 1. Formation and Structure of Oleophobic Mixed Monolayers on Solid Surfaces. *Journal of the American Chemical Society* 102/1:92–98
- Sanders JKM, Jackson SE (2009) The Discovery and Development of the Green Fluorescent Protein, GFP. *Chemical Society Review journal* 38:2821
- Schneiker C, Hameroff S, Voelker M, He J, Dereniak E, McCuskey R (1988) Scanning Tunneling Engineering. *Journal of Microscopy* 152/2:585–596

- Schneiker CW (1983) Prospects and Applications for Genesis and Ultra Mass Production of Sub-Millimeter Machines, Devices, and Replicating Systems. Unpublished manuscript of 10 August 1983. 41 pages
- Schneiker CW (1984) Beyond Fifth Generation Machines: Feynman Replicators. Unpublished manuscript of 1 December 1984. 8 pages
- Schneiker CW (1984) Some Research Topics for a New Space Development Programme. *Journal of the British Interplanetary Society*, 37:190–192
- Schneiker CW (1985) EUREKA! – Atomic Scale Machine Tools. Unpublished manuscript of 4 April 1985. 4 pages
- Schneiker CW (1985) NanoScience & NanoEngineering: Foundation for a New Renaissance. Unpublished manuscript of 22 April 1985. 4 pages
- Schneiker CW (1985) Nanotechnology. Unpublished manuscript of 31 July 1985. 30 pages
- Schneiker CW (1985) The Modified Scanning Tunneling Microscope as a Nanometer Scale Machine Tool and Multimode Interface for Precision Assembly, Manipulation, Analysis and Control of Solid State Atomic Systems. Unpublished manuscript of 26 February 1985. 4 pages
- Schneiker CW (1986) Nanotechnology with Feynman Machines. Unpublished book manuscript of 215 pages
- Schneiker CW (1986) Nanotechnology with STMs, Feynman Machines, and von Neumann Machines. Unpublished paper, 11 July 1986. Feynman Archives at Caltech, Box 27, Folder 11. 7 pages. (Note: this paper was converted into a poster by C. Schneiker, presented by S. Hameroff, at an STM Conference in Santiago de Compostela, Spain, July 14-18 1986.)
- Schneiker CW (1989) Nanotechnology with Feynman Machines: Scanning Tunneling Engineering and Artificial Life. In *Artificial Life, Volume VI: Santa Fe Institute Studies in the Sciences of Complexity* [proceedings of a September 1987 workshop in Los Alamos NM], edited by C. Langton, Addison–Wesley, Reading pp.443–500
- Schneiker CW., Hameroff S (1988) Nanotechnology Workstations, Based on Scanning Tunneling/Optical Microscopy: Applications to Molecular Scale Devices. In *Molecular Electronic Devices* [Proceedings of the Third International Symposium on Molecular Electronic Devices, Arlington VA, 6–8 October 1986], edited by F.L. Carter, R.E. Siatkowski & H. Wohltjen, North–Holland, Amsterdam pp.69–90
- Seeman NC (1982) Nucleic Acid Junctions and Lattices. *Journal of Theoretical Biology* 99/2:237–247
- Sharma N, Sharma M, Sajid Jamal QM, Kamal MA, Akhtar S (2019) Nanoinformatics and Biomolecular Nanomodeling: A Novel Move en route for Effective Cancer Treatment. *Environmental Science and Pollution Research International* 27/16:19127–19141
- Shirai Y, Osgood AJ, Zhao Y, Kelly KF, Tour JM (2005) Directional Control in Thermally Driven Single–Molecule Nanocars. *Nano Letters* 5/11:2330–2334
- Shockley W (1951) Circuit Element Utilizing Semiconductive Material. U.S. Patent 2569347A, 25 September 1951
- Simic–Krstic Y, Kelley M, Schneiker C, Krasovich M, McCuskey R, Koruga D, Hameroff S (1989) Direct Observation of microtubules with the Scanning Tunneling Microscope. *FASEB Journal* 3:2184–2188
- Steigerwald ML, Alivisatos AP, Gibson JM, Harris TD, Kortan R, Muller AJ, Thayer AM, Duncan TM, Douglass DC, Brus LE (1988) Surface Derivatization and Isolation of Semiconductor Cluster Molecules. *Journal of the American Chemical Society* 110/10:3046–3050
- Stent GS (1972) Prematurity and Uniqueness in Scientific Discovery. *Scientific American* pp.84–93. doi:10.1038/scientificamerican1272–84
- Stoddard JF (1993) Molecular Recognition and Self–Assembly. *Anales de Quimica* 89/1:51–56
- Strosio JA, Eigler DM (1991) Atomic and Molecular Manipulation with the Scanning Tunneling Microscope. *Science* 254:1319–26
- Synge EH (1928) XXXVIII. A Suggested Method for Extending Microscopic Resolution into the Ultra–Microscopic Region. *The London, Edinburgh and Dublin Philosophical Magazine and Journal of Science* 6/35:356–362
- Taniguchi N (1967) Analysis of mechanism of various materials–workings based on the concept of working energy. *Scientific Papers of the Institute of Physical and Chemical Research, Tokio* 61/3
- Taniguchi N (1973) Ion beam sputter–machining of glass. *College International pour la Recherche en Productique (CIRP) Annalen*, Berlin
- Taniguchi N, Maezawa S (1963) Temperature analysis of electron beam machining. *Proceedings of 5th Annual Electron Beam Symposium*, Boston
- Tans SJ, Verschueren ARM, Dekker C (1998) Room–Temperature Transistor based on a Single Carbon Nanotube. *Nature* 393:49–52

- Thomas TR (2004) Nanotechnology, Materials and Applications. In *Encyclopedia of Twentieth-Century Technology*, Vol. 1, edited by C. Hempstead & W. Worthington, Routledge, New York pp.521–523
- Thompson ISI (2004) The Journal Selection Process. Online: www.isinet.com/essays/selectonofmaterialforcoverage/199701.html
- Toumey C (2004) Nano Hyperbole and Lessons from Earlier Technologies. *Nanotechnology Law & Business* 1/4:397–405
- Toumey C (2004) Narratives for Nanotech: Anticipating Public Reactions to Nanotechnology. *Techné* 8/2:88–116
- Toumey C (2005) Apostolic Succession: Does Nanotechnology Descend from Richard Feynman's 1959 Talk? *Engineering & Science* 68/1:16–23
- Toumey C (2005) Feynman Unprocessed. Review of Perfectly Reasonable Deviations from the Beaten Path: the Letters of Richard P. Feynman. *Techné* 8/3:76–86
- Valand NN, Patel MB (2015) Fullerenes Chemistry & Its Applications. Scholars' Press, Chisinau
- Voelker M, He D, Dereniak E, McCuskey R, Schneiker C, Hameroff S (1988) Scanning Tunneling Microscopy (STM) for Biomolecular Imaging and Interactions. *Biophysical Journal* 53/2; Part 2:396a
- von Neumann, J, Burks AW (1966) *Theory of Self-Reproducing Automata*, University of Illinois Press, Urbana
- Wagner FE, Haslbeck S, Stievano L, Calogero S, Pankhurst QA, Martinek KP (2000) Before Striking Gold in Gold-Ruby Glass. *Nature* 407/6805:691–692
- Wang X, Cao L, Lu F, Meziani MJ, Li H, Qi G, Zhou B, Harruff BA, Kermarrec F, Sun YP (2009) Photoinduced Electron Transfers with Carbon Dots. *Chemical Communications* 25:3774–3776
- Watson JD, Crick FHC (1953) Molecular Structure of Nucleic Acids: A Structure for Deoxyribose Nucleic Acid. *Nature* 171:737–738
- Weinstein A (1977) How Unknown was Mendel's Paper? *Journal of the History of Biology* 10/2:341–364
- Williams KA, Veenhuizen PTM, de la Torre BG, Eritja R, Dekker C (2002) Nanotechnology: Carbon Nanotubes with DNA Recognition. *Nature* 420/6917:761
- Xu X, Ray R, Gu Y, Ploehn HJ, Gearheart L, Raker K, Scrivens W (2004) A Electrophoretic Analysis and Purification of Fluorescent Single-Walled Carbon Nanotube Fragments. *Journal of the American Chemical Society* 126:12736–12737
- Xue Y, Mansoori GA (2010) Self-Assembly of Diamondoid Molecules and Derivatives (MD Simulations and DFT Calculations). *International Journal of Molecular Sciences*, 11/1:288–303
- Yang ST, Cao L, Luo PG, Lu F, Wang X, Wang H, Meziani MJ, Liu Y, Qi G, Sun YP (2009) Carbon Dots for Optical Imaging in Vivo. *Journal of the American Chemical Society* 131:11308–11309
- Yang ST, Wang X, Wang H, Lu F, Luo PG, Cao L, Meziani MJ, Liu JH, Liu Y, Chen M, Huang Y, Sun YP (2009) Carbon Dots as Nontoxic and High-Performance Fluorescence Imaging Agents. *Journal of Physical Chemistry C* 113/42:18110–18114
- Yater JC (1979) Rebuttal to "Comments on 'Power Conversion of Energy Fluctuations'." *Physical Review A* 20/2:623–627
- Yater JC (1982) Physical Basis of Power Conversion of Energy Fluctuations. *Physical Review A* 26/1:522–537
- Yuan Y, Gu Z, Yao C, Luo D, Yang D (2019) Nucleic Acid-Based Functional Nanomaterials as Advanced Cancer Therapeutics. *Small* 15:e1900172
- Zheng J, Birktoft JJ, Chen Y, Wang T, Sha R, Constantinou PE, Ginell SL, Mao C, Seeman NC (2009) From Molecular to Macroscopic via the Rational Design of a Self-Assembled 3D DNA Crystal. *Nature* 461/7260:74–77
- Zhou L, Beck M, Gatzert HH, Altshuler KJ, Talke FE (2005) Slider Vibration Reduction using Slider Surface Texture. *Microsystems Technologies* 11:857–866
- Zhou L, Kato K, Umehara N, Miyake Y (1999) Nanometre Scale Island-type Texture with Controllable Height and Area Ratio Formed by Ion Beam Etching on Hard-disk Head Sliders. *Nanotechnology* 10: 363–372
- Zhou L, Lin Y, Huang Z, Ren J, Qu X (2012) Carbon Nanodots as Fluorescence Probes for Rapid, Sensitive, and Label-Free Detection of Hg²⁺ and Biothiols in Complex Matrices. *Chemical Communications* 48/8:1147–1149

PART II

Experimental Nanophysics & Mathematical Modelling

Chapter II

Lab Instrumentation and Mathematical Applications

An outline. In this second part of my paper, consisting of Chapter Two only, I will deal with the description of the instruments that are used in the field of Nanoscience. The reader will find here a brief description of the main instruments applied in electron microscopy with an explanation of their setup, the Mathematics that supports the optical laws involved and the aberration errors that are inherent in their Physics.

In the remainder of the chapter, I will describe what I consider to be among the most interesting results obtained in the development of the Mathematics that is applied in the study of Solid-State Physics, to the nanometric dimension. Ad hoc Mathematics has not always been invented, but rather a new use has been made of already known relations, such as those of Continuum Mechanics or Finite Element Theory. I will describe the results that have been achieved by applying known Mathematics and what developments have been achieved in terms of Nanophysics, considering classical, relativistic and quantum aspects.

Note: From this chapter, content was taken to compose a paper, in collaboration with my thesis supervisor, on nanomaterial analysis and production technologies. The article is currently being prepared, and bears the title *1930s–1980s, A History of Nanoscience–Nanotechnology: from Physics Scanning Devices to Nanoscale Techniques*. The first page, containing the abstract and a selection of keywords can be found in Appendix 3 of this thesis.

Prologue II

Physics is, among the so-called Hard Sciences, the one that comes closest to satisfying man's innate curiosity to find out why things happen the way they happen and is, consequently, one of the oldest sciences, whose evolution has accompanied the progress of scientific thought and method of investigation.

Research in this direction has been oriented towards discovering how the world is made and how it works, and it has benefited from the development of instruments that have helped researchers to see beyond the limits of the human eye, towards the stars and into matter. To be able to live the dream of knowledge, it was necessary to advance technologically: to be capable of observation on the smallest scale, the invention of the microscope and its progressive refinement was a must.

At the end of the 17th century, seeing bacteria and cells with the naked eye was not yet possible, but the intuition of Anton van Leeuwenhoek (1632–1723) to develop lenses for studying the quality of cloth in order to observe the world around him allowed him to be the first to discover protozoa or to see red blood cells in blood, along with many anatomical details of animals and insects. van Leeuwenhoek's discoveries made him, quite possibly, the first proper microbiologist in the history of science.

By the end of the 18th century, the optical microscope was fully developed into the instrument we know today.

However, some of the most important results and most extraordinary observations were obtained with the introduction of electron microscopy and its development in more recent times. At the beginning of the last century, visualising atoms was not yet possible, whereas the investigation of matter by means of spectroscopy and diffraction techniques subsequently made it possible to know precisely the relative position of atoms within materials. At the same time, electron microscopy and the development of increasingly powerful instruments within this investigation technique emerged.

After World War II in particular, research in the field of Solid State Physics received a major boost in the study of matter and its behaviour at dimensions much smaller than those observable with the naked eye. In particular, the billionth of a metre, or nanometre, has in recent decades been the threshold across which materials have shown completely new properties, opening up new avenues of research and innovative applications. The birth of Nanoscience and its declination in Nanotechnologies has affected practically every sector, not limiting itself solely to the field of Physics, but touching on disciplines such as Engineering, Medicine, Chemistry and Biology.

For this reason, in retracing the History of Nanoscience, we cannot neglect a brief description of the electronic instruments that have been developed and are still used today for the observation and manipulation of materials and their evolution. These are the instruments that, through their refinement, have realised Feynman's vision of 1959, taking up the challenge of being able to physically manipulate atoms and molecules at the operator's free discretion, finally exercising control over matter.

The study of matter in the nanometric dimension uses mathematical tools for its description and the creation of models that can predict its behaviour. It could not be otherwise, since the birth of modern science would not have been possible without mathematics, a science in which physics has placed great trust. The words of Galileo Galilei (1564–1642) about this concept are nowadays famous:

Philosophy is written in this immense book that is continuously open before our eyes (I say the Universe), but it cannot be understood if we do not first learn to understand the language and know the characters it is written with. It is written in a mathematical language, and the characters are triangles, circles, and other geometrical figures, without which it is impossible to man to understand a word; without these it is a vain wandering through a dark warren²⁵.

This is also the way Galilei shows us that the direct observation of Nature and its phenomena it is the only true source of truth.

It is undeniable that the discoveries that have followed and also the extraordinary applications that are in our possession today have been made on a solid mathematical basis. An interesting comment was made by Ludwig Boltzmann in 1890:

The gigantic structures of the Brooklyn Bridge that fade away into the distance and those of the Eiffel Tower that climb endlessly up to the sky, not only rest on a solid-steel structure but on the even stronger one of Theory of Elasticity²⁶.

while Richard Feynman also made his contribution to this interpretation:

To summarize, I would use the words of Jeans, who said that ‘the Great Architect seems to be a mathematician’. To those who do not know mathematics it is difficult to get across a real feeling as to the beauty, the deepest beauty, of nature. [...] It is too bad that it has to be mathematics, and that mathematics is hard for some people. [...] If you want to learn about nature, to appreciate nature, it is necessary to understand the language that she speaks in. She offers her information only in one form [...] (Feynman 1985).

even though, logically, many objections could be raised to this assumption, beauty not being a scientific concept quantifiable through a unit of measurement.

In the decades in which Nanoscience has taken shape and diversified into its various branches, the mathematical tool has proved decisive for the development of applications in the nanoworld. In most cases, mathematics has intervened with tools that are already known and developed, such as linear algebra or group theory, while more recently, computational strategies have been developed that are able to give a description of Solid State Nanophysics, taking into account both the relativistic and quantum effects that inevitably emerge when the sample size drops to one billionth of a metre.

As I remarked before, electronic microscopy has achieved results so important to allow researchers make the dream of Richard Feynman about manipulating atoms and molecules true. This is why I summarise here both SEM and TEM Microscopy together with STM and AFM Microscopy, to give a description of the most important physical techniques applied and the concepts behind the instruments, because this is also part of the History of Science.

After that, I am going to give the reader a short review of some interesting applications of Mathematics to Nanotechnology, presenting results obtained applying known relations and equations to thermal behaviour and mechanical situations and new recent insights from

²⁵ “La filosofia è scritta in questo grandissimo libro che continuamente ci sta aperto innanzi a gli occhi (io dico l’universo), ma non si può intendere se prima non s’impara a intender la lingua, e conoscer i caratteri, ne’ quali è scritto. Egli è scritto in lingua matematica, e i caratteri son triangoli, cerchi, ed altre figure geometriche, senza i quali mezzi è impossibile a intenderne umanamente parola; senza questi è un aggirarsi vanamente per un oscuro laberinto” (Galilei 1623, translation AD).

²⁶ “Le strutture gigantesche del ponte di Brooklyn che si perde in lontananza e della torre Eiffel che sale senza fine poggiano non soltanto su un solido scheletro di acciaio, ma su quello ancora più solido della teoria dell’elasticità” (Selleri 1989, translation AD).

an interesting mathematical point of view, involving the Drude Theory and its developments under a relativistic and a quantum point of view.

2.1 The Instruments of Nanophysics

Observing matter in its structure is a fundamental step towards understanding it, predicting its behaviour and determining its uses. In the case of investigating nanoparticles, this becomes particularly important precisely because it is the extraordinary properties that matter exhibits in that state that make it particularly appealing for applications in our time.

Investigating matter in the solid state can be done effectively by probing samples with electrons, neutrons or atoms, or with electromagnetic radiation of appropriate wavelengths. Particles range from energies below 100eV to relativistic energies, while photons range from the ultraviolet to the infrared and beyond.

The aim is to create an image that allows us to observe the topography of the sample, or the geometric arrangement of the atoms, or the structure, or chemical or physical information.

In the previous chapter I listed the most common techniques for investigating samples, but here I will describe the main microscopy techniques used, because this is the instrument that allows us to see samples with the greatest detail.

The term “microscope” comes from the conjunction of two Greek terms, *mikros*, meaning “small” and *skopos*, meaning “to look at” (Pradeep 2005). The microscope, therefore, is an instrument that allows one to look at something small. It was developed by Antoni van Leeuwenhoek (1632–1732) and, despite its simple construction, was instrumental in the discovery of bacteria. At the time of his death, around 500 microscope specimens existed, most of which seem to have vanished into thin air today (Robertson 2015). Pradeep argues that it was van Leeuwenhoek himself who destroyed them (Pradeep 2005).

When we talk about microscopy, it is appropriate to recapitulate its basic parameters.

- *Resolution*
The ability of an instrument to allow the observer to discriminate two points, whose spacing is very small in terms of distance, as two independent objects.
- *Resolving power*
The resolution an instrument can achieve when working under optimal conditions. This quantity is a characteristic of the instrument that must be evaluated before starting measurements. The resolving power has a value equal to or greater than the resolution.

Generally speaking, microscopes consist of a source system to illuminate the sample, lenses to condense the beam onto the sample, a lens–lens to magnify the sample, a projection lens to place the image on an image plane from where it can be stored in a database or photographed.

While working at the Carl Zeiss microscopy laboratory, the German physicist Ernst Abbe (1840–1905) introduced the concept of numerical aperture (1873), a dimensionless number that is mathematically defined as:

$$NA = n_i \sin \theta_{max} \quad (2.1)$$

where n_i is the index of refraction of the medium within which the optical system (air, oil, water,...) of the objective lens is operating, and θ_{max} half of the maximum angle of the light cone that can enter (or exit) the lens. Similarly, he was the one who recognised that the minimum distance between two objects that can be resolved – seen as distinct – the resolving power varies in direct proportion to the wavelength λ and inversely to the numerical aperture. The formula that Abbe arrived at in this respect is:

$$d = \frac{\lambda}{2nA} \text{ m} \quad (2.2)$$

although Hermann von Helmholtz (1821–1894) attributed its authorship to Giuseppe Ludovico Lagrangia (Lagrange, 1736–1813), as this passage shows:

That diffraction and consequent obscurity of microscopic image must necessarily increase with increasing amplifications of the image, and this quite independently of any particular construction of the instrument, rests as a fact upon a general law which applies to all optical apparatus, and which was first formularized by La Grange for combinations of any kind of infinitely thin lenses. This law has apparently remained almost unknown, perhaps because La Grange enunciated it in equations whose coefficients have not characters which readily present clear ideas to the mind (Helmholtz 1876).

Comparing its possibilities with those of electronic instruments, one would say that optical microscopy has been definitively abandoned in the investigation of nanomaterials in favour of more recent instruments based on the wave nature of electrons or quantum mechanical effects, mainly due to the limits imposed by light diffraction phenomena.

However, the development of Near-Field Optical Microscopy (NFOM from now on) has made it possible to test nanostructures with photons whose wavelength falls in the visible light range. This technique is applied when the distance between the instrument aperture and the sample is less than $1\mu\text{m}$ and the aperture itself measures a few hundred nanometres, and has been made possible by the development of technologies that allow the instrument to be positioned and controlled at sub-micron distances from the sample, together with the construction of apertures of a few hundred nanometres using optical fibres. It is not the light itself that is used in this technique, but the so-called evanescent field, a field whose energy does not propagate according to the wave nature, but remains confined in the vicinity of its source, the optical fibre. This evanescent wave is scattered by the sample and collected to form the surface image²⁷ (Mukhopadhyay, Dalal and Arya 2014).

Other different techniques capable of visualising ever smaller objects have been developed, and this is the case with electron microscopy, which will be described below.

²⁷ The Poynting vector allows to calculate the net flux of electromagnetic energy. For the evanescent field, this vector is zero.

2.1.1 *Electronic Microscopy*

Electron microscopy can be roughly divided into two macro categories.

- *Transmission Electron Microscopy*

Transmission Electron Microscopy (henceforth referred to as TEM, the same abbreviation denoting the instrument, Transmission Electron Microscope) is the microscopy technique whereby an electron beam is sent through the sample to form an image. A thin section, less than 100nm thick, is used as the sample. The image is obtained due to the interaction between the electrons and the sample as the beam passes through the sample. The image is then enlarged and focused on an imaging device, such as a fluorescent screen, photographic film, or a sensor such as a scintillator connected to a charge-coupled device. TEMs are able to display images with significantly higher resolution than optical microscopes due to the shorter de Broglie wavelength of the electrons. This allows the instrument to capture extremely accurate detail – even a single column of atoms, which is thousands of times smaller than a resolvable object seen in an optical microscope. TEMs are widely applied in Nanotechnology and Materials Science, as well as in Physics, Chemistry and Biology. Other applications range from cancer research to virology, from pollution to palaeontology and palynology.

- *Scanning Electron Microscopy*

Scanning Electron Microscopy (henceforth referred to as SEM, the same abbreviation as the instrument, Scanning Electron Microscope) is the technique that produces images of a sample by scanning its surface with a concentrated beam of electrons. The electrons interact with the atoms in the sample, producing different signals that contain information about the surface topography and composition of the sample. The sample is scanned by the electron beam in a sequence of swipes. The position of the beam is combined with the intensity of the detected signal to produce a TV-quality image. Secondary electrons emitted by atoms excited by the electron beam are detected using a special secondary electron detector (called the Everhart-Thornley detector). The number of secondary electrons that can be detected, and thus the signal strength, depends on, among other things, the topography of the sample. Some SEMs can achieve resolutions better than 1nm. Samples are observed in high vacuum in a conventional SEM, or in low vacuum or wet conditions in a variable or ambient pressure SEM, and in a wide range of cryogenic or elevated temperatures with specialised instruments. In SEM microscopy it is necessary for samples to be conductive, so if they are not already conductive by nature, specimens are usually covered with a layer of metal, such as gold, palladium, tungsten, iridium, chromium, osmium or graphite. Anyway, non-conductive specimens can be analysed applying low-voltage operating modes.

In the second case, we can still detail these applications.

- *Scanning Electron Microscope*

When we analyse a sample with a Scanning Electron Microscope (SEM) we focus a beam of high-energy electrons to generate a variety of signals at the surface of the solid specimens. The signals from the electron-sample interactions reveal information about the sample including external morphology, chemical composition, and crystalline structure. Also the orientation of materials making up the sample is visible. In most applications, data are collected over a selected area of the surface of the sample, and a 2D image is generated that displays spatial variations in the mentioned properties. It is possible to image areas from approximately 1cm to 5 μ m in width in a scanning mode using conventional SEM techniques (magnification ranging from 20 \times to approximately 30000 \times , spatial resolution from 50nm to 100nm). The SEM microscope is also capable of performing analyses of selected point locations on the sample; this approach is especially useful in qualitatively or semi-quantitatively determining chemical compositions (using Energy-Dispersive X-Ray Spectroscopy, henceforth EDS), crystalline structure, and crystal orientations (using Electron Backscatter Diffraction, henceforth EBSD).

- *Scanning Helium-Ion Microscope*

The Scanning Helium Ion Microscope (henceforth SHIM, HeIM or HIM) allows images of the sample to be visualised by exploiting a helium ion beam, a beam that is moved over the sample by scanning it (Bidlack *et al.* 2014). In terms of the image that is displayed, the SHIM technique has several advantages over a traditional scanning electron microscope, SEM. Due to the very high brightness of the source and the small De Broglie wavelength of the helium ions, it is possible to obtain qualitative data that cannot be obtained with conventional microscopes using photons or electrons. When the helium ion beam interacts with the sample it provides sharp images with a large depth of field over a wide range of materials or even tissues, with sub-nanometer resolution (Rice *et al.* 2013). Compared to an SEM, the secondary electron yield is quite high, allowing imaging with currents as low as 1fA. The detectors provide information-rich images that offer topographic, material, crystallographic and electrical properties of the sample. Unlike what can be caused by other ion beams, there is no visible damage to the sample due to the relatively light mass of the helium ion.

- *Scanning Acoustic Microscope*

The Scanning Acoustic Microscope (henceforth SAM) uses collimated sound to investigate, measure or visualise an object, through a process called Scanning Acoustic Tomography. This investigative tool is commonly used in failure analysis and evaluation, whenever a non-destructive sample investigation is required, not only in materials science, but also in biological and medical research. The SAM is crucial for detecting voids, cracks and delamination processes – the flaking of material into layers –

within microelectronic packages, in semiconductor physics. The first SAM, equipped with a 50MHz ultrasonic lens, was developed in 1974 by R. A. Lemons and C. F. Quate at the Microwave Laboratory. A few years later, in 1980, the first high-resolution SAM (with a frequency of up to 500MHz) was built by R. Gr. Maev and his students in his Laboratory of Biophysical Introscopy at the Russian Academy of Sciences. The first commercial ELSAM, with a wide frequency range from 100MHz up to 1.8GHz, was built at Ernst Leitz GmbH by the team led by Martin Hoppe and his advisors Abdullah Atalar (Stanford University), Roman Maev (Russian Academy of Sciences) and Andrew Briggs (Oxford University).

- *Confocal Scanning Microscope*
Confocal Microscopy (CM from now on), also known by the terms Confocal Laser Scanning Microscopy (henceforth CLSM) or, with a very similar definition, Laser Scanning Confocal Microscopy (henceforth LCSM), is an imaging technique that increases the optical resolution and contrast of a micrograph by using a spatial hole to block out-of-focus light when forming the image. By acquiring several two-dimensional images of the sample at different levels, it is possible to reconstruct the structures three-dimensionally (via optical sectioning) within an object. This technique is widely used in various fields involving life sciences, semiconductor inspection and materials science. Light travels through the sample in a conventional microscope until it can penetrate its structure, whereas a Confocal Microscope focuses only one beam of light at a time, smaller, and at a greater depth. The CLSM, for example, achieves a controlled and highly limited depth of focus. The principle of confocal imaging was patented in 1957 by Marvin Minsky (1927–2016) with the intention of overcoming some of the limitations of traditional wide-field fluorescence microscopes (Minsky 1957).

2.1.1.1 Scanning Electron Microscopy

Scanning Electron Microscopy (SEM) makes use of an electron beam to examine the sample. It is easily demonstrated that the electrons used move at speeds approximating that of light in vacuum. The rest mass of the electron is known from tables – $m_e = 9.11 \times 10^{-31} \text{kg}$ –, and so is the value of the elementary charge, which we can give as $e = 1.6 \times 10^{-19} \text{C}$. Using the principle of conservation of energy, we derive the velocity that the electron can assume, as a function of the applied potential difference:

$$\frac{1}{2} m_e v^2 = eV \rightarrow v = \sqrt{\frac{2eV}{m_e}} \text{ m/s} \quad (2.3)$$

This relationship also makes it possible to obtain the wavelength of the electron as a function of its velocity, which in turn is linked to the potential difference; it is sufficient to use De

Broglie equation (1892–1987) which, as is well known, links the mass and velocity of a particle to its wavelength, via Planck's constant (1858–1947):

$$\lambda = \frac{h}{m_e v} \quad \text{m} \quad (2.4)$$

in fact:

$$\lambda = \frac{h}{m_e \sqrt{\frac{2eV}{m_e}}} = \frac{h}{\sqrt{2m_e eV}} = \sqrt{\frac{h^2}{2m_e eV}} \quad \text{m} \quad (2.5)$$

On the basis of these relations it is possible to tabulate some data, from which it is evident that the obtained relations are not applicable to every experimental operative condition, due to the fact that – from a certain point on – relativistic effects come into play: the formulas lead to values that are obviously numerically possible but totally absurd from the physical point of view, since they contravene the postulates of the Theory of Relativity.

In fact, if we insert the data in the equations (2.3) and (2.4), we can collect the results in table 2.1.

Table. 2.1 The collection of data proving that a physical absurd arises when v exceeds certain values.

V	λ [nm]	v [m/s]	v/c [adim.]
50000	0.0055	$1.33 \cdot 10^8$	0.44
100000	0.0039	$1.87 \cdot 10^8$	0.62
500000	0.0017	$4.19 \cdot 10^8$	1.40
1000000	0.0012	$5.93 \cdot 10^8$	1.90

It is evident that the values shown are absurd, from a physical point of view, for obvious reasons. However, if we resort to the following relativistic correction:

$$m = \frac{m_0}{\sqrt{1 - \frac{v^2}{c^2}}} \quad \text{kg} \quad (2.6)$$

with obvious meaning of the symbols.

It is possible, then, to rewrite the starting energy balance equation as:

$$\begin{aligned} \frac{1}{2}mv^2 = eV &\quad \rightarrow \quad v^2 = \frac{2eV}{m} \\ \text{with correction} &\quad \rightarrow \quad v^2 = \frac{2eV}{m_0} \sqrt{1 - \frac{v^2}{c^2}} \\ &= \frac{2eV}{m_0 c} \sqrt{c^2 - v^2} \end{aligned} \quad (2.7)$$

If, for example, we assume $2eV/m_0c = k$, in order to make the equation more elegant, we obtain $v^2 = k(c^2 - v^2)^{1/2}$, without too many constants to deal with, which represents – mathematically – a parabola symmetrical with respect to the vertical Cartesian axis, as is well-known. Once the equation has been solved, using any method, only the positive solution is considered, so as not to incur in a physical absurdity, and the table 2.2 that can be obtained, in terms of voltage and speed of the electrons, becomes the following.

Table. 2.2 The corrected values bringing to no physical absurd.

V	v [m/s]	v/c [adim.]
50000	$1.26 \cdot 10^8$	0.42
100000	$1.70 \cdot 10^8$	0.56
500000	$2.72 \cdot 10^8$	0.91
1000000	$2.91 \cdot 10^8$	0.97

The data prove that even with high voltages, relativistic corrections do not lead to physically absurd values in terms of particle velocity.

An electron system is essential to overcome the limitations inherent in optical microscopy. The useful magnification in a microscope is limited by its separating power, i.e. the minimum distance between two points of the object that can be seen separately in the image. This separating power is in turn determined by the diffraction in the objective lens. I already mentioned that the Abbe diffraction limit, established by Ernst Abbe in 1873, states that the minimum separation distance (resolution) of light of wavelength λ , in motion in a medium whose refractive index is n , converging towards a point with half-open angle ϑ , can be calculated with the formula:

$$d = \frac{\lambda}{2n \sin \vartheta} = \frac{\lambda}{2NA} \quad \text{m} \quad (2.8)$$

where NA is a parameter called numerical aperture. The Abbe limit for the minimum resolvable distance is, approximately, half the applied wavelength, $d \approx \lambda/2$.

Since, even when talking about lenses, reference is made to models, one would expect an ideal lens to take a point on the observed object and project it into a single point on the image plane. In reality, those who work with microscopes know that a point on the object is projected into a disc, on the image plane, what is called an Airy disc – named after George Airy (1801–1892) –, due to the phenomena of light diffraction. According to the model of Airy model, a beam of light passing through a uniformly lit circular aperture projects a circular region of light onto a screen, due to the axial symmetry of the system, surrounded by a series of concentric rings of decreasing light intensity. The luminous intensity is calculated with the relation:

$$I(\vartheta) = I_0 \left[\frac{2J_1(ka \sin \vartheta)}{ka \sin \vartheta} \right]^2 \text{ cd} \quad (2.9)$$

where J_1 is a first-order Bessel function. Generally speaking, we know that a Bessel function of order m can be written as:

$$J_m(u) = \frac{i^{-m}}{2\pi} \int_0^{2\pi} e^{i(mv+u \cos v)} dv \quad (2.10)$$

The values of the Bessel functions are usually tabulated, especially those of $J_0(u)$ and $J_1(u)$, for different values of u .

If two points are placed close to each other, the smallest distance at which they appear distinct on the image plane is approximately half the disk width. The separation is calculated as:

$$d = 0.61 \frac{\lambda}{n \cdot \sin \vartheta} \text{ m} \quad (2.11)$$

where n is the refractive index of the medium, and ϑ is the angular half-aperture of the lens and $n \cdot \sin \vartheta$ the numerical aperture of the lens (Hecht 1998). To maximise the resolving power, one must either decrease the wavelength and refractive index, or increase the angle ϑ ; therefore, we can appreciate the difference between traditional optical microscopy and electron microscopy from the table 2.3 below.

Table. 2.3 Comparison of the parameters between optical and electron microscopy.

Microscope	Medium	$\sin \vartheta$	λ	d
Optical	Oil ($n = 1.5$)	0.87	400nm	0.2 μ m
TEM	Vacuum ($n = 1$)	10^{-2}	0.005nm	0.3nm

Apart from a greater depth-of-field, even considering the developments that optical microscopy has also made in the field of nanoscience, the use of electronic instruments

allows the operator to deal with much smaller optical aberration phenomena and higher image quality (Pradeep 2005).

A scanning electron microscope uses as its source an electron beam emitted from a filament, typically tungsten and the radius of whose tip is $100\mu\text{m}$, by thermionic effect, i.e. raising the temperature of the filament to a value sufficient to overcome the work function of the metal. The filament is kept at negative potential and reddened to 2000K – 2700K by resistive heating. A Wehnelt cylinder, effectively a holding electrode maintained at slightly higher negative potential, allows the electron beam to be controlled and focused. The electron beam is accelerated by an anode with zero ground potential and part of it passes through a hole. At the anode, the beam current, which is required for analysis, is measured. During its operational life, due to the high operating temperatures, the tungsten filament gradually evaporates until it reaches a critical thickness below which it is subject to breakage. This structure is called the electron gun. Here (Fig. 2.1) a simple scheme of the device.

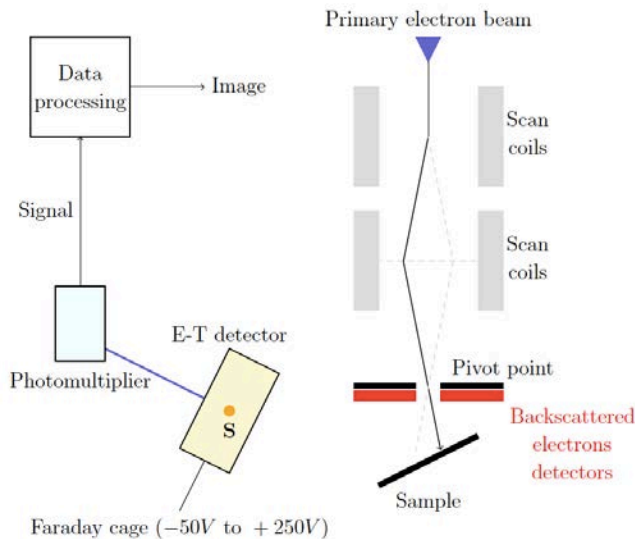

Fig. 2.1 Schematic of an electromagnetic lens and the related geometry. Source: AD

The characteristics that must be taken into account when constructing an electron gun in order to optimise its efficiency are the brightness, which is indicated by the symbol β . This is a parameter of the filament and is measured in $\text{A}\cdot\text{cm}^2\cdot\text{srad}^2$ and therefore shows dependence on the current; the change in energy on extraction, ΔE_{ext} , which is the maximum difference in energy of the extracted electrons, and which must be accurately measured to avoid chromatic aberrations; the cross-over diameter, d_0 , which is the diameter of the beam when it is extracted and whose measurement is inversely proportional to the resolution.

A tungsten filament has a measured brightness of the order of $10^5\text{A}\cdot\text{cm}^2\cdot\text{srad}^2$ while a higher brightness can be achieved in the case of a filament made from lanthanum hexaboride, LaB_6 , which also combines this characteristic with a longer operating life. In

addition, the LaB₆ filament can be mounted on devices designed for tungsten filaments, providing useful interchangeability. All these features compensate for the higher cost of LaB₆ compared to tungsten. The emitting source consists of a single crystal of LaB₆ 10 μm in size and around 200 μm long, which must operate under a higher vacuum than that required for tungsten, because the material is easily contaminated.

Another experimental method by which electrons can be obtained for analysis is field emission. This source is important because of its high brightness.

Usually, two types of field emission sources are used, the cold field emitter (henceforth CFE) and the Schottky Field Emitter (henceforth SFE). In the CFE technique, the tungsten tip, which produces a current output of around 10 μA, is sensitive to adsorbed gases, so it must be cleaned once a day with a 2500K flashing process. After a few thousand flashes, the tip blunts and its service life is over. The SFE operates at higher temperatures and the emitting tip is self-cleaning. To lower the work function value, the tip is coated with zirconium oxide, ZrO₂, and wear of the coating means that the tip has to be replaced, usually once a year. Despite this limitation, SFE allows efficient microanalysis, unlike CFE.

The electromagnetic lenses that are used to focus the electron beam are made by means of a series of toroidal windings, necessary to generate a magnetic field, enclosed in an iron casing. The radial force produced by the windings is directed towards the centre of the coil, which is why these lenses are always converging; an electron moving not exactly along the axis will spiral towards the optical axis (Fig. 2.2). For a lens of this type, we call the focal length, f , the distance separating the point at which the beam begins to deflect from the point where it crosses the axis of the lens and, unlike optical lenses, where it is fixed, it can be modified by changing the value of the current in the windings. The focal distance is calculated using the formula:

$$f = \frac{1}{p} + \frac{1}{q} \text{ m} \quad (2.12)$$

where p is the distance separating the object from the centre of the lens and q is the distance separating the image from the centre of the lens. Magnification, $M = q/p$, and demagnification, $m = p/q$, are further values that can be derived from these parameters.

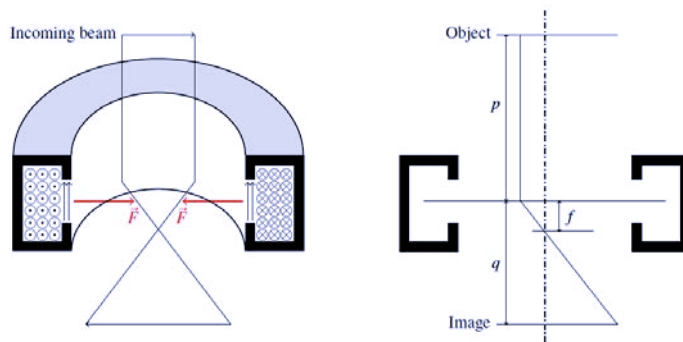

Fig. 2.2 Schematic of an electromagnetic lens and the related geometry. Source: AD

There are two different types of lenses in an electron microscope. The first lens is called the condenser lens and is characterised by a large focal length, while in the second one, the objective lens, a very strong but length-limited field acts along the axis, so that a short focal length is obtained, with a high magnification as a result. In an electromagnetic lens, it is the electric current flowing through a conductor that generates the magnetic field. The conductor wire is wound in a solenoidal form so that each coil contributes to the induced magnetic field, at the centre of the winding, as is well known. Indeed:

$$B = \mu \frac{NI}{l} \quad \text{T} \quad (2.13)$$

where μ is the magnetic permeability of the medium surrounding the solenoid, N the number of turns, I the current flowing through the device and l the length of the solenoid. Since it is also:

$$H = \frac{NI}{l} \quad \text{A/m} \quad (2.14)$$

we get:

$$B = \mu H \rightarrow \mu = \frac{B}{H} \quad \text{H/m} \quad (2.15)$$

so μ is also the magnetic flux density per unit field. The magnetic permeability of iron, for high fields, is 1, because in this condition the iron becomes magnetically saturated. This constitutes a difficulty, since the current circulating in the solenoid cannot be applied to change the focal length of the lens, precisely because of the iron hysteresis phenomena. To overcome this problem, soft iron is used, shielding the lens from external fields with a high magnetic permeability material, and cooling the apparatus with fluid circuits. The applied field strength is below 2T.

Theoretically, knowing the voltage applied to the filament, it seems possible that such an instrument could achieve truly significant resolutions; in fact, since we have shown that:

$$\lambda = \frac{1.23}{\sqrt{V}} \cdot 10^{-9} \quad \text{m} \quad (2.16)$$

a voltage of 10^6V , theoretically allows a wavelength of 1pm to be achieved. However, the reality is quite different, due to aberration phenomena that also affect electronic lenses.

One of the optical phenomena one has to deal with when working with lenses is the so-called *spherical aberration* (Fig. 2.3). In an electron microscope, electrons moving on trajectories away from the optical axis undergo greater path deflections. As a result, the electron beam entering the objective near the edge of the lens is focused at a different point

than those electrons passing closer to the centre. The image display error due to this phenomenon becomes more pronounced as the beam moves away from the optical axis of the lens. Differential focusing causes the image to be “smeared” around its perimeter instead of clustered in the centre. The end result is that the image appears as a disc and not as a dot. The smallest disc is called the disc of least spherical aberration, whose diameter is:

$$d_s = \frac{1}{2} C_s \alpha^3 \text{ m} \quad (2.17)$$

where C_s is the coefficient of spherical aberration and α is the angle of the outer ray that crosses the lens. C_s is typically a few millimetres long for lenses with short focal lengths. Spherical aberration can be minimised by removing the outer edge of the beam. This is achieved by placing an aperture with a small hole in the centre of the field or immediately below it. However, a smaller diameter reduces the beam current and leads to diffraction phenomena caused by the aperture.

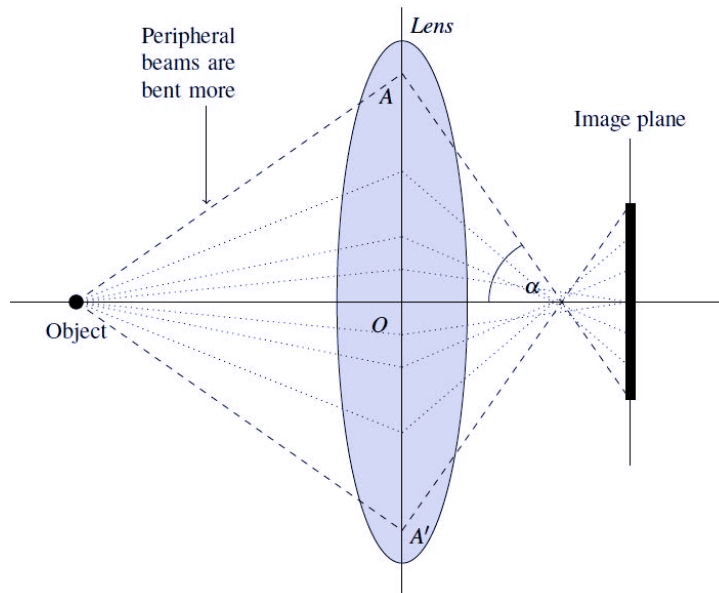

Fig. 2.3 Spherical aberration. Source: AD

Chromatic aberration is due to the different energy of the electrons, which is related to the different chromatic wavelengths (Fig. 2.4). When different wavelengths of light enter a converging lens at the same point, how much their optical path will be deflected depends on their energy. In optics, it is known that radiation of a shorter wavelength is deflected more than that of a longer wavelength. In electron optics, the opposite happens, i.e. a shorter wavelength undergoes less deflection. This is due to the fact that electrons are subject to less deflection when the energy of their beam is high, because the faster the electrons are,

the less they are affected by the applied magnetic field. The result is that beams of two different energies form images at different points. Because of this aberration, instead of a point, a disk is formed on the image plane. The diameter of the disk of least confusion can be calculated with the relation:

$$d_c = C_c \alpha \frac{\Delta E}{E_0} \text{ m} \quad (2.18)$$

where C_c is the chromatic aberration coefficient, E is the beam energy and ΔE is the spread energy. The fractional change in beam energy is the significant factor.

Chromatic aberration can be reduced by stabilising the electron beam energy.

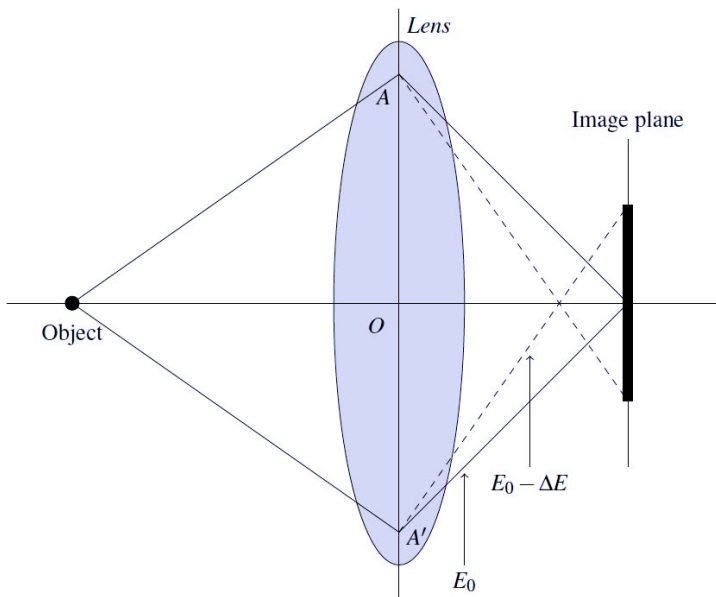

Fig. 2.4 Chromatic aberration. Source: AD

The wave nature of electrons causes the phenomenon of *diffraction* when the beam passes through a thin slit, and the resulting waves will give rise to a central bright halo, the Airy disk, and a series of concentric rings in the image plane, according to what is called the Airy model. As we have seen, the relation that allows the calculation of Airy disk is:

$$d = 0.61 \frac{\lambda}{n \cdot \sin \vartheta} \text{ m} \quad (2.19)$$

To reduce the effects of diffraction, it is necessary to maintain as large an angle as possible between the optical axis and the perimeter of the lens. However, a small aperture is

necessary to reduce the effects of spherical and chromatic aberrations, but this may lead to diffraction problems, so a compromise is needed to optimise the aperture size.

When the beam gives rise to an image for which the horizontal and vertical focal points do not coincide, *astigmatism* aberration occurs and an ellipse appears on the image plane instead of a point. The two foci on the sagittal lines can be forced to coincide to correct this defect. Astigmatism occurs due to defects in the focusing fields, since electromagnetic lenses, apertures and other components of the column may all contribute to astigmatism. An imperfection in the construction of the apparatus can lead to this problem. Astigmatism can, however, be corrected by a set of magnets called “stigmators”, which are placed around the circumference of the column, and which are adjusted according to the applied force and position of the beam in an attempt to induce an equal and opposite effect on the electrons.

The effect of all lens aberrations is important and must be considered carefully when making an electronic instrument. But, while typical spherical aberration can be corrected completely, its correction leads to the problem of diffraction phenomena inherent in the interaction of the electron beam with the aperture and so these two should be carefully controlled. Chromatic aberration, on the other hand, turns out to be significant under an accelerating voltage of 10kV.

2.1.1.2 Transmission Electron Microscopy

The Transmission Electron Microscope (TEM) uses electrons that pass through the sample, analysing its internal structure and then forming an image. As the penetration capacity of an electron is small, if the sample is thick, this size must be kept around a few tens of nanometres. This technique allows resolutions of around 0.1nm to be obtained, which is thousands of times higher than with traditional optical microscopy.

We have seen that the resolution of an optical microscope is linked to the wavelength of the light radiation used. With green light, whose wavelength can be around 550nm, the resolution achievable is about 300nm, which is not enough to resolve the distance separating, for example, two atoms in the solid state, the lattice pitch being around 0.2nm. Electrons, however, can be affected by quantum effects and behave according to wave or particle physics, which can be interpreted through De Broglie relation:

$$\lambda = \frac{h}{p} \text{ m} \quad (2.20)$$

When an electron is accelerated by a potential V , its wavelength can be calculated as:

$$\lambda = \frac{h}{\sqrt{2m_0eV \left(1 + \frac{eV}{2m_0c^2}\right)}} \text{ m} \quad (2.21)$$

This equation, theoretically, leads to picometric resolutions.

The Transmission Electron Microscope is basically based on three building blocks, the illumination system, the objective lens and the image formation system. The diffraction grating and image are formed in the back focal plane and the image plane of the objective lens. The image formation methods in the TEM microscope use the information contained in the electron waves leaving the sample. The projector lenses allow the correct positioning of this electron wave distribution on the display system. If the imaging device is of sufficiently high quality, we can assume that the intensity of the image can be considered to be proportional to the time-averaged square modulus of the amplitude of the electron wave functions, where the wave forming the output beam is denoted by Ψ (Cowley 1995):

$$I(x) = \frac{k}{t_1 - t_0} \int_{t_0}^{t_1} \psi \psi^* dt \quad (2.22)$$

Information about the sample is obtained by changing the waveform of the electrons leaving the same sample. The observed image not only depends on the beam width but also on the phase of the electrons, although phase effects can be neglected at low magnifications. High-resolution imaging processes require thin samples and high electron energies, but the thickness of the sample can result in electron phase shift, making sharp observations difficult (Cowley 1995).

The distance between two electrons impacting on the sample is around 0.15mm, if the acceleration potential is 100KeV, once we compare this measurement with the thickness of the sample, we can think of the interaction of the electron beam with the sample as a succession of single events. Expressing the incident electron as a plane wave:

$$\psi(r) = e^{2\pi i k_0 r} \quad (2.23)$$

and solving the Schrödinger equation with this electron wave function we get:

$$\psi(r) = \psi_o(r) + \frac{me}{2\pi\hbar^2} \int \frac{e^{2\pi i k|r-r'|}}{|r-r'|} V(r') \psi(r') dr' \quad (2.24)$$

If we consider the following approximation:

$$\psi(r) = e^{2\pi i k_0 r} + \frac{me}{2\pi\hbar^2} \frac{e^{2\pi i kr}}{r} \int e^{-2\pi i (k-k_0)r} V(r') dr' \quad (2.25)$$

the amplitude of the scattering beam is the Fourier transform of the sample potential.

The potential is described by the following relationship:

$$V(r) = \sum_n \sum_r V_a(r - R_n - r_a) S_p(r) \quad (2.26)$$

if the crystal is supposed perfect and $S_p(r)$ is the crystal form factor.

The Fourier transform of the potential is written as:

$$\Phi(u) = \sum_g \delta(u - g) V_g \quad (2.27)$$

where V_g is the structure factor and is written as:

$$V_g = \sum_a e^{-2\pi i g r} f_a(g) \quad (2.28)$$

Diffraction intensity is calculated as:

$$|\Phi(u)|^2 = \left| \left[\sum_g \delta(u - g) V_g \right] \otimes S_p(u) \right|^2 \quad (2.29)$$

A TEM can basically work in two modes, brightfield or darkfield. The difference lies in whether or not the beam transmitted along the direction (000) is used for image formation; the aperture of the brightfield lens directly determines the information to be magnified in the final image. If one chooses to exclude the diffracted beams, the instrument configuration is typical of analyses to search for structural defects in the sample, which is oriented so as to present a preferential diffraction grating. In this way, the image becomes sensitive to material thickness, lattice distortions and deformations.

Although the investigation with a TEM makes it possible to investigate material defects through diffraction, observing the distribution of atoms is difficult. Electron diffraction, as is well known, is a consequence of the wave nature of electrons and the wavelength of an electron becomes the characteristic quantity to characterise an incident plane wave. When an electron moves in a crystal for which an electrostatic potential $V(x,y,z)$ can be measured, we can write the equation:

$$K_E + P_E = \left[\sqrt{m_0^2 c^4 + p^2 c^2} - m_0 c^2 \right] - eV \quad (2.30)$$

Therefore, the effective electron wave number is:

$$\begin{aligned}
 W_{eff} = \frac{p}{h} &= \frac{1}{h} \left[2m_0 e(U_0 + V) \left(1 + \frac{e(U_0 + V)}{2m_0 c^2} \right) \right]^{1/2} \\
 &= \frac{1}{\lambda} \left[\left(1 + \frac{V}{U_0} \right) \left(1 + \frac{eV}{2m_0 c^2 + eU_0} \right) \right]^{1/2} \\
 &\approx \frac{1}{\lambda} \left[1 + \frac{V(r)}{U_0} \right]^{1/2} \\
 &\approx \frac{1}{\lambda} \left[1 + \frac{V(r)}{2U_0} \right]
 \end{aligned} \tag{2.31}$$

where it is assumed to be $V \ll U_0$. If the sample occupies only half the available space, the phase shift for a sample of thickness d is written as:

$$\int_0^d 2\pi \left(\frac{1}{\lambda_{eff}} - \frac{1}{\lambda} \right) dz \approx \sigma V_p(b) \tag{2.32}$$

and:

$$\sigma = \frac{\pi}{\lambda U_0} \tag{2.33}$$

The projected potential of the crystal is written as:

$$V_p(b) = \int_0^d V(r) dz \tag{2.34}$$

The effect of the potential field is obtained by multiplying the wave function by a filter function:

$$Q(b) = \exp[i\sigma V_p(b)] \tag{2.35}$$

This is known as Phase Object Approximation (POA). The crystal behaves like a filter for phase; the potential of the crystal can, therefore, change the phase of the incident electrons: the contrast produced by this mechanism is called phase contrast (Wang 2000).

The following simplified diagram (Fig. 2.5) shows the main blocks of a TEM microscope.

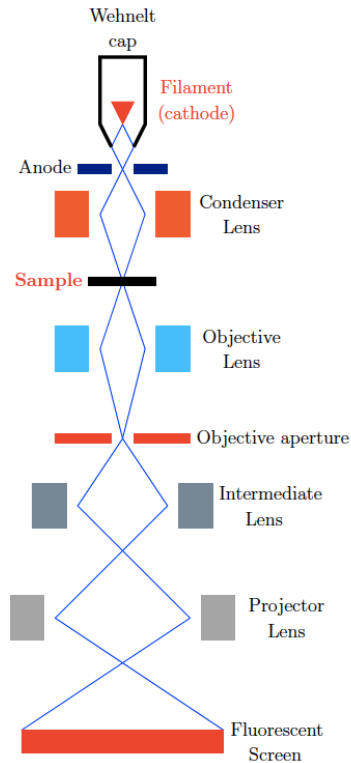

Fig. 2.5 A simple scheme of a TEM microscope. Source: AD

As we have already pointed out, a transmission microscope is essentially made up of three essential blocks: the electron gun, which is necessary to produce the electron beam and its condensation system, which is necessary to correctly direct the electron brush onto the sample, the image formation system, i.e. the objective lens, the mobile system of the sample holder, the projection lenses, which are necessary to form a high-resolution image and, finally, the image recording system which allows the image to be displayed and saved in digital form.

The cathode, which is the source of the electrons, consists of a pointed bar made of lanthanum hexaboride. The filament is surrounded by a control grid, called a Wehnelt cylinder, on which an opening is made coaxial to the filament; the end of the filament is placed at or just above the opening. The cathode and the control grid are isolated from the instrument and kept at negative potential so as to obtain the appropriate acceleration to be impressed on the electrons of the beam. The anode is made by means of a disc in which there is a coaxial opening through which the electrons accelerated by the cathode/anode system pass.

The amplitude of the beam and its intensity are adjusted by means of a lens system which is placed between the electron gun and the sample, usually two, which direct the electron brush onto the sample.

The sample holder grid is placed on a movable system. The objective lens has a focal length of 1mm–5mm and provides a real image which is then magnified by the single projection lens or the projection lens system; a system of projection lenses, generally two, which allow a very large magnification to be obtained without having to increase the size, and bulk, of the experimental apparatus itself.

On the screen, the magnification is around 1000×–250000×, any further enlargements are obtained by processing the image digitally or photographically. The quality of the image depends on the setting of the apparatus and the alignment of the lenses, which require a very stable power supply.

Today, the resolution of a transmission electron microscope can easily reach a tenth of a nanometre, but to push the resolution further, one of the most important instruments in nanotechnology, the High Resolution Transmission Electron Microscope (henceforth HRTEM), has been developed. This instrument makes it possible to directly visualise the atomic structure of samples. Advanced materials such as graphene, carbon nanotubes, sp²–hybridised carbon compounds, or semiconductors have been effectively observed. The principle of image formation is based on the interaction of electrons that have undergone elastic scattering with the sample and are transferred to the screen to display the image. Electron transfer is a phenomenon that can be described by an equation that describes it and is called the Phase Contrast Transfer Function (CTF). This is written as:

$$T(k) = -\sin \left[\frac{\pi}{2} C_s \lambda^3 k^4 + \pi \Delta f \lambda k^2 \right] \quad (2.36)$$

where C_s is the coefficient of spherical aberration, λ the wavelength of the beam, Δf the defocusing factor and k the spatial frequency.

In any type of microscope, the key parameter is resolution, i.e. the ability of the instrument to display two closely spaced points as distinct. The wavelength of electrons is of the order of picometres, so it would be legitimate to expect instrumental resolution of the same order of magnitude. However, the lenses, even if electronic, present aberration phenomena because it is impossible to obtain a coherent electron beam. Resolution can also be considered in terms of what is called the CTF cut–off frequency value (Reimer and Kohl 2008):

$$q_{max} = \frac{1}{0.67(C_s \lambda^3)^{1/4}} \text{ m}^{-1} \quad (2.37)$$

The value of C_s increases as the energy of the electron beam is increased, but the resolution improves as the acceleration voltage increases, when the wavelength λ decreases. The spherical aberration coefficient varies between 0.3mm, when operating at 100KeV, up to 1.5mm, when operating at 1MeV. The resolution can vary between 0.25nm and 0.12nm.

2.1.2 Scanning Tunneling Microscopy

One of the main challenges in Solid-State Physics is the detailed analysis of material surfaces. Arguably the instrument that has most pioneered the detailed study of the surface structure of materials is the Scanning Tunneling Microscope (STM), which was invented by Gerd Binnig and Heinrich Rohrer (1923–2013), and later implemented by Binnig and Rohrer, Christoph Gerber and Erich Weibel (Fig. 2.6).

In nearly thirty years of history, STM microscopy has evolved from the beginnings of the simple visualisation of nanostructures on an atomic scale, to the manipulation of atoms – witness the famous image of the IBM logo obtained by Don Eigler in the early 1990s – to the functionalisation of nanostructures, through the manipulation and characterisation of atoms and molecules, arranged to obtain complex nanometric structures.

What an STM can do today ranges from measuring the strength of chemical bonds to studying the friction and dielectric properties of materials, from actual manipulation to an infinity of other operations that make it possible to intervene on matter on scales that go from the micrometre down to sub-nanometre dimensions (Lounis 2014). C. Julian Chen (Chen 1994) stated that:

It was often said that STM is to nanotechnology what the telescope was to astronomy. Yet STM is capable of manipulating the objects it observes, to build nanoscale structures that never existed in Nature. No telescope is capable of bringing Mars and Venus together.

The tip is the most important part of the microscope.

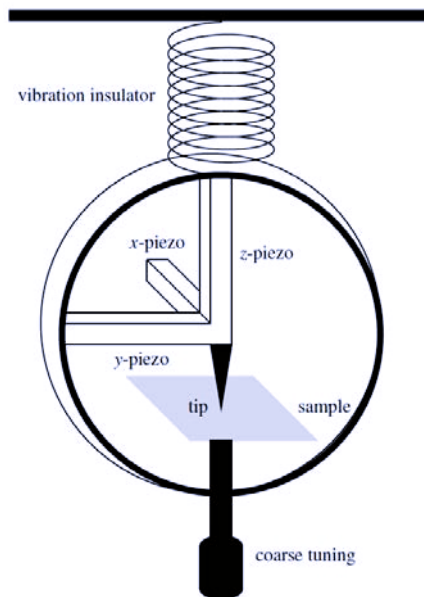

Fig. 2.6 A simple scheme of a STM microscope. Source: AD

A probe tip, usually made of tungsten or a platinum–iridium alloy, which is in fact the most important element of the microscope, is attached to a piezoelectric guide, which in turn consists of three piezoelectric transducer elements oriented along the three mutually orthogonal x , y and z axes. By exploiting the property of piezoelectric materials to deform in terms of elongation or contraction when tension is applied, it is possible to control the movement of the tip scanning the sample. Operating on the x - and y -axes, the tip inspects the surface of the sample in terms of extension, while operating along the z -axis and the sample holder – coarse positioner – the sample and tip can be moved to distances of less than a nanometre, so that the electron wavefunction in the tip overlaps with the electron wavefunction on the sample surface. The circulating current is very small because the tip is not actually in contact with the substrate, so the flow of electrons is guaranteed by the tunnel effect in vacuum.

This is usually done in such a way that the tip is virtually grounded; the bias voltage V is the sample voltage. According to these two specifications, if $V > 0$ the electron tunnel current moves from the occupied states of the tip to the vacant states of the sample; if $V < 0$ the path is reversed, from the occupied states of the sample to the vacant states at the tip. A current amplifier is required to convert the current into voltage and compare it with a reference value. The purpose is as follows: if the absolute value of the tunneling current is greater than the reference value then the voltage that is applied to the piezoelectric along the z -axis tends to move the tip away from the sample and vice versa. When equilibrium is established, the tip can scan the xy -plane, creating an image of all equilibrium positions along the z -axis, where the tunneling current always assumes the same value, and this image is displayed and stored in a computer memory. The image is displayed on a black-and-white screen and then processed graphically, so that the light parts represent the protrusions and the dark parts the depressions. For ease of interpretation, the image is often accompanied by an xz chart that gives a more quantitative representation.

Tunneling is a quantum mechanics phenomenon.

From the foundations of Quantum Mechanics, it is known that an electron can be described by a wave function $\Psi(z)$. The function depends on the variable z since we assume that the xy -plane is horizontal and that, therefore, this coordinate indicates the vertical direction. In the presence of a potential $V(z)$, we can write the Schrödinger equation as follows.

$$-\frac{\hbar^2}{2m} \frac{d^2}{dz^2} \psi(z) + V(z)\psi(z) = E\psi(z) \quad (2.38)$$

at a certain position z .

In an STM, the gap between tip and sample can be assimilated to a one-dimensional potential barrier that separates, exactly, the substrate S from the tip, T . When $E > |V|$, it is known that the solutions of the equation (2.38) are written as:

$$\psi(z) = \psi(0) e^{\pm ikz} \quad (2.39)$$

where:

$$k = \frac{\sqrt{2m(E - |V|)}}{\hbar} \quad (2.40)$$

represents the wave vector.

The potential barrier represents, from the classical point of view, a forbidden region through which the electron cannot pass, but from the quantum point of view the solution of the equation is:

$$\psi(z) = \psi(0) e^{-k'z} \quad (2.41)$$

where:

$$k' = \frac{\sqrt{2m(|V| - E)}}{\hbar} \quad (2.42)$$

is the decay constant used to describe the behaviour of the electron when it penetrates the potential barrier in the $+z$ direction. The tunneling phenomenon is bidirectional, so electrons can also migrate in the $-z$ direction.

The overall electron wave function is written for each of the three regions, the sample region, the barrier region and the tip region.

$$\psi(z)_S = e^{ikz} + Ae^{ikz} \quad (2.43)$$

$$\psi(z)_{Barrier} = Be^{-k'z} + Ce^{k'z} \quad (2.44)$$

$$\psi(z)_T = De^{ikz} \quad (2.45)$$

The coefficients of the exponentials are to be determined by imposing the fitting conditions of the wave functions and their derivatives $d\psi/dz$, at the interfaces between substrate and barrier and between barrier and tip. The transmission coefficient T of the barrier is defined by the incident current density:

$$I_i = \frac{\hbar k}{m} \quad (2.46)$$

and the transmitted current:

$$I_t = -i \frac{\hbar}{2m} \left[\psi_T^*(z) \frac{d\psi_T(z)}{dz} - \psi_T(z) \frac{d\psi_T^*(z)}{dz} \right] = \frac{\hbar k}{m} |D|^2 \quad (2.47)$$

so:

$$T = \frac{I_t}{I_i} = |D|^2 = \frac{1}{1 + \frac{(k^2 + k'^2)^2}{4k^2k'^2} \cdot \sinh^2(k's)} \quad (2.48)$$

If the decay constant k' is large, i.e. the barrier causes strong attenuation of the flow, one can simplify (2.48) as:

$$T \sim \frac{16k^2k'^2}{(k^2 + k'^2)^2} \cdot e^{-2k's} \quad (2.49)$$

where s is the position of the tip relative to the substrate.

In the analysis of a sample with an STM microscope, the atom that is placed on the end of the scanning tip is the most important.

To explain the effectiveness of the STM microscope in analysing the electronic structures of materials, Binnig and Rohrer made this observation. If the distance between the end of the probe tip and the sample, denoted by Δz , is less than the radius of the probe tip, R , significant lateral resolution is achieved due to the vacuum tunnel effect. In the vicinity of the tip, the current lines are practically perpendicular to the sample surface. At a point Δx on the probe, the distance to the sample surface, z , increases by an amount:

$$\Delta z \sim \frac{\Delta x^2}{2R} \quad (2.50)$$

Under the assumption that, point by point, the tunneling current density follows equation (2.49), an equation that refers to the one-dimensional case, the lateral current distribution becomes:

$$I(\Delta x) \sim e^{-2k' \frac{\Delta x^2}{2R}} \quad (2.51)$$

Usually, $k' \sim 0.1 \text{ nm}^{-1}$. When $R = 1 \text{ nm}$, the current decreases by a factor $\sim e^{-2}$ for $\Delta x \sim 0.45 \text{ nm}$, i.e. by about one order of magnitude. The diameter of such a current column is the resolution limit, which is about 0.9 nm .

2.1.3 Atomic Force Microscopy

One of the best-known instruments for the investigation of matter in the solid state, within the so-called Scanning Probe Microscopes, is the Atomic Force Microscope (AFM), an instrument that was invented in 1985 by Binnig, Quate (1923–2019) and Gerber. This type of microscope has proved capable of achieving resolutions of less than a nanometre and

well below the optical diffraction limit. The image of the sample is obtained by keeping the tip probing it at a distance or by physically touching the material. The scanning is adjusted with extreme accuracy by means of piezoelectric elements that allow the movement of the tip or the sample plate to be controlled by electronic commands.

Three basic analyses are possible with this microscope: measuring forces, obtaining topographical images of surfaces and manipulating atoms. The mechanical properties of the sample, for example, can be assessed by measuring the force between the sample and the end of the probe, depending on the distance between them. This gives, among other things, the Young's modulus and stiffness of the sample analysed. Conductivity or surface potential are electrical properties that can be assessed with this instrument.

An AFM basically consists of a piezoelectric scanner whose task is to move a tip over the surface of a sample. The interaction between the tip and the sample is controlled by a detector. A computer and electronics control unit of the microscope controls its operation and generates digital images (Sanders 2019). AFMs measure atomic forces on a surface by sliding a sharp tip attached to a flexible cantilever across the sample. The tips that do the scanning need to be sharp in order to trace the topography of the sample as closely as possible, and their sensitivity is good to the point of detecting forces between atoms (Rogers, Adams and Pennathur 2013). The tip diameter can be as small as 5nm (Malsch 2002).

A scanner containing piezoelectric materials is used to move the tips of an AFM across the sample surface by converting electrical signals into mechanical movement. Typically, a single piezoelectric device will deform by 0.1nm per applied volt. This means that if the voltage applied to the piezoelectric device is 2 volts, then the material will expand by approximately 0.2nm, roughly the diameter of a single atom (Sanders 2019).

The following picture (Fig. 2.7) represents a simple disposition of the fundamental elements of an Atomic Force Microscope.

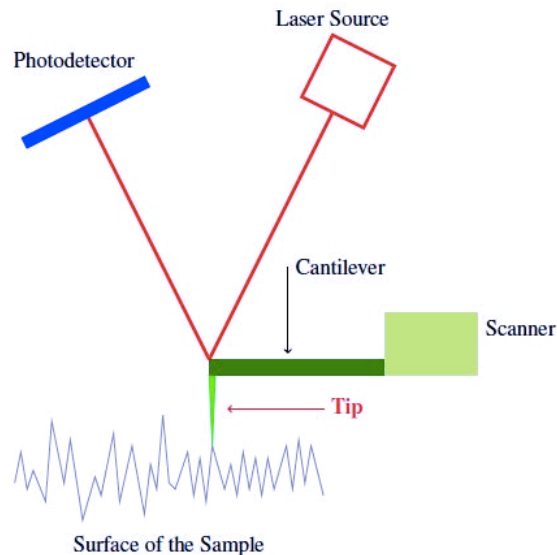

Fig. 2.7 A simple scheme of the AFM microscope. Source: AD

As the tip approaches the surface, the attractive intermolecular forces between the atoms on the surface and those on the tip come into play. When the cantilever is pushed towards the surface, repulsive forces can be measured because the tip tries to move the atoms on the surface. The attractive and repulsive forces deflect the cantilever, through the displacement of the cantilever the topography and properties of the surface can be measured (Wilson *et al.* 2002).

The AFM allows the measurement of forces as small as 10^{-12}N (Malsch 2002).

When the tip of the Atomic Force Microscope follows the surface of the sample to be analysed, the force between the tip and the surface causes a deflection of the cantilever and this is measured by an optical sensor. The latter device commonly consists of a laser beam reflected from the cantilever itself, the back of which is coated with a metal material, to a position-sensitive photodiode. The photodiode can then measure changes in the position of the incident laser beam with a resolution of up to 1nm, allowing sub-nanometre displacements to be observed. (Wilson *et al.* 2002). A force sensor measures the force between the tip and the surface, while the feedback control feeds the signal from the force sensor to the piezoelectric so that a constant value force is maintained between the tip and the sample (Malsch 2002). When the tip encounters a rough region on the sample, the distance between the roughness and the probe results in an increase in the force value being measured. In this case, feedback control causes the piezoelectric scanner to move the probe away from the surface to bring the force value back to the set value. Conversely, if the optical sensor detects a decrease in force, due to the presence of depressions on the sample surface, the probe will be moved down to follow the topography while keeping the force value constant. The amount of displacement along the z -direction of the piezoelectric, which is necessary to keep the force value constant by controlling the distance between the tip and the sample, is assumed to be completely equal to the topography of the sample.

The signal is then used to image the surface of the sample.

The AFM microscope is used according to two distinct methodologies: contact analysis and non-contact analysis (Fig. 2.8).

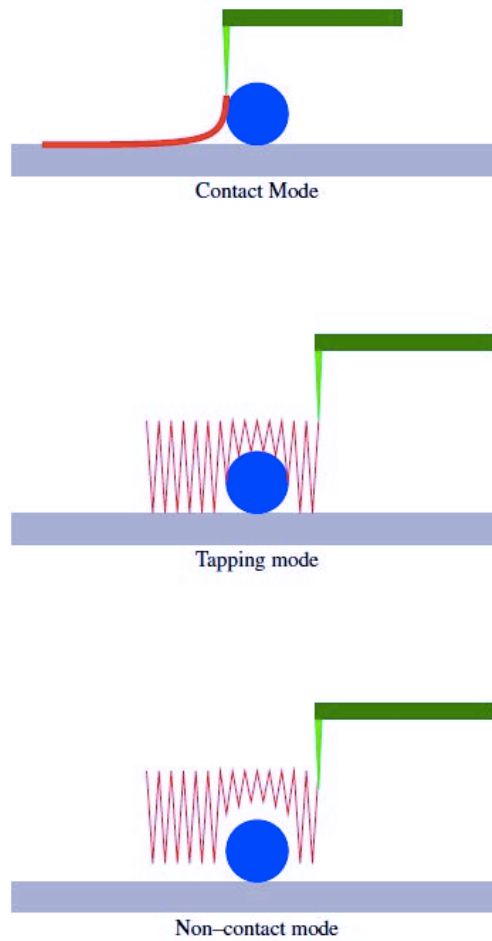

Fig. 2.8 Contact and non-contact analysis when operating the AFM microscope. Source: AD

Contact analysis involves a direct interaction between the tip and the sample surface. When the tip of the AFM microscope engages the surface roughness, the adjustment system operates on the vertical position of the tip so that the force between it and the sample remains constant (Rogers, Adams and Pennathur 2013). Consequently, during this mode of analysis, the tip comes into direct contact with the surface. However, physical damage can be caused to soft materials when scanning in this way. In the tapping mode, the cantilever is vibrated at or near its resonant frequency, allowing the tip to contact the surface intermittently.

When operating in the non-contact mode, intermolecular attraction forces are measured by oscillating the cantilever approximately 5nm–10nm above the sample surface (Fig. 2.8b) (Wilson *et al.* 2002). As the probe approaches the sample surface, the oscillation changes due to interactions between it and the sample forces, leading to a reduction in both the frequency and amplitude of the oscillation. The oscillation is monitored by the optical sensor, and the scanner adjusts the z -height through the feedback loop to maintain a constant vibrational amplitude and allow effective mapping of the surface (Eaton and West 2010).

Whenever the probe tip and the surface interact, a graph can be plotted through the control system to represent the course of the force between these two elements.

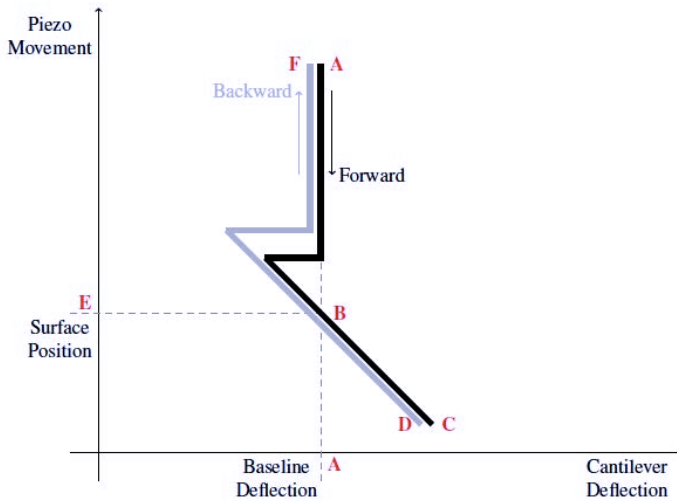

Fig. 2.9 The force-plot of an AFM. Source: AD

We can divide the graph into different sections to understand the different phases of the interaction.

- Segment A – The cantilever is approached to the surface. In the presence of attractive or repulsive forces between the tip and the sample, any downward or upward deflection of the cantilever may allow their measurement along this segment.
- Segment B – At the instant called “Snap-in”, the cantilever snaps and the tip makes contact with the sample. It is the interactions between the tip and the surface, e.g. capillary forces, that cause this snap-in.
- Segment C – Repulsive phase: the tip and sample are in contact, the cantilever bends and the z-piezo makes a further movement. This section is called the net-repulsive portion.
- Segment D – Withdrawal repulsive portion: the tip is now no longer deflected as it is moved away from the surface.
- Segment E – Withdrawal: the tip is “stuck” in an adhesive depression before it can be released.
- Segment F – The cantilever has returned to its initial state without deflection, while the z-piezo further increases the distance between the sample and the probe tip.

Atomic Force Microscopy allows operators to manipulate the atoms that are present on the surface of samples and to process nanometer-sized textures on thin films. The nanoshaving operation is possible because, through the probe tip, the AFM can exert a high value force

on a sample surface. Through this pressure, it is possible to move absorbed molecules or thin films (Yang, Amro and Liu 2003). This procedure allows precise control over the size and geometry of the fabricated features, as well as obtaining an edge resolution of better than 2nm (Xu and Liu 1997).

2.1.4 Nano-Chemical Imaging and Spectroscopy

The development of nanotechnology has gone hand in hand with the development of instruments that are used to study matter at the nanometric dimension. Spectroscopy instruments have proved fundamental in understanding the chemical composition of compounds, thanks to the development they have encountered once they have been interfaced with scanning probe analysis. Of particular interest are Photothermal Induced Resonance (PTIR), which also goes by the name of AFM-IR, and Tip-Enhanced Raman Spectroscopy (TERS). Both techniques are successfully applied to different disciplines such as Nanotechnology, Materials Science, Optics, Geology, Medicine and Biology, Chemistry and the study of catalysis and its processes.

Using Raman and Infrared (IR) Spectroscopy, we can obtain measurements of both the molecular vibrations and phonons of samples, deriving interesting information about the chemistry of the samples, in terms of the chemical structure and spatial arrangement of their functional groups.

These two techniques differ in significant details. Raman Spectroscopy measures light that is inelastically scattered through the sample polarisation tensor, i.e. the matrix of coefficients relating the Cartesian components of the dipole moment to the Cartesian components of the electric field as follows.

$$\begin{aligned} p_x &= \alpha_{xx}E_x + \alpha_{xy}E_y + \alpha_{xz}E_z \\ p_y &= \alpha_{yx}E_x + \alpha_{yy}E_y + \alpha_{yz}E_z \\ p_z &= \alpha_{zx}E_x + \alpha_{zy}E_y + \alpha_{zz}E_z \end{aligned}$$

and the matrix is written as:

$$\begin{pmatrix} \alpha_{xx} & \alpha_{xy} & \alpha_{xz} \\ \alpha_{yx} & \alpha_{yy} & \alpha_{yz} \\ \alpha_{zx} & \alpha_{zy} & \alpha_{zz} \end{pmatrix}$$

IR spectroscopy, on the other hand, measures the absorption of light through electrical dipolar interaction.

The energy of a dipole immersed in the field of a second is calculated with the:

$$\begin{aligned}
 U_{12} = -\bar{p}_1 \cdot \bar{E}_2 &= -\frac{1}{4\pi\epsilon_0 r^3} \bar{p}_1 \cdot [3(\bar{p}_2 \cdot \bar{e}_r) \bar{e}_r - \bar{p}_2] \\
 &= \frac{1}{4\pi\epsilon_0 r^3} [\bar{p}_1 \cdot \bar{p}_2 - 3(\bar{p}_1 \cdot \bar{e}_r)(\bar{p}_2 \cdot \bar{e}_r)] \\
 &= U_{21} \qquad (2.52)
 \end{aligned}$$

where \bar{e}_r is the vector joining the centre of the dipole with the point P where \bar{p} is measured.

Specific chemical groups characterised by strong dipoles give rise to localised vibrational modes and IR spectroscopy is sensitive to these. Raman spectroscopy, on the other hand, is sensitive to the collective vibrational modes characteristic of atoms with high polarizability.

Molecular symmetry means that some vibrations can only be measured by Raman or IR Spectroscopy, or vice versa. In many cases, however, different vibrations are observable with both methods of investigation.

The development of Nanotechnology has brought with it the need to investigate the structure of matter also in the field of biology, however, Raman and IR Spectroscopy, techniques which it was hoped could be used in this area, are constrained by the diffraction limit of light and the best spatial resolution obtainable is from 250nm to about 500nm for Raman methodology and from 1.5 to about 10 micrometres for IR. Details at the nanoscale are beyond the capability of instrumental observation; even comparison of structure mapping is complicated by the limitations of the techniques. The improvement of the Raman and IR methodologies was achieved when they were combined with scanning probe microscopy, so that the limitation imposed by the diffraction limit was overcome and the observation of samples at the nanoscale became possible.

Here I will briefly describe the PTIR and TERS techniques, techniques that have given excellent results and have been improved in recent years, expanding their field of application to different disciplines.

TERS and AFM–IR have had independent technological developments although the basis of their improvement is the scanning probe. The tip of the SPM is the key factor when making TERS measurements, while it is the dynamics of the thermal expansion of the sample, together with the oscillation of the SPM holder, that is important in AFM–IR. In order to combine the information about the composition of a sample that can be obtained from IR Spectroscopy with the nanoscale spatial resolution of AFM Microscopy, the new AFM–IR technique has been developed (Dazzi, Prazeres, Glotin and Ortega 2005). The device consists of a wavelength–adjustable pulsed infrared laser source operating on a narrow spectrum calibrated to the absorption band of the sample, an atomic force microscope and an optic whose purpose is to properly focus the laser beam on the AFM tip holder in contact with the sample. The laser illuminates the area of the sample around the tip of the electron microscope, and the tip of the AFM translates the photothermal expansion of the sample, because the parts of the sample that are hit by the laser pulses expand thermally very quickly, comparable to the length of the pulse itself. As a first approximation, only the part of the sample below the tip contributes to the signal. The thermal expansion is small and relaxes very quickly, which is why appropriately designed probes with a nanophotonic response time of around 10ns are essential. These results are not possible

with conventional AFM cantilevers, whose response times are in the order of tens of microseconds.

The instrumental approach that is done with the AFM–IR is interesting because the amplitude of the tip oscillation is directly proportional to the local absorption coefficient of infrared light by the sample (Fig. 2.10). Thus, by measuring the amplitude of the cantilever oscillation during the laser scan in the band of interest, the absorption spectrum of the AFM–IR can be plotted.

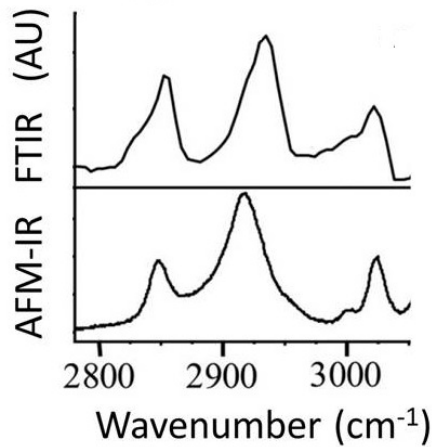

Fig. 2.10 This comparison shows that AFM–IR measurements, below, have good agreement with conventional FTIR spectrum, above. Source: Catsmeat (nickname) [https://en.wikipedia.org/wiki/Infrared_Nanospectroscopy_\(AFM-IR\)](https://en.wikipedia.org/wiki/Infrared_Nanospectroscopy_(AFM-IR)), PublicDomain, CC BY–SA 4.0 License

In 2010, Prof. Dazzi’s working group (Dazzi, Glotin and Carminati 2010) developed a theoretical framework to describe the AFM–IR device signal through a series of multiplicative factors involving the absorbed energy, the locally developed heat, the thermal expansion, the motion of the AFM probe holder, and the detected signal. The following equation (Ramer, Aksyuk and Centrone 2017) condenses the terms into a compact writing:

$$S_{AFM-IR} \propto H_{AFM} H_m H_{th} H_{opt}(\lambda) I_{inc}(\lambda) \quad (2.53)$$

where λ is the wavelength and I_{inc} the incident laser intensity. The stiffness of the scanning tip holder, the deflection frequency, the shape and the height of the tip are all parameters considered in the factor H_{AFM} . The thermal contribution H_{th} describes the experimental situation as a function of the laser pulse length and the thermal properties of the sample.

The factor $H_{opt}(\lambda)$ identifies the part of the incident radiation that is absorbed by the sample and depends on its refractive index.

$$\hat{n}(\lambda) = n(\lambda) + i\kappa(\lambda) \quad (2.54)$$

where $\kappa(\lambda)$ is the absorption coefficient.

The AFM–IR technique has two variants, depending on the point of illumination of the sample: the sample can be illuminated from below, in total internal reflection (TIR), or from above, from the so–called air–side, through a parabolic mirror (Fig. 2.11).

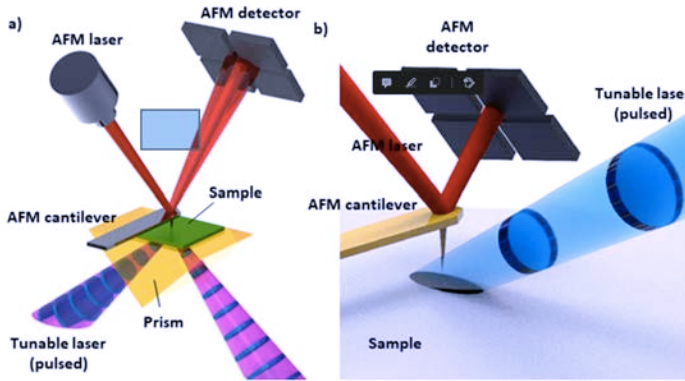

Fig. 2.11 This picture schematically represents the total internal reflection for an AFM–IR device, whose components are also briefly shown. With such a configuration the absorption of background light is minimized in AFM cantilever allowing the use of uncoated AFM cantilevers, keeping the device simpler. Source: Courtesy Kurouski

One point should be made. Due to the small depth of light penetration in the sample, the thickness of the sample must be limited to a few micrometres, possibly below 500nm, in order to maintain a correct linearity of the signal. It is easy to understand that the TIR technique requires careful preparation of the sample beforehand, even though it is proven that absorption due to the experimental background is limited. On the other hand, top illumination simplifies sample preparation and allows the analysis of samples of any thickness, but requires the cantilever to be coated with gold to avoid self–absorption phenomena within the AFM probe (Kurouski, Dazzi, Zenobi and Centrone 2020).

At the beginning of the 2000s, the ring–down technique was introduced for AFM–IR measurements (Dazzi, Prazens, Glotin and Ortega 2005). This technique is based on very short IR laser pulses that are absorbed by the sample and cause the sample temperature to rise in proportion to the amount of energy that is absorbed locally.

$$\Delta T(t) = \frac{I_{inc}(\lambda)}{\rho c_p} R(t) abs(\lambda) \quad (2.55)$$

where the factor $R(t)$ is related to the duration of the laser pulse and the geometrical parameters of the sample, c_p is the thermal capacity of the material and ρ its density, $I_{inc}(\lambda)$ is the intensity of the incident laser light and:

$$abs(\lambda) = \frac{\kappa(\lambda)}{\lambda}$$

Using the term $\Delta T(t)$, it is possible to derive a function that describes the thermal expansion of the part invested by the laser:

$$u(t) = \alpha K \Delta T(t) \quad (2.56)$$

where α is the coefficient of thermal expansion and K a factor that depends on the size, geometry and mechanical properties of the sample. The thermal expansion is rapid – and we have seen that it is short-lived – and causes an excitation on the substrate that can be written as:

$$Z(t, \lambda) = A \sum_n P_n^2 \frac{\sin 2\pi f_n t}{2\pi f_n} e^{-\Gamma t/2} abs(\lambda) \quad (2.57)$$

and in this function A contains all the mechanical and thermal parameters of the sample and the tip holder. P_n corresponds to the slope that is measured depending on the mode of operation, f_n the frequency of the n th resonant mode and Γ the damping.

The Resonance-Enhanced AFM-IR mode, is a more recent technique (Lu, Jin and Belkin 2014) is based on a quantum cascade laser whose wavelength and frequency are suitably adjustable (down to a few MHz). The resonance excitation of the cantilever is achieved by matching the repetition frequency of the laser to one of the contact resonance frequencies of the cantilever. In this way, the thermal expansion of the sample effectively excites only one of the mechanical modes of the cantilever according to the:

$$Z(t, \lambda) = A P_n^2 \frac{\sin 2\pi f_n t}{2\pi f_n} \frac{Q}{2\pi} abs(\lambda) \quad (2.58)$$

where the coefficient A contains the mechanical, thermal and optical parameters of the sample and the tip holder. P_n corresponds to the slope that is measured depending on the mode of operation, f_n the frequency of the n th resonant mode and Q contains the frequency and Q -factor of the resonant mode. If we compare equations (2.57) and (2.58) we see that the only resonant mode that is excited is amplified by a factor of $Q/2\pi$. This fact is not negligible, as it makes it possible to analyse samples whose thickness is only a few nanometres, at the limit even monolayers.

The tapping mode of operation for AFM microscopy was developed to overcome the difficulties of imaging in soft or sticky-surfaced samples in contact mode, or samples that

adhere weakly to the substrate. Samples of this nature are very difficult if not impossible to measure with AFM–IR in contact mode.

However, the recent implementation of tapping–mode AFM–IR has enabled the characterisation of soft, sticky, or rough materials, further expanding the application space of tapping–mode AFM–IR.

The laser used must have a wavelength and repetition frequency that can be adjusted from time to time. The tapping–mode in AFM–IR enables the resonance excitation of the cantilever because it exploits the non–linear mechanical interactions between the tip and the sample through the non–linear combination of the response of the cantilever oscillation modes with the sample expansion caused by the laser. In practice, the cantilever is brought to the first tapping frequency, and the AFM–IR expansion signal is detected at the second tapping–mode frequency while the laser repetition rate is set as the difference between the two modes. When the above condition is satisfied, the expansion expression is given by:

$$\|Z(\lambda)\| = B\chi_s t_{tap} \frac{f_2 - f_1}{f_2^2} f_1 Q_2 \text{abs}(\lambda) \quad (2.59)$$

where B is a coefficient encompassing the amplitude of the first tapping mode, the effective mass of the second tapping mode, the pulse duration and thermal, mechanical and optical parameters of the sample. χ_s is the non–linear elasticity term, t_{tap} and f_1 are the contact time and frequency of the first tapping mode, f_2 and Q_2 are the frequencies and quality factor of the second tapping mode.

AFM–IR tapping provides better resolution (around 10nm) than the AFM–IR contact mode because the shorter contact time t_{tap} limits the AFM–IR transduction to the initial thermal expansion and is not affected by subsequent thermal stress diffusion in the sample. Furthermore, since in the tapping mode the cantilever resonance frequencies are less affected by the mechanical properties of the sample, AFM–IR tapping is generally a less problematic experimental technique than AFM–IR contact mode.

Many innovations have benefited from AFM–IR. AFM–IR translates many of the advantages of IR analysis to the nanoscale, such as identification of materials, functional groups, molecular conformations, polymorphic crystal forms or the amorphous state, isotopic labelling and multivariate analysis. In addition to vibrational (IR) spectroscopy, AFM–IR allows nanoscale optical investigations of different optical modes and, thanks to the extension to the near–infrared and visible ranges, also the nanoscale characterisation of material structures and defects. In addition, AFM–IR measurements can also provide qualitative information on the nanoscale mechanical properties of the sample and even quantitative information on the local thermal conductivity of the sample. The recent application of the AFM–IR technique on liquids holds great promise for new applications in the fields of Biology and Medicine. To date, the list of applications of AFM–IR has steadily expanded to include Polymer Science, the photovoltaic field, Plasmonics, Chemistry, Corrosion Science, materials studies, pharmaceutical studies and drug delivery, Medicine, Biology and Phytology. Geology and conservation of works of art are also fields in which AFM–IR methodology finds application.

Raman Spectroscopy is also applied at the nanoscale, and is known as Tip–Enhanced Raman Spectroscopy (TERS), and uses Atomic Force Microscope (AFM), or Scanning Tunnelling Microscope (STM), to analyse a nanostructure. Thus, TERS combines the

chemical information provided by Raman Spectroscopy with the signal enhancement known from Surface Enhanced Raman Spectroscopy (SERS) and the high spatial resolution of AFM or STM Microscopy. A metallic or metallised tip is illuminated by a focused laser beam and the resulting strongly enhanced electromagnetic field at the tip apex acts as a highly confined light source for Raman spectroscopic measurements. In TERS experiments, the probe tip is positioned over the sample and a laser excites the particle-localised surface plasmon resonance (LSPR), a coherent oscillation of conduction electrons. The local electric field (E) in the vicinity of the nanoparticle is amplified up to 1000 times, leading to enhancements in the Raman signal by up to a factor of 10^8 . The LSPR can be described by the solution of Maxwell's equations, also known as Mie theory, according to the equation:

$$E(\lambda) = \frac{24\pi^2 N a^3 \epsilon_{out}^{3/2}}{\lambda \ln(10)} \left[\frac{\epsilon_i(\lambda)}{(\epsilon_r(\lambda) + 2\epsilon_{out})^2 + \epsilon_i(\lambda)^2} \right] \quad (2.60)$$

where a is the radius of the nanoparticle, ϵ_r and ϵ_i are the real and imaginary components of the dielectric function of the metal, respectively, ϵ_{out} is a wavelength-independent dielectric constant that belongs to the environment surrounding the nanoparticles, and λ is the wavelength of the excitation radiation. The parameter N indicates the density of the nanoparticles. The probes are made of gold or silver nanoparticles because their plasmon resonance condition is reached in the visible spectrum. It has also been proven that the LSPR value also depends on the size of the plasmonic nanostructure. In addition, the larger the size of the nanoparticle, the greater the red-shift of the LSPR.

2.2 Mathematics for Physics at the Nanoscale: Examples

It is well known that size is one of the fundamental parameters by which the properties of materials can be radically changed, which is why they are brought down to the nanometric size. Each individual nanoparticle becomes a reactive site with mechanical, electrical and thermal characteristics that are completely different from the starting material. Not only that, but the subsequent application of nanomaterials to bulk structures leads to substantial improvements in the different performances of the latter. One example is the application of Cloesite[®] to thermoplastic materials to improve their strength characteristics, without affecting the elasticity and other properties of the polymer matrix. This is how nanocomposite materials are born: by embedding the most diverse nanoparticles within a polymer matrix, depending on the final product application.

2.2.1 Mathematical Modelling

Together with the development of nanotechnology and the laboratory analyses that accompany the characterisation of new materials, it was necessary to employ, at the same time, an effective mathematical tool to be able to formalise and describe the characteristic

phenomena of the new nanoparticles and the nanomaterials derived from them. Continuum Mechanics, which is well established in physics for the study of systems whose size is not influenced by their atomic or molecular structure, has proved to be an effective means of operating in the nanoworld. Three relevant topics such as the thermal conductivity of nanofluids, electrorheological fluids and the mechanics of nanotubes have been studied as areas of application of Continuum Mechanics (Thamwattana and Hill 2017), and constitute notable examples through which to understand how mathematics is applied to the modelling of nanostructures or the study of their properties, or starting points for further investigation.

At the level of the nano-world, it is known that the properties of matter – mechanical, elastic, electrical, magnetic – are different from those at the macro-scale and are dependent on both scale and material. The nano-behaviour of materials depends on three effects that have no influence in the bulk dimension

- the effects at the interface, or surface;
- scale effects;
- quantum effects that depend on the electronic structure of the nanoparticles.

These effects are a consequence of the small size of the particles and are interdependent, so let us briefly describe their characteristics. When I speak of interface, or surface, effects, I mean that the nanoparticles are not merely an inert suspension within the matrix, but interact with the matrix itself through a layer-interface whose physical properties must be understood. The scaling effects are reflected in the free mean path of the particles, which is much larger than the particle size due to their nanometric dimension. Finally, the electronic structure of the nanoparticles can affect the electronic structure of the matrix itself.

All these effects are interdependent and contribute to highlighting effects that occur at the nanoscale. This makes it necessary to use a mathematical formulation, so as to have a tool that can reliably predict the development of the model and its evolution over time.

The progressive miniaturisation of electronic devices, for example, has made it increasingly urgent to solve the problem of component cooling; the system of heat exchange through the use of cooling liquids such as water or 1,2-ethanediol (ethylene glycol) has proved to be insufficient, which is why the use of solid nanoparticles suspended in fluids can improve efficiency in terms of heat dispersion, since the thermal conductivity of solids is greater than that of liquids. On the other hand, the presence of solids in the cooling fluid can lead to surface abrasion, sedimentation and subsequent clogging of the channels.

The development of nanofluids for heat transfer has been an improvement in this direction: a nanofluid is a material consisting of a liquid phase in which solid nanoparticles are present in a volume fraction generally between 0.00026% and 10%. Thanks to the size of the particles and their fraction in the liquid phase, the resulting colloids are extremely stable and rarely encounter problems of sedimentation and consequent clogging of the ducts. Experimentally (Eastman *et al.* 2001) it has been shown that the addition of copper nanoparticles, 10nm in diameter, equal to 0.3% in volume fraction is sufficient to improve the thermal conductivity of 1,2-ethanediol by up to 40%. Such a result is widely demonstrated in the literature (Masuda, Ebata, Teramae and Hishinuma 1993, Lee, Choi, Li and Eastman 1999, Wang, Xy and Choi 1999, Choi *et al.* 2001, Patel *et al.* 2003).

In the following description, I illustrate the results (Thamwattana and Hill 2017) through which this phenomenon is explained.

In addition, electrorheological fluids (ERFs), or smart fluids, suspensions of dielectric but electrically active particles whose viscosity changes as a function of an applied external

electric field, in a rapid and fully reversible manner, will also be described. When an electric field is applied, the particles polarise, forming chains of dipoles and structures whose presence in the fluid increases viscosity and shear stress. The most common application of ERFs is in the automotive field, where they are used in electrically switched clutches and hydraulic valves, devices that are locked or closed, respectively, by applying the electric field to the fluid and opened by removing the field. Brakes and dampers are also common applications of ERFs. Potential applications would include the use of these fluids in foldable devices, screens or keyboards, which become rigid for use and flexible for easy storage in pockets or bags when not in use.

In order to calculate the electrostatic attraction force I will show how the re-expansion method (Washizu 1992) has been compared with other existing ones (Thamwattana and Hill 2017).

Finally, a general introduction is given to the mathematical modelling used to describe the mechanics of both single-walled and multi-walled carbon nanotubes, which are fundamental materials in nanomechanical systems due to their extreme properties such as low weight and high mechanical strength, flexibility and high thermal resistance. In particular (Zheng and Jiang 2002), the reciprocal sliding of the inner and outer windings in a multi-walled carbon nanotube can generate frequencies of the order of GHz, a remarkable result that can only be achieved by nanosized oscillators.

2.2.1.1 Thermal Conductivity

The problem of heat dissipation in circuits cannot be overlooked, since as electronic circuits become smaller and smaller, the amount of heat they generate is proportionally higher, and it is therefore necessary to have effective heat transfer fluids for liquid cooling. Nanofluids seem to be the answer to this need because the presence of nanoparticles suspended in the fluid matrix increases their thermal conductivity, which allows them to be used more effectively than conventional fluids. To explain the mechanisms by which heat transport is improved, the following features have to be mentioned.

- The Brownian motion of nanoparticles: particles moving through liquids are subject to collisions, allowing direct heat transport between solid and solid.
- The Brownian motion of fluid molecules: in this phenomenon, it is the collisions between the molecules that allow the transport of heat between them.
- The surface/volume ratio of the nanoparticles: the greater concentration of atoms on the surface of the nanoparticles makes it possible to disperse heat more efficiently.
- The layer of liquid surrounding the surface of the particle: this layer has the same thermal conductivity as the liquid itself.
- The nature of the mechanism of heat transport for nanoparticles: according to macroscopic theory, diffusive heat transport satisfies Fourier's law, whereas for nanoparticles, heat transport is due to phonons, i.e. the propagation of lattice vibrations. The propagation of phonons is random, they are scattered by each other or by defects in the structure, and their propagation justifies the description of heat transport. Nanoparticles are in incessant vibration due to Brownian motion, which allows locally, there is a coherent transfer of phonons and thus the heat flux and its dissipation increase.
- The effects of nanoparticle clusters: A clustering of nanoparticles increases the volume of the cluster and the thermal conductivity improves (Kebblinski, Phillpot, Choi and Eastman

2002) and occurs without the particles necessarily being in contact, as long as they are separated by a minimum distance.

The thermal conductivity of particle suspensions within a fluid matrix was studied by James Clerk Maxwell (1831–1879), who was the first to propose an expression of the effective conductivity in a heterogeneous medium, in the third edition of his famous work *A Treatise on Electricity and Magnetism* (Maxwell 1892). Maxwell considered the problem of a dilute dispersion, with solute below 25% by volume, of spherical particles of conductivity k_l immersed in a matrix of conductivity k_m , assuming that the thermal interactions between the particles could be neglected. He derived the following expression (Pietrak and Wisniewski 2015):

$$\frac{k_{eff}}{k_m} = 1 + \frac{3\phi}{\left(\frac{k_l + 2k_m}{k_l - k_m}\right) - \phi} \quad (2.61)$$

expression that in the literature (Thamwattana and Hill 2017) is also found rearranged, after simple steps of elementary algebra, in the following way.

$$k_{eff} = k_f + \frac{3\phi(k_p - k_f) \cdot k_f}{k_p + 2k_f - \phi(k_p - k_f)} \quad (2.62)$$

where k_{eff} is made explicit and where the following substitutions must be considered, first $k_l = k_p$ (k of particle) and then $k_m = k_f$ (k of fluid), which allow one to pass easily from (2.61) to (2.62) and vice versa. This model, as mentioned, applies to dilute solutions where it can be assumed that there is no interaction between the particles of the solute.

Mathematically, Maxwell's model is accurate up to order ϕ .

Bruggeman's model extends Maxwell's model to the second order; the formalism applied allows the estimation of various properties such as electrical and thermal conductivity, thermal diffusivity, magnetic permeability or electrical permittivity. The theory predicts that the final material is obtained by gradually making infinitesimal changes to a pre-existing material and leads to an equation that is logically different from the previous one.

$$k_{eff} = \frac{(3\phi - 1)k_p + (2 - 3\phi)k_f}{4} + \frac{\left\{[(3\phi - 1)k_p + (2 - 3\phi)k_f]^2 + 8k_p k_f\right\}^{1/2}}{4} \quad (2.63)$$

The Bruggeman equation does not require any restriction on the volume concentration ϕ of the suspended particles (Thamwattana and Hill 2017).

Models have then been developed that consider both the volume concentration and the shape of the particles, which in the two models previously shown are spherical in shape, by assumption.

This is the case of Hamilton and Crosser's model (Hamilton and Crosser 1962), which develops Maxwell's model by introducing a form factor such $n = 3/\psi$, where the parameter ψ indicates sphericity, i.e. the ratio between the total surface area of a sphere having a volume equal to that of the particle and the total surface area of the particle itself. In this way, the real nanoparticle with its shape is compared with a perfectly spherical model. The formula developed for the Hamilton and Crosser's model is as follows.

$$k_{eff} = k_f + \frac{n \cdot \phi(k_p - k_f) \cdot k_f}{k_p + (n - 1)k_f - \phi(k_p - k_f)} \quad (2.64)$$

We observe that, when $n = 3$, Maxwell's model is found. Hamilton and Crosser's model confirms that the conductivity of non-spherical particles is better than that of particles whose shape is spherical.

Research into nanosuspensions and nanofluids remains an exciting field as many questions remain open. The basic theory, in fact:

- takes into account the shape of the particles and their volumetric concentration, it is interesting to investigate the importance of their size experimentally;
- considers isotropic nanoparticles;
- takes Fourier's law for heat transport by means of solid-phase and liquid-phase diffusion as a starting point;
- leaves the phenomenon of particle clustering and its consequences to be investigated;
- does not consider the mobility of particles;
- does not include temperature dependence.

Thermal conductivity at the interface has been studied in recent years (Rizvi, Jain, Ghosh and Mukherjee 2013). Based on this research, the variation of thermal conductivity at the interface of a spherical particle (Fig. 2.12) of radius r_p , at a distance between r_p and $r_p + t$, is modelled a linear trend which can be written as:

$$k(r) = k_p - \left[\frac{k_p - k_m}{t} \right] (r - r_p) \quad (2.65)$$

where the thickness at the interface can be schematised as:

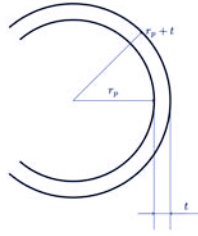

Fig. 2.12 This picture schematically represents the thickness at the interface of a spherical particle. Source: AD, adapted from Rizvi, Jain, Ghosh and Mukherjee

The value of the global thermal conductivity at the interface results from an integral calculation that leads, as a result, to:

$$k_l = \frac{t}{r_p(r_p + t) \left[A \ln \left(1 + \frac{t}{r_p} \right) + \frac{Bt}{r_p(r_p + t)} - \frac{C}{\lambda} \ln \left(1 - \frac{\lambda t}{k_p} \right) \right]} \tag{2.66}$$

where:

$$A = \frac{\lambda}{(k_p + \lambda r_p)^2} \quad B = \frac{1}{k_p + \lambda r_p} \quad C = \frac{\lambda^2}{(k_p + \lambda r_p)^2}$$

and the (2.66) takes into account the size of the particle and the substrate, the thermal conductivity of the particle and the substrate matrix.

The effective thermal conductivity of the nanofluid with the interface is determined, instead, through a complex equation, derived from Bruggeman’s theory:

$$\left(1 - \frac{\upsilon}{\tau} \right) \frac{k_{eff} - k_m}{2k_{eff} + k_m} + \frac{\upsilon (k_{eff} - k_l)(2k_l + k_p) - \tau(k_p - k_m)(2k_l + k_{eff})}{t \tau (2k_{eff} + k_l)(2k_l + k_p) + 2\tau(k_p - k_l)(k_l - k_{eff})} = 0 \tag{2.67}$$

where υ is the volume concentration of the particles, and k_{eff} the effective thermal conductivity of the nanofluid respectively.

This relationship shows that the effective thermal conductivity of nanofluids depends on the particle size and interface properties (Rizvi, Jain, Ghosh and Mukherjee 2013).

2.2.1.2 Electrorheological Fluids

Electrorheological fluids are suspensions of particles, measuring up to 50nm in diameter, that are dielectric but electrically active and immersed in an insulating fluid. The viscosity of these fluids can change as a result of an applied external electric field, hence the term apparent viscosity, and as a result the fluids vary in consistency from liquid to gel in a reversible manner with a response time in the order of milliseconds.

On 14 April 1942, Willis Winslow (1904–2000) filed a patent registered as “*Method and Means for Translating Electrical Impulses Into Mechanical Force*” which reads as follows:

This invention relates to a method and means for transmitting a mechanical movement or force in response to an electrical potential. The principal object of the invention is to provide a device of this character which will operate on exceedingly slight currents without amplification being necessary and without the use of electromagnets. The invention comprises what might be termed an electro-fluid clutch (Winslow 1942).

For this reason, it is also occasionally referred to as the Winslow effect.

When an electric field is applied to the fluid, the nanoparticles polarise and induce an electrostatic attraction force: this results in the formation of dipole chains aligned along the direction of the applied field and a consequent change in the fluid's viscosity.

ER fluids are broadly used in the automotive industry for clutches, locking systems, valves and shock absorbers. They also show great promise in a number of other applications, in areas such as biomedicine, for making artificial muscles or controlling robotic limbs.

The study of the forces that are induced by the external electric field on the particles immersed in the matrix is fundamental in rheological fluids. According to the model considered, we can think of two spheres immersed in vacuum to which an external electric field is applied, directed along the junction of the centres of the spheres themselves: they will be polarised, and their interaction will lead to a further separation of charge and the consequent appearance of an additional field (Fig. 2.13).

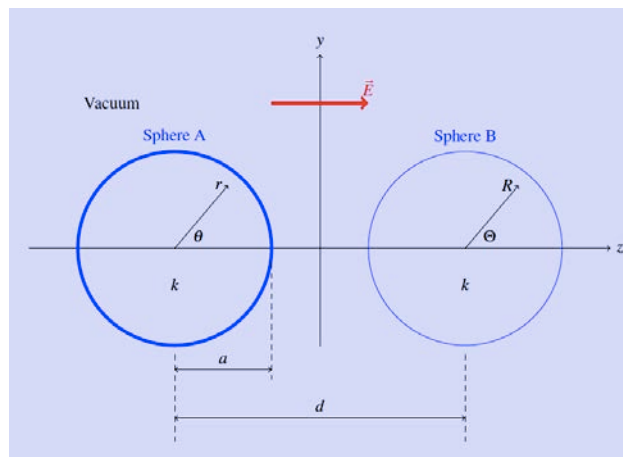

Fig. 2.13 The geometry of the considered problem. Source: AD, adapted from Thamwattana and Hill (2005)

To measure the interaction force between two particles, the method of multipole re-expansion (Cox, Thamwattana and Hill 2006) around a symmetry axis is described here, a method that was originally proposed in the early 1990s (Washizu 1992). This method allows the solution of the Laplace equation to be re-expanded around any point lying on the symmetry axis. Laplace's equation is, in fact, an extremely flexible mathematical tool: if the unknown is temperature, Laplace equation becomes Fourier's law, while, if the unknown is an electrostatic potential, the equation becomes the general equation of electrostatics in the case where no field sources are present.

In the latter case it is:

$$\nabla^2 \phi = 0 \quad (2.68)$$

Since the problem is symmetrical with respect to the z -axis, the solution of the Laplace equation can be expanded by means of Legendre polynomials and powers of r .

$\phi_0 =$

$$= \sum_{n=0}^{\infty} \left[a_n \left(\frac{a}{r}\right)^{n+1} P_n(\cos \theta) + A_n \left(\frac{a}{R}\right)^{n+1} P_n(\cos \Theta) \right] + \quad (2.69)$$

$-Ez$

where P_n is the Legendre polynomial of order n . The first term in (2.69) is the perturbative term associated with the polarisation of each particle, while the second term, $-Ez$ represents the potential of the applied electric field. In the spheres A and B respectively, the potential is given by:

$$\phi_i = \sum_{n=0}^{\infty} c_n \left(\frac{r}{a}\right)^n P_n(\cos \theta) \quad (2.70)$$

$$\Phi_i = \sum_{n=0}^{\infty} C_n \left(\frac{R}{a}\right)^n P_n(\cos \Theta) \quad (2.71)$$

By applying the method of re-expansion on multipoles, the Legendre expansion of a potential with axial symmetry in a spherical coordinate system can in turn be re-expanded on the axis of symmetry in the form:

$$\left(\frac{a}{R}\right)^{n+1} P_n(\cos \Theta) = \quad (2.72)$$

$$= (-1)^n \left(\frac{a}{d}\right)^{n+1} \sum_{m=0}^{\infty} \frac{(m+n)!}{m!n!} \left(\frac{r}{d}\right)^m P_m(\cos \theta)$$

where the expansion converges under the only assumption $r < d$.

Considering (2.70) and $z = r \cos \theta - d/2$, if it is $r < d$, in the vicinity of the sphere A it is calculated through the:

$$\phi_0 = \sum_{n=0}^{\infty} \left[a_n \left(\frac{a}{r} \right)^{n+1} + b_n \left(\frac{r}{a} \right)^n \right] P_n(\cos \theta) +$$

$$-ErP_1(\cos \theta) + \frac{Ed}{2} P_0(\cos \theta) \quad (2.73)$$

where b_n can be expressed in terms of A_n as follows:

$$b_n = - \left(\frac{a}{d} \right)^n \sum_{m=0}^{\infty} \left(-\frac{a}{d} \right)^{m+1} \frac{(m+n)!}{m!n!} A_m \quad (2.74)$$

or in terms of a_n as follows:

$$b_n = - \left(\frac{a}{d} \right)^n \sum_{m=0}^{\infty} \left(\frac{a}{d} \right)^{m+1} \frac{(m+n)!}{m!n!} a_m \quad (2.75)$$

Once we determine a_n , we immediately obtain the solution for the sphere B. Using the written expressions and the appropriate boundary conditions relating to the continuity of the potential and flux on the surface of the sphere, we derive the expressions for a_n and c_n .

$$a_n = \frac{n(k-1)}{n(k+1)+1} \left(\frac{a}{d} \right)^n \sum_{m=0}^{\infty} \left(\frac{a}{d} \right)^{m+1} \frac{(m+n)!}{m!n!} a_m$$

$$c_n = -a_n \frac{(2n+1)}{n(k-1)}$$

where k is the dielectric constant of the particle.

An explicit expression for the electrostatic force was derived in 2005 (Cox, Thamwattana and Hill 2005) following a calculation based on Coulomb's law (Washizu and Jones 1996):

$$F_e = \frac{4\pi\epsilon_0}{k-1} \sum_{n=0}^{\infty} [(n+1)(k+1)+1] a_n a_{n+1} \quad (2.76)$$

where ϵ_0 is the vacuum permittivity.

2.2.1.3 *Mechanics for Carbon Nanotubes*

In the History of Nanotechnology, 1991 is the year of the discovery of single- and multi-walled carbon nanotubes by the Japanese Sumio Iijima, structures that have had a major impact on the world of nanostructures. In the next chapter, however, I will discuss an article that appeared in 1952, to which the first real discovery, or observation, of these single-tube structures can be traced.

Carbon nanostructures are characterised by unique, extreme properties that have never before been achieved by materials made in the laboratory. In particular, the physical properties of carbon nanotubes depend on their chirality, or helicity, of structure. This concept of chirality, which is fundamental for all structures or situations involving objects in three-dimensional space, should not be confused with its namesake in organic chemistry.

To describe the chirality we are concerned with here, we use a vector constructed as:

$$\vec{C} = n\vec{a}_1 + m\vec{a}_2 \quad (2.77)$$

where n and m are integer coefficients, with the condition $n \geq m$, and \vec{a}_1 and \vec{a}_2 are the basis vectors. The vector \vec{C} is indicated, knowing the base, by writing (n,m) . The values assumed by the integer coefficients make it possible to describe the structure of the carbon nanotube in a very simple way; a nanotube is:

- armchair if $n = m$;
- zigzag if $m = 0$;
- chiral in all other cases.

In the image shown below (Fig. 2.14), we must consider $\vec{C} = 4\vec{a}_1 + 3\vec{a}_2$, where the modulus of the vector \vec{C} represents the length of the circumference of the nanotube itself (blue vector).

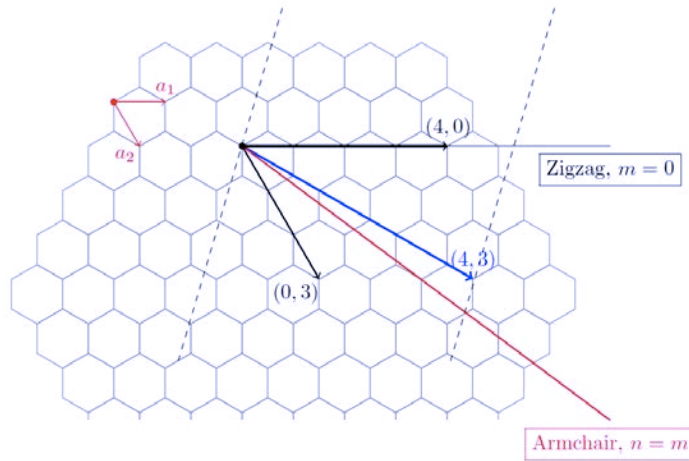

Fig. 2.14 The chirality of carbon nanotubes. Source: AD, adapted from Thamwattana, Hill (2005)

Now, the modulus of the basis vectors (Torrens 2003, Thamwattana, Hill 2017) is:

$$|\vec{a}_1| = |\vec{a}_2| = 0.246 \text{ nm} \tag{2.78}$$

so it is possible to calculate the circumference of a carbon nanotube as:

$$|\vec{C}| = 0.246 \cdot (n^2 + nm + m^2)^{1/2} \tag{2.79}$$

so the diameter of a carbon nanotube is given by $|\vec{C}| / \pi$. As far as the electrical properties are concerned, if it turns out that it is $n - m = 3k$, where k is an integer, the single-walled carbon nanotube (SWNT) has metallic or semi-metallic behaviour.

The mechanical properties of these structures are given great attention. The Young’s modulus, or modulus of elasticity, of a SWNT is approximately 1TPa and its maximum tensile strength is close to 30GPa.

In the table below, we see where SWNT ranks in comparison with other technologically used materials, both man-made and natural ones (Table 2.4).

Table. 2.4 Some values of Young’s modulus for different materials. Source: AD

Material	Maximum Young's modulus
Diamond (C), synthetic	1210
Graphene	1050
Single-walled carbon nanotube	1000
Aromatic peptide-nanospheres	275

Cobalt–chrome (CoCr)	230
Nickel ($_{28}\text{Ni}$), commercial	200
Steel, A36	200
Silicon, single crystal, different directions	185
Carbon–fiber–reinforced plastic (CFRP), 70/30 fibre/matrix, unidirectional, along fibre	181
Titanium ($_{22}\text{Ti}$)	116
Titanium alloy, Grade 5	114
Aramid (for example, Kevlar)	112.4
Stinging nettle fiber	87
Float glass	83.6
Tooth enamel, largely calcium phosphate	83
Mother–of–pearl(largely calcium carbonate)	70
Aluminium ($_{13}\text{Al}$)	68
Flax fiber	58
Carbon–fiber–reinforced plastic (CFRP), 50/50 fibre/matrix, biaxial fabric	50
Magnesium alloy	45.2
Amino–acid molecular crystals	44
High–strength concrete	30
Aromatic peptide–nanotubes	27
Glass–reinforced polyester (GRP)	17.2
Bone, human cortical	14
Nylon 66	2.93
Diatom frustules, largely silicic acid	2.77
Polycarbonate (PC)	2,2
Polypropylene (PP), molded	1.68
High–density polyethylene (HDPE)	1.38
Polytetrafluoroethylene (PTFE), molded	0.564
Low–density polyethylene (LDPE), molded	0.228
Rubber, small strain	0.1
Polystyrene, foam	0.007

Carbon nanotubes show superior mechanical properties, such as extremely high elastic moduli and strength in relation to their low bulk density, making them highly attractive structures for potential applications in composite materials and other mechanical systems.

When subjected to mechanical deformation, their behaviour is elastic with full recovery of the applied deformation. The possibility of being able to combine mechanical deformation with electrical properties makes carbon nanotubes materials applicable to

nanoscale sensing and Nano–ElectroMechanical Devices (NEMS). It has been observed that the mechanical deformation of conductive nanotubes changes their properties to the point of making them semiconductors, whereas the deformation of semiconducting nanotubes does not make the deformed materials conductive (Liu, Jiang, Johnson and Huang 2004).

One of the characteristics that make carbon nanotubes particularly attractive in the electronics sector concerns the creation of nano oscillators. It is difficult for mechanical oscillators of micrometric dimensions to reach frequencies of the order of gigahertz, but this seems to be possible for multi–walled carbon nanotubes (MWCM), structures in which a carbon nanotube is embedded in a second one with a larger radius. In 2000, an experiment was carried out by applying a nanomanipulator to the inner nanotube of an MWCN, in a transmission electron microscope: when the inner coil was extracted, it was observed that it quickly returned to the inside due to the effect of the Van der Waals interactions that take place on the coil being extracted (Cumings and Zettl 2000). These results have led some researchers such as Zheng and Jiang (Zheng, Liu and Jiang 2002) towards the study of molecular oscillators operating at frequencies of several gigahertz.

The estimate of the frequency of oscillation of this coaxial nanotube system is made by means of Newton’s second law written in the following form.

$$M \frac{d^2\zeta}{dt^2} = F_{VdW}(\zeta) - F_r \quad (2.80)$$

where M is the total mass of the inner winding and ζ is the distance measured between the centre of the inner nanotube and the centre of the outer nanotube. The Van der Waals force F_{VdW} is responsible for drawing the inner tube back to its initial position and results from the energy interaction between the two windings. F_r , on the other hand, is the resistant contribution of the slip resistant force. This last term is very small compared to the contribution of the Van der Waals force.

The calculation of F_{VdW} between core and outer shell is shown below, using the Lennard–Jones torque potential for the atomic interaction:

$$\phi(d) = \frac{A}{a^6} \left(\frac{1}{2} \frac{d_0^6}{d^{12}} - \frac{1}{d^6} \right) \quad (2.81)$$

where the interatomic distance d is normalised by using the carbon–carbon bond measure–length $a = 0.142\text{nm}$, the normalised Van der Waals distance is $d_0 = 2.7$, while the energy constant is $A = 24.3 \cdot 10^{-79} \text{Jm}^6$.

For an atom belonging to the inner coil, the energy between this atom and the atoms of the outer coil can be written as:

$$\Phi = \sigma \int \phi(d) d\Sigma \quad (2.82)$$

where d represents the distance between the atom we are considering and the surface element $d\Sigma$ of the outer envelope. In a cylindrical coordinate system, we place the z -axis as the one common to the two tubes, so an atom in the inner tube will be identified by the coordinates (r, θ, z) , while an atom on the outermost tube will be identified by the coordinates $(r+s, \Theta, Z)$, where s is the interstitial space between the nanotubes. The distance d is given by:

$$d^2 = [r - (r + s) \cos \Theta]^2 + (r + s)^2 \sin^2 \Theta + Z^2 \quad (2.83)$$

In the calculation of the integral, the average surface density of the carbon atoms of the outer nanotube is $\sigma = 4\sqrt{3}/9a^2$, an approach already followed previously (Henrard *et al.* 1999). The integral on the outer surface is written as:

$$\Phi = \frac{4\sqrt{3}}{9a^2} \int_{-\pi}^{\pi} \left\{ \int_{-\infty}^{+\infty} \phi(d) dZ \right\} (r + s) d\theta \quad (2.84)$$

With the value of d obtained above, the integral can be simplified so we can write:

$$\Phi = \frac{\pi\sqrt{3}A}{96a^6} [21d_0^6 E_{11}(s) - 64E_5(s)] (r + s) \quad (2.85)$$

where E_m is the elliptic integral defined by the:

$$E_m(s) = (2r + s)^{-m} \int_0^{\pi/2} [1 - \kappa(s) \cos^2 \omega]^{-m/2} d\omega \quad (2.86)$$

and $\kappa(s)$ is given by:

$$\kappa(s) = \frac{4r(r + s)}{(2r + s)^2} \quad (2.87)$$

The increase in energy for the Van der Waals interaction, due to the extraction of the inner tube, has also been investigated (Zheng, Liu and Jiang 2002). If ζ is the separation distance between the centre of the inner winding and the centre of the outer winding, measured after extraction, then the area of the inner nanotube remaining inside is given by the expression $\pi D [(L_c + L_0)/2 - \zeta]$, where L_c and L_0 denote the length of the inner tube and the length of the outer tube, respectively. The Van der Waals interaction between the windings is:

$$U(\zeta) = \frac{4\sqrt{3}\pi D}{9a^2} \left(\frac{L_c - L_0}{2} - \zeta \right) \Phi \quad (2.88)$$

If the condition $\zeta \leq |L_0 - L_c|/2$ is verified, and the Van der Waals energy is constant, there is no extraction. Equation (2.88) is only valid when $\zeta > |L_0 - L_c|/2$. The excess Van der Waals interaction energy caused by extraction is $-(4\sqrt{3}\pi D/9a^2)\zeta\Phi$. The Van der Waals force that restores the situation, due to the excess caused by the extraction of the internal nanotube, can be expressed as follows:

$$F_{Vaw}(\zeta) = -\frac{dU(\zeta)}{d\zeta} = \frac{4\sqrt{3}\pi D}{9a^2} \Phi \quad (2.89)$$

where $\zeta > |L_0 - L_c|/2$. Using (2.80) and (2.89), it is possible to predict the oscillation frequency of a device of this type, made from two carbon nanotubes, one inserted into the other (Zheng, Liu and Jiang 2002).

2.2.2 The Drude–Lorentz Model

Size is one of the most relevant factors when observing the different behaviours of the same material, first at bulk size and then at nanometric size: the characteristics of nanomaterials become, in fact, extremely interesting and often diametrically opposed to those of the material at macroscopic size. In particular, the phenomenon of charge transport is affected by the size of the material in which it is observed when the average free path of the carriers is greater than the size of the particles. If we observe, for example, thin films in which the smallest measurable dimension is smaller than the average free path, it is necessary to reformulate the theoretical models that have been developed in the case of the material to the bulk dimension. Analytically describing the observed phenomena by means of the transport equations, which have proven to be extremely powerful tools, makes it possible to implement the data available in the literature and to write analytical expressions of the most important equations, such as the mean square deviation of the position, the correlation function of the velocity and the calculation of the diffusion coefficient.

As the size decreases to the nanometre, the structure of matter begins to be affected by quantum effects, which have been exploited to the full in various old and new technological fields. For example, Time–Resolved THz Spectroscopy (TRTS), an ultrafast technique using a non–contact probe to investigate photoconductivity in the far infrared, allows data to be processed using the Drude–Lorentz model, the Drude–Smith model or effective medium models.

Starting from the Drude model, it is possible to describe a series of further fundamental models, recently developed (Di Sia 2019), which make it possible to explain transport phenomena on a nanometric scale and that prove to be the State–of–the–Art when modelling nanostructures.

2.2.2.1 The Drude Model

Electrical conductivity and thermal conductivity are the most significant characteristics of metallic materials. Observing these characteristics for metals has led, over time, to the development of models in which electrons can be thought of as constituting a gas that is relatively free to move, due to an applied electric field, around the structure of the solid, to which it also confers stability. Two models have emerged in the history of Solid-State Physics to describe metals.

- a) The Drude Model, first published in 1900, which is based on the kinetic theory of a gas of electrons in the solid and which gives the electrons the same average kinetic energy E_m as the kinetic theory of gases in statistical physics;
- b) The Sommerfeld Model, which is a variant of the Drude Model in which the foundations of quantum mechanics are taken into account.

In the Model of Drude, a gas of electrons is assumed to exist, consisting of the valence electrons, free to move around the structure of the metal, which, despite the density of the gas, can be described by the same equations that apply in the kinetic theory of ideal gases. As the electrons of the gas attempt to escape from the metal, they are held by the net positive charge within the metal itself and can be considered to be bound within a potential hole of depth W . The value of W , which can be associated with the depth of the hole, is generally large because the positive charges are distributed in the lattice with extreme regularity and uniformity. The value of the work required to extract an electron from the metal, the well-known $L = W - E$ formula, is sufficiently high to prevent electrons escaping from the solid. For each degree of freedom of the system, the kinetic theory allows an average energy $k_B T/2$ to be assigned, where k_B is Boltzmann's constant.

Free electrons possess kinetic energy E_m , while collisions between ions and electrons allow thermal equilibrium to be maintained. In this way, it is possible to apply the kinetic theory of gases to the model theorised by Drude and published only three years after the discovery of the electron by J.J. Thomson.

The mean square velocity, which is used in writing the kinetic energy, and the mean energy can be linked by the relation:

$$E_m = \frac{3}{2} k_B T = \frac{1}{2} m v_m^2 \quad J \quad (2.90)$$

where m is the mass of the electron. The average thermal velocity of particles at room temperature is around $v_m \cong 10^7$ cm/s. Electron collisions are considered as instantaneous events, in the sense that the actual collision event takes place in an extremely short time interval, compared to the events that characterise the observed physical situation. When involved in collision processes, electrons acquire a thermal equilibrium that corresponds to the temperature T of the metal, otherwise they obey Newton's laws.

If an external field is applied, the electrons are subject to a drift velocity calculated using the formula:

$$v_d = -\frac{eE}{m} \tau \quad \text{m/s} \quad (2.9)$$

We define the relaxation time τ as the mean time between two collisions; knowing the relaxation time and the mean velocity, it is possible to calculate the mean free path l_{mfp} , through the:

$$l_{mfp} = v_m \tau \quad \text{m} \quad (2.92)$$

From these premises, it is possible to derive several properties of the electron gas. The drift velocity associated with an external electric field is lower than the average electron velocity, which is consistent with the fact that the current flow is only a small perturbation compared to the normal behaviour of the electron gas.

In calculating the current density, Drude obtained an important result in the conduction of metals, through the relation $\vec{J} = \sigma_{\text{cond}} \vec{E}$. The value of the relaxation time, moreover, can be obtained through an estimate of the conduction electron density. For a metal it is possible to write the relation $\sigma_{\text{cond}} \approx 10^8 \Omega^{-1} \text{cm}^{-1}$, and assuming an electron density of the order of 10^{23} electrons per cm^3 , it is then obtained that the relaxation time extends between $\tau \approx 10^{-14}$ – 10^{-15} s. The free mean path corresponding to these values is $l_{mfp} \approx v \tau$ and $\tau \approx 1 - 10 \text{\AA}$, i.e. of the order of interatomic distances in a crystal lattice.

2.2.2.2 Model Description

The Drude–Lorentz model was developed in the very first years of the past Century (1905) and represents a step forward from the simple formulation of the Drude model, because the emphasis is placed on statistical aspects; electrons become free charges of value $-e$, described by a Maxwellian velocity distribution. If we assume that we confine a gas of electrons within a region of space in which an electric field of constant modulus operates, we observe that the drift velocity of the electrons remains constant in turn, which corresponds to a current density \vec{J} proportional to the applied field $\vec{J} = \sigma_0 \vec{E}$, with $\sigma_0 = ne^2\tau/m$ (n is the electron density).

Lorentz and Drude estimated the relaxation time and obtained conductivity values in good agreement with the experiments. In the presence of a time–dependent electric field of the form $E(t) = E_0 e^{-i\omega t}$, the complex conductivity results in:

$$\sigma_\omega = \frac{\sigma_0}{1 - i\omega\tau} \quad \Omega \cdot \text{m} \quad (2.93)$$

This model, which has been called the Drude–Lorentz model, has been successfully applied over the years but, at the same time, has brought several problems to light.

2.2.2.3 *The most common Drude–Lorentz–like Models*

One of the most widely applied models for studying transport phenomena in relation to electrical charges is the Drude–Lorentz model, which makes it possible to calculate the most important parameters relating to the transport phenomenon. These parameters are:

- a) the velocity correlation function, through which the velocity of the charges can be obtained;
- b) the mean square deviation of the position as a function of time, which makes it possible to obtain the space covered by the charges;
- c) the diffusion coefficient.

Numerous variants of this model have been developed, the most widely applied I describe hereafter according to the present literature.

The Maxwell–Garnett (MG) Model considers the dielectric function as given by a term derived by Drude supplemented by an additional “vibrational” contribution at a finite frequency ω_0 . In this way, a dielectric function of the form is written in this way:

$$\varepsilon_{\parallel}(\omega) = 1 - \frac{\omega_p^2}{\omega \left(\omega + \frac{i}{\tau} \right)} + \frac{\omega_s^2}{\omega_0^2 - \omega^2 - i\gamma\omega} \quad F \cdot m^{-1} \quad (2.94)$$

where the amplitude ω_s , the resonance frequency ω_0 and the damping constant γ are constants that depend on the material being considered. The MG model usually describes an isotropic matrix containing spherical inclusions isolated from each other, such as metallic particles dispersed in a surrounding matrix.

The Bruggeman Model (BR): This model is used to study the effective conductivity of systems consisting of spherical inclusions with several components and different conductivity values. The Bruggeman formula for circular and spherical particles is as follows:

$$\sum_i \delta_i \frac{\sigma_i - \sigma_e}{\sigma_i + (n-1)\sigma_e} = 0 \quad (2.95)$$

where the different terms of the equation are to be understood as follows: n is the number of dimensions in space, the summation is to be performed on all components, where δ_i (with $\sum_i \delta_i = 0$) and σ_i are the fraction and conductivity of each component, respectively, and σ_e the effective conductivity of the medium.

For elliptic and ellipsoidal inclusions, the formula to be applied is:

$$\frac{1}{n}\delta\alpha + \frac{(1-\delta)(\sigma_m - \sigma_e)}{\sigma_m + (n-1)\sigma_e} = 0 \quad (2.96)$$

Equation (2.96) is a generalisation of (2.95) for a two-phase system in which inclusions have conductivity σ_e and are dispersed in a conductivity matrix σ_m . The quantity α , for inclusions whose orientation is random, is calculated through:

$$\alpha = \sum_{j=1}^n \frac{\sigma - \sigma_e}{\sigma_e + L_j(\sigma - \sigma_e)} \quad (2.97)$$

where L_j (with $\sum_j L_j = 0$) denotes the appropriate double or triple depolarisation factors, depending on the relationship between the axes of the ellipse or ellipsoid.

Effective medium theories (EMTs) consider the electromagnetic interactions between pure materials and matrices approximately. Commonly used EMTs include the Maxwell–Garnett Model and the Bruggeman Model. Generally, in the frequency regime of the order of THz, the dielectric function $\epsilon_m(\omega)$ is calculated through the contributions of the high-frequency dielectric constant, free conduction electrons and lattice vibration. The dielectric function has the form:

$$\epsilon_m(\omega) = \epsilon_\infty - \frac{\omega_p^2}{\omega^2 + i\gamma\omega} + \sum_j \frac{\epsilon_{stj}\omega_{TOj}^2}{\omega_{TOj}^2 - \omega^2 - i\Gamma_j\omega} \quad (2.98)$$

where ϵ_∞ is the high-frequency dielectric constant, the second term describes the contribution of free electrons or plasmons, and the last term relates to optical phonons. When free electrons or plasmons are primarily responsible for the response, the following term should be written:

$$\epsilon_m(\omega) = \epsilon_\infty - \frac{\omega_p^2}{\omega^2 + i\gamma\omega} \quad (2.99)$$

which describes the dielectric properties of metals and semiconductors appropriately.

If, on the other hand, the interaction of the radiative field with the fundamental lattice vibration should become fundamental, resulting in the absorption of the electromagnetic wave, due to creation or annihilation of the lattice vibration, the dielectric function $\epsilon_m(\omega)$ will be composed of the different contributions of the lattice vibrations.

These contributions are expressed by the classical model of pseudo-harmonic phonons approximating to the first order:

$$\varepsilon_m(\omega) = \varepsilon_\infty + \frac{\varepsilon_{st}\omega_{TO}^2}{\omega_{TO}^2 - \omega^2 - i\gamma\omega} \quad (2.100)$$

2.2.2.4 The Smith Model

The first steps of Smith Model are based on the response theory for optical conductivity. An impulsive electric field, applied at time $t = 0$ to the system, is considered, and the resulting current response $j(t)$ is examined. Smith used the following Fourier Transform $j(t)$ for complex frequency-dependent conductivity:

$$\bar{\sigma}(\omega) = \int_0^{\infty} j(t) \exp(i\omega t) dt \quad S \cdot m^{-1} \quad (2.101)$$

As soon as an impulsive electric field is applied to the system, which overcomes any other external agent on the system, it is possible to formulate the hypothesis that, initially, the electrons can be considered totally free; therefore, we will write:

$$j(0) = \frac{n^* e^2}{m} \quad (2.102)$$

where n^* is the effective electron density. The writings $j(t)$ and $\bar{\sigma}(\omega)$ are the Fourier transforms each of each other; for the rule of the sum of the oscillator force on $\bar{\sigma}(\omega)$, its real part results:

$$\int_0^{\infty} \text{Re } \bar{\sigma}(\omega) d\omega = \frac{\pi}{2} j(0) = \frac{\omega_p^2}{8} \quad (2.103)$$

with $\omega_p = \sqrt{n^* e^2 / (\varepsilon_0 m)}$ being the plasma frequency. If the initial current decays exponentially, with relaxation time τ , to its initial value, we can write:

$$\frac{j(t)}{j(0)} = \exp \frac{-t}{\tau} \quad (2.104)$$

from which we get the standard formula from the model of Drude:

$$\bar{\sigma}(\omega) = \frac{\frac{n^* e^2 \tau}{m}}{1 - i\omega\tau} \quad (2.105)$$

Equation (2.105) can be considered as the first term of a series of the form:

$$\frac{j(t)}{j(0)} = \exp\left(-\frac{t}{\tau}\right) \left[1 + \sum_{n=1}^{\infty} c_n \frac{(t/\tau)^n}{n!} \right] \quad (2.106)$$

The factor c_n takes into account the initial velocity of the electrons remaining after the n -th collision. The analytical form of complex conductivity is:

$$\bar{\sigma}(\omega) = \frac{n^* e^2 \tau}{m(1 - i\omega\tau)} \left[1 + \sum_{n=1}^{\infty} \frac{c_n}{(1 - i\omega\tau)^n} \right] \quad (2.107)$$

This formula generalises that of Drude through factors c_n .

2.2.2.5 A New Point of View

Let us now consider a system whose Hamiltonian can be written as the sum of two different terms:

$$H = H_0 + H_1 \quad (2.108)$$

with H_1 giving small contributions compared to H_0 . We can write H_1 as:

$$H_1 = \lambda A e^{-i\omega t} e^{\eta t} \quad (2.109)$$

where λ is a real quantity and η a positive quantity, so that in the remote past the perturbation is negligible. One is said to be operating in adiabatic representation when:

$$\lim_{t \rightarrow \infty} H_1 = 0 \quad (2.110)$$

In the case of an electric field whose frequency is ω , we will write:

$$H_1 = e \bar{E} \cdot \bar{r} \quad (2.111)$$

If the electric field is constant in the region of space and its evolution depends only on time, we can write it as:

$$\bar{E} = \bar{E}_0 e^{i\omega t} N \cdot C^{-1} \quad (2.112)$$

The corresponding time-dependent current is:

$$\bar{J}(t) = \sigma(\omega) \bar{E}(t) A \cdot m^{-2} \quad (2.113)$$

The conductivity $\sigma(\omega)$ is, in general, a complex function of frequency and can be deduced from linear response theory as:

$$\sigma_{\beta\alpha}(\omega) = \frac{e^2}{\hbar V} \int_0^\infty dt e^{-i\omega t} \cdot \int_0^\beta d\lambda \langle \bar{v}^\alpha(t - i\lambda) \bar{v}^\beta(0) \rangle \quad (2.114)$$

where the parameters are to be understood as follows: $\beta = 1/k_B T$ and V is the volume of the system, T its temperature and $v^\alpha(t)$ the α -component of the velocity of the charge carrier at time t .

It is possible to obtain the velocity correlation function $\langle \bar{v}^\alpha(0) \bar{v}^\beta(t) \rangle_T$ by inverting equation (2.114). However, having to perform an integration from 0 to $+\infty$ does not make the calculation easy. By modifying equation (2.114) by considering the entire time axis, it is possible, however, to calculate the full Fourier Transform. If we consider the real part of the conductivity, such an extension to the entire time axis is feasible. Considering the valid results obtained at high temperatures, the condition $\hbar\omega/k_B T \ll 1$ is also verified.

Following the standard time-dependent approach, we can obtain a general formula for the linear response of a dipole moment density $\bar{B} = e\bar{r}/V$ in the β -direction with the electric field \bar{E} in the α -direction, where α is the volume of the system. This allows us to deduce the susceptibility $\chi(\omega)$, which is related to $\sigma(\omega)$ through the relation:

$$1 + 4\pi \chi(t) = 1 + 4\pi i \frac{\sigma(\omega)}{\omega} \quad (2.115)$$

After analytical calculation, the real part of the complex conductivity $\sigma(\omega)$ is written as follows:

$$\text{Re } \sigma_{\beta\alpha}(\omega) = \frac{e^2 \omega \pi}{V \hbar} S_{\beta\alpha}(\omega) (1 - e^{-\hbar\omega/KT}) \quad (2.116)$$

where:

$$S_{\beta\alpha}(\omega) = \int_{-\infty}^{+\infty} dt \langle \bar{r}^\alpha(0) \bar{r}^\beta(t) \rangle_T e^{-i\omega t} \quad (2.117)$$

The part $\langle \bar{r}^\alpha(0) \bar{r}^\beta(t) \rangle_T$, in equation (2.117) is the thermal mean value and the exponential factor is derived from the equilibrium thermal weights for the Fermi particles. If we consider the following identity:

$$v = \frac{d}{dt} r = \frac{i}{\hbar} [H, r] \quad (2.118)$$

Equation (2.118) can be written to contain the velocity correlation function instead of the position correlation function. We have:

$$\text{Re } \sigma_{\beta\alpha}(\omega) = \frac{e^2}{2VKT} \int_{-\infty}^{+\infty} dt \langle \bar{v}^\alpha(0) \bar{v}^\beta(t) \rangle_T e^{-i\omega t} \quad (2.119)$$

The integral in equation (2.119) is calculated along the entire t -axis, so it is possible to calculate the full inverse Fourier transform of this equation, obtaining:

$$\langle \bar{v}^\alpha(0) \bar{v}^\beta(t) \rangle_T = \frac{KTV}{\pi e^2} \int_{-\infty}^{+\infty} d\omega \text{Re } \sigma_{\beta\alpha}(\omega) e^{i\omega t} \quad (2.120)$$

The new insight is therefore related to the possibility of completely inverting equation (2.119) on the time scale, i.e. considering the time axis $(-\infty, +\infty)$ in its entirety, and not a simple time semi-axis $(0, +\infty)$, as usually appears in the literature. This is possible if one considers the real part of the complex conductivity $\sigma(\omega)$.

Considering the contour integration with the residue theorem in equation (2.120), the integral is determined by the poles of $\text{Re } \sigma(\omega)$. This leads to an exact formulation and provides a powerful method to obtain the analytical form of the velocity correlation function, the mean square deviation of the position and the diffusion coefficient.

The Fourier transforms involved in the calculation are as follows:

$$\tilde{f}(\omega) = \frac{1}{2\pi} \int_{-\infty}^{+\infty} dt f(t) e^{-i\omega t} \quad (2.121)$$

$$f(t) = \int_{-\infty}^{+\infty} d\omega \tilde{f}(\omega) e^{i\omega t} \quad (2.122)$$

The inversion of the expression given by equation (2.114) calculated by extending the integration to the entire time axis $(-\infty, +\infty)$ is one of the key ideas of this new formulation, called the Di Sia model (DS model). Its main advantage is the analytical derivation, avoiding numerical equations for the description of the dynamic behaviour of nanosystems; these relations are functions of parameters that can be obtained experimentally through time-resolved techniques.

A significant consequence of the application of such a model is that it allows a mathematical justification to be given to unexpected experimental results concerning the high initial mobility of charge carriers, in semiconductor devices based on nanomaterials, such as Dye Sensitised Solar Cells (DSSCs).

An increase in the diffusion coefficient leads to an increase in the efficiency of such electrochemical cells. The new model is able to describe the transport properties of nano-bio-materials quite adequately.

2.2.2.6 Key Functions

In addition to the velocity correlation function, a quantity that is interesting to consider is the mean square deviation of the particle position at equilibrium $R^2(t)$, defined as:

$$R^2(t) = \frac{KTV}{\pi e^2} \int_{-\infty}^{+\infty} d\omega \operatorname{Re} \sigma_{\beta\alpha}(\omega) e^{i\omega t} \quad (2.123)$$

where $R(t)$ is the position vector at time t . Considering that:

$$\bar{R}(t) - \bar{R}(0) = \int_0^t dt' \bar{v}(t') \quad (2.124)$$

where $\bar{v}(t)$ is the velocity and since for a homogeneous system in equilibrium the property of invariance by time translation is verified, it is possible to rewrite equation (2.123) by means of a transformation of coordinates relative to the region of integration.

We obtain:

$$R^2(t) = 2 \int_0^t dt' (t - t') \langle \bar{v}(t') \cdot \bar{v}(0) \rangle \quad (2.125)$$

The mean square deviation of the position can be evaluated by means of the velocity correlation function. Thanks to equation (2.120), it is also possible to write the diffusion coefficient D in analytical form:

$$D(t) = \frac{1}{2} \frac{d}{dt} R^2(t) = \int_0^t dt' \langle \bar{v}(t') \cdot \bar{v}(0) \rangle \quad (2.126)$$

In summary, equations (2.120), (2.125) and (2.126) provide a complete analytical description of the most important parameters of the transport phenomenon.

2.2.2.7 About Complex Conductivity

Let us consider a particle placed in a region in which there is an electric field oscillating in time, oriented, for example, along the z -axis, and suppose that an elastic force acts on the system; dynamics allows us to write the equation of the particle as:

$$m\ddot{z} = -kz + eE_0 \exp(i\omega t) \quad (2.127)$$

where m is the mass of the particle, and the charge of the electron and k is the oscillator constant. From (2.127) it is possible to obtain the diffusion equation of the harmonic oscillator:

$$\ddot{z} + \omega_0^2 z = \frac{eE_0}{m} \exp(i\omega t) \quad (2.128)$$

where use is made of the relation $\omega_0 = \sqrt{k/m}$. The solution of the differential equation is given, as per theory, by the general solution of the associated homogeneous equation to which a particular solution is added. The homogeneous solution can be neglected because it does not depend on the applied electric field and would lead to a zero current; only the field-dependent part makes a contribution to the solution.

Therefore, the following is considered as the general solution:

$$z(t) = z_0 e^{-i\omega t} \quad (2.129)$$

A suitable generalisation is obtained by adding a velocity term (friction type term), which is written in the form $-\lambda z$, with $\lambda = m/\tau$, where τ is the relaxation time. The value of z_0 is:

$$z_0 = \frac{eE_0}{m} \frac{1}{\omega_0^2 - \omega^2 - i\lambda\omega} \quad (2.130)$$

Considering the current density in the field direction:

$$j_z = ne\dot{z} = ne z_0 (-i\omega) e^{i\omega t} = \sigma E \quad (2.131)$$

we can obtain the complex conductivity as a function of frequency:

$$\sigma = \frac{i\omega ne^2}{m(\omega^2 - \omega_0^2 + i\lambda\omega)} \quad (2.132)$$

The real part of the complex conductivity from equation (2.132) is:

$$\text{Re}\sigma(\omega) = \frac{\tau ne^2}{m} \frac{\omega^2/\tau^2}{(\omega_0^2 - \omega^2)^2 + \omega^2/\tau^2} \quad (2.133)$$

Real and imaginary parts of the complex conductivity $\sigma(\omega)$ are compatible with the requirements of the Kramers–Krönig relations:

$$\sigma_1(\omega) = \frac{1}{\pi} \wp \int_{-\infty}^{+\infty} d\omega' \frac{\sigma_2(\omega')}{\omega' - \omega} \quad (2.134)$$

$$\sigma_2(\omega) = -\frac{1}{\pi} \wp \int_{-\infty}^{+\infty} d\omega' \frac{\sigma_1(\omega')}{\omega' - \omega} \quad (2.135)$$

with $\sigma_1(\omega)$ and $\sigma_2(\omega)$ being the real and imaginary part of $\sigma(\omega)$, respectively, and \wp the Cauchy principal value of the integral.

These relations are the result of the causal behaviour of the system and this leads to the function $\sigma(\omega)$, which is analytic on the complex plane. Consequently, the residue theorem allows to evaluate exactly the velocity correlation function, the equation (2.120).

Considering the DS model, it is useful to consider separately the case $\omega_0 = 0$ from the case $\omega_0 \neq 0$; for the latter, three other subcases are possible, depending on the sign of the quantity $\Delta = 4\tau^2\omega_0^2 - 1$.

Case (a): $\omega_0 = 0$ implies that equation (2.133) becomes:

$$\text{Re}\sigma(\omega) = \frac{\tau n e^2}{m} \frac{1}{1 + \tau^2 \omega^2} \quad (2.136)$$

The corresponding poles have frequencies:

$$\omega_{1/2} = \pm \frac{i}{\tau} \quad (2.137)$$

The residue obtained from integration over the complex field is:

$$\text{Res} \left[\text{Re}\sigma \left(\frac{i}{\tau} \right) \right] = -\frac{\tau}{2} i e^{-t/\tau} \quad (2.138)$$

having considered positive times.

Case (b): $\omega_0 \neq 0$ implies the poles:

$$\omega_{1/2} = \frac{1}{2\tau} (i \pm \sqrt{\Delta}) \quad (2.139)$$

It is possible to write:

$$(i) \quad \Delta > 0 \Rightarrow \omega_{1/2} = \frac{1}{2\tau} (i \pm \alpha_R) \quad (2.140)$$

$$\text{with} \quad \alpha_R = \sqrt{4\tau^2\omega_0^2 - 1} \quad (2.141)$$

$$(ii) \quad \Delta > 0 \Rightarrow \frac{1}{2\tau} i \quad (2.142)$$

$$(iii) \quad \Delta < 0 \Rightarrow \omega_{1/2} = \frac{1}{2\tau} (i \pm \alpha_I) \quad (2.143)$$

$$\text{with} \quad \alpha_I = \sqrt{1 - 4\tau^2\omega_0^2} \quad (2.144)$$

2.2.2.8 DS Model: Quantum and Relativistic Versions

Both in the general reasoning and in the application of the DS model, the transition between the classical and quantum regimes is considered to take place on a nanometric length scale. In fact, if one considers the de Broglie wavelength of the thermal electrons and compares it with the characteristic length of the system, these lengths are comparable when they are of the order of a nanometer.

The model allows the classical Drude–Lorentz formula to be generalised, based on the theory of linear response and resonant plasmonic mode; in addition to the classical approach, it allows to be described in detail, at the quantum level, the dynamic response of the carriers in nanoscale systems.

Quantum case. We consider the effect of a frequency–dependent electric field, written in the form shown in (13.23). We follow the time–dependent perturbation theory, considering the factor $e \vec{E} \cdot \vec{r}$ as a perturbative potential (in this context \vec{r} is the position vector of the particle).

The elements of the electron dipole moment matrix in the electric field direction, between the initial state Φ_0 and the excited state Φ_j , are given by:

$$e\kappa_{j0} = \int \Phi_j^* e\kappa \Phi_0 dr \quad (2.145)$$

Defining the force relative to an oscillator for the j –th transition as:

$$f_j = \frac{2m}{\hbar^2} \sum_j \hbar\omega_j |\kappa_{0j}|^2 \quad (2.146)$$

and considering the relationship between permittivity and conductivity of the system:

$$\varepsilon(\omega) = 1 + 4\pi i \frac{\sigma(\omega)}{\omega} = 1 + \frac{4\pi N e^2}{m} \sum_j \frac{f_j}{\omega_j^2 - \omega^2 + i\omega\Gamma_j} \quad (2.147)$$

we obtain the formula:

$$\frac{i\sigma(\omega)}{\omega} = \frac{1}{4\pi} \sum_i \frac{\omega_{p_i}^2}{(\omega_i^2 - \omega^2) - i\omega\Gamma_i} \quad (2.148)$$

with:

$$\omega_{pi}^2 = \frac{4\pi Ne^2}{m} f_i \quad (2.149)$$

From equations (2.147), (2.148) and (2.149), we can write the following relations:

- a) $\omega_i = (E_i - E_0)/\hbar$;
- b) E_i, E_0 respectively the energies of the excited and fundamental states;
- c) $\Gamma_i = 1/\tau$ inverse of the decay time of any mode;
- d) N carrier density.

As in the classical case, the analytical calculation leads formally to the writing of equation (2.120), but with the fundamental difference that the real part of the conductivity within the integral is calculated at the quantum level. The key factors that enclose the quantum behaviour are the weights f_i . The relaxation times can be obtained from $\tau_i = 1/\Gamma_i$ and the f_i weights from equation (2.149). The calculation of N can be obtained exactly from equation (2.149), considering that it holds $\sum_i f_i = 1$.

Relativistic case. Let us consider the possible relativistic velocities of the carriers (which are not necessarily electrons) within a nanometer-sized structure. We consider the carrier's mass variation as the main point. Starting from the law of dynamics:

$$\frac{d}{dt}(m_{part} \vec{v}) = \sum_i \vec{F}_i \quad (2.150)$$

we have studied the condition of relativistic variation of the mass along an x -axis in the reference frame fixed on the ground. As far as the forces acting on the generic vector are concerned, we have considered an external passive force of elastic type of the form $F_{el} = Kx$, a passive force of friction type of the form $F_{fr} = \lambda x$, dependent on the velocity and with $\lambda = m_{part}/\tau$ and an external oscillating electric field $E = eE_0 e^{-i\omega t}$, considering solutions of the form $\kappa = \kappa_0 e^{-i\omega t}$. The analytical calculation leads to three sets of results, depending on the value of the quantity Δ , as in the classical and quantum case.

In the classical, quantum and relativistic cases, a series of equations have been developed in a very interesting book (Di Sia 2019) through which the parameters of the key functions are defined. For the sake of completeness of the discussion and to provide the reader with a complete picture, these equations are given below.

First, we review the equations for the classical case.

(a) Case $\Delta > 0$.

$$\langle \bar{v}(0) \cdot \bar{v}(t) \rangle = \left(\frac{k_B T}{m^*} \right) \exp\left(-\frac{t}{2\tau}\right) \left[\cos\left(\frac{\alpha_R t}{2\tau}\right) - \frac{1}{\alpha_R} \sin\left(\frac{\alpha_R t}{2\tau}\right) \right] \quad (2.151)$$

$$R^2(t) = \left(\frac{k_B T}{m^*} \frac{2}{\omega_0^2} \right) \left[-\frac{1}{\alpha_R} \sin\left(\frac{\alpha_R t}{2\tau}\right) \exp\left(-\frac{t}{2\tau}\right) - \cos\left(\frac{\alpha_R t}{2\tau}\right) \exp\left(-\frac{t}{2\tau}\right) + 1 \right] \quad (2.152)$$

$$D(t) = 2 \left(\frac{k_B T}{m^*} \right) \left(\frac{\tau}{\alpha_R} \right) \left[\sin\left(\frac{\alpha_R t}{2\tau}\right) \exp\left(-\frac{t}{2\tau}\right) \right] \quad (2.153)$$

$$\text{with } \alpha_R^2 = 4\tau^2 \omega_0^2 - 1. \quad (2.154)$$

(b) Case $\Delta < 0$.

$$\langle \bar{v}(0) \cdot \bar{v}(t) \rangle = \frac{1}{2} \left(\frac{k_B T}{m^*} \right) \left(\frac{1}{\alpha_I} \right) \left[(1 + \alpha_I) \exp\left(-\frac{1 + \alpha_I t}{2\tau}\right) - (1 - \alpha_I) \exp\left(-\frac{1 - \alpha_I t}{2\tau}\right) \right] \quad (2.155)$$

$$R^2(t) = 4 \left(\frac{k_B T}{m^*} \right) (\tau^2) \left[\frac{1}{\alpha_I(1 + \alpha_I)} \exp\left(-\frac{1 + \alpha_I t}{2\tau}\right) - \frac{1}{\alpha_I(1 - \alpha_I)} \exp\left(-\frac{1 - \alpha_I t}{2\tau}\right) + \frac{2}{1 - \alpha_I^2} \right] \quad (2.156)$$

$$D(t) = \left(\frac{k_B T}{m^*} \right) \left(\frac{\tau}{\alpha_I} \right) \left[-\exp\left(-\frac{1 + \alpha_I t}{2\tau}\right) + \exp\left(-\frac{1 - \alpha_I t}{2\tau}\right) \right] \quad (2.157)$$

$$\text{with } \alpha_I^2 = 1 - 4\tau^2 \omega_0^2. \quad (2.158)$$

(c) Case $\omega_0 = 0$.

$$\langle \bar{v}(0) \cdot \bar{v}(t) \rangle = \left(\frac{k_B T}{m^*} \right) \exp\left(-\frac{t}{\tau}\right) \quad (2.159)$$

$$R^2(t) = 2 \left(\frac{k_B T}{m^*} \right) (\tau^2) \left[\exp\left(-\frac{t}{\tau}\right) + \frac{t}{\tau} - 1 \right] \quad (2.160)$$

$$D(t) = \left(\frac{k_B T}{m^*} \right) (\tau) \left[-\exp\left(-\frac{t}{\tau}\right) + 1 \right] \quad (2.161)$$

Here are the results for the quantum case.

(a) Case $\Delta > 0$.

$$\langle \bar{v}(0) \cdot \bar{v}(t) \rangle = \left(\frac{k_B T}{m^*} \right) \sum_i \left\{ f_i \exp\left(-\frac{t}{2\tau_i}\right) \left[\cos\left(\frac{\alpha_{iR} t}{2\tau_i}\right) - \frac{1}{\alpha_{iR}} \sin\left(\frac{\alpha_{iR} t}{2\tau_i}\right) \right] \right\} \quad (2.162)$$

$$R^2(t) = 2 \left(\frac{k_B T}{m^*} \right) \sum_i \frac{f_i}{\omega_i^2} \left[-\frac{1}{\alpha_{iR}} \sin\left(\frac{\alpha_{iR} t}{2\tau_i}\right) \exp\left(-\frac{t}{2\tau_i}\right) - \cos\left(\frac{\alpha_{iR} t}{2\tau_i}\right) \exp\left(-\frac{t}{2\tau_i}\right) + 1 \right] \quad (2.163)$$

$$D(t) = 2 \left(\frac{k_B T}{m^*} \right) \sum_i \left(\frac{f_i \tau_i}{\alpha_{iR}} \right) \left[\sin\left(\frac{\alpha_{iR} t}{2\tau_i}\right) \exp\left(-\frac{t}{2\tau_i}\right) \right] \quad (2.164)$$

$$\text{with } \alpha_{iR}^2 = 4\tau_i^2 \omega_i^2 - 1. \quad (2.165)$$

(b) Case $\Delta < 0$.

$$\langle \bar{v}(0) \cdot \bar{v}(t) \rangle = \frac{1}{2} \left(\frac{k_B T}{m^*} \right) \sum_i \left(\frac{f_i}{\alpha_{iI}} \right) \left[(1 + \alpha_{iI}) \exp\left(-\frac{1 + \alpha_{iI} t}{2\tau_i}\right) - (1 - \alpha_{iI}) \exp\left(-\frac{1 - \alpha_{iI} t}{2\tau_i}\right) \right] \quad (2.166)$$

$$R^2(t) = 4 \left(\frac{k_B T}{m^*} \right) \sum_i (f_i \tau_i^2) \left[\frac{1}{\alpha_{iI}(1 + \alpha_{iI})} \exp\left(-\frac{1 + \alpha_{iI} t}{2\tau_i}\right) - \frac{1}{\alpha_{iI}(1 - \alpha_{iI})} \exp\left(-\frac{1 - \alpha_{iI} t}{2\tau_i}\right) + \frac{2}{1 - \alpha_{iI}^2} \right] \quad (2.167)$$

$$D(t) = \left(\frac{k_B T}{m^*} \right) \sum_i \left(\frac{f_i \tau_i}{\alpha_{iI}} \right) \left[-\exp\left(-\frac{1 + \alpha_{iI} t}{2\tau_i}\right) + \exp\left(-\frac{1 - \alpha_{iI} t}{2\tau_i}\right) \right] \quad (2.168)$$

$$\text{with } \alpha_{iI}^2 = 1 - 4\tau_i^2 \omega_i^2. \quad (2.169)$$

(c) Case $\omega_0 = 0$.

$$\langle \bar{v}(0) \cdot \bar{v}(t) \rangle = \left(\frac{k_B T}{m^*} \right) f_0 \exp\left(-\frac{t}{\tau_0}\right) \quad (2.170)$$

$$R^2(t) = 2 \left(\frac{k_B T}{m^*} \right) \sum_i (f_i \tau_i^2) \left[\exp\left(-\frac{t}{\tau_i}\right) + \frac{t}{\tau_i} - 1 \right] \quad (2.171)$$

and :

$$D(t) = \left(\frac{k_B T}{m^*}\right) \sum_i (f_i \tau_i) \left[-\exp\left(-\frac{t}{\tau_i}\right) + 1\right] \quad (2.172)$$

Finally, I report the results obtained (Di Sia 2019) for relativistic case.

(a) Case $\Delta_{rel} > 0$.

$$\langle \bar{v}(0) \cdot \bar{v}(t) \rangle = \left(\frac{k_B T}{m_0}\right) \left(\frac{1}{\gamma \rho}\right) \exp\left(-\frac{t}{2\tau\rho}\right) \left[\cos\left(\frac{\alpha_{Rrel} t}{2\rho \tau}\right) - \frac{1}{\alpha_{Rrel}} \sin\left(\frac{\alpha_{Rrel} t}{2\rho \tau}\right) \right] \quad (2.173)$$

$$R^2(t) = \left(\frac{k_B T}{m^* \omega_0^2}\right) \left[-\frac{1}{\alpha_{Rrel}} \sin\left(\frac{\alpha_{Rrel} t}{2\rho \tau}\right) \exp\left(-\frac{t}{2\tau\rho}\right) - \cos\left(\frac{\alpha_{Rrel} t}{2\rho \tau}\right) \exp\left(-\frac{t}{2\tau\rho}\right) + 1 \right] \quad (2.174)$$

$$D(t) = 2 \left(\frac{k_B T}{m^*}\right) \left(\frac{1}{\gamma}\right) \left(\frac{\tau}{\alpha_{Rrel}}\right) \left[\sin\left(\frac{\alpha_{Rrel} t}{2\rho \tau}\right) \exp\left(-\frac{t}{2\rho\tau}\right) \right] \quad (2.175)$$

$$\text{with } \alpha_{Rrel}^2 = 4\gamma\tau^2\omega_0^2 - 1. \quad (2.176)$$

(b) Case $\Delta_{rel} < 0$.

$$\langle \bar{v}(0) \cdot \bar{v}(t) \rangle = \frac{1}{2} \left(\frac{k_B T}{m_0}\right) \left(\frac{1}{\gamma\rho}\right) \left(\frac{1}{\alpha_{Irel}}\right) \left[(1 + \alpha_{Irel}) \exp\left(-\frac{1 + \alpha_{Irel} t}{2\rho \tau}\right) - (1 - \alpha_{Irel}) \exp\left(-\frac{1 - \alpha_{Irel} t}{2\rho \tau}\right) \right] \quad (2.177)$$

$$R^2(t) = 4 \left(\frac{k_B T}{m_0}\right) (\tau^2 \gamma) \left[\frac{1}{\alpha_{Irel}(1 + \alpha_{Irel})} \exp\left(-\frac{1 + \alpha_{Irel} t}{2\rho \tau}\right) - \frac{1}{\alpha_{Irel}(1 - \alpha_{Irel})} \exp\left(-\frac{1 - \alpha_{Irel} t}{2\rho \tau}\right) + \frac{2}{1 - \alpha_{Irel}^2} \right] \quad (2.178)$$

$$D(t) = \left(\frac{k_B T}{m_0}\right) \left(\frac{\tau}{\alpha_{Irel} \gamma}\right) \left[-\exp\left(-\frac{1 + \alpha_{Irel} t}{2\rho \tau}\right) + \exp\left(-\frac{1 - \alpha_{Irel} t}{2\rho \tau}\right) \right] \quad (2.179)$$

$$\text{with } \alpha_{Irel}^2 = 1 - 4\gamma\tau^2\omega_0^2. \quad (2.180)$$

(c) Case $\omega_0 = 0$. It reduces to relativistic Drude model.

It is: $\alpha_{I_{rel}} = \sqrt{\Delta_{I_{rel}}}$, $\alpha_{R_{rel}} = \sqrt{\Delta_{R_{rel}}}$, $\gamma = 1/\sqrt{1 - \beta^2}$, $\beta = v/c$, $\rho = \gamma^2$.

2.2.3 Enhanced Flow in Carbon Nanotubes

Carbon Nanotubes (abridged as CNTs) are among the most interesting structures in nanotechnology. Applied in a variety of fields, such as DNA gene delivery or biosensors for diagnostics, tissue engineering, solar cells or microelectronics, thanks to their cylindrical structure they prove to be light yet robust and are particularly suitable for conducting heat and an electric current. Not only that, but CNTs have been shown to transport water far more efficiently than classical flow theory predicts, a flow whose value can be increased by several orders of magnitude, even by a factor of 45, according to recent studies.

To explain the increase in flow in a Carbon Nanotube (henceforth CNT), the work of Tim Myers (Myers 2011) explains how effective it is to insert a gas depletion layer in the fluid. The Hagen–Poiseuille equation provides an expression for the flow of a fluid in a circular duct.

$$Q_{HP} = -\frac{\pi R^4 p_z}{8\mu} \quad (2.181)$$

where R is the radius of the pipe, p_z the pressure gradient in the pipe and μ the fluid viscosity. In order to show how the flow in a CNT is much greater than that theoretically predicted by (2.181), one has to exclude the non-slip boundary condition, indicated by the adherence postulate, according to which the fluid layer in contact with the duct has zero slip velocity, $u(R) = 0$, with the following one, called slip length formulation:

$$u(R) = -L_s \frac{\partial u(R)}{\partial r} \quad (2.182)$$

where L_s represents the flow length. In this way, we will derive an expression for the flow which has the following form:

$$Q_{slip} = Q_{HP} \left(1 + \frac{4L_s}{R}\right) \quad (2.183)$$

The expression $\varepsilon_{slip} = Q_{slip} / Q_{HP}$ defines the flow enhancement, understood as the ratio between the observed and predicted flow, and the term L_s has an effect on the flow enhancement. When operating at the microscale, the slip length is considerably shorter than the channel size, a fact that is observed experimentally, whereas, for nanosized channels, the slip length is of the order of a micron.

To date, the flow length of a liquid moving on a solid surface is not regulated by any theory, but it has been proven that the flow length is of the order of the free mean gas path

when the fluid is gaseous. The scenario in which a fluid is flowing over a depletion layer can be modelled by assuming a bi-viscous fluid model. In this way, we obtain a set of equations for the flow region at the centre of the conduit, which we call bulk flow, and the low viscosity depletion region at the flow wall. By imposing a continuity condition between these two regions, thus matching velocity and shear stress at the $r = \alpha$ interface between these two regions, we can write the following expression for the flux:

$$Q_\mu = Q_{HP} \frac{\alpha^4}{R^4} \left[1 + \frac{\mu_1}{\mu_2} \left(\frac{R^4}{\alpha^4} - 1 \right) \right] \quad (2.184)$$

where μ_1 and μ_2 indicate the viscosities of the fluid mass and the depletion layer respectively, according to the condition $\mu_1 \gg \mu_2$. Experimental studies on CNTs report a depletion thickness value of about $\delta = 0.7\text{nm}$ and therefore $\alpha = R - 0.7\text{nm}$. The increase in flux is defined as $\varepsilon_\mu = Q_\mu / Q_{HP}$. With the experimental data retrieved in literature (Whitby, Cagnon, Thanou and Quirke 2008) one obtains $\mu_2 \approx 0.018\mu_1$. Two rather common gases, such as air and oxygen, have viscosities about 0.02 compared to water.

As we have already pointed out, the theory for a gas flow takes into account the apparent slip over a solid surface, but a similar theory does not exist for fluids. The slip length can be derived by comparing a slip model with that of the depletion layer (Myers 2011):

$$L_s = \delta \left(\frac{\mu_1}{\mu_2} - 1 \right) \left[1 - \frac{3\delta}{2R} + \left(\frac{\delta}{R} \right)^2 - \frac{1}{4} \left(\frac{\delta}{R} \right)^3 \right] \quad (2.185)$$

As predicted, (Thomas and McGaughey 2008), the flow length is a monotonically decreasing function of R . Furthermore, if we observe that $\mu_1 / \mu_2 \gg 1$, three regimes of fluid flow in a pipe can be identified, relative to wide, medium or small pipes.

1. For pipes where $\delta/R \ll \mu_2/\mu_1$, i.e. for sufficiently wide pipes, there is $\varepsilon_\mu \approx 1$ and the improvement in flow is not appreciable, so the no-slip boundary condition is not sufficient. Wide tubes characterised by smooth surfaces do not allow the observation of slip phenomena. This condition holds for $R > 3\mu\text{m}$.
2. For pipes of intermediate diameter when $(\delta/R)(\mu_1/\mu_2)$ is $O(1)$ but $\delta/R \ll 1$, only the term of the first order L_s is considered and we will write:

$$\varepsilon_\mu \approx 1 + \frac{4\delta}{R} \left(\frac{\mu_1}{\mu_2} - 1 \right) \quad (2.186)$$

This applies approximately for $R \in [21\text{nm}, 3\mu\text{m}]$ and allows a constant creep length to be determined using the following formula $L_s = \delta\mu_1/\mu_2$. Several authors report constant slip lengths around 20nm and 40nm.

3. For very small–diameter pipes, where δ/R is $O(1)$, the full expression of ϵ_μ must be used and therefore the creep length varies with R .

The model predicts a value of $\epsilon_\mu = 33.2$ for $R = 3.5\text{nm}$ but this is confirmed in literature (Thomas, McGaughey and Ottolero 2010) where $\epsilon_\mu \approx 32$ is reported. The model also predicts a maximum increase (obtained by setting $R = \delta$) of about 50, which agrees with the maximum value of 45 already recorded (Whitby, Cagnon, Thanou and Quirke 2008).

2.2.4 Nanoparticle Melting

One of the most important characteristics of nanoparticles is their surface to volume ratio, which has a significant impact on the material properties at this size. When the size of the material is reduced, as in the case of nanostructures, the phase change temperature decreases (Shim, Lee and Cho 2002). Former experimental investigation carried out (Buffat and Borel 1976) showed that the decrease is about 500K for gold particles whose radius is just over 1nm. Furthermore, molecular dynamics simulations, MD Simulations, (Shim, Lee and Cho 2002) have shown that the decrease is over 800K below the melting temperature of gold particles of around 0.8nm. This interesting property means that nanoparticles are being researched for applications that require the particles to melt after serving their primary purpose, and then pass through the system as dispersed molecules. Indeed, drugs that have poor water solubility can be administered as nanoparticles to enhance their absorption. Antibiotic (Bergese, Colombo, Gervasoni and Depero 2004) and anti–anginal drugs (Liu, Yangb and Jiang 2007), which show a change, in terms of decrease, in the melting point of about 30K. Since gold has low toxicity, gold nanoparticles are also good carriers for drug and gene delivery (Rana, Bajaj, Mout and Rotello 2012). Therefore, deriving a model that describes the thermal behaviour of a nanoparticle is crucial, especially its phase change. The mathematical model of Font and Myers (Font and Myers 2013) describes the melting process of nanoparticles.

Assuming that the density and specific heat are approximately constant in both the solid and liquid phases, the melting temperature is obtained via the generalised Gibbs–Thomson relation:

$$L_m \left(\frac{T_m}{T_m^*} - 1 \right) + \Delta c \left[T_m \ln \left(\frac{T_m}{T_m^*} \right) + T_m^* - T_m \right] = - \frac{2\sigma_{sl}K}{\rho} \quad (2.187)$$

where L_m is the latent heat, T_m is the temperature at which the phase change occurs, T_m^* , the bulk phase change temperature, $\Delta c = c_l - c_s$, the specific heat change from liquid to solid, σ_{sl} the surface tension and r the mean curvature. In this model, an equal phase density is assumed for both the solid and liquid phases, which we denote by ρ . Furthermore, the pressure variation will be assumed to be small, so any pressure–related term that may be carried over into the model will be negligible.

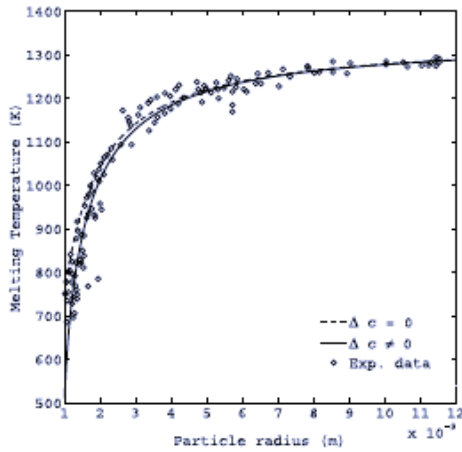

Fig. 2.15 Melting temperature versus particle radius. Source: Myers, MacDevette, Font and Cregan (2014)

The previous figure 2.15 compares the generalised Gibbs–Thomson relation with experimental data for nanoparticles of gold ranging from 2nm to 12nm.

The following dimensionless model refers to the fusion of a particle with spherical symmetry:

$$\frac{\partial T}{\partial t} = \frac{1}{r^2} \frac{\partial}{\partial r} \left(r^2 \frac{\partial T}{\partial r} \right), \quad \frac{\partial \theta}{\partial t} = \frac{k}{c} \frac{1}{r^2} \frac{\partial}{\partial r} \left(r^2 \frac{\partial \theta}{\partial r} \right) \tag{2.188}$$

where T and θ denote the temperature in the liquid and solid, and k and c are the solid to liquid conductivity and specific heat ratios, respectively. The boundary conditions are $T(1,t) = 1$, $T[R(t),t] = \theta[R(t),t] = T_m$ and $\partial\theta/\partial r|_{r=0}$, where $r = R(t)$ is the position of the solid–liquid interface. The Stefan condition is:

$$[\beta + (1 - c)T_m] \frac{dR}{dt} = k \frac{\partial \theta}{\partial r} \Big|_{r=R} - \frac{\partial T}{\partial r} \Big|_{r=R} \tag{2.189}$$

This model is similar to that of McCue, Wu and Hill (McCue, Wu and Hill 2009) but the fundamental difference is that the Gibbs–Thomson relation includes a Δc term. For large particles, this does not affect the results much, but becomes increasingly important as the particle size decreases.

The melting temperature T_m is a dimensionless term and is given by the solution of:

$$\beta \left(T_m + \frac{\Gamma}{R} \right) + \frac{1 - c}{\delta T} \left[\left(T_m + \frac{1}{\delta T} \right) \ln(T_m \delta T + 1) - T_m \right] = 0 \tag{2.190}$$

We define the dimensionless parameters as:

$$c = \frac{c_s}{c_l} \quad k = \frac{k_s}{k_l} \quad \delta T = \frac{\Delta T}{T_m^*} \quad \beta = \frac{L_m}{c_l \Delta T} \quad \Gamma = \frac{2\sigma_{sl} T_m^*}{R_0 \rho L_m \Delta T}$$

where $\Delta T = T_H - T_m^*$ indicates the temperature variation (with T_H the temperature measured on the surface of the nanoparticle) and R_0 represents the initial radius of the particle.

In the case of water, gold and lead, a temperature variation of $\Delta T = 10\text{K}$ leads to $\beta \approx 8, 40, 12$ while small increases in ΔT give rise to larger β . The small volume of the nanoparticles means that the energy required for their fusion is also small. In fact, any increase in temperature above the melting value on the surface of the nanoparticle is sufficient to cause its almost instantaneous fusion.

$$\mathcal{O}(1): \quad \frac{1}{r^2} \frac{\partial}{\partial r} \left(r^2 \frac{\partial T_0}{\partial r} \right) = 0 \quad T_0(1, \tau) = 1 \quad T_0(R, \tau) = T_m \quad (2.191)$$

$$\mathcal{O}\left(\frac{1}{\beta}\right): \quad \frac{1}{r^2} \frac{\partial}{\partial r} \left(r^2 \frac{\partial T_1}{\partial r} \right) = \frac{\partial T_0}{\partial \tau} \quad T_1(1, \tau) = 0 \quad T_1(R, \tau) = 0 \quad (2.192)$$

whose corresponding solutions are:

$$T_0 = 1 + (T_m - 1) \frac{R}{r} \left(\frac{1-r}{1-R} \right) \quad (2.193)$$

$$T_1 = \mu_1 \left\{ \left[(3-r)r - \frac{2}{r} \right] - \frac{R}{r} \left(\frac{1-r}{1-R} \right) \left[(3-R)R - \frac{2}{R} \right] \right\} \frac{dT_0}{d\tau} \quad (2.194)$$

where:

$$\mu_1 = \frac{1}{6(1-R)} \left\{ \frac{\beta \Gamma}{R \left[\beta + \frac{1-c}{\delta T} \ln(T_m \delta T + 1) \right]} + \frac{T_m - 1}{1-R} \right\} \quad (2.195)$$

In a solid:

$$\theta_0 = T_m \quad \theta_1 = -\mu_2 (R^2 - r^2) \frac{dR}{d\tau} \quad (2.196)$$

where:

$$\mu_2 = \frac{c}{6k} \frac{\beta\Gamma}{R^2 \left[\beta + \frac{1-c}{\delta T} \ln(T_m \delta T + 1) \right]} \quad (2.197)$$

The Stefan condition is written as:

$$\frac{dR}{d\tau} = \frac{T_m - 1}{R(1-R)} \left\{ 1 + \frac{1}{\beta} \left[(1-c)T_m - 2\mu_1 \frac{(1-R)^2}{R} - 2k\mu_2 R \right] \right\}^{-1} \quad (2.198)$$

and this is combined with the differentiated version of the Gibbs–Thomson equation:

$$\frac{dT_m}{d\tau} = \frac{\Gamma}{R^2 \left[1 + \frac{1-c}{\beta \delta T} \ln(T_m \delta T + 1) \right]} \frac{dR}{d\tau} \quad (2.199)$$

The initial conditions for these equations, when put into system, are $R(0) = 1$ and $T_m(0) = T_m(1)$, where the latter value is fixed by solving equation (2.10) when $R = 1$. Thus, the problem has been reduced considerably from a system of two equations for heat in the solid and liquid, defined on a variable domain specified by Stefan's condition and coupled to an equation describing the phase change temperature, to the solution of two first-order ordinary differential equations.

Figure 2.16 illustrates how the melting front, $R(t)$, evolves, where the dashed and solid lines are the approximate solution and a numerical solution of the complete system, respectively.

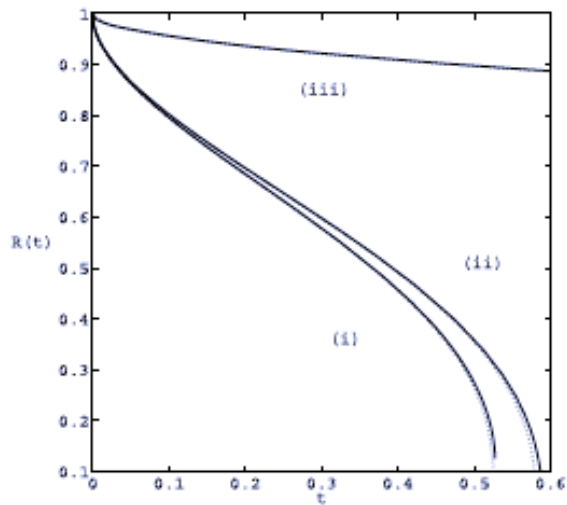

Fig. 2.16 The melt front $R(t)$ versus time. Source Myers, MacDevette, Font and Cregan (2014)

The three sets of curves indicate three sets of associated solutions. In particular, the curves denoted by (i) denote the model using the generalised Gibbs–Thomson relation, the curves denoted by (ii) take $c_s = c_l$ in Gibbs–Thomson but not the energy balance (McCue, Wu and Hill 2009) and curves (iii) are the standard model where we have $T_m = T_m^*$ and $c_s = c_l$. Clearly, the standard model overestimates the melting time considerably. Curves (i) and (ii) show that as the radius of the solid decreases, the gradient of the curve increases rapidly and tends to infinity. Physically, this implies that in the final stages of fusion, the particle will suddenly disappear, and this is the “abrupt fusion” phenomenon reported (Kofman, Cheyssac, Lereah, Stella and 1999). Figure 2.17 below depicts the temperature profile within the liquid and solid regions during particle fusion.

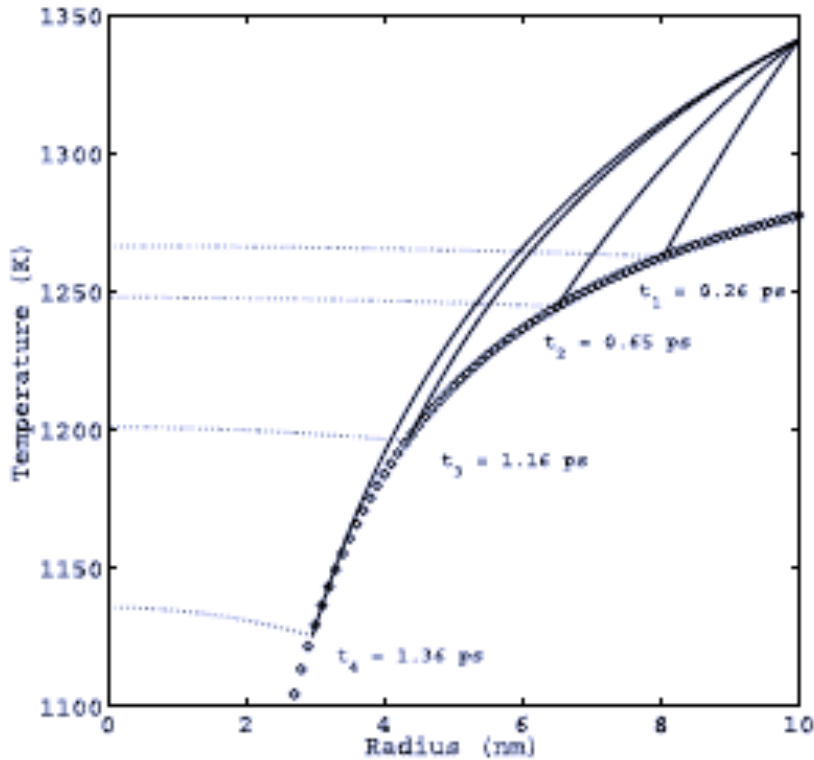

Fig. 2.17 Temperature versus radius profiles for nanoparticles in a melting process. Source: Myers, MacDevette, Font and Cregan (2014)

The circles show how the melting temperature decreases with time, the dashed line is the temperature of the solid phase and the solid line is the temperature of the liquid. An interesting feature of this graph is the fact that the temperature of the solid is greater than the temperature of the phase change. In a standard problem the solid would be below the phase change temperature and so slow down the process, in this case the decrease in the melting temperature means that the solid is actually acting to accelerate the melting.

2.2.5 Another Perspective on Thermal Conductivity

Nanofluids possess better thermal properties than the basic bulk material, and this has led to nanofluids being considered as extremely interesting materials for heat dissipation mechanisms in modern electronic devices, which has opened up a large area of research. However, the thermal response of a nanofluid is not yet described by a satisfactory theoretical model.

Based on the theory of the effective medium, the fundamental theoretical description of heat conduction made by Maxwell in solid–in–liquid suspensions (Maxwell 1892) allows the calculation of the effective thermal conductivity:

$$\frac{k_e}{k_l} = \left[\frac{2k_l + k_p + 2\phi(k_p - k_l)}{2k_l + k_p - \phi(k_p - k_l)} \right] \quad (2.200)$$

where k_e , k_p , k_l indicate the effective thermal conductivity of the particles and the liquid respectively, and ϕ indicates the volume fraction of the particles. It is known, however, that the Maxwell model has drawbacks. Firstly, the model can only be applied to the heat flow in the material surrounding an equivalent fluid, or around a particle, and not to the whole scenario of interest, i.e. a nanofluid or a real particle. Secondly, the theory is based on a region of infinite extent (Das, Choi, Wu and Pradeep 2008) and is therefore only applicable to very dilute solutions, solutions in which the particles are sufficiently far apart so that the thermal interaction between the particles can be neglected. If the concentration of the particles increases, this will give rise to complications. Finally, Maxwell's theory is based on a steady–state analysis, which limits the possibility of considering the more interesting time–dependent thermal response of the nanofluid.

Despite the limitations described, Maxwell's model applies effectively to low volume fraction fluids with relatively large particles. However, the model turns out to be inaccurate when the particle size goes down to the nanoscale. Experimental data of nanofluids subjected to different treatments were compared (Kebllinski, Eastman and Cahill 2005) and reported that, in most cases $k_e \approx (1 + C_k \phi) k_l$ with $C_k \approx 5$, a fact that is in contrast to the linearized Maxwell model, where $C_k \approx 3$. In order to improve the agreement between experimental data and theory, several authors have proposed extensions to Maxwell's model, using nanolayers (a thin layer of ordered liquid molecules surrounding the particle), particle clustering, nanoconvection and Brownian motion. For example, in literature we find examples (Prasher, Bhattacharya and Phelan 2005; Koo, Kleinstreuer 2004), of Maxwell's result modified to consider Brownian motion as well. Yu and Choi (Yu and Choi 2003) introduced a 2nm–thick nanolayer whose thermal conductivity is ten times higher than that of the base fluid. Another extensive description (Das, Choi and Pradeep 2008) illustrates that by taking into account these additional effects and the new parameters, a better agreement between the experiment and variants of Maxwell's theory can be found. In the following, we describe an alternative expression for the thermal conductivity of a nanofluid, recently proposed (Myers, MacDevette and Ribera 2013), which agrees well with the experimental data.

If we consider the time progression related to liquid diffusion, a suitable dimensionless model for the heat flow through a spherically symmetric liquid–particle system is given by:

$$\frac{\partial T}{\partial t} = \frac{\alpha}{r^2} \frac{\partial}{\partial r} \left(r^2 \frac{\partial T}{\partial r} \right), \quad r \in [0, r_p] \quad (2.201)$$

$$\frac{\partial \theta}{\partial t} = \frac{1}{r^2} \frac{\partial}{\partial r} \left(r^2 \frac{\partial \theta}{\partial r} \right), \quad r \in [r_p, 1] \quad (2.202)$$

where T and θ are the temperatures in the particle and fluid respectively, $\alpha = \alpha_p / \alpha_f$ is the ratio of the thermal diffusivities of the particle and fluid, and r_p is the radius of the particle. At the interface between fluid and particle, a fixed boundary temperature greater than the initial temperature and continuity of temperature and heat flow must be imposed. Thus, the relevant conditions are:

$$\begin{aligned} \theta(r, 0) = T(r, 0) = 0 & \quad \theta(1, t) = 1 & \quad \theta(r_p, t) = T(r_p, t) \\ & = T_p(t) \end{aligned} \quad (2.203)$$

$$\left. \frac{\partial \theta}{\partial r} \right|_{r=r_p} = k \left. \frac{\partial T}{\partial r} \right|_{r=r_p} \quad \left. \frac{\partial T}{\partial r} \right|_{r=0} = 0$$

where $k = k_p / k_f$.

To determine the effective thermal conductivity k_e we first examine an “equivalent fluid” with diffusivity α_e . Then, we consider the three equations:

$$\frac{\partial \theta_e}{\partial t} = \frac{\alpha_e}{r^2} \frac{\partial}{\partial r} \left(r^2 \frac{\partial \theta_e}{\partial r} \right) \quad \theta_e(1, t) = 1 \quad \left. \frac{\partial \theta_e}{\partial r} \right|_{r=0} = 0 \quad (2.204)$$

which can be easily put together and solved, deriving a solution in terms of Bessel functions. Of particular interest is the temperature at the centre given by:

$$\theta_e(0, t) = \theta_s(t) = 1 + \sum_{n=1}^N 2(-1)^n e^{-n^2 \pi^2 \alpha_e t} \quad (2.205)$$

The associated particle–fluid system is more complex and requires approximate solution methods. Firstly, to increase the thermal conductivity of the base fluid, nanoparticles must be introduced whose diffusivity is much higher than in the base fluid. For example, copper and aluminium oxide Al_2O_3 in water or ethylene–glycol solutions have $\alpha \gg 1$ and $k \gg 1$ values. In effect, this indicates that heat is transferred more rapidly through the particle than the fluid, and thus $T(r, t) \approx T_p(t)$. The transformation $\theta = u/r$ allows the thermal problem of the fluid to be transformed to a Cartesian coordinate system, and the resulting problem is identical to that solved previously via an extension of the Heat Balance Integral Method (HBIM) (Myers 2009; 2010). HBIM allows the temperature in the fluid and particle to be approximated by simple polynomial expressions, thus highlighting how the physical parameters affect the model. The HBIM solution results in:

$$T_p = 1 - e^{-\Lambda(t-t_1)} \quad (2.206)$$

where t_1 is the instant of time after which the temperature of the particle rises significantly above the initial temperature. Furthermore, $\Lambda = n\lambda / c_T$, so $\lambda = 1/(1-r_p)^2$ and $c_T = (1+r_p)/2 - 1/(n+1)$. From the literature (Myers 2009; 2010), we find that the constant

$n = 2.233$ is calculated by minimising the least squares error, when the approximate solution is substituted into the heat equation.

Similarly, we apply HBIM to the equivalent fluid system to obtain the temperature at the centre:

$$T_c = 1 - e^{-\Lambda'(t-t'_1)} \quad (2.207)$$

where $\Lambda' = n\alpha_e / c_{T0}$ and $c_{T0} = (n-1) / [2(n+1)]$. The accuracy of this formula can be verified by comparison with the exact solution (Pantarotto *et al.* 2004).

The HBIM solution is an acceptable approximation, so the result is to find a comparable diffusivity between the HBIM solution for a particle and that of an equivalent fluid. It is therefore possible to use a simple approach, equating the decay rates in the expressions for T_p and T_c . This is equivalent to assuming $\Lambda = \Lambda'$, which gives the result:

$$\alpha_e = \frac{\alpha_l}{(1-r_p)^2} \frac{n-1}{2(n+1)} \left(\frac{1+r_p}{2} - \frac{1}{n+1} \right)^{-1} \quad (2.208)$$

The r_p is the dimensionless radius, scaled with the fluid radius R . Typically, these relationships are posed in terms of the volume fraction ϕ where $r_p = \phi^{1/3}$, and thus:

$$\alpha_e = \frac{\alpha_l}{(1-\phi^{1/3})^2} \frac{n-1}{2(n+1)} \left(\frac{1+\phi^{1/3}}{2} - \frac{1}{n+1} \right)^{-1} \quad (2.209)$$

Upon initial examination, it is observed that the thermal diffusivity of the equivalent fluid depends only on the liquid diffusivity and volume fraction, while the nanoparticle composition does not influence α_e . Using the following relations $\alpha_e = k_e / (\rho c)_e$, and $(\rho c)_e = \phi \rho_p c_p + (1-\phi) \rho_l c_l$, we can write the effective thermal conductivity as:

$$\frac{k_e}{k_l} = \frac{\left[(1-\phi) + \phi \frac{\rho_p c_p}{\rho_l c_l} \right] (n-1)}{(1-\phi^{1/3})^2 [(1+\phi^{1/3})(n+1) - 2]} \quad (2.210)$$

which shows that the equivalent conductivity of the particles does not depend on the conductivity of the particles. This has been verified experimentally, (Yu, France, Routbort and Choi 2008; Yu and Choi 2003). The physical properties of the particles appear through density and heat, $(\rho c)_e$. However, since the ratio $\rho_p c_p / (\rho_l c_l)$ is $O(1)$ and ϕ is small, the dependence on these is weak. Consequently, the effective conductivity is mainly a function of the liquid conductivity k_l and the volume fraction ϕ .

To test the validity of the model, the model itself was compared with appropriate experimental data from the literature. Figure 17 compares the current model (solid line), given by Eq. (2.210), with that of Maxwell's relation (2.200) (dashed line) and different

experimental data sets (Fig. 2.18) for an Al_2O_3 –water nanofluid (Myers, MacDevette and Ribera 2013). For small volume fractions, Maxwell’s relation turns out to be superior to the current theory and allows for better modelling of the data. However, for $\phi > 0.008$, the current model rapidly surpasses Maxwell’s theory and most significantly by interpolating a larger amount of data. As a result, the current model clearly outperforms the basic Maxwell model for most of the experimental data for volume fractions greater than 1%.

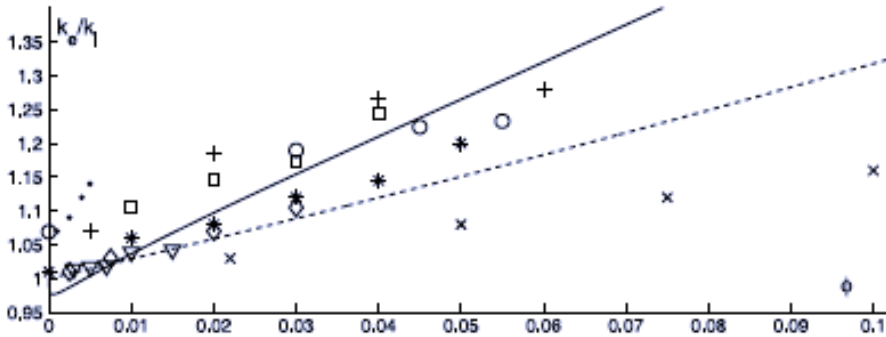

Fig. 2.18 The k_e/k_f ratio for an Al_2O_3 –water nanofluid. Source: Myers, MacDevette, Font and Cregan (2014)

Epilogue II

Solid State Physics represents a very large part of Physics and benefits from both laboratory activity and advances in Theoretical Physics. For this reason, it is necessary to describe, on the one hand, which instruments are used to carry out research in the field of Nanotechnology, without going into detail, as such a treatise would deserve more space, and, on the other, which mathematical approaches are dedicated to the study of the nanoworld. With regard to the latter, it should be pointed out that no specific mathematical theory has yet been developed for Solid State Physics from scratch; rather, there are branches of Mathematics that have already been extensively tested and which allow their application to problems relating to the study of condensed matter. Linear algebra or Group theory, to mention just two, are areas of Mathematics that find wide application in the Physics of Matter.

This part of Physics does not at present have a unified mathematical theory to encompass it in its entirety, and it is unlikely that such a result could be achieved, given the vastness of the subject. Nevertheless, the results obtained to date, resulting from the application of specific areas of mathematics to various physical problems, have led to excellent results and conditions of predictability in the behaviour of structures.

In this second chapter, which also forms the entire second part of the thesis, I have summarised the main mathematical and physical tools involved in nanotechnology research.

First of all, I have described the electron microscopy techniques that make it possible to visualise structures on a nanometric scale and to physically intervene on them, manipulating them and creating new variants. The most important instruments are electron microscopes, the most important of which, the SEM, the AFM, the STM, were developed in the last decades of the last century. They have allowed the study of matter at levels never reached before, at levels hoped for by Richard Feynman and somewhat coveted by him in his famous speech “There’s Plenty of Room at the Bottom” in 1959. Not only have these instruments enabled giant steps forward in physics and other disciplines, but they have also earned the highest international awards such as the Nobel Prize, for example to Binnig and Rohrer in 1986 for STM microscopy.

All these devices have been used not only in studies in the field of Physics, but also in various disciplines such as Biology, Medicine, Engineering, since Nanotechnologies have proved to be transversal in a very radical way, affecting all fields of pure and applied sciences and medicine.

Laboratory instrumentation is undoubtedly a fundamental aspect for the progress of research, especially in the field of Nanoscience, but the development of Nanoscience itself has benefited from mathematical models and structures that make it possible to describe the behaviour of the nanoworld, giving it a formal description. In this direction, the words of Galileo Galilei are once again confirmed.

[The universe] cannot be read until we have learnt the language and become familiar with the characters in which it is written. It is written in mathematical language [...] (Galilei 1623, translation: AD).

In this chapter I have also presented some of the mathematical models that researchers have been developing for nanotechnologies. Examples which have shown how both known models and new implementations of historically accepted models, such as Drude’s model for example, can be applied in reality, improving them by taking into account the appearance of quantum phenomena due to the dimension being worked on.

References

Primary Sources

- Helmholtz HLF (1876) On the limits of the Optical Capacity of the Microscope. Retrieved from: <https://onlinelibrary.wiley.com/doi/abs/10.1111/j.1365-2818.1876.tb05606.x>
- Minsky M (1957) Microscopy Apparatus. US Patent 3.013.467
- Myers TG, MacDevette MM, Font F, Cregan V (2014) Continuum Mathematics at the Nanoscale. *Journal of Mathematics in Industry* 4:11. doi:10.1186/2190-5983-4-11
- Thamwattana N, Hill J (2017) Mathematical Modelling in Nanotechnology. Retrieved from <https://ro.uow.edu.au/cgi/viewcontent.cgi?article=2325&context=infopapers>

Secondary Sources

- Aiton E J (1978) Kepler's Path to the Construction and Rejection of his First Oval Orbit for Mars. *Annals of Science* 35/2:173–190. doi:10.1080/00033797800200201
- Bergese P, Colombo I, Gervasoni D, Depero LE (2004) Melting of Nanostructured Drug Embedded into a Polymeric Matrix. *Journal of Physical Chemistry B* 108/40:15488–15493. doi:10.1021/jp048762u
- Bidlack FB, Huynh C, Marshman J, Goetze B (2014) Helium Ion Microscopy of Enamel Crystallites and Extracellular Tooth Enamel Matrix. *Frontiers in Physiology* 5/395. doi:10.3389/fphys.2014.00395
- Buffat P, Borel JP (1976) Size Effect on the Melting Temperature of Gold Particles. *Physical Review A* 13/6:2287–2297. doi:10.1103/PhysRevA.13.2287
- Chen J (1994) Introduction to Scanning Tunneling Microscopy, Second Edition. *American Journal of Physics* 62/6. doi:10.1119/1.17525
- Choi SUS, Zhang ZG, Yu W, Lockwood FE, Grulke EA (2001) Anomalous Thermal Conductivity Enhancement in Nanotube Suspension. *Applied Physics Letters* 79/14:2252–2254. doi:10.1063/1.1408272
- Cowley JM (1995) *Diffraction Physics*. Elsevier Science B.V., Amsterdam
- Cox BJ, Thamwattana N, Hill JM (2006) Maximising the Electrorheological Effect for Bidisperse Nanofluids from the Electrostatic Force Between Two Particles. *Rheological Acta* 45:909–917. doi:10.1007/s00397-006-0084-4
- Cummings J, Zettl A (2000) Low-Friction Nanoscale Linear Bearing Realized from Multiwall Carbon Nanotubes. *Science*: 289/5479:602–604. doi:10.1126/science.289.5479.602
- Das SK, Choi SU, Yu W, Pradeep T (2008) *Nanofluids: Science and Technology*. Wiley, New York
- Dazzi A, Glotin F, Carminati R (2010) Theory of Infrared Nano-Spectroscopy by Photo Thermal Induced Resonance. *Journal of Applied Physics* 107/12:124519–7. doi:10.1063/1.342914
- Dazzi A, Prazeres R, Glotin F, Ortega JM (2005) Local Infrared Microspectroscopy with Subwavelength Spatial Resolution with an Atomic Force Microscope Tip used as a Photothermal Sensor. *Optics Letters* 30/18:2388–2390. doi:10.1364/OL.30.002388
- Di Sia P (2019) *Mathematics and Physics for Nanotechnology*. Jenny Stanford Publishing, Boca Raton
- Eastman JA, Choi SUS, Li S, Yu W, Thompson LJ (2001) Anomalous Increased Effective Thermal Conductivities of Ethylene Glycol-Based Nanofluids Containing Copper Nanoparticles. *Applied Physics Letters* 78/6:718–720. doi:10.1063/1.1341218
- Eaton P, West P (2010) *Atomic Force Microscopy*. Oxford University Press, Oxford
- Feynman R (1985) *The Character of Physical Law*. The Massachusetts Institute of Technology Press, XII ed., Cambridge
- Font F, Myers TG (2013) Spherically Symmetric Nanoparticle Melting with a Variable Phase Change Temperature. *Journal of Nanoparticle Research* 15/12:2086. doi:10.1007/s11051-013-2086-3
- Galilei G (1623) *Il Saggiatore*. In "Opere", a cura di Franz Brunetti. 1996 UTET Libreria, Torino
- Hamilton RL, Crosser OK (1962) Thermal Conductivity of Heterogeneous Two-Component Systems. *Industrial & Engineering Chemistry Fundamentals* 1/3:187–191. doi:10.1021/i160003a005
- Hecht E (1998) *Optics*. Addison Wesley Longman, Inc., Boston

- Kebblinski P, Phillpot SR, Choi SUS, Eastman JA (2002) Mechanisms of Heat Flow in Suspension of Nano-Sited Particles (Nanofluids). *International Journal of Heat and Mass Transfer* 45/4:855–863. doi:10.1016/S0017-9310(01)00175-2
- Kebblinsky P, Eastman JA, Cahill DG (2005) Nanofluids for Thermal Transport. *Materials Today* 8/6:36–44. doi:10.1016/S1369-7021(05)70936-6
- Kofman R, Cheyssac P, Lereah Y, Stella A (1999) Melting of Clusters Approaching OD. *The European Physical Journal D*. 9/1-4:441–444. doi:10.1007/s100530050475
- Kurouski D, Dazzi A, Zenobi R, Centrone A (2005) Infrared and Raman Chemical Imaging and Spectroscopy at the Nanoscale. *Chemical Society Reviews* 2020 49:3315–3347. doi:10.1039/C8CS00916C
- Lee S, Choi SUS, Li S, Eastman JA (1999) Measuring Thermal Conductivity of Fluids Containing Oxide Nanoparticles. *Journal of Heat Transfer* 121/2:280–289. doi:10.1115/1.2825978
- Liu B, Jiang H, Johnson HT, Huang Y (2004) The Influence of Mechanical Properties of Single Wall Carbon Nanotubes. *Journal of the Mechanics and Physics of Solids* 52/1:1–26. doi:10.1016/S0022-5096(03)00112-1
- Lu F, Jin M, Belkin MA (2014) Tip-Enhanced Infrared Nanospectroscopy Via Molecular Expansion Force Detection. *Nature Photonics* 8:307–312. doi:10.1038/nphoton.2013.373
- Liu X, Yang P, Jiang Q (2007) Size Effects on the Melting Temperature of Nanostructured Drugs. *Material Chemistry and Physics A* 103:1–4
- Lounis S (2014) Theory of Scanning Tunneling Microscopy. Lecture Notes of the 45th IFF Spring School “Computing Solids - Models, ab initio methods and supercomputing”.
- Malsch I (2002) Tiny Tips Probe Nanotechnology. *The Industrial Physicist*, October:16–19
- Masuda H, Ebata A, Teramae K, Hishinuma N (1993) Alteration of Thermal Conductivity and Viscosity of Liquid by Dispersing Ultra-Fine Particles (Dispersion of γ -Al₂O₃, SiO₂, and TiO₂ Ultra-Fine Particles). *Netsu Bussei* 7:227–233. doi:10.2963/JJTP.227
- Maxwell JK (1892) *A Treatise on Electricity and Magnetism*. Dover Publications 1954, Mineola
- McCue SW, Wu B, Hill JM (2009) Micro/Nanoparticles Melting with Spherical Symmetry and Surface Tension. *IMA Journal of Applied Mathematics* 74/3:439–457. doi:10.1093/imamat/hxn038
- Myers T (2011) Why are the Slip Lengths so Large in Carbon Nanotubes? *Microfluidics and Nanofluidics* 10:1141–1145. doi:10.1007/s10404-010-0752-7
- Patel HE, Das SK, Sundararajan T, Sreekumaran Nair A, George B, Pradeep T (2003) Thermal Conductivities of Naked and Monolayer Protected Metal Nanoparticle Based nanofluids: Manifestation of Anomalous Enhancement and Chemical Effects. *Applied Physics Letters* 83/14:2931–2933. doi:10.1063/1.1602578
- Pietrak K, Wiśniewski TS (2015) A Review of Models for Effective Thermal Conductivity of Composite Materials. *Journal of Power Technologies* 95/1:14–24
- Pradeep T (2008) *Nano. The Essentials. Understanding Nanoscience and Nanotechnology*. The McGraw-Hill Companies
- Prasher R, Bhattachaya P, Phelan PE (2005) Thermal Conductivity of Nanoscale Colloidal Solutions (Nanofluids). *Physical Review Letters* 94/2:025901. doi:10.1103/PhysRevLett.94.025901
- Ramer G, Aksyuk VA, Centrone A (2017) Quantitative Chemical Analysis at the Nanoscale Using the Photothermal Induced Resonance Technique. *Analytical Chemistry* 89/24:13524–13531. doi:10.1021/acs.analchem.7b03878
- Rana S, Bajaj A, Mont R, Ratello VM (2012) Monolayer Coated Gold Nanoparticles for Delivery Applications. *Advanced Drug Delivery Reviews* 64/2:200–216. doi:10.1016/j.addr.2011.08.006
- Reimer L, Kohl H (2008) *Transmission Electron Microscopy: Physics of Image Formation*. Springer, New York
- Rice WL, Van Hoek AN, Păunescu TG, Huynh C, Goetze B, Singh B, Scipioni L, Stern LA, Brown D (2013) High Resolution Helium Ion Scanning Microscopy of the Rat Kidney. *PLOS ONE* 8/3:e57051. doi:10.1371/journal.pone.0057051
- Rizvi IH, Join A, Ghosh SK, Mukherjee PS (2013) Mathematical Modelling of Thermal Conductivity for Nanofluid Considering Interfacial Nano-Layer. *Heat Mass Transfer* 49:595–600. doi:10.1007/s00231-013-1117-7
- Robertson LA (2015) van Leeuwenhoek Microscopes – Where Are They Now? *FEMS Microbiology Letters* 362. doi:10.1093/femsle/fnv056
- Rogers B, Adams J, Pennathur S (2013) *Nanotechnology – The Whole Story*. CRC Press/Taylor and Francis Group, Boca Raton
- Sanders WC (2019) *Basic Principles of Nanotechnology*. CRC Press, Boca Raton

- Selleri F (1989) *Fisica senza Dogma, La Conoscenza Scientifica tra Sviluppo e Regressione*. Nuova Biblioteca Dedalo, Dedalo S.p.A., Bari
- Shiw JH, Lee BJ, Cho YW (2002) Thermal Stability of Unsupported Gold Nanoparticles: a Molecular Dynamic Study. *Surface Science* 512:262–268. doi:10.1016/S0039–6028(02)01692–8
- Thomas JA, McGaughey A, Ottoleo KA (2019) Pressure–Driven Water Flow Through Carbon Nanotubes: Insights from Molecular Dynamics Simulation. *International Journal of Thermal Science* 49/2:281–289. doi:10.1016/J.IJThermalsci.2009.07.008
- Wang X, Xu X, Choi SUS (1999) Thermal Conductivity of Nanoparticle Fluid Mixture. *Journal of Thermophysics and Heat Transfer* 13/4:474–480. doi:10.2514/2.6486
- Wang ZL (2000) Transmission Electron Microscopy and Spectroscopy of Nanoparticles, in *Characterization of Nanophase Materials*. Wiley VCH, Weinheim
- Washizu M (1992) Precise Calculation of Dielectrophoretic Force in an Arbitrary Field. *Journal of Electrostatics* 29:177–188. doi:10.1016/0304–3886(93)90104–F
- Washizu M, Jones TB (1996) Generalized Multipolar Dielectrophoretic Force and Electrorotational Torque Calculation. *Journal of Electrostatics* 38/3:199–211
- Whitby M, Cagnon L, Thanou M, Quirke N (2008) Enhanced Fluid Flow Through Nanoscale Carbon Pipes. *Nano Letters* 8/9:2632–7. doi:10.1021/nl080705f
- Wilson M, Kannangara K, Smith G, Simmons M, Burkhard R (2002) *Nanotechnology: Basic Science and Emerging Technologies*. Chapman and Hall/CRC Press, Boca Raton
- Xu S, Liu G (1997) Nanometric–Scale Fabrication by Simultaneous Nanoshaving and Molecular Self–Assembly. *Langmuir* 13/2:127–129. doi:10.1021/LA962029F
- Yang G, Amro N, Liu GY (2003) Scanning Probe Lithography of Self–Assembled Monolayers. *SPIE Optics + Photonics, Materials Science, Engineering* 35/6:52–65. doi:10.1117.12504613
- Zheng Q, Liu JZ, Jiang Q (2002) Excess Van der Waals Interaction Energy of a Multiwalled Carbon Nanotube with an Extruded core and Induced Core Oscillation. *Physical Review B* 65:245409. doi:10.1103/PhysRevB.65.245409
- Zheng Q, Jiang Q (2002) Multiwalled Carbon Nanotubes as Gigahertz Oscillators. *Physical Review Letters* 88/4:045503. doi:10.1103/PhysRevLett.88.045503

Selected Additional References on the Subjects Suggested for Further Reading

- Akrami SMR, Nakayachi N, Watanabe–Nakayama T, Asakawa H, Fukuma T (2014) Significant Improvements in Stability and Reproducibility of Atomic–Scale Atomic Force Microscopy in Liquid. *Nanotechnology* 25/45:455701
- Altan H, Huang F, Federici JF, Lan A, Grebel H (2004) Optical and Electronic Characteristics of Single Walled Carbon Nanotubes and Silicon Nanoclusters by Terahertz Spectroscopy. *Journal of Applied Physics* 96/11:6685
- Alvarez FX, Cimmelli VA, Jou D, Sellitto A (2012) Mesoscopic Description of Boundary Effects in Nanoscale Heat Transport. *Nano MMTA*, 1:112–142
- Aschaffenburg DJ, Williams MRC, Talbayev D, Santavicca DF, Prober DE, Schmuttenmaer CA. Efficient Measurement of Broadband Terahertz Optical Activity. *Applied Physics Letters* 100:241114 1–5
- Ashby PD, Chen L, Lieber CM (2000) Probing Intermolecular Forces and Potentials with Magnetic Feedback Chemical Force Microscopy. *Journal of the American Chemical Society* 122/39:9467–9472
- Attinger S, Koumoutsakos PD (2004) *Multiscale Modelling And Simulation*. Springer, Berlin
- Avriel M (2003) *Nonlinear Programming: Analysis and Methods*. Courier Dover Publications, Mineola
- Aya Baquero H (2015) Using the Finite Elements Method (FEM) for Nanotechnology Education. A Rectangular Cantilever as a Mass Sensor. *Journal of Physics: Conference Series* 582:012042
- Baram M, Kaplan WD (2008) Quantitative HRTEM analysis of FIB prepared specimens. *Journal of Microscopy*. 232/3:395–05
- Bardeen J (1961) Tunnelling from a Many–Particle Point of View. *Physical Review Letters* 6/2:57–59
- Baxter JB, Schmuttenmaer CA (2006) Conductivity of ZnO Nanowires, Nanoparticles, and Thin Films Using Time–Resolved Terahertz Spectroscopy. *Journal of Physical Chemistry B* 110/50:25229–25239

- Baxter JB, Schmuttenmaer CA (2009). Carrier Dynamics in Bulk ZnO. II. Transient Photoconductivity Measured by Time Resolved Terahertz Spectroscopy. *Physical Review B*, 80/235206:1–10
- Bethe HA, Sommerfeld A (1967) *Elektronentheorie der Metalle*. Springer Verlag
- Binder K, Heermann DW (2010) *Monte Carlo Simulation in Statistical Physics: An Introduction*. Springer, Berlin
- Bland JAC, H. Bretislav H (2005) *Ultrathin Magnetic Structures I: An Introduction to the Electronic, Magnetic and Structural Properties*. Springer, Berlin
- Borodich FM, Galanov BA, Gorb SN, Prostov MY, Prostov YI, Suarez–Alvarez MM (2012) An Inverse Problem for Adhesive Contact and Non–Direct Evaluation of Material Properties for Nanomechanics Applications. *Nano Metallurgical and Materials Transactions A* 1:80–92
- Bruggeman DAG (1935) Berechnung Verschiedener Physikalischer Konstanten von Heterogenen Substanzen, I. Dielektrizitätskonstanten und Leitfähigkeiten der Mischkörper aus Isotropen Substanzen. *Annalen der Physik, Leipzig* 24:636–679
- Bucalem ML, Bathe KJ (2011). *The Mechanics of Solids and Structures – Hierarchical Modeling and the Finite Element Solution*. Springer, Berlin
- Burkhardt CE, Leventhal JJ (2008) *Foundations of Quantum Physics*. Springer, Berlin
- Car R, Parrinello M (1985) Unified Approach for Molecular Dynamics and Density–Functional Theory. *Physical Review Letters* 55/20:2471
- Chandran RB (2020) *Finite Element Analysis in Nanotechnology Research*. Retrieved 17/12/2021 from: <https://www.intechopen.com/chapters/73935>
- Chen CJ (1990) Origin of Atomic Resolution on Metal Surfaces in Scanning Tunneling Microscopy. *Physical Review Letters* 65/4:448–451
- Cherkaoui M, Capolungo L (2009) *Atomistic and Continuum Modeling of Nanocrystalline Materials: Deformation Mechanisms and Scale Transition*. Springer, Berlin
- Choy TC (1999). *Effective Medium Theory: Principles and Applications*. Oxford University Press, Oxford
- Chung KH, Kim DE (2007) Wear Characteristics of Diamond–Coated Atomic Force Microscope Probe. *Ultramicroscopy* 108/1:1–10
- Claeyssens JR, Tsukazan T, Tonetto L, D. Tolfo (2013) Modeling the tip–sample interaction in Atomic Force Microscopy with Timoshenko beam theory. *Nano Metallurgical and Materials Transactions A*, 2:124–144
- Cleland AN (2003) *Foundations of Nanomechanics: From Solid-State Theory to Device Applications*. Springer, Berlin
- Coulson. CA (1958) *Electricity*. Oliver & Boyd, fifth edition, Edinburgh
- Cox BJ, Thamwattana N, Hill JM. Electric Field–Induced Force Between Two Identical Uncharged Spheres. *Applied Physics Letters*, submitted for publication
- Crewe AV, Wall J, Langmore J, (1970) Visibility of a Single Atom. *Science* 168/3937:1338–1340
- Damasceno DA, Mesquita E, Rajapakse RNKD (2017) Mechanical Behavior of Nano Structures Using Atomic–Scale Finite Element Method (AFEM). *Latin American Journal of Solids and Structures* 14:2046–2066
- Davis LC (1992) Finite–Element Analysis of Particles–particles Forces in Electrorheological Fluids. *Applied Physics Letters*, 60/3:391–321
- Davis LC (1992) Polarisation Forces and Conductivity Effects in Electrorheological Fluids. *Journal of Applied Physics* 72/4:1334–1340
- de Borst R, Ramm E (2011) *Multiscale Methods in Computational Mechanics: Progress and Accomplishments*. Springer, Berlin
- Deák P, Frauenheim T, Pederson MR (2000) *Computer Simulation of Materials at Atomic Level*. John Wiley & Sons
- Di Sia P (2010) New Theoretical Results for High Diffusive Nanosensors Based on ZnO Oxides. *Sensors & Transducers Journal* 122/1:1–8
- Di Sia P (2011) An Analytical Transport Model for Nanomaterials. *Journal of Computational and Theoretical Nanoscience* 8/1:84–89
- Di Sia P (2011) *Classical and Quantum Transport Processes in Nano–Bio–Structures: a New Theoretical Model and Applications*. Faculty of Science, Verona University, Italy, PhD Thesis
- Di Sia P (2011) Oscillating Velocity and Enhanced Diffusivity of Nanosystems from a New Quantum Transport Model. *Journal of Nano Research* 16:49–54
- Di Sia P (2012) A New Theoretical Method for Transport Processes in Nanosensoristics. *Journal of Nano Research* 20:143–149

- Di Sia P (2012) An Analytical Transport Model for Nanomaterials: The Quantum Version. *Journal of Computational and Theoretical Nanoscience* 9/1:31–34
- Di Sia P (2012) Nanotechnology between Classical and Quantum Scale: Application of a new interesting analytical Model. *Journal of Computational and Theoretical Nanoscience* 17/1:82–86
- Di Sia P (2012) THz Spectroscopy and Nanostructures: a Short Interesting Review, *Letters in Applied NanoBioScience* 1/1:008–013
- Di Sia P (2013) A New Theoretical Model for the Dynamical Analysis of Nano–Bio–Structures. *Advances in Nano Research* 1/1:29–34
- Di Sia P (2013) About the Influence of Temperature in Single–Walled Carbon Nanotubes: Details from a new Drude-Lorentz–like Model. *Applied Surface Science* 275:384–388
- Di Sia P (2013) Characteristics in Diffusion for High–Efficiency Photovoltaics Nanomaterials: an interesting Analysis. *Journal of Green Science and Technology* 1/2
- Di Sia P (2013) Relativistic Motion in Nanostructures: Interesting Details by a New Drude–Lorentz–like Model. *Conference Series, Third International Conference on Theoretical Physics Theoretical Physics and its Application, June 24–28, 2013 Moscow, Russia*
- Di Sia P (2014) Effects on Diffusion by Relativistic Motion in Nanomaterial–Based Nanodevices. *Conference Series, International conference “NANOSMAT–2013” Granada–Spain, September 22–25, 2013*
- Di Sia P (2014) Present and Future of Nanotechnologies: Peculiarities, Phenomenology, Theoretical Modelling, Perspectives. *Reviews in Theoretical Science (RITS)* 2/2:146–180
- Dresselhaus MS, Dresselhaus G, Eklund PC (1996) *Science of Fullerenes and Carbon Nanotubes*. Academic Press
- Drude P (1900). *Zur Elektronentheorie der metalle*. *Annalen der Physik* 306/3:566-613
- Engel E, Dreizler RM (2011) *Density Functional Theory: An Advanced Course*. Springer, Berlin
- Fernandes da Silva EC (2009) GaAs: effective–mass parameters. Data extract from Landolt–Börnstein III/44A: Semiconductors – New Data and Updates for I–VII, III–V, III–VI and IV–VI Compounds. Springer–Verlag, Berlin
- Fong CY, Shaughnessy M, Damewood L, Yang LH (2012) Theory, Experiment and Computation of Half Metals for Spintronics: Recent Progress in Si–based Materials. *NanoMMTA* 1:1–22
- Fujita D, Sagisaka K (2008) Topical Review: Active Nanocharacterization of Nanofunctional Materials by Scanning Tunneling Microscopy. *Science and Technology of Advanced Materials* 9/1:013003
- Gao H, Huang Y, Abraham FF (2001) Continuum and Atomistic Studies of Intersonic Crack Propagation. *Journal of the Mechanics and Physics of Solids* 49/9:2113–2132
- Gates TS, Odegard GM, Frankland SJV, Clancy TC (2005) Computational Materials: Multi–Scale Modeling and Simulation of Nanostructured Materials. *Composites Science and Technology* 65/15–16:2416–2434
- Goddard III WA, Brenner DW, Lyshevski SE, Iafate GJ (2012) *Handbook of Nanoscience, Engineering, and Technology*. CRC Press, Boca Raton
- Gogotsi Y (2006) *Nanomaterials Handbook*. CRC Press, Boca Raton
- Gorji S, Kashiwar A, Mantha LS, Kruk R, Witte R, Marek P, Hahn H; Kübel C, Scherer T (2020). Nanowire facilitated transfer of sensitive TEM samples in a FIB. *Ultramicroscopy*. 219:113075
- Green MS (1954). Markoff Random Processes and the Statistical Mechanics of Time-Dependent Phenomena. II. Irreversible Processes in Fluids. *Journal of Chemical Physics* 22:398
- Gumbsch P, Pippan R (2010) *Multiscale Modelling of Plasticity and Fracture by Means of Dislocation Mechanics*. Springer, Berlin
- Henrard L, Hernandez E, Bernier P, Rubio A (1999) van der Waals Interaction in Nanotube Bundles: Consequences on Vibrational Modes. *Physical Review B* 60:R8521–R8524
- Holman J, Parsons A, Pilling G, Price G (2013) *Chemistry: Introducing Inorganic, Organic and Physical Chemistry*. Oxford University Press, Oxford
- Hong TK, Yang S (2005) Study of the Enhanced Thermal Conductivity of Fe Nanofluids. *Journal of Applied Physics*, 97/6:064311
- Hughes TJR (2000) *The Finite Element Method: Linear Static and Dynamic Finite Element Analysis*. Dover Publications, Mineola
- Iijima (1991) Helical Microtubules of Graphitic Carbon, *Nature* 354:56–58
- Kaggwa GB, Nalam PC, Kilpatrick JI, Spencer ND, Jarvis SP (2012) Impact of Hydrophilic/Hydrophobic Surface Chemistry on Hydration Forces in the Absence of Confinement. *Langmuir* 28/16:6589–6594

- Khan SH, Hoffmann PM (2018) Diverging Effects of NaCl and CsCl on the Mechanical Properties of Nanoconfined Water. *Journal of The Electrochemical Society* 165/3:H114–H120
- Kittel C (2005) *Introduction to Solid State Physics*. John Wiley & Sons, Hoboken
- Kubo R (1957) Statistical–Mechanical Theory of Irreversible Processes. I. General Theory and Simple Applications to Magnetic and Conduction Problems. *Journal of the Physical Society of Japan* 12:570–586
- Kühne T, Krack M, Mohamed F, Parrinello M (2007) Efficient and Accurate Car–Parrinello–like Approach to Born–Oppenheimer Molecular Dynamics. *Physical Review Letters* 98/6:066401
- Kuzyk MG (2010) *Polymer Fiber Optics: Materials, Physics, and Applications*. CRC Press, Boca Raton
- Lapshin RV (2004) Feature–Oriented Scanning Methodology for Probe Microscopy and Nanotechnology. *Nanotechnology* 15/9:1135–1151
- Leszczynski J (2010) *Trends in Computational Nanomechanics*. Springer, Netherlands
- Leung C, Bestembayeva A, Thorogate R, Stinson J, Pyne A, Marcovich C, Yang J, Drechsler U, Despont M, Jankowski T, Tschöpe M, Hoogenboom BW (2012) Atomic Force Microscopy with Nanoscale Cantilevers Resolves Different Structural Conformations of the DNA Double Helix. *Nano Letters* 12/7:3846–3850
- Li S, Liu WK (2004) *Meshfree Particle Methods*. Springer, Berlin
- Liu JL (2012). Mathematical Modeling of Semiconductor Quantum Dots based on the Nonparabolic Effective–Mass Approximation. *Nano Metallurgical and Materials Transactions A* 1:58–79
- Liu P, Zhang YW, Lu C (2005) Oscillatory Behavior of C60–Nanotube Oscillators: A Molecular–Dynamics Study. *Journal of Applied Physics* 97/9:094313
- Liu WK, Karpov EG, Zhang S, Park HS (2004) An introduction to computational nanomechanics and materials. *Computer Methods in Applied Mechanics and Engineering* 193/17–20:1529–1578
- Lopez JL, Montejo–Gamez J (2013) On the Derivation and Mathematical Analysis of some Quantum–Mechanical Models accounting for Fokker–Planck type Dissipation: Phase space, Schrödinger and Hydrodynamic Descriptions. *Nano Metallurgical and Materials Transactions A* 2:49–80
- Lu D, Xie YM, Li Q, Huang X, Li YF, Zhou S (2016) A Finite–Element Approach to Evaluating the Size Effects of Complex Nanostructures. *Royal Society Open Science* 3:160625
- Marulanda JM, A. Srivastava (2008) Carrier Density and Effective Mass Calculation for Carbon Nanotubes. *Physica Status Solidi (b)*, 245/11:2558
- Meyer JC, Girit CO, Crommie MF, Zettl A. (2008) Imaging and dynamics of light atoms and molecules on graphene. *Nature*. 454/7202:319–22
- Mielke L, Belytschko T, Schatz GC (2007) Nanoscale Fracture Mechanics. *Annual Review of Physical Chemistry* 58:185–209
- Mizutani U (2001) *Introduction to the Electron Theory of Metals*. Cambridge University Press.
- Munson PJ, Singh RK (1997) Statistical Significance of Hierarchical Multi–Body Potentials based on Delaunay Tessellation and their Application in Sequence–Structure Alignment. *Protein Science* 6/7:1467–1481
- Musa SM (2012) *Computational Finite Element Methods in Nanotechnology*. CRC Press
- Panasenko G (2005) *Multi–scale Modelling for Structures and Composites*. Springer
- Parkinson P, Joyce HJ, Gao Q, Tan HH, Zhang X, Zou J, Jagadish C, Herz LM, Johnston MB (2009) Carrier Lifetime and Mobility Enhancement in Nearly Defect–Free Core–Shell Nanowires Measured Using Time–Resolved Terahertz Spectroscopy. *Nano Letters* 9/9:3349–3353
- Parkinson P, Lloyd–Hughes J, Gao Q, Tan HH, Jagadish C, Johnston MB, Herz LM (2007) Transient Terahertz Conductivity of GaAs Nanowires. *Nano Letters*, 7/7:2162–2165
- Petrova R, Genova P, Tzoneva M (2012) Finite Element Method (FEM) for Nanotechnology Application in Engineering. CRC Press, Boca Raton
- Pirozhenko I, Lambrecht A (2008) Influence of Slab Thickness on the Casimir Force. *Physical Review A* 77:013811
- Plücker J (1858). Über die Einwirkung des Magneten auf die elektrischen Entladungen in verdünnten Gasen *Poggendorffs Annalen der Physik und Chemie*. 179/1:88–106
- Ramesh KT (2009) *Nanomaterials: Mechanics and Mechanisms*. Springer, United States
- Ratner M, Ratner D (2002) *Nanotechnology: A Gentle Introduction to the Next Big Idea*. Prentice Hall, Hoboken
- Repins I, Contreras M, Romero M, Yan Y, Metzger W, Li J, Johnston S, Egaas B, DeHart C, Scharf J, McCandless BE, Nou R (2008) Characterization of 19.9%–Efficient CIGS Absorbers. 33rd IEEE Photovoltaic Specialists Conference, May 11–16, San Diego, California. Preprint available at: <http://www.semiconductors.co.uk/propiivi5410.htm>

- Ricci M, Spijker P, Voitchovsky K (2014) Water–Induced Correlation between Single Ions Imaged at the Solid–Liquid Interface. *Nature Communications* 5/1
- Ruaz U (2012) *Finite Element Methods in Nanotechnology*. CRC Press, Boca Raton
- Rudin W (1987) *Real and Complex Analysis*, McGraw–Hill International Editions: Mathematics Series, McGraw–Hill Publishing Co, New York
- Ruska E (1980) The Early Development of Electron Lenses and Electron Microscopy. *Microscopica Acta. Supplement.* 5:1–140
- Schmittenmaer CA (2008) Using Terahertz Spectroscopy to Study Nanomaterials. *Terahertz Science and Technology*, 1/1:1–8
- Sellitto A, Alvarez FX (2012) Non–Fourier Heat Removal from Hot Nanosystems through Graphene Layer. *Nano Metallurgical and Materials Transactions A* 1:38. doi:10.2478/nsmmt–2012–0003
- Sholl D, Steckel JA (2011). *Density Functional Theory: A Practical Introduction*. John Wiley & Sons, Hoboken
- Singh SC, Zeng HB, Guo C, Cai W (2012) *Nanomaterials*. John Wiley & Sons, Hoboken
- Smith NV (2001) Classical Generalization of the Drude Formula for the Optical Conductivity. *Physical Review B*, 64/15, 155106
- Sridevi D, Rajendran KV (2009) Preparation of ZnO Nanoparticles and Nanorods by Using CTAB Assisted Hydrothermal Method. *International Journal of Nanotechnology and Application* 3/2:43
- Tang W (2007) *Molecular Dynamics Simulations of Carbon Nanotubes in Liquid Flow*. ProQuest, Morrisville
- Tersoff J, Hamann DR (1985) Theory of the Scanning Tunneling Microscope. *Physical Review B* 31:805–813
- Thijssen J (2007) *Computational Physics*. Cambridge University Press, Cambridge
- Thundat T, Zheng XY, Chen GY (1993) Role of Relative Humidity in Atomic Force Microscopy Imaging. *Surface Science Letters* 294/1–2:L939–L943
- Tillman P, Hill JM (2005). Modelling the Thermal Conductivity of Nanofluids. *Proceeding of International Union of Theoretical and Applied Mechanics 2005 Symposium – Mechanical Behavior, Micro–mechanics of nano structural materials*, June 27–30, Beijing
- Van Swygenhoven H, Derlet PM, Hasnaoui A (2002) Atomic Mechanism for Dislocation Emission from Nanosized Grain Boundaries. *Physical Review B*, 66:024101
- Vasileska D, Goodnick SM (2011) *Nano–Electronic Devices: Semiclassical and Quantum Transport Modeling*. Springer, New York
- Ventura PJ, Costa LC, Carmo MC, Roman HE, Pavesi L (2000) AC Conductivity of Porous Silicon from Monte Carlo Simulations. *Journal of Porous Materials* 7/1–3:107–110
- Vinogradov SS, Smith PD, Vinogradova ED (2010) *Canonical Problems in Scattering and Potential Theory Part II: Acoustic and Electromagnetic Diffraction by Canonical Structures*. CRC Press, Boca Raton
- Wandelt K (2012) *Surface and Interface Science*. John Wiley & Sons, Hoboken, Volumes 1–2
- Wang B, Zhou L, Peng X (2003) A Fractal Model for Predicting the Effective Thermal Conductivity of Liquid with Suspension of Nanoparticles. *International Journal of Heat and Mass Transfer*, 46/14:2665–2672
- Wang J (2010) *Key Issues of Classical Molecular Dynamics Simulation*. Lambert Academic Publishing, Chisinau
- Wang Z, Peng Z, Lu K, Wen W (2003) Experimental Investigation for Field–Induced Interaction Force of Two Spheres. *Applied Physics Letters* 82:1796–1798
- Wiesendanger R (1994) *Scanning Probe Microscopy and Spectroscopy: Methods and Applications*. Cambridge University Press, Cambridge
- Xuan Y, Li Q, Hu W (2003) Aggregation Structure and Thermal Conductivity of Nanofluids. *American Institute of Chemical Engineers Journal*, 49:1038–1042
- Yan JM, Zhang QY, Gao JQ (1986) *Adsorption and Agglomeration Surface and Porosity of Solid*. Science Press, 1986
- Yu MF, Yakobson BI, Ruoff RS (2000) Controlled Sliding and Pullout of Nested Shells in Individual Multiwalled Carbon Nanotubes. *Journal of Physical Chemistry B* 104:8764–8767
- Yu W, Choi SUS (2003) The role of interfacial layers in the enhanced thermal conductivity of nanofluids: a renovated Maxwell model. *Journal of Nanoparticle Research* 5:167–171
- Yu W, Choi SUS (2004) The role of interfacial layers in the enhanced thermal conductivity of nanofluids: a renovated Hamilton–Crosser model. *Journal of Nanoparticle Research* 6:355–361
- Yussou M, Zeller R (1980) An Efficient Korringa–Kohn–Rostoker Method for “complex” Lattices. *Edition International Centre for Theoretical Physics*, Vol. 80 and Vol. 166

Zheng Q, Jiang Q (2002) Multiwalled carbon nanotubes as gigahertz oscillators. *Physical Review Letters* 88:045503

Ziman M (1979) *Principles of the Theory of Solids*. Cambridge University Press. Cambridge

PART III

A History of Nanotechnology Research

Chapter III

1950–1970

An outline. The third part of this thesis offers the reader the historical core of my work on the History of Nanoscience and Nanotechnology. It consists of four chapters in which I will divide the various decades that have followed one another from 1950 to 2022, the year in which my analysis ends. The first chapter of this third part, namely Chapter III, examines the events which I consider most significant in the two decades 1950 and 1960. The events recounted have been chosen through a very complex search, through which I have matched a discovery, or a significant event, as far as possible, to a particular year. In this way, I have given the reader the possibility of following the chronological thread of events through what I consider to be the most significant episodes identified during my research. The second chapter, i.e. Chapter IV, of this third part covers the decades from 1971 to 1990, again describing the discoveries both from the instrumental point of view, of the laboratory equipment needed for research, and from the point of view of materials in the nanometric dimension and their most significant applications. The following chapter of the third part, Chapter V, will take us through the growth of Nanoscience and Nanotechnology from 1991 to almost the present day. Chapter VI is dedicated to the History of IEMN, the Research Institute where I prepared my thesis and that celebrated its first 30 years of History in 2022. The reader will immediately see how the events during this time span have become more numerous and how research has led to increasingly surprising and refined results. The improvement of laboratory equipment and the unstoppable development of research techniques in the nanoworld have literally opened the door to interdisciplinary and virtually unlimited research opportunities. This is the research that, born and bred in the last century, is fully characterising our present.

Note: from Section 3.1.2 of this chapter has been taken some of the material that will make up a standalone article on the historical aspects of carbon. The article aims to offer the complete translation of the 1952 article by Radushkevich and Lukyanovich, together with the salient passages from the history of buckminsterfullerenes and carbon nanotubes observed in 1991 by Sumio Iijima. A preview of the content was presented by me at the XLII SISFA Congress in Perugia, Italy, in 2022, and the relevant slides are included for the benefit of the reader in Appendix 2. The title of the article is *1950s–1990s: Carbon Nanotubes Studies into Historiography of Nanoscience–Nanotechnology*. The first page containing the abstract and keywords is given in Appendix 3.

From section 3.1.5, a substantial article was drawn up together with my supervisor, Prof. Pisano, regarding the importance of the figure of Richard Feynman and his impact in terms of his contributions to thinking and writing on nanotechnology: *Feynman's Frameworks on Nanotechnology in a Historiographical Debate*. The abstract and keywords can be found in Appendix 3. Significant parts of the paper were presented by me at the XL SISFA Congress in 2020, and the relevant slides can be found in Appendix 2. The paper has been approved by Springer for publication; the following link is available:

<https://link.springer.com/referencework/10.1007/978-3-030-99498-3>

Prologue III

Since 1950, the World of Science, driven by the availability of increasingly sophisticated laboratory equipment and the progressive need to develop ever smaller devices, has turned its attention firstly to structures of microscopic dimensions, equal to one millionth of a metre, then to those whose measurements are comparable to atomic or molecular ones: research has looked at one billionth of a metre, or, as the modern scientific terminology puts it, the nanometre. Materials studied at this scale have surprising properties that do not appear on the macroscopic scale. This is why they can be applied with great results in areas that were not relevant when handled at bulk sizes.

From the point of view of the History of Nanoscience and Nanotechnology, in the early years after the Second World War, there were instrumental improvements, inventions of new instruments and discoveries that strongly characterised research in a positive way.

Although already developed in previous decades, the Field Ion Microscope was created in 1951 thanks to the research of Erwin Müller. With this instrument it was possible to image the arrangement of atoms on the sharp surface of a metal tip. A few years later, Müller and his assistant Bahadur were the first in the world to observe the individual atoms of a metal using this instrument. I will introduce the reader to Müller's work from his original 1951 article.

1952 is an important year in the History of Nanoscience because, thanks to the work of two Russian researchers, Radushkevich and Lukyanovich, it was possible to make the first observation of structures that would later be defined as Carbon Nanotubes. The article from which I describe the research of the two technicians is still the original recollection, in Russian. The fact that the article is still only available in the original language is not surprising, of course, if we think about the language barrier that at the time severely limited the dissemination of the text. Here the reader will find some significant passages from the original paper, personally translated.

Next, I introduce the reader to Arthur von Hippel's idea of Molecular Engineering through his original paper dated 1956. Then, I describe the invention of the first transistor by Jack Kilby, a tool that brought a breakthrough to miniaturisation processes and the development of modern electronics.

At the end of 1959, the world of research was shaken by a famous lecture by the future Nobel Prize winner Richard Philip Feynman, which would be transcribed in one of the most quoted papers today when discussing Nanotechnology: *There's Plenty of Room at the Bottom*. In the modern History of Nanoscience and Nanotechnology, this article is often cited as the inspirational, prophetic and founding document. What I will present here is a different point of view brought forward by the work of Cristopher Toumey and which, thanks also to the contributions of scientists who have had and still have a fundamental role in this research, provides a different viewpoint, sometimes surprising compared to the usual narrative. This opens up the possibility of an interesting discussion on the actual influence of Feynman's work in the field of Nanotechnology, a discussion that can also be extended to other papers that carry on their shoulders the responsibility of inspiring cutting-edge research.

1960 was the year of the invention of the Metal–Oxide–Semiconductor Field–Effect Transistor by Mohamed Atalla and Dawon Kahng, a class of devices that later found wide use in electronics due to their low resistance and high switching capacity. In the same year, Bollmann and Spreadborough published a paper in which they examined the action of

graphite, rolled up in multiple sheets, as a lubricant. This was an early example of the application of Carbon Nanotube Technology.

In 1962, Archer and Atalla dealt with Nanolayer-Based Junction Transistors by studying the properties of semiconductors after observing that the splitting of silicon in a vacuum into a stream of evaporating metal atoms is a procedure that allows a metal–semiconductor interface to be formed.

One of the main problems that characterised the development of electronics during the 1960s was the process of progressive miniaturisation of circuits. In 1965, Gordon Moore predicted that the number of transistors in microprocessors would double approximately every 12 months. Moore wasn't far wrong, as the trend in processor production showed that the time span required for doubling is 18 months. This is known as Moore's Law and is a parameter that is considered as an objective in the design of electronic devices still today.

Towards the end of the decade, two absolutely significant achievements in the study of solid state physics were finally reached, the first concerning the realisation of materials with controlled growth, the second making it possible to approach the study of materials at dimensions so small that quantum processes could intervene. In 1968, Alfred Cho of Bell Laboratories developed a technique for the vacuum accretion of materials layer by layer, which controlled the purity of individual layers to atomic dimensions, in effect intervening with Nanotechnology. This made it possible to create materials in crystalline form by controlling their progressive growth: this was the birth of Molecular Beam Epitaxy, a technical term that would come into use two years later.

In 1970, Esaki and Tsu, then employed by IBM, hypothesised the presence of a one-dimensional periodic potential for single-crystal semiconductor materials. They operated at such small dimensions, in fact on the order of a nanometre, that they could not ignore quantum effects in their electron confinement hypothesis. This was the discovery of the Quantum Size Effect, the combination of nanometre size with the onset of quantum phenomena.

These are the events that I have described in relation to the first twenty years of my research after the Second World War. In this way, I wanted to outline how research has evolved into different areas, setting the stage for future discoveries. Not only that, I have also shown how some results, above all the observation of carbon structures by Radushkevich and Lukyanovich in 1952 and the Quantum Size Effect, were a prelude to what is now known and widely researched.

3.1 The Beginning of a New Era

The end of the Second World War meant the resumption of scientific research in fields not strictly related to the war. Although some instruments and experimental techniques had been extensively tested before the Second World War, they were revived and proved to be fundamental to the History of Nanoscience and Nanotechnology. At the same time, research in the direction of miniaturisation of devices, together with their improved operational capacity, stimulated investigation into a world of ever smaller dimensions than the macroscopic.

At the beginning of the 1950s, it was not yet semantically possible to speak of nanotechnology – the prefix ‘nano’ would be adopted in 1960 and the full term ‘Nanotechnology’ would not see the light of day until 1974 – yet the foundations for the nanotechnological revolution, as we know it today and as we are experiencing it, were being laid in those years.

Below, the reader will find some of the most important events I have chosen in the development of nanotechnology in the twenty years following the Second World War.

3.1.1 1951: The Field Ion Microscope: a New Instrument

Despite their dramatic nature, wars are extraordinary breeding grounds for ideas and innovations, as well as tremendous opportunities for research and for setting up working groups. From a historical point of view, wars are moments of discontinuity between two distinct periods in terms of social and cultural characteristics and relations between nations. In some cases, however, there are special exceptions, in which a war event on a planetary scale, such as the Second World War, constituted, in spite of its tragic nature, only a moment of pause in the path of a scientist's research. It is from this point of view that we can interpret the academic life of Erwin Wilhelm Müller (1911–1977). Born in Berlin on 13 June 1911, Müller had the opportunity to train under Gustav Ludwig Hertz²⁸ (1887–1975).

In 1951, Müller, then a lecturer at the Free University of Berlin, built the first Field Ion Microscope, (FIM), continuing another milestone in the development of equipment for the analysis of the structure of matter, a field to which he had made a fundamental contribution in 1936 just before the outbreak of hostilities, with the invention of Field Emission Electron Microscopy (FEEM). In 1952 he moved to Pennsylvania State University where he remained until the end of his career.

²⁸ Together with his compatriot James Franck (1882–1964), Müller was awarded the Nobel Prize in Physics in 1925 for the discovery of the laws governing the impact of an electron on an atom, through what was to become known as the Franck–Hertz experiment.

Zeitschrift für Physik, Bd. 131, S. 136–142 (1951).

Das Feldionenmikroskop.

Von

ERWIN W. MÜLLER.

Mit 3 Figuren im Text.

(Eingegangen am 27. August 1951.)

Durch Umpolen des Feldelektronenmikroskopes kann man adsorbierte Atome als positive Ionen von der Objektspitze abreißen. Diese Felddesorption wird bis zu $3 \cdot 10^8$ V/cm verfolgt. Bei schnellem Nachschub der adsorbierten Atome ermöglicht die Feldionenemission eine mikroskopische Abbildung der Spitzenoberfläche, deren Auflösungsvermögen die Gitterkonstante erreicht.

Fig. 3.1 The frontispiece and abstract of Müller's original article, as it appeared in 1951 in the *Zeitschrift für Physik* magazine. Source: Müller (1951)

The FIM microscope is an instrument that achieves atomic resolution in the observation of matter in the solid state, in materials physics, making it possible to visualise the arrangement of atoms on the surface of a very sharp needle point, and was introduced by Müller in 1951, the year in which he first published images of the atomic structure of tungsten (Müller 1951) in the *Zeitschrift für Physik* (Fig. 3.1).

The analysis of a sample in a FIM microscope is carried out in a chamber that is saturated with noble gases such as Helium or Neon, chemical elements whose ionisation can only occur by applying a high external electric field (24.6eV, or 2372kJ/mol, as the energy of first ionisation and 54.4eV, or 5251kJ/mol, as the energy of second ionisation for Helium and 21.6eV, or 2080.7kJ/mol, as the energy of first ionisation and 41eV, or 3952.3kJ/mol, as the second ionisation energy for Neon) in relation to the completeness of the octet of these gases and hence to their stability. For example, the first ionisation energy of Fluorine, which is also the element with the highest electronegativity value on the Pauling scale (and the only one capable of oxidising oxygen) has a first ionisation energy of 17.4eV, about 30% lower than that of Helium, only one position further to the right on the Periodic Table. A higher applied electric field also corresponds to better resolution. A sharp point is then made of the metal to be examined, which is cooled to cryogenic temperatures of between 20K and 100K, to reduce as far as possible the Brownian motion phenomena and the probable displacement of the atoms themselves (Fig. 3.2).

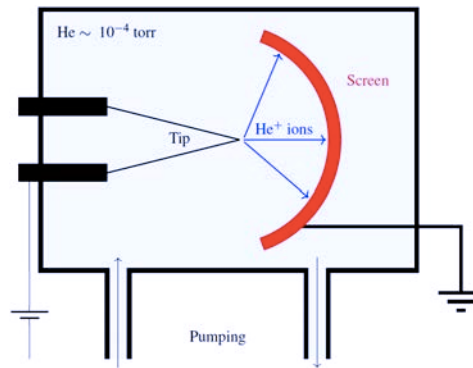

Fig. 3.2 A schematic representation of the chamber of a FIM. Source: AD

A positive potential, from 5kV to 10kV, is applied to the metal tip, resulting on a polarization effect on the imaging atoms that are thus attracted towards the tip; the gas atoms that are adsorbed on the tip are then ionised because of Quantum Tunnelling – before coming into physical contact with it, i.e. around 0.4nm that proved to be the optimal tunnelling distance – by the electric field surrounding it, assuming a positive charge and now being repelled by the positive potential applied. The applied field must be measured carefully to prevent the atoms from detaching from the metal tip, leading to the so-called field evaporation phenomenon. A negative voltage is not applied, to avoid electrons being emitted from the tip which could compromise image formation. The ions are repelled from the sample in a direction that is roughly perpendicular to the surface, and impact a detector placed to collect them after the ionization process and the following repulsion. The resolution of the image reconstructed because of the impacts of the ions on the detector is enough to give the representation of the shape of the atoms on the sample tip (Fig.3.3).

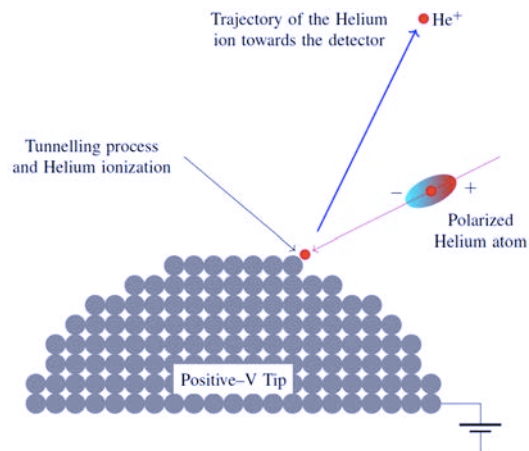

Fig. 3.3 A schematic representation of the tip of a FIM, with the ionization of the Helium atoms and their trajectories towards the screen, perpendicular with respect to the curved surface of the tip. Source: AD

Unlike conventional microscopy, where the spatial resolution is limited by the wavelength of the particles that are used to form the image, in a FIM microscope there is actually no resolution limitation and no aberration related to the presence of conventional optical elements due to the short DeBroglie wavelength of the ions, which are very massive.

The resolution of such a microscope can reach 0.2nm when the sample is maintained at a temperature of approximately 20K. The characteristic image obtained from an analysis performed with this method consists of a series of bright spots arranged along intersecting concentric rings. The rings correspond to the fundamental crystallographic atomic planes of the sample, while the bright spots are due to the ionisation phenomena occurring in these planes and give the position of the atoms on the sample. By precisely measuring the position and number of rings visible on the image, it is possible to reconstruct the topography of the sample in detail (Fig. 3.4).

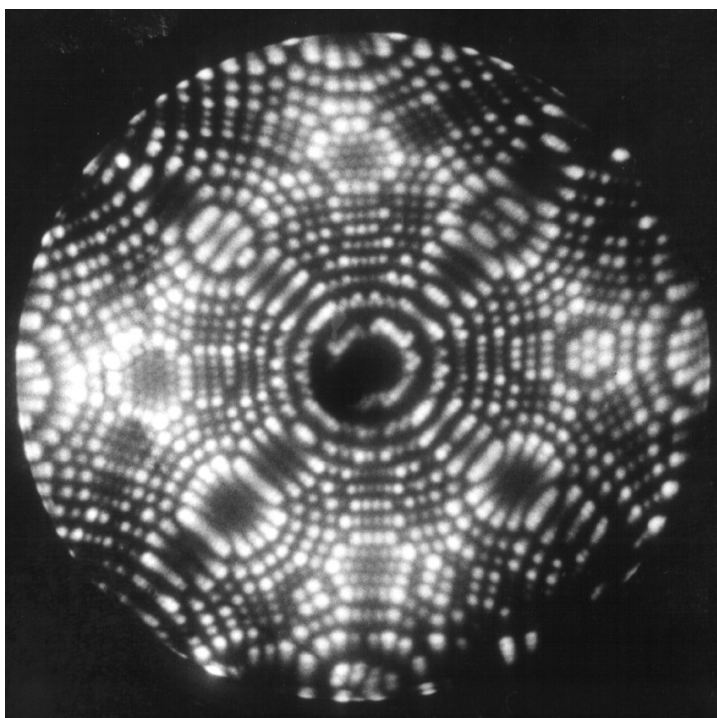

Fig. 3.4 FIM image of the tip of a Platinum needle. Source: Tatsuo Iwata, CC BY 2.0

In 1955, Müller, together with Indian microscopist Kanwar Bahadur, returned to the resolution of the FIM microscope.

The researchers observed that three factors determine image size. The first is related to the divergence of the ion orbits caused by the magnification of the tube, by straightforward central projection. The second factor is the velocity of the ions, i.e. the component parallel to the tip surface. The third is the diffraction due to the wave-like behaviour of the ions which can be well described by Heisenberg Uncertainty Principle.

The magnification of a FIM can be defined by the following relation.

$$M = \frac{R}{\beta r_0} \quad (3.1)$$

where R is the distance measured from the tip to the screen. In the formula, r_0 is the tip radius and β is what the authors call the “image compression factor”, a factor that takes into account the fact that the tip is not actually a simple suspended sphere but is shaped in a conical form; Müller and Bahadur found that, approximately, is $\beta = 1.5$. They defined the minimum image size with the formula:

$$\Delta_{min}^2 = 2\hbar \frac{\tau M}{m} + 4\bar{v}_y^2 \tau^2 \quad (3.2)$$

where the first term on the right contains \hbar so describing the effect of quantization and uncertainty, and the magnification M of the instrument. The second term is the image broadening defined with the flight time of the ion and the average tangential velocity. The time of flight can be well defined by the following relation:

$$\tau = R \sqrt{\frac{m}{2eV}} \quad (3.3)$$

They obtained the object side resolution dividing the equation (3.2) by M^2 and by extracting the square root of the expression obtained after a very simple algebra. It being:

$$R = \tau \sqrt{\frac{2eV}{m}} \quad (3.4)$$

we get:

$$\frac{\Delta_{min}^2}{M^2} = 2\hbar \frac{\tau M}{m} \frac{1}{M^2} + 4\bar{v}_y^2 \tau^2 \frac{1}{M^2} \quad (3.5)$$

Also:

$$M = \frac{R}{\beta r_0} = \frac{\tau}{\beta r_0} \sqrt{\frac{2eV}{m}} \quad (3.6)$$

so:

$$\frac{\Delta_{min}^2}{M^2} = 2\hbar \frac{\tau}{m} \frac{1}{M} + 4\bar{v}_y^2 \tau^2 \frac{1}{M^2} = \left[\frac{2\hbar r_0 \beta}{(2eV)^{1/2}} + \frac{2\beta^2 r_0^2 m \bar{v}_y^2}{eV} \right] \quad (3.7)$$

From the expression above Müller and Bahadur defined the object side resolution.

$$\delta = \sqrt{\frac{\Delta_{min}^2}{M^2}} = \left[\frac{2\hbar r_0 \beta}{(2eV)^{1/2}} + \frac{2\beta^2 r_0^2 m \bar{v}_y^2}{eV} \right]^{1/2} \quad (3.8)$$

If ions are considered, the first term on the right is approximately one–hundred times smaller than the one calculated for electrons and is then negligible. This term represents the square of the magnification–diffraction contribution. Also the second term will be smaller in the case of ions, if the transverse kinetic energy component depending on \bar{v}_y^2 is of the same size as the one of electrons. The researchers observed also that the tangential energy of the particles did not exceed kT because of the radial field and that most of the ionizations occurred when the molecules bounced back from the surface. Considering also that:

$$\frac{1}{2}mv^2 = \frac{3}{2}kT + \frac{1}{2}\alpha F^2 \quad (3.9)$$

where the kinetic energy is considered as the sum of two different terms, the well–known thermodynamic energy term, and the energy term due to the dipole attraction that is usually larger than the thermal energy.

According to the observations by Müller and Bahadur, helium proved to be the most suitable gas for operating a FIM because the value of α is small for this gas. They used noble gases, hydrogen, nitrogen, oxygen and mercury but were able to achieve the finest details in the helium–ion image of a tungsten tip. By using very small tip radii and high pressure achievable with helium they achieved the best resolution in imaging the sample.

3.1.2 1952: The First Image of a Nanotube

The end of the Second World War meant that Europe in particular had to deal on a daily basis with the opposition between two political blocs, NATO and the Warsaw Pact, which for decades marked the difference between what was considered the East and its counterpart, the West. Years of difficult exchanges, suspicions, physical barriers and prejudices, political and cultural barriers, the fall of which occurred just over thirty years ago, limited, if not completely precluded, the movement of ideas and scientific confrontation.

The language barrier of Slavic languages pitted against Western languages and vice versa has only exacerbated the difficulties and diffusion of the results of scientific research in all fields.

The example which I will illustrate below is emblematic from this point of view, as well as constituting a nodal point which can be historically relevant for the purposes of this retracing of important events in the development of the Nanosciences; it also opens up an interesting discussion of epistemology and critical analysis in different directions pertaining to the study of this new Condensed State Physics.

In 1952, an article appeared in the then Soviet Union (Fig. 3.5), signed by two scientists, Radushkevich and Lukyanovich (Radushkevich and Lukyanovich 1952), on the subject, entitled “*On the Carbon Structure Formed by the Thermal Decomposition of Carbon Monoxide on an Iron Contact*”, the dissemination of which in the West was limited by both the Russian language and the presence of what was known as the “Iron Curtain”, and remained unknown for decades in the West.

1952 ЖУРНАЛ ФИЗИЧЕСКОЙ ХИМИИ т. XXVI, вып. I

**О СТРУКТУРЕ УГЛЕРОДА, ОБРАЗУЮЩЕГОСЯ ПРИ
ТЕРМИЧЕСКОМ РАЗЛОЖЕНИИ ОКИСИ УГЛЕРОДА
НА ЖЕЛЕЗНОМ КОНТАКТЕ**

Л. В. Радушкевич и В. М. Лукьянович

Fig. 3.5 The title page of the article reporting the first observation of carbon nanotube structures. Retrieved via: <http://carbon.phys.msu.ru/publications/1952-radushkevich-lukyanovich.pdf>. Reproduced with permission of the Editorial Board of “Russian Journal of Physical Chemistry A”

The article was published in the Russian Journal of Physical Chemistry but, predictably, was not circulated in the West because of the increasingly insistent condition of the “cold war” between the two opposing blocs. If this fact can be reasonably justified from a geopolitical point of view, it is not difficult to understand how free thought found, for the same reasons, an insurmountable obstacle to its dissemination.

In the paper, the authors presented for the first time what had all the appearance and structure of single-walled carbon nanotubes.

They were already of the opinion that they had identified structures (Fig. 3.6) that had never been observed before, obtained precisely from the contact of carbon monoxide with an iron substrate, embedded in a kind of “soot”, as they describe it in the text. The authors report:

But already our first observations showed that the carbon formed in CO has a very peculiar structure that has not been described by anyone so far, and therefore our attention naturally turned to the

systematic study of this structure and also to the conditions of its formation²⁹ (Radushkevich and Lukyanovich 1952, translation: AD).

and then:

X-ray analysis can detect graphite crystals in carbon black and they are close to 75–100Å if the carbon black was obtained at temperatures between 400 and 700°C [...] The resulting carbon black was very loose and greasy to the touch and had the appearance of fluffy light lumps of intensely black colour. When grinded on paper or in a mortar, the graphite immediately had a characteristic metallic lustre. Such a condition made it extremely easy to prepare objects for study in an electron microscope³⁰ (*Ibidem*).

In the results of the analysis, described in the article, the authors report that:

As our observations have shown, carbon monoxide soot consists of very peculiarly shaped particles, and their individualization is not a great difficulty in examining the images obtained. The best insight into the external shape of individual CO soot particles is provided by photographs that show clusters of particles obtained by mashing the object into the film. Analysis of many such clusters leads to the conclusion that most of the particles have a characteristic worm-like shape. Although, at first sight, the shape of individual particles seems very different and random, it appears systematically in the images during repeated experiments. This makes it easier to classify the particles in terms of appearance. Concerning the size of worm particles one can note a great variety of length and width. Thus, on Fig. 1 in the upper left part the thinnest particles with diameter of about 0.03µm, on the lower right one can see particles with diameter of 0.2µm–0.3µm; on some images there are particles with diameter up to 0.5µm. The length of an individual particle in many cases exceeds 1µm and frequently reaches 5µm–7µm. It should be noted that the diameter is constant over the entire length of most particles³¹ (*Ibidem*).

²⁹ Но уже первые наблюдения, сделанные нами, показали, что образующийся из СО углерод имеет весьма своеобразную структуру, до настоящего времени никем не описанную, и поэтому, естественно, наше внимание было перенесено на систематическое изучение этой структуры, а также на условия образования.

³⁰ Рентгеновский анализ позволяет обнаружить в саже кристаллы графита и величина их лежит близко к 75–100Å если получение сажи производилось при температуре от 400 до 700°C [...] Полученная сажа была весьма рыхлой и жирной наощупь и имела вид пушистых легких комков интенсивно черного цвета. При растирании на бумаге или в ступке сразу же получался характерный металлический блеск графита. Такое состояние чрезвычайно облегчало приготовление из него объектов для изучения в электронном микроскопе.

³¹ Как показали наши наблюдения, сажа из окиси углерода состоит из частиц весьма своеобразной формы, причем индивидуализация их не представляет больших затруднений при рассматривании полученных снимков. Наилучшее представление о внешней форме отдельных частиц сажи из СО дают снимки, где имеются скопления частичек, полученных при затирании объекта в пленку. Анализ многих подобных скоплений приводит к заключению, что большинство частиц имеет характерную червеобразную форму. Хотя, на первый взгляд, форма отдельных частиц кажется весьма различной и случайной, все же при повторных опытах она систематически появляется на снимках. Это обстоятельство облегчает классификацию частиц по внешним признакам. Что касается размеров червеобразных частиц, то можно отметить большое разнообразие длины и ширины. Так, на рис.1 в левой верхней части видны наиболее тонкие частицы диаметром около 0.03µ, справа внизу мы замечаем частицы, диаметры которых достигают 0.2–0.3µ; на некоторых снимках встречаются частицы диаметром до 0.5µ. Длина отдельной частицы во многих случаях превышает 1µ и нередко доходит до 5–7µ. Следует отметить постоянство диаметра по всей длине большинства частиц.

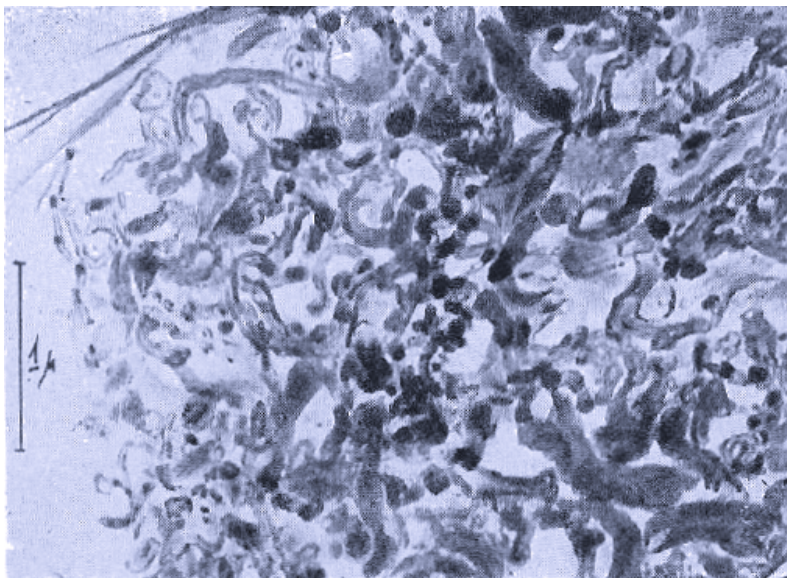

Fig. 3.6 The worm-like shaped particles observed in a cluster as described by the authors. Photograph reproduced with permission of the Editorial Board of “Russian Journal of Physical Chemistry A”

The conclusions reached by Radushkevich and Lukyanovich are the following ones.

1. When the structure of carbon monoxide carbon black was examined with an electron microscope, it was found that carbon black consists of particles of a complex structure. Most of the particles have an elongated worm-like shape with characteristic terminations, indicating the direction of growth.
2. Particles grown in some cases on single iron grains in CO atmosphere have regular filamentous shape with dense terminations. These particles consist of iron compounds, presumably carbides.
3. The authors consider it possible that the process of particle growth breaks down into two stages. In the first stage filamentous nuclei are formed as a result of a chemical reaction between CO and iron. In the second stage cross-sectional growth of particles occurs due to the formation of graphite crystals. Final grown particles are a product of growth and deformation of primary particles.
4. Unusual shapes of twin particles interlaced between each other were found. The formation of these aggregates proceeds according to a special mechanism, details of which await explanation³² (*Ibidem*).

³² 1. При исследовании структуры сажи из окиси углерода при помощи электронного микроскопа было обнаружено, что сажа состоит из частиц сложного строения. Большинство частиц имеет вытянутую червеобразную форму с характерными окончаниями, свидетельствующими о направленности роста.

2. Частицы, выращенные в некоторых случаях на отдельных крупинках железа в атмосфере CO, имеют правильную нитевидную форму с плотными окончаниями. Эти частицы состоят из соединений железа, по-видимому, из карбидов.

3. Авторы считают возможным, что процесс роста частиц распадается две стадии. В первой стадии образуются нитевидные зародыши в результате химической реакции взаимодействия CO с железом. Во второй стадии протекает поперечный рост частиц за счет образования на ней кристаллов графита. Окончательно выросшие частицы представляют собой продукт роста и деформации первичных частиц.

4. Обнаружены необычные формы сдвоенных частиц, переплетенных между собой. Образование этих агрегатов протекает по особому механизму, детали которого ждут своего объяснения.

Here it is very interesting to note how the lack, at that time, of a specific language forced the authors to resort to terms from biology when speaking of worm-like shapes. The prefix “nano”, moreover, would only be officially confirmed in 1960 by the Conférence Générale des Poids et Mesures (CGPM) along with others, which constrains the authors to express linear measurements in micrometres. This fact is important because it demonstrates, epistemologically, the evolution of the specific language in Science and at the same time allows us to note how a phenomenon that I can consider relevant in the historical course (the observation of these worm-like shapes, probably the first carbon nanotubes in History of Science) must be described with the language available in the early 1950s.

It is also interesting to outline this in the text of the original article. The paper contains a total of twelve pictures, of which four, namely 5, 7, 11 and 12, are enlargements, as can be seen from their caption in which it is possible to read, in all four cases, the wording $\times 20000$ (Fig. 3.7).

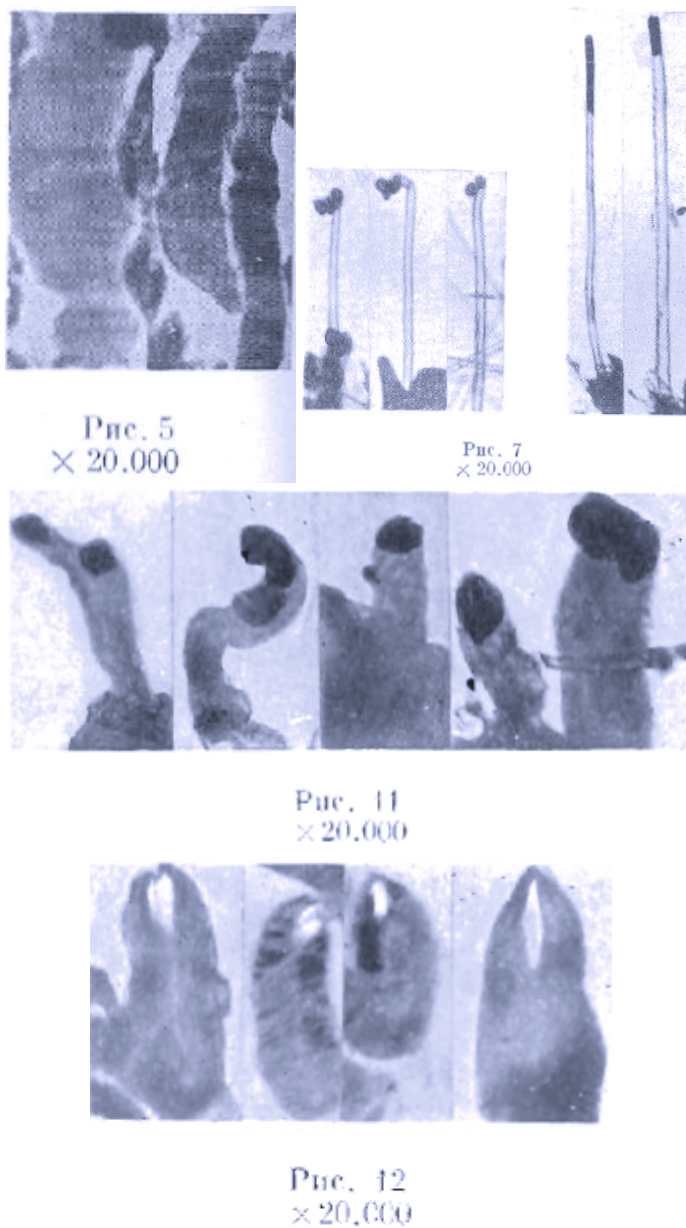

Fig. 3.7 Details of the carbon structures with magnification in pictures 5, 7 11 and 12. Photographs reproduced with permission of the Editorial Board of “Russian Journal of Physical Chemistry A”

In the other photographs, a label like those we are used to seeing in today’s electron microscopy photographs, indicating the voltage applied, the size of the sample observed, the magnification and a reference scale, is not present. The authors have limited themselves to indicating a segment next to which the indication 1μ appears for photographs 1, 4 and 6, and only a segment for the rest of the pictures (Fig. 3.8 and Fig. 3.9).

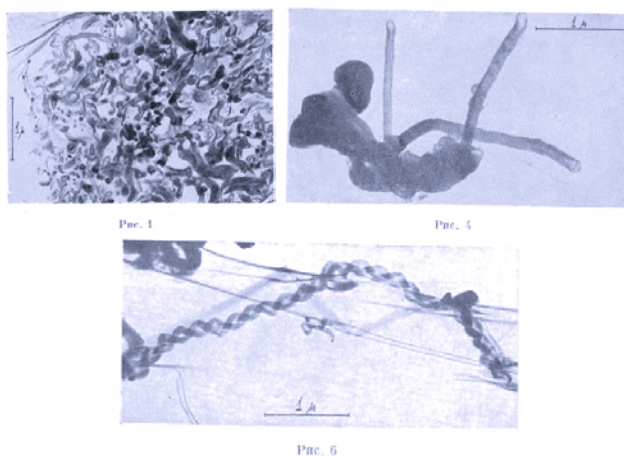

Fig. 3.8 Details of the carbon structures where a measure reference segment is illustrated within the images with measure added, in pictures 1, 4 and 6. Photographs reproduced with permission of the Editorial Board of “Russian Journal of Physical Chemistry A”

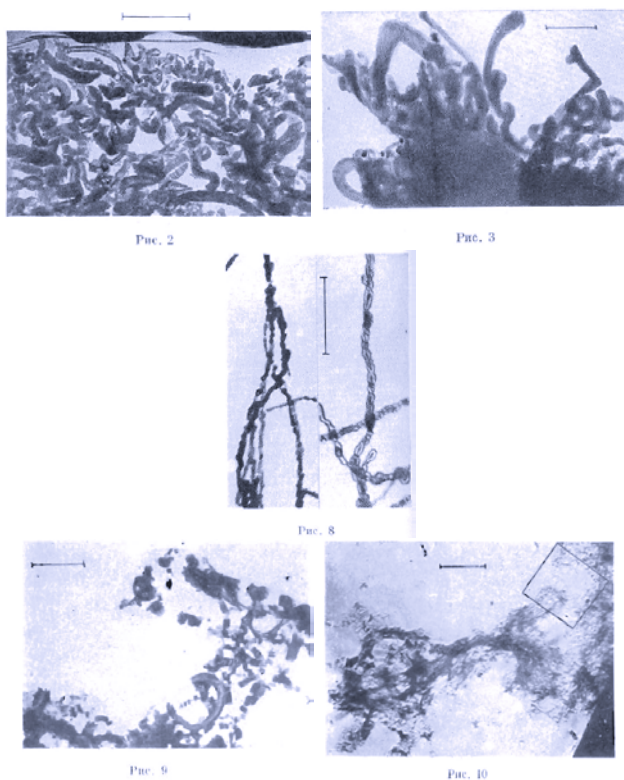

Fig. 3.9 The remaining pictures from the article where a measure reference segment only (no scale indicated) is illustrated. Photographs reproduced with permission of the Editorial Board of “Russian Journal of Physical Chemistry A”

The following consideration can be made with regard to this article. As has been pointed out in the literature (Monthioux and Kuznetsov 2006), the work of Radushkevich and Lukyanovich opens up an interesting discussion on to whom should be attributed the authorship of the first observation, given that in 1991 the name of Sumio Iijima would become universally known as the discoverer of multi-walled carbon nanotubes (MWCNTs). I will discuss Iijima's work in a later chapter, when I look at the discovery of MWCNTs. In fact, Radushkevich and Lukyanovich's observations are important for the History of Nanoscience that I am describing here, but they can be interpreted from a different point of view, and one that goes beyond simple "first to observe" attribution.

It must be kept in mind that forty years of technology separate the instrumentation available in 1952 from that which Iijima was able to use in his laboratories. This fact cannot and should not be overlooked, especially in light of the difference in resolution available between the equipment. Details that were not fully observable in the early 1950s became the subject of in-depth study towards the end of the millennium precisely because their observation became more accurate. The TEM microscope used by the Russian researchers did not allow them to observe the arrangement of carbon atoms on the wall due to instrumental limitations.

Secondly, it is worth pointing out that Radushkevich and Lukyanovich's research led, in its time, to a result which, strictly speaking, is different from Iijima's although it can be, in a very general way, assimilated in the same field of research, namely what would later be called the carbon nanotube field. Even the difference between Single-Walled and Multi-Walled Nanotubes was obviously still a long way off, in 1952.

What remains, from all these considerations, is that Radushkevich and Lukyanovich nevertheless observed long, hollow carbon filaments with a diameter of nanometre size. It is therefore not incorrect to say that they were the first to observe carbon nanotubes.

From their point of view, Monthioux and Kuznetsov add an interesting and articulate interpretation about the fact that forty years separate the work of Russian researchers from Iijima's discoveries. First, the fact that scientific research itself was not yet ready for the nanoworld, lacking favourable conditions such as dedicated theories, adequate instruments, and also a *forma-mentis* of the researchers towards this field of investigation. Monthioux and Kuznetsov define this situation as a not yet adequate "level of maturity of science". Again, in their opinion, the study of these structures between 1952 and 1991 was indeed carried out, but not with a view to studying their properties and their subsequent applications, but rather to prevent them from forming, causing problems, for example, in the conduction of steel production plants and in the cooling systems of nuclear reactors, the latter of which underwent considerable development in this period. These issues clearly have to do with engineering rather than physics. The authors also suggest that there is a lack of interest among researchers in publications on hollow carbon filaments, which are published in specialist journals and perhaps not to the attention of plant engineers or nuclear plant operators.

Iijima's article enjoyed a number of positive factors that gave the paper and the author great and well-deserved resonance. The ground had been prepared by the discovery of fullerenes, which the reader will find out about later, and the nanoworld was a fertile reality whose extraordinary potential in many fields of application was just beginning to be seen. The then recent discovery of fullerenes in 1985 is perhaps the most striking example. Moreover, Iijima's work, which I will describe later in this thesis, is supported by a high quality of research and writing, and was published in a journal of considerable scientific importance such as *Nature*, which is read by researchers from all fields.

The work of Radushkevich and Lukyanovich should not, however, be forgotten or set aside; it showed that already in the early 1950s, the observation and description of what would later be technically called carbon nanotubes was possible. This fact rightly places the authors within my research path and makes their work a fundamental stage in the History of Nanoscience and Nanotechnology.

3.1.3 1956: Molecular Engineering

Arthur Robert von Hippel (1898–2003) was the physicist and materials scientist who is credited not only with discovering the piezoelectric and ferroelectric properties of barium and titanium oxide BaTiO_3 , but also with proposing a concept of molecular engineering based on the actual construction of the materials required for technological development. This can be thought of as a first bottom–up approach to the realisation of new materials from the atomic or molecular dimension, which is why von Hippel can rightly be counted among the pioneers of modern nanotechnology and deserves to be mentioned in this paper (Fig. 3.10).

Molecular Engineering

A. von Hippel

Fig. 3.10 Headlines from the original article *Molecular Engineering*. Source: von Hippel (1956)

In his article *Molecular engineering*, von Hippel quotes:

What is molecular engineering? It is a new mode of thinking about engineering problems. Instead of taking prefabricated materials and trying to devise engineering applications consistent with their macroscopic properties, one builds materials from their atoms and molecules for the purpose at hand. This approach gives the engineer a true spiritual connection with modern science, a partnership, and a new freedom of action. He can conceive devices based on ideal characteristics and then, returning to the laboratory, inquire how far such characteristics can be made to order. He can play chess with elementary particles according to prescribed rules until new engineering solutions become apparent. He can be selective by insight, foreseeing inherent limitations of materials and making use of their actual capabilities. (von Hippel 1956)

There are several concepts in this passage that are worth analysing separately. The first relates to the possibility, hoped for by the author, of making the materials needed to solve the new engineering challenges, in this particular case, by obtaining them through the progressive “assembly” of the necessary atoms and molecules. The engineer sees new horizons, bound only by the rules identified in the research and the limits imposed by the materials and, presumably, the equipment available. There is also a hint of the transcendent,

when the author refers to a spiritual connection with science; one can theorise a point of view of the engineer as a creator of new materials when he is able to intervene, brick by brick, in the construction of new compounds with new characteristics, specifically indicated for the research in which the engineer is engaged.

At this point in his exposition, von Hippel emphasises how – it should be remembered that we are just under a decade after the end of the Second World War – the demand for new materials is excessively expensive and linked to an empirical approach, the application of materials that are already known. He also indicates how research times are too long, implicitly hoping for an acceleration in the methodologies and developments of research at lower costs, not unlike what happens today, in order to rapidly make innovative discoveries to be placed on the market as quickly as possible.

Von Hippel drew up almost a manifesto for molecular engineering, indicating precise guidelines between the worlds of education and research.

The transition from the phenomenological approach to matter to a “molecular engineering” has to be pioneered by the universities in a new teaching and research program that forgets about boundaries between departments as well as those between schools of science and engineering. It requires the generous cooperation of industry; it requires retraining of engineers in summer courses and by postgraduate fellowships; and last, not least, it requires a modest appraisal of the present capabilities of the new methods in competition with the established ones. In cases of great complexity, empirical experimentation may frequently still reach its goal faster than scientific analysis and synthesis. But the balance of power will shift rapidly to the molecular engineer as knowledge and experience grow (*ibidem*).

If, on the one hand, von Hippel looks to collaboration between the various departments and researchers, thus making several players responsible for research, on the other hand, one cannot fail to notice that he also states that there is a “power” which will be in the hands of the molecular engineer as knowledge progresses. The point in which von Hippel calls for the cooperation of industry must also be considered carefully: here we must ask ourselves whether, beyond the simple retraining of personnel – something that today resembles the concept of lifelong learning or professional development, as the case may be – there might be an interest in bending scientific research towards mere economic gain.

Von Hippel then gives a technical example, albeit a theoretical one, to illustrate the probable inadequacy of the materials then available to make an aircraft of the future, capable of travelling at speeds higher than those permitted in 1956, when supersonic speeds were only guaranteed for military aircraft. He assumes that the temperature of the outer structure of the aircraft of the future will be around 1000°F (about 537°C) due to air friction. Certainly von Hippel is correct in his assertion that no material at his disposal for fuselage construction is capable of reaching that temperature, but it is also true that he greatly overestimates; when the Aérospatiale–BAC Concorde entered service in the mid–1970s, at its maximum operational speed of Mach 2.2 it would still not have exceeded a temperature of 307°F (just under 153°C) at the nose cone. Von Hippel points out that no known material has probably ever been tested at high and critical temperatures, but once this has been done, he argues that it is possible to work on materials to achieve progressively better performance. The task of this development lies, according to von Hippel, with the molecular engineer, who knows the laws of chemistry and bonds, and his consequent ability to manipulate atoms and molecules from the ground up. The ability to work from the elementary building blocks opens up the possibility of creating a wide range of new

materials, the choice of which, depending on the specific application, will be made on the basis of a limited number of design specifications.

Let us now observe this passage.

After this prestudy has been made, a molecular analysis is required of the macroscopic phenomena to be controlled for safe operation of the aircraft: tensile strength, explosion temperature, electric failure, plasticity, and whatever else enters. What from a macroscopic point of view appears as a simple event, measured by a simple test and described by some simple parameters, is actually the outcome of complicated molecular events that, depending on circumstances, may take a variety of courses. Here lies the main fallacy of macroscopic testing: the belief that a material of the same chemical composition or trade name, subjected to the same test conditions, should give the same result. It frequently does not! For example, the mechanical or electric strength of materials thus measured varies within such wide limits that only a statistical evaluation can hide the bankruptcy of this test approach (*ibidem*).

Here we can find the first signs of what will happen with the development of actual nanomaterials. Von Hippel makes some considerations on macroscopic tests and observes how the same material subjected to the same tests can give rise to completely different results and how, consequently, a statistical approach to reading the final data is necessary. But it will be precisely the ability to manipulate atoms and molecules, even if not carried out exclusively by the molecular engineer, that will give rise to the study and development of Nanomaterials, whose properties will be completely different from those of bulk dimensions.

Von Hippel's thinking is oriented towards a future in which the development of new materials is almost unlimited. He sees no end to the possibilities of composing matter with the chemical elements available, and in the article he mentions 90 and more (at the time little more than 100 elements were actually known). Not only that, but also the opportunities offered by the control of new materials open up, in his thinking, enthusiastic scenarios of how elementary stones, as he indicates the elements, could in future enter into the design of materials through substitution phenomena. The number of substituents to be included in the new materials will depend on the new applications and their study must, in Von Hippel's view, be shared by several researchers from different fields.

For example, the engineer working in the classical way, in the 1950s, who is essentially a designer, will have to deal with physicists and chemists and master laboratory techniques which are typical of physics in that they are non-destructive, such as X-ray analysis, spectroscopy, electrical and magnetic measurements and nuclear magnetic resonance. Bringing these ideas into the perspective of the practical example of the plane of the future, he imagines interdepartmental laboratories for engineering and science that he defines molecular, the latter necessary to define an essential requirement of research, that allows the investigation of matter through molecular analysis to discover which factors, at this dimension, lead to consequences such as mechanical failures, electrical failures, even explosions, at a macroscopic level.

Such an organization in research is a stimulus, according to its thinking, critical thinking and shared evaluation of results, allowing a broader view of the approach to the problem, which involves multiple points of view. Any tool becomes relevant to get the solution of research problems.

At the end of his article, Von Hippel seems to dwell on the intent of the research with a statement that wishes to orient it from a certain ethical point of view. The first assertion in

the following excerpt is very significant and leaves the door open for very profound reflections.

The strong foundation is fundamental research leading into the unknown for the sake of knowledge only. After new knowledge has been acquired, questions can legitimately be asked about its practical implications. Thus, from the first floor of the house, mainly populated by scientists, we reach the second, where one dreams of long-range applications. Finally, when the implementation stage has been reached, the problem passes to the top floor for the development of prototypes (*ibidem*).

3.1.4 1958: The First Integrated Circuit

On September the 12th 1958, Jack St. Clair Kilby (1923–2005) invented the first integrated circuit in the History of Electronics when he was working for Texas Instruments. In 2000, “for his part in the invention of the integrated circuit”, he was awarded the Noble Prize in Physics.

In the 1960s, engineers were confronted with a design problem that came to be known as the “tyranny of numbers” and was related to the inability of the designed equipment to achieve the desired performance levels, due to the large number of components from which it had to be made. The lack of industrial automation available today meant that parts mostly had to be made and assembled by hand. In addition, the individual parts had to be interconnected with cables, which is why it seemed probable that the advancement of computers would lead to machines consisting essentially of cables only, to increase performance to the level of the design parameters.

The phrase “tyranny of numbers” first appeared in 1958 when the vice president of Bell Laboratories, electrical engineer Jack Andrew Morton (1913–1971), used it in a paper he published to celebrate the tenth year of the first computer.

For some time now, electronic man has known how “in principle” to extend greatly his visual, tactile, and mental abilities through the digital transmission and processing of all kinds of information. However, all these functions suffer from what has been called ‘the tyranny of numbers.’ Such systems, because of their complex digital nature, require hundreds, thousands, and sometimes tens of thousands of electron devices (Morton, in Love 1993).

At the dawn of the computer industry, these machines were built in a modular way, so that each single module could contain all the electronics needed to perform a single function; performing an apparently simple operation such as addition with devices of that time required the coordinated work of several modules. Not only that, but modules were not yet produced serially and, precisely because each was dedicated to a specific function, they were assembled ad hoc, with hand-welding and architectures that could be defined as customised for each purpose. Ducts or coaxial cables ensured the wiring of the elements and the transfer of information. It is understandable that the complexity of the objects and the difficulty in making them translated into almost inevitable problems of reliability, because it could be enough to have a failure in a single component to bring the whole apparatus to a standstill.

In order to overcome this difficulty and provide electronic devices with a reliable and satisfactory architecture, Jack Kilby set to work on a single-sheet component that could combine the various functionalities on a single module. As is sometimes the case with scientific discoveries, it was a series of very peculiar events that led Kilby to set about

solving this problem. He arrived at the solution on a day when the laboratories at Texas Instruments were deserted due to staff holidays. Having only just been hired, Kilby was not yet entitled to a summer holiday, and in the heat of July 1958 he set to work sketching out his ideas for an alternative to the “tyranny of numbers”.

He was able to present the solution to the problem on 12 September 1958, having had the insight that the components of a circuit could all be made together on a single semiconductor substrate. With the help of an oscilloscope, Kilby proved that his device could produce a sine wave and was, in fact, operational.

The next image (Fig. 3.11) shows the original circuit that Kilby used for his demonstration to the company’s management.

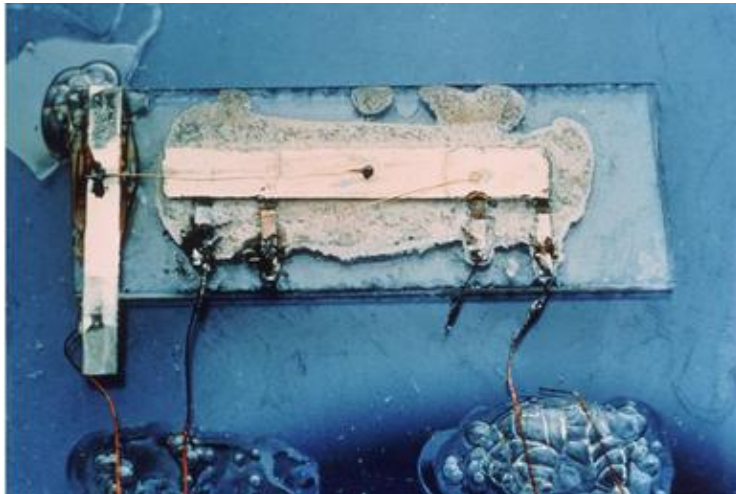

Fig. 3.11 The original hybrid integrated circuit that Jack Kilby realized at Texas Instruments, in 1958. This is, historically, the first integrated circuit ever and Kilby accomplished his task using germanium. Picture reproduced under permission of Texas Instruments

Kilby’s description of the invention was filed by the patent office on 6 February 1959 under serial number 791.602 and officially patented on 23 June 1964. If we read the official text of this patent, which is easily available online, we cannot fail to notice that Kilby describes in the first paragraphs the procedure for miniaturising electronic circuits as it was carried out in those years.

Many methods and techniques for miniaturizing electronic circuits have been proposed in the past. At first, most of the effort was spent upon reducing the size of the components and packing them more closely together. Work directed toward reducing component size is still going on but has nearly reached a limit. Other efforts have been made to reduce the size of electronic circuits such as by eliminating the protective coverings from components, by using more or less conventional techniques to form components on a single substrate, and by providing the components with a uniform size and shape to permit closer spacings in the circuit packaging therefor (Kilby 1959).

Not only that, but he then goes on to list seven steps, what he considers to be the minimum number of actions, required to fabricate resistors, the simplest circuit element. They are the

formation of the substrate and its subsequent preparation, the application of the terminations, the preparation and subsequent application of the resistor material, the heat treatment of the resistor, and its protection or stabilisation. The fate of the other circuit elements, as far as their realisation is concerned, is not very different, according to Kilby, indeed it may involve a further number of steps some of which are not compatible with each other. A heat treatment required to protect one component of the circuitry might be inadequate and damage a second, and so on.

To solve the problem, as we read in the patent text, Kilby proposed a totally different approach to the current concept of miniaturisation, requiring the use of as few operations and as few materials as possible. He actually reduced the number of materials, using only one for all the circuit elements.

[...] by utilizing a body of semiconductor material exhibiting one type of conductivity, either n-type or p-type, and having formed therein a diffused region or regions of appropriate conductivity type to form a p-n junction between such region or regions and the semiconductor body or, as the case may be, between diffused regions. According to the principles of this invention, all components of an entire electronic circuit are fabricated within the body so characterized by adapting the novel techniques to be described in detail hereinafter. It is to be noted that all components of the circuit are integrated into the body of semiconductor material and constitute portions thereof (*ibidem*).

The main purpose of his invention was to provide a miniaturized circuit based, above all, on a new concept made from a single body of semiconductor material containing a diffuse p-n junction, and that it housed all the components of the circuit that are thus “integrated” in the body of the semiconductor material.

3.1.5 1959: “There’s Plenty of Room at the Bottom”

29 December 1959 is a date that will live on in the History³³ of Science.

On that day, in Pasadena, Richard Phillip Feynman (1918–1988) gave a lecture at the annual meeting of members of the American Physical Society. The text of his speech became famous in the History of Physics. The following year, in February 1960, Caltech’s Engineering and Science magazine published an article based on the text of the lecture, under the name *There’s Plenty of Room at the Bottom. An invitation to enter a new field of physics* (Fig. 3.12).

³³ Franklin Delano Roosevelt spoke to a joint session of the U.S. Congress on December 8, 1941, the day after the attack on Pearl Harbor. The original line of his speech, before the revision that made it famous, quoted “a date which will live in world history”; it was later changed to the nowadays well-known “a date which will live in infamy”. December 29, 1959, is for sure a day that is part of History of Science.

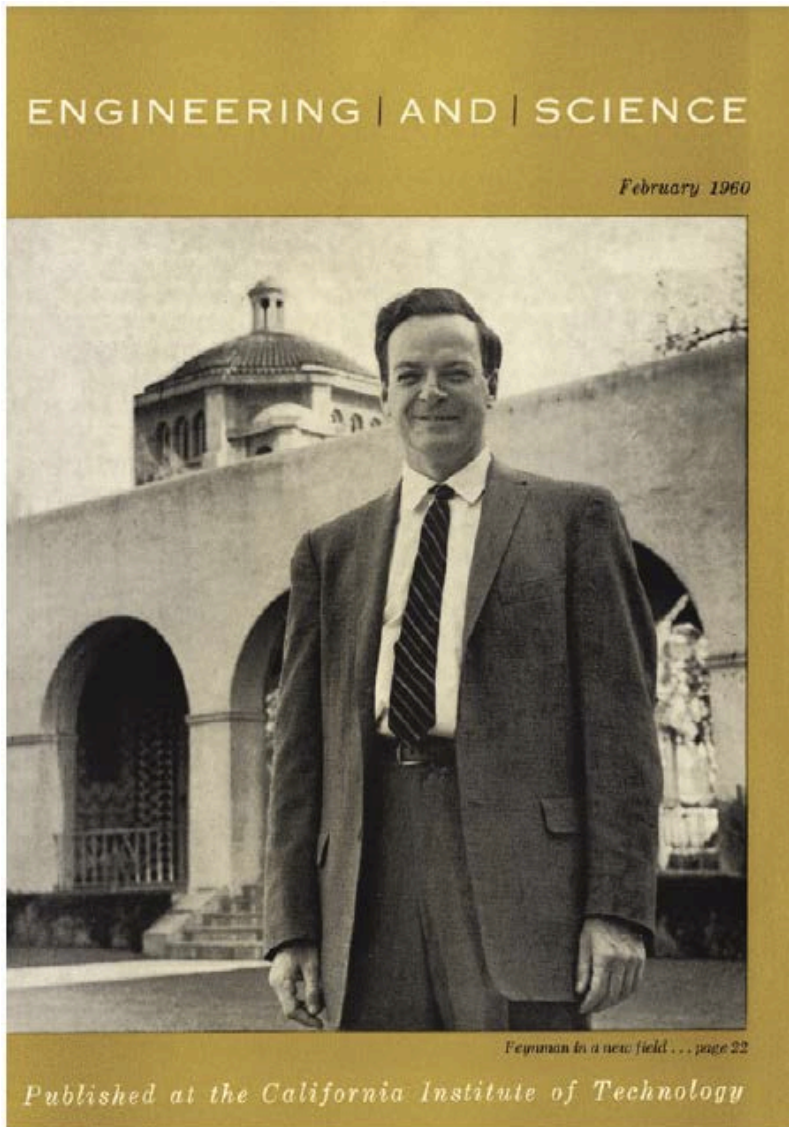

Fig. 3.12 In this issue of *Engineering and Science* lies “Feynman in a new field”, more precisely on page 22. The first edition of the transcription of “There’s Plenty of Room at the Bottom” is here (Toumey 2005). Source: Courtesy C. Toumey

This was made possible thanks to the passionate work of an anonymous admirer of Feynman. Using a magnetic tape recorder, he recorded every moment of the American physicist’s talk and then transcribed it meticulously, verbatim. Thus, the article we know today is an exact account of what was actually said that evening. For all intents and purposes, the only parts missing are the jokes that Feynman inserted – as was usual in a talk in the United States – in his speeches, perhaps to maintain the listeners’ attention. These cuts seem to have been an editorial choice, to allow easier publication in the Caltech

magazine, and in no way affect the scientific content of the conference. “Plenty of Room” (henceforth POR) was considered, and still is considered, to be the founding paper of an exciting new set of research fields, which today are grouped under the collective name of Nanotechnology, practical applications of a science that investigates the physical world at the nanoscale, and which has taken the name Nanoscience (Fig. 3.13).

There’s Plenty of Room at the Bottom

An invitation to enter a new field of physics.

by Richard P. Feynman

I imagine experimental physicists must often look with envy at men like Kamerlingh Onnes, who discovered a field like low temperature, which seems to be bottomless and in which one can go down and down. Such a man is then a leader and has some temporary monopoly in a scientific adventure. Percy Bridgman, in designing a way to obtain higher pressures, opened up another new field and was able to move into it and to lead us all along. The development of ever higher vacuum was a continuing development of the same kind.

I would like to describe a field, in which little has been done, but in which an enormous amount can be done in principle. This field is not quite the same as the others in that it will not tell us much of fundamental physics (in the sense of, “What are the strange particles?”) but it is more like solid-state physics in the sense that it might tell us much of great interest about the strange phenomena that occur in complex situations. Furthermore, a point that is most important is that it would have an enormous number of technical applications.

What I want to talk about is the problem of manipulating and controlling things on a small scale.

As soon as I mention this, people tell me about miniaturization, and how far it has progressed today. They tell me about electric motors that are the size of the nail on your small finger. And there is a device on the market, they tell me, by which you can write the Lord’s Prayer on the head of a pin. But that’s

nothing; that’s the most primitive, halting step in the direction I intend to discuss. It is a staggeringly small world that is below. In the year 2000, when they look back at this age, they will wonder why it was not until the year 1960 that anybody began seriously to move in this direction.

Why cannot we write the entire 24 volumes of the Encyclopaedia Britannica on the head of a pin?

Let’s see what would be involved. The head of a pin is a sixteenth of an inch across. If you magnify it by 25,000 diameters, the area of the head of the pin is then equal to the area of all the pages of the Encyclopaedia Britannica. Therefore, all it is necessary to do is to reduce in size all the writing in the Encyclopaedia by 25,000 times. Is that possible? The resolving power of the eye is about 1/120 of an inch – that is roughly the diameter of one of the little dots on the fine half-tone reproductions in the Encyclopaedia. This, when you demagnify it by 25,000 times, is still 80 angstroms in diameter – 32 atoms across, in an ordinary metal. In other words, one of those dots still would contain in its area 1,000 atoms. So, each dot can easily be adjusted in size as required by the photoengraving, and there is no question that there is enough room on the head of a pin to put all of the Encyclopaedia Britannica.

Furthermore, it can be read if it is so written. Let’s imagine that it is written in raised letters of metal; that is, where the black is in the Encyclopaedia, we have raised letters of metal that are actually 1/85,000

“There’s Plenty of Room at the Bottom” is a transcript of a talk given by Dr. Feynman on December 29 at the annual meeting of the American Physical Society at Caltech.

22

Engineering and Science

Fig. 3.13 The first page of the famous text from Richard Feynman. This is what we are discussing here: is this a necessary milestone, mandatory to start a new branch of Physics, or is it just an important document in History of Science? More likely, it is something in between. Source: Feynman (1960)

How important POR has become in the historical landscape of science can be easily deduced from the following observation. When consulting the historiography on Nanotechnologies, one is very likely to come across introductory historical paragraphs – or more problematically entire chapters – which mention POR as an essential starting point, referring precisely to Feynman’s intuition towards this research, and emphasising how greatly the article has been a source of inspiration for researchers.

By picking up the manuscript, and reading some of its passages, one can grasp those ideas that made it popular and may have inspired the research.

I would like to describe a field, in which little has been done, but in which an enormous amount can be done in principle. This field is not quite the same as the others in that it will not tell us much of

fundamental physics (in the sense of, “What are the strange particles?”) but it is more like solid–state physics in the sense that it might tell us much of great interest about the strange phenomena that occur in complex situations. Furthermore, a point that is most important is that it would have an enormous number of technical applications. What I want to talk about is the problem of manipulating and controlling things on a small scale. As soon as I mention this, people tell me about miniaturization, and how far it has progressed today. They tell me about electric motors that are the sizes of the nail on your small finger. And there is a device on the market, they tell me, by which you can write the Lord’s Prayer on the head of a pin. But that’s nothing; that’s the most primitive, halting step in the direction I intend to discuss. It is a staggeringly small world that is below. In the year 2000, when they look back at this age, they will wonder why it was not until the year 1960 that anybody began seriously to move in this direction. Why cannot we write the entire 24 volumes of the *Encyclopedia Britannica*³⁴ on the head of a pin? (Feynman 1960)

Starting from these words, we could really think that we are facing the document that not only refers to the investigation of matter at the solid state down to the nanometric dimension, but also to the foundation of a completely new science, which will be called Nanoscience, and its fields of research and application, Nanotechnology. In a later paragraph it is possible to read:

A biological system can be exceedingly small. Many of the cells are very tiny, but they are very active; they manufacture various substances; they walk around, they wiggle; and they do all kinds of marvelous things—all on a very small scale. Also, they store information. Consider the possibility that we too can make a thing very small which does what we want—that we can manufacture an object that maneuvers at that level! [...] A friend of mine (Albert R. Hibbs) suggests a very interesting possibility for relatively small machines. He says that, although it is a very wild idea, it would be interesting in surgery if you could swallow the surgeon. You put the mechanical surgeon inside the blood vessel and it goes into the heart and “looks” around (Of course the information has to be fed out). It finds out which valve is the faulty one and takes a little knife and slices it out. Other small machines might be permanently incorporated in the body to assist some inadequately–functioning organ (*Ibidem*).

Such a profound statement is prophetic, to say the least, since today much of the research in the nanoworld is oriented towards Nanomedicine, precisely because one of the most explored and fundamental characteristics of certain types of nanoparticles is their ability to release, with absolute precision, the active ingredient of a drug, without waste or without affecting other parts of the body other than those in need of treatment.

On the basis of these brief considerations, we propose to investigate the validity, or otherwise, of the interpretative paradigm that has set POR as a milestone in the history of nanotechnology. With the help of various documents, through which it is possible to become aware of different opinions on the subject, we will compare the paradigmatic narrative relating to the state–of–the–art of the classical interpretation with other possible ones.

Let us now try to place POR within the historical and epistemological panorama, in order to establish the fixed points from which to start discussing its interpretation.

Generally speaking, Modern Science fits into the last four hundred years of human history, a decidedly narrow time span, if we agree in establishing the appearance of Man on Earth between 2.3 and 2.4 million years ago, without pushing the date back even further, to the speciation of hominids, about 5 million years ago. Yet it is not only the practical applications of science, as it is conceived today, that have transformed man’s life and, in

³⁴ This is the way it is spelled in the original paper. The same can be said for the misspelled words in the second quotation.

many cases, improved its quality, but also the cognitive achievements, the development of new theories that have opened up the horizons of the mind (Selleri 1989).

The birth of Modern Science is a phenomenon of extreme complexity, whose origins date back to the Renaissance, when the study of the world became observational, practical, qualitative, and then firmly rooted in the scientific method as we know it today, when the phenomenon became observable, susceptible to explanatory hypotheses, verifiable, reproducible by anyone. Speculative investigation, limited to the metaphysical sphere, no longer had a place in science.

Well, science passes through characters and revolutions that often meet together, Copernicus and his heliocentric revolution, Newton and the revision of Aristotle's physics, Einstein and Newton's overcoming of absolute space and time. Each of these revolutions consists of going beyond a previous system of assertions by a new intellectual paradigm – in the sense defined by Thomas Kuhn (1922–1996) – that is new and sufficiently attractive to thinkers, and also capable of leaving room for the development of thought and the solution of the problems it poses, to the new groups of researchers who approach it.

Nanotechnology has to all intents and purposes been a revolution in the world of science, and has been at its peak in recent years. It consists of applying the properties that materials exhibit when used at nanometric dimensions and has literally opened up a world of opportunities in the most diverse technological fields. Through nanotechnology, the physics of the solid state has been studied from a completely different point of view; the same material has completely different properties depending on its size. This constitutes a revolution in the interpretation of matter itself, to which certain laws apply at the macroscopic level and different, quantum effects apply at the nanometric level. What is required, therefore, is a new interpretative paradigm of the physical phenomenon itself, certainly not the total abandonment of the previous conceptual system, but a parallel one that depends on the size of the sample and the properties that emerge precisely as a function of it.

Moreover, it is not only the interpretative idea of a new concept in the field of scientific thought that comes into play when we speak of a revolution.

Many scientific revolutions also seem to be linked to a reference text, the cornerstone of the new order of thought, which becomes the starting point of the new scientific development, both practical and theoretical. This is the case with Nicolaus Copernicus's *De Revolutionibus Orbium Caelestium*, Isaac Newton's *Philosophiae Naturalis Principia Mathematica*, and Albert Einstein's *Zur Elektrodynamik bewegter Körper*. Each of these writings is unanimously recognised as a landmark text because of the revolution in thought it triggered.

The same idea seems to apply to the writing *There's Plenty of Room at the Bottom*, the title of which we would like to quote in full here. It can be recognised as the founding document of a new vision and revolution in the field of science, at the level of the structure of condensed matter. Seeking confirmation for such an assertion could be simple if we simply consider the number of citations we can find in the literature in this precise sense, and the fact that there has apparently never been any discussion of this interpretation. In this case, some researchers who pursue this interpretation are still alive and have personally known Richard Feynman. In this sense, the discussion of the paper with the author may have led to the reinforcement of this conception.

Let us look at some examples that support this idea.

The first scientist we want to mention, and most probably the one who contributed significantly to the amplification of the thought that Feynman encapsulated in POR, is Kim Eric Drexler who, in his text *Engines of Creation*, mentions this concept.

On December 29, 1959, Richard Feynman (now a Nobel laureate) gave a talk at an annual meeting of the American Physical Society entitled “There’s Plenty of Room at the Bottom”. He described a non-biochemical approach to nanomachinery (working down, step by step, using larger machines to build smaller machines), and stated that the principles of physics “do not speak against the possibility of maneuvering³⁵ things atom by atom. It is not an attempt to violate any laws; it is something, in principle, that can be done; but in practice, it has not been done because we are too big [...]”. In brief, he sketched another, nanobiochemical path to the assembler. [...] Richard Feynman saw in 1959 that nanomachines could direct chemical synthesis, presumably including the synthesis of DNA. Yet he could not foresee neither the time nor the cost of doing so (Drexler 1986).

Drexler inserts these considerations in a paragraph – *Pitfalls of Prophecy* – in which he comments on the value of prediction, in the scientific field. Drexler’s idea is that, despite the inherent difficulty of such speculation, prediction must always be undertaken. In this regard, mention is made of the case relating to the design of the Space Shuttle when, beyond the actual possibility of realising the project, the forecasts of both times and costs had turned out to be wrong (however, stopping neither the development nor the subsequent operational service).

But we have to try to predict and guide development (*ibidem*).

Not only that, Drexler goes into considerations through which he seeks to reinforce his own view.

The nuances of detail and competitive advantage that select winning technologies make the technology race complex and its path unpredictable. But does this make long-term forecasting futile? In a race toward the limits set by natural law, the finish line is predictable even if the path and the pace of the runners are not. Not human whims but the unchanging laws of nature draw the line between what is physically possible and what is not—no political act, no social movement can change the law of gravity one whit. [...] We have only recently begun to evolve a tradition of technological foresight (*ibidem*).

In the bibliography of the quoted text, the reference leaves the reader in no doubt.

13. In 1959, Richard Feynman proposed that nanoscale mechanical devices could build atomically precise structures by manipulating matter at the atomic level: “There’s Plenty of Room at the Bottom” (Drexler and Pamlin 2013).

In this book, Feynman’s name appears only twice, in the quotations we have given, and despite this small number of references the link between the idea of nanotechnology, the character and the seminal paper is evident nonetheless. No mention is made of the man who actually coined the term *Nanotechnology*, Norio Taniguchi, who we have already mentioned.

In several other books it is possible to find quite similar quotations, which follow the same narrative thread, remaining faithful to this basic interpretation.

³⁵ Original misspelling.

The book *The Nanotech Pioneers* (Edwards 2006) by Edwards dedicates a special paragraph to the figure of Feynman, where the author quotes POR in the light of Feynman's personality.

Feynman was also known to have a great sense of humor [...]. Which is probably why most of his audience at the American Physical Society on December 29th, 1959, did not take his lecture that day too seriously. The lecture was entitled “There's Plenty of Room at the Bottom”. [...] In his short essay, Feynman anticipated much of what we see developing in nanotechnology today. He pointed out that the electron microscopes of the day were operating well below their limit of resolution. He challenged physicists to improve the resolution such that the machines would be powerful enough that biologists could see directly the interaction of molecules within cells, that DNA might be sequenced simply by looking at it. He even suggested that miniature robots that could operate within our bodies [...]. Feynman suggested a top-down approach toward manufacture whereby miniature tools sets would be used to make more miniature tools sets, which would in turn make yet smaller tools, until finally we would be able to work at the nanoscale. [...] Actually, nobody seriously began moving in that direction for another twenty years. Feynman's lecture, though published in 1960 was largely forgotten. Feynman's own autobiography doesn't even mention the Room at the Bottom talk [...] (Edwards 2006).

It is interesting to note this kind of oblivion into which POR, which Edwards quotes, would fall, and to which we shall return later.

In Pradeep's text *Nano: The Essentials* (Pradeep 2007) the words are in fact the same as those used by Drexler, with the exception of the formatting of the article's title.

On December 29, 1959, the Nobel prize winning physicist Richard Feynman gave a talk at the annual meeting of the American Physical Society entitled “There's Plenty of Room at the Bottom” (Pradeep 2007).

Even a popular and easy-to-read text like *Nanoworld*, by Romero (Romero 2016) links Feynman and POR to the very early days of nanotechnology.

One of the first messages that announced and amplified the possibilities of nanotechnology was launched by physicist Richard Feynman [...], who gave a lecture at the American Physical Society congress held on December 29, 1959, entitled “There's Plenty of Room at the Bottom”, in which he speculated on the manipulation of individual atoms. However, his vision was ignored for many years, until the convergence of nanotechnics and nanomaterials made possible the emergence of nanotechnology. Only then did we rediscover Feynman's vision of what he had not yet been able to call nanotechnology [...] (Romero 2016).

Romero correctly cites Taniguchi as the first researcher to coin the term *Nanotechnology*; however, it is curious how the excerpt we have quoted begins with “one of the first messages he announced and amplified” and then slides to “his vision was ignored for many years”, almost in a self-contradictory loop of statements.

In 2019, the Mathematics and Physics text *Mathematics and Physics for Nanotechnology* by Di Sia brings nanophysics back to Richard Feynman, rather loosely.

Nanophysics is commonly referred to as an intuition of Richard Feynman; in a famous conference of December 1959 by California Institute of Technology, he made forecasts around the possibility to control the matter and to realise devices at atomic scale, anticipating a great fields variety of scientific research and technical applications, that currently appear to be well developed (Di Sia 2019).

It should be noted that not even a reference to the title of the article appears here, and it almost seems as if the author wishes to avoid excessive in-depth study, which is

understandable since the History of Science is not the focal point of the text. Moreover, any other historical information is contained in a very limited paragraph.

The idea of Sanders (2019) in his book *Basic Principles of Nanotechnology* is interesting, in fact.

Richard Feynman was a Nobel Prize-winning physicist who presented a now famous lecture on atom-by-atom assembly. The lecture is often credited with kick-starting nanotechnology (Sanders 2019).

Here the focus is shifted to the conference itself and no longer to Feynman, who could thus be relieved of the historical responsibility for the authorship of nanotechnology; the author, moreover, underlines the fact that the conference has only recently gained notoriety, when he says “now a famous conference”.

In Sharon’s book *History of nanotechnology. From Prehistoric to Modern Times* (2019), the issue is addressed in a general way, and the author’s words are very explicit.

It is generally considered that the modern-day history of nanotechnology started from a speech by Richard Feynman entitled “There’s Plenty of Room at the Bottom”, which was given at an American Physical Society meeting at the California Institute of Technology in 1959 in which he identified the potential of nanotechnology. He did not use the word nanotechnology. He only stated the possibility of manufacturing small machines and objects with atomic precision. Norio Taniguchi first used the term “nanotechnology” in 1974 (Sharon 2019).

Here we can see how the beginning of nanotechnology is clearly traced back to Feynman’s speech, and how it is mentioned that Feynman never used the word *Nanotechnology*, a circumstance that is easily confirmed in the original text. In the following, the attribution of this term is correctly traced back to Taniguchi.

An interesting point of view is the one expressed by Durkan in his text *Size Really Does Matter* (2019), when the author points out that “There’s Plenty of Room at the Bottom” is a refrain that he has heard so many times, that it has entered his mind like a woodworm, like the lyrics of a song, to refer to the possibility of investigating matter at nanometric size and discovering its properties. In spite of everything, Durkan says that this sentence, which quotes word for word the title of the article whose influence on nanotechnology scientists we want to investigate, was a fundamental, pivotal point, and proved prophetic. His comments and remarks are addressed to POR.

[...] many of these predictions about Nanotechnology have come true, so his insightful talk back in 1959 has served as a valuable roadmap, at least in hindsight. Feynman’s talk is now the most commonly cited in the history of Nanotechnology, even though the field really kicked off over 20 years after he gave it, and it only became widely known by that generation of scientists after the publication of Eric Drexler’s book on molecular machines in 1986 wherein Drexler took Feynman’s ideas quite a bit further and into the public domain (Durkan 2019).

After this quote, we can see how Durkan points out that POR seems to be the most cited paper in the history of nanotechnology. Such a statement could lead us to think of this article as the essential starting document for the history of the nanoworld.

Not only the textbooks we have briefly reviewed, but also many articles on nanotechnology and its applications make mention of both Richard Feynman and POR, when we can find a brief historical introduction in them. In this respect, it is interesting to re-read the words used by Bensaude-Vincent and Simon in their article (2019), because they report both Feynman and Drexler in two different ways.

Is there still room at the bottom? The question providing the theme for the present issue of *Philosophia Scientiae* is, of course, adapted from Richard Feynman's well-known speech at the 1959 meeting of the American Physical Society. On this occasion he attracted physicists' attention to the vast potential of working at the scale of the nanometer if not the ångström using a catchy title: "Plenty of Room at the Bottom". This hookline from a famous Nobel laureate physicist served as a motto for the emerging field of nanoscience and nanotechnology (which we will here abbreviate to nanoresearch) in the early 2000s (Bensaude-Vincent and Simon 2019).

Here we can see a different mention of the title, along with the authors' comments that dwell on Feynman's dialectical ability to appeal to the audience regarding the potential of nanoscale applications, if not at the ångström level. We know, in fact, from the original text that Feynman only mentioned the latter unit of measurement, since the nanometre was not introduced until 1960. We can agree with the authors of the article that the title of the conference went down in history as an invitation to go and investigate and work with matter at the nanometric scale, to discover its potential and new fields of application. A subsequent quote on Drexler restores the importance of the amplification of Feynman's ideas through the work of Drexler himself.

Feynman's futuristic visions of miniaturised machines and information systems were communicated to a wider general public by K. Eric Drexler, the self-appointed prophet of the coming nanotechnological revolution, in his successful 1986 book *Engines of Creation*. In his energetic campaign for a nanotechnology revolution, Drexler featured Feynman as the founding father of the nanotechnology era (*Ibidem*).

These are very clear words and reinforce the idea of Feynman as the father of nanotechnology through Drexler's thinking, which is oriented in this sense.

In the words of Bayda and his co-authors (2019) we find a classic narrative that identifies Feynman as the founder of nanotechnology. The statement is very firm in its terms.

The American physicist and Nobel Prize laureate Richard Feynman introduced the concept of nanotechnology in 1959. During the annual meeting of the American Physical Society, Feynman presented a lecture entitled "There's Plenty of Room at the Bottom" at the California Institute of Technology. In this lecture, Feynman made the hypothesis "Why can't we write the entire 24 volumes of the Encyclopedia (at this point Bayda corrects the original) Britannica on the head of a pin?", and described a vision of using machines to construct smaller machines and down to the molecular level. This new idea demonstrated that Feynman's hypotheses have been proven correct, and for these reasons, he is considered the father of modern nanotechnology (Bayda *et al.* 2020).

The fact that atomic manipulation, carried out in the 1980s, made it possible to intervene at the nanoscale, made it possible to confirm Feynman's vision, and Bayda suggests that for this precise reason he can be crowned as the father of nanotechnology. Further on we can read:

After Feynman had discovered this new field of research [...] (*ibidem*).

Here the attribution of the authorship of nanotechnology to Feynman seems to be evident, and the POR citation remains limited to the title of the conference.

In the examples, we have given different ways of reading both POR and Feynman's role in the early days of nanoscience. Sometimes POR is cited as the seminal paper, sometimes it is used only as the title of the conference. However, the figure of Feynman is often cited in order to identify the source of inspiration for the research that was to follow.

Several interpretations are therefore possible.

The first, and by far the most classic, dates the birth of nanotechnology to 29 December 1959 and to Richard Feynman, with absolute certainty. According to this interpretation, without Feynman's vision, which would later be amplified by Drexler, and without the POR transcript that allowed Feynman's thought to be disseminated, nanotechnology would lack both a founding father and an essential reference document. According to this point of view, it is legitimate, if not actually right, to think that a scientific revolution needs a personage who is above the rest, in terms of intuition, ability to see beyond and ability to pursue his or her own vision, as well as a document from which everything could have originated, which constitutes a clear source of inspiration and from which a completely new path was started. Last but not least, a precise date is also crucial from this point of view, because it marks the discontinuity with the past and chronologically identifies the moment of the fundamental transition to a new physics, in our case. We have seen that important moments of rupture in the physical sciences have been characterised by all three of these premises: who, when, through what document. There are many interpretations of this.

A second interpretation relieves, in a more or less partial way, Richard Feynman of the paternity of nanotechnology at all costs; POR becomes the account of a conference during which an "amused audience" was able to watch and listen to Feynman's ideas, ideas that would be realised much later in time, due to an objective lack of technical means available. We will examine in a later section, however, how this fact can be the subject of various reinterpretations which, in turn, open up an interesting debate. There is no need, in this case, to link the birth of a science at all costs to a name, a date, a writing. This interpretation remains, in a sense, freer from the genesis of the official narrative of the scientific–historical event, since it does not have to fulfil the requirements we have listed for the first case.

In principle, none of these interpretations is a priori wrong. In what follows, however, we shall also examine another point of view, supported by direct evidence, from which we believe new avenues of discussion can be opened up concerning the interpretation of POR, and its role in the history of nanotechnologies.

We have already mentioned several times the principle held true by most that considers POR as the founding document of current Nanotechnology and the inspiration for many scientists in this field of research. According to the History of Science and, in particular, the History of Nanotechnology, POR is an essential step without which, in all likelihood, the evolution of Nanoscience and Nanotechnology would have followed a completely different path. However, a different interpretation of this paradigm – very interesting and suggesting many points to think about and discuss – was proposed in a 2008 article by Christopher Toumey, of the USC NanoCenter, University of South Carolina, USA. Toumey focused on the validity of the paradigm that wants POR as an essential document in the History of Nanotechnologies, and made some reflections that he supported with interesting interviews with those scientists who, for different reasons, have applied their knowledge in the nanoworld. The result reported in the article (Toumey 2008) is a paradigm break, as understood by most. POR was, at least in several cases, a fundamental document without which the light of research in nanotechnology would probably not have been turned on. To frame the issue first from a historiographic and epistemological point of view, it is interesting to note that three possible interpretations of POR are presented, which could also be applied to other scientific cases similar to ours.

The first interpretation is based on the assumption that important scientists and researchers, at whatever level, could not have conceived their ideas, or even obtained the results thanks to which they have gone down in history, without POR. This perspective fully reflects the paradigm that we can find in textbooks, historical paragraphs, articles and

essays, and which confirms Feynman's work in its fundamental role as an absolute inspirational document. This interpretation is given the name *Apostolic Succession*, a name that does not lack some religious connotation. Richard Feynman is the inspiring prophet, POR the sacred text from which everything originates, the scientists and researchers who have succeeded him are the faithful and conscious executors of his vision.

The second interpretation is called the *nano-Mendel approach*. There is no doubt that Gregor Mendel is the father of genetics as we know it, thanks to the results he first obtained and published. However, it is equally certain that later in time, other researchers, notably Hugo DeVries, Carl Correns and Erich von Tschermal independently rediscovered the same laws established by Mendel, without having been influenced by his work, let alone being aware of it. This point of view can be similarly shifted to Feynman's work. He was, without a doubt, one of the most influential scientists of the last century, but it is not necessary to attribute to him the paternity of the first vagaries of nanotechnology. Some of the most important results that have been achieved in research have been achieved without the researchers being aware of this particular article, an event that occurred later. In so doing, while acknowledging Feynman's greatness, we relieve him of the responsibility for history, for predicting and detailing where nanotechnology was to go and what results it was to bring.

The third interpretation is the one that approaches POR through a *Nostradamus-like reading* and gives an interpretation precisely in the style of his famous work *Les Prophéties* (The Prophecies, or the Centuries). According to this interpretation, no one was able to immediately understand Feynman's thought in 1959, POR was a visionary and, in some ways, obscure text. It is thanks to the discoveries that have been made over the decades, up to the present day, that we can give the right meaning to Feynman's words, just as today we can correctly interpret Nostradamus's words, in the light of the events that have taken place. In fact, what makes the Centuries a "prophetic" text is precisely their ambiguity, a factor that makes them adaptable to different situations according to individual interpretation. In fact, there is nothing prophetic in Nostradamus's words except the interpretation which is, in fact, left to the reader. The same approach can be applied POR. We now understand what Feynman meant seventy years ago, because the scientific events hidden in his words have come true, and we can finally understand, in full, his thinking on nanotechnology. It is clear that this latter approach could be applied not only to Feynman, in the case we are examining, but to any scientist; likewise, with this interpretation it is possible to "see" Feynman everywhere, within Nanotechnology. In Toumey's opinion, with which we can agree, this last approach is the weakest of the three, and is reduced to a mere attempt to bring back to the present a text published in the past, linking old words to later events.

When, in 1959, Richard Feynman gave the lecture to the American Physical Society that would later go down in history in the form of the article known as POR, readers were struck by Feynman's character and sympathy, as well as his ability as a speaker to engage people, far beyond the difficulty of the concepts he expounded. The audience was enthralled by his presentation and left satisfied, as we know from the evening's report in the words of Paul Schlichta Ph.D. who went on to say: "The general reaction was one of amusement. Most of the audience thought he was trying to be funny... It just took everyone by surprise". This comment seems to dwell little on the content of the evening, but rather makes a very clear judgement on Feynman's oratory skills.

As is well known, the first printing of the transcript of the lecture was made by *Engineering & Science* magazine, and was published in February 1960. Another summary of the lecture was published by *Saturday Review* shortly afterwards, in April of the same

year, under the title *The Wonders That Await a Micro–Microscope*; Popular Science published an interesting and well condensed version of the original, entitled *How to Make an Automobile Smaller Than This Dot*, the following November. Although this publication was, in fact, an abridged version of the original, all the salient points of Feynman’s speech are mentioned in the text. *Plenty of Room* was also mentioned again in 1960, in magazines such as *Science News*, and *Life*, and was published as a concluding essay – albeit without the subtitle that appears in *Engineering & Science* – in *Miniaturization*, a volume published by Horace Gilbert. Several years later, Feynman discussed the issue of atomic miniaturization again, on February 23, 1983, at the Jet Propulsion Lab, in a talk entitled *Infinitesimal Machinery* that he described as *There’s Plenty of Room at the Bottom. Revisited*. During his talk, Feynman reaffirmed his original views and reworked the methods and applications he had introduced more than twenty years earlier. The video of his speech is now easily accessible on the web. Two years after contributing to the commission for the Space Shuttle Challenger disaster in 1986, Feynman died, and POR reappeared in publications such as books and newspapers, following the American physicist’s renewed popularity. In 1991, *Science* magazine republished the text, citing *Engineering & Science* as the main source from which it was reprinted. The following year, the *Journal of Microelectromechanical Systems* included POR in its first publication (volume 1, released on 1 March 1992). It is curious to note that in the notes to the article there is an error, no doubt a misprint, which dates Feynman’s lecture as December 26th instead of the 29th. In fact, all sources referring to POR, with this exception, are unanimous in reporting the 29th, which we agree with. The following image (Fig. 3.14) demonstrates the unusual error.

Notes: This document is the transcript of a talk given by Richard P. Feynman on 26 December 1959, at the annual meeting of the American Physical Society (APS) at the California Institute of Technology, and was published as a chapter in the Reinhold Publishing Corporation book, *Miniaturization*, Horace D. Gilbert, Ed. It is reprinted with the consent of Van Nostrand Reinhold, New York, NY 10003.

Published in: *Journal of Microelectromechanical Systems* (Volume: 1 , Issue: 1, March 1992)

Page(s): 60 - 66

INSPEC Accession Number: 4131233

Date of Publication: March 1992 ?

DOI: 10.1109/84.128057

ISSN Information:

Publisher: IEEE

Fig. 3.14 A screenshot of the <https://ieeexplore.ieee.org/document/128057> webpage, where it is possible to retrieve the first issue of the *Journal of Microelectromechanical Systems*. The wrong date, which is obviously an error of printing, is readable in the first line. Source: AD

The Foresight Institute, founded in 1986 by Eric Drexler, reports Richard Feynman’s vision through POR on its website and, interestingly, refers to the term *Nanotechnology*, first used to label Feynman’s forward-looking vision, as quoted in Drexler’s text *Engines of Creation* (henceforth EOC) without making any reference to Taniguchi. This is how it is stated on the website. From the Foresight Institute’s web page we also learn that the 20th year edition of EOC has POR as an introductory prelude to the entire text and, since 1993, the Foresight Feynman Prizes have rewarded the best researchers in the field of nanotechnology, in the direction indicated by Feynman himself: to create tools that can operate on an atomic scale through systems of molecular machinery. In 1999, Jeffrey Robbins included POR in his collection of Feynman’s short writings, published as *The Pleasure of Finding Things Out*

(it is chapter five, more precisely), while Anthony Hey included it in his 2002 volume on Feynman’s work on computation, *Feynman and Computation* (part II, chapter seven). The text is now readily available on various sites such as Caltech, Zyvex and the National Nanotechnology Institute.

Some considerations must be made about the article *Infinitesimal Machinery*, published in the Journal of Microelectromechanical Systems in 1993, a decade after Feynman’s talk at Caltech. This article is, in effect, a recapitulation of the topic that had so entertained the participants of the American Physical Society, but which had not always gained attention. There is no mention of it in the book *The Beat of a Different Drum: The Life and Science of Richard Feynman* (1994), written by Jagdish Mehra, nor in the book *Genius: The Life and Science of Richard Feynman* (interestingly, the two texts share exactly the same subtitle) by James Gleick (1992). Both texts quote POR, but it is interesting to note that Gleick claims that Feynman had never returned to the subject of POR, implicitly stating that he was not familiar with *Infinitesimal Machinery* (Toumey 2008). From 1993 to the present day, through an online search, there are only three mentions of *Infinitesimal Machinery*.

Before going back to the ROP, it seems fair to warn the reader that research based on quotations cannot be considered an exact science, it should be noted that sometimes the spelling of Feynman’s name undergoes variations even in the texts that collect the quotations: we find him as Feynman, Feynmann, Feyman, Feymnan... (Fig. 3.15) Today, even web search engines are no exception, as the following two examples show. We could refer to the first one as a “two birds with one stone”, since the same citation has the surname Feynman misspelled twice, when it refers to *The Feynman Lectures on Physics* (a well-known text, printed in Italy under the title *La Fisica di Feynman*) and then to the same author, indicated as RP Feynmann.

La Fisica di Feyman
[RP Feynmann - 2001 - batsweb.org](#)
 Principi di conservazione 1. conservazione dell'energia 2. conservazione della quantità di moto 3. conservazione del momento della quantità di moto 4. conservazione della carica 5. conservazione dei barioni 6. conservazione dei leptoni Simmetria le leggi della fisica sono ...
 ☆ ⓘ Citato da 37 Articoli correlati ⓘ

Fig. 3.15 An Italian example of bad spelling, first Feyman, then Feynmann in the same citation on this screenshot from Google Scholar. Source: AD

This second example, however, does not do justice to the accuracy with which the author, Cameron, wrote his article (1960) available online today, where the spelling is correct (Fig. 3.16).

[LIBRO] A Family of Integrals Serving to Connect the Wiener and Feynman Integrals
[RH Cameron - 1959 - books.google.com](#)
 Introduction. In his paper, 13), Space-time approach to non-relativistic quantum mechanics, RP Feynman has defined an integral in function space somewhat similar to the Wiener integral (see, for instance,()). In particular, the one dimensional form of the Feynman integral ...
 ☆ ⓘ Citato da 292 Articoli correlati Tutte e 4 le versioni

Fig. 3.16 Another screenshot example from Google Scholar of wrong spelling, whereas the title of the original paper available online correctly reads “Feynman”. Source: AD

With figures 2 and 3, we also want to underline how historiographic research can be challenging and difficult, as even a trivial misprint can mislead the retrieval of documents, making it very difficult to find them all when possible or necessary.

Before entering into a discussion on the more or less marked influence of POR in the history of nanotechnologies, let us briefly review some of the salient points of this article, in order to understand the reasons why it is considered by historiographers to be a seminal document.

The article can be schematised very simply: it opens with an introduction and develops into ten paragraphs, before the conclusions. In the introduction, Feynman's mission statement about the conference can be read very clearly.

What I want to talk about is the manipulating and controlling things on a small scale (Feynman 1960).

It is interesting to note, from an epistemological point of view, that Feynman never uses the prefix nano in any of the terms of his discourse. In fact, the prefix nano, although first introduced in 1947 at the 14th congress of the Union Internationale de Chimie as the thousandth–millionth part, was only incorporated into the International System of Units in 1960. Furthermore, the term nanometre, as a measure of the billionth part of a metre, first appeared in 1963, this measure having previously been known as a millimetre. When he has to measure “at the bottom”, Feynman refers to 10 ångströms, for example. Then, in a rather precise description, Feynman illustrates a process by which letters can be reduced by 25,000 times using an electron microscope. Once the plastic moulds of the text had been prepared, it would be enough to reproduce them in silicon in order to read them, again with the help of an electron microscope. In the following, Feynman shifts the discussion from the strictly practical level to that concerning the compatibility of his statements with what is known, from the scientific point of view.

I will not discuss how we are going to do it, but only what is possible in principle – in other words, what is possible in principle according to the laws of Physics (*Ibidem*).

Five times he points out to his audience that what he proposes is always consistent with the laws of physics. We read:

I am not inventing anti-gravity, which is possible someday only if the laws are not what we think. I am telling you what could be done if the laws are what we think; we are not doing it simply because we haven't yet gotten around to it (*ibidem*).

Or:

I would like to try and impress upon you, while I am talking about all of these things on a small scale, the importance of improving the electron microscope by a hundred times. It is not impossible; it is not against the laws of diffraction of the electron (*ibidem*).

Yet:

There is nothing that I can see in the physical laws that says the computer elements cannot be made enormously smaller than they are now (*ibidem*).

All these statements seem very prophetic indeed. POR condenses in his lines some predictions of what is to come. In fact, the idea of arranging atoms one by one, in the way a researcher would like them, has become a reality since the manipulation of atoms is possible nowadays, and other statements almost express a wish for a more advanced

scientific future, particularly when Feynman asks whether or not it will be possible to make the electron microscope a more powerful device. Feynman expresses his thoughts by always pointing out that he cannot know exactly how to achieve certain results, but that these are not impossible, in principle.

A first reading of POR, still thinking of the histrionic figure of Richard Feynman, would certainly lead most readers to think that they are dealing with the inspirational vision of a science that has revolutionised our world in just a few decades. It cannot be denied that several ideas are suggested in the paper, and some of them have actually been realised today.

If one considers POR to be the historically inspiring document of nanotechnology, it is possible and easy to find noteworthy observations in this regard, since they are given by well-known researchers such as, for example, Kim Eric Drexler. In his 1981 article *Molecular Engineering* (Drexler 1981) Drexler makes it clear that he is well aware of the contents of POR, from the copy published in the journal *Miniaturization*, and from this text he draws inspiration for his subsequent arguments:

Feynman's 1959 talk entitled "There's Plenty of Room at the Bottom" discussed microtechnology as a frontier to be pushed back, like the frontiers of high pressure, low temperature, or high vacuum. He suggested that ordinary machines could build smaller machines that could build still smaller machines, working step by step down toward the molecular level; he also suggested using particle beams to define two-dimensional patterns. Present microtechnology (exemplified by integrated circuits) has realized some of the potential outlined by Feynman by following the same basic approach: working down from the macroscopic level to the microscopic (Drexler 1981).

Later, in his authoritative volume *Engines of Creation*, Drexler again quotes POR as a text where Feynman's inspiring ideas, relating to nanomachines capable of controlling and directing chemical syntheses, are translated into words, although he must admit that Feynman himself could foresee neither when nor the cost of such a research.

Again, in his doctoral thesis, dated back to 1991, Drexler pays his tribute to Feynman and POR, the ability to inspire research:

The body of the talk focuses on miniaturization and microtechnology; this section anticipates capabilities like those that are now basic to the microelectronics industry and proposes an alternative approach to miniaturization (using machines to build smaller machines, which build still smaller machines, and so forth) that has not, in fact, been followed (Drexler 1991).

Before going on, considering the testimonies that open the historiographical debate, it is important to underline first of all that considering POR as the inspirational document of the ideas that led to Nanotechnology, as we know it today, is not wrong; this is simply one of the different possible interpretations, and which finds its validity in the fact that many of Feynman's words on this subject have found a realization in the contemporary world. Furthermore, it is essential to bear in mind that the considerations we are making do not in any way concern Feynman as a researcher, let alone as a scientist or populariser. Our reflection is based on the interpretation of POR – a piece of paper – as the cornerstone of Nanotechnology.

Although it is objectively difficult to trace the exact number of references citing POR, nevertheless, starting from 1960 and considering the correct spelling of the name, a diagram can be drawn which, in first analysis, shows how many times this article has appeared in the literature. This will be useful to visualise how and how significant POR has become over time (Fig. 3.17).

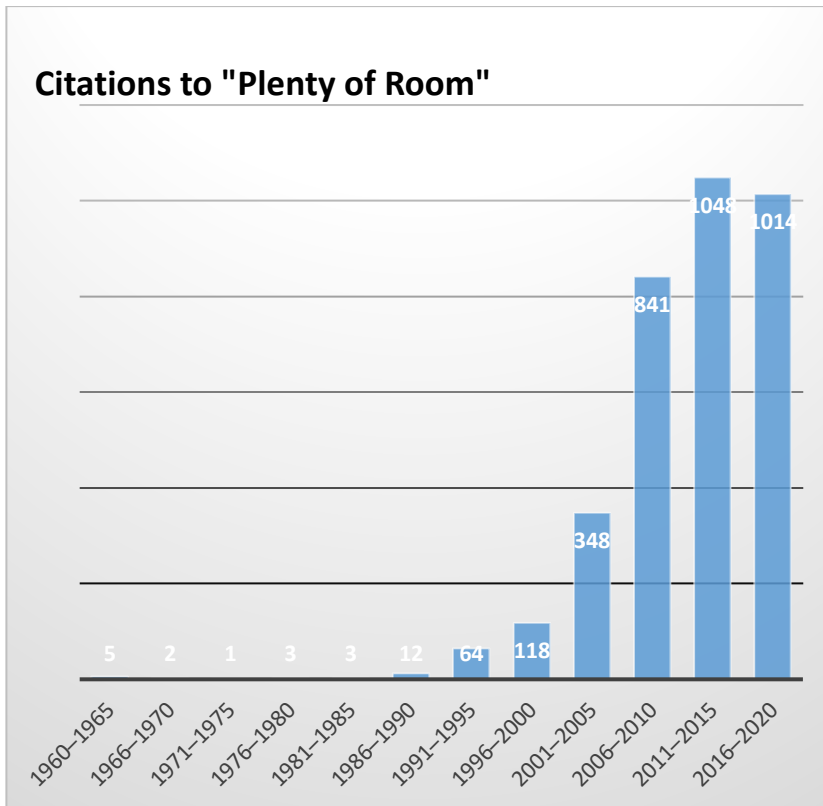

Fig. 3.17 Citations of “There’s Plenty of Room at the Bottom”. It is interesting to notice that the article’s popularity increased considerably in the last thirty years only, from 1991 on, a few years after Feynman’s death. Graph elaborated from data retrieved via Google Scholar. Source: AD

Now, in order to better understand what influence POR had on researchers, distinguished scholars of Nanoscience/Nanotechnology were interviewed by Toumey himself to find out from a direct source whether Feynman’s paper was (really) inspiring or even the bearer of new enlightening ideas. Three researchers were chosen for the interviews, because they are closely related to three of the most important (in Toumey’s opinion) discoveries in nanotechnology: the invention of the STM microscope, the invention of the AFM and the first placement of atoms, one by one, on a predefined grid, using an STM microscope. Probably, most people would cite these three events as the most significant at the beginning of nanotechnology. Thus, we might expect that, if POR is given this inspirational value that literature and history give it, it would have been widely consulted and cited in the period that preceded such important achievements in the history of science. Yet, on closer inspection, this does not seem to be the case. Although POR citations are present, they are few, far below what one might expect. In the face of such a result, can we therefore imagine that the hypothesis that POR has not been so fundamental to the progress of nanoscience may have some foundations? This assumption would remain in the pure field of hypotheses if it were not corroborated – for example – by the evidence reported by Toumey (Fig. 3.18).

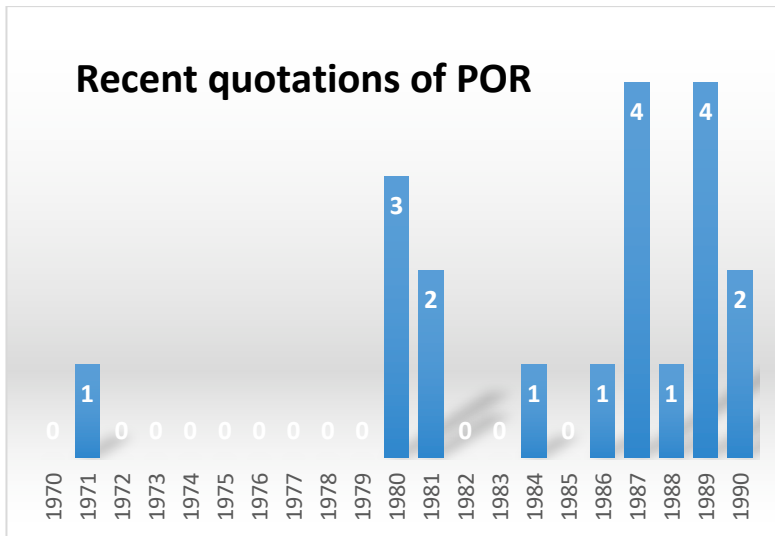

Fig. 3.18 Citations to “There’s Plenty of Room at the Bottom” in the years of the first developments of nanotechnology. Graph elaborated from data retrieved via Google Scholar. Source: AD

The figure above shows the detail of the number of citations of POR from 1970 to 1990. During these decades, STM and AFM were developed and the manipulation of xenon atoms became possible.

Heinrich Rohrer (1933–2013), Nobel Prize winner in 1986 for his research in STM together with Gerd Binnig, said that:

Binnig and I neither heard of Feynman’s paper until Scanning Tunneling Microscopy was widely accepted in the scientific community a couple of years after our first publication, nor did any referee of our papers ever refer to it... It might have been even after the Nobel [Prize] [...] I think it had no influence whatsoever (Toumey 2008).

Gerd Binnig, Nobel Laureate with Rohrer for STM, suggested:

I have not read [“Plenty of Room”]... I personally admire Feynman and his work but for other reasons than for his work on Nanotechnology (which actually does not exist) [Binnig’s brackets]. I believe people who push too much his contribution to this field do harm to his reputation. His contribution to science is certainly not minor and he needs not to be lifted [posthumously] onto the train of Nanotechnology (*ibidem*).

Calvin Quate (1923–2019), who contributed to the development of AFM, wrote that:

None of this work derived from the publications of Feynman. I had not read the Feynman article and I don’t think Binnig or Rohrer had read it. All they wanted was a better method for examining microdefects in oxides (*ibidem*).

Donald Mark “Don” Eigler, the physicist who in 1989 arranged 35 xenon atoms to compose the letters IBM, a world-famous image also known as *The Beginning*, said he may have read *Plenty of Room* when he was a graduate student, long before he manipulated the atoms with STM but he also says:

The technical aspects of my work have not been influenced by Feynman's paper (Toumey 2008).

Submitting these results to public opinion almost inevitably triggers heated debates, but these can be traced back to two fundamental levels of discussion.

The first level is the one we have analysed up to this point, and gathers the ideas of those who are in favour and those who are not in favour of the idea that POR is the document from which everything originated, as far as nanotechnologies are concerned. The opinions of the debates, at this level, dwell on the content of POR and the ideas expressed in it, in order to establish whether they constituted, to all intents and purposes, the essential starting points for the developments that were to come. The testimonies in this sense are, as we have reported, discordant. Authoritative researchers, in fact, had no difficulty in stating that they were not aware of the publication of POR, or that they did not draw enlightening opinions from it. It should be noted that such a viewpoint does not diminish the historical significance of POR at all, nor does it prevent other researchers from claiming the exact opposite, and considering it a milestone in the historiography of science. In fact, our considerations are based on the analysis, in terms of content, of a scientific article, and do not enter into the merits of the historical interpretation of its author, Richard Feynman. In other words, it is possible to consider POR as a non-“prophetic” text, relieving the figure of Feynman from the paternity of Nanotechnology, without diminishing the historical importance of Feynman himself as a scientist, Nobel Prize winner and populariser, a fact which is in no way the objective of those who have distanced themselves from POR as an inspirational document for their own research. On the other hand, it is also possible to consider POR as a fundamental article for nanoscience proper, since some of the ideas it expresses have been realised, and there is nothing to prevent us from considering the text of the 1959 conference as a source of direct inspiration for research.

The second level of discussion arises, as Toumey's direct experience confirms, when the focus of the debate shifts from the objective view of the discourse – whether POR is an inspirational paper or not – to a subjective interpretation that completely distorts the object of the question itself. Thus, one no longer dwells on POR, i.e. one does not consider it at all, and Richard Feynman becomes the object of the debate, as if the considerations on POR could be considered a simple prelude to a more decisive attack on the figure of Feynman himself. Toumey summarises these concepts in a paragraph of his article to which he gives the name *The evil anti-Feynman*. This, in fact, is the interpretation to which he was subjected, after the publication of his article, by some thinkers whose attention shifted dramatically from the article to its author, a move that Toumey never wanted to make, as we read in his own words. The clamour in defence of Feynman allows us to deduce how the subject of the dispute has been completely misrepresented, and how some have felt obliged to defend Feynman against accusations which, on closer inspection, are completely absent. Reflecting on this aspect, it is possible to expand the discussion further. The author himself is not his writing. Those who have felt compelled to defend Feynman have in fact lumped together Feynman's words and thought and the figure of Feynman, considering POR an absolutely indisputable work. To question not Feynman, not his work, but only the possible influence of one of his articles – not even the article itself, at this point – and not in an abstract way, but supporting the ideas with the direct testimony of those who, while expressing the highest esteem for Feynman himself, confirmed that POR's ideas did not direct research at all, this constitutes an intellectual scandal for some.

We can consider Feynman's contribution as a break in a scientific paradigm that has long been accepted: Feynman is the father of nanotechnology because POR predicted, in some

way, some of the results we have achieved today in this field. This paradigm has been reinforced over the decades by all those authors who have opened and still open their writings with the words *In 1959 Richard Feynman gave a lecture...* We do not believe that it is a matter of choosing one path over another, but rather of accepting the plurality of points of view, without thinking of undermining – this is absolutely not the aim – the figure of Feynman or the validity of POR itself.

Dubium sapientiae initium states an aphorism attributed to Descartes. Doubt is the beginning of wisdom. These three words have a particular meaning in the context of the debate we have been discussing, as to whether POR can be considered at all as the cornerstone of nanotechnology. Certainly, in the field of physics, it is not permissible to question any claim, since there are physical laws whose validity and universality are recognised, within the limits of their definition. The laws of physics can be likened to absolutes, the truth of which is not in question except in cases where they lose their validity, as happened to the laws of classical mechanics when they had to be applied to the quantum world.

However, speaking generally, the concept of absolute fact can be dangerous. A researcher who thinks he possesses a definitive truth closes his critical thinking to possible alternatives and, ultimately, to his own mind. At the other extreme, if everything is uncritically and systematically questioned, it will not be possible in any case to have a complex view of the world because any premise would lack certainty.

In the historical context, in general, and in the history of science in particular, there are examples where it is legitimate to ask questions, not so much to make a free criticism, but because they are necessary to reconstruct the line of certain events correctly.

This is what we intended to do, not so much to uncritically question a consolidated paradigm, but rather to analyse whether and which different points of view could be brought to the reader's attention, so as to provide the opportunity for a historical re-reading in a different key. Evaluating the actual role of POR, as far as possible, in the context of the historiographic tradition or according to the new proposals developed by Christopher Toumey, following the direct testimonies he has collected, means retracing the history of nanotechnology.

According to Toumey, three interpretations are possible.

Tab. 3.1 The possible interpretations of POR, according to Prof. Christopher Toumey intuitions, describing through which mood we can read the script, and make up our considerations.

Proposed name	Description and interpretation
Apostolic succession	<p>The reader totally believes that POR is the definitive inspiring document issued by Richard Feynman, on Nanotechnology. Moreover, Feynman is the visionary genius. Everything in Nanotechnology derives from it and everything in history proves that. There is no chance of other points of view, no criticism is allowed. Often, who criticizes POR is intended – by defenders of the apostolic succession – to be attacking Feynman himself.</p> <p>This is the most common interpretation of POR and the point of view of Feynman, found in articles, manuals and books, and other issues on the subject.</p>

Mendel-like approach	<p>Somehow, this is an axiomatic view of the issue.</p> <p>Feynman might somehow have inspired Nanotechnology, but other people came to important results without any knowledge of POR (not Feynman), discovering things, designing and assembling new tools, moving on a parallel path. This way would relieve Feynman off the responsibility of being “father of Nanotechnology”.</p> <p>This is an interesting alternative point of view, depicting an uncommon but feasible hypothesis. Such an interpretation moves away the “holy veil” of absolute certainty on the origin of Nanotechnology and opens a way to discussion.</p>
Nostradamus approach	<p>None really understood Feynman’s talk nor the power of POR. POR was then obscure. Discoveries in nanotechnology are made and the important ones, dated back to the Eighties, are now explainable only through a backwards re-reading of POR. Only now it is possible to fully understand what Feynman really meant.</p> <p>This is the weakest, although possible, interpretation as it implies a right way back only, to the original idea at the basis of POR. It sounds like “this is what it really meant at the beginning”.</p>

Thus, I have examined the article *There’s Plenty of Room at the Bottom*, a transcript of Richard Feynman’s 1959 speech to the American Physical Society, under the lights of a new point of view proposed by Christopher Toumey, of the University of South Carolina, which we have briefly reported in the table above. Two main possible interpretations emerge on the influence of Feynman’s paper on researchers who have directed their efforts towards the field of nanotechnology. Some consider this article to be the fundamental document of this new science, in that it effectively opened up the horizons of research, suggesting in principle which goals to pursue. Others, on the other hand, including Nobel Prize winners, while respecting Feynman to the utmost as a scientist and populariser, have declared that POR was not a source of inspiration for their research.

These points of view open an interesting debate on the interpretation of documents, in the context of the History of Science, and sometimes trigger very heated controversies when, as in our case, one is tempted to shift the focus from the focal point of the discussion, a document, to its author. We have seen how this change of perspective results in a rigid position on the part of those who feel Feynman is threatened by an attack that, in reality, does not exist at all. This happens because a free interpretation was made of the initial question: was POR, in fact, an indispensable document for the history of nanotechnology? The variety of answers given by the scientists reflects the logical variety of their points of view, and the real contribution that this article has made to their research. The centre of the dispute remains the article itself, not the figure of Richard Feynman, a scientist whose contribution to history is absolutely beyond question.

What seems interesting to us is the possibility of re-reading an article that has entered the history of science from a different point of view. Not only that, but also the possibility

of directly consulting researchers involved in the same field of Nanotechnology allows us to benefit from a direct testimony without interpretative filters. All this does not diminish either the figure of the author or the value of the writing but, on the contrary, opens up new interesting spaces for discussion on the different approaches to the documents and their influence on the historical and scientific panorama.

3.1.6 1960: MOSFET and Carbon Friction Nanotubes

In 1959, at Bell Labs, two researchers, the Egyptian Mohamed Atalla (1924–2009) and the Korean Dawon Kahng (1931–1992), invented the so-called Metal–Oxide–Semiconductor Field–Effect Transistor, known also as MOSFET, or MOS–FET, or MOS FET. This device is, in fact, the cornerstone of all modern electronics and, statistically, the most frequently produced device in the history of electronics. It is estimated that between its introduction in 1960 and the first two decades of the 21st century, something like 1.3×10^{22} MOSFETs were produced. In analogue and digital integrated circuits, it is the dominant semiconductor device, and also the most common power device.

As is often the case throughout the history of science, the roots of the MOSFET go back further than 1960. Julius Edgar Lilienfeld (1882–1963) first proposed the basic principle of the Field–Effect Transistor (FET) in 1926, whereby the electric current flowing through the transistor is controlled by the formation of an electric field inside it. Lilienfeld filed the first patent for such a device in the same year and, over the next two years, was able to describe various FET structures in detail. In its basic configuration, the metal was made from aluminium, the oxide part from aluminium oxides. Copper sulphide was used as a semiconductor. However, Lilienfeld’s device was not functional. Later, the German Oskar Heil (1908–1994) in the 1930s and William Bradford Shockley (1910–1989) in the 1940s also theorised the concept of FETs. Two circumstances should be noted at this point: none of the first FET devices involved thermally oxidised silicon as a semiconductor material, and in the 1950s FET technology was abandoned by researchers, who had concentrated their efforts on the bipolar junction transistor (BJT).

In 1955, Carl Frosch (1908–1984) and Lincoln Derick (no bio) accidentally covered the surface of a silicon wafer with silicon dioxide. Characterisation of the dioxide layer showed that it was able to ensure the passage of certain dopants to the wafer, while selectively blocking others. Oxidising the surface layer of the material had paved the way for the modern etching process, revealing its potential: an accidental event had opened the door to solving bigger problems. In 1957, they patented their method and described it in literature (Derick and Frosch 1957, Frosch and Derick 1957).

Atalla and Kahng’s invention came to light in November 1959, it was the first working MOSFET device, and was covered by two separate patents, the first by Atalla on 8 March 1960 as “*Semiconductor Devices having Dielectric Coatings*” and the second by Kahng on 31 May of the same year as “*Electric Field Controlled Semiconductor Device*”. The MOSFET is a rather simple device, which is why Atalla proposed MOS integrated circuit chips that same year (Fig. 3.19).

Sept. 14, 1965	M. M. ATALLA	3,206,670
SEMICONDUCTOR DEVICES HAVING DIELECTRIC COATINGS		
Filed March 8, 1960		
Aug. 27, 1963	DAWON KAHNG	3,102,230
ELECTRIC FIELD CONTROLLED SEMICONDUCTOR DEVICE		
Filed May 31, 1960		

Fig. 3.19 The patents that Atalla and Kahng filed to protect their MOSFET invention in 1960. Atalla's patent retrieved via: <https://patents.google.com/patent/US3206670A/en>, Kahng's patent retrieved via: <https://patents.google.com/patent/US3102230A/en>

At Bell Labs in the late 1950s, Mohamed Atalla was working on surface passivation and thermal oxidation processes for silicon surfaces in order to create a workable Field-Effect Transistor, based on theoretical studies in the 1920s and confirmed by Schottky in the 1940s, as described above. Atalla's idea was based on the thermal growth of a thin layer of very pure silicon oxide on top of a silicon wafer in order to neutralise the first layers of the semimetal and achieve an operational Field-Effect Transistor. (Huff 2005)

A brief although historically important description comes straight from Atalla's original patent filed in 1960.

This invention relates to semiconductor devices which utilize the properties of thermally grown oxide coatings as a basis of operation. One object of this invention is a high frequency variable capacitor. Another object of this invention is a high frequency switch. In its basic form, the invention comprises a silicon wafer which includes a PN junction typically intersecting at least one surface of the wafer and a thermally grown oxide coating over the region of intersection with such surface. By providing an electrode to the exposed Surface of the oxide to which a voltage is applied, the underlying region of the wafer can be affected to achieve desirable changes in signals impressed between other electrode connections to the wafer. The various classes of devices to be described owe their different electrical characteristics to the specific configuration of the semiconductor material employed and the various geometric arrangements of the contacts, the one or more rectifying junctions, the oxide, the electronic properties of the silicon-silicon oxide interface as well as the voltages applied. In particular, it has been found necessary to limit the thickness of the oxide coating to less than 500 angstroms, typically 100 angstroms, to obtain the high frequency capacitance variations described herein. It has also been found advantageous to electrically neutralize or passivate the underlying semiconductor surface (Atalla 1960).

The text of the patent filed by Kahng describes in detail the etching technique used and the advantages it brought to wafer processing.

A device of the kind useful in this invention was fabricated starting with a silicon wafer including a uniform concentration of phosphorous and having a resistivity of about 6 ohm centimeters. A silicon dioxide coating was grown over the surface of the wafer by heating the wafer in a water vapor atmosphere for 120 minutes at a temperature of 1200 degrees centigrade. Photo-resist techniques were used to expose two Suitably shaped portions of the underlying semi-conductor surface through the oxide and the wafer was exposed to a boron pentoxide vapor. By the closed box diffusion technique disclosed in copending application No. 740,958 of B. T. Howard, filed June 9, 1958, now issued as Patent No. 3,066,052, dated November 27, 1962, a surface concentration of about

10^{20} atoms/cc.

of boron was obtained at such exposed portions. This diffusion provided two surface portions of p-type conductivity, each having a keyhole shape and separated by an in surface region of .0018 inch by .025 inch. Advantageously, the length of this n-type surface region, divided by its width, is maximized for optimum transconductance. The residual oxide was removed in concentrated hydrofluoric acid. This acid, in about five to ten minutes, provides a coating over the p-type surface portions, which is used often to determine the position of the p-n junctions in silicon. Here, however, the coating is employed to mask the p region in a subsequent etching step wherein the wafer is washed in a 10 to 1 solution of nitric and hydrofluoric acids for twenty to thirty seconds. About .0012 inch of silicon is etched from the unmasked portions of the surface of the wafer. The advantage of this technique is that the initial surface impurity concentration of the p-type surface is maintained by protecting this surface during the etching step, facilitating the application of ohmic contacts (Kahng 1960).

Atalla and Kahng were then able to build the first MOSFET and made it public, demonstrating it in practice, in June 1960 (Atalla and Kahng 1960) at the Institute of Radio Engineers and American Institute of Electrical Engineers, (henceforth IRE-AIEE) Device Research Conference, Pittsburgh.

In 1963, the first official public announcement of the existence of MOSFET devices as a potential new technology was made. The following year, first General Microelectronics and then Fairchild commercialised MOSFETs for logic and switching applications, effectively starting a revolution in the world of electronics that has had an impact on everyday life, being the basis for the birth of home computers. (Bassett 2007) Easy to manufacture, compact and versatile, the MOSFET has quickly become the workhorse of the electronics industry, being the basic building block of most modern equipment. The miniaturisation of MOSFETs has been the impetus behind the exponential growth of semiconductor technology for electronics (Lamba, Engles, Malik and Verma 2009), the concomitant increase in transistor density, the increase in their performance accompanied by a reduction in the power consumption of chips and, more broadly, of electronic devices in general. (Sridharan and Pudi 2015)

A short article by Bollmann and Spreadborough, prepared jointly, appeared in the journal *Nature* on 2 April 1960, in which the authors reported on the results of their research into graphite as a lubricating medium (Fig. 3.20).

NO. 4718 April 2, 1960

NATURE

LETTERS TO THE EDITORS

PHYSICS

Action of Graphite as a Lubricant

W. BOLLMANN
J. SPREADBOROUGH

Battelle Memorial Institute,
Geneva.

Fig. 3.20 The opening of the article from Bollmann and Spreadborough (above). Curiously, both the names of the authors appear at the end of the article as signatures as well as the affiliation of the writers (below). Retrieved via: <https://ur.booksc.org/s/Bollmann%20Spreadborough/?e=1>

Bollmann and Spreadborough went further than the mechanism usually proposed to describe the lubricating behaviour of graphite, which involves the mutual sliding of carbon planes over each other due to the weak interaction of interplanar chemical bonds. They prepared graphite samples by rubbing a block of material on a grid, or graphite between two glass supports, and took pictures of it with an electron microscope.

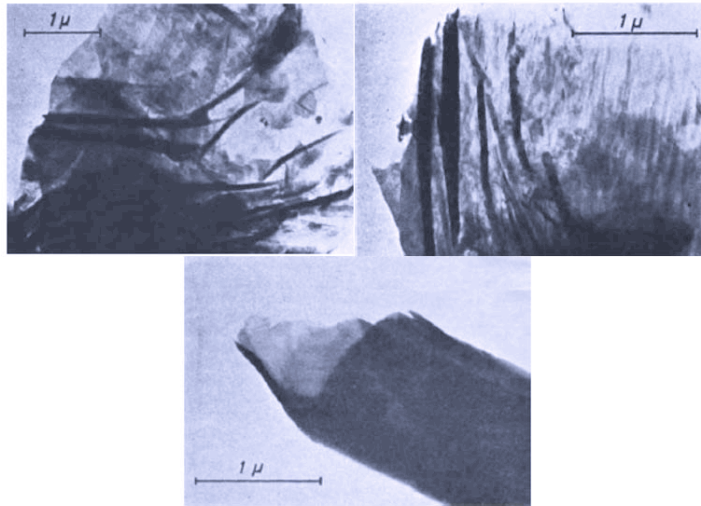

Fig. 3.21 Three pictures from the original article written in 1960 by Bollmann and Spreadborough, *Action of Graphite as a Lubricant*. Top left: a complex system of rollers. The picture is magnified $\times 15,000$. Top right: parallel carbon whiskers close to the edge of a crystal. Bottom: a detail of a single carbon structure. These last two pictures are magnified $\times 24,000$. Source: Bollmann and Spreadborough (1960)

The photographs they were able to observe, see picture above, showed the graphite sheets rolled up and forming structures so fine that they could be analysed by transmission microscopy. The rolls were of two types, the first being plain rolls and the second being spiral rolls. In both cases the outer diameters varied between 1 and 0.1 micrometres.

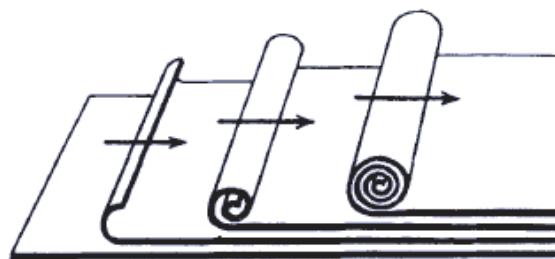

Fig. 3.22 The schematic representation of rollers according Bollmann and Spreadborough. The arrows show a possible shear stress direction. Source: Bollmann and Spreadborough (1960)

At first glance, the graphite structures appeared as long whiskers up to a hundred layers thick when rolled up. By observing these structures, the authors were able to hypothesise that the lubricating properties of graphite could be traced back to the presence of these rolls acting mechanically like roller bearings. Their intuition proved consistent with the results obtained by other researchers, who had found that:

- if graphite is first degassed in a vacuum at a temperature of 800°C, a relatively high coefficient of friction is obtained at room temperature;
- for good lubrication to be guaranteed at room temperature, water vapour, ammonia or acetone must be present; otherwise, under vacuum or operating conditions involving a very dry gas, wear of the parts is high;
- wear is negligible in dry helium at a temperature of 600°C.

According to Bollmann and Spreadborough, the hypothesis of a mechanism comparable to that of roller bearings made it possible to go beyond the idea of lubrication between two surfaces, by graphite, taking place by simple mutual sliding of the layers on each other under shear stress. If the lubrication phenomenon acted in this way, moreover, it would not be compatible with the displacement of a certain number of dislocations that would necessarily stop at the edge of the grain and also with the verified sensitivity of the phenomenon itself linked to the different operating atmospheres. Their observations therefore reinforced the hypothesis that nano-sized graphite rollers were an effective means of reducing lubrication friction between two sliding surfaces.

3.1.7 1962: A Junction Transistor Nanolayer–System

As I described earlier, in 1960, Egyptian engineer Mohammad Atalla and Korean engineer Dawon Kahng at Bell Labs made the first MOSFET (Metal–Oxide Semiconductor Field Effect Transistor) with a gate oxide thickness of 100nm and a gate length of 20µm.

In 1962, Atalla and Kahng achieved the next major breakthrough by fabricating a Nano–Layer–Base–Metal Semiconductor Transistor (M–S junction) using 10nm–thick gold (Au) thin films (Fig. 3.23). They published a very concise report entitled A New “Hot” Electron Triode Structure with Semiconductor–Metal Emitter, describing a new triode structure consisting in fact of three zones: a Semiconductor–Metal rectifying barrier whose function is to emit the hot carriers, a thin film into which the carriers are conveyed, and finally a further Metal–Semiconductor barrier whose function is to act as a collector. In this way, the triode took the name of Metal Semiconductor Triode (SMS).

**2) A New “Hot Electron” Triode Structure
with Semiconductor–Metal Emitter—M.
M. Atalla and D. Kahng, Bell Telephone
Laboratories, Inc., Murray Hill, N. J.**

Fig. 3.23 The title and authors for the article about the new “Hot Electron” Triode. Retrieved via: <https://ur.booksc.org/s/Atalla%20Kahng/?e=1>

The device could operate through carriers, electrons, or gaps, holes: in the first case they spoke of Hot Electron, in the second of Hot Hole. n -type semiconductors were used for the hot electron triode, and p -type semiconductors for the hot hole triode. With the appropriate choice of Semiconductor–Metal combinations Atalla and Kahng achieved an extremely effective electron injection, which could mathematically express the direct dependence of current on voltage by the formula:

$$I \propto \exp(qv/nKT) \quad (3.10)$$

where n is a coefficient close to unit for a wide range of current densities. The device's capacitance was then found to be comparable with that of a conventional junction–transistor.

For three emitters, the authors evaluated the Figure Of Merit (henceforth FOM), i.e. that parameter which allows the calculation of the frequency response and switching performance in MOS to be assessed, a parameter which is usually defined as:

$$\omega_0 = \frac{g_m}{C_g} \text{ S/F} \quad (3.11)$$

where g_m is the transconductance – or transfer conductance – i.e. the parameter that relates the current through the output to the voltage across the input of a device, and C_g is the gate capacitance. It being:

$$g_m = \frac{\Delta I_{out}}{\Delta V_{in}} \text{ A/V} \quad (3.12)$$

and as it is 1 siemens = 1 ampere per volt, the unit of measure of (3.11) is immediately justified.

The three emitters Atalla and Kahng considered to compare their FOM were the following.

- A silicon–gold (Si–Au) emitter whose donor concentration was $10^{16}/\text{cm}^3$;
- a n - p - n silicon (Si) transistor emitter whose base concentration of impurities was $10^{17}/\text{cm}^3$ and a value of D/w of $10^5/\text{cm}/\text{sec}$, where D is the carrier diffusion constant and w the base thickness;
- a tunnel emitter whose barrier was 1.0eV.

When the value of g_m/C_g was set equal to $10^{11}/\text{sec}$ for all the three devices, the emitter current densities were measured to be $2.5 \cdot 10^2$, $6 \cdot 10^2$ and $5 \cdot 10^4$. All these three last values are to be expressed in A/cm^2 .

The optimum product between gain and bandwidth was calculated for an SMS triode made with a simple structure using a strike emitter and base electrodes. For a silicon–gold–silicon (Si–Au–Si) triode and hot carriers having a range of 700Å , or 70nm , in the gold, the FOM was about one order of magnitude better than the analogous parameter for a junction

transistor, and about two orders of magnitude better than that for a tunnel emitter triode. Atalla and Kahng created the following structure. On a surface of n -type germanium (Ge) characterised by an electrical resistivity of 0.6 ohm per cm they deposited a gold film about ten nanometres thick, 100Å in the original text; on the back of the germanium substrate the ohmic contact was made. In this way they were able to obtain an Au–Ge junction capable of passing less than 4mA/cm² at 5V reverse. An n -type silicon element of 0.5 ohm–cm resistivity was shaped into a tip on one side and fitted with an ohmic contact on the other. When the silicon tip was brought into contact with the gold layer, the gold–silicon junction rectified the current; the basic contact was made by means of a gold wire brought into contact with the gold film by gentle pressure. The current gain, i.e. the capability to vary the amplitude of the current signal between the input and output ports of the device, measured with the apparatus recreated by Atalla and Kahng varied between a minimum of a few hundredths and a maximum of 0.4 when operating. According to electronics, this is a passive circuit, having a gain of less than one. The lack of physical dimensions for this quantity should not be surprising since it is a ratio between quantities, output and input, that have the same unit of measurement. The current gain of a common emitter proved to be numerically compatible with the values tested by the authors. They also observed the following peculiarities.

- The characteristics of the transistor proved to be sensitive to the pressure at the emission point, since the best results were obtained at the lightest pressures;
- when the emitter was moved from one point to another on the base, no significant changes were observed in the measured characteristics of the transistor;
- when the emitter tip was placed on the germanium surface, either near or far from the gold layer, the current transfer was less than 10⁻⁴;
- When the emitter was positively biased with respect to the base, the current transfer was less than 10⁻⁴;
- The inverse current gain and voltage feedback ratio in common base mode were both less than 10⁻⁴.

3.1.8 1965: Moore’s Law and Chip Sizes

The progressive reduction of electronic devices brings with it an inherent problem. What is the minimum limit below which they cannot be reduced? At what point do quantum phenomena start to occur in electronic circuits? These questions are by no means insignificant in the design of electronic components, components which, given the progress of equipment and their use over the last forty years, are becoming more and more high-performance and require ever more advanced capabilities.

In 1965, Gordon Earl Moore, director of the Research and Development Laboratories at Fairchild Semiconductors published an article (Moore 1965) in which he presented his predictions about the future of electronics. He argued that everything that could be achieved in the field of electronics would be possible through the development of integrated circuit electronics (Fig. 3.24).

The experts look ahead

Cramming more components onto integrated circuits

With unit cost falling as the number of components per circuit rises, by 1975 economics may dictate squeezing as many as 65,000 components on a single silicon chip

By Gordon E. Moore

Director, Research and Development Laboratories, Fairchild Semiconductor division of Fairchild Camera and Instrument Corp.

Fig. 3.24 Gordon Moore's prediction. Retrieved via: <https://newsroom.intel.com/wp-content/uploads/sites/11/2018/05/moores-law-electronics.pdf>

This would, in Moore's view, lead to computers that would appear in every home, the home computers to networks of terminals connected to a central memory (as is the case today with terminals connected to a single server), to automatic controls for cars and means of transport (the studies of which are today implemented in practical applications such as the automatic bus in the Lille University campus), to portable communication devices, here it is all too obvious to think of today's mobile telephony devices. Moore also pointed out that the machines would be built at ever lower costs and with rapid changes in their structure and renewal.

As Moore had witnessed the development of microelectronics at first hand from the late 1950s onwards, he was aware that the aim of miniaturisation of components was to achieve ever-smaller electronic devices, so that devices capable of performing functions of increasing complexity could be packed into a limited space with significant weight reductions. Moore had seen the development of a technology that integrated several approaches and drew on techniques from a variety of fields, from the application of thin-film structures for semiconductor Integrated Circuits (henceforth ICs) to the attachment of semiconductors to passive film arrays.

Now, as then, the supremacy of one nation over another can be measured by the state of the art of the military equipment developed. Moore noted at the time that the emergence of integrated electronics represented a quantum leap in the development of more reliable, lightweight and compact military systems. On the other hand, such equipment was too expensive for immediate introduction into the civilian market, but even then, small electronic devices using low-frequency amplifiers were appearing on the open market. Today, it is worth noting, the situation is still the same. Being able to control home devices with voice commands, having sensors that warn us if we drive our cars too close to external obstacles, or maintaining a constant distance from those ahead or behind us are not wonders of today, but previous military technologies at least forty years old, cleared through customs for consumer electronics applications.

By 1965, the electronics reliability of integrated circuits was already high enough to allow, as Moore noted, their application in the Apollo space programme. In Moore's words, the future belonged to semiconductor ICs because they were attractive due to their high reliability and low manufacturing cost, as well as the relative abundance of silicon as a raw material.

Silicon is likely to remain the basic material, although others will be of use in specific applications. For example, gallium arsenide will be important in integrated microwave functions. But silicon will predominate at lower frequencies because of the technology which has already evolved around it and its oxide, and because it is an abundant and relatively inexpensive starting material (Moore 1965).

In the continuation of his reasoning, Moore established a trend with regard to the growth of the number of components in an integrated circuit, relating it to the cost per component. For Moore, in the case of simple circuits, the cost per component turns out to be almost inversely proportional to the number of components themselves. Increasing complexity, adding more components, varying the efficiency of the integrated circuit, and increasing costs are all factors that have to find a balance between efficiency and production costs; when Moore wrote his article, this balance point stood at 50 components per circuit. He would therefore have mentioned this in his paper.

The complexity for minimum component costs has increased at a rate of roughly a factor of two per year. Certainly over the short term this rate can be expected to continue, if not to increase. Over the longer term, the rate of increase is a bit more uncertain, although there is no reason to believe it will not remain nearly constant for at least 10 years. That means by 1975, the number of components per integrated circuit for minimum cost will be 65,000.

I believe that such a large circuit can be built on a single wafer (*ibidem*).

It was also clear to Moore that the only effort that needed to be put into the research and development of smaller and smaller devices with increasing numbers of integrators was purely engineering, and that it was not necessary, in his opinion, to venture into what he described as "exotic" processes designed for the purpose and thus intended to replace the procedures then available.

Moore's law, in its most classical formulation, is the observation that the number of transistors in an integrated circuit doubles approximately every two years. Formally, Moore's Law is not a physical law in the strict meaning of the term, understood as a mathematical relationship between quantities that expresses a regularity of physical phenomena, but rather a prediction made in 1965 by Moore, based on the interpolation of data from previous years, which later proved to be correct in the history of electronics. The following picture, from Moore's paper, is interesting because shows the quasi-linear trend for the few data available at the beginning of the Sixties, while the dashed line is Moore's prediction of the future (Fig. 3.25).

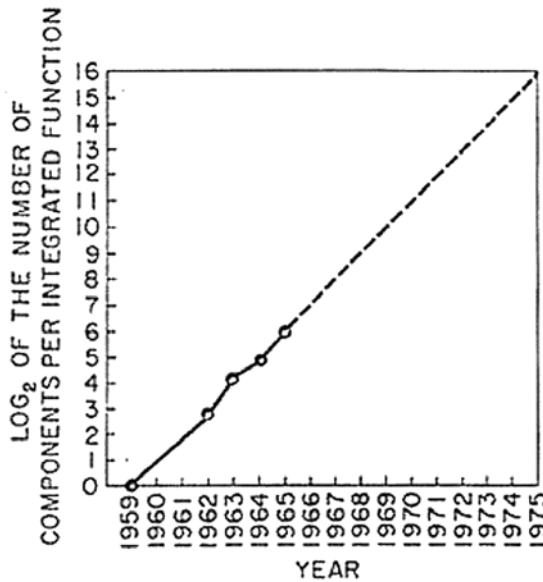

Fig. 2 Number of components per integrated function for minimum cost per component extrapolated vs time.

Fig. 3.25 The first data available regarding the number of components per integrated function plotted versus the year when data were collected. The dashed line illustrates Moore's prediction for the years to come, that proved to be correct.

Source: https://download.intel.com/newsroom/kits/ml50/gallery/images/moores_law_graph_1965.jpg

His prediction was correct beyond imagination, although we should remember that nowadays it is applied to plan the future developments in the semiconductor industry research (Disco and van der Meulen 1998).

It must be remarked that the two-year-long period hypothesised by Moore is often corrected into an 18 month period. This comes from Intel executive David House, who slightly corrected Moore's timespan considering that, as time goes by, transistors have become faster and taking into account their combined effect.

Today, the law can be plotted as follows (Fig. 3.26).

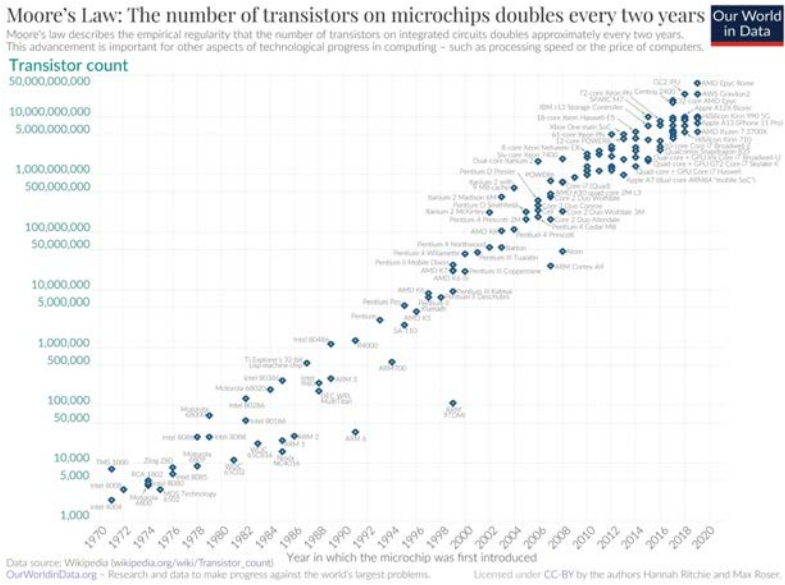

Fig. 3.26 The trend of Moore’s Law over the last fifty years. Source: https://electronicsreference.com/moores_law/

Historically, the expression “Moore’s Law” came to light a few years after the issue of the original paper. It was around 1970 when a Caltech professor, Carver Andress Mead, coined this famous expression. Moore himself credited him with the fact.

Moore’s prediction was not the first about the increases in computer power. This quotation was also prophetic in this sense.

I believe that in about fifty years’ time it will be possible, to programme computers, with a storage capacity of about 10^9 , to make them play the imitation game so well that an average interrogator will not have more than 70 per cent chance of making the right identification after five minutes of questioning (Turing 1950).

The storage capacity Turing meant is what nowadays we call it 128 megabytes.

At the end of the 1990s, the transistor industry encountered the nanoworld, thanks in part to the invention of deep UV excimer laser photolithography by Kanti Jain in 1982. The use of this technique took integrated circuits from around 500 nanometres to the remarkable size of a few tens of nanometres in the early 2000s. In early 2006, researchers at IBM developed a technique for making circuitry as small as 29.9 nanometres using excimer laser lithography, continuing on the path laid down by Moore’s Law, while, in 2010, researchers at the Tyndall National Institute in Cork, Ireland, announced that they had designed and built the first junctionless transistor. Professor Jean–Pierre Colinge and his team described a control gate around a silicon nanowire that could be tightened around the wire to the point of stopping the passage of electrons without using junctions or doping, also saying that such new devices could be produced at 10–nanometre scale with the existing fabrication techniques (Johnson 2010). In April 2011, researchers at the University of Pittsburgh developed a single–electron transistor having a diameter of 1.5–nanometres from oxide based materials. Three “wires” point to a central core through which the electrons tunnel

from one wire to another, allowing impressive conditions on the third wire such as conductive properties and the possibility, for the device, to act as a solid state memory. (Cheng *et al.* 2011)

In 2016, a team of researchers led by faculty scientist Ali Javey at the Department of Energy's Lawrence Berkeley National Laboratory (Berkeley Lab) created a transistor with a working 1-nanometer gate, the smallest device reported to-date, using carbon nanotubes and molybdenum disulfide (MoS₂). This discovery kept alive Intel co-founder Gordon Moore's prediction that the density of transistors on integrated circuits would double every two years, enabling the increased performance of laptops, mobile phones, televisions, and other electronics. (Desai *et al.* 2016)

3.1.9 1966: Nanoworld in Sci-Fi Literature

The world of Nanotechnology is not only limited to the laboratory or industrial research but is also found in the world of literature, and the science fiction novel in particular. In the 1960s, Isaac Asimov was asked to make a book out of the widely successful science fiction film "Fantastic Voyage". In the film, a defecting scientist from Czechoslovakia suffers an assassination attempt that leaves him with an inoperable brain thrombus. A team of scientists decides to intervene from the inside, aboard a miniaturised "submarine", whose laser is supposed to dissolve the thrombus. The film caused a sensation with its special effects, and anyone who has seen the film remembers the fascinating images of the tissues of a human body enlarged a million times.

Asimov's book actually appeared after the release of the film in order to make the public believe that the film was based on a novel with a solid scientific basis, given the author.

Actually, if strictly analysed, the film is a scientific nonsense, since it is not possible to reduce a macroscopic object by as much as one wants without taking into account how the forces and the effects they would produce would change. Nevertheless, beyond filmic fiction, it contains an idea that is being considered today in the field of nanomedicine. When it is not possible to intervene from the outside on a damaged tissue or organ, the idea may be to intervene from the inside, with nano-surgeons operating from inside the body, following precise instructions or being guided by an operator. Today, for example, nanoparticles are used as markers for tissues affected by neoplasms, allowing very precise identification of the area to be operated on, whatever it may be.

Isaac Asimov had a Ph.D. in biochemistry and included in his story very precise indications that reducing a submarine to the size necessary to intervene from inside a human body is definitely not possible according to the laws of physics, and he makes one of his characters, Grant, say so to another character, Michaels:

G: I think so. If you're going to reduce size you can do it in one of two ways. You can push the individual atoms of an object closer together; or you can discard a certain proportion of the atoms altogether. To push the atoms together against the inter-atomic repulsive forces would take extraordinary pressures. The pressures at the center of Jupiter would be insufficient to compress a man to the size of a mouse. Am I right so far?

M: You are luminous as the day.

G: And even if you managed it, the pressure would kill anything alive. Aside from that, an object reduced in size by pushing atoms together would retain all its original mass, and an object the size of a mouse with the mass of a man would be difficult to handle."

M: Amazing, Mr. Grant. You must have amused your girlfriends for many hours with this romantic talk. And the other method?

G: The other method is to remove atoms in careful ratio so that the mass and size of an object decreases while the relationship of the parts remains constant. Only if you reduce a man to the size of a mouse you can keep only one atom out of maybe seventy thousand. If you do that to the brain, what is left is scarcely more complicated than the brain of a mouse in the first place. Besides, how do you re-expand the object, as the miniaturizing physicists claimed to be able to do? How do you get the atoms back and put them in their right places?

M: Quite so, Mr. Grant. But then how did some reputable physicists come to think that miniaturization was practical?

G: I don't know, doctor, but you don't hear of it any more (Asimov 1966).

Another point that Asimov elegantly and skilfully avoids concerns the details of how to practically carry out the miniaturisation process in practice, almost taking it for granted, as the problem is solved by one of the scientists with the line “don't ask me how it works”.

Although both the film and the novel based on it are science fiction works of more than fifty years ago, they contain more than one interesting idea, namely that of being able to intervene in an extremely precise and selective manner on the part to be operated on by intervening from inside the organism. We get it from a dialogue between Duval and Grant.

G: Of course. Consider the future. A ship can be sent through a clogged arterial system, loosening and detaching the sclerotic regions, breaking them up, boring and reaming out the tubes.

D: Pretty expensive treatment, however.

G: Maybe it could be automated eventually, said Grant. Perhaps little housekeeping robots can be sent in to clean up the mess. Or perhaps every human being in early manhood can be injected with a permanent supply of such vessel cleansers (*ibidem*).

Today, research into nanobots is one of the main fields of study of nanotechnology applied to medicine. However, nanobots are not what we might imagine – thinking of nanomachines capable of operating autonomously inside the human body, for example. In the field of nanomedicine, nanobots could be considered an almost colloquial term, indicating a molecule that can be specifically programmed to perform a specific medical task. To date, they can be identified as self-propelled nanodevices that can place the active ingredient of the medicine exactly on the spot to be medicated, thus avoiding unnecessary waste and overwork of organs, such as the liver, to metabolise the medicine administered in the usual dosages.

As I will discuss later in this thesis, nowadays nanomedicine benefits, for example, from the properties of silver and gold nanoparticles. Silver nanoparticles, in fact, are known for their antibacterial properties and can also be used as antivirals. At well below 100nm, silver nanoparticles have been shown to effectively attack the HIV virus and can block the replication mechanism of HIV or the hepatitis B virus. Although the exact mechanism by which nanometric silver works is not fully known, it seems increasingly plausible that it catalyses oxidation-reduction reactions that destroy harmful cells.

Another of the particles whose properties are exploited when the metal is reduced to nanometric size is gold. This metal has proven to be particularly stable and, above all, is not rejected by the human organism, which is why it is used as a material in so-called core-shell structures, i.e. metal particles that are coated with a second material for their own protection, which are used to attack the cells that need to be neutralised. The concept applied is that of the Trojan horse, whereby cancer cells allow themselves to be attacked by nanoparticles ‘not knowing’ what their purpose is. We will see in the following chapters how these applications have developed over time.

3.1.10 1968: Layer-by-Layer Growth of Materials

Research into semiconductor materials and their applications, which appeared overwhelmingly in various fields in the 1960s, stimulated new production methods for achieving the vacuum growth of semiconductors. One of these methods, as is sometimes the case in different areas of science, was created by taking two existing production techniques and the knowledge behind them and merging them into something new. The development of the Molecular Beam Epitaxy (MBE) started from just such a premise, combining knowledge from Surface Physics and Ion Propulsion Technology to create an entirely new technology for growing materials in crystalline form.

Although the expression Molecular Beam Epitaxy was first introduced in 1970, the paternity of this technique is attributed to Alfred Yi Cho who developed it at Bell Laboratories in 1968 (Fig. 3.27). Cho himself made this clarification on the appearance of this term in the literature (Cho 1999).

JOURNAL OF APPLIED PHYSICS VOLUME 41, NUMBER 7 JUNE 1970

**Morphology of Epitaxial Growth of GaAs by a Molecular Beam Method:
The Observation of Surface Structures**

A. Y. CHO

Bell Telephone Laboratories, Incorporated, Murray Hill, New Jersey 07974

(Received 24 December 1969)

Fig. 3.27 The article where Cho first spoke about Molecular Beam Epitaxy, summarising the former years of his research. In the following decade only, Cho published at least 42 articles and essays in different magazines about this subject.

Retrieved via: <https://ur.booksc.org/s/Cho%20morphology%20molecular%20beam%20epitaxy>

Being able to develop a technique for growing materials layer by layer allows maximum control over the purity of the final product in terms of its thickness, which can be controlled down to molecular or atomic dimensions, and its structural characteristics. Being able to handle a ‘pure’ material in fact guarantees the possibility of conducting reproducible experiments and, in the case of semiconductor physics, this peculiarity has been of fundamental importance for the research and development of all applications based on them.

The word “epitaxy” comes from the Greek and is in turn composed of two terms ἐπί, or ‘above’, and τάξις, ‘arrangement’ or ‘ordering’, and refers to the growth of a layer of crystalline material whose thickness reaches nanometre or more on a substrate that is itself crystalline, and which directs the growth of the layer and determines its structural properties. When the material being grown is the same as the crystalline substrate, we speak of homoepitaxy, while if it differs chemically from the substrate, we speak of heteroepitaxy. The difference is substantial, especially when we are talking about heteroepitaxy. If the substrate and the film are different, there is no getting away from the knowledge of the crystalline structure of the two materials, the respective lattice parameters, the coefficients of thermal expansion, factors that could lead to strain or defects in the final product. (Orton and Foxon 2015)

Molecular beam epitaxy is a layer-by-layer deposition technique carried out under high vacuum or ultra-high vacuum conditions (10^{-8} Torr or 10^{-12} Torr). The deposition rate

(typically less than 3000nm per hour) is the key parameter of the process as it is what allows the films to grow epitaxially. The combination of deposition rate and vacuum conditions results in a material whose purity is comparable to that achievable through other deposition techniques. The absence of a gas to transport the material to be deposited on the substrate first and then on the subsequent layers, together with the ultra-high vacuum operating condition, lead to the highest possible purity during film growth.

In solid source MBE, elements in ultra-pure form of the III group such as gallium or the V group such as arsenic are heated in special evaporators such as quasi-Knudsen effusion cells (which allow fine control over the process temperature) or electron beam until they begin to sublime slowly. The elements in the gaseous state then condense on the substrate wafer, where they can react with each other. If, for example, gallium and arsenic are used, the reaction product is single crystal gallium arsenide. This is referred to as a “beam” because the free mean path of the evaporated atoms is such that they do not interact with each other or with the gases in the vacuum chamber until they reach the wafer, where they are deposited.

During the process, the growth of the different crystal layers is monitored by Reflection High-Energy Electron Diffraction (RHEED), while electronics control the shutters in front of each furnace, allowing precise control of the thickness of each layer, up to thicknesses measuring a single layer of atoms. In this way it is possible to obtain highly complex structures made of different materials. MBE can also be used for the deposition of certain types of organic semiconductors. In this case it is molecules, rather than atoms, that are evaporated and deposited on the wafer. Other variants include gas source MBE, which has operational affinities with chemical vapour deposition.

Depending on research needs, systems based on MBE, being flexible, can be modified. Oxygen sources can be incorporated, for example, to deposit oxides for advanced electronic, magnetic and optical applications, as well as for fundamental research.

Layered nanostructures such as superlattices (SLs) and quantum wells (QWs) have been essential tools for broadening the horizons of Physics and Electronics, and have found applications of decisive impact in Information Technology. All these nanostructures have been made possible by MBE, a technique that has allowed to obtain interfaces that are smooth at the atomic level or corrugated, as required. Research into materials, magnetic devices and the physics of superconductors are other fields that benefit from MBE technology. In 1976 and 1980, Japanese researcher Hiroyuki Sakaki proposed the use of quantum dots (QDs) and quantum wires (QWRs) for newly developed nonlinear transport devices and FETs respectively. Experimental studies of the 1D or 0D electrons (of quantum wires and quantum dots) of structures around 10nm received a major boost in the 1980s, and it was the self-organised MBE growth of QDs and the selective epitaxial growth of QWRs on suitably organised substrates that enabled the QD/QWR structures to be obtained, enabling research into these structures (Sakaki 2002).

More recently, this technique has been used to create nanowires on which 0D, 1D or 2D quantum structures have been obtained to handle information processing and possible on-chip applications for quantum communication and computing (de la Mata *et al.* 2013).

3.1.11 1970: QSE, the Quantum Size Effect

In 1970, Reona Leo Esaki and Raphael Tsu, then employed at IBM's Thomas J. Watson Research Center in Yorktown Heights, published their study of alloys of single-crystal semiconductor materials. They hypothesised the presence of a one-dimensional periodic potential, obtained either through a periodic change in the composition of the material or through a periodic change in the density of the impurities introduced during the growth of the crystal. Such a realization allowed them to formulate hypotheses concerning the mini-zonal subdivision that could affect the Brillouin zone and that would result in a series of mass bands and very narrow forbidden bands. A prerequisite for such a hypothesis was that the period of this periodic potential, which they also referred to as the "superlattice", was estimated to be in the order of tens of nanometres smaller than the free mean electron path (Fig. 3.28).

Communication

L. Esaki
R. Tsu

Superlattice and Negative Differential Conductivity in Semiconductors*

Fig. 3.28 The original frontispiece of the article in which Esaki and Tsu exposed their results and the Quantum Effects observed. Source: Esaki and Tsu (1970)

At such a small size, quantum effects due to the confinement of electrons in the potential theorised by Esaki and Tsu cannot be ignored. The combination of nanometric size and the emerging quantum effects is called the Quantum Size Effect. It is now known that it is precisely the emergence of quantum physics phenomena that causes materials of nanometric size to behave in a way that is completely unpredictable compared to what is normally observed at macroscopic dimensions.

The techniques for processing materials in 1970 were not comparable to those of today; in the words of Esaki and Tsu in their paper, regarding how to derive the superlattice on which to make observations, we can read between the lines the state of the art technology of that period.

The achievement of a well-defined superlattice structure with a period of, say, 100Å will require considerable effort even with the use of the most advanced epitaxial thin-film technologies. The materials should be well-known semiconductors and their alloys; for examples, Ge, Si, Ge-Si alloys, III-V compounds and their alloys, II-VI compounds and their alloys, etc. (Esaki and Tsu 1970)

In order to obtain the superlattice structure needed to carry out the experimental observations, Esaki and Tsu relied either on alternating donor and acceptor impurities in a single semiconductor or on the periodic variation of the components of an alloy that was introduced during crystal growth. With the conditions at their disposal, they opted for the

second method. Alloys have lower diffusion coefficients than semiconductors, and the relatively low preparation temperature minimised the thermal diffusion of impurities.

For this reason, the two researchers considered two systems based on solid solutions of InAs and GaAs, describing the value of the potential by means of two functions, a sine wave and a square wave, which are periodic so as to translate mathematically the alternation of donors and acceptors or of alloy composition. In the following figure, adapted from their 1970 work to also depict the reference axes, the valence and conduction bands are shown in the case of a semiconductor material doped with donor and acceptor impurities (Fig. 3.29).

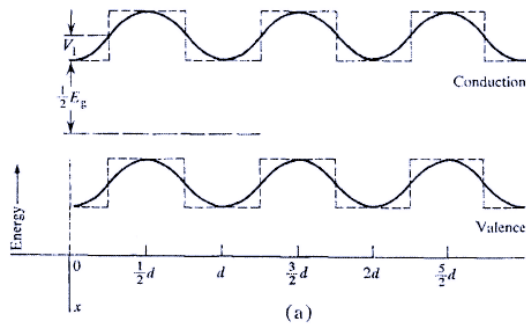

Fig. 3.29 Conduction and valence bands for alternation of donor and acceptor impurities and the electron energy as a function of distance in the direction of the superlattice. Source: Esaki and Tsu (1970)

In the next figure (Fig. 3.30), on the other hand, the bands for an alloy in which a periodic variation in composition is realised are illustrated. In both graphs, the solid lines represent sine-wave potentials, while the dashed lines represent square-wave potentials.

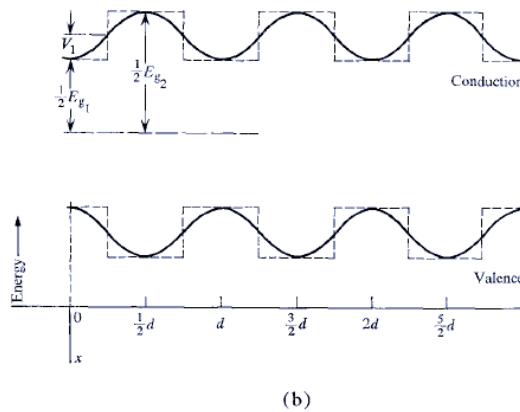

Fig. 3.30 The electron energy in the two bands of conduction and valence for an alloy whose composition changes periodically. Source: Esaki and Tsu (1970)

In order to understand how the quantum effects are involved I summarize here the work of Esaki and Tsu. As a matter of fact, they conducted a study of the band theory of the materials under consideration, in which quantum effects came into play with regard to the superlattice. The periodic potential can be defined by a simple relation of the type:

$$V(x) = V(x + nd) \quad (3.13)$$

where d is the periodicity and n an integer; the value of d is typically 10 to 20 times higher than the lattice constant a of the host crystal. In the reciprocal lattice, Brillouin zones are known to correspond to the Wigner–Seitz cells constructed in the direct lattice and thus in real space. The Brillouin zone of greatest interest is the first one and Esaki and Tsu divided it into further mini–zones and concentrated on the first of them, assuming that the E – k graph that can be drawn for it has a parabolic course, with the usual split predicted by Solid–State Physics for the free–electron condition and this due to the low concentration of carriers. As for the sinusoidal potential, they describe it mathematically as:

$$V(x) = V_1 \left[\cos\left(\frac{2\pi x}{d}\right) - 1 \right] \quad (3.14)$$

and the wave equation is written as a Mathieu equation (Abramowitz and Stegun 2014) i.e. as follows.

$$\frac{d^2 y}{dv^2} + (a - 2q \cos 2v)y = 0 \quad (3.15)$$

with a and q calculation parameters. The following parameters are therefore introduced, the reduced energy and the amplitude of the periodic potential:

$$\eta = \eta(k_x) \equiv \frac{E_x - V_1}{E_0} \quad (3.16)$$

and:

$$\gamma \equiv \frac{V_1}{E_0} \quad (3.17)$$

where V_1 is the amplitude of the periodic superlattice potential and, here we must underline the presence of \hbar in the formula, $E_0 \equiv \hbar^2 k_d^2 / 2m$. Again, m is the effective mass and this relationship stands: $k_d = \pi/d$.

In the following image, the authors represent the reduced energy and the reduced amplitude (Fig. 3.31).

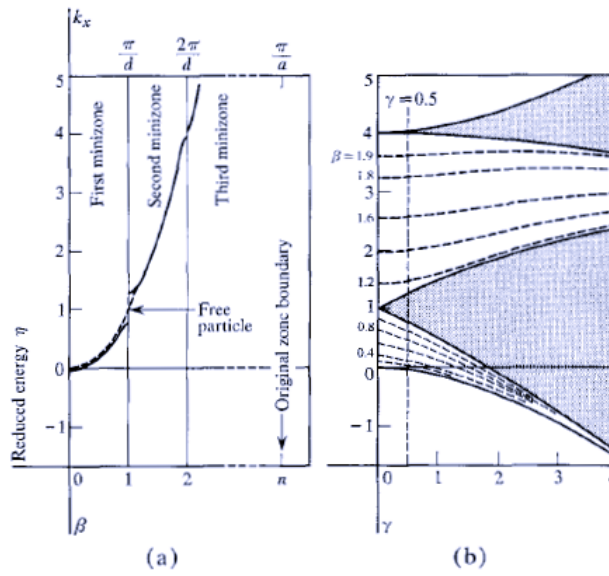

Fig. 3.31 The reduced energy (a) and amplitude (b). It is not difficult to recognize the typical parabolic shape, left, representing the well-known splitting of the energy parabola for the free electron at the edges of the first Brillouin zone, according to the theory of Solid-State Physics. Source: Esaki and Tsu (1970)

Epilogue III

In this third chapter, the first of the third part devoted to the historical development of Nanoscience and Nanotechnology, I have retraced some salient steps of research over two decades, from the post-second world war period to 1970. In fact, these twenty years laid the conceptual and experimental foundations of this science, which today covers practically every field of scientific research.

As is often the case in the History of Science, some of the most significant discoveries occur by chance. While the invention of the FIM microscope by Müller was the result of a development that had its roots between the two world wars, the observation by Radushkevich and Lukyanovic of the carbon structures that are now conventionally known as nanotubes was possible on the margins of a study that was not aimed at their specific research. With regard to the latter event, I also pointed out that, since the original article was in Russian, it could not benefit from the deserved dissemination within the international scientific community. At the same time, I pointed out that the original text did not include the terms that are commonly used today for carbon nanotubes. The prefix “nano” would come into use a few years later and the structures visualised by electron microscopy were then referred to as “worms”. The reading of the article by the Russian authors and the excerpts quoted are of great importance also because an English translation of the text does not appear to be available to date.

A. von Hippel is the personage to whom I then devoted my thoughts, as he was the theorist of Molecular Technology at a time when the possibility of physically manipulating atoms and molecules was still a long way off. Later on, I will show how this concept will be taken up and extended by the figure of Drexler.

Towards the end of the 1950s, Kilby developed an instrument that forms the basis of the electronics we know today. It was he who developed the first integrated circuit in the Texas Instruments laboratories, the device that made it possible to overcome the so-called Tyranny of Numbers, that is, the realisation that as the complexity of devices increased, the number of components grew disproportionately.

One cannot talk about the History of Science in the 1950s and 1960s without mentioning the figure of Richard Feynman. In addition to his achievements in the world of physics, which culminated in his being awarded the Nobel Prize together with Julian Schwinger (1918–1994) and Sin-Itiro Tomonaga (1906–1979), he also carved out a place for himself among many others in the history of nanotechnology. Feynman’s notoriety in this field goes back above all to the prophetic value given to his 1959 lecture, transcribed in the famous *There’s Plenty of Room at the Bottom*. In the paragraphs dedicated to Feynman, the reader was confronted with different interpretations of this article which, however, is still today counted among the founding documents and with this value cited, very often, in the scientific literature.

I then described the advances in electronics that led, in 1965, to Moore’s law: the number of transistors per chip doubles every 18 months. This result, which assesses the complexity of a microcircuit, is still valid today although it seems to have reached a limit. It will be the task of Nanotechnology to find an answer or development to this relationship.

After giving a nod to the nanoworld recounted in the sci-fi literature, I concluded the chapter with a description of layer-by-layer growth, which proved to be crucial for nanostructures, and the Quantum Size Effect. The latter is inescapable, and related to the fact that as the size decreases, and in particular at the nanometre size, quantum effects manifest themselves in all their evidence.

References

Primary Sources

- Atalla MM (1960) Semiconductor Devices having Dielectric Coatings. U.S. Patent 3,206,670 (filed March 8, 1960, issued September 14, 1965).
- Atalla MM, Kahng D (1960) Silicon–silicon dioxide field induced surface devices. Institute of Radio Engineers and American Institute of Electrical Engineers Device Research Conference, Pittsburgh.
- Atalla MM, Kahng D (1962) A new “Hot” Electron Triode Structure with Semiconductor–Metal Emitter. Solid–State Device Research Conference. IRE Transactions on Electron Devices 9/6:507–508. doi: 10.1109/t-ed.1962.15048.
- Bollmann W, Spreadborough J (1960) Action of Graphite as a Lubricant. *Nature* 4718:29–30.
- Cho AY (1999) How Molecular Beam Epitaxy (MBE) Began and its Projection into the Future. *Journal of Crystal Growth* 201/202:1–7.
- Derick L, Frosch CJ (1957) Oxidation of Semiconductive Surfaces for Controlled Diffusion. U.S. Patent 2,802,760 (filed December 2, 1956, issued August 13, 1957).
- Esaki L, Tsu R (1970) Superlattice and Negative Differential Conductivity in Semiconductors. *IBM Journal of Research and Development* 9/6:61–65. doi: 10.1016/0026-2714(70)90208–8.
- Frosch CJ, Derick L (1957) Surface Protection and Selective Masking during Diffusion in Silicon. *Journal of Electrochemical Society* 104/9:547–552.
- Kahng D (1960) Electric Field Controlled Semiconductor Device. U.S. Patent 3,102,230 (filed May 31, 1960, issued August 27, 1963).
- Kilby JSC (1959) Miniaturized Electronic Circuits. U.S. Patent 3,138,743 (filed February 6, 1959, issued June 23, 1964).
- Moore GE (1965) Cramming More Components onto Integrated Circuits. *Electronics Magazine* 38/8.
- Müller EW (1951) Das Feldionenmikroskop (The Field Emission Microscope, in German). *Zeitschrift für Physik* 131:136–142.
- Radushkevich LV, Lukyanovich VM (1952) On the Carbon Structure Formed by the Thermal Decomposition of Carbon Monoxide on an Iron Contact (in Russian). *Russian Journal of Physical Chemistry* 26/1:88–95.
- Turing AM (1950) Computing Machinery and Intelligence. *Mind* 49:433–460.
- Von Hippel AR (1956) Molecular Engineering. *Science* 123:315–317.

Secondary Sources

- Abramowitz M, Stegun I (1972) *Handbook of Mathematical Functions with Formulas, Graphs, and Mathematical Tables*. National Bureau of Standards, Washington
- Basset RK (2007) *To the Digital Age: Reserch Labs, Start-up–Companies, and the Rise of MOS Technology*. Johns Hopkins University Press, Baltimora.
- Cheng G, Siles PF, Bi F, Cen C, Bogorin DF, Bark CW, Folkman CM, Park JW, Eom CB, Medeiros–Ribeiro G, Levy J (2011) Sketched Oxide Single–Electron Transistor. *Nature Nanotechnology*. doi: 10.1038/nnano.2011.56.
- De la Mata M, Zhou X, Furtmayr F, Teubert J, Gradečak S, Eichhoff M, Fontcuberta I Morral A, Arbiol J (2013) A Review of Molecular Beam Epitaxy (MBE) Grown 0D, 1D and 2D Quantum Structures in a Nanowire. *Journal of Materials Chemistry C* 1:4300–4312. doi: 10.1039/c3tc30556b.
- Desai SB, Madhvapathy SR, Sachid AB, Llinas JP, Wang Q, Ahn GH, Pitner G, Kim MJ, Bokor J, Hu C, Wong HSP, Javey A (2016) MoS₂ Transistors with 1–Nanometer Gate Lengths. *Science* 354/6308:99–102. doi:10.1126/science.aah4698.
- Disco C, van der Meulen B (1998) *Getting New Technologies Together*. Walter de Gruyter, New York.
- Huff H (2005) *High Dielectric Constant Materials: VLSI MOSFET Applications*. Springer Science & Business Media, Berlin.

- Johnson D (2010) Junctionless Transistor Fabricated from Nanowires. Institute of Electric and Electronic Engineers Spectrum, Piscataway.
- Lamba V, Engles D, Malik SS, Verma M. (2009). Quantum transport in silicon double-gate MOSFET. 2nd International Workshop on Electron Devices and Semiconductor Technology: 1–4. doi:10.1109/EDST.2009.5166116.
- Love T (1993) Object Lessons. Lessons Learned in Object-Oriented Development Projects. SIGS Books, New York.
- Orton JW, Foxon T (2015) Molecular Beam Epitaxy: A Short History. Oxford University Press, Oxford.
- Sasaki H (2002) Prospects of Advanced Quantum Nano-Structures and Roles of Molecular Beam Epitaxy. International Conference on Molecular Beam Epitaxy. doi:10.1109/MBE.2002.1037732.
- Sanders WC (2019) Basic Principles of Nanotechnology. CRC Press, Boca Raton.
- Sridharan K, Pudi V (2015). Design of Arithmetic Circuits in Quantum Dot Cellular Automata Nanotechnology. Springer, Berlin.

Web References

- 1955: Developing of Oxide Masking
https://www.computerhistory.org/siliconengine/development-of-oxide_masking/ Retrieved: November 05, 2021.
- 1960: Metal Oxide Semiconductor (MOS) Transistor Demonstrated
<https://www.computerhistory.org/siliconengine/metal-oxide-semiconductor-mos-transistor-demonstrated/> Retrieved: November 04, 2021.
- Moore's Law to roll on for another decade
<http://news.cnet.com/2100-1001-984051.html>. Retrieved November 09, 2021.

Selected Additional References on the Subjects Suggested for Further Reading

- Albert KJ, Lewis NS, Schauer CL, Sotzing GA, Stützel SE, Vaid TP, Walt DR (2000) Cross-Reactive Chemical Sensor Arrays. *Chemical Reviews* 100/7:2595–2626
- Aarns RG (1998) The Other Transistor: Early History of the Metal–Oxide–Semiconductor Field–Effect Transistor. *Engineering Science and Education Journal*. 7/5: 233–40
- Baker RJ (2011) CMOS: Circuit Design, Layout, and Simulation. John Wiley & Sons, Hoboken
- Bakshi UA, Godse AP (2007) The Depletion Mode MOSFET. *Electronic Circuits*. Technical Publications
- Bapat YN (1992) *Electronic Circuits and Systems: Analog and Digital*, 1st edition. Tata McGraw–Hill Education, New York
- Basu PK (1997) *Theory of Optical Processes in Semiconductors*. Oxford Science Publications, Oxford
- Braun T, Schubert A, Zsindely S (1997) Nanoscience and Nanotechnology on the Balance. *Scientometrics* 38/2:321–325
- Chen H, Roco MC, Li X, Lin Y (2008) Trends in Nanotechnology Patents. *Nature Nanotechnology* 3/3:123–125
- Chen H, Schuffels C, Orwig R (1996) Internet Categorization and Search: a Machine Learning Approach. *Journal of Visual Communication and Image Representation* 7/1:88–102
- Chen WK (2004) *The Electrical Engineering Handbook*. Elsevier, Amsterdam
- Cheng Y, Hu C (1999) *MOSFET Modeling & BSIM3 User's Guide*. Springer, Cham
- Cho AY, Arthur JR Jr (1975) Molecular Beam Epitaxy. *Progress in Solid State Chemistry* 10:157–192
- Colinge JP (2008) FinFETs and Other Multi-Gate Transistors. Springer Science & Business Media, Berlin
- Colinge JP, Greer JC (2016) *Nanowire Transistors: Physics of Devices and Materials in One Dimension*. Cambridge University Press, Cambridge

- Cressler JD, Mantooh HA (2017) *Extreme Environment Electronics*. CRC Press, Boca Raton
- Davey JE, Pankey T (1968) Epitaxial GaAs Films Deposited by Vacuum Evaporation. *Journal of Applied Physics* 39/4:1941–1948
- Deal BE (1988) *The Thermal Oxidation of Silicon and Other Semiconductor Materials. Semiconductor Materials and Process Technology Handbook: For Very Large Scale Integration (VLSI) and Ultra Large Scale Integration (ULSI)*. Noyes Publications, Bonn
- Deal BE (1998) *Highlights Of Silicon Thermal Oxidation Technology*. Silicon materials science and technology. The Electrochemical Society
- Feldman LC (2001) “Introduction”. *Fundamental Aspects of Silicon Oxidation*. Springer Science & Business Media, Berlin
- Feynman R. (1993) Infinitesimal Machinery. *Journal of Microelectromechanical Systems*. 2/1:4–14
- Feynman RP, Sykes C (1995) *No Ordinary Genius: The Illustrated Richard Feynman*. W.W. Norton & Company, New York
- Fossum JG, Trivedi VP (2013) *Fundamentals of Ultra–Thin–Body MOSFETs and FinFETs*. Cambridge University Press, Cambridge
- Franco J, Kaczer B, Groeseneken G (2013) *Reliability of High Mobility SiGe Channel MOSFETs for Future CMOS Applications*. Springer Science & Business Media, Berlin
- Frank DJ, Dennard RH, Nowak E, Solomon PM, Taur Y (2001) Device Scaling Limits of Si MOSFETs and their Application Dependencies. *Proceedings of the Institute of Electric and Electronic Engineers*, Piscataway. 89/3:259–88
- Galup-Montoro C, Schneider MC (2007) *MOSFET Modeling for Circuit Analysis and Design*. World Scientific, London
- Gansner E, North S (2000) An Open Graph Visualization System and its Applications to Software Engineering. *Software–Practice and Experience* 30/11:1203–1233
- Golio M, Golio J (2018) *RF and Microwave Passive and Active Technologies*. CRC Press, Boca Raton
- Gray PR, Hurst PJ, Lewis SH, Meyer RG (2001) *Analysis and Design of Analog Integrated Circuits* (Fourth ed.). Wiley, New York
- Günther KG (1958) Aufdampfschichten aus Halbleitenden III-V-Verbindungen. *Zeitschrift für Naturforschung A* 13/12:1081–1089
- Hadziioannou G, Malliaras GG (2007) *Semiconducting Polymers: Chemistry, Physics and Engineering*. Wiley–VCH, Weinheim
- Harrison LT (2005). *Current Sources and Voltage References: A Design Reference for Electronics Engineers*. Elsevier, Amsterdam
- Harrison P (2005) *Quantum Wells, Wires and Dots*. Wiley & Sons, Hoboken
- Higgins RJ (1983) *Electronics with Digital and Analog Integrated Circuits*. Prentice–Hall, Hoboken
- Hittinger WC (1973) Metal–Oxide–Semiconductor Technology. *Scientific American* 229/2:48–59
- Hori R, Masuda H, Minato O, Nishimatsu S, Sato K, Kubo M (1975) Short Channel MOS-IC Based on Accurate Two Dimensional Device Design. *Japanese Journal of Applied Physics*. 15/S1:193
- Huang Z, Chen H, Chen ZK, Roco MC (2004) International Nanotechnology Development in 2003: Country, Institution, and Technology Field Analysis based on USPTO Patent Database. *Journal of Nanoparticle Research* 6/4:325–354
- Huang Z, Chen H, Yip A, Ng G, Guo F, Chen ZK, Roco MC (2003) Longitudinal Patent Analysis for Nanoscale Science and Engineering: Country, Institution and Technology Field. *Journal of Nanoparticle Research* 5:333–363
- Jones W (1997) *Organic Molecular Solids: Properties and Applications*. CRC Press, Boca Raton
- Joseph MK (2005) *Computer Network Security*. Springer Science & Business Media, Berlin
- Jung J, Bork J, Holmgaard T, Kortbek NA (2005) *Single–Walled Carbon Nanotubes*, 8th semester project. Technical Physics–Springer, Berlin
- Kahng D, Sze M (1967) A Floating–Gate and its Application to Memory Devices. *The Bell System Technical Journal* 46/4:1288–95
- Kalff FE, Rebergen MP, Fahrenfort E, Girovsky J, Toskovic R, Lado JL, Fernández-Rossier J, Otte AF (2016) A Kilobyte Rewritable Atomic Memory. *Nature Nanotechnology* 11/11:926–929
- Kawaura H, Sakamoto T, Baba T, Ochiai Y, Fujita J, Matsui S, Sone J (1997) Proposal of Pseudo Source and Drain MOSFETs for Evaluating 10–nm Gate MOSFETs. *Japanese Journal of Applied Physics* 36/3S:1569
- Klimecky PI (2002) *Plasma Density Control for Reactive Ion Etch Variation Reduction in Industrial Microelectronics*. University of Michigan, Ann Arbor

- Kobayashi T, Horiguchi S, Kiuchi K (1984) Deep-Submicron MOSFET Characteristics with 5nm Gate Oxide. *International Electron Devices Meeting*:414–417
- Koezuka H, Tsumura A, Ando T (1987) Field-Effect Transistor with Polythiophene Thin Film. *Synthetic Metals*. 18:699–704
- Kuo Y (2013) Thin Film Transistor Technology—Past, Present, and Future. *The Electrochemical Society Interface*, 22/1:55–61
- Lécuyer C (2006) *Making Silicon Valley: Innovation and the Growth of High Tech, 1930-1970*. The Massachusetts Institute of Technology, Boston
- Lindley D (2015) Focus: Landmarks – Accidental Discovery Leads to Calibration Standard. *Physics* 8. doi:10.1103/Physics.8.46
- Malik NR (1995) *Electronic Circuits: Analysis, Simulation, and Design*. Prentice Hall, Englewood Cliffs
- Maloberti F, Davies, AC (2016) *History of Electronic Devices. A Short History of Circuits and Systems: From Green, Mobile, Pervasive Networking to Big Data Computing*. Institute of Electric and Electronic Engineers, Circuits and Systems Society, Piscataway
- Mayer B, Janker L, Loitsch B, Treu J, Kostenbader T, Lichtmannecker S, Reichert T, Morkötter S, Kaniber M, Abstreiter G, Gies C, Koblmüller G, Finley JJ (2016) Monolithically Integrated High- β Nanowire Lasers on Silicon. *Nano Letters* 16 /1:152–156
- Mayer B, Regler A, Sterzl S, Stettner T, Koblmüller G, Kaniber M, Lingnau B, Lüdge K, Finley JJ (2017) Long-Term Mutual Phase Locking of Picosecond Pulse Pairs Generated by a Semiconductor Nanowire Laser. *Nature Communications* 8:15521
- McCluskey MD, Haller EE (2012) *Dopants and Defects in Semiconductors*. CRC Press, Boca Raton
- McCray WP (2007) Molecular Beam Epitaxy Deserves a Place in the History Books. *Nature Nanotechnology* 2/5:259–261
- Milburn C (2008) *Nanovision: Engineering the Future*. Duke University Press, Durham.
- Moskowitz SL (2016) *Advanced Materials Innovation: Managing Global Technology in the 21st century*. John Wiley & Sons, Hoboken
- Motoyoshi M (2009). Through-Silicon Via (TSV). *Proceedings of the Institute of Electrical and Electronic Engineers, Piscataway*. 97/1:43–48
- Omura Y, Mallik A, Matsuo N (2017) *MOS Devices for Low-Voltage and Low-Energy Applications*. John Wiley & Sons, Hoboken
- Rai-Choudhury P (2000) *MEMS and MOEMS Technology and Applications*. Society of Photo-Optical Instrumentation Engineers (SPIE) Press, Bellingham
- Raymer MG (2009) *The Silicon Web: Physics for the Internet Age*. CRC Press, Boca Raton
- Regis E (1997) *Nano*. Bantam, Ealing
- Saito R, Dresselhaus G, Dresselhaus M (1998) *Physical Properties of Carbon Nanotubes*. Imperial College Press, London
- Schwierz F, Wong, Hei L, Juin J (2010) *Nanometer CMOS*. Pan Stanford Publishing, Singapore
- Schwierz FW, Hei LJJ (2010) *Nanometer CMOS*. Pan Stanford Publishing, Singapore
- Sedra AS, Smith KC (2004) *Microelectronic circuits* (Fifth ed.). Oxford, New York
- Shichman H, Hodges DA (1968) Modeling and Simulation of Insulated-Gate Field-Effect Transistor Switching Circuits. *Institute of Electric and Electronic Engineers Journal of Solid-State Circuits*, SC-3/3:285–89
- Shukla SK Bahar RI (2004) *Nano, Quantum and Molecular Computing*. Springer, Cham.
- Somanathan N (2002) *Digital Electronics and Logic Design*. Prentice Hall India Learning Private Limited, New Delhi
- Sridharan K, Pudi V (2015) *Design of Arithmetic Circuits in Quantum Dot Cellular Automata Nanotechnology*. Springer, Cham
- Thompson SE, Chau RS, Ghani T, Mistry K, Tyagi S, Bohr MT (2005) In Search of “Forever”, Continued Transistor Scaling One New Material at a Time. In: *Transactions on Semiconductor Manufacturing* 18/1:26–36. Institute of Electric and Electronic Engineers, Piscataway
- Toumey C (2008) Reading Feynman into Nanotechnology: A Text for a New Science. *Techné* 13/3: 133–168
- Toumey C (2019) *Apostolic Succession*. *Engineering & Science* 1:16–23
- Trontl V, Mikšić Pletikosić I, Milun M, Pervan P, Lazić P, Šokčević D, Brako R (2005) Experimental and Ab Initio Study of the Structural and Electronic Properties of Subnanometer Thick Ag Films on Pd(111). *Physical Review B*. 72/23:235418
- van der Meer PR, van Staveren A, van Roermund AHM (2004) Low-Power Deep Sub-Micron CMOS Logic: Subthreshold Current Reduction. Springer, Dordrecht

- Voinigescu S (2013) High-Frequency Integrated Circuits. Cambridge University Press, Cambridge
- Wang GC, Lu TM (2013) RHEED Transmission Mode and Pole Figures
- Williams JB (2017). The Electronics Revolution: Inventing the Future. Springer, Cham
- Xu Q, Canutescu AA, Wang G, Shapovalov, Obradovic Z, Dunbrack RL (2008) Statistical Analysis of Interface Similarity in Crystals of Homologous Proteins. *Journal of Molecular Biology* 381/2:487–507
- Xu W, Guo C, Rhee SW (2013) High Performance Organic Field-Effect Transistors using Cyanoethyl Pullulan (CEP) High-k Polymer Cross-Linked with Trimethylolpropane Triglycidyl Ether (TTE) at Low Temperatures. *Journal of Materials Chemistry C*, 1/25: 3955
- Ye P, Ernst T, Khare MV (2019) The Nanosheet Transistor Is the Next (and Maybe Last) Step in Moore's Law. Institute of Electric and Electronic Engineers Spectrum, Piscataway
- Yusupov MM, Yusupova GZ, Baucom A, Lieberman K, Earnest TN, Cate JHD, Noller HF (2001) Crystal Structure of the Ribosome at 5.5Å Resolution. *Science* 292/5518:883–896

Chapter IV

1971–1990

Note: from section 4.1.7, material was derived to compose the standalone article *1950s-1990s: Carbon Nanotubes Studies into Historiography of Nanoscience-Nanotechnology*, which is currently being edited, and the first page of which can be found in Appendix 3.

Prologue IV

When we speak of nano–dimensions, we refer to measurements ranging from about 1 to 100 nanometres, where it is known that one nanometre corresponds to one billionth of a metre.

At these dimensions, the known properties of matter at macroscopic dimensions, those characteristics of the so–called bulk dimension, are modified to such an extent that new and unexpected features appear. It is precisely these new properties that make already–known elements and materials of absolutely new interest for research. From the early 1970s to 1990, the time span covered in this fourth chapter, the ability to first observe, then manipulate atoms and molecules, and then realise structures previously conceived theoretically became increasingly widespread. Such detailed work on materials was supported by the development of new instruments, especially in the field of electron microscopy, which extended the researcher’s scope for intervention down to the smallest scales.

Having described the early post–World War II years of nanotechnology, it is now time to look at the years that would lead to the rapid development of research. These are the years that laid the foundations for the expansion of the nanoworld into all areas of research that it invested in. For the first time in the history of nanoscience and science in general, a word appears that is fundamental: “Nanotechnology”. We know the exact date of the introduction of this term as 1974. The father of this word was the Japanese engineer Norio Taniguchi (1912–1999), who defined Nanotechnology in one of his articles about a machine designed for ion sputtering. 1974 is therefore the birth date of this word; from then on it would gradually gain more and more ground, although it must be said that it did not have such a major impact at the time of its appearance.

Only two years later, in search of nanostructures obtained from known precursors, a group of Japanese scientists, Endo, Koyama and Hishiyama, developed a procedure to obtain carbon fibres on a nanoscale from cyclic aromatic compounds such as benzene.

In 1977, the concept of Molecular Technology emerged for the first time. This was made possible thanks to the contribution of the American engineer Kim Eric Drexler, to whom the reader will find more references in this chapter, as he is considered one of the main and most significant pioneers of nanoscience. Drexler is recognised as the one who gave a new, and almost global, resonance to Richard Feynman’s 1959 lecture *There’s Plenty of Room at the Bottom*. Not only that, he is also credited in the literature as the author of probably the most inspiring book on nanotechnology, *Engines of Creation: The Coming Era of Nanotechnology*. This text, in addition to compiling Drexler’s ideas on what is meant by nanotechnology, what the developments of such an investigation might be, and the risks and promises, is remarkable because it presents the concepts in a discursive manner. Its structure and writing are, although conceptually very precise, designed to reach the greatest number of people. The text was not intended for reading limited to experts. The book, published in 1986, had been preceded by an article, authored by Drexler, and published in 1981, characteristic for its long title *Molecular Engineering: an Approach to the Development of General Capabilities for Molecular Manipulation*. In this article, the author drew remarkable parallels between the devices of biology and the structures of engineering, linking the concepts of the two disciplines to the ability to be able to intervene directly on atoms and molecules through molecular–sized devices, achieving absolute precision in the realisation of a priori engineered devices.

The 1980s saw the beginning of the growth of nanotechnology thanks to the concentration of numerous improvements in the field of electron microscopy, first and

foremost the invention of the STM microscope in 1981. Gerd Binnig and Heinrich Rohrer's research at the IBM research laboratories in Zurich earned them the Nobel Prize in 1986.

In the same year, with the development of the AFM microscope, the limits to the use of electron microscopes were removed.

1982 was an important year because, in the Soviet Union, an article was published in the journal *Metals* that in some ways gave continuity to another publication from 1952, which I presented in the previous chapter, in which the observation of particular structures of carbon was presented. Once again, the images documented the presence of hollow tubular structures. This time, moreover, diffractometric analyses and structural considerations led the researchers to the hypothesis of multiple tubular forms of carbon, based on the way in which the single layer of material was wrapped. Such a hypothesis was apparently the forerunner of the concept of chirality that would be formalised later.

Another fundamental moment in the history of nanoscience corresponds to the production of the first carbon nanostructure in addition to the already known allotropic forms of carbon, namely diamond and graphite: fullerene. In 1985, Kroto, Smalley and Curl published their research on carbon clusters of 60 or 70 atoms; in particular, the 60-atom structure of this allotropic form of carbon appeared strongly symmetrical, with the atoms arranged at the vertices of a truncated icosahedron, a figure very similar to the hexagonal and pentagonal patch balls in use until about the mid-1980s. Professor Kroto had been studying cyanopoles structures since the early 1970s, when one of his collaborators, chemist and astronomer Takeshi Oka, discovered the existence of these same molecules at the centre of the Milky Way. Kroto hypothesised that long-chain molecules, such as those found in interstellar space, could be recreated in the laboratory for analysis. In 1984, a meeting with Smalley allowed Kroto to exchange ideas and develop a laboratory methodology that, although oriented towards the search for cyanopoles, led to the formation of agglomerates of 60 carbon atoms. Once isolated, C₆₀, as fullerene is often called by its chemical formula, became a milestone in the history of nanotechnology. C₆₀ proved to be a chemically very stable structure. The search for its structure has its roots in the history of architecture. Indeed, it was thanks to Kroto's intuition and his reflections on Fuller's geodesic structure, designed for the US pavilion at the 1967 Montreal Exposition, that C₆₀ took shape and was christened buckminsterfullerene.

1986 became a milestone year in the history of science because one of the most important instruments in the technology applied to the structure of matter was described to the public: the atomic force microscope, or AFM. Already the previous year, Binnig, Quate and Gerber had developed this instrument at IBM's Swiss laboratories. Within a few years, the AFM would become commercially available, opening up new frontiers in research into the physics of matter.

The same year can also be considered a year of grace for Gerd Binnig, who received the Nobel Prize for the invention of the scanning tunnelling microscope, or STM as it is usually abbreviated, together with Heinrich Rohrer, as mentioned above.

Between 1970 and 1980, Eric Drexler developed the ideas that would reveal the potential of nanotechnology and, in 1986, published the text *Engines of Creation*, where he collected and developed his thoughts on this new science. In addition to presenting the scientific landscape of the nanoworld, according to his ideas, Drexler also addressed the question of the sociological impact that this revolution could have. The debate that arose with Smalley has already been mentioned above.

The AFM soon found application in the physics of matter. In 1987, it was used to study an insulating boron nitride surface, thus demonstrating its versatility. Only a short time earlier, in the same year, it had been applied for the observation of nanoscale structures, proving to be a perfectly suitable instrument for investigations at these dimensions.

Two years later, the dream of manipulating matter became a reality when Don Eigler became the first to use an electron microscope to arrange individual atoms on a matrix. *The beginning*, the logo of the industry to which Eigler belonged, has become one of the most famous images in the history of nanotechnology.

The end of this twenty-year period witnessed the appearance of numerous publications, showing how nanotechnology was branching out into several areas, each characterised by texts and articles dedicated to the in-depth study of individual topics.

4.1 New Instruments and Discoveries

From the 1970s onwards, Nanosciences have become increasingly important and the fields of development and application of their results have multiplied, covering practically every available scientific field. The nano world has proved to be a very fertile ground for new study in various fields, from physics to chemistry, from engineering to materials science, from biology to medicine.

In particular, the period I will describe below laid the conceptual foundations and instrumental developments that enabled Nanotechnology to become what we know it to be.

This period, in particular, saw the birth of the term Nanotechnology, although originally applied to engineering, as you can read in the next paragraph. In addition, more and more refined tools were developed to be able to manipulate matter on an atomic and molecular scale. In particular, electron microscopy has benefited greatly from the introduction of instruments such as the tunnel effect microscope and the atomic force microscope.

In addition, new materials have seen the light of day, the most relevant and fundamental in advancing this field of research being fullerenes.

4.1.1 1974: Nanotechnology: New Word for a New World

In 1974, the Japanese engineer Norio Taniguchi (Fig. 4.1), a professor at the University of Science in Tokyo, was the first scientist to explicitly use the term ‘Nanotechnology’ to describe the processes that take place on semiconductor materials at the nanoscale.

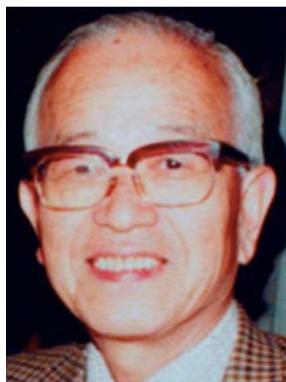

Fig. 4.1 Professor Norio Taniguchi. Source: Public Domain

In the Proceedings of the International Conference on Production Engineering published by the Japan Society of Precision Engineering (Fig. 4.2), which was founded in 1933 and whose aim since then has been to enable engineers and researchers to confront the most advanced developments in technology, Taniguchi published an article in which the term Nanotechnology appeared for the first time.

He wrote:

Nano-technology is the production technology to get the extra high accuracy and ultrafine dimensions, i.e. the preciseness and fineness of the order of 1 nm (nanometer), 10^{-9} m in length. The name of Nano-technology originates from this nanometer. In the processing of materials, the smallest bit size of stock removal, accretion or flow of materials is probably of one atom or molecule, namely 0.1~0.2nm in length. Therefore, the expected limit size of fineness would be of the order of 1 nm. Accordingly, Nano-technology mainly consists of the processing of separation, consolidation and deformation of materials by one atom or one molecule. Needless to say, the measurement and control techniques to assure the preciseness and fineness of 1nm play very important role in this technology. In the present paper, the basic concept of Nano-technology in materials processing is discussed on the basis of microscopic behaviour of materials and, as a result, the ion sputter-machining is introduced as the most promising process for the technology (Taniguchi 1974).

On the Basic Concept of 'Nano-Technology'

Naoto TANIGUCHI
Sakyo Science University
Koga-shi, Chiba-ken, 278 Japan

Abstract

'Nano-technology' is the production technology to get the extra high accuracy and ultra fine dimensions, i.e. the preciseness and fineness of the order of 1 nm (nanometer), 10^{-9} m in length. The name of 'Nano-technology' originates from this nanometer. In the processing of materials, the smallest bit size of stock removal, accretion or flow of materials is probably of one atom or one molecule, namely 0.1~0.2 nm in length. Therefore, the expected limit size of fineness would be of the order of 1 nm. Accordingly, 'Nano-technology' mainly consists of the processing of separation, consolidation and deformation of materials by one atom or one molecule. Needless to say, the measurement and control techniques to assure the preciseness and fineness of 1 nm play very important role in this technology.

In the present paper, the basic concept of 'Nano-technology' in materials processing is discussed on the basis of microscopic behaviour of materials and, as a result, the ion sputter-machining is introduced as the most promising process for the technology.

1 Introduction

In the recently developed manufacturing systems of integrated circuits, electronic devices and opto-electronic devices, there are inherently the intense needs for the processing of materials obtaining the preciseness and fineness of the order of 1 nm in length. As to the integrated circuits, this kind of processing has become to be necessary for finishing of silicon wafer with no surface damage and high grade of flatness, coating of very thin film with precise thickness onto silicon wafer and doping of impurities into precise depth and width of silicon wafer, etc., and also for electronic or opto-electronic devices, e.g. laser elements, crystal and ceramic oscillators and optical glass fibres, etc., this kind of ultra fine has become to be necessary.

Moreover, on the manufacturing of mechanical parts of high precision machinery, for instance, block gauge, injection pump, pneumatic or hydraulic bearing, memory disc or drum of electronic computer, sapphire lens, precision diamond tools, etc., such a high grade finishing in dimension and surface roughness has also become to be necessary to improve their qualities to the extreme limit.

From the urgent needs based on these industrial requirements, the system of ultra fine finishing or 'Nano-technology' has been introduced. The usual precision finishing technology has aimed to get the preciseness and fineness of 1 μ m, i.e. 10^{-6} m in length, hence it says 'micro-technology'. In contrast, the finishing technology aimed to get the preciseness and fineness of 1 nm would be called 'Nano-technology'. Needless to say, the technology includes the systems of materials processing, measurement and control for the preciseness and fineness of 1 nm.

2 Unit size and threshold energy/density of working, power density of processing energy and reaction rate process.

The main project of 'Nano-technology' is to establish the process of ultra fine finishing, the preciseness and fineness of which is about 1 nm in length.

Generally speaking, in order to get the product having such that high preciseness and fineness by stock removing process, accretion process or flowing process, it is necessary to process the work-piece materials by a bit of stock size of one figure smaller than 1 nm, i.e. by one atom or one molecule, or the order of 0.1 nm in length.

Hence it says that the unit size of working in these processes is one atom or one molecule - or the order of 0.1 nm. [1]

Whereas, there are already developed several materials processing by one atom or one molecule, as shown in Table 1. Referring to these processes, the basic concept of 'Nano-technology' will be discussed.

The most fundamental requirement for the removing process by one atom or one molecule is that the processing energy or working energy must be supplied by a bit and concentrated to the particular atom or molecule of the work-piece materials, and also the quantity of a bit of processing energy must be at least of the molecular bonding energy necessary for removing off the atom or molecule of work-piece from its surface, as shown in Fig.1.

For instance, the bonding energy of carbon, between C-C, is about 50 kcal/mole, or 2.46×10^5 J/mole, where mole of carbon is about 12 g. Considering Avogadro's No. 6.02×10^{23} /mole, the bonding energy per one molecule of carbon is about 4.06×10^{-19} J or 2.5 eV ($1\text{eV} = 1.6 \times 10^{-19}$ J), which corresponds to about 10^5 eV/cm², as the microscopic explanation of the threshold

Fig 4.2 The first page of Taniguchi's famous article where the word "Nanotechnology" appears in the abstract and on. Source: Taniguchi (1974)

Even with the meaning envisaged by Feynman in 1959, this is the first ever case in the literature of the use of this word, and historically, it constitutes the first formally structured and coherent definition of this scientific discipline.

According to the definition subsequently established by the National Nanotechnology Initiative (NNI), U.S.A., Nanotechnology is Science, Engineering and Technology on the nanoscale, where unique phenomena make possible absolutely new applications in many fields, from Chemistry, Physics and Biology to Medicine, Engineering and Electronics (Bayda *et al.* 2020).

The accredited definition, according to the Scientific Committee on Emerging and Newly Identified Health Risks (SCENIHR), today is as follows:

Nanotechnology is the term given to those areas of science and engineering where phenomena that take place at dimensions in the nanometre scale are utilised in the design, characterisation, production and application of materials, structures, devices and systems. Although in the natural world there are many examples of structures that exist with nanometre dimensions (hereafter referred to as the nanoscale), including essential molecules within the human body and components of foods, and although many technologies have incidentally involved nanoscale structures for many years, it has only been in the last quarter of a century that it has been possible to actively and intentionally modify molecules and structures within this size range. It is this control at the nanometre scale that distinguishes nanotechnology from other areas of technology (SCENIHR 2006).

We can compare these three definitions by identifying which specific items they refer to, summarising the results in the following table.

Table. 4.1 The different characteristics that appear in the definitions of Nanotechnology mentioned in the definition analysed.

Reference \ Feature	Taniguchi	NNI	SCENIHR
Dimension of material	X	X	X
New properties due to dimension		X	X
Possibilities of applications		X	X
Manufacturing properties	X		X

The characteristics that SCENIHR mentions are the most important, however, there are other profound considerations that need to be made with the utmost care:

- The first concerns the scale at which scientists operate, and that goes down to a nanometer dimension, observing and manipulating matter.
- The second concerns the importance of operations at the nanoscale. The chemical and physical properties of materials on the bulk/macroscale are known and exploited in technological applications. What makes the characteristics of the materials themselves completely new is their size. Interesting new properties appear at the nanoscale, and this is what makes nanoparticles particularly attractive for completely new applications.
- The third, but no less important, feature concerns the interdisciplinary nature of Nanotechnology. This branch of Physics ranges from Nanomechanics to

Nanomedicine, from Nanorobotics to Nanobiology, from Nanoelectronics to Molecular Engineering. Continuous progress is being made in each field and it is very difficult to establish precise boundaries within which to enclose the individual fields.

Defining what is meant by the word Nanotechnology is therefore a complex and multifaceted issue. I will return to this concept later, in the chapter dedicated to the research ethics and the implications of research in the nanoworld, to see how the concept of nanotechnology fits into the various areas of scientific research.

In 1990, Taniguchi would return again to the idea of Nanotechnology, but this time from a point of view that incorporated philosophical thinking. In that year, he defined Nanotechnology as an integrated processing technology capable of enabling the manufacture of objects with a precision of 1nm. Taniguchi warns the reader that this numerical limit, which effectively constrains the accuracy of the device, is dictated by the fact that the atoms of a solid object are of the order of 0.3nm.

In what follows, Taniguchi dwells on the meaning of the term “integration”, reflecting on the fact that the accuracy required by machining on an atomic scale is not achievable through the available mechanical equipment, nor through the conventional techniques of assembling complex devices or other technologies, employed individually. The results he advocates can only be achieved after building integrated precision systems that perform equally precise tasks such as measuring, sorting and positioning parts, and assembling them.

From this point of view, Taniguchi also perceives the field of Nanotechnology as having great potential for pushing the accuracy of processes to atomic limits, and precision technology will play a key role.

According to Taniguchi, a different approach is required to that applied with conventional techniques in the 1990s. Even if it were possible to refine the tip of a conventional tool to atomic precision, the temperature it would reach during machining would be so high that the tip would abrade abruptly and the desired precision would be lost almost immediately. This is why it is not possible to machine materials on an atomic scale with conventional tools. Machining has to be carried out at molecular or atomic dimensions, and new methods of removing individual atoms or molecules have to be employed to achieve precision machining. This can be achieved with energetic particles directed to where the machining is to be done, particles that can deform, modify or add atoms and molecules one by one.

In the words with which Taniguchi concludes his article, we can see his hope for the development of Nanotechnology.

[...] the construction of “nanotechnology” is based on the integration of the unique technologies of literature, processing and assembly, measurement and control, and the development of products with total precision on the order of nm, and future development is expected³⁶. (Taniguchi 1990, translation: AD)

³⁶ ナノテクノロジー」の構築は参 文献 加工組立, 測・制御の各固有技術を統合して, nmオーダーの総合精度をもつ 品を 発する技術をもとに行われるものであり, 今後の展 が望まれる

4.1.2 1976: Nanometric Scaled Carbon Fibres

In 1976, three Japanese researchers, Morinobu Endo, Tsuneo Koyama and Yoshihiro Hishiyama, published their research into the growth and reinforcement of carbon structures from cyclic aromatic hydrocarbons, marking a breakthrough that deserves to be remembered in the history of carbon nanotubes. For this research, Endo is remembered as one of the pioneers of nanotechnology and carbon nanotubes in particular.

By thermally decomposing benzene between 1050°C and 1080°C, it was already possible to make carbon fibres, and the three researchers achieved further structural changes in carbon through heat treatments that were gradually carried out up to 3000°C. Through X-ray diffraction, they were able to follow the structural evolution of their material. When the fibre was treated at 1400°C, it was observed that the planes of the aromatic rings were arranged approximately parallel to the axis of the fibre, which gradually assumed a turbostratic structure, while around 2000°C the rings became parallel to the main axis of the fibre. At 3000°C, the final fibre consisted of concentric layers of graphite, accumulated around the axis of the structure. (Endo, Koyama and Hishiyama 1976) It should be remembered that a turbostratic structure is said to be such when the carbon layers are arranged in a disorderly fashion or even reduced to fragments to compound larger superstructures. Some pictures that can exemplify this concept follow (Fig. 4.3 and Fig. 4.4).

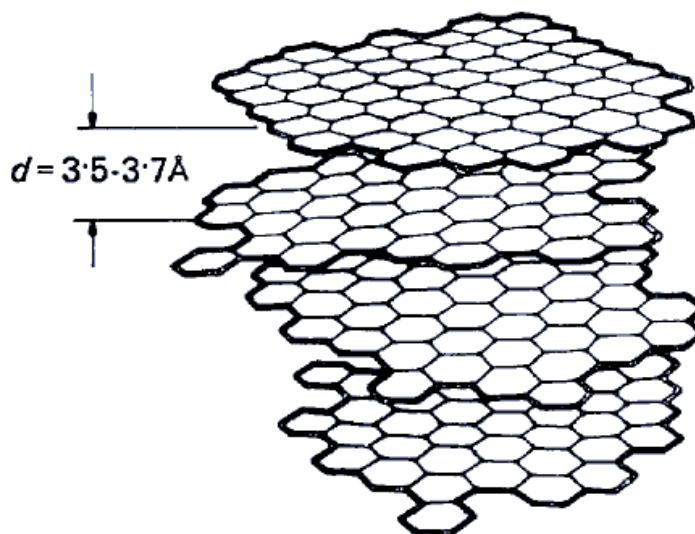

Fig 4.3 In this image layers of black carbon crystallites are represented. This is a model of black carbon turbostratic domain. Picture reproduced under permission of International Union of Crystallography

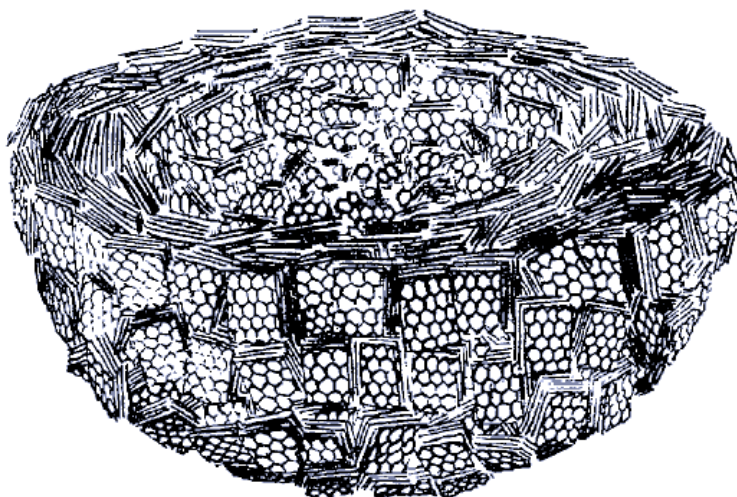

Fig 4.4 A modelling of the crystallites of black carbon in a black carbon particle that shows the arrangements of the turbostratic domain. Picture reproduced under permission of International Union of Crystallography

When working with different substrates and widely varying temperatures between 350°C and 2500°C, it is possible to achieve the growth of carbon and graphite in the form of filaments when the reaction atmosphere contains hydrocarbons in a gaseous state or carbon monoxide. In fact, in the early 1970s, it was Koyama himself who obtained carbon fibres up to 25cm long and with a diameter of a few hundred microns by thermally decomposing benzene at a reaction temperature of 1100°C and growing it on a graphite substrate.

SEM microscopy analysis then showed that these fibres were made up of concentric sheets of graphite, wound around what could be described as the fibre axis. Electron diffraction and X-ray diffraction showed unequivocally that the *c*-axis of the aromatic sheets – i.e. the axis along which the separation distance between the planes, in this case the rolled sheets, is measured – extended in a radial direction. In addition, electron microscopic analysis showed that each fibre was hollow and had a diameter of about 10nm.

Significant structural improvements in these fibres were obtained by heat treatment and confirmed by X-ray diffraction. The carbon fibres were prepared between 1050°C and 1800°C and subsequent heat treatment was carried out for 30 minutes at various temperatures between 1400°C and 3000°C in a high purity nitrogen atmosphere. The temperature was controlled by an optical pyrometer. X-ray diffraction of the powders was used for the analysis of the preparation. By referring to the standard values of silicon, it was possible to determine parameters such as the lattice constant c_0 , the apparent thickness of the crystallites $L_c(00.l)$ and the diameter $L_a(11.0)$. Particular details of the electron diffraction lattices were observed from the periphery of the sample by electron microscopy using a beam conducted in a direction practically perpendicular to the axis. The diffraction was preferentially carried out on samples with an almost cylindrical shape since the wavy surface influences the dispersion of the 00.l reflections and does not show how the planes of the aromatic rings remain parallel to the fibre axis.

The figure below shows the measurement of the cross-link constant as a function of Heat Treatment Temperature (HTT) for three different materials, a carbon fibre based on Poly-

Acryloyl-Nitrile (PAN), the carbon fibre prepared in the laboratory by the researchers and anthracene carbon (Fig. 4.5).

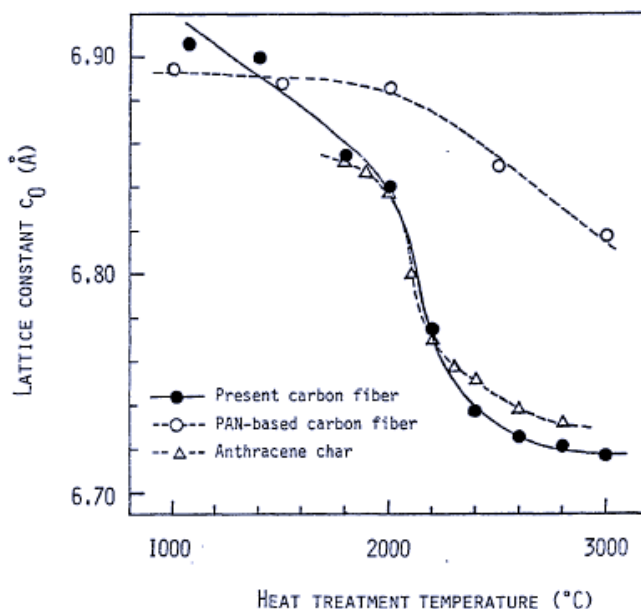

Fig 4.5 The plot of the lattice constant for different fibres compared to the benzene carbon fibre that was object of the research of Endo and his colleagues. Source: Endo, Koyama and Hishiyama (1976)

As the treatment temperature increases and for high values of the latter, starting from 2200°C, the lattice constant of the benzene carbon fibre decreases, while the three-dimensional order of the structure becomes more pronounced beyond 2400°C and tends to settle definitively at the end of the treatment temperature; the size of the crystallites, in terms of thickness and diameter, also increases considerably, while the lattice deformation gradually decreases until it disappears around 2600°C. The electron diffraction images show the growth of the crystallites which, at first, seem to follow a geometry of concentric circles that become thinner, reflections 00.2 and 00.4 become smaller and 00.4 almost imperceptible in the figure (b). This should be interpreted as a change in the orientation of the aromatic planes whose parallelism deviates by a few tens of degrees (20° or 30°) from the fibre axis. The thinning of the 00.1 reflections implies the growth of crystallites in the *c* direction and an increase in orientation.

At 2000°C the 00.1 reflections are read as point-like, which means that the planes have completed alignment parallel to the fibre axis, which completes the concentricity of the structures around the main axis. At 2600°C a 00.6 reflection also appears and becomes more readable as the temperature increases. Finally, the fibre, when treated at 3000°C, gives rise to the same diffraction spectrum as a single crystal of graphite (Fig. 4.6).

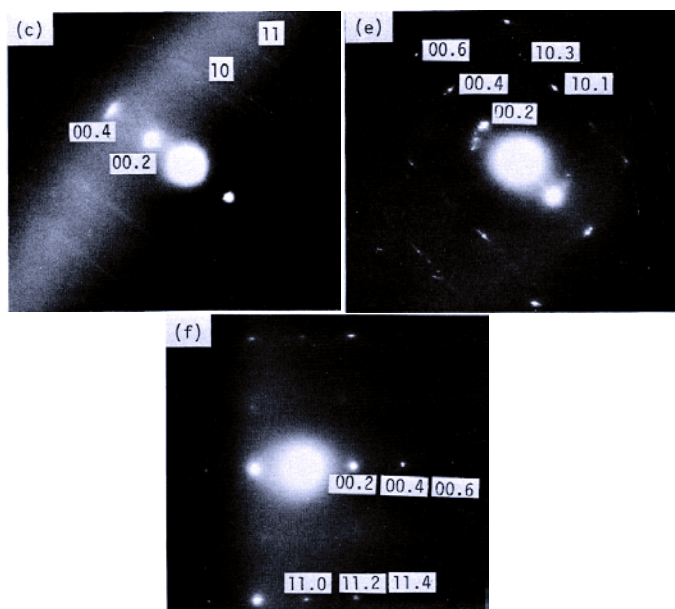

Fig 4.6 These pictures represent selected areas of the diffraction patterns taken at 2000°C (picture c), at 2600°C (picture e), and at 3000°C (picture f) to describe the structure. Source: Endo, Koyama and Hishiyama (1976)

The carbon fibre sample made from benzene therefore demonstrated significant improvements in both preferential orientation and crystallinity.

The experimental results obtained by Endo and his colleagues thus demonstrated that carbon fibres grown from aromatic benzene rings are characterised by a high degree of preferential orientation and a significant improvement in the degree of crystallinity of the final material, as demonstrated by the growth of crystallites.

Further research in this direction would be published shortly afterwards by Endo and Koyama, this time in collaboration with Agn s Oberlin. (Oberlin, Endo and Koyama 1976)

The carbon fibres required for experimental observation had been prepared by pyrolysis at 1100°C of a mixture of benzene and hydrogen. High-resolution electron microscopy allowed the detailed study of the structures obtained; in particular, the fibres had assumed various external forms and it was possible to observe that they contained a hollow tube whose diameter varied from 2 nanometres to more than 50 nanometres (the measurements were given in angstroms in the original test) arranged along the axis of the fibre. They were formed by turbostratic stacks of carbon layers, parallel to the axis of the fibre and arranged in concentric sheets, comparable to the characteristic structure recognisable in the growth rings of tall trees. These observed fibres consisted of two structures resulting from different growth processes; the core regions, consisting of long, straight and parallel carbon layers, were formed mainly by catalytic effect; the outer regions corresponded to a pyrolytic deposit observed to grow during the secondary thickening growth process. Very small cementite crystals, typically about 10 nanometres in diameter, were identified with dark-field techniques at the tip of the central tube of each fibre. The authors hypothesised a pattern of fibre growth linked to surface diffusion of a carbon species on the catalyst particle, depicted in the following picture (Fig. 4.7).

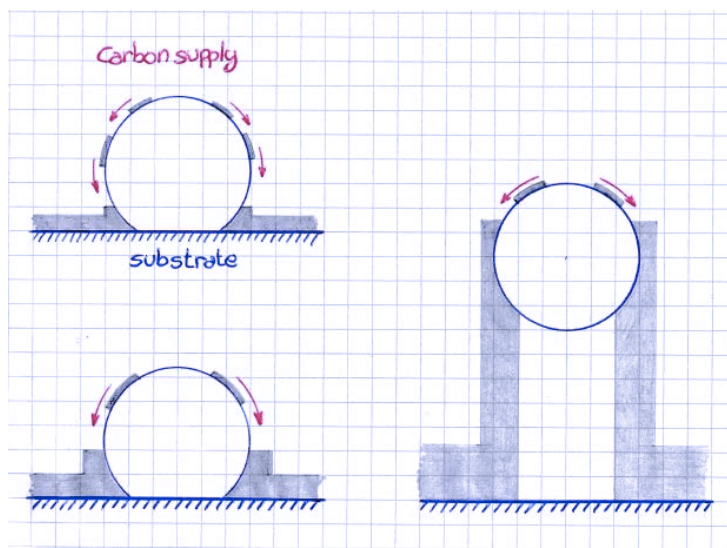

Fig 4.7 The mechanism proposed by Oberlin, Endo and Koyama. Source: AD

At the beginning of the process, small droplets of iron in the liquid phase are observed to attach to the furnace wall and result from the reduction of iron oxide soot by hydrogen. A structure consisting of metal and hydrocarbons begins to enucleate on the clean surface and dissociates at the angle of contact between the droplet and the furnace wall, which acts as a substrate. This can be considered the nucleation seed of the future carbon shell. As the process continues, new metal hydrocarbon species dissociate on its edges and the carbon layers develop following a lateral growth, and following the external profile of the catalysts. This lateral growth exerts a force strong enough to lift the catalyst particle above the surface of the substrate. The layers always advance laterally with respect to the catalyst following this growth process, thus forming a filament. The hollow channel in the centre is in fact necessarily formed, as no further carbon can reach the rear of the droplet whose surface is protected from surface migration downwards by the lateral carbon layers. The growth of the carbon layers continues, theoretically, as long as there is metal input from the top of the catalyst particle (metal is progressively trapped between the carbon layers). When the entire droplet is completely covered by carbon layers, at the end of the structure, diffusion stops and growth ends. The justification for this mechanism is strongly supported by the cementite remains found inside the carbon shell. It should be noted that cementite crystals form, of course, only when cooling occurs. This mechanism also explains well the branching on the fibres.

4.1.3 1977: Molecular Technology, a new Concept

Born in 1955, Kim Eric Drexler is the researcher who is credited with inventing and popularising the concept of Nanotechnology, despite not being the inventor of the word Nanotechnology itself. In the course of his university career, he had come into contact with extremely specific research related to space exploration in terms for colony-building, so that his vision of technology and its applications had been consolidated on the basis of very futuristic terms. In an interview he gave on 15 June 1987 for the first published issue of *Foresight Updates*, Drexler described his early interests and the activities in which he became involved in the following words.

For many years I'd been concerned about technology and the future, and had been looking at what could be built with tools that we didn't have yet. My work at MIT had focused on what we could build in space once we had inexpensive space transportation and industrial facilities in orbit... I'd been following a variety of fields in science and technology, including the work in molecular biology, genetic engineering, and so forth. I had been impressed by the fact that biological systems were based on molecular machines and that we were learning to design and build these sorts of things. This got me thinking about what sorts of things we could build when we got good at designing molecules. And this led pretty rapidly to the idea of self-assembling systems of molecules that could act as molecular machines – and the idea of molecular machines that could build other molecular machines. This was in the spring of 1977 (Granqvist and Laurila 2011).

Remarkable results were to come the following years and Drexler would later elaborate the concept of Molecular Technology to Molecular Nanotechnology.

1979 was the year that Drexler came across the transcript of Richard Feynman's 1959 speech, *There's Plenty of Room at the Bottom*, which, as I described in the previous chapter, according to one possible interpretation is the text that anticipated some fundamental discoveries in science and technology that were possible thanks to the advent of ever increasing miniaturisation. The text gave a decisive impetus to the ideas that Drexler was developing. In his imagination, Drexler envisaged a large number of tiny robots that could work with molecules as fundamental elements and move them so quickly and with such absolute precision that they could, in fact, recreate any substance imaginable in a reasonable time of a few hours. This idea came to Drexler in 1977 when he still was an undergrad at Massachusetts Institute of Technology.

A few years later in 1981, Drexler started explaining his ideas in detail, publishing for MIT a short article entitled *Molecular engineering: An approach to the development of general capabilities for molecular manipulation* (Drexler 1981).

In this article, Drexler immediately quoted Feynman's speech at Caltech in 1959, particularly at the point where Feynman imagined smaller machines capable of building even smaller ones, and so on, down toward the molecular level.

When Drexler published his article, the available microtechnology could handle statistical populations of atoms because, as the size of the devices decreased, the atomic structure of matter gave rise to more and more irregularities and imperfections, so that the atoms could not be treated individually. Yet the miniaturisation of processes did not seem capable of reaching the final level of microtechnology: the ability to structure matter at will, according to complex atomic specifications. Drexler's first effort was to chart a course from his idea towards this goal, a general technology of molecular engineering. His vision aimed to achieve an extraordinary range of objectives involving the structuring and analysis of matter.

Drexler moved step by step, using close analogies between the proposed steps and developments in nature and technology, rather than resorting to mathematical proofs accepting the feasibility of new devices without formal evidence. He considered the analogies with existing systems valid enough to proceed with a coherent discussion.

In the article, Drexler began by describing biochemical systems whose *microtechnology* is very different from traditional technology in that they are not built from the macroscopic level but from the atomic level. Biochemical microtechnology was thus, at the molecular level, the starting point from which to develop new molecular systems, providing a variety of ‘tools’ and ‘devices’ to copy and apply. By building with these tools, which in turn are made to atomic specifications, we can start on the far side of conventional microtechnology. The activity of ribosomes for protein synthesis was taken as a model by Drexler for a system of producing basic elements for the composition of larger, more complex structures. He relied on the computational power of available computers and the modelling of structures that had already been applied in the study of drugs and the construction of a polypeptide designed to interact with RNA, and firmly believed that copying the characteristics of biochemical systems would lead to the ultimate realisation of functioning molecular systems.

Drexler’s engineering background could not fail to influence his vision. He set up a comparison between biochemical and macroscopic mechanical components and illustrated what the main similarities could be by comparison with Nature. With structural members, moving parts, bearings and motive power, versatile mechanical systems can be constructed. For Drexler, molecular assemblies of atoms could act as solid objects, occupying a physical space and maintaining a defined shape to act as structural members and moving parts. Sigma bonds with a low steric size could, in his vision, serve as rotating bearings capable of bearing a load of 10^{-9} N. A line of sigma bonds could be set up as a hinge. Proteins capable of changing conformation (such as myosin) would serve as sources of motive force for linear movement; the reversible motor of a bacterial flagellum could be used as a source of motive force for rotational movement (Fig. 4.8). The existence of this range of components in Nature indicated to Drexler that mechanical systems can be constructed on a molecular scale. In the article, Drexler showed a table, reported below, where all the possible comparisons possible were made.

Table 1. Comparison of macroscopic and microscopic components

Technology	Function	Molecular example(s)
Struts, beams, casings	Transmit force, hold positions	Microtubules, cellulose, mineral structures
Cables	Transmit tension	Collagen
Fasteners, glue	Connect parts	Intermolecular forces
Solenoids, actuators	Move things	Conformation-changing proteins, actin/myosin
Motors	Turn shafts	Flagellar motor
Drive shafts	Transmit torque	Bacterial flagella
Bearings	Support moving parts	σ bonds
Containers	Hold fluids	Vesicles
Pipes	Carry fluids	Various tubular structures
Pumps	Move fluids	Flagella, membrane proteins
Conveyor belts	Move components	RNA moved by fixed ribosome (partial analog)
Clamps	Hold workpieces	Enzymatic binding sites
Tools	Modify workpieces	Metallic complexes, functional groups
Production lines	Construct devices	Enzyme systems, ribosomes
Numerical control systems	Store and read programs	Genetic system

Fig 4.8 The table Drexler elaborated in his article dated 1981. Retrieved via: <https://www.pnas.org/doi/10.1073/pnas.78.9.5275>

Drexler then made the hypothesis that the range of such tools was assumed to be large and greater than those found in Nature (Drexler 1981). All these assumptions were developed in his PhD thesis, dated 1991, *Molecular Machinery and Manufacturing with Applications to Computation*, a work Drexler himself considered an intermediate text on the way to the preparation and publication of a textbook intended to explain the latest advancements of Nanotechnology (Drexler 1991).

According to Drexler's 1981 vision, molecular machines would have to be capable of performing complex operations, and not only that, the fact that certain types of organisms do not exist in nature did not, in his view, preclude them from being made by molecular machines. The obstacles he then foresaw concerned the impossibility of designing proteins indefinitely, the impossibility of making complex machines out of proteins, and the impossibility of protein machines in turn building higher-generation machines.

Drexler also kept a close eye on the costs involved in building such machines, but did not foresee any major economic obstacles to their construction, keeping in mind above all a long-term perspective that went beyond the enthusiasm and interest of the initial successes.

In his 1991 doctoral thesis, Drexler applied his engineering training to the development of molecular machines with a chemical and physical approach that eventually enabled him to describe structural components on a nanoscale. In particular, he made use of a versatile Born–Oppenheimer approximation.

The Born–Oppenheimer potential approximation, in terms of the system geometry alone, proved to be very effective in approaching molecular mechanics problems and is therefore particularly well suited to designing and modelling the vast majority of problems relating to nanomechanics. Let us recall that in the Born–Oppenheimer approximation, the motions of the electrons and nuclei are treated separately and, since the dimensions of the masses of the atomic components are such that even the lightest atomic nucleus possesses an inertia 1836 times greater than that of the electron, the nuclei can be considered stationary. In this way, the wave function and energy of the electron system can be calculated in relation to a fixed nucleus and a fixed Coulomb potential. In this way, the energy of the fundamental state is unique. The Born–Oppenheimer potential energy $V(\mathbf{r})$, depends on the vector \mathbf{r} , the vector which only specifies the coordinates of the nucleus. The limitation of this approximation is in the possible movements of the nuclei, their high-energy collisions, and whether any displacements of the nuclei can lead to changes in the distribution of electrons. But when nanometric systems are considered, the wave functions undergo small changes coinciding with the mechanical motion of the nuclei. Under these conditions, there are no sudden changes in energy and electron distributions. Molecular dynamics depends solely on the Born–Oppenheimer potential, a parameter that can be applied in the dynamical models of classical physics and quantum physics.

The results described by Drexler in his thesis regarding the feasibility of nanomachinery analogues to macroscopic devices were so remarkable that the list he was able to obtain is practically all-inclusive. In Drexler's own words thirty-four mechanisms are mentioned:

both sliding and meshing interfaces can be constructed in a variety of nanoscale geometries, as can interfaces with intermediate properties and specially-tailored potential energy functions along a sliding coordinate. As a consequence, it will be feasible to construct nano mechanical rotary bearings, sliding shafts, screws and nuts, power screws, snaps, brakes, dampers, worm gears, constant-forces springs, roller bearings, levers, cams, toggles, cranks, calms, hinges, harmonic drives, bevel gears, spur gears, planetary gears, detents, ratchets, escapements, indexing mechanisms, chains and sprockets, differential transmissions. Clemens couplings, flywheels clutches, drive shafts, robotic

positioning mechanisms, and suitably–adapted working models of the Jacquard loom, Babbage’s Differences and Analytical Engines, and so forth (Drexler 1991).

Drexler recognized that nanoscale components, therefore, could be used both as moving parts and as connecting elements. He took as a model the stiffness of diamond, the hardest material in nature, a parameter that could be extended to objects of nanometer size and even smaller. By searching diamond-like structures (which are called diamond–like solids) for the fundamental constituents for the realization of the structural elements, he demonstrated that practically any shape could be made from them, in compliance with the engineering parameters that had to be considered.

The feasibility of the proposed devices was compatible, as a result obtained by Drexler, with a continuous model different from that applied in mechanical engineering. Drexler named this new approach as a *modified continuum model*. Actually, a modified model of the continuum was not in itself an absolute novelty. Examples of this approach can be found, for example, in the study of the profile of ions channeled within a crystalline lattice (Beck, Kopitzki, Krauss and Mertler 1983), or in the study of neutron scattering, when the model is named modified continuum shell–model (Wendler 1987). Drexler deserves credit for having applied the mechanics of continuous engineering to the nanometer world. The modified continuum model proposed by Drexler allows, as in mechanical engineering conducted on macroscopic structures, to describe structural properties in terms of conventionally known parameters, such as strength, density, module. In the modified model, however, corrections must be made to these three quantities, just as constraints on the size of the elements must be considered, a series of molecular models based on PES as regards static friction must be considered, while dynamic friction is treated with models based on the interaction of phonons. Moreover, when designing at such small dimensions, constraints linked to statistical mechanics emerge, and going to search for a realization solution involves compromises in terms of mechanical properties, errors and tolerances.

In Chapter 11 of Drexler’s doctoral thesis, paragraph 11.3.3 explains the details of this modified model. (Drexler 1991)

An idea of the contribution to Nanotechnology in particular, and to Science in general, Drexler has given since, can be condensed in this necessarily incomplete collection of articles and books.

- *Engines of Creation. Challenges and Choices of the Last Technological Revolution* (1986), in this book Drexler explained his ideas about Nanotechnology and it became a milestone in scientific literature about the nanoworld. I will describe the contents later in another paragraph.
- *Synthetic Tips* (Drexler and Foster 1990), where the authors discuss probe–tip properties in scanning tunneling (STM) and atomic force microscopes (AFM).
- *Molecular Tip Arrays for Molecular Imaging and Nanofabrication* (Drexler 1991), where he explores the possibility of realizing Molecular Tip Arrays (MTAs) to enable nanofabrication via positional chemical synthesis.
- *Unbounding the Future: the Nanotechnology Revolution* (Drexler, Peterson and Pergamit 1991), a fundamental book in History of Nanoscience and Nanotechnology for the many aspects it outlined and reviewed in those years.
- *Nanosystems: Molecular Machinery, Manufacturing and Computation* (Drexler 1993), a book searching for answers about the potential and practical applications of nanodevices. This book collected more than 15 years of results in molecular machinery research, and showed how Nanotechnology had to be interpreted as a transversal discipline, involving research in Physics, Chemistry, Biology, Medicine, and so forth.

- *Helical Logic* (Merkle and Drexler 1996), where the authors suggest a new electron-based computer logic to replace the binary signals 0 or 1 with the absence or the presence of an electron.
- *Building Molecular Machine Systems* (Drexler 1999), an article he intended to open the path for upcoming other issues toward a molecular machine technology.
- *Machine-Phase Nanotechnology* (Drexler 2001), in this article, moving from Feynman's ideas, Drexler said that, in principle, an assembler, i.e. a molecular construction system, could build almost anything and self-reply. These ideas were already published in *Engines of Creation*, which I will discuss in a following paragraph.
- *If Atomic Precision is Unfeasible, so is Life* (Drexler 2003a), this is a very short reply to an Editorial Article that appeared in Nature 421, in response to a claim that "manipulating atoms one at the time is unfeasible." Drexler clearly and politely replied that "if this is fundamentally unfeasible, then so is life."
- *Different Paths to the Nano-Scale* (Drexler 2004) is a short reply to a certain Richard Jones who referred to "flaws" when talking about Drexler's ideas and omitted, according to Drexler's point of view, some important details when talking about the advancements in Nanotechnology.
- *Safe Exponential Manufacturing* (Phoenix and Drexler 2004), is about ethics of research, since it moves from the Feynman lecture's inspiration for nanometre-scaled machines and the authors discuss serious concerns regarding Nanotechnology and its applications, such as military and bio ones.
- *Productive Nanosystems: the Physics of Molecular Fabrication* (2005), where the "father of Nanotechnology", as he is often referred to, discussed about the impact of productive nanosystems and the physical limits of fabrication of nanodevices.
- *Emerging Technologies* (Meselson, Ratner, Ratner and Drexler 2007), in which through an interview Drexler debated the benefits and dangers of technological innovations, and was especially asked to assess Nanotechnology's impact on the future.
- *The Timing of Evolutionary Transitions Suggests Intelligent Life is Rare* (Snyder-Beattie, Sandberg, Drexler and Bonsall 2021), where Drexler demonstrates his flexibility and diverse fields of interest, discussing with colleagues the probability of the development of extra-terrestrial intelligences.

This necessarily short list clearly proves the impact of Kim Eric Drexler as a pioneer of Nanotechnology.

4.1.4 1980: Quantum Dots and QSE on Nanoparticles

Semiconducting nanocrystals of near-zero size between 2 nanometres and 10 nanometres are called Quantum Dots (QDs). The remarkable feature of structures of this type is that their proper size is smaller than the Fermi wavelength of the electrons in the QDs and this gives rise to a quantum confinement, or Quantum Confinement Effect (QCE), also known as the Quantum Size Effect (QSE). The energy band structure is changed from continuous to quantized precisely because of the electronic confinement, and appropriate excitation of the system due to a precise wavelength can give rise to fluorescence phenomena.

The beginning of the 1980s was marked by a growing interest in studies of measurement effects in semiconductor materials. Quasi-bidimensional structures obtained by epitaxial growth have been the subject of repeated experiments in this direction.

Two scholars from the Vavilov State Optics Institute in St. Petersburg, Russia's largest research centre for optics, Alexey Ekimov and Alexander Onushchenko, dedicated

themselves to the study of optical phenomena, which led Ekimov, in collaboration with Onushchenko, to observe how the so-called Quantum Size Effect occurred in semiconductor crystals of microscopic size.

Ekimov's first observation of Quantum Dots was reported in 1980.

For their studies, Ekimov and Onushchenko used multicomponent glass with 1% copper and chlorine additives, referring to the results of their other research (Ekimov, Onushchenko and Tsekhomskij 1980), according to which the formation of copper(I)chloride, CuCl, crystals was observed when the additive glass paste was heated to a high temperature and the characteristic excitation-absorption spectrum appeared. The formation of the crystals was interpreted as the decomposition of a supersaturated solid solution, the presence of which was permitted during the heat treatment phase of the matrix.

Three-dimensional microcrystals of semi-conductive compounds could in fact be grown in a transparent dielectric matrix of silicate glass, and their presence could be detected by optical techniques related to absorption spectra (Ekimov and Onushchenko 1982).

The moment of the formation of large nucleation regions at the expense of smaller ones, when the supersaturation of the matrix is small, was studied from a purely theoretical point of view, in terms of diffusion phenomena, by the work of Lifshitz and Slyozov (Lifshitz and Slyozov 1958), and they were able to show that the average radius of the particles formed by the new solid phase grows in time according to the law:

$$\bar{a} = \left(\frac{4\alpha D}{9} t \right)^{1/3} \quad (4.1)$$

where D is the diffusion coefficient and alpha a coefficient that is determined through the surface tension at the interface between particle and matrix. The concentration of the new phase within the matrix remains practically constant during the growth phase, and the size distribution of the particles formed appears to be stationary. The size of the formed crystals could be determined by X-ray scattering.

Experimentally, Ekimov and Onushchenko observed that the average radius of CuCl crystals could be considered as a function of temperature through the relation (4.1), with a trend $\bar{a} \sim t^{1/3}$, a relation indicating a recondensation phenomenon underlying the growth of microscopic crystals. The growth rate of the crystals was determined by the angular coefficient of the line interpolating the experimental points and, as can be seen from the formula (4.1) depends on the thermal treatment and the diffusion coefficient.

Therefore, by appropriately choosing the experimental operating conditions, temperature and reaction time, it was possible to obtain crystals of predetermined sizes, over a wide range of possible sizes, from the nanometre to over tens of nanometres. (Ekimov and Onushchenko 1981) These heterogeneous glassy materials, which are easy to obtain, were very convenient samples for the study of size effects in semiconductors.

The synthesis of these semiconducting compounds dispersed in a dielectric matrix was not only a fundamental technique for obtaining samples for analysis, but since the concentration of the crystalline phase in a glass matrix was relatively low, the absorption spectra of the crystals could be analysed directly. (Ekimov and Onushchenko, 1982)

The authors measured the absorption spectra of three samples in which the mean radii of the CuCl crystals were 31nm, 10nm and 2.5nm (in the original text the measurements are still given in angstroms) at a temperature of 4.2K. When the mean radius of the crystals was of the order of 31nm, the absorption spectrum showed two intense and well-marked peaks,

one with wavelength $\lambda = 378.5\text{nm}$ and a second with wavelength $\lambda = 386.5\text{nm}$, resulting from the excitation of excitons associated with two spin-orbit-split valence sub-bands. As the mean radii of the crystals decreased, it was possible to observe a small shift in the spectral lines and a significant broadening of their peaks, a trend that was confirmed up to the smallest crystal of size 2.5nm .

The experimentally observed position of the absorption lines could be regarded as a consequence of the so-called Quantum Size Effect. The current carriers and excitons in a semiconductor crystal dispersed in a dielectric matrix are trapped in a potential hole whose walls coincide with the separation interface between crystal and matrix; as the crystal size decreases, the energy of the particles confined in the potential hole increases, and this increase can lead to the observation of the shift of the absorption lines, in term of wavelength.

Assuming a potential hole with spherical symmetry and infinite depth, if the size dispersion of the particles can be neglected, the displacement due to the quantisation of a particle of mass m is described by:

$$\Delta E = \frac{\hbar^2 \pi^2}{2m\bar{a}^2} \quad (4.2)$$

The displacement of the lines was also found to be a linear function of $1/\bar{a}^2$ for particles with an average radius whose size varies over a wide range of values.

The effective mass of the particles obtained from the slope of the line interpolating the values expressing the dependence of the position of the absorption lines as a function of the mean radius of the particles was equal to $m = 1.2m_0$ where m_0 is the mass of the free electron. The value of this mass was not in agreement with what is expected in the literature where one reads values of effective masses such as $m_e = 0.44m_0$ for the electron and a value of $m_h = 3.6m_0$ for the gaps, probably and mainly because of the scattering of the particle size, a value that had to be considered when calculating the radius of the crystals through X-ray scattering, and also in determining the effective mass from the dependence of the short-wave shift on $1/\bar{a}^2$ (*ibidem*).

In their 1982 work, Ekimov and Onushchenko would refine equation (4.2) into the following:

$$h\nu = E_g - E_{ex} + \frac{\hbar^2 \pi^2}{2M\bar{a}^2} \quad (4.3)$$

where E_g is the gap energy of the crystal, E_{ex} is the binding energy of the exciton and M is the translation mass of the excitons, $M = M_e + M_h$. Ignoring the contribution of the microcrystal size on the binding energy of the excitons in equation (4.3), the quantum size effect would have resulted in the linear dependence on $1/\bar{a}^2$ of the short-wave-length-shift of the excitons absorption lines. However, even with equation (4.3), the translational mass of the exciton turned out to be very different from the expected values, exactly as in the case proved by equation (4.2), for the same reasons as stated for that case.

A breakthrough in the study of light absorption by spheres of semiconductor material was made by Alexander Lwowitzch Éfros and his brother Alexei Lwowitzch Éfros in 1982

when their work on the optical properties of systems in which semiconductor particles are immersed in an insulating matrix was published. (Éfros and Éfros 1982)

In particular, they proposed an explanatory model of the phenomenon based on band theory. The conduction band and the valence band, associated with electrons (carriers) and holes (gaps) respectively, were modelled by means of parabolic profiles; their masses were denoted respectively by m_e and m_h , where it is $m_e \gg m_h$. The system was governed by three fundamental quantities, the radius of the spherical particles a and the Fermi radii of the electron and holes respectively, indicated by:

$$a_e = \frac{\hbar^2 \kappa}{m_e e^2} \quad a_h = \frac{\hbar^2 \kappa}{m_h e^2} \quad (4.4)$$

and κ the permittivity of the semiconductor.

At first, Éfros and his brother placed themselves in a condition of strong size quantization, i.e. when $a < a_e$ and $a < a_h$. The wave function for electrons and gaps in a spherically symmetric hole with infinite walls is written as:

$$\Psi_{n,l,m}(r, \vartheta, \varphi) = Y_{l,m}(\vartheta, \varphi) \frac{\sqrt{2} J_{l+1/2}(k_{l,n} r)}{a \sqrt{r} J_{l+3/2}(k_{l,n} a)} \quad (4.5)$$

where $Y_{l,m}$ are spherical functions, l the momentum, m the projection of the momentum vector along a fixed direction and J the Bessel function. Quantities $K_{l,n}$ are defined by:

$$K_{l,n} = J_{l+3/2}(k_{l,n} a) \quad (4.6)$$

The energy levels for electrons and gaps are:

$$E_{l,n}^{e,h} = \frac{\hbar^2 k_{l,n}^2}{2m_{e,h}} \quad (4.7)$$

The quantity $k_{l,n}$ is defined by:

$$k_{l,n} = \frac{\varphi_{l,n}}{a} \quad (4.8)$$

where $\varphi_{l,n}$ is a universal set of values that do not depend on a . When it is $l = 0$ you have the special case where $\varphi_{0,n} = n\pi$ where n assumes all the values from 1 to infinity.

If it is $l \neq 0$, it is not possible to obtain an analytical expression for $\varphi_{l,n}$.

The researchers considered the process of interband absorption of light because, from an experimental point of view, it was interesting to verify the consequences of radiation–matter interaction when the wavelength of the radiation is comparable with the size of the particle.

For this reason, a large number of K to relate the energy absorbed by a sphere in the unit of time to the mean value, over time, of the square of the electric field associated with the incident wave. If we multiply this size K for the number of spheres enclosed in the unit volume, this allows the heat of the electrical conductivity of the system to be obtained for the applied field, and this quantity is related to the light absorption coefficient.

According to the hypotheses established, the Éfros obtained:

$$K = A \sum_{nn' ll' mm'} \left| \int \Psi_{n,l,m}^e \Psi_{n',l',m'}^h dr \right|^2 \partial(\Delta - E_{ln}^e - E_{l'n'}^h) \quad (4.9)$$

Here $\Delta = \hbar\nu - E_g$ where ν is the frequency of the incident light and E_g the measurable energy gap for a semiconductor subject to the same temperature and pressure conditions as the sphere being studied. Considering the orthogonality of the wave functions we have:

$$\left| \Psi_{n,l,m}^e \Psi_{n',l',m'}^h dr \right|^2 = \delta_{nn'} \delta_{ll'} \delta_{m,-m'} \quad (4.10)$$

The expression of K can be rewritten as:

$$K = A \sum_{l,n} (2n + 1) \delta\left(\Delta - \frac{\hbar^2}{2\mu} k_{ln}^2\right) \quad (4.11)$$

where $\mu = m_e \cdot m_h / (m_e + m_h)$ is the reduced mass.

Therefore, it was conceivable to observe a series of discrete lines resulting from the superposition of the absorption bands. The absorption energy threshold is determined by the expression:

$$\hbar\nu_{01} = E_g + \frac{\hbar^2 \pi^2}{2\mu a^2} \quad (4.12)$$

A law is thus obtained according to which the gap between the bands increases as the radius a of the sphere decreases. The other absorption lines move towards shorter wavelengths according to the relationship:

$$\hbar\nu_{ln} = E_g + \frac{\hbar^2}{2\mu a^2} \varphi_{ln}^2 \quad (4.13)$$

As soon as the amplitude of the spectral lines is comparable with their separation distance, the size-related quantisation phenomenon would have manifested itself through aperiodic

oscillations, whose maxima would have gradually shifted towards smaller and smaller wavelengths in accordance with the law $1/a^2$. If it is instead:

$$\Delta \gg \frac{\hbar^2 \pi^2}{2\mu a^2} \quad (4.14)$$

equation (4.11) becomes the classical formula:

$$K = A \frac{4}{3} \pi a^3 \frac{\mu^{3/2}}{\sqrt{2} \pi^2 \hbar^3} \sqrt{\Delta} \quad (4.15)$$

Later on, the Efros considered the case when $a_h \ll a \ll a_e$ in the adiabatic approximation, when the energy of the electron is much greater than the energy of the hole. In this case, the symmetric potential associated with the hole is derived from the relation:

$$V_{n,l,m}(r) = -\frac{e^2}{\kappa} \int \frac{|\Psi_{n,l,m}(\mathbf{r}')|^2}{|\mathbf{r} - \mathbf{r}'|} d^2 r' \quad (4.16)$$

The Schrödinger equation is the tool with which to derive both the energy levels and the wave functions related to the problem. In the case of adiabatic approximation, the electron–hole wave function becomes:

$$\Psi(\mathbf{r}_e, \mathbf{r}_h) = \Psi_{n,l,m}(\mathbf{r}_e) \chi_{n,l,m}^{t,l',m'} \quad (4.17)$$

where χ is the wavefunction and t , l' and m' are the quantum numbers relating to the problem. Since the potential has a minimum at the centre of the sphere of the order of $e^2/\kappa a$, by developing the potential in series near the point $r = 0$ we get:

$$V_{n,0,0}(r) = -\frac{e^2}{\kappa a} \beta_n + \frac{m_h \omega_n^2 r^2}{2} \quad (4.18)$$

where:

$$\beta_n = 2 \int_0^{n\pi} \frac{\sin^2 y}{y} dy \quad (4.19)$$

and:

$$\hbar\omega_n = \left[\frac{2 \hbar^2 \pi^2 n^2 e^2}{3 m_h a^2 \chi a} \right]^{1/2} \quad (4.20)$$

To describe the energy levels in a hole we use the relation:

$$E_{n,0,0}^{t,l'} = -\frac{e^2}{\chi a} \beta_n + \hbar\omega_n \left(2t + l' + \frac{3}{2} \right) \quad (4.21)$$

The electron–hole interaction causes each line of the absorption spectrum to be converted into a series of closely spaced lines corresponding to different values of the orbital number t . The quantity K becomes, under these conditions:

$$K = A \sum_{nn' ll' mm'} \left| \int \Psi(\mathbf{r}_e, \mathbf{r}_h) \delta(\mathbf{r}_e - \mathbf{r}_h) dr_e dr_h \right|^2 \partial(\Delta - E_{ln}^e - E_{nlm}^{t,l'}) \quad (4.22)$$

For what is the lowest energy level of the electron, with $n = 1$ and $l = 0$, the expression obtained for K is more complex:

$$K = A 2\pi^{5/2} \left(\frac{\hbar}{m_h \omega_1} \right)^{3/2} \frac{1}{a^3} \sum_t \frac{(2t+1)!}{2^{2t} (t!)^2} \delta \left[\Delta - \frac{\pi^2 \hbar^2}{2m_e a^2} + \frac{e^2}{\chi a} \beta_1 - \hbar\omega_1 \left(2t + \frac{3}{2} \right) \right] \quad (4.23)$$

In this case, the shift of the optical line that depends on the variation of the radius a of the particle is determined by the size quantization of the electron and, consequently, the mass of the electron.

If we have now $a_h \ll a$ and $a_e \ll a$, the highest measured energy is the binding energy of the exciton, and is denoted by F_{ex} . If the wave function of the exciton is:

$$\Psi(\mathbf{r}_e, \mathbf{r}_h) = \varphi(\mathbf{r}) \Psi_{l,m,n}(\mathbf{R}) \quad (4.24)$$

where $\mathbf{r} = \mathbf{r}_e - \mathbf{r}_h$ and $\mathbf{R} = (m_e r_e + m_h r_h)/(m_e + m_h)$. The energy of the exciton is:

$$E_{l,m,n} = \frac{\hbar^2 k_{l,n}^2}{2M} - E_{ex} \quad (4.25)$$

where $M = m_e + m_h$. Now K becomes:

$$K = A \sum_{l,m,n} |\varphi(0)|^2 \left| \int \Psi_{lmn}(\mathbf{R}) d\mathbf{R} \right|^2 \delta \left(\Delta - E_{ex} - \frac{\hbar^2 k_{l,n}^2}{2M} \right) \quad (4.26)$$

from which it follows that only those states which have $l = m = 0$. A formula has also been derived for K around the fundamental state:

$$K = A \frac{6}{\pi^2} \frac{1}{\pi a_{ex}^3} \frac{4\pi}{3} a^3 \sum_n \frac{1}{n^2} \delta \left(\Delta + E_{ex} - \frac{\hbar^2 \pi^2 n^2}{2Ma^2} \right) \quad (4.27)$$

In this case, the shift of a level relative to an exciton when the radius of a sphere changes is governed by the total mass of the exciton.

In summary, in this work, which extended that of Ekimov and Onushchenko, Alexander and Alexei Éfros developed expressions to describe the absorption coefficients of light in three limiting cases.

In the first case, the radius of the semi-conducting spherical particle a is smaller than the Fermi radius of both the electron and the gap; in the second case, the radius of the particle is greater than the Fermi radius of the gap but smaller than that of the electron. In these two cases, the displacement of the short wavelengths referred to the maximum of the absorption coefficient is proportional to $\hbar^2/m_e a^2$, where m_e is the electron mass.

If, on the other hand, the radius of the spherical particle is greater than both Fermi radii, the displacement is regulated by the mass of the exciton and is proportional to \hbar^2/Ma^2 .

Ekimov and Onushchenko were responsible for another study (Ekimov and Onushchenko 1982) of the optical absorption spectra of CuCl crystals dispersed in a glass matrix. The microcrystals were grown by diffusive phase precipitation during the recondensation of a supersaturated solid solution, and deliberately increased in size from a few nanometres to several tens of nanometres. Again, the short wavelengths of the exciton absorption lines showed a size-dependent shift in the microcrystals due to the quantum size effect. A further, similar study, by the same authors, looked at crystals of CoSe, whose size varies from about 3nm to about 80nm, dispersed in a glassy matrix, again demonstrating a shift in the absorption spectra caused by the quantum size effect (Ekimov and Onushchenko 1984). Later, Ekimov and his co-workers showed that the profile of the luminescence spectrum of free excitons was due to the scattering of the size values of the microcrystals, a scattering given by the Lifshitz–Slezov distribution for microcrystal recondensation (Ekimov, Onushchenko, Plyukhin and Éfros 1985). They developed a theory of exciton size quantization relative to valence bands for CuCl crystals.

4.1.5 1981: The Scanning Tunneling Microscope STM

1981 was the year that Nanoscience took a major step forward with the invention of the Scanning Tunneling Microscope (STM), thanks to the research conducted by two scientists

from IBM Zurich, Gerd Binnig and Heinrich Rohrer. Their device was so revolutionary and decisive in the advancement of science that they were awarded the Nobel Prize for Physics in 1986. Indeed, it was the instrument who made the determination of a surface structure possible, and it did that in three dimensions for both regular and non-regular specimens. Scientists could really start seeing the contour map of a surface.

My description of the history of the Scanning Tunneling Microscope will begin with the Nobel Lecture that Binnig and Rohrer gave at the award ceremony in 1987. Their account is certainly the most direct testimony of a fundamental moment in the History of Nanoscience.

After these historical considerations, I will get back to the technique of the STM to review its fundamentals.

One of the most quoted myths in science states that according to the laws now known in the world of aeronautics, there is no way a bee can fly: its wings are too small. Yet the bee flies because it does not care about what humans consider impossible. The Scanning Tunneling Microscope, or rather the research towards this instrument, received a similar welcome, when outside observers judged that, in principle, such an apparatus could never work. This fact was made known to the public when, in 1986, Gerd Binnig and Heinrich Rohrer delivered their lecture 8 December, on the occasion of the presentation of the 1986 Noble Prize in Physics.

Gerd Binnig met his research partner with the help of Alex Muller, who helped Binnig to expand his research staff, and he recommended Rohrer, with whom he shared a background in superconductivity, a field which in the early 1980s would see, among other things, major successes in studying the superconductive behaviour of materials at high temperatures.

Binnig was interested in the applications of tunneling phenomena and had applied himself to the study of magnetic bubble readings and the observation of tunneling between metal grains in resistors, and had found of interest the study of growth and insulating thin films and the analysis of their electrical properties.

The idea was not to make a completely new instrument, but rather to apply the known techniques of spectroscopy to the local investigation of areas less than 100 angstroms in diameter. It is interesting to note that, although twenty years had passed since the definitive prefix “nano” was approved, Binnig and Rohrer still used the angstrom as the unit of measurement for dimensions whose order of magnitude is less than the micrometre.

One of the problems concerned the study of the inhomogeneous regions that thin layers of metal oxides present when deposited on metal substrates, but a suitable instrument was not yet available. The idea, or as he admitted “an old dream”, came to Binnig at the LT15 Conference in Grenoble, and it was the idea of vacuum tunnelling. In fact, this idea was at least twenty years old and was shared by other researchers all working on tunnelling spectroscopy. (Giaever 1974) An attempt to create an instrument based on the vacuum tunneling principle and equipped with a tip that could be positioned by the operator was made in 1976 by Thompson and Hanrahan. (Thompson and Hanrahan 1976) Creating an instrument capable of operating with this methodology was a stimulating challenge, and Binnig and Rohrer realised that not only would it be possible to design a local spectroscopic probe, but scanning would allow topographical images to be obtained, resulting in a new type of microscope that would not scan the surface of the sample through actual mechanical contact, but rather by keeping the tunnelling current between the microscope tip and the sample itself controlled.

The invention of the STM microscope had, however, been preceded by the description of another instrument, the Topografiner, described in a 1972 article (Young, Ward and Scire

1972), a field-emission microscope operating at a greater distance than that envisaged by Rohrer and Binnig and with a high field-emission current, which would lead to a lateral resolution comparable to that of an optical microscope. The Topografiner's designers thought about improving the resolution by using sharper tips and also tried tunnelling in a vacuum, discussing what the future prospects of spectroscopy might be. However, they did not superimpose vacuum tunnelling on scanning techniques and did not estimate the resolution they could achieve. Had they done so, STM would have seen the light before 1981. However, Young, Ward and Scire were the ones who came closest to making that instrument.

At the end of 1978, Christoph Gerber joined the research group and, shortly afterwards, Edi Weibel completed the team.

The first difficulties the researchers had to face were of a technical and mechanical nature. In order to avoid random errors, the device had to be designed in such a way that, due to the small distances involved between tip and sample, no external vibrations or acoustic disturbances could occur. Piezoelectric materials were to be used so that the tip could be manoeuvred very precisely without friction with the surface. Once Binnig and his team had solved all of these problems, it remained to define the shape of the tip and the process by which it could be made. At first, they envisioned the tip as something with a certain radius of curvature, but soon came to the conclusion that it was not possible to shape it in an absolutely sharp way because atoms have a dimension anyway and only through special machining would the roughness on the tip be removed. These roughnesses give rise to "mini-tips" which in turn intervene in the tunnelling process, since the mini-tip closest to the surface of the sample is the one which is preferentially selected for the passage of the current.

Binnig and Rohrer focused on the possibility of achieving atomic resolution soon after obtaining the first images from a stable STM. It was vacuum tunnelling itself that provided a new tool for efficient and sharp tips. By means of field migration or field evaporation from the locally available vacuum tunneling fields, it is possible to shape the tips in the appropriate way.

The first steps were not easy, as Binnig himself admitted.

We had no means of controlling exactly the detailed shape of the tip. We repeated our trial and error procedures until the structures we observed became sharper and sharper. Sometimes it worked, other times it did not (Binnig and Rohrer 1987).

The authors installed the isolation system inside the vacuum chamber so that the system could also be isolated from acoustic vibrations and operated in an ultra-high vacuum (UHV) at low temperatures to ensure minimal thermal drift. The UHV condition also ensured that well-defined surfaces could be prepared and stored. However, several adjustments were necessary.

The instruments was beautifully designed with sample and tip accessible for surface treatments and superconducting levitation of the tunneling unit for vibration isolation. Construction and first low-temperature and UHV tests took a year, but the instrument was so complicated, we never used it. We had been too ambitious, and it was only seven years later that the principal problems of a low-temperature and UHV instrument were solved. Instead, we used an exsiccator as a vacuum chamber, lots of old Scotch tape, and a primitive version of superconducting levitation wasting about 20l of liquid helium per hour, Hemi Haupt, our expert glass blower, helped with lots of glassware and, his enthusiasm, even made the lead bowl for the levitation. Measuring at night and hardly daring to breathe from excitement, but mainly to avoid vibrations, we obtained our first clear-cut exponential

dependence of the tunnel current I on tip–sample separation s characteristic for tunneling. It was the portentous night of 16 March, 1981 (*ibidem*).

The STM microscope therefore saw the light of day 27 months after its conception. From that moment on, the question of how to handle the information also arose. The first official document was an internal report dated March/April 1981 and Binnig himself wanted to immediately submit a post–deadline paper to the LT16 Conference that would be held in Los Angeles in September 1981, is what we read in the Nobel Lecture. STM images of strontium titanate were available and colloquium tour was organized through the USA. Shortly before the debut of this tour Binnig was made aware that once the news went public *hundreds of scientists would immediately jump onto the STM bandwagon*. A couple of years later this happened, anyway. This is an interesting observation and should make us reflect on a situation, which I am not discussing here, about who is effectively discovering something, who is the paper writer (or more people), and who is awarded prizes in the end. Not necessarily all the three steps involve the same people. Nevertheless, the first attempt to publish a letter on the STM subject failed and Nico Garcia, a Visiting Professor for the *Universidad Autónoma de Madrid*, Spain, consoled the team by saying “That’s a good sign”. And it was.

Curiously, during the Nobel Lecture Binnig admitted that the premise for the development of the new microscope did not look very good.

Perhaps we were fortunate in having common training in superconductivity, a field which radiates beauty and elegance. For Scanning Tunneling Microscopy, we brought along some experience in tunneling (Binnig and Hoenic 1978) and angstroms (Rohrer 1960), but none in microscopy or surface science. This probably gave us the courage and lightheadedness to start something which should “not have worked in principle”, as we were so often told (*ibidem*).

One of the first great successes of the STM was the 7×7 resolution of the surface of Si(111), a subject that posed an intriguing challenge and that the authors decided to tackle immediately, without wasting time on less accepted lines of research. In the autumn of 1982, the observation of the 7×7 structure had become possible; referring to a private conversation of his, Binnig said that he could not take his eyes off the images, then he had the feeling that having solved that problem was the high point of his career, and in some ways also his terminus.

The 7×7 structure of the Si(111) surface is a really complicated structure (Fig. 4.9) that can be achieved when the (111) surface of Silicon is heated enough in UHV conditions, allowing atoms to reach a more energetically stable configuration. The final unit cell is larger and totally different from the starting one, the atoms take several different positions. A very effective animation depicting how the atoms re–arrange themselves from the original (fcc) cell to the final one is available at the following link: <https://www.youtube.com/watch?v=BXdC0NhAMBY>.

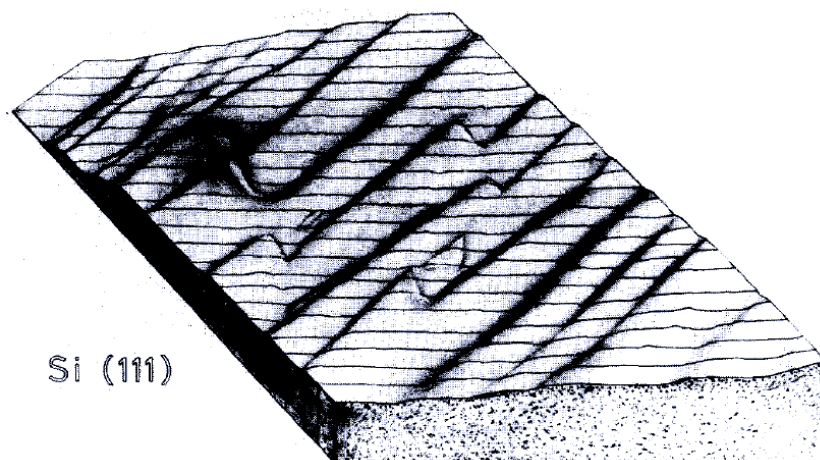

Fig 4.9 This is the topographic representation of the Si(111) with monoatomic step lines of 0.3nm height. Source: Courtesy Elsevier, Amsterdam

The use of the tunnel effect in the investigation of matter was not, actually, an absolute novelty. Twenty years earlier than Binnig and Rohrer, this quantum effect had already been exploited between two superconducting surfaces (Giaever 1960) 1.5nm or 2nm thick. The structures used for this investigation usually consisted of a succession of metal–insulator–metal layers in which the insulator was in a solid state. As Binnig and Rohrer observed, however, such a structure, although efficient, inhibited access to the covered layers for modification, treatment or repair (Binnig and Rohrer 1983). A physical gap between the conductive surfaces provided several advantages over a standard sandwich structure, first and foremost access to the metal layers and better resolution than previous solutions. In addition, the use of a vacuum allowed researchers to focus solely on the characteristics of the metals and their properties. With this insight, applied to electron microscopy, Binnig and Rohrer created an instrument capable of probing the topography of the sample with a resolution never before achieved.

Conceptually, the operating principle of an STM microscope is quite simple. The tunnel effect is realised between two metallic components of the instrument, whose purpose is to act as the metallic electrodes of the classic sandwich or vacuum technique, the first is the metallic tip that performs the scanning, the second is the actual surface of the sample to be analysed. The metal tip, as I explained in detail when I dealt with this instrument in chapter two, is controlled by three piezoelectric materials oriented along a Cartesian triplet of axes that allow its precise movement in the three directions during the scan (Fig. 4.10).

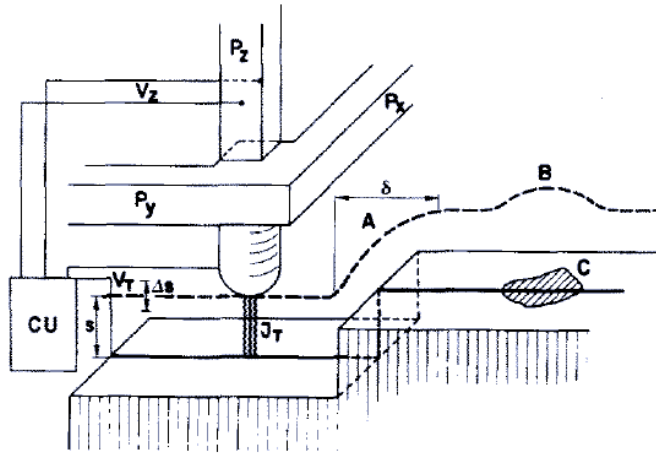

Fig 4.10 This is the schematic representation of the STM as reproduced in the article of Binnig and Rohrer. The three axes and piezoelectric materials are shown in perspective. Source: Courtesy Elsevier, Amsterdam

The tunnel current is a function of the gap distance between the surfaces:

$$J_T \propto V_T \exp(-As\sqrt{\phi}) \quad (4.28)$$

where ϕ is what is known as the work function, in other words the average height of the potential barrier, A a coefficient approximately equal to unity, and measured in a measure unit such as $[(m(eV)^{1/2})^{-1}]$, provided that the work function is measured in electron volts and the distance s between the tip and the surface is expressed in angstroms. Binnig and Rohrer observed that the tunneling current varied by an order of magnitude whenever the distance between tip and surface varied by a tenth of a micrometer, if the work functions were of the order of a few eV .

Thus, setting the device so that the tunnelling current remains constant during scanning means, in practice, maintaining the same distance between tip and surface, which in effect results in topographic mapping of the sample to be examined. A control unit applies a voltage V_z to the piezoelectric that controls the vertical movement precisely to keep this distance constant, until the other two piezoelectric units allow scanning in the xy plane of the sample. It was a really astonishing achievement in advancing the scanning probe techniques for Solid State Physics.

Binnig and Rohrer had to face several hardships, despite the conceptual simplicity of the microscope. A vibration damping system had to be installed to prevent casual errors due to unwanted oscillations that could easily affect the observation of the specimens, because of the atomic dimensions involved. With such a small gap between the scanning probe and the sample, an extremely accurate damping system was to be realised and, as we can get out of their original 1983 article, “a stability of the gap width of about 0.2\AA is reached” applying superconducting magnetic levitation. This is a really remarkable achievement, given the order of magnitude of the sizes they had to deal with. Again, correctly shaping the tip was

another demanding challenge, because the tip is a fundamental element and it has to be designed with the smallest curvature radius possible, down to a single atom to resolve the extremely rough surfaces. Binnig and Rohrer shaped the tip *in situ*, through gentle – this is how they described it – contacts between the tip and the surface, reaching a resolution down to 10Å.

The STM applications are not limited to the Solid State Physics only. The instrument proved to be very versatile in several fields of Science.

In Biology, for example, STM was adapted to investigate biological specimens. In 1988, a team of six German researchers of the Max–Planck–Institute für Biochemie in Martinsried, modified the basic set–up of the STM microscope in order to be able to investigate biological samples at ambient pressure, by combining it with a light microscope. The samples, obviously, had to be covered with conductive layers to obtain the second terminal for the tunnel effect (Guckenberger *et al.* 1988). The researchers were well aware of being at the very start of STM application in Biology, so they also described how to manufacture suitable tips in a reproducible manner and also the substrates to be used as sample holders. They decided to couple the electronic instrument with a light microscope to grant a better identification and localization of the area of interest, without the need to operate in ultra–high–vacuum (UHV), and equipping the light microscope with a camera. With the help of this second microscope, the researchers were able to determine the position of the tunneling tip on the sample.

The sample was prepared onto a substrate of glass or mica, or other equivalent materials, one of whose sides was covered with a conductive layer. Actually, the ideal substrate would be made of graphite, because this is conductive and with a really smooth surface. Unfortunately, it is not easy to adsorb samples on graphite, and its regular periodic pattern would be somehow disturbing, when performing this type of analysis. The organic specimen was adsorbed in the thin layer and observed via light microscope through the sample holder, say from top, while scanned by the tip on the conductive side, from below. The first attempt to observe the HPI layer, a bacterial protein that forms two–dimensional periodic arrays, was only partially successful because, although the characteristic contours of the layer were fairly easily identified, the expected periodic structure could not be revealed, probably due to contamination of the tip with organic material. However, by coating the sample with an additional layer of Pt–C with a nominal thickness of 4nm, it was possible to obtain images in agreement with the already known structure of the HPI layer, demonstrating the validity of the STM investigation also on biological samples.

Later, in 1988, two researchers at IBM Research Division in Zurich, Bruno Michel and Giorgio Travaglini, improved the STM concept with a better coarse positioning system and a large scan area, resulting in an instrument very suitable for biological applications. They called it the Bioscope. Before its appearance, studying an organic specimen could be rather complicated since the use of STM was dedicated to repetitive structures that would be recognized within the range of the piezo scanner; it being a repetitive pattern, correctly positioning the tip of the system would not have been a big problem, but with an organic sample the correct positioning of the tip was fundamental because the structures could be less dense or possess unique details to examine. So, introducing the Bioscope overcame all these operative hardships also giving the operator the possibility to locate the investigating area in a shorter time. (Michel and Travaglini 1988)

One of the circumstances when STM proved to be more efficient in giving images with higher resolution than SEM occurred in 1999, for example, as five Russian scientist, Permjakov, Ananyan, Luskinovich, Sorokovoi and Saveliev, used a STM to analyse chemoreceptive areas of olfactory epithelial cells, when investigating shark olfactory organ

cells. They were able to detect and visualize details like structural inhomogeneities that could not be observed with a SEM, also preparing the samples with lab-procedures simpler than before. (Permjakov *et al.* 1999)

4.1.6 1982: USSR Observation of Carbon Structures

When the metal oxides of the iron group interact with carbon monoxide in the temperature range between 400°C and 600°C, it was shown that metal reduction and the formation of active catalysts took place, which allowed the reaction $2\text{CO} = \text{C} + \text{CO}_2$ to take place intensively. As end products of this interaction, metal-carbon compositions (abridged in MCC) with different morphological characteristics were also observed (Baker and Harris 1978; Kolesnik and St. Pierre 1980).

The aim of the work of Nesterenko, Koleskin, Akhmatov, Suhoolin and Prilutsky in 1982 was precisely to study the phase composition and structure of the components of metal-carbon compounds (MCC), obtained in the interaction of chemically pure nickel oxide (later called as compounds –CH) and iron oxide (later called as compounds –CЖ) with the interaction of carbon monoxide (93.2% CO, 4.5% H₂, 0.3% O₂, 2.0% N₂) at 550±5°C (Nesterenko *et al.* 1982). The morphology and structure of the reaction products were studied by X-ray and Transmission Electron Microscopy.

On analysing the diffraction patterns of the –CH and –CЖ compounds (see the figure 4.11), two phases were detected: the first consisting of graphite and the second formed by a solid supersaturated carbon in nickel (α -Ni).

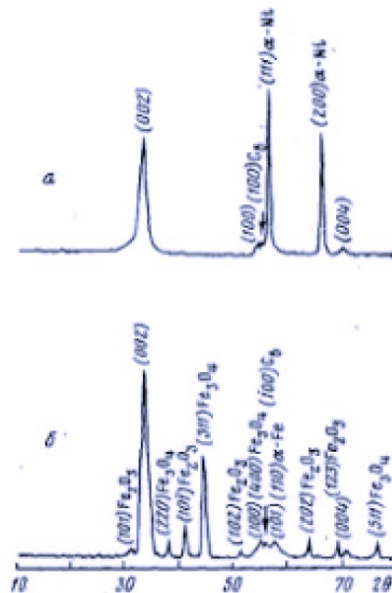

Fig 4.11 The diffraction patterns of the –CH compounds (above) and of the –CЖ compounds (below)
Source: Nesterenko *et al.* (1982)

Heat treatment of the compound obtained in a vacuum, at a temperature of 1800°C and for a duration of 6 hours, had practically no effect in changing the shape of the diffractograms, although the interference due to graphite (002) and (004) was observed more strongly. Another noted effect of the heat treatment was, on the diffractograms, the mixing of the high-index reflections of the α -Ni towards greater angles, indicating a decrease in the lattice pitch. In fact, the lattice pitch of α -Ni in the starting product measured $a=3.5289\text{\AA}$, and after heat treatment it measured $a=3.5237\text{\AA}$. It was also deduced that the implementation of 1% by weight of carbon in the nickel lattice caused an increase in its period of 0.03367\AA . The calculation indicated that the starting product's carbon content in α -Ni was 0.15% in weight. It is known that under equilibrium conditions, according to the Ni-C state diagram, a carbon concentration of 0.15% by weight in α -Ni is only reached at 900°C, and already at 725°C the solubility of carbon is 0.08% by weight. Therefore, it could be assumed without a shadow of a doubt that the metal phase in the compound -CH was a solid solution supersaturated with carbon in nickel. The carbon content in the heat-treated compound α -Ni was 0.026% by weight, which corresponds to the solubility constant of carbon in α -Ni at room temperature.

Four phases were present in the -CЖ-type compounds: graphite, Fe_2O_3 , Fe_3O_4 and iron (α -Fe). For a more detailed analysis of the results obtained through the X-ray investigation, the metal and oxide particles were completely removed from the graphite that appeared in the studied compounds by acid-etching and subsequent washing of the resulting products with other acidic ethyl alcohol solutions. The data were collected and shown in the following diffractograms (Fig. 4.12).

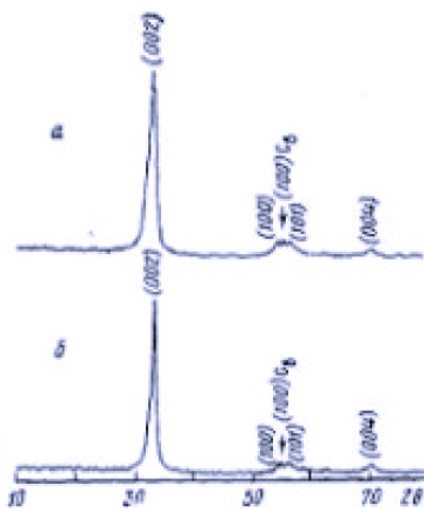

Fig 4.12 The diffraction patterns of the -CH compounds when the metal and oxide were removed to clearly read the diffraction peaks. The wide structure around $2\theta = 55$ is not so clear in the former picture because of the presence of iron compounds. Source: Nesterenko *et al.* (1982)

Whatever the sensitivity of the diffractometer recording instrumentation, interference with the indicated interplanar distances was clearly detected. From the diffractograms obtained with a higher instrumental sensitivity to measure the intensity of the diffracted radiation, it

was also observed that on the side of the smallest angles, the interference (004) of the graphites of both compounds had formed a protrusion, apparently, by the superposition of an additional interference, unknown at the time, see the figure 4.13.

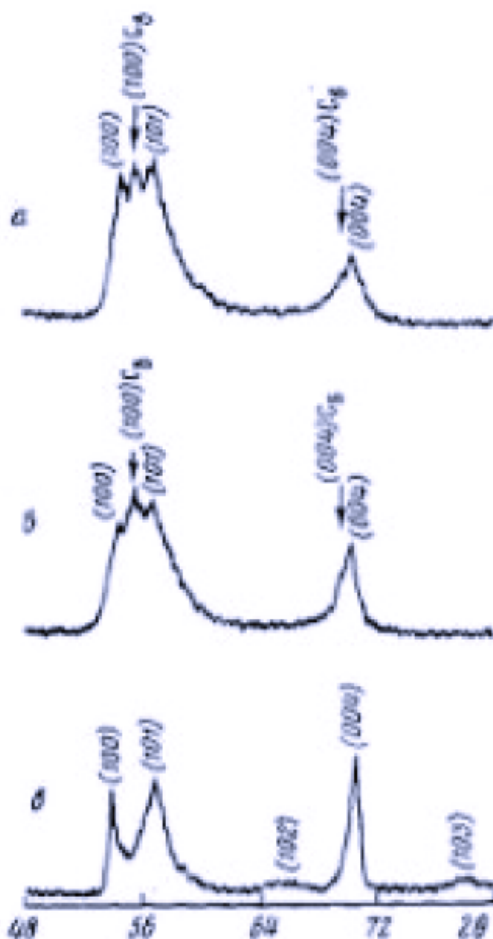

Fig 4.13 The detail diffraction patterns of the –CH compounds to highlight the (100), (101) (002), (004) and (103). Source: Nesterenko *et al.* (1982)

Comparison with the diffractogram of a high-purity, small-grain ground graphite showed that the shape of the diffraction grating of graphite obtained during the decomposition of carbon monoxide into NiO and Fe₂O₃ is specific and is due to the peculiarities of their structure.

By means of Transmission Electron Microscopy, it was proven that the products analysed consisted of graphite in the form of flakes or fibres. The fibres present in the –CH compound had a greater length than the ones measured in the –CЖ compounds. This was convincingly demonstrated by comparing the following microimages (Fig. 4.14).

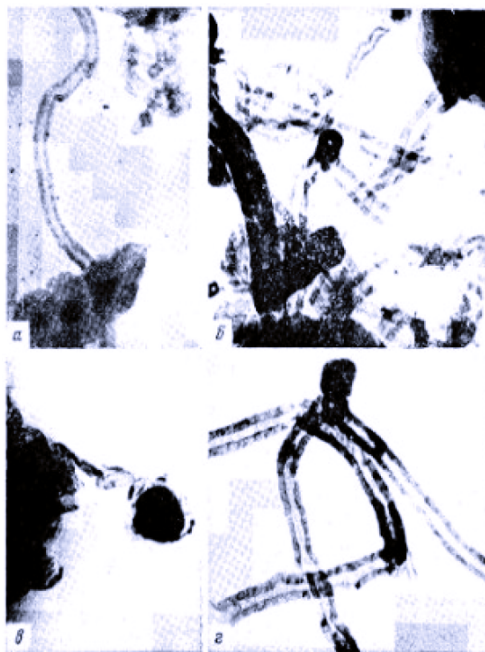

Fig 4.14 The micro images of the $-CH$ compounds show clearly long and hollow structures. Images very similar to these were obtained in 1952 by Radushkevich and Lukyanovich. Source: Nesterenko *et al.* (1982)

Another structural peculiarity observed in the fibres in the $-CH$ compounds was their tubular conformation: the cavities (the channels) within the fibres were clearly distinguishable, as can be seen in Figure 14. The channels within the fibres were rarely found in the $-CЖ$ -type compounds. Striated prominences (precipitates) perpendicular to the fibre axis were clearly observed in the fibres of the $-CЖ$ -type compound (Fig. 4.15).



Fig 4.15 The micro images of the $-CЖ$. Here the structures do not appear hollow as the $-CH$ ones. Source: Nesterenko *et al.* (1982)

A further microdiffraction analysis, to establish possible differences in fibre and lamella structure, was conducted by the research group, and the results of the analysis of electron diffraction patterns, obtained from lamellar graphite and fibre graphite volumes, respectively, are shown in the following table 4.2.

Table. 4.2 Intensity and interplanar distances of interference on electronic diffraction patterns of graphite compounds. Source: adapted from Nesterenko *et al.* (1982)

Lamellar graphite			Fibre graphite		
Lines	d. (Å)	<i>hkl</i>	Lines	d. (Å)	<i>Hkl</i>
1	3.40	002	1	3.40	002
2	2.06	100	2	2.06	100
3	1.70	004	3	1.70	004
4	1.22	110	4	1.22	110
5	1.15	112	5	1.15	112
6	1.052	200	6	1.062	200
7	0.99	114			
8	0.81	210	7	0.80	210
9	0.70	300	8	0.72	300
10	0.60	220	9	0.63	220

The analysis carried out gave rather different results from what might have been expected for graphite as it was known. In fact, the structure of the graphite present in the fibres was strongly distorted, some reflections were difficult to read on diffractograms; the (112) was blurred for fibre graphite, while the (114) for lamellar graphite was totally absent. Instead, the X-ray diffractometry results could be interpreted as indicating the presence of a three-dimensional structure with a partial structure order.

It was known that the decrease in three-dimensional order was accompanied by a decrease in lines (*hkl*) and, at the same time, by the shifting of reflections (001) towards low angles and of (*hk0*) towards large angles. The signals characterised by $d=2.0769\text{Å}$ and $d=2.07347\text{Å}$ were reflections of the planes (100) of the graphite fibres shifted towards higher angle values, precisely as a consequence of the non-regular three-dimensional order. Homologous reflections of the graphite lamellas and graphite fibres were also not found at the same angular position, the plane (004) for example.

The researchers estimated the degree of three-dimensional order (*R*) of the observed structures, whether fibre or lamellar, taking into account known parameters for three-dimensional and spatially ordered graphite. The data were tabulated as follows (Table 4.3).

Table. 4.3 Estimation of the degree of three-dimensional order of the investigated graphites. Source: Nesterenko *et al.* (1982)

Graphite	Graphite Aspect	d_{002} Å	<i>R</i>
-CH compound	Fiber	3.3860	0.39
	Lamellar	3.3650	0.64
	Fiber	3.3792	0.46
	Lamellar	3.3608	0.72
GM30C4	Lamellar	3.3608	0.72

The degree of the three-dimensional structure of graphite fibres was to all intents and purposes lower than that of graphite lamellae; this was justified by the fact that in tubular graphite fibres the atomic planes (002) were positioned parallel to the fibre axis, resulting in multilayer tubular structures. It was also important to remark that when a two-dimensional one-atomic lattice (002) was closed to form a cylindrical surface, the same carbon atoms could be stacked differently along the cylinder's generator.

In this way, we could state that Nesterenko and his collaborators possibly observed what would be later called the chirality of carbon nanotubes as early as 1982 (Fig. 4.16).

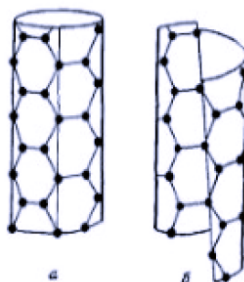

Fig 4.16 The different possible structures of carbon nanotubes. Source: Nesterenko *et al.* (1982)

The stacking variants of atoms in monoatomic cylindrical layers are shown schematically in the previous figure: circle (Fig. 4.16a) and one-step spiral (Fig. 4.16b). These are simplified and naturally do not exhaust the possibility of stacking atoms on spirals of higher helicity (spiral pitch $h=2a, 3a$, etc.).

The concentration and thermal gradients occurring during fibre growth and the elastic stresses acting at the interface could change not only the order (structure) of advancement, but also its very direction. This led to the azimuthal disorientation of the monoatomic layers and, together with their elastic bending, caused a reduction in the degree of the three-dimensional order of the fibrous graphites. In conclusion, it should be emphasised that in general the degree of three-dimensional order of the graphites in the $-CH$ and $-C\mathcal{K}$ compounds is rather high. For most industrial soots, it was only possible to obtain this three-dimensional structure after long annealing at temperatures of $3200\text{--}3600^\circ\text{C}$.

4.1.7 1985: The C₆₀ Fullerene

1985 is a landmark year in the History of Nanoscience, because it was the year that an allotropic carbon variant appeared that was to revolutionise materials science. Until then, two main allotropic forms of carbon had been known, diamond and graphite, i.e. different forms of the same chemical element with two different structural forms. Diamond and graphite are, as is well known, two natural allotropic forms of the same element.

Diamond is the natural mineral with the highest hardness value on the Mohs scale, and is a crystal that can be described by a face-centred cubic Bravais lattice (fcc), where the vectors of the primitive lattice are:

$$\vec{a}_1 = \frac{a}{2}\hat{y} + \frac{a}{2}\hat{z} \quad \vec{a}_2 = \frac{a}{2}\hat{x} + \frac{a}{2}\hat{z} \quad \vec{a}_3 = \frac{a}{2}\hat{x} + \frac{a}{2}\hat{y}$$

where a indicates the fundamental parameter of the conventional unit cell, with $a = b = c$ and the amplitudes of the angles between the faces are $\alpha = \beta = \gamma = 90^\circ$, of course. The base contains two atoms, and this information, together with the characteristics of the lattice, makes it possible to fully define the structure of the diamond. This primitive base of two identical atoms $\vec{B}_1 = (0,0,0)$ and $\vec{B}_2 = (1/4, 1/4, 1/4)$ is associated with each lattice point. Carbon crystallises in the diamond structure with a lattice constant $a = 3.567\text{\AA}$ and has an atomic density $n = 8/a^3$. (Kittel 1993)

Graphite is a three-dimensional structure of carbon atoms, stable at ordinary pressure and temperatures, organised in a two-dimensional hexagonal arrangement where the primitive lattice vectors are written as:

$$\vec{a}_1 = a\frac{\sqrt{3}}{2}\hat{x} - \frac{a}{2}\hat{y} \quad \vec{a}_2 = a\frac{\sqrt{3}}{2}\hat{x} + \frac{a}{2}\hat{y} \quad \hat{a}_3 = \hat{z}$$

with the same meaning as the symbols shown for diamond. In addition, the following lattice parameters are known for graphite:

$$|\vec{a}_1| = |\vec{a}_2| = a = 2.46\text{\AA} \quad |\vec{a}_3| = c = 6,71\text{\AA}$$

The planes of graphite are $c/2 = 3.36\text{\AA}$ apart.

Curiously enough, it was research carried out by Sir Harold Walter Kroto (1939–2016) on the formation of long carbon chains in the vast interstellar spaces near red giant stars that made it possible to observe a new allotropic carbon structure, hollow and singularly stable, consisting of 60 atoms of this nuclide. It is certainly worth mentioning the discoverers of this new molecule, who were, in addition to the aforementioned Sir Harold Walter Kroto, James Heath, Sean O'Brien, Robert Floyd Curl Jr., Yuan Liu and Richard Smalley. (1943–2005) Kroto, Curl and Smalley were awarded the Nobel Prize in Chemistry in 1996. Heath, O'Brien and Liu were then three undergraduates who made essential contributions to the early carbon experiments and results. In his Nobel Lecture in 1996, Smalley did not hide his bitterness because only three researchers were awarded the Nobel Prize compared to a larger number of collaborators. He commented on the photograph, published in the text of his paper, in which all the members of the research group, except Yu, are together. The photo was taken on 11 September 1985, the day before he sent the manuscript of the article with their discovery to Nature magazine. Smalley said:

“It is a thrill for me to be here today and to be the first of three speakers discussing the wonders of the fullerenes, an infinite new class of carbon molecules. My colleagues [...] are also thrilled to be here in Stockholm this week to see “Bucky get the Prize”. [...] you can understand that there is also some sadness in our hearts today. While the chemistry prize this year is for the discovery of the

fullerenes, it is given to individuals, and this individual honor can be shared by no more than three. The Nobel Committee has done as well as they possibly can with this problem. We understand. But the sadness remains” (Smalley 1996).

In the paper published in 1985 reporting this discovery (Kroto *et al.* 1985), it is mentioned that the authors, who had observed the cluster of carbon atoms after vaporising graphite with a laser, were faced with the challenge of describing the new structure coherently. Here I report, for reader’s sake, the original first page of the paper (Fig. 4.17).

182 LETTERS TO NATURE NOVEMBER 1985

C₆₀: Buckminsterfullerene

H. W. Kroto*, J. R. Heath, S. C. O'Brien, R. F. Curl & R. E. Smalley

Rice Quantum Institute and Departments of Chemistry and Electrical Engineering, Rice University, Houston, Texas 77251, USA

During experiments aimed at understanding the mechanisms by which long-chain carbon molecules are formed in interstellar space and circumstellar shells, graphite has been vaporised by laser irradiation, producing a remarkably stable cluster consisting of 60 carbon atoms. Concerning the question of what kind of 60-carbon atom structure might give rise to a superstable species, we suggest a truncated icosahedron, a polygon with 60 vertices and 32 faces, 12 of which are pentagonal and 20 hexagonal. This object is commonly encountered as the football shown in Fig. 1. The C₆₀ molecule which results when a carbon atom is placed at each vertex of this structure has all valences satisfied by two single bonds and one double bond, has many resonance structures, and appears to be aromatic.

The technique used to produce and detect this unusual molecule involves the vaporisation of carbon species from the surface of a solid disk of graphite into a high-density helium flow, using a focused pulsed laser. The vaporization laser was the second harmonic of Q-switched Nd:YAG producing pulse energies of ~30 mJ. The resulting carbon clusters were expanded in a supersonic molecular beam, photoionized using an excimer laser, and detected by time-of-flight mass spectrometry. The vaporization chamber is shown in Fig. 2. In the experiment the pulsed valve was opened first and then the vaporization laser was fired after a precisely controlled delay. Carbon species were vaporized into the helium stream, cooled and partially equilibrated in the expansion, and travelled in the resulting molecular beam to the ionization region. The clusters were ionized by direct one-photon excitation with a carefully synchronized excimer laser pulse. The apparatus has been fully described previously^{1,2}.

The vaporization of carbon has been studied previously in a very similar apparatus³. In that work clusters of up to 190 carbon atoms were observed and it was noted that for clusters of more than 40 atoms, only those containing an even number of atoms were observed. In the mass spectra displayed in ref. 6, the C₆₀ peak is the largest for cluster sizes of >40 atoms, but it is not completely dominant. We have recently re-examined this system and found that under certain clustering conditions the C₆₀ peak can be made about 40 times larger than neighbouring clusters.

Figure 3 shows a series of cluster distributions resulting from variations in the vaporization conditions evolving from a cluster distribution similar to that observed in ref. 3, to one in which C₆₀ is totally dominant. In Fig. 3c, where the firing of the vaporization laser was delayed until most of the He pulse had passed, a roughly gaussian distribution of large, even-numbered clusters with 38–120 atoms resulted. The C₆₀ peak was largest but not dominant. In Fig. 3b, the vaporization laser was fired at the time of maximum helium density, the C₆₀ peak grew into a feature perhaps five times stronger than its neighbours, with the exception of C₇₀. In Fig. 3a, the conditions were similar to those in Fig. 3b but in addition the integrating cup depicted in Fig. 2 was added to increase the time between vaporization and expansion. The resulting cluster distribution is completely dominated by C₆₀, in fact more than 50% of the total large cluster abundance is accounted for by C₆₀; the C₇₀ peak has diminished in relative intensity compared with C₆₀ but remains rather prominent, accounting for ~5% of the large cluster population.

Our rationalization of these results is that in the laser vaporization, fragments are torn from the surface as pieces of the planar

graphite fused six-membered ring structure. We believe that the distribution in Fig. 3c is fairly representative of the nascent distribution of larger ring fragments. When these hot ring clusters are left in contact with high-density helium, the clusters equilibrate by two- and three-body collisions towards the most stable species, which appears to be a unique cluster containing 60 atoms.

When one thinks in terms of the many fused-ring isomers with unsatisfied valences at the edges that would naturally arise from a graphite fragmentation, this result seems impossible: there is not much to choose between such isomers in terms of stability. If one tries to shift to a tetrahedral diamond structure, the entire surface of the cluster will be covered with unsatisfied valences. Thus a search was made for some other plausible structure which would satisfy all sp³ valences. Only a spherical structure appears likely to satisfy this criterion, and thus Buckminster Fuller's studies were consulted (see, for example, ref. 7). An unusually beautiful (and probably unique) choice is the truncated icosahedron depicted in Fig. 1. As mentioned above, all valences are satisfied with this structure, and the molecule appears to be aromatic. The structure has the symmetry of the icosahedral group. The inner and outer surfaces are covered with a sea of π electrons. The diameter of this C₆₀ molecule is ~7 Å, providing an inner cavity which appears to be capable of holding a variety of atoms⁸.

Assuming that our somewhat speculative structure is correct, there are a number of important ramifications arising from the existence of such a species. Because of its stability when formed under the most violent conditions, it may be widely distributed in the Universe. For example, it may be a major constituent of circumstellar shells with high carbon content. It is a feasible constituent of interstellar dust and a possible major site for

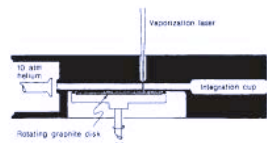
* Present address: School of Chemistry and Molecular Sciences, University of Sussex, Brighton BN1 9QJ, UK.

© 1985 Nature Publishing Group

Fig 4.17 The first page of the original article – very short, indeed, as in the second page barely one column of text appears – about the discovery of buckminsterfullerene. See how the authors take a soccer ball as a model of the new molecule. See below for a larger and colour picture. Source: Kroto *et al.* (1985)

They succeeded, assuming that such an extremely stable superstructure could have the shape of one of the Archimedean polyhedra, a truncated icosahedron, i.e. a solid with 32 faces divided into 20 hexagons and 12 pentagons (Fig. 4.18).



Fig 4.18 Almost every old-fashioned soccer ball was made up with pentagons (here white) and hexagons (here decorated), almost till the 90s. If we imagine replacing each vertex on the seams with a carbon atom, this might be one of the most common models used to visualize the truncated icosahedral structure Kroto and his colleagues suggested C_{60} to have. Source: AD

Harold Kroto described the discovery in detail in a later paper (Kroto 1992). It all began, as Kroto recalls, when long chains of polyynylcyanides were found in the dark clouds of interstellar space in the 1970s. They had been ejected by red giants, carbon stars. By 1985, experiments to replicate the chemistry of these stars had led to the observation of stable carbon structures. In the 1980s, Kroto travelled twice to Rice University in Texas to devote himself to these experiments. The first time was in 1985, the second the following year. It was during the second visit that he started working with Jim Heath, Sean O'Brien and Yuan Liu on 1 September 1985. It was in the first week of September that laboratory investigations followed, in the direction of the first observation of C_{60} . On Wednesday, 4 September 1985, Kroto and his collaborators performed mass spectrometry of their samples, and the presence of an agglomerate consisting of 60 carbon atoms was detected for the first time. The image below (Fig. 4.19) represents the experimental evidence of this discovery.

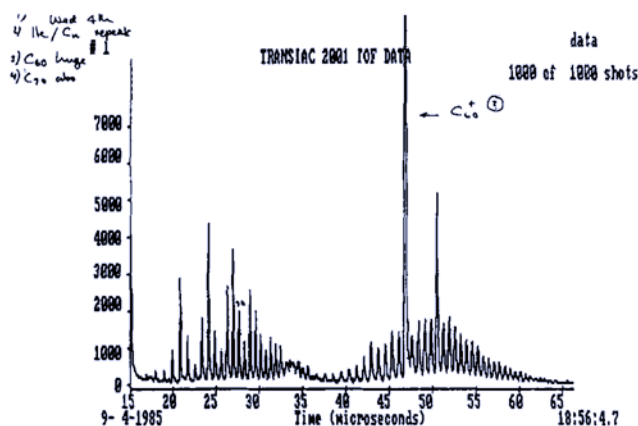

Fig 4.19 Time-of-flight mass spectrum of carbon clusters on September 4th, 1985. Original handmade notations from Kroto. Source: Kroto (1992)

The following picture (Fig. 4.120) shows the entries by Heath, Liu, and O'Brien. The first recorded note reads a strong signal from C_{60} and C_{70} . The second note reports again a strong signal.

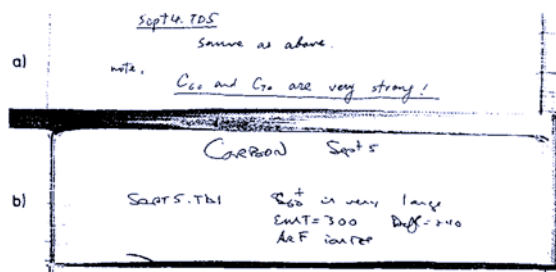

Fig 4.20 Original notes reporting the signal of C_{60} as *very strong*, a), and *very large*, b), on the 4th and 5th of September. Source: Kroto (1992)

After refining the experimental conditions, the researchers were able to take the following notes (Fig. 4.21).

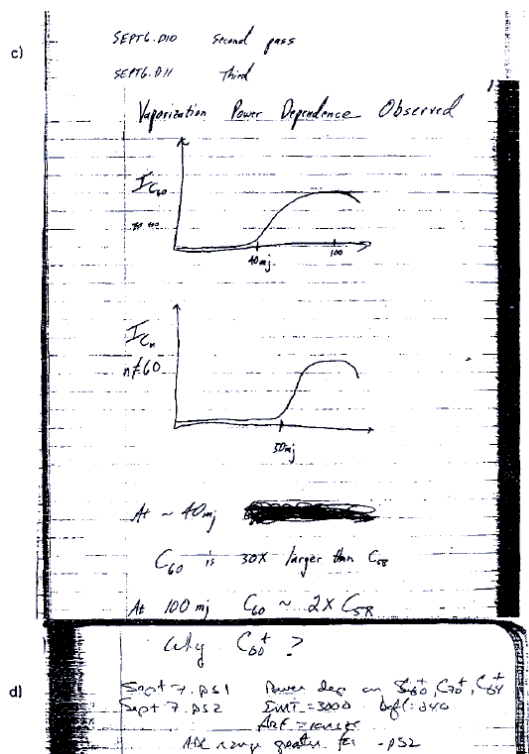

Fig 4.21 The signal of C_{60} , in note c), was reported to be 30 times stronger than C_{58} . Note d) reports further power-dependence studies. Source: Kroto (1992)

Finally, the result appeared evident (Fig. 4.22).

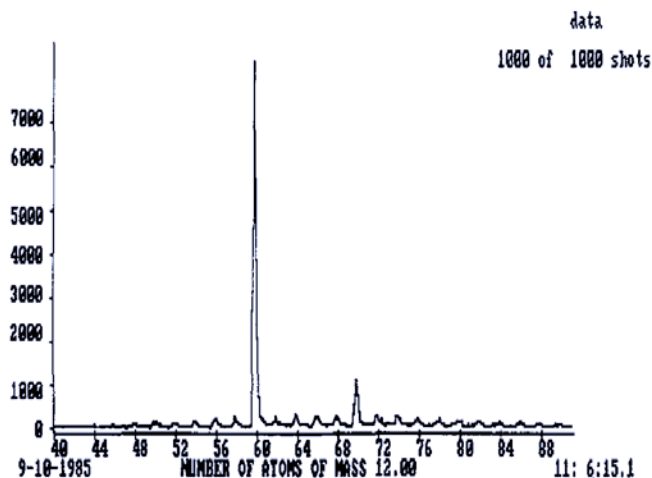

Fig 4.22 The Time Of Flight mass spectrum of carbon clusters showing the really strong signal of the C_{60} molecule. Source: Kroto (1992)

The image above clearly shows the strength of the signal corresponding to C_{60} .

After all these observations, Kroto and his colleagues started discussing the possible structure of the molecule of C_{60} .

As the weekend approached our actions, thoughts, and conversations turned at EXPO '67 in Montreal. I had actually more and more to the phenomenon. What might this special “wadge” of carbon be? Smalley had never come across this British term for a cluster and liked it so much that he started to refer to C_{60} as the “Mother Wadge”; the omnipresence of the cluster led me to call it the “Godwadge”. On Friday, September 6 during a group meeting, Curl suggested that we should concentrate on identifying the conditions under which the 720 amu peak was most prominent. O’Brien and Heath agreed to work shifts during the weekend. [...] What on earth could $C_{60}(?)$ be? (*Ibidem*)

Kroto remembered an experience he had at EXPO '67.

The quest for a structure which could account for this precocious wadge of carbon led to numerous, synergistic discussions among all five members of the team during those days. The deliberations were particularly intense on Monday, September 9th. As this day wore on and all the ideas which had surfaced during the period were assessed and reassessed, a consensus grew that C_{60} might be some sort of spheroid. One possibility we considered was that the laser had blasted flakes of carbon from the graphite surface, and that these hot graphite-like networks had somehow wrapped themselves up into closed cages, thus eliminating the dangling edge bonds and making the cage unreactive. This idea had instant appeal for all. For me this concept brought back vivid memories of Buckminster Fuller’s geodesic dome at EXPO '67 in Montreal. I had actually been inside this remarkable structure at that time and remembered pushing my small son in his pram along the ramps and up the escalators, high up among the exhibition stands and close to the delicate network of struts from which the edifice was primarily constructed. This experience had left an image in my mind which could never be erased (*Ibidem*).

The geodesic dome designed by the American architect Richard Buckminster Fuller (1895–1983), and to which Kroto referred, is the following (Fig. 4.23).



Fig 4.23 The United States' pavilion in Montreal, designed by Buckminster Fuller inspired the structure of C_{60} . The yellow circle (AD) is centred on one of the pentagons necessary to bend the structure. Source: Cédric Thévenet, CC BY-SA 3.0, Public Domain.

In order to better visualise this structure, Smalley realized the following paper model of the molecule (Fig. 4.24).



Fig 4.24 The model Smalley made with 60 vertices, 12 pentagonal and 20 hexagonal faces. Source: Kroto (1992)

The experimental apparatus, applied to detect the new material, is sketched in the following figure (Fig. 4.25).

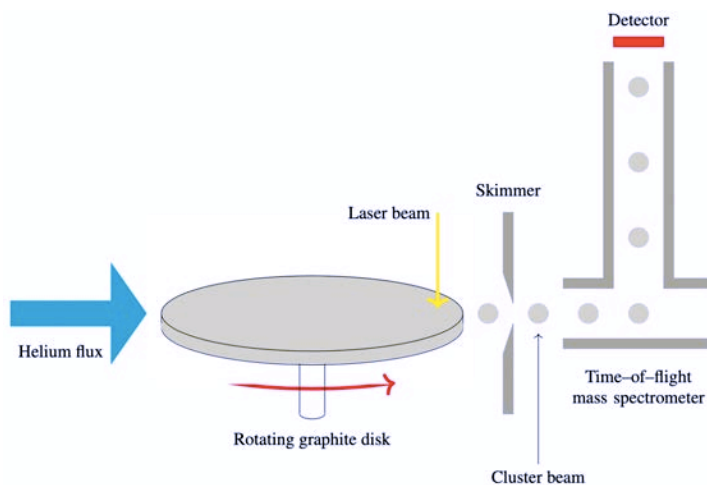

Fig 4.25 The schematic experimental apparatus applied by Kroto, Smalley and their companions to detect, first in the world, the C_{60} molecule in 1985. Source: AD

The experimental set-up consisted of a rotating disk of graphite which was irradiated by a strong laser beam, necessary to create a carbon plasma over the surface of the disk. A flux of helium blew at high speed over the disk with two purposes, the first was to carry the evaporated carbon series towards the right of the apparatus, the skimmer and the mass spectrometer, the second purpose was to cool the system. We have to imagine that the helium beam, the laser and the disk are enclosed in a containing box, so the carbon products carried by the helium are more likely to diverge as it leaves the disk towards the skimmer. Here the divergent lines are not represented. What we are interested in are the clusters that are triggered by the skimmer and enter the mass spectrometer. This time-of-flight mass spectrometer was used to analyse the clusters. The researchers were able to improve the experimental set-up and apparatus, i.e. adding an integration cup right before the beam outlet nozzle, and the device become so precise that in some experiments only C_{60} and C_{70} elements were detected (Pradeep 2005).

Further studies regarding the electronic structure (Haddon, Brus and Raghavachari 1986), or reactivity (Zhang *et al.* 1986), or magnetism (Elser and Haddon 1987) of C_{60} have been investigated in time.

The synthesis of the first fullerenes was achieved by means of a conceptually rather simple apparatus, comprising a welding transformer, a reaction chamber connected to a vacuum pump, and some graphite rods, these consisting of an extremely pure and porous material, so as to achieve rapid evaporation. Once the graphite elements are brought into contact with each other, an arc is established in an atmosphere of helium or argon at a pressure of approximately 13 or 26KPa, the arc supported by a voltage of 20V. The process, which was generally kept active for several minutes, generates soot that collects on surfaces that were water-cooled and could well be the interior surfaces of the vacuum chamber; the soot was then extracted and treated in benzene or toluene for 5 to 6 hours. Since approximately 20–30% of the soot was soluble, the solution was finally separated chromatographically. However, the chromatographic technique had the undesirable disadvantage of being expensive, which is why activated carbon and silica gel filtration was used, which allowed the desired material to be collected in a single step.

Arc evaporation was not the only method of producing the fullerenes. Their presence has been observed in combustion flames (Howard *et al.* 1991), in the production processes of synthetic diamonds (Chow *et al.* 1995), they have also been observed in Nature, in a 1.85 billion year old impact crater (Becker *et al.* 1994) and on spacecraft (Radicati di Brozolo, Bunch, Fleming and Macklin 1994).

4.1.8 1986: AFM and Engines of Creation

To study the surfaces of insulating materials on an atomic scale of investigation, a new type of microscope has been developed, called the Atomic Force Microscope (AFM), whose operating principle is a combination of the principles behind the STM microscope and the stylus profilometer. It operates with a probe that does not cause damage to the surface. In 1986, Gerd Binnig (who in the same year would receive the Nobel Prize in Physics for the STM microscope with Heinrich Rohrer), Calvin Forrest Quate (1923–2019) and Christoph Gerber published their results on the first applications of this new instrument; the vertical resolution of the microscope turned out to be less than a tenth of a nanometre, while the lateral resolution was three nanometres. Both of these numerical values were obtained operating in air; the new apparatus made it possible to overcome the difficulties in the profilometric study of insulators, a problem that had been solved for conductors by the STM.

Let us recall briefly that this type of electron microscope exploits the interactions established between a scanning tip and the sample surface. The sharper the scanning probe, the more detailed the resolution obtained, as the tip will be able to more accurately detect surface roughness. This is, for example, one of the reasons why the AFM microscope is used in surface rheological analysis. Today, tips are made of pure silicon or silicon nitride, Si_3N_4 , a material with high hardness on the Mohs scale and possessing high thermal stability, which is prepared by heating silicon in a nitrogen atmosphere at a temperature ranging from 1300°C to 1400°C (López–Suárez *et al.* 2009). As the spring constant of the tip is of the order of 1N/m, it is possible to estimate the shortest vertical displacement d achievable from the formula $\langle 1/2 kd^2 \rangle \sim 1/2 k_B T$. If $k_B T \sim 4 \times 10^{-21}$ J at 298K, then the smallest vertical displacement observable is 0.5nm. The interaction between the tip and the sample is generally in the order of the nanonewton and is not measured by the AFM. What is measured is the deflection of the tip holder as a function of the profile of the sample on which it moves. The displacement of the cantilever is observed through the reflected beam of a laser that illuminates it, which is recovered by a photodetector. This is the system that is in use today, although problems related to heating of the cantilever illuminated by laser radiation must be considered. The first AFM made, on the other hand, measured the tunneling current between tip and surface and modelled its profile by evaluating the different values this parameter took. In this way, it was possible to quantify the vertical and lateral displacements of the cantilever. The optical measurement device through laser replaced this original system because it proved to be more efficient and superior.

In AFM microscopy, resolution is not understood as in optical microscopy, where it is influenced by the so-called diffraction limit. With this technique, what matters is the workmanship that can be achieved in the fabrication of the probe tip, with regard to its geometry. It is understandable how narrower and sharper tips can probe a rough surface with greater accuracy than other tips, which are characterized by a greater width. It should

also not be forgotten that in an AFM analysis it is not only the width of the tip that is the key parameter for optimal resolution, but also its height, since this analysis technique is actually three-dimensional (Pradeep 2007).

The AFM microscope was introduced both to record atomic-scale images of surfaces and to measure forces of extremely small modulus, exploiting a historically established principle such as the deformation of a spring. Not only that, the operating concept of the AFM microscope was still very close to that of the stylus profilometer, an instrument that, historically, relied on contacting a stylus on the surface to be examined to determine its roughness, while still obtaining measurements whose vertical resolution was in the order of the nanometer. Binnig, Quate and Gerber wanted to go beyond the operational limitations of STM and realize an instrument capable of examining insulators also, reaching a different level of sensitivity in analysis.

We are proposing a new system wherein the STM is used to measure the motion of a cantilever beam with an ultrasmall mass. The force required to move this beam through measurable distances (10^{-4}\AA) can be as small as 10^{-18}N . The masses involved in the other techniques are too large to reach this value. This level of sensitivity clearly penetrates the regime of interatomic forces between single atoms and opens the door to a variety of applications. The atomic force microscope (AFM) is a new tool designed to exploit this level of sensitivity. It will be used to investigate both conductors and insulators on an atomic scale. We envision a general-purpose device that will measure any type of force; not only the interatomic forces, but electromagnetic forces as well (Binnig, Quate and Gerber 1986).

In the first experiments that were conducted, graphite was used, rather than a dielectric material, as it was a material that had already been tested in various situations with STM microscopy (Selloni, Carnevali, Tosatti and Chen 1985), operating in air and at room temperature. The tunnel effect was used, in the apparatus made by Binnig and his collaborators, to test the deflection of the cantilevered lever, made of silicon, where the gold-covered conducting tunneling tip was attached. The sample holder was made to move near the tip in the x and y directions to map its surface by measuring the force established between the tip and the atoms of the sample surface.

The use of graphite as a test material gave results that the authors compared with similar results obtained through STM microscopy. The results obtained with AFM seemed comparable to those obtainable with the STM microscope operated with a tunnel current greater than 1nA ; the hexagonal structure of graphite appeared somewhat visible even though the individual carbon atoms were not well defined as well-separated signal maxima. The atomic resolution, understood as the separation distance between adjacent carbon atoms appeared unusually small, around the remarkable value of 1.4\AA , while for other materials even an almost double resolution of 2.5\AA could be sufficient to distinguish individual atoms. To improve the performance of the instrument, Binnig and his colleagues then suggested boxing the apparatus under ultra-high vacuum (UHV) with a vibration control system to achieve more accurate sample definition (Binnig, Gerber, Stoll, Albrecht, Quate 1987). A member of the research team, Thomas Albrecht demonstrated in 1987 that Atomic Force Microscopy could be used to image not only semiconducting structures such as molybdenum disulfide, MoS_2 , but also a nonconducting sample with atomic resolution, when he obtained images of boron nitride with a lateral resolution below 3\AA (Albrecht, Quate 1987). The work of Albrecht and Quate demonstrated, once again, how the AFM microscope could be capable of providing images at an atomic resolution, this for both conducting and nonconducting surfaces immersed in air.

At the time of its appearance, *Engines of Creation* (Drexler 1986) was an incredibly visionary and ambitious text, which Drexler wrote in 1986, dedicating it to what he then referred to as “the coming era of Nanotechnology”. Browsing through this booklet, we immediately realise that Drexler was very precise in dividing up predictions and possibilities, without however avoiding thorny points such as possible dangers and the obvious hopes that might accompany such a revolutionary field of research for the times. Not only that, but it represented the first concrete attempt to bring together the ideas behind nanotechnology in such a way as to organise a coherent field of thought and research that could define and qualify it as a research field in its own right.

The text is written in a language that is not strictly for experts, so as to guarantee satisfactory dissemination; in 1992 Drexler would return to the subject with a more technical book, *Nanosystems: Molecular Machinery, Manufacturing, and Computation*.

The circulation of the book was rapid and made Drexler’s text a very popular work, not only among students of scientific disciplines, who had the opportunity to approach a new science with extraordinary promise and almost boundless horizons, which brought with it an ability to connect very different research fields as had perhaps never been seen before, but also among fans of scientific literature and science fiction.

Drexler used the term “Nanotechnology” not so much as described by Taniguchi but according to Feynman’s ideas, envisaging a technology capable of directly manipulating atoms and molecules individually, placing them with absolute precision as required. Nanotechnology and molecular technology became, for Drexler, two perfectly interchangeable terms. This was not just an editorial choice. The reason for this decision can also be traced back to his approach to the subject. An engineer by training, he drew on the world of biology, as he had done in his 1981 article, placing at the centre of his discussion a new device he called the universal assembler, based on proteins. In his view, this is indispensable, since man’s ability to manipulate atoms at will with absolute precision and maximum control is placed at the basic level of the new technology, molecular technology. Drexler contrasts this with bulk technology, the old way of making technology that manipulated atoms and molecules from flint chips to make microprocessors, for example.

For Drexler, the idea of the universal assembler is linked to what he calls second-generation nanotechnology, when protein-based machines will make nanomachines that are in turn stronger than their predecessors.

The primacy in the realisation of these devices, here Drexler is somehow self-referential, will be the prerogative of the engineers.

The engineers of the new technology will build both nanocircuits and nanomachines. [...] Yet most biochemists work as scientists, not as engineers. They work at predicting how natural proteins will fold, not at designing proteins that will fold predictably. These tasks may sound similar, but they differ greatly: the first is a scientific challenge, the second is an engineering challenge. [...] As nanotechnology moves beyond reliance on proteins, it will grow more ordinary from an engineer’s point of view (Drexler 1986).

The characteristics of assemblers are so important that Drexler holds them in very high regard, seeing them as de facto extra strong devices capable of realising almost any idea in the engineer’s mind.

These second-generation nanomachines – built of more than just proteins – will do all that proteins can do, and more. In particular, some will serve as improved devices for assembling molecular structures. Able to tolerate acid or vacuum, freezing or baking, depending on design, enzyme-like

second-generation machines will be able to use as “tools” almost any of the reactive molecules used by chemists – but they will wield them with the precision of programmed machines (*Ibidem*).

Again, the manipulation will be at atomic levels, and the name of the devices appears at this point in the text:

They will be able to bond atoms together in virtually any stable pattern, adding a few at a time to the surface of a workpiece until a complex structure is complete. Think of such nanomachines as assemblers (*Ibidem*).

The power in the hands of the researcher is almost total, limited only by the laws of nature:

Because assemblers will let us place atoms in almost any reasonable arrangement (as discussed in the Notes), they will let us build almost anything that the laws of nature allow to exist. In particular, they will let us build almost anything we can design – including more assemblers. The consequences of this will be profound, because our crude tools have let us explore only a small part of the range of possibilities that natural law permits. Assemblers will open a world of new technologies (*Ibidem*).

At the time of its appearance, *Engines of Creation* proved to be an ambitious and imaginative text. In particular, Drexler’s conceptualisation of assemblers capable of manipulating atoms and molecules gave rise to a dialectical dispute between scientists. The debate centred on the actual feasibility of these assemblers, and mainly involved Eric Drexler on the one hand and Richard Smalley on the other. The idea of a molecular assembler was fundamental to Drexler, but Smalley stated that it would not be possible according to the fundamental principles of physics. The debate was not only limited to technical aspects, but on each other’s views on nanotechnology, which each considered to be harmful to the public perception of the subject. The debate took place over about two years, between 2001 and 2003, and was fought through articles and open letters. In September 2001, Smalley published an article in *Scientific American*, *Of Chemistry, Love and Nanobots*, (Smalley 2001), in which the author wanted to settle the question of molecular assemblers rather categorically.

How soon will we see the nanometer-scale robots envisaged by K. Eric Drexler and other molecular nanotechnologists? The simple answer is never. [...] Manipulator fingers on the hypothetical self-replicating nanobot are not only too fat: they are also too sticky. Both these problems are fundamental, and neither can be avoided.

It is interesting to notice that Smalley personally mentioned Drexler’s name in this excerpt only, in his article. The rest of the script is about nanobots and their features, without any reference to Drexler himself.

The debate proceeded with a reply from Drexler the same year (Drexler *et al.* 2001) and two letters opened in early 2003. Towards the end of 2003 it was concluded in a “Point-Counterpoint” feature in *Chemical & Engineering News* in which both parties participated. The debate is part of the History of Nanotechnology, because of the depth of the protagonists and the arguments involved. The tone of the dispute also contributed to its fame. Drexler accused Smalley of publicly misrepresenting his work. Smalley accused Drexler of failing to understand basic science.

The discussion started when Smalley questioned Drexler’s ideas with two arguments: *fat fingers* and *sticky fingers*. According to Smalley, picking up atoms individually with the precision Drexler imagined was not possible. The computer-controlled fingers would be too fat and sticky to do that. I must remark that the word “finger” did not apply to anything that was really finger-like; the reader has to remember that Drexler graduated as an engineer and he tried to reduce mechanical systems to biological ones.

The fat fingers objection was related to the mechanical nature of Drexler's conception of molecular assemblers. The manipulator arms of Nanobots would themselves be made of atoms, so at the nanoscale, there would not be enough room to allow the control required to precisely locate each atom. Precise control of the chemistry would be achieved with too many fingers and too many arms (Bueno 2004).

Because the fingers of a manipulator arm must themselves be made out of atoms, they have a certain irreducible size. There just isn't enough room in the nanometer-size reaction region to accommodate all the fingers of all the manipulators necessary to have complete control of the chemistry (Smalley 2001).

The interaction among atoms is the basis of the sticky fingers objection. The precise control over positioning could not be achieved, according to Smalley, because the atoms of the fingers would interact with other atoms in unintended ways. Just positioning an atom in a given place is not enough to guarantee that it will not interact with the atoms the researcher wants it to interact with.

Manipulator fingers on the hypothetical self-replicating nanobot are [...] too sticky: the atoms of the manipulator hands will adhere to the atom that is being moved. So it will often be impossible to release this minuscule building block in precisely the right spot (*Ibidem*).

Smalley brought these arguments in support of his thesis. Furthermore, Smalley raised a further issue, molecular assemblers should be *self-assembling*. Otherwise, production would have been too low. A non-replicating assembler would take too long to make a single mole of anything.

Imagine a single assembler: working furiously, this hypothetical nanorobot would make many new bonds as it went about its assigned task, placing perhaps up to a billion new atoms in the desired structure every second. But as fast as it is, that rate would be virtually useless in running a nanofactory: generating even a tiny amount of a product would take a solitary nanobot millions of years (*Ibidem*).

Nanobots capable of self-replication would be much more efficient.

For fun, suppose that each nanobot consisted of a billion atoms (10^9 atoms) in some incredibly elaborate structure. If these nanobots could be assembled at the full billion-atoms-per-second rate imagined earlier, it would take only one second for each nanobot to make a copy of itself. The new nanobot clone would then be 'turned on' so that it could start its own reproduction. After 60 seconds of this furious cloning, there would be 260 nanobots, which is the incredibly large number of 1×10^{18} , or a billion billion. This massive army of nanobots would produce 30 grams of a product in 0.6 millisecond, or 50 kilograms per second. Now we're talking about something very big indeed! (*Ibidem*)

Smalley thought of another feature of self-replicating nanobots he said to be quite scary.

Who will control them? How do we know that some scientists or computer hacker won't design one that is truly autonomous, carrying a complete set of instructions for itself? How do we know that these nanobots won't mutate and that some of these mutants won't achieve the ability, like cancer cells, to disregard any signals that would otherwise trigger self-destruction? How could we stop them once they reached this malignant state? Self-replicating nanobots would be the equivalent of a new parasitic life-form, and there might be no way to keep them from expanding indefinitely until everything on earth became an undifferentiated mass of gray goo. Still more frightening, they would by either design or random mutation develop the ability to communicate with one another. Maybe they would form groups, constituting a primitive nervous system. Perhaps they would really become "alive" by any definition of that term (*Ibidem*).

Drexler replied to both the issues Smalley presented. Although Drexler thought self-replication was an important factor (Drexler 1986), he later developed models with Chris Phoenix that did not require such a feature (Phoenix and Drexler 2004). About the sticky-fingers problem, Drexler pointed out that his assemblers would not manipulate individual atoms but reactive molecules (Drexler 2003b). The two objections put forward by Smalley were based on individual atoms, so they were not as effective as he might have expected.

As Drexler replied, Smalley formulated a second version of the sticky-fingers objections, substituting the individual atoms with reactive molecules. In this second interpretation, the control of reactive molecules requires more fingers to manipulate the multitude of atoms. In other words, the initial difficulty of manipulating a single atom appears multiplied by the global number of atoms in the process (Bueno 2004).

Drexler replied to this by rejecting the concept of *fingers*.

Like enzymes and ribosomes, proposed assemblers neither have nor need these ‘Smalley fingers’. The task of positioning reactive molecules simply doesn’t require them (Drexler 2003b).

Although at this point both the contenders agreed on the nonexistence of such fingers, Smalley raised a new challenge. He felt the need to describe the chemical process involved.

How is it that the nanobot picks just the enzyme molecule it needs out of this cell, and how does it know just how to hold it and make sure it joins with the local region where the assembly is being done, in just the right fashion? How does the nanobot know when the enzyme is damaged and needs to be replaced? How does the nanobot do error detection and error correction? [...] The central problem I see with the nanobot self-assembler then is primarily chemistry. If the nanobot is restricted to be a water-based life-form, since this is the only way its molecular assembly tools will work, then there is a long list of vulnerabilities and limitations to what it can do. If it is a non-water-based life-form, then there is a vast area of chemistry that has eluded us for centuries. (Smalley 2003a)

Drexler then rejected the chemical approach, getting back to a purely mechanical world, emphasizing the mechanical features of his assemblers, maybe to disarm Smalley’s ideas. In his final reply, Smalley pointed out this argument. To him a mechanical conception of molecular assemblers was too far from what could be done.

I see you have now walked out of the room where I had led you to talk about real chemistry, and you are now back in your mechanical world. [...] Much like you can’t make a boy and a girl fall in love with each other simply by pushing them together, you cannot make precise chemistry occur as desired between two molecular objects with simple mechanical motion along a few degrees of freedom in the assembler-fixed frame of reference. Chemistry, like love, is more subtle than that. You need to guide the reactants down a particular reaction coordinate, and this coordinate treads through a many-dimensional hyperspace. I agree you will get a reaction when a robot arm pushes the molecules together, but most of the time it won’t be the reaction you want (Smalley 2003b).

Smalley wanted to get back to a chemical conception of the assemblers, something he thought to be crucial to understand the phenomena. Although chemical systems like catalysts, reactant enzymes and so on were available, Drexler’s vision did not appear to be fully implementable.

4.1.9 1987: Applications of AFM

The capabilities of STM microscopy were extended by the work of Binnig, Quate and Gerber, who developed the AFM microscope and enabled both conducting and non-conducting surfaces to be analysed and visualised; the latter instrument proved to be versatile and its modifications led to the tracing of surfaces by measuring the force between the sample surface and the microscope tip, maintaining a scanning distance of between 30Å and 150Å (Albrecht and Quate 1987). By maintaining a constant spacing by controlling the force exerted between tip and sample, Martin, Williams and Wickramasinghe (Martin, Williams and Wickramasinghe 1987) obtained a surface profile with a spatial resolution of 50Å. They measured the force between the sample and probe as a function of the space between the tip and surface.

A tungsten tip, installed at the end of a wire, was mounted on a piezoelectric transducer to make the tip vibrate at the resonance frequency of the wire, the function of which was analogous to that of the cantilever on an STM. The amplitude of the ac vibration was precisely measured using a heterodyne laser interferometer. The device was operated in two modes.

1) The force gradient established between the tip and the sample changed the compliance of the lever, thus inducing a change in the vibration amplitude, caused by the shift in the lever's resonance. Given the characteristics of the lever, it was then possible to measure the vibration amplitude as a function of the tip-sample distance in order to deduce the gradient of the force and, thus, the modulus of the force itself. The vibration amplitude of the lever also gave the possibility of measuring a feedback signal, through which it was possible to keep the tip-sample distance constant for all surface profiling measurements.

2) It is known that the long-range force between the tip and the sample is an attractive, van der Waals-type force. If the elastic constant of the lever were small, the force gradient of the interaction could be greater than the elastic constant itself. A continuous displacement of the tip towards the surface causes a sudden attraction exerted by the sample. The system then reaches equilibrium at a position that corresponds to the minimum potential of the interaction, as would be expected. Measuring the force required to move the tip away from the surface makes it possible to derive the peak of the attractive force, and thus characterise the sample material.

Optical sensing, as opposed to tunnel sensing, of lever deflection, had proven to be more reliable and easier to implement, insensitive to lever roughness with less sensitivity to thermal drift; in other words, it had several advantages. Laser interferometry made it possible to measure the amplitude and phase of ac displacements up to 10^{-4} Å. The optical detection scheme made it possible to monitor the vibration of the lever even when it was excited to vibrations with amplitudes of several hundred angstroms, which would have been extremely difficult with traditional tunnelling techniques.

The first mode of operation allowed the force to be mapped as a function of the spacing between the sample and probe tip, in a range from a few angstroms to a few hundred angstroms. The tip was set to vibrate at the lever resonance frequency to measure the amplitude of vibration as a function of spacing.

Large values of the spacing d allowed the effects of the sample on the tip to be mathematically neglected, so the authors arrived at a definition of the amplitude A as a function of frequency ω in Lorentzian form:

$$A = \frac{A_0(\omega_0/\omega)}{\sqrt{1 + Q^2(\omega/\omega_0 - \omega_0/\omega)^2}} \quad (4.29)$$

where the resonance frequency $\omega_0 = c\sqrt{k}$ was defined through the value of c , a function of the lever mass, and k , the spring elastic constant. In the formula (4.29), A_0 represented the resonance amplitude and $Q(\gg 1)$ the so-called quality factor. When, due to the small distance between the tip and the sample, the contribution of the Van der Waals (or VdW) force also had to be considered, an additional force term f appeared for small vibration amplitudes. Its derivative along the surface normal reduced the value of the spring constant and shifted the resonance frequency to $\omega'_0 = c\sqrt{k - f'}$. The negative sign under the square root was due to the force becoming more and more attractive as the tip approached the sample. The resonance frequency, therefore, took on smaller values. As a result of all these new considerations, the derivative of the force f' was calculated as:

$$f' = k \frac{1 - 2a^2 + \sqrt{4Q^2(a^2 - 1) + 1}}{2(Q^2 - a^2)} \quad (4.30)$$

where $a = A_0/A'$, and A' is the amplitude calculated taking this force effect into account. In performing the calculations, Martin and his colleagues made two basic assumptions. The first concerned the interaction between tip and surface, according to which there was a shift in the resonance frequency, and not an energy transfer that would have decreased the vibration amplitude. The second assumption was based on the validity of the previously introduced formula $\omega'_0 = c\sqrt{k - f'}$, and f' does not affect the vibration mode of the lever. The basic scheme measured the derivative of the force by deriving a shift in the lever resonance frequency $\Delta\omega = \omega'_0 - \omega_0$ from a change in the lever vibration amplitude. The largest variation in lever vibration for a given $\Delta\omega$ change was measured at:

$$\omega_m \simeq \omega_0[1 \pm 1/(\sqrt{8}Q)] \quad (4.31)$$

and at this point:

$$\frac{\partial A}{\partial \omega} = \frac{4A_0Q}{3\sqrt{3}\omega_0} \quad (4.32)$$

A small shift f' gave a frequency shift $\Delta\omega = \omega_0 f' / 2k$ and, as a consequence, an amplitude change:

$$\Delta A = \frac{2A_0 Q}{3\sqrt{3}k} f' \quad (4.33)$$

The effects of the optical noise, induced by the interaction of the photons from the lever bouncing on the sample, could be neglected. The thermal energy excited the lever with a vibration whose amplitude was:

$$A_T = \frac{\sqrt{4KTQB}}{k\omega_m} \quad (4.34)$$

at a frequency ω_m and in a bandwidth B . The smallest detectable force derivative was:

$$f_m = \frac{1}{A_0} \sqrt{\frac{27kKT B}{Q\omega_0}} \quad (4.35)$$

After all these mathematical considerations, Martin, Williams and Wickramasinghe were able to plot the amplitude, of the force and of the force derivative as shown in the following figure (Fig. 4.26).

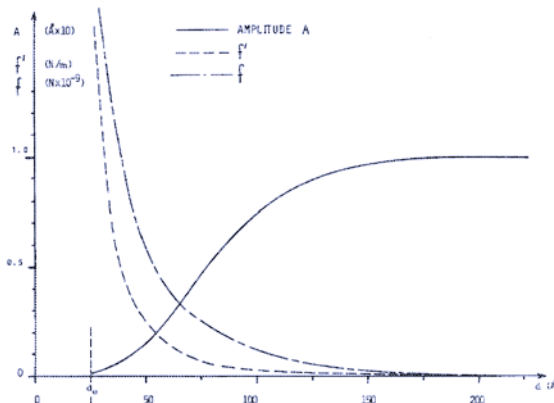

Fig 4.26 Magnitude of the forces and amplitude as a function of the tip-sample spacing. Source: Martin, Williams and Wickramasinghe (1987)

The experimental curves depicted in the picture above were the result of measuring the attractive force between a tungsten tip and a silicon surface. The resulting experimental

force was of the order of 10^{-11}N , and increments as small as $3 \times 10^{-13}\text{N}$ could be detected at tip–sample spacings of about 50\AA .

The signal obtained from the force between the tip and the sample was used as a feedback signal to keep the tip at a given distance from the surface to be scanned, so that the device could be used in a similar way to an STM microscope. In this way, representations of the surface profile were obtained with a spatial resolution of 50\AA (Fig. 4.27).

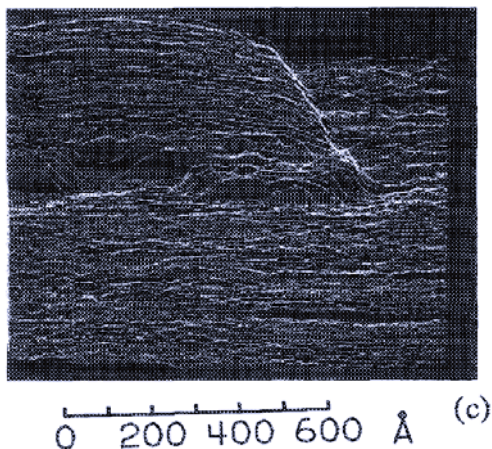

Fig 4.27 Picture of a small area on top of a V-shaped groove. The approximate height of the step is about 50\AA Source: Martin, Williams and Wickramasinghe (1987)

The image was acquired in a mean time of two minutes.

According to the researchers' opinion, with a stiffer lever – and still relying on the VdW forces – a spatial resolution below 10\AA could be reached.

[...] one could hope to sense the strong electronic repulsive force at the tip–sample distances within 1 o 2\AA from the surface, and thereby aim to achieve atomic resolution (*ibidem*).

Having described a technique that, improving the AFM, could precisely measure and control the force between two bodies separated by a distance ranging from 30\AA to 180\AA , Martin, Williams and Wickramasinghe found a new way to control the gap between the surface and the tip, also believing that by refining the apparatus further, achieving spatial resolution in the nanometer range could be possible.

Also in 1987, Albrecht and Quate explored different types of samples, ranging from conductors to semiconductors and insulators. The instrument used was an AFM sensitive to the repulsive contact forces between a flexible micro–lever attached to a fixed holder and the sample surface. The tunnelling current between a sharp tungsten tip and the back of the micro–lever was used to monitor the deflection of the lever and thus the force exerted. The sample was hooked to a piezoelectric holder operating along three X–Y–Z axes, while the tunnelling tip was hooked to a second piezoelectric responsible for its movement along the Z axis. The picture below shows the experimental device implemented for the analysis (Fig. 4.28).

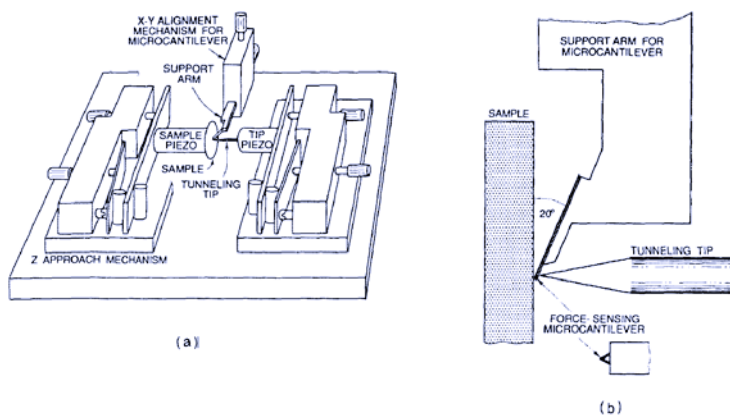

Fig 4.28 Left: the mechanical layout of the AFM; right: the detail of the micro-cantilever/tunneling tip/sample. Source: Albrecht and Quate (1987)

To calibrate the instrument, they tried to establish a stable tunneling current between the tunneling tip and the force-sensing micro-lever. A feedback system was used to maintain a separation between tip and lever that, on average, remained constant and only a few angstroms, by monitoring the tunneling current. The value of the tunneling current fluctuated rapidly due to the thermal excitation of the lever when the sample was not present. Once the sample was in place, it was brought into contact with the lever; this reduced the thermal vibrations of the lever itself. Not only that but this contact was read by the system as an abrupt reduction in noise in the tunneling current. The AFM was operated with a lever deflection of approximately 1000\AA , corresponding to a force of $2 \times 10^{-7}\text{N}$ applied. The feedback response was kept slow so as to prevent the tunneling tip from following the lever deflections caused by the corrugations of the sample surface. These deflections were in fact quite rapid. The modulation of the tunneling current was sent to a high-pass filter to eliminate background effects and then displayed on a greyscale monitor at 18 frames per second.

Three samples, differing in terms of electrical conductivity, were then analysed.

The first sample examined was highly oriented pyrolytic graphite (henceforth HOPG). The scanning apparatus was operated first as STM and then as AFM. The result of the AFM analysis, compared with that of the STM analysis, confirmed the validity of the system's calibration. The result led to an image in which the unequal sites, in which only three luminous maxima appeared distinguishable, were clearly visible. Complete hexagonal rings also appeared at times, but the individual atoms were not distinguishable as separate maxima.

The second sample examined was a layered semiconductor, molybdenite 2H, 2H-MoS_2 . The observation of this sample made it possible to establish that the lattice spacing of the material is around $3.2 \pm 0.2\text{\AA}$. Imaging of the sample made it possible to appreciate the anisotropy characteristics of the sample. The use of an AFM microscope, therefore, proved to be very suitable for the analysis of layered transition metal dichalcogenides – two-dimensional MX_2 -type semiconductor materials, where M is a transition metal atom (Mo, W, etc.) while X is a chalcogen (S, Se, or Te.) –. In these materials, a single layer of M-type atoms is sandwiched between two layers of X-type atoms.

The third sample analysed, significant because it was non-conductive, was highly oriented pyrolytic boron nitride (HOPBN). HOPBN is a layered material whose hexagonal structure has a spacing of $2.5 \pm 0.1 \text{ \AA}$, similar to that of HOPG. Each hexagon contains three atoms of each species, alternating at adjacent vertices (Fig. 4.29).

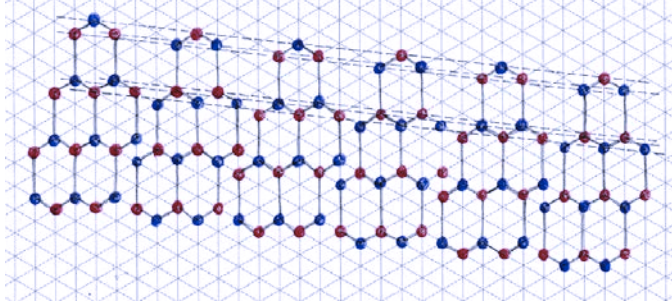

Fig 4.29 A schematic representation of hexagonal boron nitride structure, with the alternate layers of the two elements. Source: AD

The use of AFM made it possible to observe a non-conductive sample. All the images of this sample showed three dominant right spots per hexagon, and this showed that height maxima occurred over the atomic sites of one species only.

To correlate the corrugations and the actual atomic sites, the repulsive potential between an oxygen atom on the tip and single boron or nitrogen atom on the surface was modelled. The calculation was done using the Gordon–Kim potential (Gordon and Kim 1972) for the overlap of two neon atoms, according to a method presented by Walter Harrison (Harrison 1981), scaled for the B–O (boron–oxygen) and N–O (nitrogen–oxygen) cases. Harrison’s overlap potential for two atoms separated by a distance d was expressed by:

$$V_{12}(d) = \frac{\eta \hbar^2 d \mu_{12}^3}{2m_e} \exp\left(-\frac{5\mu_{12}d}{3}\right) \quad (4.36)$$

where η is an empirical constant and $\mu_{12} = (1/2)(\mu_1 + \mu_2)$. The coefficients μ_i satisfy the equation that defines the p -state energy of an atom of species i :

$$E_{pi} = \frac{\hbar^2 \mu_i^2}{2m_e} \quad (4.37)$$

This potential was quite effective in predicting the value of V_{12} when d is comparable with the lattice spacing. Comparison with the Gordon–Kim potential showed, however, that it was unreliable when used in physical situations of very strong repulsion between objects, such as those analysed by Albrecht and Quate.

Therefore, the potential (4.36) was only applied to calculate the scaling factors relating V_{12} to the potential of V_{Ne} of two neon atoms:

$$V_{12}(d) = \frac{\mu_{12}^3}{\mu_{Ne}^3} V_{Ne}(d) \exp \left[-5(\mu_{12} - \mu_{Ne}) \frac{d}{3} \right] \quad (4.38)$$

In this expression, the potential for neon atoms is replaced by the Gordon–Kim potential, approximated by the expression:

$$\overline{V_{Ne}^{GK}}(d) = Ae^{-\kappa d} \quad (4.39)$$

where $A=2800\text{eV}$ and $\kappa = 4.45\text{\AA}^{-1}$. When boron and nitrogen are considered, the charge is not symmetrical and is distributed between the B and N atoms in the ratio 0.7:1.3 (Tegeler, Kosuch, Wiech and Faessler 1979). The force in each case (boron–oxygen and nitrogen–oxygen) was:

$$f_{BO}(d) = -0.7 \left(\frac{\partial V_{BO}}{\partial d} \right) = (3.7 \times 10^{-6}) e^{-3.34d} \text{ N} \quad (4.40)$$

$$f_{NO}(d) = -1.3 \left(\frac{\partial V_{NO}}{\partial d} \right) = (1.1 \times 10^{-5}) e^{-3.68d} \text{ N} \quad (4.41)$$

where distance d was measured in angstroms. If a force of $2 \times 10^{-7}\text{N}$ acted only on two atoms, one placed on the lever and one on the sample, two values were obtained, $d = 0.88\text{\AA}$ when the tip of the lever was above a boron atom, and $d = 1.09\text{\AA}$ when the tip of the lever was above a nitrogen atom. Using this model, the maxima on the surface of the HOPBN were attributable to nitrogen.

Albrecht and Quate obtained the following pictures (Fig. 4.30).

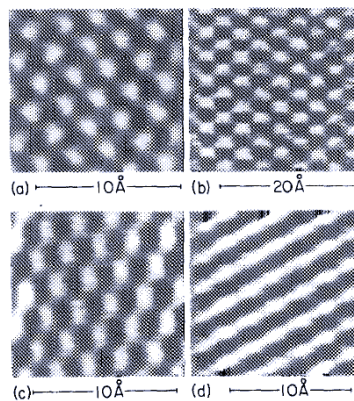

Fig 4.30 The AFM images of graphite (a), molybdenum disulfide (b), boron nitride (c). A second image of boron nitride (d) was taken and shows the effect of multiple contact points between the sample and the lever. The white lines indicate the uprisings structures from the surface. Source: Albrecht and Quate (1987)

The images showed the presence of parallel “corrugations” that could be attributed to two different contact zones between tip and sample.

The results were relevant because, in air, it was possible to investigate both conductive and semi-conductive samples and, above all, on non-conductive surfaces.

4.1.10 1989: Manipulating Atoms at Nanoscale

At the beginning of the 1980s, Binnig and Rohrer and their team completed the STM Microscope, a device that revolutionised the imaging of sample surfaces, atoms and molecules, enabling a resolution never before achieved. This instrument has become one of the milestones in the History of Nanoscience and Nanotechnology. It not only enabled visualisation on an atomic scale, but also surface modification by binding molecules to a surface and moving atoms from the microscope tip to the substrate. The ability of this microscope to position atoms with atomic precision enabled Don Eigler and Erhard Schweizer of the IBM Almaden Research Center in San Jose, California, to place 35 xenon atoms on a cold nickel substrate to compose one of the most famous images of Nanotechnology: the IBM logo, made with characters about 500,000 times smaller than those on an ordinary typewriter. The STM was used at temperatures around 4K and allowed atom-by-atom structures to be fabricated, paving the way for miniaturisation of devices. The image, shown here below, is one of the most famous in History of Science (Fig. 4.31).

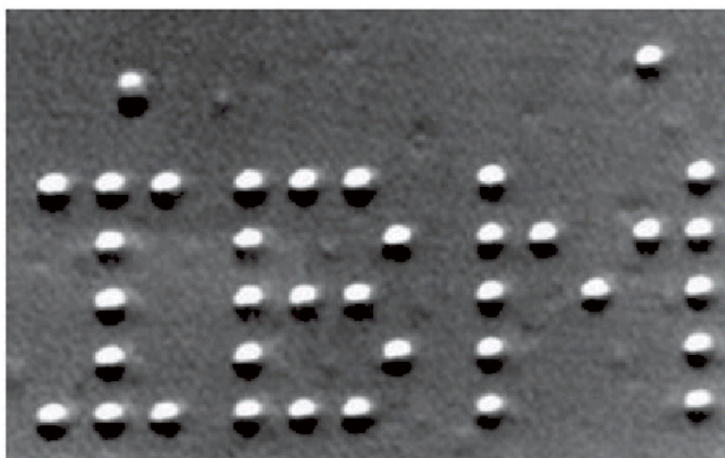

Fig 4.31 The xenon atoms located on the nickel substrate. Source: image licensed under Fair Use through Wikipedia.

Curiously, in their original paper (Eigler and Schweizer 1990) never mentioned what they were going to write nor quoted IBM except for their affiliation and the acknowledgements in a very small footnote at the end of the article.

Because the tip of an STM microscope exerts a measurable force on an atom, a force whose contributions are electrostatic and Van der Waals, it is possible to act on this force

by adjusting its modulus and direction through geometric control of the position of the tip with respect to the sample and the tension applied to the tip. Since it is energetically less expensive to capture an atom and drag it onto the substrate rather than away from the substrate itself, the STM could be set up so that the tip could move the atoms it interacted with while still keeping them bound to the surface. The choice of the binomial xenon atoms on a nickel substrate was dictated by the fact that the ripples in the surface potential could be large enough to allow imaging without causing inadvertent displacement of the atoms, but small enough to allow the application of a lateral force large enough to drag the xenon atoms to the surface.

The 4K temperature maintained in the microscope chamber was necessary to prevent contamination of the substrate through absorption of residual gases; according to the testimony of Eigler and Schweizer, the expedient ensured that the chamber did not become contaminated for weeks. The process of manipulating the atoms was not, however, dependent in any way on temperature.

On the substrate, each xenon atom appeared, upon STM observation, as a relief of 1.6Å in length in seemingly random positions. During the imaging process, the interaction between substrate and microscope tip was small enough to leave the xenon atoms in their original positions.

To accomplish the displacement of the atoms, the microscope had to be set in such a way as not to disturb the original position of the atoms to be worked on, so the tip of the STM was placed at the chosen atom. By lowering the tip toward the substrate, and varying between 1 and 6×10^{-8} amperes the tunneling current between the tip itself and the xenon nuclide, the interaction necessary for manipulation of the chosen atom was created; thereafter, the tip–atom system was made to move at a rate of 4 angstroms per second to the desired position. At this point, the tunnel current was reduced to the imaging value and the tip raised, thus terminating the interaction between atom and microscope, leaving the atom at the desired position (Fig. 4.32).

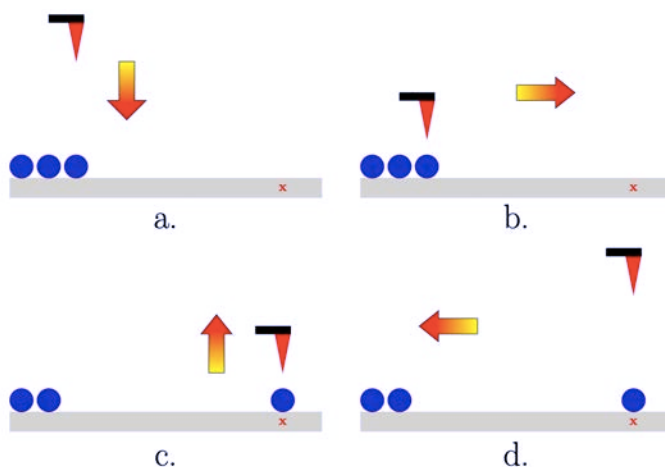

Fig 4.32 A simplified sequence of the steps involved in atom manipulation, according to the steps followed by Eigler and Schweizer. a. The tip is moved above and lowered upon the selected atom. b. the atom is dragged towards the desired position, here indicated with a red x. c. Once the position is reached, the current between the atom and the tip is diminished and the tip lifted. d. the tip is brought back to repeat the process and obtain the disposition required. Source: AD

Eigler and Schweizer's work was such that the atoms could be placed with atomic precision and, because of the crystal structure of the nickel surface (110) that served as a matrix, having a rectangular cell, also with exact periodicity of structure. The nickel atoms were found to be spaced on a rectangular grid four unit cells long on the short side and five on the long side, measuring $12.5 \times 14 \text{ \AA}$. By varying the tip types applied to the STM, the researchers verified that there was a threshold height and a bias voltage, below which drag of the xenon atoms could be observed, parallel to the substrate nickel atoms. Simple experimental tests showed that modulus or sign of the applied voltage had no effect on the relative height of the tip to the substrate. Eigler and Schweizer deduced that the dominant component of the force between tip and atom to be placed was basically Van der Waals, but they reserved further investigation to be conducted later (Eigler and Schweizer 1990).

The manipulation of atoms has also led to other new application possibilities of the STM microscope, including the induction of chemical reactions at the level of the single molecule, and the engineering of materials and structures at the nanoscale. Local quantum phenomena have been studied, quantum corrals and electron resonators have been used to investigate new phenomena (Hla 2005).

In 1996, STM microscopy achieved a significant breakthrough in nanostructure manipulation when molecules of buckminsterfullerene, C_{60} , were shifted, at room temperature and reversibly, onto a monoatomic copper step. At IBM's laboratories in Zurich, a nanometer abacus was made where the individual molecules formed the abacus rings, the monoatomic copper steps the ring-bearing rods, and the STM microscope the hand performing the operations. Historically, the term abacus is derived from the Latin abacus, which in turn is derived from the Greek word ἄβαξ declined in the genitive ἄβακος. In turn, the Greek term goes back to the Hebrew חֶשְׁבֹנִיָּה and its meaning of "dust", as, originally, early abacuses were made of wooden tablets on which sand dust was sprinkled (Harper 2013). Control of the perfect positioning of the C_{60} molecules was achieved by making a Cu(111) step as the substrate, and this made it possible to operate at room temperature, something that had not been mentioned before in the literature (Cuberes, Schittler and Gimzewski 1996). Arranging the molecules proved, in the authors' description, to be a rather tedious procedure precisely because of their shape and because of their tendency to slide off the tip, with lateral movements. That is why resorting to a one-dimensional step reduced the movement of C_{60} "spheres" to one degree of freedom. In this way, a one-dimensional abacus was made, in which the spheres representing the "counters" slid on a 1D guide representing the supporting rods. The displacement of individual fullerene molecules was done not by placing the tip exactly on the polar axis of the molecule, but rather by exploiting the force exerted laterally by the tip itself.

The following figure schematically represents the procedure followed (Fig. 4.33).

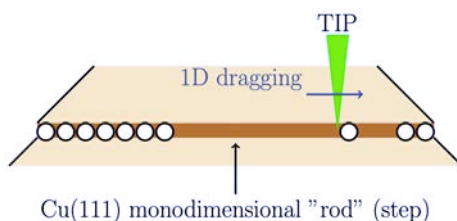

Fig 4.33 With this abacus fullerene molecules (here represented through white spheres) can be moved along. Source: AD

Another example of molecule manipulation, again of buckminsterfullerene and at room temperature, was obtained at the University of Munich and the Department of Physics of Chemnitz, Germany, in 2004. The research team developed a method to investigate and manipulate single molecules through STM microscopy without operating under ultra-high vacuum techniques. They realized a grid of organic hexagonal sites having an internal diameter of 1.1nm, where molecules of C_{60} could be nested. These molecules, in fact, proved to be very suitable for translational manipulation with STM (Griessl *et al.* 2004). The grid was made of trimesic acid (TMA) molecules arranged to enclose a space, thanks to hydrogen bonds between the carboxylic groups of adjacent molecules. The following picture represents a singular cell (Fig. 4.34).

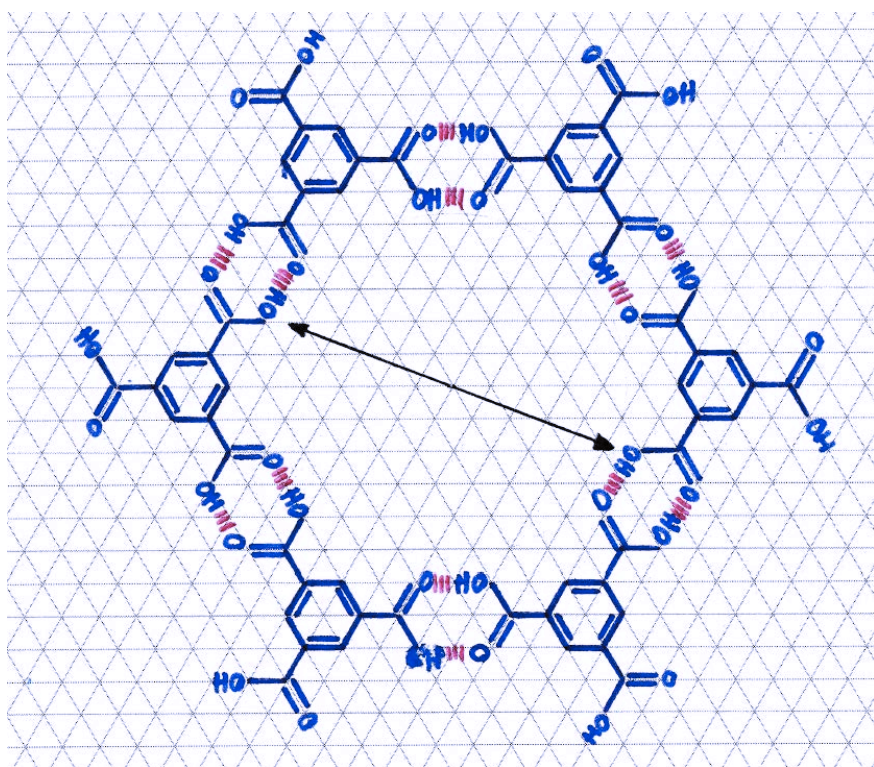

Fig 4.34 A model of TMA. The red bonds represent the hydrogen bonding. The black two-side arrow represents the diameter of a circular space where the C_{60} can be hosted. Source: AD

A simplified representation of the displacement of a fullerene molecule within this matrix is as follows (Fig. 4.35).

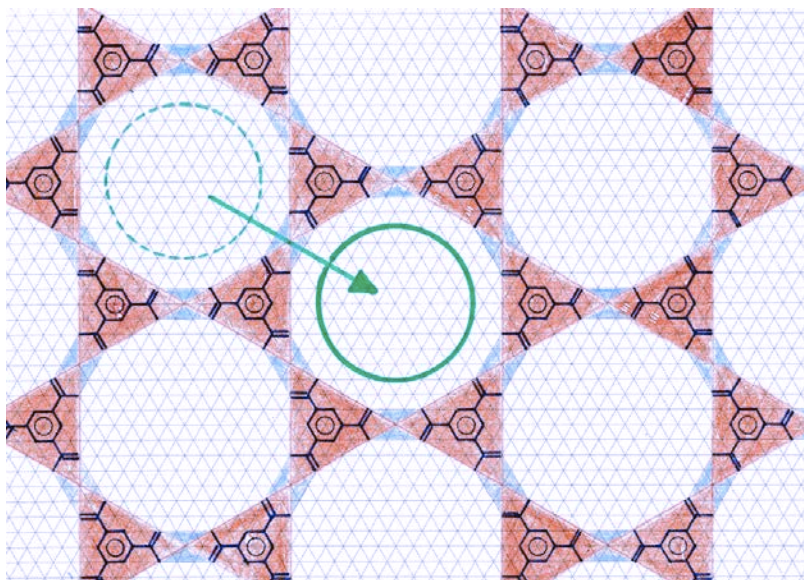

Fig 4.35 Moving fullerene in TMA. Source: AD

Here the model is not in scale and highly simplified – see there are no details about functional groups. The single TMA molecules are marked in red while the hydrogen bonds are marked in blue; the fullerene molecule is the green circle.

The size, shape and nature of C_{60} buckminsterfullerenes make them suitable guests for the circular, 1.1nm wide, periodically arranged cavities of the TMA model, where C_{60} adsorbs in the centre of the TMA cavities. Since no intermediate state of adsorption could be observed, the centre of the cavity was interpreted as the preferred site for the examined process.

In 1996, two-dimensional positioning of single molecules at room temperature was achieved by a controlled lateral “pushing” action performed by means of the tip of a Scanning Tunneling Microscope. To facilitate this process, four hydrocarbon groups whose steric bulk was significant were attached to a rigid molecule. These groups maintained sufficiently strong interactions with the surface where the molecules were positioned to prevent thermally activated diffusional motion, but still allowed controlled translation. Simulations demonstrated the crucial role of bending during the positioning process. As a result, the key role of molecular mechanics in engineering predefined mat properties at the molecular scale became evident (Jung *et al.* 1996). The process was conducted at room temperature under ultra-high vacuum conditions. Employing low temperatures allowed for repositioning of weakly bound molecules with the Scanning Tunneling Microscope (STM) tip by limiting thermal movement. However, at room temperature and to prevent an uncontrolled diffusion mechanism, the thermal energy level kT , where k is the Boltzmann constant and T the temperature, required a strong bond between an isolated molecule and the substrate. This bond was not so strong as to impede controlled movement of the molecule by the tip. The choice of molecule was therefore crucial to simultaneously achieve molecular stability and ease of placement.

At room-temperature, positioning of porphyrin-based molecules into stable predefined patterns without disruption of internal molecular bonds was demonstrated to be possible. By evaluating a range of different molecular systems, a specific copper porphyrin molecule was chosen because it matched the criteria for positioning. The molecule was Cu tetra-(3,5 di-tertiary-butyl-phenyl)-porphyrin (Cu-TBP-porphyrin) with four di-tertiary butyl phenyl (DTP) substituents. These four legs were rotated out of the plane and positioned perpendicularly to the main porphyrin ring because of a steric repulsion effect (Fig. 4.36). The following picture represents the complex molecule used for the experiment.

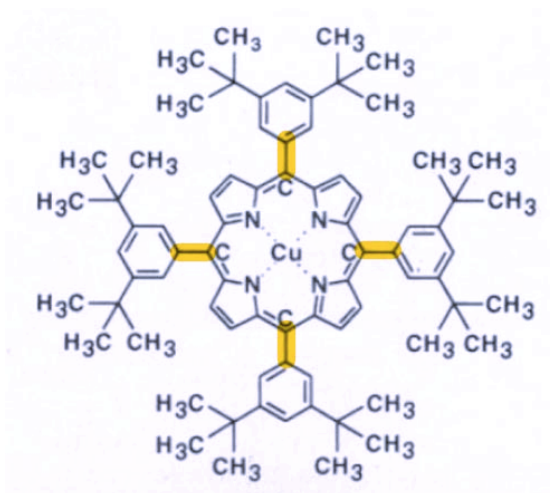

Fig 4.36 The planar representation of the complex porphyrin-based molecule used for the experiment. The yellow bonds allow the rotation of the four functional groups out of the plan of the paper, lying perpendicularly to the central ring. Source: Jung *et al.* (1996)

The translation of the molecule was attributed to the repulsive force established between the tip and the molecule itself. Before starting any positioning the surface area was scanned repeatedly to ensure that no molecular motion was due to thermal drift. Once a molecule was selected for positioning, the tip of the microscope was used to push this molecule gently in position after a lateral approach of the tip towards the molecule.

While the action of the microscope tip on the molecule blocked the rotation of two of the four large functional groups, the other two remained sufficiently stable in terms of rotation around the single bond. The experiment had thus shown that translation of the molecule was possible *en bloc*, without causing breakage of the internal bonds. This procedure had thus proved that it was possible to act, in general terms, on molecules on a given substrate, to remove or rearrange them, in order to create completely new materials.

In 2003, an experiment was carried out to understand the mechanism of desorption of chemisorbed chlorobenzene (C_6H_5Cl) molecules from the surface of silicon $Si(111)-(7\times7)$, at room temperature. The experiment was important because it could be replicated, for example, in the electronics industry, when the interface between molecular electronics and conventional silicon devices must be considered. The analysis was conducted following two

research tracks, laboratory experimental investigation and density functional calculation (Sloan, Hedouin, Palmer and Persson 2003).

4.1.11 1990: Nanotechnology Press

Nanotechnology has developed greatly since the 1990s and has understandably led to a proliferation of publications in the varied fields of its application, having immediately proved to be highly interdisciplinary. The systematization of knowledge in these areas has in turn led to the emergence of specialized and strongly oriented publications.

In July 1990, the first issue of an eloquently named journal was published: *Nanotechnology*. It was the first publication explicitly dedicated to the nanoworld, and was conceived to be a four-monthly publication, which it was to all intents and purposes until 2001. From that year on, in fact, thanks to the development of the discipline and the proliferation of publications on the subject, it was enriched with special issues and became monthly until 2005. In 2006, the issues were fortnightly, and from 2007, the journal was published on a weekly basis to support the massive publication of contributions devoted not only to nanotechnology itself, but also to all its declinations in the various disciplines.

After that, many publications followed the development of Nanoscience and Nanotechnology in time. The most important ones are listed below, with a brief description of the contents published.

A hypothetical and generic “showcase” on Nanotechnology, therefore, may include the following publications.

Nano Research: Springer Journal

Nano Research is a peer-reviewed, international and interdisciplinary research journal that focuses on all aspects of nanoscience and nanotechnology. Submissions are solicited in all topical areas, ranging from basic aspects of the science of nanoscale materials to practical applications of such materials. *Nano Research* is an open-access journal, making all research results freely available online.

Publications are possible in the following areas:

- Synthesis, characterization and manipulation of nanomaterials
- Nanoscale physics, electrical transport, quantum physics
- Scanning probe microscopy and spectroscopy
- Nanofluidics
- Nanosensors
- Nanoelectronics and molecular electronics
- Nano-optics, nano-optoelectronics and nano-photonics
- Nanomagnetism
- Nanobiotechnology and nanomedicine
- Nanoscale modeling and simulations

Angewandte Chemie International Edition: Wiley Journal

Angewandte Chemie International Edition, the journal of the German Chemical Society, has an excellent Impact Factor and occupies a leading position among general chemistry journals. It is one of the top chemistry journals in the world.

In addition, it is the only journal in the field that is able to guarantee a stimulating collection of review articles, leading articles and communications on a weekly basis. The publications summarize important recent research findings on current topics in all branches of Chemistry, present unsolved problems, and discuss possible developments. Highlights provide concise assessments of current trends in chemical research. The Communications are critically selected and report the latest research results, making the journal indispensable for the chemist who wants to stay well informed. *Angewandte Chemie International Edition* also regularly publishes Nobel Lectures in chemistry and related fields.

Small: Wiley Journal

Small is the journal that provides the best forum for experimental and theoretical studies of fundamental and applied interdisciplinary research at the micro and nano dimensions. Studies in this area are critical globally. Communications, Reviews, Concepts, Highlights, Essays and Peer-reviewed Full Papers are the types of papers that are regularly published.

Small ranks among the top 10 multidisciplinary journals, covering a broad spectrum of nanoscale and microscale topics at the interface of materials science, chemistry, physics, engineering, medicine and biology. The number of articles that find a place in the journal is sometimes so substantial that the frequency of publications has to be increased from 12 to 24 issues.

Journal of Nanotechnology: Hindawi Publishing Journal

Journal of Nanotechnology is an open-access, peer-reviewed journal interested in the publication of original research and review articles in all areas of Nanotechnology. Publication of articles in this journal is with charges to the authors.

Precision Engineering: Elsevier Journal

Precision Engineering is a journal that can be called historical, having first been published in January 1979. Since 1986 it has been known to readers under the name *Journal of the American Society of Precision Engineering*. Since January 2000 it has undergone changes, and proudly proclaimed itself as “*Journal of the International Societies for Precision Engineering and Nanotechnology*”.

Precision Engineering – Journal of the International Societies for Precision Engineering and Nanotechnology is a publication devoted to the multidisciplinary study and practice of high precision engineering, metrology and manufacturing. The journal takes an integrated approach to all topics related to the research, design, manufacture, performance validation, and application of high-precision machines, instruments, and components, including fundamental and applied research and development in manufacturing processes, fabrication technology, and advanced measurement science. The scope includes precision systems and supporting metrology across the full range of length scales, from atom-based nanotechnology and advanced lithography technology to large-scale systems, including optical and radio telescopes and macrometrology.

In addition to its continuing association with the American Society for Precision Engineering (ASPE), the journal can be found associated with two other bodies: the European Society for Precision Engineering and Nanotechnology (euspen), formed in 1999, and the historic Japan Society for Precision Engineering (JSPE), founded in 1933.

Journal of Micro–Nano Mechatronics: Springer Journal

The *Journal of Micro–Nano Mechatronics* is a quarterly journal devoted to the theory and applications of micro and nanotechnology; it promotes theoretical and practical

engineering research based on analysis and synthesis from the micro to the nano level. This publication includes survey papers, technical articles, short papers and news in the field of micro and nano mechatronics.

Micro and nano mechatronics constitute the synergistic integration of micro and nano electromechanical systems and electronic technologies, with high added value. Research is focused on developing organic combinations of miniaturized multiple actuators and sensors to perform complex movements and operations. Micro/nano technologies, as applied to future robotics and automation, are crucial for realizing high-performance systems.

Nano Today: Elsevier Journal

Nano Today is a world-class journal dedicated to researchers in nanoscience and technology. Submitted articles are peer-reviewed. *Nano Today* publishes original articles on all aspects of nanoscience and nanotechnology.

Manuscripts of three types are considered:

- Review articles that inform readers about the latest research and advances in nanoscience and nanotechnology;
- Rapid communications that present exciting discoveries in the field of research;
- News and opinion pieces that comment on current issues or express views on developments in related fields.

Contributions include a variety of topics such as:

- Synthesis and self-assembly of nanostructured materials and films
- Functionalization and size-dependent properties of nanocrystals, quantum dots, and nanowires
- Processing and templating of nanotubes and nanoporous materials
- Tailoring of polymeric nanoparticles, organic-organic nanocomposites and biohybrids
- Fabrication of nano and micro electromechanical systems
- Design and engineering of structural and functional nanomaterials
- Nanosystems for biological, medical, chemical, catalytic, energy, and environmental applications
- Nanodevices for electronic, photonic, magnetic, imaging, diagnostic, and sensor applications

Nanotechnologies in Russia: Springer Journal

Nanotechnologies in Russia focuses on the publication of interdisciplinary articles. The writings are devoted to basic issues related to the structure and properties of nanoscale objects and nanomaterials, manufacturing and processing technologies, and practical implementation of devices and structures.

The journal publishes original articles covering research in the following areas of science and technology:

- Self-organizing structures and nano-assemblies;
- nanostructures, including nanotubes;
- functional nanomaterials;
- structural nanomaterials;
- devices and implants based on nanomaterials and nanotechnology;
- metrology, standardization, and testing in nanotechnology;

- nanophotonics;
- nanobiology.

Nature Nanotechnology: Nature Publishing Group Journal

Nature Nanotechnology is a multidisciplinary journal on which you can find articles of the highest quality and relevance in all areas of Nanoscience and Nanotechnology. The journal covers research on the design, characterization, and production of structures, devices, and systems involving the manipulation and control of materials and phenomena at atomic, molecular, and macromolecular scales, considering both bottom-up and top-down approaches, and combinations thereof.

Nature Nanotechnology also encourages the exchange of ideas among chemists, physicists, materials scientists, biomedical researchers, engineers, and other researchers working at the frontiers of this diverse and multidisciplinary field. Topics range from basic research in physics, chemistry, and biology, including computational work and simulations, to the development of new devices and technologies for applications in a wide range of industries (including information technology, medicine, manufacturing, high-performance materials, and energy and environmental technologies). Organic, inorganic and hybrid materials are studied.

Research areas that find publication in the journal include:

- Carbon nanotubes and fullerenes
- Computational nanotechnology
- Electronic properties and devices
- Environmental, health and safety issues
- Molecular machines and motors
- Molecular self-assembly
- Nanobiotechnology
- Nanofluidics
- Nanomagnetism and spintronics
- Nanomaterials
- Nanomedicine
- Nanometrology and instrumentation
- Nanoparticles
- Nanosensors and other devices
- NEMS
- Organic-inorganic nanostructures
- Photonic structures and devices
- Quantum information
- Structural properties
- Patterning and surface imaging
- Synthesis and processing

In addition to primary research, *Nature Nanotechnology* also publishes review articles, news and viewpoints, in-depth reviews of important papers published in other journals, commentaries, book reviews, correspondence, and articles on the broader picture of nanotechnology-funding, commercialization, ethical and social issues, and so on. In this way, the journal aims to be the voice of the global nanoscience and nanotechnology community.

Nature Nanotechnology offers readers and authors high visibility, access to a wide readership, high standards of editing and production, rigorous peer review, rapid publication, and independence from academic societies and other vested interests.

International Journal of Green Nanotechnology: Taylor & Francis Publishing

International Journal of Green Nanotechnology is a three-part journal that focuses on the important challenges and latest advances in the chemistry, physics, biology, engineering, and other scientific aspects of green nanotechnology. Their impact on society and policies that have been or should be developed regarding the applications of the nano world and its consequences are evaluated. This journal consists of three parts.

- *International Journal of Green Nanotechnology: Physics and Chemistry:* Articles present work done in chemistry and physics to produce green nanoparticles, their characterization and properties, leading to the development of green Nanotechnology. Original articles and reviews present new green nanotechnological processes for the production of well-known nanoparticle constructs that in some cases are already in use.
- *International Journal of Green Nanotechnology: Biomedicine:* Articles cover biocompatibility and nanomedical applications of green Nanotechnology, including the development of novel diagnostic and therapeutic agents and biological sensors.
- *International Journal of Green Nanotechnology: Materials Science and Engineering:* Articles explore the engineering challenges of green nanotechnology processes and applications, including the design and development of chemical sensors, smart electronic materials, nanoscale robots, and medical devices.

In addition, the journals publish articles and commentaries on the societal impact of green Nanotechnology, including socioeconomic and regulatory impacts and perceptions of these among academics, policy makers, corporate decision makers, and the public.

Journal for Nanoscience and Nanotechnology: American Scientific Publishers Journal

Journal for Nanoscience and Nanotechnology, usually abridged as JNN, is an international, multidisciplinary peer-reviewed journal that covers a wide range of applications of the nano world and consolidates research activities in all areas of nanoscience and nanotechnology into a single reference source. JNN is the first interdisciplinary journal to publish complete original research articles, rapid communications of important new scientific and technological discoveries, timely state-of-the-art reviews with photos and short author biography, and current research news encompassing fundamental and applied research in all disciplines of science, engineering, and medicine.

Publication topics include the following:

- Synthesis of nanostructured and nanoscale materials;
- Nanofabrication and processing of nanoscale materials and devices;
- Atomic and nanoscale characterization of functional materials and bio-assemblies;
- Nanoprobes, nanoscale material properties, nanocatalysis;
- Nanocomposites, nanoparticles, nanocrystalline materials and nanoclusters;
- Superlattices, quantum dots, quantum wires, quantum wells, nanoscale thin films;
- Fullerenes, nanotubes, nanorods, molecular wires, molecular nanotechnology;
- Supramolecules, dendrimers, self-assemblies, low-dimensional structures;

- Nanophysics, nanoelectronics, nano–optics, nanomagnetism and nanodevices;
- Atomic manipulation, computational nanotechnology, molecular nanoscience;
- Nanochips, nanosensors and nanointegration, nanofluidics, nanomachining;
- Structure analysis at the atomic, molecular, and nanoscale levels;
- Nanorobotics, nanotribology and new applications of nanostructured materials;
- Nanobiotechnology, biochemical assemblies, BioMEMS, biomimetic materials;
- Nanoscale genomics, DNA sequencing, nanomedicines, drug delivery, biomedical nanotechnology.

Nanoelectronics is the usage of Nanotechnology in electronic components in terms of devices and materials having the common characteristic to be so small to undergo quantum effects. A dedicated issue for Nanoelectronics is the following one.

ACS Applied Materials & Interfaces: American Chemical Society Publications

ACS Applied Materials & Interfaces is a publication that was conceived and created with the goal of becoming the international publication of choice for an interdisciplinary community of researchers consisting of chemists, engineers, physicists, and biologists whose studies focus on how materials and interfacial processes discovered from time to time can be developed and used for specific applications, also regarding the nanoworld. The journal publishes articles and letters authored by researchers in academia and industry, and features commentaries and forums devoted to the progress of applied materials research. The publications are dedicated to the following topics.

- Advanced active and passive electronic/optical materials;
- Coatings;
- Colloids;
- Biomaterials and biointerfaces;
- Polymeric materials;
- Hybrid and composite materials;
- Friction and wear.

Nanomedicine is the development of the concepts of Nanoscience and Nanotechnology to modern medicine. The applications of Nanomedicine are dedicated to solve problems from biology to drugs, from the biological integration of nanomaterials to physical therapy applications. One of the most important characteristics of nanoparticles conceived as active ingredients carriers is, in fact, their property to deliver exactly the ingredient where necessary. This allows a lower dose to be given to the patient, without heavily affecting organs like liver or kidneys. Papers dedicated to Nanomedicine appear, for example, in these issues.

Biomaterials: Elsevier Journal

Biomaterials is an international journal dealing with the scientific developments and application of biomaterials and associated medical devices. The goal of the journal is to provide the community with a peer–reviewed forum in which to publish original and authoritative review articles addressing the most important issues affecting the use of materials in clinical practice. The areas of the journal cover the basic scientific and engineering aspects of biomaterials and their mechanical, physical, chemical, and biological properties, the design and manufacturing characteristics of devices constructed from these materials, and their clinical performance. In this context, biomaterials should be understood

as all those materials used in medical devices where contact with the patient's tissues is an important and determining feature of their use and performance. They include a range of metals and alloys, glasses and ceramics, natural synthetics, polymers, biomimetics, composites, and natural or tissue-derived materials, including combinations of synthetics and living tissue components. The journal is relevant to all applications of biomaterials, including implantable medical devices, tissue engineering, and drug delivery systems.

Journal of Biomedical Materials Research: Wiley Journal

The *Journal of Biomedical Materials Research* is an international, interdisciplinary publication that brings together original contributions concerning studies on the preparation, performance, and evaluation of biomaterials; their chemical, physical, toxicological, and mechanical behaviors of materials in physiological environments; and blood and tissue response to biomaterials. Articles are peer-reviewed on all topics related to biomaterials, including the science and technology of alloys, polymers, ceramics, and reprocessed animal and human tissues in surgery, dentistry, artificial organs, and other medical devices. The journal also publishes articles in advanced interdisciplinary areas such as tissue engineering and controlled release technology, where biomaterials play a significant role in medical device performance.

The *Journal of Biomedical Materials Research* is the official journal of the Society for Biomaterials (USA), the Japanese Society for Biomaterials, the Australasian Society for Biomaterials, and the Korean Society for Biomaterials.

NanoBiotechnology: Springer Magazine

NanoBiotechnology is an international peer-reviewed journal that publishes articles on cross-disciplinary research between nanotechnology, molecular biology, and biomedical sciences. *NanoBiotechnology* is an authoritative forum that presents state-of-the-art multidisciplinary research and technological advances in theory, instrumentation, and methods, along with applications in a variety of areas of nanotechnology related to biology and medicine. Nanotechnology and biomedical sciences together give rise to a wide range of biological research topics and medical applications at the molecular and cellular levels. The long-term goal of *NanoBiotechnology* can be recognized in contributing to information transfer and decisive growth in this important area of research.

Nanomedicine: Nanotechnology, Biology, and Medicine: Elsevier Journal

Nanomedicine: Nanotechnology, Biology, and Medicine (henceforth *Nanomedicine: NBM*) is a quarterly peer-reviewed journal published internationally. Its pages include basic, clinical, and engineering research in the field of nanomedicine. Research categories include basic, diagnostic, experimental, clinical, engineering, pharmacological and toxicological nanomedicine. In addition, articles are regularly published on commercialization of nanomedicine advances, ethics in nanomedicine, funding opportunities, and other topics of interest to researchers and clinicians. The mission of *Nanomedicine: NBM* is to promote the interdisciplinary field of nanomedicine.

Subcategories into which publications are divided include synthesis, bioavailability, and biodistribution of nanomedicines; nanomedicine delivery, pharmacodynamics, and pharmacokinetics; imaging; diagnostics; improved therapies; innovative biomaterials; interactions of nanomaterials with cells, tissues, and living organisms; public health; toxicology; therapeutics; point-of-care monitoring; nutrition; nanomedical devices; prosthetics; biomimetics; bioinformatics. The journal is indexed or reported in PubMed/MEDLINE, BIOSIS Previews, EMBASE, SCOPUS, Biological Abstracts,

Science Citation Index Expanded (SciSearch®), Biotechnology Citation Index® and Journal Citation Reports/Science Edition.

In the landscape of Nanoscience and Nanotechnology, a prominent place is occupied by research ethics. In the case of the nanoworld we shall have to speak, technically, of Nanoethics. To this absolutely not to be neglected aspect the following journal has been specifically dedicated.

NanoEthics: Springer Journal

Nanoscale technologies are surrounded by mixed feelings of enthusiasm and fear. All-out defenders of nanotechnology argue that it is desperately needed to solve a wide variety of problems, from terrorism to global warming, from water pollution to land degradation and public health. The most pessimistic, however, fear loss of privacy and autonomy, “grey goo” and weapons of mass destruction, and unforeseen environmental and health risks. There is also growing concern about a fair distribution of the costs and benefits of nanotechnology.

Introduced in 2007, *NanoEthics: Ethics for Technologies that Converge at the Nanoscale* provides a much-needed forum for informed discussion of the ethical and societal concerns related to nanotechnology and for responding to the fragmented popular debate. Although the central focus of the journal is on ethical issues, the discussion also extends to the physical, biological and social sciences and legal aspects of the issue. Overall, *NanoEthics* provides a philosophically and scientifically rigorous examination of the ethical and social considerations and policy concerns raised by Nanotechnology.

A key area with regard to the progress of Nanotechnology is related to the production of new materials, one of the main skills that researchers have achieved with the adoption of tools such as, for example, electron microscopes. The creation of new structures is fertile ground for chemical research, and indeed influential journals are geared toward publishing work in this field.

Chemistry of Materials: Publications of the American Chemical Society

Chemistry of Materials is dedicated to the publication of original contributions on cutting-edge research and cross-cutting content that spans the fields of chemistry, chemical engineering, and materials science. Theoretical and experimental studies that focus on the preparation or understanding of materials with unusual or useful properties are treated at the same level of depth.

Research areas of interest include solid-state chemistry, both inorganic and organic, and polymer chemistry. The latter is studied, in particular, with regard to the development of materials with novel and/or useful optical, electrical, magnetic, catalytic and mechanical properties, among others. Research on fundamental issues related to the fabrication and processing of electronic, magnetic, or optical materials and devices, including the generation of thin films by chemical vapor and solution deposition, is also published. Other topics include the design, synthesis, investigation, and application of polymeric and molecular precursors to inorganic materials in the solid state (including sol-gel chemistry and polymer pyrolysis) and the preparation and study of biomaterials, nanomaterials, composites, catalysts, liquid crystals, coatings, thin films, and self-organized molecular interfaces and assemblies.

Journal of the American Chemical Society: Publications of the American Chemical Society.

The *Journal of the American Chemical Society*, founded in 1879, is the most prestigious journal of the American Chemical Society and the most important journal in the field. This weekly periodical is dedicated to publishing fundamental research articles in all areas of

chemistry and publishes about 16,000 pages per year in articles, communications, book reviews, and computer software reviews. JACS provides essential research for the field of chemistry.

Nano Letters: Publications of the American Chemical Society

Nano Letters reports on fundamental research information in all branches of nanoscience and nanotechnology theory and practice, and provides rapid dissemination of key elements of a study, publishing preliminary, experimental and theoretical results on physical, chemical and biological phenomena, as well as processes and applications of structures within the nanoscale. Areas of interest whose work is published include the following ones.

- Synthesis and processing of nanoscale organic, inorganic, and hybrid materials by physical, chemical, and biological methods.
- Modelling and simulation of synthesis, assembly and interaction processes.
- Characterization of size-dependent properties
- Fabrication and application of new nanostructures and nanodevices.

Nano Letters considers all branches of nanoscience and nanotechnology theory and practice.

Epilogue IV

This chapter links the beginnings of modern nanotechnology with the results that formed the basis of this research. The years 1970–1990 saw the birth of the term “nanotechnology”. It is well known that “technology” is a term that originates from the Greek *τεχνολογία*, i.e. treatise/discourse on art; consequently, nanotechnology, with the developments to which it has led, can rightly be considered a discourse on art at the 10^{-9} m dimension. First used in 1974 by the Japanese engineer Norio Taniguchi, although it was muted in the early years, it came to be definitively used to identify the entire area of research dealing with the matter and its properties down to the size of a billionth of a millimetre. This term became the vessel for new research that, from the 1970s onwards, covered virtually all areas of science, medicine and engineering. Being able to visualise matter at such an extreme dimension, with the tools that would be developed shortly thereafter, was the first step towards atomic manipulation to create new materials.

Between 1970 and 1990, many events took place in the history of nanotechnology, in addition to the extraordinary moment of the invention of this term. We witnessed the flourishing of electron microscopy, which made a contribution to the analysis of materials and, secondarily, to their manipulation. In this chapter, I have also reported a remarkable result, dated 1982, which can be seen as the link between the observation of the first carbon nanotubes in 1952 and Sumio Iijima’s observations that would come in 1991. In the article, in Russian, we read about the confirmation of the observation of hollow carbon structures, and an interpretation of what would later become known as the chirality of nanotubes, thanks to the assumptions made by the authors, on the different windings of the carbon monolayer around a suitably chosen axis.

The manipulation of Xenon atoms by Don Eigler, of IBM, was the most important event with which the twenty years studied in this chapter ended, ending with one of the most famous images in the history of science, known as “the Beginning”.

The ever-increasing development of nanoscience and nanotechnology, with the articulation of research fields becoming more and more complex, has resulted in, as a natural consequence, growth in the number of publications. This is to encourage the dissemination of scientific knowledge within the research community. At the end of the 1990s, therefore, the literature relating to the nanoworld also diversified, with the birth of journals dedicated to the different fields of research. In this way, a veritable systematisation of publications on nanotechnology took place, which still allows us to appreciate its complexity and the vastness of the research fields towards which it extends.

References

Primary Sources

- Bayda S, Adeel M, Tuccinardi T, Cordani M, Rizzolio F. (2020) The History of Nano-science and Nanotechnology. *Molecules*, 25/112. doi:10.3390/molecules25010112
- Binnig G, Quate CF, Gerber C (1986) Atomic Force Microscope. *Physical Review Letters* 56/9:930–933. doi:10.1103/PhysRevLett.56.930
- Binnig G, Rohrer H (1987) Scanning Tunneling Microscopy—From Birth to Adolescence. *Reviews of Modern Physics* 59/3:615–625. doi:10.1002/anie.198706061
- Drexler KE (1981) Molecular Engineering: An Approach to the Development of General Capabilities for Molecular Manipulation. *Proceedings of the National Academy of Sciences of the United States of America* 78/9:5275–5278. doi:10.1073/pnas.78.9.5275
- Drexler KE (1991) Molecular Machinery and Manufacturing with Applications to Computation. Degree of Doctor of Philosophy Thesis, Massachusetts Institute of Technology, Boston
- Éfros AI, Éfros AL (1982) Interband Absorption of Light in a Semiconductor Sphere. *Fizika i Tekhnika Poluprovodn* 16/7:1209–1214
- Ekimov AI, Onushchenko AA (1981) Quantum Size Effect in Three-Dimensional Microscopic Semiconductor Crystals. *Pis'ma v Zhurnal Èksperimental'noi i Teoreticheskoi Fiziki* 34/6:363–366
- Ekimov AI, Onushchenko AA (1982) Quantum Size Effect in the Optical Spectra of Semiconductor Microcrystals. *Fizika i Tekhnika Poluprovodn* 16:1215–1219
- Ekimov AI, Onushchenko AA, Plyukhin AG, Éfros AL (1984) Size Quantization of Excitons and Determination of the Parameters of their Energy Spectrum in CuCl. *Zhurnal Èksperimental'noi i Teoreticheskoi Fiziki* 88:1490–1501
- Endo M, Koyama T, Hishiyama Y (1976) Structural Improvement of Carbon Fibers Prepared from Benzene. *Japanese Journal of Applied Physics*. doi:15/11:2073–2076.10.1143/jjap.15.2073
- Heidenreich RD, Hess WM, Ban LL (1967) A Test Object and Criteria for High Resolution Electron Microscopy. *Journal of Applied Crystallography* 1:1–19. doi:10.1107/s0021889868004930
- Kroto HW (1992) C₆₀: Buckminsterfullerene, The Celestial Sphere that Fell to Earth. *Angewandte Chemie* 31/2:111–129. doi:10.1002/anie.199201113
- Kroto HW, Heath JR, O'Brien SC, Curl RF, Smalley RE (1985) C₆₀: Buckminsterfullerene. *Nature* 318/6042:162–163. doi:10.1038/318162a0
- Martin Y, Williams CC, Wickramasinghe HK (1987) Atomic Force Microscope—Mapping and Profiling on a Sub 100-Å Scale. *Journal of Applied Physics* 61/10:4723–4729. doi:10.1063/1.338807
- Michel B, Travaglini G (1988) An STM for Biological Applications: Bioscope. *Journal of Microscopy* 152/3:681–685. doi:10.1111/j.1365-2818.1988.tb01438.x
- Nesterenko AM, Koleskin NF, Akhmatov Yu.S., Suholin VI, Prilutsky OV (1982) Особенности Фазового Состава И Структуры Продуктов Взаимодействия NiO и Fe₂O₃ С Окисью Углерода (in Russian). *Металлы* 3:12–16
- Oberlin A, Endo M, Koyama T (1976) Filamentous Growth of Carbon through Benzene Decomposition. *Journal of Crystal Growth* 32:335.349. doi:10.1016/0022-0248(76)90115-9
- Smalley RE (1996) Discovering the Fullerenes (Nobel Lecture). *Angewandte Chemie International Edition* 36/15:1594–1601. doi:10.1002/anie.199715941
- Smalley RE (2001) Of Chemistry, Love and Nanobots. *Scientific American*, 285/3:76–77. doi:10.1038/scientificamerican0901-76
- Taniguchi N (1974) On the Basic Concept of Nanotechnology. In *Proceedings of the International Conference on Production Engineering, Tokio, Part II*, 18–22
- Taniguchi N (1990) Construction and Idea of Nanotechnology (in Japanese). *Journal of the Japan Society for Precision Engineering* 56/3:427–431. doi:10.2493/jjspe.56.427
- Zhang QL, O'Brien SC, Heath JR, Liu Y, Curl RF, Kroto HW, Smalley RE (1986) Reactivity of Large Carbon Clusters: Spheroidal Carbon Shells and their possible Relevance to the Formation and Morphology of Soot. *Journal of Physical Chemistry* 90/4:525–528. doi:10.1021/j100276a001

Secondary Sources

- Albrecht TR, Quate CF (1987) Atomic Resolution Imaging of a Nonconductor by Atomic Force Microscopy. *Journal of Applied Physics* 62/7:2599–2602. doi:10.1063/1.339435
- Baker RT, Harris PS (1978) The Formation of Filamentous Carbon. *Chemistry and Physics of Carbon* 14/4:83
- Beck K, Kopitzki K, Krauss G, Mertler G (1983) A Modified Continuum Model for the Evaluation of Channeling Experiments for Foreign Atom Location. *Nuclear Instruments and Methods in Physics Research* 218:97–102. doi:10.1016/0167-5087(83)90961-4
- Becker L, Bada J, Winans R, Hunt J, Bunch T, French B (1994) Fullerenes in the 1.85–Billion–year–old Sudbury Impact Structure. *Science* 265/5172:642–645. doi:10.1126/science.11536660
- Binnig G, Gerber C, Stoll E, Albrecht TR, Quate CF (1987) Atomic Resolution with Atomic Force Microscopy. *Surface Science Letters* 189–190:1–6. doi:10.1016/0167-2584(87)90418-x
- Binnig G, Hoenig HE (1978) Tunneling Investigation of Superconducting (SN)_x. *Zeitschrift für Physik B* 32/1:23–26. doi:10.1007/bf01322182
- Chow L, Wang H, Kleckley S, Daly TK, Buseck PR (1995) Fullerene Formation during Production of Chemical Vapor Deposited Diamond. *Applied Physics Letters* 66/4:430. doi:10.1063/1.114046
- Drexler KE (1986) *Engines of Creation. Challenges and Choices of the Last Technological Revolution.* Bantam Doubleday Dell, New York
- Drexler KE (1990) Molecular Tip Arrays for Molecular Imaging and Nanofabrication. *Journal of Vacuum Science & Technology B* 9:1394–1397. doi:10.1116/1.585204
- Drexler KE (1999) Building Molecular Machine Systems. *Tibtech* 17/1:5–7. doi:10.1016/s0167-7799(98)01278-5
- Drexler KE (2001) Machine–Phase Nanotechnology. *Scientific American* 285/3:74–75. doi:10.1038/scientificamerican0901-74
- Drexler KE (2003a) If Atomic Precision is Unfeasible, so is Life. *Nature*, 422:257. doi:10.1038/422257c
- Drexler KE (2003b) Open Letter to Richard Smalley. *Chemical and Engineering News* 81:38–39
- Drexler KE (2004) Different Paths to the Nano–Scale. *Physics World* 17/10:18. doi:10.1088/2058-7058/17/10/23
- Drexler KE, Forrest D, Freitas RA, Hall JS, Jacobstein N, McKendree T, Merkle R, Peterson C (2001) On Physics, Fundamentals, and Nanorobots: A Rebuttal to Smalley’s Assertion that Self–Replicating Mechanical Nanorobots Are Simply Not Possible. Institute for Molecular Manufacturing. Retrieved 11/07/2022.
- Drexler KE, Foster JS (1990) Synthetic Tips. *Nature* 343/6259:600. doi:10.1038/343600b0
- Drexler KE, Peterson C, Pergamit G (1991) *Unbounding the Future: the Nanotechnology Revolution.* William Morrow and Company, New York
- Ekimov AI, Onushchenko AA, Tsekhomski VA (1980). Exciton Absorption by Copper Chloride Crystal in Glassy Matrix. *Fizika i Khimija. Stekla* 1980, 6:511–512
- Elser V, Haddon RC (1987) Icosahedral C₆₀: an Aromatic Molecule with a Vanishingly Small Ring Current Magnetic Susceptibility. *Nature* 325:792–794. doi:10.1038/325792a0
- Giaever I (1974) Electron Tunneling and Superconductivity. *Science* 183/4131:1253–1258. doi:10.1126/science.183.4131.1253
- Gordon RG, Kim YS (1971) Theory for the Forces between Closed–Shell Atoms and Molecules
- Haddon RC, Brus LE, Raghavachari (1986) Electronic Structure and Bonding in Icosahedral C₆₀. *Chemical Physics Letters* 125/5–6:459–464. doi:10.1016/0009-2614(86)87079-8
- Howard JB, McKinnon JT, Makarovskiy Y, Lafleur AL, Johnson ME (1991) Fullerenes C₆₀ and C₇₀ in Flames. *Nature* 11/352:139–141. doi:10.1038/352139a0
- Koleskin NF, St.Pierre GR (1980) The Influence of Water Vapor on the Decomposition of Carbon Monoxide on Reduced Iron Oxide. *Metallurgical and Materials Transactions B* 11B:285
- López–Suárez A, Torres–Torres C, Rangel–Rojo R, Reyes–Esqueda JA, Santana G, Alonso JC, Ortiz A, Oliver A (2009) Modification of the Nonlinear Optical Absorption and Optical Kerr Response Exhibited by nc–Si Embedded in a Silicon–Nitride Film. *Optics Express* 17/12:10056–10068. doi:10.1364/OE.17.010056
- Merkle RC, Drexler KE (1996) Helical Logic. *Nanotechnology* 7/4:325–339. doi:10.1088/0957-4484
- Meselson MS, Ratner D, Ratner MA, Drexler KE (2007) Emerging Technologies. *Bulletin of the Atomic Scientists* 63/1:49–58. doi:10.1080/00963402.2007.11461048

- Phoenix C, Drexler KE (2004) Safe Exponential Manufacturing. *Nanotechnology* 15/8:869–872. doi:10.1088/0957-4484/15/8/001
- Pradeep T (2005) *Nano: The Essentials. Understanding Nanoscience and Nanotechnology*. McGraw–Hill, New York
- Radicati di Brozolo F, Bunch TE, Fleming RH, Macklin J (1994) Fullerenes in an Impact Crater on the LDEF Spacecraft. *Nature* 369/6457:37–40. doi:10.1038/369037a0
- Rohrer H (1960) *Druck- und Volumeneffekte in Supraleitung*. PhD Thesis, Eidgenössischen technischen hochschule in Zürich, Zürich.
- Selloni A, Carnevali P, Tosatti E, Chen CD (1985) Voltage-Dependent Scanning-Tunneling Microscopy of a Crystal Surface: Graphite. *Physical Review B* 31/4:2602–2605. doi:10.1103/PhysRevB.31.2602
- Smalley R (2003a) Smalley Responds. *Chemical and Engineering News* 81:39–40
- Smalley R (2003b) Smalley Concludes. *Chemical and Engineering News* 81:41–42
- Snyder-Beattie AE, Sandberg A, Drexler KE, Bonsall MB (2021) The Timing of Evolutionary Transitions Suggests Intelligent Life is Rare. *Astrobiology* 21/3:265–278. doi:10.1089/ast.2019.2149
- Tegeler E, Kosuch N, Wiech G, Faessler A (1979) On the Electronic Structure of Hexagonal Boron Nitride. *Physica Status Solidi (b)* 91/1:223–231. doi:10.1002/pssb.2220910123
- Thompson WA, Hanrahan (1976) Thermal Drive Apparatus for Direct Vacuum Tunneling Experiments. *Review of Scientific Instruments* 47:1303–1304. doi:10.1063/1.1134513
- Wendler WM (1987) Modified Continuum Shell-Model Theory for (n,2n) Reactions. *Nuclear Physics A* 472:26–40. doi:10.1016/0375-9474(87)90218-1

Selected Additional References on the Subjects Suggested for Further Reading

- Averin DV, Likharev KK (1985) Coulomb Blockade of Single-Electron Tunneling, and Coherent Oscillations in Small Tunnel Junctions. *Journal of Low Temperature Physics* 62:345–373
- Averin DV, Likharev KK (1987) New Results of the Theory of Set and Bloch Oscillations in Small Tunnel Junctions. *IEEE Transactions on Magnetics* 23/2:1138–1141
- Baker RT, Barber MA, Harris PS, Feates FS, Waite RJ (1972) Nucleation and Growth of Carbon Deposites from the Nickel Catalyzed Decomposition of Acetylene. *Journal of Catalysis* 26/1:51–62
- Baker RT, Harris PS, Thomas RS, Waite RJ (1973) Formation of Filamentous Carbon from Iron, Cobalt and Chromium Catalyzed Decomposition of Acetylene. *Journal of Catalysis* 30/1:86–95
- Batra IP, Garcia N, Rohrer H, Salemnik H, Stoll E, Ciriaci S (1987) A Study of Graphite Surface with STM and Electronic Structure Calculations. *Surface Science* 181/1–2:126–138
- Bowers CW, Culver RB, Solberg WA, Spain IL (1987) Optical Absorption of Surfaces Modified by Carbon Filaments. *Applied Optics* 28/21:4625–4631
- Chadi DJ, Bauer RS, Williams RH, Hansson GV, Bachrach RZ, Mikkelsen JC, Houzay JrF, Guichar GM, Pinchaux R, Pétroff Y (1980) Atomic and Electronic Structure of the 7×7 Reconstructed Si (111) Surface. *Physical Review Letters* 44/12:799–802
- Culver RB, Solberg WA, Robinson RS, Spain IL (1985) Optical Absorption of Microtextured Graphite Surfaces in the 11–23μm Wavelength Region. *Applied Optics* 24/7:924–925
- Deslattes RD (1969) Optical and X-Ray Interferometry of a Silicon Lattice Spacing. *Applied Physics Letters* 15/11:386–388
- Dietz TG, Duncan MA, Powers DE, Smalley RE (1981) Laser Production of Supersonic Metal Cluster Beams. *Journal of Chemical Physics* 74/11:6511–6512. doi:10.1063/1.440991
- Dürig U, Gimzewski JK, Pohl DW (1986) Experimental Observation of Forces Acting during Scanning Tunneling Microscopy. *Physical Review Letters* 57/19:2403–2406
- Ekimov AI, Éfros AL (1990) Optics of Zero Dimensional Semiconductor Systems. *Acta Physica Polonica A* 79:5–14
- Ekimov AI, Onushchenko AA (1982) Quantum Size Effect in the Optical Spectra of Semiconductor Microcrystals. *Fizika i Tehnika Poluprovodn* 16/7:1215–1219
- Ekimov AI, Onushchenko AA (1984) Size Quantization of the Electron Energy Spectrum in a Microscopic Semiconductor Crystal. *Pis'ma v Zhurnal Éksperimental'noi i Teoreticheskoi Fiziki* 40/8:337–340

- Ekimov AI, Onushchenko AA, Éfros AL (1986) Quantization of the Energy Spectrum of Holes in the Adiabatic Potential of the Electron. *Pis'ma v Zhurnal Èksperimental'noi i Teoreticheskoi Fiziki* 43/6:292–294
- Ergun S (1968) Optical Studies of Carbon. In P.L. Walker Jr. *Chemistry and Physics of Carbon*, Dekker, New York
- Floro JA, Rossnagel SM, Robinson RS (1983) Ion–Bombardment–Induced Whisker Formation on Graphite. *Journal of Vacuum Science & Technology* 1/3:1398–1402
- Golovchenko JA (1986) The Tunneling Microscope: a New Look at the Atomic World. *Science* 232/4746:48–53
- Hansson GV, Bachrach RZ, Bauer RS, Chadi DJ, Gopel W (1980) SLAB–MINDO Calculations on the Si(111)2×1 Surface. *Surface Science* 225/3:225–232
- Herbig GH (1975) The Diffuse Interstellar Bands. IV–The Region 4400–6850Å. *Astrophysical Journal* 196:129–160
- Hopkins JB, Langridge–Smith PRR, Morse MD, Smalley RE (1983) Supersonic Metal Cluster Beams of Refractory Metals: Spectral Investigations of Ultracold Mo₂. *Journal of Chemical Physics* 78/4:1627–1637. doi:10.1063/1.444961
- Koyama T (1972) Formation of Carbon Fibers from Benzene. *Carbon* 10/6:757–758
- Kroto HW (1982) Tilden Lecture. Semistable Molecules in the Laboratory and in Space. *Chemical Society Reviews* 11/4:435–491
- Lifshitz IM, Slyozov VV (1958) The Kinetics of precipitation from supersaturated solutions. *Zhurnal Eksperimental'noi i Teoreticheskoi Fiziki* 35/2:479–492
- Marks RW (1960) *The Dymaxion World of Buckminster Fuller*. Reinhold, New York
- McRae EG, Caldwell CW (1981) Structure of Si(111)–(7×7)H. *Physical Review Letters* 46/25:1632–1635
- Moore AW (1973) Highly Oriented Pyrolytic Graphite and its Intercalation Compounds. *Chemistry and Physics of Carbon* 11/47:231–286
- Park S–II, Quate CF (1986) Tunneling Microscope of Graphite in Air. *Applied Physics Letters* 48/2:112–114
- Pashley MD, Pethica JB, Coombs J (1985) Scanning Tunneling Microscope Studies. *Surface Science* 152–153/P1:27–32
- Pethica JB, Pashley MD (1983) Techniques: Scanning Tunneling Microscopy. *Nature* 305/5936:666
- Pompea SM, Bergener DW, Shepherd DF, Russek S (1984) Reflectance Measurements on an Improved Optical Black for Stray Light Rejection from 0.3 to 500µm. *Optical Engineering* 23/2:149–152
- Quate CF (1986) Vacuum Tunneling: a New Technique for Microscopy. *Physics Today* 39/8:26–33
- Robinson RS, Rossnagel SM (1982) Ion–Beam–Induced Topography and Surface Diffusion. *Journal of Vacuum Science & Technology* 21/3:790–797
- Rohlfing EA, Cox DM, Kaldor A (1984) Production and Characterization of Supersonic Carbon Cluster Beams. *Journal of Chemical Physics* 81/7:3322–3330. doi:10.1063/1.447994
- Selloni A, Carnevali P, Tosatti E, Chen CD (1986) Voltage–Dependent Scanning–Tunneling Microscopy of a Crystal Surface: Graphite. *Physical Review B* 31/4:2602–2605
- Smith DPE, Binnig G (1986) Ultrasmall Scanning Tunneling Microscope for use in a Liquid–Helium Storage Dewar. *Review of Scientific Instruments* 57/10:2630–2631
- Soler JM, Baro AM, García, Rohrer H (1986) Interatomic Forces in Scanning Tunneling Microscopy: Giant Corrugations of the Graphite Surface. *Physical Review Letters* 57/4:444–447
- Sonnenfeld R, Hansma PK (1986) Atomic–Resolution Microscopy in Water. *Science* 232/4747:211–213
- Takayanagi K, Tanishiro Y, Takahashi M, Takahashi S (1985) Structural Analysis of Si(111)–7×7 by UHV–Transmission Electron Diffraction and Microscopy. *Journal of Vacuum Science & Technology A Vacuum Surfaces and Films* 3/3:1502–1506
- Tersoff J, Hamann DR (1985) Theory of the Scanning Tunneling Microscope. *Physical Review B* 31/2:805–813
- Tesner PA, Robinovitch EY, Rafalkes IS, Arafieva EF (1970) Formation of Carbon Fibers from Acetylene. *Carbon* 8/4:435–442
- Uhrberg RIG, Hansson GV, Nicholls JM, Persson PES, Flodstrom SA (1985) Photoemission study of the surface and bulk electronic structures of Si(111)7×7 and Si(111)≤3[–]×3[–]:Al. *Physical Review B* 31/6:3805–3810

Chapter V

1991–2022

Note: from section 5.1.1, contents were derived to compose the standalone article *1950s-1990s: Carbon Nanotubes Studies into Historiography of Nanoscience-Nanotechnology*, which is currently being edited, and the first page of which can be found in Appendix 3.

Prologue V

The years from 1991 to 2022 are years in which nanotechnology has proliferated in many fields. The choice of topics to be included in this last chapter proved to be a difficult but at the same time extremely interesting challenge. The available sources have multiplied, and documents have become available, and disseminated, both in hard copy and digitally.

It is precisely the dissemination of digital sources that has, on the one hand, made accessible documents that were previously only kept in libraries and archives, while on the other hand, it has enabled the publication of a huge number of works, with increasing frequency.

I began the chapter with the presentation of Sumio Iijima's article recognised as the first presentation of carbon nanotubes as we know them today. In reality, as shown in the previous chapters, there had already been experimental evidence in this direction, but language and, above all, political barriers had prevented the dissemination of scientific thought. With regard to this topic, it is interesting to note that a mathematical/geometric concept defined as chirality (with a different meaning to that attributed to this term in organic chemistry) was introduced for the description of the structures possible in carbon nanotubes.

I then went on to present some of the important results that have been achieved during the 1990s. The individual paragraphs describe the advances made: as the reader will see, these are mainly applicative and practical advances, achieved thanks to the tools and techniques perfected over time.

The 2000s saw the discovery of graphene, by Novoselov and Geim. This carbon monolayer has paved the way, thanks to its resistance and thermal and electrical conductivity characteristics, for a series of applications spanning fields as diverse as electronics and medicine. Hardness and, in spite of this, lightness, elasticity, electrical conductivity and transparency are the characteristics on which the study of graphene and its applications is focusing.

Graphene's high strength, for example, makes it highly valued as a material for coatings that are hydrophobic, conductive at the same time, and resistant to chemical attack. Furthermore, a graphene-based coating is resistant to scratching, exposure to ultraviolet radiation (which degrades some untreated polymeric materials) and, finally, resistant to breakage. Graphene's ability to detect foreign particles makes this material one of the best available for making ultra-sensitive sensors, for detecting substances at the molecular level, and thus applicable – for example – for air quality control.

In the latter field, for example, the ability of carbon nanostructures to encapsulate the active ingredients of different drugs, and the potential of the shells to be functionalised in such a way as to be virtually invisible to the immune system, has proved fundamental. This makes it possible to distribute the active ingredient precisely where it is needed, without affecting other tissues or organs that could be damaged by it.

Materials science, through the study of nanoferrites, which are now important for electronics and biosensors, or of polymeric nanoparticles, which are inexpensive and combine features such as flexibility and processability, has received great impetus from the properties of materials at the nanoscale.

The study of gold nanoparticles, due to their biocompatibility and transport capacity, are crucial in the identification and treatment of neoplasms. Not only that, but they have been used in photovoltaics, in colorimetric probes, as catalysts.

5.1 The Most Recent Applications

In this chapter I am going to show the reader the most recent discoveries and applications in Nanoscience and Nanotechnology. The research has grown considerably from the year 2000 on, involving different scientific fields, and proving how transversal Nanotechnology can be.

5.1.1 1991: New Discoveries on Nanotubes

In 1991, Professor Sumio Iijima, a physicist employed by NEC – Nippon Electric Company Limited – came to international scientific prominence for having described carbon nanotubes and their structures and, shortly afterwards, also described a mechanism for their formation (Iijima 1991). He made use of the tools available, in particular the transmission electron microscope. By exploiting the properties of certain regular polygons to allow tessellation of the plane and the properties of others to cause curvature of the plane itself, he was able to describe the growth of the tubes, and their morphology, exploiting the key role of these polygons, pentagons and heptagons in particular. Moreover, it is to be noted that the tubes obtained by Iijima were open at the ends.

The starting point of Iijima's research did not concern carbon nanotubes as such, but rather the mechanism of formation of fullerene molecules, and his first steps were along the lines of the analysis of spheroidal graphite particles, which can be depicted as closed graphite shells that are similar to fullerene molecules of larger dimensions. All of Iijima's work in this direction came to a halt when, as a by-product of the fullerene production he was achieving in a carbon plasma, the growth of tubular carbon structures was observed. These structures, for the most part, were coaxial systems on which the carbon atoms formed hexagonal structures wound helically with a recognisable pitch. Iijima posed the hypothesis that it was the helical winding that helped the formation mechanism. Since the diameters were of the order of nanometres, the hexagons were also very tightly wound around the hypothetical outer surface of the tube.

Iijima pointed out in his article that cylindrical structures in inorganic materials were only known to exist in the case of asbestos fibres, effectively ruling out the possibility that he was aware of Radushkevich and Lukyanovich's work. All those characteristics that were to be widely investigated over time, such as conductive and mechanical behaviour, the latter in terms of high stiffness, were hypothesised and were first confirmed by Iijima when he verified that the electrical behaviour depended on the diameter of the tube and its helicity.

The new type of three-dimensional carbon structure, needle-like in his own words, was produced with a discharge arc and accumulated at the negative electrode; Iijima had used a method quite similar to that used to obtain fullerenes. The coaxial carbon nanotubes ranged from a minimum of two nested structures to a maximum of almost fifty.

It was already known that sp^2 -hybridization of carbon allowed it to give rise to pure solids and a variety of graphite structures, such as those filaments produced by the thermal decomposition of hydrocarbons, which in turn produce amorphous carbon filaments that are graphitized for subsequent heat treatment. Instead, Iijima worked with a discharge arc, evaporating carbon in an argon atmosphere at an operating pressure of 100torr, just over 13Pa, which is much lower than the pressure used to make graphite filaments, resulting in carbon needles. The needles Iijima observed grew preferentially on certain areas of the

electrode, where spherical structures between 5nm and 20nm in diameter were located. Transmission Electron Microscopy proved useful in investigating the structure of the needles in detail and it was observed that the thinnest needle actually consisted of just two sheets of hexagonal graphite separated by a distance of 0.34nm and with diameters of 5.5nm and 4.8nm respectively (Fig. 5.1).

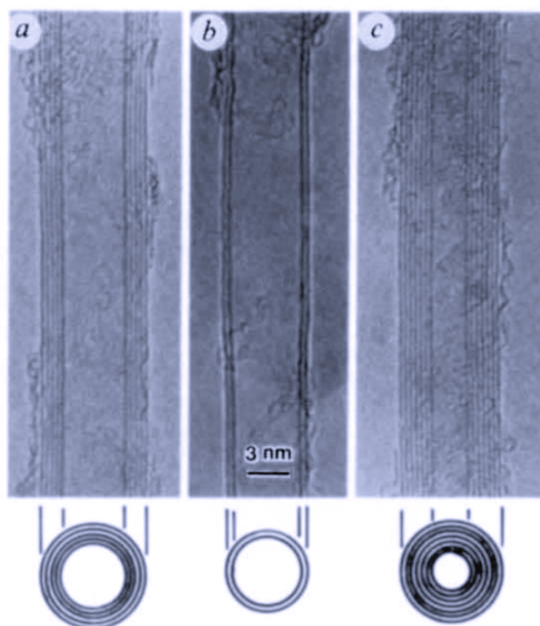

Fig 5.1 This picture represents electron images of microtubules of graphitic carbon, analysed by Iijima. From left to right we can see a structure made up with five graphitic sheets, a two-sheet tube and a seven-sheet tube on the right. The external diameters are, respectively of 6.7nm, 5.5nm and 6.5nm. Source: Iijima 1991. Reproduced under permission of Springer Nature

The separation distance was clearly comparable to that of bulk graphite. The smallest tube observed had a diameter of 2.2nm and, as might be expected, occupied the innermost position in a more complex system. Such a diameter is what can be achieved if 30 carbon hexagons are ring-shaped, establishing an angle of about 6° between each hexagonal plane. By way of comparison, let us recall that in C_{60} the same angle measures about 42° , which is much wider than that measured in tubes. A consideration of the binding energy is necessary: the C–C binding energy in the C_{60} molecule is lower than that of graphite, which may suggest that it is the different inclination of the hexagonal planes in the molecule that causes the decrease in energy value. A similar effect relating the binding energy to the angle between the hexagons could also be called into question for carbon nanotubes because it must be understood that the sequence of hexagons in graphite is relaxed, which is impossible for these coaxial tubes. In order to answer such a question, Iijima observed the diffraction gratings of a single nanotube and established the indices $\{h0l\}$ and $\{hk0\}$ for the maxima on the hexagonal symmetry. It was possible to observe strong maxima (001) when the axes

of the nanotubes were perpendicular to the $[001]$ direction, which made it possible to assume the existence of a coaxial complex structure.

The electron beam incident on coaxial systems of carbon nanotubes finds conditions for Bragg diffraction when it encounters the (002) planes and consequently the diffractogram shows light spots of type (001) , the position of these planes being diametrically opposite to the central axis of the system. There is a symmetry of type $mm2$, according to the crystallographic theory of sets, with respect to the axis of the needle (Fig. 5.2), which competes with the $\{hk0\}$ reflections of the diffractogram, and results in multiple $\{hk0\}$ spots. In the following figure it appears that three sets of spots $(hk0)$ give rise to diffraction rings, where only spots (100) and (220) are visible.

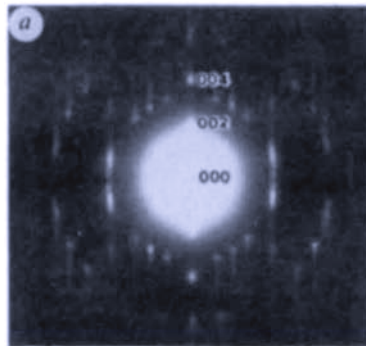

Fig 5.2 The electron diffraction pattern of a seven-graphite-sheet nanotubule whose axis is horizontal. Source: Iijima 1991. Reproduced under permission of Springer Nature

The diffraction pattern was obtained from a tube consisting of seven concentric sheets, which was also observed under an electron microscope to confirm the structure. The reflections $\{hk0\}$ are obtained from planes that are diametrically opposed and are at 90° to those giving rise to the bright spots (001) . If the two portions of the cylinder have the same orientation, the diffractograms of the $\{hk0\}$ planes are identical. If there are several concentric sheets and their orientations are different, we will have several different diffraction $\{hk0\}$ patterns. This top-bottom effect is necessary for mirror symmetry, together with the helical arrangement of carbon hexagons on each individual sheet, the helical arrangement that I will describe below.

The analysis of a carbon nanotube and its description became fundamental for their comprehension and development. Formulating new approaches for classifying the carbon nanotubes was a challenge taken up by Mildred Dresselhaus and her co-workers, and by Carter White and his colleagues, among others (Harris 2009).

Conceptually, a single-walled carbon nanotube is obtained by rolling a sheet of graphene on itself, as one would do with a sheet of paper. Since the carbon plane is sp^2 -hybridised and made up of regular hexagons, due to the mathematical properties of tessellation it is not possible to obtain a three-dimensional structure from it unless some hexagons are replaced by pentagons or the sheet is folded into a cylinder.

Carbon nanotubes can be obtained with a high rate of symmetry or with a helicity, depending on how the sheet can be rolled up. By varying this helicity of the nanotube, different properties of the structure can be obtained.

A nanotube is described by a number of fundamental parameters: the diameter d of the tube, the chiral angle ϑ and the chiral vector $C = n\mathbf{a}_1 + m\mathbf{a}_2 \equiv (n,m)$, as shown in the figure below (Fig. 5.3).

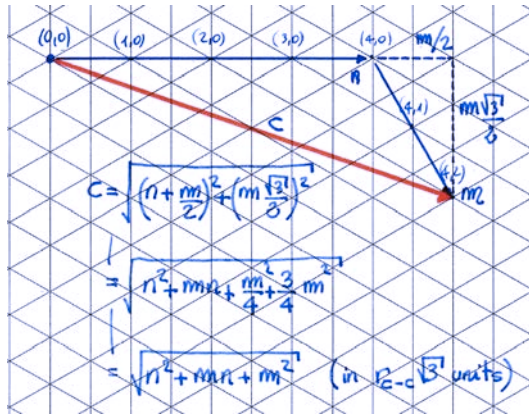

Fig 5.3 How to construct the length of C vector through m and n coefficients and a simple application of “Pythagoras” \f “a”. Source: AD

The vector C connects two points which are crystallographically equivalent. As the tip and the back of the vector overlap, the length of C vector gives the measure of the circumference of the tube.

The calculation is very simple, given the high symmetry properties of every equilateral triangle. With regard to the figure above, in fact, it is not difficult to recognize the rectangular triangle whose sides are:

$$n + \frac{m}{2} \tag{5.1}$$

and:

$$\frac{m}{2}\sqrt{3} \tag{5.2}$$

applying also the properties of the equilateral triangle. Now we also have to consider that, given r_{c-c} the distance between two consecutive carbon atoms, i.e. the side of the single hexagonal cell, it comes immediately after that the distance between two atoms like the ones in (1,0) and (2,0) positions – see the picture –, is:

$$r_{c-c} \sqrt{3} \tag{5.3}$$

so we can evaluate C in $r_{c-c} \sqrt{3}$ units.

So:

$$C = \sqrt{\left(n + \frac{m}{2}\right)^2 + \left(\frac{\sqrt{3}}{2}m\right)^2} = \sqrt{n^2 + mn + m^2} \quad (5.4)$$

after a very simple algebra. Considering the distance between two consecutive atoms, the previous formula becomes:

$$C = r_{C-C} \sqrt{3} \cdot \sqrt{n^2 + mn + m^2} \quad (5.5)$$

From this expression it is possible to obtain the diameter of the single tube:

$$d = \frac{C}{\pi} = \frac{r_{C-C} \sqrt{3} \cdot \sqrt{n^2 + mn + m^2}}{\pi} \quad (5.6)$$

After a trigonometric consideration we also get the chiral angle:

$$\vartheta = \tan^{-1} \frac{m\sqrt{3}}{m + 2n} \quad (5.7)$$

In an (n,m) index notation, two axes are defined, the Zigzag axis (n,0) and the Armchair axis oriented at 30° to the Zigzag axis. Therefore, tubes where theta angle measures 0° are called Zigzag tubes, while those (n,n) are Armchair. A conventional system for depicting the structure of a carbon nanotube is shown below (Fig. 5.4).



Fig 5.4 The conventional structure for a carbon sheet of a nanotube Source: AD

In MultiWalled Carbon Nanotubes (MWCN) several nanotubes are nested coaxially. STM measurements revealed that there is a limit beyond which is not possible to fit any tube inside another, and this limit refers to a gap of 0,344nm between the layers. So a (10,0) tube fits inside a (19,0) tube but not in a (18,0) tube, because the diameter of (19,0) is 1,509nm and the diameter of (18,0) is 1,429nm (Pradeep 2005).

If a carbon nanotube is thought of as a one-dimensional crystal, it will be possible to define a unit cell whose translation along the axis of the nanotube allows the entire structure to be structures within which chiral nanotubes can be identified. The characteristics of what we can define as boundary windings are as follows.

For a tube in Armchair configuration, the width of the cell measures the modulus of the vector \mathbf{a} , the unit vector of the original graphite lattice, which is two-dimensional. For a tube in Zigzag configuration, the cell width measures $\mathbf{a}\sqrt{3}$. The following pictures represent the unit cells for an Armchair and a Zigzag nanotube (Fig. 5.5).

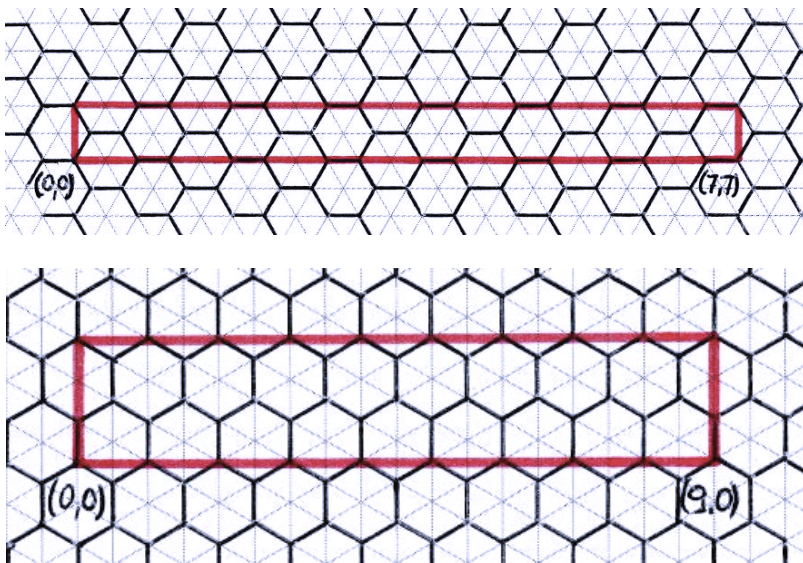

Fig 5.5 Unit cells for (above) (7,7) Armchair nanotube and (below) (9,0) Zigzag nanotube. Source: AD

Other nanotubes whose diameters are larger than these two configurations have cells that are simply larger than these. In other words, if the nanotubes are chiral, the unit cell size will be larger due to the lower symmetry of the structure. This is demonstrated in the image below, where the (5,3) nanotube cell is constructed (Fig. 5.6).

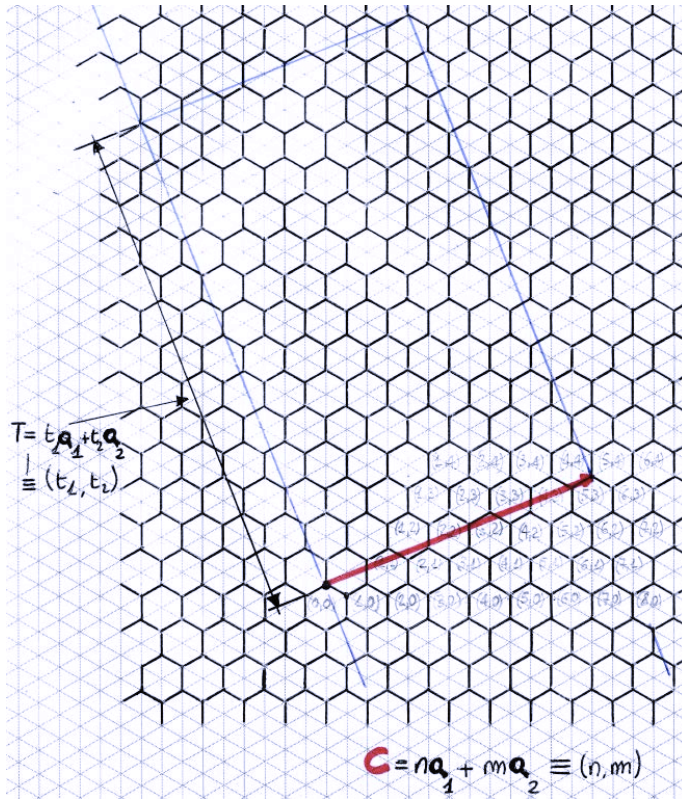

Fig 5.6 The construction of the unit cell for a (5,3) nanotube. Source: AD

Once the chiral vector C is found on the plane, the terms (n,m) being known, the translation vector of the unit cell is defined by the relation $T = t_1\mathbf{a}_1 + t_2\mathbf{a}_2 \equiv (t_1, t_2)$, in which the integer coefficients t_1 and t_2 are in turn defined by the relations:

$$t_1 = \frac{2m + n}{d_R} \qquad t_2 = -\frac{2n + m}{d_R} \qquad (5.8)$$

and d_R is the highest common divisor of $(2n+m, 2m+n)$. It is:

$$d_R = \begin{cases} d & \text{if } n-m \text{ is not a multiple of } 3d \\ 3d & \text{if } n-m \text{ is a multiple of } 3d \end{cases}$$

In the (5,3) nanotube mentioned in the figure above, for example, it is:

$$t_1 = 11 \qquad t_2 = -13 \qquad (5.9)$$

The length of the translation vector T is:

$$T = \frac{C\sqrt{3}}{d_H} \tag{5.10}$$

In $r_{C-C} \sqrt{3}$ units, for a (5,3) nanotube we have $C = 7$ and $T = 12.12$.

The number of carbon atoms per unit cell is:

$$N = \frac{2(n^2 + nm + m^2)}{d_H} \tag{5.11}$$

Another calculation to define the unit cell was made for a different nanotube, as a comparison. The nanotube chosen was (6,3), see picture below (Fig. 5.7).

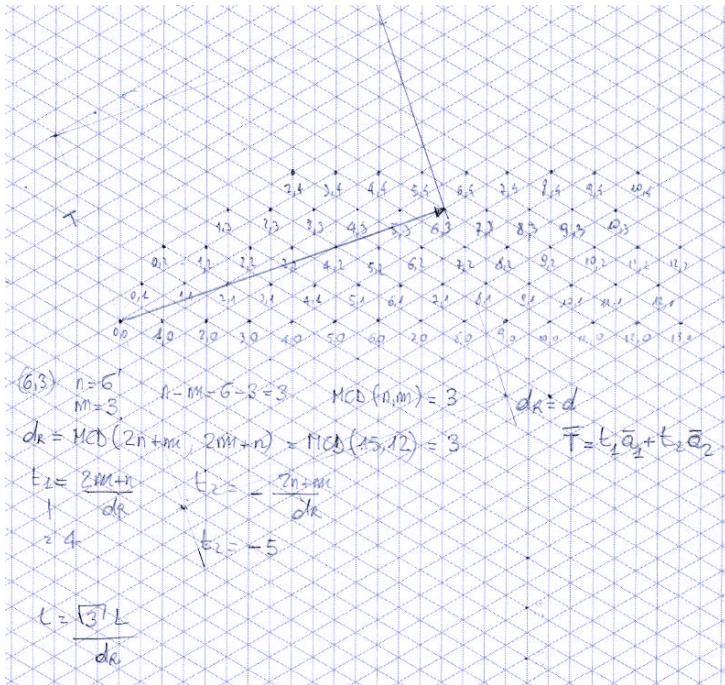

Fig 5.7 A quick pencil sketch depicting the construction of the unit cell for a (6,3) nanotube. Source: AD

In this case, the unit cell is smaller than the (5,3) one.

5.1.2 1992: Mesoporous Silica

In 1992 a large group of researchers from different Mobil Research and Development Corporation laboratories proposed the synthesis, characterization, and formation mechanism of nanomolecular mesoporous particles. These particles were made of silicate/aluminosilicate and the new material was called M41S (Beck *et al.* 1992).

According to the International Union of Pure and Applied Chemistry (IUPAC) terminology in use in 1992 (IUPAC 1992), the definition of a microporous material was that of a material whose pores had a size of 20\AA , while the pores of mesoporous materials were to be measured between 20 and 500\AA . The use of these materials should have been for heterogeneous catalysis phenomena or their application as adsorption materials.

Molecular sieves constitute a very important subclass of microporous materials. Certain clays such as zeolite, which belongs to the aluminosilicate family, are extremely interesting because the micropores observed in their structure are formed by regular and uniform arrangements of channels. Their properties include cation exchange capacity, reversible dehydration, and, indeed, structural porosity. It is precisely this last characteristic that makes zeolites of particular interest in oil cracking and reforming processes, due to their enormous internal surface area. Small aliphatic molecules and some small aromatic molecules could be incorporated into the cavities of the zeolite.

Considerable effort had been put into developing structures whose pores were, dimensionally, in the mesoporous range.

1988 saw the birth of Virginia Polytechnic Institute number 5 (or VPI-5), a family of aluminophosphate-based molecular sieves containing rings of 18 tetrahedral atoms (18 T-atoms).

In 1990, research (Dessau Schlenker and Higgins 1990) led to the first 14-ring molecular sieve, providing an initial answer to the need to find a structure larger than the 7.4\AA associated with the zeolite channel diameter. A synthetic aluminophosphate, AlPO_4-8 , had been shown to possess a porosity due to channels whose dimensions, although not perfectly circular, were around $7.9 \times 8.7\text{\AA}$, suggesting a possible line of research in materials that could be synthesised in the future, and characterised by even larger pores.

In 1991, a structure of a cubic gallo-phosphate, called cloverite, with apertures consisting of 20 co-ordinated atoms forming an aperture whose diagonal dimension was measured to be around $19-20\text{\AA}$ was identified; this material could have found application as an intermediate product in processes where zeolite was used as a reaction catalyst (Estermann *et al.* 1991).

The term M41S denotes a family of mesoporous nanostructured materials developed by a team of researchers at Mobil, materials among which the hexagonal MCM-41 (Mobil Composition of Matter-41) phase is one of the most interesting as it possesses a hexagonal arrangement of unformed mesopores. As is the case with most discoveries made about new materials, that of the M41S family of mesoporous molecular sieves can also be considered an unforeseen result, achieved through the application of observational skills, prior knowledge, and new synthetic approaches.

Laboratory investigations aimed to discover and develop new layered materials in order to convert them into stable porous catalysts by pillaring. From a theoretical point of view, pillared materials allow the pore size, active site density and composition to be adjusted more extensively than conventional aluminosilicate zeolites. The pore systems can be adjusted according to the desired application by varying the size and density of the pillars. The composition of the pillars also seemed to be adjustable in the laboratory, so that the

different reactivities and chemistries sought could be achieved. A layered compound is a crystalline material in which the atoms of the layers are bound by chemical bonds, while the atoms of adjacent layers interact through physical forces. A single layer is called a lamella, slab, or sheet (Kresge, Vartuli, Roth and Leonowicz 2004). A layered compound has a well-defined X-ray diffraction (XRD) pattern, which demonstrates its lamellar structure. Pillaring is the process by which a layered compound is transformed into a thermally stable micro- and/or mesoporous material with retention of the layered structure. The resulting material is a pillared compound or a pillared layered solid. A pillared derivative is distinguished from an ordinary intercalate by virtue of the intracrystalline porosity made possible by the lateral separation of the intercalate host (Schoonheydt, Pinnavaia, Lagaly and Gangas 1999). From a theoretical point of view, pillared materials make it possible to adjust pore size, active site density, and composition more extensively than conventional aluminosilicate zeolites. The pore systems can be adjusted to the desired application by varying the size and density of the pillars. The composition of the pillars also appears to be adjustable in the laboratory, so that different reactivities and chemistries can be achieved (Fig.5.8).

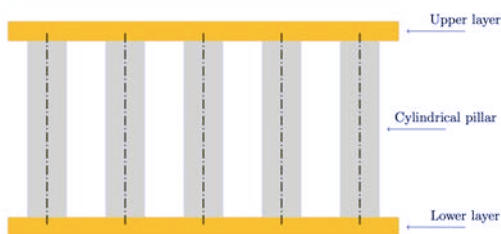

Fig 5.8 A simplified model of a pillared material. Source: AD

The genesis of M41S materials can be traced back to the early 1980s. Researchers then sought to obtain a new class of products that combined both the characteristics of pillared materials and the properties of zeolites. What they arrived at was MCM-22, a material intermediate between a layered precursor and zeolite structure. X-ray diffractometry showed that some of the material's peaks had shifted to higher 2θ values, indicating a contraction of the structure and justifying its properties. Under heat treatment, the chemical bonds had become stronger due to the packing of the layers on top of each other.

The MCM-22 zeolite appeared to be composed of crystalline layers bound to each other by weak chemical bonds, which is why it was possible to 'delaminate' it into individual layers. Once these layers were "pillared", the resulting material was identified as MCM-36. This technique consisted of interrupting the zeolite synthesis process to isolate its layered precursors, and was used to investigate other zeolite families. The synthesis process was interrupted before any diffractometric scanning could reveal the formation of a distinctly crystalline phase. Chemical "pillarizing" reagents were then added, such as high pH alkyltrimethylammonium hydroxide salts or tetramethylammonium silicate. The resulting materials possessed interesting properties attributable to mesoporous materials.

These properties were, for example, the relevant BET (Brunauer–Emmett–Teller) surfaces and the ability to absorb hydrocarbons. The BET surfaces of these products were typically above $1000\text{m}^2/\text{g}$, well above the values of known zeolites. The adsorption capacity

of n-hexane and cyclohexane were over 50% by weight compared to known values for microporous samples. In the words of the researchers themselves we read:

[...] these sorption values were so remarkable that our analytical laboratories initially believed that their test equipment was broken or out of calibration (Kresge *et al.* 2004)

The properties described were characteristic of what would become known as the M41S set of mesopore molecular sieves. Interestingly, X-ray diffractometry was unable to discriminate a well-defined set of peaks, so nothing could be said about the nature of these materials. One of the hypotheses established at the beginning of the investigation was that the dimensions of the crystalline domains were below the capability of X-Ray diffraction technique to detect them.

A better result was obtained through Transmission Electron Microscopy, which could detect a uniform hexagonal pore structure, giving evidence of a new class of materials. A second hypothesis was then made about the nature of the diffraction spectra, namely that they were due to the lattice order of the pores, rather than that of the crystal walls. Such a hypothesis was typical of a new class of materials.

As already noted, the adsorption capacity of hydrocarbons was something never observed before. Benzene adsorption isotherms clearly indicated inflections of pore condensation at benzene partial pressures, indicative of pore size channels. These inflections had not been observed with microporous materials due to the low partial pressures required. In retrospect, it can be argued that the synthesis conditions used in aluminosilicate systems to obtain layered zeolite hybrids and/or larger pore materials, i.e. high pH, high surfactant concentration, and a source of reactive silica, were precisely the synthesis conditions favourable for the formation of mesoporous molecular sieves.

According to the research continued and published in 1992, this class of materials could be obtained (Fig. 5.9) through the following hypothesized steps (Beck *et al.* 1992):

1. from a surfactant micelle a micellar rod is obtained;
2. more micellar rods are arranged in hexagonal close-packed array;
3. the array is silicated and calcinated.

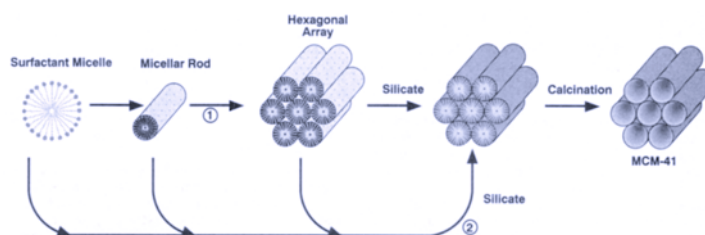

Fig 5.9 The mechanism proposed in 1992 for the formation of MCM-41. (1) Liquid crystal phase initiated and (2) silicate anion initiated. Source: Beck *et al.* (1992)

The discovery of this new class of materials, mesoporous molecular sieves, proved to be a real challenge in understanding the formation of porous materials. Initially, the concept of the formation of these materials was approached in the same way as traditional zeolites. One of the first proposals put forward was that the materials could be formed by some sort

of templating structure or pore-filling agent. This meant, in the case of helioporos molecular sieves, that the templating agent was an aggregation of molecules and not the discrete molecules that normally shape microporous structures.

Based on studies of liquid crystal structures and micelles, it was concluded that the liquid crystal structure existed prior to the formation of the molecular sieve. In the case of MCM-41, this was the hexagonal phase of the liquid crystal. As an alternative to this procedure, it was proposed that the silicate reagent also influenced the formation of these materials. This second proposal seemed to intervene in most systems as data accumulated. This resulted in a significant series that helped to establish the preferred mechanistic pathway. Experiments were then conducted in which the effect of different silica levels at the same surfactant concentration (SUR) was studied. By changing the SUR/Si molar ratio, a series of MCM-41, -48, and -50 materials were synthesised, while keeping the other synthesis conditions unchanged (Vartuli *et al.* 1994). These conditions ruled out the possibility of a pre-formed liquid crystalline phase prior to the formation of the silicone phase, as the same surfactant concentration was used for all experiments. Only the amount of silica added to each solution was changed. These data supported the idea that the anion, in this case, the silicate species, significantly influences the formation of the resulting template of the mesoporous molecular sieves (Kresge, Vartuli, Roth and Leonowicz 2004).

Today, mesoporous silicas are among the most studied materials in nanotechnology research. The importance of these types of submicron particles lies in their large surface area, achieved through the formation of pores. The size of the pores, and the control of their size during preparation of the material, extends the possibilities of their use from their activity as catalysts, to the selective adsorption of precise substances. In order to prepare the porous particles, a micelle triggers a mechanism of nucleation of the particles within the single lipid layer, their subsequent growth and self-assembly. The basic pore pattern is then removed, and the desired mesoporous particle (Fig. 5.10) is finally obtained (Nandiyanto, Kim, Iskandar and Okuyama 2009).

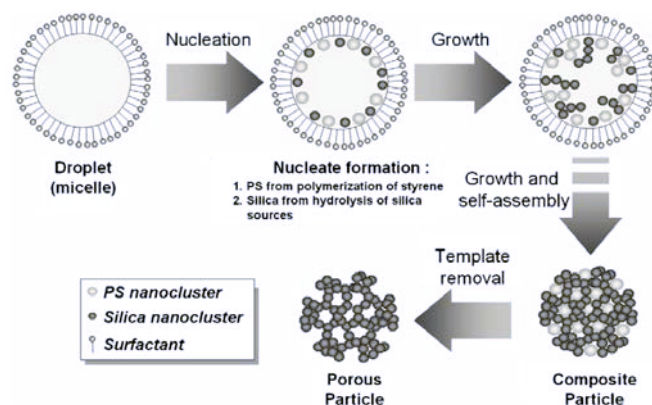

Fig 5.10 The necessary steps to prepare mesoporous silica nanoparticles. Source: Nandiyanto, Kim, Iskandar and Okuyama (2009)

The mesoporous silica nanoparticles obtained through this process can be observed through both transmission and scanning electron microscopy, as is reported in the following pictures (Fig. 5.11).

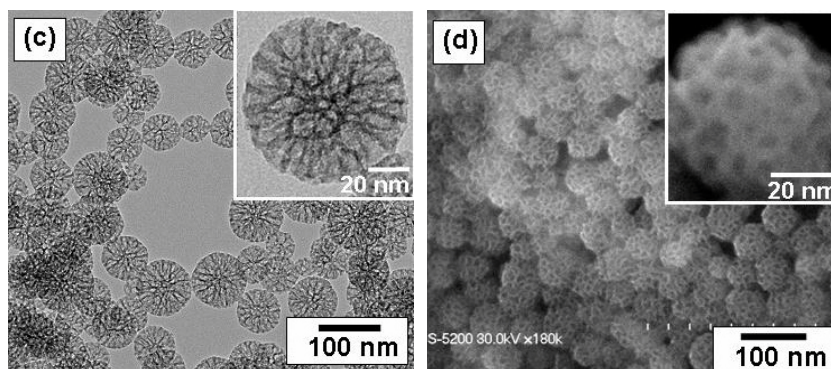

Fig 5.11 Left: Transmission Electron Microscopy image of mesoporous silica nanoparticles. Right: Scanning electron microscopy image of the same material. Source: Nandiyanto, Public Domain

The preparation technique for these materials has involved the use of tetraethyl orthosilicate (TEOS) to form silica, and the polymerisation of styrene into polystyrene, which is required as a template. More recent studies, however, have avoided technical problems in the production of mesoporous silica, such as the possibility of unwanted aggregation and the formation of spheres of uneven grain size. A better precursor proved to be (3–Mercaptopropyl)trimethoxysilane (MPTMS), and the production process proved to be more efficient (Sivanandini, Dhama, Pabla and Gupta 2014).

Common applications of mesoporous silica are grouped in the following list.

- Phospholipid/phosphoprotein removal
- Chromatography
- Drug Delivery
- Hard Templating
- Immobilization of Bioactive Molecules
- Encapsulation of natural oils, flavours and heat sensitive additives
- Polymer Reinforcement
- Catalysis
- Theoretical Confinement Studies

Mesoporous silicas with uniform and tailorable pore dimensions and high surface areas, are currently being employed in a number of advanced applications that include:

- wastewater remediation
- indoor air cleaning
- catalysis/bio-catalysis
- drug delivery
- CO₂ capture
- bioanalytical sample preparation

- pervaporation membrane improvement
- templates for controlling the aspect ratio of quantum–confined nanoparticles and nanowires.

The application areas of mesoporous silica can be individually detailed.

Application Area 1: Mesoporous Silica as Quantum Confirmed Nanowire Host.

Nanoscale semiconductor wires are key materials for interconnects and emerging technologies of the future due to their unique optical, electrical and mechanical properties. Models of semiconductor materials obtained in the gas phase have been successfully exploited by mesoporous silicas, which contain unidirectional arrays of pores, typically 2 – 15nm in diameter, running through the material. Recently, a new solution–phase approach using supercritical fluids has been developed to produce silicon nanowires inside mesoporous silica pores (Coleman *et al.* 2001).

Application area 2: Heavy metal Ion removal from Wastewater using Modified Mesoporous Silica.

Among the most significant environmental pollutants in wastewater are metal ions. Long–term exposure to solvated metal ions and their impact on human health and natural ecosystems must be taken into serious consideration. The group of metals that is always closely monitored for harmful effects on organisms includes chromium, nickel, manganese, iron and various heavy metals. A combination of their toxicity and exposure levels can have serious consequences for the organisms. Precipitation, coagulation/flocculation and ion exchange, reverse osmosis and complexation/sequestering, electrochemical operation and biological treatment are the most commonly used treatments for the removal of metal ions. However, these methods have limitations including, for example, high operational and energy costs. Sorbents such as activated carbon, zeolites and clays have been used as wastewater treatment systems. These materials bring with them structural disadvantages such as relatively low and variable loading capacities and small metal ion binding constants. Ordered mesoporous silicas (MS) are adsorbents that can be exploited due to their large surface areas (typically 200–1000cm²g⁻¹) and large pore volumes and the ease with which they can be recycled/regenerated. Functionalisation of MS with various chelating agents (or specific ligands for metal ions) allows selective removal of specific metal ion pollutants from aqueous or organic systems with large adsorption (Burke *et al.* 2009).

Application Area 3: Phosphate removal from Wastewater using metal–doped Mesoporous Silica.

In the form of phosphate ions, phosphorus is an important element, widely used in agriculture as a fertiliser and in industry as a detergent. The use of phosphorous, however, poses many problems, in particular, eutrophication (an overabundance of nitrates or phosphates) when it is released into aquatic environments. Worldwide, several environmental protection agencies have identified eutrophication as the greatest threat to freshwater supplies, as it leads to fish death and habitat degradation, with the loss of plant and animal species. The use of ordered mesoporous silica (MS) as a good adsorbent of materials such as metal ions and amino acids has proven to be very effective. This is due to a number of characteristics such as its high specific surface area, controlled pore diameter,

and the controlled morphology it can assume, e.g. in the form of spheres, rods and discs. MS is mechanically robust, non-toxic and environmentally friendly. Much research has recently focused on the use of MS functionalised with selective ligands for metal ion adsorption studies. Mesoporous silicas doped with transition metals have proven to be promising candidates for phosphate adsorption. Several doped MS are shown in Figure 3 along with their efficiencies in removing phosphate from model aqueous solutions. In all cases, the doped SBA 15 material shows a high adsorption efficiency (Delaney *et al.* 2011).

Application area 4: Removal of Volatile Organic Carbons (VOCs) from Indoor air using Porous Silica Particles.

Indoor air pollution is closely monitored due to its well-demonstrated harmful effects on human health. It is not difficult to predict that the negative health effects of indoor air pollution will become increasingly significant as lifestyles become even more sedentary. In 2001, a similar prediction was demonstrated in the United States by the National Human Activity Patterns Survey (NHAPS). The research showed that US citizens typically spend 90 per cent of their time indoors. Chemical agents such as aldehydes, in particular, which are used in the production of polymeric materials and coatings, among others, have negative health effects (irritation of the eyes and lungs): formaldehyde and acrolein are suspected carcinogens. Changes in the structural design of buildings and improvements in energy efficiency, together with maximisation of insulation and minimisation of air exchange, have led to increasingly airtight rooms. Modern synthetic building materials, such as sealants, plastics and solvent-based coatings, have further exacerbated the problem of indoor air pollutants. Volatile organic compounds (VOCs), non-volatile organic compounds (NVOCs) and semi-volatile organic compounds (SVOCs) are being studied because they are of particular concern as indoor pollutants. Recent work has shown that porous silica spheres (PSS) can be used to trap various air pollutants, both in a simulated and an indoor environment. The adsorbent was tested at relatively high concentrations (500ppb) and flow rates ($10L\ min^{-1}$). The PSS is more efficient than the commercially available Amberlite XAD-4 resin in retaining non-polar VOCs and significantly more efficient in retaining polar VOCs in ambient air. In a simulation chamber experiment, in the first 10 minutes of sampling, the PSS adsorbent was shown to trap 100 per cent of the gas-phase carbonyl compounds present, while the XAD-4 resin was shown to have various efficiency levels ranging from 100 to 8 per cent during the sampling period for the same group of carbonyl compounds. In contrast, SSPH resin is more effective than XAD-4 resin in trapping polar carbonyls in an indoor environment (Delaney *et al.* 2010).

Application area 5: Metal-doped MS for the Methanolysis of Styrene Oxide.

Hexagonal, zirconium- and titanium-doped highly ordered MS with Si/Zr and Si/Ti ratios of 40:1 and 80:1 were used as solid acid catalysts for the methanolysis of styrene oxide in a single-mode microwave reactor. The catalysts exhibited excellent substrate conversion and high product selectivity and were shown to remain highly active for several reaction cycles. The experimental results clearly showed that zirconium-doped mesoporous silica is an efficient catalyst for the liquid-phase methanolysis of styrene oxide. The isolation of the products required a simple filtration/evaporation step. A typical reaction conducted with a 40:1 Si:Zr catalyst in a single-cavity microwave reactor operating at 105W for 10 minutes resulted in a 100% conversion of styrene oxide. The products obtained from the reaction were 2-methoxy-2-phenylethanol (93%) and dimethylacetaldehyde (7%). Recycling

studies showed that the catalyst remained highly efficient for at least five cycles. Styrene oxide conversion was 95% at the fifth cycle after the catalyst was subjected to microwave irradiation while suspended in methanol (Barreca *et al.* 2006).

Application area 6: Drug/SBA-15 formulations for improving the bioavailability of poorly water-soluble drug molecules.

Increasing the effective surface area of a poorly water-soluble drug that comes into contact with the dissolution medium can, logically, help to improve drug dissolution. Such a result can be achieved by loading drugs onto ordered silica-based MSs, which are characterised by a number of features such as high surface area, large mesopore volumes, narrow mesopore size distribution (5–8nm) and ordered, unidirectional mesopore networks. All these properties enable homogeneous and reproducible drug loading and release. Drug release from its silica support is therefore a key performance indicator to be considered when OMMs are used to improve drug dissolution. Figure 6 shows the in-vitro drug release from drug-silica samples and the dissolution of the starting fenofibrate. The use of MS as carrier material improved the drug dissolution rate for all treated samples (Ahern *et al.* 2013).

Application area 7: Enzyme Encapsulation into MS for bio catalysis.

Immobilising enzymes can give them a number of advantages, including greater stability, ease of recovery and reuse, and the possibility of using them in solutions, such as non-aqueous solvents, in which the enzyme is insoluble. The main disadvantages of immobilisation are usually reduced enzyme activity and increased process costs associated with actual immobilisation. In addition, immobilisation methods tend to be non-specific. Usually, the process of immobilising a specific enzyme on support is optimised and developed on a case-by-case basis. Ideally, the desirable characteristics for support materials, designed for the immobilisation of an enzyme, should be mechanical and chemical stability, a high surface area, be inexpensive to manufacture and exhibit low non-specific protein adsorption properties. Immobilisation must take place without compromising the conformation or activity of the enzyme, while the diffusion process of the substrate and product to and from the active site must not be hindered. MS has been used in a large number of applications, such as a support for enzymes, and in optics as a support for biocatalysis. The adsorption and activity of cytochrome *c* and lipase were studied on two silica supports (SBA-15 and PPS) with the same average pore diameter but different volumes and surface areas. Cytochrome *c* and CALB loadings of 15.6mol g⁻¹ and 2.04mol g⁻¹ were obtained on SBA-15, compared to loadings of 0.94mol g⁻¹ and 6.7mol g⁻¹ on PPS, respectively. The different properties of the substrates (pore volume, surface area and morphology) can be related to the differences in loading. The catalytic activity of cytochrome *c* was comparable on both supports, whereas the activity of CALB was higher on SBA-15 than on PPS (7.8s⁻¹ vs. 4s⁻¹). These differences in activity for CALB probably result from pore morphology and the physical properties of the supports. Such a hypothesis is supported by the higher recyclability obtained with SBA-15 as a substrate. The data indicate that the physical properties of mesoporous silica substrates, such as enzyme activity and stability, may be significantly altered (Abdallah *et al.* 2014).

Application area 8: Doped MS for Phospholipid Extraction from biological matrices.

Food matrices are notoriously difficult to process, as they contain many unwanted or interfering compounds (e.g. phospholipids). Samples often require a cleaning step combined with extraction prior to LC/MS determination. Titanium-doped MS (SBA-15 doped with titanium) was used as a dispersive SPE (dSPE) approach based on Quick, Easy, Cheap, Effective, Rugged and Safe (henceforth QuEChERS) for the preparation of liver tissue samples. Titanium-doped MS was used for the preparation of biological sample matrices prior to HPLC analysis. Studies conducted on doped silica have a preferential selectivity for the phospholipid content of certain sample matrices without removing the analyte of interest from the sample. The SBA-15 class doped sorbents are based on a new high-purity silica doped with titanium. The impregnation or doping of the titanium fraction in the silica structure resulted in significant advantages in terms of robustness and chemical stability over both other metal-silica hybrid materials (in which the metal fraction is attached to pure silica) and conventional silica. The results showed that the recoveries of samples treated with titanium-doped MS were higher than those of samples treated with conventional C18 sorbent material. The average recovery of the SiTi-C18 sorbent was 116% with a standard deviation and coefficient of variation of only 6%, while the C18 sorbent only provided a recovery of 79% with a slightly higher standard deviation and coefficient of variation of 8% and 9%, respectively. The SiTi(4%)-C18 sorbent proved to be more effective than the conventional C18 sorbent used in the QuEChERS-based method for the preparation of d-SPE anthelmintic samples.

Application area 9: Incorporation of PSS into Pervaporation Membranes for the separation of Water from Ethanol.

Dehydration, solvent recovery and separation of organic-organic mixtures are processes that are implemented mainly through pervaporation a membrane separation technology. This process has two significant advantages over other separation techniques. On the one hand, it can be used to effectively “break up” the azeotropes in mixtures without the physical difficulties typically associated. On the other, it avoids the negative environmental impacts of techniques such as azeotropic distillation. The inclusion of porous particles in the polymer matrix, e.g. zeolites and silica particles, has proven to be an applicable method to improve membrane flux without significantly compromising selectivity. In hybrids in which the membrane is of the porous ceramic-polymer hybrid type, the need to engineer the particles, i.e. to intervene in size, shape, monodispersity, pore size and surface chemistry, is a major factor. The incorporation of engineered PSS into pervaporation polymer membranes can be very beneficial. A statistically significant increase in both flux and selectivity is derived from results showing the effects of incorporating discrete, dimensionally monodisperse spherical mesoporous silica particles of 1.8-2 μ m in diameter and with a pore diameter of 1.8nm, into a poly(vinyl alcohol) [PVA] polymer to produce composite membranes. Unlike zeolite systems, PSS can be engineered in a very controllable way to achieve a wide range of pore sizes and chemicals. In this way, new generations of membranes can be produced for various applications through the pervaporation process (Flynn, Keane, Tabari and Morris 2013).

Application area 10; Direct Air Capture of CO₂ using modified MS Sequestration of CO₂, either from gas mixtures or directly from air (direct air capture, DAC), could mitigate carbon emissions.

Developing a new generation of porous materials is key to enabling the “gas era”, in which new technologies are developed around the use of gases. Carbon dioxide (CO₂) represents a topical challenge in this context: anthropogenic CO₂ emissions are considered by science to be a significant risk to the global climate; carbon dioxide is an undesirable component of commodities such as natural gas and biogas. Recent work has shown that amine-functionalised SBA-15 out has functioned as a reference material for Metal Organic Frameworks (MOFs) and Zeolites. (Kumar *et al.* 2015).

5.1.3 1993: CdE Semiconductor Nanocrystallites

The evolution of the properties of materials as their size changes is one of the characteristics that are monitored with interest because it is known that nanoparticles exhibit completely different behaviours to materials of macroscopic dimensions. These behaviours appear quickly and allow the same material to be studied from different points of view. The nanometric dimension, in particular, offers the opportunity to analyse the collective behaviour of the material, moving away from the typical behaviour and characteristics of the molecular nature of substances. Among the new behaviours that have emerged at this order of magnitude are non-linear optical effects, a consequence of highly polarisable excited states, and new photochemical behaviour. It has been shown that the physical properties of semiconducting nanocrystals are dominated by the spatial confinement of electronic and vibrational excited states.

Considerable interest has been aroused by phenomena such as quantum confinement and the widening of the HOMO-LUMO (Highest Occupied Molecular Orbital-Lowest Unoccupied Molecular Orbital) gap as the crystallite size decreases, and by their consequences on the electronic structure and photophysics of the materials. The study of the properties of these materials was, however, dependent on their controlled synthesis. Polydispersions in size and shape, poor crystallinity and surface electronic defects made it difficult to interpret the results obtained through optical experiments. Each sample had to be characterised by a high degree of monodispersity in terms of size and shape, e.g. regularity of the crystallite core structure and consistent derivatisation (substitution of functional groups) of the surface.

Analyses of these properties were conducted in the early 1990s on near-monodisperse, high-quality samples of CdE, where E is a non-metal such as sulphur or selenium, or a semimetal such as tellurium (Murray, Norris and Bawendi 1993).

Organometallic reagents were injected into a hot coordinating solvent in order to activate a nucleating reaction at discrete time intervals. Maintaining a controlled reaction time and slow growth, the surface of the particles underwent uniform derivatisation, while the nucleus was regularly structured. Subsequent selective precipitation by particle size allowed the collection of practically monodisperse particles that could be incorporated into a variety of solvents. When observed, the crystallites appeared slightly prolate in shape (oval and elongated along the major axis) with an aspect ratio of between 1.1 and 1.3; the size of the crystallites, determined by the size of their major axis, ranged between 12 Å and 155 Å.

Once their quality had been examined in the laboratory by means of optical absorption and luminescence experiments at room temperature, it proved to be very high. Transmission Electron Microscopy and powder X-ray diffraction were used, along with computer simulations, to determine the structure of the crystallites and characterise them.

Lyophobic, monodisperse colloids have been the subject of study since the time of Michael Faraday (1791–1867) and his gold nanoparticle solutions, studies published by the Royal Society in 1857 (Faraday 1857). In recent times, it has been shown that the production of monodisperse lyophobic colloids depends essentially on two factors: nucleation occurring over a discrete time interval and controlled growth on the existing nuclei thus formed (LaMer and Dinegar 1950). When Murray and his collaborators proceeded with the experiment, they achieved discrete nucleation through an initial rapid increase in reagent concentrations that led to supersaturation of the solution; this was self-reduced by the formation of the nuclei and the subsequent growth on the obtained nuclei. A key factor in achieving important results in controlling the growth process turned out to be the choice of solvent, which was oriented towards mixed phosphine/phosphine oxide solutions for the high-temperature growth of, for example, CdSE crystallites.

Homogeneous nucleation occurred suddenly as soon as the reagents were introduced into the reaction environment at a high temperature; after the first nuclei had formed, and following the abrupt drop in temperature following the introduction of the reagents, nucleation stopped spontaneously. The controlled growth of crystallites was then carried out by annealing the products. This phenomenon of crystallite growth appeared chemically/physically compatible with the process known as “Ostwald ripening”. According to this process, small particles tend to disintegrate, favouring the growth of larger particles, as shown in the following picture (Fig. 5.12).

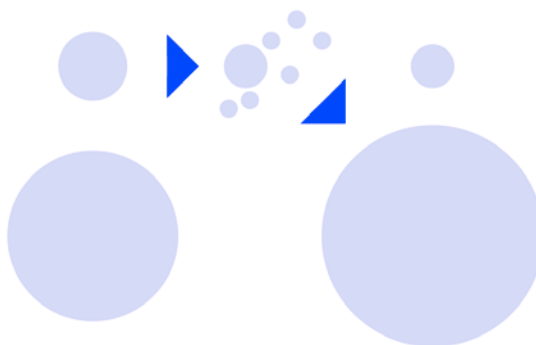

Fig 5.12 According to the Ostwald ripening process, smaller particles break into smaller ones, because of high surface tension, and these contribute to the growth of larger ones. Source: AD

In fact, smaller particles have a higher surface tension than larger ones, because their surface-to-volume ratio is energetically disadvantageous. Molecules on the surface are energetically less stable than those in the interior of the particle, are consequently more reactive, and will therefore tend to pass more easily into solution. This will make free molecules available for further growth of the larger volume particles, as a result of what can be described as a stability gradient.

The growth of the particles, a consequent result of this transport process, led the researchers to obtain high-quality monodisperse colloidal solutions from initially polydisperse systems. Both the average size and the size distribution of the crystallites were dependent on the growth temperature, a result compatible with considerations of surface free energy, which decreases with increasing surface size. The system temperature had to

be increased gradually and slowly to ensure constant growth and uniform particle size, but had to be decreased when the crystallite grain size was too heterogeneous. The width of the absorption lines was the key parameter for measuring and maintaining a constant size distribution of the growing crystallites. The Oswald ripening process, on the other hand, accentuates any kinetic or thermodynamic “bottleneck” process in crystallite growth. As this situation approaches, refining the crystallite size reduces the reaction thermodynamics and blocks any further growth. Observing the characteristics of the absorption lines at precise average particle diameter sizes, such as 12, 20, 35, 45, and 51 angstroms, could indicate the presence of these bottlenecks. Controlled, slow growth then produced a coherent crystal structure and allowed for size selection by periodically extracting samples from the reaction environment.

The force of attraction between lyophobic colloidal particles is due to Van der Waals (VdW) forces and is a very strong interaction because the forces acting between pairs of unit cells of different particles are practically additive (Sato and Ruch 1980). However, colloids remain stable, in terms of aggregation, as long as a repulsive force of sufficient modulus is established to counteract the VdW attraction.

Also in 1993, a study by Sukumar and Doremus, *Growth Kinetics of CdS Nanocrystallites in Glass through Quantum-Size Effects*, looked at the properties observed in glass in which CdS particles were contained. They observed changes in the optical absorption spectra of CdS glass and attributed the causes to quantum confinement effects. With very small particle sizes, it was possible to obtain large confinement energies of up to 4eV, measurements never before obtained. The blue shifts of the optical absorption spectra also showed that the short-term particle growth rate was controlled by diffusion, and the activation energy of the reaction was calculated for the growth of the structures. The band gaps of the CdS nanocrystallites in the glass were determined by photoluminescence measurements, which showed a high-energy peak, corresponding to the band gap, that had not been observed previously (Sukumar and Doremus 1993). CdS glass, itself colourless and transparent, developed a yellow colour and retained its transparency after heat treatment between 625°C and 725°C. Absorption spectra of this glass heated at 650°C for different times showed absorption edge shift according to the blue-shift phenomenon after longer heating times. This demonstrated quantum confinement effects in this glass. Similar absorption spectra were obtained for samples heated at 625°C, 675°C and 700°C for different times. The photoluminescence spectrum of a sample heated at 725°C for 4 hours consisted of two bands: a less intense high energy band centred around 2.55eV and a broader low energy peak around 1.71eV.

Since the glass samples contained very small CdS particles, the diffusion losses due to these particles are negligible. This blue-shift can therefore be used to study the early kinetics of CdS particle growth in glass. When the crystal size is very small, both the valence and conduction bands split into sub-bands (Borrelli, Hall, Holland and Smith 1987), and this splitting results in higher absorption energies than the bulk band gap energy (about 2.5eV for bulk CdS and inter-band transitions). This higher effective band gap energy was called the quantum confinement band gap energy. Brus (Brus 1984) calculated this confinement energy as a function of crystallite size, which could be expressed by the:

$$E_{g,c} - E_g = \frac{h^2}{8\pi^2\mu a^2} - \frac{1.8e^2}{\epsilon a} \quad (5.12)$$

where E_g , is the bulk band gap energy, h is the Planck constant, μ the reduced mass of electrons and holes, a the radius of the crystallites, e the electron charge, ϵ the dielectric constant of the crystallites. The first term is the confinement energy of electrons and holes and the second term is the coulombic interaction energy.

Some authors (Borrelli, Hall, Holland and Smith 1987, Ekimov, Efros and Onushchenko 1985) neglected the Coulombic interaction term when comparing variations in the band gap with particle size and growth kinetics. If the variation of the band gap energy $E_{g,c}-E_g$, calculated from (5.12) is plotted as a function of $1/a^2$, the trend is nearly linear for Brus' calculation (Brus 1984) for CdS particle diameters from 4nm to 10nm. However, this result does not mean that the coulombic term is negligible, as it makes an appreciable negative contribution to $E_{g,c}-E_g$. Lippens and Lannoo (Lippens and Lannoo 1989) calculated the variation of the gap energy using the tight-binding approximation and a recursion method. Their results also turned out to be almost linear on a graph of $E_{g,c}-E_g$, versus $1/a^2$ for particle diameters of about 5nm to 2.5nm, but fell below this linear graph for smaller particle diameters. Therefore, the following equation was valid in certain particle size ranges:

$$E_{g,c} - E_g = \frac{K_1}{a^2} \quad (5.13)$$

where K_1 was a proper constant. In a diffusion-controlled growth process, with all nuclei forming at the initial instant $t = 0$, the average particle size, a is proportional to $t^{1/2}$. The energy shift could then be written as:

$$E_{g,c} - E_g = \frac{K_2}{t} \quad (5.14)$$

where K_2 was another constant.

Therefore, the experimental graph of $E_{g,c}$ versus $1/t$ resulted in a straight line for diffusion-controlled growth (Fig. 5.13).

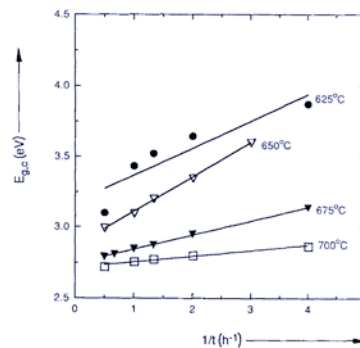

Fig 5.13 The plot of the confinement energies versus the reciprocal of time, plotted for CdS glass samples heated at different temperatures. The position of the lines at the different temperatures is to be noticed. Source: Sukumar and Doremus 1993

The figure shows good agreement with the equation (5.14) for the temperatures of 650°C, 657°C and 700°C, but the data interpolation at 625°C is not as good as the others. Despite this mathematical behaviour, it is remarkable to observe that energy values greater than 3.5eV had not been reported in literature before the research conducted by Sukumar and Doremus (Fuyu and Parker 1988).

The confinement energies were determined from the absorption spectra presented in the figure below and similar results obtained at other temperatures (Fig. 5.14).

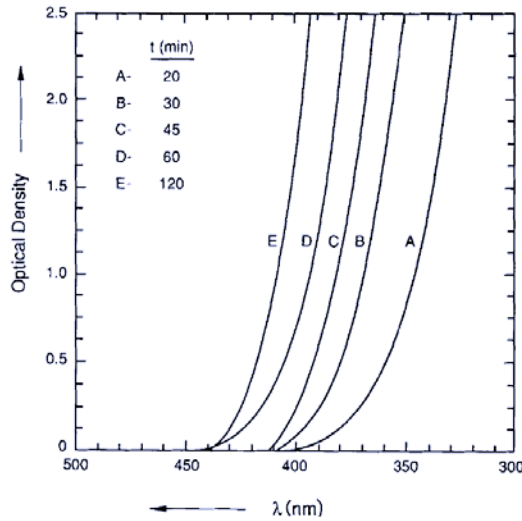

Fig 5.14 The absorption spectra of the CdS glass heat-treated for various times. Longer times of treatment result in left-shift of curves. Source: Sukumar and Doremus 1993.

The absorption of light by a semiconductor through direct band gap transitions was given by the following relationship between the absorption coefficient, α , and the frequency of light ν :

$$\alpha = [Q/(h\nu)^{1/2}][1 - (E_g/h\nu)]^{1/2} \tag{5.15}$$

where Q is a constant. Using the relation $\nu = c/\lambda$, squaring both the sides of the equation for α and rearranging we get:

$$\alpha^2/\lambda^2 = Q'/[(1/hc\lambda) - (E_g/h^2c^2)] \tag{5.16}$$

and $Q' = Q^2$. The relationship between α^2/λ^2 and $1/\lambda$ could be plotted on a straight line. The optical density (or OD) was equal to $\alpha t / 2.303$, where t was the sample thickness. So

$$OD^2/\lambda^2 = Q''/[1/hc\lambda - (E_g/h^2c^2)] \quad (5.17)$$

where Q'' is another constant. When the experimental data were plotted as OD^2/λ^2 versus $1/\lambda$ then the straight line portion of that plot represented the equation above (Fig. 5.15).

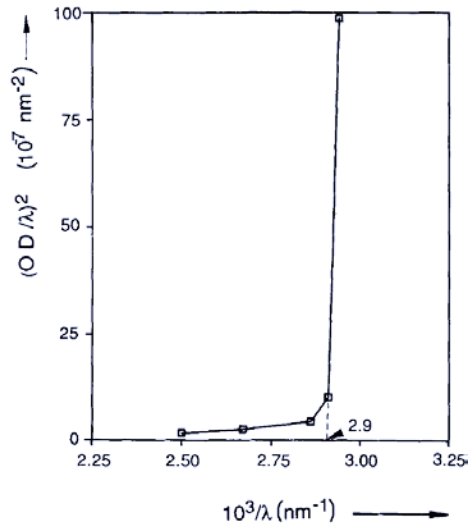

Fig 5.15 This plot allows to determine the confinement energy for the CdS glass sample heated at 650°C, for 20 minutes. Source: Sukumar and Doremus (1993)

The effect of the particle size distribution was another parameter considered. When faced with a narrow distribution, the absorption edge was sharp. But as the particle size varied, especially if the variation was large, in values, the absorption spectra were the result of a broad distribution of band gap energies. The absorption edge was not as sharp in this case as for samples heated to 625°C. The researchers hypothesised the reason for linking a broad size distribution to simultaneous nucleation and particle growth, and it was related to temperature, as it was more likely to occur at a lower temperature, such as 625°C.

The most important result obtained from the luminescence studies was to observe the presence of a high-energy peak for glasses containing pure CdS particles, as can be seen in the figure below (Fig. 5.16).

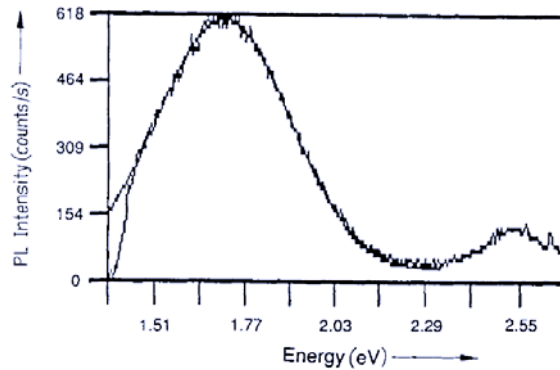

Fig 5.16 The photoluminescence spectrum of the sample treated at 725°C. Source: Sukumar and Doremus (1993)

In the literature, this high-energy peak for glass containing pure CdS samples had not been observed (Borrelli, Hall, Holland and Smith 1987). Since this peak resulted from emission caused by direct electron-hole recombinations across the band gap, the position of the peak had to correspond to the band gap energy.

The value of 2.55eV for this peak suggested that the CdS particles showed some quantum confinement even after heating the glass to 725°C for 4 hours. TEM analysis on this sample showed that the particle sizes were between 5nm and 6nm. The exciton radii for the CdS particles were between 3nm and 4nm (Ekimov, Efros and Onushchenko 1985). This value was consistent with the observed confinement effect and the band gap of 2.55eV, which is higher than the bulk band gap of about 2.4eV for CdS. The origin of the large low-energy peaks in the luminescence spectra was not well understood and was attributed to surface radiative recombinations. The study of the optical absorption of CdS glass thus provided valuable information on the growth mechanism and activation energy for the growth of CdS particles in glass. The initial growth process of CdS particles in the glass matrix was found to be controlled by diffusion phenomena. At low temperatures and short heating times, the initial size of the particles also had to be carefully taken into account in order to correctly predict their growth mechanism.

5.1.4 1994: Molecular Machines

The transversality that characterises the world of nanotechnology, in terms of the disciplines it covers, can be appreciated thanks to the work that Drexler developed in 1994, an ideal continuation of Engines of Creations and his Doctoral Thesis. In that year, in fact, he summarised advances in the realisation of molecular machines and their systems and described new strategies for the synthesis and assembly of what he called large systems (consisting of more than 106 atoms).

An early definition of a *molecular machine* denoted such devices, “usually an assembly of polymer molecules is a structure capable of converting energy from one form or place to another” (Urry 1993); Drexler, on the other hand, focused on a less extensive number of objects, where the combinations of molecules formed “a structure composed of a structure

and various fixed and movable parts, in order to perform a certain type of work” (Guralnik 1970), according to a specific terminology that could be traced back to the specific vocabulary of mechanics applied to machines.

The chemical synthesis leading to these objects, controlled through mechanical processes, what Drexler called mechanosynthesis (Drexler 1994), had been documented through a series of writings:

- that described the useful activities that molecular systems could perform (Drexler 1991, 1992);
- which described how they could perform calculations (Drexler 1987, 1988, 1992; Merkle 1993).

The importance of systems of this type thus went beyond the simple transformation/transfer of energy, as they were capable of processing information and modifying matter: mechanosynthesis was thus used to create systems capable of performing other functions.

Drexler compared solution synthesis and enzymatic synthesis with mechanosynthesis in his work, describing the physical principles of mechanosynthetic systems and processes. He later described the state-of-the-art techniques for implementing molecular machine systems through mechanosynthesis.

The atomic force microscope was the instrument Drexler had identified as the fundamental tool for performing molecular positioning, and protein engineering could be considered the basis for the design and construction of complex functional devices. Brownian self-assembly of protein-like molecules could have led, in Drexler’s idea, to the construction of molecular machines.

Chemical synthesis in solution involves the molecules of the reactants moving in diffusion and their encounter occurring either in random positions or in random orientations. This, however, poses difficulties related to the specificity of the reaction. This is because large molecules - characterised by numerous functional groups - possess a greater potential number of reaction sites and can therefore be converted into more products, which is not the case for small molecules. The net yield of a 10,000-step sequence of large molecules was measured to be 10^{-11} , effectively zero product from whatever amount of useful material is available at the start.

An enzymatic synthesis is different from a solution-phase synthesis, although there is a spectrum of intermediate cases between them. An enzymatic reaction begins with the bonding of the reactants, an operation that serves to place the molecules in specially controlled positions and orientations (Creighton 1993). High effective concentrations, derived from this placement, result in high reaction rates, while the specificity of the bonding interactions determines the reaction geometries, resulting in highly specific reactions. Most alternative reactants do not bind to the active site, while most alternative reaction geometries are avoided between the bound reactants.

By definition, mechanosynthesis differs from enzymatic catalysis, but many principles can be recognised as common and applied between the two techniques. Molecular machine systems could position reagent molecules relative to one another. Not only that, but they were able to drive chemical reactions with a degree of specificity not observed in solution-phase chemistry (Drexler 1992). The strain energy applied by enzymes was only slightly more than a fraction of the potential binding energy of the substrate (Creighton 1993), but power-driven mechanosynthetic devices could apply strains of such magnitude as to break bonds (Drexler 1994). The creation of enzyme-like reaction environments was also feasible.

Mechanosynthesis was possible, according to Drexler, using laboratory devices such as scanning tunnelling and atomic force microscope mechanisms (STM and AFM). Mechanically controlled synthesis was already achieved by arranging 35 xenon atoms on a nickel crystal to obtain the “IBM” inscription (Eigler and Schweizer 1990). According to Drexler, mechanosynthetic systems could accelerate desired reactions and block side reactions that were not functional to the overall process. Controlling the probability of a given localised reaction through the mechanical positioning of reactive groups was one of the first strategies applied.

The description of the basic parameters of mechanosynthesis was the first step taken in Drexler’s paper.

The first of these that Drexler described was effective concentration. Solution–phase processes provided a convenient reference point and allowed a description in terms of effective concentrations. Considering a reaction between two groups, called for example A and B, whether they are connected to free diffusing molecules in solution or to a single flexible molecule, it is possible to mathematically define the effective concentration through the ratio:

$$C_{\text{eff}}(M) = \frac{k_{\text{intra}}(s^{-1})}{k_{\text{inter}}(M^{-1}s^{-1})} \quad (5.18)$$

The release of steric voltages, what is known as the piezo–chemical effect, could accelerate intramolecular reactions in the same way as electronic effects, proximity, and orientation. The actual concentration values were lower than the typical concentration of water molecules in the liquid state when the A and B groups were bound by a flexible polymer, whereas when A and B are arranged in the correct orientation to give rise to a reaction, the concentration was much higher.

The effective concentration of an oriented and favourably positioned group gave rise to a spatial probability density greater than, or equal to, that of a coordinate system based in the other group. This probability density could be calculated from the temperature values and potential energy surface of the system. In terms of the reciprocal rigidities, c , measured in m/N , the potential energy of a group positioned by a linear mechanical system was obtained from the formula:

$$V = \frac{1}{2} \left(\frac{\Delta x^2}{c_x} + \frac{\Delta y^2}{c_y} + \frac{\Delta z^2}{c_z} \right) \quad (5.19)$$

made an appropriate choice of co–ordinates to measure the displacement of one group with respect to another. A prerequisite was that the deformation of the groups themselves could be approximated as linear.

Other fundamental parameters that Drexler considered for his description were the probability density and the effective concentration. The probability density of a harmonic system is, by definition, the product of the Gaussian probability densities along each of the coordinates. This definition holds true in statistic mechanics, both in its classical formulation and in its quantum formulation. The comparison between the results of classical mechanics and those of quantum mechanics had proven the adequacy of the classical

approximation in the description of most mechanical systems of nanoscale or higher at room temperature. Quantum mechanical corrections became significant (>0.1) only, for example, for displacements of individual hydrogen atoms. According to the classical approximation, the Gaussian distribution for a single coordinate is mathematically characterised by the standard deviation:

$$\sigma = \sqrt{c_x kT} \quad (5.20)$$

The local concentration of a group, C_{local} , at the peak of the Gaussian function is:

$$C_{local} = [1000N_A \cdot \sqrt{c_x c_y c_z} \cdot (2\pi kT)^{3/2}]^{-1} \text{ (M)} \quad (5.21)$$

where N_A is the number of Avogadro and the energies have to be measured in joules.

The local concentration calculated above was approximately equal to the actual concentration in the absence of orientation effects, which could increase the actual concentration by several orders of magnitude. This was verified, according to Drexler, when the transverse compliance of the transition state was small compared to the compliance of the positioning mechanism. Such a formulation neglected the steric interaction of the two reactant groups. In general, this interaction increased the effective concentration through excluded volume effects.

Another useful model for various mechanosynthetic systems examined the positioning system as if a force along the z -axis were applied to force a group against a non-rigid wall. Neglecting the rigidity along the z -axis, the probability density function has an exponential trend in z , while it remains Gaussian in x and y . The effective concentration was therefore:

$$C_{local} = F [1000N_A \cdot \sqrt{c_x c_y} \cdot 2\pi(kT)^2]^{-1} \text{ (M)} \quad (5.22)$$

where F is the force applied, measured in newtons.

Confining the reaction groups to a smaller volume of space increased the frequency of reactive encounters between the groups, while positional control of the reactants could inhibit reactions at remote sites. This effect was enthalpic: moving the group to a remote reaction site imposed large strain energy on the support structure. Mechanical forces could also reduce the reaction energy barriers through appropriate strain energy. More accurate models of mechanosynthetic control could also be developed from the theory of transition states, i.e. quasi-equilibrium states between reactants and activated products/complexes, and from knowledge of the reaction potential energy surface, but Drexler made no mention of this, limiting himself to models based on effective concentration.

They were more than adequate to show how reaction rates could be accelerated at certain sites, while reactions at alternative sites, although chemically equivalent, could be suppressed. They thus gave specific control over reactions.

In the intentions of Drexler, who, let us remember, is trained in engineering, a mechanosynthetic device had to be able to bind reactive molecules (or groups of molecules) and position them in relation to an object to be made. Such a device had to possess a structure of considerable size and stiffness, and had to be able to move with respect to

several controllable degrees of freedom (from six or more). All these design and functional requirements were in fact very similar to those required for the design of an industrial robotic arm. Such a device was quite fundamentally different from known biological structures and solution–phase systems consisting of small molecules or enzymes.

Molecular machine systems were supposed to operate in a quasi–deterministic regime, which means that the sequence of operations they performed had to be predictable. Thus, precise conditions had to be verified:

1. the mechanical stiffness of the device had to be such that it could contain oscillations due to thermal fluctuations, in other words, these fluctuations would rarely place an assembly at an unselected reaction site;
2. all energy barriers between permitted and forbidden states had to assume large values in relation to kT , in other words, Drexler interpreted this condition as one to prevent slippage between gear teeth;
3. the system had to pass through a specific sequence of states at an acceptable ratio, in other words, the positioning mechanism had to follow a predefined path during the operations to be performed.

A mechanosynthetic device, as envisioned by Drexler, was based on the principle of Stewart’s platform, where a system of six struts paired two by two allowed for the controlled motion of a platform, as shown in the image below (Fig. 5.17).

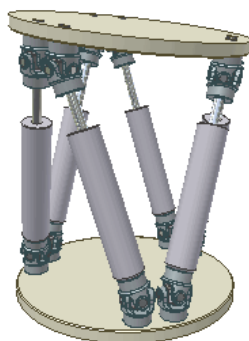

Fig 5.17 A model of a Stewart platform. See the six struts jointed to a base whose length can be changed to move the upper platform according to six degrees of freedom. Source: UtzOnBike, nickname

Molecular machine systems could also be realised through diamondoid structures. These had a very high stiffness, having Young’s modulus between 250GPa and 1000GPa, and were advantageous because the structural units consisted of single atoms. Machines of this type could be used to make bearing systems.

There were two ways thought of to develop molecular machine systems for mechanosynthesis: (a) one focused first on the mechanosynthetic capabilities that would be used to build molecular machines; (b) one first performed the design of the molecular machines, then used to perform mechanosynthesis. In both cases, the processes would lead to initial products such as polymeric structures. The solution–immersed mechanosynthetic systems were supposed to enable the assembly of complex structures from joined monomers

to form a broadly cross-linked polymer. Young's modulus for protein structures would presumably have been no less than that for structural proteins: 40Pa for wool (containing alpha-helical keratin), 10GPa for silk (along the beta-strand direction) (Vincent 1982), an estimated 10GPa for bacterial flagella and F-actin (globular protein polymers) (Oosawa and Asakura 1975). The stiffening of self-assembled structures would be possible by incorporating grooves that bind stiffer polymer chains or chemical precursors to chains or networks.

Biological and chemical components could be considered as starting points for developing self-replicating molecular systems: the chain reaction of an enzyme such as polymerase replicates DNA strands under cyclic conditions (Mullis *et al.* 1986). A laboratory-controlled biological/chemical system avoids all the complexities typical of the metabolic activities of an actual cell because all information and requirements are provided with a priori. Through this simplification, mechanosynthetic systems of molecular machines can replicate structures similar to themselves once they are externally guided (Drexler 1994, Merkle 1992).

The atomic force microscope allows the probe tip to be placed on surfaces with a positioning accuracy of approximately 0.01nm and forces of up to 0.01nN (Weisenhorn, Hansma, Albrecht and Quate 1989). These devices have been used for both imaging and dissecting biomolecular structures, such as plasmids (Hansma *et al.* 1992) and membrane gap junctions (Hoh *et al.* 1991). Due to their degree of control with regard to position, AFMs are particularly suitable for use as a means of placing structures in a mechanosynthetic system. The rigid attachment of molecules (e.g. monoclonal antibody fragments) capable of binding and orientating reagent molecules from a dilute solution (Drexler 1991, 1992; Drexler and Foster 1990) still needed, according to Drexler, to be fully investigated and developed. A possible sequence of objectives in this development was to include: (a) the attachment of desired molecules to the tips in controlled orientations, (b) the positioning and attachment of different reagent groups and (c) the realisation of increasingly complex systems by extending these operations. Drexler himself had already formulated an approach to the development of molecular machines and observed that it had considerable advantages.

Drexler then described the constraints and strategies for self-assembly in his 1994 paper. First of all, each step of self-assembly necessarily involved the coming together of two or more smaller units. All these units had to be soluble and each block had to bind in a specific way and with appropriate kinetics: improper bonds had to be rare or possibly reversible. The resulting assembly had to be kinetically stable through the consolidation of covalent bonds between the units, or be stabilised by further operations. Self-assembled structures had to be characterised by a certain stiffness in order to be used as machine components. this requirement favoured structures with dense internal packing, ideally of rigid and voluminous sub-structures. The joining of larger elements, together with the combination of many weak interactions, was generally more useful than the formation of a few strong bonds as the weak interactions could combine to give a strong bond in a particular geometry. This phenomenon resulted in reliable assembly steps. Any large asymmetric structures, suitable for use as machine systems, could be assembled using several strategies: (1) giving each subunit interface a structure with peculiar binding propensities (as in the ribosome) by simultaneously mixing blocks of all types. (2) emulating a solid-phase synthesis, using cyclic exposure to different subunits to control the sequence of component addition.

The latter approach was not comparable to biologically inspired models for controlling self-assembly (Lindsey 1991). In turn, the surfaces of the assembled components would have to satisfy various functional constraints, including the presence of binding sites for other molecules and electronically active components. Binding other molecules could have

provided a mechanism to modify the surface structure after the primary process of self-assembly. The binding of these molecules could help to fulfil the conditions (Drexler 1992) for interfacial sliding with small energy barriers, thus facilitating the design and fabrication of support surfaces.

Drexler also observed that the construction of polymeric units with stably folded conformations appeared advantageous due to their ease of design, assembly kinetics and the avoidance of unwanted aggregation, and this was an important construction goal. Nucleic acids were considered as materials of construction due to their ease of synthesis and design. However, when compared to protein structures, which are very versatile in biological systems, nucleic acids appeared less attractive as structural components. Proteins, in fact, could on the one hand be produced by biological means, and on the other hand could resemble natural models. The engineering of proteins therefore appeared to be a very promising route towards the realisation of molecular machine complexes.

Research in this direction would lead to an understanding of the relationships between structures and stability in natural proteins (Shortle 1992). Engineering non-standard molecules, on the other hand, would have extended the knowledge gained from studying standard proteins to create structures with more predictable behaviour. This approach would follow one of the cornerstones of nanotechnology, relating to the manipulation and creation of structures on a molecular scale. Individual structures could then be designed according to different conformational specifications, branched or looped, reduced flexibility or enhanced packing density, reduced torsional deformation or enhanced core hydrophobicity.

In fact, the objectives to be pursued could be summarised as follows.

1. Development of increasingly standardised procedures for the design of stable protein-like structures,
2. design of protein-like structures that can be assembled to form tightly packed structures,
3. extension of the design capability to obtain aperiodic structures of the necessary mechanical stiffness,
4. design and realisation of complex structures as basic components for molecular machine systems (Drexler 1994).

Artificial molecular machines capable of performing mechanosynthesis, therefore, can be conceived in great detail, and existing techniques make it possible to take steps towards their realisation. Consequently, realising mechanosynthetic systems is the first step towards devices capable of performing the mechanical guidance and control of molecular interactions in chemical synthesis. The development of suitable monomers, binding sites and reaction sequences, in turn, can form the basis for the realisation of complex mechanical structures. Advances in protein engineering suggest that the means to design and synthesise protein-like molecules with well-defined structures and excellent stability are in fact already available. The development of molecular machine technology promises a wide range of applications. Artificial molecular machine systems could presumably be developed to, for instance, read DNA sequences into the memory of a conventional computer, rather than transcribing them into RNA, while self-assembling structures are widely regarded as a key to molecular electronic systems that thus share an enabling technology with molecular machine systems.

Finally, some studies suggest that the use of molecular machine systems to perform mechanosynthesis of different structures will enable the development and low-cost production of a wide range of new tools and products (Drexler 1981, 1992; Merkle 1992).

5.1.5 1995: Electron Emission from Nanotubes

In the mid-1990s, interest grew in phenomena manifesting themselves at the nanoscale as new application possibilities for technologies that were being developed at the time. In particular, researchers' attention focused on semiconducting nanocrystals and their 3D quantum electronic confinement properties, and on near-field optical spectroscopy of single molecules. Both of these areas of research were oriented towards the study of phenomena on scales far below the macroscopic. When nanocrystals are considered, the fundamental scale is the intrinsic length of the delocalisation of electrons and holes, whereas, in optics, the fundamental length is known to be the optical wavelength. In the study of semiconducting nanocrystals, the study of the size-dependent band structure and the study of bulk-like optical properties, both at a scale of 1–10nm, proved to be of interest. Under these conditions, the dynamics of electrons and holes are conditioned by quantum effects in three dimensions; these are the structures that have been called quantum dots. In 1995, Brus and Trautman investigated direct gap CdSi and indirect gap Si, showing that in the former case, the main confinement effect was spectroscopic, while in the latter case, it was kinetic (Fig. 5.18). For near-field scanning microscopy (NSOM), the authors focused on studying the confinement of light at 1/10th of a wavelength, evaluating the optical properties on a scale between 10 and 100nm. They obtained the luminescence spectra of individual molecules and nanocrystals at room temperature. This made it possible to observe spectral variations and, through them, changes in structure in materials.

The figure below briefly shows how the properties of mass and estimated number of atoms of matter, in terms of increasing size, are related to spectroscopic regions. Within the latter, basically three 'regimes' are identified. The first is the molecule, followed by the quantum dot, nanocrystal or quantum crystallite, and finally the polariton, following a decreasing scale. When it comes to groups of 10–15 atoms, the study proved that the diamond lattice was not stable with respect to isomerisation, the transformation of a compound into its isomers through the breaking of chemical bonds and the formation of others, resulting in molecular structures that resolve open surface bonds. When analysing quantum dots, between 1nm and 10nm, one can imagine the object of analysis as a fragment removed from a massive lattice structure. The difference arises in the electronic properties, in relation to size. In the latter case, that of the quantum dot, a strong 3D quantum confinement was observed, with a discretization of the excited states, while the gap between the bands is shifted towards higher energy levels. At the level of quasi-particles such as polaritons, the interaction between the structure and the electromagnetic field becomes relevant and must be included in the zero order. Local field effects also develop; crystallites are affected by resonance phenomena whose amplitude was compatible with Mie's theory of the scattering of a plane electromagnetic wave by a homogeneous sphere.

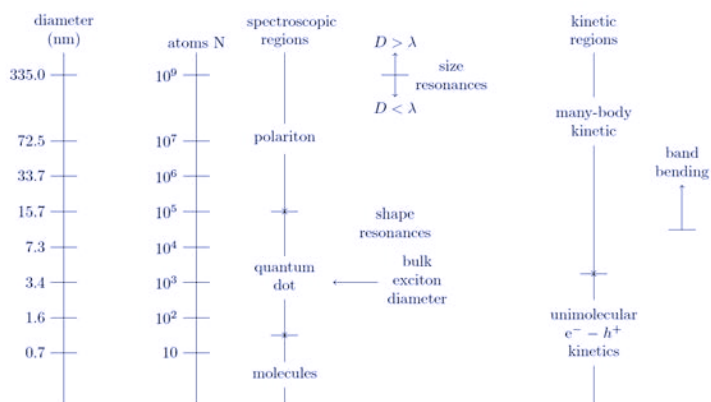

Fig 5.18 A simplified scheme of size regimes for semiconductor nanocrystals in dependence of their size. Source: Andrea Durlo, adapted from Brus and Trautman (1995)

Similarly, the study of variations in particle-related kinetic regions has proved interesting. When the size is molecular or characteristic of quantum dots, the kinetic behaviour is unimolecular, similar to that of an electron-hole pair interacting with the lattice and itself. The carriers cannot separate and interact in other crystallites precisely because of the confinement within a nanocrystal. As the size of the crystallite increases, the kinetics evolve from that of molecules to that of solid-state reactions. As the confinement energies decrease below the kT value, the carriers move independently throughout the crystallite, and their recombination occurs following the kinetics of many-body scattering.

The first practical example that Brus and Trautman examined concerned CdSe, an inorganic compound classified as an n-type II-IV semiconductor that catalysed the interest of researchers in the field of nanotechnology (Fig. 5.19).

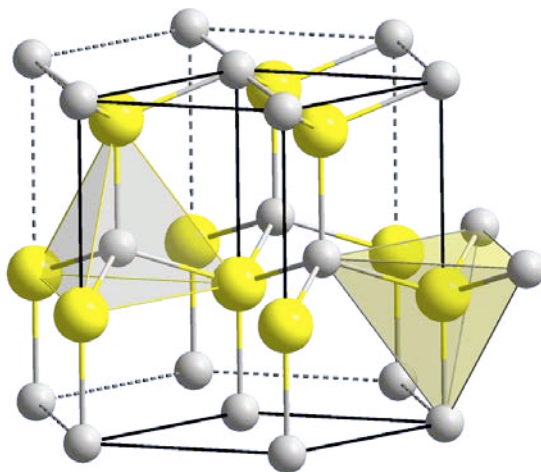

Fig 5.19 The structure of Cadmium Selenide CdSe. Source: Solid State (nickname), Public Domain

The band structure of this compound is quite similar to that of both InP, Indium phosphide, and GaAs, Gallium arsenide, and typifies the quantum confinement of II–IV and III–IV direct gap materials. The researchers obtained a series of samples of very high quality, in terms of crystallinity and size monodispersity; these characteristics made CdSe the prototype for the study of 3D quantum confinement in semiconductors.

At room temperature, the optical spectra showed a development in terms of discrete structure as the size decreased from 10nm towards 1.5nm, with a corresponding increase in the gap between the bands from 1.7eV to 3.2eV in the nanocrystals (Fig. 5.20).

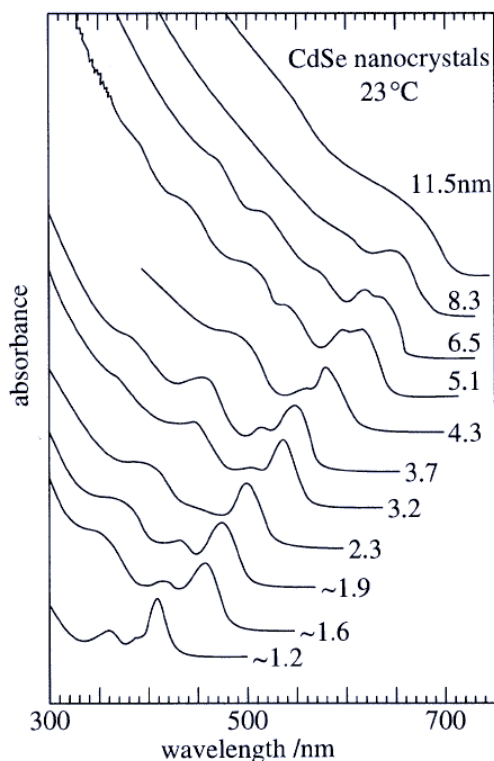

Fig 5.20 The CdSe optical spectra as it appears in the original 1995 article, adapted from Murray, Norris and Bawendi 1993. Source: Brus and Trautman (1995)

The description of the spectra was possible by means of a model in which the electron and lacuna were confined within a nanometer crystal of spherical geometry, where the surface was a barrier that could be described mathematically. In semiconductors II–IV and III–IV, one can consider the electron as type-s, and the gap as type-p, both confined within the unit cell. CdSe is such that the lowest electronic level is a totally symmetrical combination of s-type orbitals, mainly on cadmium atoms, this combination being multiplied by a function whose nodes are located on the surface of the crystallite. Molecular orbitals have a very low energy, as the effective mass of the electrons is only $0.12m_e$, the molecular orbitals related to the gaps are characterised by a higher density, due to the triple degeneracy of the p orbital, and the fact that the gap is more massive than the electron (Fig. 5.21).

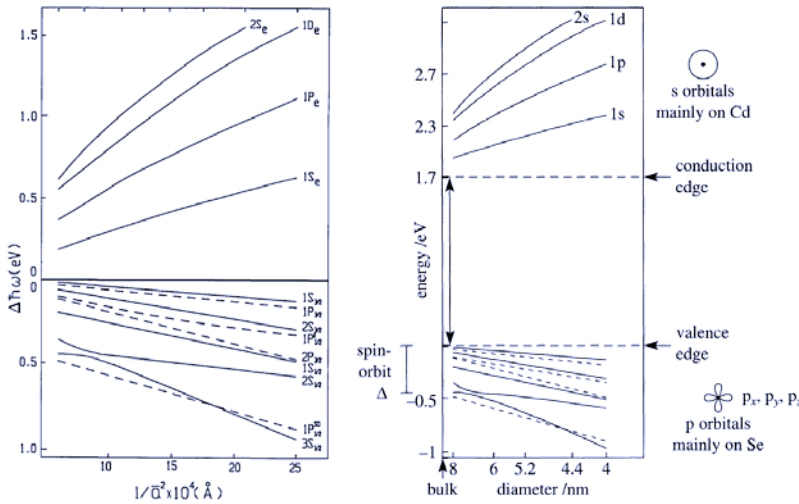

Fig 5.21 Left: the electron and hole energy spectra plotted versus the inverse-mean-square-radius. Source: Ekimov *et al.* 1993 Right: CdSe confined molecular orbitals, according to the original 1995 article, for comparison. Source: Brus and Trautman (1995)

The complexity of the optical spectrum thus represented the complexity of the valence band, quantized in three dimensions. Various optical methods were applied to study the $1S_{\text{electron}}-1S_{\text{hole}}$ transitions, such as low-temperature photoluminescence (PL), femtoseconds coherent pump-and-probe, and size selective photoluminescence excitation (PLE). The smallest crystallites in the sample were selectively probed with PLE when monitoring a narrow spectral region on the blue edge of the luminescence band. A number of discrete electronic transitions and an LO-phonon, Longitudinal-Optical phonon, progression was cleanly resolved for the first time in any nanometer-scale cluster (Bawendi *et al.* 1990). The Zero Phonon Line (ZPL) showed a temperature-dependent-width whose lineshape at low temperature reflected a fast dynamical relaxation of the $1S_{\text{hole}}$, optically created, into surface states. The surface states were interpreted to be lone pair electrons on the surface Se atoms.

Silicon is an indirect gap semiconductor, i.e. the k -wavelength vectors in the equation:

$$p_{\text{crystal}} \equiv \hbar k \tag{5.23}$$

of minimum energy in the conduction band and maximum energy in the valence band are different. Unlike CdSe, there is no discrete spectral structure and the optical spectrum possesses characteristics similar to those of a generic indirect gap material, with band gaps of approximately 2.0eV (Fig. 5.22).

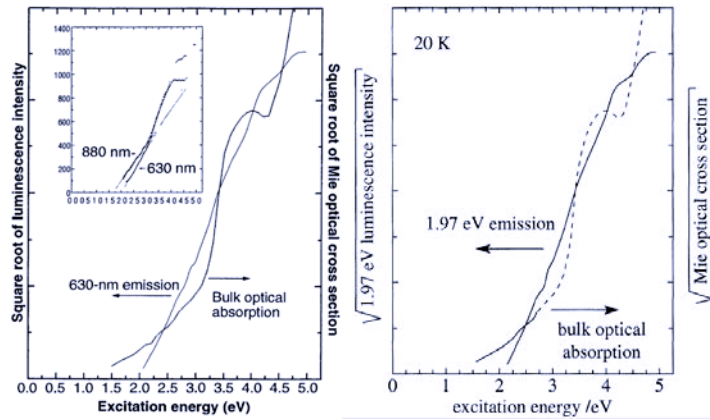

Fig 5.22 Left: the photoluminescence excitation spectra of Si nanocrystals compared to the expected absorption spectrum of bulk Si (Source: Wilson, Szajowski and Brus 1993). Right: luminescence excitation spectra of Si nanocrystals, according to the original 1995 article, for comparison. Source: Brus and Trautman (1995)

When the authors analysed the dynamics of the radiative process, they observed that the activity remained around 5×10^{-4} s; in the nanocrystalline silicon shells, the radiative activity was longer than the 5×10^{-5} s measured for the bulk material at low temperature. The increase in luminescence in the nanocrystals – and, apparently, in porous silicon – was not attributable to the increase in oscillator strength, but rather to the decrease in non-radiative transitions, which are competitive with recombination transitions, radiative this time, in the bulk material.

The electron–hole pairs in the silicon bulk material were not bound at room temperature, so the independent movement of the carriers in the crystal was observed. When the system was subjected to moderate optical excitation, the kinetics were controlled by non-radiative Auger recombination:



The three-dimensional quantum confinement gave rise to two consequences. The first concerns the superposition of $(e^- + h^+)$ at 293K, precisely because of confinement in a crystallite; the second is the stopping of the Auger process since there is no interaction and recombination of pairs confined in different crystallites. It is the shift from solid-state to molecular kinetics that caused the increase in luminescence.

The study of nanoparticles was then carried out using Near-field Scanning Optical Microscopy (NSOM).

The basic idea was to be able to obtain the spectrum of each individual particle constituting the sample, a task which, from a practical point of view, was not an immediate solution, due to the dispersion in crystallite size observed even in preparations made with the utmost purity and care. The study of the optical spectra of samples of this type, not ideal in theory, demonstrated the broadening of spectral shapes, precisely because of the size inhomogeneity.

Brus and Trautman succeeded in the task of analysing single CdSe crystallites, approximately 4nm in size, with an NSOM device at room temperature. The nanocrystals were coated, extremely diluted, on a polymer base and in this way the individual crystallites were separated from each other by several hundred nanometres, enabling the NSOM technique to analyse each individual particle. The figure below shows, in the researchers' interpretation, the spectra of the CdSe crystallites (5.23).

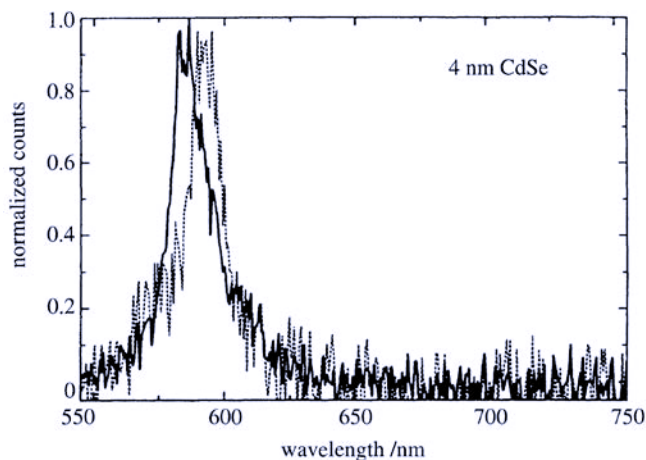

Fig 5.23 The CdSe emission spectra of single nanocrystals according to the research conducted by Brus and Trautman. Source: Brus and Trautman 1995

The sensitivity of the NSOM has therefore proven to be useful for nanocrystal spectroscopy of semiconductor materials; this instrument has proven to be versatile for applications in the field of nanotechnology, as it possesses a resolution of approximately $1/20\lambda$ in image mode. The NSOM, despite its properties, had been applied as a demonstration of its capabilities until 1995. Despite the limitation that it can, if not operated correctly, lead to probe breakage, NSOM is now a technique that is successfully applied to applications in biology.

5.1.6 1996: Gold Colloids

Colloidal gold is a suspension of gold particles, the size of which is in the nanometre range, in a fluid, be it water or a different organic solvent. Colloidal gold was first obtained in 1856 by Michael Faraday, when he was attempting to mount thin gold foils on the sample plates of a microscope. Notoriously an extremely malleable metal, gold foils were usually prepared by hammering the raw material. However, such a mechanical system resulted in plates that were still too thick for Faraday's planned experiments, so he resorted to a chemical attack and subsequent illumination with transmission light. He then observed that the liquid remaining on the plate took on a red colour. Faraday preserved these liquids, which are still optically active today, more than a hundred years after his experiments.

Precisely because of the size involved, colloidal gold cannot be observed and studied by means of optical microscopy. Metallic yellow in colour and solid when at bulk size, nanometric colloidal gold becomes liquid and of a different colour depending on the size of its agglomerates, red if the particles are smaller than 100nm or blue/purple for particles of a larger size. The figure below (Fig. 5.24) shows the colour dependency of colloidal gold preparations.

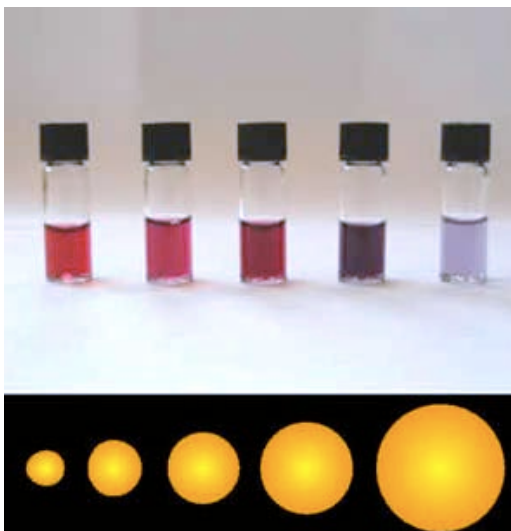

Fig 5.24 Suspensions of gold nanoparticles of various sizes. The difference of sizes is the cause of the difference in colours. Source: Aleksandar Kondinski, CC BY-SA 4.0

Colloidal gold's extraordinary optical and electronic properties and its molecular recognition capability have made it one of the materials on which nanomaterials research has focused with interest. As with all nanomaterials, colloidal gold particles have different applications depending on their size and shape. Particles in the form of sticks exhibit both transverse and longitudinal absorption peaks. On the other hand, the anisotropy of their shapes influences their self-assembly. Particles whose size approaches the nanometre are applied as catalysts for reactions. Colloids and gold nanoparticles are applied in electron microscopy, electronics, nanotechnology in general, materials science and medicine (Mingos 2014). Characterisation at the atomic level of one-dimensional crystalline samples in suspension has been made possible by the development of colloidal gold synthesis processes in organic solvents. Particles consisting of agglomerates of 3–100 atoms have been studied from cluster agglomerates. All these characterisations have contributed to building up a literature on the relationships between colloids and clusters.

Colloidal particles based on metals or semiconductors possess optical, optoelectronic properties of interest related to their nanometric dimensions, properties that distinguish them from massive bulk materials. Potential applications of such colloidal structures can be chemical sensors, quantum dots, spectroscopy, microimaging methods and the realisation of complex nanostructures. In 1996, an important result was achieved in the application of colloids to obtain macroscopic materials from nanoparticles, based on DNA. The method,

devised by Chad Mirkin, Robert Letsinger, Robert Mucic and James Storhoff, was reversible and rational and consisted of attaching non-complementary DNA oligonucleotides integrated with thiol groups, which bind to gold, to two 13nm gold particle supports. By thermal denaturation, the assembly process could be reversed. Their work, A DNA-based method for rationally assembling nanoparticles in macroscopic materials, illustrated this breakthrough in the history of nanotechnology.

Prior to the method proposed by Mirkin and his associates, the assembly of colloids of interest in research was mainly based on the use of assembling molecules that were functionalised at their ends and had a chemical affinity for the colloid. One of the most widely used methods until 1996 made use of gold nanoparticle colloids and was supported by the well-known chemistry of thiols. Linear alkane dithiols were used as the ligands of the particles, as the groups at the ends of the molecules interacted through covalent bonds with the colloidal particles so that the sought-after aggregates were realised. Such a method, however, despite its well-known chemistry had the disadvantage of being irreversible and had to be monitored systematically.

The proposed new method was instead based on the use of oligonucleotides. This made it possible to obtain supramolecular structures through gold nanoparticles on the one hand and to do so through a reversible process on the other. The oligonucleotides could also be organised into sequences of controlled length and with the required surface binding functionalities via a DNA synthesiser and in a virtually automatic manner. It was thus the molecular recognition properties of these low-number nucleotides that gave rise to the self-assembly process of colloids. Not only that, but through the a priori choice of the length of the chain and the specific nucleotides comprising it, the solvent, the temperature and the concentration of the supporting electrolyte, the methodology applied allowed control of the distances between the particles and the stability of the structures created. Thanks to the methodology developed by Mirkin's team, the fusion of the chemistry of DNA and that of colloidal inorganic materials, the usefulness of DNA as a support structure for the realisation of new biomaterials and nanostructures was recognised from a practical point of view. It became possible to obtain not only materials whose properties are hybrid between those of colloids and those of DNA precursors but also new opportunities with respect to the assembly of pure DNA-based materials.

At the time, the theory of the production of DNA structures had not yet been experimentally confirmed (Seeman *et al.* 1993), but DNA/colloid hybrid materials could instead be characterised through available techniques such as Transmission Electron Microscope (TEM), Atomic Force Microscope (AFM), or a combination of the two. Gene spectroscopic techniques used with DNA could also prove useful for this purpose.

The use of oligonucleotides to assemble gold nanoparticles in a controlled manner began with the preparation of gold particles with a diameter of 13nm; these particles gave rise to a dark red aqueous suspension, a solution that was easily modified with oligonucleotides functionalised, at the 3' position, with alkanethiols. A 17nM solution of gold colloids was treated for 24 hours with 3.75µM of 3'-thiol-TTTGCTGA, while a second colloid solution was treated with 3.75µM of 3'-thiol-TACCGTTG, where non-complementary oligonucleotides were used. After treatment with thiol-treated oligonucleotides, its colloidal gold solutions were combined without any reaction occurring, precisely because of the presence of non-complementary bases. The process of capping the colloids with nucleotides made the compounds much more stable than ordinary gold colloids due to changes in the suspension, such as an increase in salt concentration, or external parameters, such as temperature. Indeed, once heated or suspended in a highly concentrated salt solution, untreated gold colloids give rise to irreversible reactions that cause them to

precipitate. In contrast, DNA–modified gold nanoparticles have proven to be stable up to temperatures around 80°C and in aqueous sodium chloride solution for days. The hypothesis formulated to explain such a different chemical behaviour was that the DNA–modified surfaces would have constituted a clutter that would have prevented the particles from coming together and growing.

In the next step, a duplex consisting of 5′–ATGGCAACTATACGCGCTAG and 3′–ATATGCGCGATCTCAGCAA was added to the solution, which was dark red in colour, characterised by a superposition of twelve A–T and C–G pairs (underlined) and eight “sticky” pairs complementary to the nucleotides attached by covalent bonds to the gold colloids (Fig. 5.25 and 5.26).



Fig 5.25 The pairing of twelve couples of nucleotides of the duplex added to the reagents. Source: AD

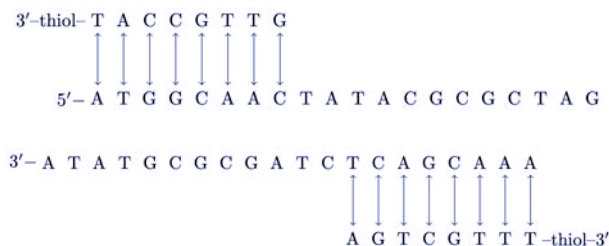

Fig 5.26 The pairing of the sticky pairs complementary to the 8–base–pair of oligonucleotides covalently attached to the colloids. Source: AD

The solution was diluted with sodium chloride and buffered at neutral pH to obtain the necessary conditions for hybridisation of the nucleotides; at the same time, the solution turned from red to violet, with precipitate formation. After leaving the solution to stand for a few hours, it became clear and the precipitate took on a pink–grey colour.

A dissociation experiment was then performed, as a control passage, by monitoring both optical absorption and the degree of aggregation of the colloid (700nm). The temperature fluctuated between 0 and 80°C, 38°C above the dissociation temperature (T_m) of the DNA–duplex ($T_m = 42^\circ\text{C}$), and an excellent correlation between the optical markings for both colloids and DNA was observed. In the absence of DNA, the ultraviolet–visible spectrum of the Au colloids was much less temperature–dependent. A substantial optical change was observed when the DNA–colloid polymer precipitate was heated above its melting point. The clear solution turned chemically dark red when the polymeric biomaterial dehybridised to generate the unbound colloids, which were soluble in the aqueous solution: this process was characterised by a high degree of reversibility. A control experiment was performed to verify that this process was due to the hybridisation of the oligonucleotides: a duplex with four mismatched base pairs in each of the “sticky ends” of the ligands did not give rise to the reversible process of particle aggregation.

Further evidence of the polymerisation/assembly process was obtained from TEM studies of the polymer precipitate. TEM images of the hybridised DNA-bound colloids showed large assemblies of Au colloids. The non-DNA-hybridised Au colloids did not aggregate in this way under similar conditions, but were subject to particle-sized growth reactions. Furthermore, no evidence of colloidal particle growth was observed, as the hybridised colloids possessed a remarkably regular size, with an average diameter of 13 nm. Smaller-scale images of one- and two-dimensional aggregates gave more convincing evidence of the self-assembly process, with aggregates separated rather uniformly by about 60 Å between particles (Fig. 5.27).

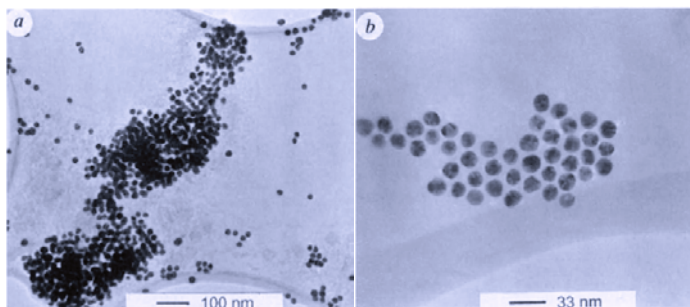

Fig 5.27 Left: the TEM image of an aggregate (hybrid material) DNA/colloid, right: the TEM image of a two-dimensional colloid aggregate that shows the ordering of DNA-linked Au nanoparticles. Source: Mirkin, Letsinger, Mucic and Storhoff 1996

The work of Mirkin, Letsinger, Mucic and Storhoff opened the door to an entirely new class of materials and hybrid DNA/nanoparticle assemblies with interesting electrical, optical and structural properties, each controllable through the choice of size, and chemical composition of the nanoparticles, sequence and length of the oligonucleotides. Colloidal gold particles structured in this way, for example, were successfully employed for the detection and colourimetric sequencing of DNA due to their intense colours.

5.1.7 1997: Helicity of Carbon Nanotubes

In 1997, Lu-Chang Qin, Toshinari Ichihashi, and Sumio Iijima studied the correlation between the helicity of a single-walled carbon nanotube and the apparent semi-splitting angle measured by means of a model obtained from single-tube X-ray diffraction (Qin, Toshinari and Iijima 1997). The difference between these angles was evaluated as dependent on the order of the Bessel function relating to the diffraction intensity of the specific layer under investigation, the structure depending on helicity, and the diameter of the nanotube. In solid-state physics, Bessel functions have proved to be useful tools for the X-ray analysis of samples when they are calculated through an asymptotic expansion when the modulus of their complex argument has a large value (Borowski 1996). The Bessel functions J_0 and J_1 are in fact used to describe the electromagnetic field of an ideal crystal

in the X–ray radiation region of the spectrum. A Bessel function $J_n(z)$ given by the expansion:

$$J_n(z) = \sum_{k=0}^{\infty} \frac{(-1)^k \left(\frac{1}{2}z\right)^{n+2k}}{k! (n+k)!} \quad (5.25)$$

regular over the entire complex plane except for the point $z = \infty$, is the solution of the Bessel equation:

$$\left(1 - \frac{n^2}{z^2}\right)u(z) + \frac{u'(z)}{z} + u''(z) = 0 \quad (5.26)$$

Every solution of this non–identically null equation is called a cylindrical function (Vladimirov 1981). Using software suitably implemented in the 1990s, the convergent series shown above allowed the Bessel function to be calculated for any finite value of z . However, in order to obtain a suitable accuracy of calculation, it was necessary to calculate an increasing modulus of z , and this implied that a greater number of terms had to be calculated, in turn. At the limit, however, such an operation leads to numerical errors so large that the result is destroyed. One such problem was solved by means of an asymptotic expansion. Under established mathematical conditions, an asymptotic expansion of a function of a complex variable is indicated by writing:

$$f(z) \propto \sum_{n=0}^{\infty} A_n z^{-n} \quad (5.27)$$

The application of Bessel functions to X–ray diffraction results of materials is, for example, part of a statistical dynamical theory. The coherent component of the signal intensity is (Kato 1980):

$$I^c = I_0 E^2 |\kappa_h|^2 |J_0(2\kappa E \sqrt{s_0 s_h})|^2 \times \exp\{-\mu_e(s_0 + s_h)\} \quad (5.28)$$

where J_0 is the zero–order Bessel function, E is the Debye–Waller factor, $\kappa_h = AF_h$, with A a real constant, F_h the structure factor, $\kappa = \sqrt{k_g k_{-g}}$, the term h is the reflection vector, μ_e the effective absorption coefficient and s_0 and s_h the coordinates in the crystal. A simulation was conducted by means of formula implementation software, and the results obtained together with those obtained by applying MoK α_1 radiation to a parallel–sided silicon sample were compared. The topography was comparable with very good agreement, demonstrating the suitability of the software implemented for studying the material, as an alternative to X–ray diffractometry in particular in the applicability of Bessel functions.

Single–walled carbon nanotubes, described by Iijima in 1991, are usually studied by evaluating two parameters: helicity (or helical angle) and diameter. While the diameter is an easy parameter to measure by electron microscopy, measuring helicity is not

straightforward. The method proposed by Iijima (Iijima 1991) neglected the curvature of carbon nanotubes and the semi-splitting angle was used to approximate the helical angle.

The cylindrical geometry of the tubes, however, allows Bessel functions to be applied, so that the electron diffraction intensity distribution can be expressed analytically. In particular, in electron diffraction models, the relative maxima of the diffraction intensity are found on well-separated layer lines, each of which is identified by a Bessel function of a given order. These functions made it possible to describe the mutual spatial structure of both single-walled and multi-walled helical nanotubes.

In particular, Qin, Ichihashi, and Iijima were able to measure the angular difference between the actual alpha helicity angle and the semi-splitting angle measured through diffraction patterns, obtained through analytical calculations (Fig.5.28 and 5.29). The difference between the values was close to 70%.

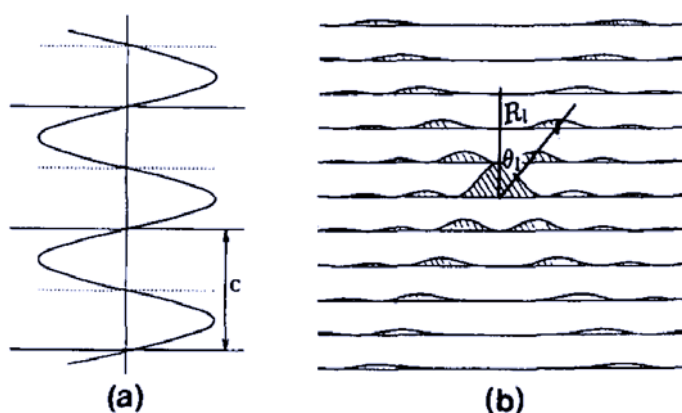

Fig 5.28 On the left (a) the pitch of the helix is shown, on the right the two sides of the apparent semi-splitting angle obtained from the corresponding diffraction geometry. Source: Qin, Ichihashi and Iijima 1997

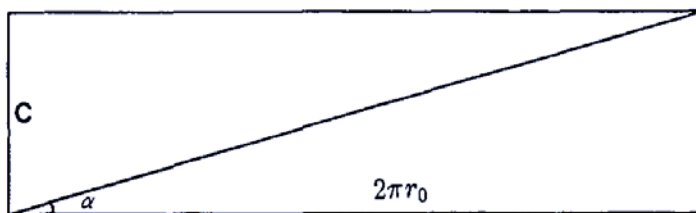

Fig 5.29 The radial projection of a single pitch-helix. Source: Qin, Ichihashi and Iijima 1997

A carbon nanotube can be obtained by rolling a sheet of graphene around an axis perpendicular to the circumference of the tube, and its structure can be fully described, once an appropriate reference system is fixed, by means of two indices, the diameter (from which the length of the nanotube's circumference is derived) and the helicity. In their work, Qin,

Ichihashi and Iijima indicated \mathbf{a}_1 and \mathbf{a}_2 as the basis vectors, plotted from a chosen origin at an angle of 120° . The corresponding diffraction vectors were thus \mathbf{a}_1^* and \mathbf{a}_2^* , while the circumference length of the nanotube is defined by two integer values $[u, v]$ specifying a lattice vector. The angle α of the helix is defined as the angle between the vector \mathbf{a}_1 and the vector $[u, v]$. The diameter of the nanotube is calculated as:

$$d = a_0(u^2 + v^2 - uv)^{1/2}/\pi \quad (5.29)$$

where $a_0 = 0.245\text{nm}$ is the lattice constant of graphene. The angle of the helix is evaluated by the formula:

$$\alpha = \cos^{-1}\{(2u - v)/[2(u^2 + v^2 - uv)^{1/2}]\} \quad (5.30)$$

When the angle of the helix exceeds 60° , it becomes degenerate due to the hexagonal symmetry of the structure that competes with graphene. If the angle is between $[-30^\circ, 30^\circ]$, right-handed structures result in positive values, while left-handed structures result in negative values. If $[U, V]$ is the direction of the axis, the indices for a given circumference are:

$$\frac{U}{V} = (u - 2v)/(2u - v) \quad (5.31)$$

When analysing a system consisting of scattering atoms each identified by a coordinate r_j , the total scattering amplitude can be expressed by writing:

$$F(R, \Phi, l) = \sum_n \exp\left[in\left(\Phi + \frac{\pi}{2}\right)\right] J_n(2\pi r_0 R) \times \sum_j f_j \exp[i(n\phi_j + 2\pi lz_j/c)] \quad (5.32)$$

where (R, Φ, l) are the polar co-ordinates in reciprocal space, (r_0, Φ_j, z_j) the polar co-ordinates of the atomic positions in real space, and $J_n(2\pi r_0 R)$ the Bessel function of order n . The sum is made over all possible values of n .

For a carbon nanotube, a correction due to the cylindrical symmetry of the structure can be applied. Given a single helicoidal winding of radius r_0 and pitch c , the scattering amplitude is expressed by a single Bessel function:

$$F(R, \Phi, l) = r_0 J_l(2\pi r_0 R) \exp[i(\Phi + \pi/2)] \quad (5.33)$$

and the intensity of the reflection is:

$$I(R, \Phi, l) = |F(R, \Phi, l)|^2 = [r_0 J_l(2\pi r_0 R)]^2 \quad (5.34)$$

Assigned an apparent semi-splitting angle θ_l measured to the diffraction line l , the following relationship can be derived:

$$\tan(\theta_l) = \frac{R_l c}{l} = \left(\frac{u_l}{l}\right) \tan \alpha \quad (5.35)$$

where R_l is the radial distance measured on the diffraction grating, and u_l the value at which the function $J_l(u)$ reaches its first maximum.

The effective helix angle is:

$$\alpha = \tan^{-1}[c/(2\pi r_0)] \quad (5.36)$$

Once these mathematical relations on the structure of the nanotubes had been established, the authors were able to deduce the value of the magnitude u_l/l that relates the apparent semi-splitting angle measured on the diffraction grating and the effective helicity angle. The data were grouped in this way.

$l = 1$	$u_1 = 1.7$	$u_l/l = 1.7$
$l = 2$	$u_2 = 3.0$	$u_l/l = 1.5$
$l = 4$	$u_4 = 5.3$	$u_l/l = 1.3$

It is observed that as the value of l increases, the value of u_l tends to the same value as l , and the magnitude u_l tends to unity. Similarly, if the helicity angle is kept constant, increasing the diameter of the tube will lead to a higher order of rotational symmetry of the structure. In turn, larger and larger orders of rotational symmetry will lead to dominant Bessel functions of progressively higher orders. Consequently, as the radius of a nanotube increases, the difference between θ angle and α angle becomes smaller and smaller, which is consistent with the experimental observation that as the radius increases, the cylindrical geometry of the tube becomes less and less decisive in influencing the intensity of the diffraction distribution. It has also been proven that for large values of the helicity angle the reflection intensity will be dominated by Bessel functions of increasing order as the order of the rotational symmetry increases in turn and the value of u_l tends towards unity.

Diameter and helicity are the two fundamental parameters that make it possible to describe the properties of carbon nanotubes. On the other hand, they identify the pair of so-called Hamada indices, n and m , that characterise the structure of a nanotube. The study of the diameter and helicity of carbon nanotubes was later conducted in 2000 by Lambin, Meunier, Henrard and Lucas, who went into detail on the mathematical description of these parameters. They made use of STM microscopy and electron diffraction, the most powerful techniques for this type of investigation (Lambin, Meunier, Henrard and Lucas 2000).

A simplified tight-binding theory for STM could be outlined, treating the interaction between the microscope tip and the sample surface as a first-order perturbation (Kobayashi

and Tsukada 1990). Assuming only one orbital for each atom, the tight-binding expression of the current assumes the integral formulation (Meunier and Lambin 1998):

$$I = (2\pi)^2 \frac{e}{h} \int_{E_F^s - eV}^{E_F^t} dE \sum_{i,i' \in t} \sum_{j,j' \in s} v_{ij} v_{i'j'}^* n_{ii'}^t (E_F^t - E_F^s + eV + E) n_{jj'}^s(E) \quad (5.37)$$

where the terms E_F denote the Fermi levels of tip (t) and sample (s), V is the tip-sample bias potential, v_{ij} the tight-binding coupling between orbitals located at sites i of the tip and sites j of the sample, and $n_{jj'}^s(E) = (-1/\pi) \text{Im} G_{jj'}^s(E)$ with $G_{jj'}^s(E)$ an element of a sample Green function. This can be calculated through a sum over eigenstates:

$$n_{jj'}^s(E) = \sum_{\beta} \langle j | \psi_{\beta} \rangle \delta(E - E_{\beta}) \langle \psi_{\beta} | j' \rangle \quad (5.38)$$

and:

$$n_{ii'}^t(E) = \sum_{\alpha} \langle i | \psi_{\alpha} \rangle \delta(E - E_{\alpha}) \langle \psi_{\alpha} | i' \rangle \quad (5.39)$$

The tip was considered as a single atom, labelled with the index i , according to the Tersoff-Hamann theory, with Gaussian density of states. On the nanotube, for each carbon atom, denoted by index j , only one orbital, β , was considered. The tip-sample coupling was described by Slater-Koster terms, where the interactions decayed exponentially with distance d_{ij} :

$$v_{ij} = v_0 w_{ij} \exp(-d_{ij}/\lambda) \cos \theta_{ij} \quad (5.40)$$

where θ_{ij} is the angle between the π orbital on site j and the ij direction, and:

$$w_{ij} = \exp(-ad_{ij}^2) / \sum_{j'} \exp(-ad_{ij'}^2) \quad (5.41)$$

introduced for convergence reasons. The values of the two parameters were $\lambda = 0.85 \text{\AA}$ and $a = 0.6 \text{\AA}$. With STM microscopy some pictures were taken and maps drawn onto the nanotubes to show the different geometries (Fig. 5.30).

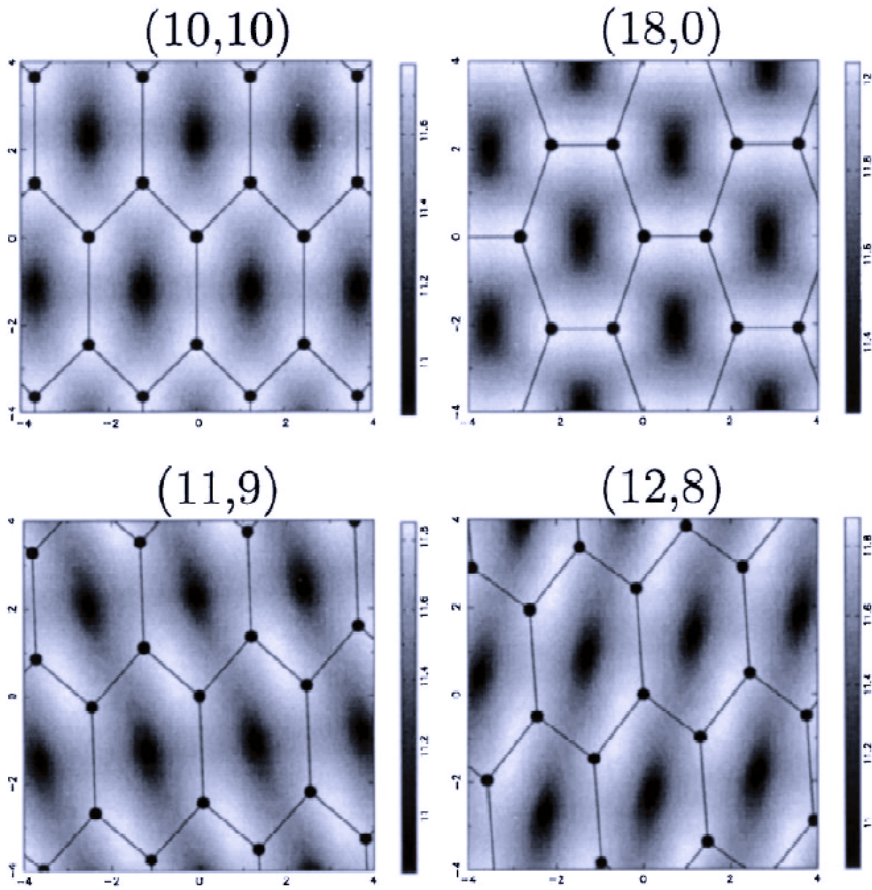

Fig 5.30 The gray-scale representation of non-chiral nanotubes, (10,10) and (18,0), and chiral nanotubes (11,9) and (12,8). Source: Lambin, Meunier, Henrard and Lucas (2000)

TEM microscopy has been used to obtain diffraction gratings of extremely small regions of a sample, of the order of a nanometre, by using an extremely focused electron beam. Multi-walled carbon nanotubes provided different data through this technique, whereas collecting information from single-walled nanotubes was more difficult due to the low intensity produced by a single layer.

From a mathematical point of view, when it comes to the kinematic theory of diffraction, it appears that the amplitude of a plane wave diffracted by an object in the direction specified by the \mathbf{K} wave vector is proportional to the structure factor indicated by:

$$S(\mathbf{q}) = \sum_j f_j(q) \exp(i\mathbf{q} \cdot \mathbf{n}) \quad (5.42)$$

where $\mathbf{q} = \mathbf{K}_i - \mathbf{K}_s$ is the diffraction wave vector, and \mathbf{K}_i is the incident wave vector. Diffraction is an elastic process so $|\mathbf{K}_i| = |\mathbf{K}_s|$. The scattering structure factor is the sum of atomic factors, $f_j(q)$, multiplied by phase factors $\exp(i\mathbf{q} \cdot \mathbf{r}_j)$, where \mathbf{r}_j is the position of each atom. When operating with electrons, the form factor of the atoms of carbon is roughly a Gaussian function, with half width at half maximum about 3\AA^{-1} and $f(0) \approx 0.4\text{nm}$. When using X-rays and neutrons the atomic factor is of the order of 10^{-14}m , so the scattering power of carbon for X-rays and neutrons is a factor of 10^{-9} smaller than electrons. This makes the difference when using X-rays, neutron or electrons for diffraction, and justifies the fact that an isolated nanotube can be detected when scanned by electrons, when a lot of sample is needed for other wavelengths. The Cochran, Crick and Vand theory (CCV) allowed to analytically obtain the scattering structure factor of a single-wall nanotube and also played a fundamental role in the discovery of the DNA structure. For a (n,m) carbon nanotube it is possible to write the following:

$$S(\mathbf{q}) = \frac{4\pi C}{a^2\sqrt{3}} \sum_{l=-\infty}^{+\infty} \exp(il2\pi z_0/T) F_l(\mathbf{q})\delta(q_z - l2\pi/T) \quad (5.43)$$

where a is the lattice parameter of the graphene, i.e. 0.246nm . C is the circumference of the tube and T the translational period of the lattice along the axis:

$$C = a\sqrt{n^2 + m^2 + nm} \quad (5.44)$$

and:

$$T = \frac{C\sqrt{3}}{N} \quad (5.45)$$

where:

$$N = \text{h. c. d.}(2n' + m', 2m' + n') \quad (5.46)$$

The scattering factor is calculated with the following formula:

$$F_l(\mathbf{q}) = f(q) \sum_{s,t=-\infty}^{+\infty} J_{sn'-tm'}(q_\perp r) \exp [i(sn' - tm')(\sigma\phi_q - \sigma\phi_0 + \pi/2)] \times \{1 + \exp[i2\pi(s + 2t)/3]\} \delta_{s(n'+2m')/N + t(2n'+m')/N, l} \quad (5.47)$$

with $n' = n, m = m, \sigma = +1$ when $m \geq 0$, and $n' = n - m|m|, m' = |m|$ with $\delta = -1$ when $m < 0$.

The symbols that appear in the expression above are the following.

The components of the diffusion wave vector \mathbf{q} parallel and perpendicular to the nanotube axis are, respectively, q_z and q_{\perp} . The azimuth angle of \mathbf{q}_{\perp} is ϕ_q ; r is the nanotube radius; z_0 and ϕ_0 are the cylindrical coordinates of the origin atoms. This formalism can be applied to multiwall carbon nanotubes properly adjusting these cylindrical coordinates.

Because of the periodicity of a single wall carbon nanotube, the z component of the wave vector can be discretized with steps $2\pi/T$. The diffracted intensity is thus concentrated along lines that lie perpendicularly to the nanotube axis. These lines are called layer-lines and are governed by the square modulus of $F_l(\mathbf{q})$. There is also a selection rule among lines due to the Kronecker δ in the formula defining $F_l(\mathbf{q})$.

Lambin and his co-workers elaborated a computer simulation to test the formalism they proposed in 2000, presented here above. The picture below shows the simulated diffraction pattern of a (18,5) nanotube (Fig. 5.31).

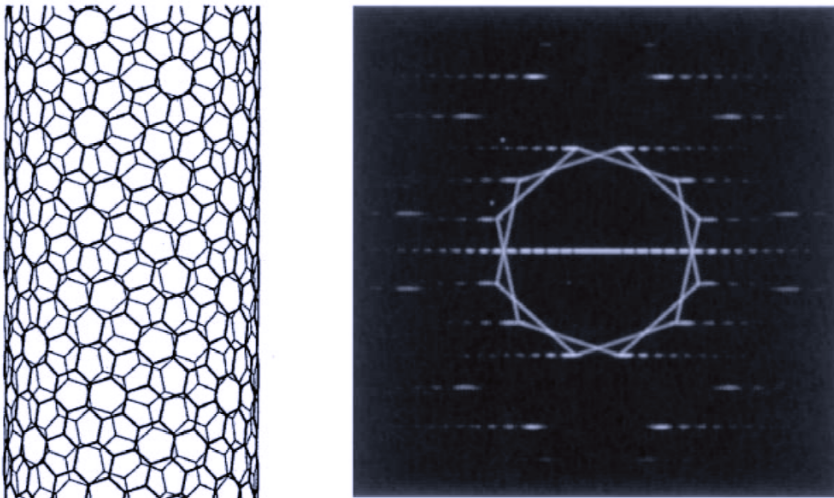

Fig 5.31 The structure (left) and the diffraction pattern (right) of (18,5) single wall nanotube. Source: Lambin, Meunier, Henrard and Lucas (2000)

The diffraction spots appeared stretched horizontally because of the progressive narrowing of the apparent lattice spacing in this direction if the observer moves aside from the centre of the nanotube. There was no effect of curvature in the direction parallel to the axis. The semi-cylindrical portions upstream and downstream of the tubule projected onto the plane in two patterns rotated with respect to each other by twice the chiral angle. Consequently, the diffraction patterns produced by the anterior and posterior halves of the tubule were also rotated by the same 2ϑ angle. The first-order diffraction spots were located at the vertices of two hexagons rotated 24° relative to each other in reciprocal space. Therefore, the chiral angle of a tubule could be obtained by measuring half the angular separation between these two hexagons.

By analysing a multi-walled carbon nanotube, it was shown that each layer produces a pair of point hexagons whose angular separation is twice the chiral angle. The representation of the diffraction pattern of a three-layer nanotube together with a TEM image of it is shown here below (Fig. 5.32).

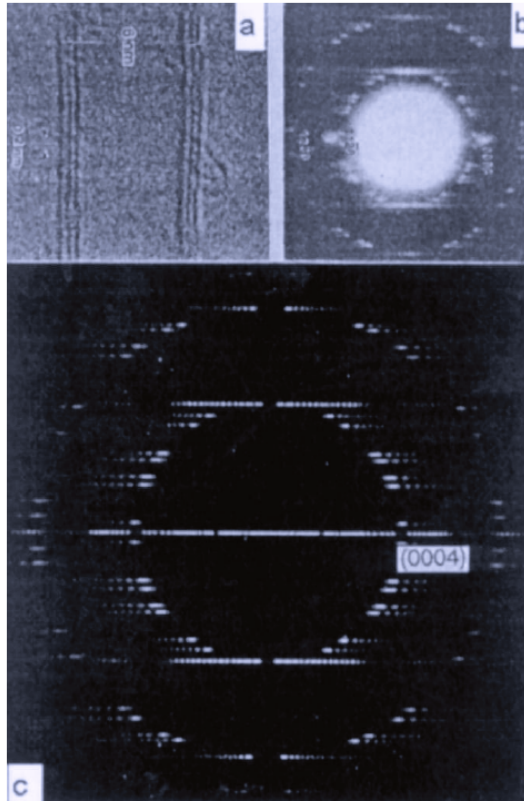

Fig 5.32 The high-resolution TEM picture of the nanotube is in picture (a). In picture (b) the diffraction pattern produced by the nanotube is shown. Picture (c) is the computer diffraction pattern of a three-coaxial layers of carbon. Source: Lambin, Meunier, Henrard and Lucas 2000

The measures of the analysis proved that the three carbon layers had different chiral angles of 4° , 8° and 26° ; the structure was composed of three nanotubes, $(38,30)$, $(62,11)$ and $(73,6)$ respectively. The layers proved to have radii and chiral angles corresponding to the experimental values; the agreement between the computed and the measured diffraction patterns was good except for small open intervals between the pair of spots near the north and south “poles”, that appear to be closed in the experimental pattern. This was due to a non-perfect perpendicular orientation between the tubule and the incident beam.

This experimental procedure, in any case, was not definitive in resolving the structure of the nanotube because for each layer different sets of Hamada indices were possible, due to the experimental error. What the setup made possible was to determine the number of helicities, simply obtained by counting the number of independent spots along the first-

order diffraction circle and the values of the chiral angles. What was demonstrated was that multi-wall nanotubes are predominantly polichiral.

5.1.8 1998: Carbon Nanotube Transistors

The conductive properties of carbon nanotubes have been used to advance research into devices such as field-effect transistors. This type of electronic device employs an electric field to control the flow of current that can be sent through a semiconductor, and are known as unipolar devices because the current transport mechanism is carried by a single type of carrier, either electrons (n-channel) or holes (p-channel). In 1998, a group of scientists from the IBM Research Division fabricated field-effect transistors, basing their device technology on single-walled or multi-walled carbon nanotubes (Martel *et al.* 1998). They measured the performance of these devices and observed how the transport phenomenon was, in nanotubes, dominated by gaps and, at room temperature, governed by the laws of diffusion. By changing the gate voltage, the conductance of a single-walled device could be changed by more than five orders of magnitude. The researchers demonstrated that multi-walled carbon nanotubes did not give rise to a gate effect and could only function as Field-Effect Transistors if they were structurally deformed.

As research in the field of nanotubes has shown (see the previous sections on this subject), the helicity angle and radius of nanotubes determine their conductive properties, causing them to behave either as semiconductors or as true metal conductors. As the radius of the nanotube increases, the gap between the semiconductive nanotube bands narrows. All these results were confirmed by scanning spectroscopy in different works published in the same year (Wildöer *et al.* 1998; Odom, Huang Kim and Lieber 1998).

Martel and his co-workers then focused on the possible applications of carbon nanotubes for new devices, realising a Field-Effect Transistor (FET) via a single-walled carbon nanotube, and investigating whether multi-walled nanotubes (MWNTs) could also be used in this respect. They obtained the remarkable result that MWNTs could in turn be applied in FETs based on carbon nanotubes.

As shown in the figure below, the basic idea was to connect the gold made source-drain electrodes, 30nm thick, with a bridge obtained through a single- or multi-walled carbon nanotube. The behaviour of the nanotube device was similar to that of a p-channel metal-oxide semiconductor FET. The transistor's source-drain current decreased strongly as the gate voltage increased, effectively demonstrating that the nanotube device functioned as a field-effect transistor and that the transport mechanism through the single-walled semiconductor nanotube is regulated by the holes (Fig. 5.33).

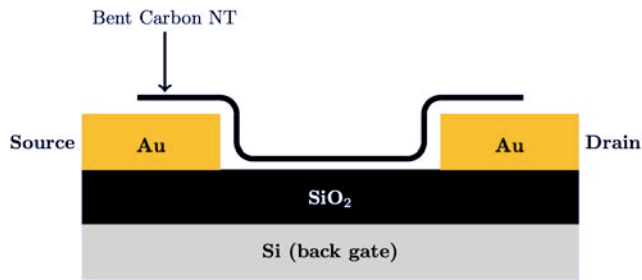

Fig 5.33 A schematic cross section of a FET device where a single NT – it may be SW or MW – works as a bridge between the two gold electrodes. Source: AD.

The study of holes was an important point in relation to such a device. The researchers first hypothesised that the concentration of the carriers was an intrinsic property of the nanotubes, then thought about the possibility of 'inserting' part of the carriers themselves at the contact regions between the electrodes and the nanotubes. Since gold has a high work function, this leads to the formation of holes in the nanotube due to the transfer of electrons from the nanotube to the gold contact. It was already hypothesised in the literature (Tans *et al.* 1997) that the operation of an FET could be explained in terms of this charge transfer: when the gate voltage V_G is zero, the device is in "on" mode and the value of the Fermi energy is close to that of the valence band edge for the entire nanotube. A different result is obtained when considering the phenomenon of band bending (Zhang and Yates 2012) over the entire length of the nanotube. In this case, a positive gate voltage gives rise to an energy barrier quantifiable in a few eV_G at the midpoint of the nanotube. At this point, the movement of the holes would be blocked by applying a threshold voltage, the value of which would depend on the thermal energy available to cross the barrier.

Martel and his collaborators then considered the possibility that the carriers were an intrinsic feature of the nanotube. They expected a homogeneous distribution of holes along the nanotube, independent of the threshold voltage. The density of these carriers was calculated and the result led to an estimate of approximately one hole for every 250 carbon atoms present in the nanotube; in graphite, as a comparison, one hole is present for every 10^4 atoms. The high density in the conductor suggested that it was doped with acceptors, for example, during the manufacturing process.

Estimating the mobility of the holes in the nanotube, with a value close to $20\text{cm}^2/\text{V s}$, made it possible to compare it with the mobility characteristic of heavily p-doped silicon, but it turned out to be much lower than that of graphite, characterised by a value of $10^4\text{cm}^2/\text{V s}$.

Once the behaviour of a single-walled nanotube had been studied, the situation involving a multi-walled nanotube was analysed, since the diameter of carbon nanotubes is proven to influence the electrical behaviour of the structure in terms of conductivity/semiconductivity. In this sense, a nanotube whose diameter is around 10nm or more exhibits conductive behaviour, rather than that of a semiconductor. Also for MWNT-FETs, the current between source and drain decreased as the gate voltage increased, which seemed to confirm that the dominant current-conducting process was hole transport. The most interesting difference from an electrical point of view was related to the geometry of the concentric nanotubes.

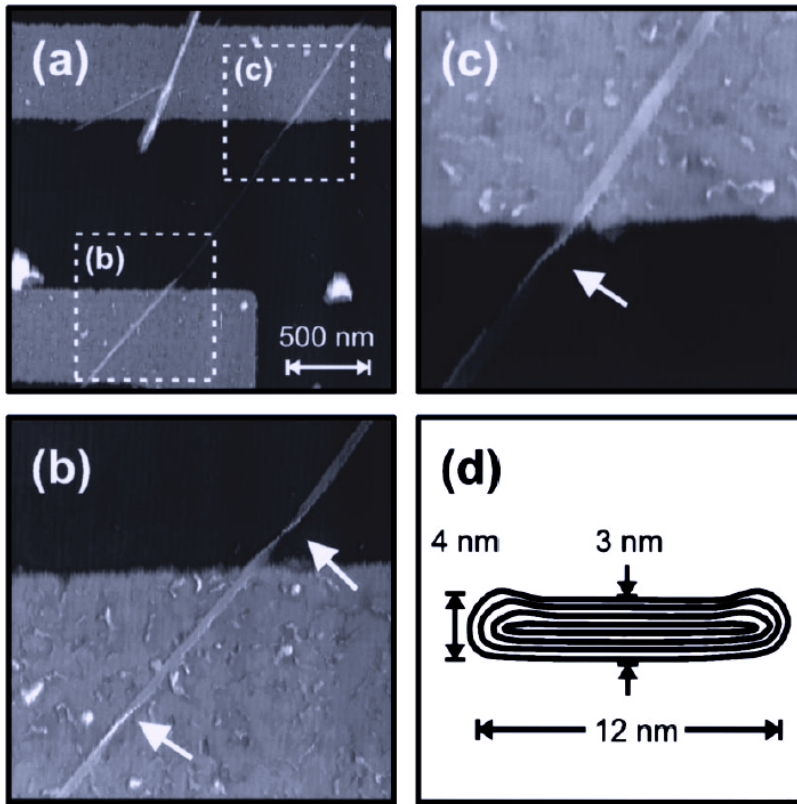

Fig 5.34 In picture (a) is shown a noncontact AFM image of the MWNT–FET. In pictures (b) and (c) it is possible to see, indicated by the arrows, three twisted structures in the collapsed NT. A simplified representation of a collapsed MWNT is shown in picture (d). Source: Martel *et al.* (1998)

When the MWNT maintained its cylindrical symmetry, no appreciable change in the value of the gate current was observed when the gate current varied. Once the nanotube system collapsed, however, see the figure 5.34 (d) above, a gate effect could be observed. Since the interactions between the individual concentric nanotubes are weak, the assumption was made that it was only the outer layer that was responsible for the transport phenomenon. What was studied was the behaviour of this layer, experimentally observing a decoupling between the lower and upper layers, attributed to quantisation effects perpendicular to the tube axis. The evaluation of the density and mobility of the holes in the MWNTs showed that, while the density was comparable to that of a SWNT, the mobility was about $220\text{cm}^2/\text{V s}$, probably attributable to a lower number of scattering centres.

The electronic properties of the NTs were thus modified by the intervening structural deformations. By plotting the gate voltage, expressed in volts, against the current intensity, expressed in nano–amperes, the effect of structural deformation was evident, as depicted in the following image (Fig. 5.35).

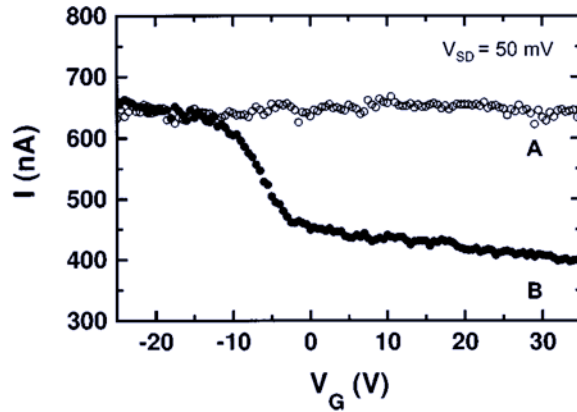

Fig 5.35 The different behaviours of gate tension and current intensity for a regular MWNT (plot A) and a collapsed MWNT (plot B). Source: Martel *et al.* (1998)

When the structure of the MWNT collapsed, this geometric deformation could lead to a particularly significant gate effect. In contrast, for a typical MWNT, the current remained almost constant as the voltage varied. As in the case of the SWNT-FET, the source-drain current of a collapsed-walled MWNT-FET would decrease (see figure above) as the gate voltage increased, i.e. the dominant conduction process was hole transport. When the electrical behaviour of the device was tested, the gate voltage V_G was varied between $-35V$ and $25V$, the resistance only increased from $76k\Omega$ to $120k\Omega$, corresponding to a modulation of the conductance by about a factor of 2. The gate effect reached a net maximum value between $V_G = -15V$ and $0V$. To explain this extremely peculiar behaviour, reference must be made to the AFM images of the structure of the MWNT-FET. The device consisted of a collapsed MWNT, which operated as a bridge between two electrodes separated by about $1\mu m$. The size of this nanowire was $3nm$. From this value, the researchers deduced that it consisted of four or five shells. The electron microscopy images (Fig.17) also showed a series of twists. Its width was estimated to be $12nm$.

Martel and his co-workers attempted to explain the behaviour of the MWNT-FET based on the interpretation of the collapsed structure. Since the interaction in the inner layers of the MWNTs was weak, it was reasonable to assume that the transport was limited to the outermost shell of the nanostructure. Modulation of the conductance by a factor of about 2 indicated that the lower "base" of the outermost shell was depleted by the gate, while the upper layer was less affected due to shielding by the inner shells and the lower layer as long as it was conductive (Martel *et.al* 1998).

The model implied the decoupling of the lower "plate" from the upper layer, which could be a consequence of lateral quantisation effects, perpendicular to the tube axis.

Indicating the "on" state through the relation:

$$R = R_{NT} + 2R_C \quad (5.48)$$

for the “on” state corresponding to $V_G = -15\text{V}$, and the relation:

$$R = 2R_{NT} + 2R_C \quad (5.49)$$

for the “off” state corresponding to $V_G = 0\text{V}$, the gate-dependent resistance R_{NT} of the nanotube was estimated to be of $32\text{k}\Omega$ for the outer shell of the nanotube and a contact resistance R_C of $23\text{k}\Omega$.

To evaluate the hole density and mobility of the collapsed MWNT, the study was conducted to the SWNT-FET. The capacitance for unit length was well expressed by the formula:

$$\frac{C}{L} = \frac{2\pi\epsilon\epsilon_0}{\ln(2h/r)} \quad (5.50)$$

despite the collapsed geometry of the carbon nanotube. Inserting data such as $L = 1.1\mu\text{m}$, $r = 5\text{nm}$, and a threshold voltage of approximately 8V , the hole density was about $1.7 \times 10^7 \text{cm}^{-1}$. The estimated mobility was about $220 \text{cm}^2/\text{V s}$. Although the hole density was comparable to that of the SWNT, the measured mobility was higher, this suggesting a reduced number of scatterers.

The research, therefore, showed that the transport phenomenon in nanotubes was governed by diffusion of holes, at room temperature. It was therefore possible to realise molecular field-effect transistors with nanotubes of different structures, obtaining, as remarkable results, a modulation of more than five orders of magnitude of the conductance, for single-walled nanotubes, and proving, moreover, that the structural deformation of multi-walled nanotubes led to possible FET behaviour.

Shortly after the publication of the Martel team’s work, a paper was published (Dimitrijevic *et al.* 1998) in which the electron emission from carbon nanotubes was studied. These structures were beginning to enjoy a lot of credit as electron field emitters. Tetrahedrally bonded amorphous carbon (*ta-C*), also known as diamond-like carbon (DLC), or amorphous hard carbon, has interesting and valuable emission properties. The chemical bonding characteristics of *ta-C* greatly influence the threshold emission.

Applications of *ta-C*, as a field-emitting material, had been suggested because this material lowered the threshold voltage required to cause electronic emission, e.g. from metal tips. Theoretically, the electron field emission should have followed the trend proposed by the Fowler-Nordheim relation, which correlates electric field and current as follows:

$$I \propto \left(\frac{\beta^2 E^2}{\phi} \right) \exp(B\phi^{3/2} / \beta E) \quad (5.51)$$

where β is the field amplification factor, ϕ the work function and B a constant whose value is $6.83 \times 10^9 \text{V eV}^{-3/2} \text{m}^{-1}$. The trend of the Fowler-Nordheim curves for a carbon nanotube and a *ta-C*-coated nanotube was as follows (Fig. 5.36).

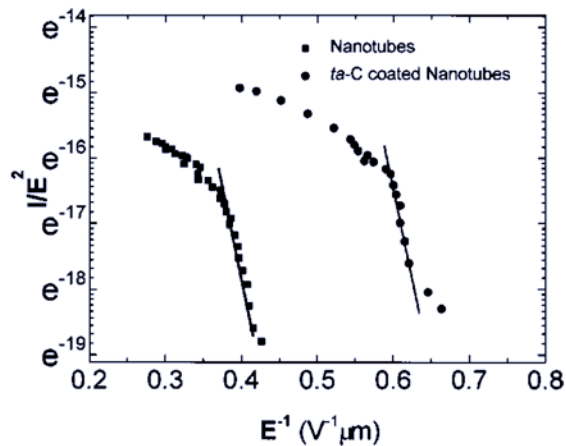

Fig 5.36 The Fowler–Nordheim plot for simple and coated nanotubes. Source: Dimitrijevic *et al.* 1998

The difference in behaviour when nanotubes are coated or not is evident. Dimitrijevic and his co-authors sought an interpretation of this fact after the deposition of *ta-C*.

Ta-C are semiconducting materials characterised by sp^2 and sp^3 sites; the gap between the bands depends largely on the $sp^3:sp^2$ ratio and ranged from less than 1eV to 4eV. In the research conducted, the measured band gap was about 0.4eV. The density of π -states in the gap increased due to dangling bonds and odd-membered rings of the sp^2 sites. Due to this increase, the resistivity of the material decreased. Under the assumption that the hybridisation of carbon nanotubes is practically (100%) sp^2 , the deposition of *ta-C* formed a much richer surface in sp^3 hybridisation. It was plausible to assume that the nanotube coating was not homogeneous, let alone uniform, and it was precisely this non-homogeneous distribution that could facilitate electron emission. Regions with different concentrations of sp^3 give rise to different local affinities with field enhancement, with preferential emission from regions rich in sp^2 .

5.1.9 1999: Dip–Pen Nanolithography

At the end of 1998, a scanning probe lithography was developed by Chad Mirkin and his team, which uses a nanoscale tip to leave a trace of molecular ink on a surface. The article that brought this innovation to light, entitled *Dip–Pen Nanolithography*, was published in the prestigious journal *Science* early the following year (Piner *et al.* 1999). Today, Dip–Pen Nanolithography (henceforth DPN) is an important technique that finds application in various basic disciplines such as physics and biology or in advanced industrial sectors such as medical diagnostics, electronic device repair, or counterfeit control. At the time of the article’s publication, nanoscale nanolithography was already a technique that had attracted the attention of nanoworld researchers, to the extent that several hundred articles in this direction had been published in the last two decades of the last century (Marcovich and Shinn 2011).

The lithographic process was one of the most important in nanotechnology and molecular electronics, and this innovative type of lithography has advanced its research and development. In DPN technology, the ink is transferred onto the substrate through a pointed pen, the tip of which is nanometric in size, via the phenomenon of capillarity. The tip is that of an Atomic Force Microscope. In the 1999 work with which Piner, Zhu, Xu, Hong and Mirkin (Piner *et al.* 1999) made this technique known, the solid–state substrate consisted of a gold foil, which functioned as the “paper” in common writing, while the ink was made from molecules that had demonstrated a chemical affinity to gold. The tracing of the ink molecules on the substrate by capillary transport allows submicrometric dimensions to be obtained without the need for further processing.

DPN is, however, not the only system that allows the direct transport of molecules onto suitable substrates using a positive printing mode. Microcontact printing, which had been described a few years earlier by James Wilbur’s research group from Harvard University’s chemistry department (Wilbur *et al.* 1996) using an elastomeric stamp, was a system that allowed functionalised thiol molecules to be deposited on gold substrates. In fact, this technique became a parallel way of depositing a single whole pattern, or several patterns on a suitable substrate in a single step. From a purely technical point of view, microcontact printing was a better way of depositing atoms, compared to DPN, when atom–by–atom positional accuracy was not required in a particular nanostructure. The two techniques, therefore, could be seen as mutually complementary.

Techniques based on electron or molecule beams, or applied through scanning instruments, allowed a negative moderation print of the substrates, removing excess material for subsequent processing operations. The advantage of DPN, compared to all other processing techniques, positive or negative printing, is the precision of deposition; this makes DPN preferred when processing is to be detailed, not on a large commercial scale.

The development of the DPN technique became necessary to overcome one of the problems that have characterised AFM since its introduction. When the AFM works in air, condensation of the surrounding air takes place in the small space between the tip and sample, which negatively affects the quality of imaging experiments. The presence of water proved to be a dynamic problem because depending on the humidity and substrate conditions, water migration from the tip to the substrate or vice versa was observed.

In their work, Piner and his co–workers examined the process of transferring 1–octadecanethiol (ODT) molecules, $\text{CH}_3(\text{CH}_2)_{17}\text{SH}$, onto gold surfaces. Their studies showed that an AFM microscope tip coated with ODT brought into contact with a substrate resulted in a flow of ODT to the sample by capillarity. The process was entirely analogous to that obtained through a Dip–Pen write. The process was studied using a conventional AFM microscope operating on a thin substrate film. The films were prepared by thermally evaporating 300\AA polycrystalline gold on mica at room temperature. For these experiments, the researchers coated a silicon nitride tip (Park Scientific, Microlever A) with ODT by immersing the cantilever in a saturated solution of ODT in acetonitrile for 1 minute. Before being used, the cantilever was dried with compressed difluoroethane.

A simple demonstration of this process consists of a raster scan of a tip prepared in this way on a section of a 1mm by 1mm Au substrate, see Fig. 5.37A.

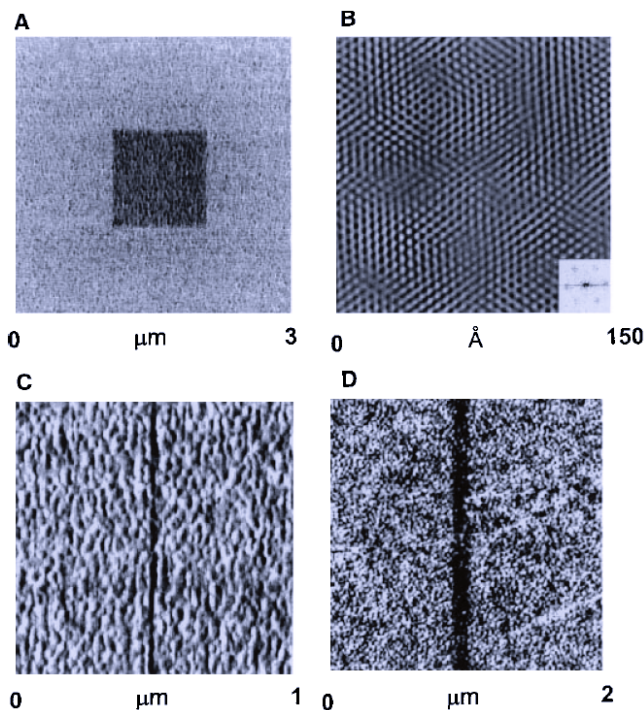

Fig 5.37 In picture A is represented the lateral force image of a $1\mu\text{m}^2$ square of ODT on an Au substrate deposited with DPN. In picture B we see a lateral force image, resolved from the grating, of a SAM ODT deposited on Au(111)/mica by DPN. The photograph was filtered with a fast Fourier transform (FFT) to construct the final image, and the FFT of the raw data is shown in the bottom right inset. Picture C is a lateral force image of a 30-nm-wide line (3mm long) deposited onto Au/mica by DPN. Picture D is the lateral force image of a 100-nm line deposited on Au by DPN. Source: Piner *et al.* (1999)

An image acquired with a Lateral Force Microscope (or LFM) of this section within a larger scan area (3mm by 3mm) shows two areas of different contrast. The inner dark area, the region where the lateral force is lowest, consists of a deposited monolayer of ODT, while the lighter outer area consists of bare Au (Fujihira *et al.* 1996). The formation of a high-quality Self-Assembled-Monolayer (henceforth SAM) was observed when the deposition process was carried out on an Au(111)/mica substrate, prepared by annealing our Au thin-film substrates at 300°C for 3 hours. In this way, it was possible to obtain a lattice image of a SAM ODT, as illustrated in Fig. 5.37B. The values reported for SAMs of ODTs deposited on Au(111) (Alves, Smith and Porter 1992) agree very well with the hexagonal lattice parameter of $5.0\pm 0.2\text{\AA}$. This proved that ODTs, rather than other adsorbates (water or acetonitrile), were transported along the direction tip to the substrate.

Although the experiments conducted on Au(111)/mica provided important information on the chemical identity of the species transported in these experiments, this substrate proves to be poor for the DPN operation. The deep depressions around the small facets of Au(111) made it difficult to draw long (micrometre) contiguous lines with an appropriate nanometre width.

The deposition of 30nm lines with DPN was possible despite the fact that the gold substrates were relatively rough, with an average square roughness of 2nm. This distance was comparable to the average diameter of Au grains and thin-film substrates, and represented the resolution limit of DPN on this type of substrate (Fig. 5.37C). A 30nm molecule-based line prepared on this type of substrate was discontinuous and followed the Au grain-edge. It was possible to draw more uniform and contiguous lines by increasing the line width to 100nm (Fig. 5.37D) or by using a smoother Au substrate. The line width depended on the scanning speed of the tip and the transport speed of alkanethiol from the tip to the substrate, as it was known that relative humidity could change the transport speed. Higher scanning speeds and fewer traces resulted in narrower lines.

The DPN technique was subsequently used to prepare molecular spots in order to demonstrate the diffusion properties of the “ink” (see Fig. 5.38, A and B) below. In this case, the ODT-coated tip was placed in contact with the Au substrate for a certain period of time. By holding the tip in contact with the substrate for 2, 4 and 16 minutes respectively. ODT dots of 0.66 μ m, 0.88 μ m and 1.6 μ m diameter were generated, as shown in Figure 38A, from left to right. The uniform appearance of the dots probably reflected a uniform flow of ODT occurring in all directions from the tip to the surface. Opposite contrast images were obtained by depositing dots of an alkanethiol derivative, 16-mercapto hexadecanoic acid, in a similar manner, see Figure 38B. In addition to providing further evidence regarding the direction of molecule transport, from the tip to the surface, this second experiment also provided evidence of the generality of DPN, which was thus not limited to specific molecules/tip coating substances.

In addition to single lines and dots, the technique was used to obtain different structures such as arrays and grids. An array of 25 ODT dots with a diameter of 0.46 μ m and spaced 0.54 μ m apart, see Figure 5.38C above as an example, was generated by holding an ODT-coated tip in contact with the surface for 20s under conditions of 45% relative humidity, without making any lateral movements during the realisation of each dot. In contrast, a grid of eight intersecting lines, 2mm long and 100nm wide, as shown in Figure 5.38D, was obtained by sliding the ODT-coated tip across an Au surface, with a scanning speed of 4mm/s, applying a force of 1nN for 1.5 minutes to make each line.

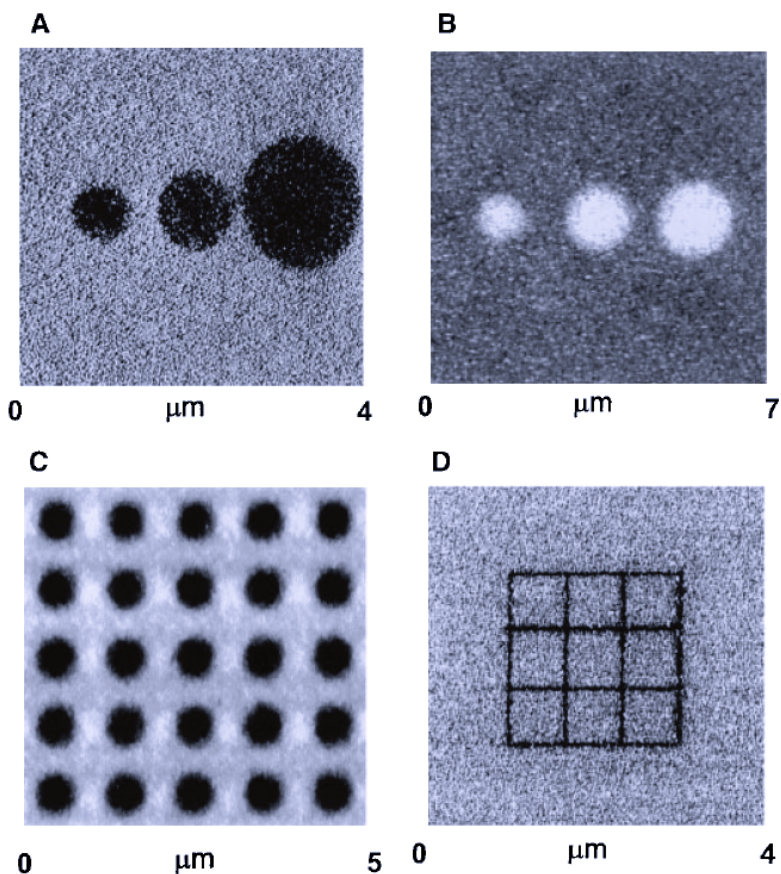

Fig 5.38 In picture A is represented the lateral force image of an Au substrate after an AFM tip, which was coated with ODT, had been in contact with the substrate for 2, 4, and 16 min (left to right). Picture B is the representation of the lattice image of a SAM ODT. In picture C we see the lateral force image of an array of dots generated by DPN. The last picture, D, represents the lateral force image of a molecule-based grid. Source: Piner *et al.* (1999)

The resolution of DPN obtained by Piner and his 1999 co-workers depended on several parameters. Firstly, the grain size of the substrate seemed to influence the resolution of DPN, just as the structure of the paper could control the resolution of conventional writing. Secondly, chemisorption and self-assembly could be used to limit the diffusion of molecules after deposition. Third, the tip-substrate contact time and thus the scanning speed were other factors that influenced the resolution of DPN. Fourth, the resolution of the lithographic process seemed to depend on the relative humidity, as it controlled the transport speed of the ODT from the tip to the substrate. The size of the water meniscus between the tip and the substrate depended on the relative humidity (Piner and Mirkin 1997).

DPN quickly proved to be a conceptually simple, yet powerful method for transporting molecules from AFM tips to substrates at resolutions comparable to those obtained by much more expensive and sophisticated competing lithographic methods, such as electron beam lithography.

5.1.10 2000: Quantum Mirages

The mirage phenomenon occurs, according to the explanation of classical physics, when light rays in the air undergo refraction phenomena between contiguous layers characterized by different temperatures, thus different refractive indices. The development of nanotechnology made it possible, in 2000, to achieve a phenomenon similar, at levels of matter in the condensed state. The electronic structure surrounding a cobalt atom was projected onto the surface of a copper crystal, coherently refocusing the waves scattered by the electrons of the cobalt atom. The refocusing device consisted of a kind of quantum elliptical corral functioning as a mechanical resonator, while the electrons on the 2D surface of the copper acted as a projection medium. Cobalt atoms possess a specific spectroscopic signature, known as Kondo resonance, a phenomenon observed when scattering of electrons whose energy is close to the Fermi level energy of conduction electrons. This occurs at low temperatures because Fermi distribution broadens as temperature increases. The effect results in an increase of resistivity.

By placing a cobalt atom at one of the two foci of the ellipse, a signal due to Kondo effect was also observed at the second empty focus of the corral.

In 2000, Manoharan, Lutz and Eigler described their results on quantum mirages formed by the coherent projection of electronic structures (Manoharan, Lutz and Eigler 2000). They worked with a scanning microscope (STM) in ultra-high vacuum and extremely low-temperature conditions at 4K. They worked with a surface (111) of copper monocrystal, prepared by sputtering cycles performed with Ar ions and UHV annealing. After bringing the sample to a low temperature, it was processed with Co ions to a coverage of 13 atoms, around 100 angstroms. Using Kondo resonance, a response that takes place around individual magnetic moments on the metal, the researchers were able to demonstrate the existence of quantum mirages. It was STM electron microscopy that enabled the identification of Kondo resonance around single magnetic atoms placed on a non-magnetic surface. The Kondo effect results from the exchange interaction between the localised magnetic moment of the impurity and the delocalised electrons of the metallic host. At low-temperature T , the conduction electrons align their spin to give rise to a spin shielding on the localised moment. This results in an overall, many-body singlet consisting of the local magnetic impurity and the spin cloud of the conduction electrons. In this way, no net moment is measurable at the Kondo site. An energy $k_B T_K$ is associated with this state, where k_B is the Boltzmann constant and T_K the Kondo temperature. The Kondo effect is expected to occur for certain conditions, e.g. $T < T_K$ and for certain combinations of the magnetic and host atoms. Since the electrons providing the Kondo shielding come from the Fermi surface of the metallic host, the Kondo effect is observed as a resonance in the density of states, close to the value of the Fermi energy. The amplitude of the resonance is proportional to the value of T_K . The copper surface used for the study of quantum mirages could be regarded as the seat of an electron gas in two dimensions, located in an energy band beginning at 450mV below the Fermi energy. The cobalt atoms placed on the surface were themselves immersed in the two-dimensional electron gas, a fundamental fact because it is precisely the electron gas that constitutes the projection medium of the quantum mirage. The discrete electronic states of elliptical quantum enclosures were used to perform the mirage projection 2,3. All the rectilinear trajectories coming out of the focus of an ellipse and bouncing on the curve delimiting the conic are reflected so as to pass through the second focus, according to the properties of the ellipse itself; moreover, precisely by definition of

an ellipse, all the possible paths from the first focus to the curve, to the second focus, have the same length $\overline{F_1PF_2} = 2a$, where a is the length of the semi-major axis. Therefore, by placing a scatterer at one focus, all scattered waves sum in a coherent phase at the other focus. Manoharan, Lutz and Eigler designed elliptical electronic resonators, as shown in the figure below (Fig. 5.39).

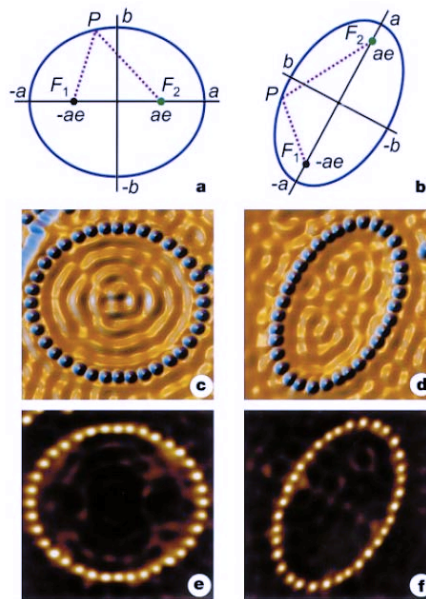

Fig 5.39 The figure shows the two elliptical configurations used, in a. that of $1/2$ eccentricity, while in b. the eccentricity is 0.786 . Figures c. and d. illustrate how the cobalt atoms form elliptical enclosures on the Cu(111) surface. Figures e. and f. are the corresponding topographies to show the Kondo resonance. Source: Manoharan, Lutz and Eigler (2000)

The average distance between the cobalt atoms forming the walls of the resonator was about four atomic sites on the underlying copper lattice, which, at $T = 4\text{K}$, has a distance between first neighbours of about 2.55\AA . The two chosen ellipses had the same semi-axis size $a = 71.3\text{\AA}$, but with a different eccentricity ($e = 1/2$ for the former and $e = 0.786$). From Figures 2e and 2f, it can be seen that there was no significant Kondo signal visible within the ellipses.

The researchers then placed a single cobalt atom within each resonator, in different positions. The results, in this case, were remarkable: two positions were revealed where the Kondo resonance was dominant for each ellipse. One signal was clearly localised on the left focus, where the real cobalt atom was located, while a second signal was also visible on the right focus, empty for all intents and purposes. By projecting the electronic structure located on the occupied focus towards the unoccupied focus, the quantum mirage was created, as seen in the next picture (5.40).

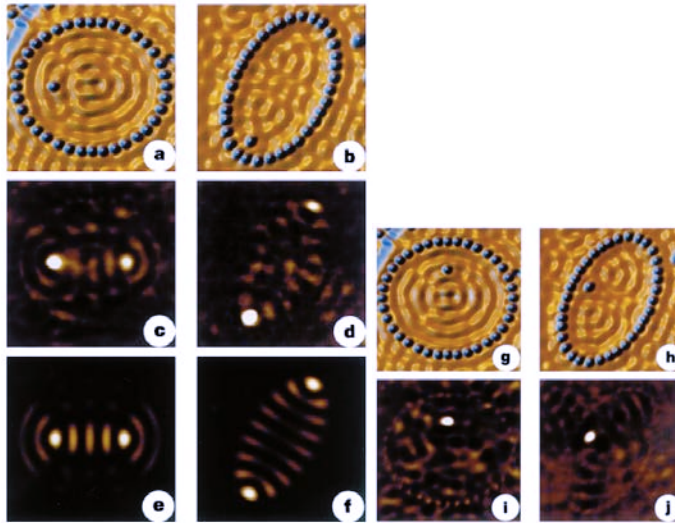

Fig 5.40 The following images represent the quantum mirages observed in 2000. Images a. and b. show the topographies of the experimental corrals, having eccentricities $1/2$ and 0.786 respectively. The cobalt atom is located at the focus of the ellipse in both cases. Figures c. and d. show the Kondo effect at the right geometric focus, which is physically empty. Figures e. and f. show the eigenmodes of the states. The last four pictures show how the quantum mirage disappears once the cobalt atom is moved to a position other than the focus. Source: Manoharan, Lutz and Eigler (2000)

The projection of the electronic structure of cobalt in an elliptical corral was then observed in the second focus. In 2001, an interesting paper by Weissmann and Bonadeo published the study of a series of theoretical questions, such as the relation of the quantum system to the classical image projection, the dependence of the mirage on the surface type, the adsorbed atom, and the shape of the corral (Weissmann and Bonadeo 2001).

The surface (111) of the noble metals had a symmetry gap in the centre of the Brillouin zone, and a surface state about 0.5eV below the Fermi energy, this decoupled from the bulk states. These conditions were considered fundamental.

The authors hypothesised a model Hamiltonian for the interaction, making a number of approximations. According to the first approximation, the substrate was represented by a two-dimensional surface of atoms arranged in a triangular lattice representing the surface (111) of copper, a material whose purpose was to determine the position of the Fermi level. Since the surface state at the centre of the Brillouin zone was approximately 0.5eV below the Fermi level, the measured Fermi energy was $E_F = -5.5\text{eV}$ and the corresponding Fermi wavelength was approximately of 5 angstroms . Corral was simulated by considering a finite number of atoms enclosed in an ellipse. The characteristics of the ellipse were as follows: its semi-axis measured $a = 26d = 70\text{ \AA}$ (where d measures the distance between first neighbours in the copper) and eccentricity $e = 0.5$. The choice of these parameters meant that the ellipse enclosed approximately 2300 copper atoms. Having resorted to the tight-binding model, which gives very good results in calculating the structure of the electronic bands, information on the wave function was obtained by diagonalising the tight-binding matrix, this in particular for levels close to the Fermi energy. As a last approximation, a resonant model was applied, where the fine-tuning of energies proved to be crucial. This

model could also be applied to Kondo's resonance to the Fermi energy. Placing an atom on top of one of the copper atoms involved, mathematically, adding both a row and a column to the Hamiltonian matrix of the problem. In the matrix, what became relevant was the only term outside the main diagonal. For if this was too large, it would result in the modification of many energy levels, distorting the surface wavelengths with which the STM microscope interacted. This approximation, however, was not confirmed by the experimental results of Manoharan, Lutz and Eigler, when the STM images showed that the topography of the sample had not been altered to such a great extent after the cobalt adsorption process.

If the off-diagonal term had been too small, its contribution would have been negligible.

The following figure shows one of the results obtained by applying the proposed model. The lighter spots indicate where the charge density is greatest. The image (Fig. 5.41) shows the elliptical shape of the corral on the one hand and the presence of two important symmetrical maxima on the major axis on the other, accompanied by other satellite maxima.

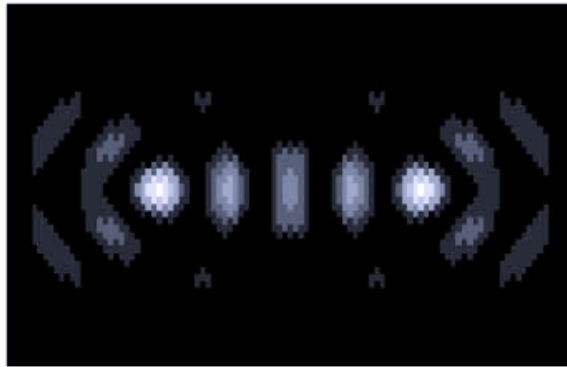

Fig. 5.41 The charge density for the studied quantum corral. Source: Weissmann and Bonadeo (2001)

Weissmann and Bonadeo were able to obtain the projection of the charge density as a function of the distance from the centre of the major axis of the ellipse in which the quantum mirage phenomenon occurs. The following image (Fig. 5.42) represents precisely this situation:

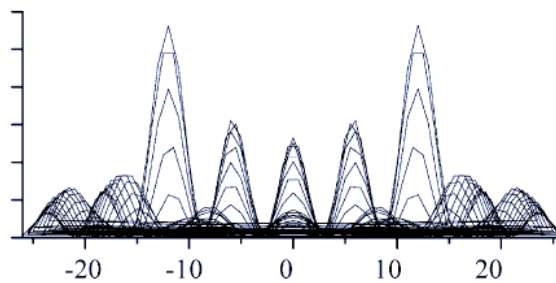

Fig 5.42 The projection of the charge density for the quantum corral. Source: Weissmann and Bonadeo (2001)

For $x = 12d$, the wave function had maxima and, in this case, they are in the vicinity of the geometric foci of the ellipse. Therefore, placing an atom near one of the maxima results in a quantum mirage, a phenomenon that disappears as soon as the atom is placed far from the maxima of the wave function. Wiessmann and Bonadeo, who treated the question from a Hamiltonian/mathematical point of view, also demonstrated that it was possible to study wave functions whose maxima were not coincident/in the vicinity of the ellipse's foci. In these cases, the position of the atom giving rise to the quantum mirage did not coincide with the foci of the ellipse. The proposed model, therefore, did not envisage the foci of the ellipse to be a particularly privileged position to locate the atom for the study of the quantum corrals phenomenon.

The ellipse can be modified, with respect to dimensions, while keeping the eccentricity constant, and wave functions with maxima near the foci appear, with the appropriate energies, in accordance with the experiments conducted the previous year.

One might ask at this point what is so special about ellipses compared to other geometric curves in which wave functions with well-defined maxima can be derived. In reality, several shapes have been considered to make a quantum corral, but ellipses proved to be the most efficient.

Finally, to achieve a quantum mirage, cobalt proved to be an optimal element due to its density of local states.

5.1.11 2002: Characterization of Nanoferrites

In 2002, at the Department of Physics of the University of Ferrara, I decided to undertake a thesis project about Nanoscience and Nanotechnology together with Franco Ronconi (who passed away in 2021) and Federico Spizzo as my research supervisors. I approached the study of the structure and the properties of Nickel Ferrite NiFe_2O_4 , a magnetic compound. The final aim of this work was to obtain ferritic nickel structures of nanometre dimensions by means of a controlled process.

The starting point of the research was established by taking as a reference the hypothesis that interdiffusion mechanisms between nickel oxides NiO and iron $\alpha\text{-Fe}_2\text{O}_3$, deposited with laser technology in alternating layers, could lead to the formation of nickel ferrite NiFe_2O_4 , also known by the mineralogical term of *trevorite*, at the interfaces of these layers. Such diffusion mechanisms were activated during the deposition of the materials due to the high temperatures reached by the samples themselves during the growth process. Taking this fact as a starting point, we proposed an alternative methodology that did not require the use of advanced devices for layer deposition, but involved a direct reaction of the mixture of the two oxides brought to a high temperature.

The formation of new phases from pure elements that are in the solid state occurs through processes known as solid-state reactions. In analogy to chemical reactions, reactants and products are also defined in the solid state and are obtained according to the laws of thermodynamics and the principles of conservation of mass. However, whereas chemical reactions presuppose reactants in contact with each other in the gaseous state or in solution, in the solid state the reactants must be able to diffuse into each other. The fundamental hypothesis on which the theory of material diffusion is based is that the particles constituting the structure of matter are mobile with respect to each other (albeit to varying degrees depending on the state of aggregation): this mobility is, in general, never equal to zero and

increases as the temperature increases. If we assume that the reacting crystalline solids are in contact with each other by means of a surface, the latter must constitute the interface through which the species can diffuse to give rise to the reaction.

The development of new ferritic materials requires the synthesis of solid phases from compounds of precise grain size to obtain products that meet certain operational requirements. Reactions in the solid state stimulated by temperature are important because, in addition to creating the phases of interest, they give the materials structural strength; it is no coincidence that annealing is performed several times when it is ascertained that diffusion of the species is slow. Not only that, but being able to count on the appropriate precursors allows the creation of ferritic materials with micrometric grain size.

Ferrites are usually prepared in both polycrystalline and monocrystalline forms: in this discussion, we were interested in polycrystalline structures (Chen 1986). Since ferrites tend to be dissociated at high temperatures, the conventional casting technique widely used for metals and alloys in general was logically impractical. Polycrystalline ferrites are therefore usually prepared through powder metallurgy or ceramic material technologies: the ferrites achieve their homogeneous compositions through solid-state diffusion reactions stimulated by chemical potentials; the different ferrite shapes are then obtained in a mould under pressure and subsequent sintering. The preparation procedure generally consists of the following four basic steps.

- A mixture of materials is prepared in which the cations are present in the stoichiometric ratio that competes with the final product. When oxides are used, this step involves a simple mixing of the materials in a fluid matrix. To avoid iron contamination, mixing is performed in a stainless steel ball mill and in fluid such as water or alcohol to prepare the mixture into a slurry, i.e. a suspension of powders in an organic liquid.
- The mixture is preheated to form ferrite. At this stage the slurry is filtered or dried then placed in a ceramic crucible for the pre-firing stage at temperatures between 900 and 1200°C. This point is the most crucial as the subsequent steps will no longer substantially alter the composition.
- The raw ferrite is pulverised and pressed into the shape of interest. The ferrite produced in the previous step usually has an irregular shape and must be pulverised in a steel ball mill. In addition to reducing the particle size to below 1 micron, grinding eliminates intraparticle pores and homogenises the ferrite.
- The material is sintered in order to have a product characterised by high density. Sintering is the heat treatment by which the compact powder mass is transformed into a solid object. As the last of the four fundamental steps to obtain ferrite products, sintering must fulfil three basic requirements:
 - bind the particles together in such a way as to impart sufficient mechanical strength to the products;
 - densifying the material that has not yet been sintered in order to eliminate porosity;
 - homogenise the material by completing those reactions that remained incomplete in the pre-baking phase.

The mechanism through which the formation of ferrites is admitted is that of counter-diffusion between two adjacent simple materials A and B. In our case, we will have to consider two oxides, nickel oxide NiO and iron oxide Fe₂O₃. The figure 5.43 illustrates the counter-diffusion mechanism we have assumed to govern the formation of the compound we have sought to obtain.

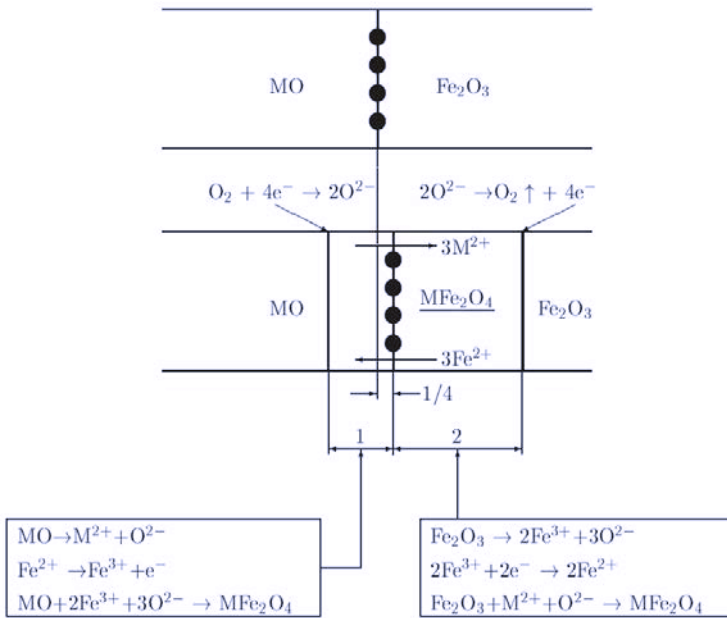

Fig 5.43 The migration process with the shift of the black markers towards the ferrite. Source: AD

The solid–state reactions leading to the formation of a ferrite are actually counter–diffusion ones. This means that the diffusion involves two or more ion species moving in opposite directions across the interface created when two oxides come into contact. Let us assume that MFe_2O_4 is the general formula of the material to be examined. The stoichiometry of reactions leading to such a compound is complicated by the fact that iron ions diffuse in the divalent state. Reduction of iron from Fe^{3+} to Fe^{2+} state occurs at the interface Fe_2O_3 – MFe_2O_4 together with a reaction of oxygen:



At the interface Fe^{2+} ions are oxidated again to Fe^{3+} while oxygen undergoes the reaction:



The formation of MFe_2O_4 involves a transfer of oxygen from the oxide Fe_2O_3 to MeO via two processes equivalent to evaporation and condensation, processes that are in addition to the counter–diffusion of cations that occurs via substitution, the so–called Kirkendall effect. To maintain the charge balance during the diffusion process, if all Fe^{3+} ions are reduced to Fe^{2+} before migration and:

- the ratio of counterdiffusion ions M^{2+} and Fe^{2+} will be 3 to 3;
- the ratio between the ferrite formed in the MO side and the ferrite formed on the Fe_2O_3 side will be 1 to 2;
- the markers will move to the Fe_2O_3 side.

Since it is experimentally observed that the ratio of the amounts of ferrite formed at the two sides of the interface is 1 to 2.7, the reduction of Fe^{3+} ions occurs only on a limited scale. Despite this incomplete reduction, it is important to realise that ferrite formation depends on the partial pressure of oxygen. Reducing conditions promote the ferrite formation ratio as larger concentration gradients are realised between the interfaces and, as a result, more Fe_2O_3 can be dissolved in the ferrite.

The mechanism described justifies the pre-heating and sintering steps performed during the preparation procedure. We have seen that ferrite is essentially formed during the second step, but the raw material thus obtained possesses properties that are poor in two respects. First, we could not expect a homogeneous composition as we have shown that the recovery of Fe^{2+} ions at the $\text{MO-MFe}_2\text{O}_4$ interface did not appear to be complete. Secondly, the ferrite formed at the Fe_2O_3 side might result to be porous due to the development of oxygen. The experimental results obtained in the realisation of NiFe_2O_4 ferrite indicated an appreciable weight loss of the samples. This loss is identified with a loss of oxygen and implied an incomplete recovery of Fe^{3+} ions.

To eliminate porosity, a simple way of joining two spherical particles was to form, through a diffusion phenomenon, a small collar at the point of contact as shown in the figure below (Fig. 5.44).

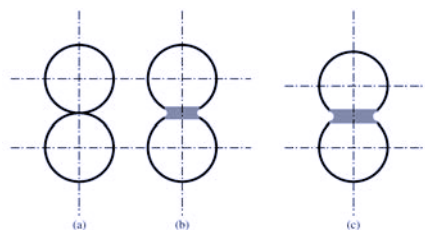

Fig 5.44 The proposed mechanism of neck formation. (a) Two precursors come in contact, (b) neck formation without shrinking, (c) neck formation with shrinking. Source: AD

The disappearance of porosity during sintering is a debated mechanism; theory focuses on the formation of collars considering volume diffusion due to surface tension as the main mechanism. Based on induced diffusion by surface tension, an important equation referring to the initial stage of sintering is the following.

$$\frac{\Delta L}{L} = \sqrt{\frac{AD^* \gamma \Omega}{\bar{r}^3 kT} t} \quad (5.54)$$

where $\Delta L/L$ is the shrinking coefficient, Ω is the volume of a single vacuum, D^* the self-diffusion coefficient of the slower species, γ the surface energy, \bar{r} the average radius of the particles, t the sintering time and A a constant value, approximately close to the unit. This equation describes a sintering process that arrives at a material whose mechanical resistance is satisfactory for the desired applications, the porosity is overcome and a more dense material is obtained.

Can a mixture of $\text{NiO} + \alpha\text{-Fe}_2\text{O}_3$ oxides brought to high temperature result in the formation of nickel ferrite? To test this feasibility hypothesis, commercial nickel oxide and iron oxide powders were taken, both having a nominal declared grain size of 150 micrometres. However, the declared grain size was considerably larger than that revealed by scanning electron microscopy. This fact is to the advantage of the solid–state reaction unfolding because, as the particles are smaller than the 150 microns assumed, it is credible that a more intimate contact between the oxides is realised, i.e. an increase in the contact surface area between the particles. Since the reaction seems to occur preferentially when the ratio of moles of the starting oxides is $1 = 1$, it can be deduced from the molecular weight value of the oxides that – for example – 75g of nickel oxide should be mixed with 160g of iron oxide.

The mixing was carried out in the laboratory, following two different methodologies:

- a. by hand;
- b. with a steel ball mill, for a time of one hour and at a stirring frequency of 20Hz.

The grinding was done in order to improve the degree of mixing of the oxides and, if necessary, to further reduce the grain size so as to improve the contact between the oxides themselves as much as possible.

The temperature at which the mixture was reacted in a muffle furnace was set at around 650°C so that the operating conditions typical of an industrial process were not applied in order to slow down the reaction, so as to limit the size of the ferritic particles; the mixture was then heat–treated for varying times from 4 to 32 hours in order to activate the solid–state reactions.

The oxides used as precursor materials are antiferromagnetic, whereas the nickel ferrite that we would like to be able to produce is ferrimagnetic and has a Curie temperature of 585°C . Consequently, in order to control the formation of the ferrite within the treated sample, it was determined whether or not the sample had a transition. For this purpose, after treating the sample, it was analysed with a Field Gradient Thermogravimeter (TG), an instrument that consists of a thermobalance in a magnetic field gradient: in this way, it is possible to record changes in the magnetic shape applied to the sample as a function of temperature.

In order for a magnetic component of the force to be generated on the sample, the system is immersed in a magnetic field gradient obtained by counterposing two permanent magnets against each other, as shown in the figure 5.45.

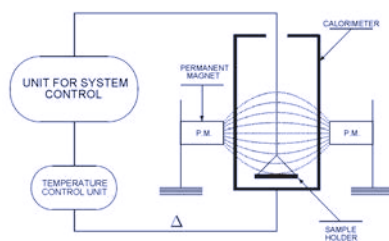

Fig 5.45 The schematic representation of a thermogravimeter such the one used to characterize the sample we obtained in lab. Source: AD

In addition to the magnetic force, which we denote by \mathbf{F}_m , the weight force $\mathbf{F}_w = m\mathbf{g}$ and the hydrostatic lift of Archimedes $\mathbf{F}_a = \rho V\mathbf{g}$ act on the sample:

$$\mathbf{F}_{\text{tot}} = \mathbf{F}_m + \mathbf{F}_w + \mathbf{F}_a \quad (5.55)$$

In this expression, the only non-constant force is the magnetic force, so a suitable analytical expression must be found for this component. Suppose we want to calculate the magnetic force acting on the sample, placing ourselves at a generic point in space and evaluating what happens when we consider an infinitesimal element dV of sample volume. Let \mathbf{r} be the radius vector from the origin of the reference system to a generic point on the surface of the sample, let \mathbf{r}' be the vector applied at the latter point which identifies the infinitesimal reference element for the calculation. The magnetic field that is measured on the volume element dV depends on the distance from the origin, $\mathbf{H} = \mathbf{H}(\mathbf{r} + \mathbf{r}')$ the magnetisation, on the other hand, is peculiar only to the material and not to empty space and is therefore a function only of the vector \mathbf{r}' , i.e. $\mathbf{M} = \mathbf{M}(\mathbf{r}')$. This method of calculation tells us that the magnetic force is not constant over the sample but must be calculated as the integral over the entire volume of the sample of the infinitesimal contribution of the force acting on dV :

$$d\mathbf{F} = \nabla_r[\mathbf{M}(\mathbf{r}') \cdot \mathbf{H}(\mathbf{r} + \mathbf{r}')] \quad (5.56)$$

The position of the sample immersed in the magnetic field remains constant, a condition guaranteed by the operating principle of the thermobalance, so that the balance is only able to detect the vertical component of this force. In reality, what is measured are the changes in the magnetic shape and these are precisely the parameter that enables us to discriminate the magnetic behaviour of materials.

The magnetic behaviour of materials can be reduced, in a simplified manner, to one of the following five categories: diamagnetism, paramagnetism, ferromagnetism and antiferromagnetism. Magnetic behaviour can be distinguished through the values assumed by certain fundamental quantities such as susceptibility χ and magnetic permeability μ .

In quantum terms, it is possible to explain ferromagnetism, ferrimagnetism and antiferromagnetism, based on the definition of the exchange integral; thus, a spin-dependent interaction between the electrons in the material represented by the exchange Hamiltonian is postulated:

$$\mathcal{H}_{ex.} = - \sum_{i>j} J_{i,j} \mathbf{S}_i \cdot \mathbf{S}_j \quad (5.57)$$

In this expression, in which the sum is understood to be performed on all pairs of electrons, the coefficients $J_{i,j}$ are called exchange integrals. An important distinction must now be made. If the exchange integrals are positive, the Hamiltonian favours the alignment of the electron spins: this situation corresponds to the ferromagnetic state. If the exchange interaction is negative, the Heisenberg Hamiltonian favours anti-parallel spin coupling, which gives rise to what is termed the antiferromagnetic state. From a quantitative point of view, therefore, in an antiferromagnetic substance it will not be possible to measure a net magnetic moment, which, on the contrary, is possible in a ferromagnetic material.

Antiferromagnetism is typical of structures consisting of two interpenetrating sublattices A and B, such as, for example, transition metal oxides. In some of these compounds, the crystal structure is entirely analogous to that of sodium chloride and the antiferromagnetism is justified by the fact that the spins in one plane [111] are parallel, but for adjacent planes [111] the spins are antiparallel. Antiferromagnetic substances, therefore, do not exhibit a net magnetic moment from the macroscopic point of view because, although there is a very high degree of local polarisation, the two opposite polarisations of the sublattices neutralise each other: the two sublattices A and B possess the same saturation magnetisation. In an antiferromagnet the spins are ordered antiparallel with zero total magnetic moment for temperatures below a particular value, known as the Néel temperature. Since the lattices A and B have the same Curie constant C we will have:

$$T_N = \mu C \quad (5.58)$$

The susceptibility in the paramagnetic region is calculated using the formula:

$$\chi = \frac{2CT - 2\mu C^2}{T^2 - (\mu C)^2} = \frac{2C}{T + \mu C} = \frac{2C}{T + T_N} \quad (5.59)$$

Both oxides and their mixture underwent heat treatment in an alumina crucible and were subsequently analysed by field gradient thermogravimetry. The analysis was performed by varying the temperature from 450°C to 650°C at a rate of 20°C/min while simultaneously recording the mass of the sample using the thermobalance.

The following figure (Fig. 5.46), which is the result of the analysis performed with this experimental setup, illustrates the thermogravimetric curve TG vs. T : it does not show any step at certain temperatures, but rather a flat course. The presence of a step on the thermogram would have meant that, where the thermogravimetric curve is lower, the sample plate of the balance would be *lightened* by the additional presence of an upward force (i.e. less force is required to balance the balance).

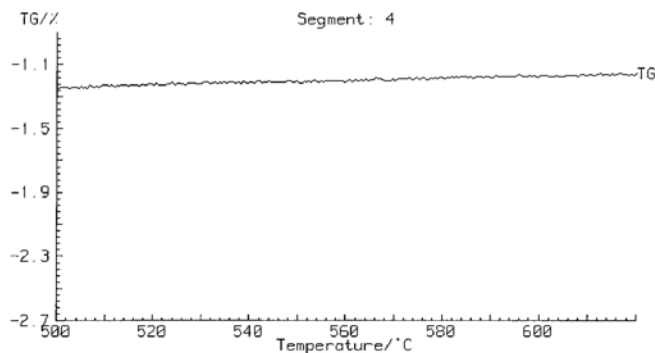

Fig 5.46 This thermogram was obtained from iron oxide and showed no magnetic transition in the sample since no “steps” appear and the line is practically flat. Source: AD

This additional component is precisely the magnetic force concomitant with the hydrostatic lift: the sample is, in this case, a ferromagnet the temperature at which the step occurs is called the Curie temperature T_c . As the thermal scan brings the sample to a temperature above T_c , the material loses its ferromagnetic characteristics and becomes paramagnetic: the magnetic force becomes zero, abruptly changing the value of F_{tot} and generating the step on the thermogram. With materials such as NiO and α -Fe₂O₃, this does not happen, which means that there is no value of T_c for which, during the scan, a contribution of the magnetic force to the equilibrium of the thermobalance can be detected, and the two oxides do not exhibit magnetic transitions, which is what we wanted to show. After experimentally proving that the two precursors did not exhibit magnetic transitions in the temperature range considered, the most important aspect had to be verified, i.e. what happened if a mixture of the two powders was subjected to heat treatment and then analysed at TG (the experimental conditions used for the latter analysis are identical to those used in the case of the precursors). The precursors were milled using different methods, and what was observed was that milling using a mill produced an improvement in the reaction yield. The reaction yield, as expected, was also increased by increasing the treatment time (Fig. 5.47).

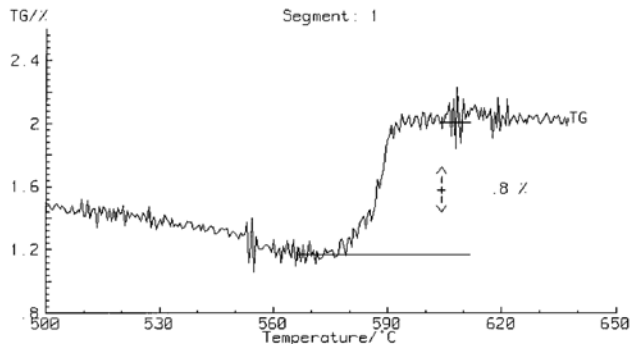

Fig 5.47 This thermogram was obtained from the reacted mix of oxides, with a step clearly showing the magnetic transition in the sample. In the sample a new ferromagnetic solid-state phase was present. Source: AD

Well, as can be seen, the thermogram for this experimental test shows a step around a temperature of 590°C: the result is remarkable, two antiferromagnetic precursors have reacted in the solid state to form a ferromagnetic phase. We associate the temperature of 590°C with a magnetic transition of the material: given the nature of the ferromagnetic/paramagnetic transition, we call this temperature the Curie temperature of the new phase.

From the literature, we find that the temperature of 590°C is very close to the Curie temperature common to two different ferrites, the nickel ferrite NiFe₂O₄ we are looking for in the sample ($T_c = 585^\circ\text{C}$), and the iron ferrite, also called *magnetite*, Fe₃O₄ ($T_c = 585^\circ\text{C}$) and also to the Curie temperature of the oxide γ -Fe₂O₃, or *maghemite*, ($T_c = 590^\circ\text{C}$).

At this point, it would seem that nothing more can be said and further investigation was to be done. Once the magnetic material was obtained, the following step was necessary to

characterize the solid phase to effectively see if trevorite was present, thereby supporting our hypothesis.

Physical techniques such as high-resolution electron microscopy or tunnelling effect microscopy make it possible to directly visualise atomic structures. However, when studying an unknown structure and wanting to determine its structural parameters, in order to obtain more detailed information of an average nature, i.e. relating to the entire sample studied, it is preferable to carry out X-ray diffraction measurements. The information that can be obtained from this methodology is in fact, linked to the extreme sensitivity of the diffraction process to the periodic nature of atomic structures in the solid state. It is commonly recognised that liquid or glassy substances (the latter also referred to as amorphous materials) produce diffraction spectra consisting of one or more broadened regions, whereas well-crystallised substances result in diffraction spectra characterised by the presence of very sharp, well-defined peaks.

We performed high-angle X-Ray Diffraction measurements of the samples – or WAXD, Wide Angle X-Ray Diffraction – at the laboratories of the University of Ferrara’s Centre for Diffractometric Studies, using a Siemens D5000 instrument with a copper anode tube; an average Cu- α wavelength with a numerical value of $\lambda = 0,1541\text{nm}$ was used for the calculations on the acquired spectra, and the data were then interpolated using Siemens Diffrac-AT® v.3.30 software. The experimental methodology followed the following steps.

1. Diffractometer scan of the sample holder, made of PVC plastic, so that the position of the *experimental background* peaks can be observed;
2. Powder scan of the starting oxides NiO and $\alpha\text{-Fe}_2\text{O}_3$;
3. Powder scan after heat treatment.

We carried out the scans in a 2θ angular range from 15° to 135° with a step of 0.03 degrees; the error to be attributed to the angular position was 0.005 degrees (in 2θ units); subsequently, the spectrum of the sample holder PVC – which is the experimental background – was subtracted from the diffractograms obtained experimentally, so that all and only the peaks relating to the chemical species examined could be clearly observed. From the precursor oxides we obtained the following experimental spectra (Fig. 5.48).

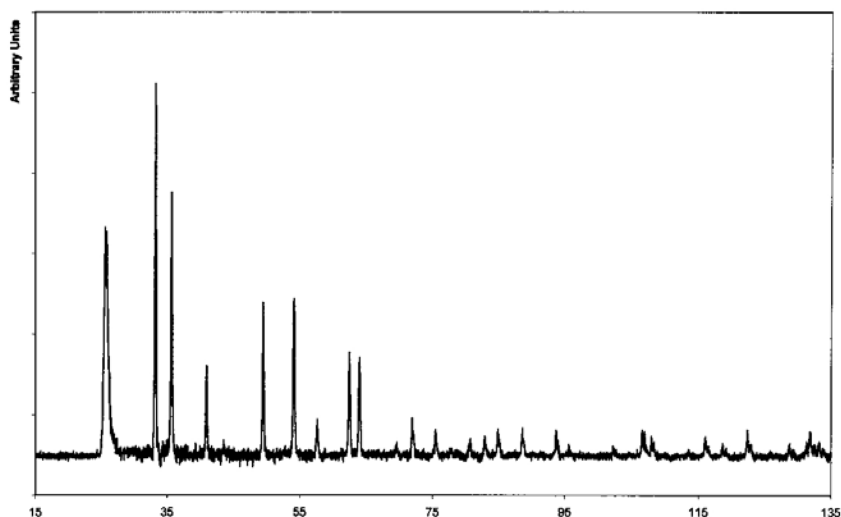

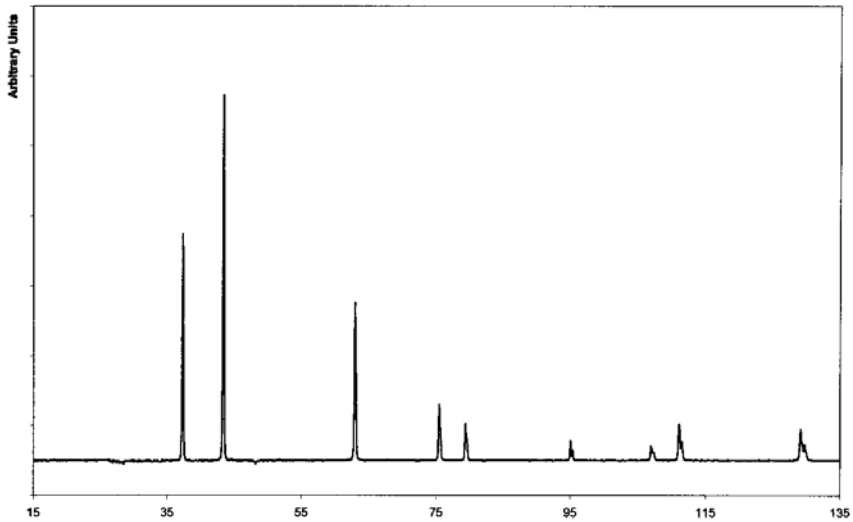

Fig 5.48 The first step of the investigation through X-Ray Diffraction was to test the precursor powders. In the previous page: the experimental diffractogram of iron oxide, above the experimental diffractogram of the nickel oxide. Source: AD

The quality of the precursor analysis was verified by comparing the results we obtained in the laboratory with the known JCPDS – The Joint Committee on Powder Diffraction Standards – and observing that both the positions of the characteristic peaks and their intensities gave an almost perfect correspondence between the literature and the experimental result. This also proved the optimal preparation of the sample examined.

The treated sample deserves more in-depth discussion. In its diffractogram, in fact, we noticed both NiO oxide peaks and α -Fe₂O₃ oxide peaks. Actually, this is not surprising, as it was to be expected that the solid-state reaction between NiO and α -Fe₂O₃ did not proceed until the reactants were completely exhausted, and so it was quite predictable to find the peaks of the precursor oxides still readable in the spectrum of the final product. The difference between the angular positions measured and those predicted by the labels was attributed to the imperfect preparation of the treated sample.

The diffractogram of the reacted material was acquired as follows (Fig. 5.49).

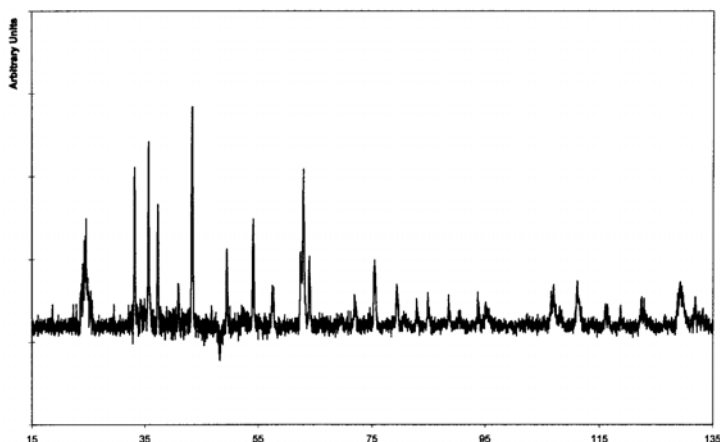

Fig 5.49 The experimental diffractogram of the reacted sample. Source: AD

We have grouped the peaks in the spectrum of the treated sample in the following table and matched them with those readable directly from the label. Peaks reported in the literature³⁷ for nickel ferrite are highlighted (Table 5.1).

Table 5.1 Comparison among diffraction peaks.

2θ treated	2θ literature	2θ treated	2θ literature	2θ treated	2θ literature
33.16	33.15 _e 33.98 _m	57.55	57.45 _m 57.58 _e	77.76	77.72 _e
35.65	35.42 _m 35.61 _e 35.69 _t 35.71 _m	49.48	49.47 _e	79.45	79.39 _n 79.63 _m
		54.07	53.80 _t	80.65	80.70 _e
			53.90 _m 54.08 _e	82.93	82.93 _e
37.30	37.05 _m 37.27 _n 37.31 _t 37.34 _m	62.41	62.44 _e	84.88	84.91 _e
		62.95	62.91 _n 62.91 _t 63.07 _m	88.51	87.44 _t 88.53 _e
				90.45	90.38 _t 90.45 _m
40.84	40.45 _m 40.85 _e	64.00	63.98 _e	93.69	93.71 _e
		69.88	69.59 _e	95.05	95.23 _e 95.28 _t 95.31 _m
43.30	43.29 _n 43.36 _t 43.37 _m	72.24	71.93 _e		
		72.48	72.26 _e		
		75.37	75.42 _e		
43.50	43.51 _e		75.56 _t		

We concentrated on observing the $90^\circ 45'$ angle because the reacted compound had shown evidence of a very low, broadened reflection, the width of which at half-height was $\Delta 2\theta = 0.66$ while the width from the tag was $\Delta 2\theta = 0.22$; the latter peak, however, was

³⁷ The subscripts in the table indicate e hematite, m magnetite, t trevorite (nickel ferrite) and n nickel oxide, respectively.

present in both nickel ferrite and maghemite, making it impossible to state with certainty to which material it might refer.

A comparison among the different diffraction spectra made the situation more evident as follows (Fig. 5.50).

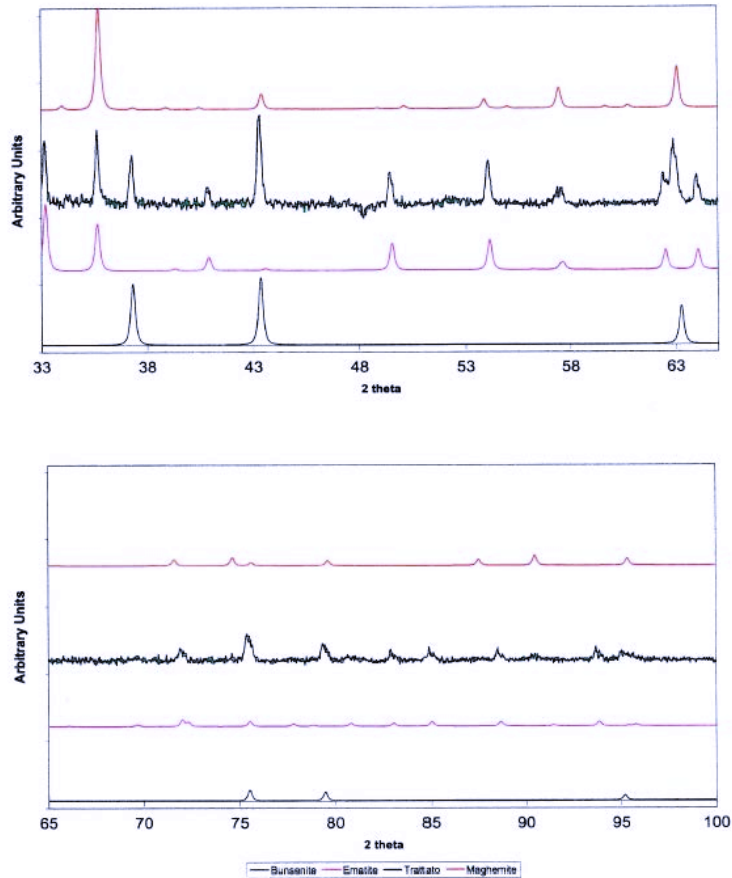

Fig 5.50 The comparison among the diffractograms shows that discriminating the correct material we were searching for was not possible through this technique. Source: AD

In an attempt to get out of this ambiguous situation, we referred to an experimental result (de Boer and Dekkers 2001) according to which it could be stated that although the transition of iron oxide from phase γ to phase α occurred rather simply by heat treatment the reverse transformation was not so straightforward. This was both because of the experimental conditions used – different from those used in this work – and because of the way in which the reaction was assumed to take place, involving solid state vacancies, induced by the sample preparation, and their concentration. We linked this assumption to the fact that no isolated peaks belonging to the γ - Fe_2O_3 phase were particularly evident in the treated sample, and could have stated that the probability of maghemite having formed

during the heat treatments carried out was low, despite the overlapping angular values of the diffraction peak considered.

With regard to the third ferromagnetic phase, Fe_3O_4 , we observed that:

- no characteristic magnetite peaks were evident since – even if they had been present – they would have been practically superimposed on the peaks of the $\alpha\text{-Fe}_2\text{O}_3$ precursor, for reasons of structure symmetry;
- once this observation was linked to the fact that the $\alpha\text{-Fe}_2\text{O}_3$ oxide subjected to the same heat treatment as the powder mixture had shown no magnetic transition, we concluded that there were reasonable experimental indications that the probability of finding Fe_3O_4 magnetite in the final compound was very low. In other words, if it had been present, the techniques employed to date would not have shown evidence of it.

Further characterisation of the available material was necessary, then.

The information we were searching for on the nature of the compound formed after heat treatment was obtained by means of Mößbauer Spectroscopy, as this technique makes it possible to study the surroundings of a given atom from the analysis of the fine structure of the absorption spectrum of the atom's nucleus.

Mößbauer spectroscopy is only applicable to certain atoms; in our case, the ^{57}Fe isotope of iron was taken into account and the absorption line considered the one corresponding to an energy of 14.4KeV. However, the structure and relative position of the nuclear levels between which the transition to which the absorption is linked occurs depend on various factors:

- from the atomic species present around the ^{57}Fe atom;
- the crystal structure in which the ^{57}Fe atoms are embedded;
- the presence of a magnetic field on the ^{57}Fe atom.

In detail, the first effect produces only a change in the energy value of the E_γ photons without altering the shape of the absorption spectrum. This phenomenon is referred to as an isometric shift. In the second case, even minimal deviations from a cubic crystal structure produce the splitting of one of the levels between which the transition occurs. This effect, known as quadrupolar splitting, thus induces a splitting of the absorption peak. Finally, the presence of a magnetic field \mathbf{H} on the absorber core causes the appearance of 6 absorption lines related to a further removal of the degeneration of the nuclear levels caused by the presence of \mathbf{H} . The magnitude of this latter effect is directly proportional to the intensity of the magnetic field acting on the core, a field usually referred to as the hyperfine field.

These phenomena induce variations in the energy of the photons which are of the order of 10^{-7}eV and therefore, in order to be observed, both a high resolution and the possibility of varying the energy of the photons incident on the material in a very fine way are required.

Both requirements were fulfilled by using for our measurement the photons emitted by a radioactive source, in our case ^{57}Co , in relative motion to the sample. In this way, the resolution was essentially determined by the width in energy of the emission line of the source itself, ΔE , of the order of $5 \cdot 10^{-9}\text{eV}$. In this way, we obtained an $E/\Delta E$ resolution of approximately 10^{12} . In addition, the relative motion of the source with respect to the material meant that the photons emitted by the former were subject to a Doppler shift; the change in energy obtained with a velocity, relative $v \approx 10\text{mm/s}$, for example, allowed us to obtain photons whose energy can be calculated through $E'_\gamma = E_\gamma + \delta E = E_\gamma + v/cE_\gamma$ with $\delta E \approx 10^{-7}\text{eV}$.

Experimental measurements were carried out along these general lines.

- The experimental background was obtained by analysing the precursors.
- The sample that reacted was subjected to measurement.
- A data-fit of the precursor was performed in order to derive the relevant parameters.
- The reactant data were fitted with three sextets:
 - a sextet to take into account the contribution of the precursor;
 - two sextets to account for the presence of two types of ferrite, both Trevorite and magnetite, as both compounds present a double sextet.

The following figure shows the spectrum we measured on iron oxide subjected to the same heat treatment as the precursors: this was necessary to obtain a reference with which to highlight the presence of haematite once the reacted sample was analysed (Fig. 5.51).

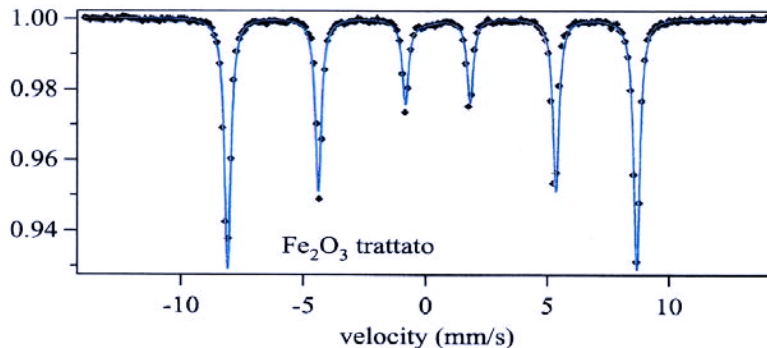

Fig 5.51 The Mössbauer spectrum of hematite obtained from one of the precursors to be compared to the sample we wanted to characterize. Source: AD

The most critical data for distinguishing between the two ferrites appeared to be the value of the hyperfine field pair relative to the two sextets, which was interpreted as follows. With reference to the nickel ferrite, one of the two sextets showed a higher value than the precursor. With regard to magnetite, on the other hand, both hyperfine fields were lower than that of the precursor.

The experimental data obtained from Mössbauer spectroscopy were as follows:

- the hyperfine field measured in the precursor was 520kOe, compared with a tabulated literature value of 517 ± 5 kOe;
- the hyperfine fields relative to the sample were 525kOe (tabulated 526kOe) and 506kOe (tabulated), respectively.

There was no need to analyse nickel oxide, which does not give rise to any spectrum, lacking the iron isotope.

The sample treated and fitted with three sextets, one to account for the presence of unreacted haematite, two arising from the nickel ferrite signal is shown (Fig. 5.52).

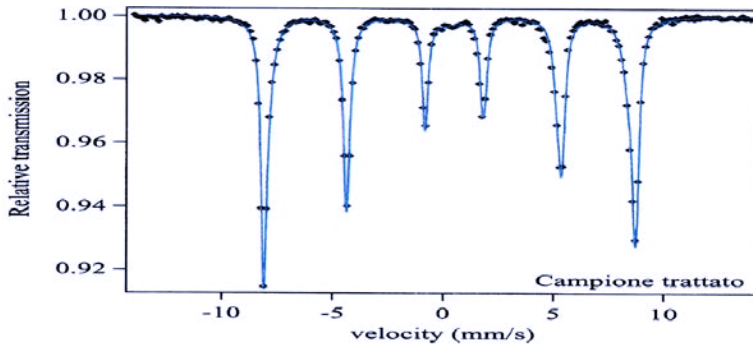

Fig 5.52 The Mössbauer spectrum of the reacted sample prepared through our lab-sintering process. Source: AD

From this spectrum, we were able to conclude that the ferrite present in the sample was nickel ferrite (or trevorite), precisely because the value of the hyperfine field of the precursor was between the values of the fields measured in the treated sample.

The spectrum allowing the final comparison between the sextets for the treated sample is shown below. The sextet shown in red represents the oxide precursor $\alpha\text{-Fe}_2\text{O}_3$ while the other two sextets are those relating to the nickel ferrite (Fig. 5.53).

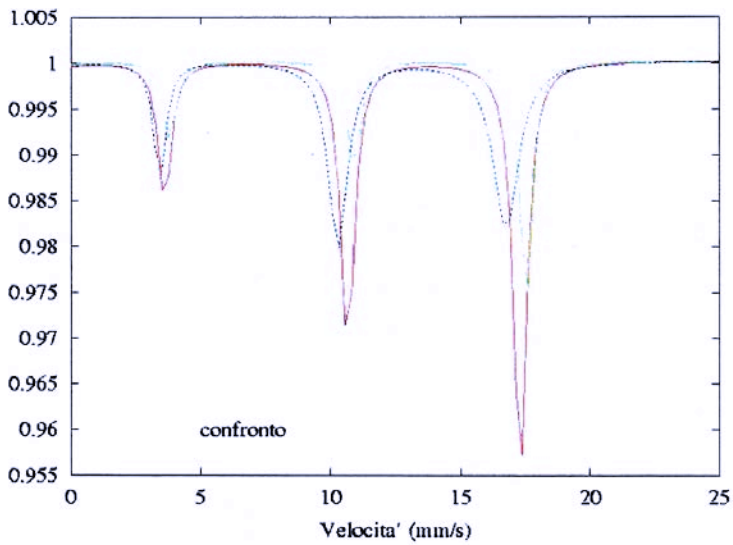

Fig 5.53 The comparison of the sextets. Source: AD

The experimental data obtained with the literature-tabulated values were grouped as follows (Table 5.2).

Table 5.2 Comparison between hyperfine fields

Material	Hyperfine Field (kOe)	
	I	II
α -Fe ₂ O ₃	517±5	
haematite	495±1	526±1
NiFe ₂ O ₄ trevorite	488±5	499±5
γ -Fe ₂ O ₃ maghemite		

Having obtained hyperfine field values of $506\pm 8kOe$ and $525\pm 4kOe$, the comparison with the previous table leads us in the direction of nickel ferrite, making the hypothesis of maghemite form less plausible. At this point, we assumed that we were in the presence of the nickel ferrite as desired at the beginning of our work.

Being in the correct direction to recognise nickel ferrite, we felt it legitimate to carry out other analyses to support the result obtained through spectroscopy.

Different types of magnetometers have been developed to measure and characterise magnetic materials, and of the different types of instruments available, the Vibrating-Sample Magnetometer – or VSM – is by far the most common instrument as it offers by far the best range of applications experimentally. As the basic instrument when it comes to examining magnetic materials (even those with very different properties), since its introduction several decades ago, it has become a workhorse whenever the fundamental magnetic properties of materials are to be measured as a function of magnetic field and temperature.

Such a device employs an electromagnet that provides the magnetising field (DC), a vibration mechanism to keep the sample in vibratory motion within the magnetic field, and sensing windings through which the signal voltage is generated due to the change in flux exiting the vibrating sample. The output measurement provides the magnetic moment \mathbf{M} as a function of the \mathbf{H} -field (Fig. 5.54).

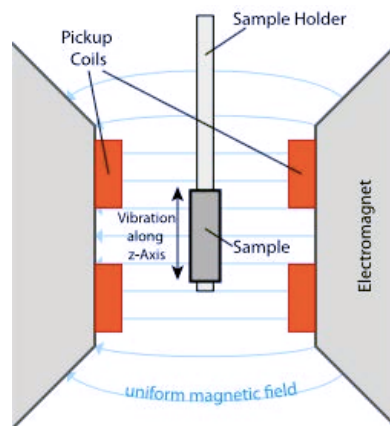

Fig 5.54 A schematic representation of a VSM device. Essentially, this instrument is a gradiometer that measures the difference in magnetic induction between two regions of space in one of which the sample is placed, while the other is left empty. This methodology is particularly used when one wants to assess the saturation magnetisation of a sample. Source: R0oland (nickname), Public Domain. CC BY-SA 3.0

The instrumental sensitivity of a VSM proves to be crucial when it comes to measuring magnetic moment (Speliotis 2003). Analytically, the measurable voltage V between the windings of a VSM can be expressed as a product of four terms that contribute to it:

$$V = MAFS \quad (5.60)$$

where:

- M is the magnetic moment of the sample, an intrinsic property which is obtained by calculating the product of the magnetisation of the sample (the magnetic moment per unit volume) times the volume of the sample;
- A is the vibration amplitude. The larger the amplitude, the greater the sensitivity, of the system as long as the windings are capable of measuring the excursions of the sample with sensitivity, uniformly;
- F is the vibration frequency, high values of this parameter correspond to high sensitivity even though there is an upper limit to the maximum usable frequency. The following conditions must be considered:
 - eddy currents can be generated in conducting samples and/or substrates;
 - vibration frequency values should be chosen distant from harmonics or subharmonics, so as to minimise measurement noise.
- S is the sensitivity function of the coils, this increases – generally – with increasing coupling between the flux leaving the sample and the sensitive coils.

The information we wanted to obtain from the vibrating scanning magnetometer was not limited to a simple measurement of magnetic moment. In fact, from the measurement of the magnetic moment of the sample, we derived an estimate of the fraction of the material we assumed to be composed of nickel ferrite.

We obtained the following table 5.3 from literature (Smit and Wijn 1965):

Table 5.3 Table of magnetic moments and densities.

Ferrite	a (nm)	M (g/mol)	d_x (g/cm ³)	σ (emu/g)
MnFe ₂ O ₄	0.850	230.6	5.00	80
Fe ₃ O ₄	0.839	231.6	5.24	92
CoFe ₂ O ₄	0.838	234.6	5.29	80
NiFe₂O₄	0.834	234.4	5.38	50
ZnFe ₂ O ₄	0.844	241.1	5.33	—
MgFe ₂ O ₄	0.836	200.0	4.52	27

As $N = 6.02 \cdot 10^{23} \text{ mol}^{-1}$ is the Avogadro's number, the density, was calculated using the formula:

$$d_x = \frac{8M}{Na^3} \left[\frac{g}{cm^3} \right] \quad (5.61)$$

where the multiplicative coefficient 8 is justified by the fact that an elementary cell contains eight MeFe₂O₄ molecules.

If we measure the magnetic moment of the sample M_v , reasoning about the size of the physical quantities available we saw that:

$$\frac{M_v}{\sigma} = emu \cdot \frac{1}{emu} g = g \quad (5.62)$$

In this way, the mass of the ferromagnetic phase formed in the sample reacted with the experimental conditions employed could be determined. If we wanted to derive the volume of ferrite, we simply went through the density value, dividing the mass by 5.38. Since the VSM analysis gave – for the magnetic moment – the value of 0.0719emu, we were able to state that the ferromagnetic phase mass was equal to:

$$\frac{M_v}{\sigma} = 1.438 \cdot 10^{-3} g \quad (5.63)$$

From the calculation (for the values used, see the table below), we have therefore determined that 12.5% of the total mass was transformed into nickel ferrite, which we obtained since we know the values of the total mass, approximately $11.9 \cdot 10^{-3} g$, of the sample analysed in VSM and the mass in grams of the ferrite. It was also interesting to compare the coercive field value obtained in our case (335Oe) with the value that competes with bulk ferrite (Table 5.4), even if it has undergone special treatment, and which is less than 60Oe (Son *et al.* 2002).

Table 5.4 Experimental data.

H_c	Res.Mom.	Sat.Mom.	Mass (g)	% reacted
335Oe	0.0219emu	0.0719emu	$1.438 \cdot 10^{-3}$	12.5

The following picture (Fig. 5.55) shows the result of the magnetisation measurement carried out on the treated sample.

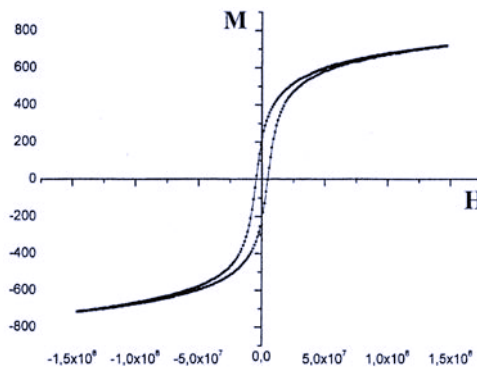

Fig 5.55 Hysteresis cycle of the sample we made react. Source: AD

The most outstanding feature of the images obtained with scanning electron microscopy is their exceptional three-dimensionality: they present a sense of reality that is lacking in microphotographs taken with other techniques. This is why we used this technique to visualise the precursors and the reacted sample. In the following figure (Fig. 5.56), which we obtained at 39000 magnifications, the structure of an iron oxide agglomerate can be seen as consisting of particles of almost spherical geometry.

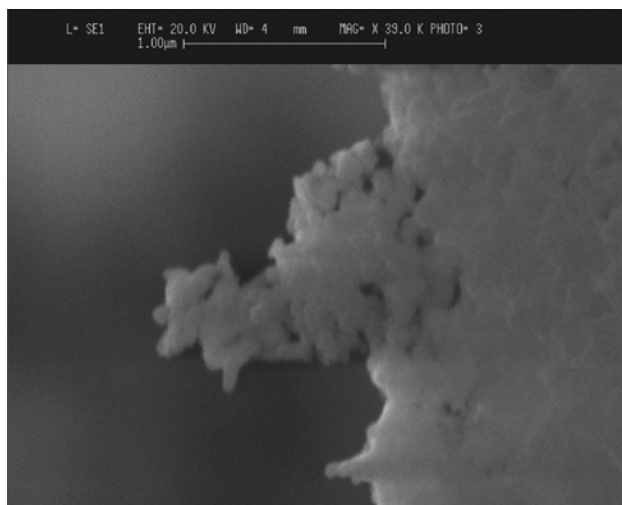

Fig 5.56 The iron oxide we procured commercially has a stated grain size of 150 microns. Source: AD

This second photograph (Fig. 5.57) shows nickel oxide, the second precursor to our reaction.

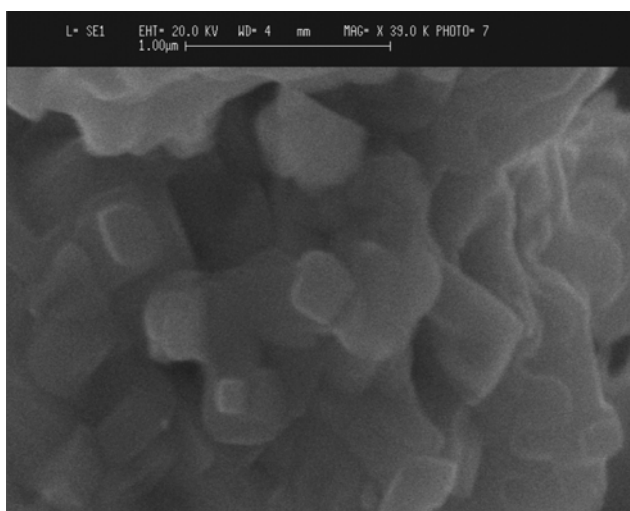

Fig 5.57 Nickel oxide, the second precursor of the reaction, observed by SEM. Source: AD

From the photographs, we observed the profound difference in the basic structures of the starting oxides: in the case of nickel oxide, no spherical elementary shapes appeared, but rather blocks with cubic geometry, in accordance with the observation that it is the fcc lattice that constitutes the fundamental structural unit of this precursor.

According to the theory regarding the formation of spinel ferrites, starting from two basic oxides, two starting particles should have been in contact across the separation edge. Thus, the interface would have become the nodal point of the entire reaction, being the region in which the formation of a collar of ferritic material would have taken place, due to counter-diffusion processes involving the starting oxides. It therefore seemed legitimate to expect the presence of similar formations linking, in some way, the cubic structures of the nickel oxide to the hematite spheres. The following image (Fig. 5.58) depicts the sample on which the magnetic transition took place.

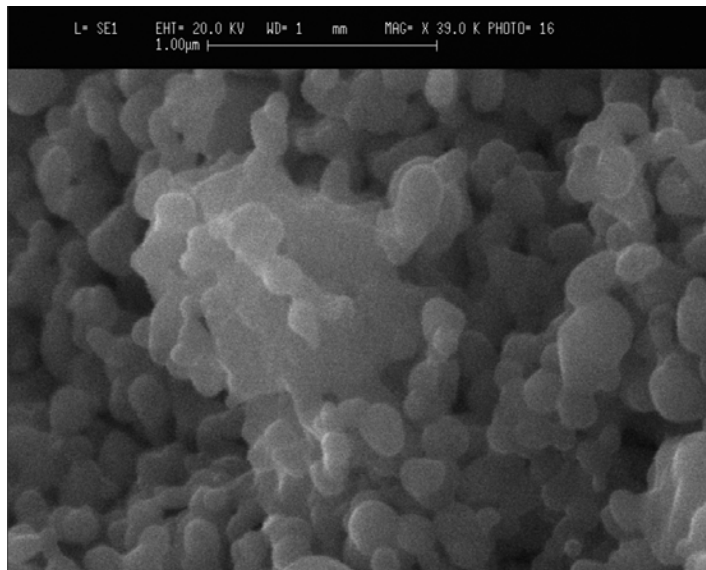

Fig 5.58 A region of the reacted sample, observed by SEM. Source: AD

In the centre of the picture, the presence of two arms extending from a block with a rectangular geometry, recognisable as nickel oxide, towards almost spherical objects, is to be noticed. Of this image, we took the relative detail, so as to carefully highlight the region we were interested in (Fig. 5.59).

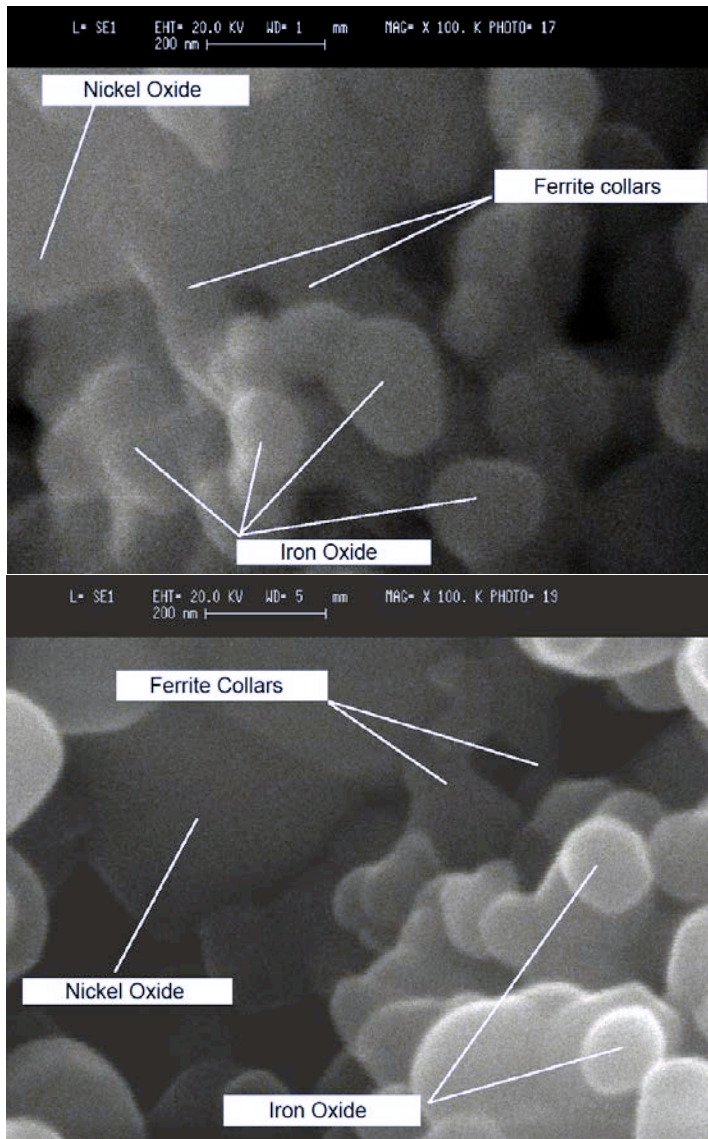

Fig 5.59 Two pictures of the details of the reacted sample, observed by SEM, are shown. The collars predicted from the theoretical model are present, demonstrating that a reaction has occurred. Source: AD

We were then in the presence of definitive experimental confirmation: in accordance with the theory of the interdiffusion of cations and the consequent formation of collars between particles of the starting materials, we actually saw the presence of ferrite. Not only that, all the considerations we made previously regarding the absence of magnetite – which has been demonstrated – lead us to conclude that the new phase consisted of nickel ferrite NiFe_2O_4 . To demonstrate that this region does not constitute a unicum on the entire material, an observation of several points of the sample allowed us to find similar formations.

Recalling our results then, the work we carried out was aimed at producing NiFe_2O_4 structures with submicron dimensions. It was known from the literature (Keller *et al.* 1998) that ferrites could be produced in the form of films during the growth process of thin layers of nickel oxide and iron oxide, due to the high temperature reached by the system during deposition. Taking this as a starting point, we put forward the hypothesis that, by activating solid–state reactions through heat treatment, NiFe_2O_4 aggregates could be obtained from particles of the iron and nickel oxides. With the DTA/TG analysis, it was not possible to immediately recognise what species of compound was obtained, nor was it possible to speculate on the size or quantity of material produced. For this reason, we proceeded with a more extensive characterisation of the systems obtained by heat treatment, in order to obtain further confirmation of the presence of the nickel ferrite we were aiming for and, at the same time, to obtain new information on the magnetic and structural properties of NiFe_2O_4 at nanometre size. The different techniques used in the laboratory, Wide–Angle X–Ray Diffractometry (WAXD), Mößbauer Spectroscopy, Vibrating Sample Magnetometry (VSM), and scanning electron microscopy (SEM), are in agreement with the expected result, but also highlight the specificity of the synthesised material compared to that produced by conventional methods. In particular, the values of some parameters were also markedly different from those reported in the literature. This was not a cause for concern, but was the starting point for understanding the origin of the differences and obtaining new information on the material obtained.

The data in our possession were summarised as follows.

- a. The material exhibited a magnetic transition at 590°C , comparable with the Curie temperature T_C of nickel ferrite reported in literature;
- b. The diffraction spectrum indicated the presence of a peak at an angle very similar to that of one of the expected reflections for the NiFe_2O_4 compound, the width at half–height of this peak being greater than that of the NiO and Fe_2O_3 peaks;
- c. The values of the hyperfine parameters of the synthesised material, isomeric shift \mathbf{I}_s , quadrupole splitting \mathbf{Q} and hyperfine field \mathbf{H}_{hyp} , compared with those reported in the literature, were the following:
- d. The material possessed a coercive field \mathbf{H} of $3350e$ and, even in the presence of an applied field equal to $1.5T$, its magnetisation did not reach saturation. The value of \mathbf{H}_c reported in the literature is about $600e$ and the saturation field did not exceed $1000e$;
- e. The images collected by Scanning Electron Microscopy shown the presence of “collars” between the NiO and Fe_2O_3 particles with a size in the order of hundreds of nanometres.

Of all the characterisations we performed, VSM (d.) was the only one that showed a very significant deviation in the sample’s behaviour from that characteristic of nickel ferrite. In fact, the coercive field of the material after heat treatment was measured to be about 5 times higher than that of massive NiFe_2O_4 and the saturation field increased by at least two orders of magnitude. Conversely, the other techniques, (a.), (b.) and (c.) indicated very small variations.

In an attempt to explain the variations in the experimental parameters from those reported in the literature and the dependence of these variations on the measurement technique, we observed to which microscopic material properties the various methodologies used were sensitive. In particular, taking as a starting point the fact that the dimensions of the aggregates were of the order of a hundred nanometres (e), and thus of the order of magnitude

we were trying to observe, it was possible to try to estimate which characteristic dimension, for each individual technique, determined a deviation of the material's response from the massive type behaviour.

Field gradient thermogravimetry (a) showed variations in the magnetic force acting on the sample as a function of temperature, thus sensitivity to variations in magnetic order within the sample analysed. In our case, the observed transition corresponded to the transition from ferromagnetic to paramagnetic behaviour and the temperature of this transition, T_C , tended to zero as the size of the magnetic region decreased. Again, this behaviour, however, was only observable when the size of the magnetic region under consideration became comparable to the characteristic distance between the atoms of the magnetic species, in the specific case of layers of magnetic material, for example, around 20 times this distance (Himpsel, Ortega, Mankey and Willis 1998). In our case, the aggregates of NiFe_2O_3 should therefore have a characteristic size of more than ten nanometres.

In the case of X-Ray diffraction (b), if the average size, $\langle D \rangle$, of the crystallites responsible for the diffraction spectra had been very small (less than a hundred nanometres), a broadening of the line would have been produced. Scherrer's formula:

$$\langle D \rangle = \frac{0.9\lambda}{\Delta\theta \cos \theta_0} \quad (5.64)$$

where, technically, $\Delta\theta$ represents the half-height width of the diffraction peak and θ_0 the Bragg angle at which the peak is observed, allowed us to connect the line broadening to $\langle D \rangle$.

Using this formula, the lower limit to the particle size was also determined. From the parameters given above, we obtained the following result: $\langle D \rangle_{\text{WAXD}} > 17\text{nm}$.

If the nanostructure had been subjected to changes in the lattice parameter, this could have led, together with the low dimensionality, to changes in the Bragg angle of the peaks; in our case, the nickel ferrite synthesised with the heat treatment presented a peak at $2\theta = 90^\circ 45'$, indicating a slight contraction in the value of d ($< 0.06\%$) when compared to the value reported in the JCPDS tag, $2\theta = 90^\circ 38'$.

In contrast to the techniques just described, it is known that Mößbauer Spectroscopy allows the material to be investigated on a length scale that is comparable with the lattice pitch of the material itself, as the measured signal depends to a large extent on the first co-ordination shell of the ^{57}Fe atom that gives resonance. Therefore, by analysing the values of the isomeric shift \mathbf{I} , and the quadrupole splitting \mathbf{Q} , we were able to derive local information on the structure and composition of the material. Both sextets showed an increase in the isomeric shift compared to the tabulated values, a phenomenon that indicated the presence of a change in composition in the first coordination sphere at both lattice sites. This could also have been interpreted in terms of the presence of small ferrite particles, since in this situation the contribution of surface atoms could not be neglected in comparison with that of volume atoms, and the former possess a different chemical background from the latter. Finally, non-zero quadrupolar splitting was found for both sextets, indicating a distortion of the crystal structure with respect to that of the massive ferrite. However, as this latter information was local, it did not allow hypotheses to be made on the minimum particle size. A different argument, however, was made with regard to the hyperfine field. In fact, although the magnetic field, \mathbf{H} , acting on the ^{57}Fe core is largely due to the first neighbours alone, whether it remains constant or varies as a function of time depends on the magnetic

order present in the structure during the measurement time. In the absence of the latter, the system exhibits e.g. paramagnetic behaviour and thus the \mathbf{H} -field rotates randomly with zero time average. Conversely, in the presence of a ferromagnetic-type order \mathbf{H} is stable. Thus, if in the characteristic time of the photon–nucleus interaction $\tau_{\text{Möbbaauer}} \approx 10^{-8}\text{s}$, i.e. the time during which the photon scans the system, the former situation occurs – the Möbbaauer spectrum consists of only two peaks – in the opposite case of a sextet. From the value of τ_{int} and some characteristic constants of the material (Xiao *et al.* 1986), it was possible to estimate the minimum size the particle had to have in order to possess stable magnetisation and, in our case, it was found that $\langle D \rangle_{\text{Möbbaauer}} > 12\text{nm}$.

With a similar reasoning, the magnetisation measurements (d) were analysed, the only difference being that the characteristic time of the VSM technique is larger than that of the previous one, $\tau_{\text{VSM}} \approx 10\text{s}$. The shape of the magnetisation cycle indicated that the system, on the whole, did not exhibit classic ferromagnetic type behaviour, the saturation field being very high, but rather superparamagnetic type behaviour, indicative of the presence of small magnetic particles. On the other hand, the system has also been shown to possess a coercive field, which is usually indicative of the stability of the magnetisation of each individual particle. Under these assumptions, therefore, we were able to estimate a lower limit to the particle size and what we find is that $\langle D \rangle_{\text{VSM}} > 27\text{nm}$. As for an estimation of the characteristic size of the nickel ferrite “collars” from SEM photos, this resulted in $\langle D \rangle_{\text{SEM}} \approx 50\text{nm}$. Thus, of the different techniques used, VSM is the one through which we derived that the properties, characteristic of the treated material are more similar to those of a nanoaggregate, rather than those of a massive material.

Thanks to the heat treatment carried out, we were able to obtain nickel ferrite from iron oxide microparticles mixed with nickel oxide microparticles. We kept the temperature of the process at 650C° so as not to make the reaction for the formation of the compound we were looking for too rapid, and we observed how the yield of the process, which in our case was 12% for a heat treatment of 32 hours, depended on the way the precursors were mixed. After verifying the presence of the NiFe_2O_4 compound, the material was characterised using different investigation techniques in order to further confirm the presence of the ferrite and to determine its properties, both magnetic and structural. The result of the analyses carried out revealed a partial discordance between the data obtained experimentally and those reported in the literature, a discordance that we interpreted in terms of the presence of nanoaggregates. The size of the latter was estimated from SEM photographs of the treated materials and was found to be in good agreement with the different sensitivity of the analysis methods used to the characteristic dimensions of the material studied. Finally, again thanks to the SEM photographs, it was seen that the formation of the nanoferrite took place through the formation of collars at the contact points between the particles of the two precursor oxides, in accordance with the mechanism we had originally hypothesised.

The main results obtained are given below for ease of reading:

- we have estimated that the characteristic size of the aggregates is of the order of 50nm; these formations develop at the points of contact between the particles of the NiO and Fe_2O_3 precursors;
- the crystallographic structure was compatible with that of massive NiFe_2O_3 and, compared with the latter, showed both a slight decrease in the lattice parameter and a deviation from cubic symmetry at the iron lattice sites;
- the intensity, of the hyperfine field acting on the Fe atoms was in good agreement with the expected values, while the isomeric shift indicated that the chemical surroundings of the iron atoms had undergone modifications;

- the coercive field of nanoferrite was about 5 times higher than that of bulk ferrite and had a very high saturation field ($> 1.5T$); its magnetic properties, therefore, differed considerably from those of a soft magnetic material, typical of bulk-sized ferrites.

5.1.12 2003: Gold Nanoshells

Colloidal gold can be regarded as the prototype of the metallic nanoparticle since the time before Michael Faraday's research. Research on this type of nanoparticle originated in the mid-1990s and has been oriented towards applications to various devices due to the nanoscopic properties of the particles. Gold nanoparticles, for instance, possess optical properties that differ significantly from those at bulk size (Averitt, Sarkar and Halas 1997).

Gold nanoparticles immediately showed great promise as they could be applied to electronic and optical devices. They were studied, from the very beginning, through experiments with a femtosecond time resolution. The experiments were aimed at observing the relaxation mechanisms of excited electrons confined within metal nanostructures. At the end of the 1990s, the optical properties of nanoparticles consisting of a dielectric core surrounded by a thin nanometric layer of metallic material, structures that were called nanoshells, were studied. The optical properties of these new preparations turned out to be quite similar to those of solid nanoparticles, a result that was attributable to the outer coating structure. More importantly, the plasmon frequency of the metallic nanoshells was a function of the core-to-shell ratio, a result that contrasted with those obtained for solid nanoparticles. Studies conducted on ultrafast electron dynamics had proven that the dynamics were due to an increased inter-electron scattering mechanism and an induced change in the screening of conduction electrons of the d-band polarisability. Even when the plasmon frequency was brought below the value that triggered the inter-band transitions, the inter-band effects were still of primary importance in determining the non-linear optical response of the nanoshells. The relaxation time of the excited electrons was also shorter than that measured for the electrons of bulk-sized gold films (Averitt, Westcott and Halas 1998).

Access to new techniques such as femtosecond laser sources had made it possible to time-resolve electron-electron (e-e) and electron-phonon (e-ph) dynamics for different metals and under very different excitation conditions. These studies were possible because, in metals, the specific heat of the electron is much smaller than the specific heat of the lattice. This allows preferential excitation of the electron gas by absorption of a femtosecond laser pulse, which results in a non-equilibrium condition: $T_e > T_l$, where T_l is the lattice temperature. The equilibrium process could then be temporally resolved with a delayed probe pulse. These studies led to a greater understanding of e-e and e-ph dynamics. In turn, the understanding of phenomena in metal systems ranging from electronic and thermal transport to the kinetics of desorption of molecules from surfaces became clearer and more understandable. Femtosecond pump probe techniques were also used to study electron dynamics in metal nanoparticles. What was carefully observed concerned the optical properties of metal nanoparticles: these properties were dominated by resonant plasmonic absorption. Excitation by a femtosecond pump pulse at a wavelength close to the plasmonic resonance collectively excited the electrons. The collective excitation of electrons was in turn rapidly reduced (10fs – 40fs), resulting in an excited, non-thermal distribution of

interacting electrons. This non-thermal distribution of electrons was thermalised by e-e scattering on a time scale of 100fs–1000fs (Averitt, Westcott and Halas 1999).

In the early 2000s, these properties of nanoparticles were the subject of considerable interest, as metal particles proved to be fundamental when applied as building blocks for photonic devices where electromagnetic waves could be controlled down to the nanoscale. Metal nanoparticle waveguides exploit the unique properties of collective electron oscillations, oscillations known as plasmons (Brongersma 2003). Of particular interest are metallic nanoshells, i.e. structures that are grown by metallic layers on top of a solid dielectric core. By simply varying the inner and outer radii of the metal shell, it is possible to influence the plasmonic frequency and, consequently, the optical properties of the nanoshell. Being able to precisely control the optical properties allows metal nanoshells to be used in different fields of application, such as plasmonic resonance shifting (Averitt, Sarkar and Halas 1997), optical collimators for the delivery of active drug ingredients through composite hydrogels (Serksen, Westcott, West and Halas 2001), or environmental sensors (Sun and Xia 2002).

Nanoparticles could be carefully tuned and this was demonstrated through Time-Dependent Local Density Approximation (TDLDA) applied to a uniform electron gas, the so-called jellium model. The optical properties calculated in this way were in very good agreement with predictions made through Mie scattering theory when the metallic phase is modelled through the Drude dielectric function, although it must be kept in mind that the Drude model neglects the dielectric function for polarisable nuclei. A realistic dielectric function is necessary in order to obtain satisfactory quantitative agreement between the experimental data and classical Mie scattering theory. This is particularly significant for noble metals where the polarisability of d electrons contributes to the dielectric response in the optical frequency range.

Prodan, Nordlander and Halas studied, in 2003, the role of d electrons in relation to the optical response of the nanoshell to include the contribution of polarisable gold nuclei (Prodan, Nordlander and Halas 2003).

The mathematical construction of the model describing a nanoshell starts with the definition of its inner radius r_1 and its radius r_2 , which is condensed as (r_1, r_2) . The conduction electrons of the nanoshell are considered to be embedded in a non-uniform, frequency-dependent dielectric region described as:

$$\begin{cases} \epsilon(r) = \epsilon_C & \text{for } r < r_1 \\ \epsilon(r) = \epsilon_J & \text{for } r_1 < r < r_2 \\ \epsilon(r) = \epsilon_E & \text{for } r > r_2 \end{cases} \quad (5.65)$$

This formalisation takes into account a dielectric core a uniform gas of polarisable electrons and a dielectric medium. The Hartree potential:

$$v_H(r) = \int \frac{n(r') - n_0}{|\mathbf{r} - \mathbf{r}'|} d\mathbf{r}' \quad (5.66)$$

can be replaced with the three following equations, where it is necessary to detail the expression of the function $v_H(r)$ according to the value of r to satisfy the usual boundary conditions.

If $r < r_1$ we get:

$$\tilde{v}_H(r) = \frac{1}{\epsilon_C} v_H(r) + \frac{\epsilon_J - \epsilon_E}{\epsilon_E \epsilon_J} v_H(r_2) + \frac{\epsilon_C - \epsilon_J}{\epsilon_J \epsilon_C} v_H(r_1) \quad (5.67)$$

If $r_1 < r < r_2$ we get:

$$\tilde{v}_H(r) = \frac{1}{\epsilon_J} v_H(r) + \frac{\epsilon_J - \epsilon_E}{\epsilon_E \epsilon_J} v_H(r_2) \quad (5.68)$$

Finally, if $r > r_2$:

$$\tilde{v}_H(r) = \frac{1}{\epsilon_E} v_H(r) \quad (5.69)$$

In this way, the presence of the dielectric can be mathematically incorporated into the LDA fundamental state of the electron gas. The overall effects on the electronic structure are, however, small; the greatest contribution is due to the ϵ_J term, that of the background due to the gas–jellium, in fact the effective potential of the nanoshell decreases while the work function increases in value. The consequence of this is a reduction in electron extraction. When the system is affected by an externally applied electromagnetic field, the dielectric media give rise to an important shielding effect because the applied field polarises the dielectric and the electrons shield both the exciting field and the electric field that results from the polarisation of the dielectric.

The study of nanoshell properties was conducted by implementing the Random–Phase Approximation (RPA), which allowed an articulated expression to be written for the local polarisability equation. This, in fact, assumes an expression of the type:

$$\begin{aligned} \alpha(r, \omega) - \int dr' \tilde{\Pi}_1^{(0)}(r, r'; \omega) r'^{-2} v'_{xc}(n(r')) \alpha(r', \omega) \\ - \frac{4\pi}{3} \int dr' \int dr'' \tilde{\Pi}_1^{(0)}(r, r'; \omega) \frac{v_1(r', r'')}{\epsilon(r'')} \alpha(r'', \omega) \\ - \frac{4\pi}{3} \sum_{i=1,2} X^{(i)}(r, \omega) \int dr' \frac{v_2(r_i, r')}{\epsilon(r')} \alpha(r', \omega) \\ = \int dr' \tilde{\Pi}_1^{(0)}(r, r'; \omega) \phi_C^0(r') \end{aligned} \quad (5.70)$$

where:

$$X^{(1)}(r, \omega) = -\frac{1}{\xi_\epsilon} \frac{\epsilon_C - \epsilon_J}{\epsilon_C + 2\epsilon_J} X_1(r, \omega) - \frac{\xi_\epsilon - 1}{\xi_\epsilon} X_2(r, \omega) \quad (5.71)$$

$$X^{(2)}(r, \omega) = \frac{\xi_\epsilon - 1}{2\xi_\epsilon} \left(\frac{r_2}{r_1}\right)^3 X_1(r, \omega) + \frac{1}{\xi_\epsilon} \frac{\epsilon_E - \epsilon_J}{\epsilon_J + 2\epsilon_E} X_2(r, \omega)$$

and:

$$X_i(r, \omega) = r_i^2 \int dr' \tilde{\Pi}_1^{(0)}(r, r'; \omega) v_1(r', r_i) \quad (5.72)$$

The function ϕ_C^0 represents the unscreened response of the dielectrics to the electric field:

$$\phi_C^0(\mathbf{r}) = \left\{ \left[\sum_{i=1,2} r_i^2 \sigma_0^{(i)} v_1(r, r_i) \right] - r \right\} E_0 \cos \theta \quad (5.73)$$

where:

$$\sigma_0^{(1)} = \frac{1}{\xi_\epsilon} \frac{\epsilon_C - \epsilon_J}{\epsilon_C + 2\epsilon_J} \frac{3\epsilon_E}{\epsilon_J + 2\epsilon_E} \quad (5.74)$$

$$\sigma_0^{(2)} = 1 - \frac{1}{\xi_\epsilon} \frac{3\epsilon_E}{\epsilon_J + 2\epsilon_E}$$

are the classical polarization charges and:

$$\xi_\epsilon = 1 - 2 \frac{\epsilon_C - \epsilon_J}{\epsilon_C + 2\epsilon_J} \frac{\epsilon_E - \epsilon_J}{\epsilon_J + 2\epsilon_E} \left(\frac{r_2}{r_1}\right)^3 \quad (5.75)$$

was a dielectric factor. The notation $\tilde{\Pi}_1^{(0)}(r, r'; \omega)$ represented the $l = 1$ component of the response function of the system multiplied by a factor $(rr')^2$.

Solving the equation to test the nanoshells, it was observed that each optical absorption spectrum was dominated by two dipolar plasmonic modes. For longer wavelengths, the ω_- mode corresponded to a symmetrical coupling of the plasmonic cavity on the inner surface and the plasmonic sphere on the outer surface. For shorter wavelengths and thus higher energies ω_+ , this corresponds to an antisymmetric coupling of the same structures. The presence of the dielectric core and a confining medium gave rise to a red shift of both plasmonic resonances. The results obtained through the solution of the equation and the prediction according to the Mie scattering theory were excellent.

The following table recollects the theoretical dielectric parameters inserted in the equation to plot the absorbance of the structures to the wavelength.

Tab 5.5 Table of the theoretical dielectric parameters.

	ϵ_E	ϵ_C	ϵ_J
(a)	2	5	1
(b)	1	1	8
(c)	2	5	8

According to these results, plots were obtained (Fig. 5.60), showing the different dielectric background media on the optical absorbance for the Au (70,100) nanoshell. In the following plots, the arrows show the position of the resonance predicted according to the Mie classical theory and the following expression:

$$\epsilon(\omega) = \epsilon_\infty - \frac{\omega_B^2}{\omega^2 + i\Gamma\omega} \quad (5.76)$$

where ω_B is the bulk plasmon energy.

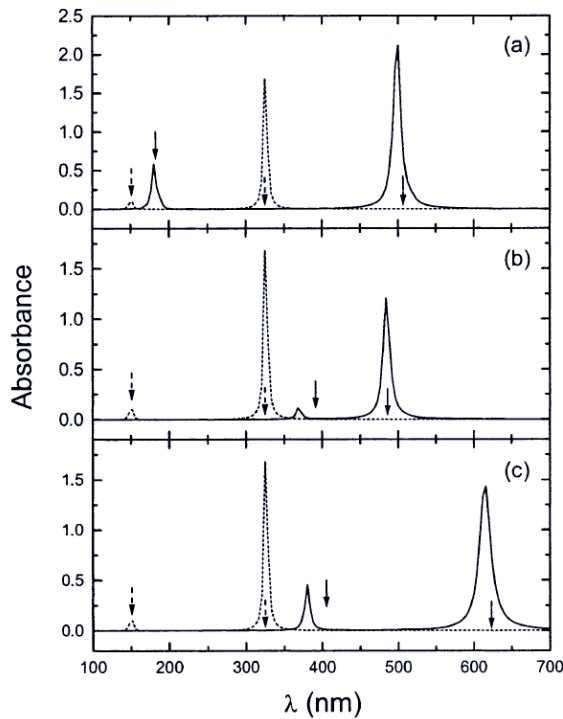

Fig 5.60 Effects of different dielectric background media on optical absorbance of gold nanoshells. Source: Prodan, Nordlander and Halas (2003)

In literature, the best fit ranged from $\epsilon_\infty = 10$ (Johnson and Christy 1972) to $\epsilon_\infty = 8$ (Innes and Sambles 1987). In the calculation performed with the formulas obtained $\epsilon_j = 8$ gave the best agreement with the experiment. The gold Nanoshells had a core made of Au₂S and were suspended in water so $\epsilon_E = 1.78$.

Once that the optical absorbance was measured, the experimental spectra displayed two peaks. In all the three measurements the short-wavelengths peak was the same because of the colloidal gold spheres whose plasmon resonance was at 520nm. At wavelengths longer than 520nm, a peak was observed, the ω_- symmetric plasmonic mode of the gold nanoparticles. Analytically calculated plasmonic resonances resulted in much narrower peaks when compared to experimental results, and this was attributed to a number of different factors.

Firstly, the dielectric background contributed an imaginary term to ϵ_j ; all calculations made with this term in mind did not result in a broadening of the resonance peaks.

Secondly, the non-uniform distribution of particle sizes was a contribution within the measured width of the peaks.

Thirdly, the geometry of the particles themselves had to be considered, which could not be guaranteed to be perfectly spherical for every nanoparticle.

Furthermore, a finite particle size effect should not be overlooked. When the particle size is smaller than the free mean electron path, the diffusion of electrons on the surface introduces a broadening of the plasmonic resonance.

A fifth parameter that had to be taken into account was the phase delay factors.

The particle size distribution was studied in detail. The size-related quantum study showed a much greater dependence of the optical properties on the particle size than would have been obtained by Mie scattering calculations, as the energy of the ω_- plasmon is lower than the work function of the nanoshell. This energy can be resonant with discrete single-electron excitations.

In conclusion, what has been proven for these structures is that polarisable metals forming the particle nuclei give rise to a red shift of the symmetric nanoshell plasmon resonance. With the appropriate choice of the dielectric constant of the uniform electron gas, it was possible to reproduce the absorption cross-section of particles of different sizes, also demonstrating that the optical response of nanoshells can be a very sensitive function of their geometry.

5.1.13 2004: Birth and Rise of Graphene

Graphene is a planar monolayer of carbon atoms packed in a two-dimensional honeycomb lattice, joined by means of a pure covalent bond, a layer that constitutes an emblematic example of a two-dimensional (2D) material, being in fact atomic 0.34nm thick (Wolf 2014). This material constitutes a basic building block for graphitic materials of different sizes: it can be shaped to obtain 0D-sized buckyballs (fullerenes), rolled to form 1D nanotubes, overlaid in multiple layers to arrive at 3D graphite (Geim and Novoselov 2007). The properties of graphite had been the subject of study since after World War II when, for example, the conductive properties of a single crystal were analysed using band theory, first by studying a single hexagonal layer, then by describing the Brillouin zones of graphite and the number of free electrons in this material (Wallace 1947). The two-dimensional

properties of a honeycomb carbon lattice, in fact graphene not yet identified by this name, would be examined shortly afterwards and extended to the three-dimensional structure of graphite (Slonczewsky, Weiss 1958). An input to the research on graphene used as a developmental model for Solid-State Physics came from (2+1)-dimensional quantum electrodynamics: until the first half of the 1980s, gauge theories on (2+1)-dimensional fermion systems did not have a satisfactory experimental background, but it was precisely a two-dimensional honeycomb structure such as that of a single layer of graphite that provided the ideal model for solving the problem. The charge carriers of this structure actually turned out to be non-massive Dirac fermions (Novoselov *et al.* 2005a). The model turned out to be optimal in the two-dimensional case but unsatisfactory in the three-dimensional one. Even the prediction of two-dimensional graphite production was made:

The model considered here has been used extensively to study the electromagnetic properties of graphite. Graphite is a semimetal which to a first approximation is composed of independent layers of carbon atoms. Each layer forms a honeycomb lattice with one valence electron per atomic site. In the planar material, the existence of two degeneracy points per Brillouin zone is a general consequence of the lattice symmetries. Here, we shall present a simple dynamical model where this degeneracy is explicit. In three-dimensional graphite, interplanar interactions break the symmetry, and this model may not be strictly applicable there. However, there may be various types of intercalated or exfoliated graphite where the interplanar coupling is negligible. Furthermore, it may be possible to fabricate a graphite monolayer where the effects which we describe would be observable (Semenoff 1984).

At the time, there was no evidence of free-state graphene and its structure was considered unstable compared to that of soot, fullerenes and carbon nanotubes, which are characterised by a specific curvature of their surface. The theoretical model of the single two-dimensional carbon layer became a reality when free-state graphene was discovered in nature in 2005. It could be described as an unrolled carbon nanotube, i.e. a single plane obtained from a bulk layer, whose crystalline quality was extremely high and continuous on a macroscopic scale. Not only that, it could be obtained by cleavage from compact layers. Novoselov and his collaborators also observed what follows.

[...] we have demonstrated the existence of 2D atomic crystals that can be prepared by cleavage from most strongly layered materials. It is most unexpected, if not counterintuitive, that isolated 2D crystals can be stable at room temperature and in air, leaving aside the fact that they maintain macroscopic continuity and such high quality that their carrier mobilities remain almost unaffected. The found class of 2D crystals offers a wide choice of new materials parameters for possible applications and promises a wealth of new phenomena usually abundant in 2D systems. We believe that, once investigated and understood, 2D crystals can also be grown in large sizes required for industrial applications, matching the progress achieved recently for the case of single-wall nanotubes (Novoselov *et al.* 2005b).

Graphene is a material that has completely revolutionised certain historical assumptions made about the non-existence of two-dimensional crystalline structures. Back in the 1930s, Peierls (Peierls 1935) and Landau (Landau 1937) had argued that 2D crystals lacked the thermodynamic stability necessary to guarantee their existence. In 2004, the discovery of graphene completely subverted this assertion, overcoming even the view that interpreted carbon monolayers as integral parts of more complex three-dimensional structures. Graphene proved to be a continuous, highly crystalline material in which charge carriers could travel without dispersion distances of thousands of interatomic spacings. Not only

that, but the size and strong interatomic bonds were such that even at high temperatures no crystalline defects or dislocations were triggered (Mermin 1968).

The discovery of graphene challenged the paradigm according to which atomic monolayers could only exist as the basic structure of larger 3D structures, generally obtained by epitaxial growth from the tops of monocrystals characterised by similar crystal lattices. Without such a base from which to start, the hypothesis of the autonomous existence of 2D structures such as graphene was discarded. 2D crystals could be obtained from substrates that were not necessarily crystalline and in liquid suspension, such as suspended membranes; the results obtained were continuous structures of high crystalline quality (Novoselov *et al.* 2004 & 2005; Zhang, Tan, Stormer and Kim 2005).

In fact, these crystals could also be explained from a theoretical point of view by observing that 2D crystallites could be bound in a metastable state precisely because they were extracted from three-dimensional structures, while thermal fluctuations – even at high temperature – did not give rise to dislocations, thanks to the extremely small size of the crystallites ($\ll 1\text{mm}$) and the strong interatomic bonds established (Mermin 1968).

The successful isolation of the structure of graphene made it possible to work out a definition for 2D and 3D crystals. It is obvious that a single atomic plane is to be considered a two-dimensional structure, whereas a superposition of a hundred planes has all the characteristics of a three-dimensional structure. The transition between 2D and 3D, in the case of graphene, is quite clear and is explained in these terms: the electronic structure, as the number of layers accumulates, evolves in a complex manner approaching what can be called 3D when graphite consists of ten layers (Partoens and Peeters 2006). Graphene and its double layer, at most, possess simple electronic spectra and are both defined as zero-gap semiconductors. For three or more layers, however less than ten in number, the bands, conduction and valence, begin to overlap and the electronic spectra become more and more complex, and the structures must necessarily be regarded as thin graphite films, hence three-dimensional. This definition also makes sense from the point of view of solid-state physics, since the shielding length of graphite is about 5\AA – less than two layers thick – a distinction must be made between surface and bulk even for structures consisting of five layers.

To obtain graphene, the first procedure applied was that of chemical exfoliation. Special substances were interspersed between the planes of graphite in order to break up the planes; in this way, other 3D materials could be obtained, but by inserting large molecules, the separation could be better and the resulting compounds could be regarded as isolated graphene layers, although still embedded in a 3D matrix (Dresselhaus and Dresselhaus 2002).

Graphene growth processes were also attempted, resulting in graphite films thicker than 100 layers. Graphene consisting of one or a few layers was grown epitaxially by Chemical Vapour Deposition (CVD) of hydrocarbons on metal substrates or by thermal decomposition of silicon carbides. Graphene obtained by the latter method has been shown to possess high-mobility carbide carriers, and has thus been appreciated for its electrical properties (Berger *et al.* 2006).

To obtain graphene samples useful for basic analyses of graphene's properties, Geim and Novoselov relied on micromechanical splitting of bulk graphite by placing the graphite on a piece of tape, folding it over and opening it several times, so as to peel off thinner and thinner graphite flakes over and over again. The technique provided high-quality graphene crystals up to $100\mu\text{m}$ in size, which was sufficient for the purposes of the research. In their words:

The reported graphene films were made by mechanical exfoliation (repeated peeling) of small mesas of highly-oriented pyrolytic graphite [...] (Novoselov et al. 2004).

or:

To extract such 2D crystallites, we used a simple but effective procedure. A fresh surface of a layered crystal was rubbed against another surface (virtually any solid surface is suitable), which left a variety of flakes attached to it (the rubbing process can be described as similar to “drawing by chalk on a blackboard”). Unexpectedly, among the resulting flakes we always found single layers. Their preliminary identification amid thicker flakes and other residue was done in an optical microscope (Novoselov et al. 2005).

A similar approach was also attempted by other groups (Ohashi *et al.* 1997; Bunch *et al.* 2005), but only graphite flakes 20 to 100 layers thick were obtained, because the graphene crystals remaining on a substrate were extremely rare and in any case hidden in a large number of thousands of thicker graphite flakes. Geim and Novoselov realised that the available techniques (which they called “modern”) did not allow them to detect such small crystals over an area of 1cm^2 ; scanning-probe microscopy had too low a throughput to detect graphene, while SEM microscopes were unable to detect the markings of individual atomic planes. The observation of graphene became possible by placing it on top of a silicon wafer, on which a carefully prepared SiO_2 layer was deposited, in order to have an interference contrast to the situation with a pure silicon wafer. In the words of Geim and Novoselov:

Indeed, even knowing the exact recipe, it requires special care and perseverance to find graphene. For example, only a 5% difference in SiO_2 thickness (315nm instead of the current standard of 300nm) can make single-layer graphene completely invisible (Geim and Novoselov 2007).

Graphene, on the other hand, showed a clear pattern in Raman spectroscopy, making this technique an effective tool for an initial analysis of the thickness of crystallites, the evidence of which is established a priori by optical microscopy.

The exceptional electronic quality of graphene meant that this 2D material eclipsed the existence of other similar materials for a time. Graphene was shown to possess a pronounced ambipolar electric field effect such that charge carriers could be tuned between electrons and lacunae with concentrations of the order of 10^{13}cm^{-2} and their mobility μ could exceed $15000\text{cm}^2\text{V}^{-1}\text{s}^{-1}$ even at room temperature, and was minimally dependent on temperature, but rather on the presence of any impurities. The electronic quality of graphene was also underlined by the study of the Quantum Hall Effect (QHE), which for this material could be observed even at room temperature. Not only that. Graphene immediately proved interesting due to the special nature of its charge carriers, which mimic relativistic particles and are more fully described from the Dirac equation:

$$(i\hbar\gamma^\mu \partial_\mu - mc) \psi(x) = 0 \quad (5.77)$$

rather than in terms of the Schrödinger equation:

$$i\hbar \frac{\partial}{\partial t} |\psi(x)\rangle = H |\psi(x)\rangle \quad (5.78)$$

which is generally sufficient to describe the electronic properties of materials. It was observed that, although there was no electron behaviour in motion around carbon atoms that could be defined as peculiarly relativistic, the electron-periodic potential interaction of the lattice, whose honeycomb structure was known, gave rise to completely new quasi-particles which, at low energies, were described, in particular, by the (2+1)-dimensional Dirac equation: these particles could be interpreted either as massless electrons at rest or as neutrinos that had acquired the electron's charge.

The experimental discovery of graphene, therefore, provided a way of verifying phenomena related to quantum electrodynamics by measuring the electronic properties of this two-dimensional structure.

Mathematically, graphene was described as a zero-gap semiconductor, the Hamiltonian of quasiparticles could be described as:

$$\hat{H} = \hbar v_F \begin{pmatrix} 0 & k_x - ik_y \\ k_x + ik_y & 0 \end{pmatrix} = \hbar v_F \boldsymbol{\sigma} \cdot \mathbf{k} \quad (5.79)$$

where \mathbf{k} stands for the quasiparticle momentum, $\boldsymbol{\sigma}$ is the 2D Pauli matrix and the k -independent Fermi velocity v_F plays the role of the speed of light. The application of the Dirac equation was a direct consequence of graphene's crystal symmetry.

Interestingly, a quantity defined as 'chirality', obtained formally by projecting $\boldsymbol{\sigma}$ in the direction of motion \mathbf{k} , could also be introduced for graphene, and this quantity is assumed positive (negative) for electrons (the gaps). For graphene, this means, in numerical terms, that k electrons and $-k$ gaps are interconnected because they originate from the same sub-grid. The conservation of chirality has proven to be one of the fundamental parameters for understanding various electronic processes in graphene.

Early in the history of graphene, chirality gave rise to phenomena that Geim and Novoselov themselves described as 'spectacular' as a result of their study of QED-like spectra: new 'chiral' Hall effects, minimum quantum conductivity in the limit of vanishing concentrations of charge carriers and strong suppression of quantum interference effects.

The first QHE behaviour observed in graphene was characteristic of a monolayer structure. It gave rise to a staircase-like, uninterrupted pattern, the steps of which were equispaced, relative to the values of the Hall σ_{xy} conductivity even after passing the neutrality point, where the carriers change from electrons to holes. The difference with the usually observed QHE was – see figure below – a shift, relative to the standard trend, of 1/2 so that:

$$\sigma_{xy} = \pm \frac{4e^2}{h} (N + 1/2) \quad (5.80)$$

where N is the Landau level, while factor 4 appears due to the double degeneracy of the electron–hole spin.

It is precisely this factor 1/2 that accounts for the fact that it is not the standard QHE that was observed for graphene. The explanation for this behaviour was deduced from the QED–like quantisation of the electronic spectrum of graphene in the presence of a magnetic field B , described by:

$$E_N = \pm v_F \sqrt{2e\hbar BN} \quad (5.81)$$

where the term \pm refers to the electrons, i.e. the holes. The E_0 level, shared by electrons and holes explained the anomaly in the sequence.

An alternative explanation for the half–integer QHE called into question the pseudospin/moto orbital coupling that gives rise to the so–called Berry phase.

The bilayer graphene showed, in turn, a somewhat anomalous but, in Geim and Novoselov’s terms, less ‘spectacular’ QHE. The sequence of Hall’s steps at different values of:

$$\sigma_{xy} = \pm \frac{4e^2}{h} N \quad (5.82)$$

was regularly observed, but the step for $N = 0$ was missing, a result that could be interpreted as the occurrence of the metallic character in graphene at the neutral point (Novoselov *et al.* 2006). This anomaly could be described mathematically due to the nature of the quasiparticles in bilayer graphene:

$$\hat{H} = -\frac{\hbar^2}{2m} \begin{pmatrix} 0 & (k_x - ik_y)^2 \\ (k_x + ik_y)^2 & 0 \end{pmatrix} \quad (5.83)$$

This Hamiltonian combines both the structure of the Dirac equation, with non–zero elements outside the main diagonal, with the Schrödinger–like term $p^2/2m$. The resulting quasiparticles were chiral, similar to massless Dirac fermions but, in fact, with finite mass $m \approx 0.05m_0$. The Landau quantization of massive Dirac fermions is given by:

$$E_N = \pm \hbar\omega \sqrt{N(N-1)} \quad (5.84)$$

with two degenerate steps for $N = 0$ and $N = 1$. This additional degeneracy led to the absence of the step for $E = 0$ and a resulting step of twice the amplitude.

The standard QHE, with the presence of all steps, could be ‘restored’ in bilayer graphene through the electric field effect; the gate voltage induced an asymmetry between the layers that resulted in a band gap typical of semiconductors; the induced electric field then eliminated the degeneracy and split the double step into two ‘singles’. This result was however arrived at by chemically doping the structure and performing measurements at

finite gate voltages. Double-layer graphene became the material for which it was possible to change the structure of the electronic bands through electric field effects.

A subsequent important observation made with regard to graphene concerned the fact that the zero-field conductivity σ did not disappear in the limit of n tending to zero, but instead showed values close to the conductivity e^2/h per carrier type. For all known materials, such a transition inevitably amounted to a metal/insulator transition at low temperatures, but something similar was not observed for graphene even when it was cooled to liquid helium. The persistence of metallic behaviour, in this case, was absolutely counterintuitive and quite exceptional. What must be emphasized is that in graphene, it is the resistivity that is quantized and not the resistance, the quantization of which is part of other transport phenomena. At low temperatures, all metallic systems with high resistivity exhibit large quantum-interference magnetoresistance, leading to a metal/insulator transition when $\sigma \approx e^2/h$; such behaviour was thought to be universal, but graphene was a notable exception.

It is interesting to note how, historically, Geim and Novoselov linked the discovery of graphene with the other carbon structures that had appeared on the nanotechnology scene.

[...] there are many other reasons that should perpetuate active interest in graphene. For the sake of brevity, they can be summarized by referring to analogies with carbon nanotubes and 2D electron gases in semiconductors. Indeed, much of the fame and glory of nanotubes can probably be credited to graphene, the very material they are made of. By projecting the accumulated knowledge about carbon nanotubes onto their flat counterpart and bearing in mind the rich physics brought about by semiconductor 2D systems, a reasonably good sketch of emerging opportunities can probably be drawn.

The relationship between 2D graphene and 1D carbon nanotubes requires a special mention. The current rapid progress on graphene has certainly benefited from the relatively mature research on nanotubes that continue to provide a near-term guide in searching for graphene applications. However, there exists a popular opinion that graphene should be considered simply as unfolded carbon nanotubes and, therefore, can compete with them in the myriad of applications already suggested. Partisans of this view often claim that graphene will make nanotubes obsolete, allowing all the promised applications to reach an industrial stage because, unlike nanotubes, graphene can (probably) be produced in large quantities with fully reproducible properties. This view is both unfair and inaccurate. Dimensionality is one of the most defining material parameters, and as carbon nanotubes exhibit properties drastically different from those of 3D graphite and 0D fullerenes, 2D graphene is also quite different from its forms in the other dimensions. Depending on the particular problem in hand, graphene's prospects can be sometimes superior, sometimes inferior, and most often completely different from those of carbon nanotubes or, for the sake of argument, of graphite (Geim and Novoselov 2007).

5.1.14 2006: Development of Polymeric Nanoparticles

2006 was the year in which an article was published, the purpose of which was to describe what progress had been made and what results had been achieved in the field of polymeric nanoparticles (Pinto Reis, Neufeld, Ribeiro and Veiga 2006). Polymeric nanoparticles had been the subject of an extensive study process to evaluate their use as particle carriers in the pharmaceutical and medical fields. Due to their size, they had been identified as promising drug delivery systems due to their controlled and sustained release properties, sub-cellular size and biocompatibility with tissues and cells. The preparation of nanoparticles was sought

through processes that were classified according to whether the particle formation involved a polymerisation reaction, or was derived from a macromolecule or a pre-formed polymer.

Nanospheres and nanocapsules are structures that are grouped together under the description of nanoparticles, structures that can be biodegradable or non-biodegradable, and that are used for the transport of active drug ingredients. Nanospheres possess a matrix structure and can be exploited either by encapsulating the active ingredient or by adsorbing it onto the surface. Nanocapsules are vesicular systems where the active ingredient is stored in a liquid-filled cavity surrounded by a polymer membrane.

Precisely because of their ability to transport active ingredients, nanoparticles have been the subject of great interest in nanomedicine.

Due to their submicron size, nanoparticles possess several advantages over microparticles: one of the most interesting properties is their ability to be absorbed intracellularly, e.g. in the intestine. The characteristics of hydrophilic and hydrophobic nanoparticles can be compiled as in the prospect below (Table 5.6).

Table 5.6 Characteristics of nanoparticles according to their chemical affinity with water.

Polymeric character	Uptake	Elimination
Hydrophobic	High	Low
Hydrophilic	Low	High

Electric charge vs. affinity			
	Uncharged	+ charged	- charged
Hydrophobic	High	High	Low
Hydrophilic	Low	Low	High

The polymeric composition of the nanoparticles, the adjuvants and the associated active ingredients proved to be the determining factors for the absorption process, biodistribution pattern and subsequent elimination. The development of pharmaceutical technology applied to the physical-chemical characteristics of active ingredients has made it possible to create different techniques from which to choose in order to have the best polymer to incorporate the active ingredient to be applied.

The preparation of nanoparticles has been made possible by various methods, which have been grouped into two macro-categories, depending on whether the formulation requires a polymerisation reaction or is obtained directly from macromolecules or pre-formed polymers.

The process of polymerising nanoparticles from a monomer generally takes place in a polymerisation emulsion. Such a process is divided into two modes, depending on whether the emulsion is in the aqueous or organic phase.

When operating in the aqueous phase, the monomer is suspended in a continuous phase and does not require surfactants or emulsifiers. Polymerisation is triggered according to various procedures, generally when the monomer encounters a reaction 'initiator' such as an ion or a free radical. Irradiation with gamma radiation, ultraviolet or high frequencies of the visible can, however, act on a monomer and change it as a reaction initiator. The collision between particles triggers the polymerisation reaction, which is an anionic polymerisation. Solid particles are formed before the reaction is terminated.

Polymerisation in the organic phase requires the monomer to be dispersed in an emulsion where the monomer is not soluble; polyacrylamide nanospheres were produced by this very process. However, this procedure had to be carefully controlled to prevent unwanted

aggregations in the early stages of the polymerisation process. Again, the use of toxic organics during the reaction and initiators made this procedure less common.

Variants of organic polymerisation with solvents such as cyclohexane, n-pentane and toluene were therefore developed to obtain polymethyl methacrylate (PMMA), polyethylcyanoacrylate (PECA) and polybutylcyanoacrylate (PBCA) nanoparticles. *Triamcinolone* (Krause, Schwarz and Rohdewald 1986), belonging to a class of drugs called corticosteroids, *fluorescein* (El-Samaligy, Rohdewald and Mahmoud 1986), a broad range of primary and secondary antibodies, *pilocarpine*, a medication used to reduce pressure inside the eye and treat dry mouth, and *timolol*, beta blocker medication used either by mouth or as eye drops (Harmia-Pulkkinen, Tuomi and Kristoffersson 1989), are examples of drugs that can be incorporated into nanoparticles of this type.

PMMA particles have proven to be adjuvants for vaccines, and have been produced by radical emulsion polymerisation mechanism. The single monomer MMA has been used to produce PMMA nanospheres since 1986, when the hydrophilicity of the particles was studied with the intention of improving their distribution within the human body. The preparation of PMMA was simple and drugs could be easily incorporated within the nanomolecules; however, they brought with them two problems: the need for a chemical/physical trigger and the non-biodegradability of the PMMA particles.

One of the mechanisms adopted was interfacial polymerisation, through which it was possible to obtain a series of nanoparticles functional for encapsulating the active ingredients of medicines. These include polyalkyl cyanoacrylate nanoparticles, whose polymerisation process, initiated by ions present in solution, is very rapid, in the order of seconds. An oily solution with absolute ethanol served as a solvent for the cyanoacrylate monomer and active ingredient; the preparation was then extruded into an aqueous solution and well mixed, where ethanol or acetone could be present – or not. The polymerisation of the cyanoacrylate in the form of spheres, with encapsulation of the active ingredient, was spontaneous. The final product was then concentrated by evaporation under a vacuum. This whole process was extremely efficient, with insulin being encapsulated for about 95% of the active ingredient present. Not only that, but the polymer was made practically in situ, and the polymer membrane could automatically follow the steric shape of the preparation to be incorporated. The disadvantage of this polymerisation was the need to wash out the organic solvent and replace it with water, a complex and time-consuming procedure (Pinto Reis, Neufeld, Ribeiro and Veiga 2006).

Interfacial polycondensation, on the other hand, involved preparing the particles by condensing the lipophilic monomer and the hydrophilic monomer, in the presence or absence of a surfactant. Particles of this type were below 500 nanometres and were also developed based on urethane polymers or copolymers of ether and urethane, as vehicles for α -tocopherol, a type of vitamin E (Bouchemal *et al.* 2004).

Another method for obtaining nanoparticles involved the use of pre-formed polymers, to avoid structures that could have proved toxic and would therefore have involved meticulous purification of the colloidal material.

Emulsification-solvent evaporation was an applied process that took place in two stages. During the first phase, emulsification of the polymer solution in the aqueous phase took place, while during the second phase, following evaporation of the solvent by operating on temperature under pressure increase or continuous stirring, precipitation of the nanoparticles within which the active ingredients were encapsulated occurred. The size of the particles could be controlled by the stirring speed or by altering the temperature and viscosity of the aqueous and organic phases. This methodology, it should be noted, was only

applicable to liposoluble active ingredients (Tice and Gilley 1985; Soppimath, Aminabhavi, Kulkarni and Rudzinski 2001).

Solvent displacement and interfacial deposition were similar methods, based on the spontaneous emulsification of the phase containing the polymer in the external aqueous phase. The difference between these techniques lay in the fact that where interfacial deposition led to the formation of nanocapsules only, solvent displacement allowed the formation of both nanocapsules and nanospheres.

In detail, interfacial deposition was not a polymerisation technique as such, but rather an emulsification/solidification technique. It made use of the introduction, during the process, of a component of an oil nature miscible with the solvent of the polymer but not with the reaction phase, so as to give rise to the deposition of the polymer at the interface between the oil particles and the aqueous phase, forming the nanocapsules. The oil particles had to be finely dispersed to ensure the reaction yield.

Solvent displacement involved the precipitation of a pre-formed polymer from an organic solution and the diffusion of the organic solvent into an aqueous medium in the presence, or absence, of a surfactant. The polymer, usually polylactic acid (PLA) was dissolved in a solvent of intermediate polarity, and from here, precipitation of the nanospheres took place. This phase was, in turn, injected into a subsequent continuously stirred aqueous solution where it encountered a stabiliser. The deposition of the polymer at the water/organic solvent interface led to the almost instantaneous formation of the colloid. This technique was effective in the preparation of nanocapsules, once a small amount of non-toxic oil was incorporated into the organic phase: these nanocapsules proved particularly efficient in the transport of lipophilic drugs. In itself, however, this operationally simple technique was limited to water-miscible solvents, where the rate of diffusion could lead to emulsification, making the method applicable to lipophilic drugs.

Solvent emulsification/diffusion (ESD) was proposed on the basis of the use of organic solvents and was therefore adapted to the salting-out procedure described later. The encapsulating polymer was dissolved in a partial water-soluble solvent, such as propylene carbonate. Saturation with water was then performed to ensure the initial thermodynamic equilibrium of the two liquids. In order to give rise to the precipitation of the polymer and the consequent formation of nanoparticles, it was in fact necessary to favour the solvent diffusion of the dispersed phase. This was implemented by dilution with an excess of water when the organic solvent was partially miscible with water or with another organic solvent in the opposite case. Subsequently, the solvent-saturated polymer-water phase was emulsified in an aqueous solution containing a stabiliser. Here, the diffusion of the solvent to the external phase and the formation of nanospheres or nanocapsules was observed. The final product obtained depended on the oil-polymer ratio. The solvent was removed by evaporation or filtration, depending on its boiling point. This technique had several advantages. The first was the high encapsulation efficiency of the active ingredient (generally greater than 70%) which was optimal for encapsulating lyophilic drugs. Homogenisation was also not necessary. Other advantages were high batch-to-batch reproducibility, easy scalability, simplicity and narrow size distribution. The drawbacks of the technique could be the high volumes of water to be removed from the suspension, and the leakage of the water-soluble drug into the external saturated aqueous phase during emulsification. This reduced the efficiency of encapsulation (Quintanar-Guerrero, Allémann, Fessi and Doelker 1998).

The salting-out technique was based on the separation of a solvent miscible with water from an aqueous solution through a salting effect. Salting-out could be considered a variant of the solvent emulsification/diffusion technique. Polymer and drug were initially dissolved in a solvent such as acetone. The solvent was then emulsified into an aqueous gel in which

the salting-out agent (electrolytes such as magnesium chloride, calcium chloride and magnesium acetate, or non-electrolytes such as sucrose) and a colloidal stabiliser were contained. The oil/water emulsion was diluted with a sufficient volume of water or aqueous solution to increase the diffusion of acetone, thus inducing the formation of nanospheres. The choice of salting agent was important because it could prove crucial in the encapsulation efficiency of the drug, the fundamental aim of the process. The solvent and salting agent were then removed by cross-flow filtration (*ibidem*). This technique, which was used for the preparation of PLA, poly(methacrylic acid) and ethyl cellulose (EC) nanospheres, was highly efficient, required no temperature variations and could be applied whenever heat-sensitive substances had to be processed. Stress on the protein encapsulants was reduced to a minimum. The most significant limitations of the technique could be found in the exclusive application to lipophilic drugs and the long washing steps of the nanoparticles.

Natural macromolecules have also proved interesting for the production of nanoparticles.

Albumin nanoparticles produced in an external-oleous emulsion were used for the preparation of albumin microspheres. These microspheres were characterised by the stabilisation method, i.e. heat treatment at high temperatures (between 95°C and 170°C), or chemical treatment in vegetable oil, iso-octane emulsions or aqueous medium. Other techniques had been developed on the basis of these two methods, with some operational variants. The albumin nanospheres, for example, were obtained by homogenising the oil phase containing the albumin droplets, and then thermally stabilised for about ten minutes by heating to 175°C–180°C. The cooled mixture was then diluted with ethyl ether in order to reduce the viscosity of the oily phase and allow subsequent separation by centrifugation.

Heat treatment of albumin had, however, proved to be effective and only applicable to non-heat-sensitive drug molecules. To overcome this functional limitation, nanoparticles were produced by emulsifying an aqueous solution of serum albumin in cottonseed oil at 25°C (Patil 2003). Albumin was then denatured by resuspending the particles in ether containing the crosslinking agents 2,3-butadiene or formaldehyde. The particles then underwent a shaking process and were isolated by centrifugation. The process ended with their drying by lyophilisation. It was then shown that the particles released doxorubicin much faster than particles formed by heat treatment. However, the purification step remained the main problem, along with the removal of cottonseed oil. Precisely because of the need to use chlorinated solvents, this technique did not offer many advantages over other techniques (Pinto Reis, Neufeld, Ribeiro and Veiga 2006).

Gelatin nanoparticles were produced in an external-oil emulsion by cooling the emulsion below the gelling point in an ice bath. The gelled nanoparticles, whose size ranged between 100nm and 600nm, with an average of 280nm, were then filtered, washed and cross-linked with formaldehyde. This technique had proved applicable for heat-sensitive ingredients; however, the covalent binding of some drugs to gelatin by formaldehyde treatment was a disadvantage. Cross-linking also significantly increased particle size. However, a significant disadvantage of the cross-linked agent concerned its toxicity, a point that had to be considered carefully. For this reason, plant protein fractions called gliadins were chosen from wheat gluten to efficiently encapsulate lipophilic substances such as α -tocopherol. These substances have proven to be particularly interesting because they consist of biocompatible molecules. Gliadins possess the ability to interact with epidermal keratin due to their richness in praline; this property leads to controlled drug release, a key feature of active ingredient nanovectors.

Sodium alginate is a water-soluble polymer that gels in the presence of multivalent cations such as calcium. Alginate particles were usually produced by drop extrusion of a

sodium alginate solution into a calcium chloride solution, and their size depended on the size of the initial extruded drop. The smallest particles produced, for example, had a minimum size of 1 μm to 5 μm . The preparation of alginate nanoparticles was first achieved in a dilute aqueous sodium alginate solution, and subsequent gelling. Through a further advancement in the production process, alginate particles were produced using a modified method of internal emulsification/gelling, without specialised equipment and at room temperature (Duclairoir, Orecchioni, Depraetere and Nakache 2002; Aslani and Kennedy 1996; Pinto Reis, Neufeld, Ribeiro and Viegas 2005).

Chitosan nanoparticles were studied and developed to encapsulate various proteins such as bovine serum albumin, tetanus and diphtheria toxoid, vaccines, anti-cancer agents, insulin and nucleic acids. Not only that, but chitosan greatly improved the absorption of peptides such as insulin and calcitonin through the nasal epithelium (Illum, Farraj and Davis 1994). Preparations of chitosan nanoparticles are based on the spontaneous formation of complexes between chitosan and polyanions (Calvo *et al.* 1997) or the gelling of a chitosan solution dispersed in an oil emulsion. The nanoparticles obtained from the formation of a spontaneous complex between chitosan and polyanions were characterised by small diameters (between 200nm and 500nm) and had an almost spherical shape, which could be observed under a transmission electron microscope. For the nanoparticles produced by promoting gelation with an emulsification-based method, a diameter of 400nm was measured. However, this technique had the major disadvantage of involving organic solvents during particle isolation; these were difficult to remove and could cause toxicity (Vauthier and Couvreur 2000).

For the delivery of therapeutic proteins and peptides, agarose nanoparticles were developed. An aqueous solution of agarose formed thermally reversible hydrogels when cooled below 31°C–36°C, forming basic helical structures of a three-dimensional network in which large quantities of water could be incorporated. The hydrogel, which was hydrophilic, inert and biocompatible, formed a matrix suitable for transporting proteins and peptides that were trapped in the gel during its formation. Agarose nanoparticles were produced using a technology based on the preparation of an agarose solution in corn oil emulsion at 40°C. Gelling of the agarose was induced by diluting the emulsion with cold maize oil under agitation at 58°C. Peptides and proteins to be encapsulated were added to the agarose solution at the start of the reaction. Finally, the desired size of the aqueous nanoparticles was obtained through a homogenisation process (Wang and Wu 1997).

Desolvation by means of charge and pH changes, or by adding a desolvating agent (ethanol or concentrated solutions of inorganic salts) has proven to be an effective technology for obtaining nanoparticles from polymer precursors. This process did not require an increase in temperature and could therefore be used when heat-sensitive drugs were employed. Nanoparticles were obtained by a reversible swelling process of macromolecules using different macromolecular materials. These include gelatin, human serum albumin, bovine serum albumin and casein. In the case of gelatin, which is useful for the release of DNA actives, various methods were applied to produce the nanoparticles, such as two-stage desolvation. This process offered the advantage of producing nanoparticles directly in an aqueous suspension, but the use of potentially toxic compounds such as glutaraldehyde and desolvating agents required subsequent purification (Marty 1977). Variants in the production of nanoparticles by the desolvation process have been described (El-Samaligy and Rohdewald 1983), but unfortunately the yield was relatively low.

Some of the processes described up to this point were rather complex and the products often characterised by a high residual solvent content. In addition, low drug loading, drug

degradation or denaturation, ineffective drug release or inadequate physical and morphological properties could also be observed.

Techniques based on supercritical or compressed fluids for the preparation of nanoparticulate and microparticulate products had proved to be very interesting (Wang, Dave and Pfeffer 2004). Drug and polymer were solubilised in a supercritical fluid and the solution then expanded through a nozzle. The supercritical fluid was evaporated during the spraying process and the solute particles precipitated at the end of the process. The technique was “clean” because the precipitated solute contained no solvent traces to any extent, and also offered advantages such as adequate biopharmaceutical properties and high quality of the final product. Protein drugs such as insulin have been encapsulated in poly(ethylene glycol)/poly(l-lactide) (PEG/PLA) nanoparticles with this technique (Elvassore, Bertucco and Caliceti 2001). However, this new process was initially rather expensive, due to the equipment set-up and operating pressures. Furthermore, compressed supercritical fluids require technically elaborate recycling measures to reduce energy costs.

The preparation of nanoparticles for medical/pharmaceutical purposes has been one of the most important events in the history of nanotechnology. The development of nanoparticle preparation methods focused on three aspects: the need for less toxic reagents, simplification of the procedure to enable economical scale-up, and process optimisation to improve the yield and trapping efficiency. Efficient drug entrapment and large-scale transition were of utmost importance for the industrial applicability and commercial dissemination of products. Numerous preparation methods for the production of nanoparticles became available as nanoproduct research progressed, and important technological breakthroughs were achieved. Depending on the physico-chemical characteristics of a drug, it is now possible to choose the best preparation method and polymer to achieve effective drug entrapment. The process must be optimised to minimise the loss of the drug or affect its pharmacological activity: developing tactics that enable the incorporation of biomolecules without altering their activity is a key goal for nanotechnology.

However, it must be borne in mind that not every process is suitable for every type of drug indiscriminately. Despite these technological challenges, nanoparticles have shown great promise for the development of drugs and their administration, in a very capillary and specific manner, avoiding affecting biological mechanisms such as digestion or passage through organs such as the liver, thus avoiding overload (Pinto Reis, Neufeld, Ribeiro and Veiga 2006).

5.1.15 2009: Nanotechnology and Drug Delivery

The industrial and technological revolution that has been triggered by nanotechnology has affected practically every aspect of people's daily lives. In particular, the reduction in particle size has demonstrated clear changes in the chemical, physical and biological properties of materials. Applications, benefits and risks of nanotechnology applied to medicine and drug delivery have aroused great interest, in relation to the ability of particles to be able to disperse effectively within the body and easily circumvent the food/brain barrier, for example.

Applying nanotechnology to speed up a medical diagnosis of aggressive and potentially fatal diseases or to improve therapy, improve imaging techniques, and, in short, prevent potentially complicated clinical situations is the aim of nanomedicine. The diagnosis of

different diseases, imaging, therapy, and the administration of increasingly safe drugs for different treatments are procedures that are the subject of nanomedical study. Nanoparticle-based agents for application in medicine are being developed and used in modern clinics.

The nanoparticle cell characteristic that is of interest in medical applications is that they are the smallest whole entities capable of retaining their transport properties. Therefore, they have been developed to improve drug delivery and specificity and reduce bio resistance to the active ingredient and non-specific toxicity. Nanomaterials, in fact, are able to cross cell membranes and thus gain access to cells, tissues, and organs on which, normally, larger particles cannot act. Nanoparticles for medical use have been synthesised according to the chemical nature of the various preparations. The active ingredients of the various drugs can be made to absorb on the surface of carbon or ceramic nanoparticles, dendrimers, chitosan, liposomes, low-density lipoproteins, nanoemulsions, and so on. In these same carriers, the active ingredients can be incorporated or dissolved in the matrix (Ranganathan *et al.* 2012).

The development of nanoparticles as vehicles for transporting active ingredients has become increasingly necessary as they have proven to be excellent devices for treating an ever-increasing range of neoplastic diseases. The general improvement in the quality of life has, on the one hand, prolonged it under better and better conditions, but, on the other hand, has led to the emergence of a greater number of different types of cancer which, sometimes in comorbidity with other diseases, undermine the health of the individual in old age.

Research in the field of these new agents has therefore been geared towards their better tolerability by the body and their greater accessibility. Advances in medical research in this direction have become necessary mainly because the agents available in the treatment of neoplasms on the one hand ensure good survival but on the other hand act by proving toxic to tissues, for example, that are not targeted by the pharmacological attack. Drug resistance proved to be another limiting factor in their use. Both of these limitations, therefore, had to be overcome through better site-specificity and less drug resistance, and nanoparticles were an important advancement in this direction. Specific research in the field of nanoparticles as vectors for the delivery of active ingredients, which began in the late 1990s, has proved to be one of the most promising areas in the development of medicine; some formulations have been placed on the market and, following approval after clinical trials, are included in the list of available treatments.

One of the clinical features of neoplastic situations where nanoparticles have proved particularly suitable is angiogenesis. This term refers to the vascularisation of tumour cells from surrounding blood vessels to ensure survival. Studies in the field have shown that this type of vascularisation has structural abnormalities that hinder drug delivery. Coated particles, between 10 and 100nm in size, are retained in tumours, unlike uncoated drugs that are usually smaller in size, are filtered by the kidneys, and rapidly excreted. This phenomenon has been termed enhanced permeability and retention (EPR) and has been found to be extremely advantageous for nanosized drug transport and in situ drug delivery systems (Puri *et al.* 2009).

Both the choice of materials and the synthesis methods have proven to be extremely flexible and have been used to produce nanometric drug delivery systems. Here I am going to report some examples of nanopreparations that have been developed from a patient-friendly perspective for the treatment of cancer.

Nanostructures, in general, have proven to be able to encapsulate pharmacological active ingredients and to protect them from attacks by the digestive juices and to be able to be ignored by the immune system. They are also able to release the active ingredient extremely selectively in different areas of the body, bypassing metabolism and consequently not being affected or damaged. Medical and pharmacological nanoparticles have improved the oral bioavailability of active ingredients due to their specialised absorption mechanisms, such

as absorptive endocytosis. They are able to remain in the blood circulation for a longer period of time, releasing the incorporated drug in a sustained and continuous manner and thus reducing plasma fluctuations, minimising side effects caused by drugs (Italia *et al.* 2007). The observed absorption of nanostructures was 15 to 250 times higher than that calculated for microparticles in the range of 1 μ m to 10 μ m. Through the manipulation of polymer characteristics, drug release from nanostructures can be controlled to achieve the desired therapeutic concentration for the desired duration. For targeted delivery, the nanostructures can be conjugated with targeting devices. In this way, the binding between the polymer and the active substance can be manipulated to control the site and duration of drug release. It was shown that binding could be achieved by incorporating amino acids, lipids, peptides or small chains as spacer molecules. Drug targeting proved crucial in chemotherapy, where a drug delivery system can only target the malignant tumour, protecting healthy cells from the uniform distribution of chemotherapeutics in the body and their harmful effects. The use of nanostructures such as polymeric nanoparticles has been a non-invasive approach to crossing the blood-brain barrier for the management of neurodegenerative, cerebrovascular and inflammatory disorders. Nanotechnology has proven to be a very effective approach to overcoming the challenges of conventional drug delivery systems. Some of the challenges associated with this technology in relation to drug efficacy, toxicity, stability, pharmacokinetics and regulatory control of drugs were grouped and described in the paper Nanotechnology and Drug Delivery (Ochekpe, Olorunfemi and Ngwuluka 2009a and 2009b). The advantages explain the extensive research undertaken in the development of nanostructures such as liposomes, nanocapsules, nanoemulsions, solid lipid nanoparticles, dendrimers, polymeric nanoparticles, etc. for drug delivery. The materials used in the manufacture of nanostructures determine the type of nanostructures obtained and the nanostructures, in turn, determine the different properties obtained and the release characteristics of the drugs encapsulated.

Polymeric nanoparticles are known as colloidal solid particles that possess dimensions between 10nm and 1000nm. They can be spherical, branched or made in the form of shells and have been developed from both biodegradable and non-biodegradable polymers. The first production of nanoparticles dates back to around 1974, as carriers for vaccines and cancer chemotherapies. Due to their small size, they could penetrate capillaries and be absorbed by cells, thus increasing the accumulation of drugs at target sites. Mechanisms of drug incorporation into nanoparticles included dissolution, entrapment, adsorption, attachment or encapsulation. Compared to a traditional drug in preparation and manner of administration, nanoparticles provide longer drug release and for longer periods, e.g. days and weeks. Immunisation through nanoparticles has proven to be better, it prevents the degradation of a vaccine, for example, and absorption by immunocells is more effective.

The polymer used to make the polymeric nanoparticles is one of the factors determining the extent of uptake by immune cells. A comparison of certain polymers such as poly(ϵ -caprolactone) (PCL), poly(lactide-coglycolide) (PLGA) and their mixture, showed that PCL nanoparticles were the most efficient in their uptake by immune cells (Fig. 5.61). This behaviour was justified due to their hydrophobicity (Singh, Pandit, Bramwell and Alpar 2006). Polymeric nanoparticles, however, did not prove to be entirely harmless: they triggered significantly higher serum vaccine-specific IgG antibody responses (diphtheria-toxoid) than free diphtheria-toxoid.

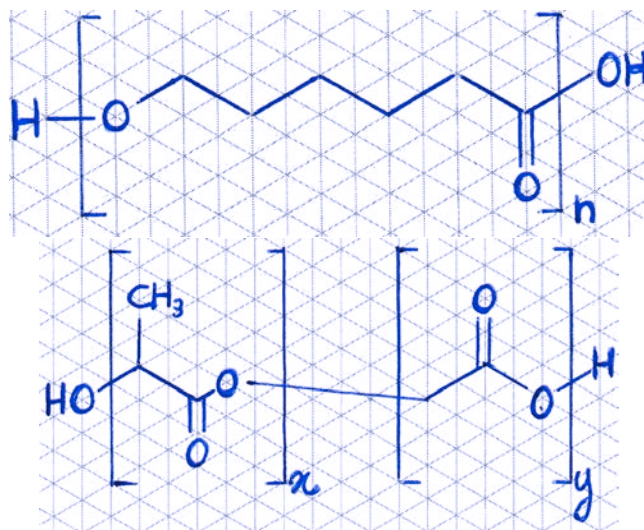

Fig 5.61 Above: the structure of poly(ϵ -caprolactone), PCL. Below: the structure of poly(lactide-co-glycolide), PLGA Source: AD

The drug could either be conjugated to a tissue-specific or cell-specific ligand, or be coupled to macromolecules that reach the target organs, in order to be correctly collimated to its site. To target an anti-cancer agent to the liver, for example, conjugated polymer nanoparticles were prepared that included biotin and poly(ethylene glycol) terminated with a galactose moiety from lactobionic acid. Some other applications of nanoparticles have been directed towards numerous clinical situations in different fields. They ranged from the possible recognition of vascular-endothelial dysfunction to the oral administration of insulin; from targeting brain drugs for neurodegenerative diseases such as Alzheimer's to topical administration to improve penetration and distribution within and across the skin barrier. pH-sensitive nanoparticles have improved the oral bioavailability of drugs such as cyclosporine. Some polymers used for nanoparticle manufacture were chitosan, alginate, albumin, gelatin, polyacrylates, polycaprolactones, poly(D,L-lactide-co-glycolide) and poly(D,L-lactide). The toxicity of some of the polymeric nanoparticles has proven to be one of the most critical factors, as well as that of their by-products, which limits their use.

Liposomes were first developed around 1970; they are small artificial vesicles, ranging in size from 50nm to 100nm. They were developed from phospholipids such as phosphatidylcholine, phosphatidylglycerol, phosphatidylethanolamine and phosphatidylserine, and have been used in biology, biochemistry, medicine, nutrition and cosmetics. The choice of lipids, the method of preparation, their size and surface charge are the factors that determine the characteristics of liposomes. In other words, liposomes are essentially self-assembled phospholipid membranes consisting of two closed phospholipid or cholesterol layers, so that an internal cavity in the structure forms a core of aqueous solution. These structures are relatively stable, biodegradable, and do not trigger any immune response in a host organism; they have proven to be optimal vehicles for the targeted delivery of hydrophobic anticancer drugs (Immordino, Dosio and Cattel 2006). As can be seen from the image below, the liposome consists of a double layer of hydrophobic/hydrophilic structures, in which the hydrophobic lipid tails are arranged opposite each other, leaving the hydrophilic endings facing outwards/the core cavity.

Water-soluble drugs, which could not be transported through hydrophobic cell membranes, are transported into the aqueous core, while hydrophobic substances can be dissolved within the lipid bilayer (Fig. 5.62). These devices are therefore extremely versatile as they can transport substances of either category.

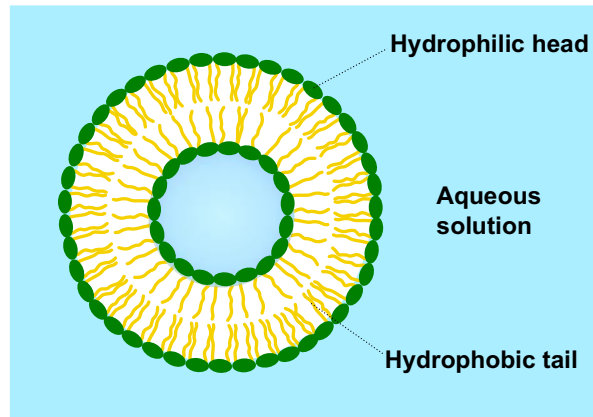

Fig 5.62 The conventional structure of a liposome. Source: Emmanuel Boutet (CC BY-SA 3.0).

Liposomes are devices used in gene therapy to deliver DNA, or in genetic engineering. In nutrition or in supplementing the body with mineral salts, liposomes are in current use. Liposomes can be synthesised in a wide variety of sizes, but the so-called nanosomes, liposomes obtained in nanometre dimensions, are the most interesting in cancer treatment, because they can transport cancer drugs, particularly those that have proven to be poorly effective because they are not very soluble. The drug, if hydrophobic, is stored between the two layers of the liposome, if hydrophilic in the nucleus. The use of polyethylene oxide molecules, polyethylene glycol (PEG) (Fig. 5.63), on the surface of the liposome causes it to be modified and causes the liposome itself to acquire “stealth” properties that prevent it from being recognised and destroyed by the endothelial reticulum (Ranganasthan *et al.* 2012).

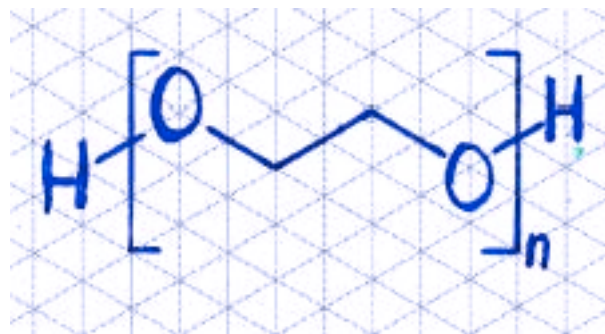

Fig 5.63 The conventional structure of polyethylene glycol PEG. Source: AD

Applying structures of this type, capable of delivering active ingredients in situ on tumour cells, has proven to be a thousand times more effective in terms of cytotoxicity than that measured Singh for the free drug.

In an attempt to achieve more and more varied and numerous lipid combinations to make liposomes with ideal qualities, carboxylated hyperramified polymeric liposomes capable of reacting to pH-dependent stimuli have been realised. Hyperramified complex polymers of poly(glycidol) 3-methyl-glutaryl (HPG) at varying degrees of polymerisation have been made to be pH-sensitive (Yuba, Harada, Sakanishi and Kono 2011). These liposomes were made on the assumption that the presence of the active, fusogenic proteins, which can facilitate membrane fusion, is stable before the membrane fusion process takes place but, at the same time, that their contents are released as soon as they are in contact with the cytoplasm. HPG polymers are similar to PEG polymer chains, but have carboxyl side groups and possess a convoluted structure that gives them a three-dimensional 3D and non-linear appearance. The 3D shape is designed to create the steric bulk required during membrane fusion. Viral peptides are conjugated with these polymers to achieve more efficient uptake by the target cell. Nanomaterial-based systems that overcome difficulties such as poor bioavailability and hydrophobicity have been developed to allow substances such as diferuloylmethane – curcumin (Fig. 5.64) –, whose efficacy as a stomach, prostate, breast, and lung chemotherapeutic agent, to act on the affected cells (Singh *et al.* 1998; Choudhuri, Pal, Das and Sa 2005).

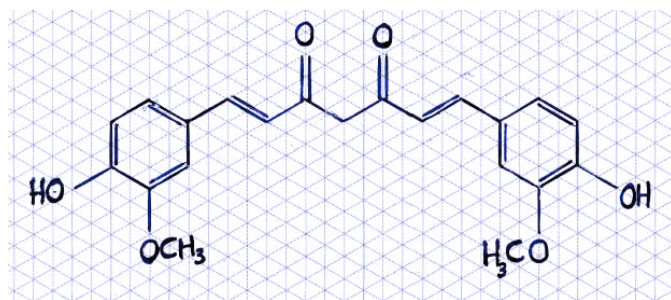

Fig 5.64 The structure of curcumin. Source: AD

Liposomes have been used as drug carriers due to their ability to prevent degradation of the active ingredient, reduce side effects and direct drugs to the site of action. However, low encapsulation efficiency, rapid loss of water-soluble drug in the presence of blood components and poor storage stability proved to be negative factors in their use. Surface modification of the structure could confer stability and integrity of the structure against the bio environment after oral or parenteral administration. Surface modification could be achieved by adhering polymers such as poly(methacrylic acid-co-stearyl methacrylate) and polyethylene glycol units to improve liposome circulation in the blood; and by conjugation with antibodies or ligands such as lectins for the delivery of drugs with specific action. Applications of liposomes include transdermal delivery to improve skin permeation of drugs that have a high molecular weight and poor water solubility. They are vectors for drug delivery, such as gentamicin, to reduce its toxicity; and they can deliver drugs to the lungs by nebulisation. Their other applications include the administration of drugs through the eye and the treatment of parasitic infections. Solid lipid nanoparticles (SLNs) have been an

effective alternative to conventional drug delivery due to their stability, easy scalability and commerciality (Ocheke, Olorunfemi and Ngwuluka 2009b).

Another type of nanoparticle that has proved effective in the transport of active drug ingredients is dendrimers. Dendrimers are nanometric structures ranging in size from one nanometre to 100nm, highly branched, characterised by the presence of an inner core, and have been developed from macromolecules such as aspoliamidoamine (PAMAM), polypropyleneimine and polyaryl ether. Studies on dendrimers began in the late 1980s and focused on their synthesis and the study of their physical and chemical properties. Shortly afterwards, the exploration of their biological applications began. Dendrimers proved to be vectors with considerable potential for drug delivery, due to their characteristic complex branching structure, their multivalence, a well-defined molecular weight and a globular structure whose surface functionality was well controlled. The globular structures of dendrimers and the presence of internal cavities allow different types of drugs to be encapsulated within the macromolecule, both hydrophilic and hydrophobic drugs. The versatility of this type of molecule has proved such that the active ingredient can be placed inside the molecule or can be attached to its surface. Not only the active ingredient but also target groups and solubilising groups can be attached to the surface in a well-defined manner. Their size (generally less than 10nm), ease of preparation, functionality and ability to transport multiple structures of surface groups for the biological recognition process are the features that make dendrimers attractive for pharmaceutical and medical applications. In addition, water-soluble dendrimers can bind and solubilise small molecules and can be used as coating agents to protect drugs and distribute them to specific sites.

A different type of structure that has found use in medicine belong to the so-called solid lipid nanoparticles or SLNs. These are, in fact, nanostructures consisting of solid lipids such as glyceryl behenate, stearic triglyceride (tristearin), cetyl palmitate and glycerol tripalmitate (tripalmitin) with sizes generally between 50nm and 1000nm. Research interest in SLNs emerged around the late 1990s ago due to their scalability potential. The lipids used are well tolerated by the body, and large-scale production has been assessed as cheap and easy due to high-pressure homogenisation. Some of the characteristics observed for SLNs are good tolerability, site-specific targeting, stability (stabilised by surfactants or polymers), controlled drug release and protection of responsible drugs from degradation. SLNs have been studied and developed for parenteral, cutaneous, ocular, oral and pulmonary routes of administration. These devices, however, were characterised by insufficient drug payload, drug expulsion after polymorph transition during storage, and the relatively high water content of dispersions. To overcome the limitations of SLNs, nanostructured lipid carriers (NLCs) were therefore introduced, composed of solid lipids and a certain amount of liquid lipids, capable of carrying a better drug load and characterised by greater stability during storage. Thus reducing concentrations, NLCs are usually incorporated into SLNs. To overcome the operational limitations of drugs that were embedded in the solid lipid matrix, conjugated lipid nanoparticles, or LDCs, were developed. Only highly potent hydrophilic drugs, effective at low concentrations, are usually incorporated into LDCs. LDCs, on the other hand, allow the incorporation of both hydrophilic active ingredients, e.g. doxorubicin and tobramycin, and lipophilic active ingredients, e.g. progesterone and cyclosporine A.

Micelles are lipid-based preparations, colloidal aggregates of surfactants, and are nanometric in size. They have proven to be effective in targeted delivery applications of active ingredients. Unlike liposomes, micelles are single-walled and therefore smaller in size; they have been used for the delivery of drugs, and foreign genes in gene therapy procedures for cancer and genetic diseases (Oerlemans *et al.* 2010). They were first proposed as drug carriers around the end of the 1990s. The inner core of a micelle is

hydrophobic and is surrounded by a shell of hydrophilic polymers, such as poly(ethylene glycol). The hydrophobic core (Fig. 5.65) allows the incorporation of poorly water-soluble and amphiphilic drugs, while the hydrophilic shell and size (<100nm) prolong the circulation time in the blood and increases their accumulation, e.g. in tumour tissues, due to increased vascular permeability (Jones and Leroux 1999).

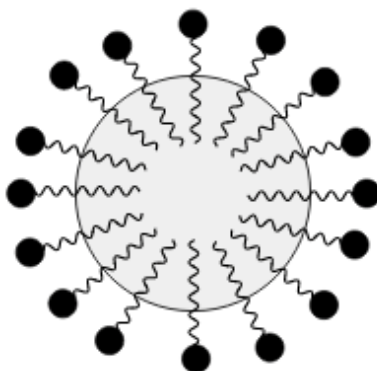

Fig 5.65 The structure of a micelle showing the only lipidic chain where one hydrophobic active ingredient can be hosted. Source: Giorgio136 nickname. Public Domain

Micelles have shown excellent efficacy in attacking neoplastic cells compared to uncoated free drugs, due to their EPR effect. Being hydrophobic, micelles can only contain one type of drug and are therefore only applicable when hydrophobic drugs are to be applied. Micelles are therefore useful for gene therapy and hydrophobic drug delivery for cancer therapy. In one of the first studies reporting the synthesis of PEG-phosphatidylethanolamine (PE), micelles contained the hydrophobic drug paclitaxel. The immunomicelles were designed with PEG-PE and possessed stealth and tumour-targeting properties. While PEG granted them the ability not to be recognised by the immune system, the ABs incorporated in the crown of the micelle confer the property of recognising tumour targeting. In addition, the constructed immunomicelle was radiolabelled with ^{111}In to quantify uptake and visualise the target site. Another example of the effective applicability of these structures is the following. Drugs such as taxol have a very low therapeutic index due to their poor solubility. When administered with these nanosystems, the drugs show better efficacy and low non-target toxicity (Torchilin, Lukyanov, Gao and Papahadjopoulos-Sternberg 2003; Musacchio *et al.* 2009). Micelles also show advantages over liposomes, which were discussed earlier, when used in several situations of cancer. In order to locate properly in the neoplastic interstitium and exploit vascularisation losses, liposomes need optimal orientation. Micelles, on the other hand, accumulate more easily at the target site (Ranganathan *et al.* 2012).

Nanocapsules are hollow spherical structures, in which the drug is confined in the cavity and surrounded by a polymer membrane, and were developed before the 1980s. For drug delivery, nanocapsules between 50nm and 300nm in size were used that could be filled with oil to dissolve lipophilic drugs. They are characterised by low density and high loading capacity. Nanocapsules are absorbed by the mononuclear phagocytic system and accumulate in target organs, such as the liver and spleen. Their uses range from confined reaction vessels to protective envelopes for cells or enzymes, from transfection vectors in

gene therapy to dye dispersants, and from vectors in heterogeneous catalysis to imaging and drug carriers. Nanocapsules have been shown to improve the oral bioavailability of proteins and peptides, including insulin, elcatonin and salmon calcitonin. Encapsulating drugs within nanocapsules protects those that are most susceptible to degradation, reduces their systemic toxicity, provides controlled release and can mask their unpleasant taste.

Nanoemulsions are emulsions that were developed with a droplet size of less than 1 μ , usually between 20nm and 200nm. Unlike microemulsions, which are white in colour due to their ability to scatter light, nanoemulsions, whose nanometre size is often less than the visible wavelength, are transparent. Nanoemulsions have considerable advantages when it comes to recruitment within an organism. They are biodegradable, biocompatible, easy to manufacture and are used as carriers of lipophilic drugs that are prone to hydrolysis. They are also used as a sustained release system for depot formation by subcutaneous injection. They proved to improve gastrointestinal absorption and reduce inter- and intra-subject variability for various drugs. Due to their very large interfacial area, they have an excellent drug release profile. Nanoemulsions have been studied and developed for parenteral, oral, ocular, pulmonary and dermal use.

Inorganic compounds, which are characterised by porous structures, have also been considered for making transport nanostructures. Ceramic nanoparticles are structures that have been obtained from silicon dioxide, alumina and titanium dioxide. They have proven to be very versatile in terms of the choice of size, generally kept below 100nm, shape and porosity that can be obtained under control. Above all, they are able to avoid absorption by the reticuloendothelial system, i.e. to be detected as foreign bodies. Molecules such as drugs, proteins and enzymes can be accommodated within them, substances that are protected from denaturation at physiological pH and temperature, as ceramic nanoparticles do not undergo porosity changes. They are, therefore, effective for transporting proteins and genes. However, these particles are not biodegradable and therefore their possible accumulation in the host organism could cause harmful effects.

Metal nanoparticles such as iron oxide, gold, silver, gadolinium and nickel have been investigated for targeted cell delivery. Gold has the most favourable optical and chemical properties at the nanoscale for biomedical imaging and therapeutic applications. In fact, it is known that it can be manipulated to sizes in the range of 0.8nm to 200nm. Its surface can be modified with different functional groups for gene transfection, or turned into a vector for gene delivery by conjugation, or modified to target proteins and peptides to the cell nucleus. Gadolinium, on the other hand, has been studied to improve drug delivery against tumour targets by modifying nanoparticles with folate, thiamine and poly(ethylene glycol). Modification with folate improved the recognition, internalisation and retention of gadolinium nanoparticles in tumour cells. Metal nanoparticles have a large surface area and thus incorporate a high dose of the drug. However, the major drawback in the use of metal nanoparticles proved to be their toxicity, which is of concern for the health of the host.

Carbon nanotubes and fullerenes are carbon-based nanoparticles that have attracted considerable interest in pharmacological and medical applications. The use of nanotubes for therapeutic applications, in particular, has been of interest due to their high electrical conductivity and excellent mechanical strength. Due to their hollow structure, fullerenes have been studied and functionalised to deliver drugs and biomolecules across cell membranes to mitochondria (Xu, Zeng, Lu and Yu 2006). Carbon nanotubes have proved to have important characteristics, which make them attractive for applications in the health sector. Among these, we should highlight their low cytotoxicity and good biocompatibility: these would suggest their use as vector systems to deliver drugs, proteins and genes into organisms. However, the toxicity in general of carbon nanotubes is a cause for concern, as

they have been shown to cause inflammatory and fibrotic reactions (Muller, Huaux and Lison 2006).

Stability and biocompatibility were two of the obstacles faced by researchers investigating polymeric formulations for drug delivery. In this respect, improvements resulted in higher solubility, longer exposure duration, selective and precise drug delivery, and better therapeutic index. The polymeric formulations studied were numerous, and those based on poly(cyanoacrylate) and poly(lactic acid) proved to be the most interesting due to their biocompatibility and subsequent biodegradability (Fig. 5.66).

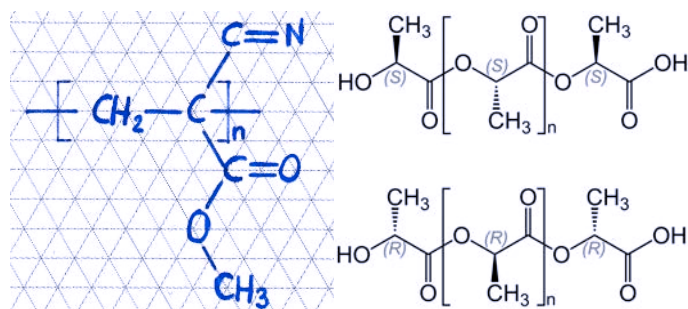

Fig 5.66 Left: the structural formula of the poly(cyanoacrylate). Source: AD Right: the two enantiomeric formulas of poly(lactic acid). Source: Jü. Public Domain

Good biocompatibility was observed for poly(alkyl cyanoacrylate) nanoparticles – PACA – that undergo degradation *in vivo*. *In vivo* studies showed that once coated with polysorbate-80 (P-80), they were able to cross the blood-brain barrier. Treatment of neoplasms, in laboratory guinea pigs, with poly(N-butyl cyanoacrylate) NPs demonstrated prolonged survival of up to six months compared to control groups treated with different drug preparations, even at nanometer size. Not only that, tolerance to the nanospheres compared to the free drug proved to be greater. The unfilled cyanoacrylate nanoparticles showed no toxicity to the cell lines. By loading these particles with curcumin, the delivery of the active ingredient *in situ* proved to be effective and without loss of efficacy, whereas the bioavailability of curcumin is known to be reduced *in vivo*.

Nanotherapeutics have proven to be an effective method of treating clinical situations, and have been implemented to solve several limitations of conventional drug delivery systems, such as non-specific biodistribution and targeting, lack of solubility in water, poor oral bioavailability, low therapeutic indexes, and action on healthy cells/tissues that were not to be affected by the action of the active ingredient. Several studies on the stability and drug load of NP formulations have shown that they are highly stable with a high transport capacity, can incorporate both hydrophilic and hydrophobic substances, and can be administered in various modalities, including oral application and inhalation, which are certainly more practical than transfusions or injections (Yousefi *et al.* 2009). NPs are designed with optimal size and surface characteristics to increase their circulation time in the bloodstream and biodistribution.

Drug delivery systems based on nanomaterials synthesized from any starting material, such as lipid-based liposomal formulations or cyanoacrylates, have been tested in various models and have proven to be useful for drug delivery. Applying NPs to oncology has made it possible to overcome the limitations associated with chemotherapeutic drugs, such as

unperfected specificity and thus biodistribution to target cells, toxicity and subsequent rejection or poor patient tolerance, and mechanisms of cell elimination and excretion.

Nanoparticles of interest for oncological applications are multifunctional and magnetic ones. One interesting approach for treating neoplastic cells is the use of hyperthermia, i.e. the regulated increase of temperature at the sites to be treated. The first research into this dates back to work by Gilchrist in 1957 (Gazeau, Lévy and Wilhelm 2008). Although various potential hyperthermic particles such as silver, zinc, and lanthanum have always been available, the most effective have proved to be gold, magnetic, and carbon nanotubes. The latter is the most advanced, as far as the application in medical research is concerned.

Heat therapy can thus be combined with new strategies such as nanotechnology or radiotherapy. The idea of using magnetic NPs for drug delivery is not a recent one, as it was proposed by Widder and Senyi in 1978 (McBain, Yiu and Dobson 2008). All magnetic NPs used were composed of the iron oxides magnetite (Fe_3O_4) and maghemite ($\gamma\text{-Fe}_2\text{O}_3$) due to their low toxicity and verified biocompatibility (Thiesen and Jordan 2008). Ferrite NPs are the most sought-after due to their physical and chemical properties that are best suited for hyperthermia applications. The magnetic properties of NPs are governed by two fundamental aspects: finite size effects and surface effects, which give rise to various special characteristics. Finite size effects result, for example, from quantum confinement of electrons, while typical surface effects are related to the symmetry breaking of the crystal structure at the edge of each particle. Therefore, for hyperthermia treatment, particles with a diameter of less than 50nm produce the highest specific absorption rate (Roca *et al.* 2009). Iron oxide particles with a diameter of less than 30–40nm are of particular interest because they exhibit superparamagnetic behaviour, i.e. once the magnetic field is removed, they do not retain any magnetisation.

Magnetic NPs have been used as heat generation systems for therapeutic applications, as they generate sufficient thermal energy when exposed to an alternating magnetic field (AMF). When these NPs were applied, median overall survival of patients was observed to be more than twice as long in clinical trials as in treated control groups (Burger *et al.* 2002).

5.1.16 2011: Introducing FinFET Technology

The nanotechnology of Fin Field Effect Transistors (FinFETs) has emerged as one of the most promising for the downscaling process of CMOS, and much attention has been paid to trying to develop accurate and reliable models of nanostructures of this type to improve circuit design technology (Marinkovic *et al.* 2011). Since the first decade of the 2000s, FinFET technology and all its variants have been a viable alternative for structuring sub-micron devices, especially below 32nm, as they possess strong electrostatic control and high density (Song, Abu-Rahma and Yeap 2011).

The double-gate structure at sizes below 50nm has been extensively studied in the development of MOSFET technology, as in a bulk MOSFET, the high-concentration punch-through stopper was indispensable, but resulted in severe drivability and leakage degradation. In dual-port MOSFET-SOI (Silicon On Insulator) devices, the energy barrier between source and drain is controlled by gates. Short channel effects can be suppressed without increasing the concentration of channel impurities. However, studies conducted on ultrathin-body devices had shown that these were affected by problems such as parasitic resistance or threshold voltage control and, not least, the complexity of their manufacturing process. This last point could be explained by the fact that the Si-planar technology was not

suitable for realising the gate–channel–gate structure required to manufacture the device, and research had to be directed towards more innovative solutions. Based on a structure called DEpleted Lean–channel TrAnsistor (from now on DELTA), described in 1991, and after reducing the vertical height, the MOSFET structure was improved by reducing the gate length to below 50nm. The new device was named FinFET (Chenming *et al.* 2000).

The following picture (Fig. 5.67) depicts the structure developed in 2000 by Chenming’s working group and describes the typical arrangement of the elements of a FinFET by means of geometric sections.

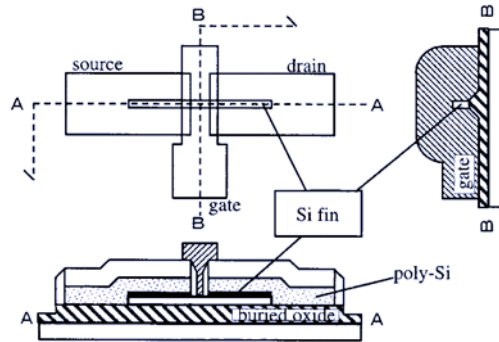

Fig 5.67 A FinFET layout with a schematic cross sectional structures. Source: Chenming *et al.* (2000)

The channel was constructed on the vertical side surface of the Si–fin device and the current was run parallel to the wafer surface. The device used the Source/Drain, or S/D, process first applied in DELTA devices. The key part of the device was a thin silicon wafer coated with a heavily doped poly–Si film that established electrical contact with the side faces of the wafer. The film reduced the S/D series resistance and, at the same time, allowed connections to be made to the metal. The poly–Si film was etched with a channel to separate source and drain, the width of which was equal to twice the width of the fin. Hence the name PinFET; since the measurements of source, drain and gate are larger than those of the fin, the structure of the device was almost planar. The manufacturing process was as follows (Fig. 5.68).

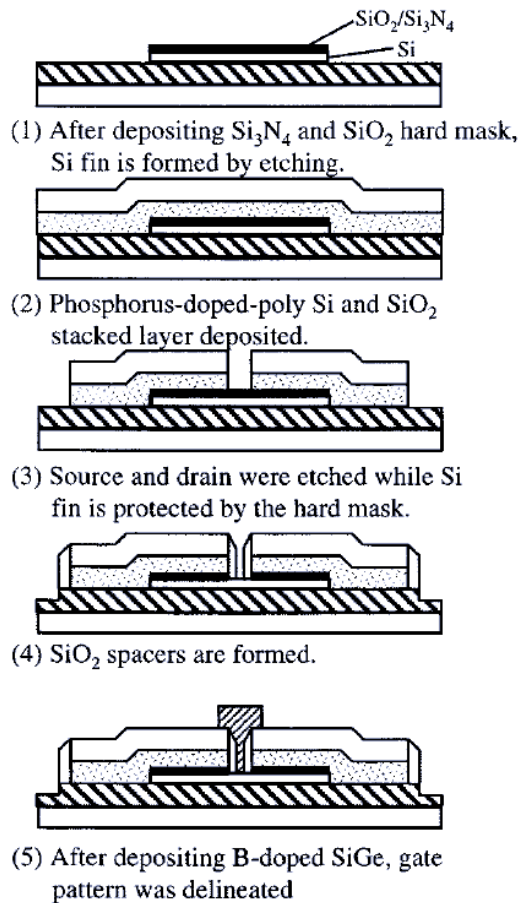

Fig 5.68 The FinFET fabrication process along the main steps required. Source: Chenming *et al.* (2000)

The starting material was a SOI wafer with a 400nm thick oxide layer and a 50nm thick silicon film. The standard deviation of the silicon was also calculated from the thickness and was found to be around 20Å; this was calculated to ensure the uniformity of the device and was acceptable, taking into account that the thickness of the silicon film determined the channel width. The Si₃N₄ and SiO₂ layer was deposited by Chemical Vapour Deposition (CVD) in order to obtain a rigid mask or cover layer, the purpose of which was to protect the Si-Fin device during the various processing steps. An electron-beam (EB) lithography with an energy of 100keV was then used to shape the surface. The width of the Si-fin was reduced by lightly ashing the resistance pattern at 5W, a treatment that was carried out for a duration of 30 seconds. The SOI layer was then etched using the SiO₂ layer as a rigid mask, and the silicon was left exposed only on the sides of the Si-fin. Dry etching and gate oxidation processes reduced the width to its final value, at around 10nm. At a temperature of 480°C, phosphorus-doped amorphous silicon was deposited, while silicon oxide was placed afterwards, before tracing the S/D with EB lithography. While the overlay layer protected the Si-fin, the amorphous Si was completely removed from the sides of the Si-

fin; the amorphous Si in contact with the Si-fin on its side surfaces was the source of diffusion of the impurities that later formed the S/D transistor.

Through CVD, the deposition of silicon oxide was achieved to obtain the spacers around the S/D pads. The measured Si-fin height was approximately 50nm, while the total thickness of the S/D pads was 400nm. Taking advantage of the difference in height, the SiO₂ spacer on either side of the Si-fin was then completely removed through sufficient over-etching of the SiO₂, while the overlay layer acted as a protection for the Si-fin; during the over-etching, both the SiO₂ and the starting oxide layer were machined. The silicon surface still remained exposed, on the sides of the device itself. By oxidising the silicon, a 2.5nm-thick oxide layer was grown, and the simultaneous crystallisation of the amorphous silicon of the S/D pads was observed. Boron-doped Si_{0.4}Ge_{0.6} was then deposited at a temperature of 475°C. After outlining the electrodes, the probing windows were etched through the oxide.

With these steps, the so-called FinFET was obtained in 2000; its technology and applications received a major boost a decade later.

Changing the properties of semiconductor materials, in particular their electrical conductivity, by adding impurities is what is known as materials doping. The progressive reduction in the size of transistors, and the ever-new design of their architectures are fundamental objectives to be pursued in order to comply with the Moore's Law trend. In FinFETs, the channel is surrounded by gates placed on multiple surfaces, and the performance of these devices has been shown to depend strongly on the size of the dopants and their placement. A 2011 study was interesting in characterising precisely the dopants to be used on FinFETs (Kambham *et al.* 2011).

To achieve the International Technology Roadmap for Semiconductors (ITRS), which set a size of 22nm and above, the semiconductor industry has been aggressively scaling down device features. Metal-oxide field-effect transistors (MOSFETs) were scaled down to a very marked extent, and the S/D junction depth was also reduced to avoid so-called short-channel effects. Fin Field-Effect Transistors (FinFETs) showed great promise to replace MOSFETs in a suitable manner. This is due to their higher performance combined with their smaller size, and better control of short-channel effects and leakage currents. The performance of these devices is mainly determined by the inhomogeneous distribution of dopants in the S/D regions, their degree of activation and their compliance. In order to optimise the performance of these devices, the application of sub-nanometer metrological techniques to characterise the 3D dopant and carrier distributions became necessary early on. For carrier profiling, 3D Scanning Spreading Resistance Microscopy (SSRM) was used. For dopants, 3D Atomic Probe Tomography (APT) provided the necessary spatial resolution and sensitivity to observe the atomic details of semiconductor devices on the required nanoscale (*ibidem*).

Kambham and his collaborators conducted experiments to characterise the dopants of FinFETs, with a view to the application of these devices to nanoelectronics. Two-dimensional test structures consisting of repeated arrays of 10 parallel fins, fabricated on p-type (1 0 0) bulk silicon wafers, were constructed. The substrate had undergone a doping of approximately 10¹⁵ atoms/cm³. Lithography enabled the fin structures to be shaped in the < 1 1 0 > direction using an optimised reactive ion etching (RIE) process. Schematic representations of the fins are shown in the next figure (Fig. 5.69).

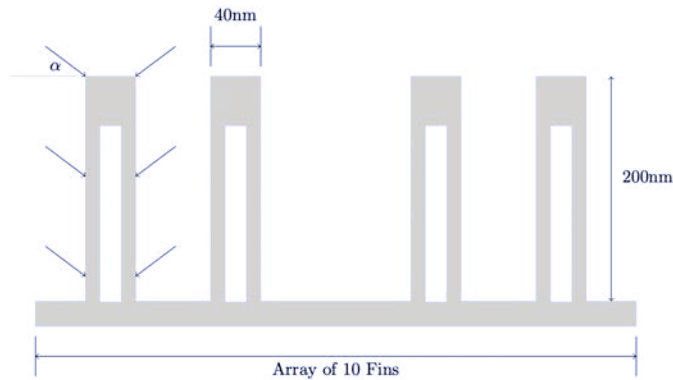

Fig 5.69 A FinFET schematic representation. Source: Kambham *et al.* (2011)

With regard to the geometry of the test device, an attempt was made to achieve a fin height (H_{fin}) around 200nm and a fin width (W_{fin}) around 40nm and 80nm. These measurements appeared to be optimal to enable dopant profiling on the individual side walls and the upper surface of the fin. The fin arrays were doped by ion implantation with boron fluoride BF_2 according to different inclination conditions, in particular 45° and 10° . Subsequently, Rapid Thermal Annealing (RTA) was performed at $1050^\circ C$ in a molecular nitrogen environment. The fins were then coated with Si (low-temperature deposition). As a further treatment, the resulting topography was polished by chemical mechanical polishing (CMP). Transmission electron microscope (TEM) images with a high-angle annular dark field (HAADF) of the test structures allowed for the calculation of the fin dimensions and the observation of the presence of silicon oxide (approximately 1–2 nm) at the deposited Si/Si-fin interface.

Sample preparation for APT analysis was performed by Focused Ion Beam with a Ga^+ ion beam. Although the sample preparation with FIB was in itself a routine method for preparing TEM lamellae, the deposited Si layer and the CMP phase made the preparation extremely challenging: all contrast (both in the scanning electron microscope analysis and in the FIB) between the fin and the area between two fins was removed, due to the presence of these two phases. Therefore, the positioning of the fin within the APT tip required the development of dedicated procedures. Basically, the operational approach was to mark the position of the invisible fin by first revealing some fins on one edge of the flap by exposing them to the ion beam after preparation above the flap. These flaps were damaged by the FIB and therefore unsuitable for APT analysis, but their observed position could be used to subsequently mark the extrapolated position of the top of the unaffected flaps by electron beam platinum deposition. Based on this marking, the centre of the annular milling could be positioned approximately above the fin.

Atom Probe Tomography analysis was performed using a laser-assisted wide-angle atom probe (400fs, 515nm). During the experiment, the sample temperature was set to 80K. The laser power was set to have an apparent Si^+/Si ratio around 10–15% during the analysis with an evaporation rate of 0.03–0.05 ions/pulse. The oxide layer was useful for assessing the height (200nm) and width of the fin (40nm), both as a reference for data reconstruction and to identify the position of the boron profiles relative to the side wall surface.

To avoid damage to the upper part of the fin due to the Ga^+ ion beam, it was necessary to optimise the ion energy, current and milling time. In this way, the damage could be

minimised by working with reduced energies of the Ga^+ beam. Therefore, in order to limit the depth of machining with Ga^+ ions during flap preparation, a method was developed in which a platinum layer, 100nm thick at low ion energies (5kV), was deposited on the area to be machined. The annular milling was performed with a Ga^+ beam energy of 30kV until a tip diameter of 300nm was reached. Then the beam energy was reduced sequentially to 16kV, 5kV and 2kV to reach the required diameter. Since the fin width was greater than the tip radius, the side walls did not enter the field of view (FOV) of the APT.

Through this experimental procedure, the dependence of the side doping profiles on the implantation angle was observed very explicitly. In the case of the 45° implant, the dopants were evenly distributed over the entire fin, whereas in the case of the 10° implant, an accumulation on the surface of the side walls could clearly be observed. Not only that, but in the case of the 10° implant, the dopants were shallower and with a significantly reduced concentration, due to the large angle of inclination (relative to the side wall surface), which reduced the depth of penetration and the probability of ion retention. This resulted in a situation of high dopant non-compliance, with the sidewall dose being only 10% of the upper dose.

As the BF_2 was implanted, fluorine (F identified as SiF) segregation was visible on the side walls of the fin at the polySi/SiO₂/Si interface. Fluorine segregation at the interface was a reaction driven mainly by the energy difference between the Si–O and Si–Si bonds in the interfacial region. The fact that an identical amount of fluorine was segregated at the interface region for both implant angles implied that the amount of segregation at this interface did not depend on the implant angles (and thus the implanted dose) but only on the number of available binding sites.

A further observation concerned the vertical thickness of the native oxide (on the side walls of the fin): this varied depending on its position in the FOV of AIII. The thickness of the oxide layer appeared to be larger (around 0.3nm) when positioned in the centre of the FOV than at the edge. This edge compression was due to the compression of the field lines at the edge of the tip surface during evaporation. To validate the results, a 1D–SIMS (SIMS–thru–Fins) analysis was performed on these samples to obtain an evaluation of the lateral dose retention. As one proceeded deeper from the surface, the first dopant concentration peak was relative to the top surface of the fin, while the plateau in the SIMS profile (around ~30–200nm) corresponded to the total concentration of the side wall (i.e. the two side walls of the fin) at each depth increment. Finally, at a depth of ~200nm, more peaks could be observed in the SIMS profiles. These resulted from the doping of the trenches between the fins. The presence of more peaks in the profile was associated with the non-planar surface after CMP. The dose results obtained from the top and side walls of the fins using APT and SIMS for BF_2 implantation at 45° and 10° tilt angles were compared with known theoretical models. While good overall agreement was observed, the subtle differences were probably due to the limited reconstruction accuracy in APT, roughness effects in SIMS and the binary collision approximation in the theoretical analysis.

Small-signal modelling applied to FinFET was based on compact models or equivalent circuit representations. An interesting alternative to this approach was developed by considering neural networks, again based on this type of device (Marinković *et al.* 2011). The extraction of a small-signal model for FinFETs was the starting point for a complete characterisation of microwave transistors. It had already been shown in the literature that an accurate small-signal model could be used as a basis for the construction of noise and large-signal models (Homayouni *et al.* 2009).

Several studies had addressed small-signal modelling for FETs based on compact models or equivalent circuit representations (Lederer *et al.* 2005). The first approach was based on tens of parameters, which were determined by means of an optimisation procedure.

On the other hand, the equivalent circuit elements could be extracted by optimisation procedures and analytical techniques. It was shown that both modelling approaches could accurately reproduce the behaviour of the transistor (Vandamme *et al.* 2002). Therefore, the motivation for choosing which approach to apply had to be related to the ease of model construction and its range of validity. To construct an accurate model with a wide validity interval, all effects contributing to the behaviour of the device had to be taken into account, and a correlation between the model parameters had to be established. This drawback could be overcome by using Artificial Neural Networks (ANNs), through which an accurate FET model could be developed without necessarily having to correlate it with the physics of the device. This was due to the ability of ANNs to learn the dependencies between two sets of parameters and thus provide the correct answer even for inputs not used during the learning process. ANNs have therefore been used as a powerful modelling tool in the microwave field (Schreurs, Verspecht, Vandenberghe and Vandamme 2002). They have also been applied to represent DC behaviour, at small signals (including noise) and large signals. As far as was known in 2011, only a few works could be found in the literature that exploited ANNs for modelling FinFETs based only on device simulations, to obtain an accurate multi-bias small-signal model directly constructed from Scattering (S-) parameters (Alam, Kranti and Armstrong 2009). Taking a completely different route from the known studies, the ANN approach to extract a FinFET model from real microwave measurements without analysing device processes represented a new idea in FinFET electronics. The proposed model exhibited high accuracy over a wide range of polarisation conditions, including pinch-off and saturation regions. Artificial neural networks were exploited to model the behaviour of the entire device and the real transistor, obtained after eliminating the effects of pads, transmission lines and substrate. The device that was studied had a gate length of 60nm and a gate width of 27.36 μ m. It was possible to obtain this value by considering that the fin height of the triple-gate FinFET tested was 60nm, a fin width of 32nm and the number of “fingers” equal to 30, where each finger was itself composed of 6 fins.

Artificial neural networks were studied, in the work of Marinković and his collaborators, to map the space of frequency and polarisation voltages into the space of S-parameters. For this purpose, Multi-Layer Neural Networks (MLP ANNs) proved to be suitable for use. Technically, an MLP ANN consists of layers of neurons: an input layer, an output layer and one or more hidden layers. The number of neurons in the input layer equals the number of independent input parameters, while the number of output neurons equals the number of parameters modelled by the ANN. In order for the target values to be accurately simulated by the network outputs, the parameters that need to be optimised during the network learning process are the thresholds of the neuron activation functions and the connection weights of the neurons. Among the most widely used optimisation algorithms are the so-called backpropagation algorithm and its modifications with a higher order of convergence, i.e. the quasi-Newton and Levenberg-Marquardt algorithms (Zhang and Gupta 2000). To ensure accurate modelling, in the model proposed in 2011, each S-parameter was modelled separately. Depending on the complexity of the behaviour of the analysed parameters, one of the two configurations shown in the figure below could be adopted. The first configuration consisted of two ANNs each with one output, one trained to model the real part and the other to model the imaginary part. The second configuration consisted of only one ANN but with two outputs, trained to model the real and imaginary parts at the same time. All ANNs had three inputs corresponding to bias voltage (gate and drain) and frequency. The training targets for the outputs of all ANNs were the corresponding measured S-parameters (Fig. 5.70).

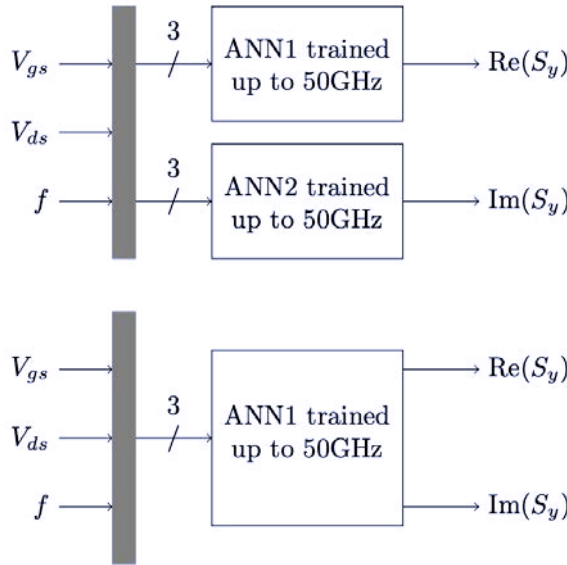

Fig 5.70 The small-signal bias-dependent neural models for FinFET scattering parameters. Top: the two-ANN model, bottom: single-ANN model. Source: adapted from Marinković *et al.* (2011)

Each ANN was described by a set of expressions, so the final model was itself a set of closed-form expressions easily implemented in the circuit simulator. In order to accurately model the entire device over the frequency range to be evaluated, a special model structure was designed, as illustrated in the figure below. The real part was modelled by a “star” type model. The real part is modelled by a two-stage hierarchical neural model consisting of two ANNs: ANN0, trained to model the behaviour of the real part in the lower frequency range, and ANN1, trained for the entire frequency range. In addition to the initial inputs, the values obtained from ANN0 are used as inputs to ANN1. The imaginary part is modelled by the basic black-box ANN model (ANN2), see Fig. 5.71.

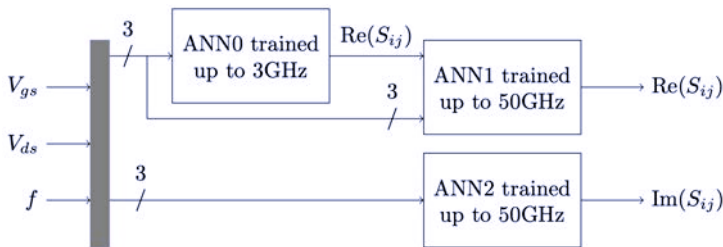

Fig 5.71 The small-signal bias-dependent hierarchical Prior Knowledge Input neural model. Source: adapted from Marinković *et al.* (2011)

The reasoning behind this model was as follows. Improving the accuracy of black-box neural models developed directly from measured data, such as the model under investigation, could be achieved by applying the so-called Prior Knowledge Input neural

approach (PKI), based on the introduction of additional inputs to the ANN. These were to provide additional information on the parameters to be modelled, thus helping the ANN to find the correct relationship between the input and output parameter sets. The aim of the research was the improvement of the model applied to low frequencies. A black–box model of the S–parameter modelled using the data measured at low frequencies was developed separately; the outputs of this model were used as prior knowledge for the neural network representing the device over the entire frequency range. Focusing on a narrower frequency range resulted in more accurate modelling in the frequency range considered, while, according to the PKI approach, the introduction of these accurate values obtained from the additional network into the main neural network, together with the initial input parameters, gave an overall improvement in accuracy. A deeper analysis of the measured data proved that the kink effect, a floating–body mechanism observed in partially–depleted (PD) SOI MOSFETs, had a greater impact on the real than on the imaginary part of the S–parameter. Furthermore, the results showed that in the case of the basic black–box approach, the modelling accuracy of the imaginary part was much better than that of the real part. For these reasons, a two–stage hierarchical neural model was applied that utilised the neural approach PKI only for modelling the real part of the S–parameter. In the case study, the kink effect appeared at frequencies below 3GHz.

The ability of the ANNs to learn from measured data was then exploited to develop a small–signal multi–bias model for FinFETs, validated up to 50GHz. The model was developed to represent the entire transistor and the actual transistor. For both cases, the model showed very good modelling accuracy not only for the bias points used for model development, but also for the bias points not seen by the ANNs during training. This allowed an accurate simulation of the S–parameters of great importance for the construction of a large–signal model. Due to the application of the ANN PKI approach, the model successfully reproduces the kink effect of the S–parameters caused by the lossy silicon substrate. Since the model was developed directly from measured data without the need to know the device processes, this modelling methodology could be applied to other FinFETs with different geometrical details or physical parameters.

A design methodology for a FinFET bitcell was also presented in an article that was available in 2011 (Song, Abu–Rahma and Yeap 2011). Such a device had proven to provide a higher cell current than a planar bitcell and be characterised by a lower current leakage. These characteristics made it possible to continue scaling SRAM bitcells $< 0.1\mu\text{m}^2$ below the 32nm node. FinFET technology and its variants have been widely accepted as alternative structures to operate with ultra–deep sub–micron devices, below 32nm nodes, due to the higher electrostatic channel control (hence better short channel control) and potentially higher layout density. The production of FinFETs, in its initial phase, was facilitated by the highly repetitive nature of the design of SRAM (Static Random Access Memory) bit cells. Continuing studies on the size of SRAM bitcells led researchers to face significant challenges, such as the management of current leakage, and the degradation of the stability of the cell itself. FinFET cells proved optimal for addressing both cell size and electrical stability issues.

The systematic evaluation of the physical layout and optimisation of electrical parameters were described in detail, along with the layout optimisation process of FinFET bit cells (Song *et al.* 2008).

Bit cell size has been one of the most important indicators of overall chip size, due to the significant percentage of area occupied by the SRAM array in the chip, which is continuously increasing due to the increasing demand for memory density embedded in

SOCs. Reducing the size of bit cells is in fact one of the most important goals of semiconductor technology and is the benchmark for all agencies involved in this field. According to the shrinkage rule for both X and Y dimensions, which involves multiplying the state-of-the-art size by a coefficient of 0.7, this results in a 50% reduction in area compared to the previous generation. The cell size, as the available technology progresses, is in fact halved approximately every two years.

Since the scale of the bit cell size is the first consideration when designing a bit cell, great efforts have always been required to ensure sufficient speed and stability with a given available area. In addition, the noise margin gradually decreased due to the greater local variation caused by the reduction in transistor area and the increase in channel doping concentration. The standby leakage current also tended to increase, as the decrease in nominal operating voltage (V_{dd}) associated with bit cell size required a change in threshold voltage (V_t) to ensure sufficient cell current. Since V_{ccmin} was the minimum voltage at which the bitcell operated stably in both read and write, minimising this parameter became a key issue as dynamic and standby power could be significantly reduced by reducing the nominal V_{dd} to V_{ccmin} . However, operating V_{dd} values was not easy, especially due to the so-called overdrive requirement ($V_g - V_t$). The increased doping concentration of the channels and the higher density of the arrays also had a negative impact on the scalability of V_{ccmin} .

In contrast, the FinFET-based SRAM bitcell improved the overall electrical characteristics of the bitcell while reducing the device size. In addition, larger effective width and lower channel doping concentration significantly improved V_{ccmin} scaling. The process of optimising FinFET bit cells had necessarily to consider several factors at the same time. This became necessary because a certain FinFET configuration could be beneficial for a certain aspect of the bit cell (e.g. area), but detrimental for another (e.g. stability or manufacturability).

Optimising a FinFET cell is a procedure that took into account three different but indispensable aspects: the first concerned the optimisation of the physical layout, the second was about the improvement of the electrical characterisation, and the third was about significant manufacturability. How to arrive at a device that encompasses all the optimal characteristics is described in the next diagram (Fig. 5.72).

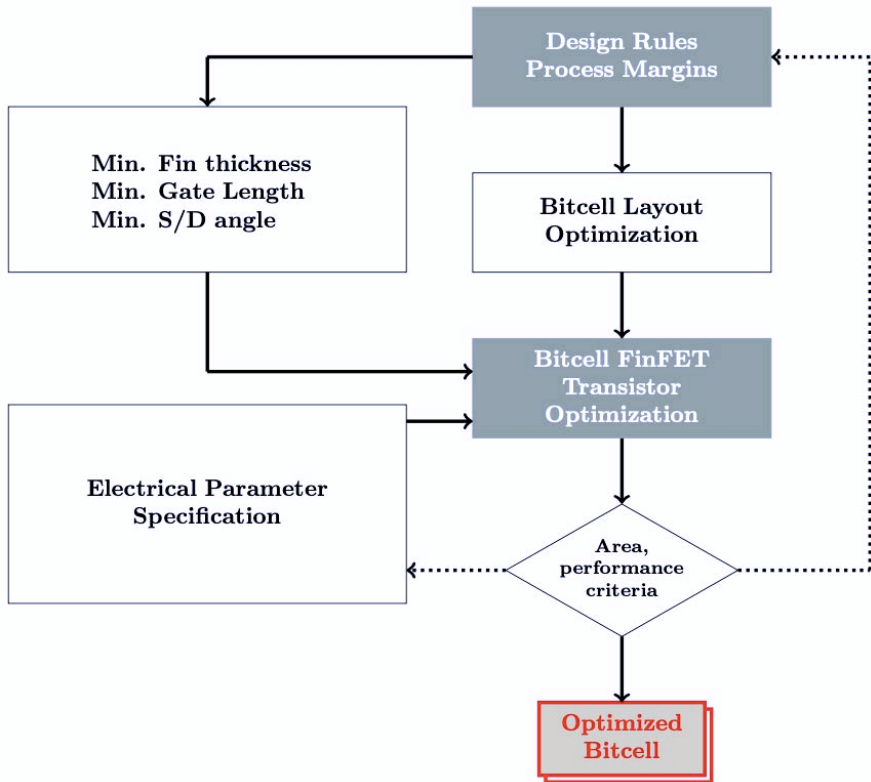

Fig 5.72 The flow-chart diagram to optimize a FinFET SRAM bitcell. Source: AD, adapted from Song, Abu-Rahma and Yeap (2011)

The design of the physical layout of the bitcell was a key point, as the size and contact pattern determined the allowable space in which to place the Fin array. Fin geometry and doping technology were the two main parameters to be considered. The layout of the SRAM FinFET bitcell could be achieved by replacing planar transistors with FinFETs in the planar bitcell. When a FinFET was used, the size of the bitcell was limited by the size of the contacts. The FinFET bitcell, therefore, could be reduced more significantly by reducing the contact size. The fin thickness (T_{fin}) was one of the critical parameters in the operation of FinFET devices, as the electrostatics in the channel region, which ultimately controls the behaviour of the short channel, and the parasitic resistance depend on it: this had to be carefully considered in order to find the optimum values. The minimum value was determined by the process of lithography and fin etching. The space between Fin and Fin was a process-limited parameter, which depends on the etching and lithography process. A wider gap was preferred in order to achieve a greater effective width and lower parasitic capacity.

To optimize the Fin configuration the following analytical equation for maximum W_{eff} calculation was derived:

$$W_{eff} = \left[\frac{\text{Contact}}{T_{fin} + S_{fin}} \right] + \begin{cases} 1, & \text{if } \left[\text{Mod} \left(\frac{\text{Contact}}{T_{fin} + S_{fin}} \right) - T_{fin} \right] \geq 0 \\ 0, & \text{if } \left[\text{Mod} \left(\frac{\text{Contact}}{T_{fin} + S_{fin}} \right) - T_{fin} \right] < 0 \end{cases} \times \left\{ 2 \times \left[\tan \left(\frac{\pi}{2} - \theta \right) \times S_{fin} \right] + T_{fin} \right\} \quad (5.85)$$

where T_{fin} is the Fin thickness, S_{fin} is the Fin to Fin space, θ is the implantation angle and Contact is the contact pad width. This analytical equation was also used to calculate the effective width based on the contact size (i.e. the area allowed for the fin array) and the parameters of the fin configuration. One of the main advantages of FinFET bitcells was the increased stability and thus further scalability of V_{ccmin} determined by the minimum V_{dd} , where the read noise margin SNM and the writing margin WM are reduced to a point where the cell state is accidentally altered. The most important point for achieving a high layout density of FinFET bitcells was the revision of the contact-related design rules. The significantly larger effective width compared to conventional planar devices made it possible to achieve very high-speed bitcells with a high bitcell density. Due to the lower channel doping and greater effective width, the FinFET bitcell also had a significantly lower V_{ccmin} , which enabled a further reduction in operating voltage and thus lower power consumption.

5.1.17 2015: Nanocrystals and Nano-Optics

The study of the quantum confinement of electrons in three dimensions within semiconductor crystals and the optical spectroscopy of molecules in the near field were two topics explored in 2015, concerning nanoscale technology. This research, conducted by L.E. Brus and J.K. Trautman, was aimed at exploring phenomena on a different length scale than bulk systems (Brus and Trautman 2015). When speaking of optics in general, one refers to optical wavelengths, varying between 0.01nm and 1cm, whose sources are atoms or molecules in which an electron transition between energy states takes place (Kořkin and Širkevič 1989). When discussing nanocrystals, the fundamental length to be considered is the intrinsic electron delocalisation length. In particular, in semi-conductive nanocrystals, the development of band structure and optical properties were studied for structures whose size ranged between 1nm and 10nm. In a similar condition, electrons and gaps were affected by quantum confinement in three dimensions, and these structures were referred to as quantum dots.

In detail, two cases were studied: the direct gap CdSe and the indirect gap Si. The result was that the main effect of confinement in CdSe was spectroscopic, while the main effect of confinement in Si was kinetic.

The nano-optical technique employed for the observations was Near-Field Scanning Optical Microscopy (NSOM), where the light underwent confinement in one-tenth of the optical wavelength, thus providing the operator with the ability to go and observe the optical properties over a length of approximately 10nm to 100nm. This allowed direct observation of variations in the spectrum caused by local variations in amorphous structure molecules and, in general, spectral variations that depended on variations in the spatial dimensions of structures.

Brus and Trautman first studied the spectroscopic and kinetic regimes.

The first approach was to bulk materials and their properties as they increased in size. As far as spectroscopic properties were concerned, three size-related regimes became clear: molecular, quantum dots and polaritons. For example, for limited clusters of 10 to 50 atoms, the diamond lattice is not stable with respect to the process of isomerisation of the diamond into a molecular structure that eliminates the unconnected surface bonds, so the existence of the unit cell in the molecular regime was not possible. In the quantum dot regime, between 1nm and 10nm, the physical structure could be likened to that of a known lattice fragment. Here electronic properties showed a very strong three-dimensional quantum confinement with the excited energy states discretized and the band gap shifted to higher energies. Such strong confinement was also observed for nanocrystals with diameters smaller than the bulk diameter of the Bohr exciton. In semi-conductive crystallites, the nanoparticles exhibiting quantum confinement effects, these excitonic radii are calculated through the formula:

$$a_x = \frac{\epsilon_r}{\mu/m_0} a_0 \quad (5.86)$$

where ϵ_r is the relative permittivity; while the reduced mass of the electron-hole system is calculated through the:

$$\mu = \frac{m_e^* m_h^*}{m_e^* + m_h^*} \quad (5.87)$$

In equation (5.86) m_0 is the mass of the electron and a_0 the atomic radius (Brus 1986).

In the polariton regime, the bulk band gap depends on the increase in energy, the interaction with the electromagnetic field is increasingly strong and must be included in the zero order. Local effects were observed and the size of the crystallites, together with their shape, agreed with those predicted by Mie's theory of scattering.

Similarly, kinetic theory was of interest. Both in the molecular regime and in the quantum dots regime, the kinetics proved to be unimolecular, i.e. they involved electron-hole interaction with other similar structures or with the lattice. The separation of carriers and their interaction with others in other crystallites were prevented by confinement within a single nanocrystal. The evolution of molecule-like to solid-state-like kinetics was linked to the growth of the crystallite. When confinement energies were below kT , carriers became independent and mobile throughout the crystallite and recombination phenomena were observed according to many-body scattering kinetics (Fig. 5.73).

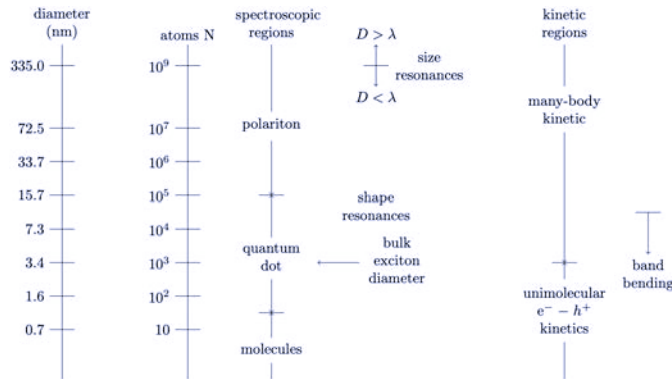

Fig 5.73 A schematic representation of the size regimes for semiconductor nanocrystals. Source: AD adapted from Brus and Trautman (2015)

Direct Gap CdSe was studied through the use of high-crystallinity, monodispersion-dimensional samples obtained from organometallic liquid phase synthesis. CdSe has thus become the prototype for the study of three-dimensional quantum confinement in semiconductors. At room temperature, it was possible to detect from the optical spectra the discrete development of the structure as the size decreased, from 10nm down to 1.5nm. In contrast, the energy gap value exhibited antisymmetrical behaviour, increasing from 1.7eV to 3.2eV in the smallest nanocrystallite size. The model involving the electron-hole system confined within a crystalline nanosphere made it possible to justify the transitions in the low-resolution spectra, where the surface of the sphere constituted a simple mathematical boundary barrier. The behaviour of electrons and gaps depended on the group to which the individual atoms belonged: semiconductors of groups II-VI and III-V had, for the unit cell, s-type electrons and p-type holes: in CdSe, the lowest electronic level is the totally symmetrical combination of s orbitals located mainly on cadmium multiplied by a function whose nodes are located on the surface of the crystallite. The result is that the energies of the molecular orbitals take on very different values, as shown in previous research (Ekimov *et al.* 1993). As the gaps were more massive than the electrons and due to the three-lobe spatial degeneration of the p orbital, the molecular orbitals referred to the holes were also denser. All these factors put together were responsible for the complexity first of the optical spectrum, and then of the three-dimensional quantized valence band (Fig. 5.74).

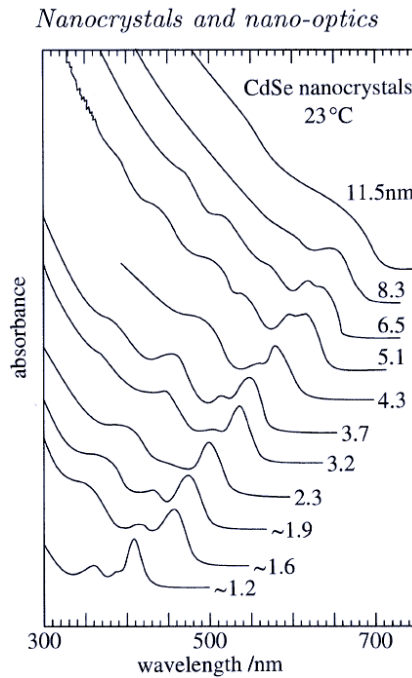
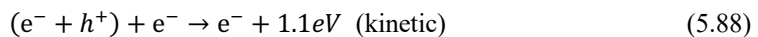

Fig 5.74 CdSe optical spectra. Source: Brus and Trautman (2015)

In the direct CdSe gap, the optical band transition occurred according to the rules of electric dipole selection.

In contrast, silicon behaves as an indirect gap, so luminescence in the bulk crystal is prohibited by the electric dipole. The use of silicon could also allow the following prediction: luminescence would lose its dependence on dipole factors without the contribution of phonons in the nanocrystal. The structure in silicon, again, was not resolved in a discrete manner as was possible for CdSe, the optical spectrum being fully comparable to that of a generic indirect gap material, with a gap around 2.0eV. Once an analysis of the temperature-dependent unimolecular decay had been carried out, the results obtained made it possible to state that the light radiation time could be considered quite long, in the order of $5 \times 10^{-4}s$. According to previous studies, the reason for the increased luminescence in nanocrystalline silicon, and apparently in porous silicon, was not to be found in oscillator characteristics, but rather in a decrease in transitions that did not give rise to radiative emission (Brus 1994). At room temperature, in silicon, the electron-hole pairs are not bound, relative to kT , so the carriers are free to move completely independently in the crystal. When moderate optical excitation was applied, the kinetics were dominated by non-radiative Auger three-body recombination:



The effect of quantum confinement is twofold. On the one hand, due to confinement in a single crystallite, electron and hole are superimposed at 293K, and on the other hand, the Auger process is terminated as there is no pair interaction between separate nanocrystals.

Ultimately, the conversion from solid–state–kinetics to molecular kinetics was the cause of the increase in luminescence (Brus *et al.* 1995).

Differences in size, shape and structural distributions that may be present even in the most selected samples are the cause of the non–homogeneous broadening of the spectra; this fact constitutes a serious problem in the optical study of nanocrystals. The optimum condition would be to obtain the spectra of the nanocrystals one by one, and this was achieved by Brus and Trautman using CdSe nanocrystals with a size of around 4nm and using an NSOM apparatus at room temperature. The nanocrystals for observation were separated by several hundred nanometres by covering them with a transparent polymer material, thus enabling NSOM observation and obtaining one spectrum at a time. From the analysis of these spectra, it was possible to appreciate the shift between crystallites; the single spectra were about 10nm narrower than the broader spectra obtained by the far–field observation technique.

The near–field spectroscopy technique had to be used with caution, because even the very presence of the probe could alter the optical properties of the sample. The instrument would therefore have to be improved and the authors studied the near–field fluorescence of single molecules of 1,1'–dioctadecyl–3,3',3'–tetramethylindolocarboyanine (diI) dispersed in polymethylmethacrylate (PMMA). The diI showed excellent behaviour as a nanoparticle coating, as it was characterised by good photostability and an emission quantum yield close to unity. Once the characteristic spectra of a single molecule were observed, they showed shifts of ± 8 nm when compared to the average spectrum, and were themselves narrower on average. The shifts had the characteristic of being time-dependent for one fifth of the particles observed. The variability of the spectra and the time dependence of shifts could be interpreted as consequences of dynamic changes in the interaction of the molecule with the local polarisation of the polymer. An interpretation on the width of the spectra was linked to the mobility of the particles: narrower spectra were related to molecules bound in more rigid sites, while wider spectra belonged to molecules placed in more dynamic contexts.

The NSOM technique showed other characteristics that were well suited to nanotechnology. NSOM using a tapered, single–mode optical fibre probe was an optical microscopy technique that could achieve a resolution of about 1/20th of the wavelength in most imaging modes. The resolution achieved was better than that of traditional far–field optics, and in some cases unique to NSOM. One application of NSOM to nanotechnology, for example, was the writing of magnetic bits down to a diameter of 60nm (Betzig *et al.* 1992).

5.1.18 2022: Recent Atom Manipulation

Tunnelling microscopy has enabled, as we have seen in this overview of the History of Nanoscience and Nanotechnology, the manipulation of atoms and, consequently, the creation of quantum states of matter based on artificial structures (Gomes *et al.* 2012). It is precisely this ability that makes it possible to create increasingly sophisticated and customised structures and to expand research into the field of exotic quantum states (Celotta *et al.* 2014). Yet unknown a priori parameters, the difficulty of modulating tip–atom interactions, and losses of tip shape make it difficult to operate at the atomic scale for long periods of time. To control atomic manipulation, the technique of Deep Reinforcement Learning (DRL) was therefore applied (Sutton and Barto 2018). DRL algorithms utilise deep neural networks and the large–scale computational capacity of computers to enhance

Reinforcement Learning (RL) capabilities. The reinforcement learning agent, for example, has *learned* to manipulate silver adatoms on Ag(111) surfaces with optimal precision and can be integrated to complete a fully autonomous atomic assembly system. The DRL can thus offer nanofabrication an effective tool for carrying out increasingly complex experiments at the nanoscale.

Research into exotic quantum states in artificial lattices and the miniaturisation of computational devices on an atomic scale are two very current areas of research that take advantage of atomic manipulation processes; being able to organise artificial structures on metallic substrates makes it possible to intervene in electronic interactions and spin in order to obtain suitably engineered materials (Moon, Lutz and Manoharan 2008). Recently, research has been extended to superconducting materials (Kim *et al.* 2018) and topological insulators (Löptien *et al.* 2014) in order to obtain characteristics that are not present in Nature. Further applications of atom manipulation are the construction and operation of computational devices whose size is, at the limit, that of individual atoms, including logic gates (Heinrich, Lutz, Gupta and Eigler 2002), memories (Kalff *et al.* 2016) and Boltzmann machines (Kiraly *et al.* 2021).

The DRL has become the preferred method for solving non-linear random control problems. When adatoms are to be arranged with atomic precision on a substrate, energy barriers between the microscope tip and the adatoms themselves must be overcome to allow vertical or lateral movement. Tip position, bias and tunnelling conductance are the factors that must be controlled and established separately for each possible operational combination of adatom and surface. DRL is particularly effective in reviewing these experimental parameters: with this technique, a neural network-based decision agent learns to perform assigned tasks through trial and error. In scanning electron microscopy, machine learning approaches have been integrated to address a wide variety of problems (Kalinin *et al.* 2016) and discretised-space DRL has been adopted for processes as diverse as tip preparation (Krull *et al.* 2020) and vertical manipulation of molecules (Leinen *et al.* 2020). The results show that the DRL agent can perform better than random or untrained agents, but have not yet been shown to be superior to conventional algorithmic approaches.

A state-of-the-art DRL algorithm, combined with replay memory techniques, can efficiently learn to manipulate atoms with atomic precision: this was described in a recent paper (Chen *et al.* 2022). The DRL agent, trained only on a database of manipulating real-world atoms, turned out to be able to place atoms with optimal precision in 100 events, after about 2000 training events. Compared to a basic algorithm whose measurement parameters are not flexible, the agent proved to be more effective against variations in the apex of the microscope tip. Combined with a path-planning algorithm, the trained DRL agent resulted in a fully autonomous atomic assembly algorithm, which in turn was used to assemble, with atomic precision, an artificial lattice with 42 atoms.

In the beginning, the problem was formulated as a reinforcement learning problem, so that it could be solved by DRL methods, as shown in the figure 5.75.

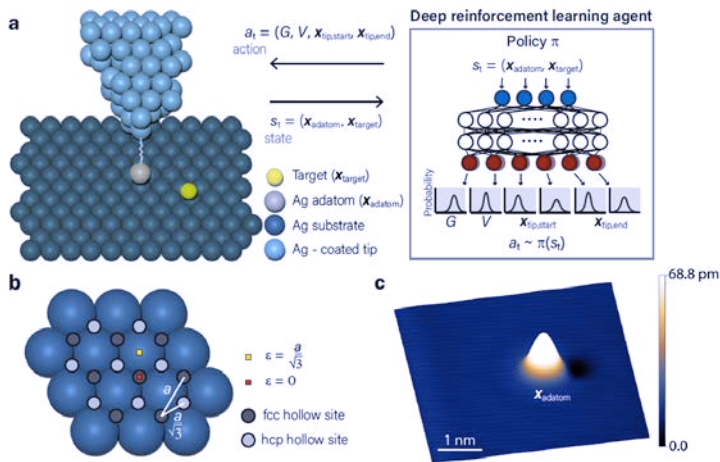

Fig 5.75 The atom manipulation with a DRL agent. Source: Courtesy of IJ Chen (2022)

With reference to the figure above, we observe that (a) the DRL agent *learns* to manipulate atoms with extreme precision and in a very efficient manner, through interaction with the STM microscope. At each t , the action command $a_t \sim \pi(s_t)$ is sampled from the code of conduct (policy) π based on the associated state s_t . The action a_t includes the following functions conductance G , bias V , and the two-dimensional tip positions at the start/end points of the manipulation process, say $x_{tip,start}/x_{tip,end}$, points used to move the STM in the adatom positioning sequence.

Learning problems are usually formalised as Markov Decision Processes (henceforth MDPs), processes where the transition that a state of the system undertakes at time t depends on the state and action at time t and not on the history of changes in the state and actions up to time $t - 1$. These processes can be divided into *episodes* each of which starts from a state that can be denoted by s_0 and ends when the agent reaches the goal or the maximum length allowed for the episode. The goal of the agent, in the case studied, was to move an adatom from its starting position to its final position as precisely as possible: a random final position between 0.288nm and 2.000nm away from the starting position was assigned, and the agent was allowed five attempts to complete the move instruction. The state vector s_t was four-dimensional in nature, its components, being the XY coordinates relative to the start and end positions, denoted by the symbols $x_{adatom}, y_{adatom}, x_{target}, y_{target}$. Based on this state vector, the agent chooses an action a_t with its policy π . The action is a six-dimensional vector because it is a function of the four coordinates, the predefined bias V over a range of 5–15mV, and the tunnelling conductance G between $3\mu A/V$ and $6\mu A/V$. Once the task was performed, the data was used to update the position of the adatom to a new state s_{t+1} and the agent received the reward $r_t(s_t, a_t, s_{t+1})$. The final goal of the reinforcement learning problem was to gain the reward and the design of the global process was aimed to maximize the total rewards.

To prove the feasibility of atom manipulation through reinforcement learning an experiment was conducted manipulating silver atoms on the Ag(111) surface at a real low temperature (5K).

A function error was defined with the adatom position and the target position:

$$\varepsilon = \|x_{adatom} - x_{target}\| \quad (5.89)$$

where ε spans from 0 to $a/\sqrt{3} = 0.166\text{nm}$, and $a = 0.288\text{nm}$ is the lattice constant on the Ag(111) surface. The parameter $a/\sqrt{3}$, then, works as the tolerance value that stops the process of the episode when $\varepsilon < a/\sqrt{3}$. With all the units defined so far, the reward is defined as:

$$r_t(s_t, s_{t+1}) = -\frac{(\varepsilon_{t+1} - \varepsilon_t)}{a} + \begin{cases} -1 & \text{if } \varepsilon_{t+1} > \frac{a}{\sqrt{3}} \\ 1 & \text{if } \varepsilon_{t+1} \leq \frac{a}{\sqrt{3}} \end{cases} \quad (5.90)$$

where the agent receives a +1 reward if the adatom is successfully manipulated and a -1 otherwise.

Once the theory was established, the RL agent was tested in practice, resulting in an artificial kagome lattice (intersecting webs of corner-sharing atoms) of 42 adatoms. The adatoms were assigned to their positions in order to operationally minimise the movements to be made, and this through the so-called Hungarian algorithm (Kuhn 2005). A Rapidly-exploring Random Tree search algorithm (LaValle 1998) was tasked with finding the path between the initial and final positions of the adatoms, avoiding any possible collisions between them. The end result was a complete software toolkit that enabled the autonomous assembly of artificial structures with atomic precision. The following image (Fig. 5.76) depicts the 42 atoms placed with atomic precision on the substrate.

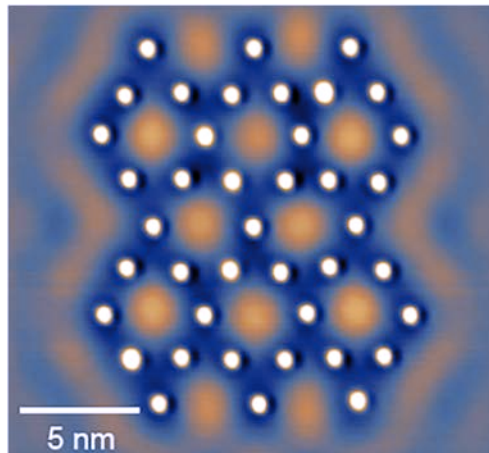

Fig 5.76 The trained DRL agent put the atoms on a kagome lattice. Source: Courtesy IJ Chen (2022)

The result shows that it was possible to create artificial structures on an atomic scale, through an RL system designed to learn directly from interactions with the environment. This is a fundamental step in the manipulation of matter on an atomic scale achieved through several state-of-the-art algorithms that, by adopting artificial intelligence, are on the way to solving automation problems in the nanofabrication of new materials.

Epilogue V

This chapter concludes the historical part of the thesis, developed from 1950 to 2022. In particular, the main achievements of the last thirty years are analysed here, characterised above all by the physics and chemistry of carbon nanotubes and graphene, gold nanoparticle-based colloids and their applications.

Here I have described some of the most significant applications that have been achieved in the last thirty years thanks to the use of the techniques perfected in the previous decades and that have opened the door to research in the nanoworld.

References

Primary Sources

- Beck JS, Vartuli JC, Roth WJ, Leonowicz ME, Kregse CT, Schmitt KD, Chu CTW, Olson DH, Sheppard EW, McCullen SB, Higgins JB, Schlenker JL (1992) A New Family of Mesoporous Molecular Sieves Prepared with Liquid Crystal Templates. *Journal of the American Society* 114/27:10834–10843. doi:10.1021/ja00053a020
- Brus LE, Trautman JK (1995) Nanocrystals and Nano–Optics. *Philosophical Transactions of the Royal Society of London. Series A: Physical and Engineering Science* 353/1703:313–321. doi:10.1098/rsta.1995.0102
- Dimitrijevic S, Withers JC, Mammana VP, Monteiro OR, Ager III JW, Brown IG (1999) Electron Emission from Films of Carbon Nanotubes and *ta*-C Coated Nanotubes. *Applied Physics Letters* 75/17:2680–2682. doi:10.1063/1.125122
- Geim AK, Novoselov KS (2007) The Rise of Graphene. *Nature Materials* 6/3:183–191. doi:10.1038/nmat1849
- Iijima S (1991) Helical Microtubules of Graphitic Carbon. *Nature* 354/6348:56–58. doi:10.1038/354056a0
- Kambham AK, Mody J, Gilbert M, Koelling S, Vandervorst W (2011). Atom–Probe for FinFET Dopant Characterization. *Ultramicroscopy* 111/6:535–539. doi:10.1016/j.ultramic.2011.01.017
- Manoharan HC, Lutz CP, Eigler DM (2000) Quantum Mirages Formed by Coherent Projection of Electronic Structure. *Letters to Nature* 403/6769:512–515. doi:10.1038/35000508
- Marcovich A, Shinn T (2011) Instrument Research, Tools and the Knowledge Enterprise 1999–2009: Birth and Development of Dip–Pen Nanolithography. *Science, Technology and Human Values* 36/6:864–896. doi:10.1177/0162243910385406
- Marinković Z, Crupi G, Schreurs DMMP, Caddemi A, Marković, V (2011). Microwave FinFET Modeling Based on Artificial Neural Networks Including Lossy Silicon Substrate. *Microelectronic Engineering* 88/10: 3158–3163. doi:10.1016/j.mee.2011.06.019
- Martel R, Schmidt T, Shea RH, Hertel T, Avouris P (1998) Single– and Multi–Wall Carbon Nanotubes Field–Effect Transistors. *Applied Physics Letters* 73/17:2447–2449. doi:10.1063/1.122477
- Novoselov KS, Geim AK, Mozorov SV, Jiang D, Dubonos SV, Grigorieva IV, Firsov AA (2004) Electric Field Effect in Atomically Thin Carbon Films. *Science* 306/5696:666–669. doi:10.1126/science.1102896
- Novoselov KS, Jiang D, Schedin F, Booth TJ, Khotkevich VV, Mozorov SV, Geim KA (2005) Two Dimensional Atomic Crystals. *Proceedings of the National Academy of Sciences* 102/30:10451–10453. doi:10.1073/pnas.0502848102
- Piner RD, Zhu J, Xu F, Hong S, Mirkin CA (1999) “Dip–Pen” Nanolithography. *Science* 293:661–663. doi:10.1126/science.283.5402.661
- Pinto Reis C, Neufeld RJ, Ribeiro AJ, Veiga F (2006) Nanoencapsulation I. Methods for Preparation of Drug–Loaded Polymeric Nanoparticles. *Nanomedicine: Nanotechnology, Biology and Medicine* 2:8–21. doi:10.1016/j.nano.2005.12.003
- Qin LC, Ichihashi T, Iijima S (1997) On the Measurement of Helicity of Carbon Nanotubes. *Ultramicroscopy* 67:181–189. doi: 10.1016/s0304–3991(96)00095–2
- Ranganathan R, Madanmohan S, Kesavan A, Baskar G, Krishnamoorthy YR, Santosham R, Ponraju D, Rayala SK, Venkatraman G (2012) Nanomedicine: Towards Development of Patient–Friendly Drug–Delivery Systems for Oncological Applications. *International Journal of Nanomedicine* 7:1043–1060. doi:10.2147/IJN.525182
- Song SC, Abu–Rahma M, Yeap G (2011) FinFET Based SRAM Bitcell Design for 32nm Node and Below. *Microelectronics Journal* 42/3:520–526. doi:10.1016/j.mejo.2010.11.001
- Weissmann M, Bonadeo H (2001) A Simple Interpretation of Quantum Mirages. *Physica E* 10/4:544–548. doi:10.1016/s1386–9477(01)00036–4

Secondary Sources

- Abdallah NH, Schlumpberger M, Gaffney DA, Hanrahan JP, Tobin JM, Magner E (2014) Comparison of mesoporous silicate supports for the immobilisation and activity of cytochrome c and lipase. *Journal of Molecular Catalysis B: Enzymatic*. 10882–88. doi:10.1016/j.molcatb.2014.06.007
- Ahern RJ, Hanrahan JP, Tobin JM, Ryan KB, Crean AM (2013) Comparison of Fenofibrate–Mesoporous Silica Drug–Loading Processes for Enhanced Drug Delivery. *European Journal of Pharmaceutical Sciences* 50/3–4:400–409. doi:10.1016/j.ejps.2013.08.026
- Alam MS, Kranti A, Armstrong GA (2009) An Efficient Neural Network Approach for Nanoscale FinFET Modelling and Circuit Simulation. *International Journal of Numerical Modelling: Electronic Networks, Devices and Fields* 22/5:379–393. doi:10.1002/jnm.715
- Alves CA, Smith EL, Porter MD (1992) Atomic Scale Imaging of Alkanethiolate Monolayers at Gold Surfaces with Atomic Force Microscopy. *Journal of the American Chemical Society* 114/4:1222–1227. doi:10.1021/ja00030a015
- Aslani P, Kennedy RA (1996) Studies on Diffusion in Alginate Gels. I. Effect of Cross–Linking with Calcium or Zinc Ions on Diffusion of Acetaminophen. *Journal of Control Release* 42/1:75–82. doi:10.1016/0168–3659(96)01369–7
- Averitt RD, Sarkar D, Halas NJ (1997) Plasmon Resonance Shifts of Au–Coated Au₂S Nanoshells: Insight into Multicomponent Nanoparticle Growth. *Physical Review Letters* 78/22:4217–4220.
- Averitt RD, Westcott SL, Halas NJ (1998) Ultrafast Electron Dynamics in Gold Nanoshells. *Physical Review B* 58/16:203–206. doi:10.1103/PhysRevB.58.R10203
- Averitt RD, Westcott SL, Halas NJ (1999) Ultrafast Optical Properties of Gold Nanoshells. *Journal of the Optical Society of America B* 16/10:1814–1823. doi:10.1364/JOSAB.16.001814
- Barreca D, Copley MP, Graham AE, Holmes JD, Morris MA, Seraglia R, Spalding TR, Tondello E (2006) Methanolysis of Styrene Oxide Catalysed by a Highly Efficient Zirconium–Doped Mesoporous Silica. *Applied Catalysis A: General*:30414–20. doi:10.1016/j.apcata.2006.02.034
- Bawendi MG, Wilson WL, Ruthberg L, Carroll PJ, Jedju TM, Steigerwald ML, Brus LE (1990) Electronic Structure and Photoexcited–Carrier Dynamics in Nanometer–Size CdSe. *Physical Review Letters* 65/13:1623–1626. doi: 10.1103/PhysRevLett.65.1623
- Berger C, Song Z, Li X, Wu X, Brown N, Naud C, Mayou D, Li T, Hass J, Marchenkov AN, Conrad EH, First PN, DeHeer WA (2006) Electronic Confinement and Coherence in Patterned Epitaxial Graphene. *Science* 312/5777:1191–1196
- Betzig E, Trautman JK, Wolfe R, Gyorgy EM, Finn PL, Kryder MH, Chang CH (1992) Near–Field Magneto–Optics and High Density Data Storage. *Applied Physics Letters* 61/2:142–144. doi:10.1063/1.108198
- Borowski J (1996) Numerical Calculations of the Bessel Functions for Complex Argument and Application to X–Ray Diffraction. *Computational Materials Science* 5/4:286–290. doi:10.1016/0927–0256(95)00080–1.
- Borrelli NF, Hall DW, Holland HD, Smith DW (1987) Quantum Confinement Effects of Semiconducting Microcrystallites in Glass. *Journal of Applied Physics* 61/12:5399–5409. doi:10.1063/1.338280
- Bouchemal K, Briancon S, Perrier E, Fessi H, Bonnet I, Zydowicz N (2004) Synthesis and Characterization of Polyurethane and Poly(ether urethane) Nanocapsules using a New Technique of Interfacial Polycondensation Combined to Spontaneous Emulsification. *International Journal of Pharmacy* 269/1:89–100. doi:10.1016/j.ijpharm.2003.09.025
- Brongersma ML (2003) Nanoscale Photonics. Nanoshells: Gifts in a Gold Wrapper. *Nature Materials* 2/5:296–297. doi:10.1038/nmat891
- Brus LE (1984) Luminescence of Silicon Materials: Chains, Sheets, Nanocrystals, Nanowires, Microcrystals, and Porous Silicon. *The Journal of Physical Chemistry* 98/14:3575–3581. doi:10.1021/j100065a007
- Brus LE (1984) Photovoltaic Properties of CdSe Quantum Dot Sensitized Inverse Opal TiO₂ Solar Cells: The Effect of TiCl₄ Post Treatment. *Journal of Chemical Physics* 80:4403–4409. doi:10.1063/1.447218
- Brus LE (1986) Electronic Wave Functions in Semiconductor Clusters: Experiment and Theory. *The Journal of Physical Chemistry* 90/12:2555–2560. doi:10.1021/j100403a003
- Brus LE, Szajowski PF, Wilson WL, Harris TD, Schuppler S, Citrin PH (1995) Electronic Spectroscopy and Photophysics of Si Nanocrystals: Relationship to Bulk c–Si and Porous Si. *Journal of the American Chemical Society* 117/10:2915–2922. doi:10.1021/ja00115a025

- Bunch S, Yaish Y, Brink M, Bolotin K, McEuen PL (2005) Coulomb Oscillations and Hall Effect in Quasi-2D Graphite Quantum Dots. *Nano Letters* 5/2:287–290. doi:10.1021/nl048111+
- Burger KNJ, Staffhorst RWHM, de Vijlder HC, Velinova MJ, Bomans PH, Frederik PM, de Kruijff B (2002) Nanocapsules: Lipid-Coated Aggregates of Cisplatin with High Cytotoxicity. *Nature Medicine* 8/1:81–84. doi:10.1038/nm0102–81
- Burke AM, Hanrahan JP, Healy DA, Sodeau JR, Holmes JD, Morris MA (2009) Large Pore Bi-Functionalised Mesoporous Silica for Metal Ion Pollution Treatment. *Journal of Hazardous Materials* 164/1:229–234. doi:10.1016/j.jhazmat.2008.07.146
- Calvo P, Remuñan-Lopez C, Vila-Jato JL, Alonso MJ (1997) Chitosan and Chitosan/Ethylene Oxide–Propylene Oxide Block Copolymer Nanoparticles as Novel Carriers for Proteins and Vaccines. *Pharmaceutical Research* 14:1431–1436. doi:10.1023/A:1012128907225
- Celotta RJ, Balakirsky SB, Fein AP, Hess FM, Rutter GM, Stroschio JA (2014) Invited Article: Autonomous Assembly of Atomically Perfect Nanostructures Using a Scanning Tunneling Microscope. *Review of Scientific Instruments* 85/12:121301 1–16. doi:10.1063/1.4902536
- Chen CW (1986) *Magnetism and Metallurgy of Soft Magnetic Materials*. Dover, New York
- Chenming H, Bokor J, Tsu-Jae K, Anderson E, Kuo C, Asano K, Takeuchi H, Kedzierski J, Lee WC, Hisamoto D (2000) FinFET–A Self-Aligned Double-Gate MOSFET Scalable to 20nm. *IEEE Transactions on Electron Devices* 47/12:2320–2325. doi:10.1109/16.887014
- Choudhuri T, Pal S, Das T, Sa G (2005) Curcumin Selectively Induces Apoptosis in Deregulated Cyclin D1-expressed Cells at G2 Phase of Cell Cycle in a p53-dependent Manner. *Journal of Biological Chemistry* 280/20:20059–20068. doi:10.1074/jbc.M410670200
- Coleman NRB, O’Sullivan N, Ryan KM, Crowley TA, Morris MA, Spalding TR, Steytler DC, Holmes JD (2001) Synthesis and Characterization of Dimensionally Ordered Semiconductor Nanowires within Mesoporous Silica. *Journal of the American Chemical Society* 123/29:7010–7016. doi:10.1021/ja015833j
- Creighton TE (1993) *Proteins: Structures and Molecular Properties*. 2nd edition. Freeman New York
- De Boer CB, Dekkers MJ (2001) Unusual Thermomagnetic Behaviour of Haematites: Neof ormation of a Highly Magnetic Spinel Phase on Heating in Air. *Geophysical Journal International* 144/2:481–494. doi:10.1046/j.0956–540X.2000.01333.x
- Delaney P, Healy RM, Hanrahan JP, Gibson LT, Wenger JC, Morris MA, Holmes JD (2010) Porous Silica Spheres as Indoor Air Pollutant Scavengers. *Journal of Environmental Monitoring* 12/12:2244. doi:10.1039/c0em00226g
- Delaney P, McManamon C, Hanrahan JP, Copley MP, Holmes JD, Morris MA (2011) Development of Chemically Engineered Porous Metal Oxides for Phosphate Removal. *Journal of Hazardous Materials* 185/1:382–391. doi:10.1016/j.jhazmat.2010.08.128
- Dessau RM, Schlenker JL, Higgins JB (1990) Framework Topology of $\text{AlPO}_4\text{-8}$: the First 14-Ring Molecular Sieve. *Zeolites* 10/6:522–524. doi: 10.1016/s0144–2449(05)80306–9
- Dresselhaus MS, Dresselhaus G (2002) Intercalation Compounds of Graphite. *Advances in Physics* 51/1:1–186. doi:10.1080/00018730110113644
- Drexler KE (1981) Molecular Engineering: an Approach to the Development of General Capabilities for Molecular Manipulation. *Proceedings of the National Academy of Science USA* 78:5275–5278. doi:10.2307/10813
- Drexler KE (1987) Molecular Machinery and Molecular Electronic Devices. In *Molecular Electronic Devices II*, FL Carter editor, pp. 549–571. Dekker New York
- Drexler KE (1988) Rod Logic and Thermal Noise in the Mechanical Nanocomputer. In *Molecular Electronic Devices*, FL Carter, R Siatkowski and H Wohltjen editors, pp. 39–56. North-Holland
- Drexler KE (1992) *Nanosystems: Molecular Machinery, Manufacturing, and Computation*. Wiley New York
- Duclairoir C, Orecchioni AM, Depraetere P, Nakache E (2002) α -Tocopherol Encapsulation and in Vitro Release from Wheat Gliadin Nanoparticles.
- Eigler OM, Schweizer EK (1990) Positioning Single Atoms with a Scanning Tunnelling Microscope. *Nature* 344:524–526. doi:10.1038/344524a0
- Ekimov AI, Efros AL, Onushchenko AA (1985) Quantum Size Effect in Semiconductor Microcrystals. *Solid State Communications* 56/11:921–924. doi:10.1016/s0038–1098(85)80025–9
- Ekimov AI, Hache F, Schanne-Klein MC, Ricard D, Flytzanis C (1993) Absorption and Intensity-Dependent Photoluminescence Measurements on CdSe Quantum Dots: Assignment of the First Electronic Transitions. *Journal of the Optical Society of America B* 10/1:100–107. doi:10.1364/JOSAB.10.000100

- Ekimov AI, Kudryavtsev IA, Efros AL, Yazeva TV, Hache F, Schanne–Klein MC, Ricard D, Rodina AV, Flytzanis C.(1993). Absorption and Intensity–Dependent Photoluminescence Measurements on CdSe Quantum Dots: Assignment of the First Electronic Transitions. *Journal of the Optical Society of America B* 10/1:100–107. doi:10.1364/josab.10.000100
- El-Samaligy MS, Rohdewald P (1983) Reconstituted Collagen Nanoparticles, a Novel Drug Carrier Delivery System. *Journal of Pharmacy and Pharmacology* 35/8:537–539. doi:10.1111/j.2042–7158.1983.tb04831.x
- El-Samaligy MS, Rohdewald P, Mahmoud HA (1986) Polyalkylcyanoacrylate Nanocapsules. *Journal of Pharmacy and Pharmacology* 38:216–218. doi:10.1111/j.2042–7158.1986.tb04547.x
- Elvassore N, Bertuccio A, Caliceti P (2001) Production of Insulin–Loaded Poly(ethylene glycol)/Poly(l–Lactide) (PEG/PLA) Nanoparticles by Gas Antisolvent Techniques. *Journal of Pharmaceutical Sciences* 90/10:1628–1636. doi:10.1002/jps.1113
- Estermann M, McCusker LB, Baerlocher C, Merrouche A, Kessler H (1991) A Synthetic Gallophosphate Molecular Sieve with a 20–Tetrahedral–Atom Pore Opening. *Nature* 352/6333:320–323. doi:10.1038/352320a0
- Faraday M (1857) The Bakerian Lecture: Experimental Relations of Gold (and Other Metals) to Light. *Philosophical Transactions of the Royal Society of London* 1/147:145–181. doi:10.1098/rstl.1857.0011
- Flynn E, Keane D, Tabari P, Morris M (2013) Pervaporation performance enhancement through the incorporation of mesoporous silica spheres into PVA membranes. *Separation and Purification Technology*. 11873–80. doi:10.1016/j.seppur.2013.06.034
- Fujihira M, Aoki D, Okabe Y, Takano H, Hokari H, Frommer J, Nagatani Y, Sakai F (1996) Effect of Capillary Force on Friction Force Microscopy: A Scanning Hydrophilicity Microscope. *Chemistry Letters* 25/7:499–500. doi:10.1246/cl.1996.499
- Fuyu Y, Parker JM (1988) Quantum Size Effects in Heat Treated, Cd(S, Se) Doped Glasses. *Materials Letters* 6/7:233–237. doi:10.1016/0167–577X(88)90028–6
- Gazeau F, Lévy M, Wilhelm C (2008) Optimizing Magnetic Nanoparticle Design for Nanothermotherapy. *Nanomedicine* 3/6:831–844. doi:10.2217/17435889.3.6.831
- Gomes KK, Mar W, Ko W, Guinea F, Manoharan HC (2012) Designer Dirac Fermions and Topological Phases in Molecular Graphene. *Nature* 483/7389:306–310. doi:10.1038/nature10941
- Guralnik DB ed. (1970) Webster’s New World Dictionary. World New York
- Hansma HG, Vesenka J, Siergerist C, Kelderman G, Morrett H (1992) Reproducible Imaging and Dissection of Plasmid DNA under Liquid with the Atomic Force Microscope. *Science* 256:1180–1184. doi:10.1126/science.256.5060.1180
- Harmia–Pulkkinen T, Tuomi A, Kristoffersson E (1989) Manufacture of Polyalkylcyanoacrylate Nanoparticles with Pilocarpine and Timolol by Micelle Polymerization: Factors Influencing Particle Formation. *Journal of Microencapsulation* 6/1:87–93. doi:10.3109/02652048909019905
- Heinrich AJ, Lutz CP, Gupta JA, Eigler DM (2002) Molecule Cascades. *Science* 298/5597:1381–1387. doi:10.1126/science.1076768
- Himpel FJ, Ortega JE, Mankey GK, Willis RF (1998) Magnetic Nanostructures. *Advanced Physics* 47/4:511–597. doi:10.1080/000187398243519
- Homayouni SM, Schreurs DMMP, Crupi G, Nauwelaers BKJC (2009) Technology–Independent Non–Quasi–Static Table–Based Nonlinear Model Generation. *IEEE Transactions on Microwave Theory and Techniques* 57/12:2845–2852. doi:10.1109/tmtt.2009.2033840
- Illum L, Farraj NF, Davis SS (1994) Chitosan as Novel Nasal Delivery System for Peptide Drugs. *Pharmaceutical Research* 11/8:1186–9. doi:10.1023/a:1018901302450.
- Immordino ML, Dosio F, Cattel L (2006) Stealth Liposome: Review of the Basic Science, Rationale, and Clinical Applications, Existing and Potential. *International Journal of Nanomedicine* 1/3: 297–315. doi:10.2217/17435889.1.3.297
- Innes RA, Sambles JR (1987) Optical Characterisation of Gold Using Surface Plasmon–Polariton. *Journal of Physics F Metal Physics* 17/1:277–287. doi:10.1088/0305–4608/17/1/031
- Johnson PB, Christy RW (1972) Optical Constant of the Noble Metals. *Physical Review B* 6/12:4370–4379. doi:10.1103/physrevb.6.4370
- Jones MC, Leroux JC (1999) Polymeric Micelles–A New Generation of Colloidal Drug Carriers. *European Journal of Pharmaceutics and Biopharmaceutics* 48:101–111. doi:10.1016/S0939–6411(99)00039–9
- Journal of Microencapsulation* 19/1:53–60. doi:10.1080/02652040110055207

- Kalff FE, Rebergen MP, Fahrenfort E, Girovsky J, Toskovic R, Lado JL, Fernández-Rossier J, Otte AF (2016) A Kilobyte Rewritable Atomic Memory. *Nature Nanotechnology* 7/11:926–929. doi:10.1038/nnano.2016.131
- Keller N, Guyot M, Das A, Porte M, Krishnan R (1998) Study of the Interdiffusion at the Interface NiO/ α -Fe₂O₃ Multilayers Prepared by Pulsed Laser Deposition. *Solid State Communications* 105/5:333–337. doi:10.1016/S0038–1098(97)10047–3
- Kim H, Palacio-Morales A, Posske T, Rózsa L, Palotás K, Szunyogh L, Thorwart M, Wiesendanger, R (2018) Toward Tailoring Majorana Bound States in Artificially Constructed Magnetic Atom Chains on Elemental Superconductors. *Science Advances* 4/5:eaar5251 1–7. doi:10.1126/sciadv.aar5251
- Kiraly B, Knol EJ, van Weerdenburg WMJ, Kappen HJ, Khajetoorians AA (2021) An Atomic Boltzmann Machine Capable of Self-Adaption. *Nature Nanotechnology* 16:414–420.
- Koškin NI, Širkevič MG (1989) *Spravočnik po elementarnoj fizike*. Nauka, Moscow
- Krause HJ, Schwarz A, Rohdewald P. (1986) Interfacial Polymerization, an Useful Method for the Preparation of Polymethylcyanoacrylat Nanoparticles. *Drug Development and Industria Pharmacy* 12/4:527–552. doi:10.3109/03639048609048026
- Kregse CT, Vartuli JC, Roth WJ, Leonowicz ME (2004) The Discovery of ExxonMobil’s M41S Family of Mesoporous Molecular Sieves. *Studies in Surface Science and Catalysis* 148:53–72. doi:10.1016/S0167–2991(04)80193–9
- Krull A, Hirsch P, Rother C, Schiffrin A, Krull C (2020) Artificial-Intelligence-Driven Scanning Probe Microscopy. *Communications Physics* 3/1:1–8. doi:10.1038/s42005–020–0317–3
- Kumar A, Madden DG, Lusi M, Chen K, Daniels EA, Curtin T, Perry JJ, Zaworotko MJ (2015) Direct Air Capture of CO₂ by Physisorbent Materials. *Angewandte Chemie International Edition* 54/48:14372–14377. doi:10.1002/anie.201506952
- LaMer VK, Dinegar RH (1950) Theory, Production and Mechanism of Formation of Monodispersed Hydrosols. *Journal of the American Chemical Society* 72/11:4847. doi:10.1021/ja01167a001
- Lederer D, Kilchytka V, Rudenko T, Collaert N, Flandre D, Dixit A, De Meyer K, Raskin JP (2005) FinFET Analogue Characterization from DC to 110GHz. *Solid-State Electronics* 49/9:1488–1496. doi:10.1016/j.sse.2005.07.011
- Leinen P, Esders M, Schütt KT, Wagner C, Mueller KR, Tautz FS (2020) Autonomous Robotic Nanofabrication with Reinforcement Learning. *Science Advances* 6/36:1–8 eabb6987. doi:10.1126/sciadv.aab6987
- Lindsey JS (1991) Self-Assembly in Synthetic Routes to Molecular Devices. *Biological Principles and Chemical Perspectives: a Review*. *New Journal of Chemistry* 15:153–180. doi:10.1002/chin.199138328
- Lippens PE, Lannoo M (1989) Calculation of the Band Gap for Small CdS and ZnS Crystallites. *Physical Review B* 39/15:10935–10942. doi:10.1103/physrevb.39.10935
- Löptien P, Zhou L, Wiebe J, Khajetoorians AA, Mi JL, Iversen BB, Hofmann P, Wiesendanger R (2014) Screening and Atomic-Scale Engineering of the Potential at a Topological Insulator Surface. *Physical Review B*, 89/8:085401 1–7. doi:10.1103/PhysRevB.89.085401
- Marcovich A, Shinn T (2011) Instrument Research, Tools, and the Knowledge Enterprise 1999–2009: Birth and Development of Dip-Pen Nanolithography. *Science, Technology & Human Values* 36/6:864–896. doi:10.1177/0162243910385406
- Marty JJ (1977) *The Preparation, Purification and Properties of Nanoparticles*. Degree Pharmacy Thesis. Victorian College of Pharmacy Parkville, Australia
- McBain SC, Yiu HH, Dobson J (2008) Magnetic Nanoparticles for Gene and Drug Delivery. *International Journal of Nanomedicine* 3/2:169–180. doi:10.0000/PMID18686777
- Merkle RC (1992) Self Replicating Systems and Molecular Manufacturing. *Journal of the British Interplanetary Society* 45:407–413
- Merkle RC (1993) Two Types of Mechanical Reversible Logic. *Nanotechnology* 4:114–131. doi:10.1088/0957–4484/4/2/007
- Mermin ND (1968) Crystalline Order in Two Dimensions. *Physical Review* 176:250–254. doi:10.1103/PhysRev.176.250
- Mingos DPM (2014) Historical Introduction to Gold Colloids, Clusters and Nanoparticles. In: *Gold Clusters, Colloids and Nanoparticles I*. Springer Cham
- Moon CR, Lutz CP, Manoharan HC (2008) Single-Atom Gating of Quantum-State Superpositions. *Nature Physics* 4/6:454–458. doi:10.1038/nphys930

- Muller J, Huaux F, Lison D (2006) Respiratory Toxicity of Carbon Nanotubes: how Worried should We be? *Carbon* 44/6:1048–1056. doi:10.1016/j.carbon.2005.10.019
- Mullis K, Faloona F, Scharf S, Saiki R, Horn O, Erlich H (1986) Specific Amplification of DNA in Vitro: the Polymerase Chain Reaction. *Cold Spring Harbor Symposia on Quantitative Biology* 51(P1):263–273. doi:10.1101/sqb.1986.051.01.032
- Murray CB, Norris DJ, Bawendi MG (1993) Synthesis and Characterization of Nearly Monodisperse CdE (E = S, Se Te) Semiconductor Nanocrystallites. *Journal of the American Chemical Society* 115/19:8706–8715. doi:10.1021/ja00072a025
- Musacchio T, Laquintana V, Latrofa A, Trapani G, Torchilin VP (2009) PEG–PE Micelles Loaded with Paclitaxel and Surface–Modified by a PBR–Ligand: Synergistic Anticancer Effect. *Molecular Pharmaceutics* 6/2:468–479. doi:10.1021/mp800158c
- Nandiyanto ABD, Kim SG, Iskandar F, Okuyama K (2009) Synthesis of Spherical Mesoporous Silica Nanoparticles with Nanometer–Size Controllable Pores and Outer Diameters. *Microporous and Mesoporous Materials* 120/3:447–453. doi:10.1016/j.micromeso.2008.12.019
- Novoselov KS, Geim AK, Morozov SV, Jiang D, Katsnelson MI, Grigorieva IV, Dubonos SV, Firsov AA (2005b) Two–Dimensional Gas of Massless Dirac Fermions in Graphene. *Nature* 428/7065:197–200. doi:10.1038/nature04233
- Novoselov KS, Jiang D, Schedin F, Booth TJ, Khotkevich VV, Morozov SV, Geim AK (2005a) Two–Dimensional Atomic Crystals. *Proceedings of the National Academy of Sciences* 102/30:10451–10453. doi:10.1073/pnas.0502848102
- Novoselov KS, McCann E, Morozov SV, Fal'ko VI, Katsnelson MI, Zeitler U, Jiang D, Schedin F, Geim AK (2006) Unconventional Quantum Hall Effect and Berry's Phase of 2π in Bilayer Graphene. *Nature Physics* 2:177–180. doi:10.1038/nphys245
- Ocheke NA, Olorunfemi PO, Ngwuluka NC (2009a) Nanotechnology and Drug Delivery Part 1: Background and Applications. *Tropical Journal of Pharmaceutical Research* 8/3:265–274.
- Ocheke NA, Olorunfemi PO, Ngwuluka NC (2009b) Nanotechnology and Drug Delivery Part 2: Nanostructures for Drug Delivery. *Tropical Journal of Pharmaceutical Research* 8/3:275–287.
- Odom TW, Huang JLP, Kim P, Lieber CM (1998) Atomic Structure and Electronic Properties of Single–Walled Carbon Nanotubes. *Nature* 391/6662:62–64. doi:10.1038/34145
- Oerlemans C, Bult W, Bos M, Storm G, Nijsen JF, Hennink WE (2010) Polymeric Micelles in Anticancer Therapy: Targeting, Imaging and Triggered Release. *Pharmaceutical Research* 27/12:2569–2589. doi:10.1007/s11095-010-0233-4
- Ohashi Y, Koizumi T, Yoshikawa T, Hironaka T, K Shiiki K (1997) Size Effect in the In–plane Electrical Resistivity of Very Thin Graphite Crystals. *TANSO* 180:235–238. doi:10.7209/tanso.1997.235
- Oosawa F, Asakura S (1975) *Thermodynamics of the Polymerization of Protein*. London: Academic
- Overbeek JTG (1982) Monodisperse Colloidal Systems, Fascinating and Useful. *Advances in Colloid and Interface Science* 15/3–5:251. doi:10.1016/0001–8686(82)80003–1
- Partoens B, Peeters FM (2006) From Graphene to Graphite: Electronic Structure around the K Point. *Physical Review B* 74/7:075404–1–11. doi:10.1103/PhysRevB.74.075404
- Patil GV (2003) Biopolymer Albumin for Diagnosis and in Drug Delivery. *Drug Development Research* 58/3:219–47. doi:10.1002/ddr.10157
- Piner RD, Mirkin CA (1997) Effect of Water on Lateral Force Microscopy in Air. *Langmuir* 13/26:6864–6868. doi:10.1021/la970921w
- Pradeep T (2005) *Nano, The Essentials*. McGraw–Hill, New York
- Prodan E, Nordlander P, Halas NJ (2003) Electronic Structure and Optical Properties of Gold Nanoshells. *Nano Letters* 3/10:1411–1415. doi:10.1021/nl034594q
- Puri A, Loomis K, Smith B, Lee JH, Yavlovich A, Heldman E, Blumenthal R (2009) Lipid–Based Nanoparticles as Pharmaceutical Drug Carriers: from Concepts to Clinic. *Critical Reviews in Therapeutic Drug Carrier Systems* 26/6:523–580. doi:10.0000/PMID20402623
- Puri A, Loomis K, Smith B, Lee JH, Yavlovich A, Heldman E, Blumenthal R (2009) Lipid–Based Nanoparticles as Pharmaceutical Drug Carriers: From Concepts to Clinic. *Critical Reviews in Therapeutic Drug Carrier Systems* 26/6:523–580. doi:10.1615/critrevtherdrugcarriersyst.v26.i6.10
- Quintanar–Guerrero D, Allémann E, Fessi H, Doelker E (1998) Preparation Techniques and Mechanism of Formation of Biodegradable Nanoparticles from Preformed Polymers. *Drug Development and Industrial Pharmacy* 24/12:1113–1128. doi:10.3109/03639049809108571

- Reis CP, Neufeld RJ, Ribeiro AJ, Viega F (2005) Insulin–Alginate Nanospheres: Influence of Calcium on Polymer Matrix Properties. *Proceedings of the 13th International Workshop on Bioencapsulation*. Queen's University Kingston, Canada
- Roca AG, Costo R, Rebolledo AF, Veintemillas–Verdaguer S, Tartaj P, González–Carreño T, Morales MP, Serna CJ (2009) Progress in the Preparation of Magnetic Nanoparticles for Applications in Biomedicine. *Journal of Physics D: Applied Physics* 42/22:224002–224012. doi:10.1088/0022–3727/42/22/224002
- Sato T, Ruch R (1980) *Stabilization of Colloidal Dispersions by Polymer Absorption*. Marcel Dekker, New York
- Schoonheydt RA, Pinnavaia T, Lagaly G, Gangas N (1999) Pillared Clays and Pillared Layered Solids. *Pure and Applied Chemistry* 71/12:2367–2371. doi:10.1351/pac199971122367
- Schreurs DMMP, Verspecht J, Vandenbergh S, Vandamme E (2002) Straightforward and Accurate Nonlinear Device Model Parameter–Estimation Method Based on Vectorial Large–Signal Measurements. *IEEE Transactions on Microwave Theory and Techniques* 50/10:2315–2319. doi:10.1109/tmtt.2002.803427
- Sershen SR, Westcott SL, West JL, Halas NJ (2001) An Opto–Mechanical Nanoshell–Polymer Composite. *Applied Physics B* 73:379–381. doi:10.1007/s003400100689
- Shortie D (1992) Mutational Studies of Protein Structures and Their Stabilities. *Quarterly Review of Biophysics* 25:205–250. doi:10.1017/s0033583500004674
- Singh J, Pandit S, Bramwell VW, Alpar OH (2006) Diphtheria toxoid loaded–(ϵ –caprolactone) nanoparticles as mucosal vaccine delivery systems. *Methods* 38/2:96–105. doi:10.1016/j.ymeth.2005.11.003
- Singh SV, Hu X, Srivastava SK, Xia H, Orchard JL (1998) Mechanism of Inhibition of Benzo(a)pyrene–induced Forestomach Cancer in Mice by Dietary Curcumin. *Carcinogenesis* 19/8:1357–1360. doi:10.1093/carcin/19.8.1357
- Sivanandini M, Dhani SS, Pabla BS, Gupta M (2014) Effect of 3–mercaptopropyltrimethoxysilane on Surface Finish and Material Removal Rate in Chemical Mechanical Polishing. *Procedia materials Science* 6:528–537. doi:10.1016/j.mspro.2014.07.067
- Slonczewski JC, Weiss PR (1958) Band Structure of Graphite. *Physical Review, Series I* 109/2:272–279. doi:10.1103/physrev.109.272
- Smit J, Wijn HPJ (1965) *Ferrites*. Philips Technical Library, Eindhoven
- Son S, Taheri M, Carpenter E, Harris VG, McHenry ME (2002) Synthesis of Ferrite and Nickel Ferrite Nanoparticles using Radio–Frequency Thermal Plasma Torch. *Journal of Applied Physics* 91/10:7589–7591. doi:10.1063/1.1452705
- Song SC, Abu–Rahma M, Han BM, Yoon SS, Wang J, Yang W, Hu C, Yeap G (2008) Physical and Electrical Design of FinFET–Based SRAM Bitcell for 22nm Node and Below. In: *Proceedings of 2008 Solid State Device and Material Conference*, pp. 256–257. doi:10.7567/SSDM.2008.B–3–2
- Soppimath KS, Aminabhavi TM, Kulkarni AR, Rudzinski WE (2001) Biodegradable Polymeric Nanoparticles as Drug Delivery Devices. *Journal of Controlled Release* 70/1–2:1–20. doi:10.1016/s0168–3659(00)00339–4
- Speliotis D (2003) *Getting the Most from Your Vibrating Sample Magnetometer*. ADE Technologies, Newton
- Sun Y, Xia Y (2002) Increased Sensitivity of Surface Plasmon Resonance of Gold Nanoshells Compared to That of Gold Solid Colloids in Response to Environmental Changes. *Analytical Chemistry* 74/20:5297–5305. doi:10.1021/ac0258352
- Sutton RS, Barto AG (2018) *Reinforcement Learning: An Introduction*, 2nd ed. The MIT Press, Boston.
- Tans SJ, Devoret MH, Dai H, Thess A, Smalley RE, Geerligs LJ, Dekker C (1997) Individual Single–Wall Carbon Nanotubes as Quantum Wires. *Nature* 386:474–477. doi:10.1038/386474a0
- Thiesen B, Jordan A (2008) Clinical Applications of Magnetic Nanoparticles for Hyperthermia. *International Journal of Hyperthermia* 24/6:467–474. doi:10.1080/02656730802104757
- Tice TR, Gilley RM (1985) Preparation of Injectable Controlled–Release Microcapsules by Solvent–Evaporation Process. *Journal of Controlled Release* 2:343–52. doi:10.1016/0168–3659(85)90056–2
- Torchilin VP, Lukyanov AN, Gao Z, Papahadjopoulos–Sternberg B (2003) Immunomicelles: Targeted Pharmaceutical Carriers for Poorly Soluble Drugs. *Proceedings of the National Academy of Sciences* 100/10:6039–6044. doi:10.1073/pnas.0931428100

- Urry OW (1993) Molecular Machines: How Motion and Other Functions of Living Organisms can Result from Reversible Chemical Changes. *Angewandte Chemie International Edition* 32:819–41. doi:10.1002/anie.199308191
- Vandamme EP, Schreurs D, van Dinther C, Badenes G, Deferm L (2002) Development of a RF Large Signal MOSFET Model, Based on an Equivalent Circuit, and Comparison with the BSIM3v3 Compact Model. *Solid-State Electronics* 46/3:353–360. doi:10.1016/s0038-1101(01)00108-3
- Vauthier C, Couvreur P (2000) Development of Polysaccharide Nanoparticles as Novel Drug Carrier Systems. In: Wise DL, Editor. *Handbook of pharmaceutical controlled release technology*. Marcel Dekker, New York
- Vincent IFV. 1982. *Structural Biomaterials*. Wiley New York
- Vladimirov VS (1981) *Uravnenija Matematičeskoj Fiziki*. Nauka, Moscow
- Wallace PR (1947) The Band Theory of Graphite. *Physical Review, Series I* 71/9:622–634. doi:10.1103/physrev.71.622
- Wang N, Wu XS (1997) Preparation and Characterization of Agarose Hydrogel Nanoparticles for Protein and Peptide Drug Delivery. *Pharmaceutical Development and Technology* 2/2:135–142. doi:10.3109/10837459709022618.
- Wang Y, Dave RN, Pfeiffer R (2004) Polymer Coating/Encapsulation of Nanoparticles using a Supercritical Anti-Solvent Process. *The Journal of Supercritical Fluids* 28/1:85–99. doi:10.1016/s0896-8446(03)00011-1
- Weisenhorn AL, Hansma PK, Albrecht TR, Quate CF (1989) Forces in Atomic Force Microscopy in Air and Water. *Applied Physics Letters* 54:2651–2653. doi:10.1063/1.101024
- Wilbur JL, Kumar A, Biebuyck HA, Enoch K, Whitesides GM (1996) Microcontact Printing of Self-Assembled Monolayers: Applications in Microfabrication. *Nanotechnology* 7:452–457. doi:10.1088/0957-4484/7/4/028
- Wildöer KWG, Venema LC, Rinzler AG, Smalley RE, Dekker C (1998) Electronic Structure of Atomically Resolved Carbon Nanotubes. *Nature* 391:59–62. doi:10.1038/34139
- Wilson WL, Szajowski PF, Brus LE (1993) Quantum Confinement in Size-Selected, Surface-Oxidized Silicon Nanocrystals. *Science* 262/5137:1242–1244. doi:10.1126/science.262.5137.1242
- Wolf EL (2014) *Application of Graphene*. Springer International, Berlin
- Xiao G, Liou SH, Levy A, Taylor JN, Chien CI (1986) Magnetic Relaxation in Fe-(SiO₂) Granular Films. *Physical Review B* 34/11:7573–7577. doi:10.1103/PhysRevB.34.7573
- Xu ZP, Zeng QH, Lu GQ, Yu AB (2006) Inorganic Nanoparticles as Carriers for Efficient Cellular Delivery. *Chemical Engineering Science* 61/3:1027–1040. doi:10.1016/j.ces.2005.06.019
- Yousefi A, Esmaceli F, Rshimian S, Atyabi F, Dinarvand R (2009) Preparation and In Vitro Evaluation of A Pegylated Nano-Liposomal Formulation Containing Docetaxel. *Scientia Pharmaceutica* 77:453–464. doi:10.3797/scipharm.0806-08
- Yuba E, Harada A, Sakanishi Y, Kono K (2011) Carboxylated Hyperbranched Poly(glycidol)s for Preparation of pH-Sensitive Liposomes. *Journal of Control Release* 149/1:72–80. doi:10.1016/j.jconrel.2010.03.001
- Zhang Y, Tan YW, Stormer HL, Kim P (2005) Experimental Observation of Quantum Hall Effect and Berry's Phase in Graphene. *Nature* 438:201–204. doi:10.1038/nature04235
- Zhang Z, Yates JT Jr (2012) Band Bending in Semiconductors: Chemical and Physical Consequences at Surfaces and Interfaces. *Chemical Reviews* 112/10:5520–5551. doi:10.1021/cr3000626

Selected Additional References on the Subjects Suggested for Further Reading

- Alber T (1989) Mutational Effects on Protein Stability. *Annual Review of Biochemistry* 58:765–98
- Allémann E, Gurny R, Doekler E (1993) Drug-Loaded Nanoparticles Preparation Methods and Drug Targeting Issues. *European Journal of Pharmacy and Biopharmacy* 39/5:173–191
- Altmann E, Altmann KH, Nebel K, Mutter M (1988) Conformational Studies on Host-Guest Peptides containing Chiral α -Methyl- α -Amino Acids. *International Journal of Peptide and Protein Research* 32:344-51

- Anelli PL, Ashton PR, Philp D, Pietraszkiewicz M, Reddington MV, Spencer N, Stoddart JF, Vicent C, Ballardini R, Balzani V, Gandolfi MT, Prodi L, Delgado M, Goodnow TT, Kaifer AE, Slawin AMZ, Williams DJ (1992) Molecular Meccano. I. [2]Rotaxanes and a [2]Catenane Made to Order. *Journal of the American Chemical Society* 114:193–218
- Attard GS, Glyde JC, Goltner CG (1995) Liquid–Crystalline Phases as Templates for the Synthesis of Mesoporous Silica. *Nature* 378/6555:366–368
- Attard GS, Leclerc SAA, Maniquet S, Russell AE, Nandakumer I, Gollas BR, Bartlett PN (2001) Ordered Mesoporous Silicas Prepared from Both Micellar Solutions and Liquid Crystal Phases. *Microporous and Mesoporous Materials* 44–45:73–80. doi:10.1016/s1387–1811(01)00170–6
- Bapat N, Boroujerdi M (1992) Uptake Capacity and Adsorption Isotherms of Doxorubicin on Polymeric Nanoparticles: Effect of Methods of Preparation. *Drug Development and Industrial Pharmacy* 18/1:65–77
- Baumann G, Frommel C, Sander C (1989) Polarity as a Criterion in Protein Design. *Protein Engineering* 2:329–34
- Beck JS, Vartuli JC, Kennedy GD, Kresge CT, Roth WJ, Schramm SE (1994) Molecular or Supramolecular Templating: Defining the Role of Surfactant Chemistry in the Formation of Microporous and Mesoporous Molecular Sieves. *Chemistry of Materials* 6/10:1816–1821
- Beck JS, Vartuli JC, Kennedy GD, Kresge CT, Roth WJ, Schramm SE (1995) Molecular or Supramolecular Templating: Defining the Role of Surfactant Chemistry in the Formation of Microporous and Mesoporous Molecular Sieves. In *Catalysis by Microporous Materials, Studies in Surface Science and Catalysis*, Vol. 98, Beyer HK, Karge HG, Kiricsi I, Nagy JB editors, Elsevier Science, 15–16
- Beck JS, Vartuli JC, Kennedy GJ, Kresge CT, Roth WJ, Schramm SE (1994) Molecular or Supramolecular Templating: Defining the Role of Surfactant Chemistry in the Formation of Microporous and Mesoporous Molecular Sieves. *Chemistry of Materials* 6/10:1816–1821
- Benoit JP, Couvreur P, Devissaguet J–P, Fessi H, Puisieux F, Roblot–Treupel L (1986) Les Formes Vectorisées ou Distribution Modulées, Nouveaux Systèmes d'Administration Médicamenteux. *Journal de Pharmacie de Belgique* 41:319–329
- Binggeli M, Mate CM (1994) Influence of Capillary Condensation of Water on Nanotribology Studied by Force Microscopy. *Applied Physics Letters* 65/4:415–417
- Byrne JD, Betancourt T, Brannon–Peppas L (2008) Active Targeting Schemes for Nanoparticle Systems in Cancer Therapeutics. *Advanced Drug Delivery Reviews* 60/15:1615–1626
- Chan YS, Heller EJ (1997) Scanning Tunnel Microscopy Surface State Electron Scattering: Two–Tip Results from One–Tip Data. *Physical Review Letters* 78:2570–2572
- Chen J, Seeman N (1991) Synthesis from DNA of a Molecule with the Connectivity of a Cube. *Nature* 350:631–633
- Chung HH, Benson DR, Schultz PG (1993) Probing the Structure and Mechanism of Ras Protein with an Expanded Genetic Code. *Science* 259:806–9
- Couvreur P (1988) Polyalkylcyanoacrylates as Colloidal Drug Carriers. *Critical Reviews in Therapeutic Drug Carrier Systems* 5/1:1–20
- Couvreur P, Dubernet C, Puisieux F (1995) Controlled Drug Delivery with Nanoparticles: Current Possibilities and Future Trends. *European Journal of Pharmaceutics and Biopharmaceutics* 41/1:2–13
- Cram DJ (1986) Preorganization from Solvents to Spherands. *Angewandte Chemie International Edition* 25:1039–1134
- Crommie MF, Lutz CP, Eigler DM (1993) Confinement of Electrons to Quantum Corrals on a Metal Surface. *Science* 262:218–220
- Crommie MF, Lutz CP, Eigler DM (1993) Imaging Standing Waves in a Two–Dimensional Electron Gas. *Nature* 363:524–527
- Davies DR, Padlan EA, Sheriff S (1990) Antibody–Antigen Complexes. *Annual Review of Biochemistry* 59:439–73
- DeGrado WF (1988) Design of Peptides and Proteins. *Advances in Protein Chemistry* 39:51–124
- DeGrado WF, Regan L, Ho SP (1987) The Design of a Four–Helix Bundle Protein. *Cold Spring Harbor Symposia on Quantum Biology* 52:521–26
- DeGrado WF, Wasserman ZR, Lear JD (1989) Protein Design, a Minimalist Approach. *Science* 243:622–28
- Desmet J, De Maeyer M, Hazes B, Lasters I (1992) The Dead–End Elimination Theorem and Its Use in Protein Side–Chain Positioning. *Nature* 356:539–42

- Dill KA (1990) Dominant Forces in Protein Folding. *Biochemistry* 29:7133–55
- Dinegar RH, Smellie RH, LaMer VK (1951) Additions and Corrections—Kinetics of the Acid Decomposition of Sodium Thiosulfate in Dilute Solutions. *Journal of the American Chemical Society* 73/12
- Dinegar RH, Smellie RH, LaMer VK (1951) Kinetics of the Acid Decomposition of Sodium Thiosulfate in Dilute Solutions. *Journal of the American Chemical Society* 73/5
- Dinegar RH, Smellie RH, LaMer VK (1951) The Limiting Degrees of Supersaturation of the Sparingly Soluble Sulfates. *Journal of the American Chemical Society* 73/1: . doi:10.1021/ja01145a127
- Drexler KE (1987) Nanomachinery: Atomically Precise Gears and Bearings. *Proceedings of IEEE Micro Robot. Teleoperators Workshop*. Hyannis
- Drexler KE (1991) Molecular Tip Arrays for Molecular Imaging and Nanofabrication. *Journal of Vacuum Science & Technology B* 9/1:394–397
- Drexler KR, Foster JS (1990) Synthetic Tips. *Nature* 343:600
- Drost R, Ojanen T, Harju A, Liljeroth P (2017) Topological States in Engineered Atomic Lattices. *Nature Physics* 13:668–671
- Eigen M, McCaskill J, Schuster P (1988) Molecular Quasi–Species. *Journal of Physical Chemistry*. 92:6881–6891
- Eigler DM, Schweizer EK (1990) Positioning Single Atoms with a Scanning Tunneling Microscope. *Nature* 344:524–526
- El–Samaligy MS, Rohdewald P (1982) Triamcinolone Diacetate Nanoparticles a Sustained Release Drug Delivery System Suitable for Parental Administration. *Pharmaceutica Acta Helveticae* 57/7:201–204
- ElBayoumi TA, Torchilin VP (2009) Tumor–Targeted Nanomedicines: Enhanced Antitumor Efficacy in Vivo of Doxorubicin–Loaded, Long–Circulating Liposomes modified with Cancer–Specific Monoclonal Antibody. *Clinical Cancer Research* 15/6:1973–1980
- Everson MP, Jaklevic RC, Shen W (1990) Measurement of the Local Density of States on a Metal Surface: Scanning Tunneling Spectroscopic Imaging of Au(111). *Journal of Vacuum Science & Technology A* 8:3662–3665
- Fano U (1961) Effects of Configuration Interaction on Intensities and Phase Shifts. *Physical Review* 124:1866–1878
- Fields GB, Noble RL (1990) Solid Phase Peptide Synthesis utilizing 9–Fluorenylmethoxycarbonyl Amino Acids. *International Journal of Peptide and Protein Research* 35:161–214
- Firouzi A, Kumar D, Bull LM, Besier T, Siegar P, Huo Q, Walker SA, Zasadzinski J, Glinka AG, Nicol J, Marogloese D, Stucky GD, Chmelka BF (1995) Cooperative Organization of Inorganic Surfactant and Biomimetic Assemblies. *Science* 267/5201:1138–1143
- Frankel AD, Brecht DS, Pabo CO (1988) Tat Protein from Human Immunodeficiency Virus Forms a Metal–Linked Dimer. *Science* 240:70–73
- Gardenier TS, van den Broeke JJ, Moes JR, Swart I, Delerue C, Slot MR, Smith CM, Vanmaekelbergh D (2020) p Orbital Flat Band and Dirac Cone in the Electronic Honeycomb Lattice. *ACS Nano* 2020 10/14:13638–13644
- Garg A, Tisdale AW, Haidari E, Kokkoli E (2009) Targeting Colon Cancer Cells using PEGylated Liposomes modified with a Fibronectin–Mimetic Peptide. *International Journal of Pharmaceutics* 366/1–2:201–210
- Ghadiri MR, Fernholz AR (1990) Peptide Architecture. Design of Stable Helical Metallopeptides Via a Novel Exchange–Inert RuIII Complex. *Journal of the American Chemical Society* 112:9633–9635
- Grangier JL, Puygrenier M, Gauthier JC, Couvreur P (1991) Nanoparticles as Carriers for Growth Hormone Releasing Factors (GRF). *Journal of Control Release* 15:3–13
- Hanahan D, Weinberg RA (2000) The Hallmarks of Cancer. *Cell*100/1:57–70
- Handel TM, Williams SA, DeGrado WF (1993) Metal Ion–Dependent Modulation of the Dynamics of a Designed Protein. *Science* 261:879–85
- Hansma PK, Elings VB, Marti O, Bracker CE (1988) Scanning Tunneling Microscopy and Atomic Force Microscopy: Application to Biology and Technology. *Science* 242:209–216
- Hasegawa Y, Avouris P (1993) Direct Observation of Standing Wave Formation at Surface Steps using Scanning Tunneling Spectroscopy. *Physical Review Letters* 71:1071–1074
- Heinrich AJ, Lutz CP, Gupta JA, Eigler DM (2002) Molecule Cascades. *Science* 11/298:1381–1387

- Hellinga HW, Richards FM (1991) Construction of New Ligand Binding Sites in Proteins of Known Structure. II. Grafting of a Buried Transition Metal Binding Site into Escherichia Coli Thioredoxin. *Journal of Molecular Biology*. 222:787–803
- Heremans JJ, von Molnár S, Awschalom DD, Gossard AC (1999) Ballistic Electron Focusing by Elliptic Reflecting Barriers. *Applied Physics Letters* 74:1281–1283
- Hewson AC (1997) *The Kondo Problem to Heavy Fermions*. Cambridge University Press, Cambridge
- Hoh IH, Lal R, John SA, Revel JP, Arnsdorf MF (1991) Atomic Force Microscopy and Dissection of Gap Junctions. *Science* 253:1405–1408
- Holm L, Sander C (1992) Fast and Simple Monte Carlo Algorithm for Side Chain Optimization in Proteins: Application to Model Building by Homology. *Proteins: Structure, Functions and Genetics* 14:213–223
- Kaszynski P, Friedli AC, Michl J (1992) Toward a Molecular-Size “Tinkertoy” Construction Set. Preparation of Terminally Functionalized [n]-Staffanes from [1.1.1]Propellane. *Journal of the American Chemical Society* 114:601–620
- Kellis JT Jr, Nyberg K, Sali O, Fersht AR (1988) Contribution of Hydrophobic Interactions to Protein Stability. *Nature* 333:784–786
- Kempkes SN, Slot MR, Freeney SE, Zevenhuizen SJM, Vanmaekelbergh D, Swart I, Smith CM (2019) Design and Characterization of Electrons in a Fractal Geometry. *Nature Physics* 11/15:127–131
- Kent SBH (1988) Chemical Synthesis of Peptides and Proteins. *Annual Review of Biochemistry* 57:957–989
- Khajetoorians AA, Wegner D, Otte AF, Swart I (2019) Creating Designer Quantum States of Matter Atom-by-Atom. *Nature Reviews Physics* 1/9:703–715
- Kittel C (1963) *Quantum Theory of Solids*. Wiley, New York
- Kittel C (1968) Indirect Exchange Interactions in Metals. *Solid State Physics* 22:1–26
- Klibanov AM (1989) Enzymatic Catalysis in Anhydrous Organic Solvents. *Trends in Biochemical Sciences* 14:141–144
- Kondo J (1964) Resistance Minimum in Dilute Magnetic Alloys. *Progress of Theoretical Physics* 32:37–49
- Krafft MP, Giulieri F, Riess JG (1993) Can Single-Chain Perfluoroalkylated Amphiphiles Alone form Vesicles and other Organized Supramolecular Systems? *Angewandte Chemie International Edition* 32:741–743
- Kresge CT, Vartuli JC, Roth WJ, Leonowicz ME, Beck JS, KD Schmitt KD, Chu CT-W, Olson DH, Sheppard EW, McCullen SB, Higgins JB, Schlenker JL (1994) M41S: A New Family of Mesoporous Molecular Sieves Prepared with Liquid Crystal Templates. In *Science and Technology in Catalysis*, Izumi Y, Arai H, Iwamoto M editors, Elsevier Science, 11
- Kubiak C, Manil L, Couvreur P (1988) Sorptive Properties of Antibodies onto Cyanoacrylic Nanoparticles. *International Journal of Pharmaceutics* 41:181–187
- Kuhn HW (2005) The Hungarian Method for the Assignment Problem. *Naval Research Logistic* 52/1:83–97
- Landis ME, Aufdembrink BA, Chu P, Johnson ID, Kirker GW, Rubin MK, (1991) Preparation of Molecular Sieves from Dense Layered Metal Oxides. *Journal of the American Chemical Society* 113/8:3189–3192
- Lang ND (1986) Spectroscopy of Single Atoms in the Scanning Tunneling Microscope. *Physical Review B* 34:5947–5950
- LaValle SM (1998) Rapidly-Exploring Random Trees: a New Tool for Path Planning. *Mathematics The Annual Research Report* 1–4.
- Lee C, Subbiah S (1991) Prediction of Protein Side-Chain Conformation by Packing Optimization. *Journal of Molecular Biology* 217:373–388
- Leonowicz ME, Lawton JA, Lawton SL, Rubin MK (1994) MCM-22: A Molecular Sieve with Two Independent Multidimensional Channel Systems. *Science* 264/5167:1910–1915
- Li J, Schneider WD, Berndt R, Delley B (1998) Kondo Scattering Observed at a Single Magnetic Impurity. *Physical Review Letters* 80:2893–2896
- Li VHK, Wood RW, Kreuter J, Harmia T, Robinson JR (1986) Ocular Drug Delivery of Progesterone using Nanoparticles. *Journal of Microencapsulation* 3/3:213–218
- Lyo IW, Avouris P (1991) Field-Induced Nanometer-to Atomic-Scale Manipulation of Silicon Surfaces with the STM. *Science* 253:173–176
- Madhavan V, Chen W, Jamneala T, Crommie MF, Wingreen NS (1998) Tunnelling into a Single Magnetic Atom: Spectroscopic Evidence of the Kondo Resonance. *Science* 280:567–569

- Marqusee S, Baldwin RL (1987) Helix Stabilization by Glu...Lys+ Salt Bridges in Short Peptides of De Novo Design. *Proceedings of the National Academy of Science USA* 84:8898–8902
- Matthews BW, Nicholson H, Becktel WJ (1987) Enhanced Protein Thermostability from Site-Directed Mutations that Decrease the Entropy of Unfolding. *Proceedings of the National Academy of Science USA* 84:6663–6667
- McClellan S, Prosser E, Meehan E, O'Malley D, Clarke N, Ramtoola Z, Brayden D (1998) Binding and Uptake of Biodegradable Poly-lactide Micro and Nanoparticles in Intestinal Epithelia. *European Journal of Pharmaceutical Science* 6:153–163
- Mendel D, Ellman J A, Chang Z, Veenstra DL, Kollman PA, Schultz PG (1992) Probing Protein Stability with Unnatural Amino Acids. *Science* 256:1798–1802
- Merkle RC (1991) Computational Nanotechnology. *Nanotechnology* 2:134–141
- Merkle RC (1993) A Proof About Molecular Bearings. *Nanotechnology* 4:86–90
- Michel C, Roques M, Couvreur P, Vranckx H, Baldschmidt P. Isobutyrylcianoacrylate Nanoparticles as Drug Carrier for Oral Administration of Insulin. *Proceedings of the International Symposium Control of Released Bioactive Materials* 18:97–98
- Mirkin CA, Ratner MA (1992) Molecular Electronics. *Annual Review of Physical Chemistry* 43:719–754
- Mislow K (1989) Molecular Machinery in Organic Chemistry. *Chemtracts: Organic Chemistry* 2:151–174
- Musgrave CB, Perry JK, Merkle RC, Goddard WA III (1991) Theoretical Studies of a Hydrogen Abstraction Tool for Nanotechnology. *Nanotechnology* 2:187–195
- Mutter M, Vuilleumier S (1989) A chemical Approach to Protein Design—Template—Assembled Synthetic Proteins (TASP). *Angewandte Chemie International Edition* 28:535–676
- Némati F, Dubernet C, Fessi H, Verdière AC, Poupon MF, Puisieux F (1996) Reversion of Multidrug Resistance using Nanoparticles in Vitro: Influence of the Nature of the Polymer. *International Journal of Pharmaceutics* 138/2:237–246
- Nielsen PE, Egholm M, Berg RH, Buchardt O (1991) Sequence-Selective Recognition of DNA by Strand Displacement with a Thymine-Substituted Polyamide. *Science* 254:1497–1500
- Noren CJ, Anthony-Cahill SJ, Griffith MC, Schultz PO (1989) A General Method for Site-Specific Incorporation of Unnatural Amino Acids into Proteins. *Science* 244:182–188
- Nyffenegger RM, Penner RM (1997) Nanometer-Scale Surface Modification Using the Scanning Probe Microscope: Progress since 1991 *Chemical Reviews* 97/4:1195–1230
- Pabo CP, Suchanek EG (1986) Computer-Aided Model-Building Strategies for Protein Design. *Biochemistry* 25:5987–5991
- Pellegrini M, Doniach S (1993) Computer Simulation of Antibody Binding Specificity. *Proteins Structure, Function and Genetics* 15:436–444
- Pessi A, Bianchi E, Crameri A, Venturini S, Tramontano A, Sollazzo M (1993) A Designed Metal-Binding Protein with a Novel Fold. *Nature* 362:367–369
- Pickett SD, Sternberg MJE (1993) Empirical Scale of Side-Chain Conformational Entropy in Protein Folding. *Journal of Molecular Biology*. 23 1:825–839
- Poland DC, Scheraga HA (1965) Statistical Mechanics of Noncovalent Bonds in Polyamino Acids. VIII. Covalent Loops in Proteins. *Biopolymers* 3:379–399
- Privalov PL, Gill SI (1988) Stability of Protein Structure and Hydrophobic Interaction. *Advanced Protein Chemistry* 39:191–234
- Rain JD, Switzer C, Chamberlin AR, Benner SA (1992) Ribosome-Mediated Incorporation of a Non-Standard Amino Acid into a Peptide through Expansion of the Genetic Code. *Nature* 356:537–39
- Richards PM (1977) Areas, Volumes, Packing, and Protein Structure. *Annual Review of Biophysics and Bioengineering* 6:151–176
- Rizo I, Gierasch LM (1992) Constrained Peptides: Models of Bioactive Peptides and Protein Structures. *Annual Review of Biochemistry* 61:387–418
- Rose GO, Wolfenden R (1993) Hydrogen Bonding, Hydrophobicity, Packing, and Protein Folding. *Annual Review of Biophysics and Biomolecular Structure* 22:381–415
- Roth WJ, Vartuli JC (2002) The Effect of Stoichiometry and Synthesis Conditions on the Properties of Mesoporous M41S Family Silicates. *Studies in Surface Science and Catalysis* 141:273
- Ruan F, Chen Y, Hopkins PB (1990) Metal Ion Enhanced Helicity in Synthetic Peptides Containing Unnatural, Metal-Ligating Residues. *Journal of the American Chemical Society* 112:9403–9404
- Saad M, Garbuzenko OB, Minko T (2008) Co-Delivery of siRNA and an Anticancer Drug for Treatment of Multidrug-Resistant Cancer. *Nanomedicine* 3/6:761–776

- Schrauber H, Eisenhaber F, Argos P (1993) Rotamers: To Be or Not To Be? An Analysis of Amino Acid Side-Chain Conformations in Globular Proteins. *Journal of Molecular Biology* 230:592–612
- Seijo B, Fattal E, Roblot-Treupel L, Couvreur P (1990) Design of Nanoparticles of Less than 50nm Diameter: Preparation, Characterization and Drug Loading. *International Journal of Pharmaceutics* 62/1:1–7
- Smith IL, Hendrickson W A, Honzatko RB, Sheriff S (1986) Structural Heterogeneity in Protein Crystals. *Biochemistry* 25:5018–5827
- Smith JV, Dydrich WJ (1984) Nets With Channels of Unlimited Diameter. *Nature*. 309/5969:607–08
- Sondag-Huethorst JAM, van Helleputte HRJ, Fokkink LGJ (1994) Generation of Electrochemically Deposited Metal Patterns by Means of Electron Beam (Nano)lithography of Self-Assembled Monolayer Resists. *Applied Physics Letters* 64/3:285–287
- Spector J, Stormer HL, Baldwin KW, Pfeiffer LN, West KW (1990) Electron Focusing in Two Dimensional Systems by Means of an Electrostatic Lens. *Applied Physics Letters* 56:1290–1292
- Stipe BC, Rezaei MA, Ho W (1998) Single-Molecule Vibrational Spectroscopy and Microscopy. *Science* 280:1732–1735
- Strijkers GJ, Kluz E, Van Tilborg GA, van der Schaft DWJ, Griffioen AW, Mulder WJM, Nicolay K (2010) Paramagnetic and Fluorescent Liposomes for Target-Specific Imaging and Therapy of Tumor Angiogenesis. *Angiogenesis* 13/2:161–173
- Strosio JA, Eigler DM (1991) Atomic and Molecular Manipulation with the Scanning Tunneling Microscope. *Science* 254:1319–1326
- Stucky GD, Monnier A, Schueth F, Huo Q, Firouzi DI, Janicke M, Chmelka BF (1994) Molecular and Atomic Arrays in Nano- and Mesoporous Materials Synthesis. *Molecular Crystals and Liquid Crystals* 240/1:187–196
- Tapley BD, Poston TR (1990) Eschbach's Handbook of Engineering Fundamentals. Wiley New York
- Tomalia DA, Naylor AM, Goddard WA III (1990) Starburst Dendrimers: Molecular-Level Control of Size, Shape, Surface Chemistry, Topology, and Flexibility from Atoms to Macroscopic Matter. *Angewandte Chemie International Edition* 29:138–175
- Tomsovic S, Heller EJ (1993) Semiclassical Construction of Chaotic Eigenstates. *Physical Review Letters* 70:1405–1408
- Vartuli JC, Kresge CT, Leonowicz ME, Chu AS, McCullen SB, Johnson ID, Sheppard EW (1994) Synthesis of Mesoporous Materials: Liquid Crystal Templating versus Intercalation of Layered Silicates. *Chemistry of Materials*, 6/11:2070–2077
- Vartuli JC, Schmitt KD, Kresge CT, Roth WJ, Leonowicz ME, McCullen SB, Hellring SD, Beck JS, Schlenker JL, Olsen DH, Sheppard EW (1994) Effects of Surfactant/Silica Molar Ratios on the Formation of Mesoporous Molecular Sieves: Inorganic Mimicry of Surfactant Liquid-Crystal Phases and Mechanistic Implications. *Chemistry of Materials* 6/12:2317–2326
- Volkin DB, Staubli A, Langer R, KJibanov AM (1991) Enzyme Thermo-inactivation in Anhydrous Organic Solvents. *Biotechnology and Bioengineering* 37:843–853
- Whitesides GM, Mathias IP, Seto CT (1991) Molecular Self-Assembly and Nanochemistry: a Chemical Strategy for the Synthesis of Nanostructures. *Science* 254:1312–1319
- Wilson C, Mace JE, Agard DA (1991) Computational Method for the Design of Enzymes with Altered Substrate Specificity. *Journal of Molecular Biology* 220:495–506
- Xia Y, Whitesides GM (1998) Soft Lithography. *Angewandte Chemie International Edition* 37/5:550–575
- Yang A-S, Sharp KA, Honig B (1992) Analysis of the Heat Capacity Dependence of Protein Folding. *Journal of Molecular Bioengineering* 227:889–900
- Yun-yu S, Mark AE, Cun-xi W, Fuhua H, Berendsen HIC, van Gunsteren WF (1993) Can the Stability of Protein Mutants be Predicted by Free Energy Calculations? *Protein Engineering* 6:289–295
- Zamboni WC (2008) Concept and Clinical Evaluation of Carrier-Mediated Anticancer Agents. *The Oncologist* 13/3:248–260. doi:10.1634/theoncologist.2007-0180

Chapter VI

From 1992 to 2022: A History of the Nanotechnologies at IEMN

An outline. This chapter is dedicated to the 30 years of History of IEMN – Institut d'Électronique de Microélectronique et de Nanotechnologie, or Institute of Electronics, Microelectronics and Nanotechnology – and the most outstanding outcomes from its foundation to 2022, when the thirtieth year of its history was celebrated. With this chapter, a homage to the institute and people who gave me the opportunity to develop this historical research, I conclude the central and historical part of my thesis.



The big banner celebrating 30 years of activity at IEMN. Source: Courtesy Anne Duchene

Prologue VI

The IEMN, Institut d'Électronique de Microélectronique et de Nanotechnologie, or Institute of Electronics, Microelectronics and Nanotechnology, was founded in 1992 as an advanced research centre of the University of Lille, the CNRS and the Ecole Centrale de Lille. Research is mainly developed in the field of Physics, along six main research strands, Physics of Materials and Nanostructures, Microtechnology – Microsystems, Micro and Optoelectronics, Circuits and Communication Systems, Acoustics and Instrumentation. In 2022, therefore, the IEMN celebrated its first 30 years of existence. On this occasion, the most significant articles from the vast scientific production that has characterised the work of this centre have been collected. In this chapter, I give the reader access to these articles, through a brief excerpt of their content, and then compare what has been published in the History of Nanotechnology, with the work of the IEMN, in terms of the topics covered. This chapter is intended as a tribute to the IEMN structure both because it gave me the opportunity to elaborate this thesis, also participating in the events organised periodically, and to commemorate the structure's 30th anniversary.

For the sake of ease of reading, I have divided the articles into three periods of a decade each, concluding each paragraph with a table in which I have listed both the IEMN articles and those that I considered important within the History of Nanotechnology.

Special Acknowledgements

The Institute for Electronics, Microelectronics and Nanotechnology (IEMN) was set up in 1992 with the support of three regional partners: the University of Lille; the University of Valenciennes and Hainaut Cambrésis; ISEN–Lille and the CNRS (National Centre for Scientific Research); its research is funded by the government, and administrative control is delegated to the French Ministry of Research. Since 1992, the IEMN has been publishing and contributing to the scientific literature and History of Nanoscience and Nanotechnology. To date, thousands of articles have been published, covering the most diverse areas of research. The acronym itself, which refers to Electronics, Microelectronics and Nanotechnology, declares the Institute's explicit vocation. Searching through so many articles, therefore, would have made it impossible to accurately pinpoint the most important moments in the history of the IEMN, due to the quantity of documents and lack of time.

A great help came from Dir. Christophe Delerue, who nowadays is Research Director at IEMN, who kindly suggested me a choice of works that describe the evolution of the research year by year, from 1992 to 2022. Some of them are real premieres in the history of science and prove the absolute quality of the labs.

A second great help came from my supervisor, Prof. Raffaele Pisano, who assisted me organizing a comparison among the most important results achieved at IEMN and the most important ones in History of Nanotechnology. Prof. Pisano is also the founder of the History of Physics and Applied Sciences & Technology – HOPAST – at IEMN, and together with him I contributed to a huge historical banner that was prepared and exhibited for the 30th anniversary celebrations. The pictures of this banner, kindly taken from Prof. Pisano, are included in this chapter. Also, a poster we discussed and prepared together was exhibited and is today available to visitors in the corridors of the IEMN.

To them both I am deeply grateful.

Eventually, it is also right to mention two figures without whose contribution it would not have been possible to illustrate the history of the Institute.

My heartfelt thanks therefore go to Anne Duchene, of the IEMN, Service Editions, Communication et Multimédias, who prepared the large banner that was displayed at the celebrations, and for the exchanges of ideas that enabled us to supplement and enrich this work. Thanks to her active collaboration, my supervisor and I prepared and displayed poster material for several events, not least the one for the celebration of the 30th anniversary of the IEMN.

Again, special thanks go to Julie Robarts, University of Melbourne, for her meticulous proofreading of the posters that were put on display at the occasion.

6.1 Introduction: Birth of the IEMN Laboratory

The roots of the IEMN go all the way back to the late 1960s, in social and political conditions that were not easy. Yet it was precisely from that terrain of unrest and tensions that the Faculty of Science of the University of Lille developed, finding its home on the campus it still occupies today. The organisation of personnel, teaching, student management and research was certainly not structured as we know it today, and they have grown and improved over the years, opening up to new realities such as, for example, collaboration with the world of industry and business. The history of this research centre was documented in a 2016 publication from the *Association de Solidarité des Anciens* (abridged ASA), in which the testimonies of those who experienced first-hand the birth of what would become, two decades later, the Institute of Electronics, Microelectronics and Nanotechnology are collected.

At the time, the recruitment of teachers was, for example, completely different from what one would expect nowadays, through exams, interviews, qualifications and evaluation of publications. New teachers were contacted in person, as reported in Jean Gadrey's testimony.

Michel Parreau came to my parents' house to recruit me. There was no official recruitment procedure, no examination whatsoever. No commitment to research was required (ASA 2016).

Interpersonal relations were also profoundly different from those we are used to experiencing on a daily basis nowadays, when communication, not only scientific but also informal, is dynamic and frequent. The individual departments lived and operated as separate scientific cells; opportunities to meet and exchange ideas, to circulate information and knowledge were limited if not entirely absent. This way of operating should not, however, be the object of criticism or censure, more simply it represented, according to the accounts of the witnesses of the time, the normal way of proceeding in past decades. It would have changed and benefited significantly as the years went by, the structures and the number of researchers in the various fields expanded, with the increasing exchange of information and interdepartmental cooperation.

Beyond the considerations that can be made about the development of communication that would come over time, some testimonies are particularly significant because they give an idea of the state of the art of the instrumentation available to researchers, and become important from the point of view of historical memory.

How do I do my thesis? I need a computer to do my calculations. We have nothing in Lille. I use an old piece of equipment salvaged from Grenoble. It is installed on the ground floor of the Philippe Lebon square. It is a tube apparatus, placed in an air-conditioned room. When it's too hot, we open the windows; if that's not enough, we pour liquid nitrogen under the apparatus. Fortunately, I met someone (Guy Steenbeckeliers) who had access to a huge computer at the Catholic University of Louvain. My calculations were therefore done in Leuven. I began my collaborations with Louvain, then with a few laboratories in the USA, then Orsay. I then discovered the huge resources that existed elsewhere (Jean Bellet, *ibidem*).

The memory of laboratory activity also takes on significant value (Fig. 6.1): the respect, gratitude and, one might say, a veneration for the professors in charge of the laboratories are almost tangible, complements of an activity that was carried out with sometimes limited means, but which precisely because of this gave value to the inventiveness and capacity for

intuition and adaptation of the researchers who, on the other hand, could sometimes be exposed to unrecognised risks to their own health.

Within this operational framework, the foundations were laid for Lille's scientific research centre, and the physics department in particular, which began to take shape in 1962. It was the stubbornness of Raymond Wertheimer, the director of the department, who ensured that human and material resources were pooled, thus creating an efficient and dynamic structure.

Wertheimer almost forced this organisation through with the opposition of the others. This is a great merit that we must give him credit for. By bringing together small and scattered means, he created a structure with sufficient critical mass (Jean Bellet *ibidem*).



La mémoire de la faculté des sciences et de l'université de Lille 1

1960 – 1975

Aperçu des entretiens réalisés par le Groupe Mémoire Orale de l'ASA

Ce texte veut donner un aperçu de la quarantaine d'entretiens que le Groupe Mémoire Orale (GMO) de l'ASA a réalisés avec des anciens de l'université. Ces entretiens portaient principalement sur le passage de l'ancienne faculté des sciences à la nouvelle université de Lille 1.

Il est impossible de faire une synthèse du contenu des entretiens. On peut quand même essayer de dégager quelques lignes de force. L'ancien monde est dépeint en détail. L'enseignement reçu sur les bancs de la faculté est principalement de type magistral. Le manque d'encadrement est manifeste, comme l'absence d'aide aux étudiants en difficulté. Dans plusieurs secteurs, la recherche est balbutiante. Là où elle existe, elle est menée dans des conditions difficiles, avec peu de moyens. Néanmoins, des pionniers ouvrent des voies d'avenir. Certains professeurs laissent les thésards se débrouiller seuls. Pour les recrutements d'assistants, il n'y a pas de procédure officielle. Au niveau de la faculté, il n'y a pas non plus de structure institutionnelle véritable. Les non-professeurs ne sont pas impliqués dans le fonctionnement du système. De nombreuses interviews éclairent les relations de type mandarinaal existant à cette époque.

Mais l'augmentation importante des effectifs entraîne la mise en place d'une gestion collective et une évolution des relations humaines. A Lille, on n'attend pas la loi d'orientation de novembre 1968 pour créer de nouvelles structures, par exemple les départements, officialisés en 1967, mais en gestation dès le début des années 1960. Quand arrive mai 1968, la faculté des sciences, déplacée depuis peu sur le campus, ne tarde pas à élaborer ses statuts. Dans ces périodes troublées, notre université est le lieu de vives tensions. Selon que l'on était, à l'époque, professeur ou assistant ou AITOS, on peut avoir aujourd'hui, sur la genèse de la nouvelle université, des opinions bien différentes.

Jusqu'au début des années 1970, la recherche est encore considérée, dans certains secteurs, comme une activité nécessaire, sans plus. Ensuite, les idées évoluent, plus ou moins vite selon les disciplines. La recherche se structure, en lien avec le CNRS. Plusieurs interviewés présentent avec passion la genèse et le développement de leur laboratoire. Ils fournissent un éclairage intéressant sur leur contribution personnelle, sur leurs collaborateurs, sur les difficultés des relations humaines, sur l'importance des relations avec des personnalités de premier plan pour l'avancement d'un dossier, etc. Aujourd'hui, le développement des collaborations avec les entreprises va de soi, il n'en était pas de même vers 1970. Les

Fig. 6.1 The first page of the 2016 publication recollecting the history of the scientific pole at Lille University that lead to the foundation of IEMN in 1992. Source: courtesy Prof. Delerue 2023

Again:

“Physics” has been established as a department since 1962, and the initiator of this structuring is Wertheimer. As for EEA (Electronics, Electrotechnics and Automation), the grouping into departments came several years later, while the geographical separation of the different components was still in place. The electronic engineers made up the Radiotechnical Institute and were housed in the buildings of the Institute of Physics, rue Gauthier-de-Châtillon. The electrotechnicians constituted the Electromechanical Institute, located in the Arts et Métiers buildings on bd Louis XIV. The automatic component was emerging in Lille: it owed its creation to Roger Dehors, the head of the Electromechanical Institute, and was therefore also located in the Boulevard Louis XIV. It was in this context that, in the spring of 1966, the grouping of the three components was decided and the SEE department was created at a memorable meeting in the Boulevard Louis XIV. Among the participants were Panet, Maizières and Dehors for electrical engineering, Liébaert, Lebrun, Gabillard, Constant, Razy and Lefebvre for electronics, Vidal and another for automation. Deeply imbued with the model of the electronics institution created at Orsay by his thesis advisor, Pierre Grivet, he most probably saw in the opportunity of this Lille creation the possibility of a similar development. The definitive replacement of the word “radioelectricity” with the word “electronics” in Lille’s vocabulary is also, most probably, a sign of this impregnation. In any case, Gabillard’s plans did not go as hoped: during the first election of the director of the AEA’s brand new department, Lebrun was elected! In fact, Lebrun left Gabillard’s post by resigning immediately... (Arsène Risbourg *ibidem*).

As Georges Salmer explained, the electronics specialists found themselves divided in 1966 between those who wanted to get closer to physicists and their world, and those who preferred to form a working group with electrotechnicians and automation experts, the latter of whom were in fact little known to the others due to the distance separating the departments. However, Wertheimer did not always take the work of electrical engineers into account, as he was inclined to work in the world of physics; a rift therefore developed between physicists and electronics that did not benefit the exchange of ideas and results.

According to physicist Bruno Macke, the adversarial relationship between physicists and EEA members was accentuated by the events of 1968 and the EEA’s refusal to accept a merger of all subjects, partly due to an attitude on the part of the physicists that Macke described as “aggressive”.

An important step towards the establishment of scientific clusters was taken in the second half of the 1960s. The “Instituts Universitaires de Technologie”, IUT, were in fact established by decree on 7 January 1966 and the first department of the IUT in Lille, Electrical Engineering, saw the light of day in the same year. This was not created from scratch, but by the school’s technicians, as Yves Leroy, director of the department from 69 to 76, recalled.

From 63 to 66, I was a lecturer at the Radiotechnical Institute (one of the two components of the Institute of Physics), in the school for technicians directed by Robert Liébaert. This was the period when the project to create IUTs was being developed nationwide. Liébaert was brilliant, he realised there was something to be done, he saw the interest in turning the school for technicians into a department of the IUT. He got in touch with Francis Dubus, who was in charge of the IUT project at national level. This was how the Lille GE – Génie Électrique – department was created, the second GE department in France, after Cachan (Yves Leroy *ibidem*).

The establishment of research centres also necessarily changed the way the staff related to each other. Jean-Claude Doukhan, a physicist, recognised this in people’s attitudes.

The increase in personnel implies an adaptation to find new ways of relating to people. At the Institute of Physics, the days are over when the director, Jean Roig, managed everything alone. It was R. Wertheimer, the new director, who instituted this collective management and introduced new

relationships. When Wertheimer met an assistant or a technician, he would greet him, shake his hand and ask how he was doing. Today this seems trivial. At the time it was not. Warmer and more polite human relationships were established. So the world began to change a little before the move to the campus. Then came May '68, which amplified this evolution enormously and led to new behaviour (Jean-Claude Doukhan *ibidem*).

As is well known, 1968 saw the emergence of international movements of ethical contestation to widespread values. The university environment in Lille was also affected by the events. Bruno Macke, a member of the first university council described them as follows.

During the events of May–June 1968, the rector's advisors were replaced by an office. It seems to me that the university statute was drawn up before the first council took office. I remember the attitude of some mandarins: one in tears during the first council meeting (10 June 1968), others like Bouriquet and, above all, Tridot (director of the School of Chemistry) fiercely resisting. Wertheimer was more open and accepted the changes, but not without first putting on the brakes. For example, he had to relinquish responsibility for the physics department's study committee because, after 1968, one could only exercise power if one was elected.

In 1969, the separation of Lille 1, Lille 2 and Lille 3 occurred.

Immediately after 1968, the university campus witnessed other events characterised by high social tension. In March 1971, in fact, the police invaded the campus and intervened with tear gas in a climate, between the different forces and university currents, even more tense than the one that had been established only three years earlier. The reason, fundamentally, was political and electoral and concerned the election as mayor of Lille between two candidates, Ortolini and Mauroy. The protests of the University Council were taken to the prefecture, but the situation did not turn out to be an easy one.

The University of Lille emerged from this complicated situation bringing with it a different communication between the staff and the management team and a certain autonomy; when compared to other provincial universities, however, it did not obtain many research credits, perhaps due to a lack of decisive and non-meritocratic management. It was the creation of new structures that acted as a stimulus for shared participation in university life at different levels.

1974 marked a turning point for the laboratories with the establishment of LASIR (Laboratoire de Spectrochimie Infrarouge et Raman), a collaborative laboratory between Thiais, specialising in infrared, and Lille, specialising in Raman spectrometry. Lille had designed a spectrometer capable of competing with other instruments on the market: it was the first French Raman spectrometer, which gave international prominence to the research activity conducted at the university campus.

The merger-creation of the IEMN, which officially took place on 1 January 1992 between three CNRS laboratories attached to the University of Lille 1, the University of Valenciennes and the Catho de Lille, is not only the result of a more or less artificially imposed rapprochement but is above all the concretisation of very old pre-existing affinities. The main protagonists of the merger were Eugène Constant for the Centre hyperfréquences et semi-conducteurs (CHS), Christian Bruneel for the Laboratoire d'optoacousto-électronique (LOAE) and Michel Lannoo for ISEN. Eugène Constant was the group's leader and the linchpin of all the negotiations with the various state and local institutional bodies. The notoriety acquired with the CHS in the decades preceding 1990 greatly supported him. In this leading role, he highlighted the development that the CHS

was able to achieve thanks to the cohesion of the so-called “four musketeers” group formed with his companions of the first hour: Yves Leroy, Ladislav Raczky and Georges Salmer.

The creation of the IEMN was the result of a not at all smooth path, whose roots go back decades, involving different institutions. Eugène Constant described it with the wealth of experience accumulated since 1992, he made some reflections on what could have motivated his institutional interlocutors favourably or unfavourably. One very important element emerged repeatedly in his thinking: in order to succeed in creating a large laboratory and guarantee its operational durability, it was necessary not only to achieve an appropriate number of major discoveries, but also to know how to promote them, making them known to the scientific community, going as far as possible in terms of significant practical spin-offs. Implicitly, the success of large research training programmes requires both great scientists and great communicators. In reality, these two types of profile rarely co-exist in the same person, so it was crucial that effective Lille 1 *relays* were placed over time at different institutional decision-making levels. Besides the IEMN, other major research groups at our university are instructive examples. Jean Bellet participated in the creation of the IEMN as scientific advisor to the president of the Conseil régional du Nord – Pas de-Calais, Noël Joseph. In particular, Jean Bellet sought to realise the commitment of the Minister of Research and Technology, Hubert Curien, by setting up two major regional projects. In his words:

Now I have to finalise the two major projects. I have a first idea, it is Eugène Constant. I am going to see the director of the CNRS, the biologist François Kourilsky. He had a completely different idea, he wanted a large biology institute in the north. I meet Dominique Stéhelin, a brilliant man; he tells me he is not interested and I realise he will never realise the project. He has not yet recovered from his disappointment at not being awarded the Nobel Prize. After Stéhelin, I go to see Eugène Constant. I explain to him what is at stake and the dimensions of the project. Constant is a person who knows how to listen. He answers me “why not?”. I ask him “Can you do it?” and he replies “Yes”. He has the right reflex to involve all the regional partners and in a short time we have a project. He knows how to involve his whole team in the adventure. Creating an institute like the IEMN is not like building a TGV line. This is what I explain to the region’s elected representatives. You need not only the will and the funds, but above all a leader and a team. In electronics we have them, in biology the team does not exist. So I end up with these two projects. I have no problems with Constant, but with Stéhelin it is a different matter. I went to see the director of the Pasteur Institute in Lille, who told me: “I don’t know how to reason with him, there’s no way”. Then I met François Kourilsky again with Christian Bataille, Vice-President of the Regional Council. Kourilsky told us that he wanted the Institute of Biology, but that he didn’t have enough money to finance the two projects. We told him we would find the money. At that point, the region doubled the research credits in order to have a substantial financial mass. The doubling of the research credits was voted unanimously by the plenary. Right and left were in agreement on this research policy. Nevertheless, the battle is not won. Kourilsky does not want to talk too much about microelectronics, but for our part we think it is safer with Constant than with biology at present. Under Eugène Constant’s impetus, things are progressing well and I have a meeting with the director of the SPI science department at CNRS. He is not from Paris and that is good for us. In fact, there is a competition for the creation of a microelectronics institute. More than once I have been told privately that “creating such an institute in the northern desert is a waste of money”. The director of the SPI, who knows Eugène Constant and supports the project, does not think so. I was told that I had to meet the Secretary General of the CNRS because he could block the funds. I went with Christian Bataille and the director of the SPI department. The meeting was epic, the secretary general looked down on us. I would later find out that the money that CNRS was going to allocate to IEMN had already been earmarked for another project in Orsay and the Secretary General had no intention of postponing the Orsay operation. He argued that it was money lost if it was allocated to the IEMN project. So Christian Bataille, who gave me a nod and told me what he thought of the man, asked me if he could intervene. I told him yes. Bataille then called the Secretary General a “colonialist” and other such epithets, as he was wont to do. The Secretary General, who had never been abused like that in his entire career, closed the meeting. In

addition to this unpleasant episode, there is another opposition to our project, coming from Grenoble and Orsay.

The genesis and development of scientific and technical production brings with it the historical development of scientific and technical, laboratories and institutions.

This is why it is important, as part of a work on the history of Nanotechnology, to examine what work was prepared by a prestigious laboratory such as the IEMN, at which this thesis was compiled.

6.2 IEMN: A History of Success in Science and Nanotechnology

The IEMN was formed in 1992 and set itself three main goals.

- Research, covering multidisciplinary activities from nanoscience and nanotechnologies to instrumentation through telecommunications and acoustics;
- Education, mainly through Masters and Ph.D. programs;
- Innovation and transfer to industry, in particular regional SMEs.

To achieve the goal of multidisciplinary research, scientific policy is based on a balance between the acquisition of knowledge and the development of applications. More precisely, around one third of the Institute's activity is related to fundamental research or long-term applications. This long-term research forms the basis for the scientific and technological renewal of concepts and skills. The remaining two-thirds of the activities correspond to medium-term research carried out in close cooperation with national and international companies, or short-term research. This type of activity aims at the realisation of prototypes with cutting-edge performance and their transfer to regional SMEs. The borders between these different fields are, of course, not always well defined within the IEMN, but this turns into an advantage, as researchers have the opportunity to constantly interact with specialists working on more theoretical or more applied topics. Innovation can thus be pushed forward thanks to new ideas and concepts, or driven by the need for new products.

Thanks to these premises, since 1992 then, the history of IEMN has become more and more important and prestigious day by day, and has been enriched through top-level achievements, national and international awards to its members, and collaborations with French and global research institutions. Among the objectives of excellence set and achieved in these first thirty years of its history, the IEMN has brought together, in a single research structure, the disciplines that contribute to the advancement of electronics, acoustics and their applications, facilitating and expanding interdisciplinary research across a broad spectrum of activities ranging from theoretical physics to telecommunications. Medium-term joint programmes with industrial partners or other national institutions and long-term research initiatives stimulate cooperation between research institutions and attract funding for research projects; the constant inflow of funds, to be mentioned is the one coming from the Nord-Pas de Calais Regional Council together with that of the trustees, allows the IEMN to have exceptional, state-of-the-art laboratory facilities. As a member of the Basic Technological Research Network with four other CNRS laboratories dealing with micro and nano fabrication, the IEMN offers the scientific community one of the best technical platforms in Europe. The success of the IEMN is above all the result of the

commitment of all the scientific, technical and administrative staff, who are constantly involved in all the Institute's projects, through a positive attitude of cohesion and general interest.

Some of the goals that scientific research has set for itself, at the University of Lille, were realised for the first time in the world in the IEMN's laboratories. Over its 30-year history, the IEMN has published thousands of articles testifying to its prolific research activity. These articles cover the most diverse topics, from electronics to telecommunications, from Nanotechnology used in the most diverse fields to devices for automatic vehicle guidance, from microelectronics to engineering.

The most important publications are presented in this chapter; their selection was made by Prof. Christophe Delerue, to whom I am grateful for this. In parallel, I also present the most important steps taken in the field of nanoscience and Nanotechnology. The information on the history of the IEMN is taken directly from the banner displayed at the 30th anniversary celebration events on the Institute's premises in January 2023.

Tab. 6.1: the comparison between the milestones in the History of IEMN in parallel with the corresponding most important moments in History of Nanoscience and Nanotechnology.

Year	History of IEMN	History of Nanotechnology
1992	In 1992 the UMR (Unité Mixte de Recherche) was created, under the direction of Eugène Constant, from the Centre Hyperfréquences et Semi-conducteurs (CHS), with Michel Lannoo, Institut Supérieur de l'Électronique et du numérique (ISEN), Georges Salmer and Christian Bruneel, this one from the Laboratoire d'Optoacousto-électronique (LOAE). Also the building of the department of the IEMN was in progress.	The first microprocessor realized with more than a million transistors was manufactured.
1993	The buildings of the IEMN department were opened to research activity, devices for nanolithography were acquired to work materials at nano dimensions. Later, the IEMN Transfer was launched and epitaxy was developed for III-V.	The first carbon nanotubes whose diameter was about 1nm large by Iijima and Ichihashi. The First edition of the International Technology Roadmap for Semiconductors was held.
1994	The IEMN TRANSFERT program was launched to develop local partnerships with Small and Medium Industries (SMIs) and Enterprises (SMEs), answering to their questions and offering personnel and resources. The III-V gas source Molecular Beam Epitaxy building was commissioned.	Molecular machines were developed.
1995	An ultra-vacuum tunnel-effect microscope was installed for research.	Brus and Ekimov showed, for the first time, the synthesis of nanocrystals whose optical properties depended on their size.
1996		The first technologies based on gold nanoparticle colloids was developed.
1997	The IEMN received a fundamental international credit as Mihail C. Roco, founding chair of the US National	The chess world champion Garry Kasparov was

	Science and Technology Council subcommittee on Nanoscale Science, Engineering and Technology (NSET), appointed the IEMN as one of the most influential French pioneering research centres on Nanotechnology.	beaten by a computer at a chess game.
1998	The IEMN was under the direction of Georges Salmer and Didier Stiévenard, new clean-rooms were built and opened. New startup on silicon microsystems was launched. Didier Théron was awarded the Bronze Medal of CNRS for research.	Dekker and Avouris obtained the first field-effect transistor from a carbon nanotube. SGS-Thomson becomes the STMicroelectronics.
1999	The new Central-Extension was opened to research activities.	Dip-pen nanolithography was developed and introduced.
2000	In 2000 many pivotal events occurred. The expansion of IEMN was supported by contribution of the Region and Federation. The first Thesis Forum was held at the Institute and a common laboratory is set between IEMN and RIBER S.A, the world's leading supplier of Molecular Beam Epitaxy (MBE) products and related services for the compound semiconductor research and industrial field, to apply this technique at industrial level on III-V compounds. As for the administration, Didier Stévanard was appointed new joint director, as Michel Lannoo moved out.	Don Eigler observed the quantum mirages through tunnel-effect microscopy. McEcen obtained the first transistor based on an only molecule of Buckminster fullerene C ₆₀ .
2001	Jean-Philippe Nys was awarded the Crystal Medal of CNRS for his contribution to knowledge and excellence of French research. The Acoustique Impulsionnelle & Magnéto-Acoustique Nonlinéaire (AIMAN) group was joint to IEMN.	The United States launched the National Nanotechnology Initiative (NNI)
2002	The direction of the IEMN was now under Alain Cappy and Didier Stiévenard. A common enterprise was launched between IEMN and THALES Research Technology, establishing a common laboratory. Studies on gallium nitride were carried on to develop hyper-frequency power devices. Lionel Bouchailot was awarded the CNRS bronze medal. The IEMN was honoured by the visit of Geneviève Berger, General Director of IEMN. A new extension of the site in Valenciennes was opened; the IEMN officially was named Institute of Electronics, Microelectronics and Nanotechnology	The first 3G mobile technology was launched.
2003	The IEMN became a national platform within the national technology network for the basic technology research programme. Claudie Haignere, Minister for Research, visited the facilities in 2003. A joint IEMN-STMicroelectronics laboratory was lauched. Bernard Larrouturou, Director General of CNRS, visited the labs.	The first 64-bits microchip holding 100 million transistors, based on Silicon, was realised.
2004	The TELICE group, Télécommunications, Interférences et Compatibilité Electromagnétique, whose activity is	Geim and Novoselov obtained graphene for the

	<p>focused on reliable in-vehicle communication, vehicular connectivity and localization, was integrated with IEMN. A new start-up dedicated to civilian and military applications of hyperfrequency operating devices and named after Einstein's MC2 was launched.</p> <p>The platform dedicated to near-field microscopy and nanocharacterization of materials was created.</p>	<p>first time opening, <i>de facto</i>, the new era of 2D materials.</p>
2005	<p>The international vocation of the Institute was confirmed by the launch of a new start-up between three countries, France, Russia and Ukraine, called LIA LEMAC, Laboratoire Européen associé en Magneto-Acoustique nonlinéaire de la matière condensée, (2005–2012) a group of joint laboratories whose target was the investigation of Critical and Supercritical phenomena in Functional Electronics, Acoustics and fluidics.</p> <p>Electromechanical systems operating at radiofrequencies were investigated by another new start-up that linked DELFMEMS Company to IEMN.</p>	<p>The first Wifi technology operating above 100Mbps/s was launched.</p>
2006	<p>In 2006, another group was integrated to the labs, the EPHONI research group, whose activities are focused on acoustic and electromagnetic waves interactions in complex media.</p> <p>The IEMN's focus on cooperation and industry partnership was recognised by awarding the laboratories the Carnot Label, which rewards those institutes that, in addition to dedicating themselves to research excellence, also turn their attention to the business world in its socio-economic aspects.</p> <p>The interest raised by the IEMN's activities during its years of existence was also witnessed by the visit of the Minister of National Education, Higher Education and Research, Gilles Robien.</p>	<p>Twitter was made available to users.</p>
2007	<p>In 2007, the IEMN received a visit from the Director General of the CNRS, Arnold Migus, and the President of the Nord-Pas-de-Calais region, Daniel Percheron.</p> <p>The Telecoms Platform was commissioned.</p> <p>The "Dual Degree Masters in Nanotechnology" programme was established as a part of the "French American Cultural Exchange" programme.</p>	<p>Geim, Novoselov and Lemme realized the first transistor based on graphene.</p> <p>Apple launched on the market the first touch screen smartphone.</p>
2008	<p>Bernhard Legrand won a scholarship at Strasbourg University.</p> <p>Arnaud Devos was awarded the Bronze medal of CNRS.</p> <p>David Troadec was awarded the Crystal medal of CNRS.</p> <p>Bernard Legrand, won an ERC Starting Grant.</p>	<p>HP Labs realized the first memristor.</p> <p>The experimental demonstration of the Fully Depleted Silicon On Insulator architecture with back gate was given.</p>
2009	<p>LIA was the Laboratoire Internationale Associé created in this year with the MATEO project between France and the US on Nanomaterials and optics.</p> <p>The CiNTrA project took off as a cooperation between Singapore, Thales and Lille for a joint research on nanophotonics and nanoelectronics.</p>	<p>First materials with specific topological properties emerged in research.</p>
2010	<p>Lionel Buchaillet and Gilles Dambrines were appointed new directors of IEMN.</p> <p>The MENAPIC startup was launched about the research on analysis of materials with acoustic picoprobe.</p>	<p>The fourth generation 4G of mobile telephones was on the market.</p>

	A major achievement of this decade was the conception of a new idea, the SYNAPSTOR (synapse–transistor), and its demonstration, through the realisation of a memory transistor with metal nanoparticles and molecules, whose behaviour could mimic that of a biological synapse.	
2011	The IEMN was the winner of a two EQUIPEX ExCELSIOR (www.excelsiorncc.eu) coupling near–field microscopy to electrical and/or optical excitations of the THz continuum, and LEAF. Sabine Szunerits was appointed junior member of the IUF (Institut Universitaire de France)	The first transistor based on a 2D semiconducting material was manufactured. FinFET technology was introduced.
2012	The labs of IEMN received the visit of the Minister of Superior Instruction and Research, Laurent Wauquiez. Also, an IRT, Institut de Recherche Technologique, was established. The Labex GaNex, national network on group III element nitrides was created. The IEMN was accepted as part of the Electrochemical Energy Storage Network (RS2E). Bernard Legrand, won an European Research Council (ERC) Proof of Concept grant.	The first photovoltaic cells based on perovskite, a product that would prove a later remarkable development and efficiency, were realized.
2013	The IEMN became partner of the European Graphene Flagship, a European Union scientific research initiative. Jean–François Robillard received a Starting Grant from the European Research Council (ERC).	A new technological paradigm appeared when innovative optical technologies based on metasurfaces were introduced.
2014	A cooperation contract was concluded between several research institutes, the CNRS, the University of Lille1, the University of Tokyo and the Oscar Lambret Centre. The aim of this cooperation was the creation of the project Seeding Microsystems in Medicine in Lille–European–Japanese Technologies against Cancer (SMMiLe). The IEMN’s laboratories were expanded in terms of the number of rooms and facilities, with the laying of the foundation stone of a new series of works. The field of MEMS technologies received a new impetus with the launch of a new start–up company, Vmicro, which specialises in engineering and technical applications.	Carbon nanotubes were applied to new devices in technologies such soft electronics.
2015	The new department was completed after one year only of works. The Ecole Centrale de Lille supervised the IEMN.	For the first time a transistor amplified a signal beyond 1THz. Reconfigurable logic based on nanoparticle arrays was developed.
2016	The BioMicroFluid platform was created and made operative.	A.I. proved to be superior to human in the Go game.
2017	Wavely, a start–up company born from the intersection of research and engineering, moved to IEMN to develop research on sound and vibration for application to industry and the environment.	An optical fibre transmitted a signal made of more than 10^{16} bits/s.

2018	<p>IEMN and HORIBA JOBIN YVON joined forces to create a joint research team, an equips–mixed, in order to develop innovative characterisation tools and the physicochemical characterisation of nanomaterials. The startup BESTTIC was launched, to develop new information technologies for the railway and building industries.</p> <p>2018 witnessed the integration of the IEMN in the Labex Store–Ex electrochemical energy storage.</p> <p>As far as the successes of IEMN’s researchers, CNRS Silver Medal was awarded to Sabine Szunerits and Anne–Christine Hladky.</p> <p>Fabien Alibart was proclaimed winner of an ERC Consolidator grant.</p>	<p>A programmable quantum processor with two silicon substrates was manufactured.</p> <p>Neurotechnology restored walking in humans with spinal cord injuries.</p>
2019	<p>The IEMN’s research activities was structured into 9 flagship projects:</p> <ul style="list-style-type: none"> • Nano Characterization • Materials • Smart Energy • IoT Make Sense • Neuromorphic Technologies • Telecom UHD • Transportation • Technologies for Health • Micro/Nano Devices <p>Michael Baudoin was appointed junior member of the IUF (Institut Universitaire de France).</p> <p>The AXORUS startup about artificial neuron technologies was launched.</p> <p>The ZYMOPTIQ startup was launched, about new quantitative analytical technology for enzyme measurement.</p> <p>Launch of an industrial chair TERIL–WAVES with MC2 Technologies.</p> <p>The History of Physics and Applied Sciences & Technology (HOPAST), an international and interdisciplinary scholarly academic team in the fields of Physics, Physics–Mathematics & Applied Sciences (Technique/Technology) into the History, inquiring Historical Foundations of Sciences, Methods and Scientific Thought was founded by Prof. Raffaele Pisano HDR.</p>	<p>Scanning Tunneling Microscopy allowed atomic–scale manipulation and in situ characterization.</p>
2020	<p>The management of the IEMN was now under Thierry Mélin, Christophe Demeure and Christophe Lethien.</p> <p>E–COST, a joint IEMN–Gustave Eiffel University team on the intelligent city and transport was launched.</p> <p>The Nanofutur project in nanofabrication and nanotechnologies selected in the EquipEx+ started calling for projects.</p> <p>The Vision startup on surface acoustic waves to eliminate water drops or frost on a surface started.</p> <p>The Labex GaNex was extended into GaNeXT.</p>	<p>Pure carbon nanotubes were studied regarding their chirality and subsequent properties.</p>
2021	<p>Christophe Boyaval was awarded the Crystal medal of CNRS.</p>	<p>Extreme UV lithography allowed a new technology below 7nm.</p>

	Marco Miniaci received a Starting Grant from the European Research Council (ERC). Christophe Lethien was appointed senior member of the IUF (Institut Universitaire de France).	
2022	Daniel Leca, Vice-President of the Hauts-de-France Regional Council in charge of universities, research, innovation and Europe visited the IEMN. A RIVA Chair of Excellence at the Université Polytechnique Hauts-de-France was created. Sabine Szunerits was appointed senior member of the IUF (Institut Universitaire de France).	One single chip contained 100 billion transistors.
2023	Construction of a building to house Junia's research activities. Romain Peretti, winner of an European Research Council (ERC) Consolidator grant.	

6.3 IEMN Publications and History of Nanotechnology

The IEMN's research activity is differentiated in several areas, from materials and nanostructures research to micro and nanosystems, from microelectronics to optoelectronics to circuits and systems, and acoustics.

In detail, the study of materials and nanostructures involves studies on thin layers, heterostructures and nanomaterials of great interest for electronics, optoelectronics and Nanotechnology. Theoretical and experimental research is conducted on the growth and physics of these semiconductor materials, through investigations such as optical spectroscopy, STM spectroscopy and charge detection in nanostructures. Molecular electronics, simulation of high- k dielectrics, phonon crystals and nanophotonics, and nanoacoustics are aspects of materials towards which cutting-edge research is directed. Experimental studies make use of the latest generation of dedicated equipment (Molecular Beam Epitaxy, ESCA, near-field microscopes, femtosecond lasers, etc.) and the resources of the facility.

The IEMN's Micro and Nano Systems department has developed a world-class expertise over several years, and draws on the professionalism of lecturers, researchers and students who devote their skills to the broad area of micro and nano systems. The department shares a set of world-class design, fabrication and testing facilities with, for example, 1,200 square metres of clean room space managed by the Institute. Members of the department conduct industry-leading interdisciplinary research on materials, processes, sensors and actuators at the micro- and/or nanoscale and microfluidics that exploit advances in integrated circuit, biotechnology and polymer technologies. The department's main research topics are materials and processes for MEMS, power actuators and MEMS, and biological MEMS.

The research activity carried out in Micro and Optoelectronics concerns modelling, fabrication and characterisation in the field of nanometric devices for high-frequency electronic or photonic applications. Such devices are fabricated on a wide variety of materials, such as narrow- and broadband III-V compound semiconductors, silicon and carbon. The targeted applications are numerous, the devices operate from centimetre to sub-micrometre wavelengths. There are seven lines of research: nanometric devices for high-frequency and low-power electronics, unconventional silicon technology, wide band gap compound semiconductors for HF power electronics and photodetectors, metamaterials

and photonic crystals, opto–microwaves and nanophotonics, sources, detectors and passive THz devices, and modelling of nanometric devices.

Communications is one of the institute’s main research fields, and its work in this area focuses on three main themes: Internet of Things and sensor networks at frequencies of 60GHz and 140GHz, software–defined digital RF and radio communication, and communication for transport systems. Applied research can rely on highly advanced facilities and equipment, micro–nano–optoelectronics technology structures, telecommunication and electromagnetic compatibility platforms, and the CAD platform. Most of the new concepts and architectures are validated by functional demonstrators. An original feature of this activity is the wide range of frequencies considered, from radio frequencies to millimetre waves around 60GHz and 140GHz.

The IEMN also conducts research in the field of acoustics, to develop fundamental knowledge on active materials and acoustic meta–materials. Investigations focus on unusual properties of acoustic wave propagation, acoustic microsystems, and the use of this knowledge to design, fabricate and characterise electronic components and systems. There are two main cross–cutting themes of applied research. The first concerns sensor networks, including work on general concepts (correlation of environmental noise) and on those components that provide specific functions (acoustic resonators and filters for telecommunications, acoustic microsystems for biology, microactuators and magneto–mechanical microsensors). The second deals with acoustic imaging in the broadest sense, with the development of new principles for imaging (conjugation of magneto–acoustic waves, super–lenses made from acoustic left–handed meta–materials) and for non–destructive evaluation (ultrasound–laser interaction) of materials.

Precisely because of such a diverse and high level of research activity, the work of the IEMN results in a considerable number of publications, through which the results of research and collaborations are disseminated to the scientific community. The IEMN has published hundreds of articles throughout its 30 years long history. The most important ones are collected in the following table, compared – year by year – with the articles that have marked the most important milestones in the History of Nanoscience. The tables also indicate the scientific fields, such as materials science, mathematics, electronics, engineering and so on, that are relevant to the various articles.

Tab. 6.2: Comparison between the research in the History of Nanotechnology and that of the IEMN in the first decade of its history. The titles mentioned in the History of Nanotechnology are mentioned/commented on in the previous chapters of this thesis. The titles in History of IEMN were recommended by the researchers of IEMN. Titles not covered in depth in the historical part of the thesis for various reasons are given in italics.

Year	History of Nanotechnology	Subject	History of IEMN	Subject
1992	A New Family of Mesoporous Molecular Sieves Prepared with Liquid Crystal Templates (Beck <i>et al.</i>) Ordered Mesoporous Molecular Sieves Synthesized by a Liquid-Crystal Template Mechanism (Kresge <i>et al.</i>)	Mat. science Mat. science	Metamorphic In _{0.3} Ga _{0.7} As/In _{0.29} Al _{0.71} As layer on GaAs: A New Structure for High Performance High Electron Mobility Transistor Realization (Win <i>et al.</i>)	Mat. science
1993	Synthesis and Characterization of Nearly Monodisperse CdE (E = S, Se, Te) Semiconductor Nanocrystallites (Murray, Norris and Bawendi)	Mat. science	A New Method for On Wafer Noise Measurement (Dambrine, Happy, Danneville and Cappy)	Electr.
1994	Molecular Nanomachines: Physical Principles and Implementation Strategies (Drexler)	Eng.		
1995	Nanocrystals and Nano-Optics (Brus and Trautman)	Mat. science	Analysis of the Propagation of Plane Acoustic Waves in Passive Periodic Materials using the Finite Element Method (Langlet, Hladky-Hennion and Decarpigny)	Mat. science
1996	Phospholipid Mediated Synthesis and Characterization of Gold Nanoparticles (Chow <i>et al.</i>)	Mat. science	Suppression of Charge Carrier Tunneling through Organic Self-Assembled Monolayers (Boulas, Davidovits, Rondelez and Vuillaume)	Mat. science

	Self-Assembled Monolayers on Gold Nanoparticles (Badia <i>et al.</i>)	Mat. science		
1997	On the Measurement of Helicity of Carbon Nanotubes (Qin, Ichihashi and Iijima) Helicity and Packing of Single-Walled Carbon Nanotubes studied by Electron Nanodiffraction (Qin <i>et al.</i>)	Math. Math.	Unimolecular Electrical Rectification in Hexadecylquinolinium Tricyanoquinodimethanide (Metzger <i>et al.</i>)	Electr.
1998	Single- and Multi-Wall Carbon Nanotube Field-Effect Transistors (Martel <i>et al.</i>)	Electr.		
1999	“Dip-Pen” Nanolithography (Piner <i>et al.</i>)	Mat. science	Metamorphic $\text{In}_{0.4}\text{Al}_{0.6}\text{As}/\text{In}_{0.4}\text{Ga}_{0.6}\text{As}$ HEMT's on GaAs Substrate (Bollaert <i>et al.</i>) Electronic States and Luminescence in Porous Silicon Quantum Dots: The Role of Oxygen (Wolkin, Jorne and Fauchet, Allan and Delerue)	Mat. science Electr.
2000	Quantum Mirages formed by Coherent Projection of Electronic Structure (Manoharan, Lutz and Eigler)	Mat. science	Low-voltage, 30nm channel length, organic transistors with a self-assembled monolayer as gate insulating films (Collet, Tharaud, Chapoton and Vuillaume) Imaging the Wave-Function Amplitudes in Cleaved Semiconductor Quantum Boxes (Grandier <i>et al.</i>)	Electr. Electr.

2001	<p><i>Microscopic Theory for Quantum Mirages in Quantum Corrals</i> (Porrás, Fernández-Rossier and Tejedor)</p> <p><i>A Simple Interpretation of Quantum Mirages</i> (Weissmann and Bonadeo)</p>	<p>Mat. science</p> <p>Mat. science</p>	<p>Low driving voltages and memory effect in organic thin-film transistors with a ferroelectric gate insulator (Velu <i>et al.</i>)</p> <p>Ultrasonic Characterization of Residual Stresses in Steel Rods using a Laser Line Source and Piezoelectric Transducers (Duquennoy <i>et al.</i>)</p>	<p>Electr.</p> <p>Eng.</p>
2002	<p>Magnetic and Structural Properties of NiFe₂O₄ Nanoferrites (Durlo: Master Thesis)</p>	<p>Mat. science</p>	<p>Charge injection in individual silicon nanoparticles deposited on a conductive substrate (Mélin, Deresmes and Stiévenard)</p> <p>Fatigue Crack Monitoring of Riveted Aluminium Strap Joints by Lamb Wave Analysis and Acoustic Emission Measurement Techniques (Grondel <i>et al.</i>)</p> <p>Low Schottky Barrier Source/Drain for Advanced MOS Architecture: Device Design and Material Consideration (Dubois and Larrieu)</p>	<p>Mat. science</p> <p>Eng.</p> <p>Electr.</p>

Tab. 6.3: Comparison between the research in the History of Nanotechnology and that of IEMN in the second decade of its history. The titles mentioned in the History of Nanotechnology are mentioned/commented on in the previous chapters of this thesis. The titles in History of IEMN were recommended by the researchers of IEMN. Titles not covered in depth in the historical part of the thesis for various reasons are given in italics.

Year	History of Nanotechnology	Subject	History of IEMN	Subject
2003	Electronic Structure and Optical Properties of Gold Nanoshells (Prodan, Nordlander and Halas) Structural Tunability of the Plasmon Resonances in Metallic Nanoshells (Prodan and Nordlander)	Electr. Electr.		
2004	Electric Field Effect in Atomically Thin Carbon Films (Novoselov <i>et al.</i>) Nanowires in Ancient Damascus Steel (Kochmann <i>et al.</i>)	Mat. science Mat. science	Terahertz Emission by Plasma Waves in 60nm Gate High Electron Mobility Transistors (Knap <i>et al.</i>) Strong Oscillations detected by Picosecond Ultrasonics in Silicon: Evidence for an Electronic-Structure Effect (Devos and Côte) Integrated Microfluidics based on Multi-Layered SU-8 for Mass Spectrometry Analysis (Carlier <i>et al.</i>)	Electr. Electr. Mat. science
2005	<i>Productive Nanosystems: the Physics of Molecular Fabrication (Drexler)</i>	Eng.	Terahertz radiation from heavy-ion-irradiated $\text{In}_{0.53}\text{Ga}_{0.47}\text{As}$ photoconductive antenna excited at $1.55\mu\text{m}$ (Chimot <i>et al.</i>)	Electr.
2006	Nanoencapsulation I. Methods for preparation of drug-loaded polymeric nanoparticles (Pinto Reis <i>et al.</i>) Nanomedicine, Poverty and Development (Invernizzi and Foladori)	Med. Med.	Active Properties of Carbon Nanotube Field-Effect Transistors Deduced From S Parameters Measurements (Bethoux <i>et al.</i>) Output Power Density of 5.1/mm at 18GHz With an AlGaIn/GaN HEMT on Si Substrate (Ducatteau <i>et al.</i>)	Electr. Electr.
2007	<i>Nanomaterials and Nanoparticles:</i>	Mat. science	Reversible Electrowetting on Superhydrophobic Silicon Nanowires (Verplanck, Galopin, Camart and Thomy)	Mat. science

	<p><i>Sources and Toxicity (Buzea, Pacheco Blandino and Robbie)</i></p> <p><i>Toxic Effects of Nanoparticles and Nanomaterials: Implications for Public Health, Risk Assessment and the Public Perception of Nanotechnology (Handy and Shaw)</i></p>	Med.	Spatially Resolved Raman Spectroscopy of Single- and Few-Layer Graphene (Graf <i>et al.</i>)	Mat. science
2008	<p><i>Teaching Nanoscience across Scientific and Geographical Borders – A European Master programme in Nanoscience and Nanotechnology (Chesneau <i>et al.</i>)</i></p>	Educ.	<p>Probing the Carrier Capture Rate of a Single Quantum Level (Berthe <i>et al.</i>)</p> <p>Impulsive Noise Characterization of In- Vehicle Power Line (Degardin <i>et al.</i>)</p> <p>Low-Frequency Gaps in a Phononic Crystal constituted of Cylindrical Dots deposited on a Thin Homogeneous Plate (Pennec <i>et al.</i>)</p>	<p>Mat. science</p> <p>Electr.</p> <p>Mat. science</p>
2009	<p>Nanotechnology and Drug Delivery Part 1: Background and Applications (Ochekpe, Olorunfemi and Ngwuluka)</p> <p>Nanotechnology and Drug Delivery Part 2: Nanostructures for Drug Delivery (Ochekpe, Olorunfemi and Ngwuluka)</p> <p>Why Do We Need to Know What the Public Thinks about Nanotechnology? (Cormick)</p>	<p>Med.</p> <p>Med.</p> <p>Ethics</p>		
2010	<p><i>DNA Origami: a History and Current Perspective (Nangreave, Han Liu and Yan)</i></p>	Med.	<p>Gold-Free Growth of GaAs Nanowires on Silicon: Arrays and Polytypism (Plissard <i>et al.</i>)</p> <p>An Organic Nanoparticle Transistor Behaving as a Biological Spiking Synapse (Alibart <i>et al.</i>)</p>	<p>Mat. science</p> <p>Med.</p>
2011	<p>Atom-Probe for FinFET Dopant</p>	Mat. science	High-Performance Low-Leakage-Current AlN/GaN	Mat. science

	<p>Characterization (Kambham <i>et al.</i>)</p> <p>Microwave FinFET Modeling based on Artificial Neural Networks Including Lossy Silicon Substrate (Marinković <i>et al.</i>)</p>	Med.	HEMTs Grown on Silicon Substrate (Medjdoub <i>et al.</i>)	
2012	<p><i>Nanotribology at High Temperatures (Goel et al.)</i></p> <p><i>Nanotribology–Based Novel Characterization Techniques for the Dielectric Charging Failure Mechanism in Electrostatically Actuated NEMS/MEMS Devices using Force–Distance Curve Measurements (Zaghloul et al.)</i></p>	<p>Eng.</p> <p>Eng.</p>	<p>A 1 k–Pixel Video Camera for 0.7–1.1 Terahertz Imaging Applications in 65–nm CMOS (Al–Hadi <i>et al.</i>)</p> <p>Band Gap Tunability of Magneto–Elastic Phononic Crystal (Bou Matar <i>et al.</i>)</p> <p>Blind Digital Modulation Identification for Spatially–Correlated MIMO Systems (Hassan <i>et al.</i>)</p>	<p>Electr.</p> <p>Mat. science</p> <p>Electr.</p>

Tab. 6.4: Comparison between the research in the History of Nanotechnology and that of IEMN in the third decade of its history. The titles mentioned in the History of Nanotechnology are mentioned/commented on in the previous chapters of this thesis. The titles in History of IEMN were recommended by the researchers of IEMN. Titles not covered in depth in the historical part of the thesis for various reasons are given in italics.

Year	History of Nanotechnology	Subject	History of IEMN	Subject
2013	<i>A Review on Carbon Nano-Tubes A New Era of Nanotechnology (Das)</i>	Mat. science	Recent Advances in the Development of Graphene-Based Surface Plasmon Resonance (SPR) Interfaces (Szunerits <i>et al.</i>) Thermal Conductivity from Approach-to-Equilibrium Molecular Dynamics (Lampin, Cleri, <i>et al.</i>) An interferometric scanning microwave microscope and calibration method for sub-fF microwave measurements (Dargent <i>et al.</i>)	Mat. science Mat. science Mat. science
2014	<i>Carbon Nanotubes and Graphene Towards Soft Electronics (Chae and Lee)</i> <i>Carbon Nanotube Yarns as Strong Flexible Conductive Capacitive Electrodes (Liu et al.)</i>	Mat. science Mat. science	Gallium Nitride as an Electromechanical Material (Rais-Zadeh <i>et al.</i>) Ultrawide-Bandwidth Single-Channel 0.4–THz Wireless Link Combining Broadband Quasi-Optic Photomixer and Coherent Detection (Ducournau <i>et al.</i>) Demonstrating kHz Frequency Actuation for Conducting Polymer Microactuators (Maziz <i>et al.</i>) Multilayer Magnetostrictive Structure based Surface Acoustic Wave Devices (Zhou <i>et al.</i>)	Mat. science Electr. Electr.
2015	Nanocrystals and Nano-Optics (Brus and Trautman)	Electr.	Towards High Quality CVD Graphene Growth and Transfer (Deokar <i>et al.</i>)	Mat. science
2016	<i>Manipulation and Detection of Single Nanoparticles and Biomolecules by a Photonic Nanojet (Li et al.)</i>	Med.	A 17 GHz Molecular Rectifier (Trasobares, Vuillaume, Théron and Clement) On-chip and Freestanding Elastic Carbon Films for Micro-Supercapacitors (Huang <i>et al.</i>)	Electr. Mat. science
2017	<i>Point Defects in Turbostratic Stacked Bilayer Graphene</i>	Mat. science	Atomic Layer Deposition of Functional Layers for on Chip	Mat. science

	<i>(Gong, Lee, Hong, Yoo, Lee and Warner)</i>		3D Li-Ion All Solid State Microbattery (Létiche <i>et al.</i>) A 4-fJ/Spike Artificial Neuron in 65nm CMOS Technology (Sourikopoulos <i>et al.</i>)	Electr.
2018	<i>Synthesis & Characterization of ZnSe/CdSe/ZnS Nano-particles embedded in Polymer matrix – A Review (Kushwaha)</i>	Mat. science		
2019	<i>Atomic-Scale Manipulation and in situ Characterization with Scanning Tunneling Microscopy (Ko et al.)</i>	Mat. science	Functional Carbon Quantum Dots as Medical Countermeasures to Human Coronavirus (Łoczechin <i>et al.</i>)	Med.
2020	<i>Chirality Pure Carbon Nanotubes: Growth, Sorting, and Characterization (Yang et al.)</i>	Math.	Spatially Selective Manipulation of Cells with Single-Beam Acoustical Tweezers (Baudoin <i>et al.</i>)	Mat. science
2021	<i>Nanostructure Quantification of Turbostratic Carbon by HRTEM Image Analysis: State of the Art, Biases, Sensitivity and Best Practices (Toth)</i>	Mat. science	Ultrafast Quantum-Well Photodetectors operating at 10µm with Flat Frequency Response up to 70GHz at Room Temperature (Hakl <i>et al.</i>) Measurement of the V2I Massive Radio Channel with the MaMIMOSA Sounder in a Suburban Environment (Gaillot <i>et al.</i>)	Electr. Electr.
2022	<i>Precise Atom Manipulation Through Deep Reinforcement Learning (Chen et al.)</i>	Mat. science	Capacitively Coupled Distinct Mechanical Resonators for Room Temperature Phonon-Cavity Electromechanics (Pokharel <i>et al.</i>)	Electr.

6.4. IEMN Premieres

This subsection summarises the most important results achieved by the IEMN, i.e. when research led the laboratory to be the first in the world to achieve the goals set by the various research teams.

The IEMN produced by epitaxial growth the first highly maladaptive layers on GaAs, demonstrating that lattice tuning is not a requirement. IEMN called these layers ‘metamorphic’, a term that would later become popular in the scientific community. A few years later, high-performance transistors were produced. In 1992, a new High Electron Mobility Transistor (HEMT) was successfully realised at the newly established IEMN laboratories, using InAlAs/InGaAs grown on GaAs. This structure had a content of In close

to 30%, and was characterised by several advantages over conventional pseudomorphic HEMTs grown on GaAs and lattice-matched HEMTs on InP. High electron mobility was measured for such a device with a high two-dimensional electron gas density ($20700\text{cm}^2/\text{Vs}$ with $4 \times 10^{12}\text{ cm}^{-2}$) and a high Schottky barrier quality ($V_b=0.68\text{V}$ with $\eta=1.1$). The transconductance at $3\mu\text{m}$ reached a value of 530mS/mm . Devices that preceded transistors such as this had proven to be extremely high-performance when used in low-noise amplifiers. Yet, carrier density values and electronic confinement were low, and the quality of the Schottky barrier was poor. Therefore, a different structure with an indium content of around 30% was investigated. The results obtained were remarkable. The carrier density and electronic confinement were very good, due to the high value of the conduction band discontinuity, $\Delta E_c \approx 0.7\text{eV}$, of the realised ternary alloy. The material also ensured a high electron velocity and better Schottky barrier quality due to the high band gap of the InAlAs. Furthermore, the high InGaAs band gap allowed higher drain voltage operations and reduced impact ionization (Win *et al.* 1992). For the first time, IEMN developed so-called ‘metamorphic’ semiconductor layers through crystal growth, i.e. layers with a high degree of mesh size mismatch relative to the substrate.

Studies on HEMT transistors were deepened by a paper (Dambrine, Happy, Danneville and Cappy 1993) devoted to the measurement of noise in a wafer. The four noise parameters of a FET transistor are not independent of each other; the equivalent noise resistance and the magnitude of the optimal admittance could be obtained by measuring the noise figure with a 50Ω impedance of the generator, indicated by F_{50} . This measure was enough to obtain the four noise parameters, thus a very simple and easy-to-develop method was presented for systematic control in lab or industry serial production of devices. It is known that the admittance of a generator is defined by the complex expression:

$$Y_g = G_g + jB_g \quad (6.1)$$

where the real part represents dissipative phenomena and corresponds to conductance, G , and the imaginary part, called susceptance, B , is associated with energy storage phenomena. Now, the noise figure is:

$$F = F_{min} + \frac{R_n}{G_g} |Y_g - Y_{opt}|^2 \quad (6.2)$$

where R_n is the equivalent noise resistance. It is:

$$F_{min} = 1 + 2R_n (G_{opt} + G_{cor}) \quad (6.3)$$

With a generator impedance of 50Ω , we write that:

$$Y_g = G_0 = 20\text{mS} \quad (6.4)$$

Now, substituting the (6.3) in (6.2), considering the condition in (6.4), it is possible to get:

$$F_{50} = 1 + 2R_n (G_{opt} + G_{cor}) + \frac{R_n}{G_0} |G_0 - Y_{opt}|^2 \quad (6.5)$$

$$1 + 2R_n G_0 + 2R_n G_{cor} + \frac{R_n}{G_0} (G_0^2 - 2G_0 |Y_{opt}| + |Y_{opt}|^2) \quad (6.6)$$

$$1 + R_n G_0 + \frac{R_n}{G_0} (2G_0 G_{cor} + |Y_{opt}|^2) \quad (6.7)$$

This equation allows the following considerations to be made. Since R_n is, primarily, independent of frequency while both G_{cor} and $|Y_{opt}|^2$ vary with the square of the frequency, the graph of F_{50} plot as a function of w^2 is linear and, for $w=0$, the value of F_{50} is:

$$F_{50}(\omega = 0) = 1 + R_n G_0 \quad (6.8)$$

a condition that makes it easy to derive the value of R_n . Furthermore, the value of the optimal admittance is obtained from the slope of the line. In this way, in a rather simple way, it was possible to obtain two fundamental characteristic values with high accuracy. Analysing the noise through equation (6.7) then allows the fundamental quantities of an FET to be derived. In this year, the technique for extracting RF noise parameters from transistors was perfected. This internationally pioneering technique has been widely used for the optimisation of industrial technologies.

Another of the achievements concerned the development of self-assembled molecular nanodielectrics and molecular electronics. The first results were obtained and a specific research strand on molecular electronics was established at the IEMN, whose project had started in 1992. For the first time, extremely low charge transfer through self-assembled monolayers (SAMs) of organic molecules (alkylsilane) on silicon was demonstrated. The study of tunnelling current through polymer structures was the subject of a 1996 publication. The design of nanoscale devices requires fabricating very thin layers (below a few nm) of various materials with a well-controlled architecture. In the search for ever smaller dimensions, inorganic materials are the most popular. However, while they have proven to be performing, they have limitations. For example, when an insulating silicon dioxide barrier is reduced below 3–4nm, high tunnelling currents begin to appear, which precludes the use of these materials in devices that make reliability one of their key features. This is why organic materials were thought to be useful substitutes in this field, due to their inherent low electrical conductivity and their processability, through which monolayers and multilayers of nanometre thickness could be formed (Ulman 1991). Measurements on long-chain fatty acid monolayers (Mann and Kuhn 1971, Polymeropoulos and Sagiv 1978, Polymeropoulos 1977) showed that carrier tunnelling dominated charge transfer. By controlling the organisation of the layers and the packing density within the organic layer, tunnelling could be avoided. Self-assembled monolayers of long chains of alkanes deposited on silicon wafers proved to possess very large energy barriers (around 4.5eV) with respect to the carrier tunnel effect. The conductivity dc was found to be of 4.6×10^{-15} S/cm, a value close to that of polyethylene and independent of monolayer thickness. This proved that the contribution of the tunnelling carriers to the overall conductivity could be

neglected, once the organic structure was densely packed and highly ordered. Significantly higher conductivity values were measured when the monolayers were characterised by a disordered arrangement of chains (Boulas, Davidovits, Rondelez and Vuillaume 1996). The effectiveness of an ultra-thin (<3nm) organic molecular insulator was thus demonstrated.

In 1999, the first metamorphic HEMT transistor made of InAlAs/GaAs on a GaAs substrate was realised. It was the subject of a fruitful collaboration between two groups, one that was dedicated to epitaxy research and the other to nanocomponent research. This proved the feasibility of the metamorphic approach, developed at IEMN over the previous ten years, and first published in *Applied Physics Letters* in 1992. This field is now industrial.

In the late 1999, the IEMN achieved one of the many remarkable achievements in its history, when new metamorphic high-electron-mobility transistors, MM-HEMT, were fabricated and their potential tested. HEMT transistors made on InP substrates were shown to provide superior performance compared to analogous GaAs-based devices. However, the superior performance did not compensate for mechanical problems such as their fragility and, not least, their higher cost, a factor that discouraged their large-scale production. The background of experience acquired with InAlAs/InGaAs structures made it possible to achieve a suitable numerical model expressed by $\text{In}_x\text{Al}_{1-x}\text{As}/\text{In}_x\text{Ga}_{1-x}\text{As}$. The optimal ratio among the partially present chemical elements led to $\text{In}_{0.4}\text{Al}_{0.6}\text{As}/\text{In}_{0.4}\text{Ga}_{0.6}\text{As}$, bringing high microwave and low-noise performance. The Schottky characteristics measured in the laboratory for such a device were a forward turn-on-voltage of 0.7V and a gate breakdown voltage of -10.5V. These devices showed good Schottky diode breakdown, a feature that makes them suitable for power applications. The new MM-HEMT device exhibited a drain current of 600mA/mm and an extrinsic transconductance above 720mS/mm. Also, an extrinsic cutoff frequency of 195GHz was achieved with a 0.1 μm gate length. In spite of an Indium ratio of 0.4, the results were comparable to the ones obtained through HEMT on InP devices. Microwave performance was better than the HEMT on Ga substrate for the same gate length. All these values were the first ever reported for such a device and showed the potential of such a transistor. Its low costs also make it suitable for large-scale production (Bollaert *et al.* 1999).

Using a self-assembled monolayer 2nm thick, the first organic thin-film transistors with a gate length of 30nm were realised in the early 2000s. The devices were fabricated by crossing different techniques, from electron beam lithography to lift-off techniques to lay down the metal electrodes and organic semiconductors with a chemical approach. The self-assembly of the organic molecules (alkyl chains) was used to obtain the gate insulator, and also to keep the global cost low. In this way, a good degree of compatibility with other microelectronics-related processes was achieved and improved efficiencies could be observed, relating to the threshold voltage, protector mobility and so on. These transistors have proven to be very high-performance (Collet, Tharaud, Chapoton and Vuillaume 2000).

A major achievement at the end of the IEMN's first decade was the design of an alternative architecture for MOSFETs (Dubois and Larrieu 2002). For these new devices, source/drain contacts with a low Schottky barrier were designed, installed on an insulating substrate and coupled to a thin silicon film. The basic idea was to demonstrate how a low Schottky S/D barrier was advantageous compared to the transistor technologies in use at the time. One of the most important problems in electronics concerns the reduction of resistance in carrier motion. For this, new transistors needed new architectures, to decrease the value of this parameter, and go against the trend of studies that indicated 50nm, approximately, as the limit below which the performance of devices would degrade to the point of rendering them unusable. The first attempt at further miniaturisation was the introduction of SOI,

Silicon–On–Insulator devices, the aim of Dubois and Larrieu’s work was instead to aim for the ideality of a Schottky junction at virtually 0eV. The proposed new structure was based on the accumulation mode, and was named Accumulation Low Schottky Barrier MOSFET, (ALSB–SOI–MOSFET). The architecture of these new transistors developed at IEMN did not require the design of highly doped S/D regions, while the specific resistivity of the contacts was kept very low. The use of silicides in the silicon layer reduced the resistance of the contacts, drastically limiting the current drive for the conventional MOS architecture. MOS transistor technology suffered from an inherent limitation related to the source/drain resistance of the transistors. To overcome this limitation, a new device based on silicides, characterised by a very low Schottky barrier height, was therefore studied and proposed.

At the IEMN, a pioneering paper was published in 2004 demonstrating how a nanogate transistor designed and manufactured in the laboratory can generate plasma waves in the terahertz range. The transistor had a 60nm gate. The paper was highly cited, introducing a new way of generating and detecting terahertz waves. The collaboration with the GES in Montpellier proved the quality of the devices produced at IEMN. Picosecond ultrasounds sent into silicon were the instrument with which to observe strong oscillations in the material. They gave confirmation of an electronic–structure effect. In another work, new microfabrication processes were efficiently developed and microfluidic–flows studied. The development of lab–on–a–chip for mass spectrometry started from this research. Many types of research were oriented toward improvements in electronic devices. The resonant emission of radiation, having a frequency in the order of terahertz (0.4–1.0THz), by a two–dimensional electron gas in a 60nm transistor, and consisting of InGaAs with high electron mobility, was studied by a research group at IEMN. The emission pattern was interpreted as the result of an instability in the plasma waves, an instability that led to oscillations in the transistor channel. The transistor channel acted as a resonant cavity for plasma waves, whose linear dispersion law was similar to that of acoustic waves. The passage of a current through a FET caused instability towards the generation of plasma waves. The emission of electromagnetic radiation at the characteristic frequency of plasma waves was then observed, and this was the first report of resonant THz emission by plasma generation. The resonant emission of the order of THz was interpreted as being caused by the Dyakonov–Shur instability of plasma waves in a two–dimensional electron system, which became unstable in a FET whose source and drain conditions were asymmetrical. The observed emission appeared once the device current exceeded a certain threshold value, as the correct boundary conditions were reached driving the transistor into the saturation region. The experimental value of the resonant frequency and the range of its tunability agreed with the theoretical predictions (Knap *et al.* 2004).

In 2006 year, the IEMN achieved, among others, two outstanding results, transistors designed and built on carbon nanotubes with record results measured for microwaves, on both rigid and flexible substrates. A second study focused on gallium nitride–based transistors fabricated on silicon substrates and dedicated to 18GHz microwave power applications, demonstrating IEMN’s innovative capabilities and pioneering research in this field.

Studies of carbon nanotube field–effect transistors (CNT–FETs) have shown that they are faster devices than conventional semiconductor devices. In fact, they exhibit high current densities (up to $10^9\text{A}/\text{cm}^2$), high mobility in the diffusive regime ($100.000\text{cm}^2/\text{Vs}$) and a very long mean electron path, relative to semiconducting carbon nanotubes (CNTs), which allows the transistors to operate in the so–called ballistic regime (at room temperature and low electric field) (Javey *et al.* 2003). All these characteristics make them attractive

candidates for high-frequency (HF) operation. In addition, their nanoscale was very attractive for the electronics that were to come. However, while the scale emphasised the qualities of the materials, it also posed measurement problems, especially with regard to HF properties. For example, the current in CNTs remained low due to their small diameter (about 1nm). This resulted in a very low ac level and poor accuracy of the scattering parameters, the so-called S-parameters. The properties of CNT-FETs in alternating current were investigated by means of S-parameter measurements performed on a device comprising a number of self-assembled CNTs arranged in parallel over a Si n⁺⁺ gate placed between the source and drain metal electrodes. The apparent transconductance and output conductance were evaluated, and the active operation of the CNT-FET was demonstrated. A method to extract a small-signal equivalent circuit was also proposed, and this equivalent circuit was first validated on an active CNT-FET. The intrinsic ac transconductance deduced from this equivalent circuit was much higher (10times) than the measured apparent value, due to the high contact resistances. The frequency limitation was attributed to the high input parasitic capacitances and resistances in the current layout. Consequently, lower contact resistances and parasitic capacitances led to much higher HF performance. The parallel arrangement of CNTs has proven to be efficient for probing HF properties through standard VNA measurements. This research constituted an important step in refining device design, with a substantial reduction in eddy currents (Bethoux *et al.* 2006).

GaN-based HEMT transistors have proven to be high-performance tools for high-power, low-noise applications, but materials with different properties, such as AlGaIn/GaN heterostructures, have been combined to improve device performance. GaN-based devices have also been effectively applied in low-noise receivers without a limiting stage due to the properties of GaN wide gap and its low-noise RF capabilities. GaN-based epitaxial devices were usually grown on very cheap SiC substrates. Therefore, for many applications, the alternative epitaxy grown on Si substrates had been an attractive solution for developing low-cost devices. For this, the microwave capabilities of AlGaIn/GaN high electron mobility transistors (HEMTs) on a high-strength silicon substrate (111) and a resistivity of about 2kΩ cm, dedicated to power applications, were demonstrated in the laboratory. When a device with a gate length of 0.25μm was tested, a maximum continuous current density of 1A/mm was achieved, and an extrinsic current gain (FT) cutoff frequency of 50GHz. Pulse and large-signal measurements demonstrated the good quality of the epilayer and how accurately the device had been constructed. Trapping phenomena were minimised and as a result, an output power density of 5.1W/mm was achieved at 18 GHz on a HEMT 2×50×0.25μm² with a power gain of 9.1dB. The results obtained by testing the devices clearly demonstrated the good potential of AlGaIn/GaN HEMTs fabricated on Si substrates, leading to the data shown above. Trapping phenomena, an inherent limitation for GaN-based transistors, were however severely limited by fabrication techniques, good epitaxy and good device processing. An improvement in the capacitance of these power devices had proved possible through the fabrication of a field-plate HEMT that allowed the breakdown voltage to be improved. This paved the way for the fabrication of high-power, low-cost solid-state amplifiers operating up to the Ku-band using a flip-chip assembly. In this case, heat was dissipated by the epitaxy and the limitation due to lower thermal conductivity compared to SiC material could be avoided (Ducatteau *et al.* 2006).

In 2007, IEMN added another success story to its history, achieving for the first time the so-called Reversible Electrowetting on Superhydrophobic Silicon Nanowires (Verplanck, Galopin, Camart and Thomy 2007). In the first decade of the 2000s, a rapidly growing field

was the implementation and manipulation of liquids on solid substrates by means of electrodeposition. Studies in this field were very active from both a basic research and application point of view. Electrodeposition had found applications in various fields, from lab-on-chip devices to adjustable lenses, display technology, fibre optics and microelectromechanical systems (MEMS). The technique of electrodeposition on dielectrics was based on the reduction of the contact angle and the movement of liquid droplets following the application of an electric field. In common electrowetting set-up, the insulating layer was composed of an inorganic material such as SiO_2 or Si_3N_4 or organic polymers, while hydrophobicity was induced by applying a coating with a hydrophobic layer, such as fluoropolymers. The main criteria required to ensure effective reversible electrophotography concerned the hysteresis of the hydrophobic layer, which had to be as low as possible, and the contact angle at zero voltage, which had to be as high as possible. The thickness of insulation layer had to be very thin. The research also aimed to achieve so-called superhydrophobicity, following the lotus leaf model. The experience, however, showed that generating reversible wetting in the air on superhydrophobic surfaces was not only a technical challenge but would lead to a real advantage for potential applications of the structures in a wide variety of fields. Superhydrophobicity was achieved by combining the high roughness of SiNWs grown on a silicon dioxide layer with a C_4F_8 fluoropolymer coating. At zero voltage, in an air atmosphere, a contact angle with water of 160° was measured. The contact angle decreased to 137° when a voltage of $150 \text{ V}_{\text{TRMS}}$ was applied and returned to the initial value when the voltage was removed. The reversible behaviour of the system was tested by repeating the cycle a thousand times, with no apparent decrease in contact angle. Reversible electrodeposition was performed on superhydrophobic silicon nanowires: the roughness of the surface, combined with the low surface energy induced by the coating, ensured the entrapment of air between the substrate and the liquid droplets, which is necessary to achieve superhydrophobicity. This research opened new opportunities for designing electrowetting systems at very low voltages, with potential applications in the field of lab-on-chip, and particularly in the preparation of highly functional microfluidic devices.

Gathering the necessary data to build a vehicle noise model to be implemented in a Power Line Carrier PLC simulation tool to enable optimisation of channel coding was the subject of a fundamental study conducted in 2008. It was assumed that impulsive noise greatly influenced the performance of power line communication systems in vehicles. Therefore, intensive time domain noise measurements were carried out on five different vehicles, as not many studies on this precise domain had been published. The publication by Virginie Degardin and her colleagues became particularly important to overcome the lack of available data on the subject. The experiment was divided into two parts, the first with the vehicle stationary and the second with the vehicle in motion. The impulse signals detected when the vehicle was stationary were the same as those that could be read for a vehicle in traffic, in the most realistic condition possible, so the focus was on the impulses detected in the driving condition. However, the preliminary tests were carried out on a stationary vehicle with the engine idling, and the characteristics of the measured low-amplitude pulses varied considerably from one car to another. For this reason, it was preferred to highlight the characteristics of the high-amplitude pulses, above 70mV , observed when the vehicles were moving in traffic, during a 20-minute journey. The noise was statistically characterised in terms of features such as duration, frequency content, peak amplitude and time interval between successive pulses. Stochastic models based on mathematical distribution functions were subsequently proposed and adapted to the experimental

distribution of the various pulse characteristics. It turned out that the time interval between two successive pulses was rather short and thus proved to be the most critical parameter in the optimisation of the physical layer of power line communication. In the case of a stationary vehicle, pulse sequences of between 100 μ s and 1ms duration were observed, probably due to interference from dedicated communication networks already implemented in the vehicle and pulses also generated by control–command devices. The average amplitude of these pulses could vary considerably from car to car, and further measurement campaigns, carried out on a much larger number of cars, would be necessary before conclusions could be drawn on the statistics of this low–amplitude noise. For a moving vehicle, the trigger level was chosen at 70 or 200mV, to be higher than the peak value of the pulses observed under stationary conditions. Once the experimental data were obtained, average distribution functions were plotted and proposed. To find the mathematical expression of the most appropriate distribution functions, six well–known functions were tried: the Gauss function, the gamma function, the Weibull function, the beta function, the Rayleigh function and the exponential function. As might be expected, a single function obviously could not cover the entire range of possible amplitude A values, and it was necessary to consider the distribution of the data over successive subintervals. The function that best approximated the data was:

$$y\left(\frac{x}{a}, b\right) = \frac{1}{b^a \Gamma(a)} e^{-x/b} x^{a-1} \quad (6.10)$$

where $\Gamma(a)$ is the gamma function (Degardin *et al.* 2008).

The theoretical study of the band structure of a phononic crystal, of finite thickness, and consisting of a periodic array of cylindrical dots deposited on a thin sheet of homogeneous material was conducted in 2008. Over time, such material found applications in waveguiding, as a filter, and in sound insulation. The band structure was studied in a new finite–thickness structure consisting of a square array of cylindrical dots deposited on a thin homogeneous plate. The remarkable effect observed in this geometry was the possibility of finding a low–frequency gap, i.e. a frequency at which the wavelengths in the constituent materials were much longer than the typical lengths of the structure, such as the lattice period or the thickness of the plate. The opening of this gap resulted from an abrupt bending of the dispersion curves at a given frequency and required an appropriate choice of geometric parameters, in particular, the thickness of the homogeneous plate and the height of the points (Fig. 6.2).

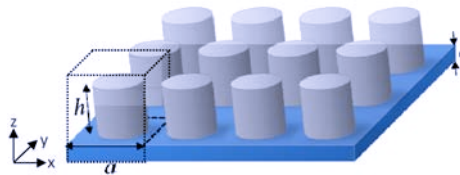

Fig. 6.2 The schematic view of a phononic crystal. A square lattice of finite cylinders of height h , is deposited on a homogeneous plate whose thickness is e . The dashed cube represents the unit cell. Source: Pennec *et al.* 2008

The gap was generated by bending the plate's Shear Horizontal (SH) and Symmetric Lamb mode (S0). The centre frequency of the gap depended on all geometric parameters: plate thickness, point height and fill factor. This last factor was defined as:

$$\beta = \frac{\pi r^2}{a^2} \quad (6.11)$$

Due to the geometry of the structure, a gap could exist for very different combinations of constituent materials. In particular, for acoustic insulation purposes, choosing a high-density material for the cylinders and a low-density one for the plate would be appropriate. The existence of larger gaps, mainly obtained by increasing the height of the cylinders, was also demonstrated. These gaps could also appear at low frequencies for values much larger than the height of the cylinders. This system was designed to find an original application in the field of waveguiding and filtering as well as sound insulation within vibrating plate structures (Pennec *et al.* 2008).

Some of the fields in which the nanoworld has found interesting application outlets are biology and neurobiology. In this respect, molecule-based devices have been developed and designed to complement existing silicon devices. They provide new functions or implement existing ones at a simpler process level and at a lower cost, thanks to their self-organising capabilities. Furthermore, molecular devices are not bound to the standard von Neuman architecture, and this feature may open the way for other structural paradigms. Neuromorphic electronics, inspired by the structure and functioning of the human brain, is one such paradigm. A device made of molecules and nanoparticles – an organic field-effect memory transistor, or Nanoparticle Organic Memory Field-Effect Transistor (NOMFET) – has been shown to exhibit the typical behaviour of a biological synapse. Facilitating and depressing synaptic behaviour could be reproduced by the NOMFET and programmed. These results paved the way for the rate-coding use of the NOMFET in dynamic neuromorphic computing circuits. A work developed in 2010 at the IEMN laboratories (Alibart *et al.* 2010) demonstrated how the NOMFET can be programmed to provide facilitating or depressing behaviour. By adjusting the size of the device down to 200nm and the diameter of the nanoparticle down to 5nm, it was possible to vary the operating frequency between 0.01Hz and 10Hz. The synapse behaviour of the NOMFET was also simulated by adapting a model developed for the biological synapse. In the literature (Varela *et al.* 1997), the output of biological synapses had been described through an iterative process, as the product of several depression factors (D-terms) and facilitation factors (F-terms) (Eq. 6.12), each of which is associated with a particular characteristic time.

$$I = \tilde{I} F_1 \dots F_n D_1 \dots D_n \quad (6.12)$$

For the NOMFET, by approximating the NP-discharge relaxation function with an exponential, the IEMN researchers obtained a simpler model of this type.

The NOMFET behaves with the following dynamic model.

$$I_{n+1} = I_n K e^{-(T-P)/\tau_d} + \hat{I}(1 - e^{-(T-P)/\tau_d})K \quad (6.13)$$

In equation (6.13) K is a multiplicative factor smaller than 1; I_{n+1} and I_n was the currents of the NOMFET measured at the end of the $(n+1)^{\text{th}}$ and n^{th} voltage pulses sent to the device, \hat{I} the intrinsic drain current, T was the period between two pulses and P the width of the pulses. The developed NOMFET behaved within this approximation as the simplest depressive synapse with only one D-term

In 2011, a remarkable transistor achievement was achieved: the highest known value for the output current density of a transistor with high electron mobility. Ultra-thin barrier AlN/GaN high-electron-mobility transistors (HEMTs) coated with SiN drowned by in-situ chemical-metallic deposition were successfully fabricated on 100mm Si substrates. The output current density achieved for such a device was over 2A/mm, and this was at the time, the highest known value for GaN-on-Si HEMTs. This was due to the high 2DEG (Two-Dimensional Electron gas) density of the optimised AlN/GaN heterostructure. Despite an ultra-thin barrier of 6 nm, low gate and drain leakage currents of around 10 μ A/mm were measured without the use of a gate dielectric, which had generally demonstrated reliability problems. The cross-section of the device is the following (Fig. 6.3).

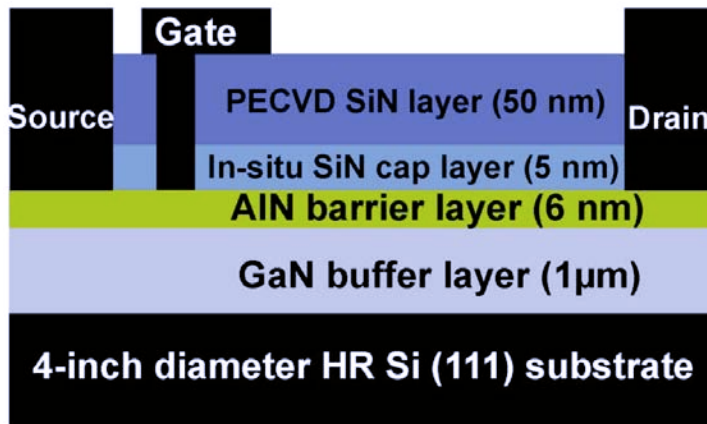

Fig. 6.3 The fabricated AlN/GaN-on-Si HEMT. Source: Medjdoub *et al.* 2011

A low leakage current was observed in these devices without the use of any gate dielectric, resulting in a planar technology that can show high reliability. Excellent small signal parameters have been extracted for a 0.2- μ m gate length, L_g , resulting from the high transconductance, despite the relatively high access resistances and residual losses most probably located at the buffer/Si substrate interface due to the high lattice mismatch between the two materials. These results were proof of the high quality of the AlN/GaN material already achieved and the maturity of the processing technology, which could lead to a

revolutionary millimetre–wave performance in a cost–effective manner (Medjdoub *et al.* 2011).

In 2012, the first demonstration by IEMN gave evidence of the functionality of a THz (32×32 pixel) camera at 650GHz for viewing objects, through tissue or opaque materials, with the considerable advantage of not damaging living cells. A second pioneering work developed in the labs concerns the blind identification of digital modulations in multiple–input multiple–output (MIMO) systems, using an artificial neural network. A third work described photonic crystals and, in particular, how they can block sound waves of fixed frequencies. It was shown how the use of magnetostrictive constituents and a variable external magnetic field allows these frequencies to be modulated. Emerging applications such as airport security screening have brought terahertz technologies to the fore. Their ability to transcend obstacles, while at the same time not being as dangerous as ionising radiation, make them attractive for several uses in firefighting equipment for gas detection, medical imaging and pharmaceutical applications, astronomy, communication, and the analysis of biological samples and materials. In this application area, Very Large–Scale Integration (VLSI) in silicon process technologies is becoming a cost-effective alternative to technologies such as the Schottky Barrier Diode (SBD) or High Electron Mobility Transistors (HEMTs), Vacuum Electronic Devices (VEDs), bolometers, instruments to measure radiant heat through a temperature–dependent–resistance material, micro– and nanobolometers. In addition, silicon technologies’ high–frequency capabilities have proven to improve steadily due to scaling, which allows high levels of integration and low power consumption at higher frequencies. However, their low f_i/f_{\max} ratio was a limiting factor for terahertz applications. To delve deeper into terahertz technology, at the IEMN labs, a 1 k–pixel camera chip for actively recording terahertz video at room temperature was fully integrated into a 65nm bulk CMOS process technology. The chip used an innovative reset and read architecture with an average power consumption of only 2.5W. The 32×32 pixel array consisted of 1024 on–chip differential ring antennas coupled to direct NMOS detectors operating well above their cutoff frequency, based on the distributed resistive self–mixing principle. The array included row and column selection, and integration and download circuits, capable of capturing terahertz video at up to 500fps. The camera chip was packaged together with a 41.7dBi silicon lens (measured at 856GHz) in a 5×5×3cm module. Conventional CMOS image sensors for the visual spectrum typically used a photodiode detector and required a separate reset transistor to zero all integrated charges of a floating diffuser. In contrast to the conventional technique, the readout circuit diagram studied used the detector’s NMOS transistor to reset the accumulated charges from the integration capacitor. This reduced the number of circuit elements required within the pixel and decreased the number of unwanted noisy elements connected to the detector node. To the authors’ knowledge, this was the first time a focal–plane CMOS array was used to capture terahertz video streams in real–time transmission mode without the need for raster scanning and source modulation. Promising recognised applications of this active imager were stand–off imaging in NDT (non–destructive testing) applications, particularly when low–power and battery–powered imaging systems are required. Silicon–based terahertz circuits and terahertz applications, in general, may find application in the future. These demonstrate that terahertz imagers can be realised in an industrially qualified CMOS process technology, and as such can be mass–produced to significantly reduce the cost of terahertz equipment in the future (Al Hadi *et al.* 2012).

Graphene research has grown at a spectacular pace since the first isolation of single-layer flakes in 2004. Within a decade, this material has become the focus of efforts by scientists from different disciplines. Further advances in this exciting field of graphene have involved multidisciplinary efforts by chemists, physicists, biologists and material science researchers. Graphene and graphene oxide are good carriers for biomolecules due to their large surface area and rich π -conjugation structure, which makes them suitable as upper dielectric layers for a new type of analysis, which is called Surface Plasmon Resonance (SPR) detection. Some key new issues in the development of graphene-based SPR chips were explored at IEMN (Szunerits *et al.* 2013), where applications for the use of these interfaces to study biomolecular interactions were discussed, and the first examples of graphene-metal SPR interfaces for biological sensing were presented. Research to improve the performance of an SPR sensor had been directed towards the application of a thin top layer of dielectric material, chosen on the basis of a suitable dielectric constant, as long as the thickness of the layer is controlled. Over time, the use of mechanical approaches to transfer high-quality CVD-grown graphene onto metal enabled the reproducible formation of high-quality SPR interfaces. This approach could be used to construct graphene-silver SPR interfaces and develop high-performance SPR chips. It was observed that the advantages of SPR techniques were related to the sensitivity of surface plasmons and refractive index changes in the immediate vicinity of the metal thin film, allowing direct indication of whether a single sheet of graphene or a few sheets of material had been deposited. This direct means made it possible to tune and improve the sensing interface for the development of plasmonic devices. The possibility of coupling SPR with electrochemical deposition techniques proved very attractive in this regard, as it would allow the electrochemical deposition of graphene by reducing graphene oxide solutions. The main limitation of graphene-on-metal SPR substrates for real-time sensing was, however, the lack of specificity of these interfaces. Indeed, most biomolecules adsorb onto graphene, making selective detection rather difficult. A real-world detection application using graphene-metal interfaces was based on the ability of α -thrombin to remove a specific aptamer from the surface of graphene on metal. This suggested that the binding strength of biomolecules to graphene was influenced, in addition to π -stacking interactions, by several other factors, e.g. pH and ionic strength. This problem had been highlighted by the investigation of the adsorption and desorption of DNA on graphene oxide. The IEMN group demonstrated that the organic molecule tetrathiafulvalene (TTF), integrated on graphene by π -stacking interactions, could be released from the graphene matrix as its oxidation state changed.

Micro ionic muscles ElectroActive Polymers EAP can convert the electrical response into a micromechanical response in the open air; innovative results were achieved in 2014 at IEMN (Maziz *et al.* 2014). In electrochemical devices, it is possible to observe ionic vibrations at a frequency of 1000Hz; this was verified by translating the movement of small ions into a large deformation in a micro-bending actuator. The motion was then amplified via the fundamental resonance frequency. These results were achieved through the micrometre-scale fabrication of ultra-thin conducting polymer microactuators. The synthesis of robust Interpenetrating Polymer Networks (IPNs) was combined with a spin-coating technique in order to tune and drastically reduce the thickness of conductive IPN microactuators using a so-called “trilayer” configuration. The possibility of modelling electroactive materials as thin as 6 μ m had been demonstrated with existing technologies such as standard photolithography and dry etching. In fact, the Nitrile Butadiene Rubber (NBR) mesh that was inserted into the IPN provided sufficient mechanical properties to

handle materials as thin as 3.5 μm without compromising the ionic conductivity provided by polyethylene oxide (PEO). Poly(3,4-ethylenedioxythiophene) (PEDOT) was successfully applied on both sides of the film with three different thicknesses, mimicking the trilayer architecture. On the one hand, high ionic conductivity in the presence of an electrolyte was the main characteristic required for Solid Polymer Electrolytes (SPE). On the other hand, the use of materials with a mechanical behaviour similar to that of an elastomer became critical when dealing with electrochemomechanical devices. It was shown, in fact, that an interpenetrating polymer network architecture can be a powerful approach for such materials, as such a morphology can combine the specific properties of each polymer network in a stable manner, e.g. ionic conductivity of the PEO network and mechanical robustness of the rubber X network in PEO/X IPNs (Plesse *et al.* 2007).

2016 was the bringer of premieres. In fact, it demonstrated for the first time that a molecular diode could operate without performance degradation, up to 17 GHz and estimation of an ultimate cut-off frequency at 500 GHz was made. Another fundamental result was the first demonstration of a new line of micro-supercapacitors based on nanoporous carbon films on silicon. It resulted in significantly improved energy density to power intelligent sensors.

One of the most important areas of research in molecular electronics is the study of small molecules sandwiched between electrodes, molecules that could perform electronic functions and achieve maximum scalability. However, functional molecular devices had only been tested at low frequencies. In 2016, molecular diodes operating up to a frequency of 17.8 GHz were realised. This frequency domain called the THz gap, corresponding to frequencies between microwaves and far-infrared, is a field of research attracting much attention. Electronic devices such as Schottky diodes, resonant tunnelling diodes or THz single photon detectors continue to operate in the THz gap. The field of molecular electronics has become very active in terms of basic research, enabling rapid advances in device performance and reliability. Direct current and radio frequency (RF) properties were measured simultaneously on a large molecular junction array consisting of gold nanocrystal electrodes, ferrocenyl undecane-thiol molecules and the tip of a wave scanning interferometric microscope. The nanoscale molecular diodes offered, according to the test results, an increase in current density of several orders of magnitude compared to micrometre-scale molecular diodes, enabling radio-frequency operation (Trasobares, Vuillaume, Théron and Clement 2016). The RF molecular diodes were operated at up to 17 GHz with an estimated cutoff frequency of 520 GHz. A high-frequency molecular rectifier composed of self-assembled small molecules has become operational, thanks to research conducted in 2016. This has brought important perspectives for chemistry-based electronics. The experimental setup was optimised to demonstrate the effectiveness of a 17 GHz molecular rectifier with a cutoff frequency of 520 GHz. Approximately 150 molecules sandwiched between a gold nanocrystal and a pointed electrode, made of platinum, Pt achieved a dynamic conductance of about 0.36 mS, while maintaining a small capacitance in the range of 100 aF. Simply reducing the fringe capacitance to 50 aF by using an ultra-sharp tip or functionalising the surface between the nanocrystals would allow these diodes to be operated in the THz range, where new functionalities are theoretically expected, such as an enormous increase in the dynamic conductance of molecular devices.

The integration of electrochemical capacitors with silicon-based electronics is a major challenge, limiting energy storage on chips. A wafer-scale process for the production of carbide-derived carbon films that are fully compatible with current microfabrication technology and silicon-based devices was investigated in 2016 (Huang *et al.* 2016). The

capacity of these films reached 410 farads per cubic centimetre, 200 millifarads per square centimetre, in an aqueous electrolyte and 170 farads per cubic centimetre, 85 millifarads per square centimetre, in an organic electrolyte. The feasibility of preparing self-supporting, mechanically stable, micrometer-thick porous carbon films was also demonstrated. Its Young's modulus value was 14.5 gigapascals, and the possibility of further transfer onto flexible substrates was demonstrated. These materials proved interesting for applications in structural energy storage, tribology and gas separation. The growing number of portable electronic devices and the continuous expansion of electronics into new applications put the need to develop new devices at the forefront. Based on electrochemical storage, they are getting smaller and smaller in size and still have to guarantee high performance by being able to supply energy from their environment. Consequently, the design of efficient miniaturised energy storage or harvesting devices with high power capabilities is a challenge to be faced. Electrochemical double-layer capacitors (EDLCs), also known as supercapacitors, store charge through reversible adsorption of ions on the surface of high surface area carbons. In addition to exceptional cycle life, electrostatic charge storage has enabled devices with average energy density (around $6\text{Wh}\cdot\text{kg}^{-1}$) and high power density ($>10\text{kW}\cdot\text{kg}^{-1}$). As a result, supercapacitors have complemented, or sometimes replaced, batteries in applications ranging from electronics to public transport and renewable energy storage, where high power delivery and absorption and very long cycle life are required (Simon and Gogotsi 2002). A wide variety of materials such as graphene, carbon nanotubes, carbide-derived carbons (CDCs) and pseudocapacitive materials in micro-supercapacitors were explored in the early 2000s. Loose carbide-derived carbons CDC films showed high capacity and high areal and volumetric energy density, but poor film integrity due to cracking and delamination. For this, TiC-CDC structures were studied. Excellent mechanical properties are found in the absence of large pores or cracks, which act as defects that can weaken the film. Another key feature observed for these compounds is the possibility offered by these self-supporting CDC films to be transferred onto flexible substrates. The electrochemical performance of an 8-mm-thick CDC film transferred onto a flexible polyethylene terephthalate (PET) substrate reached $240\text{mF}\cdot\text{cm}^{-2}$. It was then possible to prepare patterned CDC microelectrodes independent of the complete chlorination of patterned TiC, which paved the way for the further development of high-performance self-contained supercapacitors that could be used in flexible or wearable applications.

It was demonstrated in 2017 that a new 3D silicon skeleton significantly improved the geometric surface area of solid-state lithium-ion microbatteries. The energy density was sufficient to meet IoT requirements. Millimetre-scale energy sources are key devices for providing autonomy to intelligent, interconnected and miniaturised sensors. However, so far, it is not yet possible to store sufficient surface energy density in flat solid-state micro-batteries to meet the needs of increasingly complex and high-performance devices. In this context, 3D-designed micro-batteries seem to be a good solution to improve the mass loading of the material while maintaining a small footprint. To significantly improve the surface capabilities of 3D lithium-ion micro-batteries on a chip, which are integrated as micropower sources for smart, connected microsensors, robust, efficient and easily scalable 3D topologies were proposed. In this way, single and dual silicon microtube scaffolds could be realized, achieving an area with an enhancement factor of 50 ± 5 . This is the same order as fragile nanostructured models for 3D-based devices (Fig. 6.4).

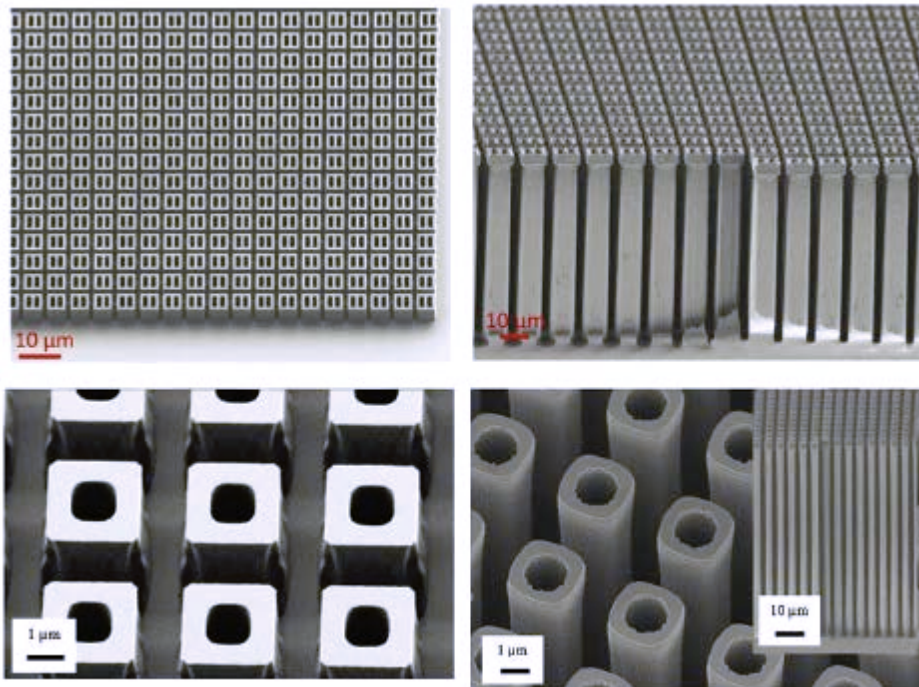

Fig. 6.4 Above: the SEM images of the Double MicroTubules, the photoresist mask on the left and the 3D silicon scaffold on the right, after the deep reactive ion etching of the wafer. Below the same structures for a Single MicroTubule series of structures. Source: Létiche *et al.* 2017

In the presented design, the distance between two robust microstructures and the inner diameter of each tube ($1\mu\text{m}$) allowed thicker layers to be deposited than were usually deposited on highly flexible nanostructured models. Four functional layers (100nm thick) of the 3D microstructure were deposited by Atomic Layer Deposition (ALD) on the proposed scaffold. An insulating layer, a current collector, a negative electrode and the solid electrolyte were then deposited gradually onto the 3D microtubes. The analyses performed, from chemical mapping obtained with TEM to synchrotron X-ray nanotomography, confirmed the shape of the deposited layers and the good quality of each interface, which did not lead to interdiffusion phenomena between the thin layers. The proposed three-dimensional pinhole-free solid electrolyte Li_3PO_4 achieved good compliance by combining a high ionic conductivity ($6.2 \times 10^{-7} \text{S} \cdot \text{cm}^{-1}$) with a low layer thickness (10nm). The surface capacity of the TiO_2 -based negative electrode when combined with this solid Li_3PO_4 electrolyte was tested to demonstrate the battery potential. For the first time, according to what is known from the literature (Létiche *et al.* 2017), an exceptional surface capacitance was achieved, close to $0.37 \text{mA} \cdot \text{h} \cdot \text{cm}^{-2}$ (at least 220% higher than the best value obtained with a TiO_2 electrode deposited on a 3D nanostructured scaffold and tested in the liquid electrolyte).

At the end of 2019, the world was confronted with the spread of a coronavirus, identified as a carrier of the disease SARS-Cov-2, about which the most controversial news has been spread. From a medical and epidemiological point of view, coronaviruses are RNA viruses,

carriers of infections that affect the respiratory tract at different levels of severity. For this reason, they are the subject of frequent research. The application of functional carbon quantum dots was studied by a collaboration between the IEMN and the University of Bochum. The antiviral activity of seven different carbon quantum dots (CQDs) was investigated for the treatment of human coronavirus HCoV–229E infections; the first generation of antiviral CQDs was derived by hydrothermal carbonisation of ethylenediamine/citric acid as carbon precursors and postmodified with boronic acid ligands. CQDs, with an average diameter of less than 10nm and characterised by excellent dispersion in water, have proved very attractive for nanomedical applications due to the lack of clear evidence of toxicity in animals. They can be synthesised rapidly, by several simple and inexpensive methods. Their excellent optical properties also offer possibilities for in vivo tracking. It has recently been shown that CQDs are suitable structures for interfering with the entry of viruses into cells. Boronic acid–modified CQDs were able to inhibit, for instance, the entry of HIV–1 by suppressing the formation of syncytia (cells or cytoplasmic mass containing several nuclei). This unique study revealed that boronic acid functions could be responsible for anti-HCoV activity. Multiple types of CQDs were prepared (Fig. 6.5 and Fig. 6.6).

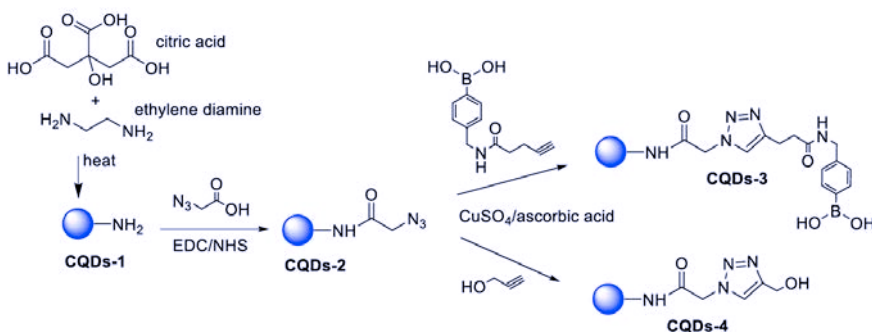

Fig. 6.5 The schematic synthesis of the first four CQDs. Source: Łoczechin *et al.* 2019

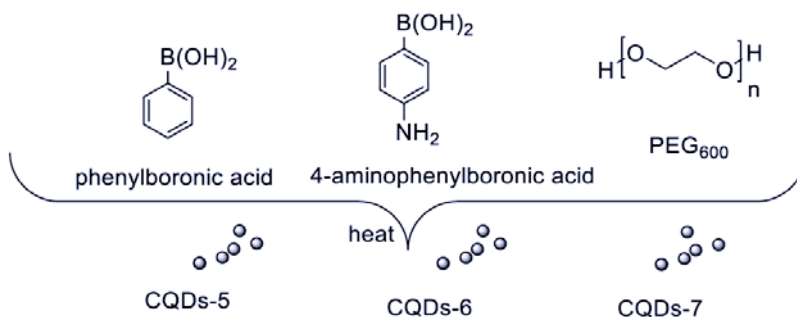

Fig. 6.6 The structure of the other three CQDs. Source: Łoczechin *et al.* 2019

The cycle of a viral infection produces important biological and structural changes in the host cell, resulting in cell damage. The possibility of interfering with viral attachment to cells and with the replication of the infecting agent, in order to reduce the infection and spread of the virus, represents an appropriate antiviral approach. Here, the antiviral performance of seven different CQDs was presented. Three of these CQDs (CQD 3, 5 and 6) were shown to significantly interfere with HCoV-229E infection in a concentration-dependent manner, whereas CQDs-4 showed very moderate antiviral activity. The estimated value of the EC_{50} , the half-maximal Effective Concentration (EC_{50}) is a measure of the concentration of a drug that induces a response midway between baseline and maximum after a given exposure time, decreased considerably from CQDs-3, quantum dots modified with boronic acid derived from ethylenediamine/citric acid as carbon precursors ($EC_{50} = 52 \pm 8 \mu\text{g mL}^{-1}$) to $5.2 \pm 0.7 \mu\text{g mL}^{-1}$ in the case of CQDs-6. While the presence of boronic acid functions proved crucial in coating CQDs-3 with antiviral activity, CQDs-5 and CQDs-6 lacked a substantial amount of boronic acid functions, as revealed by BNMR and validated by mannose addition experiments. These results revealed the complex nature of identifying viral inhibitors for human coronaviruses such as HCoV-229E-Luc. Mechanistic studies suggest that the particles act in the initial state of viral infection through inhibition of entry, which could be due to inhibition of the interaction of the S-protein receptor with the host cell membrane.

In 2019, a group was founded at IEMN to study the history of physics, the history of applied science and technology. Created thanks to the initiative of my thesis coordinator, Prof. Raffaele Pisano HDR, the History of Physics and Applied Sciences & Technology (HOPAST) brings together the international legacy of IEMN in the fields of Physics, Physics-Mathematics & Applied Sciences (Technique/Technology) into the History, inquiring Historical Foundations of Sciences, Methods and Scientific Thought. The fields of study towards which this research group is oriented are the History of Physics, History of Applied Science & Technology, Science-Society, Historical Epistemology of Science, Intellectual History & Ideas, Comparative History and the Nature of Science. In detail, the historical subjects are Mathematization of Nature, Science of Weights & Early Technologies, Galilean & Newtonian Sciences, Revolutions, Modelling Physics-Mathematics Relationships, Number Theory, Mathematical Approaches to Physics, Modelling Applied Science, Machines, the Works of Lazare and Sadi Carnot, Thermodynamics, Electromagnetism, Blackbody Radiation, Quantum Mechanics, Nanotechnology, Logical Organization & Structures, Historical-Epistemological Foundations of Scientific Thinking, Rethinking Mathematical Models & Physical Phenomena, Concepts, Visualization of Knowledge, Civilization & Science. I myself am a member of this group; the first co-authored papers have already been prepared and are awaiting official publication (Pisano, Marmottini and Durlo exp. 2023, Pisano and Durlo exp. 2024, Durlo preprint).

Acoustic tweezers were inspired by an instrument known as “optical tweezers”, invented in the 1980s, which is basically a laser focused on a point. An object placed in a laser beam feels a push from the photons striking it. If the beam is shaped so that the object feels a balance of forces at the centre of the laser, this device is useful for grasping very small objects. Individual atoms and molecules have been trapped and manipulated in optical tweezers. Tweezers were also used to measure the elasticity of the DNA double helix. Precisely because of this potential, acoustic tweezers have opened up important perspectives in microbiology to manipulate cells and microorganisms without contact. They can also be used for organising and testing mechanical properties, as they are biocompatible, label-free

and have the potential to exert forces several orders of magnitude greater than their optical counterparts with equivalent power. However, these prospects have so far been hampered by the lack of spatial selectivity the acoustic tweezers made. There is, for them, neither the ability to select and move objects individually, nor good resolution. Their use is therefore limited to the manipulation of large particles, and/or, finally, by the limited forces they can apply. In 2020, a selective manipulation was performed at the IEMN laboratories that resulted in the positioning of individual cells, using forces of up to around 200pN, without affecting their viability (Baudoin *et al.* 2020). The results were obtained with miniaturised acoustic tweezers that combine holography with active materials to synthesise specific wave fields called focused acoustic vortices, designed to produce localised hard traps with reduced acoustic power. In order to trap the particles, spherically focused acoustic vortices were chosen. The concentration of energy resulting from a 3D focus allowed high amplitude to be achieved at the focus by low-power transducers. These spherical vortices were synthesised by materialising the hologram of a vortex at ~45MHz with metal electrodes on the surface of an active piezoelectric substrate. The hologram was then discretized on two levels, resulting in two intertwined spiral electrodes, which were modelled in a clean room using standard photolithography techniques. Secondly, the design of the electrodes was optimised to reduce the consequences of the Joule effect (amplified by scale reduction) within the electrodes. To avoid this effect, (i) the thickness of the metal electrodes was increased by a factor of 2 (400nm gold and 40nm titanium); (ii) the width of the electrical connections supplying power to the spirals was significantly increased to avoid any dissipation before the active region; and (iii) two radial electrodes covering half of the spirals were added as a dispositive to efficiently bring power to the guide electrode. Thirdly, a 1.1mm glass substrate was bonded to the electrodes and placed between the transducers and the microfluidic chamber where the cells are manipulated. The glass substrate had a dual function: (i) it allowed the focusing of the wave and (ii) it thermally insulated the microfluidic device from the electrodes. The final device thus consisted of: (i) holographic spiral transducers excited with a sinusoidal electrical signal that generated an acoustic vortex that propagated and focused within a glass substrate; (ii) a PDMS microfluidic chamber, supported by a slide containing cells and placed above the substrate, where the acoustic vortex created a trap; and (iii) a motorised stage that allowed X and Y displacement of the microfluidic chamber relative to the trap. The entire transparent system was integrated into an inverted microscope. The first demonstration of the selective nature of the tweezers was given by the ability to pick up a single MDA-MB-231 cell, $7\pm 1\mu\text{m}$ in radius, from a set of cells. The harvested cell was then moved along a slalom path between other cells that were free to move and acted as poles. A second cell, which initially acted as a slalom marker, was then moved to show that it was free. The precise movement could be performed in any direction, and even in the presence of other cells without any risk of coalescence. Some of the key abilities enabled by the selective acoustic tweezers, and demonstrated in practice, were thus the capture, positioning and release of cells at precise, pre-defined points. As an example, a total of ten individual MDA cells were positioned to spell out the letters A and T of the words Acoustic Tweezers. It took just under 10 minutes, in total, of manipulation to achieve these results, i.e. less than 2 minutes per cell.

The contemporary world has made network connectivity a *de facto* prerequisite, and mobile connectivity an indispensable necessity for many of its users. The need of our times is to develop information technology to provide users with increasingly fast, secure, accessible and intelligent networks capable of communicating with a wide variety of devices. The introduction of the so-called 5G NR (New Radio) by the 3GPP (3rd Generation

Partnership Project) is expected soon. In this way, it should be possible to achieve higher data rates, characterised by greater stability and efficiency than the current standard, such as 4GLTE (Long-Term Evolution). The application domain of the networks is extending beyond conventional telephony to industrial automation and vehicle communications (Vehicle-to-Everything, V2X), smart devices and smart cities. Massive MIMO (Multiple Input Multiple Output, where the number of terminals is much lower than the number of base stations) and the use of higher bandwidths at millimetre wave (mmW) frequencies are the most studied by the research community, among the new technologies that should guarantee the specifications expected from 5G NR. Massive MIMO is an asymptotic extension of Multi-User MIMO (MUMIMO) where the number of transmit antennas is very high compared to previous MIMO techniques. In 2021, the first V2I (Vehicle-to-Infrastructure) channel detection campaign was launched using a massive real-time radio sounder called MaMIMOSA (Gaillot *et al.* 2021). The system was equipped with a massive array of 64 antennas for Tx, the transmission, while up to 16 individual antennas could be used for Rx, the reception. MaMIMOSA's hardware and software capabilities proved to freely adapt the sounder's parameters to the studied scenario, demonstrating its versatility and flexibility. Radio channels were measured at 5.89GHz with a bandwidth of 80MHz at the University of Lille campus, with an average vehicle speed of 30km/h. In addition to this suburban mobility scenario, static line-of-sight radio channels were collected for a road-parking configuration to study the influence of vegetation. To this end, the University of Lille (France) and the University of Ghent (Belgium) jointly developed a massive 64×16 MIMO real-time radio channel operating between 2GHz and 12GHz with a bandwidth of 80MHz for 5G mobility scenarios such as V2X communications. The architecture is based on the physical and software reconfigurable MaMIMOSA (MIMO Sounding Architecture) radio channel. MaMIMOSA (Massive MIMOSA) is designed to fulfil all constraints identified in time-varying massive MIMO channels, such as high Doppler resolution, antenna spatial selection, compactness, power consumption, etc. The sounder parameters of the developed massive system can be freely selected according to the studied environment, resulting in the measured massive MIMO radio channel without the need for further post-processing. The MaMIMOSA antenna array was realised through a 10×10 vertical planar antenna array built by the University of Ghent. 64 elements of the array were connected to the Tx transmission unit via coaxial cables, while the 36 remaining antennas on the perimeter were used as dummies to attenuate the side effects of the finished array. In this work, MaMIMOSA was configured to perform radio channel measurements of up to 64×8 at 5.89GHz with a bandwidth of 80MHz for V2I communications. In the first set of measurements, 64×1 time-varying radio channels were evaluated in the scientific campus of the University of Lille, with an average vehicle speed of 30km/h and a No Line-Of-Sight/Line-Of-Sight (NLOS/LOS) shadowing condition (Fig. 6.7).

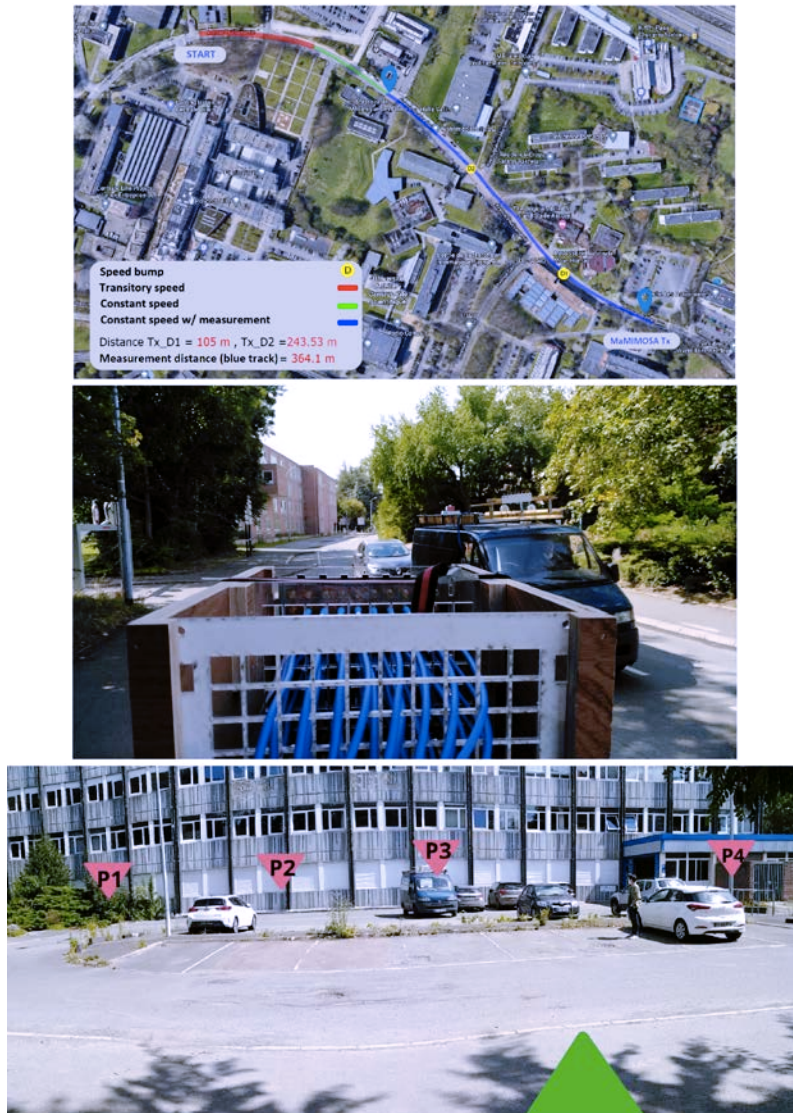

Fig. 6.7 Top: schematic top view of the V21 measurement campaign at the University of Lille campus. Centre: Picture from the rear side of the Tx array with the van completing its drive test. The Rx antenna was one of the 8 antennas located on the van Rooftop. Bottom: the schematic top view of the 4 OLOS static measurement positions. The green triangle corresponds to the Tx position on the sidewalk behind the trees observable by their shadows on the ground. Source: Gaillot *et al.* 2021

The massive array of 64 antennas was placed on a tripod, on the same position on the pavement, during the entire measurement campaign. The emitted power for the RF chain was set to 0dB·m during the entire measurement campaign, knowing that the maximum power per RF chain is 30dB·m. The Tx transmitter was positioned so that its main radiation lobe was parallel to the main driveway where the vehicle would move. The single Rx receiver antenna was placed on the roof of a van; it is the same as the array's elementary

antenna. The van performed a test drive along the avenue, maintaining an average speed of 30km/h towards the Tx. The radio channel was measured during 89 frames with the streaming mode for a total recording time of 45 seconds. Static LOS (OLOS) 64×8 radio channels were measured between the transmitter located on the roadside and the receiver in an adjacent car park, to assess the influence of the presence of vegetation on the signals. Static LOS (OLOS) 64×8 radio channels were measured between the transmitter located on the roadside and the receiver in an adjacent car park, to assess the influence of the presence of vegetation on the signals. From the measured channels, an initial analysis of the RMS delay spread, received SNR and Doppler/speed characteristics were performed. The results showed that these characteristics are highly uniform over the entire massive antenna array, with no masking effects. The campaign has already highlighted the potential of MaMIMOSA in faithfully capturing the main characteristics of radio channels, which can subsequently be used to develop realistic models of massive MIMO radio channels.

Signal processing can be carried out not only electronically, but also on a mechanical basis through devices such as electromechanically coupled resonators, which can be driven and integrated with external circuits. In the field of research, great efforts have been made to study the coupling that exists between different mechanical modes in a single system, and between different resonators. Coupled mechanical modes not only increase the sensitivity in detecting information but also give access to the exchange of energy between different mechanical modes, an exchange that allows, for example, the transmission or filtering of information in different frequency bands. In 2022, a room-temperature electromechanical phonon cavity system consisting of two separate resonators, i.e. an electromechanical silicon nitride drum capacitively coupled to an aluminium drum, was examined at IEMN. Phonon cavities have been extensively exploited in mechanical mode coupling studies. To generate phonon-phonon interactions, the typical method is to implement the mechanical mode with the highest resonance frequency Ω_1 in the coupled system as a “phonon cavity”. The system is then sent into a sideband at an approximate frequency of $\Omega_1 \pm \Omega_2$, where Ω_2 is the resonance frequency of the other mode. It has also been shown that an optomechanical system consisting of coupled mechanical modes offers greater flexibility in adjusting the window for signal processing and increased information storage time. In research conducted at IEMN, the feasibility of transducing mechanical motion between two separate, capacitively coupled electromechanical resonators, the first consisting of an Al drum and the second of a SiN drum, was demonstrated. Both resonators can be driven and sensed independently. In a two-tone driving scheme, the electromechanics of the phonon cavity was explored on the basis of a simple theoretical model analogous to microwave optomechanics. Modulations of the mechanical damping rate were observed in both resonators and show the trend predicted by the theoretical model. These results indicate that this new type of device could be used for phonon-based information processing in both classical and quantum regimes, as well as for their storage. A simple coupling model was therefore constructed to describe the transduction of mechanical motion within the two capacitively coupled electromechanical resonators. In a two-tone drive scheme, the transparency and electromechanical amplification of the injected signals were created and manipulated at room temperature. The unique device structure made it possible to observe the phonon-cavity force influencing the mechanical damping rates of both coupled resonators. These optomechanical characteristics are described by the equations of linear mechanical motion and provide theoretical analyses quantitatively adapted to the results. Investigations have established connections between a

setup with two directly coupled moving objects and a standard optomechanical system in classical regime. This type of distinct capacitively coupled electromechanical systems can be useful for constructing multimodal optomechanical systems operating in both classical and quantum regimes, providing a new degree of freedom in engineering photon/phonon processing, such as delay, storage and signal amplification (Pokharel *et al.* 2022).

Epilogue VI

2022 marked the 30th anniversary of the founding of the IEMN, Institut d'Électronique de Microélectronique et de Nanotechnologie, which was celebrated with a series of events at the end of January 2023.

In its first 30 years of existence, thanks to the research activities carried out with constant enthusiasm by its staff, the availability of state-of-the-art research equipment, and close collaborations with national and international organisations and industries, the IEMN has come to the world's attention as one of the leading materials research centres.

The focus on the fields of electronics, whether micro- or nanosystems, telecommunications, materials and their properties has enabled this centre to establish itself as a pole of excellence in scientific innovation.

The three decades in which the IEMN's activities laid its first foundations and subsequently developed have witnessed successes, recognised in the value of the discoveries made, some of which were absolutely pioneering, and in the national and international awards that the centre's staff have won. Merit medals for research and scholarships awarded to IEMN researchers are tangible evidence of the very high quality of the work that is carried out daily in the laboratories.

The fruitful collaboration with small and medium-sized industries and with international partners also confirms the IEMN's vocation for working in partnership with external parties, in order to meet the needs of the industrial world through the quality of the results obtained.

One of the tangible testimonies to the amount of work that has been and is being done in IEMN circles is certainly the bibliography of publications produced over time. The articles written at the IEMN report results in the most diverse areas of research that have to do with the institute's vocation for the exploration of electronics and materials at different scales. This fact, perfectly in line with the transversality of the study of Nanotechnology, for example, is further proof of the dynamism and collaboration between the various research areas.

Choosing which of the published articles could be the most significant in order to best represent the thirty years of the IEMN to the public was undoubtedly a very difficult task. A great deal of help in this regard came from Dir. Delerue, Director of Research, and Prof. Pisano, Director of HOPAST, whose experience made it possible to select the articles from two perspectives, the scientific and the historical. The volume of publications has thus been reduced to around fifty works, which have been commented on in this chapter and compared with the literature that has marked the thirty years of history, in parallel with that of the IEMN.

To celebrate this important occasion, a large-scale banner was created and exhibited, that collected the highlights of three decades of the history of this technological pole, at the forefront of materials and electronics research.

Added to this paper was my contribution regarding the History of Nanoscience and Nanotechnology, covering the most important events and publications from 1992 to 2022 (Fig. 6.8).





Fig. 6.8 The pictures of the commemorative banner exhibit the entrance hall of IEMN. Source: Courtesy Prof. Raffaele Pisano HDR 2023

To emphasise the breadth and complexity of the work being carried out by the institute, comparisons are made here. First, the reader is shown which events have occurred in the history of the IEMN since its foundation, in parallel with the most important moments in the History of Nanoscience. Then, the titles of the most important articles in the history of Nanotechnology are given, and those that have featured prominently in the history of the institute. Both of these comparisons reveal the undoubted scientific standing that makes the IEMN one of the most advanced and prestigious research centres on the international scientific scene.

During its first 30 years of research history, the IEMN has seen its researchers publish more than 4600 papers on a wide variety of topics related to electronics, microelectronics and nanotechnology. As a special tribute to my supervisor, Prof. Pisano, and to Prof. Delerue, Fabrizio

Cleri and Stefano Giordano, with whom I had the opportunity to exchange ideas and impressions at the Department Day, held in Ennevelin, on 19 July 2022, I have dedicated a special section in the bibliography of this chapter to them. The history of their work is collected in this section, together with the publications of my supervisor. I have also included those papers that, also with my contribution, are planned to be published soon.

Finally, during the Department Day, it was my privilege to be able to display a poster, created together with my supervisor, in which I collected the contents of my thesis.

References

Primary Sources

- Al Hadi R, Sherry H, Grzyb J, Zhao Y, Förster W, Keller HM, Cathelin A, Kaiser A, Pfeiffer UR (2012) A 1 k-Pixel Video Camera for 0.7–1.1 Terahertz Imaging Applications in 65-nm CMOS. *IEEE Journal of Solid-State Circuits* 47/12:2999–3012. doi:10.1109/JSSC.2012.2217851
- Alibart F, Pleutin S, Guérin D, Novembre C, Lenfant S, Lmimouni K, Gamarat C, Vuillaume D (2010) An Organic Nanoparticle Transistor Behaving as a Biological Spiking Synapse. *Advanced Functional Materials* 20:330–337. doi:10.1002/adfm.200901335
- Association de Solidarité des Anciens De l'Université Lille 1 – Sciences et Technologies (2016) La Mémoire de la Faculté des Sciences et de l'Université de Lille 1 1960–1975. *Bulletin de l'A.S.A.* Imprimerie de l'Université Lille 1
- Baudoin M, Thomas JL, Al Sahely R, Gerbedoen JC, Gong Z, Sivery A, Bou Matar O, Smagin N, Favreau P, Vlandas A (2020) Spatially Selective Manipulation of Cell with Single-Beam Acoustical Tweezers. *Nature Communications* 11/4244:1–10. doi:10.1038/s41467-020-18000-y
- Berthe M, Stiufiuc R, Grandidier B, Deresmes D, Delerue C, Stiévenard D (2008) Probing the Carrier Capture Rate of a Single Quantum Level. *Science* 319/5862:436–438. doi:10.1126/science.1151186
- Bethoux JM, Happy H, Siligaris A, Dambrine G, Borghetti J, Derycke V, Burgoin JP (2006) Active Properties of Carbon Nanotube Field-Effect Transistors Deduced From S Parameters Measurements. *IEEE Transactions on Nanotechnology* 5/4:335–342. doi:10.1109/TNANO.2006.876931
- Bollaert S, Cordier Y, Hoel V, Zaknoute M, Happy H, Lepilliet S, Cappy A (1999) Metamorphic $\text{In}_{0.4}\text{Al}_{0.6}\text{As}/\text{In}_{0.4}\text{Ga}_{0.6}\text{As}$ HEMT's on GaAs Substrate. *IEEE Electronic Device Letters* 20/3:123–125. doi:10.1109/55.748908
- Bou Matar O, Robillard JF, Vasseur JO, Hladky-Hennion AC, Deymier PA, Pernod P, Preobrazhensky V (2012) Band Gap Tunability of Magneto-Elastic Phononic Crystal. *Journal of Applied Physics* 111/5:1–14. doi:10.1063/1.3687928
- Boulas C, Davidovits JV, Rondelez F, Vuillaume D (1996) Suppression of Charge Carrier Tunneling through Organic Self-Assembled Monolayers. *Physical Review Letters* 76/25:4797–4800. doi:10.1103/PhysRevLett.76.4797
- Carlier J, Arscott S, Thomy V, Fourrier JC, Caron F, Camart JC, Druon C, Tabourier P (2004) Integrated Microfluidics based on Multi-Layered SU-8 for Mass Spectrometry Analysis. *Journal of Micromechanics and Microengineering* 14/4:619–624. doi:10.1088/0960-1317/14/4/024
- Chimot N, Mangeney J, Joulaud L, Crozat P, Bernas H, Blary K, Lampin JF (2005) Terahertz Radiation from Heavy-Ion-Irradiated $\text{In}_{0.53}\text{Ga}_{0.47}\text{As}$ Photoconductive Antenna Excited at 1.55 μm . *Applied Physics Letters* 87/19:1–3. doi:10.1063/1.2126110
- Collet J, Tharaud O, Chapoton A, Vuillaume (2000) Low-Voltage, 30nm Channel Length, Organic Transistors with a Self-Assembled Monolayer as Gate Insulating Films. *Applied Physics Letters* 76/14:1941–1943. doi:10.1063/1.126219
- Dambrine G, Happy H, Danneville F, Cappy A (1993) A New Method for On Wafer Noise Measurement. *IEEE Transactions on Microwave Theory and Techniques* 41/3:375–381. doi:10.1109/22.223734
- Dargent T, Haddadi K, Lasri T, Clément N, Ducatteau D, Legrand B, Tanbakuchi H, Theron D (2013) An Interferometric Scanning Microwave Microscope and Calibration Method for Sub-fF Microwave Measurements. *Review of Scientific Instruments* 84/12:1–7. doi:10.1063/1.4848995
- Degardin V, Lienard M, Degauque P, Simon E, Laly P (2008) Impulsive Noise Characterization of In-Vehicle Power Line. *IEEE Transactions on Electromagnetic Compatibility* 50/4:861–868. doi:10.1109/TEMC.2008.2006851
- Deokar G, Avila J, Razado-Colombo I, Codron JL, Boyaval C, Galopin E, Asencio MC, Vignaud D (2015) Towards High Quality CVD Graphene Growth and Transfer. *Carbon* 89:82–92. doi:10.1016/j.carbon.2015.03.017
- Devos A, Côte R (2004) Strong Oscillations Detected by Picosecond Ultrasonics in Silicon: Evidence for an Electronic-Structure Effect. *Physical Review B* 70/12:1–6. doi:10.1103/PhysRevB.70.125208

- Ducatteau D, Minko A, Hoël V, Morvan E, Delos E, Grimbert B, Lahreche H, Bove P, Giaquière C, De Jaeger JC, Delage S (2006) Output Power Density of 5.1/mm at 18 GHz with an AlGaIn/GaN HEMT on Si Substrate. *IEEE Electron Device Letters* 27/1:7–9. doi:10.1109/LED.2005.860385
- Ducournau G, Szriftgiser P, Beck A, Bacquet D, Pavanello F, Peytavit E, Zaknoute M, Akalin T, Lampin JF (2014) Ultrawide-Bandwidth Single-Channel 0.4–THz Wireless Link Combining Broadband Quasi-Optic Photomixer and Coherent Detection. *IEEE Transactions on Terahertz Science and Technology* 4/3:328–337. doi:10.1109/TTHZ.2014.2309006
- Duquennoy M, Ouafitouch M, Qian ML, Jenot F, Ourak M (2001) Ultrasonic Characterization of Residual Stresses in Steel Rods Using a Laser Line Source and Piezoelectric Transducers. *NDT&E International* 34/5:355–362. doi:10.1016/S0963-8695(00)00075-X
- Durlo A (2023) 1950s–1990s: Carbon Nanotubes Studies into Historiography of Nanoscience–Nanotechnology, *pre-print*
- Graf D, Molitor F, Ensslin K, Stampfer C, Jungen A, Hierold C, Wirtz L (2007) Spatially Resolved Raman Spectroscopy of Single- and Few-Layer Graphene. *Nano Letters* 7/2:238–242. doi:10.1021/nl061702a
- Grandidier B, Niquet YM, Legrand B, Nys JP, Priester C, Stiévenard, Gérard JM, Thierry–Mieg V (2000) Imaging the Wave-Function Amplitudes in Cleaved Semiconductor Quantum Boxes. *Physical Review Letters* 85/5:1068–1071. doi:10.1103/PhysRevLett.85.1068
- Grondel S, Delebarre C, Assaad J, Dupuis JP, Reithler L (2002) Fatigue Crack Monitoring of Riveted Aluminium Strap Joints by Lamb Wave Analysis and Acoustic Emission Measurement Techniques. *NDT&E International* 35/3:137–146. doi:10.1016/S0963-8695(01)00027-5
- Hassan K, Dayoub I, Hamouda W, Nzéza CN, Berbineau M (2012) Blind Digital Modulation Identification for Spatially-Correlated MIMO Systems. *IEEE Transactions on Wireless Communications* 11/2:683–693. doi:10.1109/TWC.2011.122211.110236
- Huang P, Lethien C, Pinaud S, Brousse K, Laloo R, Turq V, Respaud M, Demortière A, Daffos B, Taberna PL, Chaudret B, Gogotsi Y, Simon P (2016) On-Chip and Freestanding Elastic Carbon Films for Micro-Supercapacitors. *Materials Science* 351/6274:691–695. doi:10.1126/science.aad3345
- Knap W, Lusakowski J, Parenty T, Bollaert S, Cappy A, Popov VV, Shur MS (2004) Terahertz Emission by Plasma Waves in 60nm Gate High Electron Mobility Transistors. *Applied Physics Letters* 84/13:2331–2333. doi:10.1063/1.1689401
- Lampin E, Cleri F, et al. (2013) Thermal Conductivity from Approach-to-Equilibrium Molecular Dynamics. *Journal of Applied Physics* 114/3:1–5. doi:10.1063/1.4815945
- Langlet P, Hladky–Hennion AC, Decarpigny JN (1995) Analysis of the Propagation of Plane Acoustic Waves in Passive Periodic Materials using the Finite Element Method. *The Journal of the Acoustical Society of America* 98/5:2792–2800. doi:10.1121/1.413244
- Létiche M, Eustache E, Freixas J, Demortière A, De Andrade V, Morgenroth L, Tilmant P, Vaurette F, Troadec D, Roussel P, Brousse T, Lethien C (2017) Atomic Layer Deposition of Functional Layers for on Chip 3D Li–Ion All Solid State Microbattery. *Advanced Energy Materials* 7/2:1–12. doi:10.1002/aenm.201601402
- Łoczechin A, Séron K, Barras A, Giovanelli E, Belouzard S, Chen YT, Metzler–Nolte, Boukherroub R, Dubuisson J, Szunerits S (2019) Functional Carbon Quantum Dots as Medical Countermeasures to Human Coronavirus. *ACS Applied Materials & Interfaces* 11/46:42964–42974. doi:10.1021/acsami.9b15032
- Medjdoub F, Zegaoui M, Ducatteau D, Rolland N, Rolland PA (2011) High Performance Low–Leakage–Current AlN/GaN HEMTs Grown on Silicon Substrate. *IEEE Electron Device Letters* 32/7:874–876. doi:10.1109/LED.2011.2138674
- Mélin T, Deresmes D, Stiévenard D (2002) Charge Injection in Individual Silicon Nanoparticles Deposited on a Conductive Substrate. *Applied Physics Letters* 81/26:5054–5056. doi:10.1063/1.1532110
- Metzger RM, Chen B, Höpfner U, Lakshminantham MV, Vuillaume D, Kawai T, Wu X, Tachibana H, Hughes TV, Sakurai H, Baldwin JW, Hosch C Cava MP, Brehmer L, Ashwell GJ (1997) Unimolecular Electrical Rectification in Hexadecylquinolinium Tricyanoquinodimethanide. *Journal of the American Chemical Society* 119:10455–10466
- Pennec Y, Djafari–Rouhani B, Larabi, H, Vasseur, Hladky–Hennion AC (2008) Low-Frequency Gaps in a Phononic Crystal Constituted of Cylindrical Dots deposited on a Thin Homogeneous Plate. *Physical Review B* 78/10:1–8. doi:10.1103/PhysRevB.78.104105

- Pisano R, Durlo A (2024) A Feynman's Frameworks on Nanotechnology in a Historiographical Debate. In Conde M, Salomon M (eds), *Handbook of the historiography of science*, Dordrecht: Springer, *In press*
- Pisano R, Marmottini D, Durlo A (2023) Lagrange's Method and Lagrangian's Mechanism in Maxwell's. A Treatise on Electricity and Magnetism (1873). In R. Pisano (ed.), *A history of physics: phenomena, ideas & mechanisms – Essays in honour of Salvo D'Agostino*, Dordrecht: Springer, *Forthcoming*
- Plissard S, Dick KA, Larrieu G, Godey S, Addad A, Wallart X, Caroff P (2010) Gold-Free Growth of GaAs Nanowires on Silicon: Arrays and Polytypism. *Nanotechnology* 21/38:1–8. doi:10.1088/0957-4484/21/38/385602
- Rais-Zadeh M, Gokhale VJ, Ansari A, Faucher M, Théron D, Cordier Y, Buchailot L (2014) Gallium Nitride as an Electromechanical Material. *Journal of Microelectromechanical Systems* 23/6:1252–1270. doi:10.1109/JMEMS.2014.2352617
- Sourikopoulos I, Hedayat S, Loyez C, Danneville F, Hoel V, Mercier E, Cappy A (2017) A 4-fJ/Spike Artificial Neuron in 65nm CMOS Technology. *Frontiers in Neurosciences* 11/123:1–14. doi:10.3389/fnins.2017.00123
- Szunerits S, Maalouli N, Wijaya E, Vilcot JP, Boukherroub R (2013) Recent Advances in the Development of Graphene-Based Surface Plasmon Resonance (SPR) Interfaces. *Analytical and Bioanalytical Chemistry* 405/5. doi:10.1007/s00216-012-6624-0
- Trasobares J, Vuillaume D, Théron D, Clément N (2016) A 17 GHz Molecular Rectifier. *Nature Communications* 7:1–9. doi:10.1038/ncomms12850
- Velu G, Legrand C, Tharaud O, Chapoton A, Remiens D, Horowitz G (2001) Low Driving Voltages and Memory Effect in Organic Thin-Film Transistors with a Ferroelectric Gate Insulator. *Applied Physics Letters* 79/5:659–661. doi:10.1063/1.1379059
- Win P, Druelle Y, Cappy A, Cordier Y, Favre J, Bouillet C (1992) Metamorphic In_{0.3}Ga_{0.7}As/In_{0.29}Al_{0.71}As Layer on GaAs: A New Structure for High Performance High Electron Mobility Transistor Realization. *Applied Physics Letters* 61/8:922–924. doi:10.1063/1.107729
- Wolkin MV, Jorne J, Fauchet PM, Allan G, Delerue C (1999) Electronic States and Luminescence in Porous Silicon Quantum Dots: The Role of Oxygen. *Physical Review Letters* 82/1:197–200. doi:10.1103/PhysRevLett.82.197
- Zhou H, Talbi A, Tiercelin N, Bou Matar O (2014) Multilayer Magnetostrictive Structure Based Surface Acoustic Wave Devices. *Applied Physics Letters* 104/11:111401.1–111401.4. doi:10.1063/1.4868530

Secondary Sources

- Al-Otaify A, Kershaw SV, Gupta S, Rogach AL, Allan G, Delerue C, Binks DJ, David (2013) Multiple Exciton Generation and Ultrafast Exciton Dynamics in HgTe Colloidal Quantum Dots. *Physical Chemistry Chemical Physics* 15/39:16864–16873
- Allan G, Barbet S, Coffinier Y, Delerue C, Deresmes D, Diarra M, Diesinger H, Grandidier B, Marcon L, Melin T, Melnyk O, Stievenard D, Wirtz L, Zdrojek M (2008) Fundamental Studies in Nanosciences at the Institute of Electronics, Microelectronics, and Nanotechnology (IEMN). *International Journal of Nanotechnology* 5/6–8:631–648
- Allan G, Delerue C (2002) Efficient Intraband Optical Transitions in Si Nanocrystals. *Physical Review B* 66/23:233303–233307
- Allan G, Delerue C (2004) Confinement Effects in PbSe Quantum Wells and Nanocrystals. *Physical Review B* 70/24:245321–245330
- Allan G, Delerue C (2005) Unusual Quantum Confinement Effects in IV–VI Materials. *Materials Science & Engineering C–Biomimetic and Supramolecular System* 25-5/8:687–690
- Allan G, Delerue C (2006) Role of Impact Ionization in Multiple Exciton Generation in PbSe Nanocrystals. *Physical Review B* 73/20:205423–205428
- Allan G, Delerue C (2007) Energy Transfer between Semiconductor Nanocrystals: Validity of Forster's Theory. *Physical Review B* 75/19:195311–195319
- Allan G, Delerue C (2009) Fast Relaxation of Hot Carriers by Impact Ionization in Semiconductor Nanocrystals: Role of Defects. *Physical Review B* 79/19:195324–195329

- Allan G, Delerue C (2011) Optimization of Carrier Multiplication for More Efficient Solar Cells: The Case of Sn Quantum Dots. *ACS Nano* 5/9:7318–7323
- Allan G, Delerue C (2012) Tight-Binding Calculations of the Optical Properties of HgTe Nanocrystals. *Physical Review B* 86/16:165437–165443
- Benedito M, Giordano S (2018a) Isotensional and Isometric Force–Extension Response of Chains with Bistable Units and Ising Interactions. *Physical Review E* 98/5:052146–051164
- Benedito M, Giordano S (2018b) Thermodynamics of Small Systems with Conformational Transitions: The Case of Two–State Freely Jointed Chains with Extensible Units. *Journal of Chemical Physics* 149/5:054901
- Benedito M, Giordano S (2019) Full Statistics of Conjugated Thermodynamic Ensembles in Chains of Bistable Units. *Inventions* 4/1:1–23
- Benedito M, Giordano S (2020) Unfolding Pathway and its Identifiability in Heterogeneous Chains of Bistable Units. *Physics Letters A* 384/5:126124–125133
- Berthe M, Stiufluic R, Grandidier B, Deresmes D, Delerue C, Stievenard D (2008) Probing the Carrier Capture Rate of a Single Quantum Level. *Science* 329/5862:436–438
- Berthe M, Urbietta A, Perdigo L, Grandidier B, Deresmes D, Delerue C, Stievenard D, Rurali R, Lorente N, Magaud L, Ordejon P (2006) Electron Transport Via Local Polarons at Interface Atoms. *Physical Review Letters* 97/20:206801–206805
- Beugeling W, Kalesaki E, Delerue C, Niquet YM, Vanmaekelbergh D, Smith CM (2015) Topological States in Multi–Orbital HgTe Honeycomb Lattices. *Nature Communications* 6:6316
- Biadala L, Peng W, Lambert Y, Kim JH, Cannesson D, Houppé A, Berthe M, Troadec D, Deresmes D, Patriarche G, Xu T, Pi X, Wallart X, Delerue C, Bayer M, Xu J, Grandidier B (2019) Trap–Free Heterostructure of PbS Nanoplatelets on InP(001) by Chemical Epitaxy. *ACS Nano* 13/2:1961–1967
- Biaye M, Amit Y, Gradkowski K, Turek N, Godey S, Makoudi Y, Deresmes D, Tadjine A, Delerue C, Bailin U, Melin T (2019) Doped Colloidal InAs Nanocrystals in the Single Ionized Dopant Limit. *Journal of Physical Chemistry C* 123/23:14803–14812
- Biaye M, Zbydniewska E, Mélin T, Deresmes D, Copie G, Cleri F, Sangeetha N, Decorde N, Viallet B, Grisolia J, Ressler L, Diesinger H (2016) Tunneling Mechanism and Contact Mechanics of Colloidal Nanoparticle Assemblies. *Nanotechnology* 27/47:475502
- Bourgoin JC, Hammadi H, Stellmacher M, Nagle J, Grandidier B, Stievenard D, Nys JP, Delerue C, Lannoo M (1999) As Antisite Incorporation in Epitaxial Growth of GaAs. *Physica B–Condensed Matter* 273–4:725–728
- Buzea C, Pacheco Blandino II, Robbie K (2007) Nanomaterials and Nanoparticles: Sources and Toxicity. *Biointerphases* 2/4: MR17–MR172. doi:10.1116/1.2815690
- Cadirci M, Stubbs SK, Hardman SJO, Masala O, Allan G, Delerue C, Pickett N, Binks DJ (2012) Ultrafast Exciton Dynamics in InAs/ZnSe Nanocrystal Quantum Dots. *Physical Chemistry Chemical Physics* 14/43:15166–15172
- Cannizzo A, Bellino L, Florio G, Puglisi G, Giordano S (2022) Thermal Control of Nucleation and Propagation Transition Stresses in Discrete Lattices with non–Local Interactions and non–Convex Energy. *European Physical Journal Plus* 137/5:1–55
- Cannizzo A, Florio G, Puglisi G, Giordano S (2021) Temperature Controlled Decohesion Regimes of an Elastic Chain Adhering to a Fixed Substrate by Softening and Breakable Bonds. *Journal of Physics A–Mathematical and Theoretical* 54/44:445001
- Capiod P, van der Sluijs M, de Boer J, Delerue C, Swart I, Vanmaekelbergh D (2021) Electronic Properties of Atomically Coherent Square PbSe Nanocrystal Superlattice Resolved by Scanning Tunneling Spectroscopy. *Nanotechnology* 32/32:325706
- Chae SH, Lee YH (2014) Carbon Nanotubes and Graphene towards Soft Electronics. *Nano Convergence* 1/1:1–26. doi:10.1186/s40580–014–0015–5
- Chehaibou B, Izquierdo E, Chu A, Abadie C, Cavallo M, Khalili A, Dang TH, Greboval C, Xu XZ, Ithurria S, Vincent G, Gallas B, Mugny G, Arnaud A, Lhuillier E, Delerue C (2022) The Complex Optical Index of PbS Nanocrystal Thin Films and their Use for Short Wave Infrared Sensor Design. *Nanoscale* 14/7:2711–2721
- Chesenau A, Groeseneken G, Heremans P, Rep D, Rudquist P, Schwille P, Sluijter B, Wendin G (2008) Teaching Nanoscience Across Scientific and Geographical Borders - A European Master Programme in Nanoscience and Nanotechnology. *Journal of Physics: Conference Series* 100:1–5. doi:10.1088/1742–6596/100/3/032002

- Chu A, Greboval C, Prado Y, Majjad H, Delerue C, Dayen JF, Vincent G, Lhuillier E (2021) Infrared Photoconduction at the Diffusion Length Limit in HgTe Nanocrystal Arrays. *Nature Communications* 12/1:1794
- Cleri F (2008) Energy Band and Vacuum Level Alignment at a Semiconductor–Molecule–Metal Interface. *Applied Physics Letters* 92/10:103112
- Cleri F (2009) Surface Ordering of Molecular Structures by Dispersion Forces. *Physical Review B Condensed Matter* 80/23:235406–234512
- Cleri F (2012) A Two–Phase Model of Large–Strain Plasticity in Covalent Nanostructures. *International Journal of Plasticity* 37:31–52
- Cleri F (2015) Ballistic to Diffusive Transition in a Two–Dimensional Quantum Dot Lattice. *Physical Review Letters* B 92/21:214203–214209
- Cleri F (2019) Agent–Based Model of Multicellular Tumor Spheroid Evolution Including Cell Metabolism. *The European Physics Journal E Soft Matter* 42/8:112
- Cleri F, Lampin E, et al. (2017) Fourier–Like Conduction and Finite One–Dimensional Thermal Conductivity in Long Silicon Nanowires by Approach–to–Equilibrium Molecular Dynamics. *Physical Review B* 95:104309
- Cleri F, et al. (2015) Molecular Dynamics of Ionic Self–Diffusion at an MgO Grain Boundary. *Journal of Material Science* 50:2502–2509
- Cleri F, et al. (2017) Stability of Radiation–Damaged DNA after Multiple Strand Breaks. *Physical Chemistry Chemical Physics* 19/22:14641
- Cleri F, et al. (2018) On the Occurrence of Size Effects in the Calculation of Thermal Conductivity by First–Principles Molecular Dynamics: The Case of Glassy GeTe₄. *Journal of Non–Crystalline Solids* 498:190–193
- Cleri F, et al. (2019) Interface Thermal Behavior in Nanomaterials by Thermal Grating Relaxation. *International Journal of Heat and Mass Transfer* 131:932–943
- Cleri F, et al. (2020) Detection of Single DNA Mismatches by Force Spectroscopy in Short DNA Hairpins. *Journal of Chemical Physics* 152/7:074204
- Cleri F, Giordano S, et al. (2016) Characteristic Lengths in Natural Bundle Assemblies arising from Fiber–Matrix Energy Competition: A Floquet–Based Homogenization Theory. *European Journal of Mechanics – A/Solids* 60:145–165
- Cleri F, Giordano S, et al. (2020) A Stochastic Force Model for the Ballistic–Diffusive Transition of Heat Conduction. *Physica Scripta* 95/7
- Cleri F, Ishida T, Collard D, Fujita H (2010) Atomistic Simulation of Plasticity in Silicon Nanowires. *Applied Physics Letters* 97/15:153106
- Cleri F, Lampin E, et al. (2016) Length Dependence of Thermal Conductivity by Approach–to–Equilibrium Molecular Dynamics. *Physical Review B* 94:054304
- Cleri F, Lampin E, et al. (2017) Thermal Conductivity of Glassy GeTe₄ by First–Principles Molecular Dynamics. *Physical Chemistry Chemical Physics* 19/15:9729–9732
- Cleri F, Landuzzi F, Blossey R (2018) Mechanical Evolution of DNA Double–Strand Breaks in the Nucleosome. *PLOS Computational Biology* 14/6:e1006224
- Cleri F, Lensink MF, Blossey R (2021) DNA Aptamers Block the Receptor Binding Domain at the Spike Protein of SARS–CoV–2. *Frontiers in Molecular Biosciences* 8/713003:1–14
- Cleri F, Letardi S, Delerue C (2006) Screening and Surface States in Molecular Monolayers Adsorbed on Silicon. *The Journal of Physical Chemistry B* 110/23:11496
- Cleri F, Noda T (2006) Phonon Instability in Nanocrystalline Silicon Carbide. *Physica Status Solidi B–Solid State Physics* 243/13:1133
- Copie G, Biaye M, Diesinger H, Melin T, Krzeminski C, Cleri F (2017) Deformation Localization in Molecular Layers Constrained between Self–Assembled Au Nanoparticles. *Langmuir* 33/10:2677–2687
- Copie G, Cleri F, Blossey R, Lensink MF (2016) On the Ability of Molecular Dynamics Simulation and Continuum Electrostatics to Treat Interfacial Water Molecules in Protein–Protein Complexes. *Scientific Reports* 6:1–10
- Copie G, Cleri F, Makoudi Y, Krzeminski C, Berthe M, Cherioux F, Palmino F, Grandidier B (2015) Surface–Induced Optimal Packing of Two–Dimensional Molecular Networks. *Physical Review Letters* 114/6:066101
- Copie G, Makoudi Y, Krzeminski C, Chérioux F, Palmino F, Lamare S, Grandidier B, Cleri F (2014) Atomic Scale Modeling of Two–Dimensional Molecular Self–Assembly on a Passivated Si Surface. *Journal of Chemical Physics* C 118/24:12817–12825

- Cuny V, Brulin Q, Lampin E, Lecat E, Krzeminski C, Cleri F (2006) Diffusion of Boron in Silicon: Compatibility of Empirical Molecular Dynamics with Continuum Simulations. *Europhysics Letters* 76/5:842
- Da Pieve F, Gronoff G, Guo J, Mertens C, Neary L, Gu B, Koval N, Kohanoff A, Vandaele A, Cleri F (2021) Radiation Environment and Doses on Mars at Oxia Planum and Mawrth Vallis: Support for Exploration at Sites With High Biosignature Preservation Potential. *Journal of Geophysical Research: Planets* 126:1–20
- Dang TH, Vasanelli A, Todorov Y, Sirtori C, Prado Y, Chu A, Greboval C, Khalili A, Cruguel H, Delerue C, Vincent G, Lhuillier E (2021) Bias Tunable Spectral Response of Nanocrystal Array in a Plasmonic Cavity. *Nano Letters* 21/15:1–12
- Das S (2013) A Review on Carbon Nano-Tubes – A New Era of Nanotechnology. *International Journal of Emerging Technology and Advanced Engineering* 3/3:774–783.
- De Geyter B, Houtepen AJ, Carrillo S, Geiregat P, Gao Y, ten Cate S, Schins JM, Van Thourhout D, Delerue C, Siebbeles LDA, Hens Z (2012) Broadband and Picosecond Intraband Absorption in Lead-Based Colloidal Quantum Dots. *ACS Nano* 6/7:6067–6074
- Delerue C (2014) From Semiconductor Nanocrystals to Artificial Solids with Dimensionality Below Two. *Physical Chemistry Chemical Physics* 16/47:25734–25740
- Delerue C (2014) Prediction of Robust Two-Dimensional Topological Insulators Based on Ge/Si Nanotechnology. *Physical Review B* 90/7:075424–075432
- Delerue C (2017) Minimum Line Width of Surface Plasmon Resonance in Doped ZnO Nanocrystals. *Nano Letters* 17/12:7599–7605
- Delerue C (2018) Electronic Structure of Si Nanocrystals Codoped with Boron and Phosphorus. *Physical Review B* 98/4:045434–045442
- Delerue C, Allan G (2006) Effective Dielectric Constant of Nanostructured Si Layers. *Applied Physics Letters* 88/17:173117
- Delerue C, Allan G, Lannoo M (2001) Electron-Phonon Coupling and Optical Transitions for Indirect-Gap Semiconductor Nanocrystals. *Physical Review B* 64/19:193402–193406
- Delerue C, Allan G, Lannoo M (2003) Dimensionality-Dependent Self-Energy Corrections and Exchange-Correlation Potential in Semiconductor Nanostructures. *Physical Review Letters* 90/7:076803–076807
- Delerue C, Allan G, Niquet YM (2005) Collective Excitations in Charged Nanocrystals and in Close-Packed Arrays of Charged Nanocrystals. *Physical Review B* 72/19:195316–195322
- Delerue C, Allan G, Pijpers JH, Bonn M (2010) Carrier Multiplication in Bulk and Nanocrystalline Semiconductors: Mechanism, Efficiency, and Interest for Solar Cells. *Physical Review B* 81/12:125306–125312
- Delerue C, Allan G, Reynaud C, Guillois O, Ledoux G, Huisken F (2006) Multiexponential Photoluminescence Decay in Indirect-Gap Semiconductor Nanocrystals. *Physical Review B* 73/23:235318–235322
- Delerue C, et al. (1995) Theoretical Description of Porous Silicon. *Thin Solid Films* 255/1–2:27–34
- Delerue C, Lannoo M, Allan G (2003) Concept of Dielectric Constant for Nanosized Systems. *Physical Review B* 68/11:115411
- Delerue C, Vanmaekelbergh D (2015) Electronic Band Structure of Zinc Blende CdSe and Rock Salt PbSe Semiconductors with Silicene-Type Honeycomb Geometry. *2D Materials* 2/3
- Diarra M, Delerue C, Niquet YM, Allan G (2008) Screening and Polaronic Effects Induced by a Metallic Gate and a Surrounding Oxide on Donor and Acceptor Impurities in Silicon Nanowires. *Journal of Applied Physics* 103/7:073703–073703–5
- Diarra M, Niquet YM, Delerue C, Allan G (2007) Ionization Energy of Donor and Acceptor Impurities in Semiconductor Nanowires: Importance of Dielectric Confinement. *Physical Review B* 75/4:045301–045305
- Drexler KE (2005) Productive Nanosystems: the Physics of Molecular Fabrication. *Physics Education* 40/4:340–346. doi:10.1088/0031-9120/40/4/003
- Dubois M, Delerue C, Allan G (2005) Scanning Tunneling Microscopy and Spectroscopy of Conjugated Oligomers Weakly Bonded to Si(100) Surfaces: A Theoretical Study. *Physical Review B* 71/16:165435–165441
- Dubois M, Delerue C, Rubio A (2007) Adsorption and Electronic Excitation of Biphenyl on Si(100): A Theoretical STM Analysis. *Physical Review B* 75/4:041302–041306

- Dubois M, Perdigao L, Delerue C, Allan G, Grandidier B, Deresmes D, Stievenard D (2005) Scanning Tunneling Microscopy and Spectroscopy of Reconstructed Si(100) Surfaces. *Physical Review B* 71/16:165322–165332
- Dufour M, Izquierdo E, Livache C, Martinez B, Silly MG, Pons T, Lhuillier E, Delerue C, Ithurria S (2019) Doping as a Strategy to Tune Color of 2D Colloidal Nanoplatelets. *ACS Applied Materials & Interfaces* 11/10:10128–10134
- Durand C, Capiod P, Berthe M, Nys JP, Krzeminski C, Stievenard D, Delerue C, Grandidier B (2014) Nanoscale Carrier Multiplication Mapping in a Si Diode. *Nano Letters* 14/10:5636–5640
- Dusch Y, Tiercelin N, Klimov A, Giordano S, Preobrazhensky V, Pernod P (2013) Stress-Mediated Magnetoelectric Memory Effect with Uni-Axial TbCo₂/FeCo Multilayer on 011-Cut PMN-PT Ferroelectric Relaxor. *Journal of Applied Physics* 113/17:17C719
- Evers WH, Schins JM, Aerts M, Kulkarni A, Capiod P, Berthe M, Grandidier B, Delerue C, van der Zant HSJ, van Overbeek C, Peters JL, Vanmaekelbergh D, Siebbeles LDA (2015) High Charge Mobility in Two-Dimensional Percolative Networks of PbSe Quantum Dots Connected by Atomic Bonds. *Nature Communications* 6:8195
- Florio G, Puglisi G, Giordano S (2020) Role of Temperature in the Decoherence of an Elastic Chain Tethered to a Substrate by Onsite Breakable Links. *Physical Review Research* 2:033227
- Geiregat P, Allan G, Hens Z, Delerue C (2016) Single-Exciton Optical Gain in Semiconductor Nanocrystals: Positive Role of Electron-Phonon Coupling. *Physical Review B* 93/11
- Geiregat P, Delerue C, Justo Y, Aerts M, Spoor F, Van Thourhout D, Siebbeles LDA, Allan G, Houtepen AJ, Hens Z (2015) A Phonon Scattering Bottleneck for Carrier Cooling in Lead Chalcogenide Nanocrystals. *ACS Nano* 9/1:778–788
- Geiregat P, Houtepen AJ, Sagar LK, Infante I, Zapata F, Grigel V, Allan G, Delerue C, Van Thourhout D, Hens Z (2018) Continuous-Wave Infrared Optical Gain and Amplified Spontaneous Emission at Ultralow Threshold by Colloidal HgTe Quantum Dots. *Nature Materials* 17/1:35–42
- Germeau A, Roest AL, Vanmaekelbergh D, Allan G, Delerue C, Meulenkaamp EA (2003) Optical Transitions in Artificial Few-Electron Atoms Strongly Confined Inside ZnO Nanocrystals. *Physical Review Letters* 90/9:097401–097405
- Gianese G, Rosato V, Cleri F, Celino M, Morales P (2009) Atomic-Scale Modeling of the Interaction between Short Polypeptides and Carbon Surfaces. *Journal of Physical Chemistry B* 113/35:12105–12112
- Giordano S (2013) Analytical Procedure for Determining the Linear and Nonlinear Effective Properties of the Elastic Composite Cylinder. *International Journal of Solids and Structures* 90/24:4055
- Giordano S (2014) Explicit Nonlinear Homogenization for Magneto-Electro-Elastic Laminated Materials. *Mechanics Research Communications* 55:18–29
- Giordano S (2016) Nonlinear Effective Behavior of a Dispersion of Randomly Oriented Coated Ellipsoids with Arbitrary Temporal Dispersion. *International Journal of Engineering Science* 98:14–35
- Giordano S (2017a) Nonlinear Effective Properties of Heterogeneous Materials with Ellipsoidal Microstructure. *Mechanics of Materials* 105:16–28
- Giordano S (2017b) Spin Variable Approach for the Statistical Mechanics of Folding and Unfolding Chains. *Soft Matter* 13/38:6877–6893
- Giordano S (2018) Helmholtz and Gibbs Ensembles, Thermodynamic Limit and Bistability in Polymer Lattice Models. *Continuum Mechanics and Thermodynamics* 30:459–483
- Giordano S (2019) Stochastic Thermodynamics of Holonomic Systems. *European Physical Journal B* 92/8:1–18
- Giordano S (2021) Entropy Production and Onsager Reciprocal Relations Describing the Relaxation to Equilibrium in Stochastic Thermodynamics. *Physical Review E* 103/5:052116–052129
- Giordano S (2022) Statistical Mechanics of Rate-Independent Stick-Slip on a Corrugated Surface Composed of Parabolic Wells. *Continuum Mechanics and Thermodynamics* 34/5:1343–1372
- Giordano S, Cleri F, Collard D, et al. (2016) Real-Time Mechanical Characterization of DNA Degradation under Therapeutic X-Rays and its Theoretical Modeling. *Microsystems & Nanotechnology* 5/2:16062
- Giordano S, Cleri F, et al. (2009) On the Equivalence of Thermodynamics Ensembles for Flexible Polymer Chains. *Physica A Statistical Mechanics and its Applications* 395/1:154–170
- Giordano S, Cleri F, et al. (2012) Elasticity of Flexible and Semiflexible Polymers with Extensible Bonds in the Gibbs and Helmholtz Ensembles. *Journal of Chemical Physics* 136/15:154906

- Giordano S, Cleri F, et al. (2012) Theory and Monte Carlo Simulations for the Stretching of Flexible and Semiflexible Single Polymer Chains Under External Fields. *Journal of Chemical Physics* 137/24:244907
- Giordano S, Cleri F, et al. (2013) Two-State Theory of Single-Molecule Stretching Experiments. *Physical Review E* 87:032705
- Giordano S, Cleri F, et al. (2014) Scaling Shift in Multicracked Fiber Bundles. *Physical Review Letters* 113:255501
- Giordano S, Cleri F, et al. (2015) Stochastic Mechanical Degradation of Multi-Cracked Fiber Bundles with Elastic and Viscous Interactions. *The European Physics Journal E* 38/5:1–21
- Giordano S, Cleri F, et al. (2018) Thermal Conductivity of Deca-Nanometric Patterned Si Membranes by Multiscale Simulations. *International Journal of Heat and Mass Transfer* 126/B:830
- Giordano S, DeJardin PM (2020) Derivation of Magnetic Inertial Effects from the Classical Mechanics of a Circular Current Loop. *Physical Review B* 102/21:214406–214419
- Giordano S, Dusch Y, Tiercelin N, Pernod P, Preobrazhensky V (2013a) Thermal Effects in Magnetolectric Memories with Stress-Mediated Switching. *Journal of Physics D–Applied Physics* 46/32:325002
- Giordano S, Dusch Y, Tiercelin N, Pernod P, Preobrazhensky V (2012) Combined Nanomechanical and Nanomagnetic Analysis of Magnetolectric Memories. *Physical Review B* 85/15:155321
- Giordano S, Dusch Y, Tiercelin N, Pernod P, Preobrazhensky V (2013b) Stochastic Magnetization Dynamics in Single Domain Particles. *European Physical Journal B* 86:249
- Giordano S, et al. (2012) Conduction Degradation in Anisotropic Multi-Cracked Materials. *European Physical Journal B* 85/2:1–15
- Giordano S, et al. (2012) Elastic Behavior of Inhomogeneities with Size and Shape Different from their Hosting Cavities. *Mechanics of Materials* 44:4–22
- Giordano S, et al. (2012) Generalized Interface Models for Transport Phenomena: Unusual Scale Effects in Composite Nanomaterials. *Journal of Applied Physics* 112/8
- Giordano S, et al. (2014) Analysis of Heterogeneous Structures Described by the Two-Temperature Model. *International Journal of Heat and Mass Transfer* 78:189–202
- Giordano S, et al. (2016) Statistical Mechanics of Holonomic Systems as a Brownian Motion on Smooth Manifolds. *Annalen der Physik* 528/5:381
- Giordano S, et al. (2016) Transport Properties of Multigrained Nanocomposites with Imperfect Interfaces. *Journal of Applied Physics* 120/18:184301
- Giordano S, et al. (2020) Rate-Dependent Force-Extension Models for Single-Molecule Force Spectroscopy Experiments. *Physical Biology* 17/5:056002
- Giordano S, Goueygou M, Tiercelin N, Talbi A, Pernod P, Preobrazhensky V (2014) Magneto-Electro-Elastic Effective Properties of Multilayered Artificial Multiferroics with Arbitrary Lamination Direction. *International Journal of Engineering Science* 78:134–153
- Giusepponi S, Celino M, Cleri F, Montone A (2009) Hydrogen storage in MgH₂ matrices: A study of Mg–MgH₂ interface using CPMD code on ENEA–GRID. *Nuovo Cimento–Società Italiana di Fisica Sezione C* 32:139–142
- Goel A, Stukowski A, Goel G, Luo X, Reuben RL (2012) Nanotribology at High Temperatures. *Beilstein Journal of Nanotechnology* 3:586–588. doi:10.3762/bjnano.3.68
- Gong C, Lee S, Hong S, Yoon E, Lee GD, Warner JH (2017) Point Defects in Turbostratic Stacked Bilayer Graphene. *Nanoscale* 9/36:1–6. doi:10.1039/C7NR03879H
- Goy E, Tomezak M, Facchin C, Martin N, Bouchaert E, Benoit J, de Schutter C, Nassour J, Saas L, Drullion C, Brodin PM, Vandeputte A, Molendi-Coste O, Pineau L, Goormachtigh G, Pluquet O, Poutier A, Cleri F, Lartigau E, Penel N, Abbadie C (2022) The Out-Of-Field Dose in Radiation Therapy Induces Delayed Tumorigenesis by Senescence Evasion. *Elife* 11:e67190
- Grandier B, de la Broise X, Stievenard D, Delerue C, Lannoo M, Stellmacher M, Bourgoin J (2000) Defect-Assisted Tunneling Current: A Revised Interpretation of Scanning Tunneling Spectroscopy Measurements. *Applied Physics Letters* 76/21:3142–3144
- Grandier B, Nys JP, Delerue C, Stievenard D, Higo Y, Tanaka M (2000) Atomic-Scale Study of GaMnAs/GaAs Layers. *Applied Physics Letters* 77/24:4001
- Grandier B, Nys JP, Stievenard D, de la Broise X, Delerue C, Lannoo M (1998) STM Measurements of Barrier Height on Si(111)–7x7 and GaAs(110) Cleaved Surfaces Using I(z), z(V) and I(z(V), V) Techniques. *Applied Physics A–Materials Science & Processing* 66:S977–S980

- Grandidier B, Nys JP, Stievenard D, Krzeminski C, Delerue C, Frere P, Blanchard P, Roncali J (2001) Effect of Alkyl Substituents on the Adsorption of Thienylenevinylene Oligomers on the Si(100) Surface. *Surface Science* 473/1–2:1–7
- Greboval C, Chu A, Magalhaes DV, Ramade J, Qu J, Rastogi P, Khalili A, Chee SS, Aubin H, Vincent G, Bals S, Delerue C, Lhuillier E (2021) Ferroelectric Gating of Narrow Band–Gap Nanocrystal Arrays with Enhanced Light–Matter Coupling. *ACS Photonics* 8/1
- Groeneveld E, Delerue C, Allan G, Niquet YM, Donega CdM (2012) Size Dependence of the Exciton Transitions in Colloidal CdTe Quantum Dots. *Journal of Physical Chemistry C* 116/43:23160–23167
- Gu B, Munoz–Santiburcio D, Cleri F, Artacho E, Kohanoff J, Da Pieve F (2022) Bragg’s Additivity Rule and Core and Bond Model Studied by Real–Time TDDFT Electronic Stopping Simulations: The Case of Water Vapor. *Radiation Physics and Chemistry* 193:109961
- Guerder PY, Giordano S, Matar OB, Vasseur JO (2015) Tuning the Elastic Nonlinearities in Composite Nanomaterials. *Journal of Physics–Condensed Matters* 27/14:145304
- Guiraud P, Giordano S, Bou Matar O, Pernod P, Lardat R (2021) Thermoacoustic Wave Generation in Multilayered Thermophones with Cylindrical and Spherical Geometries. *Journal of Applied Physics* 129:115103
- Guiraud P, Giordano S, Bou–Matar O, Pernod P, Lardat R, (2019) Multilayer Modeling of Thermoacoustic Sound Generation for Thermophone Analysis and Design. *Journal of Sound and Vibration* 455:275–298
- Guiraud P, Giordano S, Bou–Matar O, Philippe P, Raphael L (2019) Two Temperature Model for Thermoacoustic Sound Generation in Thick Porous Thermophones. *Journal of Applied Physics* 126:165111–165111–12
- Handy RD, Shaw BJ (2007) Toxic Effects of Nanoparticles and Nanomaterials: Implications for Public Health, Risk Assessment and the Public Perception of Nanotechnology. *Health Risk & Society* 9/2:125–144. doi:10.1080/13698570701306807
- Hens Z, Grandidier B, Deresmes D, Allan G, Delerue C, Stievenard D, Vanmaekelbergh D (2004) Evolution of the Density of States on Going from a Two– to a Zero–Dimensional Semiconductor. *Europhysics Letters* 65/6:809–815
- Hens Z, Vanmaekelbergh D, Kooij ES, Wormeester H, Allan G, Delerue C (2004) Effect of Quantum Confinement on the Dielectric Function of PbSe. *Physical Review Letters* 92/2:06828
- Hladky–Hennion AC, Decarpigny JN (1991) Analysis of the Scattering of a Plane Acoustic Wave by a Doubly Periodic Structure using the Finite Element Method: Application to Alberich Anechoic Coating. *The Journal of the Acoustical Society of America* 90/6:3356–3367. doi:10.1121/1.401395
- Hudson MH, Chen M, Kamysbayev V, Janke EM, Lan X, Allan G, Delerue C, Lee B, Guyot–Sionnest P, Talapin DV (2018) Conduction Band Fine Structure in Colloidal HgTe Quantum Dots. *ACS Nano* 12/9:9397–9404
- Ishida T, Cleri F, Kakushima K, Mita M, Sato T, Miyata M, Itamura N, Endo J, Toshiyoshi H, Sasaki N, Collard D, Fujita H (2011) Exceptional Plasticity of Silicon Nanobridges. *Nanotechnology* 22/35:355704
- Javey A, Guo J, Wang Q, Lundstrom M, Dai H (2003) Ballistic Carbon Nanotube Field–Effect Transistors. *Nature* 424/6949:654–657. doi:10.1038/nature01797
- Jazi MA, Janssen VAEC, Evers WH, Tadjine A, Delerue C, Siebbeles LDA, van der Zant HSJ, Houtepen AJ, Vanmaekelbergh D (2017) Transport Properties of a Two–Dimensional PbSe Square Superstructure in an Electrolyte–Gated Transistor. *Nano Letters* 17/9:5238–5243
- Jazi MA, Kulkarni A, Sinai SB, Peters JL, Geschiere E, Failla M, Delerue C, Houtepen AJ, Siebbeles LDA, Vanmaekelbergh D (2019) Room–Temperature Electron Transport in Self–Assembled Sheets of PbSe Nanocrystals with a Honeycomb Nanogeometry. *Journal of Physical Chemistry B* 123/22:14058–14066
- Jdira L, Overgaag K, Stuijuc R, Grandidier B, Delerue C, Speller S, Vanmaekelbergh D (2008) Linewidth of Resonances in Scanning Tunneling Spectroscopy. *Physical Review B* 77/20:205308–205308–11
- Jomaa N, Delerue C, Said M (2017) Intrinsic Strain Effects on Ge/Si Core/Shell Nanowires: Insights from Atomistic Simulations. *Superlattices and Microstructures* 107:83–90
- Kalesaki E, Delerue C, Smith CM, Beugeling W, Allan G, Vanmaekelbergh D, (2014) Dirac Cones, Topological Edge States, and Nontrivial Flat Bands in Two–Dimensional Semiconductors with a Honeycomb Nanogeometry. *Physical Review X* 4/1:011010–01122

- Kalesaki E, Evers WH, Allan G, Vanmaekelbergh D, Delerue C (2013) Electronic Structure of Atomically Coherent Square Semiconductor Superlattices with Dimensionality Below Two. *Physical Review B* 88/11:115431–115431–9
- Keuleyan SE, Guyot-Sionnest P, Delerue C, Allan G (2014) Mercury Telluride Colloidal Quantum Dots: Electronic Structure, Size-Dependent Spectra, and Photocurrent Detection up to 12 μ m. *ACS Nano* 8/8: 8676–8682
- Klimov A, Tiercelin N, Dusch Y, Giordano S, Mathurin T, Pernod P, Preobrazhensky V, Churbanov A, Nikitov S (2017) Magnetolectric Write and Read Operations in a Stress-Mediated Multiferroic Memory Cell. *Applied Physics Letters* 110/22:222401
- Ko W, Ma C, N GD, Kolmer A, Li AP, Nguyen GD (2019) Atomic-Scale Manipulation and in situ Characterization with Scanning Tunneling Microscopy. *Advanced Functional Materials* 29/52:1–56
- Koole R, Allan G, Delerue C, Meijerink A, Vanmaekelbergh D, Houtepen AJ (2008) Optical Investigation of Quantum Confinement in PbSe Nanocrystals at Different Points in the Brillouin Zone. *Small* 4/1:127–133
- Kriso C, Triozon F, Delerue C, Schneider L, Abbate F, Nolot E, Rideau D, Niquet YM, Mugny G, Tavernier C (2017) Modeled Optical Properties of SiGe and Si Layers Compared to Spectroscopic Ellipsometry Measurements. *Solid-State Electronics* 129:93–96
- Krzeminski C, Brulin Q, Cuny V, Lecat E, Lampin E, Cleri F. (2006) Molecular Dynamics Simulation of the Recrystallization of Amorphous Si Layers: Comprehensive Study of the Dependence of the Recrystallization Velocity on the Interatomic Potential. *Journal of Applied Physics* 101/12:123506
- Kunst FK, Delerue C, Smith CM, Juricic V (2015) Kekule Versus Hidden Superconducting Order in Graphene-Like Systems: Competition and Coexistence. *Physical Review B* 92/16:165423–165435
- Kushwaha KK, Kumari S, Mahobia SK, Tiwary SK, Sinha BK, Ramrakhiani M (2018) Synthesis and Characterization of ZnSe/CdSe/ZnS Nano-Particles Embedded in Polymer Matrix: A Review. *International Journal of Composite and Constituent Materials* 4/1:28–33. doi:10.1021/jp046481g
- Lampin E, Cleri F, et al. (2013) Thermal Conductivity from Approach-to-Equilibrium Molecular Dynamics. *Journal of Applied Physics* 114/3:033525
- Lampin E, Delerue C, Lannoo M, Allan G (1998) Frequency-Dependent Hopping Conductivity between Silicon Nanocrystallites: Application to Porous Silicon. *Physical Review B* 58/18:12044–12048
- Lampin E, Nguyen QH, Francioso PA, Cleri F (2012) Thermal Boundary Resistance at Silicon-Silica Interfaces by Molecular Dynamics Simulations. *Applied Physics Letters* 100/13:131906
- Lannoo M, Delerue C, et al. (1995) Theory of Physical Properties of Silicon Crystallites. *Annales des Physique* 20/3:271–276
- Lannoo M, Prins PT, Hens Z, Vanmaekelbergh D, Delerue C (2022) Universality of Optical Absorptance Quantization in Two-Dimensional Group-IV, III-V, II-VI, and IV-VI Semiconductors. *Physical Review B* 105/3:035421–035434
- Lenfant S, Krzeminski C, Delerue C, Allan G, Vuillaume D (2003) Molecular Rectifying Diodes from Self-Assembly on Silicon. *Nano Letters* 3/6:741–746
- Li J, Delerue C (2019) Intrinsic Transport Properties of Nanoporous Graphene Highly Suitable for Complementary Field-Effect Transistors. *2D Materials* 6/3
- Li J, Gu T, Delerue C, Niquet YM (2013) Electronic Structure and Transport Properties of Si Nanotubes. *Journal of Applied Physics* 114/5:053706
- Li J, Jomaa N, Niquet YM, Said M, Delerue C (2014) Hole Mobility in Ge/Si Core/Shell Nanowires: What Could be the Optimum? *Applied Physics Letters* 105/23:233104
- Li J, Lampin E, Delerue C, Niquet YM (2016) Theoretical Investigation of the Phonon-Limited Carrier Mobility in (001) Si Films. *Journal of Applied Physics* 120/17:1480–1487
- Li J, Mugny G, Niquet YM, Delerue C (2015) Drift Velocity Versus Electric Field in < 110 > Si Nanowires: Strong Confinement Effects. *Applied Physics Letters* 107/6:063103
- Li J, Niquet YM, Delerue C (2016) Magnetic-Phase Dependence of the Spin Carrier Mean Free Path in Graphene Nanoribbons. *Physical Review Letters* 116/23:236602–236607
- Li YC, Xin HB, Lei HX, Liu LL, Li YZ, Zhang Y, Li BJ (2016) Manipulation and Detection of Single Nanoparticles and Biomolecules by a Photonic Nanojet. *Light Science & Applications* 5:1–9. doi:10.1038/lsa.2016.176

- Liu F, Wagterveld RM, Gebben B, Otto MJ, Biesheuvel PM, Hamelers HVM (2014) Carbon Nanotube Yarns as Strong Flexible Conductive Capacitive Electrodes. *Colloids and Interface Science Communications* 3:9–12. doi:10.1016/j.colcom.2015.02.001
- Mahieu G, Grandidier B, Stievenard D, Krzeminski C, Delerue C, Martineau C, Roncali J (2003) Adsorption Behavior of Conjugated {C}(3)-Oligomers on Si(100) and Highly Oriented Pyrolytic Graphite Surfaces. *Langmuir* 19/8:3350–3356
- Mann B, Kuhn H (1971) Tunneling through Fatty Acid Salt Monolayers. *Journal of Applied Physics* 42:4398–4405. doi:10.1063/1.1659785
- Mathurin T, Giordano S, Dusch Y, Tiercelin N, Pernod P, Preobrazhensky V (2016) Stress-Mediated Magnetoelectric Control of Ferromagnetic Domain Wall Position in Multiferroic Heterostructures. *Applied Physics Letters* 108/8:082401
- Mathurin T, Giordano S, Dusch Y, Tiercelin N, Pernod P, Preobrazhensky V, (2017) Domain-Wall Dynamics in Magnetoelastic Nanostripes. *Physical Review B* 95:140405(R)
- Mathurin T, Giordano S, Dusch Y, Tiercelin N, Pernod P, Preobrazhensky V (2016) Mechanically Driven Domain Wall Movement in Magnetoelastic Nanomagnets. *European Physical Journal B* 89/169
- Melis C, Giordano S, Colombo L (2017) Surface Elastic Properties in Silicon Nanoparticles. *EPL* 119/6:66005
- Melis C, Giordano S, Colombo L, Mana G (2016) Density Functional Theory Calculations of the Stress of Oxidised (110) Silicon Surfaces. *Metrologia* 53/6:1339
- Melis C, Pia G, Sogne E, Falqui A, Giordano S, Delogu F, Colombo L (2022) Stiffening of Nanoporous Gold: Experiment, Simulation and Theory. *European Physical Journal Plus* 137/7:19151–19159
- Moreels I, Allan G, De Geyter B, Wirtz L, Delerue C, Hens Z (2010) Dielectric Function of Colloidal Lead Chalcogenide Quantum Dots Obtained by a Kramers-Kronig Analysis of the Absorbance Spectrum. *Physical Review B* 81/23:235319–235319–7
- Moreels I, Lambert K, Smeets D, De Muynck D, Nollet T, Martins JC, Vanhaecke F, Vantomme A, Delerue C, Allan G, Hens Z (2009) Size-Dependent Optical Properties of Colloidal PbS Quantum Dots. *ACS Nano* 3/10:3023–3030
- Mugny G, Li J, Triozon F, Niquet YM, Rideau D, Delerue C (2017) Electronic Structure and Electron Mobility in Si-1-Ge-x(x) Nanowires. *Applied Physics Letters* 110/5:052102
- Nangreave J, Han D, Liu Y, Yan H (2010) DNA Origami: a History and Current Perspective. *Current Opinion in Chemical Biology* 14/5:608–615. doi:10.1016/j.cbpa.2010.06.182
- Ngoh ZL, Guiraud P, Tan D, Giordano S, Bou-Matar O, Teo EHT, Pernod P, Coquet P, Lardat R (2020) Experimental Characterization of Three-Dimensional Graphene's Thermoacoustic Response and its Theoretical Modelling. *Carbon* 169:382–394
- Nguyen TH, Mahieu G, Berthe M, Grandidier B, Delerue C, Stievenard D, Ebert P (2010) Coulomb Energy Determination of a Single Si Dangling Bond. *Physical Review Letters* 105/22:226404–226408
- Niquet YM, Delerue C (2011) Band Offsets, Wells, and Barriers at Nanoscale Semiconductor Heterojunctions. *Physical Review B* 84/7:075478–075487
- Niquet YM, Delerue C (2012) Carrier Mobility in Strained Ge Nanowires. *Journal of Applied Physics* 112/8:084301
- Niquet YM, Delerue C, Krzeminski C (2012) Effects of Strain on the Carrier Mobility in Silicon Nanowires. *Nano Letters* 12/7:3545–3550
- Niquet YM, Delerue C, Rideau D, Videau B (2012) Fully Atomistic Simulations of Phonon-Limited Mobility of Electrons and Holes in $\langle 001 \rangle$ -, $\langle 110 \rangle$ -, and $\langle 111 \rangle$ -Oriented Si Nanowires. *IEEE Transactions on Electron Devices* 59/5:1480–1487
- Niquet YM, Genovese L, Delerue C, Deutsch T (2010) Ab Initio Calculation of the Binding Energy of Impurities in Semiconductors: Application to Si Nanowires. *Physical Review B* 81/16:161301–161305
- Niquet YM, Lherbier A, Quang NH, Fernandez-Serra MV, Blase X, Delerue C (2006) Electronic Structure of Semiconductor Nanowires. *Physical Review B* 73/16:165319–165332
- Niquet YM, Mera H, Delerue C (2012) Impurity-Limited Mobility and Variability in Gate-All-Around Silicon Nanowires. *Applied Physics Letters* 100/15:153119
- Notot V, Walravens W, Berthe M, Peric N, Addad A, Wallart X, Delerue C, Hens Z, Grandidier B, Biadala L (2022) Quantum Dot Acceptors in Two-Dimensional Epitaxially Fused PbSe Quantum Dot Superlattices. *ACS Nano* 16/2:3081–3091
- Novoselov KS, Geim AK (2007) The Rise of Graphene. *Nature Materials* 6/3:183–191. doi:10.1038/nmat1849

- Overgaag K, Vanmaekelbergh D, Liljeroth P, Mahieu G, Grandidier B, Delerue C, Allan G (2009) Electron–Phonon Coupling and Intervalley Splitting Determine the Linewidth of Single–Electron Transport Through PbSe Nanocrystals. *Journal of Chemical Physics* 131/22:224510
- Pavanello F, Giordano S (2013) How Imperfect Interfaces Affect the Nonlinear Transport Properties in Composite Nanomaterials. *Journal of Applied Physics* 113/15:154310
- Perdigao L, Deresmes D, Grandidier B, Dubois M, Delerue C, Allan G, Stievenard D (2004) Semiconducting Surface Reconstructions of p–type Si(100) Substrates at 5K. *Physical Review Letters* 92/21:216101
- Peric N, Lambert Y, Singh S, Khan AH, Vergel NAF, Deresmes D, Berthe M, Hens Z, Moreels I, Delerue C, Grandidier B, Biadala L (2021) Van Hove Singularities and Trap States in Two–Dimensional CdSe Nanoplatelets. *Nano Letters* 21/4:1702–1708
- Perret G, Ginet P, Tarhan MC, Baccouche A, Lacornerie T, Kumemura M, Jalabert L, Cleri F, Lartigau EF, Kim BJ, Karsten SL, Fujita H, Rondelez Y, Fujii T, Collard D (2016) Nano Systems and Devices for Applications in Biology and Nanotechnology. *Solid–State Electronics* 115/B:66–73
- Persson MP, Mera H, Niquet YM, Delerue C, Diarra M (2010) Charged Impurity Scattering and Mobility in Gated Silicon Nanowires. *Physical Review B* 82/11:115318–115326
- Peterson JJ, Huang L, Delerue C, Allan G, Krauss TD (2007) Uncovering Forbidden Optical Transitions in PbSe Nanocrystals. *Nano Letters* 7/12:3827–3831
- Pi X, Delerue C (2013) Tight–Binding Calculations of the Optical Response of Optimally P–Doped Si Nanocrystals: A Model for Localized Surface Plasmon Resonance. *Physical Review Letters* 111/17:177402–177407
- Pi X, Ni Z, Yang D, Delerue C (2014) Ab Initio Study on the Effect of Structural Relaxation on the Electronic and Optical Properties of P–Doped Si Nanocrystals. *Journal of Applied Physics* 116/19:194304
- Pijpers JH, Milder MTW, Delerue C, Bonn M (2010) (Multi)exciton Dynamics and Exciton Polarizability in Colloidal InAs Quantum Dots. *Journal of Physical Chemistry C* 114/14
- Pijpers JH, Ulbricht R, Tielrooij KJ, Osherov A, Golan Y, Delerue C, Allan G, Bonn M (2009) Assessment of Carrier–Multiplication Efficiency in Bulk PbSe and PbS. *Nature Physics* 5/11:811–814
- Pisano R (2006) Mathematics of Logic and Logic of Mathematics. *Critical problems in History of Science. The Bulletin of Symbolic Logic* 12/2:358
- Pisano R (2008) A History of Chemistry à la Koyré? Introduction and Setting of an Epistemological Problem. *Khimiya Journal* 2/17:143–161
- Pisano R (2009) Continuity and discontinuity. On method in Leonardo da Vinci’ Mechanics. *Organon* 41:165–182
- Pisano R (2010) On Principles In Sadi Carnot’s Theory (1824). *Epistemological reflections. Almagest* 2/1:128–179
- Pisano R (2013) On the New Bosen Higgs’s Studies at the CERN–ATLAS Experiment. The Emergency of a Historical Discovery. *Advances in Historical Studies* 2/1:3–5
- Pisano R (2014) Introduction to Advances Historical Studies—Newton Special Issue. *History and Historical Epistemology of Science. Advances in Historical Studies Newton Special Issue* 3/1:1
- Pisano R (2016) Details on the mathematical interplay between Leonardo da Vinci and Luca Pacioli. *Journal of the British Society for the History of Mathematics* 31:104–111
- Pisano R (2017a) A Development of the Principle of Virtual Laws and its Framework in Lazare Carnot’s Mechanics as Manifest Relationship between Physics and Mathematics. *International Journal for Historiography of science* 2:166–203
- Pisano R (2017b) Introduction. 1564–2014. Homage to Galileo Galilei. In: Pisano R, Bussotti P (eds) *Homage to Galileo Galilei 1564–2014. Reading Iuvenilia Galilean Works within History and Historical Epistemology of Science. Special Issue Philosophia Scientiae*, 21/1:5–13
- Pisano R (2017c) Reading Science, Technology and Education: A Tradition Dating back to Science into the History and Historiography *Transversal* 3:77–97
- Pisano R (2020) A Tale of Tartaglia’s Libro Sesto & La Gionta in Quesiti et Inventioni Diverse (1546–1554): Exploring the Historical and Cultural Foundations. *Foundations of Science* 25/2
- Pisano R, Aberšek B, Dolenc K, Aberšek MK (2014) Reflections on the Relationship between Cybernetic Pedagogy, Cognitive Science & Language. *Pedagogika* 115/3:70–87
- Pisano R, Anakkar A, Pellegrino E, Nagels M (2019) Thermodynamic Foundations of Physical Chemistry. Reversible Processes and Thermal Equilibrium into History. *Foundations of Chemistry, Springer* 21:297–323

- Pisano R, Bussotti P (2012) Galileo and Kepler. On Theoremata Circa Centrum Gravitatis Solidorum And Mysterium Cosmographicum. *History Research* 2/2:110–145
- Pisano R, Bussotti P (2013a) On Popularization of Scientific Education In Italy Between 12th And 16th Centuries. *Problems of Education in the 21st Century* 57:90–101
- Pisano R, Bussotti P (2013b) On the Conceptual Frames in René Descartes' Physical Works. *Advances in Historical Studies* 2/3:106–125
- Pisano R, Bussotti P (2013c) Open Problems in Mathematical Modelling and Physical Experiments: Exploring Exponential Function. *Problems of Education in the 21st century* 50/50:56–69
- Pisano R, Bussotti P (2013d) Reflections on the Scientific Conceptual Streams in Leonardo da Vinci and his Relationship with Luca Pacioli. *Advances in Historical Studies* 2/2:32–45
- Pisano R, Bussotti P (2014a) Galileo a Padova: un Itinerario tra Architettura, Fortificazioni, Matematica e Scienza "Pratica". *Lettera Matematica* 91:48–58
- Pisano R, Bussotti P (2014b) Historical and Philosophical Reflections on the Culture of Machines around the Renaissance. How Science and Technique Work? *Acta Baltica Historiae et Philosophiae Scientiarum* 2/2:20–42
- Pisano R, Bussotti P (2014c) Newton's Philosophiae Naturalis Principia Mathematica "Jesuit" Edition: The Tenor of a Huge Work. *Atti Accademia Nazionale Lincei Rendiconti Lincei Matematica e Applicazioni* 25:413–444
- Pisano R, Bussotti P (2014d) Notes on Mechanics and Mathematics in Torricelli as Physics Mathematics Relationships in the History of Science. *Problems of Education In The 21st Century International Journal. Special Issue* 61/61:88–97
- Pisano R, Bussotti P (2014e) On the Jesuit Edition of Newton's Principia. Science and Advanced Researches in the Western Civilization. *Newton Sp. Issue: History and Historical Epistemology of Science. Advances in Historical Studies* 3/1:33–55
- Pisano R, Bussotti P (2015a) The Emergencies of Mechanics and Thermodynamics in the Western Society during 18th–19th Century. In: Pisano R (ed). *A Bridge between Conceptual Frameworks, Science, Society and Technology Studies*. Springer, Dordrecht, pp. 399–436
- Pisano R, Bussotti P (2015b) Fibonacci and the Abacus Schools in Italy. *Mathematical Conceptual Streams, Science Education and its Changing Relationship with Society, Almagest* 6/2:126–165
- Pisano R, Bussotti P (2015c) Galileo in Padua: Architecture, Fortifications, Mathematics and "Practical" Science. *Lettera Matematica Pristem International – Springer*, pp. 209–221
- Pisano R, Bussotti P (2015d) Historical and Philosophical Reflections on the Culture of Machines around the Renaissance: Machines, Machineries and Perpetual Motion. *Acta Baltica Historiae et Philosophiae Scientiarum* 3/1:69–87
- Pisano R, Bussotti P (2015e) Introduction. Exploring Changes in How the Histories of the Exact Sciences Have Been Written: Interpreting the Dynamics of Change in These Sciences and Interrelations amongst Them—Past Problems, Future Cures? *Advances in Historical Studies Special Issue* 4/2:65–67
- Pisano R, Bussotti P (2015f) The Geometrical Foundation of Federigo Enriques' Gnoseology and Epistemology. *Special Issue: Advances in Historical Studies* 4:118–145
- Pisano R, Bussotti P (2016) A Newtonian Tale Details on Notes and Proofs in Geneva Edition of Newton's Principia. *British Journal for the History of Mathematics* 31/3:160–178
- Pisano R, Bussotti P (2017) The Fiction of the Infinitesimals in Newton's Works: A note on the Metaphoric use of Infinitesimals in Newton. *Special Issue Isonomia* 9:141–160
- Pisano R, Bussotti P (2020) Historical and Foundational Details on the Method of Infinite Descent: Every Prime Number of the Form $4n+1$ is the Sum of Two Squares. *Foundations of Science, Springer*, 25/4:671–702
- Pisano R, Bussotti P (2022) Conceptual Frameworks on the Relationship between Physics–Mathematics in the Newton Principia Geneva Edition (1822). *Foundations of Sciences, Springer* 27/3:1127–1182
- Pisano R, Capecchi D (2007) La Teoria dei Baricentri di Torricelli come Fondamento della Statica. *Physis – Rivista Internazionale di Storia della Scienza* XLIV/1:1–29
- Pisano R, Capecchi D (2010) Reflections on Torricelli's Principle in Mechanics. *Organon* 42:81–98
- Pisano R, Capecchi D (2013) Conceptual and Mathematical Structures of Mechanical Science in the Western Civilization around 18th Century. *Almagest* 4/2:86–121
- Pisano R, Capecchi D (2016) Tartaglia's science weights. *Mechanics in XVI century. Selections from Quesiti et inventioni diverse* Springer, Dordrecht

- Pisano R, Casolaro F (2011) An Historical Inquiry On Geometry In Relativity. Reflections on Early Relationship Geometry–Physics (Part I). *History Research* 1/1:47–60
- Pisano R, Casolaro F (2012) An Historical Inquiry On Geometry In Relativity. Reflections on Late Relationship Geometry–Physics (Part II). *History Research* 2/1:56–64
- Pisano R, Coopersmith J, Peacke M (2021) *Essay on Machines in General (1786)*. Monograph. Text, Translations and Commentaries. Lazare Carnot's Mechanics – Vol. 1. Springer, Dordrecht
- Pisano R, Drago A (2002) S. Carnot's *Réflexions*: a Theory based on Non–Classical Logic. *The Bulletin Symbolic Logic* 8:131–132
- Pisano R, Drago A (2004) Interpretation and Reconstruction of Sadi Carnot's *Réflexions* through Original Sentences belonging to Non–Classical Logic. *Fond. Ronchi, LIX/5*:615–644
- Pisano R, Drago A (2005) La Nota Matematica nelle “*Réflexions sur la Puissance motrice du feu*” di Sadi Carnot: interpretazione del Calcolo con il Metodo Sintetico, *Quaderni di Storia della Fisica–Giornale di Fisica* 13, 37–58
- Pisano R, Drago A (2007a) La Novità del Rapporto Fisica–Matematica nelle *Réflexions* di Sadi Carnot, *Fondazione Ronchi LXII/4*:497–525
- Pisano R, Drago A (2007b). Interpretazione e ricostruzione delle *Réflexions* di Sadi Carnot mediante la logica non–classica, *Giornale di Fisica, XLI/4*, 195–217
- Pisano R, Gaudiello (2009) Continuity and discontinuity. An epistemological inquiry based on the use of categories in history of science. *Polish Academy of Sciences. Organon* 41:245–265
- Pisano R, Guerriero A (2008) The History of Science and Scientific Education. *Problems and Perspectives. Problems of Education in the 21st Century* 6:145–158
- Pisano R et al. (2020) Introduction. Joule's Bicentenary: History of Science, Foundations and Nature of Science. *Foundations of Science, Springer* 26:531–551
- Pisano R, Mellone M (2012) Learning Mathematics In Physics Phenomenology and Historical Conceptual Streams. *Problems of Education in The 21st Century* 46:93–100
- Pisano R, Pellegrino EM, Anakkur A, Nagels M. (2021) Conceptual Polymorphism of Entropy into the History: Extensions of the Second Law of Thermodynamics Towards Statistical Physics and Chemistry during Nineteenth–Twentieth Centuries, *Foundations of Chemistry, Springer* 23:337–378
- Pisano R, Robarts J (2022) Short Comparative Historiography of Science & Technology of Mechanics into Engineering—and—Architecture Literatures during the Renaissance In: Ceccarelli M, López-García R (eds). *Explorations in the History and Heritage of Machines and Mechanisms*. Springer, pp. 227–240
- Pisano R, Sozzo S. (2020) A Unified Theory of Human Judgements and Decision–making under Uncertainty. In Khrenikov A and Bagarello F (eds) *Entropy. Special Issue. Quantum Models of Cognition and Decision–Making* 22/7:1–34
- Pisano R et al. (2019) Introduction. In Pisano R (ed): *Methods and Cognitive Modelling in the History and Philosophy of Science–&–Education Special Issue Transversal Historiography of Science* 5:3–9
- Pisano R, Dolenc K, Ploj–Vrtič M (2020) Historical Foundations of Physics & Applied Technology as Dynamic Frameworks in Pre–Service STEM. *Foundations of Science, Springer* 26:727–756
- Plesse C, Vidal F, Gauthier C, Pelletier JM, Chevrot C, Teyssié D (2007) Poly(ethylene oxide)/Polybutadiene based IPNs Synthesis and Characterization. *Journal of Polymer Science* 48:696–703. doi:10.1016/J.POLYMER.2006.11.053
- Polymeropoulos EE, Sagiv J (1978) Electrical Conduction through Adsorbed Monolayers. *Journal of Chemical Physics* 69:1836–1847. doi:10.1063/1.436844
- Polymoropoulos EE (1977) Electron Tunneling through Fatty–Acid Monolayers. *Journal of Applied Physics* 48/6:2404–2407. doi:10.1063/1.324002
- Porras D, Fernández–Rossier J, Tejedor C (2001) Nanostructure Quantification of Turbostratic Carbon by HRTEM Image Analysis: State of the Art, Biases, Sensitivity and Best Practices. *Physical Review B* 63/155406:1–7. doi:10.1103/PhysRevB.63.155406
- Post LC, Xu T, Vergei NAF, Tadjine A, Lambert Y, Vaurette F, Yarekha D, Desplanque L, Stievenard D, Wallart X, Grandidier B, Delerue C, Vanmaekelbergh D (2019) Triangular Nanoperforation and Band Engineering of InGaAs Quantum Wells: a Lithographic Route Toward Dirac Cones in III–V Semiconductors. *Nanotechnology* 30/15:155301
- Prado Y, Qu J, Greboval C, Dabard C, Rastogi P, Chu A, Khalili A, Xu XZ, Delerue C, Ithurria S, Lhuillier E (2021) Seeded Growth of HgTe Nanocrystals for Shape Control and Their Use in Narrow Infrared Electroluminescence. *Chemistry of Materials* 33/6:2054–2061

- Prasher RS, Hu XJ, Chalopin Y, Mingo N, Lofgreen K, Volz S, Cleri F, Koblinski P (2009) Turning Carbon Nanotubes from Exceptional Heat Conductors into Insulators. *Physical Review Letters* 102:105901
- Preobrazhensky V, Klimov A, Tiercelin N, Dusch Y, Giordano S, Churbanov A, Mathurin T, Pernod P, Sigov A (2018) Dynamics of the Stress-Mediated Magnetoelectric Memory Cell $Nx(TbCo_2/FeCo)/PMN-PT$. *Journal of Magnetism and Magnetic Materials* 459:66
- Preobrazhensky V, Krutyansky L, Tiercelin N, Dusch Y, Sigov A, Pernod P, Giordano S (2018) Strain-Mediated All-Magnetoelectric Memory Cell. *Ferroelectrics* 532/1:160–167
- Ranjan V, Allan G, Priester C, Delerue C (2003) Self-Consistent Calculations of the Optical Properties of GaN Quantum Dots. *Physical Review B* 68/11:115305–115312
- Sallet V, Sartet C, Hassani S, Vilar C, Amiri G, Lusson A, Jomard F, Galtier P, Lefebvre I, Delerue C, Hamza MK, Canu B, Masenelli B (2018) Crystal Facet Engineering in Ga-Doped ZnO Nanowires for Mid-Infrared Plasmonics. *Crystal Growth & Design* 18/8:4287–4295
- Simon P, Gogotsi Y (2002) Materials for Electrochemical Capacitors. *Nature Materials* 7/11:845–854. doi:10.1038/nmat2297
- Singh RP, Blossley R, Cleri F (2013) Structure and Mechanical Characterization of DNA i-Motif Nanowires by Molecular Dynamics Simulation. *Biophysical Journal* 105/12:2820–2831
- Soulaïrol R, Cleri F (2010) Interface Structure of Cilicon Nanocrystals Embedded in an Amorphous Silica Matrix. *Solid State Science* 12/2:163–171
- Spaldin NA, Fiebig M (2005) Materials Science. The Renaissance of Magnetoelectric Multiferroics. *Science* 309/5733:391–392. doi:10.1126/science.1113357
- Spoor FCM, Grimaldi G, Delerue C, Evers WH, Crisp RW, Geiregat P, Hens Z, Houtepen AJ, Siebbeles LDA (2018) Asymmetric Optical Transitions Determine the Onset of Carrier Multiplication in Lead Chalcogenide Quantum Confined and Bulk Crystals. *ACS Nano* 12/5:4796–4802
- Stiufiuc R, Perdigao LMA, Grandidier B, Deresmes D, Allan G, Delerue C, Stievenard D, Beton PH, Erwin SC, Sassi M, Oison V, Debierre JM (2010) Above-Barrier Surface Electron Resonances Induced by a Molecular Network. *Physical Review B* 81/4:045421–045426
- Sun Z, Swart I, Delerue C, Vanmaekelbergh D, Liljeroth P (2009) Orbital and Charge-Resolved Polaron States in CdSe Dots and Rods Probed by Scanning Tunneling Spectroscopy. *Physical Review Letters* 102/19:196401
- Tadjine A, Allan G, Delerue C (2016) From Lattice Hamiltonians to Tunable Band Structures by Lithographic Design. *Physical Review B* 94/7:075441–075454
- Tadjine A, Delerue C (2017) Robustness of States at the Interface Between Topological Insulators of Opposite Spin Chern Number. *EPL* 118/6
- Tadjine A, Delerue C (2017) Topological Protection of Electronic States Against Disorder Probed by their Magnetic Moment. *Physical Review B* 95/23:235426–235431
- Tadjine A, Delerue C (2018) Anderson Localization Induced by Gauge-Invariant Bond-Sign Disorder in Square PbSe Nanocrystal Lattices. *Physical Review B* 98/12:125412–126522
- Tadjine A, Delerue C (2018) Colloidal Nanocrystals as LEGO® Bricks for Building Electronic Band Structure Models. *Physical Chemistry Chemical Physics* 20/12:8177–8184
- Tadjine A, Niquet YM, Delerue C (2017) Universal Behavior of Electron g -Factors in Semiconductor Nanostructures. *Physical Review B* 95/23:235437–235453
- Tiercelin N, Dusch Y, Klimov A, Giordano S, Preobrazhensky V, Pernod P (2011) Room Temperature Magnetoelectric Memory Cell Using Stress-Mediated Magnetoelastic Switching in Nanostructured Multilayers. *Applied Physics Letters* 99/19:192507
- Tomezak M, Abbadie C, Lartigau E, Cleri F (2016) A Biophysical Model of Cell Evolution after Cytotoxic Treatments: Damage, Repair and Cell Response. *Journal of Theoretical Biology* 389:146–158
- Toth P (2021) Nanostructure Quantification of Turbostratic Carbon by HRTEM Image Analysis: State of the Art, Biases, Sensitivity and Best Practices. *Carbon* 178:688–707. doi:10.1016/j.carbon.2021.03.043
- Ulbricht R, Pijpers JHH, Groeneveld E, Koole R, Donega CdM, Vanmaekelbergh D, Delerue C, Allan G, Bonn M (2012) Loosening Quantum Confinement: Observation of Real Conductivity Caused by Hole Polarons in Semiconductor Nanocrystals Smaller than the Bohr Radius. *Nano Letters* 12/9:4937–4942
- Ulman A (1991) *Introduction to Ultrathin Organic Films: From Langmuir-Blodgett to Self-Assembly*. Academic Press, San Diego

- van Driel AF, Allan G, Delerue C, Lodahl P, Vos WL, Vanmaekelbergh D (2005) Frequency-Dependent Spontaneous Emission Rate from CdSe and CdTe Nanocrystals: Influence of Dark States. *Physical Review Letters* 95/23:236804–236808
- Varela JA, Sen K, Gibson J, Fost J, Abbott LF, Nelson SB (1997) A Quantitative Description of Short-Term Plasticity at Excitatory Synapses in Layer 2/3 of Rat Primary Visual Cortex. *Journal of Neuroscience* 17/20:7926–7940. doi:10.1523/JNEUROSCI.17–20–07926.1997
- Vergel NAF, Tadjine A, Notot V, Mohr M, N'Guissan AK, Coinon C, Berthe M, Biadala L, Sossue KK, Dzagli MM, Girard JC, Rodary G, Desplanque L, Berndt R, Stivenard D, Wallart X, Delerue C, Grandier B (2019) Influence of Doping Level and Surface States in Tunneling Spectroscopy of an In_{0.53}Ga_{0.47}As Quantum Well Grown on p-Type Doped InP(001). *Physical Review Materials* 3/9:094604–094613
- Viero Y, Copie G, Guérin D, Krzeminski C, Vuillaume D, Lenfant S, Cleri F (2015) High Conductance Ratio in Molecular Optical Switching of Functionalized Nanoparticle Self-Assembled Nanodevices. *Journal of Physical Chemistry C* 119/36:21173–21183
- Voisin B, Cobian M, Jehl X, Vinet M, Niquet YM, Delerue C, de Franceschi S, Sanquer M (2014) Control of the Ionization State of Three Single Donor Atoms in Silicon. *Physical Review B* 89/16:161404
- Vuillaume D, Lenfant S, Guerin D, Delerue C, Petit C, Salace G (2006) Electronic Properties of Organic, Monolayers and Molecular Devices. *Pramana–Journal of Physics* 67/1:17–32
- Walravens W, Solano E, Geenen F, Dendooven J, Gorobtsov O, Tadjine A, Mahmoud N, Ding PP, Ruff JPC, Singer A, Roelkens G, Delerue C, Detavernier C, Hens Z (2019) Setting Carriers Free: Healing Faulty Interfaces Promotes Delocalization and Transport in Nanocrystal Solids. *ACS Nano* 13/11: 12774–12786
- Weissmann M, Bonadeo H (2001) A Simple Interpretation of Quantum Mirages. *Physica E* 10/4:544–548. doi:10.1016/S1386–9477(01)00036–4
- Yang F, Wang M, Zhang D, Yang J, Zheng M, Li Y (2020) Chirality Pure Carbon Nanotubes: Growth, Sorting, and Characterization. *Chemical Reviews* 120/5:2693–2758. doi:10.1021/acs.chemrev.9b00835
- Zaghloul U, Bhushan B, Papaioannou G, Coccetti F, Pons P, Plana R (2011) Nanotribology-Based Novel Characterization Techniques for the Dielectric Charging Failure Mechanism in Electrostatically Actuated NEMS/MEMS Devices using Force-Distance Curve Measurements. *Journal of Colloid and Interface Science* 1/1:236–253. doi:10.1016/j.jcis.2011.08.005
- Zhang T, Vlaic S, Pons S, Assouline A, Zimmers A, Roditchev D, Aubin H, Allan G, Delerue C, David C, Rodary G, Girard JC (2018) Quantum Confinement Effects in Pb Nanocrystals Grown on InAs. *Physical Review B* 97/21:214514–214525
- Zhang W, Delerue C, Niquet YM, Allan G, Wang E (2010) Atomistic Modeling of Electron-Phonon Coupling and Transport Properties in n-type [110] Silicon Nanowires. *Physical Review B* 82/11:115319–115326
- Zhou S, Pi X, Ni Z, Ding Y, Jiang Y, Jin C, Delerue C, Yang D, Nozaki T (2015) Comparative Study on the Localized Surface Plasmon Resonance of Boron- and Phosphorus-Doped Silicon Nanocrystals. *ACS Nano* 9/1:378–386
- Zucca R, Boero M, Massobrio C, Molteni C, Cleri F (2011) Interacting Lewis-X Carbohydrates in Condensed Phase: A First-Principles Molecular Dynamics Study. *Journal of Physical Chemistry B* 115/43:12599–12606

PART IV

Nanotechnology and Science in Society

Chapter VII

Nanoparticles and Society

An outline. Nanoparticles are a class of materials with properties distinctly different from their molecular and bulk counterparts. In this chapter, I present the interactions between nanoparticles and the environment or organisms and what social implications arise from such an advanced technology. The potential effects on human health and the environment, both negative and positive, are important aspects to consider. As will be described, the study of “environmental nanoparticles” is a new and rapidly growing field. There is still a lot of work to be done before the full benefits of nanoparticles can be realised and to ensure that there are no potential negative consequences on the environment or living organisms, with a focus on humans. It is with this in mind that the regulations to be applied must be considered, for research that is ethical and shared.

Prologue VII

The impact of a technological revolution such as Nanoscience and its countless declinations in Nanotechnology is having strong implications, ethical, sociological, and behavioural, in contemporary society. It has opened up completely new research horizons beyond those abilities discussed so far, that allow scientists to assemble matter, atoms and molecules, for specific purposes.

People's perception of nanotechnology depends largely on the individual's ability to process the information on the subject. The reasonably uneven level of scientific knowledge among the masses means that the acquisition of information is highly dependent on the quality of the scientific narrative. This is why it is desirable for information to be as complete as possible, in every direction, and for its recipients to be fairly and ethically prepared.

In this chapter, I will describe the most relevant aspects of the nanoworld in Society, involving the considerations outlined above.

7.1 Nanoparticles and Society

7.1.1 Introduction

The idea we have of the scientist is often that of a person in a white coat, locked up in the safety of his own laboratory, perpetually jealous of his results which he does not divulge so as not to compromise his success and career, the sole custodian of knowledge which is destined for an elite. Generally, it is common for the scientist to have the desire to be the first to write in the specialised literature, rather than a desire for publicity with a large audience, and publication in the dedicated press, especially in the most prestigious journals, is perceived as being a better vehicle than media dissemination. Yet, as the last few dramatic years have also shown, communicating the latest results to the general public has become necessary to inform people about scientific achievements, and clarity in scientific disclosure is essential to avoid dangerous misunderstandings.

Communication is a fundamental process of relating between individuals, it is used not only to disseminate news and facts aridly but also to move the masses, guide their decisions, and make them acquire new knowledge and skills. According to Colin Fraser and Sonia Restrepo–Estrada (Fraser, Restrepo–Estrada 1998), communication for development is:

the use of the communication process, techniques and media to help people become fully aware of their situation and options for change, to resolve conflicts, to work towards consensus, to help people plan actions for change and sustainable development, to help people acquire the knowledge and skills they need to improve their condition, society and the effectiveness of institutions.

Access to information in the western world is guaranteed twenty–four hours a day with virtually any kind of electronic device.

The term Nanotechnology has long been in common use, and its practical results are available to a vast mass of people in a wide variety of fields. Yet perception of what Nanotechnology may be, for all intents and purposes, may be [is] far from clear to everyone.

There is a term called “scientific literacy”, defined as “knowing ‘how science works’, thus promoting science to the public for a better understanding of new scientific knowledge” (Miller 2001). In order to engage the public with the new frontiers of science, such as Nanotechnology, they need to be familiar with the basic concepts, historical facts, theories and also controversial issues, which should not be marginalised. This requires education in scientific language, science as such, the method, the potential, the limits, and the ethics of research. In other words, the public must be accustomed to thinking critically. Yet, scientific communication has only been reserved for the general public after the fact, when the technology described has already been developed (Nelkin 1987).

Nanotechnology has been part of the contemporary world for at least thirty years, and the public must be “told” of it in the correct way, to avoid misunderstandings and false certainties that shape thinking about the nanoworld in a predetermined direction. In this way, confidence is also acquired in the public, supported on the one hand by correct information, and on the other by possession of the semantic tools of decoding. Knowing the factors that influence public perception is essential for conveying concepts correctly.

Several studies have been conducted to investigate how demographic factors influence audience perceptions. Nanotechnology–based products have a longer lifespan than others on the market and provide better performance. On the one hand, the development of nanotechnology brings benefits associated with the new properties of nanodimensioned

materials, but it also exposes the public to uncertain risks associated with the development of such an advanced and rapidly advancing technology. Despite their proven ability, for example, to improve the quality of life of human beings, the public rejects other technologies, such as genetic modification or nuclear energy. This is both due to the lack of knowledge of the basic concepts among the masses and the failure to describe the benefits of these. Conversely, the risks perceived by the public during the initial development may be amplified due to incorrect information or lack of scientific basis.

The perception of benefits and risks associated with nanotechnology development is crucial to increase objective public understanding and enhance informed acceptance of the emerging technology. Communicating, without emphasising either side, both the benefits and risks of nanotechnology is an effective approach to gaining the public's trust and preparing them with adequate information, which will enable them to make informed decisions and avoid the fear of the unknown due to a lack of adequate information and scientific knowledge (Kamarulzaman, Lee, Siow and Mokhtar 2020).

An example of the “perception” of nanotechnology is the article published in 2003 by S.K. Sahoo and V. Labhasetwar, *Nanotech Approaches to Drug Delivery and Imaging*, where the account of the potential of Nanotechnology in drug delivery and diagnosis is very optimistic (Sahoo and Labhasetwar 2003). The work examines different nanometer-sized transport systems, yet traces this wide range of systems back to the same functioning. Since this is medicine, some nanotechnological approaches will work and others will not, depending on the type of disease to be treated and, above all, the patient's response. The authors have consulted a very wide variety of sources and, rightly, selected the data that generally illustrate the advantages of nanosystems only. The reader, therefore, might be led to believe that this technology is exclusively advantageous. From a historical point of view, however, it is worth remembering that many researchers were already working in this field before modern nomenclature was invented. As early as the early 1970s, the process of micellar polymerisation was referred to as “nanoparticles”.

“Nanoparts” are solidified micelles containing drugs; they are spherical particles of nontoxic polymeric material with entrapped bioactive materials. The extremely small diameter of nanoparts, smaller than 80nm, is measured by electron scanning microscopy. The lower limit for the particle diameter ranges between 20 and 35nm, as shown by ultrafiltration with special diaphragms of an average pore size between 20 and 50nm. These ultrafine capsules or polymer pellets represent a narrow distribution in particle size. The electron scanning photographs show an aggregation of homogeneous, spherical particles of nearly the same shape and size, being small enough to give colloidal aqueous solutions. According to polarity, dielectric constant, and steric effect of the reactants, a more or less shell-like polymer construction (“Nanocapsule” of “a”) or a compact polymer particle (“nanopellet”) can be proposed [...]. The minuteness of the nanoparts and the homogeneity of the final product also enable the formulation of parenteral drug delivery systems (Birrenbach and Speiser 1976).

A differentiation of the particles themselves into nanoparticles and nanocapsules was established, and these were studied as vaccine vectors. The development of nanoparticles, actually, took place over a quarter of a century.

The unifying feature of the field of pharmaceutical nanotechnology is, of course, the size range of the particles or systems under investigation. Nanometric dimensions are indeed important to allow access to tissues from which larger carriers are excluded, or can be recognised and attacked by the immune system. But at the same time, the extremely small size offers two characteristics: low volumetric capacity and high surface area.

Up to this point, nanoparticle descriptions are characterised by features that tend to provide a uniquely positive connotation of their application.

However, there are features that tend to downgrade the purely positive view of nanoparticles, and which are being researched, such as a limited capacity for active compounds and the potential for instability. For dendrimers, the maximum size of which is of the order of 10nm, the capacity for housing inside is low and, unlike micellar structures with their “liquid” interiors, dendrimers usually possess a largely inflexible branched core. Similarly, proteins often have a diameter equivalent to that of many nanometer-sized carriers and thus, as specific protein carriers, smaller nanoparticles possess limitations. One topic that needs further investigation is the behaviour of the particles in the circulatory system. This will be determined by:

- i. the interaction of nanoparticles with erythrocytes and other blood components;
- ii. the association of primary nanoparticles with themselves and blood vessel walls;
- iii. the influence of elasticity, when the diameter of the system exceeds that of the capillary vessels.

The last point is unlikely to be a problem for nanoparticles unless they have aggregated; in this case, the reversibility of particle-to-component or particle-to-particle interactions is crucial. Significant numbers of nanoparticles, e.g. in lymphatic vessels, can influence lymph flow.

There is no doubt that nanosystems offer the potential for greater diffusion and better targeting. The enormous variety of structures that can be constructed by self-assembly or covalent attachment of components, e.g. dendrimers or dendrons, offers a great deal of scope, especially if these structures can be fabricated at will. This is certainly a positive factor. The success criteria for drug targeting, however, are much stricter than those for diagnostic success, where essentially only an increase in signal over background is required. In treatment, if true success is to be achieved, the accumulation at the target site should, ideally, be complete. So far, this has not been achieved, and this is information that should in any case be shared: the balance of drug concentration has been only moderately shifted in favour of the target. The potential of nanosystems to cause adverse effects also needs to be studied in depth, as their size partly determines their distribution in different organs.

There are both beneficial and adverse possibilities as a result. It is the gradual piecing together of information about the fate of these particles that will lead to a better understanding of the relationships between nanoparticle diameter, surface character, interactions and transport, leading to the optimal choice of systems for therapy and diagnosis (Ng and Ilag 2004).

7.1.2 Nanotechnology: a Concept Difficult to Define?

The fact that Nanotechnology is a fascinating but at the same time complex subject is demonstrated, in the first analysis, by the fact that its definition has been the result of successive reworkings that have led to the expansion and integration of the very concept of this science. Understanding how the concept of Nanotechnology has evolved over time is

our starting point for the following considerations (Lindquist, Mosher–Howe and Liu 2010). This is why I briefly review these ideas.

The term Nanotechnology officially came into being in 1974, when Japanese engineer Norio Taniguchi was the first in the world to mention it in an article entitled *On the Basic use of Nano–Technology*. His abstract explains the basic idea.

‘Nano–technology’ is the production technology to get the extra high accuracy and ultrafine dimensions, i.e. the preciseness and fineness of the order of 1nm (nanometer), 10^{-9} m in length. The name of Nano–technology originates from this nanometer. In the processing of materials, the smallest bit size of stock removal, accretion or flow of materials is probably of one atom or molecule, namely 0.1–0.2nm in length. Therefore, the expected limit size of fineness would be of the order of 1nm. Accordingly, Nanotechnology mainly consists of the processing of separation, consolidation and deformation of materials by one atom or one molecule. Needless to say, the measurement and control techniques to assure the preciseness and fineness of 1nm play very important role in this technology. In the present paper, the basic concept of Nanotechnology in materials processing is discussed on the basis of microscopic behaviour of materials and, as a result, the ion sputter–machining is introduced as the most promising process for the technology (Taniguchi 1974).

Despite the specifics provided by Taniguchi in his description, a precise and unambiguous definition of the concept of Nanotechnology lacks certain details that would make it unambiguous. It is defined through other technologies, through procedures and innovations that come from an endless range of research fields, from physics to chemistry, from engineering to materials science, from electronics to biology, from medicine to earth sciences (Arnall 2003).

The history of defining Nanotechnology has gone through several iterations. According to the initial volume of the *Journal of Nanoparticle Research* for example:

Nanotechnology is concerned with the development and utilization of structures and devices with organizational features at the intermediate scale between individual molecules and about 100nm where novel properties occur as compared to bulk materials. It implies the capability to build up tailored nanostructures and devices for given functions by control at the atomic and molecular levels (Roco, 1999).

According to a later definition, Nanotechnology is a fusion of physics and engineering that takes advantage of the new ability to manipulate matter, and thus characterise it, at the level of individual atoms or small groups of atoms (National Research Council 2002).

The Royal Society, in U.K., defines it as:

the ability to engineer new attributes through controlling features at a very small scale – at or around the scale of a nanometre. One nanometre is a billionth of a metre; or about 1/80,000 the width of a human hair... any product which possesses a characteristic or attribute that involves some manipulation or measurement at or below 100 nanometres (or 0.1 of a micrometre) falls under the umbrella of nanotechnology (Royal Society 2003).

Even the US government has found it difficult, despite drawing up a protocol of guidelines and grants for research in nanotechnology, to deal with the definitions given by each of the 26 federal departments on this subject. A single possible definition has been proposed by the National Nanotechnology Initiative (NNI), as:

Nanotechnology is the understanding and control of matter at dimensions of roughly 1–100 nanometers, where unique phenomena enable novel applications. Encompassing nanoscale science, engineering and technology, nanotechnology involves imaging, measuring, modeling, and manipulating matter at this length scale (<http://www.nano.gov/html/facts/whatIsNano.htm>).

The National Science Foundation (NSF) proposes (2003) a definition of it, within what is called the potential of nanotechnology.

Science and technology on the scale of a nanometer – one billionth of a meter – is revolutionary. Nanotechnology refers to the ability to manipulate individual atoms and molecules, making it possible to build machines on the scale of human cells or create materials and structures from the bottom up with novel properties. Nanotechnology could change the way almost everything is designed and made, from automobile tires to vaccines to objects not yet imagined (https://www.nsf.gov/news/news_summ.jsp?cntn_id=100602).

It is worth comparing this definition with the one given by another agency, the National Institutes for Health (NIH):

Nanotechnology involves the creation and use of materials and devices at the level of molecules and atoms (<http://nihroadmap.nih.gov/nanomedicine>).

Let us look at an example from the medical/clinical literature:

Nanotechnology can be defined as the science and engineering involved in the design, synthesis, characterization, and application of materials and devices whose smallest functional organization, in at least one dimension, is on the nanometer scale or one billionth of a meter. At these scales, consideration of individual molecules and interacting groups of molecules in relation to the bulk macroscopic properties of the material or device becomes important, as it has a control over the fundamental molecular structure, which allows control over the macroscopic chemical and physical properties (Saini, Saini and Sharma 2010).

The NIH itself proposes a specific definition for Nanomedicine:

Nanomedicine, an offshoot of nanotechnology, refers to highly specific medical intervention at the molecular scale for curing disease or repairing damaged tissues, such as bone, muscle, or nerve. A nanometer is one-billionth of a meter, too small to be seen with a conventional lab microscope. It is at this size scale – about 100 nanometers or less – that biological molecules and structures operate in living cells (<https://commonfund.nih.gov/nanomedicine/overview>).

What we find is that many attempts to define nanotechnology focus on the potential prospects and applications. Definitions decline towards each specific application such as medicine, agriculture, military industry, chemistry and materials (Lindquist, Mosher–Howe and Liu 2010).

In the archives of the National Science Foundation, we find that the National Science and Technology Council, the Committee on Technology, the Subcommittee on Nanoscience and Engineering have proposed a rather long and complicated definition.

Research and technology development at the atomic, molecular, or macromolecular levels, in the length scale of approximately 1–100 nanometer range, to provide a fundamental understanding of phenomena and materials at the nanoscale and to create and use structures, devices and systems that have novel properties and functions because of their small and/or intermediate size. The novel and differentiating properties and functions are developed at a critical length scale of matter typically under 100nm. Nanotechnology research and development includes manipulation under control of the nanoscale structures and their integration into larger material components, systems and architectures. Within these larger scale assemblies, the control and construction of their structures and components remains at the nanometer scale. In some particular cases, the critical length scale for novel properties and phenomena may be under 1nm (e.g., manipulation of atoms at ~0.1nm) or be larger than 100nm (e.g., nanoparticle reinforced polymers have the unique feature at ~200–300nm as a function of the local bridges or bonds between the nano particles and the polymer).

(http://www.nsf.gov/crssprgm/nano/reports/omb_nifty50.jsp, 3/21/2007).

In 2007, Mihail C. Roco presented a definition at an NSF meeting that was much more streamlined and focused on the concept of nanotechnology.

Nanotechnology is the control and restructuring of matter at the dimension of roughly 1–100 nanometers (from atomic size to about 100 molecular diameters), where new phenomena enable new applications (Roco 2007).

The following year, Roco mentioned the same definition once more in a presentation at the National Science Foundation in Arlington, but at the same time reiterated the need for research and development in this field to be supported by secure subsidies (Lindquist, Mosher–Howe and Liu 2010).

7.1.3 A Review on Classification of Nanomaterials

Here I remind the reader some fundamental features of nanomaterials to review their characteristics for the sake of clarity in further ethical discussions.

It is well known that nanomaterials are divided into different categories according to the number of nanometric dimensions it is possible to measure them.

- Quantum dots are so-called zero-dimensional structures, i.e. each of their dimension is at the nanometric scale. To this category belong nanoparticles, metals, semiconductors, fullerenes, oxides and so on.
- Quantum wires are the mono-dimensional structures, i.e. one of their dimensions is measurable (finite). Examples of mono-dimensional structures are nanowires and carbon nanotubes, or nanorods.
- Quantum wells are instead two-dimensional structures, i.e. the ones with two finite dimensions, like thin monolayer/multilayer films.
- Nanocomposite materials belong to the last category of materials, the three-dimensional structures.

Besides a first classification based on the physical dimensions of the materials, another description is possible and is based on the principles of inorganic and organic chemistry (Barbato 2018).

The most important inorganic nanoparticles are without doubt the fullerenes and carbon nanotubes, whose description I gave in the previous chapters. Other inorganic nanoparticles may be made of iron oxide and they are applied as active/passive agents for targeting (Gupta and Gupta 2005). Also, gold nanoparticles or silver ones are applied, the latter especially for their antibacterial and disinfectant properties. Ceramic nanoparticles can be applied as carrier media for active ingredients in drugs because of their porous surface (Cherian, Rana and Jain 2000).

The next examples belong instead to the world of organic nanoparticles. Liposomes and micelles are types of nanoparticles where a double lipidic layer encloses a watery nucleus. Such molecules are very similar to organic biological membranes so they can be used to improve the effectiveness of drugs as well as their safety.

In the language of chemistry, an emulsion is a two-phase mixture in which one phase is dispersed in the other. Technically, the first is called the dispersed phase and the second is

the dispersant phase. The two components are necessarily immiscible, otherwise, we would speak of a solution. Nanoemulsions are very interesting systems in that, in the long term, they manage to maintain interesting kinetic stability. They are sometimes referred to as “Approaching Thermodynamic Stability” (Tadros, Izquierdos, Esquena and Solans 2004).

Dendrimers are synthetic monodisperse polymeric macromolecular compounds characterised by a layered architecture consisting of a polyfunctional core, a series of branching units and functional groups, the latter determining their characteristics (Barbato 2018).

7.1.4 Nanoparticles and Life

Discussing the interactions among nanoparticles and the different organic subjects is fundamental to describing the issues concerning their effects. In the next paragraphs, I discuss these fundamental aspects of the nanoworld.

7.1.4.1 Interactions with the Human body

Nanoparticles interact with an organism in a variety of ways; the beneficial and/or deleterious effects of these interactions ultimately arise from interactions at the cellular and subcellular levels. Nanoparticles can intervene and alter cell fate, induce or prevent mutations, initiate cell–cell communication and modulate cell structure in a manner largely dictated by phenomena at the nano–bio interface. Recent advances in chemical synthesis continue to produce new nanoscale materials whose biochemical characteristics can be precisely defined. Emerging analytical techniques have shed light on nano–bio and context–dependent interactions within cells.

An account of the current understanding of the cellular uptake of NPs and the underlying parameters that control nano–cellular interactions, along with the analytical techniques available to track and trace these processes, is outlined below (Behzadi *et al.* 2017).

One of the purposes of the cell membrane (CM) is to protect the nucleus and intracellular components from the surrounding environment. In addition, the CM maintains cellular homeostasis, provides structural support, maintains ionic concentration gradients and controls the entry and exit of small charged molecules and nutrients or waste substances (Shi and Massagué 2003). Almost all natural membranes share a common general structure: a double layer of amphiphilic lipids with hydrophilic heads and hydrophobic tails (Eddin 2003). The amphiphilic properties of phospholipids make their assembly an efficient selective barrier, as 'balanced' hydrophobicity/hydrophilicity is required to allow a wide range of small biomolecules to enter the cell by passive diffusion. Despite this, in some cases entry is regulated by other mechanisms.

The development of NPs for a wide range of biomedical applications promises safer and more effective solutions to numerous medical problems (Shi, Kantoff, Wooster and Farokhzad 2017). Here, by nanoparticles we refer to an exogenous synthetic structure of nanometre size. For many NPs, their safe entry into cells is an important step in achieving high prognostic and therapeutic efficacy. Furthermore, the intracellular fate of NPs is crucial for their success in medicine, considering that these vectors are intended to transport specific molecules (e.g. genes, drugs and contrast agents) into the cytosol, nucleus or other

specific intracellular sites. The efficient and controlled entry/trafficking of NPs into cells remains a major challenge. In addition to interactions with CMs, a more comprehensive understanding of the uptake and cellular trafficking mechanisms of NPs is crucial to design efficient and safe nanomedicines by carefully tuning the physicochemical properties of NPs to optimise targeting, uptake and cellular trafficking (Chou, Ming and Chan 2011).

When a nanoparticle reaches the outer membrane of a cell, it interacts with components of the plasma membrane or extracellular matrix and can enter the cell, mainly through the phenomenon of endocytosis. Endocytosis causes nanoparticles to become embedded in membrane folds. The endocytic vesicles are then transported to specialised intracellular sorting/trafficking compartments. Depending on the cell type and the proteins, lipids and other molecules involved in the process, endocytosis can be classified differently (Doherty and MacMahon 2009). The five different main mechanisms of endocytosis are phagocytosis, clathrin-mediated endocytosis, caveolae-mediated endocytosis, clathrin/caveolin-independent endocytosis and macropinocytosis.

Phagocytosis: Phagocytosis occurs mainly when structures such as macrophages, monocytes, neutrophils and dendritic cells, which are responsible for host defence and the uptake of dead cells and cellular debris, are involved. Biologically, other cell types (e.g. fibroblasts, epithelial and endothelial cells) also have phagocytic activity, but to a lesser extent, and are referred to as paraphagocytes. Phagocytosis of NPs is usually initiated by immunoglobulins (i.e., antibodies), complement proteins or other blood proteins (e.g., laminin and fibronectin) that are adsorbed onto the NP surface (Swanson 2008). The NPs are then recognised and attached to phagocytes through specific ligand-receptor interactions. This initiates a cascade of signals that can trigger the incorporation and internalisation of the particles, forming the so-called “phagosome”.

Clathrin-mediated endocytosis (CME): Clathrin-mediated endocytosis (CME) is the main mechanism by which cells obtain nutrients and plasma membrane components, such as cholesterol through low-density lipoprotein (LDL) and iron through the transferrin transporter. CME occurs through both receptor-specific uptake and non-specific adsorptive uptake, also referred to as receptor-independent CME. In receptor-independent CME, uptake occurs without direct binding to membrane constituents. ECM occurs in a clathrin-rich area of the plasma membrane. The clathrin assembly unit, known as the triskelion, has a three-legged structure consisting of three heavy and three light chains (Ungewickell and Branton 1981). This unique protein and others are responsible for spontaneous co-assembly into a complex architecture that generates and stabilises the membrane curvature and thus the incorporation of vesicles. During CME, vesicles with a diameter of 100–150nm are formed, which engulf a volume of extracellular fluid proportional to the available internal volume of the formed vesicle. However, particles entering the cell by this route often end up in degradative lysosomes (Erlich *et al.* 2004) and may not be suitable for coating NPs made of materials susceptible to degradation by lysosomal enzymes. Several types of NPs have been studied for their uptake by CME. For example, NPs made of D,L-poly(lactide) (PLA) and poly(ethylene glycol co-lactide) (PEG-co-PLA) have been incorporated through both the CME pathway and caveolae-mediated endocytosis. Furthermore, it has been observed that surface charge has a dominant effect on both the uptake mechanism and intracellular fate. For instance, anionic particles demonstrated cellular uptake through both mechanisms in HeLa cervical cancer cells, whereas positively charged particles were strictly subject to the ECM (Harush-Frenkel, Debotton, Benita and Altschuler 2006). In the same context, the uptake mechanism of silica nanotubes (SNTs) was studied using MDA-MB-231 cells by co-localisation of clathrin and LysoTracker (to track lysosomal uptake).

Confocal microscopy indicated that the positively charged particles achieved higher cellular interaction and uptake than the unmodified naked SNTs (Nan *et al.* 2008).

Caveolae-dependent endocytosis: Caveolae-dependent endocytosis plays a critical role in many biological processes. These include cell signalling, transcytosis and the regulation of lipids, fatty acids, membrane proteins and membrane tension. Furthermore, this mechanism is believed to be involved in a number of diseases, including cancer, diabetes and viral infections. Caveolae are membrane folds found in epithelial and non-epithelial cells, interspersed with regions of dense bodies that anchor the cytoskeleton. In the case of non-epithelial cells, caveolae form a substantial part of the cell membrane, increasing its surface area by up to 75% (Gabella and Blundell 1978). Caveolae are 50–80nm in size and are coated with caveolin, a dimeric protein involved in the formation of their characteristic flask shape. Caveolin proteins promote membrane curvature, dynamin mediates vesicle cleavage and release during budding, and vesicle-associated membrane protein (VAMP2) and synaptosome-associated protein (SNAP) are involved in subsequent vesicle fusion (Schnitzer, Liu and Oh 1995). The commercially available nanotherapeutic Abraxane[®] was found to be taken up by tumour cells through caveolae-mediated endocytosis. Albumin is a great value addition to the preparation, as it binds to gp60, the albumin receptor present in the caveolae of endothelial cells, facilitating its transport into the interstitial spaces of the tumour, where it exerts its action on tumour cells. Since particles entering the cell via these caveolin-dependent mechanisms can sometimes escape lysosomal degradation, this route of entry is exploited by certain pathogens such as viruses to escape degradation. In terms of drug delivery, this pathway appears to be useful for the release of degradable materials such as genes and proteins (Rejman, Conese and Hoekstra 2006). Trafficking in acidic lysosomes could be the basis for engineering nanotherapeutics with acid-triggered release characteristics (Karimi *et al.* 2016). In some studies (Sahay, Kim, Kabanov and Bronich 2010), cellular uptake mediated by caveolae of NPs loaded with the chemotherapeutic agent doxorubicin through pH-sensitive hydrazonic bonds was evaluated in an attempt to achieve intracellular drug release in the acidic environment of epithelial cancer cell lysosomes.

Clathrin/caveolae independent endocytosis: Clathrin- and caveolae-independent endocytosis occurs in cells without clathrin and caveolae. These cells take up various cargoes, cellular fluids, and growth hormones via other pathways, which require a specific lipid composition (mainly cholesterol) without clathrin and caveolae. It is known, for example, that folic acid is also internalised through this pathway. Bearing in mind the growth process of cancer cells, including the increased demand for folic acid, the biofunctionalisation of folates has often been addressed for targeting purposes. Folate-modified NPs are an excellent example of particles that can be exploited via this pathway. Particles internalised via folate receptor-mediated endocytosis could also bypass lysosomes and be incorporated directly into the cytoplasm (Lim and Gleeson 2011).

Macropinocytosis: Macropinocytosis is a unique process, as it does not involve the use of lipid transporters or proteins. In this case, following rearrangement of the cytoskeleton, large membrane extensions are formed, that fuse back onto the plasma membrane, creating a large vesicle (0.2–5µm) capable of trapping a large amount of extracellular fluid. In macropinocytosis, all of the particles and molecules dissolved in the extracellular fluid are accommodated in the endocytic vesicle, making the process a form of non-specific fluid uptake, en masse. Macropinocytosis is important in many physiological functions, such as antigen 80 presentation, and acts as a portal of entry for microbial pathogens, including many bacteria and viruses. As this process involves the formation of large vesicles, it is

considered important for the uptake of larger NPs that would not be possible through clathrin- or caveolae-dependent endocytosis (Kuhn *et al.* 2014).

Determining exposure to nanoparticles is an important aspect before any health impacts can be established. There are many studies on exposure to chemicals and particles in the workplace, but data on nanoparticle exposure are only partially available. Limited data and guidelines for the handling and treatment of nanoparticles, not only in workplaces but also in research laboratories, have been compiled. However, particular care must be taken when choosing respiratory protection for specific applications of nanoparticle systems. Fine particle mass (PM_{2.5}) has been shown to be associated with increased symptoms and deaths from cardiovascular and respiratory causes (Seaton, Macnee, Donaldson and Godden 1995). Fine particles have been reported to be more strongly related to certain symptoms than ultrafine particles (de Hartog *et al.* 2003). Continued investigations are needed to arrive at a better and clearer understanding of the health effects of nanoparticles, one of the causes of greatest public concern. It is essential to invest significantly in research on a day-to-day basis in order to find the answers to vital questions and to derive the solutions that will enable society to rapidly adopt and implement nanotechnology while remaining within tolerable limits for humans and the environment.

The human body basically communicates with the external environment through three structures: the skin, the lungs and the gastrointestinal tract. A complex mixture of compounds in the gastrointestinal tract can interact with nanoparticles and reduce, for example, the negative effects of ingested toxins. The greatest concern regarding the potential health and environmental effects of nanoparticles is when they are transported by gases in the form of aerosols. Nanoparticles in the air have high mobility and can enter the human body by inhalation. Although there are some defence mechanisms of the respiratory system, the alveolar tissue in the lungs is not as well protected from environmental damage as the skin or the gastrointestinal tract, and is therefore the most vulnerable contact site. The challenge is to understand the effects of man-made nanoparticles, particularly those from daily traffic, energy production or industrial processes.

Several hypotheses have been proposed on the physiochemical characteristics of particles responsible for adverse health effects (Samet 2000). These include general properties, such as surface area or size, and also more specific chemical properties, such as acidity or metal content. The number and surface area of particles can cause greater effects than the mass concentration (Vincent and Clement 2000). Nanoparticles also act synergistically with other pollutants, such as ozone or nitrogen oxides. The complex interactions between particles and gaseous components complicate the assessment of nanoparticle effects.

It should be emphasised, however, that nanoparticles have also provided a broad spectrum of opportunities to improve quality of life, advancing our ability to diagnose and treat diseases.

7.1.4.2 Nanoparticles in Medicine

For obvious reasons, it is not ethically possible to conduct experimental trials on humans as laboratory guinea pigs. The research results presented below are based on laboratory tests conducted, as is customary, on animal species chosen for the purpose. With due precautions, the results obtained are then extended to mankind, for all relevant considerations. What is

described below is neither intended to demonstrate the absolute dangerousness of nanoparticles, nor their certain biocompatibility and safety of use when introduced into an organism, but rather the need for careful evaluation and continued experimentation.

Before getting into the results obtained from the interaction of nanoparticles with organisms, it is better to review what the approval process is for human therapeutics, as nanomedicine is a field of research rapidly expanding.

The procedures required for the approval of a drug are usually variable worldwide. A convergence on these processes has been facilitated by the work developed at the International Harmonisation Conferences, which began in 1990. They established a set of guidelines in order to unify procedures and to discuss technical and scientific aspects related to the registration of medicinal products (Molzon *et al.* 2011). However, fundamental to the new drug development process is the ability, upstream, to characterise the critical product attributes that ensure the identity, strength, quality, purity and therapeutic efficacy of the final product. New technologies require new approaches to achieve this assessment. Moreover, before a product can be submitted for approval for use in humans, at least four different sets of studies are required, which are described below.

Firstly, animal toxicity studies must be conducted under so-called Good Laboratory Practice (GLP). These studies often require the testing of more than one species, usually a rodent and another non-rodent species, to ensure that expected and even unexpected drug toxicities can be safely identified and characterised, so that the active ingredient can be safely administered, with reference to the doses expected in human studies.

Animal studies are normally followed by three phases of human drug development.

Phase I studies involve the evaluation of safety, tolerability and pharmacokinetics, in order to determine the maximum doses tolerated by the body, and certain pharmacokinetic parameters.

Phase II studies, on the other hand, are exploratory studies, conducted with varying doses in carefully selected patients. This specifies the target of interest in order to further define the safety and tolerability of the drug and obtain positive results on preliminary evidence of efficacy.

Finally, Phase III studies are initiated to confirm efficacy and safety in the patient population most likely to receive the treatment after its approval.

These large-scale studies are usually conducted in duplicate and require a large number of subjects to provide adequate statistical significance to demonstrate that a clinical effect, if any, can be observed.

The drug development and approval processes often take up to 10 years and an economic effort of hundreds of millions of dollars, or euros. In contrast, the approval process for medical devices is often shorter and requires fewer studies and subjects. First and foremost, it is necessary to prove that the device is effective and acts appropriately for its intended use, without obvious difficulties or side effects of varying severity. This process must necessarily be rigorous. In some cases, it may require a series of studies similar to those required for the approval of therapeutic drugs.

The development of a drug cannot be considered finished when research ends and, at the same time, clinical development begins. This step is only the first of a long and arduous process needed to obtain regulatory approval. It is clearly very important to understand exactly how nanomaterials can be developed into officially approved drugs and devices. The publication of preclinical and clinical studies related to the therapeutic approval process becomes an important part of the scientific dissemination of the results obtained.

Studies that provide an overview of the pathway to regulatory approval of a new therapy, and studies that outline how specific therapies are tested and evaluated, both in terms of toxicity and clinical efficacy, are fundamental to good medical/scientific practice. Indeed, the publication of such papers improves understanding of the approval process for nanotherapeutics and drug devices. It would also enable feedback from readers on potential process improvements. Improving the efficiency of clinical trials is an important way to reduce costs and time in therapeutic development. The second and most interesting area is the publication of the results of clinical studies conducted with nanomedicines. The presentation of the results of clinical studies with both positive and negative results should then find a place in scientific publications. Positive studies inform about new active substances under development and present their fields of application and levels of effectiveness. Negative clinical studies can, on the other hand, provide important lessons on the problems associated with the development of nanomedicines or the use of nanomaterials in clinical trials. These “lessons learnt” can greatly enhance the ability of others to develop therapies. Furthermore, publishing summaries of regulatory interactions related to nanomedicine development would provide valuable insight into how nanotechnology is perceived in the regulated environment. It is important to understand why a drug or device has embarked on a specific path to the clinic and what results will be/have been necessary to obtain approval. A frank discussion of the obstacles to characterising nanomedicines, assessing their safety in animals and entering clinical development raises awareness about the development of these products into nanomedicines from nanomaterials (Baker 2011).

The most recent nanotechnology research has focused on a new type of anti-cancer drugs, the so-called nano-drugs, which not only effectively reach the tumour site but are also easily captured by tumour cells. The researchers believe that by carefully designing the unique physicochemical properties of nano-drugs, it is possible to enhance their anti-tumour efficacy. Indeed, nano-drugs have the ability to bypass tumour pumps and optimise the intracellular endosomal distribution of the active ingredient, allowing the nano-drugs to selectively destroy tumour cells without affecting surrounding tissues. However, in the face of such a feature, the main disadvantages of administering nano-drugs for clinical applications are toxicity and clearance problems. Although several efforts have been made to maximise the efficiency of tumour targeting and minimise clearance problems, the expected toxicity of nano-drugs has prevented them from becoming the ultimate cure for cancer.

Numerous research studies have been initiated to harness the power of nanoparticles to improve human health, and investigate the efficacy of new drugs, e.g. for the treatment of cancer. Nanotechnologies have become a multifunctional tool for the diagnosis, prevention and treatment of neoplasms. Due to their size, comparable to large biological macromolecules such as enzymes and receptors, nanoparticles can easily interact with biomolecules both on the cell surface and within the cell. These interactions occur, importantly, without altering the behaviour and properties of the molecules. Multi-component magnetic nanorods have been developed for biodetection with high sensitivity and selectivity with separation and purification capabilities (Lee, Park and Mirkin 2004). Multifunctional nanoparticles can serve as contrast agents in imaging, such as in MRI, or for cancer diagnosis or monitoring the performance of drug therapy. Multifunctional nanoparticles with a magnetic core, a silica shell, optical probes and a ligand for cell surface receptors have also been proposed. The ligands bind specifically to molecules on the surface of tumour cells, thus enabling the delivery of active ingredients directly to tumour cells and their supporting endothelial cells without unpleasant side effects. Another research front is

the development of ‘smart’ nanostructures capable of detecting malignant cells *in vivo*, locating the cell's position in the body, destroying the cells and communicating their outcome (Monson, Brazil, Philbert and Kopelman 2003).

7.1.4.3 Nanoparticles and Environment

Nanotechnology has shown great potential in improving the quality of elements such as air, water and soil in the environment. They can improve pollutant detection processes and contribute, for example, to the development of new technologies for remediation. Understanding the dynamic processes of nanoparticle formation and growth makes it possible to develop efficient methodologies for minimising the formation of pollutants and reducing their emissions. Although nanotechnology has the potential to improve the quality of the environment, it is legitimate to assume that it may also lead to a new class of environmental hazards. However, these concerns are in fact associated with all new technologies and must be addressed at an early stage of development. With proper attention, careful research and incorporation of results at an early stage, the safety of nanotechnology can be ensured.

Although the above concerns are relevant, appropriate and justified, it is extremely important to be able to distinguish between “popular literature” and scientifically conducted research. For example, some groups have called for a moratorium on nanotechnology research. Faced with these misinterpretations and misunderstandings on the part of the public, scientists have a responsibility to raise questions, design studies to answer them, and effectively communicate the results to both the public and policymakers (Biswas and Wu 2005).

The topic of nanoparticles and the environment is definitely very broad. The promise of nanotechnology has led to an increase in funding, research and development projects have multiplied, and with them the number of publications in the various facets of nanotechnology. The number of publications has blossomed to such an extent that it is impossible to mention all the titles in this field. Certainly, from a practical point of view, there are numerous scientific and technological challenges and opportunities to be met through multidisciplinary efforts aimed at improving our understanding of the concepts.

There are several sources that lead to the formation of nanoparticles: stationary industrial sources (Chang *et al.* 2004), such as coal combustion systems and incinerators; mobile sources (Kittelson 1998), such as cars and diesel-powered vehicles; and occupational environments (Vincent and Clement 2000), such as those where welding processes are prevalent and those where engineered nanoparticles are deliberately synthesised. There are also several natural sources and nanoparticles of biological origin (Hogan, Lee and Biswas 2004) to which significant attention should be paid. For example, pollen fragments are potential causes of allergies and viral nanoparticles can be used as vaccines or play a significant role in the spread of diseases. Once emitted into the atmosphere, nanoparticles are easily transformed, which can lead to changes in their size and composition compared to their initial situation.

In addition, nanoparticles are also formed in the atmosphere through nucleation events resulting from photochemical processes. These nanoparticles can also be transported in the atmosphere over large distances and can ultimately cause harm to humans through

inhalation. Nanoparticles can also be deposited on soil or groundwater and cause secondary contamination or other environmental effects.

Nanoparticle science and technology can improve processes to reduce pollutant formation and emissions. In fact, nanomaterials can be used as catalysts to reduce emissions from mobile sources. Nanoparticles can be injected into subsurface aquifers to clean up contaminated areas. Due to their size and certain surface characteristics, nanoparticles can easily reach contaminated areas and can be transported over great distances via underground channels. Adsorbents made of nanoparticles can be used to purify drinking water, for example, to remove toxic materials such as arsenic. Human activities and industrial and environmental processes are considered sources of different types of nanoparticles. In some systems, processes lead to the formation of unwanted nanoparticle emissions. In others, processes create useful and functional nanoparticles.

In processes, a control/collection and measurement/characterisation device must be present: if nanoparticles are unwanted by-products, they must be removed from the effluent before disposal. If nanoparticles are intentionally synthesised, the aim is to collect them efficiently as a useful product. In many cases, unwanted nanoparticle emissions can even be converted into a useful by-product. Since many pollutants are formed from the combustion of fossil fuels for energy production, the alternative energy generation enabled by nanoparticle science and technology appears to have the potential to reduce emissions (Biswas and Wu 2005).

Stationary combustion systems have long been known as an important source of fine particle emissions. The characterisation of ultrafine or nano-sized particulate emissions is therefore being studied in depth. The analysis of ultrafine particles in the flue gas and stack of a municipal waste incinerator showed that the peak size was 90nm at 700°C (in the combustor) (Maguhn, Karg, Kettrup and Zimmermann 2003).

Several studies under different operating conditions have proven the presence of nanoparticles, ranging in size from 15nm to 100nm. The composition of the fuel proved to be a determining factor in the resulting size distribution. Laboratory-scale studies were conducted to understand the emissions from coal combustors, and the way in which metal species are transformed was established to determine the formation of nanoparticles. Sampling ultra-fine particles at high temperatures, however, proved difficult due to the dilution process affecting nucleation, coagulation and growth by condensation. The dynamic nature of nanoscale particles can cause their chemical profiles and size distributions to change between source and receptor (Liu and Daum 2000; Zhuang and Biswas 2001; Chang *et al.* 2004).

Some sources are called mobile sources. Internal combustion engines on a diesel cycle are the main sources of nanoparticles around 50nm, which dominate by number concentration. Recent advances in instrumentation have also revealed a particle nucleation mode around 10nm for newly formed particles. Nanoparticles from diesel engines are typically hydrocarbon or sulphate particles formed by nucleation, while particles in accumulation mode are mainly aggregates of carbonaceous soot. Diesel exhaust nanoparticles consist mainly of fuel from incomplete combustion and lubricating oil (Tobias *et al.* 2001). Sulphuric acid represented a small percentage but played a critical role as it provided a surface for the condensation of organic species. The volatile component is 95 per cent unburnt lubricating oil (Sakurai *et al.* 2003). Lower emission standards for diesel engines reduce mass emissions of particles, but nanoparticle number concentrations may increase due to the reduced availability of condensation surfaces. A study was conducted to assess the impact of diesel truck emissions on ambient aerosol near motorways

(McDonald *et al.* 2004). The mass concentration was not a function of distance from the motorway, while the numerical concentrations showed clear peaks in the ultrafine range in the immediate vicinity of the motorway.

Unlike diesel engines, spark-ignition (SI) engines generally emit a lower total numerical concentration of particles. However, under high-speed motorway travel conditions, they have been found to emit levels equivalent to diesel engine exhaust (Rickeard *et al.* 1996). Positive-ignition engines emit higher numerical concentrations of particles in nucleation mode (10nm) than diesel engines. Positive-ignition engine emissions have a numerical nucleation mode size of 20–40nm, and these particles mainly contain a high fraction of volatile material. Two-stroke engine vehicles are common in developing countries and have high emissions. However, no studies were found in the literature that measured nanoparticle emissions from two-stroke engines.

Nucleation is another process, long known, that leads to the formation of ultrafine particles in the atmosphere. Aitken (Aitken 1884), at the end of the 19th century, reported the observation of particles, typically in the 20–50nm range, which are now also known as the Aitken mode. The key species mainly present in the atmosphere are sulphuric acid and nitric acid.

With the advances in instrumentation in recent years for the detection of ultrafine particles (Saros, Weber, Marti and McMurry 1996), the formation of a new species of atmospheric particles as small as a few nanometres has been reported, especially in large urban areas. It has been suggested that nucleation mode particles may be produced high in the cloud streams of the free troposphere and then transported to the surface. The formation of ultrafine particles in the upper troposphere is a source of global atmospheric particles. The lifetime of ultrafine particles in the atmosphere is typically short (15 minutes for 10nm particles), but they can become fine particles that can be transported over long distances, resulting in local/regional air quality degradation. An annual pattern was observed with higher concentrations in winter and spring, while lower concentrations were observed in summer (Biswas and Hu 2005).

A specific example is now described.

Natural silica nanoparticles are a major source of inorganic particulate pollution in the air. With the rapid development of nanotechnology, an important class of nanomaterials, such as silica nanoparticles, have found wide and rapid use in products such as plastics, biopesticides, food additives and cosmetics (Barik, Sahu and Swain 2008; Park, Park and Heo 2007; Contado, Ravani and Passarella 2013) and also find application in the biomedical field, as drug delivery vectors, gene transfection reagents and cell markers (Al-Sadoon, Rabah and Badr 2013; Lin *et al.* 2005) so the biological safety of nanomaterials has necessarily attracted increasing attention, for the assessment of possible adverse effects on organisms at all levels. Silica nanoparticles have been shown to induce reproductive toxicity, but their mechanism of action is still unknown. To investigate the toxic mechanism of silica nanoparticles (SiNPs), a test was performed on 60 male mice that were randomly divided into three groups: a control group, a so-called saline group and a group subjected to the nanoparticles, with two evaluation points (45 and 75 days after the first dose) per group. The subjects in the SiNPs group were treated with SiNPs at a dose of 2.0mg kg⁻¹ every three days, a total of 15 times over 45 days, the mice in the saline group received the same volume of saline, and the control group, as such, received no laboratory treatment. Then, half of the mice in each group were sacrificed to retrieve tissue samples on days 45 and 75. In vitro, GC-2spd sperm cells were exposed to various concentrations of SiNPs for 24 hours. The results showed that the SiNPs particles damaged the seminiferous epithelium,

leading to a decrease in seminal fluid quality. These results suggested that SiNPs could induce cell cycle arrest and inhibit cell proliferation by lowering the expressions of meiotic regulators, while DNA damage caused by oxidative stress could be associated with meiosis and seminal fluid production. Furthermore, damage to the male reproductive system caused by SiNPs may be reversible. (Zhang *et al.* 2016). Furthermore, further research (Zhao, Jin, Zhang and Liu 2007) showed that the pregnancy rate of female rats and the average number of fetuses of rats decreased significantly after intra-tracheal instillation of SiNPs. Furthermore, SiNPs could damage the quantity and quality of spermatozoa in the epididymis by causing oxidative stress and damaging the structure of mitochondria, resulting in dysfunctional energy metabolism (Xu *et al.* 2014). However, there is little information on the effects of SiNPs on the cell cycle of spermatogenic cells and the process of meiosis.

7.2 Regulations

Nanotechnology has been a revolution through which science has been able to reformulate the form and purpose of materials, both of natural and synthetic origin. The long-term and short-term benefits, advantages and limitations of nanotechnology, and the impact of nanotechnological developments are all parameters whose growth can be considered to be continuous over time. The contribution of nanotechnology provides added value to society in a wide variety of fields; for example, in the improvement of diagnosis and therapy and the automation of surgery, which will have a positive impact on waiting lists in healthcare services, reducing healthcare worker errors and the associated costs of treatment and public health support. As the quality of life improves, nanotechnology is expected to contribute to a longer human lifespan, stimulating the need for the state-of-the-art healthcare services (Schulte and Salamanca-Buentello 2007). Advances in nanotechnology face several challenges and also pose potential health and environmental risks. The need to establish appropriate methodologies and protocols to determine the risks associated with the use of nanoparticles is crucial and should be implemented by regulatory agencies. Four main challenges need to be addressed in the short term:

- i. technological progression;
- ii. the technological perspective;
- iii. the ability of the technology to be accredited and understood;
- iv. public policy-making (Iavicoli *et al.* 2014).

The application of nanotechnology began in the absence of specific legislation for this type of product. The complexity of nanoparticles and their applications spans disciplines as diverse as genetics, physiology, chemistry, physics and engineering, among others (Cheng, Doemeny, Geraci and Grob Schmidt 2014). The main problem associated with this market is the possibility of producing an adequate assessment of the opportunities and uncertainties associated with the risk of its implementation.

All emerging technologies have advantages and limitations, and the determination of the associated risks is mandatory. The uncertainty associated with these potential risks must also be addressed in terms of legislation applied to industrial production processes, such as the methodologies and materials used in production (Maynard 2006).

7.2.1 A Brief Overview

Designing, characterising, producing and applying materials, structures, apparatuses and systems at nanometric dimensions is part of those fields of science that we have grouped under the name of nanotechnology; this technology, as I have described in this thesis, has developed mainly over the last thirty years and has become one of the most prolific research fields, a scientific area that is characterising not only the present, but also the future of mankind. The impact of nanotechnology on society is decisive, and the research that has opened up in this field has involved individual researchers, laboratories and research bodies, organisations and government agencies.

The applications of nanotechnology have affected practically all fields of science and research has led to materials in the form of thin films used in chemical catalysis processes, in electronics, to carbon nanotubes and nanowires used in magnetic and optical systems. Nanoparticles are applied, for example, in sectors such as pharmaceuticals, coatings and cosmetics. Electronics and optoelectronics, food technology, energy technology and the medical products sector, including many different aspects of pharmaceuticals and drug delivery systems, diagnostics and medical technology are some of the areas where nanomaterials find application and where research is focused. However, the extraordinary properties that nanomaterials exhibit compared to their macroscopic counterparts, which are their strength and benefit, could prove to be a health risk precisely because they could involve processes that would interfere with the physiology of the human species and the animal and plant species that coexist with it. The production process of these new materials could expose operators to biological risks during their manufacture. A product based on nanotechnology could therefore have a decisive impact if released unintentionally, or worse, voluntarily. These new products are engineered: in the course of its evolution and interaction with the environment, the human being has developed defence mechanisms against external agents, the immune system first and foremost. The infections that the human body fends off are caused by agents, viruses and bacteria, for which size is an important factor. The immune system could be easily circumvented by nanoparticles with previously unseen peculiarities and, as a result, the attacked organism could suffer borderline lethal consequences. It is also possible that there is an environmental impact of nanotechnology products, linked to the processes of dispersion and possible subsequent persistence of nanoparticles in the environment. Whenever the potential for a completely new risk is identified, it is absolutely necessary to carry out a thorough analysis of the nature of the risk, which can then, if necessary, be used in risk management processes. Like all materials or substances that are hazardous to handle and have the potential to endanger the safety of the environment or of animals and humans, nanomaterials are analysed by relevant bodies. Some of them are the Asia Pacific Nanotechnology Forum, the European Commission, the United States National Science and Technology Council, the United States National Institute of Environmental Health Sciences, the Institute of Electrical and Electronic Engineers, the Australian Academy of Science, the Royal Society and the Royal Academy of Engineering.

For some years now, the European Council has stressed the need to pay particular attention to potential risks throughout the life cycle of nanotechnology-based products, and the European Commission has signalled its intention to work at an international level to establish a framework of shared principles for the safe, sustainable, responsible and socially acceptable use of nanotechnologies.

7.2.2 Some Remarks about Dimensions

According to the European report prepared by SCHENIR, the nanoscale should be considered as including dimensions up to 100nm, but some of the literature has represented the nanoscale as having dimensions greater than 100nm. Much of the literature relating to particles, concerning aerosols, air pollution and inhalation toxicology of particles, in particular, has referred to the nomenclature of particles as ultra-fine, fine or conventional. However, the SCHENIR report assumed that, unless otherwise stated, 'ultrafine particles' are essentially equivalent to nanoparticles. Furthermore, in relation to nanoparticles, it must be borne in mind that a sample of a substance containing nanoparticles will not be monodisperse, but will normally contain a range of particle sizes. This makes it even more difficult to accurately assess nanoscale parameters, especially when considering doses for toxicological studies. Often, reference is made to exposure studies and toxicological data on particles, and particle sizes given in documents are quoted as single figures (e.g. 40nm) or ranges (e.g. 40–80nm), effectively recognising that these are approximations.

With regard to both intrinsic properties and health risks, two different types of nanostructures must be considered, those in which the structure itself is a free particle and those in which the nanostructure is an integral feature of a larger object. The latter group includes nanocomposites, which are solid materials in which one or more dispersed phases are present as nanoscale particles, and nanocrystalline solids, in which individual crystals have nanoscale dimensions. This group also includes objects that have been provided with a surface topography with nanoscale characteristics, and functional components that have critical nanoscale characteristics, including mainly electronic components.

7.2.3 Some Concerns on Ethical Issues

The ethical issues raised by nanotechnology research and development are not only related to the risk of its misuse. In general, the ideal purpose of technology is to improve the quality of life and to contribute to a better world by providing high-quality products such as food, clean water, a safe environment, medical services, a well-defined education, social insurance, democracy and freedom (Florczyk and Saha 2007). However, the field of nanotechnology is so vast, and so many sectors are affected by it, that attention needs to be paid to the efficiency and economy of the movement of nanotechnology-generated products and structures. For example, nanotechnology applications in the military sphere should only be used for defence purposes and to ensure the security of each individual country interested in developing them in this direction (Patenaude *et al.* 2015).

The question of disseminating knowledge about nanotechnology to the general public, whether it should be shared in full or not, remains fundamental. Experts in this field should have a solid background in the concepts of ecology and environmental safety, and ultimately be responsible for the damage caused by any self-destructive practices of science. This last point is extremely critical, given the interests that often underlie the most advanced research and that which guarantees the best economic returns.

It is desirable that the production of these products be based on models that incorporate sustainable methods, such as resource economics, green industrial processes, the absence of toxic materials, fair earnings for workers, and legal and humane rules in the workplace.

In the area of responsible nanotechnology research, four main objectives have been set:

- i. responsible development
- ii. training of workers and the future workforce
- iii. knowledge transfer;
- iv. continuous efforts in research and development of modern technologies in sustainable infrastructure (Salamanca–Buentello *et al.* 2005).

The National Nanotechnology Initiative (NNI) proposed to set up a committee of experts on ethical, legal and social issues related to nanotechnology, to draw appropriate connections between the previous terms and consumers, researchers, manufacturers, governmental and non-governmental institutions, and also legislators. To set up their work properly, all agencies should consider the benefits and risks of these new achievements. The NNI and stakeholders together can also generate valuable resources as a result of the combination of intellectual property and ethics in these developments. The cumulative knowledge of nanotechnology should then be passed on to future generations while upholding principles of ethics and integrity.

Biotechnology legislation can in some cases be applied to nanotechnology products, as they result from the manipulation of living entities or inert matter on a nanoscale.

For a given technology to be successful on the market, it must be well accepted and, for this, society's claims and values must be considered in order to avoid moral judgements. The EU has issued several regulations to guide the design of projects according to a public safety ideology, but space is reserved for the contribution of each Member State. Several new properties of nanomaterials will add socioeconomic value to developed products. Indeed, nanotechnology is developing very rapidly and socioeconomic issues must follow these developments. Currently, nanotechnologies are making great strides in several industrial sectors (Singh 2016).

7.2.4 Risks of Nano and Emerging Techniques

Khara Greiger's working group at North Carolina State University addressed the issue of risk assessments related to nanotechnologies and how they could progress and be extended to new emerging technologies. The first series of international research programmes to understand the potential health, environmental and societal impacts of nanotechnology and engineered nanomaterials saw the light of day in the early 2000s. Among other areas, investigations into the adequacy of the chemical risk assessment framework for nanomaterials soon became a key research endeavour. Indeed, chemical risks can lead to health hazards, fire and/or explosion hazards, and environmental hazards. Although great strides have been made (Oomen *et al.* 2018), uncertainty still significantly hinders risk assessments of nanomaterials. Today, there seems to be a lack of concrete conclusions about the health and environmental risks of most nanomaterials and the products in which they are contained, and regulations are struggling to keep pace with the rapid evolution of this branch of science and the resulting data underpinning nanomaterial risk assessments (Jantunen, Mech and Rasmussen 2018). In addition, entrusting risk assessment to supervisors, all the necessary steps to inform supervisory decision-making for nanomaterials, is a complex process that has led to numerous challenges due to the complexities and uncertainties associated with nanomaterial characterisation and associated

risks (Linkov *et al.* 2014). Not only that, but it has also highlighted several underlying and unresolved tensions regarding the use of specific test methods and existing risk assessment frameworks for decision-making.

Given these experiences, the challenges and lessons learnt over time should lead to the identification of best practices that could be applicable to other emerging technologies, in which nanotechnology is involved, and whose impact on society is considerable (e.g. advanced materials, synthetic biology, quantum technologies, artificial intelligence and machine learning, three-dimensional printing and climate engineering). Risk analysis and responsible innovation for other emerging technologies could be effectively addressed by following five cornerstones (Grieger *et al.* 2019).

The first point concerns the decision-making process.

Fundamental issues are at stake, and nanomaterials risk research has largely been oriented towards understanding the science rather than providing guidelines for decision-making and regulatory requirements. In this context, a distinction can be made between “traditional science” (i.e. science based on hypotheses and results that are not necessarily relevant to regulation, but highly relevant in scientific terms) and “regulatory-relevant science” (i.e. science designed to support regulatory decision-making). Several authors have emphasised the challenge of supporting decision-making needs while developing the scientific areas of nanomaterial risk analysis and nanosafety (Jantunen, Mech and Rasmussen 2018, Linkov *et al.* 2014). It has been shown that it is possible to link the development of nanosafety data to decision-making and policy needs using “bottom-up” strategies (Jantunen, Mech and Rasmussen 2018). The initiation of strategic and targeted scientific programmes of regulatory relevance (i.e. the use of “top-down” strategies) could help to direct research more effectively towards regulatory decision-making, at least for short- and medium-term decisions, when new technologies appear. This could also provide a solution to the so-called pacing problem often encountered between new technological innovations, efforts to understand their potential impacts, and subsequent regulatory responses.

Time and cost estimates to be incurred are two other key points considered.

Following the hectic pace of research, the number of discoveries, the development of techniques, and the refinement of risk assessment strategies, including the development of robust test procedures and data sets for different nanomaterials, proves to be an ever-evolving process. The different types of nanomaterials, the variability in their size, the coatings of their structures, the functional groups that activate them and the products in which they are used only amplify the existing challenges and the time, resources and complexities involved. After nearly two decades of research and significant investment in the risk analysis of nanomaterials (estimated at between hundreds of millions and billions of dollars/euros), additional time and resources are therefore needed to comprehensively understand the potential impacts of nanomaterials. This is not entirely surprising when one reflects on it. In the past, it took more than thirty years to develop robust chemical risk assessments (Syberg and Hanssen 2015), about twenty years to develop quantitative microbial risk assessments in food (Dennis, Buchanan and Miller 2001), and similar timescales in other risk assessment fields (Aven 2015). Earlier similar estimates made for nanotechnology predicted that the development and completion of quantitative risk assessments for nanomaterials and products would cost between \$249 million and \$1.18 billion, taking 24 to 53 years (Choi, Ramachandran and Kandlikar 2009). It is likely that the process of identifying risks, adapting or developing assessment protocols and procedures, and testing, validating and harmonising risk assessment methods for other emerging

technologies will be complex, time-consuming and costly. This may be especially the case if this process is based on a traditional approach, relying on experimental evidence and knowledge-based considerations for risk assessment. It may be useful to consider the expectations of stakeholders at an early stage by having realistic estimates of the time, cost and degree of complexity required to draw concrete risk conclusions. These estimates can help prepare all agencies involved so that they can prioritise research efforts in the short term, while at the same time developing the underlying safety science so that the state of the science is reflected in the presentation of data.

Science is not based on dogma; its language, rather, is that of doubt.

Scientific uncertainty is one of the main obstacles in the risk analysis of nanomaterials. While many knowledge gaps have been reduced, new research challenges and areas of uncertainty have arisen. To help overcome these challenges related to the prevalence of large uncertainties in nanomaterials data and risk analysis, several alternative approaches have been proposed, such as risk screening, prioritisation, control banding and decision support tools (Jantunen, Gottardo, Rasmussen and Crutzen 2018). The central question, of how best to manage uncertainties in different risk assessments of nanomaterials, does not yet appear to be addressed in depth, despite numerous appeals (Hjorth 2017; Grieger, Hansen and Baun 2009, Subramanian *et al.* 2016). In general, standard approaches to deal with uncertainties in risk assessment, a probabilistic analysis, may not be suitable for emerging technologies, which are characterised by profound uncertainties in potential risk assessments. In nanotechnology, risk assessment activities would benefit from the inclusion or integration of uncertainty assessments of different scientific uncertainties. Dynamic risk assessment and risk management processes also allow for adaptive responses to rapidly changing scenarios or in light of new information (Grieger *et al.* 2019).

Data management is the fourth point to be examined.

Concrete conclusions on the potential risks of nanomaterials have been hampered by data management challenges, and issues of privacy, confidentiality and intellectual property. The integration of disparate datasets without harmonised approaches to data production, collection and management has consequently led to non-comparable data (Karcher *et al.* 2018) and varying levels of completeness, quality, and transparency of documentation. Data access and sharing between projects and consortia was also an obstacle, although some projects have started to implement the principles of findability, accessibility, interoperability and reusability. In the future, different, multi-scale and even decision-oriented approaches might help to avoid the challenges of data harmonisation and integration. However, it might be difficult to develop harmonised data management, data access and ontologies in a rapidly evolving field between research consortia. Future risk assessment and risk management activities could build on established communication mechanisms between researchers and, with adequate funding, integrate risk research activities regarding curation functionalities, infrastructure and communication processes from the outset (Grieger *et al.* 2019).

The last point relates to risk analysis tools.

In order to understand and quantify the potential risks of nanomaterials for use in regulatory contexts, the chemical risk assessment framework was chosen as a starting point, because it was established by years of experience. This decision was made without significant or extensive stakeholder dialogue specifically focused on identifying and selecting appropriate and fit-for-purpose assessment approaches. Although the use of the chemical risk assessment framework for nanomaterials was a logical step, agencies could have benefited from being involved in an initial process that critically evaluated a range of

tools, frameworks and methods to assess risks and make subsequent decisions. A thorough and critical evaluation of robust and fit-for-purpose risk analysis tools or frameworks could have improved practitioners' understanding and expectations of their usefulness. For example, probabilistic risk analysis, microbial risk analysis and pest risk analysis have been proposed for active nanomaterials that interact with and respond to biological systems. Furthermore, not all decisions regarding potential risks need to be made on the basis of quantitative estimates, as other options may include the selection of alternatives. A completely new way of thinking about risks for emerging technologies might be justified, such as the use of "risk innovation", which incorporates risk assessments within evolving innovation processes (*ibidem*).

Epilogue VII

Defining nanoscience and nanotechnology has been a process that has gone through several stages over time, and successive definitions have gradually refined the content towards an increasingly precise definition. Nanomaterials, in turn, have been classified in terms of both dimensionality and organic chemistry principles.

The introduction of new-generation materials has certainly brought with it advantages and, from another point of view, a number of criticalities that are not immediately obvious but should not be overlooked.

In fact, the sudden development of nanotechnology, which has had such an impact on society in recent decades, has brought and continues to bring with it a series of implications that go beyond the moment of scientific research in the laboratory. This research has certainly contributed to improving the quality of life by bringing extraordinary results to the fore. Yet nanoparticles and their applications are often described in the literature in terms that are always positive, almost as if to provide a point of view that aims to make their presence uncritically accepted in everyday life. Such rapid progress as that of nanotechnology brings with it a series of necessary assessments of research methodology, the quality of the materials produced and their impact in terms of possible danger to humans and the environment. This is why it became necessary to pursue the idea of developing a safety protocol to regulate the behaviour of the various agencies in the face of this scientific revolution. In the medical field, for example, nanoproducts are required to undergo strict testing and acceptance protocols. Controls are also necessary for nanoparticles that derive from industrial activities and that, when carried in the atmosphere, can be inhaled and cause varying degrees of damage to organisms.

There remains the fundamental issue of risk assessment related to nanotechnology, which must necessarily complement research to ensure the safety and usability of a range of new materials and structures that are revolutionising contemporary society.

References

Primary Sources

- Baker JR Jr (2011) The Need to Pursue and Publish Clinical Trials in Nanomedicine. *Nanobiotechnology* 3/4:341–342. doi:10.1002/wnan.141
- Behzadia S, Serpooshanb V, Taosa W, Hamaly MA, Alkawarekd MY, Dreadene EC, Brown D, Alkilanyd AM, Farokhzada OC, Mahmoudia M (2017) Cellular Uptake of Nanoparticles: Journey Inside the Cell. *Chemical Society Reviews* 46/14:4218–4244. doi:10.1039/c6cs00636a
- Birrenbach G, Speiser PP (1978) Polymerized Micelles and Their Use as Adjuvants in Immunology. *Journal of Pharmaceutical Sciences* 65/12:1763–1766. doi:10.1002/jps.2600651217
- Biswas P, Wu CY (2005) Nanoparticles and the Environment. *Journal of the Air and Waste Management Association* 55/6:708–746. doi:10.1080/10473289.10464656
- Grieger K, Jacob Jones JL, Hansen SF, Hendren CO, Jensen KA, Kuzma J, Baun A (2019) Best Practices from Nano–Risk Analysis Relevant for other Emerging Technologies. *Nature Nanotechnology* 14:996–1001. doi:10.1038/s41565–019–0572–1
- Kamarulzaman NA, Lee KE, Siow KS, Mokhtar M (2020) Public Benefit and Risk Perceptions of Nanotechnology Development: Psychological and Sociological Aspects. *Technology in Society* 62/101329:1–9. doi:10.1016/j.techsoc.2020.101329
- Ng JH, Ilag LL (2004) The Dangers of Generalization in Nanotechnology. *Drug Discovery Today* 9/2:60–61. doi:10.1016/S1359–6446(03)02934–9
- Sahay G, Kim JO, Kabanov AV, Bronich TK (2010) The Exploitation of Differential Endocytic Pathways in Normal and Tumor Cells in the Selective Targeting of Nanoparticulate Chemotherapeutic Agents. *Biomaterials* 31/5:923–933. doi:10.1016/j.biomaterials.2009.09.101
- Souto EB, Dias–Ferreira J, Shegokar R, Durazzo A, Santini A (2020) Ethical Issues in Research and Development of Nanoparticles. *Drug Delivery Aspects* 157–167. doi:10.1016/B978–0–12–821222–6.00007–5
- Taniguchi N (1974) On the Basic Concept of Nanotechnology. *Proceedings of the International Conference on Production Engineering, Tokyo*, 18–23
- Zhang J, Lihua R, Yang Z, Lianshuang Z, Jialiu W, Yanbo L, Ji W, Zhiwei S, Xianqing Z (2016) Silica Nanoparticles Induce Start Inhibition of Meiosis and Cell Cycle Arrest *via* Down–Regulating Meiotic Relevant Factors. *Toxicology Research* 5. doi:10.1039/C6TX00236F

Secondary Sources

- Aitken J (1884) On the Formation of Small Clear Spaces in Dusty Air. *Earth and Environmental Science Transactions of the Royal Society Edinburgh* 32/2:239–272. doi:10.1017/S0080456800026764
- Al–Sadoon MK, Rabah DM, Badr G (2013) Enhanced Anticancer Efficacy of Snake Venom combined with Silica Nanoparticles in a Murine Model of Human Multiple Melanoma: Molecular Targets for Cell Cycle Arrest and Apoptosis Induction. *Cellular Immunology* 284/1:129–138. doi:10.1016/j.cellimm.2013.07.016.
- Arnall AH (2003) *Future Technologies, Today’s Choices*. Greenpeace Environmental Trust, London.
- Aven T (2015) Risk Assessment and Risk Management: Review of Recent Advances on their Foundation. *European Journal of Operational Research* 253/1:1–13. doi:10.1016/j.ejor.2015.12.023
- Barbato C (2018) *Nanoscienza e Nanotecnologia. La Tossicità del Nanomateriali (Nanoscience and Nanotechnology. Toxicity of Nanomaterials)*. Gnasso Editore, Teverola.
- Barik TK, Sahu B, Swain V (2008) Nanosilica—from Medicine to Pest Control. *Parasitology Research* 103/2:253–258. doi:10.1007/s00436–008–0975–7.
- Chang MCO, Chow JC, Watson JG, Hopke PK, Yi SM, England GC (2004) Measurement of Ultrafine Particle Size Distributions From Coal–, Oil–, and Gas–Fired Stationary Combustion Sources. *Journal of the Air and Waste Management Association* 54/12:1494–1505. doi:10.1080/10473289.2004.10471010

- Cheng HN, Doemeny LJ, Geraci CL, Grob Schmidt D (2016) Nanotechnology Overview: Opportunities and Challenges. In: *Nanotechnology: Delivering on the Promise* volume 1, vol. 1220. American Chemical Society
- Cherian AK, Rana AC, Jain SK (2000) Self-Assembled Carbohydrate-Stabilized Ceramics Nanoparticles for the Parental Delivery of Insulin. *Drug Development and Industrial Pharmacy* 26:459–463.
- Choi JY, Ramachandran G, Kandlikar M (2009) The Impact of Toxicity Testing Costs on Nanomaterial Regulation. *Environmental Health Sciences* 43/9:3030–3034. doi:10.1021/es802388s
- Contado C, Ravani L, Passarella M (2013) Size Characterization by Sedimentation Field Flow Fractionation of Silica Particles used as Food Additives. *Analytica Chimica Acta* 788:183–192. doi: 10.1016/j.aca.2013.05.056.
- de Hartog JJ, Hoek G, Peters A, Timonen KL, Ibalde-Mulli A, Brunekreef B, Heinrich J, Tiittanen P, van Wijnen JH, Kreyling W, Kulmala M, Pekkanen J (2003) Effects of Fine and Ultrafine Particles on Cardiorespiratory Symptoms in Elderly Subjects With Coronary Heart Disease – the ULTRA Study. *American Journal of Epidemiology* 157/7:613–623. doi:10.1093/aje/kwg021
- Dennis SD, Buchanan RL, Miller AJ (2001) Microbial Risk Assessment: Achievements and Future Challenges. *Food Safety Magazine*
- Doherty GJ, MacMahon HT (2009) Mechanisms of Endocytosis. *Annual Review of Biochemistry* 78/1:857–902. doi:10.1146/annurev.biochem.78.081307.11054
- Ehrlich M, Boll W, Van Oijen A, Hariharan R, Chandran K, Nibert ML, Kirchhausen T (2004) Endocytosis by Random Initiation and Stabilization of Clathrin-Coated Pits. *Cell* 118/5:591–605. doi:10.1016/j.cell.2004.08.017
- Florczyk SJ, Saha S (2007) Ethical Issues in Nanotechnology. *Journal of Long-Term Effects of Medical Implants* 17/3:271–280. doi:10.1615/jlongtermeffmedimplants.v17.i3.90
- Fraser C, Restrepo-Estrada S (1998) *Communicating for Development: Human Change for Survival*. I.B Tauris and Co Ltd, London.
- Gabella G, Blundell D (1978) Effect of Stretch and Contraction on Caveolae of Smooth Muscle Cells. *Cell and Tissue Research* 190/2:255–271. doi:10.1007/bf00218174
- Grieger KD, Hansen SF, Baun A (2009) The Known Unknowns of Nanomaterials: Describing and Characterizing Uncertainty within Environmental, Health and Safety Risks. *Nanotoxicology* 3/3:222–223. doi:10.1080/17435390902944069
- Gupta AK, Gupta M (2005) Synthesis and Surface Engineering of Iron Oxide Nanoparticles for Biomedical Applications. *Biomaterials* 26:3995–4021.
- Harush-Frenkel O, Debotton N, Benita S, Altschuler Y (2006) Targeting of Nanoparticles to the Clathrin-Mediated Endocytic Pathway. *Biochemical and Biophysical Research Communications* 353/1:26–32. doi:10.1016/j.bbrc.2006.11.135
- Hjorth R (2017) The Shortfall of Risk Assessment for Decision-Making. *Nature Nanotechnology* 12/12:1109–1110. doi:10.1038/nnano.2017.232
- Hogan CJ, Lee MH, Biswas P (2004) Capture of Viral Particles in Soft X-Ray-Enhanced Corona Systems: Charge Distribution and Transport Characteristics. *Aerosol Science and Technology* 38/5:475–486. doi:10.1080/02786820490462183
- Iavicoli I, Leso V, Ricciardi W, Hodson LL, Hoover MD (2014) Opportunities and Challenges of Nanotechnology in the Green Economy. *Environmental Health* 13/1:1–11. doi:10.1186/1476-069X-13-78
- Jantunen APK, Gottardo S, Rasmussen K, Crutzen HP (2018) An Inventory of Ready-to-Use and Publicly Available Tools for the Safety Assessment of Nanomaterials *NanoImpact* 12:18–28. doi:10.1016/j.impact.2018.08.007
- Jantunen P, Mech A, Rasmussen K (2018) Workshop on Regulatory Preparedness for Innovation in Nanotechnology. Joint Research Centre Conference and Workshop Reports
- Karcher S, Willighagen EL, Rumble J, Ehrhart F, Evelo CT, Fritts M, Gaheen S, Harper SL, Hoover MD, Jeliaskova N, Lewinski N, Marchese Robinson RL, Mills KC, Mustad AP, Thomas DG, Tsiliki G, Hendren CO (2018) Integration among Databases and Data Sets to Support Productive Nanotechnology: Challenges and Recommendations. *Nanoimpact* 9:85–101. doi:10.1016/j.impact.2017.11.002
- Karimi M, Ghasemi A, Zangabad PS, Rahighi R, Basri SMM, Mirshekari H, Amiri M, Pishabad ZS, Aslani A, Bozorgomid M, Ghosh D, Beyzavi A, Vaseghi A, Aref AR, Haghani L, Bahrami S, Hamblin MR (2016) Smart Micro/Nanoparticles in Stimulus-Responsive Drug/Gene Delivery Systems. *Chemical Society Reviews* 45/5:1457–1501. doi:10.1039/c5cs00798d

- Kittelson DB (1998) Engines and Nanoparticles: A Review; *Journal of Aerosol Science* 29/5–6:575–588. doi:10.1016/s0021–8502(97)10037–4
- Kuhn DA, Vanhecke D, Michen B, Blank F, Gehr P, Petri–Fink A, Rothen–Rutishauser B. Beilstein (2014) Different Endocytotic Uptake Mechanisms for Nanoparticles in Epithelial Cells and Macrophages. *Journal of Nanotechnology* 5:1625–1636. doi:10.3762/bjnano.5.174
- Lee KB, Park S, Mirkin CA (2004) Multicomponent Magnetic Nanorods for Biomolecular Separations. *Angewandte Chemie–International Edition* 43/23:3048–3050. doi:10.1002/anie.200454088
- Lim JP, Gleeson PA (2011) Macropinocytosis: an Endocytic Pathway for Internalising Large Gulpes. *Immunology and Cell Biology* 89/8:836–843. doi:10.1038/icb.2011.20
- Lin YS, Tsai CP, Huang HY, Kuo CT, Hung Y, Huang DM, Chen YC, Mou CY (2005) Well–ordered Mesoporous Silica Nanoparticles as Cell Markers[J]. *Chemistry of Materials* 17/18:4570–4573. doi: 10.1021/cm051014c.
- Lindquist E, Mosher–Howe KN, Liu X (2010) Nanotechnology... What Is It Good For? (Absolutely Everything): A Problem Definition Approach. *Review of Policy Research* 27/3:255–271.
- Linkov I, Anklam E, Collier ZA, DiMase D, Renn O (2014) Risk–Based Standards: Integrating Top–Down and Bottom–Up Approaches. *Environment Systems and Decisions* 34/1:134–137. doi:10.1007/s10669–014–9488–3
- Liu Y, Daum PH (2000) The Effect of Refractive Index on Size Distributions and Light Scattering Coefficients Derived From Optical Particle Counters. *Journal of Aerosol Science* 31/8:945–957. doi:10.1016/S0021–8502(99)00573–X
- Maguhn J, Karg E, Ketrup A, Zimmermann R (2003) On–Line Analysis of the Size Distribution of Fine and Ultrafine Aerosol Particles in Flue and Stack Gas of a Municipal Waste Incineration Plant: Effects of Dynamic Process Control Measures and Emission Reduction Devices. *Environmental Science and Technology* 37/20:4761–4770. doi:10.1021/es020227p
- Maynard AD (2006) Nanotechnology: Assessing the Risks. *Nano Today* 1/2:22–33. doi:10.1016/s1748–0132(06)70045–7
- McDonald R, Hu SH, Martuzevicius D, Grinshpun SA, LeMasters G, Biswas P (2004) Intensive Short Term Measurements of the Ambient Aerosol in the Greater Cincinnati Airshed. *Aerosol Science and Technology* 38/2:70–79. doi:10.1080/027868290502263
- Miller S (2001) Public Understanding of Science at the Crossroads. *Public Understanding of Science* 10:115–120.
- Molzon JA, Giaquinto A, Lindstrom L, Tominaga T, Ward M, Doerr P, Hunt L, Rago L (2011) The Value and Benefits of the International Conference on Harmonisation to Drug Regulatory Authorities: Advancing Harmonization for Better Public Health. *Clinical Pharmacology and Therapeutics* 89/4:503–512. doi:10.1038/clpt.2011.10
- Monson E, Brasuel M, Philbert MA, Kopelman R (2003) Nanosensors for In Vitro Bioanalysis. In *Biomedical Photonics Handbook*. Vo–Dinh Editor CRC Press, Boca Raton
- Nan A, Bai X, Son SJ, Lee SB, Ghandehari H (2008). Cellular Uptake and Cytotoxicity of Silica Nanotubes. *Nano Letters* 8/8:2150–2154. doi:10.1021/nl0802741
- Nelkin D (1987) *Selling Science: How the Press Covers Science and Technology*. Freeman and Company, New York.
- Oomen AG, Steinhäuser KG, Bleeker EAJ, Broekhuizen F, Sips A, Dekkers S, Wijnhoven SWP, Sayre PG (2018) Risk Assessment Frameworks for Nanomaterials: Scope, Link to Regulations, Applicability, and Outline for Future Directions in View of Needed Increase in Efficiency. *Nanoimpact* 9:1–13. doi:10.1016/j.impact.2017.09.001
- Park JS, Park YJ, Heo J (2007) Solidification and Recycling of Incinerator Bottom Ash through the Addition of Colloidal Silica (SiO₂) Solution. *Waste Management* 27/9:1207–1212. doi:10.1016/j.wasman.2006.08.010.
- Patenaude J, Legault GA, Beauvais J, Bernier L, Beland JP, Boissy P, Chenel V, Daniel CE, Genest J, Poirier MS, (2015) Framework for the Analysis of Nanotechnologies’ Impacts and Ethical Acceptability: Basis of an Interdisciplinary Approach to Assessing Novel Technologies. *Science and Engineering Ethics* 21/2:293–315. doi:10.1007/s11948–014–9543–y
- Rejman J, Conese M, Hoekstra D (2006) Gene Transfer by Means of Lipo– and Polyplexes: Role of Clathrin and Caveolae–Mediated Endocytosis. *Journal of Liposome Research* 16/3:237–247. doi:10.1080/08982100600848819
- Rickeard DJ, Bateman JR, Kwon YK, McAughey JJ, Dickens CJ (1996) Exhaust Particulate Size Distribution: Vehicle and Fuel Influences in Light Duty Vehicles. *Society of Automotive Engineers*. Warrendale

- Roco MC (1999) Nanoparticles and Nanotechnology Research. *Journal of Nanoparticle Research* 1/1:1–6. doi:10.1023/a:1010093308079.
- Saini R, Saini S, Sharma S (2010) Nanotechnology: the Future Medicine. *Journal of Cutaneous and Aesthetic Surgery* 3/1:32–33. doi: 10.4103/0974-2077.63301.
- Sakurai H, Tobias HJ, Park K, Zarling D, Docherty S, Kittelson DB, McMurry PH, Ziemann PJ (2003) On-Line Measurements of Diesel Nanoparticle Composition and Volatility. *Atmospheric Environment* 37/9–10:1199–1210. doi:10.1016/S1352–2310(02)01017–8
- Salamanca–Buentello F, Persad DL, Court EB, Martin DK, Daar AS, Singer PA. (2005) Nanotechnology and the Developing World. *PLoS Medicine* 2/5:383–386. doi:10.1371/journal.pmed.0020097
- Samet JM (2000) What Properties of Particulate Matter Are Responsible for Health Effects? *Inhalation Toxicology* 12/!:19–21. doi:10.1080/0895–8378.1987.11463175
- Saros MT, Weber RJ, Marti JJ, McMurry PH (1996) Ultrafine Aerosol Measurement Using a Condensation Nucleus Counter With Pulse Height Analysis. *Aerosol Science and Technology* 25/2:200–213. doi:10.1080/02786829608965391
- Schnitzer J, Liu J, Oh P (1995) Endothelial Caveolae Have the Molecular Transport Machinery for Vesicle Budding, Docking, and Fusion Including VAMP, NSF, SNAP, Annexins, and GTPases. *Journal of Biological Chemistry* 270/24:14399–14404. doi:10.1074/jbc.270.24.14399
- Schulte PA, Salamanca–Buentello F (2007) Ethical and Scientific Issues of Nanotechnology in the Workplace. *Environmental Health Perspectives* 115:5–12. doi:10.1289/ehp.9456
- Seaton A, Macnee W, Donaldson K, Godden D (1995) Particulate Air–Pollution and Acute Health–Effects. *Lancet* 345/8943:176–178. doi:10.1016/s0140–6736(95)90173–6
- Singh AK (2016) The Past, Present, and the Future of Nanotechnology. Engineered nanoparticles. Boston: Academic Press, Boston.10.1016/B978–0–12–801406–6.00010–8
- Subramanian V, Semenzin E, Hristozov D, Zabeo A, Malsch I, McAlea E, Murphy F, Mullins M, van Harmelen T, Ligthart T, Linkov I, Marcomini A (2016) Sustainable Nanotechnology Decision Support System: Bridging Risk Management, Sustainable Innovation and Risk Governance. *Journal of Nanoparticle Research* 18:89. doi:10.1007/s11051–016–3375–4
- Swanson JA (2008) Shaping Cups into Phagosomes and Macropinosomes. *Nature Reviews Molecular Cell Biology* 9/8:639–649. doi:10.1038/nrm2447
- Syberg K, Hansen SF (2015) Environmental risk assessment of chemicals and nanomaterials – The best foundation for regulatory decision–making? *Science of the Total Environment* 541:784–794. doi:10.1016/j.scitotenv.2015.09.112
- Tadros T, Izquierdo P, Esquena J, Solans C (2004) Formations and Stability of Nano–Emulsions. *Advances in Colloids and Interface Science* 108–109:303–318. doi:10.1016/j.cis.2003.10.023.
- Tobias HJ, Beving DE, Ziemann PJ, Sakurai H, Zuk M, Mc–Murry PH, Zarling D, Waytulonis R, Kittelson DB (2001) Chemical Analysis of Diesel Engine Nanoparticles Using a Nano–DMA/Thermal Desorption Particle Beam Mass Spectrometer. *Environmental Science and Technology* 35/11:2233–2243. doi:10.1021/es0016654
- Ungewickell E, Branton D (1981) Assembly Units of Clathrin Coats. *Nature* 289/5796:420–422. doi:10.1038/289420a0
- Vincent JH, Clement CF (2000) Ultrafine Particles in Workplace Atmospheres. *Philosophical Transactions Mathematical Physical and Engineering Science* 358/1775:2673–2682. doi:10.1098/rsta.2000.0676
- Xu Y, Wang N, Yu Y, Li Y, Li YB, Yu YB, Zhou XQ, Sun ZW, McCormick DL (2014) Exposure to Silica Nanoparticles Causes Reversible Damage of the Spermatogenic Process in Mice. *PLoS ONE* 9/7:E101572. doi: 10.1371/journal.pone.0101572.
- Zhao C, Jin Y, Zhang Y, Liu B (2007) Comparative study of effects of nanosized and microsized silicon dioxide dust on mouse embryos. *Journal of Hygiene Research* 36/4:414–416.
- Zhuang Y, Biswas P (2001) Submicrometer Particle Formation and Control in a Bench–Scale Pulverized Coal Combustor. *Energy Fuels* 15/3:510–516. doi:10.1021/ef000080s

Web References

- http://www.nsf.gov/crssprgm/nano/reports/omb_nifty50.jsp, 3/21/2007

Selected Additional References on the Subjects Suggested for Further Reading

- Almeida JP, Figueroa ER, Drezek RA (2014) Gold Nanoparticle Mediated Cancer Immunotherapy. *Nanomedicine* 10/3:503–514.
- Amenta V, Aschberger K, Arena M, Bouwmeester H, Botelho Moniz F, Brandhoff P, Gottardo S, Marvin HJP, Mech A, Quiros Pesudo L (2015) Regulatory Aspects of Nanotechnology in the Agri/Feed/Food Sector in EU and non-EU Countries. *Regulatory Toxicology and Pharmacology* 73:463–476
- Arvizo R, Bhattacharya R, Mukherjee P (2010) Gold Nanoparticles: Opportunities and Challenges in Nanomedicine. *Expert Opinion on Drug Delivery* 7/6:753–763
- Atkinson JW (1979) The Importance of the History of Science to the American Society of Zoologists. *American Zoologist* 19:1243–1246
- Bahadar H, Maqbool F, Niaz K, Abdollahi M (2016) Toxicity of Nanoparticles and an Overview of Current Experimental Models. *Iran Biomedical Journal* 20:1–11
- Barbosa GP, Debone HS, Severino P, Souto EB, da Silva CF (2016) Design and Characterization of Chitosan/Zeolite Composite Films—Effect of Zeolite Type and Zeolite Dose on the Film Properties. *Materials Science and Engineering C* 60:246–254
- Bijsterveld K (2001) The Diabolical Symphony of the Mechanical Age: Technology and Symbolism of Sound in European and North American Noise Abatement Campaigns, 1900–40. *Social Studies of Science* 31:37–70
- Bogunia-Kubik K, Sugisaka M (2002) From Molecular Biology to Nanotechnology and Nanomedicine. *Biosystems* 65:123–138
- Brush SG (1974) Should the History of Science be Rated X?: the Way Scientists Behave (according to Historians) Might not be a Good Model for Students. *Science* 183:1164–1172
- Burian RM (1977) More than a Marriage of Convenience: on the Inextricability of History and Philosophy of Science. *Philosophy of Science* 44:1–42
- Casadevall A, Fang FC (2015) Field Science—the Nature and Utility of Scientific Fields. *mBio* 6:e01259–15
- Casadevall A, Steen RG, Fang FC. 2014. Sources of Error in the Retracted Scientific Literature. *FASEB Journal* 28:3847–3855
- Chen YW, Su YL, Hu SH, Chen SY (2016) Functionalized Graphene Nanocomposites for Enhancing Photothermal Therapy in Tumor Treatment. *Advanced Drug Delivery Reviews* 105/Pt B:190–204
- Cozzens S, Cortes R, Soumonni O, Woodson T (2013) Nanotechnology and the Millennium Development Goals: Water, Energy, and Agri–Food. *Journal of Nanoparticle Research* 15:2001
- da Silva PB, Machado RTA, Pironi AM, Alves RC, de Araujo PR, Dragalzew AC, Dalberto I, Chorilli M (2019) Recent Advances in the Use of Metallic Nanoparticles with Antitumoral Action—Review. *Current Medicinal Chemistry* 26:2108–2146
- Doktorovova S, Santos DL, Costa I, Andreani T, Souto EB, Silva AM (2014) Cationic solid lipid nanoparticles interfere with the activity of antioxidant enzymes in hepatocellular carcinoma cells. *International Journal of Pharmaceutics* 471:18–27
- Doktorovova S, Silva AM, Gaivao I, Souto EB, Teixeira JP, Martins–Lopes P (2014) Comet Assay Reveals no Genotoxicity Risk of Cationic Solid Lipid Nanoparticles. *Journal of Applied Toxicology* 34:395–403
- Dowling AP (2004) Development of Nanotechnologies. *Materials Today* 7:30–35
- Fang FC, Casadevall A (2010) Lost in Translation— Basic Science in the Era of Translational Research. *Infection and Immunity* 78:563–566
- Fang FC, Casadevall A (2015) Competitive Science: is Competition Ruining Science? *Infection and Immunity* 83:1229–1233
- Fang RH, Zhang L (2016) Nanoparticle–Based Modulation of the Immune System. *Annual Review of Chemical and Biomolecular Engineering* 7:305–326
- Fu PP, Xia Q, Hwang HM, Ray PC, Yu H (2014) Mechanisms of Nanotoxicity: Generation of Reactive Oxygen Species. *Journal of Food and Drug Analysis* 22:64–75
- Gehrke I, Geiser A, Somborn–Schulz A (2015) Innovations in Nanotechnology for Water Treatment. *Nanotechnology, Science and Application* 8:1–17

- Gökçay B, Arda B (2015) Nanotechnology, Nanomedicine; Ethical Aspects, *Revista Romana de Bioetica* 13
- Guinée JB, Heijungs R, Vijver MG, Peijnenburg WJGM (2017) Setting the Stage for Debating the Roles of Risk Assessment and Life–Cycle Assessment of Engineered Nanomaterials. *Nature Nanotechnology* 12:727
- Hoshyar N, Gray S, Han H, Bao G (2016) The Effect of Nanoparticle Size on in Vivo Pharmacokinetics and Cellular Interaction. *Nanomedicine London* 11/6:673–692
- Howitt SM, Wilson AN (2014) Revisiting “Is the Scientific Paper a Fraud?”: the Way Textbooks and Scientific Research Articles are being Used to Teach Undergraduate Students Could Convey a Misleading Image of Scientific Research. *EMBO Reports* 15:481–484
- Huang YW, Cambre M, Lee HJ (2017) The Toxicity of Nanoparticles Depends on Multiple Molecular and Physicochemical Mechanisms. *International Journal of Molecular Science* 18:2702
- Khafaji M, Zamani M, Golizadeh M, Bavi O (2019) Inorganic Nanomaterials for Chemo/Photothermal Therapy: a Promising Horizon on Effective Cancer Treatment. *Biophysical Reviews* 11/3:335–352
- Kim SW, Kyung Lee Y, Yeon Lee J, Hee Hong J, Khang D (2017) PEGylated Anticancer–Carbon Nanotubes Complex Targeting Mitochondria of Lung Cancer Cells. *Nanotechnology* 28/46:465102
- Lee WM, Kim SW, Kwak JI, Nam SH, Shin YJ, An YJ (2010) Research Trends of Ecotoxicity of Nanoparticles in Soil Environment. *Toxicology Research* 26:253–259
- Liong M, Lu J, Kovochich M, Xia T, Ruehm SG, Nel AE, Tamanoi F, Zink JI (2008) Multifunctional Inorganic Nanoparticles for Imaging, Targeting, and Drug Delivery. *ACS Nano* 2/5:889–896
- Luttge R (2011) Nanotechnology. In: *Microfabrication for Industrial Applications*. William Andrew Publishing, Boston
- Meng H, Xue M, Xia T, Zhao YL, Tamanoi F, Stoddart JF, Jeffrey I, Zink JI, Nel AE (2010) Autonomous in Vitro Anticancer Drug Release from Mesoporous Silica Nanoparticles by pH–Sensitive Nanovalves. *Journal of the American Chemical Society* 132/36:12690–12697
- Meyers MA (1995) Glen W. Hartman lecture. Science, Creativity, and Serendipity. *American Journal of Roentgenology* 165:755–764
- Parhi P, Mohanty C, Sahoo SK (2012) Nanotechnology–Based Combinational Drug Delivery: an Emerging Approach for Cancer Therapy. *Drug Discovery Today* 17/17–18:1044–1052
- Park W, Heo YJ, Han DK (2018) New Opportunities for Nanoparticles in Cancer Immunotherapy. *Biomaterials Research* 22:24
- Patil M, Mehta DS, Guvva S (2008) Future Impact of Nanotechnology on Medicine and Dentistry. *Journal of Indian Society of Periodontology* 12:34–40
- Qiu J (2016) Nanotechnology Development in China: Challenges and opportunities. *National Science Review* 3:148–152
- Renn O, Roco MC (2006) Nanotechnology and the Need for Risk Governance. *Journal of Nanoparticle Research* 8:153–191
- Resnik DB, Tinkle SS (2007) Ethics in Nanomedicine. *Nanomedicine (London)* 2:345–350
- Roco MC (2001) International Strategy for Nanotechnology Research. *Journal of Nanoparticle Research* 3:353–360
- Roco MC (2003) Nanotechnology: Convergence with Modern Biology and Medicine. *Current Opinion in Biotechnology* 14/3:337–346
- Roco MC (2011) The Long View of Nanotechnology Development: the National Nanotechnology Initiative at 10 Years. *Journal of Nanoparticle Research* 13/2:427–445
- Roco MC, Mirkin CA, Hersam MC (2011) Nanotechnology Research Directions for Societal Needs in 2020: Retrospective and Outlook. *Springer Science & Business Media*
- Salata OV (2004) Applications of Nanoparticles in Biology and Medicine. *Journal of Nanobiotechnology* 2:3
- Shinde SK, Grampurohit ND, Gaikwad DD, Jadhav SL, Gadhave MV, Shelke PK (2012) Toxicity Induced by Nanoparticles. *Asian Pacific Journal of Tropical Disease* 2:331–334
- Singh S, Nalwa HS (2007) Nanotechnology and Health Safety—Toxicity and Risk Assessments of Nanostructured Materials on Human Health. *Journal of Nanoscience and Nanotechnology* 7:3048–3070
- Smita S, Gupta SK, Bartonova A, Dusinska M, Gutleb AC, Rahman Q (2012) Nanoparticles in the Environment: Assessment Using the Causal Diagram Approach. *Environmental Health* 11:S13

- Souto EB, Silva GF, Dias-Ferreira J, Zielinska A, Ventura F, Durazzo A, Lucarini M, Novellino E, Santini A (2020) Nanopharmaceutics: part I—Clinical Trials Legislation and Good Manufacturing Practices (GMP) of Nanotherapeutics in the EU. *Pharmaceutics* 12:146
- Taghavi SM, Momenpour M, Azarian M, Ahmadian M, Souri F, Taghavi SA, Sadeghain M, Karchani M (2013) Effects of Nanoparticles on the Environment and Outdoor Workplaces. *Electron Physician* 5:706–712
- Xia T, Li N, Nel AE (2009) Potential Health Impact of Nanoparticles. *Annual Review of Public Health* 30:137–150
- Zhuang J, Holay M, Park JH, Fang RH, Zhang J, Zhang L (2019) Nanoparticle Delivery of Immunostimulatory Agents for Cancer Immunotherapy. *Theranostics* 9/25:7826–7848

PART V

Conclusions

Chapter VIII

8.1 Conclusions

Here I present the final conclusions of my work.

8.1.1 General Conclusions

Nanoscience and Nanotechnology are part of a veritable scientific revolution that is affecting, in an ever more massive way, the life of human beings, and that has conditioned and is still conditioning their existence, questioning man's relationship with his environment on several levels.

To speak of a scientific revolution is not hyperbole, as the nanoworld and the new approach to the atomic/molecular dimension have, on the one hand, opened the door to properties and uses of materials that could not be foreseen on the macroscopic scale, but on the other have forced us to rethink physics and many other scientific disciplines in the light of quantum phenomena and the rules of modern physics.

Consequently, everyday life has been altered by the introduction of materials and tools that have impacted human life, making improvements available in many fields, from medicine to biology, from engineering to materials science, and from telecommunications to pure science. The entry of this new science into everyday life has also brought with it necessary ethical considerations. Introducing new materials means having to deal with considerations of their impact on the health of living beings and, more generally, on the surrounding environment. In turn, this has an influence on the agencies involved in the development of Nanotechnology and makes it necessary to enter into the more ethical aspects of the issue.

Tracing the history of Nanoscience and Nanotechnology thus becomes interesting because it leads to a reconstruction of events through an analysis of the problems that had to be solved from time to time, the researchers involved, the results achieved and the consequences that these brought. The study of the laboratory instruments and their invention, the mathematical basis behind them and the results they enabled is just as compelling as the story of the people who took part in the events, in the role of both scientists and pioneers. Being able to reconstruct the events in a chronological sequence has led to a compelling narrative of a journey of more than seventy years in which the significant steps of such a complex history have been brought together.

8.1.2 Specific Conclusions

This thesis has synthesised multiple purposes.

The first and most immediate was to group together chronologically the most important moments in the history of Nanoscience and Nanotechnology from 1950 to the present day. Naturally, I had to make a not-always-easy choice of topics to include in my research. This has proved to be a very particular challenge, especially as regards the last thirty years, when the spread of the Internet and the proliferation of sources, both paper and electronic, and the ever-increasing number of publications, especially in terms of specific journals, each

dedicated to a precise sector or sub-sector of the nanoworld, has made the choice of topics to be described decidedly interesting.

In this aspect, under the guidance of my supervisor, Professor Raffaele Pisano HDR, I approached my research by following the historiographic method, searching for the original historical sources, mainly consisting of specific articles, less often of fuller volumes, and presenting their contents in a detailed manner at times integrating, for ease of reading, some mathematical passages that the drafting and synthesis of a scientific article imposes. Finding the articles has not always been easy, despite the historical interval examined, which is decidedly recent. Above all, having managed to find and analyse documents from the former Soviet Union, which are cited in the literature but not exactly easy to find, was a challenge that, when completed, gives this paper a special value.

In turn, the construction of this path made it possible to satisfy a need: that of providing, as far as is known, an initial text in which to read the history of Nanotechnology in a somewhat broader manner. At the beginning of this doctoral activity, my search turned towards the existing literature to understand the state of the art in the history of Nanoscience and Nanotechnology. In this regard, I did not find a wide choice of specific sources; there are texts on Nanotechnology that are also used as textbooks for university courses, but those that have devoted themselves to the history of this science have only dealt with the main moments, in terms of personalities and events, and in a rather synthetic manner. There are articles and websites but, again, the choice of topics is limited to what could be defined as the fundamental episodes. Confirmation in this direction came to me from a student who took a history of science course with me, taught by my thesis supervisor, a student who admitted: “I would like to read about Nanotechnology, but I have not yet been able to find a text in which, year by year, I can read about what happened in this field.”

For this reason, my thesis work was organised in such a way as to give as historically and critically structured a picture as possible.

The first step in the preparation of this paper was to carry out a bibliographic search of the existing material in terms of published books. There is a relatively recent literature, from the early 2000s onwards, that deals with Nanotechnology, describing it above all from a laboratory point of view, and in particular what techniques are used to investigate and construct nanostructures, with a focus on the world of electronics, the results of which seem to be characterised by a higher specific weight, compared to those of the other topics of investigation. One text in particular, such as the one prepared by T. Pradeep (Pradeep 2007), is very well organised in its description of instrumental techniques and also proposes a series of questions intended for teaching purposes, but limits the historical part to just a few notes.

The volume *History of Nanotechnology: From Pre-Historic to Modern Times* by Madhuri Sharon, does provide a historical overview from prehistoric times to the present day, focusing in its contents on interesting aspects of the nanoworld and the Nanotechnology in India.

These two examples have served as an encouragement for me to proceed to research the history of Nanoscience and Nanotechnology with the level of detail applied here.

In the lengthy Introduction to the paper, I presented the reader with a series of issues on Nanoscience and Nanotechnology, in terms of the basic definitions of these two terms and their complex historical evolution, related to their meaning but also to the agencies involved in their formalisation. I then described how Nanotechnology has constituted a paradigm shift in thinking and interpreting the behaviour of materials, precisely because this is completely different from that manifested in the macroscopic dimension, and how it can in fact be considered a scientific revolution in all respects, as it can be traced back to a description such as that established by Thomas Kuhn, in his general steps.

I then described how Nature, which we have to consider the first Nanotechnology in History, presents us with structures on living beings that can be traced back to this dimension and allow survival, with all its related activities, in environments hostile to plants, insects and animals.

Next, I briefly analysed - this would have been the subject of a separate chapter - some of the application fields of the dwarf world.

I then outlined the general and specific objectives for my paper, immediately organising the chronological outline of the historical part, which then became the backbone of the work; from an initial reading of how many topics were to be developed, it was already clear to me that this thesis would be characterised by a compulgence that went beyond that of other texts on the subject. Similarly, the organisation of the topics – as far as could be gleaned from the preliminary and indispensable bibliographic research – had no analogy with what could be found in the literature.

In the first chapter, *The World of Nano*, I described the history of Nanotechnology in relation to ancient civilisations and the main historical artefacts that have come down to us from them, such as the Cup of Lycurgus, preserved in London, which shows red reflections in transmitted light and green in reflected light, thanks to the presence of nanoparticles dispersed in its vitreous paste, or Damascus steel and pigments, some of which are present in the historical stained glass windows of the most beautiful cathedrals in Christendom. I then delved into the aspects of Nanotechnology in nature, also describing the mathematics that has been proposed to describe the behaviour of the gecko's legs, which are one of the most classical and studied examples. In addition, I also dealt with the hydrophobic behaviour of lotus leaves, the result of the nanostructure characteristic of the upper surface of its leaf, also presenting models that have intrigued and mimicked Nature. I then described the engineered materials and the evolution, over time, of the techniques gradually perfected to obtain them on a laboratory or industrial scale. Among the techniques mentioned were lithography and those of chemical and physical deposition. I then analysed some of the so-called pioneers of Nanotechnology such as Richard Feynman, Eric Drexler and Norio Taniguchi, also mentioning the Smalley–Drexler debate, concerning the feasibility (supported by Drexler and rejected by Smalley) of self-assembling structures, which was only interrupted by Smalley's death. Finally, I presented a brief description of some of the most important areas in which Nanotechnology is of interest and, indeed, has created real disciplines.

In the second chapter, *Experimental Nanophysics & Mathematical Modelling*, I have collected the evolution of the main instruments of electron microscopy applied in Nanotechnology, accompanying it with an explanation of the principles of physics (recalling lenses, the laws of optics and aberration phenomena) and the mathematics describing them. I have therefore collected and described what I consider to be some of the most interesting results obtained in the development of mathematics applied to the study of Solid State Physics, down to the nanometric dimension, developed by various authors in this field. Ad hoc mathematics has not always been invented, but rather new use has been made of already known relations, such as those of the Mechanics of Continuum or the Theory of Finite Elements. I reported what results have been obtained by applying known mathematics and what developments have been achieved in terms of nanophysics, considering classical, relativistic and quantum aspects.

The historical chapters form the very heart of the thesis. In the first chapter of this sequence, I have collected the events that I considered most significant, which occurred in the two decades 1950 and 1960. The events recounted were chosen through a very complex search, through which I matched, as far as possible, a significant discovery or event to a particular year in a one-to-one ratio. In this way, I want to give the reader the opportunity

to follow the chronological thread of events through what I consider to be the most significant episodes identified during my research. In the early 1950s, for example, an article was published in the former USSR that would seem to predate by thirty years the publications of Sumio Iijima, considered the father of carbon nanotubes. The other major event of these two decades can be identified in the lecture “There’s Plenty of Room at the Bottom”, delivered by Richard Feynman at the end of 1959, and which is almost universally recognised as the founding act of Nanotechnology as we know it. Interesting alternative interpretations were proposed by Chris Toumey and, in his memory, are presented as worthy of attention and initiators of an interesting epistemological debate. The second chapter of this extensive third part of the thesis covers the decades from 1971 to 1990, again describing the discoveries both from the instrumental point of view, of the laboratory equipment needed for research, and from the point of view of materials in the nanometric dimension and their most significant applications.

Here it was important to point out that in 1974 Norio Taniguchi used the word Nanotechnology for the first time. The invention and refinement of microscopes such as the Topografiner, STM and AFM are milestones in the history of science. The next chapter in part three traces the growth of Nanoscience and Nanotechnology from 1991 to the present day and is the most extensive of the three. Writing it was not easy, but resulted in a real challenge, precisely because the number of publications on Nanotechnology increased dramatically during this period. The reader will immediately see how events over this time span have become more numerous and how research has led to increasingly surprising and refined results. The improvement of laboratory equipment and the unstoppable development of research techniques in the nanoworld have literally opened the door to interdisciplinary and virtually unlimited research opportunities. The last chapter is dedicated to the activities carried out by the IEMN from 1992 on, when it was formally founded. This institute welcomed me for my studies and the preparation of this thesis. I have presented significant publications, suggested to me by researchers in the various laboratories to whom I am grateful. This research, born and bred in the last century, is also fully characterising our present.

The seventh chapter was dedicated to the implications that Nanotechnology brings with it, related to its influence on the health of humans and other living things. They are in fact external agents that can break through the body’s defence barriers and their possible toxicity in certain circumstances is still being defined. Nanoparticles are not all of artificial origin, but for those that are, there is a need for international consensus on establishing parameters and enforceable regulations, in order not to harm the environment and living things in general. There is an ethical necessity behind the creation of these particles, for this world has opened up to the researcher the possibility of manipulating matter and creating, literally, new materials from atomic and molecular dimensions.

The results I achieved with this thesis can be summarised as follows.

- I have collected the history of the main events in a volume, in chronological order, devoting a moment in the history of Nanoscience and Nanotechnology to almost every year, from 1950 to 2022, realising something that cannot yet be found in the literature, as far as is known.
- I have produced a work on the basis of the historiographical method which, I hope, will be the starting point for much broader research into the history of Nanoscience and Nanotechnology, to be developed in the years to come among several researchers.

- I have rediscovered documents in Russian that were mentioned in the various bibliographies but very difficult to find, and I have made their contents available here, and shortly the translations, organised in critical articles that will be extracted from the thesis.
- Under the guidance of my supervisor, I learnt which steps to follow in the historiographical method and the correct way to compose a historical/scientific article.
- I have derived articles and provided a broad base from which it will be possible to extrapolate others.
- I have had the opportunity to showcase my work at national and international history of science meetings, making contact with other researchers and engaging with different schools of research.

Appendix 1

Copyright Permissions

An Outline: this Appendix One contains the permission to re-use published material, such as images or contents, from other authors. Requesting these permissions also gave me the opportunity to get in touch with different researchers who helped me writing my manuscript.

Zimbra**durlo.andrea.etu@univ-lille.fr**

AW: Coyright Permission

De : ck@ckc-berlin.de <ck@ckc-berlin.de>

dim., 17 janv. 2021 17:16

Objet : AW: Coyright Permission**À :** Andrea Durlo <durlo.andrea.etu@univ-lille.fr>,
cornelia keck <cornelia.keck@pharmazie.uni-marburg.de>

Dear Andrea,

yes great! Go ahead. All the best.

Prof. Dr. Cornelia M. Keck

Institut für Pharmazeutische Technologie und Biopharmazie
Philipps-Universität Marburg
Robert-Koch-Str. 4
35037 Marburg

Telefon: 06421 2825881

Homepage: www.keck-marburg.de

----- Ursprüngliche Nachricht -----

Von: Andrea Durlo <durlo.andrea.etu@univ-lille.fr>

Datum: So., 17. Jan. 2021, 17:14

An: cornelia.keck@pharmazie.uni-marburg.de

Betreff: Coyright Permission

Kind Dr. Keck

I'm Andrea Durlo and I'm currently working on my Ph.D. thesis at Lille University, under the supervision of Dr. Prof. Raffaele Pisano HDR. The subject of my thesis is about the History of Nanoscience and Nanotechnology, and I'm writing you to kindly request your permission to use the pictures and the information reported in your article "Natural Nanoparticles: A Particular Matter Inspired by Nature", giving the

Zimbra

11/02/21, 08:58

Zimbra**durlo.andrea.etu@univ-lille.fr**

History of nanotech

De : TOUMEY, CHRIS <TOUMEY@mailbox.sc.edu> mer., 10 févr. 2021 21:09
Objet : History of nanotech 9 pièces jointes
À : Andrea Durlo <durlo.andrea.etu@univ-lille.fr>

Andrea,

Many thanks for your interest in my work on the history of nanotechnology. I have attached several papers that you might not have seen.

Let me know, please if you need good pdf's of "Apostolic Succession" or "Reading Feynman..."

Yes, you are welcome to extract graphs, etc., from my papers if you give proper credit.

Two more things for you to see:

"instrumental community" is Cyrus Mody's social history of the invention and dissemination of the STM and the AFM. In my opinion, one of the most important pieces in the history of nanotech.

And "The visioneers" is Patrick McCray's account of how Eric Drexler created his role as the primary visionary of nanotech.

Best of luck with your work. Let me know please if I can be helpful with additional topics.

sincerely, Chris Toumey

 **TOUMEY. 2008. RHAPSODY in C .pdf**
183 ko

 **TOUMEY. 2010.35 ATOMS.pdf**
527 ko

 **TOUMEY. 2010.Elegance & Empiricism.pdf**
332 ko

 **TOUMEY. 2010.Nanotech Controversies.pdf**
258 ko

Zimbra

30/06/21, 16:23

Zimbra

durlo.andrea.etu@univ-lille.fr

Re: Copyright permission

De : Dzmityr Kurouski <dkurouski@tamu.edu>

mar., 29 juin 2021 18:29

Objet : Re: Copyright permission**À :** Andrea Durlo <durlo.andrea.etu@univ-lille.fr>

hi Andrea,
please fond it on our website: kurouskilab.com.
best,
Dmitry

On Tue, Jun 29, 2021, 9:15 AM Andrea Durlo <durlo.andrea.etu@univ-lille.fr> wrote:
Dear Dr. Kurouski

I'm Andrea Durlo, currently PhD student at Lille University under the supervision of prof. Raffaele Pisano HDR.
My research regards the History of Nanotechnology from 1950 to 2020.
As one chapter of my script is about the techniques developed to investigate matter at the nanosize, I had the chance to read the article "Infrared and Raman chemical imaging and spectroscopy at the nanoscale" you wrote with other three researchers.

I'm kindly asking you the permission to use, always given the appropriate credit, contents and images form the mentioned article.

With my best regards
Andrea Durlo

Andrea Durlo
Ph.D. Student
Lille University, France
Mobile: +39 328 6371732
durlo.andrea.etu@univ-lille.fr / artbach@yahoo.com

"Est modus in rebus, sunt certi denique fines, quos ultra citraque nequit consistere rectum".

Orazio, *Satire* I, 1, 106-107

This message and any attachments is intended solely for the addressees and is confidential. It may be considered privileged and confidential. If you receive this message in error, please ignore it and immediately notify the sender, furthermore, delete it without saving a copy. Your receipt of this message is not intended to waive any applicable privilege. Please do not disseminate this message without the permission of the author. Any use not in accord with its purpose, totally or partially, any dissemination or disclosure, either whole or partial, is prohibited except formal approval. The internet cannot guarantee the integrity of this message. I shall (will) not therefore be liable for the message if modified.

Ce message et toutes les pièces jointes sont confidentiels et transmis à l'intention exclusive de leurs destinataires. Toute utilisation de ce message non conforme à sa destination, toute diffusion ou toute publication, totale ou partielle, ne peut être faite qu'avec l'autorisation expresse de l'émetteur. Si vous recevez ce message par erreur, merci de le détruire sans en

Zimbra

Zimbra

durlo.andrea.etu@univ-lille.fr

RE: Copyright permission

De : Natalie Thamwattana
<Natalie.Thamwattana@newcastle.edu.au>

ven., 03 sept. 2021 00:46

 1 pièce jointe

Objet : RE: Copyright permission

À : Andrea Durlo <durlo.andrea.etu@univ-lille.fr>

Dear Andrea,

You have my permission.

All the best for your PhD, it sounds very interesting.

Best wishes,

Natalie

From: [Andrea Durlo](#)

Sent: Thursday, 2 September 2021 5:15 PM

To: [Natalie Thamwattana](#)

Subject: Copyright permission

Kind Prof. Thamwattana,

I am Andrea Durlo, now PhD student at Lille University, IEMN, under the supervision of Prof. Raffaele Pisano HDR.

The subject of my thesis is History of Nanoscience and Nanotechnology and it will result in a volume collecting the most important advancements in this subject from 1950 to 2020.

As I want it to be comprehensive of also of the lab and mathematical instruments applied, I have been searching for articles and I found the work you and your colleague, Prof. J.M. Hill, wrote in 2005 under the title "Mathematical modelling in nanotechnology". I found the examples very interesting and valuable for my thesis, so I would like to include your results in the chapter about the mathematical methods applied.

You can easily imagine that I am collecting an huge amount of information and I have to choose, with my supervisor's agreement, those I consider to be the most important results.

So, I am kindly asking you the permission to withdraw information (contents, formulas, pictures,...) from the aforementioned article.

With my most respectful regards.
Andrea Durlo

Zimbra**durlo.andrea.etu@univ-lille.fr****Copyright Permission (Paolo Di Sia)**

De : Paolo Di Sia <paolo.disia@gmail.com>

jeu., 02 sept. 2021 21:50

Objet : Copyright Permission (Paolo Di Sia)**À :** Andrea Durlo <durlo.andrea.etu@univ-lille.fr>**Cc :** paolo.disia <paolo.disia@gmail.com>

Kind Dr. Andrea Durlo,

thank you for your email and for your interest in my research and my works.

I give you the permission to get information (formulas, contents, tables,...) from my works.

Best regards.

Paolo Di Sia, Adj. Prof., Dr., Dr., Dr.

www.paolodisia.comIl giorno gio 2 set 2021 alle ore 08:45 Andrea Durlo <durlo.andrea.etu@univ-lille.fr> ha scritto:

Kind Prof. Di Sia,

I'm Andrea Durlo, currently PhD student at Lille University, IEMN, under the supervision of Prof. Raffaele Pisano HDR.

The subject of my research is History of Nanotechnology and Nanoscience from 1950 to 2020; my thesis will result in a volume containing the most important steps and advancements on this topic. The historical part is going to be introduced by a section describing the lab tools and the mathematical methods used to investigate nanomaterials. Searching for documentation I ran into your book "Mathematics and Physics for Nanotechnology" where I found interesting contents.

I also found an interesting description of the Drude-Lorentz models in your article named "Overview of Drude-Lorentz type models and their applications" which I could download from the ResearchGate website.

I am kindly asking you the permission to get information (formulas, contents, tables,...) from these two works.

With my respectful regards.
Andrea Durlo

19/11/21, 18:27

Zimbra

Zimbra**durlo.andrea.etu@univ-lille.fr**

RE: Copyright Permission

De : Wyner, Lindsy <lwyner@ti.com>

ven., 19 nov. 2021 14:41

Objet : RE: Copyright Permission**À :** Andrea Durlo <durlo.andrea.etu@univ-lille.fr>,
copyrightcounsel@list.ti.com - Copyright and trademark web
requests (May contain non-TIers)
<copyrightcounsel@list.ti.com>

Hello Andrea-

Thank you for your interest in Texas Instruments. We grant the permission you request in your email below.

On each copy, please provide the following credit:

Courtesy Texas Instruments

Lindsy Wyner, CMP

From: Andrea Durlo <durlo.andrea.etu@univ-lille.fr>**Sent:** Friday, November 19, 2021 5:44 AM**To:** copyrightcounsel@list.ti.com - Copyright and trademark web requests (May contain non-TIers) <copyrightcounsel@list.ti.com>**Subject:** [EXTERNAL] Copyright Permission

Dear Ladies and Gentlemen,

I am Andrea Durlo and I am now writing my PhD thesis at Lille University, on History of Nanoscience and Nanotechnology, under the supervision of prof. Raffaele Pisano. Since my work spans more or less seventy years of history, and embraces subjects as the invention of transistor (there, at Texas Instruments), it would be for me of great value to add to my work the image of the first device Jack Kilby invented in 1958.

So, I am kindly asking you the permission to include the picture that is available here

https://en.wikipedia.org/wiki/Jack_Kilby

depicting the first transistor ever.

It being a PhD thesis, the script is non-commercial and, as far as I am concerned, it will not be released for sale.

With my best regards.

Andrea Durlo

Zimbra**durlo.andrea.etu@univ-lille.fr****Re: Copyright permission**

De : Kinshuk Dasgupta <kdg@barc.gov.in>

mer, 19 janv. 2022 14:09

Objet : Re: Copyright permission**À :** Andrea Durlo <durlo.andrea.etu@univ-lille.fr>

Dear Mr. Durlo

Many thanks for your email. I am happy in giving permission to use the pictures and information published in the said article. However, I believe that you need to take actual permission from the publisher. All the best.

Regards

Kinshuk Dasguta

Dr. K. Dasgupta

Head, Advanced Carbon Materials Section
GAMD, Materials Group
Bhabha Atomic Research Centre
Mumbai 400085, India
Email: kdg@barc.gov.in; dasguptakinshuk@yahoo.com
Tel:+91 22 25594951 (0); Fax: +91 22 25505151

and

Associate Professor
Homi Bhabha National Institute
Anushaktinagar, Mumbai 400094

On 2022-01-19 16:34, Andrea Durlo wrote:

> Professor Dasgupta,

>

> I am Andrea Durlo and I am nowadays PhD student at Lille University

> under the supervision of Prof. Raffaele Pisano HDR.

>

> I am writing my thesis on History of Nanoscience and Nanotechnology

> from 1950 to 2020 and I found interesting information

>

04/02/22, 10:21

Zimbra

Zimbra

durlo.andrea.etu@univ-lille.fr

RE: ymst20:Disordered carbon—its preparation, structure, and characterisation

De : Academic UK Non Rightslink
<permissionrequest@tandf.co.uk>

mer, 02 févr. 2022 17:31

📎 1 pièce jointe

Objet : RE: ymst20:Disordered carbon—its preparation, structure,
and characterisation

À : Andrea Durlo <durlo.andrea.etu@univ-lille.fr>

Dear Sir/Madam

Thank you for your correspondence requesting permission to reproduce content from a Taylor & Francis Group content from our Journal in your thesis to be posted on your University's repository.

We will be pleased to grant the permission without fee on the condition that you acknowledge the original source of publication and insert a reference to the Journal's web site: www.tandfonline.com

This permission does not cover any third party copyrighted work which may appear in the material requested. Please ensure you have checked all original source details for the rights holder.

Please note that this licence **does not allow you to post our content on any third-party websites.**

Please note permission does not provide access to our article, if you are affiliated to an institution and your institution holds a subscription to the content you are requesting you will be able to view the article free of charge, if your institution does not hold a subscription or you are not affiliated to an institution that has a subscription then you will need to purchase this for your own personal use as we do not provide our articles free of charge for research.

Thank you for your interest in our Journal.

With best wishes,

Journal Permissions
Journals, Taylor & Francis Group
Permissions e-mail: permissionrequest@tandf.co.uk
Web: www.tandfonline.com

📍 4 Park Square, Milton Park, Abingdon, OX14 4RN
☎ +44 (0)20 8052 0600



Taylor & Francis is a trading name of Informa UK Limited,
registered in England under no. 1072954

🌱 Before printing, think about the environment.

[Information Classification: General](#)

From: Andrea Durlo <durlo.andrea.etu@univ-lille.fr>

Sent: 19 January 2022 18:00



Helical microtubules of graphitic carbon

Author: Sumio Iijima
Publication: Nature
Publisher: Springer Nature
Date: Nov 7, 1991
 Copyright © 1991, Nature Publishing Group

Order Completed

Thank you for your order.

This Agreement between Lille University – Andrea Durlo ("You") and Springer Nature ("Springer Nature") consists of your license details and the terms and conditions provided by Springer Nature and Copyright Clearance Center.

Your confirmation email will contain your order number for future reference.

License Number: 5241820839846 [Printable Details](#)

License date: Feb 04, 2022

Licensed Content		Order Details	
Licensed Content Publisher	Springer Nature	Type of Use	Thesis/Dissertation
Licensed Content Publication	Nature	Requestor type	academic/university or research institute
Licensed Content Title	Helical microtubules of graphitic carbon	Format	print and electronic
Licensed Content Author	Sumio Iijima	Portion	figures/tables/illustrations
Licensed Content Date	Nov 7, 1991	Number of figures/tables/illustrations	3
		Will you be translating?	no
		Circulation/distribution	30 - 99
		Author of this Springer Nature content	no

About Your Work		Additional Data	
Title	1950: Historical and Epistemological Edge of Nanotechnology	Portions	Images on page 56 and 57
Institution name	Lille University - IEMN		
Expected presentation date	Feb 2023		

Requestor Location		Tax Details	
	Lille University Via Silvio Pellico, 15		
Requestor Location	Montegrotto Terme, Padova 35036 Italy Attn: Lille University		

\$ Price	
Total	0.00 EUR

Total: 0.00 EUR

04/02/22, 10:42

Zimbra

Zimbra**durlo.andrea.etu@univ-lille.fr**

Thank you for your order with RightsLink / Springer Nature

De : no-reply@copyright.com ven., 04 févr. 2022 10:40
Objet : Thank you for your order with RightsLink / Springer Nature
À : durlo andrea etu <durlo.andrea.etu@univ-lille.fr>
Les images externes ne seront pas affichées. [Montre les images ci-dessous](#)

 Header**Thank you for your order!**

Dear Dr. Andrea Durlo,

Thank you for placing your order through Copyright Clearance Center's RightsLink® service.

Order Summary

Licensee:	Lille University
Order Date:	Feb 4, 2022
Order Number:	5241820839846
Publication:	Nature
Title:	Helical microtubules of graphitic carbon
Type of Use:	Thesis/Dissertation
Order Total:	0.00 EUR

View or print complete [details](#) of your order and the publisher's terms and conditions.

Sincerely,

Copyright Clearance Center

Tel: +1-855-239-3415 / +1-978-646-2777

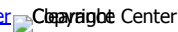
customercare@copyright.com<https://myaccount.copyright.com> Copyright Center Copyright Center

This message (including attachments) is confidential, unless marked otherwise. It is intended for the addressee(s) only. If you are not an intended recipient, please delete it without further distribution and reply to the sender that you have received the message in error.



Terms and conditions of use of the article titled

A test object and criteria for high resolution electron microscopy

[Heidenreich et al. (1968). *J. Appl. Cryst.* **1**, 1-19
<https://doi.org/10.1107/S0021889868004930>]

Permission to reprint Figure 8 and Figure 9 from the above article in 1950–:
A History and Epistemological Edge of Nanotechnology PhD Thesis Lille
University France - IEMN is granted to

Andrea Durlo

provided that the reused material is not subject to additional explicit statements of copyright or prior reproduction permission from other organizations or individuals, and is accompanied by a citation of the original article and a statement that the material was reproduced with permission of the International Union of Crystallography, according to the terms and conditions of use of material published by the International Union of Crystallography.



Peter Strickland
Executive Managing Editor, IUCr Journals

Permission

The Editorial Board of "Russian Journal of Physical Chemistry A" (Zhurnal Fizicheskoi Khimii) permit to use the contents and the figures of the article

1952, V.26, # 1.

**О СТРУКТУРЕ УГЛЕРОДА, ОБРАЗУЮЩЕГОСЯ ПРИ
ТЕРМИЧЕСКОМ РАЗЛОЖЕНИИ ОКИСИ УГЛЕРОДА
НА ЖЕЛЕЗНОМ КОНТАКТЕ**

Л. В. Радужевич и В. М. Лукьянович

April 14, 2022



A.K. Buryak

Editor-in-Chief Russian Journal of Physical Chemistry A

Zimbra

18/07/22, 18:25

Zimbra**andrea.durlo.etu@univ-lille.fr**

Re: Copyright permission

De : Chen I-Ju <i-ju.chen@aalto.fi> mar., 12 juil. 2022 08:24
Objet : Re: Copyright permission 1 pièce jointe
À : Andrea Durlo <andrea.durlo.etu@univ-lille.fr>

Dear Andrea,

Thanks a lot for reaching out. I am happy that you found our work useful.

There is no problem for you to use the content of the manuscript as long as it's properly cited.

Good luck with your thesis!

Best,
I-Ju

From: Andrea Durlo <andrea.durlo.etu@univ-lille.fr>
Sent: Friday, July 8, 2022 7:47 PM
To: Chen I-Ju <i-ju.chen@aalto.fi>
Subject: Copyright permission

Dear Dr. Chen,

I am Andrea Durlo and I am now completing my PhD Thesis in History of Nanotechnology under the supervision of Prof. Raffaele Pisano HDR, at Lille University. I have come across the recent article "Precise atom manipulation through deep reinforcement learning" you and your colleagues wrote this year.

As it gathers and nanotechnology and DRL algorithms, it would be a great conclusion of my work and a due mention to the latest achievements in these fields.

So, I am kindly asking you the permission to use the contents and the images in the article, due the proper credit to you all, in my thesis.

I will wait for your kind reply.

With my best regards.
Andrea Durlo

**Handbook of the Historiography of Science**

Approval of Proposal – Belo Horizonte, September 1st, 2021.

Dear Prof. Pisano and Mr. Durlo,

It is a pleasure to inform you that your chapter proposal for the *Handbook of the Historiography of science* was accepted.

We are waiting for your complete chapter by September 2021.

Thank you very much for sending your contribution:

“Feynman’s Frameworks on Nanotechnology in a Current Historiographical Debate”

Raffaele Pisano
IEMN, Lille University, Lille, France raffaele.pisano@univ-lille.fr

Andrea Durlo
IEMN, Lille University, Lille, France durlo.andrea.etu@univ-lille.fr

Sincerely,

A handwritten signature in blue ink that reads "Mauro L. Condé".

Mauro L. Condé
On behalf of the editors

Appendix 2

National and International Events

An Outline: this Appendix Two contains the contributions I brought to different International Meetings and the participations to events I needed for my personal portfolio as a Ph.D. student. Here the reader will find the posters and PowerPoint slides I prepared with the help of my supervisor.

Due to the pandemic situation that hit Europe in the past three years, and the impossibility to fly over foreign countries to participate in presence at the events, all these activities were grouped in 2022, except my participation to the SISFA meeting which was held online in 2020.

SISFA XL Congress 2020 – 8/10 September 2020 Napoli



UMR 8520 - INSTITUT
D'ELECTRONIQUE, DE
MICROELECTRONIQUE ET DE
NANOTECHNOLOGIE

10⁻⁹

1950-: A Historical and Epistemological
Edge of Nanotechnology

Feynman's Frameworks on the Nanotechnology in a Current Historiographical Debate

XL SISFA Conference – NAPOLI
8 – 10 Settembre 2020

Raffaele PISANO | Dr. Prof., IEMN, Lille University, France; CPNSS, LSE, UK
raffaele.pisano@univ-lille.fr
Andrea DURLO | Ph.D. Student, IEMN, Lille University-CNRS, France
artbach@yahoo.com | durlo.andrea.etu@univ-lille.fr

An inspiring document (?)

Richard Phillips Feynman, Nobel Laureate
(May 11, 1918 – February 15, 1988)



Source:
Alchetron, Free Social Encyclopedia for the World

There's Plenty of Room at the Bottom

An invitation to enter a new field of physics.

by Richard P. Feynman

I imagine experimental physicists must often look with envy at men like Ernest Rutherford, who discovered a field like low temperature, which seems to be bottomless and in which one can go down and down. Such a man is then a leader and has some temporary monopoly in a scientific adventure. Percy Williams Bridgman, in designing a way to obtain higher pressures, opened up another new field and was able to move into it and to lead on all about. The development of ever higher vacuums was a continuing development of the same kind.

I would like to describe a field, in which little has been done, but in which an enormous amount can be done in principle. This field is not quite the same as the others in that it will not call on much of fundamental physics (in the sense of "What are the strange particles?") but it is more like solid-state physics in the sense that it might tell us much of great interest about the strange phenomena that occur in complex situations. Furthermore, a point that is most important is that it would have an enormous number of technical applications.

What I want to talk about is the problem of manipulating and controlling things on a small scale.

nothing, that's the most primitive, halting step in the direction I want to discuss. It is a staggeringly small world that is below. In the year 2000, when they look back at this age, they will wonder why it was not until the year 1960 that anybody began seriously to stare in this direction.

Why cannot we write the entire 24 volumes of the *Encyclopaedia Britannica* on the head of a pin?

Let's see what would be involved. The head of a pin is a sixteenth of an inch across. If you magnify it by 25,000 diameters, the area of the head of the pin is then equal to the area of all the pages of the *Encyclopaedia Britannica*. Therefore, all it is necessary to do is to reduce in size all the writing in the *Encyclopaedia* by 25,000 times, in that direction. The resolving power of the eye is about 1/120 of an inch – that is roughly the diameter of one of the little dots on the fine halftone reproductions in the *Encyclopaedia*. This, when you magnify it by 25,000 times, is still 80 microns in diameter – 32 atoms across, in an ordinary pencil. In other words, one of these dots still would contain in its area 1,000 atoms. So, each dot can only be adjusted in size as required by the photoreproducing, and there is no question that there

What The Story Is

- A Brief Summary on Nanoscience et Nanotechnology
- Richard P. Feynman & “Plenty of Room”
- My PhD Thesis in History of Nanotechnology at Lille University, France
 - ✓ The State-of-the Art
 - ✓ The Work-in-progress

What does “nano” mean?

- Etymology: ancient Greek **nanos**  **dwarf**
- Physics: multiply a measure by 10^{-9}

To be “nano”:

one of the dimensions of the object must be between 1nm and 100nm.

By Royal Society/Royal Academy of Engineering Working Group – U.K.

Nanoscience: the study of those phenomena and the manipulation of materials on atomic, molecular or macromolecular scale, where the properties differ significantly from those measured on a large scale.

Bayda S, Adeel M, Tuccinardi T, Cordani M, Rizzolio F (2020) The History of Nanoscience and Nanotechnology: From Chemical-Physical Applications to Nanomedicine. *Molecules*, 25/112. doi:10.3390/molecules25010112

Nanotechnology: the design, characterization, production and application of structures, devices and systems by controlling their shape and size on a nanometric scale (10^{-9}m).

Bayda S, Adeel M, Tuccinardi T, Cordani M, Rizzolio F (2020) The History of Nanoscience and Nanotechnology: From Chemical-Physical Applications to Nanomedicine. *Molecules*, 25/112. doi:10.3390/molecules25010112

By National Nanotechnology Initiative (NNI) – U.S.A.

Nanotechnology: nanoscale science, engineering and technology, where unique phenomena make possible absolutely new applications in many fields, from chemistry, physics and biology, to medicine, engineering and electronics.

Bayda S, Adeel M, Tuccinardi T, Cordani M, Rizzolio F (2020) The History of Nanoscience and Nanotechnology: From Chemical-Physical Applications to Nanomedicine. *Molecules*, 25/112. doi:10.3390/molecules25010112

1 – Operative at a nanometric scale

2 – Importance of the nanoscale (material properties)

3 – Interdisciplinary

Norio Taniguchi (May 27, 1912 – November 15, 1999)

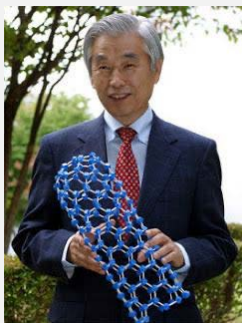

Source:
Alchetron, Free Social Encyclopedia for the World

On the Basic Concept of Nano-Technology

Taniguchi N, Arakawa C, Kobayashi T (1974) On the basic concept of nano-technology. *International Conference on Production Engineering*, 26-29 August 1974, Tokyo. *J-Proceedings of the Japan Society of Precision Engineering* 8/2:18–23.

An inspiring document? YES

Richard Phillips Feynman, Nobel Laureate
(May 11, 1918 – February 15, 1988)



Source:
Achetron, Free Social Encyclopedia for the World

There's Plenty of Room at the Bottom

An invitation to enter a new field of physics.

by Richard P. Feynman

I imagine experimental physicists must often look with envy at men like Keesling Omer, who discovered a field like low temperature, which seems to be bottomless and in which one can go down and down. Such a man is there a leader and his contemporary concepts in a scientific adventure. Percy Bridgman, in designing a way to obtain higher pressures, opened up another new field and was able to move into it and to lead on all along. The development of our higher vacuum was a continuing development of the same kind.

I would like to discuss a field, in which little has been done, but in which an enormous amount can be done in principle. The field is not quite the same as the others in that it will not tell us much of fundamental physics (in the sense of "What are the strange particles?") but it is more like solid-state physics in the sense that it might tell us much of great interest about the strange phenomena that occur in complex situations. Furthermore, a point that is most important is that it would have an enormous number of technical applications.

What I want to talk about is the problem of manipulating and controlling things on a small scale.

nothing that's the most primitive, having step in the direction I intend to discuss. It is a staggeringly small world that it takes. In the year 2000, when they look back at this age, they will wonder why it was not until the year 1959 that anybody began seriously to enter in this direction.

Why cannot we write the entire 24 volumes of the *Encyclopedia Britannica* on the head of a pin?

Let's see what would be involved. The head of a pin is a sixteenth of an inch across. If you magnify it by 25,000 diameters, the size of the head of the pin is then equal to the size of all the pages of the *Encyclopedia Britannica*. Therefore, all it is necessary to do is to reduce in size all the writing in the *Encyclopedia Britannica* to that size. The resulting piece of the size is about 1/125th of an inch – that is roughly the diameter of one of the little dots on the fine halftone reproduction in the *Encyclopedia*. This, when you magnify it by 25,000 times, is still 50 microns in diameter – 50 microns means, in an ordinary yard, in other words, one of those dots still would contain in its area 1,000 atoms. So, each dot can easily be adjusted in size as required by the photoreplicating, and there is no question that there

Inspiring...

Eric Drexler

Feynman's 1959 talk entitled 'There's Plenty of Room at the Bottom' discussed microtechnology as a frontier to be pushed back, like the frontiers of high pressure, low temperature, or high vacuum. He suggested that ordinary machines could build smaller machines that could build still smaller machines, working step by step down toward the molecular level [...] Present microtechnology (exemplified by integrated circuits) has realized **some of the potential outlined by Feynman** by following the same basic approach: working down from the macroscopic level to the microscopic.

Drexler E (1981) Molecular Engineering: An approach to the development of general capabilities for molecular manipulation. Proceedings of the National Academy of Sciences 78/9:5275

James A. Krumhansl and Yoh-Han Pao

Just about twenty years ago, at the Christmas, 1959, meeting of The American Physical Society at Cal Tech, Richard P. Feynman gave a delightful talk [...] In the past twenty years there has been an explosive growth in 'microscience', in **exploring that room at the bottom Feynman mentioned.**"

Krumhansl JA, Pao YH (1979) Microscience: an overview. *Physics Today* XI:25-26

A different Interpretation of “Plenty of room” inspiring...

Techné 12/3 Fall 2008

Toumey, Reading Feynman Into Nanotechnology/133

Reading Feynman Into Nanotechnology: A Text for a New Science

Christopher Toumey
USC NanoCenter
University of South Carolina

Christopher Toumey USC Nano Center – University of South Carolina (2008)

1. Apostolic Succession

2. Nano-Mendel interpretation

3. Nostradamus-like reading

A Debate

Heinrich Rohrer (Nobel Prize 1986): *“I think it had no influence whatsoever [...] Feynman’s lecture remained practically unnoticed during nearly three decades, while the miniaturization progressed in the same time at a fantastic pace, driven by the needs of the data processing industry.”*

Toumey C (2008) Reading Feynman Into Nanotechnology: A Text for a New Science. Techné: Research in Philosophy and Technology 12/3:133-168.

Gerd Binnig (Nobel Prize 1986): *“I have not read [Plenty of Room]... I personally admire Feynman and his work but for other reasons than for his work in nanotechnology (which actually does not exist) [Binnig’s parentheses]. I believe people who push too much his contribution to this field do harm to his reputation. His contribution to science is certainly not minor and he needs not to be lifted... [posthumously] onto the train of nanotechnology.”*

Toumey C (2008) Reading Feynman Into Nanotechnology: A Text for a New Science. Techné: Research in Philosophy and Technology 12/3:133-168.

In Toumey’s paper we also read: Feynman’s paper is absent in the references in the U.S. patents for the STM (Binnig & Rohrer 1982) and the AFM (Binnig 1990), and two recent articles describing Binnig’s role in inventing the STM have no mention of Feynman as an influence or inspiration (ETQ 2004; Goldstein 2004).

Toumey C (2008) Reading Feynman Into Nanotechnology: A Text for a New Science. Techné: Research in Philosophy and Technology 12/3:133-168.

My PhD Research in History of Nanotechnology (1)

Main Objectives:

- ✓ Analyzing and structure an History of Nanotechnology from 1950 to nowadays according to the Historical Methodology,
- ✓ Recollecting the sources and guidelines chronologically ordered & grouping under a single, structured volume the main steps that have marked this period of the History of Physics,
- ✓ Focusing on the interdisciplinarity that makes this current field of Physics of absolute interest.

Methodology:

- ✓ Overview the discoveries, the ideas, the researchers, the scientific instruments & Labs, the situations that have been making this branch of Physics so revolutionary. Participation to seminars and meetings.
- ✓ Presenting results at meeting international conferences & publishing systematically peer reviewed articles and a final book in the field.

Because I am concluding the first doctoral year, at this stage yet there is no immediate evidence that such a comprehensive work has been written so far.

My PhD Research in History of Nanotechnology (2)

Expected result:

- ✓ a structure scientific history of Nanosciences & Nanotechnologies by a notable work, considering the subject by historical, epistemological and science in society points of view.

Impact:

- ✓ A structured contribution to the History of Science in Nanotechnology, such as a new source to get information from, to teach/think about science, its history and technologies at different levels.
- ✓ Essays and articles may be obtained from the readers' most interesting points and they may be subjects for further researches.

A Short Current Review on the State of the Art

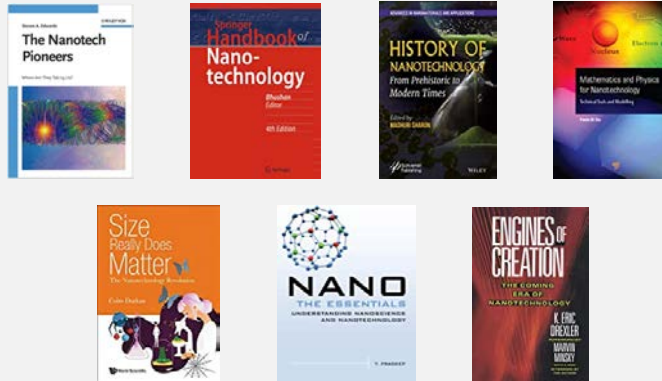

PhD Thesis' Contents – Chapters 1 and 2

SCIENTIFIC PART

The Nanophysics

- Nanoscience and Nanotechnology
 - ✓ Definitions
 - ✓ How old is Nano?
 - ✓ What Nanomaterials do we know?
- Pioneers in Nanotechnology

Lab Instruments and Maths-Phys Applications

- Instruments of Nanophysics
 - ✓ Electronic Microscopy, AFM, STM
 - ✓ Imaging and Spectroscopy
- Mathematics for Nanophysics
 - ✓ Mathematical Modelling
 - ✓ The Drude-Lorentz Model

PhD thesis' Contents – Chapters 3 and 4 (abridged)

HISTORICAL PART

- 1951: Field Ion Microscope
- 1952: First Image of a Nanotube
- 1958: First Integrated Circuit
- **1959: "Plenty of Room..."**
- 1960: MOSFET
- 1965: Moore's Law
- 1970: Quantum Size Effect
- **1974: First use of the Word "Nanotechnology"**
- 1977: Molecular Nanotechnology
- 1981: Scanning Tunneling Microscope and Quantum Dots
- 1985: Fullerene
- **1986: AFM and "Engines of Creation"**

PhD Thesis' Contents – Chapter 5

HISTORICAL PART

- 1993: Single Wall Nanotubes
- 1996: Gold Colloids
- 1997: First Nanotech Factory and Nanorobots
- 1998: Carbon Nanotubes Transistor
- 1999: Dip-pen Nanolithography
- 2001: Molecular Nanomachines
- 2002: Carbon Nanotubes and DNA
- 2006: DNA Origami and Medicine
- 2008: Memristors and Proteins
- 2011: New Polymers
- 2013: Nanotube Computer
- 2018: DNA Tic-tac-toe

PhD Thesis' Contents – Chapter 6

SCIENCE IN SOCIETY PART

- “Nano” and Society
 - ✓ Research Programs
 - ✓ Security Policies & Regulations
 - ✓ Nanoparticles and Everyday Life
 - Influence on Human Health
 - Influence on Environment

An Early Thesis Schedule

2020 – 2023

- Keep Researching Fonts
- Expanding Continuously the References
- Participations to Seminars and Colloquia
- Following Courses for Doctoral Credits
- Publications on the Subject

2020 – 2021

- Part I Pre-print
- Hypothesis: Contact Researchers and Professors

2021 – 2022

- Completing Part I and Part II, Preprint of Part III

2022 – 2023

- Completing Part III, Part IV and Part V
- A Final Release

Selected References

- Bayda S, Adeel M, Tuccinardi T, Cordani M, Rizzolio F (2020) The History of Nanoscience and Nanotechnology: From Chemical-Physical Applications to Nanomedicine. *Molecules* 25/112
- Bussotti P, Pisano R (2020) Historical and Foundational Details on the Method of Infinite Descent: Every Prime Number of the Form $4n+1$ is the Sum of Two Squares. *Foundations of Science* 1:1-32 doi.org/10.1007/s10699-019-09642-3
- Drexler KE (1988) *Engines of Creation: The Coming Era of Nanotechnology*. New York, Doubleday-Anchor Books
- ETQ The Economist Technology Quarterly (2004) Touching the atom. *Economist Technology Quarterly* 18 September 2004, pp.42-43
- Feynman RP (1960) There's Plenty of Room at the Bottom. *Engineering and Science* 23/5:22-36
- Feynman RP (1984) Tiny machines: a lecture on nanotechnology. Retrieved via:
<https://cosmolearning.org/courses/richard-feynman-lecture-on-nanotechnology-tiny-machines-473/>
- Goldstein H (2004) A Beautiful Noise. *IEEE Spectrum* 41/5:50-52. doi:10.1109/MSPEC.2004.1296015.
- Krumhansl JA, Pao YH (1979) Microscience: an overview. *Physics Today* 32/11 doi.org/10.1063/1.2995274
- Madhuri S (2019) *History of Nanotechnology. From Prehistoric to Modern Times*. Beverly, Scrivener Publishing, Wiley
- Mansoori GA (2017) An Introduction to Nanoscience & Nanotechnology. In Ghorbanpour M., Manika K., Varma A (Editors) *Nanoscience and Plant-Soil Systems*. Cham, Springer, pp. 1-20.
- Myers TG, MacDevette MM, Font F, Cregan V (2014) Continuum mathematics at the nanoscale. *Journal of Mathematics in Industry* 4:11
- Pisano R, Sozzo S (2020) A Unified Theory of Human Judgements and Decision-making under Uncertainty. *Entropy Special Issue Andrei Khrennikov A, Bagarello F (eds). Quantum Models of Cognition and Decision-Making*, 22/7:1-34
- Pisano R, Anakkur A, Pellegrino EM, Nagels M (2019) Thermodynamic Foundations of Physical Chemistry Reversible Processes and Thermal Equilibrium into History. *Foundations of Chemistry* 21:297-323
- Toumey C (2008) Reading Feynman Into Nanotechnology: A Text for a New Science. *Techné: Research in Philosophy and Technology* 12/3:133-168

Colloque National GDR SOC2 – Strasbourg 27/29 June 2022

NiFe₂O₄ Nanoferrites: a Case-Study into the History of Nanotechnology

Andrea Durlo – PhD Candidate

Lille University – IEMN, France
andrea.durlo.etu@univ-lille.fr – [0000-0001-8847-5614]

Raffaele Pisano

Lille University – IEMN, France
raffaele.pisano@univ-lille.fr – [0000-0002-8040-5088]

Franco Ronconi

Ferrara University – Department of Physics and Earth Sciences, Italy
In memoriam of

Federico Spizzo

Ferrara University – Department of Physics and Earth Sciences, Italy
federico.spizzo@unife.it

Abstract

Generally speaking the History of Nanoscience and Nanotechnology (HNN) deals with studies and discoveries in the range of structures, instruments, and matter properties at nanoscale. HNN includes scientific studies, e.g., in physics, mathematics, chemistry, engineering, biology, medicine–health etc., and numerous applications in the development of devices and contributions of science in society, e.g., in the field of transportation, communications, cancer treatment, etc. One of the shared fields of research involves the manipulation of the matter at the nanoscale dimension, e.g., Nanoferrites. These are fundamental materials for electronic devices, due to their properties to the size of the particles. Below we present methods and results of a study accomplished by AD, FR and FS at Ferrara University (Italy) since 2000. At the IEMN, Lille University (France), correlated PhD research (AD, supervised by RP) in History of Nanoscience and Nanotechnology is a work in progress. It includes the development of above cited subject.

Introduction

In 2002, a lab sintering operation to initiate solid-state diffusion reactions, postulated to be at the base of the diffusion process assumed to obtain collars between the two precursors, was made at Ferrara University. We (AD, FR, FS) investigated a process to get nanoparticles of nickel ferrite, NiFe₂O₄, or tervorite, starting from two paramagnetic precursors, nickel oxide NiO (bunsenite), and iron oxide α -Fe₂O₃ (haematite). The sample was scanned with different techniques. Thermogravimetry, X-Ray Diffraction (XRD) and Mössbauer Spectroscopy (MS): Vibrating Sample Magnetometer (VSM) and Scanning Electron Microscopy (SEM) were applied. Although the techniques applied were not originally conceived to investigate the nanoworld, this research proved how different techniques could be applied and their results merged toward the characterization of nanomaterials.

Main Objectives

1. Lab sintering of Nickel Ferrite from commercial nickel oxide and iron oxide.
2. Characterisation of the sample and observation of properties due to nanodimension.
3. Including and discussing methods and results into the History of Nanosciences and Nanotechnology.

Materials and Methods

Commercial nickel oxide and iron oxide powders, declared grain size of 150 micrometers, were mixed in the laboratory first by hand and then with a steel ball mill, for a time of one hour and at a stirring frequency of 20Hz. The reaction temperature in a muffle furnace was set at 650°C to slow down the reaction, to limit the size of the ferritic particles; the mixture was then heat-treated for varying times from 4 to 32 hours to activate solid-state reactions.

Thermogravimetry

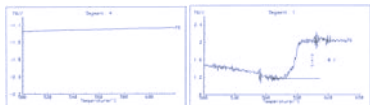

Figure 1: Left: the thermogram of the iron oxide used as precursor, right: the thermogram of the reacted compound, showing that a magnetic transition had occurred. There was no need to test nickel oxide because it was known to possess paramagnetic behavior. Source: AD (2002) Magnetic and Structural Properties of NiFe₂O₄ Nanoferrites. Unpublished Master's Thesis, University of Ferrara, Italy.

X-Ray Diffraction

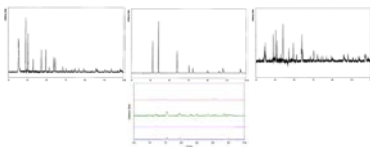

Figure 2: Top left: XRD spectrum of iron oxide, top center: XRD spectrum of nickel oxide, top right: XRD spectrum of reacted specimen. Bottom: detail of XRD of reacted specimen to demonstrate the presence of a broad and low peak expected for nickel ferrite. The broadening of the peak was related to the nanodimension of the particles. Source: AD (2002) Magnetic and Structural Properties of NiFe₂O₄ Nanoferrites. Unpublished Master's Thesis, University of Ferrara, Italy.



Mössbauer Spectroscopy

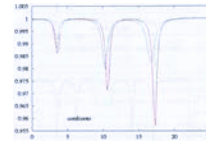

Figure 3: The comparison among the sextets of nickel ferrite (red) and precursor iron oxide (blue and green). Source: AD (2002) Magnetic and Structural Properties of NiFe₂O₄ Nanoferrites. Unpublished Master's Thesis, University of Ferrara, Italy.

VSM Analysis

He	Rec.Mom.	Sat.Mom.	Mass (in g)	% _{min} ferr.
3350e	0.0219emu	0.0719emu	1.438 × 10 ⁻⁴	12.5

Table 1: The values obtained from VSM analysis. Source: AD (2002) Magnetic and Structural Properties of NiFe₂O₄ Nanoferrites. Unpublished Master's Thesis, University of Ferrara, Italy.

SEM Imaging

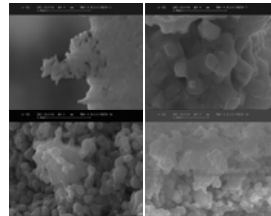

Figure 4: Top left: α -Fe₂O₃ spherulic structure. Top right: NiO cubic geometry, according to *fcc* crystallographic unit cell. Bottom pictures: SEM details of the reacted samples where the collars are visible and nanodimensioned. Source: AD (2002) Magnetic and Structural Properties of NiFe₂O₄ Nanoferrites. Unpublished Master's Thesis, University of Ferrara, Italy.

Conclusions

- The material exhibited a magnetic transition at 590°C, comparable with the Curie temperature T_c of nickel ferrite reported in literature.
- The diffraction spectrum indicated the presence of a peak at an angle very similar to that of one of the expected reflections for the NiFe₂O₄ compound, the width at half-height of this peak being greater than that of the NiO and Fe₂O₃ peaks.
- The material possessed a coercive field H_c of 3350e and, even in the presence of an applied field equal to 1.5T, its magnetisation did not reach saturation. The value of H_c reported in the literature is about 600e and the saturation field did not exceed 1000e.
- The images collected by Scanning Electron Microscopy shown the presence of “collars” between the NiO and Fe₂O₃ particles with a size in the order of hundreds of nanometers.

Forthcoming Research

At present, a current PhD research project (AD, Supervised by RP) in History of Nanoscience and Nanotechnology at Lille University is a work in progress, as an extensive historical and chronological study in nanosciencetechnologies since the 1950s, planned to be completed and discussed in January 2023. The thesis is going to group and chronologically describe in detail the most significant steps of the nanoworld. Since 1950 on, Nanoresearch has been achieving remarkable results in instruments (SEM,TEM, STM, AFM). Pioneers of this new science opened new research paths (Feynman, Taniguchi, Drexler, Iijima, ...) and new materials have been discovered or engineered (fullerenes, graphene, nanocarriers, ...), as a matter of fact, in almost every field of research. Physics, medicine, engineering, biology have taken significant advantages from the nanotechnology revolution. We chose a study on nanoferrites because of their importance in conventional electronic, electrical and magnetic devices. Today they find applications in biomedical sciences and biotechnology also.

Journée du Département «Matériaux, Nanostructures et Composants» – Ennevelin 19 July 2022

Ph.D. Research 1950-: A History and Epistemological Edge of Nanotechnology [Defend Dissertation expected 2023]



HOPAST

History of Physics and Applied Sciences & Technology
Inquiring Historical Foundations of Sciences, Methods and Scientific Thought

The Nanosciences and Nanotechnology into the History

The PhD research in History of Nanoscience and Nanotechnology deals with studies and discoveries in the range of structures, instruments, and matter properties at nanoscale. Nanoscience and nanotechnology have developed greatly since 1950 onward. New properties of the matter and technological manipulations appeared; several fields of science have been affected by this scientific and technological revolution. Based on a selection of works & discoverers, the most significant activities and their results of research in this field have been scientifically—and—historically analysed, discussed and chronologically presented. This doctoral research has no similar studies in the literature so far.

1960 - 1969

- 1960 – M.M. Atalla and D. Kahng invent the Metal-Oxide-Semiconductor *Field-Effect Transistor*, the MOSFET.
- 1962 – M.M. Atalla and D. Kahng realize the *Nano-Layer-Base-Metal* Semiconductor Transistor.
- 1965 – G.E. Moore predicts that the number of transistors on an integrated circuit doubles every two years.
- 1968 – A.Y. Cho develops the Molecular Beam Epitaxy combining Surface Physics and Ion Propulsion Technology.

1980 - 1989

- 1980 – A.I. Ekimov, A.A. Onushchenko and V.A. Tsekhomskij observe Quantum Dots and *Quantum Size Effect* on Nanoparticles.
- 1981 – G. Binnig and H. Rohrer build the first *Scanning Tunneling Microscope*, STM, and are awarded the Nobel Prize in 1986.
- 1985 – H.W. Kroto, J.R. Heath, S. O'Brien, R.F. Curl Jr., Y. Liu and R. Smalley discover the *C₆₀ Fullerene*.
- 1986 – G. Binnig, C.F. Quate and C. Gerber develop the *Atomic Force Microscope*, AFM.
- 1989 – D.M. Eigler and E.K. Schweizer manipulate *xenon atoms* to compose the IBM logo.

2000 - 2009

- 2000 – H.C. Manoharan, C.P. Lutz and D.M. Eigler observe *quantum mirages* formed by coherent projection of electronic structure.
- 2001 – K.E. Drexler, pioneer of nanotechnology, discusses about *assemblers* and their capability to build almost everything.
- 2004 – A.K. Geim and K.S. Novoselov discover a stable form of carbon today known as *graphene*.
- 2006 – C. Pinto Reis, R.J. Neufeld, A.J. Ribeiro and F. Veiga prepare and develop *drug-loaded polymeric nanoparticles*.
- 2009 – P.O. Vontobel and his team discover how to write and read from a nano-scale memory based on *memristors*.

Mr. Andrea Durlo, *Ph.D. Candidate*

HOPAST, Physics Group, IEMN, Lille University, France
andrea.durlo.etu@univ-lille.fr

Prof. Dr. Raffaele Pisano, HDR, *Supervisor*

HOPAST, Physics Group, IEMN, Lille University, France
raffaele.pisano@univ-lille.fr

1950 - 1959

- 1952 – L.V. Radushkevich and M.V. Lukyanovich observe whisker-like hollow *carbon structures*; the first nanotubes.
- 1956 – A. von Hippel defines the concept of Molecular Engineering as a new way to think to engineering problems.
- 1958 – J. St. Clair Kilby invents the first *integrated circuit* and is awarded the Nobel prize in year 2000.
- 1959 – R.P. Feynman gives the lecture *There's Plenty of Room at the Bottom*, considered the founding moment of Nanotechnology.

1970 - 1979

- 1970 – R.L. Esaki and R. Tsu observe the *Quantum Size Effect* due to trapped electron in a potential.
- 1974 – N. Taniguchi uses the word *Nanotechnology* for the first time in history to describe processes on semiconductors.
- 1976 – M. Endo, T. Koyama and Y. Hishiyama obtain reinforced nano structures from *aromatic compounds*.
- 1979 – K.E. Drexler gets back to the concept of *Molecular Engineering* as the capability of molecular manipulation.

1990 - 1999

- 1991 – S. Iijima studies the helical microtubules of graphitic carbon and is recognized as the *father of carbon nanotubes*.
- 1993 – S. Iijima and T. Ichihashi synthesize *single-walled nanotubes* and confirm the helical arrangement of carbon hexagons.
- 1996 – R.F. Curl, H.W. Kroto and R. Smalley are awarded the Nobel Prize in Chemistry for their discovery of *fullerenes*.
- 1998 – R. Martel, T. Schmidt, H.R. Shea, T. Hertel and P. Avouris fabricate *single-and multi walled carbon nanotube transistors*.
- 1999 – The team of C. Mirkin develops Dip-Pen *Nanolithography*, one of the most important processes in Nanotechnology.

2010 - 2019

- 2010 – M. Pfister files a patent for aiding carbon-base self-organizing *nanorobots*.
- 2013 – R.P. Singh, R. Blossey and F. Cleri study structure and mechanical properties of DNA *i-motif* nanowires.
- 2016 – J.P. Sauvage, J.F. Stoddart and B.L. Feringa are awarded the Nobel Prize for the design and synthesis of *molecular machines*.
- 2017 – S. Giordano proposes a *spin variables* approach for *statistical mechanics* of folded and unfolded chains.
- 2019 – L. Qian and her team at Caltech realize the *smallest Tic Tac Toe* game based on DNA.



<https://www.iemn.fr>

SISFA XLII Congress 2022 – 26/29 September 2022 Perugia



UMR 8520 - INSTITUT
D'ELECTRONIQUE, DE
MICROELECTRONIQUE ET DE
NANOTECHNOLOGIE

10⁻⁹

1950–: A Historical and Epistemological
Edge of Nanotechnology

History of Physics/Solid State Physics

1950s–1990s: Carbon Nanotubes Studies into Historiography of Nanoscience–Nanotechnology

XLII SISFA Conference – PERUGIA
26 – 29 Settembre 2022



Raffaele PISANO | Dr. Prof., HDR (Habil.), Thesis Supervisor, IEMN, Lille University, France;
raffaele.pisano@univ-lille.fr
Andrea DURLO | Ph.D. Student, IEMN, Lille University-CNRS, France
andrea.durlo.etu@univ-lille.fr

Advancements in Solid State Physics: Carbon Structures in History of Physics

We propose a short review of some significant steps in the recent History of Physics focusing on Solid State Physics and Carbon Nanotubes, and also mentioning the discovery of Buckminsterfullerene, through fundamental articles.

Radushkevich LV, Lukyanovich VM (1952) On the Carbon Structure Formed by the Thermal Decomposition of Carbon Monoxide on an Iron Contact (in Russian). Russian Journal of Physical Chemistry 26/1:88–95

Endo M, Koyama T, Hishiyama Y (1976) Structural Improvement of Carbon Fibers Prepared from Benzene. Japanese Journal of Applied Physics 15/11:2073–2076

Kroto HW, Heath JR, O'Brien SC, Curl RF, Smalley RE (1985) C₆₀: Buckminsterfullerene. Nature 318/6042:162–163

Iijima S (1991) Helical Microtubules of Graphitic Carbon. Nature 354/6348:56–58

Keywords: Nanoscience, Nanotechnology, Carbon Nanotechnology, History of Physics, History of Science, Epistemology, Carbon Fibers, Benzene, Buckminsterfullerene, Graphitic Microtubules, Helicity, Radushkevich, Lukyanovich, Endo, Kroto, Curl, Smalley, Iijima

1952 – Radushkevich & Lukyanovich A new Solid State Structure

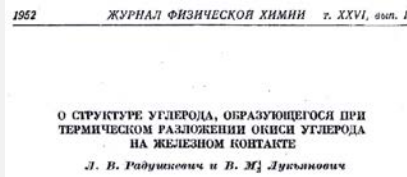

On the Carbon Structure Formed by the Thermal Decomposition of Carbon Monoxide on an Iron Contact

Headings and authors of the original article.
Source: Radushkevich and Lukyanovich 1952, p. 88.

“But already our first observations showed that **the carbon formed in CO has a very peculiar structure that has not been described by anyone so far**, and therefore our attention naturally turned to the systematic study of this structure and also to the conditions of its formation”. (Radushkevich and Lukyanovich, p. 88. Translation: Authors)

Но уже первые наблюдения, сделанные нами, показали, что образующийся из CO углерод имеет весьма своеобразную структуру, до настоящего времени никем не описанную, и поэтому, естественно, наше внимание было перенесено на систематическое изучение этой структуры, а также на условия образования.
(Original excerpt of the translation above. Radushkevich and Lukyanovich 1952, p. 88.)

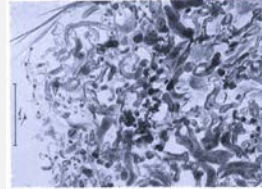

Worm-like shaped particles. Source: Radushkevich and Lukyanovich 1952, no page number.

Lab Process and Hypothesized Mechanism of Growth

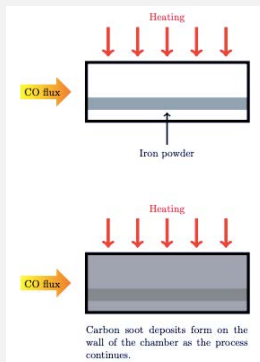

Left: a simplified rendering of the experimental device.
Below: the mechanism of growth at the solid-state hypothesized by the Russian authors.

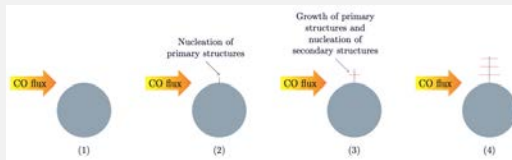

Operative Lab Temperature = 600°C (a few tests at 400°C and 500°C)

Primary structures = iron compounds (carbides)
Secondary structures = graphite compounds

Investigation of the Structures: Electron Microscope Pictures

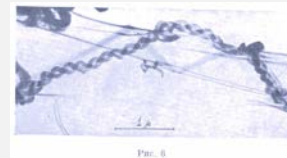
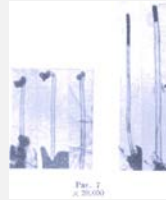

Pictures of the carbon structures taken after the chemical removal of carbide. Structures appear to be **hollow** and proved to be **resistant** to electron beams.

Microscope magnifications: between 8000 and 15000 times
Cathode voltage: 60kV
Current intensity: 0.03mA

According to a rough calculation, in Fig.4, the apparent diameter of a tubular structure is approximately 130nm.

Source: Radushkevich and Lukyanovich 1952, no page number.

Results and Conclusions of the Russian Research

1. [...] Most of the particles have an **elongated worm-like shape** with characteristic terminations, indicating the direction of growth.
2. Particles grown in some cases on single iron grains in CO atmosphere have regular filamentous shapes with dense terminations. [...]
3. The authors consider it possible that the process of particle growth breaks down into two stages. In the first stage, filamentous nuclei are formed as a result of a chemical reaction between CO and iron. In the second stage cross-sectional growth of particles occurs due to the formation of graphite crystals. Final grown particles are a product of the growth and deformation of primary particles.
4. Unusual **shapes of twin particles interlaced between each other were found**. The formation of these aggregates proceeds according to a special mechanism, details of which await explanation. (Radushkevich and Lukyanovic 1952, p. 95. Translation: Authors)

**We can consider this discovery as the first observation
of carbon nanotubes-like structures**

1976 – Endo, Koyama and Hishiyama Inorganic and Organic Chemistry put together

JAPANESE JOURNAL OF APPLIED PHYSICS
VOL. 15, NO. 11, NOVEMBER, 1976 pp. 2073-2076

Structural Improvement of Carbon Fibers Prepared from Benzene

Morinobu ENDO, Tsuneo KOYAMA and Yoshihiro HISHIYAMA[†]

Shinshu University, Faculty of Engineering, Nagano-shi

[†]Musashi Institute of Technology, Setagaya-ku, Tokyo

(Received April 14, 1976)

Headings, authors and affiliations from the original article.
Source: Endo, Koyama and Hishiyama 1976, p. 2073.

A Comparison of Carbon Structures

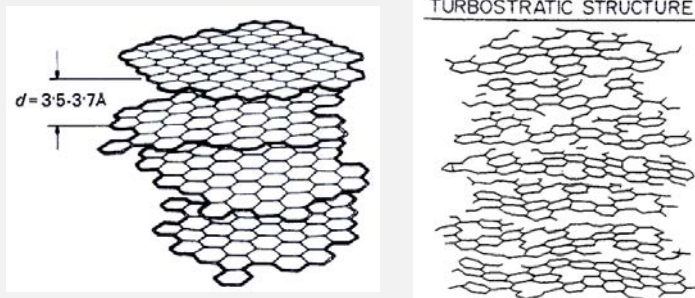

Left: layers of black carbon crystallites. Source: Heidenreich 1967, p. 11. Reproduced under permission of the International Union of Crystallography. Right: the turbostratic structure recognized by Endo. Source: Dasgupta and Sathiyamoorthy 2003, p. 996. Reproduced under permission of Taylor & Francis.

Investigating Matter: X-Ray Diffraction

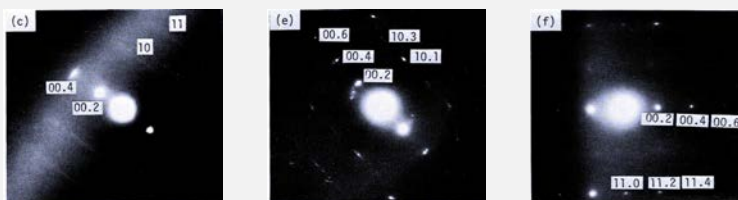

These pictures represent selected areas of the diffraction patterns taken at 2000°C (picture c), at 2600°C (picture e), and at 3000°C (picture f) to describe the structure. Source: Endo, Koyama and Hishiyama 1976, p. 2075.

The growth process of carbon structures is similar to Radushkevich's.

As the Thermal Treatment Temperature increases, the diffraction pattern of the carbon nanotube becomes similar to the one observed for graphite single crystals.

Right: the diffraction pattern of graphite. Source: Finch and Wilman 1936, plate 7.

1985 – Kroto, Heath, O'Brien, Curl and Smalley A new Structure and a Nobel Prize

C₆₀: Buckminsterfullerene

**H. W. Kroto*, J. R. Heath, S. C. O'Brien, R. F. Curl
& R. E. Smalley**

Rice Quantum Institute and Departments of Chemistry and Electrical
Engineering, Rice University, Houston, Texas 77251, USA

Headings, authors and affiliations from the original article.
Source: Kroto, Heath, O'Brien, Curl and Smalley 1985, p. 162.

Experimental device and Lab Results

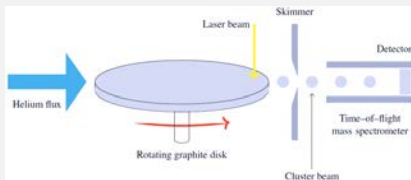

Top: a schematic representation of the experimental apparatus. Source: Andrea Durlo.

Left: original notes reporting the signal of C_{60} as *very strong*, a), and *very large*, b), on the 4th and 5th of September. Right: the Time Of Flight mass spectrum of carbon clusters. Source: Kroto 1992, pp. 115 and 116.

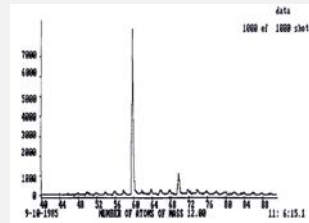
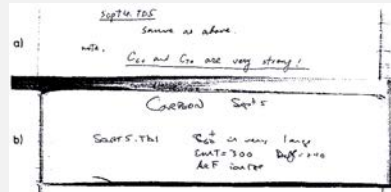

The Research for a Consistent Structure



Source: Andrea Durlo

"On Friday, September 6 [1985] during a group meeting, Curl suggested that we should concentrate on identifying the conditions under which the 720 amu peak was most prominent. [...] What on earth could $C_{60}(?)$ be? [...] The deliberations were particularly intense on Monday, September 9th. As this day wore on and all the ideas which had surfaced during the period were assessed and reassessed, a consensus grew that C_{60} might be some sort of spheroid. One possibility we considered was that the laser had blasted flakes of carbon from the graphite surface, and that these hot graphite-like networks had somehow wrapped themselves up into closed cages, thus eliminating the dangling edge bonds and making the cage unreactive. This idea had instant appeal for all. For me this concept brought back vivid memories of Buckminster Fuller's geodesic dome at EXPO '67 in Montreal." (Kroto 1992, p. 116)

[...] there is also some sadness in our hearts today. While the chemistry prize this year is for the discovery of the fullerenes, it is given to individuals, and this individual honour can be shared by no more than three. The Nobel Committee has done as well as they possibly can with this problem. We understand. But the sadness remains. [...]

The notion that C_{60} could be a closed shell molecule [...] fell to Bocharov, Gal'pern and Stankevich who actually did the relevant Hückel calculations in Russia well over a decade before we ever got into the game." (Smalley 1996, Nobel Lecture, p. 89)



Top: the United States' pavilion in Montreal. Source: Cédric Thévenet (Wikipedia).



The model Smalley made with 60 vertices, 12 pentagonal and 20 hexagonal faces. Source: Kroto 1992, p. 117.

Applications of C₆₀

Improvements brought in by Fullerene

- **Semiconductor Technology:** applications in diodes, photocells, transistors...
- **Solar Cells:** fullerene is an electron acceptor and can mimic photosynthetic process if tied to molecules yielding electrons
- **Fire Retardants:** fullerene charged paint swells under fire protecting structures
- **Medical Applications**
 - **Antioxidants:** can easily penetrate cells, nucleus, and mitochondria acting as free radicals hunter. Anti neurovegetative diseases contrast agents
 - **Nanomedicine:** can enclose active ingredients and release them to bacteria/cancer cells over a long time
 - **Proactive Agents:** reduces oxidative stress in cells
 - **Antibacterial/Antiviral Action:** can penetrate bacteria causing the rupture of the cell membrane or react with oxygen blocking the respiratory chain of the bacteria

1991 – Iijima Carbon Nanotubes (NCT)

LETTERS TO NATURE

Helical microtubules of graphitic carbon

Sumio Iijima

NEC Corporation, Fundamental Research Laboratories,
34 Miyukigaoka, Tsukuba, Ibaraki 305, Japan

Headings, author and affiliations from the original article.
Source: Iijima 1991, p. 56.

Lab Pictures and a 2D Description of the Structure

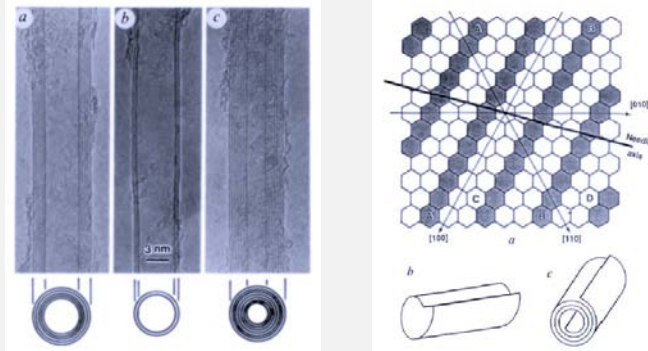

Left: electron micrographs of the microtubules. Right: planar representation of a microtubule. Superimposing A and A', B and B' gives helicity to the tube. Superimposing A and C, B and D gives a tube without spiraling hexagons. Source: Iijima 1991, p. 57.

Coordinates and Distances: how to measure them on a NCT

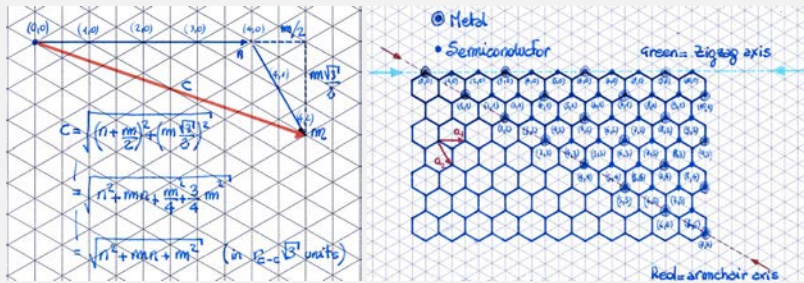

Left: how to construct the chiral vector $C = na_1 + ma_2$ for a carbon nanotube. Right: the conventional structure for a carbon sheet of a nanotube. Source: Andrea Durlo.

Physical/Mathematical description of Nanotubes

Sources: Harris 2009, Friedrichs et al. 2001

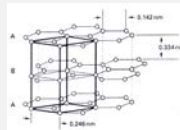

Left: The Electronic properties of MWNTs are dominated by the ones of SWCNTs because the distance among layers is larger than the one separating neighbor atoms.

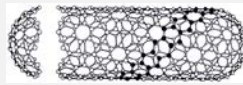

Top: representation of a chiral nanotube

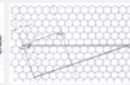

Left: symmetry operations for chiral NT

$R = (\psi, \tau)$ basic symmetry operation
 ψ rotation, τ translation

Conditions for chirality

a_1, a_2 unit cell base vectors

Integers (n, m) with $n \geq m \rightarrow C = na_1 + ma_2$

$n = m \rightarrow$ armchair tube

$m = 0 \rightarrow$ zigzag tube

All other tubes \rightarrow chiral

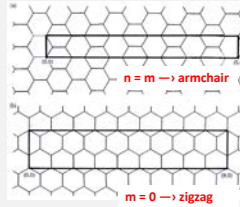

Fundamental parameters

Unit cell base vectors modulus

$$|a_1| = |a_2| = 0.246 \text{ nm}$$

Magnitude of vector C in nanometers

$$C = 0.246(n^2 + nm + m^2)^{1/2}$$

$$Diameter \quad d_t = 0.246(n^2 + nm + m^2)^{1/2} / \pi$$

Chiral angle

$$\theta = \sin^{-1} [m(3)^{1/2}] / [2(n^2 + nm + m^2)^{1/2}]$$

d_H = maximum common divisor of n and m

Length of the unit cell in the tube axis direction

$$T = (3)^{1/2} C / d_H, \text{ if } n - m \neq 3d_H$$

$$T = (3)^{1/2} C / 3d_H, \text{ if } n - m = 3d_H$$

Number of carbon atoms in the unit cell

$$N = 2(n^2 + nm + m^2) / d_H, \text{ if } n - m \neq 3d_H$$

$$N = 2(n^2 + nm + m^2) / 3d_H, \text{ if } n - m = 3d_H$$

(p, q) coordinates after symmetry operation on atom at $(0,0)$
 $R = pa_1 + qa_2$
 $mp - nq = d_H$
 $\psi = 2\pi \Omega / Nd_H$
 $\tau = Td_H / N$
 $\Omega = [p(m + 2n) + q(n + 2m)] / (d_H / d_H)$

$d_H = d_t$ if $n - m$ is not a multiple of $3d_H$
 $d_H = 3d_t$ if $n - m$ is a multiple of $3d_H$

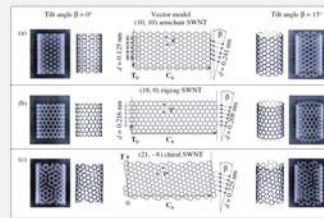

Electrical Behaviour and Applications

Chirality, Conducting Behaviour and Applications of Nanotubes

θ = chirality angle – sides: $(n,0)$ axis and Chirality vector – $0^\circ < \theta < 30^\circ$

$(n - m) / 3 = 0$ the carbon nanotube (armchair) is metallic

$(n - m) / 3 \neq 0$ the carbon nanotube is semiconducting (also zigzag configuration $m = 0$)

Main Properties

1. Size: 0.6nm to 1.8nm diameter
2. Density: up to 1.40 g/cm^3 ($\text{Al} = 2.7 \text{ g/cm}^3$)
3. Tensile strength: $45 \cdot 10^9 \text{ Pa}$ (Steel alloys = $2 \cdot 10^9 \text{ Pa}$)
4. Current carrying capacity: estimated 10^9 A/cm^2 (1000 times larger than Ag and Cu)
5. Heat transmission: estimated 6000 W/(m / K) ($\text{Cu} = 385 \text{ W/(m / K)}$)
6. Temperature stability: up to 2800°C in vacuum, 750°C in air

Applications

- Composite Materials
- Energy Storage for Fuel Cells
- Field Emitting Devices
- Nanotube Chemical Sensors
- Transistors
- Nanomedicine

Source: <https://www.slideserve.com/dwight/carbon-nanotubes>

Conclusions

- In 1952, in Russia, the first evidence of long hollow carbon structures was observed by Radushkevich and Lukyanovich. Their report was not spread because of linguistic and political reasons, but it seems to represent the first documented lab observation of CNTs.
- In 1976, Endo, Koyama, and Hishiyama obtained reinforced carbon tubes preparing them from benzene. Their products had a great degree of crystallinity and orientation than the other fibrous carbon known at the time.
- In 1985, a remarkable C_{60} allotropic hollow carbon structure was identified, described, and then called Buckminsterfullerene. Nowadays C_{60} is applied in advanced electronics and nanomedicine applications.
- In 1991, the Japanese researcher Sumio Iijima discovered the structures that are nowadays known as carbon nanotubes. Nowadays they are applied to material science, electronics and nanomedicine.
- The 1952 discovery opens an interesting historical debate on the authorship of the discovery of nanotubes, to be shared between Radushkevich and Lukyanovich, and Iijima's study in 1991.
- The 1952 article highlights details of the pictures and the measure indications, where the prefix "nano" was not used although already introduced.
- The 1976 research proved that inorganic coaxial structures could be obtained from organic molecules.
- The modelization of Fullerene molecule in 1985 was solved by mimicking architectonic structures.

My PhD Research in History of Physics Topic: Nanoscience/Nanotechnology

Andrea Durlo, PhD Student, IEMN, Lille University-CNRS, France
Raffaele Pisano, Dr. Prof., HDR (Habil.), IEMN, Lille University, France – Supervisor

Main Objectives:

- ✓ Analysis and structuring of History of Nanoscience/Nanotechnology from 1950 to nowadays according to the Historical Methodology, recollecting sources chronologically ordered;
- ✓ Focusing on the interdisciplinarity that makes this current field of Physics of absolute interest.

Methodology:

- ✓ Overview of the discoveries, the ideas, the researchers, the scientific instruments & Labs, and the situations that have been making this branch of Physics so revolutionary. Participation in international seminars and meetings presenting results & publishing systematically peer-reviewed articles and a final book in the field.

Expected result and impact:

- ✓ A structured scientific History of Nanosciences/Nanotechnologies by a notable work, considering the subject from historical, epistemological, and science in society points of view. Essays and articles may be taken out of the script, and they may be subjects for further research.

I am concluding the third doctoral year, and yet there is no immediate evidence that such a comprehensive work has been written so far.

PhD Thesis Contents – Scientific and Historical Parts (Abridged)

The Nanophysics

- Nanoscience and Nanotechnology
 - ✓ Definitions
 - ✓ How old is Nano?
 - ✓ What Nanomaterials do we know?
- Pioneers in Nanotechnology

Lab Instruments and Maths-Phys Applications

- Instruments of Nanophysics
 - ✓ Electronic Microscopy, AFM, STM
 - ✓ Imaging and Spectroscopy
- Mathematics for Nanophysics
 - ✓ Mathematical Modelling and Drude model

History of Nanoscience and Nanotechnology

- 1951: Field Ion Microscope
- 1952: First Image of a Nanotube
- 1958: First Integrated Circuit
- 1959: "There's Plenty of Room at the Bottom"
- 1960: MOSFET
- 1965: Moore's Law
- 1970: Quantum Size Effect
- 1974: First use of the Word "Nanotechnology"
- 1976: Carbon Fibres from Benzene
- 1981: Scanning Tunneling Microscope and Quantum Dots
- 1985: C60 Fullerene
- 1986: AFM and "Engines of Creation"
- 1991: Helical Microtubules of Graphitic Carbon
- 1993: Synthesis and Characterization of Nanocrystallites
- 1997: Helicity of Carbon Nanotubes
- 1998: Carbon Nanotubes Transistor
- 1999: Dip-pen Nanolithography
- 2001: Molecular Nanomachines
- 2002: Characterization of Nanoferrites
- 2006: Development of Nanomedicine
- 2009: Nanotechnology and Drug Delivery
- 2012: Nanomedicine Patient-Friendly
- 2017: Folded and Unfolded Chains
- 2022: Recent Atom Manipulations

PhD Thesis Contents – Science in Society (Abridged)

- "Nano" and Society
 - ✓ Societal Implications of Nanoscience and Nanotechnology
 - ✓ Research Programs and Policies
 - ✓ Nanoparticles and Everyday Life
 - How do they enter the Body
 - Nanoparticles and Human Toxicity
 - Nanoparticles and the Environment

Thesis Schedule

2020 – 2023

- Keep Researching Fonts
- Expanding Continuously the References
- Participations to Seminars and Colloquia
- Following Courses for Doctoral Credits
- Publications on the Subject

2020 – 2021

- Part I Pre-print
- Hypothesis: Contact Researchers and Professors

2021 – 2022

- Completing Part I and Part II, Preprint of Part III

2022 – 2023

- Completing Part III, Part IV and Part V
- A Final Release

Selected References

- Radushkevich LV, Lukyanovich VM (1952) On the Carbon Structure Formed by the Thermal Decomposition of Carbon Monoxide on an Iron Contact (in Russian). *Russian Journal of Physical Chemistry* 26/1:88–95
- Endo M, Koyama T, Hishiyama Y (1976) Structural Improvement of Carbon Fibers Prepared from Benzene. *Japanese Journal of Applied Physics* 15/11:2073–2076
- Finch GI, Wilman H (1936) The Diffraction of Electrons by Graphite. *Proceedings of the Royal Society A*, 155:345–365
- Dasgupta K, Sathiyamoorthy D (2003) Disordered Carbon – Its Preparation, Structure, and Characterisation. *Materials Science and Technology* 19/8:995–1002
- Heidenreich RD, Hess WM, Ban LL (1967) A Test Object and Criteria for High Resolution Electron Microscopy. *Journal of Applied Crystallography* 1:1–19
- Kroto HW, Heath JR, O'Brien SC, Curl RF, Smalley RE (1985) C₆₀: Buckminsterfullerene. *Nature* 318/6042:162–163
- Kroto HW (1992) C₆₀ Buckminsterfullerene: The Celestial Sphere that Fell to Earth. *Angewandte Chemie* 31/2:111–246
- Iijima S (1991) Helical Microtubules of Graphitic Carbon. *Nature* 354/6348:56–58
- Harris PJF (2009) *Carbon Nanotube Science*. Cambridge University Press, Cambridge
- Friedrichs S, Meyer RR, Sloan J, Kirkland AI, Hutchison JL, Green MLH (2001) Complete Characterization of an (Sb₂O₃)_n/SWNT Inclusion Composite. *Physics of the Solid State* 44/3:463–466

IEMN 30th Year Celebrations – Lille

1992-2022

30 Years of Research & Development at IEMN

A History of Nanoscience and Nanotechnology—Discoveries in the International Context



Extract from: Prof. Raffaele Pisano (IEMN, Lille University, France) & Andrea Durlò (PhD Student, IEMN, Lille University, France)

1992 – 2000 International Events

- 1992: Studies on Mesoporous Silica
- 1993: Synthesis and Characterization of Nanocrystallites
- 1994: Molecular Machines
- 1995: Electron Emission from Nanotubes
- 1996: Gold Colloids
- 1997: Helicity of Carbon Nanotubes
- 1998: Carbon Nanotubes Transistors
- 1999: Dip–Pen Nanolithography
- 2000: Quantum Mirages and first Transistor based on a Single Molecule of C60

1992 – 2000 IEMN Events

- 1992: Metamorphic In_{0.3}Ga_{0.7}/In_{0.29}Al_{0.71}As Layer on GaAs
- 1993: A New Method for On Wafer Noise Measurement
- 1995: Analysis of the Propagation of Plane Acoustic Waves in Passive
- 1997: Unimolecular Electrical Rectification in Hexadecylquinolinium Tricyanoquinodimethanide
- 1999: Metamorphic In_{0.4}Al_{0.6}As/In_{0.4}Ga_{0.6}As HEMT's on GaAs Substrate
- 1999: Electronic States and Luminescence in Porous Silicon Quantum Dots: The Role of Oxygen
- 2000: Low-voltage, 30nm channel length, organic transistors with a self-assembled monolayer as gate-insulating films
- 2000: Imaging the Wave-Function Amplitudes in Cleaved Semiconductor Quantum Boxes
- 2001: Low driving voltages and memory effect in organic thin-film transistors with a ferroelectric gate insulator
- 2001: Ultrasonic characterization of residual stresses in steel rods using a laser line source and piezoelectric transducers
- 2002: Charge injection in individual silicon nanoparticles deposited on a conductive substrate
- 2002: Fatigue crack monitoring of riveted aluminum strap joints by Lamb wave analysis and acoustic emission measurements techniques
- 2002: Low Schottky barrier source/drain for advanced MOS architecture: device design and material consideration
- 2004: Terahertz emission by plasma waves in 60 nm gate high electron mobility transistors and piezoelectric transducers
- 2004: Strong oscillators detected by picosecond ultrasonics in silicon: Evidence for an electronic-structure effect
- 2004: Integrated microfluidics based on multi-layered SU-8 for mass spectrometry analysis
- 2005: Terahertz radiation from heavy-ion-irradiated In_{0.53}Ga_{0.47}As photoconductive antenna excited at 1.55µm
- 2006: Active Properties of Carbon Nanotube Field-Effect Transistors Deduced From S Parameters Measurements
- 2006: Output Power Density of 5.1J/mm at 18 GHz With an AlGaIn/GaN HEMT on Si Substrate
- 2007: Reversible Electro wetting on Superhydrophobic Silicon Nanowires
- 2007: Spatially Resolved Raman Spectroscopy of Single- and Few-Layer Graphene
- 2008: Probing the Carrier Capture Rate of a Single Quantum Level
- 2008: Impulsive Noise Characterization of In-Vehicle Power Line
- 2008: Low-frequency gaps in a phononic crystal constituted of cylindrical dots deposited on a thin homogeneous plate
- 2010: Gold-free growth of GaAs nanowires on silicon: arrays and polyplytym
- 2010: An Organic Nanoparticle Transistor Behaving as a Biological Spiking Synapse
- 2011: High-Performance Low-Leakage-Current AlN/GaN HEMTs Grown on Silicon Substrate
- 2012: A 1 k-Pixel Video Camera for 0.7–1.1 Terahertz Imaging Applications in 65-nm CMOS
- 2012: Band gap tunability of magneto-elastic phononic crystal
- 2012: Blind Digital Modulation Identification for Spatially-Correlated MIMO Systems
- 2013: Recent advances in the development of graphene-based surface plasmon resonance (SPR) interfaces
- 2013: An interferometric scanning microwave microscope and calibration method for sub-fJ microwave measurements
- 2014: Gallium Nitride as an Electromechanical Material
- 2014: Ultrawide-Bandwidth Single-Channel 0.4-THz Wireless Link Combining Broadband Quasi-Optic Photomixer and Coherent Detection
- 2014: Demonstrating kHz Frequency Actuation for Conducting Polymer Microactuators
- 2014: Multilayer magnetostrictive structure based surface acoustic wave devices
- 2015: Towards high quality CVD graphene growth and transfer
- 2016: A 17GHz molecular rectifier
- 2016: On-chip and freestanding elastic carbon films for micro-supercapacitors
- 2017: Atomic Layer Deposition of Functional Layers for on Chip 3D Li-Ion All Solid State Microbattery
- 2017: A 4-fJ/Spike Artificial Neuron in 65nm CMOS Technology
- 2019: Functional Carbon Quantum Dots as Medical Countermeasures to Human Coronavirus
- 2019: The Birth of New Team, History of Physics and Applied Sciences & Technology (HOPAST, Dir. Pisano R.), as Manifest Integration of Inquiring Historical Foundations of Sciences, Methods and Scientific Thought within Making Science at IEMN
- 2020: Spatially selective manipulation of cells with single-beam acoustical tweezers
- 2021: Ultrafast quantum-well photodetectors operating at 10µm with flat frequency response up to 70GHz at room temperature
- 2021: Measurement of the V21 Massive Radio Channel with the MaMIMOSA Sounder in a Suburban Environment
- 2022: Capacitively coupled distinct mechanical resonators for room temperature phonon-convity electromechanics

2001 – 2010 International Events

- 2001: Molecular Nanomachines
- 2002: Characterization of Nanoferrites
- 2003: Gold Nanoshells and Launch of 3G Mobile Technology
- 2004: Birth and Rise of Graphene
- 2005: Launch of WiFi Networks over 100Mbps/s
- 2006: Development of Polymeric Nanoparticles
- 2007: First Graphene-Based Transistor
- 2008: Realization of the first Memristor and Experimental demonstration of the Fully Depleted Silicon On Insulator architecture with back gate
- 2009: Nanotechnology and Drug Delivery
- 2010: Fourth-Generation of Mobile Telephones

2011 – 2022 International Events

- 2011: Introducing FinFET Technology and First 2D Semiconductor Material Transistor
- 2012: New Studies on Nanotribology
- 2013: DNA i-motif Nanowires
- 2014: Carbon Nanotubes and Graphene Electronics
- 2015: Nanocrystals and Nano-Optics, First Signal Amplification over 1THz by Transistor and Reconfigurable Logic Based on Nanoparticle Arrays
- 2016: Structure of Junction between Carbon NT and Graphene
- 2017: Record Transmission of over 10 petabits/s (1016 bit/s) over an Optical Fibre
- 2018: Buckling of Carbon Nanotubes
- 2019: Atomic Scale Manipulation via STM
- 2020: Ultrasmall in NanoTherapeutics
- 2021: Extreme UV lithography provides access to <7nm Technologies
- 2022: Recent Atom Manipulation and 100 Billion Transistors on a Chip



HOPAST
History of Physics and Applied Sciences & Technology
Inquiring Historical Foundations of Sciences, Methods and Scientific Thought







<https://www.iemn.fr>

Appendix 3

My Outcomes

An Outline: this Appendix Three contains the first pages of the articles whose contents were specifically withdrawn from the Thesis, and that are now at different steps of the publication process. The articles were prepared both in cooperation with my supervisor, and standalone. The reader will find the Abstracts of the different papers, that anticipate the contents and a selection of the specific keywords. The full text of the articles is not included, as it fundamentally would duplicate the contents already available in the main matter of this Thesis.

Publications

1. **Durlo A (2021)** The Role of Models in the Discovery of the Nucleus: Ernest Rutherford and his School. ESHS 2/2:21-28.

Forthcoming

1. **Durlo A (2024)** 1950s–1990s: Carbon Nanotubes Studies into Historiography of Nanoscience–Nanotechnology, pre-print
2. Pisano R, **Durlo A (2024)** 1930s–1980s: A History of Nanotechnology from Physics Scanning Devices to Nanoscale Techniques. In Pisano R (ed): Nanoscience & Nanotechnologies. Critical Problems, Science in Society, Historical Perspectives. Dordrecht, Springer. Accepted & pre-print.
3. Pisano R, **Durlo A (2023)** A Feynman’s Frameworks on Nanotechnology in a Historiographical Debate. In Conde M, Salomon M (eds): Handbook of the Historiography of Science. Dordrecht, Springer, in press
4. Pisano R, Marmottini D, **Durlo A (2023)** Lagrange’s Method and *Lagrangian's* Mechanism in Maxwell’s *A Treatise on Electricity and Magnetism* (1873). In Pisano R (ed): A History of Physics: Phenomena, Ideas & Mechanisms – Essays in honour of Salvo D’Agostino. Dordrecht, Springer, in press

Feynman’s Frameworks on Nanotechnology in a Historiographical Debate

Raffaele Pisano¹[0000-0002-8040-5088] and Andrea Durlo²[0000-0001-8847-5614]

¹ IEMN, Lille University, Villeneuve d’Ascq, France
raffaele.pisano@univ-lille.fr

² IEMN, PhD Student, Lille University, Villeneuve d’Ascq, France
andrea.durlo.etu@univ-lille.fr

Abstract. Since the early 1950s, the research in the Nanoworld has continued its unceasing exploration and achieved new results in the field of Pure Sciences, Applied Sciences & Technology as such. In late 1959, Richard Phillips Feynman (1918–1988) gave a famous lecture for the American Physical Society of Pasadena members, in which he explored the possibilities offered by research in miniaturization that were yet to come named “There’s Plenty of Room at the Bottom”. According to the current historiographical and scientific narrative, this article constitutes the milestone nanoscientists have been inspired from. Self-assembling machines, atom manipulation, nano-transporters in Medicine, new advanced materials like fullerene and graphene, and innovations in the field of electron microscopy are some of the results obtained, and whose origins can be traced back to Feynman’s article. Feynman’s legacy has been consolidated in the following decades, and “Plenty of Room” appears today as the framework from which all research in the field of Nanotechnology has taken off. Yet, this paper has also opened an interesting historiographical debate, regarding its influence as a founding document of a new discipline. *Is this Feynman’s work really the early inspiring frame of nano research?* In literature, it is possible to find examples where different points of view are reported, and the opinions of authoritative researchers constitute interesting different points of view. We intend to establish a historical—and—historiographical interplay—and—parallel among the different interpretations possible in a current historiographical debate.

Keywords: Feynman, Plenty of Room, Taniguchi, Drexler, Toumey, Nanotechnology, History of Physics, Epistemological debates, Nanoscience.

1930s–1980s, A History of Nanoscience–Nanotechnology: from Physics Scanning Devices to Nanoscale Techniques

Raffaele Pisano¹[0000-0002-8040-5088] and Andrea Durlo¹[0000-0001-8847-5614]

¹ IEMN, Lille University, Villeneuve d'Ascq, France

Abstract. It is known, that since the Second World War, nanotechnology has represented an intellectual revolution from a scientific point of view and is now at the centre of the transformation mechanism of science and society. The study of nanoscience and nanotechnology has had a great impetus, generally speaking, since the 1950s. Research into nanomaterials and their applications has made great strides to date: new tools for manipulating matter have been developed and new materials have been obtained. Electron microscopes have been designed and progressively improved in their basic operating principle. Tunnelling electron microscopy (TEM) has made it possible to analyse fine details in the structure of nanomaterials, while the scanning electron microscope (SEM) has made it possible to acquire detailed images of the sample thanks to its greater resolving power. At the beginning of the 1970s, the Topografiner opened the way to scanning probe microscopy (SPM). The development of this technique, with the scanning tunnelling microscope (STM) and atomic force microscope (AFM), allowed researchers to scan the surface of samples down to atomic size and manipulate individual atoms. In this field, scientists such as Gerd Binnig and Heinrich Rohrer (1933–2013), for example, who were awarded the Nobel Prize in 1986, came to the forefront of nanotechnology history. Laboratory techniques such as soft lithography, which uses elastomers to replicate structures, and physical and chemical vapour deposition have been developed to obtain extremely high-quality materials. This article presents historical–scientific technical details on the development of scanning devices and laboratory techniques applied to nanotechnology. We also address the mathematics that underpins, from a theoretical point of view, some of the techniques presented. A brief discussion on the impact of science on society will be proposed.

Keywords: Transmission Electron Microscope, Scanning Electron Microscope, Topografiner, Scanning Probe Microscopy, Scanning Tunneling Microscopy, Atomic Force Microscopy, Soft Lithography, Physical Vapor Deposition, Chemical Vapour Deposition, Electron Beam Lithography, Focused Ion Beam, Photolithography, History of Physics and Applied Science/Technology, History and Technology

1950s–1990s: Carbon Nanotubes Studies into Historiography of Nanoscience–Nanotechnology

Andrea Durlo¹[0000-0001-8847-5614]

¹ IEMN, PhD Student, Lille University, Villeneuve d’Ascq, France
andrea.durlo.etu@univ-lille.fr

Abstract. The discovery of carbon nanotubes was a significant moment in the history of solid–state physics, nanoscience, and nanotechnology. This article reviews some of the most significant steps in the history of carbon nanotubes through their historiographic and scientific literature. The first paper examined is *On the Carbon Structure Formed by the Thermal Decomposition of Carbon Monoxide on an Iron Contact*, written in 1952 by two Russian researchers, Radushkevich and Lukyanovich, whom that year observed and described tubular carbon structures through images obtained with an electron microscope. A second milestone in the history of carbon at the nanoscale was the discovery of Buckminsterfullerene in 1985, when Kroto, Heath, O’Brien, Curl, Liu, and Smalley enriched studies of the physics of matter by publishing a seminal paper entitled *C₆₀: Buckminsterfullerene*. The discovery led to three of the authors being awarded the Nobel Prize in Chemistry in 1996. Finally, in 1991, the Japanese researcher Iijima published his article *Helical Microtubules of Graphitic Carbon* in which he reported on the characteristics of coaxial needle–like tubular structures of carbon, a paper that earned him the nickname of the father of carbon nanotubes in the history of nanoscience. The historiographical debate in the history of nanoscience–nanotechnology (1950s–1990s) regarding the description of these structures from a physical, mathematical and historical perspective is presented here.

Keywords: History of Physics, Nanoscience, Nanotechnology, Carbon Nanotubes, Buckminsterfullerene, Helical–Walled Nanotubes, Solid–State Physics, Chirality, Radushkevich, Lukyanovich, Smalley, Kroto, Curl, Iijima, Chirality

Lagrange’s Method and *Lagrangian’s* Mechanism in Maxwell’s *A Treatise on Electricity and Magnetism* (1873)

Raffaele Pisano¹[0000-0002-8040-5088], Donatella Marmottini²[0000-0002-0205-1878],
Andrea Durlo³[0000-0001-8847-5614]

¹IEMN, Lille University, Villeneuve d’Ascq, France
raffaele.pisano@univ-lille.fr

²Campus dei Licei, Cisterna di Latina, Italy
d.marmottini@yahoo.it

³IEMN, PhD Student, Lille University, Villeneuve d’Ascq, France
andrea.durlo.etu@univ-lille.fr

Abstract. James Clerk Maxwell advanced in his Electromagnetic theory also enlarging mathematically Michael Faraday’s works. He declined Newtonian mechanics for the formulation of new conceptual frameworks because more adequate for describing a field of new phenomena like those of electromagnetism; so he also went beyond the Newtonian paradigm introducing a novelty in the relationship physics–mathematics based on new magnitudes, e.g., electric charge and energy instead of mass and force. However, in which terms exactly? Particularly, in *A Treatise on Electricity and Magnetism, II, Part IV, Chapter IV-VII* (1873) Maxwell aimed to formulate a dynamical justification to field equations; he focused on the fact that magnetic field appeared as a completely a kinetic energy system. In this paper, we analyse and describe both, as he called, Lagrange’s *method of reducing the ordinary dynamical equations* in *Mécanique analytique* (1788)—including—three methods used by Maxwell for *expressing the kinetic energy—detecting the existence of the terms of the form T_{me}* , and the application of Lagrangian formulating through the *equations of motion of a connected system*.

Keywords: Maxwell, Faraday, Lagrange, *Mécanique analytique*, Lagrange’s Method, Lagrangian, Maxwell’s Equation, Relationship Physics–Mathematics

Bibliography

In this Chapter, the readers are provided with the complete list of references that can be already found at the end of the Introduction, and of each Chapter. In addition to the Primary, Secondary and *In situ* sources, also a list of references I did not use for this thesis but that can be considered as the state-of-the-art of the subjects discussed in the Chapters of this work.

References

Primary Sources

- Atalla MM (1960) Semiconductor Devices having Dielectric Coatings. U.S. Patent 3,206,670 (filed March 8, 1960, issued September 14, 1965)
- Atalla MM, Kahng D (1960) Silicon–Silicon Dioxide Field Induced Surface Devices. Institute of Radio Engineers and American Institute of Electrical Engineers Device Research Conference, Pittsburgh
- Atalla MM, Kahng D (1962) A new “Hot” Electron Triode Structure with Semiconductor–Metal Emitter. Solid–State Device Research Conference. IRE Transactions on Electron Devices 9/6:507–508. doi: 10.1109/t-ed.1962.15048
- Baker JR Jr (2011) The Need to Pursue and Publish Clinical Trials in Nanomedicine. *Nanobiotechnology* 3/4:341–342. doi:10.1002/wnan.141
- Bayda S, Adeel M, Tuccinardi T, Cordani M, Rizzolio F (2020) The History of Nanoscience and Nanotechnology: From Chemical–Physical Applications to Nanomedicine. *Molecules* 25/1:112. doi:10.3390/molecules25010112
- Beck JS, Vartuli JC, Roth WJ, Leonowicz ME, Kregse CT, Schmitt KD, Chu CTW, Olson DH, Sheppard EW, McCullen SB, Higgins JB, Schlenker JL (1992) A New Family of Mesoporous Molecular Sieves Prepared with Liquid Crystal Templates. *Journal of the American Society* 114/27:10834–10843. doi:10.1021/ja00053a020
- Behzadia S, Serpooshanb V, Taoa W, Hamalyc MA, Alkawarekd MY, Dreadene EC, Brown D, Alkilanyd AM, Farokhzada OC, Mahmoudia M (2017) Cellular Uptake of Nanoparticles: Journey Inside the Cell. *Chemical Society Reviews* 46/14:4218–4244. doi:10.1039/c6cs00636a
- Binnig G, Quate CF, Gerber C (1986) Atomic Force Microscope. *Physical Review Letters* 56/9:930–933. doi:10.1103/PhysRevLett.56.930
- Binnig G, Rohrer H (1987) Scanning Tunneling Microscopy–From Birth to Adolescence. *Reviews of Modern Physics* 59/3:615–625. doi:10.1002/anie.198706061
- Birrenbach G, Speiser PP (1978) Polymerized Micelles and Their Use as Adjuvants in Immunology. *Journal of Pharmaceutical Sciences* 65/12:1763–1766. doi:10.1002/jps.2600651217
- Biswas P, Wu CY (2005) Nanoparticles and the Environment. *Journal of the Air and Waste Management Association* 55/6:708–746. doi:10.1080/10473289.10464656
- Bollmann W, Spreadborough J (1960) Action of Graphite as a Lubricant. *Nature* 4718:29–30.
- Brus LE, Trautman JK (1995) Nanocrystals and Nano–Optics. *Philosophical Transactions of the Royal Society of London. Series A: Physical and Engineering Science* 353/1703:313–321. doi:10.1098/rsta.1995.0102
- Cho AY (1999) How Molecular Beam Epitaxy (MBE) Began and its Projection into the Future. *Journal of Crystal Growth* 201/202:1–7
- Derick L, Frosch CJ (1957) Oxidation of Semiconductive Surfaces for Controlled Diffusion. U.S. Patent 2,802,760 (filed December 2, 1956, issued August 13, 1957)
- Dimitrijevic S, Withers JC, Mammana VP, Monteiro OR, Ager III JW, Brown IG (1998) Electron Emission from Films of Carbon Nanotubes and *ta*–C Coated Nanotubes. *Applied Physics Letters* 75/17:2680–2682. doi:10.1063/1.125122
- Drexler KE (1981) Molecular Engineering: An Approach to the Development of General Capabilities for Molecular Manipulation. *Proceedings of the National Academy of Sciences of the United States of America* 78/9:5275–5278. doi:10.1073/pnas.78.9.5275
- Drexler KE (1986) *Engines of Creation. The Coming Era of Nanotechnology*. Doubleday, New York
- Drexler KE (1991) *Molecular Machinery and Manufacturing with Applications to Computation*. Degree of Doctor of Philosophy Thesis, Massachusetts Institute of Technology, Boston
- Drexler KE, Peterson C, Pergamit G (1991) *Unbounding the Future: the Nanotechnology Revolution*. William Morrow and Company, Inc. New York
- Éfros AI, Éfros AL (1982) Interband Absorption of Light in a Semiconductor Sphere. *Fizika i Tehnika Poluprovodn* 16/7:1209–1214

- Ekimov AI, Onushchenko AA (1981) Quantum Size Effect in Three-Dimensional Microscopic Semiconductor Crystals. *Pis'ma v Zhurnal Èksperimental'noi i Teoreticheskoi Fiziki* 34/6:363–366
- Ekimov AI, Onushchenko AA (1982) Quantum Size Effect in the Optical Spectra of Semiconductor Microcrystals. *Fizika i Tekhnika Poluprovodn* 16:1215–1219
- Ekimov AI, Onushchenko AA, Plyukhin AG, Èfros AL (1984) Size Quantization of Excitons and Determination of the Parameters of their Energy Spectrum in CuCl. *Zhurnal Èksperimental'noi i Teoreticheskoi Fiziki* 88:1490–1501
- Endo M, Koyama T, Hishiyama Y (1976) Structural Improvement of Carbon Fibers Prepared from Benzene. *Japanese Journal of Applied Physics*. doi:15/11:2073–2076.10.1143/jjap.15.2073
- Esaki L, Tsu R (1970) Superlattice and Negative Differential Conductivity in Semiconductors. *IBM Journal of Research and Development* 9/6:61–65. doi: 10.1016/0026-2714(70)90208-8
- Faraday M (1856) *Faraday's Diary. Being the Various Philosophical Notes of Experimental Investigations*. G. Bell and Sons, London (1936 printing)
- Feynman RP (1960) There's Plenty of Room at the Bottom. *Engineering and Science* 23/5:22–36
- Frosch CJ, Derick L (1957) Surface Protection and Selective Masking during Diffusion in Silicon. *Journal of Electrochemical Society* 104/9:547–552
- Geim AK, Novoselov KS (2007) The Rise of Graphene. *Nature Materials* 6/3:183–191. doi:10.1038/nmat1849
- Grieger K, Jacob Jones JL, Hansen SF, Hendren CO, Jensen KA, Kuzma J, Baun A (2019) Best Practices from Nano-Risk Analysis Relevant for other Emerging Technologies. *Nature Nanotechnology* 14:996–1001. doi:10.1038/s41565-019-0572-1
- Griffin S, Masood MI, Nasim MJ, Sarfraz M, Ebokaiwe AP, Schäfer KH, Keck CM, Jacob C (2018) Natural Nanoparticles: A Particular Matter Inspired by Nature. *Antioxidants* 7/1:3. doi:10.3390/antiox7010003
- Heidenreich RD, Hess WM, Ban LL (1967) A Test Object and Criteria for High Resolution Electron Microscopy. *Journal of Applied Crystallography* 1:1–19. doi:10.1107/s0021889868004930
- Helmholtz HLF (1876) On the limits of the Optical Capacity of the Microscope. Retrieved from: <https://onlinelibrary.wiley.com/doi/abs/10.1111/j.1365-2818.1876.tb05606.x>
- Iijima S (1991) Helical Microtubules of Graphitic Carbon. *Nature* 354/6348:56–58. doi:10.1038/354056a0
- Jia Z, Lei W, Yang H, Wang G (2016) Dynamic Wetting Behaviour of Vibrated Droplets on a Micropillared Surface. *Advances in Materials Science and Engineering* 2016. doi:10.1155/2016/8409683
- Kahng D (1960) Electric Field Controlled Semiconductor Device. U.S. Patent 3,102,230 (filed May 31, 1960, issued August 27, 1963)
- Kamarulzaman NA, Lee KE, Siow KS, Mokhtar M (2020) Public Benefit and Risk Perceptions of Nanotechnology Development: Psychological and Sociological Aspects. *Technology in Society* 62/101329:1–9. doi:10.1016/j.techsoc.2020.101329
- Kambham AK, Mody J, Gilbert M, Koelling S, Vandervorst W (2011). Atom-Probe for FinFET Dopant Characterization. *Ultramicroscopy* 111/6:535–539. doi:10.1016/j.ultramic.2011.01.017
- Kilby JSC (1959) Miniaturized Electronic Circuits. U.S. Patent 3,138,743 (filed February 6, 1959, issued June 23, 1964)
- Kroto HW (1992) C₆₀: Buckminsterfullerene, The Celestial Sphere that Fell to Earth. *Angewandte Chemie* 31/2:111–129. doi:10.1002/anie.199201113
- Kroto HW, Heath JR, O'Brien SC, Curl RF, Smalley RE (1985) C₆₀: Buckminsterfullerene. *Nature* 318/6042:162–163. doi:10.1038/318162a0
- Manoharan HC, Lutz CP, Eigler DM (2000) Quantum Mirages Formed by Coherent Projection of Electronic Structure. *Letters to Nature* 403/6769:512–515. doi:10.1038/35000508
- Marcovich A, Shinn T (2011) Instrument Research, Tools and the Knowledge Enterprise 1999–2009: Birth and Development of Dip-Pen Nanolithography. *Science, Technology and Human Values* 36/6:864–896. doi:10.1177/0162243910385406
- Marinković Z, Crupi G, Schreurs DMMP, Caddemi A, Marković, V (2011). Microwave FinFET Modeling Based on Artificial Neural Networks Including Lossy Silicon Substrate. *Microelectronic Engineering* 88/10: 3158–3163. doi:10.1016/j.mee.2011.06.019
- Martel R, Schmidt T, Shea RH, Hertel T, Avouris P (1998) Single- and Multi-Wall Carbon Nanotubes Field-Effect Transistors. *Applied Physics Letters* 73/17:2447–2449. doi:10.1063/1.122477

- Martin Y, Williams CC, Wickramasinghe HK (1987) Atomic Force Microscope–Mapping and Profiling on a Sub 100–Å Scale. *Journal of Applied Physics* 61/10:4723–4729. doi:10.1063/1.338807
- Michel B, Travaglini G (1988) An STM for Biological Applications: Bioscope. *Journal of Microscopy* 152/3:681–685. doi:10.1111/j.1365–2818.1988.tb01438.x
- Minsky M (1957) Microscopy Apparatus. US Patent 3.013.467
- Moore GE (1965) Cramming More Components onto Integrated Circuits. *Electronics Magazine* 38/8.
- Müller EW (1951) Das Feldionenmikroskop (The Field Emission Microscope, in German). *Zeitschrift für Physik* 131:136–142.
- Myers TG, MacDevette MM, Font F, Cregan V (2014) Continuum Mathematics at the Nanoscale. *Journal of Mathematics in Industry* 4:11. doi:10.1186/2190–5983–4–11
- National Nanotechnology Initiative (2020) What It Is and How It Works. <https://www.nano.gov/nanotech-101/what> Retrieved April 20, 2020
- Nesterenko AM, Koleskin NF, Akhmatov Yu.S., Suhoilin VI, Prilutsky OV (1982) Особенности Фазового Состава И Структуры Продуктов Взаимодействия NiO и Fe₂O₃ С Окисью Углерода (in Russian). *Металлы* 3:12–16
- Ng JH, Ilag LL (2004) The Dangers of Generalization in Nanotechnology. *Drug Discovery Today* 9/2:60–61. doi:10.1016/S1359–6446(03)02934–9
- Novoselov KS, Geim AK, Mozorov SV, Jiang D, Dubonos SV, Grigorieva IV, Firsov AA (2004) Electric Field Effect in Atomically Thin Carbon Films. *Science* 306/5696:666–669. doi:10.1126/science.1102896
- Novoselov KS, Jiang D, Schedin F, Booth TJ, Khotkevich VV, Mozorov SV, Geim KA (2005) Two Dimensional Atomic Crystals. *Proceedings of the National Academy of Sciences* 102/30:10451–10453. doi:10.1073/pnas.0502848102
- Oberlin A, Endo M, Koyama T (1976) Filamentous Growth of Carbon through Benzene Decomposition. *Journal of Crystal Growth* 32:335.349. doi:10.1016/0022–0248(76)90115–9
- Oparin AI (1977) L'origine della vita. *Universale scientifica Boringhieri*, Torino
- Piner RD, Zhu J, Xu F, Hong S, Mirkin CA (1999) “Dip–Pen” Nanolithography. *Science* 293:661–663. doi:10.1126/science.283.5402.661
- Pinto Reis C, Neufeld RJ, Ribeiro AJ, Veiga F (2006) Nanoencapsulation I. Methods for Preparation of Drug–Loaded Polymeric Nanoparticles. *Nanomedicine: Nanotechnology, Biology and Medicine* 2:8–21. doi:10.1016/j.nano.2005.12.003
- Qin LC, Ichihashi T, Iijima S (1997) On the Measurement of Helicity of Carbon Nanotubes. *Ultramicroscopy* 67:181–189. doi: 10.1016/s0304–3991(96)00095–2
- Radushkevich LV, Lukyanovich VM (1952) On the Carbon Structure Formed by the Thermal Decomposition of Carbon Monoxide on an Iron Contact (in Russian). *Russian Journal of Physical Chemistry* 26/1:88–95
- Ranganathan R, Madanmohan S, Kesavan A, Baskar G, Krishnamoorthy YR, Santosham R, Ponraju D, Rayala SK, Venkatraman G (2012) Nanomedicine: Towards Development of Patient–Friendly Drug–Delivery Systems for Oncological Applications. *International Journal of Nanomedicine* 7:1043–1060. doi:10.2147/IJN.525182
- Sahay G, Kim JO, Kabanov AV, Bronich TK (2010) The Exploitation of Differential Endocytic Pathways in Normal and Tumor Cells in the Selective Targeting of Nanoparticulate Chemotherapeutic Agents. *Biomaterials* 31/5:923–933. doi:10.1016/j.biomaterials.2009.09.101
- Smalley RE (1996) Discovering the Fullerenes (Nobel Lecture). *Angewandte Chemie International Edition* 36/15:1594–1601. doi:10.1002/anie.199715941
- Smalley RE (2001) Of Chemistry, Love and Nanobots. *Scientific American*, 285/3:76–77. doi:10.1038/scientificamerican0901–76
- Song SC, Abu–Rahma M, Yeap G (2011) FinFET Based SRAM Bitcell Design for 32nm Node and Below. *Microelectronics Journal* 42/3:520–526. doi:10.1016/j.mejo.2010.11.001
- Souto EB, Dias–Ferreira J, Shegokar R, Durazzo A, Santini A (2020) Ethical Issues in Research and Development of Nanoparticles. *Drug Delivery Aspects* 157–167. doi:10.1016/B978–0–12–821222–6.00007–5
- Taniguchi N (1974) On the Basic Concept of Nanotechnology. In *Proceedings of the International Conference on Production Engineering, Tokio, Part II*, 18–22
- Taniguchi N (1990) Construction and Idea of Nanotechnology (in Japanese). *Journal of the Japan Society for Precision Engineer* 56/3:427–431. doi:10.2493/jjspe.56.427
- Thamwattana N, Hill J (2017) Mathematical Modelling in Nanotechnology. Retrieved from <https://ro.uow.edu.au/cgi/viewcontent.cgi?article=2325&context=infopapers>

- Tian Y, Pesika N, Zeng H, Rosenberg K, Zhao B, McGuiggan P, Autumn, Israelachvili J. (2006) Adhesion and Friction in Gecko Toe Attachment and Detachment. *Proceedings of the National Academy of Science* 103/51:19320–19325. doi:10.1073/pnas.0608841103
- Turing AM (1950) Computing Machinery and Intelligence. *Mind* 49:433–460
- Von Hippel AR (1956) Molecular Engineering. *Science* 123:315–317
- Weissmann M, Bonadeo H (2001) A Simple Interpretation of Quantum Mirages. *Physica E* 10/4:544–548. doi:10.1016/s1386–9477(01)00036–4
- Zhang J, Lihua R, Yang Z, Lianshuang Z, Jialiu W, Yanbo L, Ji W, Zhiwei S, Xianqing Z (2016) Silica Nanoparticles Induce Start Inhibition of Meiosis and Cell Cycle Arrest *via* Down-Regulating Meiotic Relevant Factors. *Toxicology Research* 5. doi:10.1039/C6TX00236F
- Zhang QL, O'Brien SC, Heath JR, Liu Y, Curl RF, Kroto HW, Smalley RE (1986) Reactivity of Large Carbon Clusters: Spheroidal Carbon Shells and their possible Relevance to the Formation and Morphology of Soot. *Journal of Physical Chemistry* 90/4:525–528. doi:10.1021/j100276a001

Secondary Sources

- Abdallah NH, Schlumpberger M, Gaffney DA, Hanrahan JP, Tobin JM, Magner E (2014) Comparison of Mesoporous Silicate Supports for the Immobilisation and Activity of Cytochrome c and Lipase. *Journal of Molecular Catalysis B: Enzymatic*. 10882–88. doi:10.1016/j.molcatb.2014.06.007
- Acuna G, Grohmann D, Tinnefeld P (2014) Enhancing Single-Molecule Fluorescence with Nanophotonics. *FEBS Letters* 588/19:3547–3552. doi:10.1016/j.febslet.2014.06.016
- Agache V, Legrand B, Collard D, Buchaillot L (2002) Adhesive Forces Investigation on a Silicon Tip by Contact-Mode Atomic Force Microscope. *Applied Physics Letters* 81/14:2623–2625
- Agache V, Legrand B, Collard D, Buchaillot L, Fujita H (2005) Fabrication and Characterization of 1.1 GHz Blade Nanoelectromechanical Resonator. *Applied Physics Letters* 86/21: 213104–213104–3
- Agache V, Quevy E, Collard D, Buchaillot L (2001) Stiction-Controlled Locking System for Three-Dimensional Self-Assembled Microstructures: Theory and Experimental Validation. *Applied Physics Letters* 79/23
- Agache V, Ringot R, Bigotte P, Senez V, Legrand B, Buchaillot L, Collard D (2005) Modeling and Experimental Validation of Sharpening Mechanism based on Thermal Oxidation for Fabrication of Ultra-Sharp Silicon Nanotips. *IEEE Transactions on Nanotechnology* 4/5
- Ahern RJ, Hanrahan JP, Tobin JM, Ryan KB, Crean AM (2013) Comparison of Fenofibrate-Mesoporous Silica Drug-Loading Processes for Enhanced Drug Delivery. *European Journal of Pharmaceutical Sciences* 50/3–4:400–409. doi:10.1016/j.ejps.2013.08.026
- Aitken J (1884) On the Formation of Small Clear Spaces in Dusty Air. *Earth and Environmental Science Transactions of the Royal Society Edinburgh* 32/2:239–272. doi:10.1017/S0080456800026764
- Aiton E J (1978) Kepler's Path to the Construction and Rejection of his First Oval Orbit for Mars. *Annals of Science* 35/2:173–190. doi:10.1080/00033797800200201
- Al Hadi R, Sherry H, Grzyb J, Zhao Y, Förster W, Keller HM, Cathelin A, Kaiser A, Pfeiffer UR (2012) A 1 k-Pixel Video Camera for 0.7–1.1 Terahertz Imaging Applications in 65-nm CMOS. *IEEE Journal of Solid-State Circuits* 47/12:2999–3012. doi:10.1109/JSSC.2012.2217851
- Al Hadi R, Sherry H, Grzyb J, Zhao Y, Förster W, Keller HM, Cathelin A, Kaiser A, Pfeiffer UR (2012) A 1 k-Pixel Video Camera for 0.7–1.1 Terahertz Imaging Applications in 65-nm CMOS. *IEEE Journal of Solid-State Circuits* 47/12:2999–3012. doi:10.1109/JSSC.2012.2217851
- Al-Otaify A, Kershaw SV, Gupta S, Rogach AL, Allan G, Delerue C, Binks DJ, David (2013) Multiple Exciton Generation and Ultrafast Exciton Dynamics in HgTe Colloidal Quantum Dots. *Physical Chemistry Chemical Physics* 15/39:16864–16873
- Al-Sadoon MK, Rabah DM, Badr G (2013) Enhanced Anticancer Efficacy of Snake Venom combined with Silica Nanoparticles in a Murine Model of Human Multiple Melanoma: Molecular Targets for Cell Cycle Arrest and Apoptosis Induction. *Cellular Immunology* 284/1:129–138. doi:10.1016/j.cellimm.2013.07.016.
- Alam MS, Kranti A, Armstrong GA (2009) An Efficient Neural Network Approach for Nanoscale FinFET Modelling and Circuit Simulation. *International Journal of Numerical Modelling: Electronic Networks, Devices and Fields* 22/5:379–393. doi:10.1002/jnm.715

- Albrecht TR, Quate CF (1987) Atomic Resolution Imaging of a Nonconductor by Atomic Force Microscopy. *Journal of Applied Physics* 62/7:2599–2602. doi:10.1063/1.339435
- Alibart F, Pleutin S, Guérin D, Novembre C, Lenfant S, Lmimouni K, Gamarat C, Vuillaume D (2010) An Organic Nanoparticle Transistor Behaving as a Biological Spiking Synapse. *Advanced Functional Materials* 20:330–337. doi:10.1002/adfm.200901335
- Alibart F, Pleutin S, Guérin D, Novembre C, Lenfant S, Lmimouni K, Gamarat C, Vuillaume D (2010) An Organic Nanoparticle Transistor Behaving as a Biological Spiking Synapse. *Advanced Functional Materials* 20:330–337. doi:10.1002/adfm.200901335
- Allan G, Barbet S, Coffinier Y, Delerue C, Deresmes D, Diarra M, Diesinger H, Grandidier B, Marcon L, Melin T, Melyk O, Stievenard D, Wirtz L, Zdrojek M (2008) Fundamental Studies in Nanosciences at the Institute of Electronics, Microelectronics, and Nanotechnology (IEMN). *International Journal of Nanotechnology* 5/6–8:631–648
- Allan G, Delerue C (2002) Efficient Intraband Optical Transitions in Si Nanocrystals. *Physical Review B* 66/23:233303–233307
- Allan G, Delerue C (2004) Confinement Effects in PbSe Quantum Wells and Nanocrystals. *Physical Review B* 70/24:245321–245330
- Allan G, Delerue C (2005) Unusual Quantum Confinement Effects in IV–VI Materials. *Materials Science & Engineering C–Biomimetic and Supramolecular System* 25/5–8:687–690
- Allan G, Delerue C (2006) Role of Impact Ionization in Multiple Exciton Generation in PbSe Nanocrystals. *Physical Review B* 73/20:205423–205438
- Allan G, Delerue C (2007) Energy Transfer between Semiconductor Nanocrystals: Validity of Forster's Theory. *Physical Review B* 75/19:195311–195319
- Allan G, Delerue C (2009) Fast Relaxation of Hot Carriers by Impact Ionization in Semiconductor Nanocrystals: Role of Defects. *Physical Review B* 79/19:195324–195329
- Allan G, Delerue C (2011) Optimization of Carrier Multiplication for More Efficient Solar Cells: The Case of Sn Quantum Dots. *ACS Nano* 5/9:7318–7323
- Allan G, Delerue C (2012) Tight-Binding Calculations of the Optical Properties of HgTe Nanocrystals. *Physical Review B* 86/16:165437–165443
- Alves CA, Smith EL, Porter MD (1992) Atomic Scale Imaging of Alkanethiolate Monolayers at Gold Surfaces with Atomic Force Microscopy. *Journal of the American Chemical Society* 114/4:1222–1227. doi:10.1021/ja00030a015
- Armasu L (2019) Samsung Plan Mass Production of 3nm GAAFET Chips in 2021. Saved from: <https://www.tomshardware.com/nesw/samsung-3nm-gaafet-production-2021,38426.html>
- Arnall AH (2003) *Future Technologies, Today's Choices*. Greenpeace Environmental Trust, London.
- Aslani P, Kennedy RA (1996) Studies on Diffusion in Alginate Gels. I. Effect of Cross-Linking with Calcium or Zinc Ions on Diffusion of Acetaminophen. *Journal of Control Release* 42/1:75–82. doi:10.1016/0168-3659(96)01369-7
- Assefa S, Xia F, Vlasov YA (2010) Reinventing Germanium Avalanche Photodetector for Nanophotonic On-Chip Optical Interconnects. *Nature* 464/7285:80–4. doi:10.1038/nature08813
- Association de Solidarité des Anciens De l'Université Lille 1 – Sciences et Technologies (2016) *La Mémoire de la Faculté des Sciences et de l'Université de Lille 1 1960–1975*. Bulletin de l'A.S.A. Imprimerie de l'Université Lille 1
- Ataka M, Legrand B, Buchaillot L, Collard D, Fujita H (2009) Design, Fabrication, and Operation of Two-Dimensional Conveyance System With Ciliary Actuator Arrays. *IEEE–ASME Transactions on Mechatronics* 14/1:119–125
- Aven T (2015) Risk Assessment and Risk Management: Review of Recent Advances on their Foundation. *European Journal of Operational Research* 253/1:1–13. doi:10.1016/j.ejor.2015.12.023
- Aventaggiato M, Preziosi A, Cheraghi Bidsorkhi H, Schifano E, Mardente S, Zicari A, Uccelletti D, Mancini P, Lotti LV, Sarto MS, Tafani M (2023) ZnO Nanorods Create a Hypoxic State with Induction of HIF-1 and EPAS1, Autophagy, and Mitophagy in Cancer and Non-Cancer Cells. *International Journal of Molecular Science* 24/8:6971. doi:10.3390/ijms24086971
- Averitt RD, Sarkar D, Halas NJ (1997) Plasmon Resonance Shifts of Au-Coated Au₂S Nanoshells: Insight into Multicomponent Nanoparticle Growth. *Physical Review Letters* 78/22:4217–4220.
- Averitt RD, Westcott SL, Halas NJ (1998) Ultrafast Electron Dynamics in Gold Nanoshells. *Physical Review B* 58/16:203–206. doi:10.1103/PhysRevB.58.R10203
- Averitt RD, Westcott SL, Halas NJ (1999) Ultrafast Optical Properties of Gold Nanoshells. *Journal of the Optical Society of America B* 16/10:1814–1823. doi:10.1364/JOSAB.16.001814

- AZoNano (2006) Nanoscale Tribology and Lubrication Analysis Using Atomic Force Microscopy. Saved from <https://www.azonano.com/article.aspx?ArticleID=1507>
- Baker RT, Harris PS (1978) The Formation of Filamentous Carbon. *Chemistry and Physics of Carbon* 14/4:83
- Baral C, Kreinovich V, Trejo R (2000) Computational Complexity of Planning and Approximate Planning in the Presence of Incompleteness. *Artificial Intelligence* 122/1–2:241–267. doi:10.1016/S0004–3702(00)00043–6
- Barbato C (2018) *Nanoscienza e Nanotecnologia. La Tossicità dei Nanomateriali (Nanoscience and Nanotechnology. Toxicity of Nanomaterials)*. Gnasso Editore, Teverola.
- Barik TK, Sahu B, Swain V (2008) Nanosilica—from Medicine to Pest Control. *Parasitology Research* 103/2:253–258. doi:10.1007/s00436–008–0975–7.
- Barreca D, Copley MP, Graham AE, Holmes JD, Morris MA, Seraglia R, Spalding TR, Tondello E (2006) Methanolysis of Styrene Oxide Catalysed by a Highly Efficient Zirconium–Doped Mesoporous Silica. *Applied Catalysis A: General*:30414–20. doi:10.1016/j.apcata.2006.02.034
- Basset P, Kaiser A, Collard D, Buchaillot L (2002) Process and Realization of a Three–Dimensional Gold Electroplated Antenna on a Flexible Epoxy Film for Wireless Micromotion System. *Journal of Vacuum Science & Technology B* 20/4:1465–1470
- Basset P, Kaiser A, Legrand B, Collard D, Buchaillot L (2007) Complete System for Wireless Powering and Remote Control of Electrostatic Actuators by Inductive Coupling. *IEEE–ASME Transactions on Mechatronics* 12/1
- Basset RK (2007) *To the Digital Age: Reserch Labs, Start–up–Companies, and the Rise of MOS Technology*. Johns Hopkins University Press, Baltimore
- Baudoin M, Thomas JL, Al Sahely R, Gerbedoen JC, Gong Z, Sivery A, Bou Matar O, Smagin N, Favreau P, Vlandas A (2020) Spatially Selective Manipulation of Cell with Single–Beam Acoustical Tweezers. *Nature Communications* 11/4244:1–10. doi:10.1038/s41467–020–18000–y
- Baudoin M, Thomas JL, Al Sahely R, Gerbedoen JC, Gong Z, Sivery A, Bou Matar O, Smagin N, Favreau P, Vlandas A (2020) Spatially Selective Manipulation of Cell with Single–Beam Acoustical Tweezers. *Nature Communications* 11/4244:1–10. doi:10.1038/s41467–020–18000–y
- Bawendi MG, Wilson WL, Ruthberg L, Carroll PJ, Jedju TM, Steigerwald ML, Brus LE (1990) Electronic Structure and Photoexcited–Carrier Dynamics in Nanometer–Size CdSe. *Physical Review Letters* 65/13:1623–1626. doi: 10.1103/PhysRevLett.65.1623
- Beck K, Kopitzki K, Krauss G, Mertler G (1983) A Modified Continuum Model for the Evaluation of Channeling Experiments for Foreign Atom Location. *Nuclear Instruments and Methods in Physics Research* 218:97–102. doi:10.1016/0167–5087(83)90961–4
- Becker L, Bada J, Winans R, Hunt J, Bunch T, French B (1994) Fullerenes in the 1.85–Billion–year–old Sudbury Impact Structure. *Science* 265/5172:642–645. doi:10.1126/science.11536660
- Beer M, Ferson S, Kreinovich V (2013) Imprecise Probabilities in Engineering Analyses. *Mechanical Systems and Signal Processing* 37/1–2:4–29. doi:10.1016/j.ymsp.2013.01.024
- Bellagamba I, Marra F, Sarto MS (2020) Workers' Exposure Assessment during the Production of Graphene Nanoplatelets in r&d Laboratory. *Nanomaterials* 10/8:1520. doi:10.3390/nano10081520
- Benedito M, Giordano S (2018a) Isotensional and Isometric Force–Extension Response of Chains with Bistable Units and Ising Interactions. *Physical Review E* 98/5:052146–051164
- Benedito M, Giordano S (2018b) Thermodynamics of Small Systems with Conformational Transitions: The Case of Two–State Freely Jointed Chains with Extensible Units. *Journal of Chemical Physics* 149/5:054901
- Benedito M, Giordano S (2019) Full Statistics of Conjugated Thermodynamic Ensembles in Chains of Bistable Units. *Inventions* 4/1:1–23
- Benedito M, Giordano S (2020) Unfolding Pathway and its Identifiability in Heterogeneous Chains of Bistable Units. *Physics Letters A* 384/5:126124–125133
- Berger C, Song Z, Li X, Wu X, Brown N, Naud C, Mayou D, Li T, Hass J, Marchenkov AN, Conrad EH, First PN, DeHeer WA (2006) Electronic Confinement and Coherence in Patterned Epitaxial Graphene. *Science* 312/5777:1191–1196
- Bergese P, Colombo I, Gervasoni D, Depero LE (2004) Melting of Nanostructured Drug Embedded into a Polymeric Matrix. *Journal of Physical Chemistry B* 108/40:15488–15493. doi:10.1021/jp048762u

- Berthe M, Stiuftuc R, Grandidier B, Deresmes D, Delerue C, Stiévenard D (2008) Probing the Carrier Capture Rate of a Single Quantum Level. *Science* 319/5862:436–438. doi:10.1126/science.1151186
- Berthe M, Stiuftuc R, Grandidier B, Deresmes D, Delerue C, Stiévenard D (2008) Probing the Carrier Capture Rate of a Single Quantum Level. *Science* 319/5862:436–438. doi:10.1126/science.1151186
- Berthe M, Urbietta A, Perdigoal L, Grandidier B, Deresmes D, Delerue C, Stiévenard D, Rurali R, Lorente N, Magaud L, Ordejon P (2006) Electron Transport Via Local Polarons at Interface Atoms. *Physical Review Letters* 97/20:206801–206805
- Bethoux JM, Happy H, Siligaris A, Dambrine G, Borghetti J, Derycke V, Burgoin JP (2006) Active Properties of Carbon Nanotube Field–Effect Transistors Deduced From S Parameters Measurements. *IEEE Transactions on Nanotechnology* 5/4:335–342. doi:10.1109/TNANO.2006.876931
- Bethoux JM, Happy H, Siligaris A, Dambrine G, Borghetti J, Derycke V, Burgoin JP (2006) Active Properties of Carbon Nanotube Field–Effect Transistors Deduced From S Parameters Measurements. *IEEE Transactions on Nanotechnology* 5/4:335–342. doi:10.1109/TNANO.2006.876931
- Betzig E, Harootunian A, Isaacson M, Kratschmer E (1986) Near Field Scanning Optical Microscopy (NSOM). *Biophysical Journal* 49/1:269–279. doi:10.1016/s0006–3495(86)83640–2
- Betzig E, Trautman JK, Wolfe R, Gyorgy EM, Finn PL, Kryder MH, Chang CH (1992) Near–Field Magneto–Optics and High Density Data Storage. *Applied Physics Letters* 61/2:142–144. doi:10.1063/1.108198
- Beugeling W, Kalesaki E, Delerue C, Niquet YM, Vanmaekelbergh D, Smith CM (2015) Topological States in Multi–Orbital HgTe Honeycomb Lattices. *Nature Communications* 6:6316
- Bhushan B (2001) *Fundamentals of Tribology and Bridging Gap between Macro–and Micro/Nanoscales*. Springer, Dordrecht
- Biadala L, Peng W, Lambert Y, Kim JH, Cannesson D, Houppé A, Berthe M, Troadec D, Deresmes D, Patriarche G, Xu T, Pi X, Wallart X, Delerue C, Bayer M, Xu J, Grandidier B (2019) Trap–Free Heterostructure of PbS Nanoplatelets on InP(001) by Chemical Epitaxy. *ACS Nano* 13/2:1961–1967
- Biaye M, Amit Y, Gradkowski K, Turek N, Godey S, Makoudi Y, Deresmes D, Tadjine A, Delerue C, Bailin U, Melin T (2019) Doped Colloidal InAs Nanocrystals in the Single Ionized Dopant Limit. *Journal of Physical Chemistry C* 123/23:14803–14812
- Biaye M, Zbydniowska E, Mélin T, Deresmes D, Copie G, Cleri F, Sangeetha N, Decorde N, Viallet B, Grisolia J, Ressler L, Diesinger H (2016) Tunneling Mechanism and Contact Mechanics of Colloidal Nanoparticle Assemblies. *Nanotechnology* 27/47:475502
- Bidlack FB, Huynh C, Marshman J, Goetze B (2014) Helium Ion Microscopy of Enamel Crystallites and Extracellular Tooth Enamel Matrix. *Frontiers in Physiology* 5/395. doi:10.3389/fphys.2014.00395
- Binnig G, Gerber C, Stoll E, Albrecht TR, Quate CF (1987) Atomic Resolution with Atomic Force Microscopy. *Surface Science Letters* 189–190:1–6. doi:10.1016/0167–2584(87)90418–x
- Binnig G, Hoenig HE (1978) Tunneling Investigation of Superconducting (SN)_x. *Zeitschrift für Physik B* 32/1:23–26. doi:10.1007/bf01322182
- Bollaert S, Cordier Y, Hoel V, Zaknune M, Happy H, Lepilliet S, Cappy A (1999) Metamorphic In_{0.4}Al_{0.6}As/In_{0.4}Ga_{0.6}As HEMT's on GaAs Substrate. *IEEE Electronic Device Letters* 20/3:123–125. doi:10.1109/55.748908
- Bollaert S, Cordier Y, Hoel V, Zaknune M, Happy H, Lepilliet S, Cappy A (1999) Metamorphic In_{0.4}Al_{0.6}As/In_{0.4}Ga_{0.6}As HEMT's on GaAs Substrate. *IEEE Electronic Device Letters* 20/3:123–125. doi:10.1109/55.748908
- Borowski J (1996) Numerical Calculations of the Bessel Functions for Complex Argument and Application to X–Ray Diffraction. *Computational Materials Science* 5/4:286–290. doi:10.1016/0927–0256(95)00080–1.
- Borrelli NF, Hall DW, Holland HD, Smith DW (1987) Quantum Confinement Effects of Semiconducting Microcrystallites in Glass. *Journal of Applied Physics* 61/12:5399–5409. doi:10.1063/1.338280
- Bou Matar O, Robillard JF, Vasseur JO, Hladky–Hennion AC, Deymier PA, Pernod P, Preobrazhensky V (2012) Band Gap Tunability of Magneto–Elastic Phononic Crystal. *Journal of Applied Physics* 111/5:1–14. doi:10.1063/1.3687928

- Bou Matar O, Robillard JF, Vasseur JO, Hladky-Hennion AC, Deymier PA, Pernod P, Preobrazhensky V (2012) Band Gap Tunability of Magneto–Elastic Phononic Crystal. *Journal of Applied Physics* 111/5:1–14. doi:10.1063/1.3687928
- Bouchemal K, Briancon S, Perrier E, Fessi H, Bonnet I, Zydowicz N (2004) Synthesis and Characterization of Polyurethane and Poly(ether urethane) Nanocapsules using a New Technique of Interfacial Polycondensation Combined to Spontaneous Emulsification. *International Journal of Pharmacy* 269/1:89–100. doi:10.1016/j.ijpharm.2003.09.025
- Boulas C, Davidovits JV, Rondelez F, Vuillaume D (1996) Suppression of Charge Carrier Tunneling through Organic Self-Assembled Monolayers. *Physical Review Letters* 76/25:4797–4800. doi:10.1103/PhysRevLett.76.4797
- Boulas C, Davidovits JV, Rondelez F, Vuillaume D (1996) Suppression of Charge Carrier Tunneling through Organic Self-Assembled Monolayers. *Physical Review Letters* 76/25:4797–4800. doi:10.1103/PhysRevLett.76.4797
- Bourgoin JC, Hammadi H, Stelmacher M, Nagle J, Grandidier B, Stievenard D, Nys JP, Delerue C, Lannoo M (1999) As Antisite Incorporation in Epitaxial Growth of GaAs. *Physica B–Condensed Matter* 273–4:725–728
- Bregnocchi A, Zanni E, Uccelletti D, Marra F, De Angelis F, De Bellis G, Bossu' M, Ierardo G, Polimeni A, Sarto MS (2017) Graphene–Based Dental Adhesive with Anti–Biofilm Activity. *Journal of Nanobiotechnology* 15:89. doi:10.1186/s12951–017–0322–1
- Brongersma ML (2003) Nanoscale Photonics. *Nanoshells: Gifts in a Gold Wrapper. Nature Materials* 2/5:296–297. doi:10.1038/nmat891
- Brus LE (1984a) Luminescence of Silicon Materials: Chains, Sheets, Nanocrystals, Nanowires, Microcrystals, and Porous Silicon. *The Journal of Physical Chemistry* 98/14:3575–3581. doi:10.1021/j100065a007
- Brus LE (1984b) Photovoltaic Properties of CdSe Quantum Dot Sensitized Inverse Opal TiO₂ Solar Cells: The Effect of TiCl₄ Post Treatment. *Journal of Chemical Physics* 80:4403–4409. doi:10.1063/1.447218
- Brus LE (1986) Electronic Wave Functions in Semiconductor Clusters: Experiment and Theory. *The Journal of Physical Chemistry* 90/12:2555–2560. doi:10.1021/j100403a003
- Brus LE, Szajowski PF, Wilson WL, Harris TD, Schuppler S, Citrin PH (1995) Electronic Spectroscopy and Photophysics of Si Nanocrystals: Relationship to Bulk *c*–Si and Porous Si. *Journal of the American Chemical Society* 117/10:2915–2922. doi:10.1021/ja00115a025
- Buchaillet L, Millet O, Quevy E, Collard D (2008) Post–Buckling Dynamic behavior of Self-Assembled 3D Microstructures. *Microsystem Technologies–Micro–and Nanosystems–Information Storage and Processing Systems* 14/1:69–78
- Buffat P, Borel JP (1976) Size Effect on the Melting Temperature of Gold Particles. *Physical Review A* 13/6:2287–2297. doi:10.1103/PhysRevA.13.2287
- Bunch S, Yaish Y, Brink M, Bolotin K, McEuen PL (2005) Coulomb Oscillations and Hall Effect in Quasi–2D Graphite Quantum Dots. *Nano Letters* 5/2:287–290. doi:10.1021/nl048111+
- Burger KNJ, Staffhorst RWHM, de Vijlder HC, Velinova MJ, Bomans PH, Frederik PM, de Kruijff B (2002) Nanocapsules: Lipid–Coated Aggregates of Cisplatin with High Cytotoxicity. *Nature Medicine* 8/1:81–84. doi:10.1038/nm0102–81
- Burke AM, Hanrahan JP, Healy DA, Sodeau JR, Holmes JD, Morris MA (2009) Large Pore Bi-Functionalised Mesoporous Silica for Metal Ion Pollution Treatment. *Journal of Hazardous Materials* 164/1:229–234. doi:10.1016/j.jhazmat.2008.07.146
- Bussotti P, Pisano R (2013a) On the Conceptual Frames in René Descartes' Physical Works. *Advances in Historical Studies* 2/3:106–125
- Bussotti P, Pisano R (2014a) Newton's *Philosophiae Naturalis Principia Mathematica* “Jesuit” Edition: The Tenor of a Huge Work. *Accademia Nazionale Lincei-Rendiconti Matematica e Applicazioni* 25/4:413–444
- Bussotti P, Pisano R (2014b) On the Jesuit Edition of Newton's *Principia*. *Science and Advanced Researches in the Western Civilization*. In Pisano 2014 3/1:33–55
- Buzea C, Pacheco Blandino II, Robbie K (2007) Nanomaterials and Nanoparticles: Sources and Toxicity. *Biointerphases* 2/4: MR17–MR172. doi:10.1116/1.2815690
- Cademartiri L, Ozin G (2009) *Concept of Nanochemistry*. Wiley VCH, Weinheim
- Cadirci M, Stubbs SK, Hardman SJO, Masala O, Allan G, Delerue C, Pickett N, Binks DJ (2012) Ultrafast Exciton Dynamics in InAs/ZnSe Nanocrystal Quantum Dots. *Physical Chemistry Chemical Physics* 14/43:15166–15172

- Calvo P, Remuñan-Lopez C, Vila-Jato JL, Alonso MJ (1997) Chitosan and Chitosan/Ethylene Oxide-Propylene Oxide Block Copolymer Nanoparticles as Novel Carriers for Proteins and Vaccines. *Pharmaceutical Research* 14:1431–1436. doi:10.1023/A:1012128907225
- Cannizzo A, Bellino L, Florio G, Puglisi G, Giordano S (2022) Thermal Control of Nucleation and Propagation Transition Stresses in Discrete Lattices with non-Local Interactions and non-Convex Energy. *European Physical Journal Plus* 137/5:1–55
- Cannizzo A, Florio G, Puglisi G, Giordano S (2021) Temperature Controlled Decohesion Regimes of an Elastic Chain Adhering to a Fixed Substrate by Softening and Breakable Bonds. *Journal of Physics A—Mathematical and Theoretical* 54/44:445001
- Capiod P, van der Sluijs M, de Boer J, Delerue C, Swart I, Vanmaekelbergh D (2021) Electronic Properties of Atomically Coherent Square PbSe Nanocrystal Superlattice Resolved by Scanning Tunneling Spectroscopy. *Nanotechnology* 32/32:325706
- Carlier J, Arscott S, Thomy V, Fourier JC, Caron F, Camart JC, Druon C, Tabourier P (2004) Integrated Microfluidics based on Multi-Layered SU-8 for Mass Spectrometry Analysis. *Journal of Micromechanics and Microengineering* 14/4:619–624. doi:10.1088/0960–1317/14/4/024
- Carlier J, Arscott S, Thomy V, Fourier JC, Caron F, Camart JC, Druon C, Tabourier P (2004) Integrated Microfluidics based on Multi-Layered SU-8 for Mass Spectrometry Analysis. *Journal of Micromechanics and Microengineering* 14/4:619–624. doi:10.1088/0960–1317/14/4/024
- Carmona ER, García-Rodríguez A, Marcos R (2018) Genotoxicity of Copper and Nickel Nanoparticles in Somati Cells of *Drosophila melanogaster*. *Journal of Toxicology*. Doi:10.1155/2018/7278036
- Cassano D, Pocovi-Martinez S, Voliani V (2018) Ultrasmall-in-Nano Approach: Enabling the Translation of Metal Nanomaterials to Clinics. *Bioconjugate Chemistry* 29/1:4–16. doi:10.1021/acs.bioconjchem.7b00664
- Castello M, Sharan M, Sharon M (2012) In Vitro Culture studies of *Bixa orellana* L: IV–In Vitro and In Vivo Trials for Breaking the Dormancy of Seeds of *Bixa Orellana*. *European Journal of Experimental Biology* 2/1:174–179
- Cavalcanti A, Shirinzadeh B, Freitas RA, Hogg T (2008) Nanorobot Architecture for Medical Target Identification. *Nanotechnology* 19/1:015103. doi:10.1088/0957–4484/19/01/015103
- Celotta RJ, Balakirsky SB, Fein AP, Hess FM, Rutter GM, Stroschio JA (2014) Invited Article: Autonomous Assembly of Atomically Perfect Nanostructures Using a Scanning Tunneling Microscope. *Review of Scientific Instruments* 85/12:121301 1–16. doi:10.1063/1.4902536
- Chae SH, Lee YH (2014) Carbon Nanotubes and Graphene towards Soft Electronics. *Nano Convergence* 1/1:1–26. doi:10.1186/s40580–014–0015–5
- Chan WCW (2007) *Bio–Applications of Nanoparticles*. Springer Science, Berlin
- Chang MCO, Chow JC, Watson JG, Hopke PK, Yi SM, England GC (2004) Measurement of Ultrafine Particle Size Distributions From Coal-, Oil-, and Gas-Fired Stationary Combustion Sources. *Journal of the Air and Waste Management Association* 54/12:1494–1505. doi:10.1080/10473289.2004.10471010
- Chehaibou B, Izquierdo E, Chu A, Abadie C, Cavallo M, Khalili A, Dang TH, Greboval C, Xu XZ, Ithurria S, Vincent G, Gallas B, Mugny G, Arnaud A, Lhuillier E, Delerue C (2022) The Complex Optical Index of PbS Nanocrystal Thin Films and their Use for Short Wave Infrared Sensor Design. *Nanoscale* 14/7:2711–2721
- Chen CW (1986) *Magnetism and Metallurgy of Soft Magnetic Materials*. Dover, New York
- Chen J (1994) *Introduction to Scanning Tunneling Microscopy*, Second Edition. *American Journal of Physics* 62/6. doi:10.1119/1.17525
- Cheng G, Siles PF, Bi F, Cen C, Bogorin DF, Bark CW, Folkman CM, Park JW, Eom CB, Medeiros-Ribeiro G, Levy J (2011) Sketched Oxide Single-Electron Transistor. *Nature Nanotechnology*. doi: 10.1038/nnano.2011.56
- Cheng HN, Doemeny LJ, Geraci CL, Grob Schmidt D (2016) *Nanotechnology Overview: Opportunities and Challenges*. In: *Nanotechnology: Delivering on the Promise* volume 1, vol. 1220. American Chemical Society
- Chenming H, Bokor J, Tsu-Jae K, Anderson E, Kuo C, Asano K, Takeuchi H, Kedzierski J, Lee WC, Hisamoto D (2000) FinFET–A Self-Aligned Double-Gate MOSFET Scalable to 20nm. *IEEE Transactions on Electron Devices* 47/12:2320–2325. doi:10.1109/16.887014
- Cheraghi Bidsorkhi H, D’Aloia AG, Tamburrano A, De Bellis G, Delfini A, Ballirano P, Sarto MS (2019) 3D Porous Graphene based Aerogel for Electromagnetic Applications. *Scientific Reports* 9. doi: 10.1038/s41598-019-52230-5

- Cheraghi Bidsorkhi H, D'Aloia AG, Tamburrano A, De Bellis G, Sarto MS (2021) Waterproof Graphene–PVDF Wearable Strain Sensors for Movement Detection in Smart Gloves. *Sensors* 21/16:5277. doi:10.3390/s21165277
- Cherian AK, Rana AC, Jain SK (2000) Self-Assembled Carbohydrate-Stabilized Ceramics Nanoparticles for the Parental Delivery of Insulin. *Drug Development and Industrial Pharmacy* 26:459–463.
- Chesenau A, Groeseneken G, Heremans P, Rep D, Rudquist P, Schwille P, Sluijter B, Wendin G (2008) Teaching Nanoscience Across Scientific and Geographical Borders - A European Master Programme in Nanoscience and Nanotechnology. *Journal of Physics: Conference Series* 100:1–5. doi:10.1088/1742–6596/100/3/032002
- Chiang CK, Fincher CR Jr, Park YW, Heeger AJ, Shirakawa H, Louis EJ, Gau SC, MacDiarmid AG (1977) Electrical Conductivity in Doped Polyacetylene. *Physical Review Letters* 39/17:1098–1101. doi:10.1103/PhysRevLett.39.1098
- Chimot N, Mangeney J, Joulaud L, Crozat P, Bernas H, Blary K, Lampin JF (2005) Terahertz Radiation from Heavy-Ion-Irradiated In_{0.53}Ga_{0.47}As Photoconductive Antenna Excited at 1.55μm. *Applied Physics Letters* 87/19:1–3. doi:10.1063/1.2126110
- Chimot N, Mangeney J, Joulaud L, Crozat P, Bernas H, Blary K, Lampin JF (2005) Terahertz Radiation from Heavy-Ion-Irradiated In_{0.53}Ga_{0.47}As Photoconductive Antenna Excited at 1.55μm. *Applied Physics Letters* 87/19:1–3. doi:10.1063/1.2126110
- Cho YH, Collard D, Buchaillet L, Conseil F, Kim BJ (2005) Fabrication and Optimization of Bimorph Micro Probes for the Measurement of Individual Biocells. *Microsystem Technologies–Micro- and Nanosystems–Information Storage and Processing Systems* 12/1–2:30–37
- Choi JY, Ramachandran G, Kandlikar M (2009) The Impact of Toxicity Testing Costs on Nanomaterial Regulation. *Environmental Health Sciences* 43/9:3030–3034. doi:10.1021/es802388s
- Choi SUS, Zhang ZG, Yu W, Lockwood FE, Grulke EA (2001) Anomalous Thermal Conductivity Enhancement in Nanotube Suspension. *Applied Physics Letters* 79/14:2252–2254. doi:10.1063/1.1408272
- Choudhuri T, Pal S, Das T, Sa G (2005) Curcumin Selectively Induces Apoptosis in Deregulated Cyclin D1-expressed Cells at G2 Phase of Cell Cycle in a p53-dependent Manner. *Journal of Biological Chemistry* 280/20:20059–20068. doi:10.1074/jbc.M410670200
- Chow L, Wang H, Kleckley S, Daly TK, Buseck PR (1995) Fullerene Formation during Production of Chemical Vapor Deposited Diamond. *Applied Physics Letters* 66/4:430. doi:10.1063/1.114046
- Chu A, Greboval C, Prado Y, Majjad H, Delerue C, Dayen JF, Vincent G, Lhuillier E (2021) Infrared Photoconduction at the Diffusion Length Limit in HgTe Nanocrystal Arrays. *Nature Communications* 12/1:1794
- Cleri F (2008) Energy Band and Vacuum Level Alignment at a Semiconductor–Molecule–Metal Interface. *Applied Physics Letters* 92/10:103112
- Cleri F (2009) Surface Ordering of Molecular Structures by Dispersion Forces. *Physical Review B Condensed Matter* 80/23:235406–234512
- Cleri F (2012) A Two-Phase Model of Large-Strain Plasticity in Covalent Nanostructures. *International Journal of Plasticity* 37:31–52
- Cleri F (2015) Ballistic to Diffusive Transition in a Two-Dimensional Quantum Dot Lattice. *Physical Review Letters* B 92/21:214203–214209
- Cleri F (2019) Agent-Based Model of Multicellular Tumor Spheroid Evolution Including Cell Metabolism. *The European Physics Journal E Soft Matter* 42/8:112
- Cleri F (2019) Agent-Based Model of Multicellular Tumor Spheroid Evolution Including Cell Metabolism. *The European Physical Journal E* 42/112. doi: 10.1140/epje/i2019–11878–7
- Cleri F, Lampin E, et al. (2017) Fourier-Like Conduction and Finite One-Dimensional Thermal Conductivity in Long Silicon Nanowires by Approach-to-Equilibrium Molecular Dynamics. *Physical Review B* 95:104309
- Cleri F, et al. (2015) Molecular Dynamics of Ionic Self-Diffusion at an MgO Grain Boundary. *Journal of Material Science* 50:2502–2509
- Cleri F, et al. (2017) Stability of Radiation-Damaged DNA after Multiple Strand Breaks. *Physical Chemistry Chemical Physics* 19/22:14641
- Cleri F, et al. (2018) On the Occurrence of Size Effects in the Calculation of Thermal Conductivity by First-Principle Molecular Dynamics: The Case of Glassy GeTe₄. *Journal of Non-Crystalline Solids* 498:190–193. doi: 10.1016/j.jnoncrysol.2018.05.014
- Cleri F, et al. (2019) Interface Thermal Behavior in Nanomaterials by Thermal Grating Relaxation. *International Journal of Heat and Mass Transfer* 131:932–943

- Cleri F, Giordano S, et al. (2016) Characteristic Lengths in Natural Bundle Assemblies arising from Fiber–Matrix Energy Competition: A Floquet–Based Homogenization Theory. *European Journal of Mechanics – A/Solids* 60:145–165
- Cleri F, Giordano S, et al. (2020) A Stochastic Force Model for the Ballistic–Diffusive Transition of Heat Conduction. *Physica Scripta* 95/7. doi: 10.1088/1402-4896/ab8d56
- Cleri F, Ishida T, Collard D, Fujita H (2010) Atomistic Simulation of Plasticity in Silicon Nanowires. *Applied Physics Letters* 97/15:153106
- Cleri F, Lampin E, et al. (2016) Length Dependence of Thermal Conductivity by Approach–to–Equilibrium Molecular Dynamics. *Physical Review B* 94/054303. doi:10.1103/PhysRevB.94.054304
- Cleri F, Lampin E, et al. (2017a) Fourier–Like Conduction and Finite One–Dimensional Thermal Conductivity in Long Silicon Nanowires by Approach–to–Equilibrium Molecular Dynamics. *Physical Review B* 95/10:104309. doi:10.1103/PhysRevB.95.104309
- Cleri F, Lampin E, et al. (2017b) Thermal Conductivity of Glass GeTe₄ by First–Principles Molecular Dynamics. *Physical Chemistry Chemical Physics* 19:9729–9732. doi:10.1039/C7CP01063J
- Cleri F, Landuzzi F, Blossey R (2018) Mechanical Evolution of DNA Double–Strand Breaks in the Nucleosome. *PLOS Computational Biology* 14/6:e1006224. doi: 10.1371/journal.pcbi.1006224
- Cleri F, Lensink MF, Blossey R (2021) DNA Aptamers Block the Receptor Binding Domain at the Spike Protein of SARS–CoV–2. *Frontiers in Molecular Biosciences* 8:713003
- Cleri F, Letardi S, Delerue C (2006) Screening and Surface States in Molecular Monolayers Adsorbed on Silicon. *The Journal of Physical Chemistry B* 110/23:11496
- Cleri F, Noda T (2006) Phonon Instability in Nanocrystalline Silicon Carbide. *Physica Status Solidi B–Solid State Physics* 243/13:1133
- Coleman NRB, O’Sullivan N, Ryan KM, Crowley TA, Morris MA, Spalding TR, Steyler DC, Holmes JD (2001) Synthesis and Characterization of Dimensionally Ordered Semiconductor Nanowires within Mesoporous Silica. *Journal of the American Chemical Society* 123/29:7010–7016. doi:10.1021/ja015833j
- Colinge JP (2008) FinFETs and Other Multi–Gate Transistors. Springer Science & Business Media, p.11
- Collard D, Baccus B, Senz V (1992) Pseudoanalytical Modeling of Stress Dependent Silicon Oxidation. *Microelectronic Engineering* 19/1–4:491–494
- Collet J, Tharaud O, Chapoton A, Vuillaume (2000) Low–Voltage, 30nm Channel Length, Organic Transistors with a Self–Assembled Monolayer as Gate Insulating Films. *Applied Physics Letters* 76/14:1941–1943. doi:10.1063/1.126219
- Collet J, Tharaud O, Chapoton A, Vuillaume (2000) Low–Voltage, 30nm Channel Length, Organic Transistors with a Self–Assembled Monolayer as Gate Insulating Films. *Applied Physics Letters* 76/14:1941–1943. doi:10.1063/1.126219
- Contado C, Ravani L, Passarella M (2013) Size Characterization by Sedimentation Field Flow Fractionation of Silica Particles used as Food Additives. *Analytica Chimica Acta* 788:183–192. doi: 10.1016/j.aca.2013.05.056
- Copie G, Biaye M, Diesinger H, Melin T, Krzeminski C, Cleri F (2017) Deformation Localization in Molecular Layers Constrained between Self–Assembled Au Nanoparticles. *Langmuir* 33/10:2677–2687
- Copie G, Cleri F, Blossey R, Lensink MF (2016) On the Ability of Molecular Dynamics Simulation and Continuum Electrostatics to Treat Interfacial Water Molecules in Protein–Protein Complexes. *Scientific Reports* 6:1–10
- Copie G, Cleri F, Makoudi Y, Krzeminski C, Berthe M, Cherioux F, Palmino F, Grandidier B (2015) Surface–Induced Optimal Packing of Two–Dimensional Molecular Networks. *Physical Review Letters* 114/066101. doi: 10.1103/PhysRevLett.114.066101
- Copie G, Makoudi Y, Krzeminski C, Chérioux F, Palmino F, Lamare S, Grandidier B, Cleri F (2014) Atomic Scale Modeling of Two–Dimensional Molecular Self–Assembly on a Passivated Si Surface. *Journal of Chemical Physics C* 118/24:12817–12825
- Cowley JM (1995) Diffraction Physics. Elsevier Science B.V., Amsterdam
- Cox BJ, Thamwattana N, Hill JM (2006) Maximising the Electrorheological Effect for Bidisperse Nanofluids from the Electrostatic Force Between Two Particles. *Rheological Acta* 45:909–917. doi:10.1007/s00397–006–0084–4
- Creighton TE (1993) Proteins: Structures and Molecular Properties. 2nd edition. Freeman New York
- Cumings J, Zettl A (2000) Low–Friction Nanoscale Linear Bearing Realized from Multiwall Carbon Nanotubes. *Science*: 289/5479:602–604. doi:10.1126/science.289.5479.602

- Cuny V, Brulin Q, Lampin E, Lecat E, Krzeminski C, Cleri F (2006) Diffusion of Boron in Silicon: Compatibility of Empirical Molecular Dynamics with Continuum Simulations. *Europhysics Letters* 76/5:842
- Cuong BC, Kreinovich V (2013) Picture Fuzzy Sets—a New Concept for Computational Intelligence Problems. *IEEE Xplore*
- Cuong BC, Kreinovich V (2014) Picture Fuzzy Sets. *Journal of Computer Science and Cybernetics* 30/4:409–420. doi:10.15625/1813–9663/30/4/5032
- D’Aloia AG, D’Amore M, Sarto MS (2016) Adaptive Broadband Radar Absorber Based on Tunable Graphene. *IEEE Transactions on Antennas and Propagation* 64/6:2527–2531. doi:10.1109/TAP.2016.2547022
- D’Aloia AG, D’Amore M, Sarto MS (2018) Tunable Graphene/Dielectric Laminate for Adaptive Low_Gigahertz Shielding and Absorbing Screens. *IEEE Electromagnetic Compatibility Magazine* 7/2:82–87. doi:10.1109/MEMC.2018.8410687
- D’Aloia GA, Cheraghi Bidsorkhi H, De Bellis G, Sarto MS (2022) Graphene based Wideband Electromagnetic Absorbing Textiles at Microwave Bands. *IEEE Transaction on Electromagnetic Compatibility* 64/3:710–719. doi:10.1109/TEMC.2021.3133665
- D’Aloia GA, D’Amore M, Sarto MS (2020) Low–Terahertz Transparent Graphene–Based Absorber. *Nanomaterials* 10/5:843. doi:10.3390/nano10050843
- Da Pieve F, Gronoff G, Guo J, Mertens C, Neary L, Gu B, Koval N, Kohanoff A, Vandaele A, Cleri F (2021) Radiation Environment and Doses on Mars at Oxia Planum and Mawrth Vallis: Support for Exploration at Sites With High Biosignature Preservation Potential. *Journal of Geophysical Research: Planets* 126:1–20
- Dambrine G, Happy H, Danneville F, Cappy A (1993) A New Method for On Wafer Noise Measurement. *IEEE Transactions on Microwave Theory and Techniques* 41/3:375–381. doi:10.1109/22.223734
- Dambrine G, Happy H, Danneville F, Cappy A (1993) A New Method for On Wafer Noise Measurement. *IEEE Transactions on Microwave Theory and Techniques* 41/3:375–381. doi:10.1109/22.223734
- Dang TH, Vasaneli A, Todorov Y, Sirtori C, Prado Y, Chu A, Greboval C, Khalili A, Cruguel H, Delerue C, Vincent G, Lhuillier E (2021) Bias Tunable Spectral Response of Nanocrystal Array in a Plasmonic Cavity. *Nano Letters* 21/15:1–12
- Danoy M, Shinohara M, Rizki–Safitri A, Collard D, Senez V, Sakai Y (2017) Alteration of Pancreatic Carcinoma and Promyeloblastic Cell Adhesion in Liver Microvasculature by Co–Culture of Hepatocytes, Hepatic Stellate Cells and Endothelial Cells in a Physiologically–Relevant Model. *Integrative Biology* 9/4:350–361
- Dargent T, Haddadi K, Lasri T, Clément N, Ducatteau D, Legrand B, Tanbakuchi H, Theron D (2013) An Interferometric Scanning Microwave Microscope and Calibration Method for Sub–ff Microwave Measurements. *Review of Scientific Instruments* 84/12:1–7. doi:10.1063/1.4848995
- Dargent T, Haddadi K, Lasri T, Clément N, Ducatteau D, Legrand B, Tanbakuchi H, Theron D (2013) An Interferometric Scanning Microwave Microscope and Calibration Method for Sub–ff Microwave Measurements. *Review of Scientific Instruments* 84/12:1–7. doi:10.1063/1.4848995
- Das S (2013) A Review on Carbon Nano–Tubes – A New Era of Nanotechnology. *International Journal of Emerging Technology and Advanced Engineering* 3/3:774–783
- Das SK, Choi SU, Yu W, Pradeep T (2008) *Nanofluids: Science and Technology*. Wiley, New York
- Davari B, Ting CY, Ahn KY, Basavaiah S, Hu CK, Taur Y, Wordeman MR, Aboelfotoh O, Krusin–Elbaum L, Joshi RV, Polcari MR (1987) Submicron Tungsten Gate MOSFET with 10 nm Gate Oxide. 1987 Symposium on VLSI Technology. *Digest of Technical Papers*
- Dazzi A, Glotin F, Carminati R (2010) Theory of Infrared Nano–Spectroscopy by Photo Thermal Induced Resonance. *Journal of Applied Physics* 107/12:124519–7. doi:10.1063/1.342914
- Dazzi A, Prazeres R, Glotin F, Ortega JM (2005) Local Infrared Microspectroscopy with Subwavelength Spatial Resolution with an Atomic Force Microscope Tip used as a Photothermal Sensor. *Optics Letters* 30/18:2388–2390. doi:10.1364/OL.30.002388
- De Boer CB, Dekkers MJ (2001) Unusual Thermomagnetic Behaviour of Haematites: Neof ormation of a Highly Magnetic Spinel Phase on Heating in Air. *Geophysical Journal International* 144/2:481–494. doi:10.1046/j.0956–540X.2000.01333.x
- De Geyter B, Houtepen AJ, Carrillo S, Geiregat P, Gao Y, ten Cate S, Schins JM, Van Thourhout D, Delerue C, Siebbeles LDA, Hens Z (2012) Broadband and Picosecond Intraband Absorption in Lead–Based Colloidal Quantum Dots. *ACS Nano* 6/7:6067–6074

- de Hartog JJ, Hoek G, Peters A, Timonen KL, Ibald–Mulli A, Brunekreef B, Heinrich J, Tiittanen P, van Wijnen JH, Kreyling W, Kulmala M, Pekkanen J (2003) Effects of Fine and Ultrafine Particles on Cardiorespiratory Symptoms in Elderly Subjects With Coronary Heart Disease – the ULTRA Study. *American Journal of Epidemiology* 157/7:613–623. doi:10.1093/aje/kwg021
- De la Mata M, Zhou X, Furtmayr F, Teubert J, Gradečak S, Eichhoff M, Fontcuberta I Morral A, Arbiol J (2013) A Review of Molecular Beam Epitaxy (MBE) Grown 0D, 1D and 2D Quantum Structures in a Nanowire. *Journal of Materials Chemistry C* 1:4300–4312. doi: 10.1039/c3tc30556b.
- Degardin V, Lienard M, Degauque P, Simon E, Laly P (2008) Impulsive Noise Characterization of In–Vehicle Power Line. *IEEE Transactions on Electromagnetic Compatibility* 50/4:861–868. doi:10.1109/TEMC.2008.2006851
- Degardin V, Lienard M, Degauque P, Simon E, Laly P (2008) Impulsive Noise Characterization of In–Vehicle Power Line. *IEEE Transactions on Electromagnetic Compatibility* 50/4:861–868. doi:10.1109/TEMC.2008.2006851
- Del Rio MS, Doménech A, Doménech–Carbó MT, Vázquez de Agredo Pascual ML, Suárez M, García–Romero E (2011) The Maya Blue Pigment, in *Developments in Clay Science*, Chapter 18,453–481. Elsevier Amsterdam
- Delaney P, Healy RM, Hanrahan JP, Gibson LT, Wenger JC, Morris MA, Holmes JD (2010) Porous Silica Spheres as Indoor Air Pollutant Scavengers. *Journal of Environmental Monitoring* 12/12:2244. doi:10.1039/c0em00226g
- Delaney P, McManamon C, Hanrahan JP, Copley MP, Holmes JD, Morris MA (2011) Development of Chemically Engineered Porous Metal Oxides for Phosphate Removal. *Journal of Hazardous Materials* 185/1:382–391. doi:10.1016/j.jhazmat.2010.08.128
- Delerue C (2014a) From Semiconductor Nanocrystals to Artificial Solids with Dimensionality Below Two. *Physical Chemistry Chemical Physics* 16/47:25734–25740
- Delerue C (2014b) Prediction of Robust Two–Dimensional Topological Insulators Based on Ge/Si Nanotechnology. *Physical Review B* 90/7:075424–075432
- Delerue C (2017) Minimum Line Width of Surface Plasmon Resonance in Doped ZnO Nanocrystals. *Nano Letters* 17/12:7599–7605
- Delerue C (2018) Electronic Structure of Si Nanocrystals Codoped with Boron and Phosphorus. *Physical Review B* 98/4:045434–045442
- Delerue C, Allan G (2006) Effective Dielectric Constant of Nanostructured Si Layers. *Applied Physics Letters* 88/17:173117
- Delerue C, Allan G, Lannoo M (2001) Electron–Phonon Coupling and Optical Transitions for Indirect–Gap Semiconductor Nanocrystals. 64/19:193402–193406
- Delerue C, Allan G, Lannoo M (2003) Dimensionality–Dependent Self–Energy Corrections and Exchange–Correlation Potential in Semiconductor Nanostructures. *Physical Review Letters* 90/7:076803–076807
- Delerue C, Allan G, Niquet YM (2005) Collective Excitations in Charged Nanocrystals and in Close–Packed Arrays of Charged Nanocrystals. *Physical Review B* 72/19:195316–195322
- Delerue C, Allan G, Pijpers JJH, Bonn M (2010) Carrier Multiplication in Bulk and Nanocrystalline Semiconductors: Mechanism, Efficiency, and Interest for Solar Cells. *Physical Review B* 81/12:125306–125312
- Delerue C, Allan G, Reynaud C, Guillois O, Ledoux G, Huisken F (2006) Multiexponential Photoluminescence Decay in Indirect–Gap Semiconductor Nanocrystals. *Physical Review B* 73/23:235318–235322
- Delerue C, et al. (1995a) Theoretical Description of Porous Silicon. *Thin Solid Films* 255/1–2:27–34
- Delerue C, et al. (1995b) Theory of Physical Properties of Silicon Crystallites. *Annales des Physique* 20/3:271–276
- Delerue C, Lannoo M (2004) *Nanostructures. Theory and Modeling*. Springer, Berlin
- Delerue C, Lannoo M, Allan G (2003) Concept of Dielectric Constant for Nanosized Systems. *Physical Review B* 68/11:115411
- Delerue C, Vanmaekelbergh D (2015) Electronic Band Structure of Zinc Blende CdSe and Rock Salt PbSe Semiconductors with Silicene–Type Honeycomb Geometry. *2D Materials* 2/3
- Dennis SD, Buchanan RL, Miller AJ (2001) *Microbial Risk Assessment: Achievements and Future Challenges*. Food Safety Magazine
- Deokar G, Avila J, Razado–Colombo I, Codron JL, Boyaval C, Galopin E, Asencio MC, Vignaud D (2015) Towards High Quality CVD Graphene Growth and Transfer. *Carbon* 89:82–92. doi:10.1016/j.carbon.2015.03.017

- Deokar G, Avila J, Razado-Colombo I, Codron JL, Boyaval C, Galopin E, Asencio MC, Vignaud D (2015) Towards High Quality CVD Graphene Growth and Transfer. *Carbon* 89:82–92. doi:10.1016/j.carbon.2015.03.017
- Desai SB, Madhvapathy SR, Sachid AB, Llinas JP, Wang Q, Ahn GH, Pitner G, Kim MJ, Bokor J, Hu C, Wong HSP, Javey A (2016) MoS₂ Transistors with 1–Nanometer Gate Lengths. *Science* 354/6308:99–102. doi:10.1126/science.aah4698
- Dessau RM, Schlenker JL, Higgins JB (1990) Framework Topology of AlPO₄-8: the First 14–Ring Molecular Sieve. *Zeolites* 10/6:522–524. doi: 10.1016/s0144–2449(05)80306–9
- Devos A, Côte R (2004) Strong Oscillations Detected by Picosecond Ultrasonics in Silicon: Evidence for an Electronic–Structure Effect. *Physical Review B* 70/12:1–6. doi:10.1103/PhysRevB.70.125208
- Devos A, Côte R (2004) Strong Oscillations Detected by Picosecond Ultrasonics in Silicon: Evidence for an Electronic–Structure Effect. *Physical Review B* 70/12:1–6. doi:10.1103/PhysRevB.70.125208
- Di Sia P (2019) *Mathematics and Physics for Nanotechnology*. Pan Stanford Publishing, Singapore
- Diarra M, Delerue C, Niquet YM, Allan G (2008) Screening and Polaronic Effects Induced by a Metallic Gate and a Surrounding Oxide on Donor and Acceptor Impurities in Silicon Nanowires. *Journal of Applied Physics* 103/7:073703–073703–5
- Diarra M, Niquet YM, Delerue C, Allan G (2007) Ionization Energy of Donor and Acceptor Impurities in Semiconductor Nanowires: Importance of Dielectric Confinement. *Physical Review B* 75/4:045301–045305
- Diener P, Janod E, Corraze B, Querre M, Adda C, Guilloux–Viry M, Cordier S, Camjayi A, Rozenberg M, Besland MP, Cario L (2018) How a dc Electric Field Drives Mott Insulators Out of Equilibrium. *Physical Review Letters* 121/1:016601–106607
- Disco C, van der Meulen B (1998) *Getting New Technologies Together*. Walter de Gruyter, New York
- Doherty GJ, MacMahon HT (2009) Mechanisms of Endocytosis. *Annual Review of Biochemistry* 78/1:857–902. doi:10.1146/annurev.biochem.78.081307.11054
- Dresselhaus MS, Dresselhaus G (2002) Intercalation Compounds of Graphite. *Advances in Physics* 51/1:1–186. doi:10.1080/00018730110113644
- Drexler KE (1981) Molecular Engineering: an Approach to the Development of General Capabilities for Molecular Manipulation. *Proceedings of the National Academy of Science USA* 78:5275–5278. doi:10.2307/10813
- Drexler KE (1986) *Engines of Creation. Challenges and Choices of the Last Technological Revolution*. Bantam Doubleday Dell, New York
- Drexler KE (1987) Molecular Machinery and Molecular Electronic Devices. In *Molecular Electronic Devices II*, FL Carter editor, pp. 549–571. Dekker New York
- Drexler KE (1988) Rod Logic and Thermal Noise in the Mechanical Nanocomputer. In *Molecular Electronic Devices*, FL Carter, R Siatkowski and H Wohltjen editors, pp. 39–56. North–Holland
- Drexler KE (1990) Molecular Tip Arrays for Molecular Imaging and Nanofabrication. *Journal of Vacuum Science & Technology B*/9:1394–1397. doi:10.1116/1.585204
- Drexler KE (1992) *Nanosystems: Molecular Machinery, Manufacturing, and Computation*. Wiley New York
- Drexler KE (1999) Building Molecular Machine Systems. *Tibtech* 17/1:5–7. doi:10.1016/s0167–7799(98)01278–5
- Drexler KE (2001) Machine–Phase Nanotechnology. *Scientific American* 285/3:74–75. doi:10.1038/scientificamerican0901–74
- Drexler KE (2003a) If Atomic Precision is Unfeasible, so is Life. *Nature*, 422:257. doi:10.1038/422257c
- Drexler KE (2003b) Open Letter to Richard Smalley. *Chemical and Engineering News* 81:38–39
- Drexler KE (2004) Different Paths to the Nano–Scale. *Physics World* 17/10:18. doi:10.1088/2058–7058/17/10/23
- Drexler KE (2005) Productive Nanosystems: the Physics of Molecular Fabrication. *Physics Education* 40/4:340–346. doi:10.1088/0031–9120/40/4/003
- Drexler KE, Forrest D, Freitas RA, Hall JS, Jacobstein N, McKendree T, Merkle R, Peterson C (2001) On Physics, Fundamentals, and Nanorobots: A Rebuttal to Smalley’s Assertion that Self–Replicating Mechanical Nanorobots Are Simply Not Possible. Institute for Molecular Manufacturing. Retrieved 11/07/2022
- Drexler KE, Foster JS (1990) Synthetic Tips. *Nature* 343/6259:600. doi:10.1038/343600b0
- Drexler KE, Peterson C, Pergamit G (1991) *Unbounding the Future: the Nanotechnology Revolution*. William Morrow and Company, New York

- Dubois M, Delerue C, Allan G (2005) Scanning Tunneling Microscopy and Spectroscopy of Conjugated Oligomers Weakly Bonded to Si(100) Surfaces: A Theoretical Study. *Physical Review B* 71/16:165435–165441
- Dubois M, Delerue C, Rubio A (2007) Adsorption and Electronic Excitation of Biphenyl on Si(100): A Theoretical STM Analysis. *Physical Review B* 75/4:041302–041306
- Dubois M, Perdigo L, Delerue C, Allan G, Grandidier B, Deresmes D, Stievenard D (2005) Scanning Tunneling Microscopy and Spectroscopy of Reconstructed Si(100) Surfaces. *Physical Review B* 71/16:165322–165332
- Ducatteau D, Minko A, Hoël V, Morvan E, Delos E, Grimbert B, Lahreche H, Bove P, Giaquière C, De Jaeger JC, Delage S (2006) Output Power Density of 5.1/mm at 18 GHz with an AlGaIn/GaN HEMT on Si Substrate. *IEEE Electron Device Letters* 27/1:7–9. doi:10.1109/LED.2005.860385
- Ducatteau D, Minko A, Hoël V, Morvan E, Delos E, Grimbert B, Lahreche H, Bove P, Giaquière C, De Jaeger JC, Delage S (2006) Output Power Density of 5.1/mm at 18 GHz with an AlGaIn/GaN HEMT on Si Substrate. *IEEE Electron Device Letters* 27/1:7–9. doi:10.1109/LED.2005.860385
- Duclairoir C, Orecchioni AM, Depaetere P, Nakache E (2002) α -Tocopherol Encapsulation and in Vitro Release from Wheat Gliadin Nanoparticles.
- Ducournau G, Szriftgiser P, Beck A, Bacquet D, Pavanello F, Peytavit E, Zaknoute M, Akalin T, Lampin JF (2014) Ultrawide-Bandwidth Single-Channel 0.4–THz Wireless Link Combining Broadband Quasi-Optic Photomixer and Coherent Detection. *IEEE Transactions on Terahertz Science and Technology* 4/3:328–337. doi:10.1109/TTHZ.2014.2309006
- Ducournau G, Szriftgiser P, Beck A, Bacquet D, Pavanello F, Peytavit E, Zaknoute M, Akalin T, Lampin JF (2014) Ultrawide-Bandwidth Single-Channel 0.4–THz Wireless Link Combining Broadband Quasi-Optic Photomixer and Coherent Detection. *IEEE Transactions on Terahertz Science and Technology* 4/3:328–337. doi:10.1109/TTHZ.2014.2309006
- Dufour M, Izquierdo E, Livache C, Martinez B, Silly MG, Pons T, Lhuillier E, Delerue C, Ithurria S (2019) Doping as a Strategy to Tune Color of 2D Colloidal Nanoplatelets. *ACS Applied Materials & Interfaces* 11/10:10128–10134. doi: 10.1021/acsami.8b18650
- Duong QH, Buchaillot L, Collard D, Schmitt P, Lafontan X, Pons P, Flourens F, Pressecq F (2005) Thermal and Electrostatic Reliability Characterization in RF MEMS Switches. *Microelectronics Reliability* 45/9–11:1790–1793
- Duquennoy M, Ouaftouh M, Qian ML, Jenot F, Ourak M (2001) Ultrasonic Characterization of Residual Stresses in Steel Rods Using a Laser Line Source and Piezoelectric Transducers. *NDT&E International* 34/5:355–362. doi:10.1016/S0963–8695(00)00075–X
- Duquennoy M, Ouaftouh M, Qian ML, Jenot F, Ourak M (2001) Ultrasonic Characterization of Residual Stresses in Steel Rods Using a Laser Line Source and Piezoelectric Transducers. *NDT&E International* 34/5:355–362. doi:10.1016/S0963–8695(00)00075–X
- Durand C, Capiod P, Berthe M, Nys JP, Krzeminski C, Stievenard D, Delerue C, Grandidier B (2014) Nanoscale Carrier Multiplication Mapping in a Si Diode. *Nano Letters* 14/10:5636–5640
- Dürig U, Pohl DW, Rohner F (1986) Near-Field Optical Scanning Microscopy. *Journal of Applied Physics* 59/10:3318–3327. doi:10.1063/1.336848
- Durkan C (2019) Size Does Really Matter. *The Nanotechnology Revolution*. World Scientific Publishing Europe Ltd., London
- Dusch Y, Tiercelin N, Klimov A, Giordano S, Preobrazhensky V, Pernod P (2013) Stress-Mediated Magnetoelectric Memory Effect with Uni-Axial TbCo₂/FeCo Multilayer on 011–Cut PMN–PT Ferroelectric Relaxor. *Journal of Applied Physics* 113/17:17C719
- Eastman JA, Choi SUS, Li S, Yu W, Thompson LJ (2001) Anomalous Increased Effective Thermal Conductivities of Ethylene Glycol-Based Nanofluids Containing Copper Nanoparticles. *Applied Physics Letters* 78/6:718–720. doi:10.1063/1.1341218
- Eaton P, West P (2010) *Atomic Force Microscopy*. Oxford University Press, Oxford
- Edwards SA (2006) *The Nanotech Pioneers. Where Are They Taking Us?* WILEY–VCH Verlag GmbH & Co. KGaA, Weinheim
- Ehrlich M, Boll W, Van Oijen A, Hariharan R, Chandran K, Nibert ML, Kirchhausen T (2004) Endocytosis by Random Initiation and Stabilization of Clathrin-Coated Pits. *Cell* 118/5:591–605. doi:10.1016/j.cell.2004.08.017
- Eigler OM, Schweizer EK (1990) Positioning Single Atoms with a Scanning Tunneling Microscope. *Nature* 344:524–526. doi:10.1038/344524a0
- Ekimov AI, Efros AL, Onushchenko AA (1985) Quantum Size Effect in Semiconductor Microcrystals. *Solid State Communications* 56/11:921–924. doi:10.1016/s0038–1098(85)80025–9

- Ekimov AI, Hache F, Schanne-Klein MC, Ricard D, Flytzanis C (1993) Absorption and Intensity-Dependent Photoluminescence Measurements on CdSe Quantum Dots: Assignment of the First Electronic Transitions. *Journal of the Optical Society of America B* 10/1:100–107. doi:10.1364/JOSAB.10.000100
- Ekimov AI, Kudryavtsev IA, Efros AL, Yazeva TV, Hache F, Schanne-Klein MC, Ricard D, Rodina AV, Flytzanis C (1993). Absorption and Intensity-Dependent Photoluminescence Measurements on CdSe Quantum Dots: Assignment of the First Electronic Transitions. *Journal of the Optical Society of America B* 10/1:100–107. doi:10.1364/josab.10.000100
- Ekimov AI, Onushchenko AA, Tsekhomski VA (1980). Exciton Absorption by Copper Chloride Crystal in Glassy Matrix. *Fizika i Khimija. Stekla* 1980, 6:511–512
- El-Samaligy MS, Rohdewald P (1983) Reconstituted Collagen Nanoparticles, a Novel Drug Carrier Delivery System. *Journal of Pharmacy and Pharmacology* 35/8:537–539. doi:10.1111/j.2042–7158.1983.tb04831.x
- El-Samaligy MS, Rohdewald P, Mahmoud HA (1986) Polyalkylcyanoacrylate Nanocapsules. *Journal of Pharmacy and Pharmacology* 38:216–218. doi:10.1111/j.2042–7158.1986.tb04547.x
- Elser V, Haddon RC (1987) Icosahedral C₆₀: an Aromatic Molecule with a Vanishingly Small Ring Current Magnetic Susceptibility. *Nature* 325:792–794. doi:10.1038/325792a0
- Elvassore N, Bertucco A, Caliceti P (2001) Production of Insulin-Loaded Poly(ethylene glycol)/Poly(l-Lactide) (PEG/PLA) Nanoparticles by Gas Antisolvent Techniques. *Journal of Pharmaceutical Sciences* 90/10:1628–1636. doi:10.1002/jps.1113
- Ensikat HJ, Ditsche-Kuru P, Neinhuis C, Barthlott W (2011) Superhydrophobicity in Perfection: the Outstanding Properties of the Lotus Leaf. *Beilstein Journal of Nanotechnology* 2:152–161. doi:10.3762/bjnano.2.19
- Erdely A, Dahm M, Chen BT, Zeidler-Erdely PC, Fernbach JE, Birch ME, Evans DE, Kashon ML, Deddens JA, Hulderman T, Bilgesu SA, Battelli L, Schwegler-Berry D, Leonard HD, McKinney W, Frazer DG, Antonini JM, Porter DW, Castranova V, Schubauer-Berigan MK (2013) Carbon Nanotube Dosimetry: from Workplace Exposure Assessment to Inhalation Toxicology. *Particle and Fibre Toxicology* 10/1:53. doi:10.1186/1743–8977–10–53
- Estermann M, McCusker LB, Baerlocher C, Merrouche A, Kessler H (1991) A Synthetic Gallophosphate Molecular Sieve with a 20-Tetrahedral-Atom Pore Opening. *Nature* 352/6333:320–323. doi:10.1038/352320a0
- Evers WH, Schins JM, Aerts M, Kulkarni A, Capiod P, Berthe M, Grandidier B, Delerue C, van der Zant HSJ, van Overbeek C, Peters JL, Vanmaekelbergh D, Siebbeles LDA (2015) High Charge Mobility in Two-Dimensional Percolative Networks of PbSe Quantum Dots Connected by Atomic Bonds. *Nature Communications* 6:8195
- Fano V, Graziani P, Marcacci F, Tagliaferri M (2020) Melissus as an Analytic Metaphysicist. *Axiomathes* 32/3. doi:10.1007/s10516–020–09507–6
- Faraday M (1857) The Bakerian Lecture: Experimental Relations of Gold (and Other Metals) to Light. *Philosophical Transactions of the Royal Society of London* 1/147:145–181. doi:10.1098/rstl.1857.0011
- Ferry VE, Munday JN, Atwater HA (2010) Design Considerations for Plasmonic Photovoltaics. *Advanced Materials* 22/43:4794–4808
- Ferson S, Ginzburg L, Kreinovich V, Longpré L, Aviles M (2002) Computing Variance for Interval Data is NP-Hard. *ACM SIGACT News* 33/2:108–118. doi:10.1145/564585.564604
- Ferson S, Kreinovich V, Ginzburg L, Sents F (2003) Constructing Probability Boxes and Dempster-Shafer Structures. *Sandia Report SAND2002–4015*. doi:10.2172/809606
- Ferson S, Kreinovich V, Hajagos J, Oberkampf WL, Ginzburg L (2007) Experimental Uncertainty Estimation and Statistics for Data having Interval Uncertainty. *Sandia Report SAND2007–0939*. doi:10.2172/910198
- Feynman R (1985) *The Character of Physical Law*. The Massachusetts Institute of Technology Press, XII ed., Cambridge
- Florczyk SJ, Saha S (2007) Ethical Issues in Nanotechnology. *Journal of Long-Term Effects of Medical Implants* 17/3:271–280. doi:10.1615/jlongtermeffmedimplants.v17.i3.90
- Florio G, Puglisi G, Giordano S (2020) Role of Temperature in the Decohesion of an Elastic Chain Tethered to a Substrate by Onsite Breakable Links. *Physical Review Reserch* 2:033227
- Flynn E, Keane D, Tabari P, Morris M (2013) Pervaporation performance enhancement through the incorporation of mesoporous silica spheres into PVA membranes. *Separation and Purification Technology*. 11873–80. doi:10.1016/j.seppur.2013.06.034

- Font F, Myers TG (2013) Spherically Symmetric Nanoparticle Melting with a Variable Phase Change Temperature. *Journal of Nanoparticle Research* 15/12:2086. doi:10.1007/s11051-013-2086-3
- Fortunato M, Chandraiahgari CR, De Bellis G, Ballirano P, Sarto MS (2018) Piezoelectric Thin Films of ZnO–Nanorods/Nanowalls grown by Chemical Bath Deposition. *IEEE Transactions on Nanotechnology* 17/2:311–319. doi:10.1109/TNANO.2018.2800406
- Fortunato M, Tamburrano A, Bracciale MP, Santarelli ML, Sarto MS (2021) Enhancement of the Piezoelectric Coefficient in PVDF–TrFe/CoFe₂O₄ Nanocomposites through DC Magnetic Poling. *Beilstein Journal of Nanotechnology* 12:1262–1270. doi:10.3762/bjnano.12.93
- Franchina Vergel NA, Post LC, Sciacca D, Berthe M, Vaurette F, Lambert Y, Yarekha D, Troadec D, Coinon C, Fleury G, Patriarche G, Xu T, Desplanque L, Wallart X, Vanmaekelberg D, Delerue C, Grandidier B (2020) Engineering a Robust Flat Band in III–V Semiconductor Heterostructures. *Nano Letters* 12/2020. doi: 10.1021/acs.nanolett.0c04268
- Franchina Vergel NA, Tadjine A, Notot V, Mohr M, Kouassi N’Guissan A, Coinon C, Berthe M, Biadala L, Sossoe KK, Dzagli MM, Girard JC, Rodary G, Desplanque L, Berndt R, Stiévenard D, Wallart X, Delerue C, Grandidier B (2019) Influence of Doping Level and Surface States in Tunneling Spectroscopy of an In_{0.53}Ga_{0.47}As Quantum Well Grown on *p*-type Doped InP(001). *Physical Review Materials* 3/094604. doi:10.1103/PhysRevMaterials.3.094604
- Fraser C, Restrepo–Estrada S (1998) *Communicating for Development: Human Change for Survival*. I.B Tauris and Co Ltd, London.
- Freitas RA (2005) What is Nanomedicine? 1/1:2–9. doi:10.1016/j.nano.2004.11.003
- Fu Y, Kao WJ (2010) Drug Release Kinetics and Transport Mechanisms of Non–Degradable and Degradable Polymeric Delivery Systems. *Expert Opinion on Drug Delivery* 7/4:429–444. doi:10.1517/17425241003602259
- Fujihira M, Aoki D, Okabe Y, Takano H, Hokari H, Frommer J, Nagatani Y, Sakai F (1996) Effect of Capillary Force on Friction Force Microscopy: A Scanning Hydrophilicity Microscope. *Chemistry Letters* 25/7:499–500. doi:10.1246/cl.1996.499
- Fuyu Y, Parker JM (1988) Quantum Size Effects in Heat Treated, Cd(S, Se) Doped Glasses. *Materials Letters* 6/7:233–237. doi:10.1016/0167–577X(88)90028–6
- Gabella G, Blundell D (1978) Effect of Stretch and Contraction on Caveolae of Smooth Muscle Cells. *Cell and Tissue Research* 190/2:255–271. doi:10.1007/bf00218174
- Galayko D, Kaiser A, Buchaillot L, Legrand B, Collard D, Combi C (2003) Design, Realization and Testing of Micro–Mechanical Resonators in Thick–Film Silicon Technology with Postprocess Electrode–to–Resonator Gap Reduction. *Journal of Micromechanics and Microengineering* 13/1:1–7
- Galayko D, Kaiser A, Legrand B, Buchaillot L, Collard D, Combi C (2005) Tunable Passband T–Filter with Electrostatically–Driven Polysilicon Micromechanical Resonators. *Sensors and Actuators A–Physical* 117/1:115–120
- Galayko D, Kaiser A, Legrand B, Buchaillot L, Combi C, Collard D (2006) Coupled–Resonator Micromechanical Filters with Voltage Tuneable Bandpass Characteristic in Thick–Film Polysilicon Technology. *Sensors and Actuators A–Physical* 126/1:227–240
- Galilei G (1623) *Il Saggiatore*. In “Opere”, a cura di Franz Brunetti. 1996 UTET Libreria, Torino
- Gazeau F, Lévy M, Wilhelm C (2008) Optimizing Magnetic Nanoparticle Design for Nanothermotherapy. *Nanomedicine* 3/6:831–844. doi:10.2217/17435889.3.6.831
- Geiregat P, Allan G, Hens Z, Delerue C (2016) Single–Exciton Optical Gain in Semiconductor Nanocrystals: Positive Role of Electron–Phonon Coupling. *Physical Review B* 93/11:115416–115426
- Geiregat P, Delerue C, Justo Y, Aerts M, Spoor F, Van Thourhout D, Siebbeles LDA, Allan G, Houtepen AJ, Hens Z (2015) A Phonon Scattering Bottleneck for Carrier Cooling in Lead Chalcogenide Nanocrystals. *ACS Nano* 9/1:778–788
- Geiregat P, Houtepen AJ, Sagar LK, Infante I, Zapata F, Grigel V, Allan G, Delerue C, Van Thourhot D, Hens Z (2018) Continuous–Wave Infrared Optical Gain and Amplified Spontaneous Emission at Ultralow Threshold by Colloidal HgTe Quantum Dots. *Nature Materials* 17:35–42. doi: 10.1038/nmat5000
- Germeau A, Roest AL, Vanmaekelbergh D, Allan G, Delerue C, Meulenkaamp EA (2003) Optical Transitions in Artificial Few–Electron Atoms Strongly Confined Inside ZnO Nanocrystals. *Physical Review Letters* 90/9:097401–097405
- Gholamy A, Kreinovich V, Kosheleva O (2018) Why 70/30 or 80/20 Relation between Training and Testing Sets: A Pedagogical Explanation. *ScholarWorks@UTEP*

- Giaever I (1974) Electron Tunneling and Superconductivity. *Science* 183/4131:1253–1258. doi:10.1126/science.183.4131.1253
- Gianese G, Rosato V, Cleri F, Celino M, Morales P (2009) Atomic-Scale Modeling of the Interaction between Short Polypeptides and Carbon Surfaces. *Journal of Physical Chemistry B* 113/35:12105–12112
- Gilder G (1990) *Microcosm: The Quantum Revolution In Economics And Technology*. Simon and Schuster pp.144–5
- Giordano S (2013) Analytical Procedure for Determining the Linear and Nonlinear Effective Properties of the Elastic Composite Cylinder. *International Journal of Solids and Structures* 90/24:4055
- Giordano S (2014) Explicit Nonlinear Homogenization for Magneto–Electro–Elastic Laminated Materials. *Mechanics Research Communications* 55:18–29
- Giordano S (2016) Nonlinear Effective Behavior of a Dispersion of Randomly Oriented Coated Ellipsoids with Arbitrary Temporal Dispersion. *International Journal of Engineering Science* 98:14–35
- Giordano S (2017a) Nonlinear Effective Properties of Heterogeneous Materials with Ellipsoidal Microstructure. *Mechanics of Materials* 105:16–28
- Giordano S (2017b) Spin Variable Approach for the Statistical Mechanics of Folding and Unfolding Chains. *Soft Matter* 13/38:6877–6893
- Giordano S (2018) Helmholtz and Gibbs Ensembles, Thermodynamic Limit and Bistability in Polymer Lattice Models. *Continuum Mechanics and Thermodynamics* 30:459–483
- Giordano S (2019) Stochastic Thermodynamics of Holonomic Systems. *European Physical Journal B* 92/8:1–18
- Giordano S (2021) Entropy Production and Onsager Reciprocal Relations Describing the Relaxation to Equilibrium in Stochastic Thermodynamics. *Physical Review E* 103/5:052116–052129
- Giordano S (2022) Statistical Mechanics of Rate-Independent Stick-Slip on a Corrugated Surface Composed of Parabolic Wells. *Continuum Mechanics and Thermodynamics* 34/5:1343–1372
- Giordano S, Cleri F, Collard D, et al. (2016) Real-Time Mechanical Characterization of DNA Degradation under Therapeutic X-Rays and its Theoretical Modeling. *Microsystems & Nanotechnology* 5/2:16062
- Giordano S, Cleri F, Collard D, et al. (2016) Real-time Mechanical Characterization of DNA Degradation Under Therapeutic X-Rays and its Theoretical Modeling. *Microsystems & Nanoengineering* 2/16062. doi:10.1038/micronano.2016.62
- Giordano S, Cleri F, et al. (2009) On the Equivalence of Thermodynamics Ensembles for Flexible Polymer Chains. *Physica A Statistical Mechanics and its Applications* 395/1:154–170
- Giordano S, Cleri F, et al. (2012a) Elasticity of Flexible and Semiflexible Polymers with Extensible Bonds in the Gibbs and Helmholtz Ensembles. *Journal of Chemical Physics* 136/15:154906
- Giordano S, Cleri F, et al. (2012b) Theory and Monte Carlo Simulations for the Stretching of Flexible and Semiflexible Single Polymer Chains Under External Fields. *Journal of Chemical Physics* 137/244907. doi:10.1063/1.4772656
- Giordano S, Cleri F, et al. (2013) Two-State Theory of Single-Molecule Stretching Experiments. *Physical Review E* 87:032705
- Giordano S, Cleri F, et al. (2014) Scaling Shift in Multicracked Fiber Bundles. *Physical Review Letters* 113:255501
- Giordano S, Cleri F, et al. (2015) Stochastic Mechanical Degradation of Multi-Cracked Fiber Bundles with Elastic and Viscous Interactions. *The European Physics Journal E* 38/5:1–21
- Giordano S, Cleri F, et al. (2018) Thermal Conductivity of Deca-Nanometric Patterned Si Membranes by Multiscale Simulations. *International Journal of Heat and Mass Transfer* 126/B:830
- Giordano S, Dejardin PM (2020) Derivation of Magnetic Inertial Effects from the Classical Mechanics of a Circular Current Loop. *Physical Review B* 102/21:214406–214419
- Giordano S, Dusch Y, Tiercelin N, Pernod P, Preobrazhensky V (2013a) Thermal Effects in Magnetoelectric Memories with Stress-Mediated Switching. *Journal of Physics D–Applied Physics* 46/32:325002
- Giordano S, Dusch Y, Tiercelin N, Pernod P, Preobrazhensky V (2012) Combined Nanomechanical and Nanomagnetic Analysis of Magnetoelectric Memories. *Physical Review B* 85/15:155321
- Giordano S, Dusch Y, Tiercelin N, Pernod P, Preobrazhensky V (2013b) Stochastic Magnetization Dynamics in Single Domain Particles. *European Physical Journal B* 86:249
- Giordano S, et al. (2012a) Conduction Degradation in Anisotropic Multi-Cracked Materials. *European Physical Journal B* 85/2:1–15

- Giordano S, et al. (2012b) Elastic Behavior of Inhomogeneities with Size and Shape Different from their Hosting Cavities. *Mechanics of Materials* 44:4–22
- Giordano S, et al. (2012c) Generalized Interface Models for Transport Phenomena: Unusual Scale Effects in Composite Nanomaterials. *Journal of Applied Physics* 112/8:084306
- Giordano S, et al. (2014) Analysis of Heterogeneous Structures Described by the Two-Temperature Model. *International Journal of Heat and Mass Transfer* 78:189–202
- Giordano S, et al. (2016a) Statistical Mechanics of Holonomic Systems as a Brownian Motion on Smooth Manifolds. *Annalen der Physik* 528/5:381
- Giordano S, et al. (2016b) Transport Properties of Multigrained Nanocomposites with Imperfect Interfaces. *Journal of Applied Physics* 120/18:184301
- Giordano S, et al. (2020) Rate-Dependent Force-Extension Models for Single-Molecule Force Spectroscopy Experiments. *Physical Biology* 17/5:056002
- Giordano S, Goueygou M, Tiercelin N, Talbi A, Pernod P, Preobrazhensky V (2014) Magneto-Electro-Elastic Effective Properties of Multilayered Artificial Multiferroics with Arbitrary Lamination Direction. *International Journal of Engineering Science* 78:134–153
- Giusepponi S, Celino M, Cleri F, Montone A (2009) Hydrogen storage in MgH₂ matrices: A study of Mg-MgH₂ interface using CPMD code on ENEA-GRID. *Nuovo Cimento-Società Italiana di Fisica Sezione C* 32:139
- Goel A, Stukowski A, Goel G, Luo X, Reuben RL (2012) Nanotribology at High Temperatures. *Beilstein Journal of Nanotechnology* 3:586–588. doi:10.3762/bjnano.3.68
- Gomes KK, Mar W, Ko W, Guinea F, Manoharan HC (2012) Designer Dirac Fermions and Topological Phases in Molecular Graphene. *Nature* 483/7389:306–310. doi:10.1038/nature10941
- Gong C, Lee S, Hong S, Yoon E, Lee GD, Warner JH (2017) Point Defects in Turbostratic Stacked Bilayer Graphene. *Nanoscale* 9/36:1–6. doi:10.1039/C7NR03879H
- Gordon RG, Kim YS (1971) Theory for the Forces between Closed-Shell Atoms and Molecules
- Goy E, Tomezak M, Facchin C, Martin N, Bouchaert E, Benoit J, de Schutter C, Nassour J, Saas L, Drullion C, Brodin PM, Vandeputte A, Molendi-Coste O, Pineau L, Goormachtigh G, Pluquet O, Pourtier A, Cleri F, Lartigau E, Penel N, Abbadie C (2022) The Out-Of-Field Dose in Radiation Therapy Induces Delayed Tumorigenesis by Senescence Evasion. *Elife* 11:e67190
- Graf D, Molitor F, Ensslin K, Stampfer C, Jungen A, Hierold C, Wirtz L (2007) Spatially Resolved Raman Spectroscopy of Single- and Few-Layer Graphene. *Nano Letters* 7/2:238–242. doi:10.1021/nl061702a
- Graf D, Molitor F, Ensslin K, Stampfer C, Jungen A, Hierold C, Wirtz L (2007) Spatially Resolved Raman Spectroscopy of Single- and Few-Layer Graphene. *Nano Letters* 7/2:238–242. doi:10.1021/nl061702a
- Grandidier B, de la Broise X, Stievenard D, Delerue C, Lannoo M, Stellmacher M, Bourgoin J (2000) Defect-Assisted Tunneling Current: A Revised Interpretation of Scanning Tunneling Spectroscopy Measurements. *Applied Physics Letters* 76/21:3142–3144
- Grandidier B, Niquet YM, Legrand B, Nys JP, Priester C, Stievenard, Gérard JM, Thierry-Mieg V (2000) Imaging the Wave-Function Amplitudes in Cleaved Semiconductor Quantum Boxes. *Physical Review Letters* 85/5:1068–1071. doi:10.1103/PhysRevLett.85.1068
- Grandidier B, Niquet YM, Legrand B, Nys JP, Priester C, Stievenard, Gérard JM, Thierry-Mieg V (2000) Imaging the Wave-Function Amplitudes in Cleaved Semiconductor Quantum Boxes. *Physical Review Letters* 85/5:1068–1071. doi:10.1103/PhysRevLett.85.1068
- Grandidier B, Nys JP, Delerue C, Stievenard D, Higo Y, Tanaka M (2000) Atomic-Scale Study of GaMnAs/GaAs Layers. *Applied Physics Letters* 77/24:4001
- Grandidier B, Nys JP, Stievenard D, de la Broise X, Delerue C, Lannoo M (1998) STM Measurements of Barrier Height on Si(111)-7x7 and GaAs(110) Cleaved Surfaces Using I(z), z(V) and I(z(V), V) Techniques. *Applied Physics A-Materials Science & Processing* 66:S977–S980
- Grandidier B, Nys JP, Stievenard D, Krzeminski C, Delerue C, Frere P, Blanchard P, Roncali J (2001) Effect of Alkyl Substituents on the Adsorption of Thienylenevinylene Oligomers on the Si(100) Surface. *Surface Science* 473/1–2:1–7
- Greboval C, Chu A, Magalhaes DV, Ramade J, Qu J, Rastogi P, Khalili A, Chee SS, Aubin H, Vincent G, Bals S, Delerue C, Lhuillier E (2021) Ferroelectric Gating of Narrow Band-Gap Nanocrystal Arrays with Enhanced Light-Matter Coupling. *ACS Photonics* 8/1:259–268
- Grieger KD, Hansen SF, Baun A (2009) The Known Unknowns of Nanomaterials: Describing and Characterizing Uncertainty within Environmental, Health and Safety Risks. *Nanotoxicology* 3/3:222–223. doi:10.1080/17435390902944069

- Groeneveld E, Delerue C, Allan G, Niquet YM, Donega CdM (2012) Size Dependence of the Exciton Transitions in Colloidal CdTe Quantum Dots. *Journal of Physical Chemistry C* 116/43:23160–23167
- Grondel S, Delebarre C, Assaad J, Dupuis JP, Reithler L (2002) Fatigue Crack Monitoring of Riveted Aluminium Strap Joints by Lamb Wave Analysis and Acoustic Emission Measurement Techniques. *NDT&E International* 35/3:137–146. doi:10.1016/S0963–8695(01)00027–5
- Grondel S, Delebarre C, Assaad J, Dupuis JP, Reithler L (2002) Fatigue Crack Monitoring of Riveted Aluminium Strap Joints by Lamb Wave Analysis and Acoustic Emission Measurement Techniques. *NDT&E International* 35/3:137–146. doi:10.1016/S0963–8695(01)00027–5
- Gu B, Munoz-Santiburcio D, Cleri F, Artacho E, Kohanoff J, Da Pieve F (2022) Bragg's Additivity Rule and Core and Bond Model Studied by Real-Time TDDFT Electronic Stopping Simulations: The Case of Water Vapor. *Radiation Physics and Chemistry* 193:109961
- Guerder PY, Giordano S, Matar OB, Vasseur JO (2015) Tuning the Elastic Nonlinearities in Composite Nanomaterials. *Journal of Physics–Condensed Matters* 27/14:145304
- Guiraud P, Giordano S, Bou Matar O, Pernod P, Lardat R (2021) Thermoacoustic Wave Generation in Multilayered Thermophones with Cylindrical and Spherical Geometries. *Journal of Applied Physics* 129/11
- Guiraud P, Giordano S, Bou–Matar O, Pernod P, Lardar R, (2019) Multilayer Modeling of Thermoacoustic Sound Generation for Thermophone Analysis and Design. *Journal of Sound and Vibration* 455:275–298
- Guiraud P, Giordano S, Bou–Matar O, Philippe P, Raphael L (2019) Two Temperature Model for Thermoacoustic Sound Generation in Thick Porous Thermophones. *Journal of Applied Physics* 126:165111–165111–12
- Gupta AK, Gupta M (2005) Synthesis and Surface Engineering of Iron Oxide Nanoparticles for Biomedical Applications. *Biomaterials* 26:3995–4021.
- Guralnik DB ed. (1970) Webster's New World Dictionary. World New York
- Haddon RC, Brus LE, Raghavachari (1986) Electronic Structure and Bonding in Icosahedral C₆₀. *Chemical Physics Letters* 125/5–6:459–464. doi:10.1016/0009–2614(86)87079–8
- Hall JS (2005) Nanofuture: What's Next for Nanotechnology. Prometheus Books, Amherst, New York
- Hamilton RL, Crosser OK (1962) Thermal Conductivity of Heterogeneous Two–Component Systems. *Industrial & Engineering Chemistry Fundamentals* 1/3:187–191. doi:10.1021/i160003a005
- Hammoudi K, Benhabiles H, Melkemi M, Dornaika F, Arganda–Carreras I, Collard D, Scherpereel A (2021) Deep Learning on Chest X–Ray Images to Detect and Evaluate Pneumonia Cases at the Era of COVID–19. *Journal of Medical Systems* 45/7:75
- Handy RD, Shaw BJ (2007) Toxic Effects of Nanoparticles and Nanomaterials: Implications for Public Health, Risk Assessment and the Public Perception of Nanotechnology. *Health Risk & Society* 9/2:125–144. doi:10.1080/13698570701306807
- Hansma HG, Vesenka J, Siergerist C, Kelderman G, Morrett H (1992) Reproducible Imaging and Dissection of Plasmid DNA under Liquid with the Atomic Force Microscope. *Science* 256:1180–1184. doi:10.1126/science.256.5060.1180
- Harmia–Pulkkinen T, Tuomi A, Kristoffersson E (1989) Manufacture of Polyalkylcyanoacrylate Nanoparticles with Pilocarpine and Timolol by Micelle Polymerization: Factors Influencing Particle Formation. *Journal of Microencapsulation* 6/1:87–93. doi:10.3109/02652048909019905
- Harush–Frenkel O, Debotton N, Benita S, Altschuler Y (2006) Targeting of Nanoparticles to the Clathrin–Mediated Endocytic Pathway. *Biochemical and Biophysical Research Communications* 353/1:26–32. doi:10.1016/j.bbrc.2006.11.135
- Hasan A, Morshed M, Memic A, Hassan S, Webster TJ, Marei HES (2018) Nanoparticles in Tissue Engineering: Applications, Challenges and Prospects. *International Journal of Nanomedicine* 13:5637–5655. doi:10.2147/IJN.S153758
- Hassan K, Dayoub I, Hamouda W, Nzéza CN, Berbineau M (2012) Blind Digital Modulation Identification for Spatially–Correlated MIMO Systems. *IEEE Transactions on Wireless Communications* 11/2:683–693. doi:10.1109/TWC.2011.122211.110236
- Hassan K, Dayoub I, Hamouda W, Nzéza CN, Berbineau M (2012) Blind Digital Modulation Identification for Spatially–Correlated MIMO Systems. *IEEE Transactions on Wireless Communications* 11/2:683–693. doi:10.1109/TWC.2011.122211.110236
- Havrlant L, Kreinovich V (2017) A Simple Probabilistic Explanation of Term Frequency–Inverse Document Frequency (tf-idf) Heuristic (and variations motivated by this explanation). *International Journal of General Systems* 46/1:27–36. doi:10.1080/03081079.2017.1291635

- He R, Benhabiles H, Windal F, Even G, Audebert C, Decherf A, Collard D, Taleb–Ahmed A (2022) A CNN–based Methodology for Cow Heat Analysis from Endoscopic Images. *Applied Intelligence* 52/8:8372–8385
- Hecht E (1998) *Optics*. Addison Wesley Longman, Inc., Boston
- Heinrich AJ, Lutz CP, Gupta JA, Eigler DM (2002) Molecule Cascades. *Science* 298/5597:1381–1387. doi:10.1126/science.1076768
- Hens Z, Grandidier B, Deresmes D, Allan G, Delerue C, Stievenard D, Vanmaekelbergh D (2004) Evolution of the Density of States on Going from a Two– to a Zero–Dimensional Semiconductor. *Europhysics Letters* 65/6:809–815
- Hens Z, Vanmaekelbergh D, Kooij ES, Wormeester H, Allan G, Delerue C (2004) Effect of Quantum Confinement on the Dielectric Function of PbSe. *Physical Review Letters* 92/2:06828
- Herrera–Basurto R, Simoet BM (2013) Nanometrology. In *Encyclopedia of Analytical Chemistry*. John Wiley and Sons, Ltd New York. doi:10.1002/9780470027318.a9177
- Herrmann IK, Grass RN, Stark WJ (2009) High–Strength Metal Nanomagnets for Diagnostics and Medicine: Carbon Shells allow Long–Term Stability and Reliable Linker Chemistry. *Nanomedicine* 4/7:787–98. doi:10.2217/nmm.09.55
- Herrmann IK, Schlegel A, Graf R, Schumacher CM, Senn N, Hasler M, Gschwind S, Hirt AM, Günther D, Clavien PA, Stark WJ, Beck–Schimmer B (2013a) Nanomagnet–Based Removal of Lead and Digoxin from Living Rats. *Nanoscale* 5/18:8718–23. doi:10.1039/c3nr02468g
- Herrmann IK, Urner M, Graf S, Schumacher CM, Roth–Z’graggen B, Hasler M, Stark WJ, Beck–Schimmer B (2013b) Endotoxin Removal by Magnetic Separation–Based Blood Purification. *Advanced Healthcare Materials* 2/6:829–835. doi:10.1002/adhm.201200358
- Himpfel FJ, Ortega JE, Mankey GK, Willis RF (1998) Magnetic Nanostructures. *Advanced Physics* 47/4:511–597. doi:10.1080/000187398243519
- Hjorth R (2017) The Shortfall of Risk Assessment for Decision–Making. *Nature Nanotechnology* 12/12:1109–1110. doi:10.1038/nnano.2017.232
- Hladky–Hennion AC, Decarpigny JN (1991) Analysis of the Scattering of a Plane Acoustic Wave by a Doubly Periodic Structure using the Finite Element Method: Application to Alberich Anechoic Coating. *The Journal of the Acoustical Society of America* 90/6:3356–3367. doi:10.1121/1.401395
- Hoet PHM, Brüske–Holfield I, Salata OV (2004) Nanoparticles – Known and Unknown Health Risks. *Journal of Nanobiotechnology* 2/1:12. doi:10.1186/1477–3155–2–12
- Hogan CJ, Lee MH, Biswas P (2004) Capture of Viral Particles in Soft X–Ray–Enhanced Corona Systems: Charge Distribution and Transport Characteristics. *Aerosol Science and Technology* 38/5:475–486. doi:10.1080/02786820490462183
- Holsapple MP, Farland WH, Landry TD, Monteiro–Riviere NA, Carter JM, Walker NJ, Thomas KV (2005) Research Strategies for Safety Evaluation of Nanomaterials, part II: Toxicological and Safety Evaluation of Nanomaterials, Current Challenges and Data Needs. *Toxicological Sciences* 88/1:12–7. doi:10.1093/toxsci/kfi293
- Homayouni SM, Schreurs DMMP, Crupi G, Nauwelaers BKJC (2009) Technology–Independent Non–Quasi–Static Table–Based Nonlinear Model Generation. *IEEE Transactions on Microwave Theory and Techniques* 57/12:2845–2852. doi:10.1109/tmtt.2009.2033840
- Howard JB, McKinnon JT, Makarovskiy Y, Lafleur AL, Johnson ME (1991) Fullerenes C60 and C70 in Flames. *Nature* 11/352:139–141. doi:10.1038/352139a0
- Hsu SM, Ying CZ (2002) *Nanotribology: Critical Assessment and Research Need*. Kluwer Academic Publishers, Alphen aan der Rijn
- Huang P, Lethien C, Pinaud S, Brousse K, Laloo R, Turq V, Respaud M, Demortière A, Daffos B, Taberna PL, Chaudret B, Gogotsi Y, Simon P (2016) On–Chip and Freestanding Elastic Carbon Films for Micro–Supercapacitors. *Materials Science* 351/6274:691–695. doi:10.1126/science.aad3345
- Huang P, Lethien C, Pinaud S, Brousse K, Laloo R, Turq V, Respaud M, Demortière A, Daffos B, Taberna PL, Chaudret B, Gogotsi Y, Simon P (2016) On–Chip and Freestanding Elastic Carbon Films for Micro–Supercapacitors. *Materials Science* 351/6274:691–695. doi:10.1126/science.aad3345
- Hudson MH, Chen M, Kamysbayev V, Janke EM, Lan X, Allan G, Delerue C, Lee B, Guyot–Sionnest P, Talapin DV (2018) Conduction Band Fine Structure in Colloidal HgTe Quantum Dots. *ACS Nano* 12/9:9397–9404
- Huff H (2005) *High Dielectric Constant Materials: VLSI MOSFET Applications*. Springer Science & Business Media, Berlin

- Iavicoli I, Leso V, Ricciardi W, Hodson LL, Hoover MD (2014) Opportunities and Challenges of Nanotechnology in the Green Economy. *Environmental Health* 13/1:1–11. doi:10.1186/1476-069X-13-78
- Ignatyev MB (2010) Necessary and Sufficient Conditions of Nanorobot Synthesis. *Doklady Mathematics* 82/1:671–675. doi:10.1134/S1064562410040435
- Illum L, Farraj NF, Davis SS (1994) Chitosan as Novel Nasal Delivery System for Peptide Drugs. *Pharmaceutical Research* 11/8:1186–9. doi:10.1023/a:1018901302450.
- Immordino ML, Dosio F, Cattel L (2006) Stealth Liposome: Review of the Basic Science, Rationale, and Clinical Applications, Existing and Potential. *International Journal of Nanomedicine* 1/3: 297–315. doi:10.2217/17435889.1.3.297
- Innes RA, Sambles JR (1987) Optical Characterisation of Gold Using Surface Plasmon–Polariton. *Journal of Physics F Metal Physics* 17/1:277–287. doi:10.1088/0305-4608/17/1/031
- Ishida T, Cleri F, Kakushima K, Mita M, Sato T, Miyata M, Itamura N, Endo J, Toshiyoshi H, Sasaki N, Collard D, Fujita H (2011) Exceptional Plasticity of Silicon Nanobridges. *Nanotechnology* 22/35:355704
- ISO/TS 80004-1 (2015) Nanotechnologies – Vocabulary – Part 1: Core Terms. <https://www.iso.org/obp/ui/#iso:std:iso:ts:80004:-1:ed-2:v1:en>
- Jaiswal JK, Goldman ER, Mattoussi H, Simon SM (2004) Use of Quantum Dots for Live Cell Imaging. *Nature Methods* 1:73–78. <https://doi.org/10.1038/nmeth1004-73>
- Jantunen APK, Gottardo S, Rasmussen K, Crutzen HP (2018) An Inventory of Ready-to-Use and Publicly Available Tools for the Safety Assessment of Nanomaterials *NanoImpact* 12:18–28. doi:10.1016/j.impact.2018.08.007
- Jantunen APK, Mech A, Rasmussen K (2018) Workshop on Regulatory Preparedness for Innovation in Nanotechnology. Joint Research Centre Conference and Workshop Reports
- Javey A, Guo J, Wang Q, Lundstrom M, Dai H (2003) Ballistic Carbon Nanotube Field-Effect Transistors. *Nature* 424/6949:654–657. doi:10.1038/nature01797
- Jazi MA, Janssen VAEC, Evers WH, Tadjine A, Delerue C, Siebbeles LDA, van der Zant HSJ, Houtepen AJ, Vanmaekelbergh D (2017) Transport Properties of a Two-Dimensional PbSe Square Superstructure in an Electrolyte-Gated Transistor. *Nano Letters* 17/9:5238–5243
- Jazi MA, Kulkarni A, Sinai SB, Peters JL, Geschiere E, Failla M, Delerue C, Houtepen AJ, Siebbeles LDA, Vanmaekelbergh D (2019) Room-Temperature Electron Transport in Self-Assembled Sheets of PbSe Nanocrystals with a Honeycomb Nanogeometry. *The Journal of Physical Chemistry* 123:14058–14066. doi:10.1021/acs.jpcc.9b03549
- Jdira L, Overgaag K, Stiuftuc R, Grandidier B, Delerue C, Speller S, Vanmaekelbergh D (2008) Linewidth of Resonances in Scanning Tunneling Spectroscopy. *Physical Review B* 77/20:205308–205308–11
- Johnson D (2010) Junctionless Transistor Fabricated from Nanowires. Institute of Electric and Electronic Engineers Spectrum, Piscataway
- Johnson PB, Christy RW (1972) Optical Constant of the Noble Metals. *Physical Review B* 6/12:4370–4379. doi:10.1103/physrevb.6.4370
- Jomaa N, Delerue C, Said M (2017) Intrinsic Strain Effects on Ge/Si Core/Shell Nanowires: Insights from Atomistic Simulations. *Superlattices and Microstructures* 107:83–90
- Jones MC, Leroux JC (1999) Polymeric Micelles—A New Generation of Colloidal Drug Carriers. *European Journal of Pharmaceutics and Biopharmaceutics* 48:101–111. doi:10.1016/S0939-6411(99)00039-9
- Journal of Microencapsulation* 19/1:53–60. doi:10.1080/02652040110055207
- Juzgado A, Solda A, Ostric A, Criado A, Valenti G, Rapino S (2017) Highly Sensitive Electrochemiluminescence Detection of a Prostate Cancer Biomarker. *Journal of Materials Chemistry B* 5/32:6681–6687. doi:10.1039/c7tb01557g
- Kalesaki E, Delerue C, Smith CM, Beugeling W, Allan G, Vanmaekelbergh D, (2014) Dirac Cones, Topological Edge States, and Nontrivial Flat Bands in Two-Dimensional Semiconductors with a Honeycomb Nanogeometry. *Physical Review X* 4/1:011010–011022
- Kalesaki E, Evers WH, Allan G, Vanmaekelbergh D, Delerue C (2013) 88/11 Electronic Structure of Atomically Coherent Square Semiconductor Superlattices with Dimensionality Below Two. *Physical Review B* 88/11:115431–115431–9
- Kalff FE, Rebergen MP, Fahrenfort E, Girovsky J, Toskovic R, Lado JL, Fernández-Rossier J, Otte AF (2016) A Kilobyte Rewritable Atomic Memory. *Nature Nanotechnology* 7/11:926–929. doi:10.1038/nnano.2016.131

- Kamal RA, Sanni ML, Kanj MY (2010) System, Method, and Nanorobot to Explore Subterranean Geophysical Formations. United States Patent 9,063,252 B2. Washington DC: USTPO
- Kang JH, Super M, Yung CW, Cooper RM, Domansky K, Graveline AR, Mammoto T, Berthet JB, Tobin H, Cartwright MJ, Watters AL, Rottman M, Waterhouse A, Mammoto A, Gamini N, Rodas MJ, Kole A, Jiang A, Valentin TM, Diaz A, Takahashi K, Ingber DE (2014) An Extracorporeal Blood–Cleansing Device for Sepsis Therapy. *Nature Medicine* 20/10:1211–6. doi:10.1038/nm.3640
- Karcher S, Willighagen EL, Rumble J, Ehrhart F, Evelo CT, Fritts M, Gaheen S, Harper SL, Hoover MD, Jeliakova N, Lewinski N, Marchese Robinson RL, Mills KC, Mustad AP, Thomas DG, Tsiliki G, Hendren CO (2018) Integration among Databases and Data Sets to Support Productive Nanotechnology: Challenges and Recommendations. *Nanoimpact* 9:85–101. doi:10.1016/j.impact.2017.11.002
- Karimi M, Ghasemi A, Zangabad PS, Rahighi R, Basri SMM, Mirshekari H, Amiri M, Pishabad ZS, Aslani A, Bozorgomid M, Ghosh D, Beyzavi A, Vaseghi A, Aref AR, Haghani L, Bahrami S, Hamblin MR (2016) Smart Micro/Nanoparticles in Stimulus–Responsive Drug/Gene Delivery Systems. *Chemical Society Reviews* 45/5:1457–1501. doi:10.1039/c5cs00798d
- Karlsson S, Albertsson AC (1995) *Degradable Polymers: Principles and Applications*. Chapman & Hall, London
- Kearfott RB, Kreinovich V (1996) Applications of Interval Computations: An Introduction. Application of Interval Computations In: Kearfott, R.B., Kreinovich, V. (eds) *Applications of Interval Computations*. Applied Optimization, vol 3. Springer, Boston
- Keblinski P, Phillpot SR, Choi SUS, Eastman JA (2002) Mechanisms of Heat Flow in Suspension of Nano–Sized Particles (Nanofluids). *International Journal of Heat and Mass Transfer* 45/4:855–863. doi:10.1016/S0017–9310(01)00175–2
- Keblinsky P, Eastman JA, Cahill DG (2005) Nanofluids for Thermal Transport. *Materials Today* 8/6:36–44. doi:10.1016/S1369–7021(05)70936–6
- Keller N, Guyot M, Das A, Porte M, Krishnan R (1998) Study of the Interdiffusion at the Interface NiO/ α -Fe₂O₃ Multilayers Prepared by Pulsed Laser Deposition. *Solid State Communications* 105/5:333–337. doi:10.1016/S0038–1098(97)10047–3
- Kelly TR, De Silva H, Silva RA (1999) Unidirectional Rotary Motion in a Molecular System. *Nature* 401/6749:150–152. doi:10.1038/43639
- Keuleyan SE, Guyot–Sionnest P, Delerue C, Allan G (2014) Mercury Telluride Colloidal Quantum Dots: Electronic Structure, Size–Dependent Spectra, and Photocurrent Detection up to 12 μ m. *ACS Nano* 8/8:8676–8682
- Kim H, Palacio–Morales A, Posske T, Rózsa L, Palotás K, Szunyogh L, Thorwart M, Wiesendanger, R (2018) Toward Tailoring Majorana Bound States in Artificially Constructed Magnetic Atom Chains on Elemental Superconductors. *Science Advances* 4/5:ear5251 1–7. doi:10.1126/sciadv.aar5251
- Kiraly B, Knol EJ, van Weerdenburg WMJ, Kappen HJ, Khajetoorians AA (2021) An Atomic Boltzmann Machine Capable of Self–Adaption. *Nature Nanotechnology* 16:414–420.
- Kittelson DB (1998) Engines and Nanoparticles: A Review; *Journal of Aerosol Science* 29/5–6:575–588. doi:10.1016/s0021–8502(97)10037–4
- Klimov A, Tiercelin N, Dusch Y, Giordano S, Mathurin T, Pernod P, Preobrazhensky V, Churbanov A, Nikitov S (2017) Magnetolectric Write and Read Operations in a Stress–Mediated Multiferroic Memory Cell. *Applied Physics Letters* 110/22:222401
- Knap W, Lusakowski J, Parenty T, Bollaert S, Cappy A, Popov VV, Shur MS (2004) Terahertz Emission by Plasma Waves in 60nm Gate High Electron Mobility Transistors. *Applied Physics Letters* 84/13:2331–2333. doi:10.1063/1.1689401
- Knap W, Lusakowski J, Parenty T, Bollaert S, Cappy A, Popov VV, Shur MS (2004) Terahertz Emission by Plasma Waves in 60nm Gate High Electron Mobility Transistors. *Applied Physics Letters* 84/13:2331–2333. doi:10.1063/1.1689401
- Ko W, Ma C, N GD, Kolmer A, Li AP, Nguyen GD (2019) Atomic–Scale Manipulation and in situ Characterization with Scanning Tunneling Microscopy. *Advanced Functional Materials* 29/52:1–56
- Kofman R, Cheyssac P, Lereah Y, Stella A (1999) Melting of Clusters Approaching OD. *The European Physical Journal D*. 9/1–4:441–444. doi:10.1007/s100530050475
- Koleskin NF, St.Pierre GR (1980) The Influence of Water Vapor on the Decomposition of Carbon Monoxide on Reduced Iron Oxide. *Metallurgical and Materials Transactions B* 11B:285

- Koole R, Allan G, Delerue C, Meijerink A, Vanmaekelbergh D, Houtepen AJ (2008) Optical Investigation of Quantum Confinement in PbSe Nanocrystals at Different Points in the Brillouin Zone. *Small* 4/1:127–133
- Koškin NI, Širkevič MG (1989) *Spravočnik po elementarnoj fizike*. Nauka, Moscow
- Krause HJ, Schwarz A, Rohdewald P. (1986) Interfacial Polymerization, an Useful Method for the Preparation of Polymethylcyanoacrylate Nanoparticles. *Drug Development and Industrial Pharmacy* 12/4:527–552. doi:10.3109/03639048609048026
- Kregse CT, Vartuli JC, Roth WJ, Leonowicz ME (2004) The Discovery of ExxonMobil's M41S Family of Mesoporous Molecular Sieves. *Studies in Surface Science and Catalysis* 148:53–72. doi:10.1016/S0167-2991(04)80193-9
- Kreinovich V (1991) Arbitrary Nonlinearity is Sufficient to Represent all Functions by Neural Networks: a Theorem. *Neural Networks* 4/3:381–383. doi:10.1016/0893-6080(91)90074-F
- Kreinovich V (2014) Decision Making Under Interval Uncertainty (and Beyond). In: Guo, P., Pedrycz, W. (eds) *Human-Centric Decision-Making Models for Social Sciences*. Studies in Computational Intelligence, vol 502. Springer, Berlin, Heidelberg
- Kreinovich V, Ferson SA (2004) A New Cauchy-Based Black-Box Technique for Uncertainty in Risk Analysis. *Reliability Engineering & System Safety* 85/1–3:267–279. doi:10.1016/j.res.2004.03.016
- Kreinovich V, Lakeyev AV, Rohn J, Kahl PT (2013) *Computational Complexity and Feasibility of Data Processing and Interval Computations*. Springer Science & Business Media, Dordrecht
- Kreinovich V, Quintana C, Fuentes (1993) Genetic Algorithms: What Fitness Scaling is Optimal? *Cybernetics and Systems* 24/1:9–26. doi:10.1080/01969729308961696
- Kriso C, Triozon F, Delerue C, Schneider L, Abbate F, Nolot E, Rideau D, Niquet YM, Mugny G, Tavernier C (2017) Modeled Optical Properties of SiGe and Si Layers Compared to Spectroscopic Ellipsometry Measurements. *Solid-State Electronics* 129:93–96
- Krull A, Hirsch P, Rother C, Schiffrin A, Krull C (2020) Artificial-Intelligence-Driven Scanning Probe Microscopy. *Communications Physics* 3/1:1–8. doi:10.1038/s42005-020-0317-3
- Krzeminski C, Brulin Q, Cuny V, Lecat E, Lampin E, Cleri F. (2006) Molecular Dynamics Simulation of the Recrystallization of Amorphous Si Layers: Comprehensive Study of the Dependence of the Recrystallization Velocity on the Interatomic Potential. *Journal of Applied Physics* 101/12:123506
- Kuhn DA, Vanhecke D, Michen B, Blank F, Gehr P, Petri-Fink A, Rothen-Rutishauser B. Beilstein (2014) Different Endocytotic Uptake Mechanisms for Nanoparticles in Epithelial Cells and Macrophages. *Journal of Nanotechnology* 5:1625–1636. doi:10.3762/bjnano.5.174
- Kuhn K (2018) CMOS and Beyond CMOS: Scaling Challenges. In *High Mobility Materials for CMOS Applications*. Woodhead Publishing, Sawston
- Kumar A, Madden DG, Lusi M, Chen K, Daniels EA, Curtin T, Perry JJ, Zaworotko MJ (2015) Direct Air Capture of CO₂ by Physisorbent Materials. *Angewandte Chemie International Edition* 54/48:14372–14377. doi:10.1002/anie.201506952
- Kumemura M, Pekin D, Menon VA, Van Seuning I, Collard D, Tarhan MC (2021) Fabricating Silicon Resonators for Analysing Biological Samples. *Micromachines* 12/12:1536
- Kunst FK, Delerue C, Smith CM, Juricic V (2015) Kekule Versus Hidden Superconducting Order in Graphene-Like Systems: Competition and Coexistence. *Physical Review B* 92/16:165423–165423–13
- Kurouski D, Dazzi A, Zenobi R, Centrone A (2005) Infrared and Raman Chemical Imaging and Spectroscopy at the Nanoscale. *Chemical Society Reviews* 2020 49:3315–3347. doi:10.1039/C8CS00916C
- Kurzweil R (2005) *The Singularity is Near. When Humans Transcend Biology*. Viking Penguin Books, London
- Kushwaha KK, Kumari S, Mahobia SK, Tiwary SK, Sinha BK, Ramrakhiani M (2018) Synthesis and Characterization of ZnSe/CdSe/ZnS Nano-Particles Embedded in Polymer Matrix: A Review. *International Journal of Composite and Constituent Materials* 4/1:28–33. doi:10.1021/jp046481g
- Lalwani G, Henslee AM, Farshid B, Lin L, Kasper FK, Qin YX, Mikos AG, Sitharaman B (2013) Two-Dimensional Nanostructure-Reinforced Biodegradable Polymeric Nanocomposites for Bone Tissue Engineering. *Biomacromolecules* 14/3:900–9. doi:10.1021/bm301995s
- Lalwani G, Henslee AM, Farshid B, Parmar P, Lin L, Qin YX, Kurtis Kasper F, Mikos AG, Sitharaman B (2013) Tungsten Disulphide Nanotubes Reinforced Biodegradable Polymers for Bone Tissue Engineering. *Acta Biomaterialia* 9/9:8365–73. doi:10.1016/j.actbio.2013.05.018

- Lamba V, Engles D, Malik SS, Verma M. (2009). Quantum transport in silicon double-gate MOSFET. 2nd International Workshop on Electron Devices and Semiconductor Technology: 1–4. doi:10.1109/EDST.2009.5166116
- LaMer VK, Dinegar RH (1950) Theory, Production and Mechanism of Formation of Monodispersed Hydrosols. *Journal of the American Chemical Society* 72/11:4847. doi:10.1021/ja01167a001
- Lampin E, Cleri F, et al. (2013) Thermal Conductivity from Approach-to-Equilibrium Molecular Dynamics. *Journal of Applied Physics* 114/033525. doi: 10.1063/1.4815945
- Lampin E, Cleri F, et al. (2013) Thermal Conductivity from Approach-to-Equilibrium Molecular Dynamics. *Journal of Applied Physics* 114/3:1–5. doi:10.1063/1.4815945
- Lampin E, Cleri F, et al. (2018) Interface Thermal Behavior in Nanomaterials by Thermal Grating Relaxation. *International Journal of Heat and Mass Transfer*. Retrieved December 15 2020 from <https://arxiv.org/abs/1805.12086>
- Lampin E, Delerue C, Lannoo M, Allan G (1998) Frequency-Dependent Hopping Conductivity between Silicon Nanocrystallites: Application to Porous Silicon. *Physical Review B* 58/18:12044–12048
- Lampin E, Nguyen QH, Francioso PA, Cleri F (2012) Thermal Boundary Resistance at Silicon-Silica Interfaces by Molecular Dynamics Simulations. *Applied Physics Letters* 100/131906. doi:10.1063/1.3698325
- Landuzzi F, Viader-Godoy X, Cleri F, Pastor I, Ritort F (2020) Detection of Single DNA Mismatches by Force Spectroscopy in Short DNA Hairpins. *Journal of Chemical Physics* 152/7:074204
- Langlet P, Hladky-Hennion AC, Decarpigny JN (1995) Analysis of the Propagation of Plane Acoustic Waves in Passive Periodic Materials using the Finite Element Method. *The Journal of the Acoustical Society of America* 98/5:2792–2800. doi:10.1121/1.413244
- Langlet P, Hladky-Hennion AC, Decarpigny JN (1995) Analysis of the Propagation of Plane Acoustic Waves in Passive Periodic Materials using the Finite Element Method. *The Journal of the Acoustical Society of America* 98/5:2792–2800. doi:10.1121/1.413244
- Lannoo M, Prins PT, Hens Z, Vanmaekelbergh D, Delerue C (2022) Universality of Optical Absorbance Quantization in Two-Dimensional Group-IV, III-V, II-VI, and IV-VI Semiconductors. *Physical Review B* 105/3:035421–035434
- Larese Filon F, Bello D, Cherrie JW, Sleuwenhoek A, Spaan S, Brouwer DH (2016) Occupational Dermal Exposure to Nanoparticles and Nano-Enabled Products: Part I-Factors Affecting Skin Absorption. *International Journal of Hygiene and Environmental Health* 219/6/8:536–544
- Latthe SS, Terashima C, Nakata K, Fujishima A (2014) Superhydrophobic Surfaces Developed by Mimicking Hierarchical Surface Morphology of Lotus Leaf. *Molecules* 19:4256–4283. doi:10.3390/molecules19044256
- LaVan DA, McGuire T, Langer R (2003) Small-Scale Systems for *in vivo* Drug Delivery. *Nature Biotechnology* 21/10:1184–91. doi:10.1038/nbt876
- Lederer D, Kilchytska V, Rudenko T, Collaert N, Flandre D, Dixit A, De Meyer K, Raskin JP (2005) FinFET Analogue Characterization from DC to 110GHz. *Solid-State Electronics* 49/9:1488–1496. doi:10.1016/j.sse.2005.07.011
- Lee H, Yu, LE, Ryu SW, Han JW, Jeon K, Jang DY, Kim KH, Lee J, Kim JH, Jeon S, Lee G, Oh J, Park Y, Bae W, Lee H, Yang J, Yoo J, Kim S Choi YK (2006) Sub-5nm All-Around Gate FinFET for Ultimate Scaling. 2006 Symposium on VLSI Technology. 2006 Digest of Technical Papers
- Lee JJ, Jeong KJ, Hashimoto M, Kwon AH, Rwei A, Shankarappa SA, Tsui JH, Kohane DS (2014) Synthetic Ligand-Coated Magnetic Nanoparticles for Microfluidic Bacterial Separation from Blood. *Nano Letters* 14/1:1–5. doi:10.1021/nl3047305
- Lee KB, Park S, Mirkin CA (2004) Multicomponent Magnetic Nanorods for Biomolecular Separations. *Angewandte Chemie-International Edition* 43/23:3048–3050. doi:10.1002/anie.200454088
- Lee S, Choi SUS, Li S, Eastman JA (1999) Measuring Thermal Conductivity of Fluids Containing Oxide Nanoparticles. *Journal of Heat Transfer* 121/2:280–289. doi:10.1115/1.2825978
- Legrand B, Quevy E, Stefanelli B, Collard D, Buchaillot L (2002) Vacuum and Cryogenic Station for Microelectromechanical Systems Probing and Testing. *Review of Scientific Instruments* 73/12:4393–4395
- Legrand B, Rollier AS, Collard D, Buchaillot L (2006) Suppression of the Pull-In Instability for Parallel-Plate Electrostatic Actuators Operated in Dielectric Liquids. *Applied Physics Letters* 88/3:034105
- Leinen P, Esders M, Schütt KT, Wagner C, Mueller KR, Tautz FS (2020) Autonomous Robotic Nanofabrication with Reinforcement Learning. *Science Advances* 6/36:1–8 eabb6987. doi:10.1126/sciadv.abb6987

- Lenfant S, Krzeminski C, Delerue C, Allan G, Vuillaume D (2003) Molecular Rectifying Diodes from Self-Assembly on Silicon. *Nano Letters* 3/6:741–746
- Létiche M, Eustache E, Freixas J, Demortière A, De Andrade V, Morgenroth L, Tilmant P, Vaurette F, Troadec D, Roussel P, Brousse T, Lethien C (2017) Atomic Layer Deposition of Functional Layers for on Chip 3D Li-Ion All Solid State Microbattery. *Advanced Energy Materials* 7/2:1–12. doi:10.1002/aenm.201601402
- Létiche M, Eustache E, Freixas J, Demortière A, De Andrade V, Morgenroth L, Tilmant P, Vaurette F, Troadec D, Roussel P, Brousse T, Lethien C (2017) Atomic Layer Deposition of Functional Layers for on Chip 3D Li-Ion All Solid State Microbattery. *Advanced Energy Materials* 7/2:1–12. doi:10.1002/aenm.201601402
- Lewis DD (1990) *Biodegradable Polymers as Drug Delivery Systems*. Marcel Dekker, New York
- Li J, Delerue C (2019) Intrinsic Transport Properties of Nanoporous Graphene Highly Suitable for Complementary Field-Effect Transistors. *2D Materials* 6/3
- Li J, Gu T, Delerue C, Niquet YM (2013) Electronic Structure and Transport Properties of Si Nanotubes. *Journal of Applied Physics* 114/5:053706
- Li J, Jomaa N, Niquet YM, Said M, Delerue C (2014) Hole Mobility in Ge/Si Core/Shell Nanowires: What Could be the Optimum? *Applied Physics Letters* 105/23:233104
- Li J, Lampin E, Delerue C, Niquet YM (2016) Theoretical Investigation of the Phonon-Limited Carrier Mobility in (001) Si Films. *Journal of Applied Physics* 120/17:1480–1487
- Li J, Mugny G, Niquet YM, Delerue C (2015) Drift Velocity Versus Electric Field in < 110 > Si Nanowires: Strong Confinement Effects. *Applied Physics Letters* 107/6:063103
- Li J, Niquet YM, Delerue C (2016) Magnetic-Phase Dependence of the Spin Carrier Mean Free Path in Graphene Nanoribbons. *Physical Review Letters* 116/23:236602–236607
- Li S, Ogura Y, Kreinovich V (2013) *Limit Theorems and Applications of Set-Valued and Fuzzy Set-Valued Random Variables*. Springer Science & Business Media, Dordrecht
- Li YC, Xin HB, Lei HX, Liu LL, Li YZ, Zhang Y, Li BJ (2016) Manipulation and Detection of Single Nanoparticles and Biomolecules by a Photonic Nanojet. *Light Science & Applications* 5:1–9. doi:10.1038/lsa.2016.176
- Lim JP, Gleeson PA (2011) Macropinocytosis: an Endocytic Pathway for Internalising Large Gulp. *Immunology and Cell Biology* 89/8:836–843. doi:10.1038/icb.2011.20
- Lin YS, Tsai CP, Huang HY, Kuo CT, Hung Y, Huang DM, Chen YC, Mou CY (2005) Well-ordered Mesoporous Silica Nanoparticles as Cell Markers[J]. *Chemistry of Materials* 17/18:4570–4573. doi: 10.1021/cm051014c.
- Lindquist E, Mosher-Howe KN, Liu X (2010) Nanotechnology... What Is It Good For? (Absolutely Everything): A Problem Definition Approach. *Review of Policy Research* 27/3:255–271.
- Lindsey JS (1991) Self-Assembly in Synthetic Routes to Molecular Devices. *Biological Principles and Chemical Perspectives: a Review*. *New Journal of Chemistry* 15:153–180. doi:10.1002/chin.199138328
- Linkov I, Anklam E, Collier ZA, DiMase D, Renn O (2014) Risk-Based Standards: Integrating Top-Down and Bottom-Up Approaches. *Environment Systems and Decisions* 34/1:134–137. doi:10.1007/s10669-014-9488-3
- Lippens PE, Lannoo M (1989) Calculation of the Band Gap for Small CdS and ZnS Crystallites. *Physical Review B* 39/15:10935–10942. doi:10.1103/physrevb.39.10935
- Liu B, Jiang H, Johnson HT, Huang Y (2004) The Influence of Mechanical Properties of Single Wall Carbon Nanotubes. *Journal of the Mechanics and Physics of Solids* 52/1:1–26. doi:10.1016/S0022-5096(03)00112-1
- Liu F, Wagterveld RM, Gebben B, Otto MJ, Biesheuvel PM, Hamelers HVM (2014) Carbon Nanotube Yarns as Strong Flexible Conductive Capacitive Electrodes. *Colloids and Interface Science Communications* 3:9–12. doi:10.1016/j.colcom.2015.02.001
- Liu X, Yang P, Jiang Q (2007) Size Effects on the Melting Temperature of Nanostructured Drugs. *Material Chemistry and Physics* A 103:1–4
- Liu Y, Daum PH (2000) The Effect of Refractive Index on Size Distributions and Light Scattering Coefficients Derived From Optical Particle Counters. *Journal of Aerosol Science* 31/8:945–957. doi:10.1016/S0021-8502(99)00573-X
- Łoczechin A, Séron K, Barras A, Giovanelli E, Belouzard S, Chen YT, Metzler-Nolte, Boukherroub R, Dubuisson J, Szunerits S (2019) Functional Carbon Quantum Dots as Medical Countermeasures to Human Coronavirus. *ACS Applied Materials & Interfaces* 11/46:42964–42974. doi:10.1021/acsami.9b15032

- Łoczechin A, Séron K, Barras A, Giovanelli E, Belouzard S, Chen YT, Metzler–Nolte, Boukherroub R, Dubuisson J, Szunerits S (2019) Functional Carbon Quantum Dots as Medical Countermeasures to Human Coronavirus. *ACS Applied Materials & Interfaces* 11/46:42964–42974. doi:10.1021/acsami.9b15032
- Loeblein M, Perry G, Tsang SH, Xiao W, Collard D, Coquet P, Sakai Y, Teo EHT (2016) Three–Dimensional Graphene: A Biocompatible and Biodegradable Scaffold with Enhanced Oxygenation. *Advanced Healthcare Materials* 5/10:1177–1191
- López–Suárez A, Torres–Torres C, Rangel–Rojo R, Reyes–Esqueda JA, Santana G, Alonso JC, Ortiz A, Oliver A (2009) Modification of the Nonlinear Optical Absorption and Optical Kerr Response Exhibited by nc–Si Embedded in a Silicon–Nitride Film. *Optics Express* 17/12:10056–10068. doi:10.1364/OE.17.010056
- Löptien P, Zhou L, Wiebe J, Khajetoorians AA, Mi JL, Iversen BB, Hofmann P, Wiesendanger R (2014) Screening and Atomic–Scale Engineering of the Potential at a Topological Insulator Surface. *Physical Review B*, 89/8:085401 1–7. doi:10.1103/PhysRevB.89.085401
- Lounis S (2014) Theory of Scanning Tunneling Microscopy. Lecture Notes of the 45th IFF Spring School “Computing Solids – Models, ab initio methods and supercomputing”
- Love T (1993) Object Lessons. Lessons Learned in Object–Oriented Development Projects. SIGS Books, New York
- Lu F, Jin M, Belkin MA (2014) Tip–Enhanced Infrared Nanospectroscopy Via Molecular Expansion Force Detection. *Nature Photonics* 8:307–312. doi:10.1038/nphoton.2013.373
- Madhuri S (2019) History of Nanotechnology. From Prehistoric to Modern Times. Beverly, Scrivener Publishing, Wiley
- Maguhn J, Karg E, Kettrup A, Zimmermann R (2003) On–Line Analysis of the Size Distribution of Fine and Ultrafine Aerosol Particles in Flue and Stack Gas of a Municipal Waste Incineration Plant: Effects of Dynamic Process Control Measures and Emission Reduction Devices. *Environmental Science and Technology* 37/20:4761–4770. doi:10.1021/es020227p
- Mahieu G, Grandidier B, Stievenard D, Krzeminski C, Delerue C, Martineau C, Roncali J (2003) Adsorption Behavior of Conjugated {C}(3)–Oligomers on Si(100) and Highly Oriented Pyrolytic Graphite Surfaces. *Langmuir* 19/8:3350–3356
- Mahmoudi M, Hofmann H, Rothen–Ruitshauer B, Petri–Fink A (2012) Assessing the *in vitro* and *in vivo* Toxicity of Superparamagnetic Iron Oxide Nanoparticles. *Chemical Reviews* 112/4:2323–38. doi:10.1021/cr2002596
- Malsch I (2002) Tiny Tips Probe Nanotechnology. *The Industrial Physicist*, October:16–19
- Mann B, Kuhn H (1971) Tunneling through Fatty Acid Salt Monolayers. *Journal of Applied Physics* 42:4398–4405. doi:10.1063/1.1659785
- Mansoori GA (2017) An Introduction to Nanoscience & Nanotechnology, in *Nanoscience and Plant–Soil Systems*. Springer Soil Biology Series, Switzerland. doi:10.1007/978–3–319–46835–8
- Marcacci F (2015) La Rivoluzione Scientifica di un Franciscano: Ilario Altabelli tra Astronomia e Astrologia. *Franciscan Studies* 73/1:199–213. doi:10.1353/frc.2015.0006
- Marcacci F (2015) The World–System of Giovanni Battista Riccioli and the Phases of Venus and Mercury. *Advances in Historical Studies* 04/02:106–117. doi:10.4236/ahs.2015.42011
- Marcacci F (2017) Roger Bacon's Mathematics: Demonstrative System and Metaphysics in the *Communium Mathematica*. *Franciscan Studies* 75/1:407–421. doi:10.1353/frc.2017.0015
- Marcacci F (2019) *Cieli in Contraddizione: Giovanni Battista Riccioli e il Terzo Sistema del Mondo*. Aguaplano, Modena
- Marcacci F (2019) Lo Statuto dell’Astronomia e il Metodo delle Ipotesi secondo Giovanni Battista Riccioli. *Syzetesis* VI/1:111–126
- Marcacci F (2020) Argumentation and Counterfactual Reasoning in Parmenides and Melissus. *Revista Archaia* 30. doi:10.14195/1984–249X_30_4
- Marcacci F (2021) Seeing at a Glance: The World–System Debate and the Role of the Comparative Tables in Giovanni Battista Riccioli’s *Almagestum novum*. *Nuncius/Istituto e Museo di Storia della Scienza* 36/1:119–142. doi:10.1163/18253911–bj10010
- Marcacci F, Muzzi S (2016) Roger Bacon and Ramon Llull, Expressions of a Multicultural Middle Ages. Novelty Emerging from Tradition. *Anuario Filosofico* 49/1:155:175. doi:10.15581/009.49.1.155–175
- Marcacci F, Oleksowicz M (2022) *Scientia Petita*, *Theologia Manifesta* Scientific Rationality and Theological Proposals in the Pandemic. *European Journal of Science and Theology* 18/4:133–147

- Marcacci F, Oleksowicz M (2023) The World as a Gift: Scientific Change and Intelligibility for a Theology of Science. *Religions* 14/5 doi:10.3390/rel14050572
- Marcovich A, Shinn T (2011) Instrument Research, Tools, and the Knowledge Enterprise 1999–2009: Birth and Development of Dip–Pen Nanolithography. *Science, Technology & Human Values* 36/6:864–896. doi:10–1177/0162243910385406
- Marra F, Minutillo S, Tamburrano A, Sarto MS (2021) Production and Characterization of Graphene Nanoplatelet–Based Ink for Smart Textile Strain Sensors via Screen Printing Technique. *Materials & Design* 198:1–7. doi:10.1016/j.matdes.2020.109306
- Marty JJ (1977) The Preparation, Purification and Properties of Nanoparticles. Degree Pharmacy Thesis. Victorian College of Pharmacy Parkville, Australia
- Masuda H, Ebata A, Teramae K, Hishinuma N (1993) Alteration of Thermal Conductivity and Viscosity of Liquid by Dispersing Ultra–Fine Particles (Dispersion of γ -Al₂O₃, SiO₂, and TiO₂ Ultra–Fine Particles). *Netsu Bussei* 7:227–233. doi:10.2963/JJTP.227
- Mathurin T, Giordano S, Dusch Y, Tiercelin N, Pernod P, Preobrazhensky V (2016) Stress–Mediated Magnetolectric Control of Ferromagnetic Domain Wall Position in Multiferroic Heterostructures. *Applied Physics Letters* 108/8:082401
- Mathurin T, Giordano S, Dusch Y, Tiercelin N, Pernod P, Preobrazhensky V, (2017) Domain–Wall Dynamics in Magnetoelastic Nanostripes. *Physical Review B* 95:140405(R)
- Mathurin T, Giordano S, Dusch Y, Tiercelin N, Pernod P, Preobrazhensky V (2016) Mechanically Driven Domain Wall Movement in Magnetoelastic Nanomagnets. *European Physical Journal B* 89/7:169
- Mattoni A, Colombo L, Cleri F (2005) Atomic Scale Origin of Crack Resistance in Brittle Fracture. *Physical Review Letters* 95/115501. doi:10.1103/PhysRevLett.95.115501
- Maxwell JK (1892) *A Treatise on Electricity and Magnetism*. Dover Publications 1954, Mineola
- Maylaa T, Windal F, Benhabiles H, Maubon G, Maubon N, Vandenhoute E, Collard D (2022) An Evaluation of Computational Learning–based Methods for the Segmentation of Nuclei in Cervical Cancer Cells from Microscopic Images. *Current Computer–Aided Drug Design* 18/2:81–94
- Maynard AD (2006) Nanotechnology: Assessing the Risks. *Nano Today* 1/2:22–33. doi:10.1016/s1748–0132(06)70045–7
- McBain SC, Yiu HH, Dobson J (2008) Magnetic Nanoparticles for Gene and Drug Delivery. *International Journal of Nanomedicine* 3/2:169–180. doi:10.0000/PMID18686777
- McCue SW, Wu B, Hill JM (2009) Micro/Nanoparticles Melting with Spherical Symmetry and Surface Tension. *IMA Journal of Applied Mathematics* 74/3:439–457. doi:10.1093/imamat/hxn038
- McDonald R, Hu SH, Martuzevicius D, Grinshpun SA, LeMasters G, Biswas P (2004) Intensive Short Term Measurements of the Ambient Aerosol in the Greater Cincinnati Airshed. *Aerosol Science and Technology* 38/2:70–79. doi:10.1080/027868290502263
- Medjdoub F, Zegaoui M, Ducatteau D, Rolland N, Rolland PA (2011) High Performance Low–Leakage–Current AlN/GaN HEMTs Grown on Silicon Substrate. *IEEE Electron Device Letters* 32/7:874–876. doi:10.1109/LED.2011.2138674
- Medjdoub F, Zegaoui M, Ducatteau D, Rolland N, Rolland PA (2011) High Performance Low–Leakage–Current AlN/GaN HEMTs Grown on Silicon Substrate. *IEEE Electron Device Letters* 32/7:874–876. doi:10.1109/LED.2011.2138674
- Mélin T, Deresmes D, Stiévenard D (2002) Charge Injection in Individual Silicon Nanoparticles Deposited on a Conductive Substrate. *Applied Physics Letters* 81/26:5054–5056. doi:10.1063/1.1532110
- Mélin T, Deresmes D, Stiévenard D (2002) Charge Injection in Individual Silicon Nanoparticles Deposited on a Conductive Substrate. *Applied Physics Letters* 81/26:5054–5056. doi:10.1063/1.1532110
- Melis C, Giordano S, Colombo L (2017) Surface Elastic Properties in Silicon Nanoparticles. *EPL* 119/6:66005
- Melis C, Giordano S, Colombo L, Mana G (2016) Density Functional Theory Calculations of the Stress of Oxidised (110) Silicon Surfaces. *Metrologia* 53/6:1339
- Melis C, Pia G, Sogno E, Falqui A, Giordano S, Delogu F, Colombo L (2022) Stiffening of Nanoporous Gold: Experiment, Simulation and Theory. *European Physical Journal Plus* 137/7:19151–19159
- Merkle RC (1992) Self Replicating Systems and Molecular Manufacturing. *Journal of the British Interplanetary Society* 45:407–413
- Merkle RC (1993) Two Types of Mechanical Reversible Logic. *Nanotechnology* 4:114–131. doi:10.1088/0957–4484/4/2/007
- Merkle RC (1996) Design Considerations for an Assembler. *Nanotechnology* 7:210–215

- Merkle RC (1997) A Proposed ‘Metabolism’ for a Hydrocarbon Assembler. *Nanotechnology* 8:149–162
- Merkle RC, Drexler KE (1996) Helical Logic. *Nanotechnology* 7/4:325–339. doi:10.1088/0957-4484
- Mermin ND (1968) Crystalline Order in Two Dimensions. *Physical Review* 176:250–254. doi:10.1103/PhysRev.176.250
- Meselson MS, Ratner D, Ratner MA, Drexler KE (2007) Emerging Technologies. *Bulletin of the Atomic Scientists* 63/1:49–58. doi:10.1080/00963402.2007.11461048
- Metzger RM, Chen B, Höpfner U, Lakshmikantham MV, Vuillaume D, Kawai T, Wu X, Tachibana H, Hughes TV, Sakurai H, Baldwin JW, Hosch C Cava MP, Brehmer L, Ashwell GJ (1997) Unimolecular Electrical Rectification in Hexadecylquinolinium Tricyanoquinodimethanide. *Journal of the American Chemical Society* 119:10455–10466
- Metzger RM, Chen B, Höpfner U, Lakshmikantham MV, Vuillaume D, Kawai T, Wu X, Tachibana H, Hughes TV, Sakurai H, Baldwin JW, Hosch C Cava MP, Brehmer L, Ashwell GJ (1997) Unimolecular Electrical Rectification in Hexadecylquinolinium Tricyanoquinodimethanide. *Journal of the American Chemical Society* 119:10455–10466
- Miller S (2001) Public Understanding of Science at the Crossroads. *Public Understanding of Science* 10:115–120.
- Miller–Keane Encyclopedia and Dictionary of Medicine, Nursing and Allied Health, Seventh Edition 2003. Retrieved August 23 2020 from <https://medical-dictionary.thefreedictionary.com/carcinogenicity>
- Millet O, Bernardoni P, Regnier S, Bidaud P, Tsitsiris E, Collard D, Buchaillet L (2004) Electrostatic Actuated Micro Gripper using an Amplification Mechanism. *Sensors and Actuators A* 114/2–3:371–378
- Millet O, Collard D, Buchaillet L (2002) Reliability of Polysilicon Microstructures: in Situ Test Benches. *Microelectronics Reliability* 42/9–11:1795–1800
- Millet O, Legrand B, Collard D, Buchaillet L (2002) Influence of the Step Covering on Fatigue Phenomenon for Polycrystalline Silicon Micro–Electro–Mechanical–Systems (MEMS). *Japanese Journal of Applied Physics Part 2–Letters & Express Letters* 41/11B:1339
- Mingos DPM (2014) Historical Introduction to Gold Colloids, Clusters and Nanoparticles. In: *Gold Clusters, Colloids and Nanoparticles I*. Springer Cham
- Molzon JA, Giaquinto A, Lindstrom L, Tominaga T, Ward M, Doerr P, Hunt L, Rago L (2011) The Value and Benefits of the International Conference on Harmonisation to Drug Regulatory Authorities: Advancing Harmonization for Better Public Health. *Clinical Pharmacology and Therapeutics* 89/4:503–512. doi:10.1038/clpt.2011.10
- Monson E, Brasuel M, Philbert MA, Kopelman R (2003) Nanosensors for In Vitro Bioanalysis. In *Biomedical Photonics Handbook*. Vo–Dinh Editor CRC Press, Boca Raton
- Montasser I, Coleman AW, Tauran Y, Perret G, Jalabert L, Collard D, Kim BJ, Tarhan MC (2017) Direct Measurement of the Mechanism by which Magnesium Specifically Modifies the Mechanical Properties of DNA. *Biomicrofluidics* 11/5:051102
- Montemagno CD, Bachand G, Stelick S, Bachand M (1999) Constructing Biological Motor Powered Nanomechanical Devices. *Nanotechnology* 10:225–231
- Moon CR, Lutz CP, Manoharan HC (2008) Single–Atom Gating of Quantum–State Superpositions. *Nature Physics* 4/6:454–458. doi:10.1038/nphys930
- Moreels I, Allan G, De Geyter B, Wirtz L, Delerue C, Hens Z (2010) Dielectric Function of Colloidal Lead Chalcogenide Quantum Dots Obtained by a Kramers–Kronig Analysis of the Absorbance Spectrum. *Physical Review B* 81/23:235319–235326
- Moreels I, Lambert K, Smeets D, De Muynck D, Nollet T, Martins JC, Vanhaecke F, Vantomme A, Delerue C, Allan G, Hens Z (2009) Size–Dependent Optical Properties of Colloidal PbS Quantum Dots. *ACS Nano* 3/10:3023–3030
- Mugny G, Li J, Triozon F, Niquet YM, Rideau D, Delerue C (2017) Electronic Structure and Electron Mobility in Si–1–Ge–x(x) Nanowires. *Applied Physics Letters* 110/5:052102
- Muller J, Huaux F, Lison D (2006) Respiratory Toxicity of Carbon Nanotubes: how Worried should We be? *Carbon* 44/6:1048–1056. doi:10.1016/j.carbon.2005.10.019
- Mullis K, Faloona F, Scharf S, Saiki R, Horn O, Erlich H (1986) Specific Amplification of DNA in Vitro: the Polymerase Chain Reaction. *Cold Spring Harbor Symposia on Quantitative Biology* 51(P1):263–273. doi:10.1101/sqb.1986.051.01.032
- Murray CB, Norris DJ, Bawendi MG (1993) Synthesis and Characterization of Nearly Monodisperse CdE (E = S, Se Te) Semiconductor Nanocrystallites. *Journal of the American Chemical Society* 115/19:8706–8715. doi:10.1021/ja00072a025

- Murty BS, Shankar P, Raj Baldev, Rath BB, Murday J (2013) Textbook of Nanoscience and Nanotechnology. Universities Press Private Limited, Himayatnagar, Hyderabad
- Musacchio T, Laquintana V, Latrofa A, Trapani G, Torchilin VP (2009) PEG–PE Micelles Loaded with Paclitaxel and Surface–Modified by a PBR–Ligand: Synergistic Anticancer Effect. *Molecular Pharmaceutics* 6/2:468–479. doi:10.1021/mp800158c
- Myers T (2011) Why are the Slip Lengths so Large in Carbon Nanotubes? *Microfluidics and Nanofluidics* 10:1141–1145. doi:10.1007/s10404–010–0752–7
- Nan A, Bai X, Son SJ, Lee SB, Ghandehari H (2008). Cellular Uptake and Cytotoxicity of Silica Nanotubes. *Nano Letters* 8/8:2150–2154. doi:10.1021/nl0802741
- Nandiyanto ABD, Kim SG, Iskandar F, Okuyama K (2009) Synthesis of Spherical Mesoporous Silica Nanoparticles with Nanometer–Size Controllable Pores and Outer Diameters. *Microporous and Mesoporous Materials* 120/3:447–453. doi:10.1016/j.micromeso.2008.12.019
- Nangreave J, Han D, Liu Y, Yan H (2010) DNA Origami: a History and Current Perspective. *Current Opinion in Chemical Biology* 14/5:608–615. doi:10.1016/j.cbpa.2010.06.182
- National Council on Radiation Protection and Measurements (2017) Radiation Safety Aspects of Nanotechnology. <http://www.ncrppublications.org/Reports/176>
- National Nanotechnology Initiative (2020) What It Is and How It Works. <https://www.nano.gov/nanotech-101/what> Retrieved 02 April 2020
- Neinhuis C, Barthlott W (1997) Characterization and Distribution of Water–Repellent, Self–Cleaning Plant Surfaces. *Annals of Botany* 79:667–677
- Nel A, Xia T, Mädler L, Li N (2006) Toxic Potential of Materials at the Nanolevel. *Science* 311/5761:622–7. doi:10.1126/science.1114397
- Nelkin D (1987) *Selling Science: How the Press Covers Science and Technology*. Freeman and Company, New York.
- Ngoh ZL, Guiraud P, Tan D, Giordano S, Bou–Matar O, Teo EHT, Pernod P, Coquet P, Lardat R (2020) Experimental Characterization of Three–Dimensional Graphene’s Thermoacoustic Response and its Theoretical Modelling. *Carbon* 169:382–394
- Nguyen HT, Kosheleva O, Kreinovich V (2009) Decision Making Beyond Arrow’s “Impossibility Theorem,” with the Analysis of Effects of Collusion and Mutual Attraction. *International Journal of Intelligent Systems* 24/1:27–47. doi:10.1002/int.20324
- Nguyen HT, Kreinovich V (1996) Nested Intervals and Sets: Concepts, Relations to Fuzzy Sets, and Applications. In: Kearfott, R.B., Kreinovich, V. (eds) *Applications of Interval Computations*. Applied Optimization, vol 3. Springer, Boston
- Nguyen HT, Kreinovich V (1997) *Applications of Continuous Mathematics to Computer Science*. Springer Science & Business Media, Dordrecht
- Nguyen HT, Kreinovich V, Wu B, Xiang G (2012) *Computing Statistics under Interval and Fuzzy Uncertainty*. Springer Verlag, Berlin, Heidelberg
- Nguyen HT, Kreinovich V, Zuo Q (1997) Interval–Valued Degrees of Belief: Applications of Interval Computations to Expert Systems and Intelligent Control. *International Journal of Uncertainty, Fuzziness and Knowledge–Based Systems* 5/03:317–358. doi:10.1142/S0218488597000257
- Nguyen TH, Mahieu G, Berthe M, Grandidier B, Delerue C, Stievenard D, Ebert P (2010) Coulomb Energy Determination of a Single Si Dangling Bond. *Physical Review Letters* 105/22:226404–226408
- NIOSH (2009) Managing the Health and Safety Concerns Associated with Engineered Nanomaterials. 125:11–12. Retrieved August 24 2020 from <https://www.cdc.gov/niosh/docs/2009-125>
- NIOSH (2013) Current Intelligent Bulletin 65: Occupational Exposure to Carbon Nanotubes and Nanofibers. pp.v–ix:33–35,63–64
- NIOSH (2013) Current Strategies for Engineering Controls in Nanomaterial Production and Downstream Handling Process. Retrieved August 23 2020 from https://en.wikisource.org/wiki/Current_Strategies_for_Engineering_Controls_in_Nanomaterial_Production_and_Downstream_Handling_Processes
- Niquet YM, Delerue C (2011) Band Offsets, Wells, and Barriers at Nanoscale Semiconductor Heterojunctions. *Physical Review B* 84/7:075478–075487
- Niquet YM, Delerue C (2012) Carrier Mobility in Strained Ge Nanowires. *Journal of Applied Physics* 112/8:084301
- Niquet YM, Delerue C, Krzeminski C (2012) Effects of Strain on the Carrier Mobility in Silicon Nanowires. *Nano Letters* 12/7:3545–3550

- Niquet YM, Delerue C, Rideau D, Videau B (2012) Fully Atomistic Simulations of Phonon-Limited Mobility of Electrons and Holes in $\langle 001 \rangle$ -, $\langle 110 \rangle$ -, and $\langle 111 \rangle$ -Oriented Si Nanowires. *IEEE Transactions on Electron Devices* 59/5:1480–1487
- Niquet YM, Genovese L, Delerue C, Deutsch T (2010) Ab Initio Calculation of the Binding Energy of Impurities in Semiconductors: Application to Si Nanowires. *Physical Review B* 81/16:161301–161305
- Niquet YM, Lherbier A, Quang NH, Fernandez-Serra MV, Blase X, Delerue C (2006) Electronic Structure of Semiconductor Nanowires. *Physical Review B* 73/16:165319–165332
- Niquet YM, Mera H, Delerue C (2012) Impurity-Limited Mobility and Variability in Gate-All-Around Silicon Nanowires. *Applied Physics Letters* 100/15:153119
- Notot V, Walravens W, Berthe M, Peric N, Addad A, Wallart X, Delerue C, Hens Z, Grandidier B, Biadala L (2022) Quantum Dot Acceptors in Two-Dimensional Epitaxially Fused PbSe Quantum Dot Superlattices. *ACS Nano* 16/2:3081–3091
- Novoselov KS, Geim AK (2007) The Rise of Graphene. *Nature Materials* 6/3:183–191. doi:10.1038/nmat1849
- Novoselov KS, Geim AK, Morozov SV, Jiang D, Katsnelson MI, Grigorieva IV, Dubonos SV, Firsov AA (2005a) Two-Dimensional Gas of Massless Dirac Fermions in Graphene. *Nature* 428/7065:197–200. doi:10.1038/nature04233
- Novoselov KS, Jiang D, Schedin F, Booth TJ, Khotkevich VV, Morozov SV, Geim AK (2005b) Two-Dimensional Atomic Crystals. *Proceedings of the National Academy of Sciences* 102/30:10451–10453. doi:10.1073/pnas.0502848102
- Novoselov KS, McCann E, Morozov SV, Fal'ko VI, Katsnelson MI, Zeitler U, Jiang D, Schedin F, Geim AK (2006) Unconventional Quantum Hall Effect and Berry's Phase of 2π in Bilayer Graphene. *Nature Physics* 2:177–180. doi:10.1038/nphys245
- O'Toole Marie (2003) *Miller-Keane Encyclopedia & Dictionary of Medicine, Nursing and Allied Health*. Saunders Elsevier, Philadelphia
- Oberdörster G, Maynard A, Donaldson K, Castranova V, Fitzpatrick J, Ausman K, Carter J, Karn B, Kreyling W (2005) Principles for Characterizing the Potential Human Health Effects from Exposure to Nanomaterials: Elements of a Screening Strategy. *Particle and Fiber Toxicology* 2/8. doi:10.1186/1743-8977-2-8
- Oberdörster G, Oberdörster E, Oberdörster J (2005) Nanotoxicology: an Emerging Discipline Evolving from Studies of Ultrafine Particles. *Environmental Health Perspectives* 113/7:823–39. doi:10.1289/ehp.7339
- Ochekepe NA, Olorunfemi PO, Ngwuluka NC (2009a) Nanotechnology and Drug Delivery Part 1: Background and Applications. *Tropical Journal of Pharmaceutical Research* 8/3:265–274.
- Ochekepe NA, Olorunfemi PO, Ngwuluka NC (2009b) Nanotechnology and Drug Delivery Part 2: Nanostructures for Drug Delivery. *Tropical Journal of Pharmaceutical Research* 8/3:275–287.
- Odum TW, Huang JLP, Kim P, Lieber CM (1998) Atomic Structure and Electronic Properties of Single-Walled Carbon Nanotubes. *Nature* 391/6662:62–64. doi:10.1038/34145
- Oerlemans C, Bult W, Bos M, Storm G, Nijssen JF, Hennink WE (2010) Polymeric Micelles in Anticancer Therapy: Targeting, Imaging and Triggered Release. *Pharmaceutical Research* 27/12:2569–2589. doi:10.1007/s11095-010-0233-4
- Ohashi Y, Koizumi T, Yoshikawa T, Hironaka T, K Shiiki K (1997) Size Effect in the In-plane Electrical Resistivity of Very Thin Graphite Crystals. *TANSO* 180:235–238. doi:10.7209/tanso.1997.235
- Oomen AG, Steinhäuser KG, Bleeker EAJ, Broekhuizen F, Sips A, Dekkers S, Wijnhoven SWP, Sayre PG (2018) Risk Assessment Frameworks for Nanomaterials: Scope, Link to Regulations, Applicability, and Outline for Future Directions in View of Needed Increase in Efficiency. *Nanoimpact* 9:1–13. doi:10.1016/j.impact.2017.09.001
- Oosawa F, Asakura S (1975) *Thermodynamics of the Polymerization of Protein*. London: Academic
- Orton JW, Foxon T (2015) *Molecular Beam Epitaxy: A Short History*. Oxford University Press, Oxford
- Overbeek JTG (1982) Monodisperse Colloidal Systems, Fascinating and Useful. *Advances in Colloid and Interface Science* 15/3–5:251. doi:10.1016/0001-8686(82)80003-1
- Overgaag K, Vanmaekelbergh D, Liljeroth P, Mahieu G, Grandidier B, Delerue C, Allan G (2009) Electron-Phonon Coupling and Intervalley Splitting Determine the Linewidth of Single-Electron Transport Through PbSe Nanocrystals. *Journal of Chemical Physics* 131/22:224510
- Pan L, Park Y, Xiong Y, Ulin-Avila E, Wang Y, Zeng L, Xiong S, Rho J, Sun C, Bogy DB, Zhang X (2011) Maskless Plasmonic Lithography at 22nm Resolution. *Scientific Reports* 1:175. doi:10.1038/srep00175

- Park JS, Park YJ, Heo J (2007) Solidification and Recycling of Incinerator Bottom Ash through the Addition of Colloidal Silica (SiO₂) Solution. *Waste Management* 27/9:1207–1212. doi:10.1016/j.wasman.2006.08.010.
- Partoens B, Peeters FM (2006) From Graphene to Graphite: Electronic Structure around the K Point. *Physical Review B* 74/7:075404–1–11. doi:10.1103/PhysRevB.74.075404
- Pasa AA (2010) Chapter 13: Metal Nanolayer–Base Transistor. *Handbook of Nanophysics: Nanoelectronics and Nanophotonics*, pp.13–1, 13-4. CRC Press, Boca Raton
- Patel HE, Das SK, Sundararajan T, Sreekumaran Nair A, George B, Pradeep T (2003) Thermal Conductivities of Naked and Monolayer Protected Metal Nanoparticle Based nanofluids: Manifestation of Anomalous Enhancement and Chemical Effects. *Applied Physics Letters* 83/14:2931–2933. doi:10.1063/1.1602578
- Patenaude J, Legault GA, Beauvais J, Bernier L, Beland JP, Boissy P, Chenel V, Daniel CE, Genest J, Poirier MS, (2015) Framework for the Analysis of Nanotechnologies' Impacts and Ethical Acceptability: Basis of an Interdisciplinary Approach to Assessing Novel Technologies. *Science and Engineering Ethics* 21/2:293–315. doi:10.1007/s11948–014–9543–y
- Patil GV (2003) Biopolymer Albumin for Diagnosis and in Drug Delivery. *Drug Development Research* 58/3:219–47. doi:10.1002/ddr.10157
- Pavanello F, Giordano S (2013) How Imperfect Interfaces Affect the Nonlinear Transport Properties in Composite Nanomaterials. *Journal of Applied Physics* 113/15:154310
- Pedrycz W, Skowron A, Kreinovich V (2008) *Handbook of Granular Computing*. John Wiley & Sons, Chichester
- Peng W, Xu T, Diener P, Biadala L, Berthe M, Pi X, Borensztein Y, Curcella A, Bernard R, Prevot G, Grandidier B (2018) Resolving the Controversial Existence of Silicene and Germanene Nanosheets Grown on Graphite. *ACS NANO* 12/5:4754–4760
- Penneç Y, Djafari–Rouhani B, Larabi, H, Vasseur, Hladky–Hennion AC (2008) Low–Frequency Gaps in a Phononic Crystal Constituted of Cylindrical Dots deposited on a Thin Homogeneous Plate. *Physical Review B* 78/10:1–8. doi:10.1103/PhysRevB.78.104105
- Penneç Y, Djafari–Rouhani B, Larabi, H, Vasseur, Hladky–Hennion AC (2008) Low–Frequency Gaps in a Phononic Crystal Constituted of Cylindrical Dots deposited on a Thin Homogeneous Plate. *Physical Review B* 78/10:1–8. doi:10.1103/PhysRevB.78.104105
- Perdigao L, Deresmes D, Grandidier B, Dubois M, Delerue C, Allan G, Stievenard D (2004) Semiconducting Surface Reconstructions of p–type Si(100) Substrates at 5K. *Physical Review Letters* 92/21:216101
- Peric N, Lambert Y, Singh S, Khan AH, Vergel NAF, Deresmes D, Berthe M, Hens Z, Moreels I, Delerue C, Grandidier B, Biadala L (2021) Van Hove Singularities and Trap States in Two–Dimensional CdSe Nanoplatelets. *Nano Letters* 21/4:1702–1708
- Perret G, Ginet P, Tarhan MC, Baccouche A, Lacornerie T, Kumemura M, Jalabert L, Cleri F, Lartigau EF, Kim BJ, Karsten SL, Fujita H, Rondelez Y, Fujii T, Collard D (2016) Nano Systems and Devices for Applications in Biology and Nanotechnology. *Solid–State Electronics* 115/B:66–73
- Persson MP, Mera H, Niquet YM, Delerue C, Diarra M (2010) Charged Impurity Scattering and Mobility in Gated Silicon Nanowires. *Physical Review B* 82/11:115318–115326
- Peterson JJ, Huang L, Delerue C, Allan G, Krauss TD (2007) Uncovering Forbidden Optical Transitions in PbSe Nanocrystals. *Nano Letters* 7/12:3827–3831
- Phoenix C, Drexler KE (2004) Safe Exponential Manufacturing. *Nanotechnology* 15/8:869–872. doi:10.1088/0957–4484/15/8/001
- Phuong NH, Kreinovich V (2001) Fuzzy Logic and its Applications in Medicine. *International Journal of Medical Informatics* 62/2–3:165–173. doi:10.1016/S1386–5056(01)00160–5
- Pi X, Delerue C (2013) Tight–Binding Calculations of the Optical Response of Optimally P–Doped Si Nanocrystals: A Model for Localized Surface Plasmon Resonance. *Physical Review Letters* 111/17:177402–177407
- Pi X, Ni Z, Yang D, Delerue C (2014) Ab Initio Study on the Effect of Structural Relaxation on the Electronic and Optical Properties of P–Doped Si Nanocrystals. *Journal of Applied Physics* 116/19:194304
- Pietrak K, Wiśniewski TS (2015) A Review of Models for Effective Thermal Conductivity of Composite Materials. *Journal of Power Technologies* 95/1:14–24
- Pijpers JJH, Milder MTW, Delerue C, Bonn M (2010) (Multi)exciton Dynamics and Exciton Polarizability in Colloidal InAs Quantum Dots. *Journal of Physical Chemistry C* 114/14

- Pijpers JH, Ulbricht R, Tielrooij KJ, Oshero A, Golan Y, Delerue C, Allan G, Bonn M (2009) Assessment of Carrier–Multiplication Efficiency in Bulk PbSe and PbS. *Nature Physics* 5/11:811–814
- Piner RD, Mirkin CA (1997) Effect of Water on Lateral Force Microscopy in Air. *Langmuir* 13/26:6864–6868. doi:10.1021/la970921w
- Pisano R (2006) Mathematics of Logic and Logic of Mathematics. *Critical problems in History of Science. The Bulletin of Symbolic Logic* 12/2:358
- Pisano R (2008) A History of Chemistry à la Koyré? Introduction and Setting of an Epistemological Problem. *Khimiya Journal* 2/17:143–161
- Pisano R (2009) Continuity and discontinuity. On method in Leonardo da Vinci’ Mechanics. *Organon* 41:165–182
- Pisano R (2009) On method in Galileo Galilei’s mechanics. In Hunger H (ed.), *Proceedings of 3rd Congress of the European Society for the History of Science. The Austrian Academy of Science, Vienna*, pp. 174–186
- Pisano R (2010) On Principles In Sadi Carnot’s Theory (1824). *Epistemological reflections. Almagest* 2/1:128–179
- Pisano R (2011) Physics–Mathematics Relationship. Historical and Epistemological notes. In Barbin E, Kronfeller M and Tzanakis C (eds.), *Proceedings of the ESU 6 European Summer University History And Epistemology in Mathematics. Verlag Holzhausen GmbH–Holzhausen Publishing Ltd., Vienna*, pp. 457–472
- Pisano R (2013a) On the New Boson Higgs’s Studies at the CERN–ATLAS Experiment. *The Emergency of a Historical Discovery. Advances in Historical Studies* 2/1:3–5
- Pisano R (2013b) History Reflections on Physics Mathematics Relationship in Electromagnetic Theory. In Barbin and Pisano 2013, pp. 31–58
- Pisano R (2014a) (ed.) Isaac Newton and his Scientific Heritage: New Studies in the History and Historical Epistemology of Science. *Special Issue. Advances in Historical Studies* 3/3
- Pisano R (2014b) Introduction to Advances Historical Studies—Newton Special Issue. *History and Historical Epistemology of Science. Advances in Historical Studies Newton Special Issue* 3/1:1
- Pisano R (2016a) Details on the mathematical interplay between Leonardo da Vinci and Luca Pacioli. *Journal of the British Society for the History of Mathematics* 31:104–111
- Pisano R (2016b) What kind of Mathematics in Leonardo da Vinci and Luca Pacioli? *Bulletin–British Society for the History of Mathematics* 31:104–111
- Pisano R (2016c) A Development of the Principle of Virtual Laws and its Framework in Lazare Carnot’s Mechanics as Manifest Relationship between Physics and Mathematics. *Transversal–International Journal for Historiography of Science*, in press.
- Pisano R (2017a) A Development of the Principle of Virtual Laws and its Framework in Lazare Carnot’s Mechanics as Manifest Relationship between Physics and Mathematics. *International Journal for Historiography of science* 2:166–203
- Pisano R (2017b) Introduction. 1564–2014. Homage to Galileo Galilei. In: Pisano R, Bussotti P (eds) *Homage to Galileo Galilei 1564–2014. Reading Iuvenilia Galilean Works within History and Historical Epistemology of Science. Special Issue Philosophia Scientiae*, 21/1:5–13
- Pisano R (2017c) Reading Science, Technology and Education: A Tradition Dating back to Science into the History and Historiography *Transversal* 3:77–97
- Pisano R (2020) A Tale of Tartaglia’s Libro Sesto & Gionta in Quesiti et Inventioni diverse (1546-1554). *Exploring the Historical and Cultural Foundations. Foundations of Science (Springer)* 25/2:477–505
- Pisano R, Aberšek B, Dolenc K, Aberšek MK (2014) Reflections on the Relationship between Cybernetic Pedagogy, Cognitive Science & Language. *Pedagogika* 115/3:70–87
- Pisano R, Anakkur A, Pellergrino E, Nagels M (2019) Thermodynamic Foundations of Physical Chemistry. Reversible Processes and Thermal Equilibrium into History. *Foundations of Chemistry (Springer)* 21:297-323. <https://link.springer.com/journal/10698>
- Pisano R, Bussotti P (2012) Galileo and Kepler: On Theoremata Circa Centrum Gravitatis Solidorum and Mysterium Cosmographicum. *History Research* 2/2:110–145
- Pisano R, Bussotti P (2013a) Notes on the Concept of Force in Kepler. In Pisano, Capecchi and Lukešová 2013, pp. 337–344
- Pisano R, Bussotti P (2013b) On Popularization of Scientific Education In Italy Between 12th And 16th Centuries. *Problems of Education in the 21st Century* 57:90–101

- Pisano R, Bussotti P (2013c) On the Conceptual Frames in René Descartes' Physical Works. *Advances in Historical Studies* 2/3:106–125
- Pisano R, Bussotti P (2013d) Open Problems in Mathematical Modelling and Physical Experiments: Exploring Exponential Function. *Problems of Education in the 21st century* 50/50:56–69
- Pisano R, Bussotti P (2013e) Reflections on the Scientific Conceptual Streams in Leonardo da Vinci and his Relationship with Luca Pacioli. *Advances in Historical Studies* 2/2:32–45
- Pisano R, Bussotti P (2014a) Galileo a Padova: un Itinerario tra Architettura, Fortificazioni, Matematica e Scienza “Pratica”, *Lettera Matematica* 91:48–58
- Pisano R, Bussotti P (2014b) Galileo in Padua: architecture, fortifications, mathematics and “practical” science. *Lettera Matematica Pristem International* 2/4:209–221
- Pisano R, Bussotti P (2014c) Historical and Philosophical Reflections on the Culture of Machines around the Renaissance. How Science and Technique Work? *Acta Baltica Historiae et Philosophiae Scientiarum* 2/2:20–42
- Pisano R, Bussotti P (2014d) Newton's *Philosophiae Naturalis Principia Mathematica* “Jesuit” Edition: The Tenor of a Huge Work. *Atti Accademia Nazionale Lincei Rendiconti Lincei Matematica e Applicazioni* 25:413–444
- Pisano R, Bussotti P (2014e) Notes on Mechanics and Mathematics in Torricelli as Physics Mathematics Relationships in the History of Science. *Problems of Education In The 21st Century International Journal. Special Issue* 61/61:88–97
- Pisano R, Bussotti P (2014f) On the Jesuit Edition of Newton's *Principia*. Science and Advanced Researches in the Western Civilization. *Newton Sp. Issue: History and Historical Epistemology of Science. Advances in Historical Studies* 3/1:33–55
- Pisano R, Bussotti P (2015a) Historical and Philosophical Reflections on the Culture of Machines around the Renaissance: Machines, Machineries and Perpetual Motion. *Acta Baltica Historiae et Philosophiae Scientiarum* 3/1:69–87
- Pisano R, Bussotti P (2015b) The Emergencies of Mechanics and Thermodynamics in the Western Society during 18th–19th Century. In: Pisano R (ed). *A Bridge between Conceptual Frameworks, Science, Society and Technology Studies*. Springer, Dordrecht, pp. 399–436
- Pisano R, Bussotti P (2015c) Fibonacci and the Abacus Schools in Italy. *Mathematical Conceptual Streams, Science Education and its Changing Relationship with Society, Almagest* 6/2:126–165
- Pisano R, Bussotti P (2015d) Introduction to Exploring Changes in How the Histories of the Exact Sciences from the 18th to through the 20th Century Have Been Written: Interpreting the Dynamics of Change in these Sciences and Interrelations Amongst Them—Past Problems, Future Cures? *Advances in Historical Studies Special Issue* 4/2:65–67
- Pisano R, Bussotti P (2015e) Galileo in Padua: Architecture, Fortifications, Mathematics and “Practical” Science, *Lettera Matematica Pristem International – Springer*, pp. 209–221
- Pisano R, Bussotti P (2015f) Historical and Philosophical Reflections on the Culture of Machines around the Renaissance: Machines, Machineries and Perpetual Motion. *Acta Baltica Historiae et Philosophiae Scientiarum* 3/1:69–87
- Pisano R, Bussotti P (2015g) Introduction. Exploring Changes in How the Histories of the Exact Sciences Have Been Written: Interpreting the Dynamics of Change in These Sciences and Interrelations amongst Them—Past Problems, Future Cures? *Advances in Historical Studies Special Issue* 4/2:65–67
- Pisano R, Bussotti P (2015h) The Geometrical Foundation of Federigo Enriques' Gnoseology and Epistemology. *Special Issue: Advances in Historical Studies* 4:118–145
- Pisano R, Bussotti P (2016a) A Newtonian Tale Details on Notes and Proofs in Geneva Edition of Newton's *Principia*. *British Journal for the History of Mathematics* 31/3:160–178
- Pisano R, Bussotti P (2016b) A Newtonian Tale Details on Notes and Proofs in Geneva Edition of Newton's *Principia*. *Bulletin—British Society for the History of Mathematics* 32:1–19
- Pisano R, Bussotti P (2017) The Fiction of the Infinitesimals in Newton's Works: A note on the Metaphoric use of Infinitesimals in Newton. *Special Issue Isonomia* 9:141–160
- Pisano R, Bussotti P (2020) Historical and Foundational Details on the Method of Infinite Descent: Every Prime Number of the Form $4n+1$ is the Sum of Two Squares. *Foundations of Science, Springer*, 25/4:671–702
- Pisano R, Bussotti P (2022) Conceptual Frameworks on the Relationship between Physics–Mathematics in the Newton *Principia* Geneva Edition (1822). *Foundations of Sciences, Springer* 27/3:1127–1182

- Pisano R, Capecchi D (2007) La Teoria dei Baricentri di Torricelli come Fondamento della Statica. *Physis – Rivista Internazionale di Storia della Scienza* XLIV/1:1–29
- Pisano R, Capecchi D (2010) Reflections on Torricelli's Principle in Mechanics. *Organon* 42:81–98
- Pisano R, Capecchi D (2013) Conceptual and Mathematical Structures of Mechanical Science in the Western Civilization around 18th Century. *Almagest* 4/2:86–121
- Pisano R, Capecchi D (2015) Tartaglia's science weights. *Mechanics in sixteenth century. Selection from Quesiti et invention diverse: Books VII–VIII*. Dordrecht, Springer
- Pisano R, Capecchi D (2016) Tartaglia's science weights. *Mechanics in XVI century. Selections from Quesiti et inventioni diverse* Springer, Dordrecht
- Pisano R, Capecchi D, Lukešová A (eds.) (2013) *Physics, Astronomy and Engineering. Critical Problems in the History of Science*. International 32nd Congress for The SISFA–Italian Society of Historians of Physics and Astronomy. The Scientia Socialis UAB & Scientific Methodical Centre Scientia Educologica Press, Šiauliai University, Lithuania
- Pisano R, Casolaro F (2011) An Historical Inquiry On Geometry In Relativity. Reflections on Early Relationship Geometry–Physics (Part I). *History Research* 1/1:47–60
- Pisano R, Casolaro F (2012) An Historical Inquiry On Geometry In Relativity. Reflections on Late Relationship Geometry–Physics (Part II). *History Research* 2/1:56–64
- Pisano R, Coopersmith J, Peacke M (2021) *Essay on Machines in General (1786)*. Monograph. Text, Translations and Commentaries. *Lazare Carnot's Mechanics – Vol. 1*. Springer, Dordrecht
- Pisano R, Drago A (2002) S. Carnot's Réflexions: a Theory based on Non–Classical Logic. *The Bulletin Symbolic Logic* 8:131–132
- Pisano R, Drago A (2004) Interpretation and Reconstruction of Sadi Carnot's Réflexions through Original Sentences belonging to Non–Classical Logic. *Fond. Ronchi*, LIX/5:615–644
- Pisano R, Drago A (2005) La Nota Matematica nelle "Réflexions sur la Puissance motrice du feu" di Sadi Carnot: interpretazione del Calcolo con il Metodo Sintetico, *Quaderni di Storia della Fisica–Giornale di Fisica* 13, 37–58
- Pisano R, Drago A (2007a) La Novità del Rapporto Fisica–Matematica nelle Réflexions di Sadi Carnot, *Fondazione Ronchi* LXII/4:497–525
- Pisano R, Drago A (2007b). Interpretazione e ricostruzione delle Réflexions di Sadi Carnot mediante la logica non–classica, *Giornale di Fisica*, XLI/4, 195–217
- Pisano R, Fichant M, Bussotti P, Oliveira ARE (2017) (eds.) *Leibniz and the Dialogue between Sciences, Philosophy and Engineering, 1646–2016*. New Historical and Epistemological Insights. The College Publications, London, in press
- Pisano R, Gaudiello I (2009a) Continuity and discontinuity. An epistemological inquiry based on the use of categories in history of science. *Organon* 41:245–265
- Pisano R, Gaudiello I (2009b) On categories and scientific approach in historical discourse. In Hunger H (ed.) *Proceedings of ESHS 3rd conference*. The Austrian Academy of Science, Vienna, pp. 187–197
- Pisano R, Guerriero A (2008) The History of Science and Scientific Education. Problems and Perspectives. *Problems of Education in the 21st Century* 6:145–158
- Pisano R et al (2020) Introduction. *Joule's Bicentenary: History of Science, Foundations and Nature of Science*. Foundations of Science. Springer, Cham. <https://doi.org/10.1007/s10699-020-09680-2>
- Pisano R, Mellone M (2012) Learning Mathematics In Physics Phenomenology and Historical Conceptual Streams. *Problems of Education in The 21st Century* 46:93–100
- Pisano R, Pellegrino EM, Anakkar A, Nagels M. (2021) Conceptual Polymorphism of Entropy into the History: Extensions of the Second Law of Thermodynamics Towards Statistical Physics and Chemistry during Nineteenth–Twentieth Centuries, *Foundations of Chemistry*, Springer 23:337–378
- Pisano R, Robarts J (2022) Short Comparative Historiography of Science & Technology of Mechanics into Engineering—and—Architecture Literatures during the Renaissance In: Ceccarelli M, López-García R (eds). *Explorations in the History and Heritage of Machines and Mechanisms*. Springer, pp. 227–240
- Pisano R, Sozzo S (2020) A Unified Theory of Human Judgements and Decision–making under Uncertainty. *Entropy*. Special Issue. Khrennikov A, Bagarello F (eds). *Quantum Models of Cognition and Decision-Making* 22/7:1–34. <https://www.mdpi.com/1099-4300/22/7/738>
- Pisano R (2019) Introduction. In Pisano R (ed): *Methods and Cognitive Modelling in the History and Philosophy of Science–&–Education Special Issue Transversal Historiography of Science* 5:3–9

- Pisano R, Dolenc K, Ploj-Vrtič M (2020) Historical Foundations of Physics & Applied Technology as Dynamic Frameworks in Pre-Service STEM. *Foundations of Science*. doi:10.1007/s10699-020-09662-4
- Plesse C, Vidal F, Gauthier C, Pelletier JM, Chevrot C, Teyssié D (2007) Poly(ethylene oxide)/Polybutadiene based IPNs Synthesis and Characterization. *Journal of Polymer Science* 48:696–703. doi:10.1016/J.POLYMER.2006.11.053
- Plissard S, Dick KA, Larrieu G, Godey S, Addad A, Wallart X, Caroff P (2010) Gold-Free Growth of GaAs Nanowires on Silicon: Arrays and Polytypism. *Nanotechnology* 21/38:1–8. doi:10.1088/0957-4484/21/38/385602
- Plissard S, Dick KA, Larrieu G, Godey S, Addad A, Wallart X, Caroff P (2010) Gold-Free Growth of GaAs Nanowires on Silicon: Arrays and Polytypism. *Nanotechnology* 21/38:1–8. doi:10.1088/0957-4484/21/38/385602
- Pohl DW (2000) Near Field Optics Seen as an Antenna Problem. *Near Field Optics: Principles and Applications/The Second Asia-Pacific Workshop on Near Field Optics* pp-9–21 World Scientific, Singapore
- Pohl DW, Denk W, Lanz M (1984) Optical Stethoscopy: Image Recording with Resolution $\lambda/20$. *Applied Physics Letters* 44/7:651–653. doi: 10.1063/1.94865
- Polymeropoulos EE (1977) Electron Tunneling through Fatty-Acid Monolayers. *Journal of Applied Physics* 48/6:2404–2407. doi:10.1063/1.324002
- Polymeropoulos EE, Sagiv J (1978) Electrical Conduction through Adsorbed Monolayers. *Journal of Chemical Physics* 69:1836–1847. doi:10.1063/1.436844
- Porras D, Fernández-Rossier J, Tejedor C (2001) Nanostructure Quantification of Turbostratic Carbon by HRTEM Image Analysis: State of the Art, Biases, Sensitivity and Best Practices. *Physical Review B* 63/155406:1–7. doi:10.1103/PhysRevB.63.155406
- Post LC, Xu T, Vergei NAF, Tadjine A, Lambert Y, Vaurette F, Yarekha D, Desplanque L, Stievenard D, Wallart X, Grandidier B, Delerue C, Vanmaekelbergh D (2019) Triangular Nanoperforation and Band Engineering of InGaAs Quantum Wells: a Lithographic Route Toward Dirac Cones in III–V Semiconductors. *Nanotechnology* 30/15:155301
- Postma HWC, Teepen T, Yao Z, Grifoni M, Dekker C (2001) Carbon Nanotube Single-Electron Transistors at Room Temperature. *Science* 293/5527:76–79. doi:10.1126/science.1061797
- Powers KW, Brown SC, Krishna VB, Wasdo SC, Moudgil BM, Roberts SM (2006) Research Strategies for Safety Evaluation of Nanomaterials. Part VI. Characterization of Nanoscale Particles for Toxicological Evaluation. *Toxicological Sciences* 90/2:296–303. doi:10.1093/toxsci/kfj099
- Powers KW, Palazuelos M, Moudgil BM, Roberts SM (2007) Characterization of the Size, Shape, and State of Dispersion of Nanoparticles for Toxicological Studies. *Nanotoxicology* 1/1:42–51. doi:10.1080/17435390701314902
- Pradeep T (2005) *Nano: The Essentials. Understanding Nanoscience and Nanotechnology*. McGraw-Hill, New York
- Prado Y, Qu J, Greboval C, Dabard C, Rastogi P, Chu A, Khalili A, Xu XZ, Delerue C, Ithurria S, Lhuillier E (2021) Seeded Growth of HgTe Nanocrystals for Shape Control and Their Use in Narrow Infrared Electroluminescence. *Chemistry of Materials* 33/6:2054–2061
- Prasher R, Bhattachaya P, Phelan PE (2005) Thermal Conductivity of Nanoscale Colloidal Solutions (Nanofluids). *Physical Review Letters* 94/2:025901. doi:10.1103/PhysRevLett.94.025901
- Prasher RS, Hu XJ, Chalopin Y, Mingo N, Lofgreen K, Volz S, Cleri F, Keblinski P (2009) Turning Carbon Nanotubes from Exceptional Heat Conductors into Insulators. *Physical Review Letters* 102/105901. doi:10.1103/PhysRevLett.102.105901
- Preobrazhensky V, Klimov A, Tiercelin N, Dusch Y, Giordano S, Churbanov A, Mathurin T, Pernod P, Sigov A (2018) Dynamics of the Stress-Mediated Magnetoelectric Memory Cell $N_x(\text{TbCo}_2/\text{FeCo})/\text{PMN-PT}$. *Journal of Magnetism and Magnetic Materials* 459:66–70
- Preobrazhensky V, Krutyansky L, Tiercelin N, Dusch Y, Sigov A, Pernod P, Giordano S (2018) Strain-Mediated All-Magnetoelectric Memory Cell. *Ferroelectrics* 532/1:160–167
- Prodan E, Nordlander P, Halas NJ (2003) Electronic Structure and Optical Properties of Gold Nanoshells. *Nano Letters* 3/10:1411–1415. doi:10.1021/nl034594q
- Prodromakis T (2016) Five ways Nanotechnology is Securing your Future. Retrieved July 07 2020 from <https://www.southampton.ac.uk/news/2016/03/themis-Nanotechnology-article.page>
- Puri A, Loomis K, Smith B, Lee JH, Yavlovich A, Heldman E, Blumenthal R (2009) Lipid-Based Nanoparticles as Pharmaceutical Drug Carriers: from Concepts to Clinic. *Critical Reviews in Therapeutic Drug Carrier Systems* 26/6:523–580. doi:10.0000/PMID20402623

- Quevy E, Bigotte P, Collard D, Buchaillot L, (2002) Large Stroke Actuation of Continuous Membrane for Adaptive Optics by 3D Self-Assembled Microplates. *Sensors and Actuators A-Physical* 95/2–3:183–195
- Quevy E, Buchaillot L, Collard D (2001) 3-D Self-Assembling and Actuation of Electrostatic Microstructures. *IEEE Transactions on Electron Devices* 48/8:1833–1839
- Quevy E, Parvais B, Raskin JP, Buchaillot L, Flandre D, Collard D (2002) A Modified Bosch-Type Process for Precise Surface Micromachining of Polysilicon. *Journal of Micromechanics and Microengineering* 12/3:328
- Quintanar-Guerrero D, Allémann E, Fessi H, Doelker E (1998) Preparation Techniques and Mechanism of Formation of Biodegradable Nanoparticles from Preformed Polymers. *Drug Development and Industrial Pharmacy* 24/12:1113–1128. doi:10.3109/03639049809108571
- Radicati di Brozolo F, Bunch TE, Fleming RH, Macklin J (1994) Fullerenes in an Impact Crater on the LDEF Spacecraft. *Nature* 369/6457:37–40. doi:10.1038/369037a0
- Rais-Zadeh M, Gokhale VJ, Ansari A, Faucher M, Théron D, Cordier Y, Buchaillot L (2014) Gallium Nitride as an Electromechanical Material. *Journal of Microelectromechanical Systems* 23/6:1252–1270. doi:10.1109/JMEMS.2014.2352617
- Rais-Zadeh M, Gokhale VJ, Ansari A, Faucher M, Théron D, Cordier Y, Buchaillot L (2014) Gallium Nitride as an Electromechanical Material. *Journal of Microelectromechanical Systems* 23/6:1252–1270. doi:10.1109/JMEMS.2014.2352617
- Ramer G, Aksyuk VA, Centrone A (2017) Quantitative Chemical Analysis at the Nanoscale Using the Photothermal Induced Resonance Technique. *Analytical Chemistry* 89/24:13524–13531. doi:10.1021/acs.analchem.7b03878
- Rana S, Bajaj A, Mont R, Ratello VM (2012) Monolayer Coated Gold Nanoparticles for Delivery Applications. *Advanced Drug Delivery Reviews* 64/2:200–216. doi:10.1016/j.addr.2011.08.006
- Ranganathan R, Madanmohan S, Kesavan A, Baskar G, Krishnamoorthy YR, Santosham R, Ponraju D, Rayala SK, Venkatraman G (2012) Nanomedicine: Towards Development of Patient-Friendly Drug-Delivery Systems for Oncological Applications. *International Journal of Nanomedicine* 7:1043–60
- Ranjan V, Allan G, Priester C, Delerue C (2003) Self-Consistent Calculations of the Optical Properties of GaN Quantum Dots. *Physical Review B* 68/11:115305–115312
- Rauscher H, Mech A, Gibson N, Gilliland D, Held A, Kestens V, Koeber R, Lisinger TPJ, Stefaniak EA (2019) Identification of Nanomaterials through Measurements. Publication Office of the European Union, Luxembourg
- Reimer L, Kohl H (2008) *Transmission Electron Microscopy: Physics of Image Formation*. Springer, New York
- Reis CP, Neufeld RJ, Ribeiro AJ, Viega F (2005) Insulin-Alginate Nanospheres: Influence of Calcium on Polymer Matrix Properties. *Proceedings of the 13th International Workshop on Bioencapsulation*. Queen's University Kingston, Canada
- Rejman J, Conese M, Hoekstra D (2006) Gene Transfer by Means of Lipo- and Polyplexes: Role of Clathrin and Caveolae-Mediated Endocytosis. *Journal of Liposome Research* 16/3:237–247. doi:10.1080/08982100600848819
- Rice WL, Van Hoek AN, Păunescu TG, Huynh C, Goetze B, Singh B, Scipioni L, Stern LA, Brown D (2013) High Resolution Helium Ion Scanning Microscopy of the Rat Kidney. *PLOS ONE* 8/3:e57051. doi:10.1371/journal.pone.0057051
- Riccardi DJ, Bateman JR, Kwon YK, McAughy JJ, Dickens CJ (1996) Exhaust Particulate Size Distribution: Vehicle and Fuel Influences in Light Duty Vehicles. Society of Automotive Engineers. Warrendale
- Rinaldi A, Proietti A, Tamburrano A, Sarto MS (2018) Graphene-Coated Honeycomb for Broadband Lightweight Absorbers. *IEEE Transactions on Electromagnetic Compatibility* 60/5:1454–1462. doi:10.1109/TEMC.2017.2775660
- Rinaldi A, Tamburrano A, Fortunato M, Sarto MS (2016) A Flexible and Highly Sensitive Pressure Sensor based on a PDMS Foam Coated with Graphene Nanoplatelets. *Sensors* 16/12:2148. doi:10.3390/s16122148
- Rizvi IH, Join A, Ghosh SK, Mukherjee PS (2013) Mathematical Modelling of Thermal Conductivity for Nanofluid Considering Interfacial Nano-Layer. *Heat Mass Transfer* 49:595–600. doi:10.1007/s00231–013–1117–7
- Robertson LA (2015) van Leeuwenhoek Microscopes – Where Are They Now? *FEMS Microbiology Letters* 362. doi:10.1093/femsle/fnv056

- Roca AG, Costo R, Rebolledo AF, Veintemillas-Verdaguer S, Tartaj P, González-Carreño T, Morales MP, Serna CJ (2009) Progress in the Preparation of Magnetic Nanoparticles for Applications in Biomedicine. *Journal of Physics D: Applied Physics* 42/22:224002–224012. doi:10.1088/0022-3727/42/22/224002
- Roch I, Bidaud P, Collard D, Buchaillot L (2003) Fabrication and Characterization of an SU–8 Gripper actuated by a Shape Memory Alloy Thin Film. *Journal of Micromechanics and Microengineering* 13/2:330
- Roch I, Buchaillot L, Wallart X, Collard D (2001) Silicon Nitride as an Effective Protection against Oxidation of a TiNi Thin Film in High Temperature Oxidizing Air Environment at Atmospheric Pressure. *Journal of Vacuum Science & Technology B* 19/1:305–307
- Roco MC (1999) Nanoparticles and Nanotechnology Research. *Journal of Nanoparticle Research* 1/1:1–6. doi:10.1023/a:1010093308079.
- Rogers B, Adams J, Pennathur S (2013) *Nanotechnology – The Whole Story*. CRC Press/Taylor and Francis Group, Boca Raton
- Rohrer H (1960) Druck- und Volumeneffekte in Supraleitung. PhD Thesis, Eidgenössischen technischen hochschule in Zürich, Zürich.
- Rollier AS, Legrand B, Collard D, Buchaillot L (2006) The Stability and Pull-In Voltage of Electrostatic Parallel-Plate Actuators in Liquid Solutions. *Journal of Micromechanics and Microengineering* 16/4:794
- Sah CT, Wanlass F (1963) Nanowatt Logic using Field-Effect Metal-Oxide Semiconductor Triodes. IEEE International Solid-State Circuits Conference. Digest of Technical Papers. VI:32–33
- Saini R, Saini S, Sharma S (2010) Nanotechnology: the Future Medicine. *Journal of Cutaneous and Aesthetic Surgery* 3/1:32–33. doi: 10.4103/0974-2077.63301
- Sakaki H (2002) Prospects of Advanced Quantum Nano-Structures and Roles of Molecular Beam Epitaxy. International Conference on Molecular Beam Epitaxy. doi:10.1109/MBE.2002.1037732
- Sakurai H, Tobias HJ, Park K, Zarling D, Docherty S, Kittelson DB, McMurry PH, Ziemann PJ (2003) On-Line Measurements of Diesel Nanoparticle Composition and Volatility. *Atmospheric Environment* 37/9–10:1199–1210. doi:10.1016/S1352-2310(02)01017-8
- Salamanca-Buentello F, Persad DL, Court EB, Martin DK, Daar AS, Singer PA. (2005) Nanotechnology and the Developing World. *PLoS Medicine* 2/5:383–386. doi:10.1371/journal.pmed.0020097
- Sallet V, Sartel C, Hassani S, Vilar C, Amiri G, Lusson A, Jomard F, Galtier P, Lefebvre I, Delerue C, Hamza MK, Canu B, Masenelli B (2018) Crystal Facet Engineering in Ga-Doped ZnO Nanowires for Mid-Infrared Plasmonics. *Crystal Growth & Design* 18/8:4287–4295
- Samet JM (2000) What Properties of Particulate Matter Are Responsible for Health Effects? *Inhalation Toxicology* 12/1:19–21. doi:10.1080/0895-8378.1987.11463175
- Sanders WC (2019) *Basic Principles of Nanotechnology*. CRC Press, Taylor & Francis Group, Boca Raton
- Santi M, Mapanao AK, Cassano D, Vlamidis Y, Cappello V, Voliani V (2020) Endogenously-Activated Ultrasmall-in-Nano Therapeutics: Assessment on 3D Head and Neck Squamous Cell Carcinomas. *Cancers* 12/5:1063. doi:10.3390/cancers12051063
- Saros MT, Weber RJ, Marti JJ, McMurry PH (1996) Ultrafine Aerosol Measurement Using a Condensation Nucleus Counter With Pulse Height Analysis. *Aerosol Science and Technology* 25/2:200–213. doi:10.1080/02786829608965391
- Sato T, Ruch R (1980) *Stabilization of Colloidal Dispersions by Polymer Absorption*. Marcel Dekker, New York
- Scheunert G, Cohen SR, Kullock R, McCarron R, Rechev K, Kaplan-Asnhiri I, Bitton O, Dawson P, Hecht B, Oron D (2017) Grazing-Incidence Optical Magnetic Recording with Super-Resolution. *Beilstein Journal of Nanotechnology* 8:28–37. doi:10.3762/bjnano.8.4
- Schnitzer J, Liu J, Oh P (1995) Endothelial Caveolae Have the Molecular Transport Machinery for Vesicle Budding, Docking, and Fusion Including VAMP, NSF, SNAP, Annexins, and GTPases. *Journal of Biological Chemistry* 270/24:14399–14404. doi:10.1074/jbc.270.24.14399
- Schoonheydt RA, Pinnavaia T, Lagaly G, Gangas N (1999) Pillared Clays and Pillared Layered Solids. *Pure and Applied Chemistry* 71/12:2367–2371. doi:10.1351/pac199971122367
- Schrand AM, Rahman MF, Hussain SM, Schlager JJ, Smith DA, Syed AF (2010) Metal-based Nanoparticles and their Toxicity Assessment. *Wiley Interdisciplinary Reviews: Nanomedicine and Nanobiotechnology* 2/5:544–568. doi:10.1002/wnan.103
- Schreurs DMMP, Verspecht J, Vandenberghe S, Vandamme E (2002) Straightforward and Accurate Nonlinear Device Model Parameter-Estimation Method Based on Vectorial Large-Signal

- Measurements. *IEEE Transactions on Microwave Theory and Techniques* 50/10:2315–2319. doi:10.1109/tmtt.2002.803427
- Schulte PA, Salamanca-Buentello F (2007) Ethical and Scientific Issues of Nanotechnology in the Workplace. *Environmental Health Perspectives* 115:5–12. doi:10.1289/ehp.9456
- Schumacher CM, Hermann IK, Bubenhofer SB, Gschwind S, Hirt A, Beck-Schimmer B, Günther D, Stark WJ (2013) Quantitative Recovery of Magnetic Nanoparticles from Flowing Blood: Trace Analysis and the Role of Magnetization. *Advanced Functional Materials* 23/39:4888–4896. doi:10.1002/adfm.201300696
- Sciacca D, Berthe M, Ryan B, Bradley J, Peric N, Deresmes D, Biadala L, Boyaval C, Addad A, Lancry O, Makarem R, Legendre S, Hocrelle D, Panthani MG, Prevot G, Lhuillier E, Diener P, Grandidier B (2022) Transport Properties of Methyl-Terminated Germanane Microcrystallites. *Nanomaterials* 12/7:1128
- Sciacca D, Peric N, Berthe M, Biadala L, Pirri C, Derivaz M, Massara N, Diener P, Grandidier B (2020) Account of the Diversity of Tunneling Spectra at the Germanene/Al(111) Interface. *Journal of Physics-Condensed Matter* 32/5:055002
- Seabra AB, Durán N (2015) Nanotoxicology of Metal Oxide Nanoparticles. *Metals* 5/2:934–975. doi:10.3390/met5020934
- Seaton A, Macnee W, Donaldson K, Godden D (1995) Particulate Air-Pollution and Acute Health-Effects. *Lancet* 345/8943:176–178. doi:10.1016/s0140-6736(95)90173-6
- Selleri F (1989) *Fisica senza Dogma, La Conoscenza Scientifica tra Sviluppo e Regressione*. Nuova Biblioteca Dedalo, Dedalo S.p.A., Bari
- Selloni A, Carnevali P, Tosatti E, Chen CD (1985) Voltage-Dependent Scanning-Tunneling Microscopy of a Crystal Surface: Graphite. *Physical Review B* 31/4:2602–2605. doi:10.1103/PhysRevB.31.2602
- Selvaggio G, Chizhik A, Nißler R, Kuhlemann I, Meyer D, Vuong L, Preiß H, Hermann N, Mann FA, Lv Z, Oswald TA, Spreinat A, Erpenbeck L, Großhans J, Janshoff A, Giraldo JP, Kruss S (2020) Exfoliated Near Infrared Fluorescent Silicate Nanosheets for (bio)Photonics. *Nature Communications* 11/1495:1–11. doi:10.1038/s41467-020-15299-5
- Semiconductor History Museum of Japan (2019) 1978:Double-Well Fast CMOS SRAM. Version 2019/1/23. Retrieved 27 August 2020
- Senez V, Collard D, Baccus B, Brault M, Lebailly J (1994) Analysis and Application of Viscoelastic Model for Silicon Oxidation. *Journal of Applied Physics* 76/6:3285–3296
- Senez V, Collard D, Ferreira P, Baccus B (1996) Two-Dimensional Simulation of Local Oxidation of Silicon: Calibrated Viscoelastic Flow Analysis. *IEEE Transactions on Electron Devices* 43/5:720–731
- Sershen SR, Westcott SL, West JL, Halas NJ (2001) An Opto-Mechanical Nanoshell-Polymer Composite. *Applied Physics B* 73:379–381. doi:10.1007/s003400100689
- Shaik FA, Lewuillon C, Guillemette A, Ahmadian B, Brinster C, Quesnel B, Collard D, Touil Y, Lemonnier L, Tarhan MC (2022) Pairing Cells of Different Sizes in a Microfluidic Device for Immunological Synapse Monitoring. *Lab on a Chip* 22/5:908–920
- Sharan M, Gonda K, Taguchi G, Jouke T (1998) Effects of Methyl Jasmonate and Elicitor on the Activation of Phenylalanine Ammonia-Lyase and the Accumulation of Scopoletin in Tobacco Cell Cultures. *Plant Science* 132/1:13–19
- Sharan M, Sharon M (2021) Carbon Nanofibers and Agro-Technology. In *Carbon Nanofibers* pp. 389–406. Wiley Online Library
- Sharan M, Sharon M, Dhumne I (2010) Micropropagation of Chlorophytum Borivilliens through Direct Organogenesis. *Advances in Applied Science Research* 1/2:41–46
- Sharan M, Sharon M, Nene C (2011) Regeneration of Asparagus Racemosus by Shoot Apex and Nodal Explants. *Asian Journal of Plant Science and Research* 1/2:49–56
- Sharon M, Rajaram C, Sharan M (2011) Effect of γ -Irradiation on Seedling Growth and Endogenous Level of IAA in Seedlings and Callus of Punica granatum L. cv. Ganesh. *Advances in Applied Science Research* 2/5:8–18
- Sherrington I, Rowe WB, Wood RJ (2002) *Total Tribology. Towards an Integrated Approach*. Professional Engineering Publishing Ltd., London
- Shiw JH, Lee BJ, Cho YW (2002) Thermal Stability of Unsupported Gold Nanoparticles: a Molecular Dynamic Study. *Surface Science* 512:262–268. doi:10.1016/S0039-6028(02)01692-8
- Shong CW, Haur SC, Wee ATS (2010) *Science at the Nanoscale. An Introductory Textbook*. Pan Stanford Publishing Pte. Ltd., Singapore

- Shortie D (1992) Mutational Studies of Protein Structures and Their Stabilities. *Quarterly Review of Biophysics* 25:205–250. doi:10.1017/s0033583500004674
- Sierra DP, Weir NA, Jones JF (2005) A Review of Research in the Field of Nanorobotics. U.S. Department of Energy – Office of Scientific and Technical Information Oak Ridge. doi:10.2172/875622
- Simon P, Gogotsi Y (2002) Materials for Electrochemical Capacitors. *Nature Materials* 7/11:845–854. doi:10.1038/nmat2297
- Singh AK (2016) The Past, Present, and the Future of Nanotechnology. Engineered nanoparticles. Boston: Academic Press, Boston.10.1016/B978-0-12-801406-6.00010-8
- Singh J, Pandit S, Bramwell VW, Alpar OH (2006) Diphtheria toxoid loaded-(ϵ -caprolactone) nanoparticles as mucosal vaccine delivery systems. *Methods* 38/2:96–105. doi:10.1016/j.ymeth.2005.11.003
- Singh PR, Blosssey R, Cleri F (2013) Structure and Mechanical Characterization of DNA i-Motif Nanowires by Molecular Dynamics Simulation. *Biophysical Journal* 105:2820–2831. doi:10.1016/j.bpj.2013.10.021
- Singh SV, Hu X, Srivastava SK, Xia H, Orchard JL (1998) Mechanism of Inhibition of Benzo(a)pyrene-induced Forestomach Cancer in Mice by Dietary Curcumin. *Carcinogenesis* 19/8:1357–1360. doi:10.1093/carcin/19.8.1357
- Sivanandini M, Dharmi SS, Pabla BS, Gupta M (2014) Effect of 3-mercaptopropyltrimethoxysilane on Surface Finish and Material Removal Rate in Chemical Mechanical Polishing. *Procedia materials Science* 6:528–537. doi:10.1016/j.mspro.2014.07.067
- SK Hynix (2010) History: 2010s. <https://www.skhynix.com/eng/about/history2010.jsp>. Retrieved 28 August 2020
- Slonczewski JC, Weiss PR (1958) Band Structure of Graphite. *Physical Review, Series I* 109/2:272–279. doi:10.1103/physrev.109.272
- Smalley RE (2001) Of Chemistry, Love and Nanobots. *Scientific American Magazine* 285/3:76–77. doi:10.1038/scientificamerican0901-76
- Smalley RE (2003a) Smalley Responds. *Chemical and Engineering News* 81:39–40
- Smalley RE (2003b) Smalley Concludes. *Chemical and Engineering News* 81:41–42
- Smit J, Wijn HPJ (1965) Ferrites. Philips Technical Library, Eindhoven
- Smith HI (2006) The Promise of Nanotechnology. In: NANOTECHNOLOGY. The Industrial Revolution of the 21st Century. Fundación de la Innovación Bankinter. Madrid. Spain
- Snyder-Beattie AE, Sandberg A, Drexler KE, Bonsall MB (2021) The Timing of Evolutionary Transitions Suggests Intelligent Life is Rare. *Astrobiology* 21/3:265–278. doi:10.1089/ast.2019.2149
- Son S, Taheri M, Carpenter E, Harris VG, McHenry ME (2002) Synthesis of Ferrite and Nickel Ferrite Nanoparticles using Radio-Frequency Thermal Plasma Torch. *Journal of Applied Physics* 91/10:7589–7591. doi:10.1063/1.1452705
- Song SC, Abu-Rahma M, Han BM, Yoon SS, Wang J, Yang W, Hu C, Yeap G (2008) Physical and Electrical Design of FinFET-Based SRAM Bitcell for 22nm Node and Below. In: Proceedings of 2008 Solid State Device and Material Conference, pp. 256–257. doi:10.7567/SSDM.2008.B-3-2
- Sonin D, Pochaeva E, Zhuravskii S, Postnov V, Korolev D, Vasina L, Kostina D, Mukhametdinova D, Zelinskaya I, Skorik Y, Naumysheva E, Malashicheva A, Somov P, Istomina M, Rubanova N, Aleksandrov I, Vasyutina M, Galagudza M (2020) Biological Safety and Biodistribution of Chitosan Nanoparticles. *Nanomaterials* 10/4/810. doi:10.3390/nano10040810
- Soppimath KS, Aminabhavi TM, Kulkarni AR, Rudzinski WE (2001) Biodegradable Polymeric Nanoparticles as Drug Delivery Devices. *Journal of Controlled Release* 70/1-2:1–20. doi:10.1016/s0168-3659(00)00339-4
- Soulaïrol R, Cleri F (2010) Interface Structure of Silicon Nanocrystals Embedded in an Amorphous Silica Matrix. *Solid State Science* 12/2:163–171
- Sourikopoulos I, Hedayat S, Loyez C, Danneville F, Hoel V, Mercier E, Cappy A (2017) A 4-fJ/Spike Artificial Neuron in 65nm CMOS Technology. *Frontiers in Neurosciences* 11/123:1–14. doi:10.3389/fnins.2017.00123
- Sourikopoulos I, Hedayat S, Loyez C, Danneville F, Hoel V, Mercier E, Cappy A (2017) A 4-fJ/Spike Artificial Neuron in 65nm CMOS Technology. *Frontiers in Neurosciences* 11/123:1–14. doi:10.3389/fnins.2017.00123
- Spaldin NA, Fiebig M (2005) Materials Science. The Renaissance of Magnetoelectric Multiferroics. *Science* 309/5733:391–392. doi:10.1126/science.1113357
- Speliotis D (2003) Getting the Most from Your Vibrating Sample Magnetometer. ADE Technologies, Newton

- Spoor FCM, Grimaldi G, Delerue C, Evers WH, Crisp RW, Geiregat P, Hens Z, Houtepen AJ, Siebbeles LDA (2018) Asymmetric Optical Transitions Determine the Onset of Carrier Multiplication in Lead Chalcogenide Quantum Confined and Bulk Crystals. *ACS Nano* 12/5:4796–4802
- Sridharan K, Pudi V (2015). *Design of Arithmetic Circuits in Quantum Dot Cellular Automata Nanotechnology*. Springer, Berlin
- Stiufiuc R, Perdigao LMA, Grandidier B, Deresmes D, Allan G, Delerue C, Stievenard D, Beton PH, Erwin SC, Sassi M, Oison V, Debierre JM (2010) Above-Barrier Surface Electron Resonances Induced by a Molecular Network. *Physical Review B* 81/4:045421–045426
- Subramanian V, Semenzin E, Hristozov D, Zabeo A, Malsch I, McAlea E, Murphy F, Mullins M, van Harmelen T, Ligthart T, Linkov I, Marcomini A (2016) Sustainable Nanotechnology Decision Support System: Bridging Risk Management, Sustainable Innovation and Risk Governance. *Journal of Nanoparticle Research* 18:89. doi:10.1007/s11051-016-3375-4
- Sun Y, Myers BT, Xia Y (2002) Template-Engaged Replacement Reactions: A One-Step Approach to the Large-Scale Synthesis of Metal Nanostructures with Hollow Interiors. *Nano Letters* 2/5:481–485
- Sun Y, Xia Y (2002) Increased Sensitivity of Surface Plasmon Resonance of Gold Nanoshells Compared to That of Gold Solid Colloids in Response to Environmental Changes. *Analytical Chemistry* 74/20:5297–5305. doi:10.1021/ac0258352
- Sun Z, Swart I, Delerue C, Vanmaekelbergh D, Liljeroth P (2009) Orbital and Charge-Resolved Polaron States in CdSe Dots and Rods Probed by Scanning Tunneling Spectroscopy. *Physical Review Letters* 102/19:196401
- Sutton RS, Barto AG (2018) *Reinforcement Learning: An Introduction*, 2nd ed. The MIT Press, Boston.
- Swanson JA (2008) Shaping Cups into Phagosomes and Macropinosomes. *Nature Reviews Molecular Cell Biology* 9/8:639–649. doi:10.1038/nrm2447
- Syberg K, Hansen SF (2015) Environmental risk assessment of chemicals and nanomaterials – The best foundation for regulatory decision-making? *Science of the Total Environment* 541:784–794. doi:10.1016/j.scitotenv.2015.09.112
- Sydney Morning Herald (2003) Power from blood could lead to human batteries. <https://www.smh.com.au/articles/2003/08/03/1059849278131>. Retrieved 29 August 2020
- Sze SS (2002) *Semiconductor Devices: Physics and Technology*. John Wiley & Sons, New York
- Szunerits S, Maalouli N, Wijaya E, Vilcot JP, Boukherroub R (2013) Recent Advances in the Development of Graphene-Based Surface Plasmon Resonance (SPR) Interfaces. *Analytical and Bioanalytical Chemistry* 405/5. doi:10.1007/s00216-012-6624-0
- Szunerits S, Maalouli N, Wijaya E, Vilcot JP, Boukherroub R (2013) Recent Advances in the Development of Graphene-Based Surface Plasmon Resonance (SPR) Interfaces. *Analytical and Bioanalytical Chemistry* 405/5. doi:10.1007/s00216-012-6624-0
- Tadias Magazine (2010) Research Discovery By Ethiopian Scientist At IBM. Tadias Magazine. <http://www.tadias.com/index.php?s=research+discovery+by+ethiopian+scientist+at+ibm>. Retrieved 29 August 2020
- Tadjine A, Allan G, Delerue C (2016) From Lattice Hamiltonians to Tunable Band Structures by Lithographic Design. *Physical Review B* 94/7:075441–075454
- Tadjine A, Delerue C (2017a) Robustness of States at the Interface Between Topological Insulators of Opposite Spin Chern Number. *EPL* 118/6:67003
- Tadjine A, Delerue C (2017b) Topological Protection of Electronic States Against Disorder Probed by their Magnetic Moment. *Physical Review B* 95/23:235426–235431
- Tadjine A, Delerue C (2018a) Anderson Localization Induced by Gauge-Invariant Bond-Sign Disorder in Square PbSe Nanocrystal Lattices. *Physical Review B* 98/12:125412–125422
- Tadjine A, Delerue C (2018b) Colloidal Nanocrystals as LEGO® Bricks for Building Electronic Band Structure Models. *Physical Chemistry Chemical Physics* 20/12:8177–8184
- Tadjine A, Niquet YM, Delerue C (2017) Universal Behavior of Electron g-Factors in Semiconductor Nanostructures. *Physical Review B* 95/23:235437–235453
- Tadros T, Izquierdo P, Esquena J, Solans C (2004) Formations and Stability of Nano-Emulsions. *Advances in Colloids and Interface Science* 108–109:303–318. doi:10.1016/j.cis.2003.10.023.
- Takayama Y, Perret G, Kumemura M, Ataka M, Meignan S, Karsten SL, Fujita H, Collard D, Lagadee C, Tarhan MC (2018) Developing a MEMS Device with Built-in Microfluidics for Biophysical Single Cell Characterization. *Micromachines* 9/6:275

- Tamburrano A, Fortunato M, Pesce N, Sarto MS (2022) Exploring the Capabilities of a Piezoresistive Graphene-Loaded Waterborne Paint for Discrete Strain and Spatial Sensing. *Sensors* 22/11:4241. doi:10.3390/s22114241
- Tans SJ, Devoret MH, Dai H, Thess A, Smalley RE, Geerligs LJ, Dekker C (1997) Individual Single-Wall Carbon Nanotubes as Quantum Wires. *Nature* 386:474–477. doi:10.1038/386474a0
- Tarhan MC, Lafitte N, Tauran Y, Jalabert L, Kumemura M, Perret G, Kim B, Coleman AW, Fujita H, Collard D (2016) A Rapid and Practical Technique for Real-Time Monitoring of Biomolecular Interactions using Mechanical Responses of Macromolecules. *Scientific Reports* 6
- Tarhan MC, Yokokawa R, Jalabert L, Collard D, Fujita H (2017) Pick-and-Place Assembly of Single Microtubules. *Small* 13/32
- Tauran Y, Ceron-Carrasco JP, Rhimi M, Perret F, Kim B, Collard D, Coleman AW, Perez-Sanchez H (2019) Size and Flexibility Define the Inhibition of the H3N2 Influenza Endonuclease Enzyme by Calix[n]arenes. *Antibiotics-Basel* 8/2
- Tauran Y, Kumemura M, Tarhan MC, Perret G, Perret F, Jalabert L, Collard D, Fujita H, Coleman AW (2019) Direct Measurement of the Mechanical Properties of a Chromatin analog and the Epigenetic Effects of Para-Sulphonato-Calix[4]arene. *Scientific Reports* 9
- Tauran Y, Tarhan MC, Mollet L, Gerves JB, Kumemura M, Jalabert L, Lafitte N, Byun I, Kim B, Fujita H, Collard D, Perret F, Desbrosses M, Leonard D, Goutaudier C, Coleman AW (2018) Elucidating the Mechanism of the Considerable Mechanical Stiffening of DNA Induced by the Couple Zn(2+)-Calix[4]arene-1,3-O-diphosphorous Acid. *Scientific Reports* 8
- Tegeler E, Kosuch N, Wiech G, Faessler A (1979) On the Electronic Structure of Hexagonal Boron Nitride. *Physica Status Solidi (b)* 91/1:223–231. doi:10.1002/pssb.2220910123
- Themistoklis Sidiropoulos PH, Röder R, Geburt S, Hess O, Maier SA, Ronning C, Oulton RF (2014) Ultrafast Plasmonic Nanowire Lasers near the Surface Plasmon Frequency. *Nature Physics* 10/11:870–876. doi:10.1038/nphys3103
- Thiesen B, Jordan A (2008) Clinical Applications of Magnetic Nanoparticles for Hyperthermia. *International Journal of Hyperthermia* 24/6:467–474. doi:10.1080/02656730802104757
- Thomas JA, McGaughey A, Ottoleo KA (2019) Pressure-Driven Water Flow Through Carbon Nanotubes: Insights from Molecular Dynamics Simulation. *International Journal of Thermal Science* 49/2:281–289. doi:10.1016/J.IJThermalsci.2009.07.008
- Thompson WA, Hanrahan (1976) Thermal Drive Apparatus for Direct Vacuum Tunneling Experiments. *Review of Scientific Instruments* 47:1303–1304. doi:10.1063/1.1134513
- Tian B, Zheng X, Kempa TJ, Fang Y, Yu N, Yu G, Huang J, Lieber CM (2007) Coaxial Silicon Nanowires as Solar Cells and Nanoelectronic Power Sources. *Nature* 449/7164:885–889. doi:10.1038/nature06181
- Tian Y, Pesika N, Zeng H, Rosenberg K, Zhao B, McGuiggan P, Autumn K, Israelachvili J (2006) Adhesion and Friction in Gecko Toe Attachment and Detachment. *Proceedings of the National Academy of Science of the United States of America* 103/51:19320–19325. doi:10.1073/pnas.0608841103
- Tice TR, Gilley RM (1985) Preparation of Injectable Controlled-Release Microcapsules by Solvent-Evaporation Process. *Journal of Controlled Release* 2:343–52. doi:10.1016/0168-3659(85)90056-2
- Tiercelin N, Dusch Y, Klimov A, Giordano S, Preobrazhensky V, Pernod P (2011) Room Temperature Magnetoelectric Memory Cell Using Stress-Mediated Magnetoelastic Switching in Nanostructured Multilayers. *Applied Physics Letters* 99/19:192507
- Tobias HJ, Beving DE, Ziemann PJ, Sakurai H, Zuk M, Mc-Murry PH, Zarling D, Waytulonis R, Kittelson DB (2001) Chemical Analysis of Diesel Engine Nanoparticles Using a Nano-DMA/Thermal Desorption Particle Beam Mass Spectrometer. *Environmental Science and Technology* 35/11:2233–2243. doi:10.1021/es0016654
- Tomezak M, Abbadie C, Lartigau E, Cleri F (2016) A Biophysical Model of Cell Evolution after Cytotoxic Treatments: Damage, Repair and Cell Response. *Journal of Theoretical Biology* 389:146–158
- Torchilin VP, Lukyanov AN, Gao Z, Papahadjopoulos-Sternberg B (2003) Immunomicelles: Targeted Pharmaceutical Carriers for Poorly Soluble Drugs. *Proceedings of the National Academy of Sciences* 100/10:6039–6044. doi:10.1073/pnas.0931428100
- Toth P (2021) Nanostructure Quantification of Turbostratic Carbon by HRTEM Image Analysis: State of the Art, Biases, Sensitivity and Best Practices. *Carbon* 178:688–707. doi:10.1016/j.carbon.2021.03.043

- Toumey C (2008) Reading Feynman Into Nanotechnology: A Text for a New Science. *Techné: Research in Philosophy and Technology* 12/3:133–168. doi:10.5840/techne20081231
- Trasobares J, Vuillaume D, Théron D, Clément N (2016) A 17 GHz Molecular Rectifier. *Nature Communications* 7:1–9. doi:10.1038/ncomms12850
- Trasobares J, Vuillaume D, Théron D, Clément N (2016) A 17 GHz Molecular Rectifier. *Nature Communications* 7:1–9. doi:10.1038/ncomms12850
- TSMC Taiwan Semiconductor Manufacturing Company Limited (2019) 5nm Technology. https://www.tsmc.com/english/dedicatedFoundry/technology/logic.htm#l_5nm_technology Retrieved 28 August 2020
- Ulbricht R, Pijpers JH, Groeneveld E, Koole R, Donega CdM, Vanmaekelbergh D, Delerue C, Allan G, Bonn M (2012) Loosening Quantum Confinement: Observation of Real Conductivity Caused by Hole Polarons in Semiconductor Nanocrystals Smaller than the Bohr Radius. *Nano Letters* 12/9:4937–4942
- Ulman A (1991) Introduction to Ultrathin Organic Films: From Langmuir–Blodgett to Self–Assembly. Academic Press, San Diego
- Ungewickell E, Branton D (1981) Assembly Units of Clathrin Coats. *Nature* 289/5796:420–422. doi:10.1038/289420a0
- Urry OW (1993) Molecular Machines: How Motion and Other Functions of Living Organisms can Result from Reversible Chemical Changes. *Angewandte Chemie International Edition* 32:819–41. doi:10.1002/anie.199308191
- Valenti G, Rampazzo E, Bonacchi S, Petrizza L, Marcaccio M, Montalti M, Prodi L, Paolucci F. (2016) 2+ Core–Shell Silica Nanoparticles. *Journal of the American Chemical Society* 138/49:15935–15942. doi:10.1021/jacs.6b08239
- van Driel AF, Allan G, Delerue C, Lodahl P, Vos WL, Vanmaekelbergh D (2005) Frequency–Dependent Spontaneous Emission Rate from CdSe and CdTe Nanocrystals: Influence of Dark States. *Physical Review Letters* 95/23:236804–236808
- Vandamme EP, Schreurs D, van Dinther C, Badenes G, Deferm L (2002) Development of a RF Large Signal MOSFET Model, Based on an Equivalent Circuit, and Comparison with the BSIM3v3 Compact Model. *Solid–State Electronics* 46/3:353–360. doi:10.1016/s0038–1101(01)00108–3
- Varela JA, Sen K, Gibson J, Fost J, Abbott LF, Nelson SB (1997) A Quantitative Description of Short–Term Plasticity at Excitatory Synapses in Layer 2/3 of Rat Primary Visual Cortex. *Journal of Neuroscience* 17/20:7926–7940. doi:10.1523/JNEUROSCI.17–20–07926.1997
- Vauthier C, Couvreur P (2000) Development of Polysaccharide Nanoparticles as Novel Drug Carrier Systems. In: Wise DL, Editor. *Handbook of pharmaceutical controlled release technology*. Marcel Dekker, New York
- Velu G, Legrand C, Tharaud O, Chapoton A, Remiens D, Horowitz G (2001) Low Driving Voltages and Memory Effect in Organic Thin–Film Transistors with a Ferroelectric Gate Insulator. *Applied Physics Letters* 79/5:659–661. doi:10.1063/1.1379059
- Velu G, Legrand C, Tharaud O, Chapoton A, Remiens D, Horowitz G (2001) Low Driving Voltages and Memory Effect in Organic Thin–Film Transistors with a Ferroelectric Gate Insulator. *Applied Physics Letters* 79/5:659–661. doi:10.1063/1.1379059
- Vergel NAF, Tadjine A, Notot V, Mohr M, N’Guissan AK, Coinon C, Berthe M, Biadala L, Sossoe KK, Dzagli MM, Girard JC, Rodary G, Desplanque L, Berndt R, Stivenard D, Wallart X, Delerue C, Grandidier B (2019) Influence of Doping Level and Surface States in Tunneling Spectroscopy of an In_{0.53}Ga_{0.47}As Quantum Well Grown on p–Type Doped InP(001). *Physical Review Materials* 3/9:094604–094613
- Viero Y, Copie G, Guérin D, Krzeminski C, Vuillaume D, Lenfant S, Cleri F (2015) High Conductance Ratio in Molecular Optical Switching of Functionalized Nanoparticles Self–Assembled Nanodevices. *Journal of Physical Chemistry C* 119/36:21173–21183. doi:10.1021/acs.jpcc.5b05839
- Viero Y, Copie G, Guérin D, Krzeminski C, Vuillaume D, Lenfant S, Cleri F (2015) High Conductance Ratio in Molecular Optical Switching of Functionalized Nanoparticle Self–Assembled Nanodevices. *Journal of Physical Chemistry C* 119/36:21173–21183
- Vincent IFV (1982) *Structural Biomaterials*. Wiley New York
- Vincent JH, Clement CF (2000) Ultrafine Particles in Workplace Atmospheres. *Philosophical Transactions Mathematical Physical and Engineering Science* 358/1775:2673–2682. doi:10.1098/rsta.2000.0676
- Vladimirov VS (1981) *Urvnenija Matematičeskoj Fisiki*. Nauka, Moscow

- Voisin B, Cobian M, Jehl X, Vinet M, Niquet YM, Delerue C, de Franceschi S, Sanquer M (2014) Control of the Ionization State of Three Single Donor Atoms in Silicon. *Physical Review B* 89/16:161404
- Von Hippel AR (1956) Molecular Engineering. *Science* 123/3191:315–317. doi:10.1126/science.123.3191.315
- Vuillaume D, Lenfant S, Guerin D, Delerue C, Petit C, Salace G (2006) Electronic Properties of Organic, Monolayers and Molecular Devices. *Pramana—Journal of Physics* 67/1:17–32
- Wagner V, Dullaart A, Bock AK, Zweck A (2006) The Emerging Nanomedicine Landscape. *Nature Biotechnology* 24/10:1211–7. doi:10.1038/nbt1006-1211
- Wallace PR (1947) The Band Theory of Graphite. *Physical Review, Series I* 71/9:622–634. doi:10.1103/physrev.71.622
- Walravens W, Solano E, Geenen F, Dendooven J, Gorobtsov O, Tadjine A, Mahmoud N, Ding PP, Ruff JPC, Singer A, Roelkens G, Delerue C, Detavernier C, Hens Z (2019) Setting Carriers Free: Healing Faulty Interfaces Promotes Delocalization and Transport in Nanocrystal Solids. *ACS Nano* 13/11: 12774–12786
- Wang N, Wu XS (1997) Preparation and Characterization of Agarose Hydrogel Nanoparticles for Protein and Peptide Drug Delivery. *Pharmaceutical Development and Technology* 2/2:135–142. doi:10.3109/10837459709022618.
- Wang X, Xu X, Choi SUS (1999) Thermal Conductivity of Nanoparticle Fluid Mixture. *Journal of Thermophysics and Heat Transfer* 13/4:474–480. doi:10.2514/2.6486
- Wang Y, Dave RN, Pfeffer R (2004) Polymer Coating/Encapsulation of Nanoparticles using a Supercritical Anti-Solvent Process. *The Journal of Supercritical Fluids* 28/1:85–99. doi:10.1016/s0896-8446(03)00011-1
- Wang ZL (2000) Transmission Electron Microscopy and Spectroscopy of Nanoparticles, in *Characterization of Nanophase Materials*. Wiley VCH, Weinheim
- Wang ZZ, Suski J, Collard D (1995) Silicon Piezoresistivity Modeling – Application to the Simulation of Mosfets. *Sensors and Actuators A—Physical* 47/1–3:628–631
- Washizu M (1992) Precise Calculation of Dielectrophoretic Force in an Arbitrary Field. *Journal of Electrostatics* 29:177–188. doi:10.1016/0304-3886(93)90104-F
- Washizu M, Jones TB (1996) Generalized Multipolar Dielectrophoretic Force and Electrorotational Torque Calculation. *Journal of Electrostatics* 38/3:199–211
- Weisenhorn AL, Hansma PK, Albrecht TR, Quate CF (1989) Forces in Atomic Force Microscopy in Air and Water. *Applied Physics Letters* 54:2651–2653. doi:10.1063/1.101024
- Weissmann M, Bonadeo H (2001) A Simple Interpretation of Quantum Mirages. *Physica E* 10/4:544–548. doi:10.1016/S1386-9477(01)00036-4
- Wendler WM (1987) Modified Continuum Shell-Model Theory for (n,2n) Reactions. *Nuclear Physics A* 472:26–40. doi:10.1016/0375-9474(87)90218-1
- Whatmore RW (2006) Nanotechnology—What is it? Should we be worried? *Occupational Medicine* 56:295–299. doi:10.1093/occmed/kql050
- Whitby M, Cagnon L, Thanou M, Quirke N (2008) Enhanced Fluid Flow Through Nanoscale Carbon Pipes. *Nano Letters* 8/9:2632–7. doi:10.1021/nl080705f
- Wilbur JL, Kumar A, Biebuyck HA, Enoch K, Whitesides GM (1996) Microcontact Printing of Self-Assembled Monolayers: Applications in Microfabrication. *Nanotechnology* 7:452–457. doi:10.1088/0957-4484/7/4/028
- Wildöer KWG, Venema LC, Rinzler AG, Smalley RE, Dekker C (1998) Electronic Structure of Atomically Resolved Carbon Nanotubes. *Nature* 391:59–62. doi:10.1038/34139
- Wilson M, Kannangara K, Smith G, Simmons M, Burkhard R (2002) *Nanotechnology: Basic Science and Emerging Technologies*. Chapman and Hall/CRC Press, Boca Raton
- Wilson WL, Szajowski PF, Brus LE (1993) Quantum Confinement in Size-Selected, Surface-Oxidized Silicon Nanocrystals. *Science* 262/5137:1242–1244. doi:10.1126/science.262.5137.1242
- Win P, Druelle Y, Cappy A, Cordier Y, Favre J, Bouillet C (1992) Metamorphic In_{0.3}Ga_{0.7}As/In_{0.29}Al_{0.71}As Layer on GaAs: A New Structure for High Performance High Electron Mobility Transistor Realization. *Applied Physics Letters* 61/8:922–924. doi:10.1063/1.107729
- Win P, Druelle Y, Cappy A, Cordier Y, Favre J, Bouillet C (1992) Metamorphic In_{0.3}Ga_{0.7}As/In_{0.29}Al_{0.71}As Layer on GaAs: A New Structure for High Performance High Electron Mobility Transistor Realization. *Applied Physics Letters* 61/8:922–924. doi:10.1063/1.107729
- Wolf EL (2014) *Application of Graphene*. Springer International, Berlin

- Wolkin MV, Jorne J, Fauchet PM, Allan G, Delerue C (1999) Electronic States and Luminescence in Porous Silicon Quantum Dots: The Role of Oxygen. *Physical Review Letters* 82/1:197–200. doi:10.1103/PhysRevLett.82.197
- Wolkin MV, Jorne J, Fauchet PM, Allan G, Delerue C (1999) Electronic States and Luminescence in Porous Silicon Quantum Dots: The Role of Oxygen. *Physical Review Letters* 82/1:197–200. doi:10.1103/PhysRevLett.82.197
- Wu P, Yan XP (2013) Doped Quantum Dots for Chemo/Biosensing and Bioimaging. *Chemical Society Reviews* 42/12:5489–521. doi:10.1039/c3cs60017c
- Xiang J, Lu W, Hu Y, Wu Y, Yan H, Lieber CM (2006) Ge/Si Nanowire Heterostructures as High Performance Field-Effect Transistors. *Nature* 441/7092:489–493. doi:10.1038/nature04796
- Xiao G, Liou SH, Levy A, Taylor JN, Chien CI (1986) Magnetic Relaxation in Fe-(SiO₂) Granular Films. *Physical Review B* 34/11:7573–7577. doi:10.1103/PhysRevB.34.7573
- Xie H, Hicks N, Keller GR, Huang H, Kreinovich V (2003) An IDL/ENVI Implementation of the FFT-Based Algorithm for Automatic Image Registration. *Computer & Geoscience* 29/8:1045–1055. doi:10.1016/S0098-3004(03)00104-3
- Xu S, Liu G (1997) Nanometric-Scale Fabrication by Simultaneous Nanoshaving and Molecular Self-Assembly. *Langmuir* 13/2:127–129. doi:10.1021/LA962029F
- Xu Y, Wang N, Yu Y, Li Y, Li YB, Yu YB, Zhou XQ, Sun ZW, McCormick DL (2014) Exposure to Silica Nanoparticles Causes Reversible Damage of the Spermatogenic Process in Mice. *PLoS ONE* 9/7:E101572. doi:10.1371/journal.pone.0101572
- Xu ZP, Zeng QH, Lu GQ, Yu AB (2006) Inorganic Nanoparticles as Carriers for Efficient Cellular Delivery. *Chemical Engineering Science* 61/3:1027–1040. doi:10.1016/j.ces.2005.06.019
- Yager RR, Kreinovich V (1999) Decision Making Under Interval Probabilities. *International Journal of Approximate Reasoning* 22/3:195–215. doi:10.1016/S0888-613X(99)00028-6
- Yamahata C, Collard D, Legrand B, Takekawa T, Kunternura M, Hashiguchi G, Fujita H (2008) Silicon Nanotweezers with Subnanometer Resolution for the Micromanipulation of Biomolecules. *Journal of Microelectromechanical Systems* 17/3:623–631
- Yang F, Wang M, Zhang D, Yang J, Zheng M, Li Y (2020) Chirality Pure Carbon Nanotubes: Growth, Sorting, and Characterization. *Chemical Reviews* 120/5:2693–2758. doi:10.1021/acs.chemrev.9b00835
- Yang G, Amro N, Liu GY (2003) Scanning Probe Lithography of Self-Assembled Monolayers. *SPIE Optics + Photonics, Materials Science, Engineering* 35/6:52–65. doi:10.1117.12504613
- Yang Z, Benhabiles H, Hammoudi K, Windal F He R, Collard D (2022) A Generalized Deep Learning-Based Framework for Assistance to the Human Malaria Diagnosis from Microscopic Images. *Neural Computing & Applications* 34/17: 14223–14238
- Yousefi A, Esmaeili F, Rshimian S, Atyabi F, Dinarvand R (2009) Preparation and In Vitro Evaluation of A Pegylated Nano-Liposomal Formulation Containing Docetaxel. *Scientia Pharmaceutica* 77:453–464. doi:10.3797/scipharm.0806-08
- Yuba E, Harada A, Sakanishi Y, Kono K (2011) Carboxylated Hyperbranched Poly(glycidol)s for Preparation of pH-Sensitive Liposomes. *Journal of Control Release* 149/1:72–80. doi:10.1016/j.jconrel.2010.03.001
- Yung CW, Fiering J, Mueller AJ, Ingber DE (2009) Micromagnetic-Microfluidic Blood Cleansing Device. *Lab on a Chip* 9/9:1171–7. doi:10.1039/b816986a
- Zaghloul U, Bhushan B, Papaioannou G, Coccetti F, Pons P, Plana R (2011) Nanotribology-Based Novel Characterization Techniques for the Dielectric Charging Failure Mechanism in Electrostatically Actuated NEMS/MEMS Devices using Force-Distance Curve Measurements. *Journal of Colloid and Interface Science* 1/1:236–253. doi:10.1016/j.jcis.2011.08.005
- Zaibaq NG, Pollard AC, Collins MJ, Pisaneschi F, Pagel MD, Wilson LJ (2020) Evaluation of the Biodistribution of Serinolamide-Derivatized C₆₀ Fullerene. *Nanomaterials* 10/1/143. doi:10.3390/nano10010143
- Zaks A, Klibanov AM (1984) Enzymatic Catalysis in Organic Media at 100 Degree °C. *Science* 224/4654:1249–1251. doi:10.1126/science.6729453
- Zhang J, Bingqing Y, Cjao H, Yuanyuan H (2020) Urease Immobilized Magnetic Graphene Oxide as Safe and Effective Urea Removal Recyclable Nano-catalyst for Blood Purification. *Industrial & Engineering Chemistry Research* 59/19:8955–8964. doi:10.1021/acs.iecr.0c00302
- Zhang K, Sciacca D, Coati A, Bernard R, Borensztein Y, Diener P, Granddier B, Lefebvre I, Derivaz M, Pirri C, Prevot G (2021) Resolving the Structure of the Striped Ge Layer on Ag(111): Ag₂Ge Surface Alloy with Alternate fcc and hcp Domains. *Physical Review B* 104/15:155403–155409

- Zhang R, Zhang Y, Dong ZC, Jiang S, Zhang C, Chen LG, Zhang L, Liao Y, Aizpurua J, Luo Y, Yang JL, Hou JG (2013) Chemical Mapping of a Single Molecule by Plasmon-Enhanced Raman Scattering. *Nature* 498/7452:82–86. doi:10.1038/nature12151
- Zhang T, Vlaic S, Pons S, Assouline A, Zimmers A, Roditchev D, Aubin H, Allan G, Delerue C, David C, Rodary G, Girard JC (2018) Quantum Confinement Effects in Pb Nanocrystals Grown on InAs. *Physical Review B* 97/21:214514–214525
- Zhang W, Delerue C, Niquet YM, Allan G, Wang E (2010) Atomistic Modeling of Electron-Phonon Coupling and Transport Properties in n-type [110] Silicon Nanowires. *Physical Review B* 82/11:115319–115326
- Zhang Y, Tan YW, Stormer HL, Kim P (2005) Experimental Observation of Quantum Hall Effect and Berry's Phase in Graphene. *Nature* 438:201–204. doi:10.1038/nature04235
- Zhang Z, Yates JT Jr (2012) Band Bending in Semiconductors: Chemical and Physical Consequences at Surfaces and Interfaces. *Chemical Reviews* 112/10:5520–5551. doi:10.1021/cr3000626
- Zhao C, Jin Y, Zhang Y, Liu B (2007) Comparative study of effects of nanosized and microsized silicon dioxide dust on mouse embryos. *Journal of Hygiene Research* 36/4:414–416.
- Zheng G, Patolsky F, Cui Y, Wang WU, Lieber CM (2005) Multiplexed Electrical Detection of Cancer Markers with Nanowire Sensor Arrays. *Nature Biotechnology* 23/10:1294–301. doi:10.1038/nbt1138
- Zheng Q, Jiang Q (2002) Multiwalled Carbon Nanotubes as Gigahertz Oscillators. *Physical Review Letters* 88/4:045503. doi:10.1103/PhysRevLett.88.045503
- Zheng Q, Liu JZ, Jiang Q (2002) Excess Van der Waals Interaction Energy of a Multiwalled Carbon Nanotube with an Extruded core and Induced Core Oscillation. *Physical Review B* 65:245409. doi:10.1103/PhysRevB.65.245409
- Zhou H, Talbi A, Tiercelin N, Bou Matar O (2014) Multilayer Magnetostrictive Structure Based Surface Acoustic Wave Devices. *Applied Physics Letters* 104/11:111401.1–111401.4. doi:10.1063/1.4868530
- Zhou H, Talbi A, Tiercelin N, Bou Matar O (2014) Multilayer Magnetostrictive Structure Based Surface Acoustic Wave Devices. *Applied Physics Letters* 104/11:111401.1–111401.4. doi:10.1063/1.4868530
- Zhou S, Pi X, Ni Z, Ding Y, Jiang Y, Jin C, Delerue C, Yang D, Nozaki T (2015) Comparative Study on the Localized Surface Plasmon Resonance of Boron- and Phosphorus-Doped Silicon Nanocrystals. *ACS Nano* 9/1:378–386
- Zhuang Y, Biswas P (2001) Submicrometer Particle Formation and Control in a Bench-Scale Pulverized Coal Combustor. *Energy Fuels* 15/3:510–516. doi:10.1021/ef000080s
- Zucca R, Boero M, Massobrio C, Molteni C, Cleri F (2011) Interacting Lewis-X Carbohydrates in Condensed Phase: A First-Principles Molecular Dynamics Study. *Journal of Physical Chemistry B* 115/43:12599–1

Web References

- Kurzweil R (2003) The Drexler-Smalley Debate on Molecular Assembly. Retrieved February the 21st 2021 via: <https://www.kurzweilai.net/the-drexler-smalley-debate-on-molecular-assembly>.
- Merkle RC (2001) That's Impossible! How Good Scientists Reach Bad Conclusions. Retrieved March the 12th 2021 via: <http://www.zyvex.com/nanotech/impossible.html>.
- 1955: Developing of Oxide Masking https://www.computerhistory.org/siliconengine/development-of-oxide_masking/ Retrieved: November 05, 2021
- 1960: Metal Oxide Semiconductor (MOS) Transistor Demonstrated <https://www.computerhistory.org/siliconengine/metal-oxide-semiconductor-mos-transistor-demonstrated/> Retrieved: November 04, 2021
- Moore's Law to roll on for another decade <http://news.cnet.com/2100-1001-984051.html>. Retrieved November 09, 2021

Selected Additional References on the Subjects – Non-Cited in the Running Text

- Aghdam MTB, Mohammadi H, Ghorbanpour M (2015) Effects of Nanoparticulate Anatase Titanium Dioxide on Physiological and Biochemical Performance of *Linum usitatissimum* (Linaceae) under Well-Watered and Drought. *Brazilian Journal of Botany*, 23:1–8
- Akrami SMR, Nakayachi N, Watanabe–Nakayama T, Asakawa H, Fukuma T (2014) Significant Improvements in Stability and Reproducibility of Atomic–Scale Atomic Force Microscopy in Liquid. *Nanotechnology* 25/45:455701
- Alber T (1989) Mutational Effects on Protein Stability. *Annual Review of Biochemistry* 58:765–98
- Albert KJ, Lewis NS, Schauer CL, Sotzing GA, Stitzel SE, Vaid TP, Walt DR (2000) Cross-Reactive Chemical Sensor Arrays. *Chemical Reviews* 100/7:2595–2626
- Allémann E, Gurny R, Doekler E (1993) Drug–Loaded Nanoparticles Preparation Methods and Drug Targeting Issues. *European Journal of Pharmacy and Biopharmacy* 39/5:173–191
- Allho F (2007) On the Autonomy and Justification of Nanoethics. *Nanoethics* 1:185–210
- Almeida JP, Figueroa ER, Drezek RA (2014) Gold Nanoparticle Mediated Cancer Immunotherapy. *Nanomedicine* 10/3:503–514.
- Altan H, Huang F, Federici JF, Lan A, Grebel H (2004) Optical and Electronic Characteristics of Single Walled Carbon Nanotubes and Silicon Nanoclusters by Terahertz Spectroscopy. *Journal of Applied Physics* 96/11:6685
- Altmann E, Altmann KH, Nebel K, Mutter M (1988) Conformational Studies on Host–Guest Peptides containing Chiral α -Methyl- α -Amino Acids. *International Journal of Peptide and Protein Research* 32:344–51
- Alvarez FX, Cimmelli VA, Jou D, Sellitto A (2012) Mesoscopic Description of Boundary Effects in Nanoscale Heat Transport. *Nano MMTA*, 1:112–142
- Amabilino DB, Stoddard JF, Williams DJ (1994) From Solid–State Structures and Superstructures to Self–Assembly Processes. *Chemistry of Materials* 6/8:1159–1167
- Amato I (1999) *Nanotechnology: Shaping the World Atom by Atom*. Washington, DC: National Science & Technology Council
- Amenta V, Aschberger K, Arena M, Bouwmeester H, Botelho Moniz F, Brandhoff P, Gottardo S, Marvin HJP, Mech A, Quiros Pseudo L (2015) Regulatory Aspects of Nanotechnology in the Agri/Feed/Food Sector in EU and non–EU Countries. *Regulatory Toxicology and Pharmacology* 73:463–476
- Anelli PL, Ashton PR, Philp D, Pietraszkiewicz M, Reddington MV, Spencer N, Stoddart JF, Vicent C, Ballardini R, Balzani V, Gandolfi MT, Prodi L, Delgado M, Goodnow TT, Kaifer AE, Slawin AMZ, Williams DJ (1992) Molecular Meccano. I. [2]Rotaxanes and a [2]Catenane Made to Order. *Journal of the American Chemical Society* 114:193–218
- Anischik VM, Borisenko VE, Zhdanok SA, Tolochko NK, Fedosyuk VM (2008). *Nanomaterials and Nanotechnologies*. Izd. Ben–Gurion University, Negev
- Appenzeller T (1991) The Man Who Dared to Think Small. *Science* 254/5036:1300–01
- Arns RG (1998) The Other Transistor: Early History of the Metal–Oxide–Semiconductor Field–Effect Transistor. *Engineering Science and Education Journal*. 7/5: 233–40
- Arvizo R, Bhattacharya R, Mukherjee P (2010) Gold Nanoparticles: Opportunities and Challenges in Nanomedicine. *Expert Opinion on Drug Delivery* 7/6:753–763
- Aschaffenburg DJ, Williams MRC, Talbayev D, Santavicca DF, Prober DE, Schmuttenmaer CA. Efficient Measurement of Broadband Terahertz Optical Activity. *Applied Physics Letters* 100:241114 1–5
- Ashby PD, Chen L, Lieber CM (2000) Probing Intermolecular Forces and Potentials with Magnetic Feedback Chemical Force Microscopy. *Journal of the American Chemical Society* 122/39:9467–9472
- Atkinson JW (1979) The Importance of the History of Science to the American Society of Zoologists. *American Zoologist* 19:1243–1246
- Attard GS, Glyde JC, Goltner CG (1995) Liquid–Crystalline Phases as Templates for the Synthesis of Mesoporous Silica. *Nature* 378/6555:366–368
- Attard GS, Leclerc SAA, Maniquet S, Russell AE, Nandakumer I, Gollas BR, Bartlett PN (2001) Ordered Mesoporous Silicas Prepared from Both Micellar Solutions and Liquid Crystal Phases. *Microporous and Mesoporous Materials* 44–45:73–80. doi:10.1016/s1387–1811(01)00170–6
- Attinger S, Koumoutsakos PD (2004) *Multiscale Modelling And Simulation*. Springer, Berlin

- Averin DV, Likharev KK (1985) Coulomb Blockade of Single-Electron Tunneling, and Coherent Oscillations in Small Tunnel Junctions. *Journal of Low Temperature Physics* 62:345–373
- Averin DV, Likharev KK (1987) New Results of the Theory of Set and Bloch Oscillations in Small Tunnel Junctions. *IEEE Transactions on Magnetics* 23/2:1138–1141
- Aviram A, Ratner MA (1974) Molecular Rectifiers. *Chemical Physics Letters* 29:277–283. doi:10.1016/0009-2614(74)85031-1
- Avriel M (2003) *Nonlinear Programming: Analysis and Methods*. Courier Dover Publications, Mineola
- Aya Baquero H (2015) Using the Finite Elements Method (FEM) for Nanotechnology Education. *A Rectangular Cantilever as a Mass Sensor*. *Journal of Physics: Conference Series* 582:012042
- Bahadar H, Maqbool F, Niaz K, Abdollahi M (2016) Toxicity of Nanoparticles and an Overview of Current Experimental Models. *Iran Biomedical Journal* 20:1–11
- Baird D, Shew A (2003) *The Mythology of Nanotechnology: Changing the Epistemology of Science*. Unpublished paper
- Baker RJ (2011) *CMOS: Circuit Design, Layout, and Simulation*. John Wiley & Sons, Hoboken
- Baker RT, Barber MA, Harris PS, Feates FS, Waite RJ (1972) Nucleation and Growth of Carbon Deposites from the Nickel Catalyzed Decomposition of Acetylene. *Journal of Catalysis* 26/1:51–62
- Baker RT, Harris PS, Thomas RS, Waite RJ (1973) Formation of Filamentous Carbon from Iron, Cobalt and Chromium Catalyzed Decomposition of Acetylene. *Journal of Catalysis* 30/1:86–95
- Baker SN, Baker GA (2010) Luminescent Carbon Nanodots: Emergent Nanolights. *Angewandte Chemie International Edition in English* 49:6726–6744
- Bakshi UA, Godse AP (2007) *The Depletion Mode MOSFET*. *Electronic Circuits*. Technical Publications
- Bapat N, Boroujerdi M (1992) Uptake Capacity and Adsorption Isotherms of Doxorubicin on Polymeric Nanoparticles: Effect of Methods of Preparation. *Drug Development and Industrial Pharmacy* 18/1:65–77
- Bapat YN (1992) *Electronic Circuits and Systems: Analog and Digital*, 1st edition. Tata McGraw–Hill Education, New York
- Baram M, Kaplan WD (2008) Quantitative HRTEM analysis of FIB prepared specimens. *Journal of Microscopy*. 232/3:395–05
- Barber DJ, Freestone IC (1990) An Investigation of the Origin of the Colour of the Lycurgus Cup by Analytical Transmission Electron Microscopy. *Archaeometry* 32:33–45
- Barbosa GP, Debone HS, Severino P, Souto EB, da Silva CF (2016) Design and Characterization of Chitosan/Zeolite Composite Films—Effect of Zeolite Type and Zeolite Dose on the Film Properties. *Materials Science and Engineering C* 60:246–254
- Bardeen J (1961) Tunnelling from a Many-Particle Point of View. *Physical Review Letters* 6/2:57–59
- Basu PK (1997) *Theory of Optical Processes in Semiconductors*. Oxford Science Publications, Oxford
- Batra IP, Garcia N, Rohrer H, Salemnik H, Stoll E, Ciriaci S (1987) A Study of Graphite Surface with STM and Electronic Structure Calculations. *Surface Science* 181/1–2:126–138
- Baumann G, Frommel C, Sander C (1989) Polarity as a Criterion in Protein Design. *Protein Engineering* 2:329–34
- Baxter JB, Schmuttenmaer CA (2006) Conductivity of ZnO Nanowires, Nanoparticles, and Thin Films Using Time-Resolved Terahertz Spectroscopy. *Journal of Physical Chemistry B* 110/50:25229–25239
- Baxter JB, Schmuttenmaer CA (2009). Carrier Dynamics in Bulk ZnO. II. Transient Photoconductivity Measured by Time Resolved Terahertz Spectroscopy. *Physical Review B*, 80/235206:1–10
- Bayda S, Hadla M, Palazzolo S, Kumar V, Caligiuri I, Ambrosi E, Pontoglio E, Agostini M, Tuccinardi T, Benedetti A, Riello P, Canzonieri V, corona G, Toffoli G, Rizzolio F (2017) Bottom-up Synthesis of Carbon Nanoparticles with Higher Doxorubicin efficacy. *Journal of Controlled Release* 248:144–152
- Beck JS, Vartuli JC, Kennedy GD, Kresge CT, Roth WJ, Schramm SE (1994) Molecular or Supramolecular Templating: Defining the Role of Surfactant Chemistry in the Formation of Microporous and Mesoporous Molecular Sieves. *Chemistry of Materials* 6/10:1816–1821
- Beck JS, Vartuli JC, Kennedy GJ, Kresge CT, Roth WJ, Schramm SE (1994) Molecular or Supramolecular Templating: Defining the Role of Surfactant Chemistry in the Formation of Microporous and Mesoporous Molecular Sieves. *Chemistry of Materials* 6/10:1816–1821
- Beck JS, Vartuli JC, Roth WJ, Leonowicz ME, Kresge CT, Schmitt KD, Chu CTW, Sheppard EW, McCullen SB, Higgins JB, Schlenker JL (1992) A New Family of Mesoporous Molecular Sieves prepared with Liquid Crystal Templates. *Journal of the American Chemical Society* 114/27:10834–10843

- Becker RS, Golovchenko JA, Swarzenruber BS (1987) Atomic-scale Surface Modifications Using a Tunneling Microscope. *Nature* 325:419–421
- Benoit JP, Couvreur P, Devissaguet J-P, Fessi H, Puisieux F, Roblot-Treupel L (1986) Les Formes Vectorisées ou Distribution Modulée, Nouveaux Systèmes d'Administration Médicaments. *Journal de Pharmacie de Belgique* 41:319–329
- Berube D (2004) Denialism: Drexler vs. Roco. *IEEE Technology and Society Magazine* Winter 2004:22–26
- Bethe HA, Sommerfeld A (1967) *Elektronentheorie der Metalle*. Springer Verlag
- Bethune DS, Klang CH, de Vries MS, Gorman G, Savoy R, Vazquez J, Beyers R (1993) Cobalt-catalysed Growth of Carbon Nanotubes with Single-atomic-layer Walls. *Nature* 363:605–607
- Bhushan B (2008) nanotribology and Nanomechanics in Nano/Biotechnology. *Philosophical Transactions of the Royal Society A* 366:1499–1537
- Bijsterveld K (2001) The Diabolical Symphony of the Mechanical Age: Technology and Symbolism of Sound in European and North American Noise Abatement Campaigns, 1900–40. *Social Studies of Science* 31:37–70
- Binder K, Heermann DW (2010) *Monte Carlo Simulation in Statistical Physics: An Introduction*. Springer, Berlin
- Binggeli M, Mate CM (1994) Influence of Capillary Condensation of Water on Nanotribology Studied by Force Microscopy. *Applied Physics Letters* 65/4:415–417
- Binnig G (1990) Atomic Force Microscope and Method for Imaging Surfaces with Atomic Resolution. United States Patent RE33,387. Washington DC: USPTO
- Binnig G, Gerber C, Rohrer H, Wiebel E (1985) Nano-Aperture. *IBM Technical Disclosure Bulletin* 27/8:4893
- Binnig G, Rohrer H (1982) Scanning Tunneling Microscope. United States Patent 4,343,993. Washington DC: USPTO
- Binnig G, Rohrer H (1984) Scanning Tunneling Microscopy. *Physica* 125B:37–95
- Binnig G, Rohrer H (1985) The Scanning Tunneling Microscope. *Scientific American* August, pp.50–56
- Binnig G, Rohrer H (1986) Scanning Tunneling Microscopy. *IBM Journal of Research & Development* 30/4:355–369
- Binnig G, Rohrer H, Gerber C, Weibel E (1982) Surface Studies by Scanning Tunneling Microscopy. *Physical Review Letters* 49:57–61
- Binnig G, Rohrer H, Gerber C, Weibel E (1982) Tunneling through a controllable vacuum gap. *Applied Physics Letters* 40:178
- Binnig G, Rohrer H, Gerber C, Weibel E (1983) 7x7 Reconstruction on Si(111) Resolved in Real Space. *Physical Review Letters* 50/2:120–123
- Bland JAC, H. Bretislav H (2005) *Ultrathin Magnetic Structures I: An Introduction to the Electronic, Magnetic and Structural Properties*. Springer, Berlin
- Bogunia-Kubik K, Sugisaka M (2002) From Molecular Biology to Nanotechnology and Nanomedicine. *Biosystems* 65:123–138
- Borodich FM, Galanov BA, Gorb SN, Prostov MY, Prostov YI, Suarez-Alvarez MM (2012) An Inverse Problem for Adhesive Contact and Non-Direct Evaluation of Material Properties for Nanomechanics Applications. *Nano Metallurgical and Materials Transactions A* 1:80–92
- Bowers CW, Culver RB, Solberg WA, Spain IL (1987) Optical Absorption of Surfaces Modified by Carbon Filaments. *Applied Optics* 28/21:4625–4631
- Brannigan A (1979) The Reification of Mendel. *Social Studies of Science* 9:423–454
- Braun T, Schubert A, Zsindely S (1997) Nanoscience and Nanotechnology on the Balance. *Scientometrics* 38/2:321–325
- Brown LM (2000) *Selected Papers of Richard Feynman*. Singapore: World Scientific
- Bruggeman DAG (1935) Berechnung Verschiedener Physikalischer Konstanten von Heterogenen Substanzen, I. Dielektrizitätskonstanten und Leitfähigkeiten der Mischkörper aus Isotropen Substanzen. *Annalen der Physik, Leipzig* 24:636–679
- Brush SG (1974) Should the History of Science be Rated X?: the Way Scientists Behave (according to Historians) Might not be a Good Model for Students. *Science* 183:1164–1172
- Bucalem ML, Bathe KJ (2011). *The Mechanics of Solids and Structures – Hierarchical Modeling and the Finite Element Solution*. Springer, Berlin
- Burian RM (1977) More than a Marriage of Convenience: on the Inextricability of History and Philosophy of Science. *Philosophy of Science* 44:1–42
- Burkhardt CE, Leventhal JJ (2008) *Foundations of Quantum Physics*. Springer, Berlin

- Byrne JD, Betancourt T, Brannon–Peppas L (2008) Active Targeting Schemes for Nanoparticle Systems in Cancer Therapeutics. *Advanced Drug Delivery Reviews* 60/15:1615–1626
- Cao L, Wang X, Meziani MJ, Lu F, Wang H, Luo PG, Lin Y, Haru BA, Veca LM, Murray D, Xie SY, SunYP (2007) Carbon Dots for Multiphoton Bioimaging. *Journal of the American Chemical Society* 129:11318–11319
- Car R, Parrinello M (1985) Unified Approach for Molecular Dynamics and Density–Functional Theory. *Physical Review Letters* 55/20:2471
- Carpick RW, Salmeron M (1997) Scratching the Surface: Fundamental Investigations of Tribology with Atomic Force Microscopy. *Chemical Reviews* 97/4:1163–1194
- Casadevall A, Fang FC (2015) Field Science—the Nature and Utility of Scientific Fields. *mBio* 6:e01259–15
- Casadevall A, Steen RG, Fang FC. 2014. Sources of Error in the Retracted Scientific Literature. *FASEB Journal* 28:3847–3855
- Chadi DJ, Bauer RS, Williams RH, Hansson GV, Bachrach RZ, Mikkelsen JC, Houzay JrF, Guichar GM, Pinchaux R, Pétrouff Y (1980) Atomic and Electronic Structure of the 7×7 Reconstructed Si (111) Surface. *Physical Review Letters* 44/12:799–802
- Chan YS, Heller EJ (1997) Scanning Tunnel Microscopy Surface State Electron Scattering: Two–Tip Results from One–Tip Data. *Physical Review Letters* 78:2570–2572
- Chandran RB (2020) Finite Element Analysis in Nanotechnology Research. Retrieved 17/12/2021 from: <https://www.intechopen.com/chapters/73935>
- Chen CJ (1990) Origin of Atomic Resolution on Metal Surfaces in Scanning Tunneling Microscopy. *Physical Review Letters* 65/4:448–451
- Chen H, Roco MC, Li X, Lin Y (2008) Trends in Nanotechnology Patents. *Nature Nanotechnology* 3/3:123–125
- Chen H, Schuffels C, Orwig R (1996) Internet Categorization and Search: a Machine Learning Approach. *Journal of Visual Communication and Image Representation* 7/1:88–102
- Chen J, Seeman N (1991) Synthesis from DNA of a Molecule with the Connectivity of a Cube. *Nature* 350:631–33
- Chen WK (2004) *The Electrical Engineering Handbook*. Elsevier, Amsterdam
- Chen YW, Su YL, Hu SH, Chen SY (2016) Functionalized Graphene Nanocomposites for Enhancing Photothermal Therapy in Tumor Treatment. *Advanced Drug Delivery Reviews* 105/Pt B:190–204
- Cheng Y, Hu C (1999) *MOSFET Modeling & BSIM3 User’s Guide*. Springer, Cham
- Cherkaoui M, Capolungo L (2009) Atomistic and Continuum Modeling of Nanocrystalline Materials: Deformation Mechanisms and Scale Transition. Springer, Berlin
- Cho AY, Arthur JR Jr (1975) Molecular Beam Epitaxy. *Progress in Solid State Chemistry* 10:157–192
- Choy TC (1999). *Effective Medium Theory: Principles and Applications*. Oxford University Press, Oxford
- Chung HH, Benson DR, Schultz PG (1993) Probing the Structure and Mechanism of Ras Protein with an Expanded Genetic Code. *Science* 259:806–9
- Chung KH, Kim DE (2007) Wear Characteristics of Diamond–Coated Atomic Force Microscope Probe. *Ultramicroscopy* 108/1:1–10
- Claeysen JR, Tsukazan T, Tonetto L, D. Tolfo (2013) Modeling the tip–sample interaction in Atomic Force Microscopy with Timoshenko beam theory. *Nano Metallurgical and Materials Transactions A*, 2:124–144
- Cleland AN (2003) *Foundations of Nanomechanics: From Solid-State Theory to Device Applications*. Springer, Berlin
- Clinton WJ (2000) President Clinton’s Remarks at Science and Technology Event. Online: <http://mrs.org/pa/nanotech/clinton.html>
- Coleman RV, Dranke B, Hansma PK, Slough G (1985) Charge–Density Waves Observed with a Tunneling Microscope. *Physical Review Letters* 55/4:394–398
- Colinge JP (2008) *FinFETs and Other Multi–Gate Transistors*. Springer Science & Business Media, Berlin
- Colinge JP, Greer JC (2016) *Nanowire Transistors: Physics of Devices and Materials in One Dimension*. Cambridge University Press, Cambridge
- Cordani M, Somoza Á (2019) Targeting Autophagy using Metallic Nanoparticles: A Promising Strategy for Cancer Treatment. *Cellular and Molecular Life Sciences* 76/7:1215–1242
- Coulson. CA (1958) *Electricity*. Oliver & Boyd, fifth edition, Edinburgh
- Couvreur P (1988) Polyalkylcyanoacrylates as Colloidal Drug Carriers. *Critical Reviews in Therapeutic Drug Carrier Systems* 5/1:1–20

- Couvreur P, Dubernet C, Puisieux F (1995) Controlled Drug Delivery with Nanoparticles: Current Possibilities and Future Trends. *European Journal of Pharmaceutics and Biopharmaceutics* 41/1:2–13
- Cox BJ, Thamwattana N, Hill JM. Electric Field–Induced Force Between Two Identical Uncharged Spheres. *Applied Physics Letters*, submitted for publication
- Cozzens S, Cortes R, Soumonni O, Woodson T (2013) Nanotechnology and the Millennium Development Goals: Water, Energy, and Agri–Food. *Journal of Nanoparticle Research* 15:2001
- Cram DJ (1986) Preorganization from Solvents to Spherands. *Angewandte Chemie International Edition* 25:1039–1134
- Cressler JD, Mantooth HA (2017) *Extreme Environment Electronics*. CRC Press, Boca Raton
- Crewe AV, Wall J, Langmore J, (1970) Visibility of a Single Atom. *Science* 168/3937:1338–1340
- Crommie MF, Lutz CP, Eigler DM (1993) Confinement of Electrons to Quantum Corrals on a Metal Surface. *Science* 262:218–220
- Crommie MF, Lutz CP, Eigler DM (1993) Imaging Standing Waves in a Two–Dimensional Electron Gas. *Nature* 363:524–527
- Culver RB, Solberg WA, Robinson RS, Spain IL (1985) Optical Absorption of Microtextured Graphite Surfaces in the 11–23 μ m Wavelength Region. *Applied Optics* 24/7:924–925
- da Silva PB, Machado RTA, Pironi AM, Alves RC, de Araujo PR, Dragalzew AC, Dalberto I, Chorilli M (2019) Recent Advances in the Use of Metallic Nanoparticles with Antitumoral Action—Review. *Current Medicinal Chemistry* 26:2108–2146
- Dahl JE, Liu SG, Carlson RMK (2003) Isolation and Structure of Higher Diamondoids, Nanometer–Sized Diamond Molecules. *Science* 299/5603:96–99
- Damasceno DA, Mesquita E, Rajapakse RNKD (2017) Mechanical Behavior of Nano Structures Using Atomic–Scale Finite Element Method (AFEM). *Latin American Journal of Solids and Structures* 14:2046–2066
- Davey JE, Pankey T (1968) Epitaxial GaAs Films Deposited by Vacuum Evaporation. *Journal of Applied Physics* 39/4:1941–1948
- Davies DR, Padlan EA, Sheriff S (1990) Antibody–Antigen Complexes. *Annual Review of Biochemistry* 59:439–73
- Davis LC (1992) Finite–Element Analysis of Particles–particles Forces in Electrorheological Fluids. *Applied Physics Letters*, 60/3:391–321
- Davis LC (1992) Polarisation Forces and Conductivity Effects in Electrorheological Fluids. *Journal of Applied Physics* 72/4:1334–1340
- de Borst R, Ramm E (2011) *Multiscale Methods in Computational Mechanics: Progress and Accomplishments*. Springer, Berlin
- Deák P, Frauenheim T, Pederson MR (2000) *Computer Simulation of Materials at Atomic Level*. John Wiley & Sons
- Deal BE (1988) *The Thermal Oxidation of Silicon and Other Semiconductor Materials. Semiconductor Materials and Process Technology Handbook: For Very Large Scale Integration (VLSI) and Ultra Large Scale Integration (ULSI)*. Noyes Publications, Bonn
- Deal BE (1998) *Highlights Of Silicon Thermal Oxidation Technology*. Silicon materials science and technology. The Electrochemical Society
- DeGrado WF (1988) Design of Peptides and Proteins. *Advances in Protein Chemistry* 39:51–124
- DeGrado WF (1997) Proteins from Scratch. *Science* 278/5335:80–81
- DeGrado WF, Regan L, Ho SP (1987) The Design of a Four–Helix Bundle Protein. *Cold Spring Harbor Symposia on Quantum Biology* 52:521–26
- DeGrado WF, Wasserman ZR, Lear JD (1989) Protein Design, a Minimalist Approach. *Science* 243:622–28
- Deslattes RD (1969) Optical and X–Ray Interferometry of a Silicon Lattice Spacing. *Applied Physics Letters* 15/11:386–388
- Desmet J, De Maeyer M, Hazes B, Lasters I (1992) The Dead–End Elimination Theorem and Its Use in Protein Side–Chain Positioning. *Nature* 356:539–42
- Di Sia P (2010) New Theoretical Results for High Diffusive Nanosensors Based on ZnO Oxides. *Sensors & Transducers Journal* 122/1:1–8
- Di Sia P (2011) An Analytical Transport Model for Nanomaterials. *Journal of Computational and Theoretical Nanoscience* 8/1:84–89
- Di Sia P (2011) *Classical and Quantum Transport Processes in Nano–Bio–Structures: a New Theoretical Model and Applications*. Faculty of Science, Verona University, Italy, PhD Thesis

- Di Sia P (2011) Oscillating Velocity and Enhanced Diffusivity of Nanosystems from a New Quantum Transport Model. *Journal of Nano Research* 16:49–54
- Di Sia P (2012) A New Theoretical Method for Transport Processes in Nanosensoristics. *Journal of Nano Research* 20:143–149
- Di Sia P (2012) An Analytical Transport Model for Nanomaterials: The Quantum Version. *Journal of Computational and Theoretical Nanoscience* 9/1:31–34
- Di Sia P (2012) Nanotechnology between Classical and Quantum Scale: Application of a new interesting analytical Model. *Journal of Computational and Theoretical Nanoscience* 17/1:82–86
- Di Sia P (2012) THz Spectroscopy and Nanostructures: a Short Interesting Review, *Letters in Applied NanoBioScience* 1/1:008–013
- Di Sia P (2013) A New Theoretical Model for the Dynamical Analysis of Nano–Bio–Structures. *Advances in Nano Research* 1/1:29–34
- Di Sia P (2013) About the Influence of Temperature in Single–Walled Carbon Nanotubes: Details from a new Drude–Lorentz–like Model. *Applied Surface Science* 275:384–388
- Di Sia P (2013) Characteristics in Diffusion for High–Efficiency Photovoltaics Nanomaterials: an interesting Analysis. *Journal of Green Science and Technology* 1/2
- Di Sia P (2013) Relativistic Motion in Nanostructures: Interesting Details by a New Drude–Lorentz–like Model. *Conference Series, Third International Conference on Theoretical Physics Theoretical Physics and its Application, June 24–28, 2013 Moscow, Russia*
- Di Sia P (2014) Effects on Diffusion by Relativistic Motion in Nanomaterial–Based Nanodevices. *Conference Series, International conference “NANOSMAT–2013” Granada–Spain, September 22–25, 2013*
- Di Sia P (2014) Present and Future of Nanotechnologies: Peculiarities, Phenomenology, Theoretical Modelling, Perspectives. *Reviews in Theoretical Science (RITS)* 2/2:146–180
- Dienwiebel M, Pradeep N, Verhoeven GS, Zandbergen HW, Frenken JWM (2005) Model Experiments of Superlubricity of Graphite. *Surface Science* 576:197–211
- Dienwiebel M, Verhoeven GS, Pradeep N, Frenken JWM, Heimberg JA, Zandbergen HW (2004) Superlubricity of Graphite. *Physical Review Letters* 92:126101
- Dietz TG, Duncan MA, Powers DE, Smalley RE (1981) Laser Production of Supersonic Metal Cluster Beams. *Journal of Chemical Physics* 74/11:6511–6512. doi:10.1063/1.440991
- Dill KA (1990) Dominant Forces in Protein Folding. *Biochemistry* 29:7133–55
- Dinegar RH, Smellie RH, LaMer VK (1951) Additions and Corrections–Kinetics of the Acid Decomposition of Sodium Thiosulfate in Dilute Solutions. *Journal of the American Chemical Society* 73/12
- Dinegar RH, Smellie RH, LaMer VK (1951) Kinetics of the Acid Decomposition of Sodium Thiosulfate in Dilute Solutions. *Journal of the American Chemical Society* 73/5
- Dinegar RH, Smellie RH, LaMer VK (1951) The Limiting Degrees of Supersaturation of the Sparingly Soluble Sulfates. *Journal of the American Chemical Society* 73/1. doi:10.1021/ja01145a127
- Doktorovova S, Santos DL, Costa I, Andreani T, Souto EB, Silva AM (2014) Cationic solid lipid nanoparticles interfere with the activity of antioxidant enzymes in hepatocellular carcinoma cells. *International Journal of Pharmaceutics* 471:18–27
- Doktorovova S, Silva AM, Gaivao I, Souto EB, Teixeira JP, Martins–Lopes P (2014) Comet Assay Reveals no Genotoxicity Risk of Cationic Solid Lipid Nanoparticles. *Journal of Applied Toxicology* 34:395–403
- Dowling AP (2004) Development of Nanotechnologies. *Materials Today* 7:30–35
- Dresselhaus MS, Dresselhaus G, Eklund PC (1996) *Science of Fullerenes and Carbon Nanotubes*. Academic Press
- Drexler KE (1987) Nanomachinery: Atomically Precise Gears and Bearings. *Proceedings of IEEE Micro Robot. Teleoperators Workshop*. Hyannis
- Drexler KE (1991) Molecular Tip Arrays for Molecular Imaging and Nanofabrication. *Journal of Vacuum Science & Technology B* 9/1:394–397
- Drexler KE (1992) *Nanosystems*. Wiley & Sons, New York
- Drexler KE (2004) Nanotechnology: From Feynman to Funding. *Bulletin of Science, Technology & Society* 24/1:21–27
- Drexler KE, Smalley R (2003) Nanotechnology. *Chemical & Engineering News* pp.37–42
- Drexler KR, Foster JS (1990) Synthetic Tips. *Nature* 343:600
- Drost R, Ojanen T, Harju A, Liljeroth P (2017) Topological States in Engineered Atomic Lattices. *Nature Physics* 13:668–671

- Drude P (1900). Zur Elektronentheorie der metalle. *Annalen der Physik* 306/3:566-613
- Du G, Moulin E, Jouault N, Buhler E, Giuseppone N (2012) Muscle-like Supramolecular Polymers: Integrated Motion from Thousands of Molecular Machines. *Angewandte Chemie* 124:12672–12676
- Dürig U, Gimzewski JK, Pohl DW (1986) Experimental Observation of Forces Acting during Scanning Tunneling Microscopy. *Physical Review Letters* 57/19:2403–2406
- Ebrahimi N, Mansoori GA (2014) Reliability for Drug Targeting in Cancer Treatment through Nanotechnology. *International Journal of Medical Nano Research* 1/1:ISSN:2378–3664
- Economist Technology Quarterly, The (ETQ) (2004) Touching the Atom. *Economist Technology Quarterly* September pp.42–43
- Eigen M, McCaskill J, Schuster P (1988) Molecular Quasi-Species. *Journal of Physical Chemistry*. 92:6881–6891
- Eigler DM, Schweizer EK (1990) Positioning Single Atoms with a Scanning Tunneling Microscope. *Nature* 344:524–526
- Ekimov AI, Éfros AL (1990) Optics of Zero Dimensional Semiconductor Systems. *Acta Physica Polonica A* 79:5–14
- Ekimov AI, Onushchenko AA (1982) Quantum Size Effect in the Optical Spectra of Semiconductor Microcrystals. *Fizika i Tekhnika Poluprovodn* 16/7:1215–1219
- Ekimov AI, Onushchenko AA (1984) Size Quantization of the Electron Energy Spectrum in a Microscopic Semiconductor Crystal. *Pis'ma v Zhurnal Èksperimental'noi i Teoreticheskoi Fiziki* 40/8:337–340
- Ekimov AI, Onushchenko AA, Éfros AL (1986) Quantization of the Energy Spectrum of Holes in the Adiabatic Potential of the Electron. *Pis'ma v Zhurnal Èksperimental'noi i Teoreticheskoi Fiziki* 43/6:292–294
- El-Samaly MS, Rohdewald P (1982) Triamcinolone Diacetate Nanoparticles a Sustained Release Drug Delivery System Suitable for Parental Administration. *Pharmaceutica Acta Helvetiae* 57/7:201–204
- ElBayoumi TA, Torchilin VP (2009) Tumor-Targeted Nanomedicines: Enhanced Antitumor Efficacy in Vivo of Doxorubicin-Loaded, Long-Circulating Liposomes modified with Cancer-Specific Monoclonal Antibody. *Clinical Cancer Research* 15/6:1973–1980
- Eliassi A, Eikani MH, Mansoori GA (2002) Production of Single-Walled Carbon Nanotubes. *Proceedings of the First Conference on Nanotechnology – The next industrial revolution*, 2, 160, March
- Engel E, Dreizler RM (2011) *Density Functional Theory: An Advanced Course*. Springer, Berlin
- Ergun S (1968) *Optical Studies of Carbon*. In P.L. Walker Jr. *Chemistry and Physics of Carbon*, Dekker, New York
- Esaki L (1958) New Phenomenon in Narrow Germanium p-n Junctions. *Physical Reviews* 109:603–604
- Esteves da Silva JCG, Gonçalves HMR (2011) Analytical and Bioanalytical Applications of Carbon Dots. *Trends in Analytical Chemistry* 30:1327–1336
- Everson MP, Jaklevic RC, Shen W (1990) Measurement of the Local Density of States on a Metal Surface: Scanning Tunneling Spectroscopic Imaging of Au(111). *Journal of Vacuum Science & Technology A* 8:3662–3665
- Fang FC, Casadevall A (2010) Lost in Translation— Basic Science in the Era of Translational Research. *Infection and Immunity* 78:563–566
- Fang FC, Casadevall A (2015) Competitive Science: is Competition Ruining Science? *Infection and Immunity* 83:1229–1233
- Fang RH, Zhang L (2016) Nanoparticle-Based Modulation of the Immune System. *Annual Review of Chemical and Biomolecular Engineering* 7:305–326
- Fano U (1961) Effects of Configuration Interaction on Intensities and Phase Shifts. *Physical Review* 124:1866–1878
- Feldman LC (2001) “Introduction”. *Fundamental Aspects of Silicon Oxidation*. Springer Science & Business Media, Berlin
- Fernandes da Silva EC (2009) GaAs: effective-mass parameters. Data extract from Landolt-Börnstein III/44A: Semiconductors – New Data and Updates for I–VII, III–V, III–VI and IV–VI Compounds. Springer-Verlag, Berlin
- Feynman RP (1960) How to Build an Automobile Smaller Than This Dot. *Popular Science* pp.114–ff
- Feynman RP (1960) The Wonders That Await a Micro-Microscope. *Saturday Review* pp.45–47
- Feynman RP (1984) *Tiny Machines*. Videotape available online <https://www.youtube.com/watch?v=4eRCygdW--c>

- Feynman RP (1986) Quantum Mechanical Computers. *Foundations of Physics* 16:507–521
- Feynman RP (1986) The ORIGINAL Nanotechnology Paper (sic; reprint of “There’s Plenty of Room at the Bottom”). In *Nanotechnology with Feynman Machines*, by Conrad W. Schneiker, unpublished book manuscript of 215 pages, pp. 133–149
- Feynman RP (2005) *Perfectly Reasonable Deviations from the Beaten Path: The Letters of Richard P. Feynman*, edited by Michelle Feynman. Perseus, Cambridge MA.
- Feynman RP (2006) *Infinitesimal Machinery*. In *Nanotechnology: Science, Innovation, and Opportunity*, edited by L.E. Foster, Prentice Hall, Upper saddle River NJ pp.247–268.
- Feynman RP, Sykes C (1995) *No Ordinary Genius: The Illustrated Richard Feynman*. W.W. Norton & Company, New York
- Fields GB, Noble RL (1990) Solid Phase Peptide Synthesis utilizing 9–Fluorenylmethoxycarbonyl Amino Acids. *International Journal of Peptide and Protein Research* 35:161–214
- Firouzi A, Kumar D, Bull LM, Besier T, Siegar P, Huo Q, Walker SA, Zasadzinski J, Glinka AG, Nicol J, Marogloese D, Stucky GD, Chmelka BF (1995) Cooperative Organization of Inorganic Surfactant and Biomimetic Assemblies. *Science* 267/5201:1138–1143
- Floro JA, Rosnagel SM, Robinson RS (1983) Ion–Bombardment–Induced Whisker Formation on Graphite. *Journal of Vacuum Science & Technology* 1/3:1398–1402
- Fong CY, Shaughnessy M, Damewood L, Yang LH (2012) Theory, Experiment and Computation of Half Metals for Spintronics: Recent Progress in Si–based Materials. *NanoMMTA* 1:1–22
- Fossum JG, Trivedi VP (2013) *Fundamentals of Ultra–Thin–Body MOSFETs and FinFETs*. Cambridge University Press, Cambridge
- Foster JS, Frommer JE, Arnett PC (1988) Molecular Manipulation Using a Tunneling Microscope. *Nature*, 331:324–326
- Foster L (2005). *Nanotechnology Science, Innovation and Opportunity*. Prentice Hall, New York
- Franco J, Kaczer B, Groeseneken G (2013) *Reliability of High Mobility SiGe Channel MOSFETs for Future CMOS Applications*. Springer Science & Business Media, Berlin
- Frank DJ, Dennard RH, Nowak E, Solomon PM, Taur Y (2001) Device Scaling Limits of Si MOSFETs and their Application Dependencies. *Proceedings of the Institute of Electric and Electronic Engineers, Piscataway*. 89/3:259–88
- Frankel AD, Bredt DS, Pabo CO (1988) Tat Protein from Human Immunodeficiency Virus Forms a Metal–Linked Dimer. *Science* 240:70–73
- Freestone I, Meeks N, Sax M, Higgitt C (2007) The Lycurgus Cup—A Roman Nanotechnology. *Gold Bull* 40:270–277
- Freiser MJ, Marcus PM (1969) A Survey of Some Physical Limitations on Computer Elements. *IEEE Transactions on Magnetics* 5/2:82–90
- Fu PP, Xia Q, Hwang HM, Ray PC, Yu H (2014) Mechanisms of Nanotoxicity: Generation of Reactive Oxygen Species. *Journal of Food and Drug Analysis* 22:64–75
- Fujita D, Sagisaka K (2008) Topical Review: Active Nanocharacterization of Nanofunctional Materials by Scanning Tunneling Microscopy. *Science and Technology of Advanced Materials* 9/1:013003
- Galup–Montoro C, Schneider MC (2007) *MOSFET Modeling for Circuit Analysis and Design*. World Scientific, London
- Gansner E, North S (2000) An Open Graph Visualization System and its Applications to Software Engineering. *Software–Practice and Experience* 30/11:1203–1233
- Gao H, Huang Y, Abraham FF (2001) Continuum and Atomistic Studies of Intersonic Crack Propagation. *Journal of the Mechanics and Physics of Solids* 49/9:2113–2132
- Gardenier TS, van den Broeke JJ, Moes JR, Swart I, Delerue C, Slot MR, Smith CM, Vanmaekelbergh D (2020) p Orbital Flat Band and Dirac Cone in the Electronic Honeycomb Lattice. *ACS Nano* 2020 10/14:13638–13644
- Garg A, Tisdale AW, Haidari E, Kokkoli E (2009) Targeting Colon Cancer Cells using PEGylated Liposomes modified with a Fibronectin–Mimetic Peptide. *International Journal of Pharmaceutics* 366/1–2:201–210
- Gates TS, Odegard GM, Frankland SJV, Clancy TC (2005) Computational Materials: Multi–Scale Modeling and Simulation of Nanostructured Materials. *Composites Science and Technology* 65/15–16:2416–2434
- Gehrke I, Geiser A, Somborn–Schulz A (2015) Innovations in Nanotechnology for Water Treatment. *Nanotechnology, Science and Application* 8:1–17

- Ghadiri MR, Fernholz AR (1990) Peptide Architecture. Design of Stable Helical Metallopeptides Via a Novel Exchange–Inert RuIII Complex. *Journal of the American Chemical Society* 112:9633–9635
- Ghorbanpour M (2015) Major Essential Oil Constituents, Total Phenolics and Flavonoids Content and Antioxidant Activity of *Salvia Officinalis* Plant in Response to Nano–Titanium Dioxide. *Indian Journal of Plant Physiology* 20/3:249–256
- Ghorbanpour M, Hadian J (2015) Multi–Walled Carbon Nanotubes Stimulate Callus Induction, Secondary Metabolites Biosynthesis and Antioxidant Capacity in Medicinal Plant. *Carbon* 94: 749–759
- Ghorbanpour M, Hatami M (2015) Changes in Growth, Antioxidant Defense System and Major Essential Oils Constituents of *Pelargonium Graveolens* Plant Exposed to Nano–Scale Silver and Thidiazuron. *Indian Journal of Plant Physiology* 20/2:116–123
- Ghorbanpour M, Hatami M, Hatami M (2015) Activating Antioxidant Enzymes, Hyoscyamine and Scopolamine Biosynthesis of *Hyoscyamus Niger* L. Plants with Nano–Sized Titanium Dioxide and Bulk Application. *Acta Agriculturae Slovenica* 105/1:23–32
- Gleick J (1992) *Genius: The Life and Times of Richard Feynman*. Pantheon, New York
- Gnach A, Lipinski T, Bednarkiewicz A, Rybka J, Capobianco JA (2015) Upconverting nanoparticles: Assessing the toxicity. *Chemical Society Reviews* 44:1561–1584
- Goddard III WA, Brenner DW, Lyshevski SE, Iafrate GJ (2012) *Handbook of Nanoscience, Engineering, and Technology*. CRC Press, Boca Raton
- Gogotsi Y (2006) *Nanomaterials Handbook*. CRC Press, Boca Raton
- Gökçay B, Arda B (2015) Nanotechnology, Nanomedicine; Ethical Aspects, *Revista Romana de Bioetica* 13
- Goldstein H (2004) A Beautiful Noise. *IEEE Spectrum* pp.50–52
- Golio M, Golio J (2018) *RF and Microwave Passive and Active Technologies*. CRC Press, Boca Raton
- Golovchenko JA (1986) The Tunneling Microscope: a New Look at the Atomic World. *Science* 232/4746:48–53
- Gorji S, Kashiwar A, Mantha LS, Kruk R, Witte R, Marek P, Hahn H; Kübel C, Scherer T (2020). Nanowire facilitated transfer of sensitive TEM samples in a FIB. *Ultramicroscopy*. 219:113075
- Grangier JL, Puygrenier M, Gauthier JC, Couvreur P (1991) Nanoparticles as Carriers for Growth Hormone Releasing Factors (GRF). *Journal of Control Release* 15:3–13
- Gray PR, Hurst PJ, Lewis SH, Meyer RG (2001) *Analysis and Design of Analog Integrated Circuits* (Fourth ed.). Wiley, New York
- Green MS (1954). Markoff Random Processes and the Statistical Mechanics of Time-Dependent Phenomena. II. Irreversible Processes in Fluids. *Journal of Chemical Physics* 22:398
- Guinée JB, Heijungs R, Vijver MG, Peijnenburg WJGM (2017) Setting the Stage for Debating the Roles of Risk Assessment and Life–Cycle Assessment of Engineered Nanomaterials. *Nature Nanotechnology* 12:727
- Gumbsch P, Pippan R (2010) *Multiscale Modelling of Plasticity and Fracture by Means of Dislocation Mechanics*. Springer, Berlin
- Günther KG (1958) Aufdampfschichten aus Halbleitenden III-V-Verbindungen. *Zeitschrift für Naturforschung A* 13/12:1081–1089
- Hadziioannou G, Malliaras GG (2007) *Semiconducting Polymers: Chemistry, Physics and Engineering*. Wiley–VCH, Weinheim
- Hameroff SR (1987) *Ultimate Computing: Biomolecular Consciousness and Nanotechnology*. North-Holland, Amsterdam
- Hanahan D, Weinberg RA (2000) The Hallmarks of Cancer. *Cell*100/1:57–70
- Handel TM, Williams SA, DeGrado WF (1993) Metal Ion–Dependent Modulation of the Dynamics of a Designed Protein. *Science* 261:879–85
- Hansma PK, Elings VB, Marti O, Bracker CE (1988) Scanning Tunneling Microscopy and Atomic Force Microscopy: Application to Biology and Technology. *Science* 242:209–216
- Hansma PK, Tersoff J (1987) Scanning Tunneling Microscopy. *Journal of Applied Physics*, 61/2:R1–R23
- Hansson GV, Bachrach RZ, Bauer RS, Chadi DJ, Gopel W (1980) SLAB–MINDO Calculations on the Si(111)2×1 Surface. *Surface Science* 225/3:225–232
- Harrison LT (2005). *Current Sources and Voltage References: A Design Reference for Electronics Engineers*. Elsevier, Amsterdam
- Harrison P (2005) *Quantum Wells, Wires and Dots*. Wiley & Sons, Hoboken
- Hasegawa Y, Avouris P (1993) Direct Observation of Standing Wave Formation at Surface Steps using Scanning Tunneling Spectroscopy. *Physical Review Letters* 71:1071–1074

- Hatami M, Ghorbanpour M (2014) Defense Enzyme Activities and Biochemical Variations of *Pelargonium Zonale* in Response to Nanosilver Application and Dark Storage. *Turkish Journal of Biology* 38/1:130–139
- Hatami M, Ghorbanpour M, Salehjarjomand H (2014) Nano-Anatase TiO₂ Modulates the Germination Behavior and Seedling Vigority of some Commercially Important Medicinal and Aromatic Plants. *Journal of Biological & Environmental Sciences* 8/22:53–59
- Heinrich AJ, Lutz CP, Gupta JA, Eigler DM (2002) Molecule Cascades. *Science* 11/298:1381–1387
- Hellinga HW, Richards FM (1991) Construction of New Ligand Binding Sites in Proteins of Known Structure. II. Grafting of a Buried Transition Metal Binding Site into *Escherichia Coli* Thioredoxin. *Journal of Molecular Biology*. 222:787–803
- Henrard L, Hernandez E, Bernier P, Rubio A (1999) van der Waals Interaction in Nanotube Bundles: Consequences on Vibrational Modes. *Physical Review B* 60:R8521–R8524
- Henson K, Schneiker CW (1984) The Annual Von Neumann-Feynman Award. Unpublished manuscript of 22 May 1984, 3 pages
- Herbig GH (1975) The Diffuse Interstellar Bands. IV–The Region 4400–6850Å. *Astrophysical Journal* 196:129–160
- Heremans JJ, von Molnár S, Awschalom DD, Gossard AC (1999) Ballistic Electron Focusing by Elliptic Reflecting Barriers. *Applied Physics Letters* 74:1281–1283
- Hersam MC; Guisinger NP, Lyding JW (2000) Isolating, Imaging, and Electrically Characterizing Individual Organic Molecules on the Si(100) Surface with the Scanning Tunneling Microscope. *Journal of Vacuum Science and Technology A and Vacuum Surface Films* 18:1349
- Hessenbruch, A (2004) Nanotechnology and the Negotiation of Novelty. In *Discovering the Nanoscale*, ed. by D. Baird, A. Nordmann & J. Schummer. IOS Press, Amsterdam pp.135–144
- Hewson AC (1997) *The Kondo Problem to Heavy Fermions*. Cambridge University Press, Cambridge
- Hey AJG (1999) Feynman and Computation: An Overview. In *Feynman and Computation*, edited by A.J.G. Hey. Westview, Reading, MA pp.ix–xxiii
- Higgins RJ (1983) *Electronics with Digital and Analog Integrated Circuits*. Prentice–Hall, Hoboken
- Hill TL (2001) A Different Approach to Nanothermodynamics. *Nano Letters* 1/5:273–275
- Hirsch LR, Stafford RJ, Bankson JA, Sershen SR, Rivera B, Price RE, Hazle JD, Halas NJ, West JL (2003) Nanoshell–Mediated Near–Infrared Thermal Therapy of Tumors under Magnetic Resonance Guidance. *Proceedings of the National Academy of Science USA* 100/23:13549–13554
- Hittinger WC (1973) Metal–Oxide–Semiconductor Technology. *Scientific American* 229/2:48–59
- Hoh IH, Lal R, John SA, Revel JP, Arnsdorf MF (1991) Atomic Force Microscopy and Dissection of Gap Junctions. *Science* 253:1405–1408
- Holm L, Sander C (1992) Fast and Simple Monte Carlo Algorithm for Side Chain Optimization in Proteins: Application to Model Building by Homology. *Proteins: Structure, Functions and Genetics* 14:213–223
- Holman J, Parsons A, Pilling G, Price G (2013) *Chemistry: Introducing Inorganic, Organic and Physical Chemistry*. Oxford University Press, Oxford
- Hong TK, Yang S (2005) Study of the Enhanced Thermal Conductivity of Fe Nanofluids. *Journal of Applied Physics*, 97/6:064311
- Hopkins JB, Langridge–Smith PRR, Morse MD, Smalley RE (1983) Supersonic Metal Cluster Beams of Refractory Metals: Spectral Investigations of Ultracold Mo₂. *Journal of Chemical Physics* 78/4:1627–1637. doi:10.1063/1.444961
- Hori R, Masuda H, Minato O, Nishimatsu S, Sato K, Kubo M (1975) Short Channel MOS-IC Based on Accurate Two Dimensional Device Design. *Japanese Journal of Applied Physics*. 15/S1:193
- Hoshyar N, Gray S, Han H, Bao G (2016) The Effect of Nanoparticle Size on in Vivo Pharmacokinetics and Cellular Interaction. *Nanomedicine London* 11/6:673–692
- Howitt SM, Wilson AN (2014) Revisiting “Is the Scientific Paper a Fraud?”: the Way Textbooks and Scientific Research Articles are being Used to Teach Undergraduate Students Could Convey a Misleading Image of Scientific Research. *EMBO Reports* 15:481–484
- Huang YW, Cambre M, Lee HJ (2017) The Toxicity of Nanoparticles Depends on Multiple Molecular and Physicochemical Mechanisms. *International Journal of Molecular Science* 18:2702
- Huang Z, Chen H, Chen ZK, Roco MC (2004) International Nanotechnology Development in 2003: Country, Institution, and Technology Field Analysis based on USPTO Patent Database. *Journal of Nanoparticle Research* 6/4:325–354

- Huang Z, Chen H, Yip A, Ng G, Guo F, Chen ZK, Roco MC (2003) Longitudinal Patent Analysis for Nanoscale Science and Engineering: Country, Institution and Technology Field. *Journal of Nanoparticle Research* 5:333–363
- Hughes TJR (2000) *The Finite Element Method: Linear Static and Dynamic Finite Element Analysis*. Dover Publications, Mineola
- Hulla J, Sahu S, Hayes A (2015) *Nanotechnology. History and Future*. *Human & Experimental Toxicology* 34:1318–1321
- Iqbal P, Preece JA, Mendes PM (2012) Nanotechnology: The “Top–Down” and “Bottom–Up” Approaches. In *Supramolecular Chemistry*. John Wiley & Sons, Ltd, Chichester
- Jeanmaire DL, Van Duyne RP (1977) Surface Raman Spectroelectrochemistry. *Journal of Electroanalytical Chemistry and Interfacial Electrochemistry* 84:1–20
- Jones W (1997) *Organic Molecular Solids: Properties and Applications*. CRC Press, Boca Raton
- Joseph MK (2005) *Computer Network Security*. Springer Science & Business Media, Berlin
- Joy B (2000) Why the Future Doesn’t Need Us. *Wired* pp.238–262
- Jung J, Bork J, Holmgaard T, Kortbek NA (2005) Single–Walled Carbon Nanotubes, 8th semester project. Technical Physics–Springer, Berlin
- Junk, A. and F. Riess. 2006. From an Idea to a Vision: There’s Plenty of Room at the Bottom. *American Journal of Physics*, 74/9:825–830
- Kaggwa GB, Nalam PC, Kilpatrick JJ, Spencer ND, Jarvis SP (2012) Impact of Hydrophilic/Hydrophobic Surface Chemistry on Hydration Forces in the Absence of Confinement. *Langmuir* 28/16:6589–6594
- Kahng D, Sze M (1967) A Floating–Gate and its Application to Memory Devices. *The Bell System Technical Journal* 46/4:1288–95
- Kalff FE, Rebergen MP, Fahrenfort E, Girovsky J, Toskovic R, Lado JL, Fernández-Rossier J, Otte AF (2016) A Kilobyte Rewritable Atomic Memory. *Nature Nanotechnology* 11/11:926–929
- Kaszynski P, Friedli AC, Michl J (1992) Toward a Molecular–Size “Tinkertoy” Construction Set. Preparation of Terminally Functionalized [n]–Staffanes from [1.1.1]Propellane. *Journal of the American Chemical Society* 114:601–620
- Kawaura H, Sakamoto T, Baba T, Ochiai Y, Fujita J, Matsui S, Sone J (1997) Proposal of Pseudo Source and Drain MOSFETs for Evaluating 10–nm Gate MOSFETs. *Japanese Journal of Applied Physics* 36/3S:1569
- Keiper A (2003) *The Nanotechnology Revolution*. *The New Atlantis* pp.17–34
- Kellis JT Jr, Nyberg K, Sali O, Fersht AR (1988) Contribution of Hydrophobic Interactions to Protein Stability. *Nature* 333:784–786
- Kempkes SN, Slot MR, Freney SE, Zevenhuizen SJM, Vanmaekelbergh D, Swart I, Smith CM (2019) Design and Characterization of Electrons in a Fractal Geometry. *Nature Physics* 11/15:127–131
- Kent SBH (1988) Chemical Synthesis of Peptides and Proteins. *Annual Review of Biochemistry* 57:957–989
- Keyes RW (1969) Physical Problems and Limits in Computer Logic. *IEEE Spectrum* 6/5:36–45
- Keyes RW (1975) Physical Limits in Digital Electronics. *Proceedings of the IEEE* 63/5:740–767
- Khafaji M, Zamani M, Golizadeh M, Bavi O (2019) Inorganic Nanomaterials for Chemo/Photothermal Therapy: a Promising Horizon on Effective Cancer Treatment. *Biophysical Reviews* 11/3:335–352
- Khajetoorians AA, Wegner D, Otte AF, Swart I (2019) Creating Designer Quantum States of Matter Atom–by–Atom. *Nature Reviews Physics* 1/9:703–715
- Khan SH, Hoffmann PM (2018) Diverging Effects of NaCl and CsCl on the Mechanical Properties of Nanoconfined Water. *Journal of The Electrochemical Society* 165/3:H114–H120
- Khataee AR, Mansoori GA (2011) *Nanostructured Titanium Dioxide Materials (Properties, Preparation and Applications)*. World Scientific Publishing Company, Hackensack
- Kim SW, Kyung Lee Y, Yeon Lee J, Hee Hong J, Khang D (2017) PEGylated Anticancer–Carbon Nanotubes Complex Targeting Mitochondria of Lung Cancer Cells. *Nanotechnology* 28/46:465102
- Kinney C, Moore TL, Rodriguez–Lorenzo L, Rothen–Rutishauser B, Petri–Fink A (2017) Form Follows Function: Nanoparticle Shape and Its Implications for Nanomedicine. *Chemical Reviews* 117/17:11476–11521
- Kittel C (1963) *Quantum Theory of Solids*. Wiley, New York
- Kittel C (1968) Indirect Exchange Interactions in Metals. *Solid State Physics* 22:1–26
- Kittel C (2005) *Introduction to Solid State Physics*. John Wiley & Sons, Hoboken

- Klibanov AM (1989) Enzymatic Catalysis in Anhydrous Organic Solvents. *Trends in Biochemical Sciences* 14:141–144
- Klimecky PI (2002) Plasma Density Control for Reactive Ion Etch Variation Reduction in Industrial Microelectronics. University of Michigan, Ann Arbor
- Knoll AW, Pires D, Coulembier O, Dubois P, Hedrick JL, Frommer J, Duerig U (2010) Probe-Based 3-D Nanolithography Using Self-Amplified Depolymerization Polymers. *Advanced Materials* 22:3361–3365
- Knoll M, Ruska E (1932) Beitrag zur Geometrischen Elektronenoptik. I. *Annalen der Physik* 404:607–640
- Kobayashi T, Horiguchi S, Kiuchi K (1984) Deep-Submicron MOSFET Characteristics with 5nm Gate Oxide. *International Electron Devices Meeting*:414–417
- Koezuka H, Tsumura A, Ando T (1987) Field-Effect Transistor with Polythiophene Thin Film. *Synthetic Metals*. 18:699–704
- Kondo J (1964) Resistance Minimum in Dilute Magnetic Alloys. *Progress of Theoretical Physics* 32:37–49
- Koyama T (1972) Formation of Carbon Fibers from Benzene. *Carbon* 10/6:757–758
- Krafft MP, Giulieri F, Riess JG (1993) Can Single-Chain Perfluoroalkylated Amphiphiles Alone form Vesicles and other Organized Supramolecular Systems? *Angewandte Chemie International Edition* 32:741–743
- Kresge CT, Leonowicz ME, Roth WJ, Vartuli JC, Beck JS (1992) Ordered Mesoporous Molecular Sieves Synthesized by a Liquid-Crystal Template Mechanism. *Nature* 359:710–712
- Kresge CT, Vartuli JC, Roth WJ, Leonowicz ME, Beck JS, KD Schmitt KD, Chu CT-W, Olson DH, Sheppard EW, McCullen SB, Higgins JB, Schlenker JL (1994) M41S: A New Family of Mesoporous Molecular Sieves Prepared with Liquid Crystal Templates. In *Science and Technology in Catalysis*, Izumi Y, Arai H, Iwamoto M editors, Elsevier Science, 11
- Krieger M (2006) Epilogue. In *Nanotechnology: Science, Innovation, and Opportunity*, edited by L.E. Foster. Prentice Hall, Upper Saddle River NJ pp.243–245
- Krim J (2002) Surface Science and the Atomic-Scale Origins of Friction: What Once was old is New Again. *Surface Science* 500:741–758
- Kroto HW (1982) Tilden Lecture. Semistable Molecules in the Laboratory and in Space. *Chemical Society Reviews* 11/4:435–491
- Krumhansl JA, Pao YH (1979) Microscience: An Overview. *Physics Today* pp.25–32
- Kubiak C, Manil L, Couvreur P (1988) Sorptive Properties of Antibodies onto Cyanoacrylic Nanoparticles. *International Journal of Pharmaceutics* 41:181–187
- Kubo R (1957) Statistical-Mechanical Theory of Irreversible Processes. I. General Theory and Simple Applications to Magnetic and Conduction Problems. *Journal of the Physical Society of Japan* 12:570–586
- Kuhn HW (2005) The Hungarian Method for the Assignment Problem. *Naval Research Logistic* 52/1:83–97
- Kühne T, Krack M, Mohamed F, Parrinello M (2007) Efficient and Accurate Car-Parrinello-like Approach to Born-Oppenheimer Molecular Dynamics. *Physical Review Letters* 98/6:066401
- Kumar V, Bayda S, Hadla M, Caligiuri I, Russo Spena C, Palazzolo S, Kempter S, Corona G, Toffoli G, Rizzolio F (2016) Enhanced Chemotherapeutic Behavior of Open-Caged DNA@Doxorubicin Nanostructures for Cancer Cells. *Journal of Cellular Physiology* 231:106–110
- Kumar V, Palazzolo S, Bayda S, Corona G, Toffoli G, Rizzolio F (2016) DNA Nanotechnology for Cancer Therapy. *Theranostics* 6/5:710–725
- Kuo Y (2013) Thin Film Transistor Technology—Past, Present, and Future. *The Electrochemical Society Interface*, 22/1:55–61
- Kurzweil R (2005) *The Singularity Is Near: When Humans Transcend Biology*. Penguin, London
- Kuzyk MG (2010) *Polymer Fiber Optics: Materials, Physics, and Applications*. CRC Press, Boca Raton
- Laffrentz L, Ample F, Yu H, Hecht S, Joachim C, Grill L (2009) Conductance of a Single Conjugated Polymer as a Continuous Function of Its Length. *Science* 323/5918:1193–1197
- Landis ME, Aufdembrink BA, Chu P, Johnson ID, Kirker GW, Rubin MK, (1991) Preparation of Molecular Sieves from Dense Layered Metal Oxides. *Journal of the American Chemical Society* 113/8:3189–3192
- Lang ND (1986) Spectroscopy of Single Atoms in the Scanning Tunneling Microscope. *Physical Review B* 34:5947–5950

- Lapshin RV (2004) Feature-Oriented Scanning Methodology for Probe Microscopy and Nanotechnology. *Nanotechnology* 15/9:1135–1151
- LaValle SM (1998) Rapidly-Exploring Random Trees: a New Tool for Path Planning. *Mathematics The Annual Research Report* 1–4.
- Lécuyer C (2006) *Making Silicon Valley: Innovation and the Growth of High Tech, 1930-1970*. The Massachusetts Institute of Technology, Boston
- Lee C, Subbiah S (1991) Prediction of Protein Side-Chain Conformation by Packing Optimization. *Journal of Molecular Biology* 217:373–388
- Lee PY, Wong KKY (2011) Nanomedicine: A New Frontier in Cancer Therapeutics. *Current Drug Delivery* 8:245–253
- Lee WM, Kim SW, Kwak JI, Nam SH, Shin YJ, An YJ (2010) Research Trends of Ecotoxicity of Nanoparticles in Soil Environment. *Toxicology Research* 26:253–259
- Leonowicz ME, Lawton JA, Lawton SL, Rubin MK (1994) MCM-22: A Molecular Sieve with Two Independent Multidimensional Channel Systems. *Science* 264/5167:1910–1915
- Leszczynski J (2010) *Trends in Computational Nanomechanics*. Springer, Netherlands
- Leung C, Bestembayeva A, Thorogate R, Stinson J, Pyne A, Marcovich C, Yang J, Drechsler U, Despont M, Jankowski T, Tschöpe M, Hoogenboom BW (2012) Atomic Force Microscopy with Nanoscale Cantilevers Resolves Different Structural Conformations of the DNA Double Helix. *Nano Letters* 12/7:3846–3850
- Li J, Schneider WD, Berndt R, Delley B (1998) Kondo Scattering Observed at a Single Magnetic Impurity. *Physical Review Letters* 80:2893–2896
- Li Q, Ohulchanskyy TY, Liu R, Koynov K, Wu D, Best A, Kumar R, Bonoio A, Prasad PN (2010) Photoluminescent Carbon Dots as Biocompatible Nanoprobes for Targeting Cancer Cells in Vitro. *Journal of Physical Chemistry C* 114:12062–12068
- Li S, Liu WK (2004) *Meshfree Particle Methods*. Springer, Berlin
- Li VHK, Wood RW, Kreuter J, Harmia T, Robinson JR (1986) Ocular Drug Delivery of Progesterone using Nanoparticles. *Journal of Microencapsulation* 3/3:213–218
- Li Y, Hu Y, Zhao Y, Shi G, Deng L, Hou Y, Qu L (2011) An Electrochemical Avenue to Green-Luminescent Graphene Quantum Dots as Potential Electron-Acceptors for Photovoltaics. *Advanced Materials* 23/6:776–780
- Lifshitz IM, Slyozov VV (1958) The Kinetics of precipitation from supersaturated solutions. *Zhurnal Eksperimental'noi Teoreticheskoi Fiziki* 35/2:479–492
- Lindley D (2015) Focus: Landmarks – Accidental Discovery Leads to Calibration Standard. *Physics* 8. doi:10.1103/Physics.8.46
- Liong M, Lu J, Kovochich M, Xia T, Ruehm SG, Nel AE, Tamanoi F, Zink JI (2008) Multifunctional Inorganic Nanoparticles for Imaging, Targeting, and Drug Delivery. *ACS Nano* 2/5:889–896
- Liu JL (2012). Mathematical Modeling of Semiconductor Quantum Dots based on the Nonparabolic Effective-Mass Approximation. *Nano Metallurgical and Materials Transactions A* 1:58–79
- Liu L, Li Y, Zhan L, Liu Y, Huang C (2011) One-step Synthesis of Fluorescent Hydroxyls-coated Carbon Dots with Hydrothermal Reaction and its Application to Optical Sensing of Metal Ions. *Science China Chemistry* 54:1342–1347
- Liu P, Zhang YW, Lu C (2005) Oscillatory Behavior of C60-Nanotube Oscillators: A Molecular-Dynamics Study. *Journal of Applied Physics* 97/9:094313
- Liu WK, Karpov EG, Zhang S, Park HS (2004) An introduction to computational nanomechanics and materials. *Computer Methods in Applied Mechanics and Engineering* 193/17–20:1529–1578
- Lok C (2010) Nanotechnology: Small wonders. *Nature* 467/7311:18–21
- Loo C, Lin A, Hirsch L, Lee MH, Barton J, Halas N, West J, Drezek R (2004) Nanoshell-Enabled Photonics-Based Imaging and Therapy of Cancer. *Technology in Cancer Research & Treatment* 3/1:33–40
- Lopez JL, Montejo-Gamez J (2013) On the Derivation and Mathematical Analysis of some Quantum-Mechanical Models accounting for Fokker-Planck type Dissipation: Phase space, Schrödinger and Hydrodynamic Descriptions. *Nano Metallurgical and Materials Transactions A* 2:49–80
- Lu D, Xie YM, Li Q, Huang X, Li YF, Zhou S (2016) A Finite-Element Approach to Evaluating the Size Effects of Complex Nanostructures. *Royal Society Open Science* 3:160625
- Luttge R (2011) *Nanotechnology*. In: *Microfabrication for Industrial Applications*. William Andrew Publishing, Boston
- Lyo IW, Avouris P (1991) Field-Induced Nanometer-to Atomic-Scale Manipulation of Silicon Surfaces with the STM. *Science* 253:173–176

- Madhavan V, Chen W, Jamneala T, Crommie MF, Wingreen NS (1998) Tunnelling into a Single Magnetic Atom: Spectroscopic Evidence of the Kondo Resonance. *Science* 280:567–569
- Malik NR (1995) *Electronic Circuits: Analysis, Simulation, and Design*. Prentice Hall, Englewood Cliffs
- Maloberti F, Davies, AC (2016) *History of Electronic Devices. A Short History of Circuits and Systems: From Green, Mobile, Pervasive Networking to Big Data Computing*. Institute of Electric and Electronic Engineers, Circuits and Systems Society, Piscataway
- Mann AB, Pethica JB (1996) Nanoindentation Studies in a Liquid Environment. *Langmuir* 12/19:4583–4586
- Mann AB, Pethica JB (1996) The Role of Atomic Size Asperities in the Mechanical Deformation of Nanocontacts. *Applied Physics Letters* 69/7:907–909
- Mansoori G, Fauzi Soelaiman T (2005) Nanotechnology—An Introduction for the Standards Community. *Journal of ASTM International* 2:1–22
- Mansoori GA (2002) Organic Nanostructures and Their Phase Transitions. *Proceedings of the first Conference on Nanotechnology - The Next Industrial Revolution* 2, 345
- Mansoori GA (2005) *Principles of Nanotechnology*. World Scientific Publishing Company, Hackensack
- Mansoori GA (2013) Diamondoids – The Molecular Lego of Biomedicine, Materials Science and Nanotechnology. *Journal of Bioanalysis & Biomedicine* 5/2:1–3
- Mansoori GA, Brandenburg KS, Shakeri-Zadeh A (2010) A Comparative Study of Two Folate-Conjugated Gold Nanoparticles for Cancer Nanotechnology Applications. *Cancers* 2/4:1911–1928
- Mansoori GA, de Araujo PLB, de Araujo ES (2012) *Diamondoid Molecules with Applications in Biomedicine, Materials Science, Nanotechnology & Petroleum Science*. World Scientific Publishing Company, Hackensack
- Mansoori GA, Enayati N, Agyarko L (2016) *Energy: Sources, Utilization, Legislation, Sustainability, Illinois as the Model State*. World Scientific Publishing Company, Hackensack
- Mansoori GA, George TF, Assoufid L, Zhang G (Eds) (2007) *Molecular Building Blocks for Nanotechnology: From Diamondoids to Nanoscale Materials and Applications*. Topics in Applied Physics 109, Springer, Berlin
- Mansoori GA, Mohazzabi P, McCormack P, Jabbari S (2007) *Nanotechnology in Cancer Prevention, Detection and Treatment: Bright Future Lies Ahead*. *World Review of Science, Technology and Sustainable Development* 4/2,3:226–257
- Mansoori GA, Vakili-Nezhaad GR, Ashrafi AR (2005) Some Mathematical Concepts Applicable in Nanothermodynamics. *International Journal of Pure & Applied Mathematical Sciences* 2/1:58–61
- Marks RW (1960) *The Dymaxion World of Buckminster Fuller*. Reinhold, New York
- Marqusee S, Baldwin RL (1987) Helix Stabilization by Glu...Lys⁺ Salt Bridges in Short Peptides of De Novo Design. *Proceedings of the National Academy of Science USA* 84:8898–8902
- Marulanda JM, A. Srivastava (2008) Carrier Density and Effective Mass Calculation for Carbon Nanotubes. *Physica Status Solidi (b)*, 245/11:2558
- Matthews BW, Nicholson H, Becktel WJ (1987) Enhanced Protein Thermostability from Site-Directed Mutations that Decrease the Entropy of Unfolding. *Proceedings of the National Academy of Science USA* 84:6663–6667
- Mayer B, Janker L, Loitsch B, Treu J, Kostenbader T, Lichtmannecker S, Reichert T, Morkötter S, Kaniber M, Abstreiter G, Gies C, Koblmüller G, Finley JJ (2016) Monolithically Integrated High- β Nanowire Lasers on Silicon. *Nano Letters* 16 /1:152–156
- Mayer B, Regler A, Sterzl S, Stettner T, Koblmüller G, Kaniber M, Lingnau B, Lüdge K, Finley JJ (2017) Long-Term Mutual Phase Locking of Picosecond Pulse Pairs Generated by a Semiconductor Nanowire Laser. *Nature Communications* 8:15521
- McClellan S, Prosser E, Meehan E, O'Malley D, Clarke N, Ramtools Z, Brayden D (1998) Binding and Uptake of Biodegradable Poly-lactide Micro and Nanoparticles in Intestinal Epithelia. *European Journal of Pharmaceutical Science* 6:153–163
- McCluskey MD, Haller EE (2012) *Dopants and Defects in Semiconductors*. CRC Press, Boca Raton
- McCray WP (2005) Will Small Be Beautiful? Making Policies for Our Nanotech Future. *History and Technology* 212:177–203
- McCray WP (2007) Molecular Beam Epitaxy Deserves a Place in the History Books. *Nature Nanotechnology* 2/5:259–261
- McRae EG, Caldwell CW (1981) Structure of Si(111)-(7 \times 7)H. *Physical Review Letters* 46/25:1632–1635

- Mehra J (1994) *The Beat of a Different Drum: The Life and Science of Richard Feynman*. Clarendon, Oxford
- Mendel D, Ellman J A, Chang Z, Veenstra DL, Kollman PA, Schultz PG (1992) Probing Protein Stability with Unnatural Amino Acids. *Science* 256:1798–1802
- Meng H, Xue M, Xia T, Zhao YL, Tamanoi F, Stoddart JF, Jeffrey I, Zink JI, Nel AE (2010) Autonomous in Vitro Anticancer Drug Release from Mesoporous Silica Nanoparticles by pH-Sensitive Nanovalves. *Journal of the American Chemical Society* 132/36:12690–12697
- Merkle RC (1991) Computational Nanotechnology. *Nanotechnology* 2:134–141
- Merkle RC (1993) A Proof About Molecular Bearings. *Nanotechnology* 4:86–90
- Meyer JC, Girit CO, Crommie MF, Zettl A. (2008) Imaging and dynamics of light atoms and molecules on graphene. *Nature*. 454/7202:319–22
- Meyers MA (1995) Glen W. Hartman lecture. Science, Creativity, and Serendipity. *American Journal of Roentgenology* 165:755–764
- Michel C, Roques M, Couvreur P, Vranckx H, Baldschmidt P. Isobutylcyanoacrylate Nanoparticles as Drug Carrier for Oral Administration of Insulin. *Proceedings of the International Symposium Control of Released Bioactive Materials* 18:97–98
- Mie G (1908) Beiträge zur Optik trüber Medien, speziell Kolloidaler Metallösungen. *Annalen der Physik* 330:377–445
- Mielke L, Belytschko T, Schatz GC (2007) Nanoscale Fracture Mechanics. *Annual Review of Physical Chemistry* 58:185–209
- Milburn C (2002) Nanotechnology in the Age of Posthuman Engineering: Science Fiction as Science. *Configurations* 10:261–295
- Milburn C (2008) *Nanovision: Engineering the Future*. Duke University Press, Durham.
- Mirkin CA, Letsinger RL, Mucic RC, Stroh JJ (1996) A DNA-Based Method for Rationally Assembling Nanoparticles into Macroscopic Materials. *Nature* 382:607–609
- Mirkin CA, Ratner MA (1992) Molecular Electronics. *Annual Review of Physical Chemistry* 43:719–754
- Mislow K (1989) Molecular Machinery in Organic Chemistry. *Chemtracts: Organic Chemistry* 2:151–174
- Mizutani U (2001) *Introduction to the Electron Theory of Metals*. Cambridge University Press.
- Montemagno CD (2001) Nanomachines: A Roadmap for Realizing the Vision. *Journal of Nanoparticle Research* 3:1–3
- Moore AW (1973) Highly Oriented Pyrolytic Graphite and its Intercalation Compounds. *Chemistry and Physics of Carbon* 11/47:231–286
- Moore GE (1965) Cramming more Components onto Integrated Circuits. *Electronics* 38:114–117
- Moreland J, Alexander S, Cox M, Sonnenfeld R, Hansma PK (1983) Squeezable Electron Tunneling Junctions. *Applied Physics Letters* 43/4:387–388
- Morin JF, Shirai Y, Tour JM (2006) En Route to a Motorized Nanocar. *Organic Letters* 8/8:1713–1716
- Morris JE, Iniewski K (Eds) (2013) *Graphene, Carbon Nanotubes, and Nanostructures: Techniques and Applications (Devices, Circuits, and Systems)*. CRC Press, Boca Raton
- Moskowitz SL (2016) *Advanced Materials Innovation: Managing Global Technology in the 21st century*. John Wiley & Sons, Hoboken
- Motoyoshi M (2009). Through-Silicon Via (TSV). *Proceedings of the Institute of Electrical and Electronic Engineers, Piscataway*. 97/1:43–48
- Müller EW (1936) Experimente zur Theorie der Elektronenemission unter dem Einfluß starker Felder. *Physikalische Zeitschrift* 37:838–841
- Müller EW, Bahadur K (1956) Field Ionization of Gases at a Metal Surface and the Resolution of the Field Ion Microscope. *Physical Reviews* 102:624–631
- Munson PJ, Singh RK (1997) Statistical Significance of Hierarchical Multi-Body Potentials based on Delaunay Tessellation and their Application in Sequence-Structure Alignment. *Protein Science* 6/7:1467–1481
- Musa SM (2012) *Computational Finite Element Methods in Nanotechnology*. CRC Press
- Musgrave CB, Perry JK, Merkle RC, Goddard WA III (1991) Theoretical Studies of a Hydrogen Abstraction Tool for Nanotechnology. *Nanotechnology* 2:187–195
- Mutter M, Vuilleumier S (1989) A chemical Approach to Protein Design-Template-Assembled Synthetic Proteins (TASP). *Angewandte Chemie International Edition* 28:535–676
- Nazem A, Mansoori GA (2008) Nanotechnology Solutions for Alzheimer's Disease: Advances in Research Tools, Diagnostic Methods and Therapeutic Agents. *Journal of Alzheimer's Disease*, 13/2:199–223

- Nazem A, Mansoori GA (2014) Nanotechnology Building Blocks for Intervention with Alzheimer's Disease Pathology: Implications in Disease Modifying Strategies. *J Bioanal. & Biomed* 6/2,6:009–014
- Némati F, Dubernet C, Fessi H, Verdière AC, Poupon MF, Puisieux F (1996) Reversion of Multidrug Resistance using Nanoparticles in Vitro: Influence of the Nature of the Polymer. *International Journal of Pharmaceutics* 138/2:237–246
- Newman TH, Williams KE, Pease RFW (1987) High Resolution Patterning System with a Single Bore Objective Lens. *Journal of Vacuum Science Technology B* 5/1:88–91
- Nielsen PE, Egholm M, Berg RH, Buchardt O (1991) Sequence-Selective Recognition of DNA by Strand Displacement with a Thymine-Substituted Polyamide. *Science* 254:1497–1500
- Niemeyer CM (1997) DNA as a Material for Nanotechnology. *Angewandte Chemie – International Edition in English* 36/6:585–587
- Niemeyer CM (1999) Progress in “Engineered Up” Nanotechnology Devices Utilizing DNA as a Construction Material. *Applied Physics A* 68:119–124
- Niemeyer CM (2000) Self-assembled Nanostructures Based on DNA: Towards the Development of Nanobiotechnology. *Current Opinion in Chemical Biology* 4/6:609–618
- Niemeyer CM (2001) Bioorganic Applications of Semisynthetic DNA-Protein Conjugates. *Chemistry–A European Journal* 7/15:3189–95
- Niemeyer CM (2001) Nanoparticles, Proteins, and Nucleic Acids: Biotechnology Meets Materials Science. *Angewandte Chemie – International Edition in English* 40/22:585–587
- Niemeyer CM (2002) The Developments of Semisynthetic DNA-Protein Conjugates. *Trends in Biotechnology* 20/9:395–401
- Niemeyer CM, Adler M, Song G, Lifeng C (2002) Supramolecular DNA-Streptavidin Nanocircles with a Covalently Attached Oligonucleotide Moiety. *Journal of Biomolecular Structure & Dynamics* 20/2:223–230
- Niemeyer CM, Burger W, Peplies J (1998) Covalent DNA-Streptavidin Conjugates as Building Blocks for Novel Biometallic Nanostructures. *Angewandte Chemie – International Edition in English* 37/16:2265–68
- Niemeyer, CM (2000) Self-Assembled Nanostructures Based on DNA: Towards the Development of Nanobiotechnology. *Current Opinion in Chemical Biology* 4/6:609–618
- Noren CJ, Anthony-Cahill SJ, Griffith MC, Schultz PO (1989) A General Method for Site-Specific Incorporation of Unnatural Amino Acids into Proteins. *Science* 244:182–188
- Novoselov KS, Geim AK, Morozov SV, Jiang D, Zhang Y, Dubonos SV, Grigorieva IV, Firsov AA (2004) Electric Field Effect in Atomically Thin Carbon Films. *Science* 306/5696:666–669
- Nyffenegger RM, Penner RM (1997) Nanometer-Scale Surface Modification Using the Scanning Probe Microscope: Progress since 1991 *Chemical Reviews* 97/4:1195–1230
- Olby R (1979) Mendel No Mendelian? *History of Science* 17:53–72
- Olby R (1989) Rediscovery as an Historical Concept. In *New Trends in the History of Science*, edited by R. Visser, H. Bos, L. Palm & H. Snelders. Rodopi, Amsterdam pp.197–208.
- Omura Y, Mallik A, Matsuo N (2017) MOS Devices for Low-Voltage and Low-Energy Applications. John Wiley & Sons, Hoboken
- Oran D, Rodrigues SG, Gao R, Asano S, Skylar-Scott MA, Chen F, Tillberg PW, Marblestone AH, Boyden ES (2018) 3D Nanofabrication by Volumetric Deposition and Controlled Shrinkage of Patterned Scaffolds. *Science* 362/6420:1281–1285
- Osawa E (1970) Superaromaticity. *Kagaku Kyoto* 1970, 25, 854–863
- Pabo C (1983) Designing Proteins and Peptides. *Nature* 301:200
- Pabo CP, Suchanek EG (1986) Computer-Aided Model-Building Strategies for Protein Design. *Biochemistry* 25:5987–5991
- Palazzolo S, Hadla M, Russo Spina C, Caligiuri I, Rotondo R, Adeel M, Kumar V, Corona G, Canzonieri V, Toffoli G, Rizzolio F (2019) An Effective Multi-Stage Liposomal DNA Origami Nanosystem for In Vivo Cancer Therapy. *Cancers* 11/12:1997
- Palazzolo S, Hadla M, Spina CR, Bayda S, Kumar V, Lo Re F, Adeel M, Caligiuri I, Romano F, Corona G, Canzonieri V, Toffoli G, Rizzolio F (2019) Proof-of-Concept Multistage Biomimetic Liposomal DNA Origami Nanosystem for the Remote Loading of Doxorubicin. *ACS Medical Chemistry Letters* 10/4:517–521
- Panasenko G (2005) Multi-scale Modelling for Structures and Composites. Springer
- Papell SS (1965) Low Viscosity Magnetic Fluid Obtained by the Colloidal Suspension of Magnetic Particles. U.S.Patent 3215572A, 2 November 1965

- Parhi P, Mohanty C, Sahoo SK (2012) Nanotechnology–Based Combinational Drug Delivery: an Emerging Approach for Cancer Therapy. *Drug Discovery Today* 17/17–18:1044–1052
- Park S-II, Quate CF (1986) Tunneling Microscope of Graphite in Air. *Applied Physics Letters* 48/2:112–114
- Park W, Heo YJ, Han DK (2018) New Opportunities for Nanoparticles in Cancer Immunotherapy. *Biomaterials Research* 22:24
- Parkinson P, Joyce HJ, Gao Q, Tan HH, Zhang X, Zou J, Jagadish C, Herz LM, Johnston MB (2009) Carrier Lifetime and Mobility Enhancement in Nearly Defect–Free Core–Shell Nanowires Measured Using Time–Resolved Terahertz Spectroscopy. *Nano Letters* 9/9:3349–3353
- Parkinson P, Lloyd–Hughes J, Gao Q, Tan HH, Jagadish C, Johnston MB, Herz LM (2007) Transient Terahertz Conductivity of GaAs Nanowires. *Nano Letters*, 7/7:2162–2165
- Pashley MD, Pethica JB, Coombs J (1985) Scanning Tunneling Microscope Studies. *Surface Science* 152–153/P1:27–32
- Patil M, Mehta DS, Guvva S (2008) Future Impact of Nanotechnology on Medicine and Dentistry. *Journal of Indian Society of Periodontology* 12:34–40
- Pellegrini M, Doniach S (1993) Computer Simulation of Antibody Binding Specificity. *Proteins Structure, Function and Genetics* 15:436–444
- Pessi A, Bianchi E, Crameri A, Venturini S, Tramontano A, Sollazzo M (1993) A Designed Metal–Binding Protein with a Novel Fold. *Nature* 362:367–369
- Petersen P, Tikhomirov G, Qian L Information–Based Autonomous Reconfiguration in Systems of Interacting DNA Nanostructures. *Nature Communications* 9:5362
- Pethica JB, Pashley MD (1983) Techniques: Scanning Tunneling Microscopy. *Nature* 305/5936:666
- Petrova R, Genova P, Tzoneva M (2012) Finite Element Method (FEM) for Nanotechnology Application in Engineering. CRC Press, Boca Raton
- Philp D, Stoddard JF (1996) Self-Assembly in Natural and Unnatural Systems. *Angewandte Chemie, International Edition in English* 35:1154–1196
- Pickett SD, Sternberg MJE (1993) Empirical Scale of Side–Chain Conformational Entropy in Protein Folding. *Journal of Molecular Biology*. 23 1:825–839
- Piner RD, Zhu J, Xu F, Hong S, Mirkin CA (1999) “Dip–Pen” Nanolithography. *Science* 283/5402:661–663
- Pinheiro AV, Han D, Shih WM, Yan H (2011) Challenges and Opportunities for Structural DNA Nanotechnology. *Nature Nanotechnology* 6/12:763–772
- Pirozhenko I, Lambrecht A (2008) Influence of Slab Thickness on the Casimir Force. *Physical Review A* 77:013811
- Plank CJ, Rosinski EJ (1964) Catalytic Cracking of Hydrocarbons with a Crystalline Zeolite Catalyst Composite. U.S. Patent 3140249A, 7 July 1964
- Platt JR (1962) National Laboratories for Biology? *Science* 136/3519:859–861
- Plücker J (1858). Über die Einwirkung des Magneten auf die elektrischen Entladungen in verdünnten Gasen Poggendorffs *Annalen der Physik und Chemie*. 179/1:88–106
- Pohl WD, Schneiker C (1991) Distance-controlled Tunneling Transducer. U.S. Patent Number 5,043,577 [see also U.S. patents 5,210,714 and RE36,603]
- Poland DC, Scheraga HA (1965) Statistical Mechanics of Noncovalent Bonds in Polyamino Acids. VIII. Covalent Loops in Proteins. *Biopolymers* 3:379–399
- Pompea SM, Bergener DW, Shepherd DF, Russek S (1984) Reflectance Measurements on an Improved Optical Black for Stray Light Rejection from 0.3 to 500 μm . *Optical Engineering* 23/2:149–152
- Poole C Jr., Owens F (2003). *Introduction to Nanotechnology*. Wiley, Hoboken
- Pradell T, Climent–Font A, Molera J, Zucchiatti A, Ynsa MD, Roura P, Crespo D (2007) Metallic and Nonmetallic Shine in Luster: An Elastic Ion Backscattering Study. *Journal of Applied Physics* 101:103518
- Privalov PL, Gill SI (1988) Stability of Protein Structure and Hydrophobic Interaction. *Advanced Protein Chemistry* 39:191–234
- Priyanto S, Mansoori GA, Suwono A (2001) Measurement of Property Relationships of Nanostructure Micelles and Coacervates of Asphaltene in a Pure Solvent. *Chemical Engineering Science* 56/24:6933–6939
- Qiu J (2016) Nanotechnology Development in China: Challenges and opportunities. *National Science Review* 3:148–152
- Quate CF (1986) Vacuum Tunneling: a New Technique for Microscopy. *Physics Today* 39/8:26–33

- Rafii-Tabar H, Mansoori GA (2004) Interatomic Potential Models for Nanostructures. *Encyclopedia of Nanoscience & Nanotechnology* 4:231–248
- Rai-Choudhury P (2000) MEMS and MOEMS Technology and Applications. Society of Photo-Optical Instrumentation Engineers (SPIE) Press, Bellingham
- Rain JD, Switzer C, Chamberlin AR, Benner SA (1992) Ribosome-Mediated Incorporation of a Non-Standard Amino Acid into a Peptide through Expansion of the Genetic Code. *Nature* 356:537–39
- Ramesh KT (2009) *Nanomaterials: Mechanics and Mechanisms*. Springer, United States
- Ramezani H, Mansoori GA (2007) *Diamondoids as Molecular Building Blocks for Biotechnology Wet Nanotechnology, Drug Targeting and Gene Delivery*. Topics in Applied Physics 109:44–71, Springer
- Ratner M, Ratner D (2002) *Nanotechnology: A Gentle Introduction to the Next Big Idea*. Prentice Hall, Hoboken
- Raymer MG (2009) *The Silicon Web: Physics for the Internet Age*. CRC Press, Boca Raton
- Regis E (1995) *Nano: The Emerging Science of Nanotechnology: Remaking the World – Molecule by Molecule*. Little and Brown, Boston
- Regis E (1997) *Nano*. Bantam, Ealing
- Regis E (2004) *The Incredible Shrinking Man*. Available online: <https://www.wired.com/2004/10/drexler/pp.179-181,204-205>
- Reibold M, Paufler P, Levin AA, Kochmann W, Pätzke N, Meyer DC (2006) Materials: Carbon nanotubes in an ancient Damascus sabre. *Nature* 444:286
- Renn O, Roco MC (2006) Nanotechnology and the Need for Risk Governance. *Journal of Nanoparticle Research* 8:153–191
- Repins I, Contreras M, Romero M, Yan Y, Metzger W, Li J, Johnston S, Egaas B, DeHart C, Scharf J, McCandless BE, Nou R (2008) Characterization of 19.9%-Efficient CIGS Absorbers. 33rd IEEE Photovoltaic Specialists Conference, May 11–16, San Diego, California. Preprint available at: <http://www.semiconductors.co.uk/propiivi5410.htm>
- Resnik DB, Tinkle SS (2007) Ethics in Nanomedicine. *Nanomedicine (London)* 2:345–350
- Ricci M, Spijker P, Voitchovsky K (2014) Water-Induced Correlation between Single Ions Imaged at the Solid-Liquid Interface. *Nature Communications* 5/1
- Richards PM (1977) Areas, Volumes, Packing, and Protein Structure. *Annual Review of Biophysics and Bioengineering* 6:151–176
- Rizo I, Gierasch LM (1992) Constrained Peptides: Models of Bioactive Peptides and Protein Structures. *Annual Review of Biochemistry* 61:387–418
- Robinson RS, Rossmagel SM (1982) Ion-Beam-Induced Topography and Surface Diffusion. *Journal of Vacuum Science & Technology* 21/3:790–797
- Roco MC (2001) International Strategy for Nanotechnology Research. *Journal of Nanoparticle Research* 3:353–360
- Roco MC (2003) Nanotechnology: Convergence with Modern Biology and Medicine. *Current Opinion in Biotechnology* 14/3:337–346
- Roco MC (2011) The Long View of Nanotechnology Development: the National Nanotechnology Initiative at 10 Years. *Journal of Nanoparticle Research* 13/2:427–445
- Roco MC, Mirkin CA, Hersam MC (2011) *Nanotechnology Research Directions for Societal Needs in 2020: Retrospective and Outlook*. Springer Science & Business Media
- Roco MC, Williams S, Alivisatos P (Ed's) (1999) *Nanotechnology Research Directions: IWGN Workshop Report – Vision for Nanotechnology R&D in the Next Decade*. WTEC, Loyola College in Maryland
- Rohlfing EA, Cox DM, Kaldor A (1984) Production and Characterization of Supersonic Carbon Cluster Beams. *Journal of Chemical Physics* 81/7:3322–3330. doi:10.1063/1.447994
- Rohrer H (undated) There Is Plenty of Room at the Bottom. Undated unpublished comments on Feynman's "Plenty of Room" by H. Rohrer; sent to C. Toumey by email from H. Rohrer in November 2004
- Roco MC, Williams RS, Alivisatos P, eds. (2000). *Nanotechnology Research Directions: Vision for Nanotechnology in the Next Decade*. Springer, New York
- Rose GO, Wolfenden R (1993) Hydrogen Bonding, Hydrophobicity, Packing, and Protein Folding. *Annual Review of Biophysics and Biomolecular Structure* 22:381–415
- Rossetti R, Nakahara S, Brus LE (1983) Quantum Size Effects in the Redox Potentials, Resonance Raman Spectra, and Electronic Spectra of CdS Crystallites in Aqueous Solution. *Journal of Chemical Physics* 79:1086

- Roth WJ, Vartuli JC (2002) The Effect of Stoichiometry and Synthesis Conditions on the Properties of Mesoporous M41S Family Silicates. *Studies in Surface Science and Catalysis* 141:273
- Rothemund PWK (2006) Folding DNA to Create Nanoscale Shapes and Patterns. *Nature* 440:297–302
- Roukes M (2001) Plenty of Room, Indeed. *Scientific American* pp.42–49
- Ruan F, Chen Y, Hopkins PB (1990) Metal Ion Enhanced Helicity in Synthetic Peptides Containing Unnatural, Metal–Ligating Residues. *Journal of the American Chemical Society* 112:9403–9404
- Ruaz U (2012) *Finite Element Methods in Nanotechnology*. CRC Press, Boca Raton
- Rudin W (1987) *Real and Complex Analysis*, McGraw–Hill International Editions: Mathematics Series, McGraw–Hill Publishing Co, New York
- Ruska E (1980) The Early Development of Electron Lenses and Electron Microscopy. *Microscopica Acta*. Supplement. 5:1–140
- Saad M, Garbuzenko OB, Minko T (2008) Co–Delivery of siRNA and an Anticancer Drug for Treatment of Multidrug–Resistant Cancer. *Nanomedicine* 3/6:761–776
- Sagiv J (1980) Organized Monolayers by Adsorption. 1. Formation and Structure of Oleophobic Mixed Monolayers on Solid Surfaces. *Journal of the American Chemical Society* 102/1:92–98
- Saito R, Dresselhaus G, Dresselhaus M (1998) *Physical Properties of Carbon Nanotubes*. Imperial College Press, London
- Salata OV (2004) Applications of Nanoparticles in Biology and Medicine. *Journal of Nanobiotechnology* 2:3
- Sanders JKM, Jackson SE (2009) The Discovery and Development of the Green Fluorescent Protein, GFP. *Chemical Society Review* journal 38:2821
- Schmittenmaer CA (2008) Using Terahertz Spectroscopy to Study Nanomaterials. *Terahertz Science and Technology*, 1/1:1–8
- Schneiker C, Hameroff S, Voelker M, He J, Dereniak E, McCuskey R (1988) Scanning Tunneling Engineering. *Journal of Microscopy* 152/2:585–596
- Schneiker CW (1983) Prospects and Applications for Genesis and Ultra Mass Production of Sub–Millimeter Machines, Devices, and Replicating Systems. Unpublished manuscript of 10 August 1983. 41 pages
- Schneiker CW (1984) Beyond Fifth Generation Machines: Feynman Replicators. Unpublished manuscript of 1 December 1984. 8 pages
- Schneiker CW (1984) Some Research Topics for a New Space Development Programme. *Journal of the British Interplanetary Society*, 37:190–192
- Schneiker CW (1985) EUREKA! – Atomic Scale Machine Tools. Unpublished manuscript of 4 April 1985. 4 pages
- Schneiker CW (1985) Nanoscience & NanoEngineering: Foundation for a New Renaissance. Unpublished manuscript of 22 April 1985. 4 pages
- Schneiker CW (1985) Nanotechnology. Unpublished manuscript of 31 July 1985. 30 pages
- Schneiker CW (1985) The Modified Scanning Tunneling Microscope as a Nanometer Scale Machine Tool and Multimode Interface for Precision Assembly, Manipulation, Analysis and Control of Solid State Atomic Systems. Unpublished manuscript of 26 February 1985. 4 pages
- Schneiker CW (1986) Nanotechnology with Feynman Machines. Unpublished book manuscript of 215 pages
- Schneiker CW (1986) Nanotechnology with STMs, Feynman Machines, and von Neumann Machines. Unpublished paper, 11 July 1986. Feynman Archives at Caltech, Box 27, Folder 11. 7 pages. (Note: this paper was converted into a poster by C. Schneiker, presented by S. Hameroff, at an STM Conference in Santiago de Compostela, Spain, July 14–18 1986.)
- Schneiker CW (1989) Nanotechnology with Feynman Machines: Scanning Tunneling Engineering and Artificial Life. In *Artificial Life, Volume VI: Santa Fe Institute Studies in the Sciences of Complexity* [proceedings of a September 1987 workshop in Los Alamos NM], edited by C. Langton, Addison–Wesley, Reading pp.443–500
- Schneiker CW, Hameroff S (1988) Nanotechnology Workstations, Based on Scanning Tunneling/Optical Microscopy: Applications to Molecular Scale Devices. In *Molecular Electronic Devices* [Proceedings of the Third International Symposium on Molecular Electronic Devices, Arlington VA, 6–8 October 1986], edited by F.L. Carter, R.E. Siatkowski & H. Wohltjen, North–Holland, Amsterdam pp.69–90
- Schrauber H, Eisenhaber F, Argos P (1993) Rotamers: To Be or Not To Be? An Analysis of Amino Acid Side–Chain Conformations in Globular Proteins. *Journal of Molecular Biology* 230:592–612
- Schwierz FW, Wong, Hei L, Juin J (2010) *Nanometer CMOS*. Pan Stanford Publishing, Singapore

- Sedra AS, Smith KC (2004) *Microelectronic circuits* (Fifth ed.). Oxford, New York
- Seeman NC (1982) Nucleic Acid Junctions and Lattices. *Journal of Theoretical Biology* 99/2:237–247
- Seijo B, Fattal E, Roblot-Treupel L, Couvreur P (1990) Design of Nanoparticles of Less than 50nm Diameter: Preparation, Characterization and Drug Loading. *International Journal of Pharmaceutics* 62/1:1–7
- Sellitto A, Alvarez FX (2012) Non-Fourier Heat Removal from Hot Nanosystems through Graphene Layer. *Nano Metallurgical and Materials Transactions A* 1:38. doi:10.2478/nsmmt-2012-0003
- Selloni A, Carnevali P, Tosatti E, Chen CD (1986) Voltage-Dependent Scanning-Tunneling Microscopy of a Crystal Surface: Graphite. *Physical Review B* 31/4:2602–2605
- Sharma N, Sharma M, Sajid Jamal QM, Kamal RA, Akhtar S (2019) Nanoinformatics and Biomolecular Nanomodeling: A Novel Move en route for Effective Cancer Treatment. *Environmental Science and Pollution Research International* 27/16:19127–19141
- Shichman H, Hodges DA (1968) Modeling and Simulation of Insulated-Gate Field-Effect Transistor Switching Circuits. *Institute of Electric and Electronic Engineers Journal of Solid-State Circuits, SC-3/3:285–89*
- Shinde SK, Grampurohit ND, Gaikwad DD, Jadhav SL, Gadhave MV, Shelke PK (2012) Toxicity Induced by Nanoparticles. *Asian Pacific Journal of Tropical Disease* 2:331–334
- Shirai Y, Osgood AJ, Zhao Y, Kelly KF, Tour JM (2005) Directional Control in Thermally Driven Single-Molecule Nanocars. *Nano Letters* 5/11:2330–2334
- Shockley W (1951) Circuit Element Utilizing Semiconductive Material. U.S. Patent 2569347A, 25 September 1951
- Sholl D, Steckel JA (2011). *Density Functional Theory: A Practical Introduction*. John Wiley & Sons, Hoboken
- Shukla SK Bahar RI (2004) *Nano, Quantum and Molecular Computing*. Springer, Cham.
- Simic-Krstic Y, Kelley M, Schneiker C, Krasovich M, McCuskey R, Koruga D, Hameroff S (1989) Direct Observation of microtubules with the Scanning Tunneling Microscope. *FASEB Journal* 3:2184–2188
- Singh S, Nalwa HS (2007) Nanotechnology and Health Safety—Toxicity and Risk Assessments of Nanostructured Materials on Human Health. *Journal of Nanoscience and Nanotechnology* 7:3048–3070
- Singh SC, Zeng HB, Guo C, Cai W (2012) *Nanomaterials*. John Wiley & Sons, Hoboken
- Smita S, Gupta SK, Bartonova A, Dusinska M, Gutleb AC, Rahman Q (2012) Nanoparticles in the Environment: Assessment Using the Causal Diagram Approach. *Environmental Health* 11:S13
- Smith DPE, Binnig G (1986) Ultrasmall Scanning Tunneling Microscope for use in a Liquid-Helium Storage Dewar. *Review of Scientific Instruments* 57/10:2630–2631
- Smith IL, Hendrickson W A, Honzatko RB, Sheriff S (1986) Structural Heterogeneity in Protein Crystals. *Biochemistry* 25:5018–5827
- Smith JV, Dydrich WJ (1984) Nets With Channels of Unlimited Diameter. *Nature*. 309/5969:607–08
- Smith NV (2001) Classical Generalization of the Drude Formula for the Optical Conductivity. *Physical Review B*, 64/15, 155106
- Soler JM, Baro AM, García, Rohrer H (1986) Interatomic Forces in Scanning Tunneling Microscopy: Giant Corrugations of the Graphite Surface. *Physical Review Letters* 57/4:444–447
- Somanathan N (2002) *Digital Electronics and Logic Design*. Prentice Hall India Learning Private Limited, New Delhi
- Sondag-Huethorst JAM, van Helleputte HRJ, Fokkink LGJ (1994) Generation of Electrochemically Deposited Metal Patterns by Means of Electron Beam (Nano)lithography of Self-Assembled Monolayer Resists. *Applied Physics Letters* 64/3:285–287
- Sonnenfeld R, Hansma PK (1986) Atomic-Resolution Microscopy in Water. *Science* 232/4747:211–213
- Souto EB, Silva GF, Dias-Ferreira J, Zielinska A, Ventura F, Durazzo A, Lucarini M, Novellino E, Santini A (2020) Nanopharmaceutics: part I—Clinical Trials Legislation and Good Manufacturing Practices (GMP) of Nanotherapeutics in the EU. *Pharmaceutics* 12:146
- Spector J, Stormer HL, Baldwin KW, Pfeiffer LN, West KW (1990) Electron Focusing in Two Dimensional Systems by Means of an Electrostatic Lens. *Applied Physics Letters* 56:1290–1292
- Sridevi D, Rajendran KV (2009) Preparation of ZnO Nanoparticles and Nanorods by Using CTAB Assisted Hydrothermal Method. *International Journal of Nanotechnology and Application* 3/2:43
- Sridharan K, Pudi V (2015) *Design of Arithmetic Circuits in Quantum Dot Cellular Automata Nanotechnology*. Springer, Cham

- Steigerwald ML, Alivisatos AP, Gibson JM, Harris TD, Kortan R, Muller AJ, Thayer AM, Duncan TM, Douglass DC, Brus LE (1988) Surface Derivatization and Isolation of Semiconductor Cluster Molecules. *Journal of the American Chemical Society* 110/10:3046–3050
- Stent GS (1972) Prematurity and Uniqueness in Scientific Discovery. *Scientific American* pp.84–93
- Stipe BC, Rezaei MA, Ho W (1998) Single-Molecule Vibrational Spectroscopy and Microscopy. *Science* 280:1732–1735
- Stoddard JF (1993) Molecular Recognition and Self-Assembly. *Anales de Quimica* 89/1:51–56.
- Strijkers GJ, Kluza E, Van Tilborg GA, van der Schaft DWJ, Griffioen AW, Mulder WJM, Nicolay K (2010) Paramagnetic and Fluorescent Liposomes for Target-Specific Imaging and Therapy of Tumor Angiogenesis. *Angiogenesis* 13/2:161–173
- Strosio JA, Eigler DM (1991) Atomic and Molecular Manipulation with the Scanning Tunneling Microscope. *Science* 254:1319–26
- Stucky GD, Monnier A, Schueth F, Huo Q, Firouzi DI, Janicke M, Chmelka BF (1994) Molecular and Atomic Arrays in Nano- and Mesoporous Materials Synthesis. *Molecular Crystals and Liquid Crystals* 240/1:187–196
- Synge EH (1928) XXXVIII. A Suggested Method for Extending Microscopic Resolution into the Ultra-Microscopic Region. *The London, Edinburgh and Dublin Philosophical Magazine and Journal of Science* 6/35:356–362
- Taghavi SM, Momenpour M, Azarian M, Ahmadian M, Souri F, Taghavi SA, Sadeghain M, Karchani M (2013) Effects of Nanoparticles on the Environment and Outdoor Workplaces. *Electron Physician* 5:706–712
- Takayanagi K, Tanishiro Y, Takahashi M, Takahashi S (1985) Structural Analysis of Si(111)–7×7 by UHV-Transmission Electron Diffraction and Microscopy. *Journal of Vacuum Science & Technology A Vacuum Surfaces and Films* 3/3:1502–1506
- Tang W (2007) *Molecular Dynamics Simulations of Carbon Nanotubes in Liquid Flow*. ProQuest, Morrisville
- Taniguchi N (1967) Analysis of mechanism of various materials-workings based on the concept of working energy. *Scientific Papers of the Institute of Physical and Chemical Research, Tokio* 61/3
- Taniguchi N (1973) Ion beam sputter-machining of glass. *College International pour la Recherche en Productique (CIRP) Annalen*, Berlin
- Taniguchi N, Maezawa S (1963) Temperature analysis of electron beam machining. *Proceedings of 5th Annual Electron Beam Symposium*, Boston
- Tans SJ, Verschueren ARM, Dekker C (1998) Room-Temperature Transistor based on a Single Carbon Nanotube. *Nature* 393:49–52
- Tapley BD, Poston TR (1990) *Eschbach's Handbook of Engineering Fundamentals*. Wiley New York
- Tersoff J, Hamann DR (1985) Theory of the Scanning Tunneling Microscope. *Physical Review B* 31:805–813
- Thijssen J (2007) *Computational Physics*. Cambridge University Press, Cambridge
- Thomas TR (2004) Nanotechnology, Materials and Applications. In *Encyclopedia of Twentieth-Century Technology*, Vol. 1, edited by C. Hempstead & W. Worthington, Routledge, New York pp.521–523
- Thompson ISI (2004) The Journal Selection Process. Online: www.isinet.com/essays/selectonofmaterialforcoverage/199701.html
- Thompson SE, Chau RS, Ghani T, Mistry K, Tyagi S, Bohr MT (2005) In Search of “Forever”, Continued Transistor Scaling One New Material at a Time. In: *Transactions on Semiconductor Manufacturing* 18/1:26–36. Institute of Electric and Electronic Engineers, Piscataway
- Thundat T, Zheng XY, Chen GY (1993) Role of Relative Humidity in Atomic Force Microscopy Imaging. *Surface Science Letters* 294/1–2:L939–L943
- Tillman P, Hill JM (2005). Modelling the Thermal Conductivity of Nanofluids. *Proceeding of International Union of Theoretical and Applied Mechanics 2005 Symposium – Mechanical Behavior, Micro-mechanics of nano structural materials*, June 27–30, Beijing
- Tomalia DA, Naylor AM, Goddard WA III (1990) Starburst Dendrimers: Molecular-Level Control of Size, Shape, Surface Chemistry, Topology, and Flexibility from Atoms to Macroscopic Matter. *Angewandte Chemie International Edition* 29:138–175
- Tomsovic S, Heller EJ (1993) Semiclassical Construction of Chaotic Eigenstates. *Physical Review Letters* 70:1405–1408
- Toumey C (2004) Nano Hyperbole and Lessons from Earlier Technologies. *Nanotechnology Law & Business* 1/4:397–405

- Toumey C (2004) Narratives for Nanotech: Anticipating Public Reactions to Nanotechnology. *Techné* 8/2:88–116
- Toumey C (2005) Apostolic Succession: Does Nanotechnology Descend from Richard Feynman's 1959 Talk? *Engineering & Science* 68/1:16–23
- Toumey C (2005) Feynman Unprocessed. Review of Perfectly Reasonable Deviations from the Beaten Path: the Letters of Richard P. Feynman. *Techné* 8/3:76–86
- Toumey C (2019) Apostolic Succession. *Engineering & Science* 1:16–23
- Trontl V, Mikšić Pletikosić I, Milun M, Pervan P, Lazić P, Šokčević D, Brako R (2005) Experimental and Ab Initio Study of the Structural and Electronic Properties of Subnanometer Thick Ag Films on Pd(111). *Physical Review B*. 72/23:235418
- Valand NN, Patel MB (2015) *Fullerenes Chemistry & Its Applications*. Scholars' Press, Chisinau
- van der Meer PR, van Staveren A, van Roermund AHM (2004) Low-Power Deep Sub-Micron CMOS Logic: Subthreshold Current Reduction. Springer, Dordrecht
- Van Swygenhoven H, Derlet PM, Hasnaoui A (2002) Atomic Mechanism for Dislocation Emission from Nanosized Grain Boundaries. *Physical Review B*, 66:024101
- Vartuli JC, Kresge CT, Leonowicz ME, Chu AS, McCullen SB, Johnson ID, Sheppard EW (1994) Synthesis of Mesoporous Materials: Liquid Crystal Templating versus Intercalation of Layered Silicates. *Chemistry of Materials*, 6/11:2070–2077
- Vartuli JC, Schmitt KD, Kresge CT, Roth WJ, Leonowicz ME, McCullen SB, Hellring SD, Beck JS, Schlenker JL, Olsen DH, Sheppard EW (1994) Effects of Surfactant/Silica Molar Ratios on the Formation of Mesoporous Molecular Sieves: Inorganic Mimicry of Surfactant Liquid-Crystal Phases and Mechanistic Implications. *Chemistry of Materials* 6/12:2317–2326
- Vasileška D, Goodnick SM (2011) *Nano-Electronic Devices: Semiclassical and Quantum Transport Modeling*. Springer, New York
- Ventura PJ, Costa LC, Carmo MC, Roman HE, Pavesi L (2000) AC Conductivity of Porous Silicon from Monte Carlo Simulations. *Journal of Porous Materials* 7/1–3:107–110
- Vinogradov SS, Smith PD, Vinogradova ED (2010) Canonical Problems in Scattering and Potential Theory Part II: Acoustic and Electromagnetic Diffraction by Canonical Structures. CRC Press, Boca Raton
- Voelker M, He D, Dereniak E, McCuskey R, Schneiker C, Hameroff S (1988) Scanning Tunneling Microscopy (STM) for Biomolecular Imaging and Interactions. *Biophysical Journal* 53/2; Part 2:396a
- Voinigescu S (2013) *High-Frequency Integrated Circuits*. Cambridge University Press, Cambridge
- Volkin DB, Staubli A, Langer R, KJibanov AM (1991) Enzyme Thermo-inactivation in Anhydrous Organic Solvents. *Biotechnology and Bioengineering* 37:843–853
- von Neumann, J, Burks AW (1966) *Theory of Self-Reproducing Automata*, University of Illinois Press, Urbana
- Wagner FE, Haslbeck S, Stievano L, Calogero S, Pankhurst QA, Martinek KP (2000) Before Striking Gold in Gold-Ruby Glass. *Nature* 407/6805:691–692
- Wandelt K (2012) *Surface and Interface Science*. John Wiley & Sons, Hoboken, Volumes 1–2
- Wang B, Zhou L, Peng X (2003) A Fractal Model for Predicting the Effective Thermal Conductivity of Liquid with Suspension of Nanoparticles. *International Journal of Heat and Mass Transfer*, 46/14:2665–2672
- Wang GC, Lu TM (2013) RHEED Transmission Mode and Pole Figures
- Wang J (2010) *Key Issues of Classical Molecular Dynamics Simulation*. Lambert Academic Publishing, Chisinau
- Wang X, Cao L, Lu F, Mezziani MJ, Li H, Qi G, Zhou B, Harruff BA, Kermarrec F, Sun YP (2009) Photoinduced Electron Transfers with Carbon Dots. *Chemical Communications* 25:3774–3776
- Wang Z, Peng Z, Lu K, Wen W (2003) Experimental Investigation for Field-Induced Interaction Force of Two Spheres. *Applied Physics Letters* 82:1796–1798
- Watson JD, Crick FHC (1953) Molecular Structure of Nucleic Acids: A Structure for Deoxyribose Nucleic Acid. *Nature* 171:737–738
- Weinstein A (1977) How Unknown was Mendel's Paper? *Journal of the History of Biology* 10/2:341–364
- Whitesides GM, Mathias IP, Seto CT (1991) Molecular Self-Assembly and Nanochemistry: a Chemical Strategy for the Synthesis of Nanostructures. *Science* 254:1312–1319
- Wiesendanger R (1994) *Scanning Probe Microscopy and Spectroscopy: Methods and Applications*. Cambridge University Press, Cambridge
- Williams JB (2017). *The Electronics Revolution: Inventing the Future*. Springer, Cham

- Williams KA, Veenhuizen PTM, de la Torre BG, Eritja R, Dekker C (2002) Nanotechnology: Carbon Nanotubes with DNA Recognition. *Nature* 420:6917:761
- Wilson C, Mace JE, Agard DA (1991) Computational Method for the Design of Enzymes with Altered Substrate Specificity. *Journal of Molecular Biology* 220:495–506
- Xia T, Li N, Nel AE (2009) Potential Health Impact of Nanoparticles. *Annual Review of Public Health* 30:137–150
- Xia Y, Whitesides GM (1998) Soft Lithography. *Angewandte Chemie International Edition* 37/5:550–575
- Xu Q, Canutescu AA, Wang G, Shapovalov, Obradovic Z, Dunbrack RL (2008) Statistical Analysis of Interface Similarity in Crystals of Homologous Proteins. *Journal of Molecular Biology* 381/2:487–507
- Xu W, Guo C, Rhee SW (2013) High Performance Organic Field-Effect Transistors using Cyanoethyl Pullulan (CEP) High-k Polymer Cross-Linked with Trimethylolpropane Triglycidyl Ether (TTE) at Low Temperatures. *Journal of Materials Chemistry C*, 1/25: 3955
- Xu X, Ray R, Gu Y, Ploehn HJ, Gearheart L, Raker K, Scrivens W (2004) A Electrophoretic Analysis and Purification of Fluorescent Single-Walled Carbon Nanotube Fragments. *Journal of the American Chemical Society* 126:12736–12737
- Xuan Y, Li Q, Hu W (2003) Aggregation Structure and Thermal Conductivity of Nanofluids. *American Institute of Chemical Engineers Journal*, 49:1038–1042
- Xue Y, Mansoori GA (2010) Self-Assembly of Diamondoid Molecules and Derivatives (MD Simulations and DFT Calculations). *International Journal of Molecular Sciences*, 11/1:288–303
- Yan JM, Zhang QY, Gao JQ (1986) Adsorption and Agglomeration Surface and Porosity of Solid. Science Press, 1986
- Yang A-S, Sharp KA, Honig B (1992) Analysis of the Heat Capacity Dependence of Protein Folding. *Journal of Molecular Bioengineering* 227:889–900
- Yang ST, Cao L, Luo PG, Lu F, Wang X, Wang H, Meziani MJ, Liu Y, Qi G, Sun YP (2009) Carbon Dots for Optical Imaging in Vivo. *Journal of the American Chemical Society* 131:11308–11309
- Yang ST, Wang X, Wang H, Lu F, Luo PG, Cao L, Meziani MJ, Liu JH, Liu Y, Chen M, Huang Y, Sun YP (2009) Carbon Dots as Nontoxic and High-Performance Fluorescence Imaging Agents. *Journal of Physical Chemistry C* 113/42:18110–18114
- Yater JC (1979) Rebuttal to “Comments on ‘Power Conversion of Energy Fluctuations.’” *Physical Review A* 20/2:623–627
- Yater JC (1982) Physical Basis of Power Conversion of Energy Fluctuations. *Physical Review A* 26/1:522–537
- Ye P, Ernst T, Khare MV (2019) The Nanosheet Transistor Is the Next (and Maybe Last) Step in Moore’s Law. Institute of Electric and Electronic Engineers Spectrum, Piscataway
- Yu MF, Yakobson BI, Ruoff RS (2000) Controlled Sliding and Pullout of Nested Shells in Individual Multiwalled Carbon Nanotubes. *Journal of Physical Chemistry B* 104:8764–8767
- Yu W, Choi SUS (2003) The role of interfacial layers in the enhanced thermal conductivity of nanofluids: a renovated Maxwell model. *Journal of Nanoparticle Research* 5:167–171
- Yu W, Choi SUS (2004) The role of interfacial layers in the enhanced thermal conductivity of nanofluids: a renovated Hamilton-Crosser model. *Journal of Nanoparticle Research* 6:355–361
- Yuan Y, Gu Z, Yao C, Luo D, Yang D (2019) Nucleic Acid-Based Functional Nanomaterials as Advanced Cancer Therapeutics. *Small* 15:e1900172
- Yun-yu S, Mark AE, Cun-xi W, Fuhua H, Berendsen HIC, van Gunsteren WF (1993) Can the Stability of Protein Mutants be Predicted by Free Energy Calculations? *Protein Engineering* 6:289–295
- Yussou M, Zeller R (1980) An Efficient Korringa-Kohn-Rostoker Method for “complex” Lattices. Edition International Centre for Theoretical Physics, Vol. 80 and Vol. 166
- Yusupov MM, Yusupova GZ, Baucom A, Lieberman K, Earnest TN, Cate JHD, Noller HF (2001) Crystal Structure of the Ribosome at 5.5 Å Resolution. *Science* 292/5518:883–896
- Zamboni WC (2008) Concept and Clinical Evaluation of Carrier-Mediated Anticancer Agents. *The Oncologist* 13/3:248–260. doi:10.1634/theoncologist.2007-0180
- Zheng J, Birktoft JJ, Chen Y, Wang T, Sha R, Constantinou PE, Ginell SL, Mao C, Seeman NC (2009) From Molecular to Macroscopic via the Rational Design of a Self-Assembled 3D DNA Crystal. *Nature* 461/7260:74–77
- Zheng Q, Jiang Q (2002) Multiwalled carbon nanotubes as gigahertz oscillators. *Physical Review Letters* 88:045503
- Zhou L, Beck M, Gatzhen HH, Altschuler KJ, Talke FE (2005) Slider Vibration Reduction using Slider Surface Texture. *Microsystems Technologies* 11:857–866

- Zhou L, Kato K, Umehara N, Miyake Y (1999) Nanometre Scale Island-type Texture with Controllable Height and Area Ratio Formed by Ion Beam Etching on Hard-disk Head Sliders. *Nanotechnology* 10: 363–372
- Zhou L, Lin Y, Huang Z, Ren J, Qu X (2012) Carbon Nanodots as Fluorescence Probes for Rapid, Sensitive, and Label-Free Detection of Hg²⁺ and Biothiols in Complex Matrices. *Chemical Communications* 48/8:1147–1149
- Zhuang J, Holay M, Park JH, Fang RH, Zhang J, Zhang L (2019) Nanoparticle Delivery of Immunostimulatory Agents for Cancer Immunotherapy. *Theranostics* 9/25:7826–7848
- Ziman M (1979) *Principles of the Theory of Solids*. Cambridge University Press. Cambridge

Expected Papers

- Durlo A** (2024) 1950s–1990s: Carbon Nanotubes Studies into Historiography of Nanoscience–Nanotechnology, [pre-print](#)
- Pisano R, **Durlo A** (2024) 1930s–1980s: A History of Nanotechnology from Physics Scanning Devices to Nanoscale Techniques. In Pisano R (ed): *Nanoscience & Nanotechnologies. Critical Problems, Science in Society, Historical Perspectives*. Dordrecht, Springer. [Accepted & pre-print](#).
- Pisano R, **Durlo A** (2023) A Feynman’s Frameworks on Nanotechnology in a Historiographical Debate. In Conde M, Salomon M (eds): *Handbook of the Historiography of Science*. Dordrecht, Springer, [in press](#)
- Pisano R, Marmottini D, **Durlo A** (2023) Lagrange’s Method and *Lagrangian’s* Mechanism in Maxwell’s *A Treatise on Electricity and Magnetism* (1873). In Pisano R (ed): *A History of Physics: Phenomena, Ideas & Mechanisms – Essays in honour of Salvo D’Agostino*. Dordrecht, Springer, [in press](#)

Analytical Index

In the following pages the reader will find the Name Index and the Subject Index of the Thesis; both the indexes are kept divided for ease of reading of the most important entries in the text.

Name Index

Adeel, M; 160; 234; 241; 478; 790; 851
Albrecht, TR; 450; 455; 458; 459; 460; 461; 479; 513; 627; 794; 796; 833
Asimov, I; 391; 392
Atalla, MM; 18; 130; 137; 138; 340; 341; 380; 381; 382; 384; 385; 386; 400; 790
Barras, A; 683; 815; 816
Bayda, S; 6; 160; 177; 234; 236; 239; 241; 368; 411; 478; 790; 837; 847; 851
Biaye, M; 685; 686; 796; 800
Binnig, G; 131; 137; 140; 143; 167; 177; 198; 216; 236; 269; 272; 327; 376; 407; 430; 431; 432; 433; 434;
435; 449; 450; 455; 462; 478; 479; 481; 787; 790; 796; 838; 855
Bollmann, W; 340; 382; 383; 384; 400; 790
Boukherroub, R; 683; 684; 815; 816; 830
Brus, LE; 241; 242; 448; 479; 504; 505; 515; 516; 517; 518; 519; 520; 610; 611; 612; 613; 614; 620; 621;
627; 642; 649; 655; 790; 795; 797; 809; 833; 853; 856
Buckminster Fuller, R; 142; 446; 447; 481; 849
Bussotti, P; 160; 164; 693; 694; 797; 822; 823; 824
Cassius, A; 134
Chenming, H; 600; 601; 622; 798
Cho, AY; 317; 330; 341; 393; 400; 401; 790; 799; 828; 839
Cléri, F; 39; 40; 41; 42; 160; 161; 162; 163; 165; 166; 655; 681; 683; 685; 686; 687; 688; 689; 690; 691; 693;
696; 697; 796; 799; 800; 801; 807; 808; 809; 811; 813; 814; 817; 821; 825; 829; 831; 832; 835
Collard, D; 161; 686; 688; 690; 693; 793; 794; 795; 797; 799; 800; 801; 804; 806; 807; 809; 810; 811; 813;
814; 816; 817; 818; 821; 826; 827; 828; 830; 831; 833; 834
Copernicus, N; 364
Copie, G; 41; 161; 166; 685; 686; 697; 796; 800; 832
Cordani, M; 160; 234; 237; 478; 790; 839
Correns, C; 213; 370
Curl, RF jr; 142; 177; 199; 407; 442; 446; 478; 788; 791; 793
Delerue, C; iii; 131; 161; 162; 629; 634; 637; 642; 650; 678; 680; 682; 684; 685; 686; 687; 688; 689; 690;
691; 692; 693; 695; 696; 697; 793; 794; 796; 797; 798; 799; 800; 801; 802; 803; 804; 805; 806; 808; 809;
810; 811; 812; 813; 814; 815; 816; 818; 819; 820; 821; 822; 825; 826; 827; 830; 832; 833; 834; 835; 843
DeVries, H; 213; 370
Diener, P; 803; 821; 828; 834
Diesinger, H; 684; 685; 686; 794; 796; 800
Drexler, KE; iv; 28; 130; 141; 142; 155; 157; 161; 167; 174; 176; 209; 211; 212; 215; 217; 218; 219; 220;
221; 222; 223; 224; 225; 233; 234; 235; 236; 237; 365; 366; 367; 368; 369; 371; 374; 399; 406; 407; 418;
419; 420; 421; 422; 451; 452; 453; 454; 478; 479; 480; 508; 509; 510; 511; 512; 513; 514; 622; 629; 649;
652; 687; 737; 786; 790; 803; 818; 821; 829; 835; 838; 841
Durkan, C; 37; 136; 161; 234; 367; 804
Durló, A; vii; 516; 651; 672; 683; 684; 785; 859
Edwards, SA; 37; 161; 234; 366; 804
Eigler, DM; 131; 143; 167; 169; 216; 237; 242; 269; 376; 408; 462; 463; 464; 477; 510; 544; 545; 546; 547;
615; 620; 622; 623; 628; 629; 632; 643; 650; 791; 804; 810; 840; 842; 845; 856
Ekimov, AI; 141; 237; 422; 423; 424; 429; 478; 479; 480; 481; 505; 508; 518; 612; 622; 623; 642; 791; 804;
805; 842
Endo, M; 406; 413; 415; 416; 417; 478; 690; 791; 792; 811
Esaki, RL; 237; 341; 395; 396; 397; 398; 400; 791; 842
Faraday, M; 37; 197; 198; 233; 234; 237; 503; 520; 572; 623; 791; 805
Feynman, RP; iii; iv; 28; 30; 31; 37; 130; 136; 137; 139; 150; 155; 157; 160; 167; 168; 169; 170; 174; 175;
176; 209; 210; 211; 213; 214; 215; 216; 217; 221; 233; 234; 235; 236; 237; 238; 240; 241; 242; 243; 248;
249; 327; 328; 340; 360; 361; 362; 363; 364; 365; 366; 367; 368; 369; 370; 371; 372; 373; 374; 375; 376;
377; 378; 379; 399; 402; 403; 411; 418; 422; 451; 684; 737; 738; 785; 786; 791; 805; 832; 838; 841; 842;
843; 844; 845; 850; 853; 854; 857; 859
Fontana, N; 39
Geim, A; 145; 177; 200; 240; 484; 577; 579; 580; 581; 582; 583; 620; 625; 643; 644; 692; 791; 792; 820;
851
Gerber, C; 143; 167; 236; 269; 272; 407; 431; 449; 450; 455; 478; 479; 790; 796; 838
Gilbert, H; 371; 620; 791

Giordano, S; 40; 161; 162; 681; 685; 686; 688; 689; 690; 691; 692; 693; 696; 795; 798; 800; 804; 805; 807; 808; 809; 812; 817; 819; 821; 825; 831
 Heath, JR; 199; 442; 444; 445; 446; 478; 788; 791; 793
 Hey, AJG; 168; 238; 372; 845
 Hibbs, AR; 136; 363
 Hippel, AR von; 27; 28; 166; 340; 355; 356; 357; 399; 400; 793; 833
 Hishiyama, Y; 406; 413; 415; 416; 478; 791
 Iijima, S; 144; 199; 292; 332; 354; 477; 484; 485; 486; 487; 524; 525; 526; 527; 620; 642; 650; 738; 788; 791; 792
 Kahng, D; 18; 130; 137; 138; 340; 380; 381; 382; 384; 385; 386; 400; 402; 790; 791; 846
 Kambham, AK; 602; 603; 620; 653; 791
 Kilbi J; 340; 358; 359; 360; 399; 400; 791
 Koleskin, NF; 436; 478; 479; 792; 812
 Koyama, T; 406; 413; 414; 415; 416; 417; 478; 481; 791; 792; 847
 Kreinovich, V; i; 795; 801; 805; 806; 809; 812; 813; 815; 819; 821; 834
 Kroto, HW Sir; 142; 177; 199; 407; 442; 443; 444; 445; 446; 447; 448; 478; 481; 788; 791; 793; 847
 Krzeminski, C; 41; 161; 166; 686; 687; 688; 690; 691; 692; 697; 800; 801; 804; 808; 813; 815; 816; 819; 832
 Lampin, E; 41; 160; 161; 163; 655; 682; 683; 686; 687; 691; 799; 800; 801; 804; 813; 814; 815
 Lederer, D; 604; 624; 814
 Liu, Y; 237; 239; 243; 277; 295; 296; 297; 317; 329; 330; 333; 442; 444; 445; 478; 653; 655; 691; 692; 706; 707; 708; 711; 716; 718; 728; 729; 788; 793; 815; 819; 827; 834; 835; 840; 848; 858
 Lukyanovich, VM; iii; 160; 199; 340; 341; 348; 349; 350; 354; 355; 400; 439; 485; 788; 792
 Lutz, CP; 544; 545; 546; 547; 615; 620; 623; 624; 628; 629; 650; 791; 810; 818; 840; 845
 Lycurgus; 134; 179; 180; 236; 237; 737; 837; 843
 Manoharan, HC; 544; 545; 546; 547; 615; 620; 623; 624; 650; 791; 808; 818
 Marcacci, F; 805; 816; 817
 Martel, R; 534; 535; 536; 537; 538; 620; 650; 791
 McCray, P; 168; 239; 403; 849
 Mehra, J; 168; 240; 372; 850
 Mélin, T; 646; 651; 683; 685; 796; 817
 Mendel, G; 167; 169; 170; 213; 236; 240; 243; 370; 379; 631; 838; 850; 851; 857
 Mirkin, C; 240; 241; 522; 524; 539; 540; 543; 620; 625; 631; 714; 728; 731; 792; 814; 822; 850; 852; 853
 Moon, CR; 615; 624; 818
 Moore, GE; v; 130; 138; 139; 238; 240; 341; 386; 387; 388; 389; 390; 391; 399; 400; 401; 404; 481; 602; 792; 835; 846; 850; 858
 Morton, JA; 358
 Nesterenko, AM; iii; 436; 437; 438; 439; 440; 441; 478; 792
 Newton, I; 160; 164; 295; 298; 364; 605; 626; 693; 694; 797; 822; 823; 829
 Novoselov, K; 145; 177; 200; 240; 484; 577; 578; 579; 580; 581; 582; 583; 620; 625; 643; 644; 652; 692; 791; 792; 820; 851
 O'Brien, S; 199; 442; 444; 445; 446; 478; 788; 791; 793
 Ochekpe, NA; 591; 595; 625; 653; 820
 Onushchenko, AA; 237; 422; 423; 424; 429; 478; 479; 480; 481; 505; 508; 622; 791; 804; 805; 842
 Pamlin, D; 365
 Pinto Reis, C; 583; 585; 587; 588; 589; 620; 652; 792
 Pisano, P; iii; vi; 39; 131; 160; 163; 164; 165; 634; 646; 672; 678; 680; 684; 693; 694; 695; 736; 785; 797; 822; 823; 824; 825; 859
 Pradeep, T; 37; 165; 207; 230; 235; 237; 250; 258; 323; 328; 329; 366; 448; 450; 480; 490; 625; 736; 801; 821; 825; 841
 Quate, CF; 137; 143; 167; 216; 254; 272; 376; 407; 449; 450; 455; 458; 459; 460; 461; 478; 479; 481; 513; 627; 790; 794; 796; 833; 852
 Radushkevich, LV; iii; 160; 199; 340; 348; 349; 350; 354; 355; 399; 400; 439; 485; 788; 792
 Ranganathan, R; 24; 165; 590; 596; 620; 792; 826
 Regis, E; 169; 241; 403; 853
 Rizzolio, F; 160; 234; 236; 239; 241; 478; 790; 837; 847; 851
 Robbins, J; 371
 Rohrer, H; 131; 137; 140; 143; 167; 169; 177; 198; 216; 236; 241; 269; 272; 327; 376; 407; 430; 431; 432; 433; 434; 435; 449; 462; 478; 480; 481; 787; 790; 827; 837; 838; 853; 855

Romero, PG; 234; 333; 366; 802; 853
Sanders, W; 235; 241; 273; 330; 367; 401; 827; 854
Sarto, MS; 794; 795; 797; 798; 799; 801; 806; 817; 826; 831
Schweizer, EK; 167; 237; 462; 463; 464; 510; 622; 629; 804; 842
Sharan, M; 798; 828
Sharon, M; 37; 165; 235; 367; 736; 798; 828
Smalley, R; 142; 155; 167; 177; 199; 217; 218; 220; 221; 222; 223; 224; 225; 235; 237; 407; 442; 443; 446;
447; 448; 452; 453; 454; 478; 479; 480; 481; 626; 627; 737; 788; 791; 792; 793; 803; 829; 831; 833; 835;
841; 845
Spreadborough, J; 340; 382; 383; 384; 400; 790
Szunerits, S; 645; 646; 647; 655; 667; 683; 684; 815; 816; 830
Taniguchi, J; iii
Taniguchi, N; iii; iv; 6; 36; 130; 131; 139; 155; 157; 160; 170; 174; 176; 209; 225; 226; 227; 233; 234; 242;
365; 366; 367; 371; 406; 409; 410; 411; 412; 451; 477; 478; 706; 726; 737; 738; 786; 792; 856
Toumey, C; iii; 137; 169; 170; 176; 212; 213; 214; 215; 216; 217; 235; 241; 243; 340; 361; 369; 370; 372;
375; 376; 377; 378; 379; 403; 738; 786; 832; 853; 856; 857
Trautman, JK; 515; 516; 517; 518; 519; 520; 610; 611; 612; 613; 614; 620; 621; 649; 655; 790; 796
Tsu, JK; 622; 798
Tsu, R; 341; 395; 396; 397; 398; 400; 791
Tuccinardi, T; 160; 234; 236; 478; 790; 837
Vandamme, E; 605; 626; 627; 827; 832

Subject Index

Apostolic Succession; 170; 213; 243; 370; 403; 857
Armchair; 489; 490
Atomic Force Microscope
AFM; 99; 136; 137; 143; 167; 221; 236; 272; 274; 328; 331; 449; 478; 540; 623; 790; 792; 793; 801; 809; 838; 839
Atomic Force Microscopy; iv; 31; 45; 160; 230; 237; 272; 273; 282; 328; 330; 333; 334; 479; 621; 627; 629; 630; 787; 794; 795; 796; 804; 833; 836; 839; 844; 845; 848; 856
Australian and New Zealand Standard Research Classification; 8
Australian Bureau of Statistics; 8
Bessel equation; 525
Bessel function
Bessel functions; 257; 425; 524; 525; 526; 527
Boston College; 220
Bottom-up approach; 65; 83; 84; 91; 201; 355; 471; 722
Buckyball; 142; 144
Caveolae-mediated endocytosis; 710; 711
Central University of Lille; 37
Centre National de la Recherche Scientifique; 37
Chemical Vapour Deposition; iv; 204; 579; 601; 787
Chiral angle; 488; 489; 532; 533
Chirality
Chiral; 144; 292; 293; 407; 441; 477; 484; 581; 646
Circuits et Systèmes de Télécommunication; 38
Classical Physics; 34; 174
Clathrin/caveolin-independent endocytosis and macropinocytosis; 710; 711
Clathrin-mediated endocytosis; 710
Collodal gold; 520; 521; 524; 572
Curie temperature; 552; 555; 569
Deep Reinforcement Learning
DRL; 614; 615; 616; 617; 656
Dendrimer
Dendrimers; 199; 472; 590; 591; 595; 705
Dip-Pen nanolithography; 539
Dispositifs Opto et MicroElectroniques; 38
Dry-Etching; 206
Ecole d'ingéneurs des Hautes Technologies et du Numérique; 37
Egyptian blue; 133; 178
Electron Beam Lithography; 99; 206; 207; 787
Engineering and Science; 52; 160; 209; 210; 234; 360; 361; 791
Engines of Creation. The coming Era of Nanotechnology; vi; 28; 142; 155; 161; 174; 215; 234; 365; 368; 371; 374; 406; 407; 421; 422; 449; 451; 452; 479; 790; 803
EPitaxy and heterostructures PHYsics; 38
Etching; 205; 206; 226; 380; 381; 382; 437; 601; 602; 609; 667; 670
Fin Field Effect Transistor
FinFET; 599; 600; 601; 602; 605; 607; 608; 609; 610
Fin Field-Effect Transistor; 19
Focused Ion Beam; iv; 32; 174; 207; 603; 787
Gecko; 10; 11; 12; 17; 191; 192; 195; 737
Health and Safety Executive; 16
Helical Microtubules of Graphitic Carbon; 332; 620; 788; 791
High Electron Mobility Transistor
HEMT; 649; 656; 684; 833
High Electron Mobility Transistors; 666; 683; 812
Highest Occupied Molecular Orbital-Lowest Unoccupied Molecular Orbital; 502
History of Nanotechnology. From Prehistoric to Modern Times; 37; 165; 235; 367; 816
History of Physics and Applied Sciences & Technology
HOPAST; 634; 646; 672

History of Physics And Science Technology; 39
IBM Zurich Research Laboratory; 140
Institut d'Electronique, de Microélectronique et de Nanotechnologie; 4; 633; 634; 678
International System of Units of Measures; 4
International Union of Pure and Applied Chemistry; 493
Kondo effect; 544; 546
Lamella
Lamellae; 11; 440; 494
Liposome
Liposomes; 592; 593; 594; 627; 629; 632; 708; 834; 842; 843; 856
Lycurgus Cup; 134; 179; 180; 236; 237; 837; 843
Massachusetts Institute of Technology; 43; 141; 144; 328; 403; 418; 478; 790; 805; 848
Matériaux, Nanostructures et Composants; 38; 770
Mathematics and Physics for Nanotechnology; 37
Maya Blue; 134; 234; 802
Mesoporous silica; vi; 493; 498; 621; 622; 625; 628; 728; 731; 793; 795; 797; 800; 815; 819; 836; 850
Micelle
Micelles; 495; 496; 595; 596
Micro et Nano-Systèmes; 38
Mobil Composition of Matter-41; 493
Molecular machine; 212; 219; 422; 508; 509; 512; 514
Molecular Machinery and Manufacturing with Applications to Computation; 142; 420; 478; 790
Mößbauer Spectroscopy; 560; 569; 570
Multi-walled nanotube
MWNTs; 189; 199; 285; 292; 295; 354; 526; 533; 534; 535; 538
Nanoage; 8
Nanoarray; 8
Nanoassembly; 8
Nanobacteria; 8; 189
Nanobiologist; 8
Nanobiology; 3; 7; 8; 88; 412
Nanobiomedicine; 8
Nanobiotechnology; 3; 8; 79; 114; 162; 165; 168; 240; 468; 471; 473; 726; 731; 790; 797; 810; 827; 851; 854
Nanobot; 8
Nanocapsule; 8
Nanocar; 8; 147; 240; 850
Nanocassette; 8
Nanocatalyst; 8
Nanochemistry; iv; 6; 7; 8; 73; 95; 115; 229; 234; 632; 797; 857
Nanoclay; 9
Nanocoating; 9
Nanocomponent; 9
Nanocomposite; 9; 708
Nanoconnection; 9
Nanocosm; 9
Nanocrystal
Nanocrystals; 9; 685; 686; 687; 690; 696; 697; 797; 798; 799; 801; 808; 830; 833
Nanocrystalline; 8; 331; 686; 687; 800; 802; 839
Nanocube; 8
Nanodevice; 8; 79
Nanodivide; 8
Nanodomain; 8
Nanodot; 8
Nanodrug; 8
Nanoelectromechanical; 8; 123; 793
Nanoelectronics; iii; iv; 7; 8; 18; 35; 49; 85; 86; 93; 94; 109; 112; 123; 163; 228; 412; 468; 473; 821
Nanoencapsulation; 8; 620; 652; 792
Nanofabrication; 3; 8; 104; 240; 421; 472; 479; 624; 629; 803; 814; 841; 851

- Nanoferrites; 484
Nanofibers; 8; 163; 819; 828
Nanofilter; 8
Nanofluidics; 8; 81; 82; 123; 329; 468; 471; 819
Nanohealth; iii; 3; 9; 25; 35
Nanolayer; v; 9; 163; 341; 384; 821
Nanoliter; 9
Nanolithography; vi; 9; 152; 238; 241; 539; 624; 650; 817; 847; 852
Nanomachine; 9
Nanomagnetic; 9; 689; 807
Nanomanipulator; 9
Nanomanufacturing; 3; 8
Nanomaterial; 8; 16; 114; 163; 200; 229; 332; 594; 721; 722; 727; 799; 819; 841
Nanomaterials; iii; iv; vii; 3; 8; 16; 17; 26; 35; 58; 84; 88; 92; 95; 96; 108; 115; 119; 122; 129; 160; 162; 163; 165; 166; 174; 183; 184; 197; 201; 229; 234; 236; 243; 331; 332; 333; 334; 357; 471; 590; 644; 652; 685; 686; 689; 690; 693; 708; 725; 726; 727; 728; 731; 795; 797; 798; 799; 801; 808; 809; 810; 811; 814; 819; 820; 821; 825; 826; 828; 829; 834; 836; 840; 841; 844; 846; 853; 854; 855; 858
Nanomechanics; iii; iv; 7; 8; 19; 35; 74; 78; 227; 236; 331; 333; 411; 838; 839; 848
Nanomedicine; iii; iv; 3; 7; 8; 24; 25; 35; 58; 77; 89; 96; 117; 160; 161; 162; 165; 166; 232; 234; 238; 239; 363; 412; 471; 473; 474; 620; 623; 624; 631; 652; 707; 726; 730; 731; 790; 792; 806; 809; 810; 811; 817; 826; 827; 833; 836; 838; 844; 845; 846; 848; 853; 854
Nanomembrane; 8
Nano–Mendel approach; 213; 370
Nanometre; 8; 105; 169; 237; 242; 400; 403; 621; 625; 630; 631; 795; 803; 819; 840; 848; 851; 854
Nanometrology; iii; 3; 8; 21; 35; 162; 471; 810
Nanomicelle; 8
Nanomotor; 8; 20
Nanoparticle; v; 8; 62; 238; 240; 317; 328; 329; 330; 334; 402; 590; 621; 623; 628; 653; 664; 682; 685; 697; 706; 716; 729; 730; 731; 732; 794; 796; 806; 821; 827; 830; 832; 833; 836; 839; 840; 842; 845; 846; 850; 853; 858; 859
Nanoparticulate; 8; 236; 726; 792; 836
Nanophase; 8; 330; 833
Nanophotonics; iii; iv; 3; 7; 8; 24; 35; 59; 60; 84; 100; 102; 107; 115; 123; 125; 160; 163; 228; 793; 821
Nanophysics; v; iv; 6; 7; 8; 45; 47; 110; 115; 157; 163; 229; 245; 247; 249; 250; 366; 473; 737; 821
Nanoplatelates; 8
Nanoporous; 9; 102; 691; 692; 815; 817
Nanopowder; 9
Nanoproduct; 9
Nanoreactor; 9
Nanoreplicator; 9
Nanoribbon; 9
Nanorobot; 9; 160; 162; 798; 811; 812
Nanoscience
Nanosciences; v; ix; iii; iv; 3; 4; 5; 6; 7; 8; 10; 21; 28; 30; 31; 32; 33; 34; 35; 36; 37; 42; 43; 44; 45; 46; 47; 48; 49; 53; 54; 55; 61; 62; 63; 64; 65; 66; 71; 74; 75; 77; 82; 83; 84; 86; 87; 88; 89; 90; 95; 96; 97; 98; 99; 101; 102; 103; 104; 105; 108; 110; 113; 114; 115; 116; 117; 119; 120; 121; 123; 124; 125; 126; 128; 130; 131; 135; 136; 140; 145; 148; 149; 151; 154; 155; 156; 157; 160; 163; 165; 169; 173; 174; 175; 176; 177; 209; 211; 213; 227; 233; 234; 235; 241; 247; 248; 249; 327; 329; 331; 332; 339; 340; 342; 354; 355; 362; 363; 369; 375; 399; 401; 421; 429; 430; 441; 462; 468; 471; 472; 473; 475; 480; 485; 548; 614; 634; 642; 648; 653; 678; 680; 683; 685; 702; 707; 726; 731; 735; 736; 738; 786; 787; 788; 790; 795; 799; 816; 819; 825; 838; 840; 841; 844; 853; 854; 855
Nanoscope; 8
Nanosecond; 8
Nanoshell; 8; 238; 239; 626; 828; 845; 848
Nanostructured; 8; 84; 89; 98; 102; 121; 238; 328; 329; 332; 687; 696; 731; 795; 802; 815; 831; 843; 846; 855

Nanostructures; 8; 45; 70; 74; 75; 89; 97; 101; 106; 108; 161; 166; 168; 239; 240; 241; 332; 333; 590; 622; 623; 625; 632; 634; 653; 686; 687; 696; 770; 798; 799; 802; 810; 820; 830; 841; 847; 848; 849; 850; 851; 852; 853; 857
 Nanostructures nanoComposants et Molécules; 38
 Nanoswarm; 8
 Nanosystem; 8; 103; 241; 851
 Nanotechnology
 Nanotechnologies; i; v; vi; ix; iii; iv; v; vi; vii; 3; 4; 5; 6; 7; 8; 10; 16; 18; 20; 21; 22; 23; 24; 26; 27; 28; 29; 30; 33; 35; 36; 37; 42; 43; 44; 45; 46; 48; 50; 51; 53; 54; 55; 56; 57; 58; 59; 60; 61; 62; 63; 64; 65; 66; 68; 69; 70; 71; 73; 74; 76; 78; 79; 80; 82; 83; 85; 88; 90; 92; 93; 94; 95; 96; 97; 98; 99; 100; 101; 102; 103; 104; 105; 107; 108; 109; 110; 113; 114; 115; 116; 117; 118; 119; 120; 121; 122; 123; 124; 125; 126; 127; 129; 130; 131; 134; 136; 137; 139; 140; 142; 144; 145; 146; 148; 149; 150; 151; 152; 153; 154; 155; 156; 157; 158; 160; 161; 162; 163; 165; 166; 167; 168; 169; 170; 173; 174; 175; 176; 177; 198; 209; 210; 211; 213; 214; 215; 216; 217; 221; 225; 227; 228; 229; 232; 233; 234; 235; 236; 237; 238; 239; 240; 241; 242; 243; 249; 252; 277; 278; 292; 327; 328; 329; 330; 331; 332; 333; 334; 337; 339; 340; 341; 342; 355; 362; 363; 364; 365; 366; 367; 369; 370; 371; 372; 374; 375; 376; 377; 378; 379; 380; 391; 399; 400; 401; 402; 403; 406; 409; 410; 411; 412; 418; 420; 421; 422; 451; 452; 462; 468; 469; 471; 472; 473; 474; 475; 478; 479; 480; 485; 548; 589; 591; 614; 620; 624; 625; 627; 631; 633; 634; 636; 641; 642; 643; 644; 647; 649; 652; 653; 655; 672; 678; 680; 682; 683; 684; 685; 687; 689; 690; 693; 695; 699; 702; 703; 704; 705; 706; 707; 708; 715; 718; 719; 721; 726; 727; 728; 729; 730; 731; 735; 736; 737; 738; 785; 786; 787; 788; 790; 791; 792; 793; 794; 795; 796; 798; 799; 801; 802; 803; 804; 805; 806; 808; 809; 810; 811; 812; 813; 815; 816; 817; 818; 819; 820; 821; 825; 827; 828; 829; 830; 832; 833; 836; 837; 838; 839; 840; 841; 842; 843; 844; 845; 846; 847; 848; 849; 850; 851; 852; 853; 854; 855; 856; 857; 858; 859
 Nanotool; 8
 Nanotoxicology; iii; iv; 3; 8; 26; 36; 75; 163; 165; 232; 727; 808; 820; 825; 828
 Nanotransistor; 9
 Nanotribology; iv; 3; 9; 162; 228; 628; 654; 689; 697; 808; 834; 838
 Nanotube; v; vi; 9; 152; 161; 165; 243; 315; 328; 330; 332; 333; 341; 347; 534; 650; 652; 655; 682; 690; 692; 796; 799; 805; 811; 815; 825; 835; 845; 848; 858
 Nanotubes; ix; x; xi; xii; 12; 17; 18; 19; 27; 33; 58; 66; 78; 79; 81; 87; 106; 107; 140; 144; 145; 151; 152; 155; 180; 189; 199; 218; 219; 221; 222; 227; 232; 241; 268; 284; 285; 292; 293; 294; 295; 296; 297; 335; 348; 351; 354; 355; 391; 399; 413; 441; 470; 471; 472; 477; 484; 485; 486; 487; 490; 524; 525; 526; 528; 529; 530; 532; 533; 534; 535; 536; 538; 539; 577; 578; 583; 597; 599; 619; 642; 645; 646; 660; 669; 708; 710; 719; 738; 788; 853; 858
 Nanotweezers; 9; 834
 Nanowire; 9; 17; 166; 167; 332; 400; 401; 403; 498; 802; 831; 834; 835; 839; 844; 849
 Nanoworks; 9
 Nanoworld; v; 9; 35; 132; 156; 175; 366; 390; 391; 786
 NASA Research Center; 138
 National Nanotechnology Initiative; 5; 6; 145; 155; 163; 177; 234; 411; 643; 706; 721; 731; 792; 819; 853
 Near-field Scanning Optical Microscopy; 228; 519
 Near-Field Scanning Optical Microscopy
 NSOM; 611
 Nippon Electric Company, Limited; 144
 Nostradamus-like reading; 213; 370
 Papilla
 Papillae; 14
 Phagocytosis; 710
 Phonon; 21; 518; 572; 647; 676; 677
 Photolithography; 23; 208; 390; 667; 673
 Physical Vapour Deposition; iv; 203
 Physique, SIMuLation PHYsique de Dispositifs Electroniques et optoelectroniques; 38
 PolyTetraFluoroethylene
 Teflon; 10
 Purple of Cassius; 134; 135
 Quantum confinement; 141; 422; 502; 504; 508; 515; 517; 519; 599; 610; 611; 612; 613
 Quantum Mechanics; 31; 139; 148; 174; 175; 229; 270; 672
 Reading Feynman Into Nanotechnology

- A Text for a New Science; 137; 235; 403; 832
Reinforcement Learning
RL; 615; 618; 624; 626; 814; 830
Resist; 206; 207; 208; 381
Royal Society/Royal Academy for Engineering Working Group; 5; 177
Scanning Tunneling Microscope
SEM; v; 31; 136; 140; 141; 143; 167; 169; 177; 236; 238; 242; 269; 334; 429; 430; 481; 622; 630; 632; 798;
838; 842; 845; 847; 852; 854; 855; 856
Scanning Tunneling Microscopy; iv; 40; 45; 137; 167; 168; 170; 216; 231; 236; 238; 243; 269; 328; 329;
331; 332; 376; 478; 480; 481; 629; 656; 687; 688; 691; 787; 790; 798; 804; 812; 816; 838; 839; 842; 843;
844; 852; 855; 857
Schottky Barrier Diode; 666
Scientific American; 167; 169; 221; 222; 235; 236; 241; 242; 402; 452; 478; 479; 792; 803; 829; 838; 845;
854; 856
Seta
Setae; 11; 191
Single-walled nanotube
SWNT; 285; 293; 348; 487; 524; 526; 530; 534; 535; 538; 595
Soft lithography; iv; 201; 202
Springer Handbook of Nanotechnology; 36
Sticky fingers; 221; 222; 452; 453
Surface Plasmon Resonance; 231; 626; 655; 667; 684; 687; 693; 697; 802; 821; 830; 835
The New Scientist; 210
The Structure of Scientific Revolutions; 9; 162
There's Plenty of Room at the Bottom; v; 28; 29; 30; 37; 130; 136; 155; 160; 168; 174; 176; 209; 215; 234;
237; 238; 327; 340; 360; 361; 364; 365; 366; 367; 368; 371; 374; 375; 376; 379; 399; 406; 418; 738; 786;
791; 843; 846
Time-Resolved THz Spectroscopy; 297
Top-down approach; 83; 84; 201; 366; 471; 722
U.S. Naval Research Laboratory; 144
Union Internationale de Chimie; 214; 373
Université de Lille; 37; 682; 794
Université Polytechnique Hauts-de-France; 37; 647
University of Hainaut Cambrésis; 634
University of Lille 1; 639
University of Melbourne; iii; vii; 635
University of Valenciennes; 634; 639
Vacuum Electronic Devices; 666
Very Large-Scale Integration; 666
Virginia Polytechnic Institute number 5
VPI-5; 493
Wet-Etching; 206
X-ray diffraction; 179; 413; 414; 494; 502; 524; 525; 556
Zigzag; 489; 490