



**HAL**  
open science

# A Game Theoretic Framework for User Association & Inter-cell Interference Management in LTE Cellular Networks

Nessrine Trabelsi

► **To cite this version:**

Nessrine Trabelsi. A Game Theoretic Framework for User Association & Inter-cell Interference Management in LTE Cellular Networks. Computer Science and Game Theory [cs.GT]. Université d'Avignon, 2016. English. NNT : 2016AVIG0215 . tel-04360884

**HAL Id: tel-04360884**

**<https://theses.hal.science/tel-04360884>**

Submitted on 22 Dec 2023

**HAL** is a multi-disciplinary open access archive for the deposit and dissemination of scientific research documents, whether they are published or not. The documents may come from teaching and research institutions in France or abroad, or from public or private research centers.

L'archive ouverte pluridisciplinaire **HAL**, est destinée au dépôt et à la diffusion de documents scientifiques de niveau recherche, publiés ou non, émanant des établissements d'enseignement et de recherche français ou étrangers, des laboratoires publics ou privés.

# **A Game Theoretic Framework for User Association & Inter-cell Interference Management in LTE Cellular Networks**

by

Nessrine TRABELSI

A dissertation submitted in partial fulfillment  
of the requirements for the degree of  
Doctor of Computer Science  
(Ed 536)  
in The University of Avignon  
2016

Doctoral Committee:

Tijani Chahed, Jury President  
Samson Lasaulce, Reviewer  
Salah-Eddine El Ayoubi, Reviewer  
Issam Mabrouki, Examiner  
Francesco de Pellegrini, Examiner  
Eitan Altman, Advisor  
Rachid El Azouzi, Co-Advisor  
Laurent Roullet, Co-Advisor

© Nessrine TRABELSI 2016  
All Rights Reserved

In the name of God, the Most Gracious, the Most Merciful.

I dedicate this work as a token of my deep love and gratitude

To my dearly beloved parents Wissem and Noura,

for their unconditional love and continuous support.

To my dear brother Achraf,

for standing by my side in difficult moments and for believing in me.

To my deceased grandmothers and grandfathers, to all my family and friends,

for being there for me during all these years.

## ACKNOWLEDGEMENTS

All praise and gratitude be to God. I praise Him and ask for His forgiveness, help and guidance. I repent to Him and I seek refuge in Him from the evils of myself and from my sinful deeds. He gave me the patience and inspiration to finish this work.

I would like thank Mr Samson Lasaulce and Mr Salah-Eddine El Ayoubi for kindly accepting to review my thesis. Also, my thanks go to the members of the jury, Mr Tijani Chahed, Mr Issam Mabrouki and Mr Francesco de Pellegrini for the interest they showed in my research.

I would like to express my gratitude to my supervisor Mr Eitan Altman and my co-supervisor Prof Rachid El Azouzi for their continuous support and encouragement during my Ph.D. study. Their knowledge, patience and guidance helped me throughout the research and writing this manuscript. I would like to thank both of them for facilitating all the administrative procedures of my stay in France and my participation in international conferences.

My deepest and sincerest gratitude goes to my Ph.D. advisor at Bell Labs, Mr Laurent Rouillet, for his kindness, knowledge and patience. He was always present to comfort me and kept believing in me until the very end. Without his encouragement and effort, this thesis would not have been completed. I could not wish for a better advisor and mentor for my Ph.D. study. Dear Laurent, I remain eternally indebted to you.

I thank my colleagues and friends from Bell Labs for making my stay there very enjoyable. My special appreciation goes to Chung Shue Chen (Calvin), Dora Boviz,

Aravinthan Gopalasingham, Marie Line Alberi-Morel, Afef Feki, Véronique Capdevielle, Erick Bizouarn and Abdelkrim Hebbar. Thank you for encouraging my research and for helping me. I have been honored to work with all of you.

My sincere thanks go to my colleagues from INRIA and LIA, especially the team MAESTRO. I also thank Laurie Vermeersch for her valuable help and support. She always made my administrative tasks so much easier.

I extend my heartfelt thanks to all my friends and my dearly beloved family for their moral support and constant motivation.

I would like to especially thank my parents and my brother for their unconditional love and infinite support. Dear mum and dad, I know you always wished me to have this Ph.D. degree. I did my very best to make you proud and I really hope that it made your sacrifices worthwhile. I love you !

Finally, I thank all those people who made this thesis possible and an unforgettable experience for me.

---

The results of this thesis have been produced in the framework of the common research lab between INRIA and Alcatel-Lucent Bell Labs. Part of this work has received funding from the European Union's Seventh Framework Programme (FP7/2007-2013) under grant no. 318115 (Connectivity management for eneRgy Optimized Wireless Dense networks CROWD).

# TABLE OF CONTENTS

<b>DEDICATION</b> . . . . .	ii
<b>ACKNOWLEDGEMENTS</b> . . . . .	iii
<b>LIST OF FIGURES</b> . . . . .	viii
<b>LIST OF TABLES</b> . . . . .	x
<b>LIST OF ABBREVIATIONS</b> . . . . .	xi
<b>ABSTRACT</b> . . . . .	xv
<b>RÉSUMÉ</b> . . . . .	xvii
<b>CHAPTER</b>	
<b>I. Introduction</b> . . . . .	1
1.1 Overview . . . . .	2
1.2 Motivations . . . . .	6
1.2.1 HetNets Overview . . . . .	6
1.2.2 HetNets Challenges . . . . .	9
1.3 Contributions & Outline . . . . .	11
1.3.1 Contributions . . . . .	11
1.3.2 List of Publications . . . . .	13
1.3.3 Outline . . . . .	13
<b>II. Fundamental Concepts and State of the Art</b> . . . . .	14
2.1 Introduction . . . . .	14
2.2 LTE & OFDMA Overview . . . . .	15
2.2.1 LTE Overview . . . . .	15
2.2.2 OFDM/OFDMA overview . . . . .	17
2.3 Interference Management . . . . .	20
2.3.1 Inter-Cell Interference Coordination (ICIC) . . . . .	20

2.3.2	enhanced ICIC (eICIC)	28
2.4	User Association	31
2.4.1	User Association in Homogeneous Networks	31
2.4.2	User Association in HetNets	32
2.5	User Association, Resource Allocation & Inter-Cell Interference Optimization in HetNets	37
2.5.1	Disjoint optimization	37
2.5.2	Joint Optimization	38
2.6	Software Defined Networking	39
2.6.1	Trends & Challenges	39
2.6.2	SDN Architecture & Benefits	39
2.6.3	Research Work on SDN	41
2.7	Conclusion	41
<b>III. Problem formulation</b>		<b>43</b>
3.1	System Model	43
3.2	Problem Setup	46
3.3	Special Cases	49
3.3.1	Disjoint Frequency Sub-bands Optimization	50
3.3.2	Disjoint Power Level Optimization	50
3.3.3	Almost Blank Sub-frames Optimization	51
3.3.4	User Association Optimization	52
3.3.5	Utility Function Maximization	53
3.4	Conclusion	53
<b>IV. A Game Theoretic Framework</b>		<b>54</b>
4.1	Theoretical Background	54
4.1.1	Potential Game Formulation	54
4.1.2	Discussion	57
4.2	Proposed Solution	59
4.2.1	Step 1 – Data Collection	60
4.2.2	Step 2 – Optimization	62
4.2.3	Step 3 – Distribution & Execution	65
4.2.4	Centralized vs Distributed	66
4.3	Conclusion	67
<b>V. Performance Evaluation</b>		<b>68</b>
5.1	Simulation setup & metrics	68
5.2	Disjoint Frequency Sub-band Optimization	71
5.2.1	Specific optimization settings	71
5.2.2	Results	71
5.3	Disjoint Power Levels Optimization	75



5.3.1	Specific optimization settings . . . . .	75
5.3.2	Results . . . . .	76
5.4	Almost Blank Sub-frames Optimization . . . . .	79
5.4.1	Specific optimization settings . . . . .	79
5.4.2	Results . . . . .	80
5.5	User Association & Resource Allocation Optimization . . . . .	81
5.5.1	Specific optimization settings . . . . .	81
5.5.2	Results . . . . .	82
5.6	From X2-Proxy to SDN Controller . . . . .	84
5.6.1	X2Proxy . . . . .	84
5.6.2	SDN-based Prototype . . . . .	85
5.7	Conclusion . . . . .	89
<b>VI.</b>	<b>Conclusion . . . . .</b>	<b>90</b>
<b>APPENDICES</b>	<b>. . . . .</b>	<b>92</b>
<b>BIBLIOGRAPHY</b>	<b>. . . . .</b>	<b>107</b>

## LIST OF FIGURES

### Figure

1.1	<i>Homogeneous hexagonal-grid macro cells network.</i> . . . . .	2
1.2	<i>Mobile data traffic growth 2015-2020.</i> . . . . .	3
1.3	<i>Global mobile devices and connections growth 2015-2020.</i> . . . . .	4
1.4	<i>HetNets deployment with a mix of macro, pico, femto and relay base stations.</i> . . . . .	6
1.5	<i>Cell Range Extension and Almost Blank Sub-frames.</i> . . . . .	8
2.1	<i>Simplified LTE network architecture.</i> . . . . .	15
2.2	<i>OFDM vs OFDMA.</i> . . . . .	17
2.3	<i>LTE generic frame structure.</i> . . . . .	18
2.4	<i>Resource Block structure.</i> . . . . .	19
2.5	<i>Interference scenario.</i> . . . . .	20
2.6	<i>Resource Block collision.</i> . . . . .	21
2.7	<i>Interference avoidance schemes.</i> . . . . .	23
2.8	<i>Frequency Reuse 1.</i> . . . . .	24
2.9	<i>Frequency Reuse 3.</i> . . . . .	24
2.10	<i>Partial Frequency Reuse - PFR.</i> . . . . .	25
2.11	<i>Soft Frequency Reuse - PFR.</i> . . . . .	25
2.12	<i>Almost Blank Sub-frames.</i> . . . . .	29
2.13	<i>User association based on strongest RSRP.</i> . . . . .	33
2.14	<i>Cell Range Extension.</i> . . . . .	35
2.15	<i>SDN architecture.</i> . . . . .	40
4.1	<i>Framework overview.</i> . . . . .	59
4.2	<i>Step 1: Data Collection.</i> . . . . .	60
4.3	<i>Example of various UE grouping policies.</i> . . . . .	61
4.4	<i>Resource blocks grouped into frequency sub-bands.</i> . . . . .	63
4.5	<i>Clustering.</i> . . . . .	67
5.1	<i>LTE system level simulator.</i> . . . . .	69
5.2	<i>Example of a users' distribution.</i> . . . . .	70
5.3	<i>CDF user throughput (Freq Optim vs Reuse-1)- Macros.</i> . . . . .	74
5.4	<i>CDF user throughput (Freq Optim vs Reuse-1)- HetNets.</i> . . . . .	74
5.5	<i>CDF user throughput (Power levels optimization vs Reuse-1) - Macros.</i> . . . . .	76
5.6	<i>CDF user throughput (Power levels optimization vs Reuse-1) - Hetnets.</i> . . . . .	77

5.7	<i>Average and cell edge throughput gains - only Macro.</i>	78
5.8	<i>Average and cell edge throughput gains - HetNets.</i>	79
5.9	<i>CDF user throughput (ABS Optim vs Reuse-1)- HetNets.</i>	81
5.10	<i>CDF user throughput (CIO and Frequency Resource Optimization vs Reuse-1).</i>	83
5.11	<i>X2-Proxy architecture.</i>	85
5.12	<i>SDN Platform for RAN architecture.</i>	86
5.13	<i>RAN inventory in database.</i>	87
5.14	<i>Prototype for performance validation.</i>	88
B.1	<i>X2-Proxy Poster - Bell Labs Open Days 2013.</i>	105
B.2	<i>SDN Controller Poster - Bell Labs Future X Days 2015.</i>	106

## LIST OF TABLES

### Table

2.1	<i>Available RBs.</i> . . . . .	19
3.1	<i>Descriptions of notations.</i> . . . . .	47
5.1	<i>General simulation parameters</i> . . . . .	70
5.2	<i>Frequency sub-bands optimization - sampling parameters</i> . . . . .	71
5.3	<i>Disjoint frequency sub-bands optimization results - Only Macros</i> . . . . .	72
5.4	<i>Disjoint frequency sub-bands optimization result - HetNets</i> . . . . .	73
5.5	<i>Power levels optimization - sampling parameters</i> . . . . .	75
5.6	<i>Disjoint power levels optimization result - only Macros</i> . . . . .	76
5.7	<i>Power levels optimization result - HetNets</i> . . . . .	77
5.8	<i>ABS optimization - sampling parameters</i> . . . . .	80
5.9	<i>Disjoint ABS optimization result</i> . . . . .	80
5.10	<i>CIO &amp; Frequency sub-bands optimization - sampling parameters</i> . . . . .	82
5.11	<i>User association and resource allocation optimization result</i> . . . . .	83

## LIST OF ABBREVIATIONS

<b>3GPP</b>	3rd Generation Partnership Project
<b>ABS</b>	Almost Blank Sub-frames
<b>API</b>	Application Programming Interface
<b>Avg-EE</b>	Average energy efficiency
<b>Avg-user-Th</b>	Average user throughput
<b>AWGN</b>	Additive white Gaussian Noise
<b>BS</b>	Base Stations
<b>CAGR</b>	Compound Annual Growth Rate
<b>CDF</b>	Cumulative Distribution Function
<b>Cell-edge-EE</b>	Cell edge energy efficiency
<b>Cell-edge-Th</b>	Cell edge throughput
<b>CIO</b>	Cell Individual Offset
<b>CP</b>	Cyclic Prefix
<b>CQI</b>	Channel Quality Indicator
<b>CRE</b>	Cell Range Extension
<b>CRS</b>	Common Reference Signals
<b>CSB</b>	Cell Selection Bias
<b>CSI</b>	Channel State Information
<b>DL</b>	downlink
<b>eCoMP</b>	enhanced Coordinated Multi Point

**eICIC** enhanced Inter-Cell Interference Coordination  
**eNB** eNodeB  
**eNodeB** E-UTRAN Node B  
**EPC** Evolved Packet Core  
**E-UTRAN** Evolved UMTS Terrestrial Radio Access Network  
**FIP** Finite Improvement Path  
**HetNets** Heterogeneous Networks  
**HSPA** High Speed Packet Access  
**HSS** Home Subscriber Server  
**ICI** inter-cell interference  
**ICIC** Inter-Cell Interference Coordination  
**ISD** Inter-Site Distance  
**ITU** International Telecommunication Union  
**KPIs** Key Performance Indicators  
**LTE** Long Term Evolution  
**LTE-A** LTE-Advanced  
**MC** Macro Cell  
**Median-Th** Median throughput  
**MIMO** multiple input multiple output  
**MME** Mobility Management Entity  
**ms** millisecond  
**NB** North Bound  
**OAM** Operation Administration and Maintenance  
**ODL** OpenDayLight  
**OFDM** Orthogonal Frequency Division Multiplexing  
**OFDMA** Orthogonal Frequency Division Multiple Access  
**PBCH** Physical Broadcast Channel

**PCRF** Policy Control and Charging Rules Function  
**PDCCH** Physical Downlink Control Channel  
**PDSCH** Physical Downlink Shared Channel  
**PFR** Partial Frequency Reuse  
**PFS** Proportional Fair Scheduler  
**P-GW** Packet Data Network Gateway  
**PHY** physical layer  
**PSS** Primary Synchronization Signals  
**QoS** Quality of Service  
**RAN** Radio Access Networks  
**RB** Resource Block  
**REB** Range Extension Bias  
**RF** Radio Frequency  
**RF1** Reuse Frequency 1  
**RF3** Reuse Frequency 3  
**RNF** Radio Net Flow  
**RNFA** Radio Net Flow Agent  
**ROI** Region Of Interest  
**RRM** Radio Resource Management  
**RSRP** Reference Signal Received Power  
**SAL** Service Abstraction Layer  
**SB** South Bound  
**SC** Small Cell  
**SC-FDMA** Single Carrier Frequency Division Multiple Access  
**SCTP** Stream Control Transmission Protocol  
**SDN** Software Defined Networking  
**SDWN** Software Defined Wireless Network

**SFR** Soft Frequency Reuse  
**S-GW** Serving Gateway  
**SIB-1** System Information Block-1  
**SINR** Signal-to-Interference-plus-Noise Ratio  
**SISO** Single Input Single Output  
**SSS** Secondary Synchronization Signals  
**TTI** Transmission Time Interval  
**UDP** User Datagram Protocol  
**UE** User Equipment  
**UL** Uplink  
**VNI** Visual Networking Index



## ABSTRACT

Driven by an exponential growth in mobile broadband-enabled devices and a continued increase in individual data consumption, mobile data traffic has grown 4000-fold over the past 10 years and almost 400-million-fold over the past 15 years. Homogeneous cellular networks have been facing limitations to handle soaring mobile data traffic and to meet the growing end-user demand for more bandwidth and better quality of experience. These limitations are mainly related to the available spectrum and the capacity of the network. Telecommunication industry has to address these challenges and meet exploding demand. At the same time, it has to guarantee a healthy economic model to reduce the carbon footprint which is caused by mobile communications.

Heterogeneous Networks (**HetNets**), composed of macro base stations and low-power base stations of different types, are seen as the key solution to improve spectral efficiency per unit area and to eliminate coverage holes. In such networks, intelligent user association and interference management schemes are needed to achieve gains in performance. Due to the large imbalance in transmission power between macro and small cells, user association based on strongest signal received is not adapted in **HetNets** as only few users would attach to low power nodes. A technique based on Cell Individual Offset (**CIO**) is therefore required to perform load balancing and to favor some Small Cell (**SC**) attraction against Macro Cell (**MC**). This offset is added to users' Reference Signal Received Power (**RSRP**) measurements and hence inducing handover towards different eNodeBs. As Long Term Evolution (**LTE**) cellular networks use the same frequency sub-bands, mobile users may experience strong inter-cell

interference, especially at cell edge. Therefore, there is a need to coordinate resource allocation among the cells and minimize inter-cell interference. To mitigate strong inter-cell interference, the resource, in time, frequency and power domain, should be allocated efficiently. A pattern for each dimension is computed to permit especially for cell edge users to benefit of higher throughput and quality of experience. The optimization of all these parameters can also offer gain in energy use. In this thesis, we propose a concrete versatile dynamic solution performing an optimization of user association and resource allocation in LTE cellular networks maximizing a certain network utility function that can be adequately chosen. Our solution, based on game theory, permits to compute Cell Individual Offset and a pattern of power transmission over frequency and time domain for each cell. We present numerical simulations to illustrate the important performance gain brought by this optimization. We obtain significant benefits in the average throughput and also cell edge user throughput of 40% and 55% gains respectively. Furthermore, we also obtain a meaningful improvement in energy efficiency. This work addresses industrial research challenges and as such, a prototype acting on emulated HetNets traffic has been implemented.

***Index terms***— enhanced Inter Cell Interference Coordination eICIC, Cell Individual Offset CIO, time pattern, frequency sub-bands, power control, optimization, HetNets.

## RÉSUMÉ

Conduit par une croissance exponentielle dans les appareils mobiles et une augmentation continue de la consommation individuelle des données, le trafic de données mobiles a augmenté de 4000 fois au cours des 10 dernières années et près de 400 millions de fois au cours des 15 dernières années. Les réseaux cellulaires homogènes rencontrent de plus en plus de difficultés à gérer l'énorme trafic de données mobiles et à assurer un débit plus élevé et une meilleure qualité d'expérience pour les utilisateurs. Ces difficultés sont essentiellement liées au spectre disponible et à la capacité du réseau. L'industrie de télécommunication doit relever ces défis et en même temps doit garantir un modèle économique pour les opérateurs qui leur permettra de continuer à investir pour répondre à la demande croissante et réduire l'empreinte carbone due aux communications mobiles. Les réseaux cellulaires hétérogènes (HetNets), composés de stations de base macro et de différentes stations de base de faible puissance, sont considérés comme la solution clé pour améliorer l'efficacité spectrale par unité de surface et pour éliminer les trous de couverture. Dans de tels réseaux, il est primordial d'attacher intelligemment les utilisateurs aux stations de base et de bien gérer les interférences afin de gagner en performance. Comme la différence de puissance d'émission est importante entre les grandes et petites cellules, l'association habituelle des mobiles aux stations de bases en se basant sur le signal le plus fort, n'est plus adaptée dans les HetNets. Une technique basée sur des offsets individuelles par cellule Offset (CIO) est donc nécessaire afin d'équilibrer la charge entre les cellules et d'augmenter l'attraction des petites cellules (SC) par rapport aux cellules macro (MC). Cette offset est ajoutée à la valeur moyenne de la puissance reçue du signal de référence (RSRP) mesurée par le mobile et peut donc induire à un changement d'attachement vers différents eNodeB. Comme les stations de bases dans les réseaux cellulaires LTE utilisent les mêmes sous-bandes de fréquences, les mobiles peuvent connaître une forte

interférence intercellulaire, en particulier en bordure de cellules. Par conséquent, il est primordial de coordonner l'allocation des ressources entre les cellules et de minimiser l'interférence entre les cellules. Pour atténuer la forte interférence intercellulaire, les ressources, en termes de temps, fréquence et puissance d'émission, devraient être alloués efficacement. Un modèle pour chaque dimension est calculé pour permettre en particulier aux utilisateurs en bordure de cellule de bénéficier d'un débit plus élevé et d'une meilleure qualité de l'expérience. L'optimisation de tous ces paramètres peut également offrir un gain en consommation d'énergie

Dans cette thèse, nous proposons une solution dynamique polyvalente effectuant une optimisation de l'attachement des mobiles aux stations de base et de l'allocation des ressources dans les réseaux cellulaires LTE maximisant une fonction d'utilité du réseau qui peut être choisie de manière adéquate.

Notre solution, basée sur la théorie des jeux, permet de calculer les meilleures valeurs pour l'offset individuelle par cellule (CIO) et pour les niveaux de puissance à appliquer au niveau temporel et fréquentiel pour chaque cellule. Nous présentons des résultats des simulations effectuées pour illustrer le gain de performance important apporté par cette optimisation. Nous obtenons une significative hausse dans le débit moyen et le débit des utilisateurs en bordure de cellule avec 40 % et 55 % de gains respectivement. En outre, on obtient un gain important en énergie. Ce travail aborde des défis pour l'industrie des télécoms et en tant que tel, un prototype de l'optimiseur a été implémenté en se basant sur un trafic HetNets émulé.

**Mots-clés**— gestion de l'interférence intercellulaire, Offset, ressources temporel, sous-bandes de fréquences, niveau de puissance, optimisation, HetNets.

# CHAPTER I

## Introduction

Over the last decade, mobile data services have become an essential part of users' lives. The number of mobile subscribers has grown rapidly and mobile data traffic has nearly doubled each year. The pace of growth is expected to continue over the next years with the never ending launch of new data-hungry applications. As the demand of more bandwidth and capacity is increasing, current networks are reaching some limits. Service providers need to find profitable and green solutions to handle this growth level. Fortunately, there are multiple techniques that operators can leverage today.

In this thesis, we explore one of the most popular solutions enhancing network capacity, i.e, **HetNets**. The introduction of small cells within a macro cells coverage permits to efficiently use the available spectrum and thus increase the network capacity. However, two main challenges are facing the **HetNets** cellular technology: User Association and inter-cell interference (**ICI**) Management.

This chapter is structured as follows. First, we will present a general overview of current cellular networks and the limitations they face due to mobile data growth. Then, we will explore some of the techniques that operators can use to increase network capacity. In the second part, we will explain why **HetNets** are seen as the key solution to improve spectrum efficiency and the challenges they face, namely user

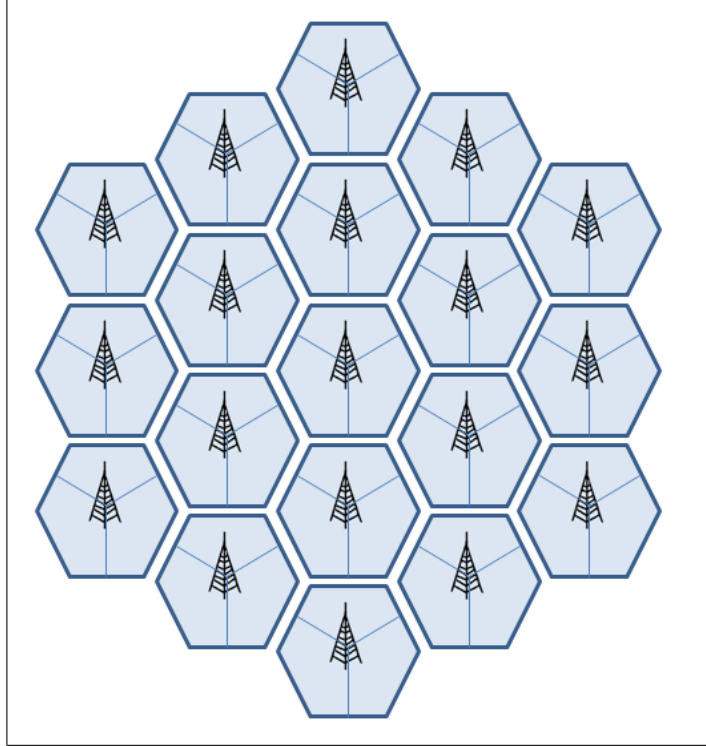

Figure 1.1: *Homogeneous hexagonal-grid macro cells network.*

association and interference management. Afterward, we will describe the problem addressed in this work and summarize the thesis contributions.

## 1.1 Overview

Current cellular networks are typically deployed as homogeneous networks, i.e., a set of identical Base Stations (**BS**) called macro BSs, having similar characteristics, such as transmit power levels, backhaul capacities, antenna patterns, etc. These networks use a macro-centric planning process and the cell sites are placed in a regular pattern over an area as shown in Figure. 1.1.

Such homogeneous networks are also called “macro-only” networks, as only macro cells are present in the deployment [18]. The base stations are carefully configured to maximize the coverage, mitigate the interference with other BSs, and ensure a roughly equivalent number of users connected to each cell.

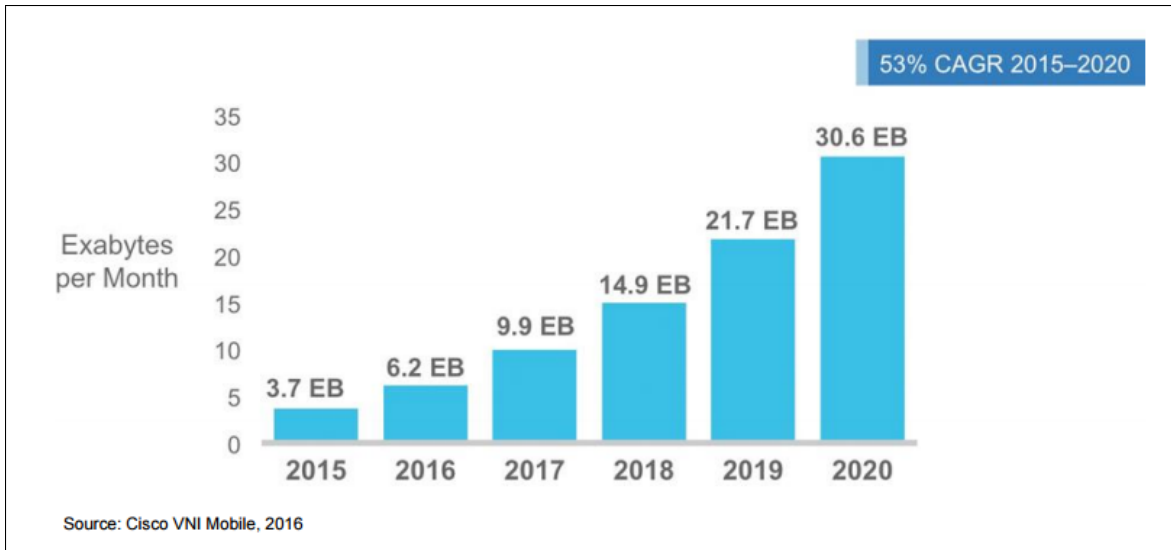

Figure 1.2: *Mobile data traffic growth 2015-2020.*

Yet, one of the most significant technology challenges operators face today is coping with the data consumption deluge. According to the Cisco Visual Networking Index (VNI) in 2016, [21] mobile data traffic has grown 4,000-fold over the past 10 years and almost 400-million-fold over the past 15 years. It grew an estimated 74 percent in 2015 and is expected to grow to 30.6 exabytes per month by 2020, an eightfold increase over 2015. Mobile data traffic will grow at a Compound Annual Growth Rate (CAGR) of 53 percent from 2015 to 2020, as shown in Figure. 1.2.

One of the primary contributors to global mobile traffic growth is the increasing number of wireless connected devices. In 2015, more than half a billion (563 million) mobile devices and connections were added. Global mobile devices and connections grew to 7.9 billion in 2015, up from 7.3 billion in 2014 and are expected to grow to 11.6 billion by 2020 at a CAGR of 8 percent as shown in Figure. 1.3.

Till the past few years, homogeneous LTE cellular networks managed to optimize the coverage and to handle the data traffic generated by users. The performance of LTE networks has been improved in terms of data throughput and latency, thanks to advancements in the air interface, using multi-antenna techniques and implementing more efficient modulation and coding schemes. However, because of the exponential

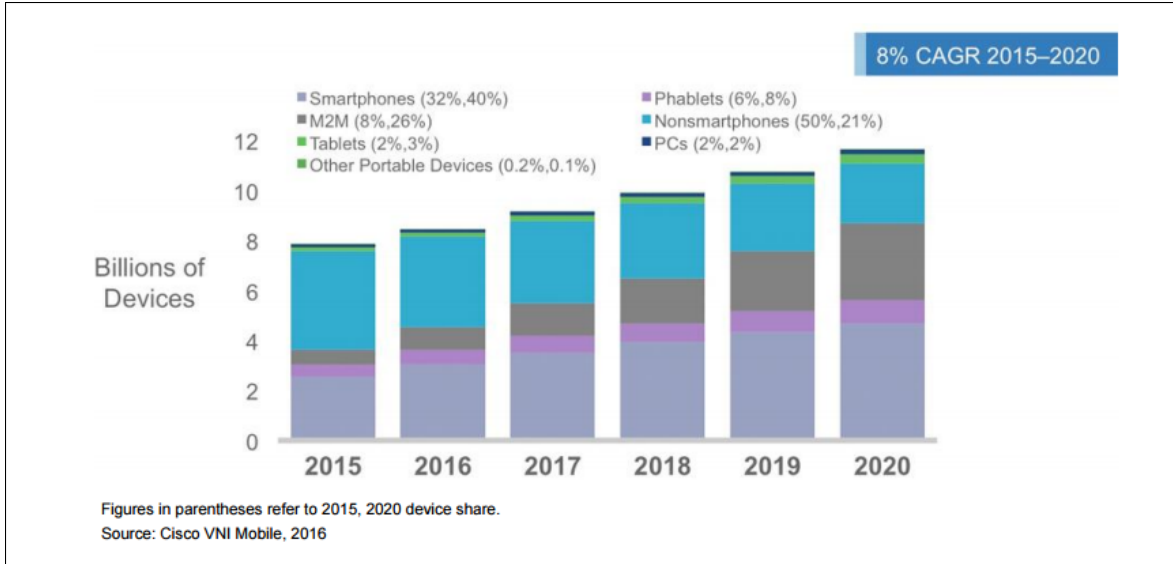

Figure 1.3: *Global mobile devices and connections growth 2015-2020.*

increase in the number of connected devices, the rapid growth of data traffic and the demand for higher data rates, homogeneous **LTE** cellular networks have been facing great difficulty to handle the data amount, especially in the most crowded environments and at cell edges. These limitations are related to the available spectrum and network capacity bound.

Claude Shannon showed that the capacity of any channel can be defined as the maximum rate at which information can be transmitted over the channel [14]. This theoretical maximum hasn't been yet achieved, and, moreover, there are many methods to increase such capacity. How actual cellular networks can be optimized to get closer to that theoretical maximum channel capacity?

The first element to increase channel capacity is bandwidth. We can either use new frequency bands, or develop new ways to make better use of existing spectrum. As spectrum is scarce; the acquisition of licensed bands is an expensive technique, at least for now. Network operators prefer to use the available licensed spectrum more efficiently. The **LTE** Release 10 standard specifies procedures for implementing carrier aggregation, so that operators can use non-adjacent frequency band in the



spectrum. But this aggregation does not come without a cost.

Another approach consists in enhancing macro network layer efficiency through some technology upgrades [67]. For instance, the spatial dimension can be exploited using a multiple input multiple output (MIMO) system. Such implementation increases the number of antennas of the base station and the terminal, and as such, requires more signal processing than in a single-antenna configuration. Operators can also rely on smart scheduling to assign spectrum blocks to users every millisecond, or on enhanced Coordinated Multi Point (eCoMP), which permits to transmit data to a mobile device from multiple cells at the same time.

Cell size is another factor that affects the number of users connected to one base station. One of the most well-known capacity-enhancing strategies is the use of smaller cells. This permits to increase frequency reuse, also known as cell-splitting gain. The macrocell network can also be densified by adding more sectors per macro site or by deploying more BSs. However, it becomes more difficult and expensive to find new macro sites.

Based on cell densification, heterogeneous cellular networks have been proposed in 3rd Generation Partnership Project (3GPP) LTE/LTE-Advanced (LTE-A) to cope with the limited amount of spectrum. Generally, in homogeneous networks, the deployment of macro BSs is planned in a way that minimizes overlapping cells and at the same time guarantees a continuous coverage for all users in the network. HetNets fundamentally change this notion by overlaying existing homogeneous LTE networks, commonly called macro layer, with additional smaller power low-complexity base stations while keeping infrastructure cost low.

The emergence of HetNets gives rise to two challenging network management problems, i.e. user-cell association and inter-cell interference management. How to ensure that small cells actually serve enough users? What is the best user attachment policy? How to mitigate inter-cell interference, especially at cell edge? And what is

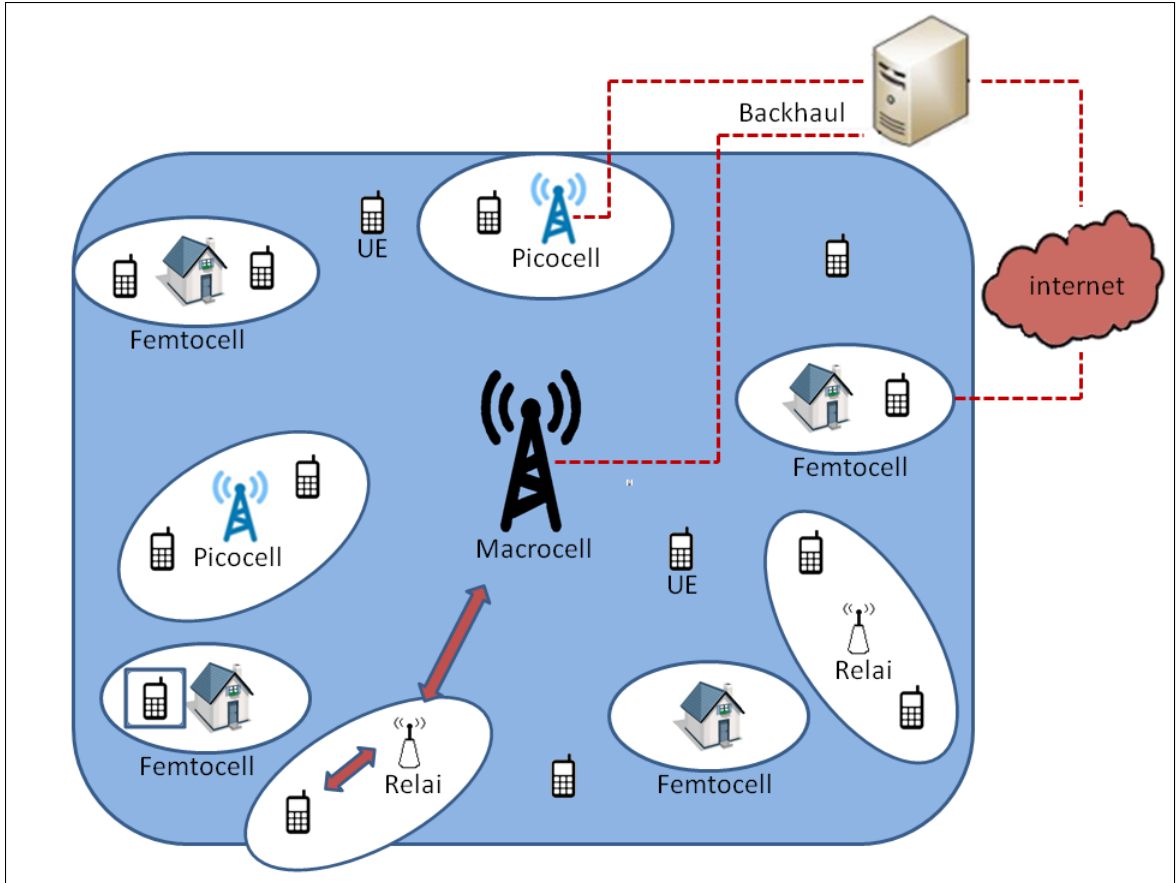

Figure 1.4: *HetNets deployment with a mix of macro, pico, femto and relay base stations.*

the best manner to distribute the available resources to connected users?

There is clearly a complex interplay between the different decisions an operator needs to take to achieve optimal user association, resource allocation and interference management. In the next section, we discuss these schemes in more detail.

## 1.2 Motivations

### 1.2.1 HetNets Overview

At a high level, **HetNets** represent a strategic evolution of the mobile access network to augment macrocell capacity in a cost effective way. This cellular system consists of planned deployment of macro base stations that typically transmit at high

power level ( 5W - 40W), overlaid with several types of small base stations, which transmit at substantially lower power levels ( 100mW - 2W). Since coverage is already provided by macro BSs, small cells are often deployed in densely populated areas to boost the capacity of LTE network or to fill in coverage holes. Due to their lower transmit power and smaller physical size, these small base stations can offer flexible site acquisitions and substantially reduces the network operational and capital expenditures. As illustrated in Fig. 1.4, among the different types of small cells we can cite:

- Femtocell, also known as home BSs or home eNodeB (eNB)s: initially intended for home use, but also used in businesses, and in rural and metropolitan areas. Its range is less than 50 m and its transmit power is less than 23 dBm.
- Picocell: intended for businesses and public indoor areas and sometimes used in outdoor settings as well. It usually serves a few tens of users within a range of 300 m, and has a typical transmit power range from 23 to 30.
- Relay: connects to the rest of the network and routes data from macro cell. It has a transmit power ranging from 23 to 33 dBm for outdoor deployment, and 20 dBm or less for indoor deployment.

**HetNets** are considered as the most promising approach to improve network capacity and to increase coverage. But how do small cells actually enhance the network overall performance?

The channel capacity of a cellular network can be defined as the achievable spectral efficiency expressed in bits/s/Hz. In a co-channel deployment, small cells use the same time-frequency resources as the macro cells. As the lower power nodes are placed on top the macro cells layer, the spatial reuse of the time-frequency resources is highly increased which results in higher network capacity. In this case, we talk about area spectral efficiency.

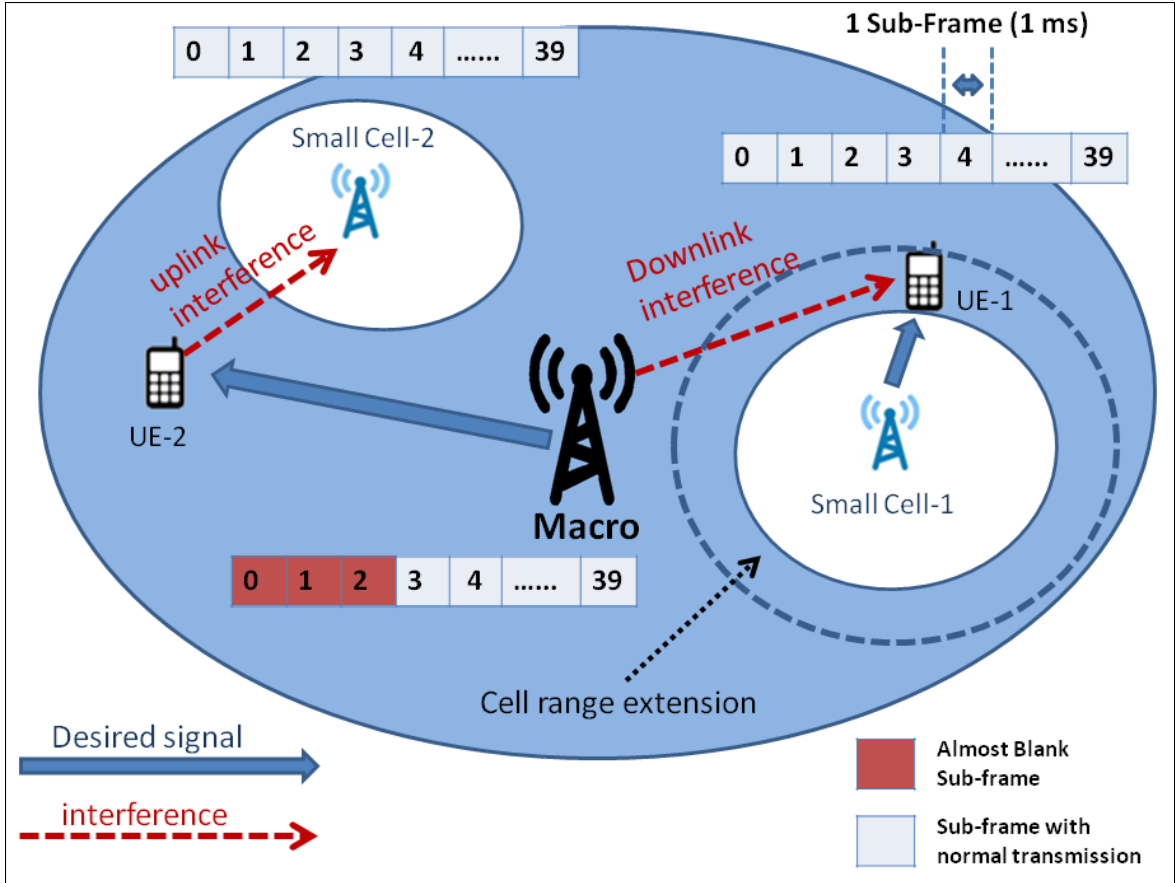

Figure 1.5: *Cell Range Extension and Almost Blank Sub-frames.*

The densification of the network results in reducing the average distances between a user and the nearest BS and thus decreasing the pathloss experienced by the transmitted signal and improving the link gain and the capacity of the channel.

Furthermore, the use of lower power base stations permits to reduce inter-cell interference and carbon footprint of mobile communications in the network.

An additional benefit of small cell deployments is that it allows offloading some users from macro to small cells, balancing the traffic load and also increasing the overall network throughput and efficiency.

### 1.2.2 HetNets Challenges

While considered as the most attractive way to improve the network capacity, **HetNets** are facing two main challenges. The first one is user association which consists in a policy to assign the mobiles to different base stations in the network. Attaching a user to a certain **BS** will not only impact the throughput of that user but also the overall throughput.

In traditional cellular networks with frequency reuse equal to 1 (reuse-1), users usually associate with the E-UTRAN Node B (**eNodeB**) that provides the strongest received signal. The measure of signal strength depends essentially on the transmission power of the cell and the pathloss encountered. In homogeneous cellular networks where the **BSs** have similar transmission power, the user association is determined by the pathloss, i.e., mainly by the user-**BS** distance. In **HetNets**, with high-power nodes in the macro cells (e.g., 40 Watts) and low-power nodes in the small cells (e.g., 1 Watt), only few users would attach to these small cells. It could happen that a user, which is closer to a **SC** and has a low pathloss, compared to that with a **MC**, has a stronger signal strength from the **MC** as the latter transmits with a larger power. And thus this user would attach to the **MC**, instead of the closer **SC**. Attaching to the **eNB** with the strongest signal in such cases is often sub-optimal or even negative to the system performance since we may under-utilize the small cells. Small cells, with low transmission power and small coverage areas, may be lightly loaded compared to macro cells.

This first challenge faced by the **HetNets** can be tackled with an intelligent users' association policy that is more adapted to this new architecture. To address this problem, one can systematically expand the area served by the small cell. This mechanism, shown in Fig. 1.5 is called Cell Range Extension (**CRE**). To offload **MCs** and associate more users with **SCs**, a Cell Individual Offset is added to the users' **RSRP** measurements. This would enforce some User Equipment (**UE**)s, especially those in

SC edge, to associate with their nearest SC instead of the MC, inducing a better load balancing in the network. One question that we will address in this work is the optimization of CIO values and the user association.

Although the CRE significantly mitigates interference in the Uplink (UL), the downlink (DL) signal quality of UEs located in the range expanded area decreases. Such UEs may suffer from downlink Signal-to-Interference-plus-Noise Ratio (SINR) below 0 dB because they are connected to cells that do not have the best downlink RSRP.

The second challenge facing HetNets is to mitigate the interference in order to enhance the SINR.

Note that in an Orthogonal Frequency Division Multiplexing (OFDM) system, the whole bandwidth is divided into physical Resource Block (RB)s in frequency sub-carrier and time slot that are orthogonal to each other. Thus, the intra-cell interference is negligible. However, inter-cell interference is usually severe due to the practice of reuse-1 cellular networks [82]. It could happen that neighboring macro and small cells use the same resource blocks and result in high inter-cell interference, which is even more severe to cell edge users. Reducing inter-cell interference is necessary. Note that employing cell range extension in HetNets could also generate higher inter-cell interference, especially for the users that change their attachment from macro to small cells. Figure 1.5 illustrates this scenario. UE-1 which is located at the SC-1 border and attached to this eNB when CRE is applied, experiences high interference from the macro.

It is vital to ensure that the reuse of the spectrum does not lead to high interference scenarios in LTE networks. To mitigate the inter-cell interference, 3GPP LTE standard has introduced Inter-Cell Interference Coordination (ICIC) and enhanced Inter-Cell Interference Coordination (eICIC) methods at Release 8 and Release 10 specifications, respectively. They are provided to address interference issues in HetNets and mitigate interference on data traffic and control channels. Generally, the

**ICIC** techniques are limited to the frequency and/or power domain, for example splitting the frequency bandwidth into parts for adjacent cells or having their transmissions with different power levels. In addition, **eICIC** focuses on time domain solution through Almost Blank Sub-frames (**ABS**). This technique, shown in Figure 1.5, aims to mute a cell during specific time slots so that its neighboring cells could transmit under minimal interference.

As one can understand, users' association and interference mitigation are closely related since the available resources for each cell should be in relation with the amount of users actually attached to the cell and their actual traffic demand. Better cell selection strategies and more advanced techniques for efficient interference management and resource coordination can improve the average user throughput and support high spatial reuse in **LTE** networks. Substantial gains can be achieved in cell edge throughput and the energy consumption.

A detailed explanation and a literature study of user association and interference management are given in the next chapter.

## **1.3 Contributions & Outline**

### **1.3.1 Contributions**

In this thesis, starting from a powerful mathematical approach based on game theory, we set up a flexible framework that supports the joint optimization of user association, inter-cell interference management and radio resource sharing in **LTE** cellular networks for enhancing an overall network utility. Our work is based on a two-tier model that permits the separation of some control decisions among the eNodeBs and the coordinator. The latter receives periodically, updated measurements from the eNBs. Then, it performs a global optimization to select the best **CIOs** for user association, to coordinate the allocation of subset of frequency and time

resources to the eNBs, and to adjust the transmission power on each resource. This optimization is based on an iterative algorithm and considering the state of the whole network, it results in the best CIOs, frequency and power settings for each cell. These values are then sent to the eNBs and to be used by their LTE local schedulers for transmissions. Coordinating the transmission power and frequency reuse across cells allows limiting the interference experienced by mobile users and improving the average throughput and also at cell edge. It could also yield higher energy efficiency. The proposed framework supports centralized or distributed architecture and different utility functions depending on the operator optimization strategy.

The contributions of this work are listed below:

- we formulate the joint optimization problem of user association and inter-cell interference management and describe certain relevant sub-problems, such as ABS or CIO optimization.
- We model the problem as a non-cooperative game where the players are the base stations and prove that it is a potential game.
- We present a dynamic solution of user association and inter-cell interference coordination optimizing Cell Individual Offsets and transmission power over time and frequency domains in order to maximize a certain network utility.
- We provide an analytical investigation of the algorithm and comprehensive performance study. Simulation results have shown significant improvement in the user throughputs and also energy efficiency.
- We develop a prototype of the optimizer to demonstrate the feasibility and performance of the approach. Connected to a logically centralized Software Defined Networking (SDN) controller, the optimizer has a global view of the network and delivers optimal settings.



### 1.3.2 List of Publications

#### *International Conferences*

1. Trabelsi, N., L. Roullet and A. Feki (2014), A Generic Framework for Dynamic eICIC Optimization in LTE Heterogeneous Networks, in *Vehicular Technology Conference VTC 2014-Fall*, pp. 1-6, IEEE.
2. Trabelsi, N., C. S. Chen, L. Roullet, E. Altman and R. El Azouzi(2016), Co-ordinated scheduling via frequency and power allocation optimization in LTE cellular networks, in *IEEE/IFIP Network Operations and Management Symposium (NOMS)*, pp. 44-51, IEEE.
3. Gopalasingham, A., L. Roullet, N. Trabelsi, C. S. Chen, A. Hebbbar, É. Bizouarn (2016), Generalized software defined network platform for Radio Access Networks, in *IEEE Annual Consumer Communications & Networking Conference (CCNC)*, pp. 626-629, IEEE.

#### *Submitted to an International Journal*

1. Trabelsi, N., C. S. Chen, R. El Azouzi, L. Roullet and E. Altman, User Association and Resource Allocation Optimization in LTE Cellular Networks

### 1.3.3 Outline

The rest of the thesis is organized as follows. Chapter. **II** presents an overview of the related works. In Chapter. **III**, we define the system model and formulate a user association and interference management problem. We describe the proposed solution, based on game theory, and its technical implementation in Chapter. **IV**. In Chapter. **V**, we present the simulation settings and show the numerical results by comparing different configurations. A detailed description of the framework prototype is also provided. Finally, Chapter. **VI** draws the conclusion and highlights some potential future work.

## CHAPTER II

# Fundamental Concepts and State of the Art

### 2.1 Introduction

User association and inter-cell interference management are well known problems in the area of cellular networking with a direct impact on each other.

Associating a user with a specific base station will affect not only the throughput of that user but also the throughput of all the users associated to the neighboring base stations. Conventionally, **UEs** are attached to the BS providing the best **SINR**. In **HetNets**, however, the BSs can have large differences in power transmission, so a max-**SINR** user-cell association leads to lightly loaded small cells compared to macro cells. This results in an inefficient use of available resources, and strongly motivates intelligent user association (also known as cell selection) policy.

In order to satisfy the constantly expanding capacity demands of mobile applications, homogeneous and heterogeneous cellular networks usually use all the frequency bands to achieve high spectral efficiencies, which leads to strong inter-cell interference, especially for the users in the border of the cell. Cellular networks should be able to provide efficient and flexible interference management schemes among the different cells in the system. It is then necessary to have a good understanding of interference management and user association in **LTE** cellular networks and to study the interplay between these mechanisms.

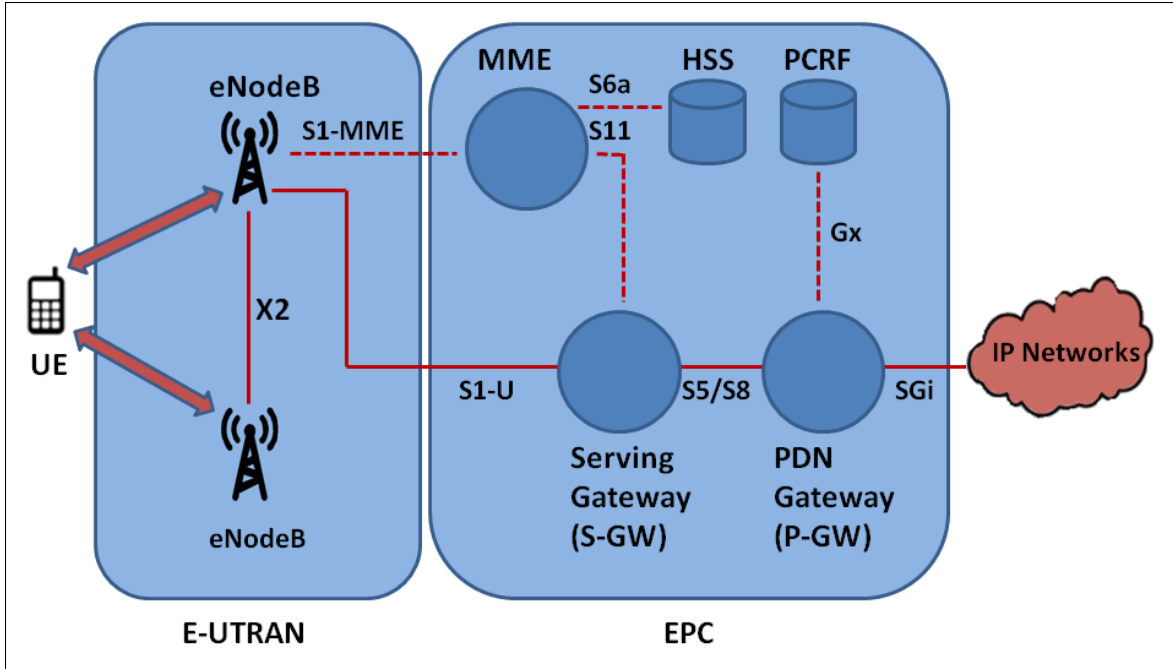

Figure 2.1: *Simplified LTE network architecture.*

In this chapter, first, we introduce the **LTE** cellular networks using Orthogonal Frequency Division Multiple Access (**OFDMA**) as an access technology. Then an overview of fundamental concepts and state of the art for interference management and user association in both homogeneous and heterogeneous cellular networks is provided. Finally we present the Software Defined Wireless Network (**SDWN**) architecture and explain how this new paradigm can handle the major growth in data traffic.

## 2.2 LTE & OFDMA Overview

### 2.2.1 LTE Overview

Due to the fast increase of mobile traffic and the emergence of new applications, the **3GPP** started to work on the Long-Term Evolution on the road to 4th Generation mobile. The first version of **LTE** was documented in the **3GPP** Release 8. **LTE-A** was approved by the International Telecommunication Union (**ITU**) as a 4G technology

and documented on the release 10. The main objective of **LTE** is to provide high quality of service and data rates to all the users and to support flexible bandwidth deployments and packet-switched traffic.

**LTE** has a flat, all-IP architecture with separation of control plane and user plane traffic. As shown in Figure. 2.1, the main components of **LTE** networks are:

- **User Equipment (UE)**: is any device used by an end-user to communicate and connected to the **LTE** network via Radio Frequency (**RF**) channel. **UE** handles different tasks, such as call control and identity management. Furthermore, **UE** detects and monitors the presence of multiple cells to associate to the best cell. It measures essentially **RSRP** and Channel Quality Indicator (**CQI**).
- **Evolved UMTS Terrestrial Radio Access Network (E-UTRAN)**: is responsible for all radio-related functions which include: (i) Radio Resource Management (**RRM**) for both **UL** and **DL** like scheduling, dynamic resource allocation, radio admission and mobility control, (ii) IP header compression, (iii) data encryption and (iv) connectivity to the Evolved Packet Core (**EPC**). The E-UTRAN has just one component: the evolved base stations, called eNodeB or eNB. It sends and receives radio transmissions to all the mobiles using the functions of the **LTE** air interface. The eNBs are inter-connected via the X2 interface and communicate with the core by means of the S1 interface.
- **The Evolved Packet Core**: composed by different entities: the Mobility Management Entity (**MME**), the Serving Gateway (**S-GW**), the Packet Data Network Gateway (**P-GW**), the Home Subscriber Server (**HSS**) and the Policy Control and Charging Rules Function (**PCRF**). The EPC is connected to the outside world such as the internet or the IP multimedia subsystem.

**LTE** uses **OFDM** and **OFDMA** as modulation scheme and multiple access technology respectively [23]. In the next section, an overview of **OFDM/OFDMA** is given.

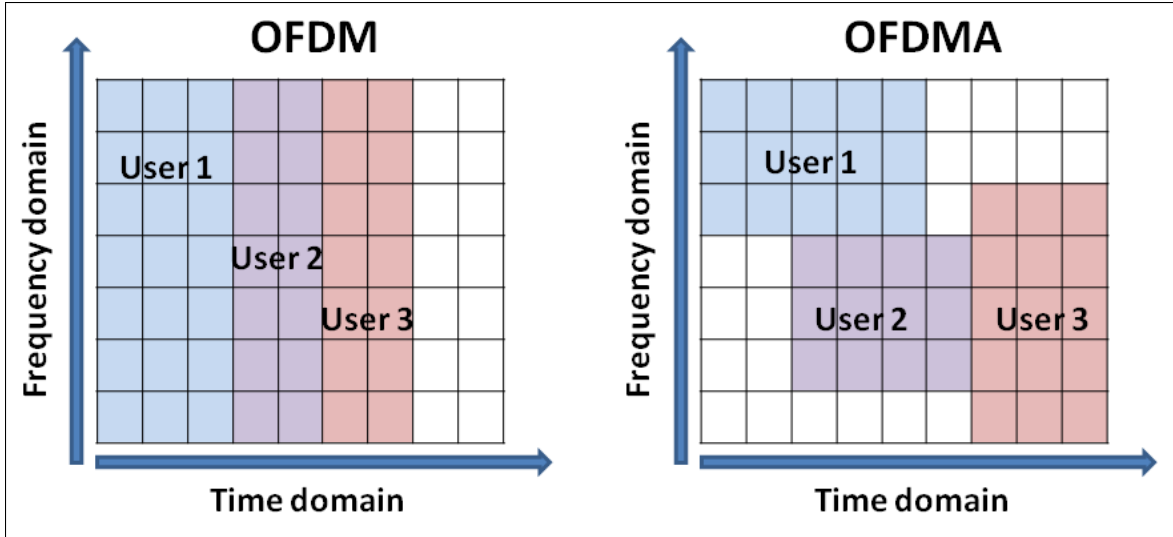

Figure 2.2: *OFDM vs OFDMA*.

### 2.2.2 OFDM/OFDMA overview

The **LTE** physical layer (**PHY**) is a highly efficient means of carrying both data and control information between an eNodeB and a **UE**. It employs some advanced technologies such **OFDM**, as the signal bearer and the associated access schemes, **OFDMA** for the **DL** and Single Carrier Frequency Division Multiple Access (**SC-FDMA**) for the **UL**.

For **LTE**, **OFDM** splits the carrier frequency bandwidth into many narrower sub-carriers spaced at 15 kHz. The spacing is such that the sub-carriers are orthogonal to each other, so they won't interfere with one another despite the lack of guard bands between them. The use of orthogonal sub-carriers avoids intra-cell interference and allows more sub-carriers per bandwidth resulting in an increase in spectral efficiency.

**OFDMA** uses **OFDM**; however, it is the scheduling and power assignment to the resources that makes **OFDMA** distinctive. The **OFDM** diagram in Figure. 2.2 shows that only a single user can transmit on all of the sub-carriers at any given time. In the **OFDMA** diagram, multiple users share the bandwidth at each point in time. This is valuable for **LTE** since **OFDMA** exploits the multi-user diversity and makes conceivable to dynamically assign the best non-fading and low interference channels

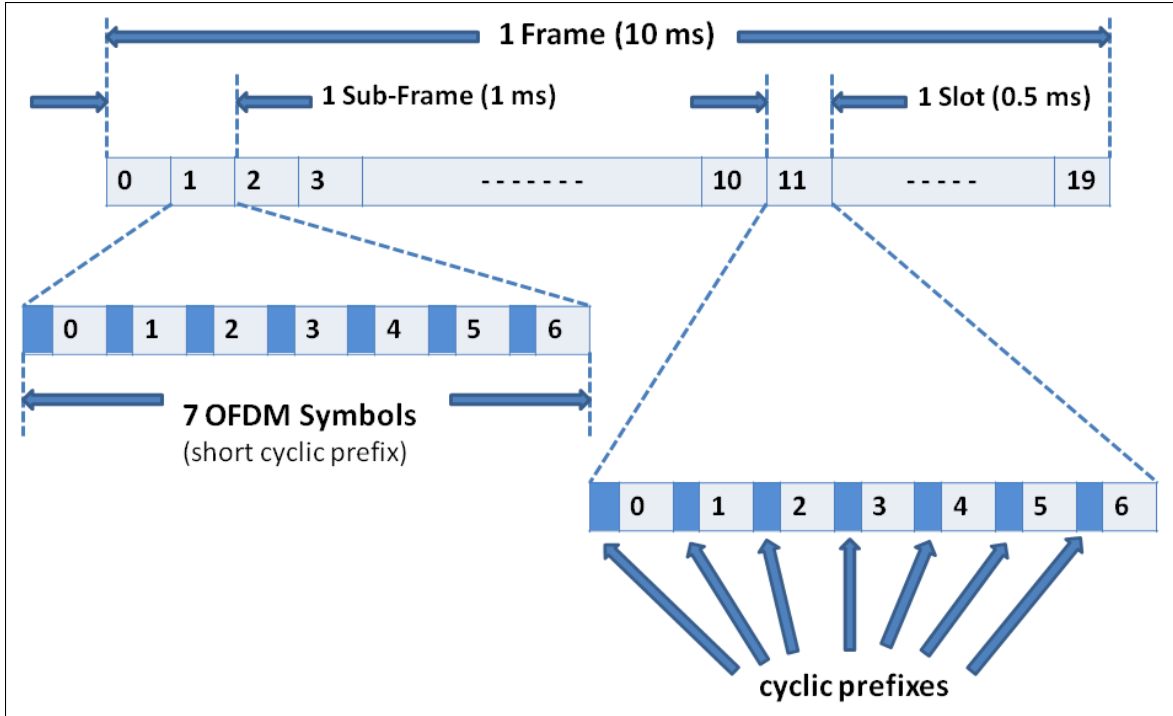

Figure 2.3: *LTE generic frame structure.*

for a particular user and avoid bad sub-carriers.

Although it involves added complexity, **OFDMA** is an excellent choice of multiplexing scheme for the **DL** in **LTE**, as it improves efficiency and latency. In **OFDMA**, users are allocated a specific number of subcarriers for a predetermined amount of time. These are referred to as resource blocks. RBs thus have both a time and frequency dimension. The more resource blocks a user gets, the higher the bit-rate. Advanced scheduling mechanisms determine which RBs and how many the user gets at a given point in time.

In order to adequately explain **OFDMA** within the context of the **LTE**, we must study its generic frame structure. As shown in Figure. 2.3, **LTE** frames are 10 millisecond (**ms**) in duration and are divided into 10 sub-frames. Each sub-frame is 1 ms long and is also divided into 2 slots, each of 0.5 ms duration. Slots consist of either 6 or 7 **OFDM** symbols depending on the **Cyclic Prefix (CP)** in use. When a normal CP is used, one slot contains 7 symbols. When an extended CP is used, it

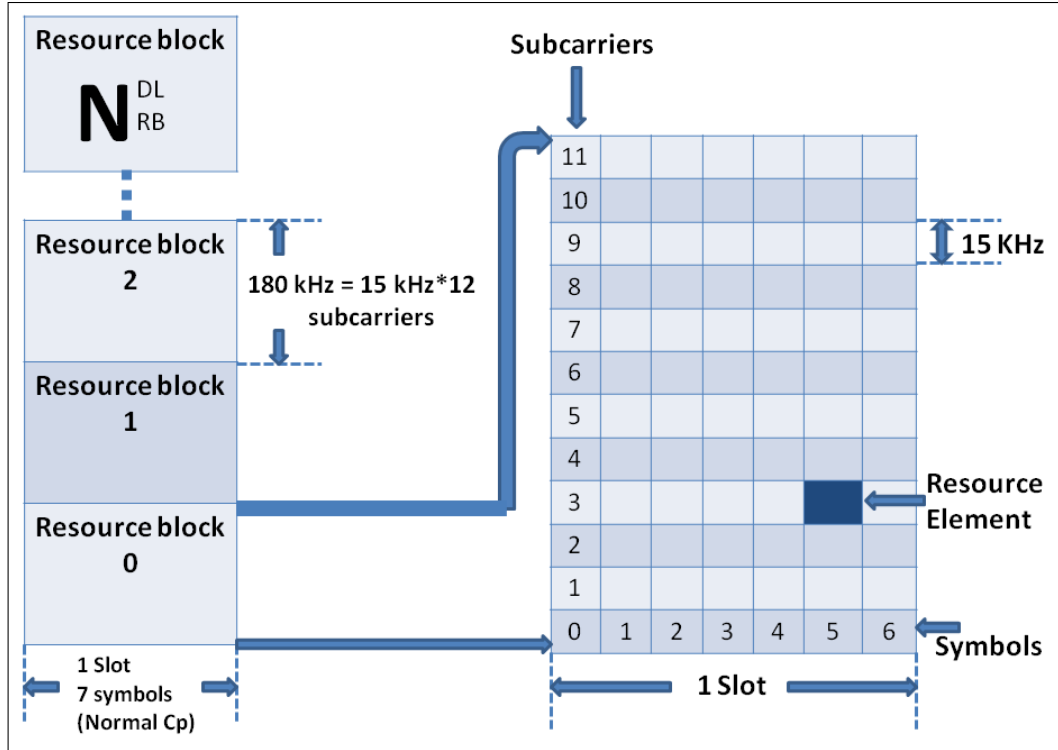

Figure 2.4: Resource Block structure.

Bandwidth (MHz)	1.25	2.5	5	10	15	20
Subcarrier bandwidth (kHz)	15					
Resource Block bandwidth (kHz)	180					
Number of available RBs	6	12	25	50	75	100

Table 2.1: Available RBs.

contains 6 symbols. The smallest modulation structure in LTE is the Resource Element which is one 15 kHz subcarrier by one symbol. The smallest element of resource allocation is the RB which consists of 12 consecutive subcarriers in the frequency domain for 1 slot in the time domain (Figure. 2.4). The total number of available subcarriers depends on the overall transmission bandwidth of the network. The LTE specifications define parameters for bandwidths from 1.25 MHz to 20 MHz as shown in Table 2.1.

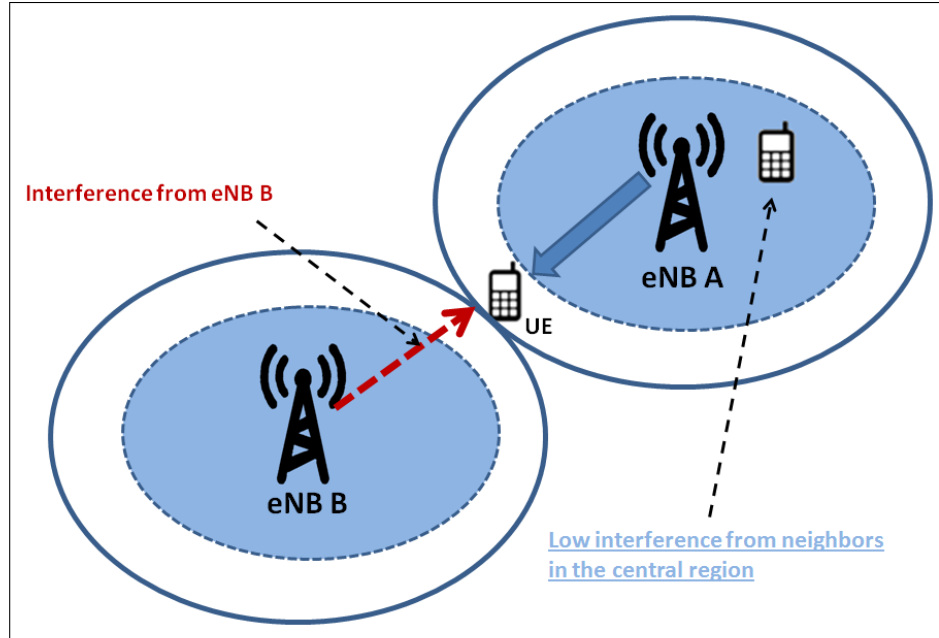

Figure 2.5: *Interference scenario.*

## 2.3 Interference Management

By orthogonal allocation of the **OFDMA** sub-carriers, intra-cell interference can be avoided. However, inter-cell interference presents a great challenge that limits the network performance, especially for users located at the cell edge. As **LTE** is originally designed to reuse the same frequency among all the cells, there is a high probability that a resource block scheduled to cell edge user, is also being transmitted by neighbor cell, resulting in high interference and eventually low throughput (see Figure. 2.5).

### 2.3.1 Inter-Cell Interference Coordination (ICIC)

As illustrated in Figure. 2.6, inter-cell interference can be seen as a collision between resource blocks [16]. **ICIC** mechanisms aim to reduce the collision probabilities and to mitigate the **SINR** degradation caused by the collisions in order to improve the overall network performance.

**ICIC** was introduced by the **3GPP** in Release 8. Several **ICIC** techniques have been proposed in the literature. [38] and [102] survey various **ICIC** schemes used to



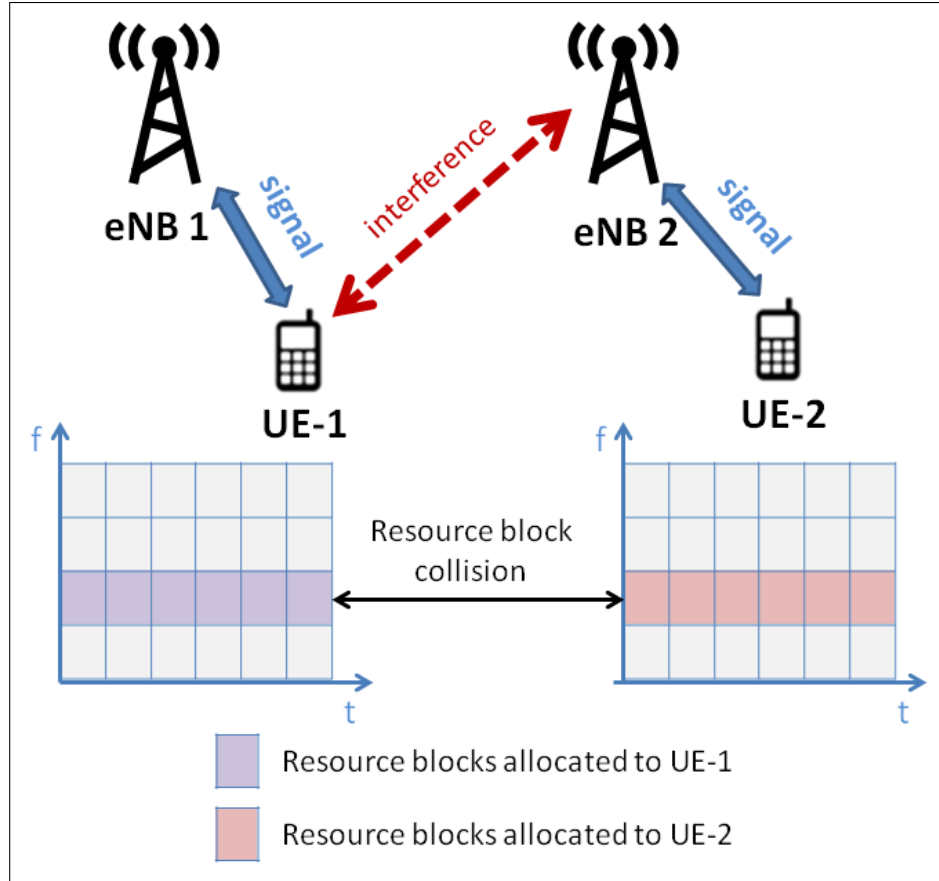

Figure 2.6: *Resource Block collision.*

mitigate inter-cell interference in **LTE** networks. Due to the large number of published papers treating **ICIC**, there have been several attempts to categorize **ICIC** schemes. Authors of [38] and [30] classified them according to cell cooperation and frequency reuse patterns. According to [4], there are 3 principal inter-cell interference mitigation techniques: cancellation, randomization, and avoidance. The **3GPP** recommended these following schemes [6]:

- *Interference randomization*: to randomize the interference and achieve frequency diversity using cell specific scrambling, interleaving or spreading spectrum techniques. Thus, the cell edge users will not always suffer strong **ICI** during the entire transmission period [6].
- *Interference cancellation*: based on spatial filtering, to estimate and subtract the

interference from the received signal. If the **UE** has multiple receiver antennas, it can select the best quality signal among the various received signals.

- *Adaptive beamforming*: to change antenna radiation pattern depending on the interference levels. The signals are combined in a manner which increases the signal strength to/from a chosen direction.
- *Interference avoidance/coordination*: controls the resource allocation by coordination between network entities. Interference avoidance schemes are mostly limited to the frequency/power domain where there is a partial use of frequency resources or adaptation of power levels. Figure. 2.7 depicts the various types of interference avoidance schemes [38]: static **ICIC** (Frequency reuse-based schemes) and dynamic **ICIC** (Cell coordinated-based schemes).

### 2.3.1.1 Static ICIC: Frequency Reuse-Based Schemes

Frequency reuse-based schemes include: conventional frequency reuse and fractional frequency reuse schemes. All these schemes need to specify: (i) the set sub-bands to be used in each cell, (ii) the transmission power of each channel, and (iii) the region of the cell in which this set of channels are used .

- **Conventional Frequency Reuse** [60]: We focus on 2 well known schemes in this category: Reuse Frequency 1 (**RF1**) and Reuse Frequency 3 (**RF3**). In the first scheme, shown in Figure 2.8, all the bandwidth can be reused in each cell in the system without any restrictions on power allocation or frequency resource usage. RF1 permits to achieve a high network capacity. However, **ICI** increases and the overall spectral efficiency degrade. In reuse factor of 3, shown in Figure 2.9, the total bandwidth is divided into 3 equal sub-bands which are allocated to cells in such a way that adjacent cells use different frequencies. This scheme leads to lower **ICI**. However, as each cell only uses  $\frac{1}{3}$  of available

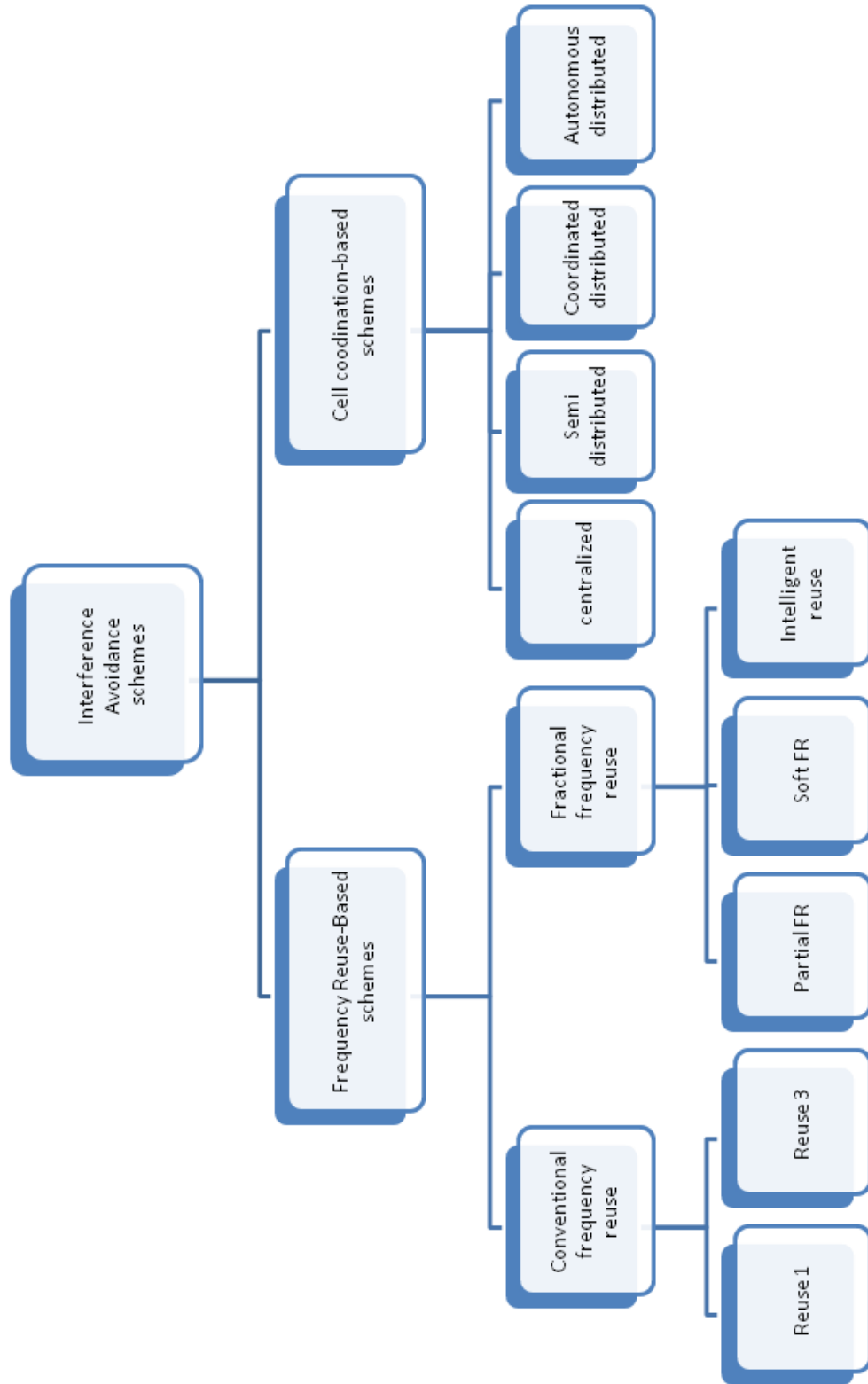

Figure 2.7: *Interference avoidance schemes.*

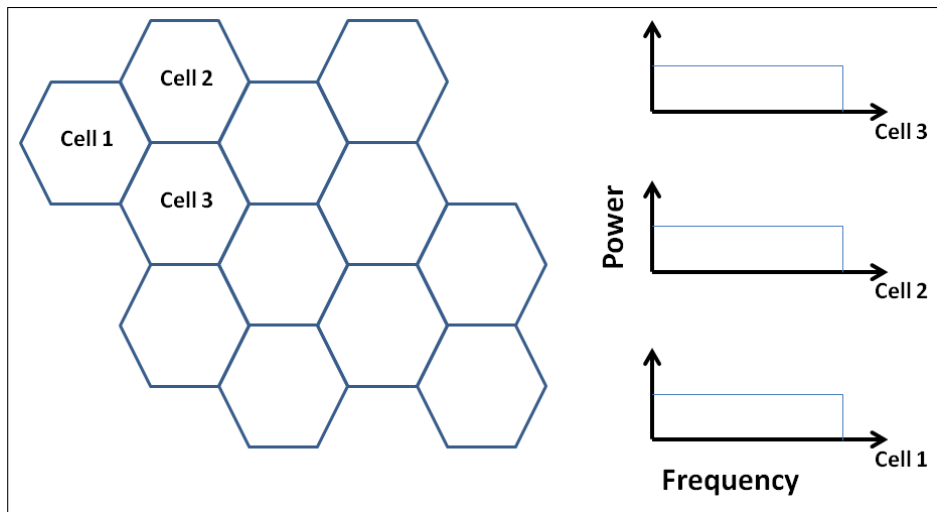

Figure 2.8: *Frequency Reuse 1.*

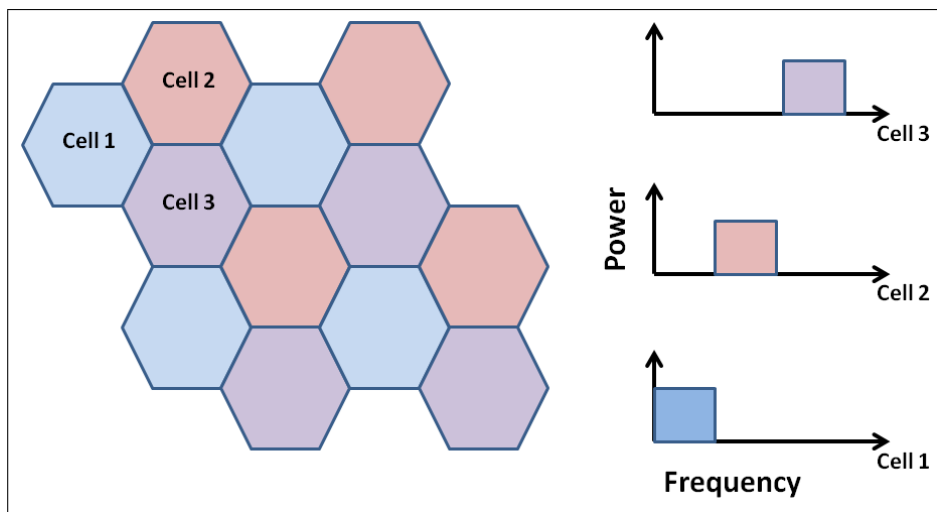

Figure 2.9: *Frequency Reuse 3.*

bandwidth, there is a large capacity loss. The higher the cluster size, the greater the reduction in inter-cell interference is. However, this also generally leads to a reduction in cell throughput as we underutilize the available resources.

- **Partial Frequency Reuse (PFR)**: a part of the fractional frequency reuse scheme. The idea of PFR was first presented in [88], then it has been studied in the 3GPP and WINNER projects (see, [3], [4] and [10]). In PFR scheme, shown in Figure 2.10, we use the same frequency subset with equal power in

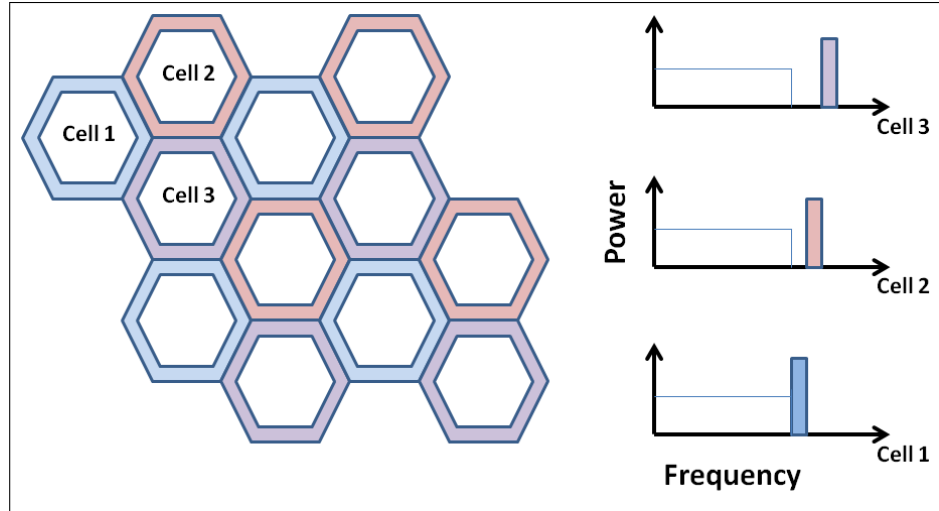

Figure 2.10: *Partial Frequency Reuse - PFR.*

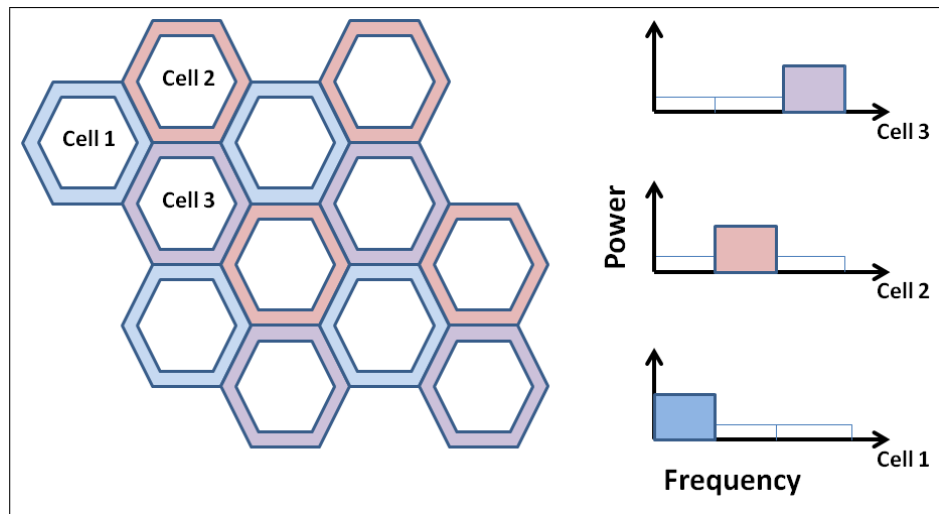

Figure 2.11: *Soft Frequency Reuse - PFR.*

all the cell center regions. Cell edge **UEs** are allocated in the complementary frequency subset using a reuse factor of 3. As PFR does not employ the whole available bandwidth, it leads to lower cell throughput compared with reuse 1 scheme.

- **Soft Frequency Reuse (SFR)**: initially proposed in [1] and [2]. In SFR (shown in Figure 2.11), each cell uses the total available bandwidth. Cell edge users are allocated in the subset of bandwidth with highest power level and

cell centre users are allocated with lower power in the rest of the frequency band. **RF1** is used in the cell centre region and reuse factor greater than one is employed at the cell edge regions.

Although such frequency reuse-based schemes can be easily implemented, they can not cope with changes in data traffic. These shortcomings of static schemes are addressed by dynamic **ICIC** schemes as they do not require prior frequency planning.

### 2.3.1.2 Dynamic ICIC:Cell Coordination-Based Schemes

Cell coordination schemes are considered as an efficient solution to cope with the continuous dynamic traffic load changes in the system. To efficiently manage the resource allocation and reduce the **ICI**, these schemes operate based on dynamic interference information from neighboring cells. Coordination-based schemes can be categorized, based on the level of coordination, into four main categorizes:

- **Centralized:** A central control entity collects the Channel State Information (**CSI**) of all **UEs** in the network, that have been forwarded from their serving eNBs. Then, it allocates the available resources to each cell and each **UE** trying to maximize the overall capacity. These exchanges between the central coordinator and the eNBs may result in high backhaul signaling. Examples of centralized schemes can be found in [15], [24] and [35].
- **Semi-distributed** (e.g., [53], [78], [77]): Coordination is performed at the central entity and at the eNB. First, the controller allocates in each slot of time (for each 10 ms), a subset of resources to each eNB. Then the eNB is responsible to schedule its **UEs** on the frame level using the envelope of allowed resources. In this scheme, it is still required to exchange scheduling information and feedback between the eNBs and the controller. But, as the resource allocation problem is distributed, the computational complexity of the overall scheme is reduced.

- **Coordinated-distributed:** Several Coordinated distributed schemes have been proposed in the literature (e.g., [28], [32], [76], [97], [105]). There is no need of a central entity, as resource allocation is performed only at the eNB level. However, some coordination is still needed between eNBs in order to perform global **ICIC**. The optimization problem is divided into distributed single-cell optimization problems that can be solved by each eNB using local information from its attached **UEs** while exchanging minimal amount of information with neighboring eNBs.

Coordinated distributed schemes permit to reduce network infrastructure complexity and signaling overhead resulted from regular communication between eNBs and the central entity. However, the realization of these schemes remains limited due to constraints on inter-eNB communication and the non negligible latency of the X2 interface.

- **Autonomous-distributed:** In these schemes, there is no need for a central controller, neither for coordination between the **eNBs**. Each **eNB** is responsible for assigning its resources to attached **UEs**, based on their local reported measurements. To efficiently manage the **ICI**, each **eNB** has to individually apply some restrictions on power levels of selected **RBs** with low **SINR**. It is clearly a trade-off between the value of reducing the **ICI** in neighboring cells and the cost of under-utilizing the available spectrum [30]. The key advantage of autonomous schemes is that the scheduling algorithm becomes independent of the latency caused by the X2 interface and adapts faster to the changing traffic conditions. Due to the complexity of autonomous distributed algorithms, there is a limited, but growing, research effort reported in the literature for developing autonomous distributed **ICIC** schemes (e.g., [89], [90], [19], [48], [51]).

### 2.3.2 enhanced ICIC (eICIC)

ICIC techniques are mainly designed for homogeneous networks, and only provide improvements for the physical data channels. In HetNets, where macro cells have much higher transmission power than small cells, control channels of SCs are interfered by those of MCs, making ICIC applied to the data channel ineffective. To support increasing data traffic in mobile networks and to address LTE HetNets challenges, 3GPP Release 10 [5] introduced enhanced ICIC techniques. A comprehensive study of the evolution of interference management techniques from simple ICIC to eICIC is given in [75] and [84]. In [59], the authors present a comprehensive introduction of eICIC in HetNets and [54] provides a survey on different eICIC techniques and a summary of the evolution of LTE standards.

There are three different categories of eICIC solutions: time-domain techniques, power control techniques and frequency-domain techniques. The major change compared to ICIC, is the addition of time domain schemes based on time resource partitioning to limit the interference to small cell edge users. In the following, we only concentrate on the time domain eICIC techniques, which we designate with eICIC.

The basic idea with eICIC is that an aggressor macro eNB creates “protected” sub-frames for a victim small eNB by reducing its power or muting transmission during certain sub-frames, called Almost Blank Sub-frames. During ABS, the aggressor eNodeB does not transmit Physical Downlink Shared Channel (PDSCH) but, for backward compatibility, certain signals must be transmitted in all DL sub-frames even if they should be muted, namely:

- Common Reference Signals (CRS)
- Primary Synchronization Signals (PSS) and Secondary Synchronization Signals (SSS)
- Physical Broadcast Channel (PBCH)



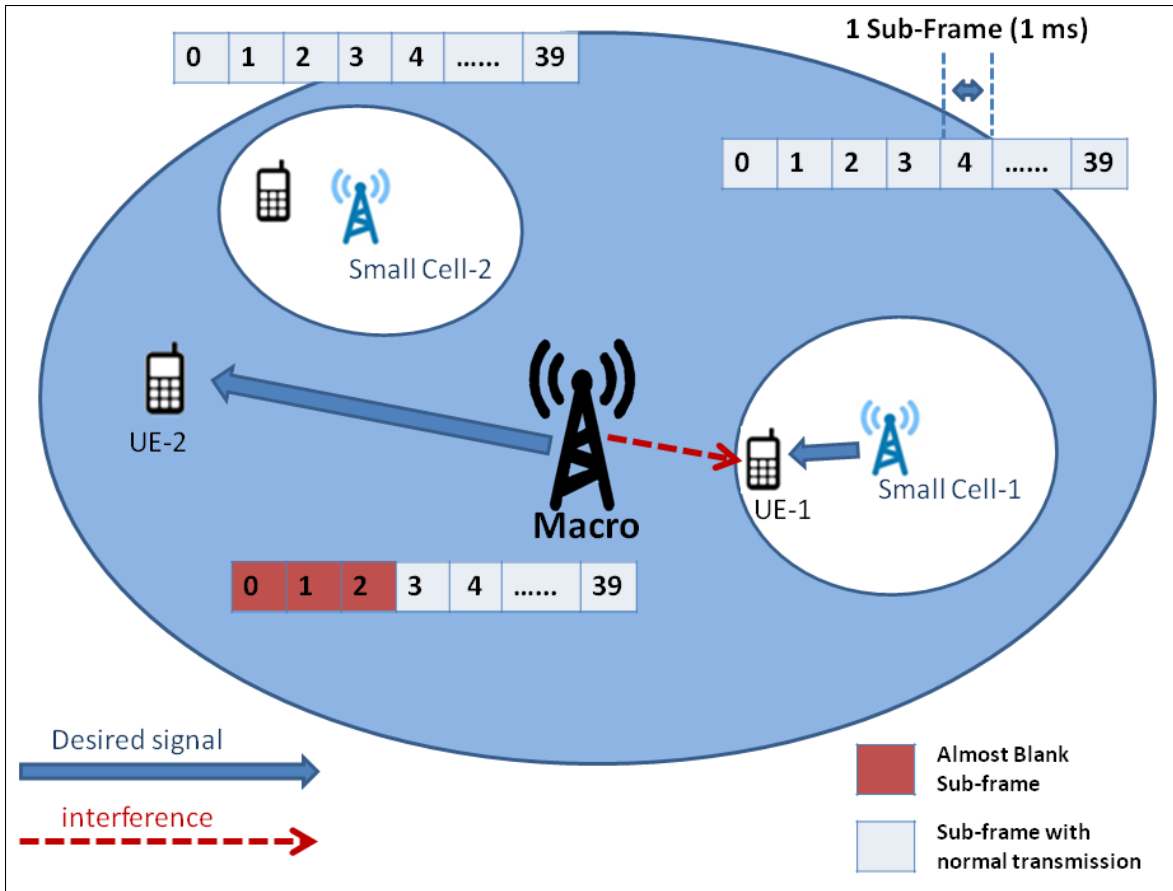

Figure 2.12: *Almost Blank Sub-frames.*

- System Information Block-1 (**SIB-1**) and paging with their associated Physical Downlink Control Channel (**PDCCH**)

Therefore, an **ABS** is characterized by minimum transmission, but not completely null; that is why these sub-frames are called almost blank.

A neighboring **SC** having **UEs** that are interfered by the **MC** will preferentially schedule those **UEs** in the protected sub-frames. Other **UEs** located at the cell center can be scheduled over all sub-frames since the interference experienced from the macro **eNB** aggressor is negligible compared to the signal of the **SC**. **3GPP** specifications define **ABS** in the format of a bitmap pattern of 40 sub-frames lasting 40 ms. The coordinating eNBs exchange these **ABS** patterns via customized Operation Administration and Maintenance (**OAM**) or via X2-interface. In order to enable this,

time-domain **ICIC** requires time-synchronized eNodeB transmissions. The mechanism of **ABS** is illustrated in Figure 2.12. **UE-1**, associated to Small Cell-1 is highly interfered by the macro cell, as it is located in **SC** edge. During each first three sub-frames of the 40 ms pattern, macro cell is muted and does not send any traffic data. Interference is lowered during these **ABS** and thus Small Cell-1 will take advantage to schedule **UE-1**.

Although the principle of **ABS** has been described in **3GPP**, its actual implementation is not clearly specified by the standard and there is no indication on how to set the **ABS** patterns in different scenarios. The question remains on what amount of sub-frames should be reserved from macros to small cells, balancing between the performance gain of small cell border **UEs** and the capacity loss of remaining macro cell **UEs**.

A wide range of solutions using **ABS** have been proposed in the literature. In [81], the authors present an **ABS** scheme following a two-tiers approach consisting of (i) the local schedulers, which perform the scheduling decisions locally and compute **ABS** patterns, and (ii) a central coordinator, which supervises **ABS** decisions. In [43], a strategy to estimate the **SINR** level during an **ABS** is proposed, based on the reported **CQI** feedbacks from previous **ABS** instants. [20] proposes a way to approximate the required number of **ABS** based on Poisson point process network deployment statistics and derives the necessary number of **ABS** as a semi-analytical formula.

The **eICIC** proposal in **LTE** standards enables time sharing of spectrum for downlink transmissions between **MCs** and **SCs** so as to mitigate the high interference experienced especially by **SC** users in the downlink. The notion of **eICIC** via **ABS** is generally coupled in the literature with another important technique for **HetNets**, i.e., user association using Cell Individual Offset to ensure that small cells are neither underutilized nor overloaded. We discuss some user association policies in the next section.

## 2.4 User Association

Before being able to receive and send data, as soon as it is powered on, a **UE** must perform certain steps:

- Cell search: it includes some synchronization stages to determine time and frequency parameters and to acquire critical system parameters such as cell identity and access mode. This procedure is performed for initial synchronization and for detecting nearby eNodeBs in preparation for handover.
- Cell selection: Once **UE** knows the ID of a given cell, it also knows the location of cell reference signals to be used in measuring the channel quality. Based on a user association policy, the **UE** selects the best eNB to be associated with. We give an overview of state of art of user association schemes in both homogeneous and heterogeneous networks in the following.
- Attach procedure: It consists on establishing a connection between the **UE** and the selected eNB. RRC messages are used for authentication, to verify the id of the **UE** and request the activation of an EPS bearer context. The decision whether a new radio-bearer admission request is admitted or rejected is made according to the quality of service (QoS) requirements of the requesting radio bearer, to the priority level of the request and to the availability of radio resources, with the goal of maximizing the radio resource exploitation.

### 2.4.1 User Association in Homogeneous Networks

User association can be defined as a set of rules to optimally attach users to different eNBs in the network. Attaching a user to the best eNB can significantly improve its throughput as well as the overall network utility.

There has been an extensive work on user association focusing on different objectives such as load balancing, decreasing call blocking probability, and increasing

the number of connected users. In [39], the authors provide a distributed joint power control and cell-site selection optimization algorithm in spread spectrum cellular networks. In [80], the problem of load balancing in High Speed Packet Access (HSPA) networks is addressed and a distributed load-awareness scheme is proposed. [79] proposed an integrated framework consisting of MAC-layer cell breathing and load-aware handover/cell-site selection based on load, throughput, and channel measurements. [62] deals with cell site selection and frequency allocation in FDMA system. The authors try to maximize the number of connected users in the system given a certain blocking probability. Many anterior works on user association, used strategies based on channel borrowing from lightly-loaded cells (e.g., [25] and [26]). Other works were based on traffic transfer to lightly-loaded cells (e.g., [24] and [101]).

The most prevalent rule of cell selection in homogeneous deployments, where all the cells transmit on similar power levels, is undoubtedly the comparison of the Reference Signal Received Power [9]. That is to say, each UE selects its serving cell ID according to the cell from which the largest RSRP is provided (See Figure 2.13).

#### 2.4.2 User Association in HetNets

In conventional homogeneous LTE networks, user association is based on the strongest downlink received signal. This policy is not suitable to HetNets, where small cells and macro cells operate at different transmission power. Based on this traditional association rule, most of UEs would attach to macro eNBs, hence potentially resulting in inefficient small cell deployment. While highly loaded macro cells may not have enough resources to efficiently serve all the UEs, small cells may be underutilized. Furthermore, because of the limited coverage of small cells, it could happen that a UE located in the proximity of a low power node, selects a far macro base station with larger pathloss. This creates disparity between the UL and DL coverage and affects the uplink transmission.

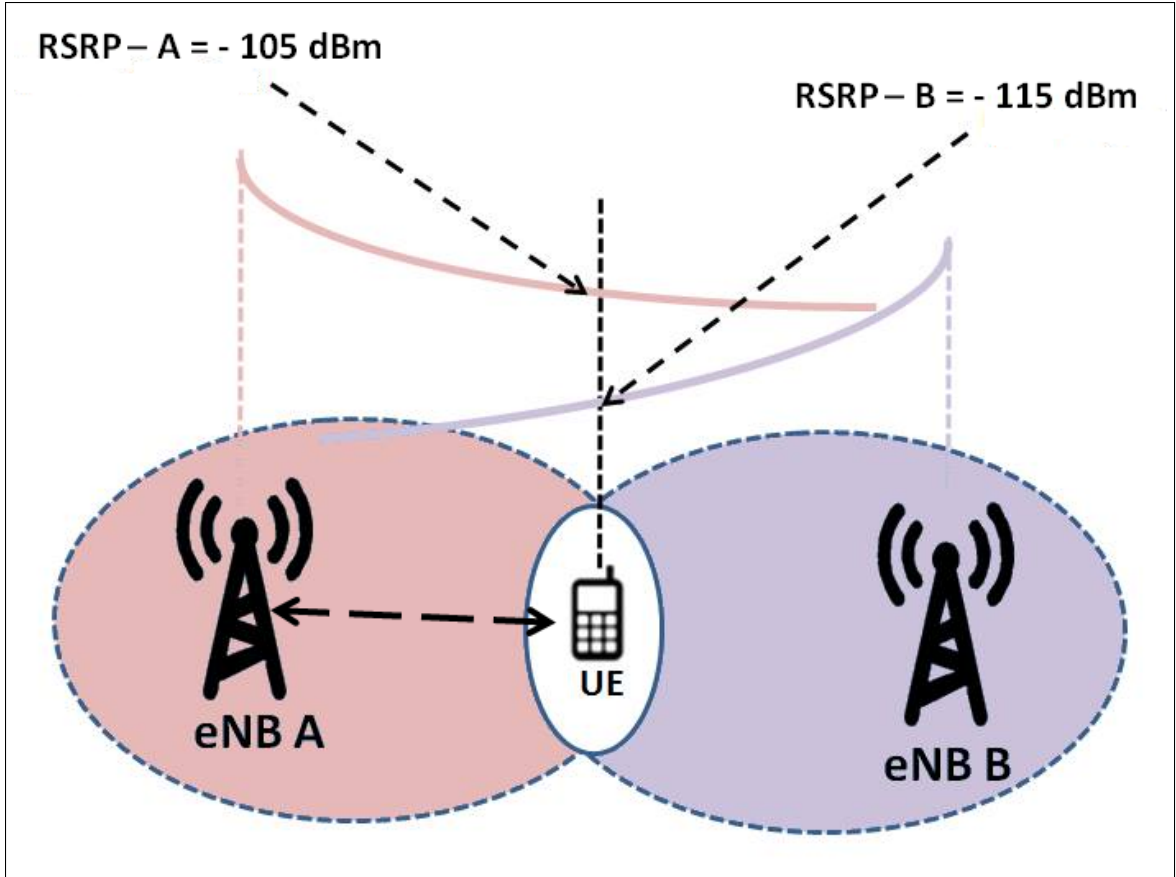

Figure 2.13: *User association based on strongest RSRP.*

User association has been extensively studied in the literature using various approaches ([22],[55], [56] [57],[99], [104]). [57] presented a detailed overview of the state of the art for user association algorithms conceived for **HetNets**. In [104], a distributed user association algorithm was proposed to maximize a logarithmic concave function of user data rate. Using convex optimization, the authors in [22], compute an upper bound on the downlink sum rate and propose a heuristic user association to maximize the achievable sum rate of all users in the network. With the goal of achieving a network wide proportional fairness, [99] defines a dynamic programming and a greedy approach to optimize user association in **HetNets**. Certain works applied game theory in the context of user association. The user association in **HetNets** was formulated as a Nash bargaining problem in ([55], [56]) to maximize the sum of

rate related utility, under users' minimal rate constraints. User association decision was modeled as Markov decision process (MDP) in a centralized approach in [29]. A distributed algorithm for load balancing is formulated as a convex optimization problem in [46].

An important approach for user association that has attracted a lot of interest lately is the concept of biased user association. It has been proposed by 3GPP in Release 10 [8], to extend the coverage of small cells and increase their load. This mechanism is also called Cell Range Extension (or Cell Range Expansion). The power strength received at a user from small cell would be artificially added by an offset, in order to offload macro cells and to ensure that more users would attach to small cells. This offset is often named Cell Individual Offset. Other names can be found in the literature like Cell Selection Bias (CSB) or Range Extension Bias (REB). The mechanism of CRE is described in Figure. 2.14.

Each UE makes periodical RSRP measurements to its serving cell and to its neighboring interfering cells. Based on these measurements, it may enter an A3 event triggering a handover decision if one neighbor cell becomes more attractive than the serving cell. There are 2 types of conditions for A3 event:

- Entering condition:  $RSRP_n + OC_n + Hys > RSRP_s + Off$
- Leaving condition:  $RSRP_n + OC_n + Hys < RSRP_s + Off$

Where:

- $RSRP_n = L3$  RSRP from the neighbor cell  $n$  (dBm) ;
- $RSRP_s = L3$  RSRP from the serving cell  $s$  (dBm) ;
- $Hys =$  Hysteresis for HO Event A3 (dB) ;
- $OC_n =$  Cell Individual Offset(CIO) for the neighbor cell  $n$  (dB) ;

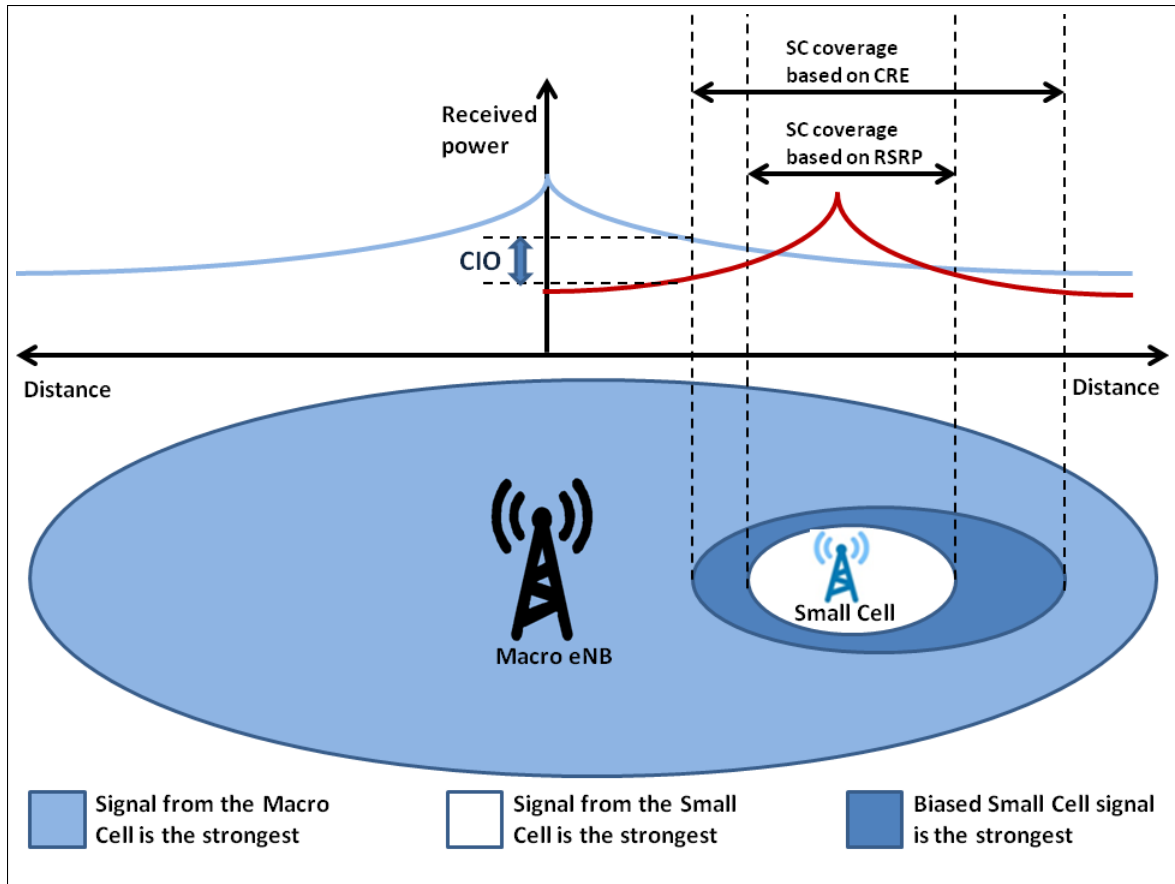

Figure 2.14: *Cell Range Extension.*

- $Off$  = Offset parameter (dB).

The possible  $CIO$  values between each two neighboring cells range from  $(-24dB)$  to  $(24dB)$  but reasonable values are in the  $10dB$  range. Generally some reciprocity is required in the  $CIO$  where  $CIO$  from eNB1 to eNB2 is equal to minus  $CIO$  from eNB2 to eNB1. Playing with the offset artificially biases the attraction of a neighboring cell. This can “force” the user to perform the handover from or towards this neighboring cell in an indirect manner. For instance, when  $CIO$  from macro to small eNB increases, it implies that more users would be offloaded from the macro to the  $SC$  and this enlarges the coverage area of  $SC$ .

$CRE$  is a natural enabler of offloading. However, the main challenge of this mechanism is to determine the optimal  $CIO$  values for a desired optimal performance of

the network.

Many of the available works on **CRE** in the literature assume fixed bias ([87], [65]). However, using a common fixed offset for all the eNBs and users turns out to be not effective [12]. When the **CIO** value is very large, the footprint of the concerned cell, typically **SC**, will be increased. The group of **UEs** in the extended range could be very important and thus many **UEs** will suffer from higher interference and lack of resources in **SC**. A set of papers determines the optimal range of **CIO** values by simulations for a specific requirements of the network ([47], [70]). [47] evaluates the impact of **CRE** on the performance of handover through system simulations and estimates the optimal **CIO** range to be below 6 dB. Authors of [70] implemented a testbed to prove that range expansion improves uplink bit rates at the cost of a limited reduction in downlink throughput. To choose the best offset values, many researchers used learning algorithms, heuristic or optimization techniques. In [93], the bias is set adaptively according based on the feedback from the network performance. [45] presents an adaptive **CRE** scheme in which, depending on its **SINR**, each user can choose its optimal bias among two possible choices. The simulations results show improvement in cell edge throughput. In [50], a Q-learning algorithm was proposed to determine the offset value to be used by each **UE** minimizing the number of **UE** outages. ([42],[86]) investigated the effect of **CRE** with the aid of stochastic geometry. The authors in [91], proposed a polynomial time heuristic scheme with rate-based **CRE** offsets in **HetNets** so that each user can decide on its attachment based on its traffic demand.

Generally, users in the extended range of small cells, experience high interference from the nearby macro cells and thus lower **SINR**, because they are no longer attached to the strongest cell. For this reason, **CRE** is usually combined with suitable interference management and resource allocation schemes.



## 2.5 User Association, Resource Allocation & Inter-Cell Interference Optimization in HetNets

### 2.5.1 Disjoint optimization

Disjoint optimization of cell selection and resource allocation/interference management has been the subject of massive research.

In [98] all small cells use the same pre-determined CIO, and only the ABS is permitted to vary in response to network dynamics. However, in [92], the proposed algorithm comprises two self-optimizing mechanisms: a load balancing algorithm to adapt the CIO values, and one algorithm to adapt ABS ratio maximizing a proportional fair utility of user throughputs. Using a time based ICIC method, [11] proposes a heuristic method that changes dynamically the bias value to adapt the range of small cells to the load and interference situation. Through CDFs of the SINR difference between macro cells and small cells, the authors of [37] analyzed the benefits of biased user association offloading with a resource partitioning method in terms of system capacity and fairness. [69] Analyzed the system capacity and user throughput using different bias values with Lightly Load CCH transmission Sub-frame (LLCS) to support ICIC. In order to improve the spectrum efficiency in the time domain, [65] proposed to associate the users based on their SINR with an additional fixed offset value and to manage interference using ABS with flexible ABS ratio which depends on the number of UEs in macro cell/small cell/CRE region. In, [58], The authors provided closed-form expressions to compute the appropriate CIO values to be added to the DL received signal strengths to expand small cell to its Hot Spot Boundry and its equal path-loss boundary. To mitigate both DL and UL interference and to increase the performance of CRE, a cooperative scheduling schemes is also derived. Using long term statistics, [74] proposed a distributed method to determine victim UEs protected by ABS via dynamic programming, and then find the optimal amount

of **ABS** by evaluating the overall system utility.

### 2.5.2 Joint Optimization

The joint optimization of user association, resource allocation and interference management has prompted significant research efforts ([61], [31], [44], [83]). We note that this joint optimization is NP-hard; hence finding the optimal solution is not trivial. Joint user association and power control was investigated in ([83], [61]). The optimization was distributed and performed sequentially in an iterative manner. While [83] considers the network utility maximization problem under the proportional fairness, [61] aims to maximize the sum utility of average rates. In [31], a joint association, channel allocation, and inter-cell interference management problem was formulated with the objective of maximizing the minimum data rate. The authors of ([44],[27]) presented a centralized self-optimization scheme delivering optimum offset and muting ratio for **HetNets** deployment. In [44], the proposed method is based on a surrogate model and only performs well for a pre-defined constrained optimization. The joint optimization of almost blank sub-frame and user association was studied in [103] and [41], where each macro **BS** is assumed to have the same muted sub-frames. As the joint optimization is combinatorial if users can only associate with one **BS**, the authors of [103] relaxed this assumption to allow users to attach with different eNBs for a fraction of time, which results in a convex optimization. In [41], the optimal **ABS** is considered as the ratio of the number of vulnerable users and total users. Based on this assumption, the original combinatorial problem can be reformulated to a pure optimal user association problem and solved with a greedy approach.

## 2.6 Software Defined Networking

### 2.6.1 Trends & Challenges

Mobile operators must carry higher traffic volumes and simultaneously support different wireless technologies (i.e., 3G, 4G and Wi-Fi) along with more sophisticated applications (VoIP, videos, streaming media). Growing traffic has pushed operators to deploy more and more cells in the Radio Access Networks (RAN). The introduction of small cells and HetNets to increase capacity and spectrum efficiency, has however brought more challenges, including user association, inter-cell interference, and radio resource management. The current implementations of mobile networks are very expensive and difficult to modify, which slows down the time-to-market for new innovations and impacts the operators' revenue. Furthermore, the tightly coupling between the control and data planes in LTE core network makes the current mobile network very slow and difficult to manage and control. Traditionally, radio resource management is performed in a distributed manner [72], where each base station has its own decision on radio resources. This distributed control plane of wireless networks is complex and suboptimal for managing the limited spectrum, and performing efficient user-cell association.

To address these challenges, operators should radically change current architectures.

### 2.6.2 SDN Architecture & Benefits

The software-defined network (SDN) [71] is an emerging centralized paradigm that has been designed to enable more agile and cost-effective networks. SDN separates the control and data plane and facilitates network configuration and management by pushing all control tasks to a logically centralized controller. This migration of control enables the underlying infrastructure to be abstracted for applications and network services, which can treat the network as a logical or virtual entity. By centralizing

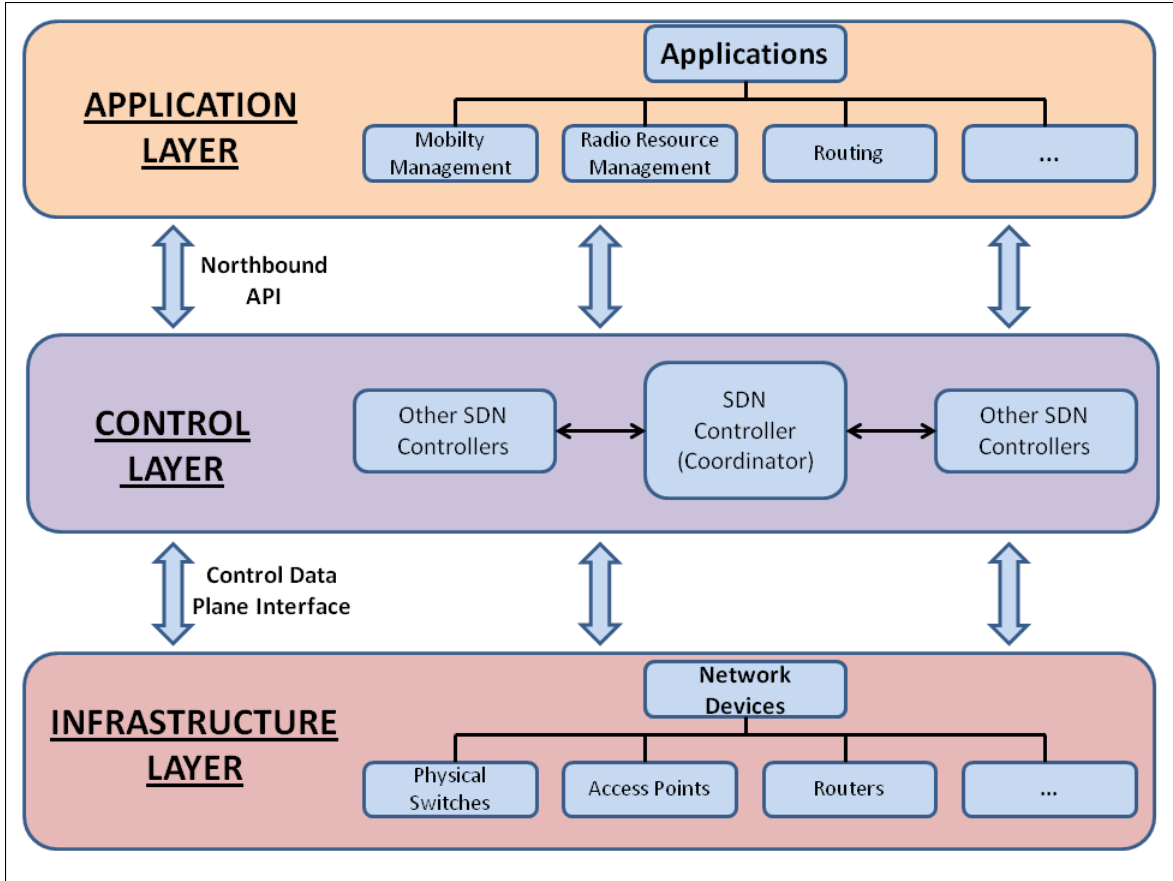

Figure 2.15: *SDN architecture.*

network intelligence, decision-making is facilitated based on a global view of the network, as opposed to today's networks, which are built on a local system view. Moreover, SDN can achieve rapid deployment of new services at lower costs through programmable interfaces (e.g., Openflow [73]) in the controller.

The Open Networking Foundation (ONF) is taking the lead in SDN standardization, and has defined an SDN architecture model as depicted in Figure. 2.15.

The SDN architecture is composed of three principal layers:

- **the infrastructure layer** also called data plane consists of the network elements that provide packet switching and forwarding.
- **the control layer** or control plane comprises a set of SDN controllers that provide the consolidated control functionality that supervises the network for-

warding behavior through southbound interfaces. These controllers communicate with others using east/westbound interfaces.

- **the application layer** or application plane consists of one or more applications, such as routing, resource management and load balancing. The boundary between the SDN applications and the controllers is traversed by northbound interfaces such as REST API or Java API.

### 2.6.3 Research Work on SDN

There have been several approaches for SDN, as surveyed in [40], [49], [68], [94], [66], [52]. In [94], the authors briefly presented a survey on SDN concepts and its benefits while considering a limited number of surveyed works. An overview of OpenFlow and a short literature review can be found in [52] and [68]. In [100], the authors considered two main streams: SDN-based mobile network and wireless network virtualization, as well as the simple integration of these two approaches. [66] presented a comprehensive survey about the impact of SDN and virtualization on mobile network architecture. The paper covered a wide range of up-to-date research works on SDN and virtualization in mobile network.

## 2.7 Conclusion

Generally speaking, today's solutions are usually limited in their scope due to the inherent complexity of the optimization problem. Previous studies often either consider:

- Often only disjoint optimization of **ABS** and **CIO** is performed because joint optimization is considered as NP-hard ([98] and [92]), leading to inherent sub-optimality.

- When joint optimization is done, it is often in a centralized entity because the search algorithm is too complex to implement locally ([44]).
- Frequently the optimization is only done for static configurations ([74], [13]) using long term statistics.
- When the optimization is performed in a decentralized manner, it does not yield to the best results due to the local optimum search ([92]).
- Very often the search is only performed for specific cost functions, exhibiting specific facilitating characteristics such as convexity ([27]). Many papers considered the sum of throughput as the utility function. However, it is widely recognized that maximizing the sum data rate of all users may result in an unfair data rate allocation.

To summarize, the above-mentioned studies handle either the disjoint optimization of user association and interference management or consider specific network utility functions for facilitating optimization algorithms using convexity and specific implementation constraints (e.g., centralized, distributed). To the best of our knowledge, there has not been, so far, efficient and practical solution able to handle all these requirements with high deployment flexibility.

## CHAPTER III

### Problem formulation

In this chapter, we will first describe the system model and formulate a joint user association and interference management/ resource allocation problem. Then, we will relax the generalized problem and specify some relevant optimization sub-problems.

#### 3.1 System Model

We consider an LTE cellular network composed of  $K$  cells:  $M$  macro cells and  $L$  small cells, where  $L \geq 0$ , to model both homogeneous and heterogeneous networks. Denote  $\mathcal{K}$ ,  $\mathcal{M}$  and  $\mathcal{L}$  as the set of all cells, macro cells and small cells in the network respectively. Each base station  $k$  has  $S$  sub-frames in the time domain and  $R$  resource blocks in the frequency domain. The duration of all sub-frames is the same and the bandwidth of all RBs is also a constant. According to 3GPP LTE standard [5], they are 1 ms and 180 kHz, respectively. All the resource blocks are first grouped into  $F$  frequency sub-bands, where each sub-band consists of a number  $R_f$  of RBs,  $f \in \{1, 2, \dots, F\}$ . The bandwidth of each frequency sub-band is thus given by  $R_f \times B$ , where  $B = 180$  kHz. Similarly, we reorganize the  $S$  sub-frames into  $T$  time slots, where each slot consists of a number  $S_t$  of sub-frames,  $t \in \{1, 2, \dots, T\}$ . The duration of each slot  $t$  is equal to  $S_t$  ms. We note that this definition of a time slot is different from the one used in LTE frame discussed in chapter II.

We only consider downlink transmissions and make the following assumptions:

- A reuse factor of one is adopted, i.e., the whole bandwidth can be used by all the cells in the system.
- The LTE transmissions in each cell are synchronized such that there is no intra-cell interference. However, there exists inter-cell interference, i.e., a transmission from a cell will cause interference to other cells which reuse the same resource block at the same time.
- All base stations are active all the time. Also, a BS uses all its available transmit power.

We will use  $P_{k,f,t}$  to denote the power (in Watt) allocated by cell  $k$  to frequency sub-band  $f$  during time slot  $t$ . It means that during  $S_t$  ms, the cell  $k$  transmits with same power  $P_{k,f,t}$  over sub-band  $f$ . We assume that the power is equally divided between the  $R_f$  resource blocks, i.e., each RB is allocated  $\frac{P_{k,f,t}}{R_f}$ . Note that  $P_{k,f,t}$  is in discrete value. The total power of a cell  $k$  during time slot  $t$  (and at each sub-frame in  $t$ ) is limited by a maximum value  $P_k^{\max}$  (in watt) such that:

$$\begin{cases} \sum_{f=1}^F P_{k,f,t} \leq P_k^{\max}, \forall t \in \{1, 2, \dots, T\}, \forall k \in \mathcal{K} \\ P_{k,f,t} \leq R_f \times \frac{P_k^{\max}}{R}, \forall t \in \{1, 2, \dots, T\}, \forall f \in \{1, 2, \dots, F\}, \forall k \in \mathcal{K} \end{cases} \quad (3.1)$$

We define vector  $P_k := (P_{k,1,1}, P_{k,2,1}, \dots, P_{k,F,1}, P_{k,1,2}, P_{k,2,2}, \dots, P_{k,F,2}, \dots, P_{k,F,T})$  to represent the power pattern of cell  $k$  during each time slot and over each sub-band.

Denote  $\mathcal{U}_k$  as the set of users who are associated with cell  $k$  and  $\mathcal{U}$  as the set of all the users in the network. We use binary variable  $q_{u,k}$  to indicate whether a user  $u$  is served by cell  $k$  or not. We assume that each user can be served by only one cell such that:

$$\sum_{k=1}^K q_{u,k} = 1, \forall u \in \mathcal{U}. \quad (3.2)$$



Let  $\mathcal{N}_k$  be the set of the  $N_k$  neighboring eNBs of cell  $k$ . The actual definition of this set will be presented in the next section. We will use  $\bar{O}_{k,k'}$  to denote the Cell Individual Offset (in dB) from cell  $k$  to its neighboring cell  $k'$ . The set of real numbers  $\mathcal{C}$  defines all possible values that  $\bar{O}_{k,k'}$  can take. Generally, some reciprocity is required in the offset settings, i.e.,  $\bar{O}_{k,k'} = -\bar{O}_{k',k}$ . We define vector  $\bar{O}_k := (\bar{O}_{k,1}, \bar{O}_{k,2}, \dots, \bar{O}_{k,N_k})$ .

We use  $s_k := (P_k, \bar{O}_k)$  to represent the power and CIO settings for each cell and  $s := (s_1, s_2, \dots, s_K)$  to denote the network profile. Given a network state  $s$ , where  $s$  is a configuration of  $P_k$ 's and  $\bar{O}_k$ 's of the  $K$  cells, we aim to determine the optimal values of  $P_k$ 's and  $\bar{O}_k$ 's for maximizing the network utility  $U(s)$ :

$$U(s) = \sum_{k=1}^K U_k(s) \quad (3.3)$$

where  $U_k(s)$  is the utility for cell  $k$ , which is usually determined by the achievable throughputs of users attached to cell  $k$  given a network state  $s$ . Any cost function can be chosen, as there is no requirement of specific characteristics. In the following, we consider proportional fairness network utility, then we have

$$U_k(s) = \sum_{u \in \mathcal{U}_k} \log(r_u(s)) \quad (3.4)$$

where  $r_u(s)$  denotes the throughput of user  $u$  given  $s$ . In the coming discussion, we may write  $r_u$  instead of  $r_u(s)$  for notation simplicity.

Under the Additive white Gaussian Noise (AWGN) model by Shannon-Hartley theorem, the achievable throughput (in bits/s) by user  $u$  can be expressed as

$$r_u = W \log(1 + \text{SINR}_u) \quad (3.5)$$

where  $W$  is the bandwidth of the channel (in Hz) and  $\text{SINR}_u$  is the signal-to-interference-plus-noise ratio of user  $u$ .

The SINR of user  $u$  when served by cell  $k$  which transmits over frequency sub-band  $f$  during time slot  $t$  is expressible as

$$\text{SINR}_{u,k,f,t} = \frac{P_{k,f,t}G_{u,k,f,t}}{\eta_u + \sum_{l \neq k} P_{l,f,t}G_{u,l,f,t}} \quad (3.6)$$

where  $\eta_u$  represents the additive white Gaussian noise,  $G_{u,k,f,t}$  denotes the link gain from cell  $k$  to user  $u$  over frequency sub-band  $f$  during slot  $t$  and  $\sum_{l \neq k} P_{l,f,t}G_{u,l,f,t}$  is the interference received from the cells in the network over frequency sub-band  $f$  during slot  $t$ . The link gain accounts for antenna physical properties, pathloss, shadow fading, fast fading and equipment losses.

### 3.2 Problem Setup

For generality, one can re-write (3.4) as

$$U_k(s) = \sum_{u \in \mathcal{U}_k} C(\text{SINR}_u(s)) \quad (3.7)$$

where  $C(\cdot)$  is a utility function.

Let  $\tau_{u,k,f,t}$  be the number of RBs out of  $R_f$  of frequency sub-band  $f$  granted by cell  $k$  to user  $u$  during slot time  $t$ . Clearly, in the resource allocation and transmission scheduling at each eNB, we will have the following constraints

$$\sum_{t=1}^T \sum_{f=1}^F \sum_{u \in \mathcal{U}_k} \tau_{u,k,f,t} \leq R \times S \quad (3.8)$$

where  $R \times S$  is the total amount of resource blocks (RBs) in the system during  $S$  sub-frames, and

$$\sum_{u \in \mathcal{U}_k} \tau_{u,k,f,t} \leq R_f \times S_t \quad (3.9)$$

for each frequency sub-band and time slot.

Notation	Description
$K$	Number of cells in the network
$M$	Number of macro cells
$L$	Number of small cells
$S$	Number of sub-frames
$R$	Total number of resource blocks
$R_f$	Number of resource blocks in sub-band $f$
$F$	Number of frequency sub-bands
$T$	Number of time slots
$S_t$	Number of sub-frames in time slot $t$
$P_{k,f,t}$	Power allocated by cell $k$ to sub-band $f$ and time slot $t$
$P_k$	Power vector of cell $k$
$P_k^{\max}$	Maximum transmission power by cell $k$
$\mathcal{U}_k$	Set of users associated with cell $k$
$\mathcal{U}$	Set of all users in the system
$q_{u,k}$	indicator of whether user $u$ is served by cell $k$
$N_k$	Set of neighboring base stations of cell $k$
$\bar{O}_{k,k'}$	CIO from cell $k$ to cell $k'$
$\bar{O}_k$	CIO vector of cell $k$
$s$	Network state
$U$	Utility function
$r_u$	Throughput of user $u$
$W$	Total bandwidth
$B$	Resource block bandwidth
$\eta_u$	Additive white Gaussian noise
$G_{u,k,f,t}$	Link gain from cell $k$ to user $u$ over frequency sub-band $f$ during slot $t$
$\tau_{u,k,f,t}$	Number of RBs out of frequency sub-band $f$ granted by cell $k$ to user $u$ during slot time $t$
$\text{SINR}_u$	Signal-to-interference-plus-noise ratio of user $u$

Table 3.1: *Descriptions of notations.*

To address the power allocation optimization problem for LTE network management, we will use long-term statistics in both frequency and time domains such that  $\text{SINR}_{u,k,f,t}$  is a measure of averaged SINR of user  $u$  over RBs in the frequency sub-band  $f$  and during time slot  $t$ . We will therefore write  $\text{SINR}_{u,k,f,t}$  after averaging the channel variations which may be due to fast fading and frequency selectiveness. This is also done to reduce the optimization problem and its dimension.

As a result, the total throughput received by a user  $u$  can be measured by

$$r_u = \sum_{k=1}^K q_{u,k} \frac{1}{S} \sum_{t=1}^T \sum_{f=1}^F [\tau_{u,k,f,t} \times B \log(1 + \text{SINR}_{u,k,f,t})]. \quad (3.10)$$

The bias user association problem using cell individual offsets can be addressed as follows:

$$q_{u,k} = \begin{cases} 1 & \text{if } \forall k' \in \mathcal{N}_k, \overline{RSRP}_{u,k} > \overline{RSRP}_{u,k'} + \overline{O}_{k,k'} \\ 0 & \text{otherwise.} \end{cases} \quad (3.11)$$

where  $\overline{RSRP}_{u,k}$  and  $\overline{RSRP}_{u,k'}$  are the Reference Signal Received Power measurements in dB of user  $u$  corresponding to the cells  $k$  and  $k'$  and can be approximated in this manner:

$$\begin{cases} \overline{RSRP}_{u,k} = \overline{P}_k^{\max} + \overline{G}_{u,k} \\ \overline{RSRP}_{u,k'} = \overline{P}_{k'}^{\max} + \overline{G}_{u,k'} \end{cases} \quad (3.12)$$

where  $\overline{G}_{u,k}$  and  $\overline{G}_{u,k'}$  are the averaged link gain from cell  $k$  and  $k'$  respectively to user  $u$  over all the bandwidth and over a certain time duration, expressed in dB. Similarly,  $\overline{P}_k^{\max}$  and  $\overline{P}_{k'}^{\max}$  are the maximum power transmission in dB of the cells  $k$  and  $k'$ , respectively.

To summarize, our goal is to maximize the network utility (3.3) (for instance, the sum of logarithmic throughput of all the users in the system) with the following decision variables:

- $\bar{O}_k := (\bar{O}_{k,1}, \bar{O}_{k,2}, \dots, \bar{O}_{k,N_k})$ : Cell Individual Offsets vector that defines the bias to be added to RSRP measurements and directly affects User Association,
- $P_k = (P_{k,1,1}, P_{k,2,1}, \dots, P_{k,F,1}, P_{k,1,2}, \dots, P_{k,F,2}, \dots, P_{k,F,T})$ : Power vector over frequency and time domain that defines the power allocation by each cell over each frequency sub-band and time slot, and directly impacts inter-cell interference.

The generalized optimization problem is described in 1. The resource scheduling specified by variable  $\tau_{k,u,f,t}$  can be formulated into another optimization procedure or one may use a simple LTE downlink scheduler.

---

**Algorithm 1** Generalized Optimization Problem

---

$$\begin{aligned}
& \text{Maximize } \sum_{u \in \mathcal{U}} \log(r_u(s)) \\
& \text{Subject to :} \\
& r_u = \sum_{k=1}^K q_{u,k} \frac{1}{S} \sum_{t=1}^T \sum_{f=1}^F \left[ \tau_{u,k,f,t} \times B \log\left(1 + \frac{P_{k,f,t} G_{u,k,f,t}}{\eta_u + \sum_{l \neq k} P_{l,f,t} G_{u,l,f,t}}\right) \right] \\
& q_{u,k} = \begin{cases} 1 & \text{if } \forall k' \in N_k, \overline{RSRP}_{u,k} > \overline{RSRP}_{u,k'} + \bar{O}_{k,k'} \\ 0 & \text{otherwise.} \end{cases} \\
& \sum_{f=1}^F P_{k,f,t} \leq P_k^{\max}, \quad \forall t \in \{1, 2, \dots, T\}, \quad \forall k \in \mathcal{K} \\
& P_{k,f,t} \leq R_f \times \frac{P_k^{\max}}{R}, \quad \forall t \in \{1, 2, \dots, T\}, \quad \forall f \in \{1, 2, \dots, F\}, \quad \forall k \in \mathcal{K} \\
& \sum_{u \in \mathcal{U}_k} \tau_{u,k,f,t} \leq R_f \times S_t
\end{aligned}$$

---

### 3.3 Special Cases

From our generalized problem, we can specify certain special cases, with simple modifications or restrictions to the optimization problem parameters.

### 3.3.1 Disjoint Frequency Sub-bands Optimization

This sub-problem is to determine for each cell  $k$  which frequency sub-bands it is allowed to use.

- We consider that  $T$  and  $S$  are equal to 1. We redefine all variables including  $\tau_{u,k,f,t}$  and  $P_{k,f,t}$  without taking into consideration the time dimension of the problem. The same power pattern is applied all the time. The power vector is then defined as  $P_k = (P_{k,1}, P_{k,2}, \dots, P_{k,F})$ .
- We restrict the possible power levels per sub-band to either zero, i.e., the frequency sub-band cannot be used by the cell  $k$ , or to the maximum power per frequency sub-band, which is equal to  $R_f \times \frac{P_k^{\max}}{R}$ .
- The user association can be done according to the usual policy of strongest received signal by restricting the possible values of CIO to zero.

By playing with the number of frequency sub-bands  $F$  and the size of each sub-band, we obtain different frequency sub-bands optimization problems. We can distinguish a special case which is to take  $F = R$ , i.e., each frequency sub-band is composed of one RB. This optimization can yield to the best results. However, its complexity is very high as we increase the number of possible combinations. The formulation of this disjoint frequency sub-bands optimization is described in [2](#).

### 3.3.2 Disjoint Power Level Optimization

In this disjoint power level optimization problem, the goal is to determine for each cell  $k$  the power value to be used over each frequency sub-band.

- The time dimension is not taken into account and the number of frequency sub-bands and their size are fixed.
- Compared to the previous case, no restriction is performed to  $P_{k,f}$ .

---

**Algorithm 2** Disjoint Frequency Sub-bands Optimization Problem
 

---

Maximize  $\sum_{u \in \mathcal{U}} \log(r_u(s))$

Subject to :

$$r_u = \sum_{k=1}^K q_{u,k} \sum_{f=1}^F \left[ \tau_{u,k,f} \times B \log\left(1 + \frac{P_{k,f} G_{u,k,f}}{\eta_u + \sum_{l \neq k} P_{l,f} G_{u,l,f}}\right) \right]$$

$$q_{u,k} = \begin{cases} 1 & \text{if } \forall k' \in N_k, \overline{RSRP}_{u,k} > \overline{RSRP}_{u,k'} \\ 0 & \text{otherwise.} \end{cases}$$

$$P_{k,f} \in \{0, R_f \times \frac{P_k^{\max}}{R}\}, \forall f \in \{1, 2, \dots, F\}, \forall k \in \mathcal{K}$$

$$\sum_{u \in \mathcal{U}_k} \tau_{u,k,f} \leq R_f$$

---

- The offsets values are set to 0.

The optimization is accomplished by playing with the possible power values per RB. Generally, each resource has a maximum power level defined as  $\frac{P_k^{\max}}{R}$ . With the power level optimization, it is possible to boost the power on some resources or lower it.

---

**Algorithm 3** Almost Blank Sub-frames Optimization Problem
 

---

Maximize  $\sum_{u \in \mathcal{U}} \log(r_u(s))$

Subject to :

$$r_u = \sum_{k=1}^K q_{u,k} \frac{1}{S} \sum_{t=1}^T \left[ \tau_{u,k,t} \times B \log\left(1 + \frac{P_{k,t} G_{u,k,t}}{\eta_u + \sum_{l \neq k} P_{l,t} G_{u,l,t}}\right) \right]$$

$$q_{u,k} = \begin{cases} 1 & \text{if } \forall k' \in N_k, \overline{RSRP}_{u,k} > \overline{RSRP}_{u,k'} \\ 0 & \text{otherwise.} \end{cases}$$

$$\begin{cases} P_{k,t} \in \{0, P_k^{\max}\}, \forall k \in \mathcal{M} \\ P_{k,t} = P_k^{\max}, \forall k \in \mathcal{L} \end{cases}$$

$$\sum_{u \in \mathcal{U}_k} \tau_{u,k,t} \leq R \times S_t$$

---

### 3.3.3 Almost Blank Sub-frames Optimization

In the same way as the frequency sub-bands optimization, it is also possible to determine for each cell  $k$  a time pattern over all the bandwidth, i.e., during which time

slots the **BS** can transmit. **3GPP** Release 10 has defined Almost Blank Sub-frames to mute macro cells during certain slots and minimize their interference, while small cells can transmit all the time. The **ABS** optimization problem can be expressed by adding some restrictions to our generalized problem formulation.

- We regroup all RBs into one frequency sub-band, i.e.,  $F = 1$  and we redefine the variables without considering the frequency dimension of the problem. The power vector can be simply written as  $P_k = (P_{k,1}, P_{k,2}, \dots, P_{k,T})$ .
- Generally, we only mute macro cells, while small cells always transmit with maximum power.  $P_{k,t}$  is then defined by:
 
$$\begin{cases} P_{k,t} \in \{0, P_k^{\max}\}, \forall k \in \mathcal{M} \\ P_{k,t} = P_k^{\max}, \forall k \in \mathcal{L} \end{cases}$$

The formulation of the **ABS** optimization is described in **3**.

### 3.3.4 User Association Optimization

Several user association policies already exist in the literature and may be integrated to our problem formulation. It is also possible to integrate directly the resulting attachments from any chosen policy by the operators. The most relevant rule in homogeneous networks is to attach the user with the base station offering the best signal. It can be integrated by setting the bias value to zero in our generalized problem. When using cell range extension to define the user association, a general formulation of the problem is to take different CIO values between each two neighboring cells. However, the problem can be restricted by choosing a unique CIO value for each cell  $k$  towards all its neighboring cells, we got then  $\bar{O}_k = \text{constant}$ . It is also possible to define an offset for each user class, for instance depending on its speed or traffic.



### 3.3.5 Utility Function Maximization

The use of the proportional fair is just an example of one possible network utility to be used in the optimization. Other parameters can be taken into account in the cost function such as other Quality of Service (QoS) criteria and minimum rate requirement.

## 3.4 Conclusion

In this chapter, we formulated the joint user association and inter-cell interference optimization problem using two decision variables: (i) cell individual offsets vector and (ii) power patterns over frequency and time domains. Relevant sub-problems have been also expressed. A detailed description of our proposed flexible framework to solve these formulated problems is given in the next chapter.

## CHAPTER IV

# A Game Theoretic Framework

In this chapter, we present an approach using potential games that achieve an optimal solution for the user association, inter-cell interference coordination and resource allocation optimization. Then, we describe the framework in details and explain the different steps of the proposed algorithm.

### 4.1 Theoretical Background

We model the problem as a non-cooperative game where the eNBs are players and we introduce the potential game approach that relies on approximating the non-cooperative games with potential games.

#### 4.1.1 Potential Game Formulation

Let the eNodeBs periodically broadcast pilot signals of a priori fixed power. We formulate our objective function into a potential game by designing cost functions of the base stations and their neighbors. To begin with, we define the set of all neighbors of an eNB  $k$ , named  $\mathcal{N}_k$ , as follows: eNB  $j$  is a neighbor of eNB  $k$ , if there exists a user  $u$  served by cell  $k$ , i.e.,  $u \in \mathcal{U}_k$ , such that the received pilot signal power at user  $u$  from eNB  $j$  is greater than a certain threshold, say  $\theta$ .

In our development we use the following propriety: For any eNBs pair  $(k, j)$ ,  $j \in \mathcal{N}_k \Leftrightarrow k \in \mathcal{N}_j$ . We use  $\mathcal{N}_k^+$  to denote the set of eNBs including eNB  $k$  and its neighbors, i.e.,  $\mathcal{N}_k^+ = k \cup \mathcal{N}_k$ .

We model our optimization problem as the following non-cooperative game:

**Players:** Let the base stations be the players and  $\mathcal{K}$  denotes the set of players. In the sequel we use base station (or eNB) and player interchangeably.

**Strategies:** For eNB  $k$ , a strategy is a tuple  $s_k = (P_k, \bar{O}_k)$  and its strategy set is  $\mathcal{S}_k := \mathcal{P}_k \times \bar{\mathcal{O}}_k$ , where  $\mathcal{P}_k$  and  $\bar{\mathcal{O}}_k$  are the spaces of  $P_k$  and  $\bar{O}_k$ , respectively. A joint strategy  $\mathbf{s} = (s_k, k \in \mathcal{K})$  specifies the strategies of all players and belongs to the joint strategy space  $\mathcal{S} := \times_{k \in \mathcal{K}} \mathcal{S}_k$ . We define the strategies selected by all eNBs except eNB  $k$  as:

$$\mathbf{s}_{-k} := (s_1, \dots, s_{k-1}, s_{k+1}, \dots, s_K),$$

and we define:

$$(s'_k, \mathbf{s}_{-k}) := (s_1, \dots, s_{k-1}, s'_k, s_{k+1}, \dots, s_K)$$

where player  $k$  adopts strategy  $s'_k$  and  $\mathbf{s}_{-k}$  specify the strategies of other players.

**Payoffs:** eNB  $k$ 's payoff function  $P_k : \mathcal{S} \rightarrow \mathbb{R}$  is defined as

$$P_k(s) := \sum_{j \in \mathcal{N}_k^+} U_j(s) \quad (4.1)$$

where the function  $U_j(s)$  is defined as in (3.7) but the SINR defined in (3.6) is replaced by:

$$\text{SINR}_{u,k,f,t} = \frac{P_{k,f,t} G_{u,k,f,t}}{\eta_u + \sum_{l \in \mathcal{N}_k} P_{l,f,t} G_{u,l,f,t}}. \quad (4.2)$$

With this modification, each eNB  $k$  needs only to know some specific information from its neighbors  $\mathcal{N}_k$ .

We refer to this non-cooperative game as the strategic form game  $(\mathcal{K}, (\mathcal{S}_k, k \in \mathcal{K}), (P_k, k \in \mathcal{K}))$ .

In the following, we will prove that this non-cooperative game is a potential game, which is known to have interesting properties, such as existence of a Nash equilibrium and convergence of best-response algorithm to this equilibrium in a finite number of steps, for the completeness.

A game is said to be a potential game if the game admits a real-valued function, called potential function, defined on the space of pure strategy profiles, such that the change in any player's payoffs is exactly matched by the change in potential. Nash equilibrium can be reached within a finite number of plays if a player is randomly chosen to update its strategy so that the player's utility is maximized in each step.

Recall that our goal is to maximize the sum of logarithmic throughputs, based on the selection of power and offsets patterns. When a base station  $k$  changes its settings, it affects the neighboring eNBs' user attachment and the throughputs of the UEs who are associated to  $k$  and its neighboring stations. Besides power and offset patterns, the utility of a station is also dependent on the downlink scheduler. We assume that all eNBs use the same Proportional Fair Scheduler (PFS).

**Theorem IV.1.** *The finite strategic form game  $(\mathcal{K}, (\mathcal{S}_k, k \in \mathcal{K}), (P_k, k \in \mathcal{K}))$  is a potential game and thus admits Finite Improvement Path (FIP) ([64]).*

*Proof.* Let players use a strategy  $\mathbf{s} = (s_k, k \in \mathcal{K})$ . Consider a player  $k$  and assume that it changes its strategy from  $s_k$  to  $s'_k$ . The change on  $U(\cdot)$  due to the change of player  $k$ 's strategy is:

$$\begin{aligned}
U(s'_k, \mathbf{s}_{-k}) - U(\mathbf{s}) &= \sum_{j \in \mathcal{K}} (U_j(s'_k, \mathbf{s}_{-k}) - U_j(\mathbf{s})) \\
&\stackrel{(*)}{=} \sum_{j \in \mathcal{N}_k^+} (U_j(s'_k, \mathbf{s}_{-k}) - U_j(\mathbf{s})) + \sum_{j \notin \mathcal{N}_k^+} (U_j(s'_k, \mathbf{s}_{-k}) - U_j(\mathbf{s})) \\
&= \sum_{j \in \mathcal{N}_k^+} (U_j(s'_k, \mathbf{s}_{-k}) - U_j(\mathbf{s})) \\
&\stackrel{(\#)}{=} P_k(s'_k, \mathbf{s}_{-k}) - P_k(\mathbf{s})
\end{aligned}$$

where (\*) is due to the fact that  $\forall j \notin \mathcal{N}_k^+, k \notin \mathcal{N}_j^+$  and thus  $U_j(\mathbf{s})$  is independent of eNB  $k$ 's strategy. (#) indicates that the change of  $U(\cdot)$  due to the change of a player's strategy equals the change of the payoff function of that player. Therefore, the function  $U(\cdot)$  is a potential function for the game  $(\mathcal{K}, (\mathcal{S}_k, k \in \mathcal{K}), (P_k, k \in \mathcal{K}))$ . This implies FIP property.  $\square$

Note that the accuracy of the potential game approach depends on the value of the sensitivity threshold  $\theta$  since the size of the neighborhood increases when the value of  $\theta$  decreases. With  $\theta = 0$ , the Nash equilibrium of the potential game coincides with the optimal solution of the utility (3.3).

#### 4.1.2 Discussion

Based on game theory and potential game previously formulated, we propose a generic framework performing these 3-steps optimization.

- (1): Start with any arbitrary initialization and fix the strategies of all the base stations.
- (2): Randomly select a player  $k$  from  $\mathcal{K}$ . For each strategy  $s_k \in S_k$ , evaluate the payoff of the base station. Based on the jointly chosen power and offset settings, evaluate the payoff of the selected player. We note that this algorithm is not limited to the PF utility. Other kinds of utility functions can be used. Based on best response algorithm, Select one strategy the best strategy that maximizes  $P_k$ . In game theory, the best response is the strategy which produces the most favorable outcome for a player, taking other players' strategies as given [34]. It is also possible to select a strategy with a certain distribution probability such as Gibbs.
- (3): Repeat (2) until some stopping criterion is met. After a number of iterations, utility function saturates to a value called Nash equilibrium, i.e., the

point at which each player in a game has selected the best response (or one of the best responses) to the other players' strategies [33]. Depending on the selection method, this equilibrium can be guaranteed to be a local or global optimum. While best response algorithm is very efficient, some other algorithms can drive the system to a state of strict optimal solution by proper probabilistic relaxation [17].

Although this game theoretic approach is meant to be implemented in a distributed fashion, in practice it may be useful to support also more centralized architecture, as distributed implementations require modification of the eNodeB code and also some exchanges between the eNBs to converge to global optimum. To adapt to these practical constraints, we propose a more pragmatic framework that is a trade-off between complexity and performance: a centralized coordinator using the best response Proportional Fairness approach and which fits with the characteristics of existing LTE cellular networks:

- Limited CPU capacity on the eNBs: eNBs are primarily modems designed to handle radio and network interfaces, hence the optimization algorithm should be offloaded to a separate and more sophisticated node;
- Limited exchange capacity between the eNBs and the non negligible latency of LTE X2 interface: distributed optimization requires, for fast convergence, explicit data exchange between neighboring eNBs that does not scale;
- Introduction of a central entity in charge of performing the optimization and called the coordinator;
- Precise cell state known locally by each eNB: to lower transport load to the controller, Channel State Information should be aggregated by the eNB to create meaningful scaled information later transmitted to the controller;

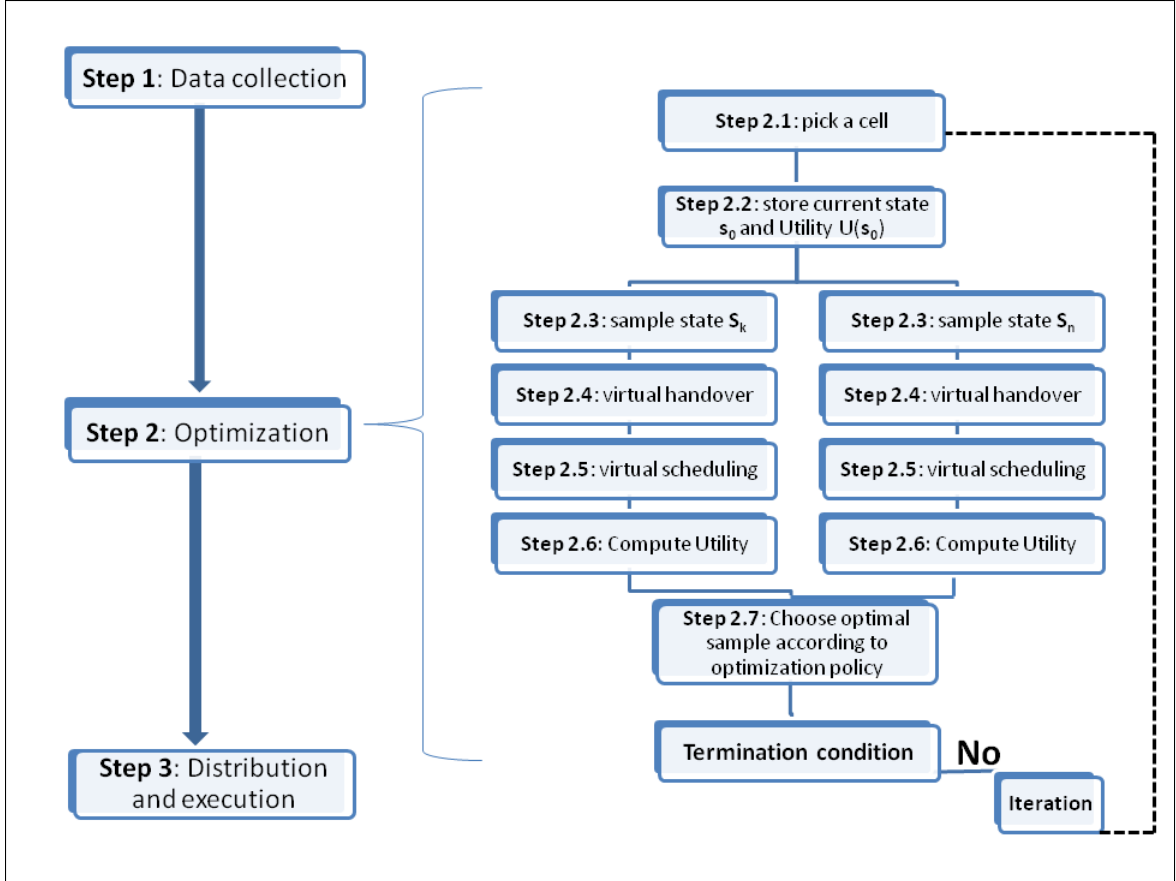

Figure 4.1: *Framework overview.*

- Support of decentralization of the optimization computation: in some cases it should be possible to relocate the computation next to the “high quality data” source.

## 4.2 Proposed Solution

In the following, we will describe the algorithm and its operation in performing user association and frequency/time resource allocation via power patterns optimization for LTE cellular networks ([95], [96]). The algorithm in the more simple case of the fully centralized and best response approach is represented in Figure. 4.1.

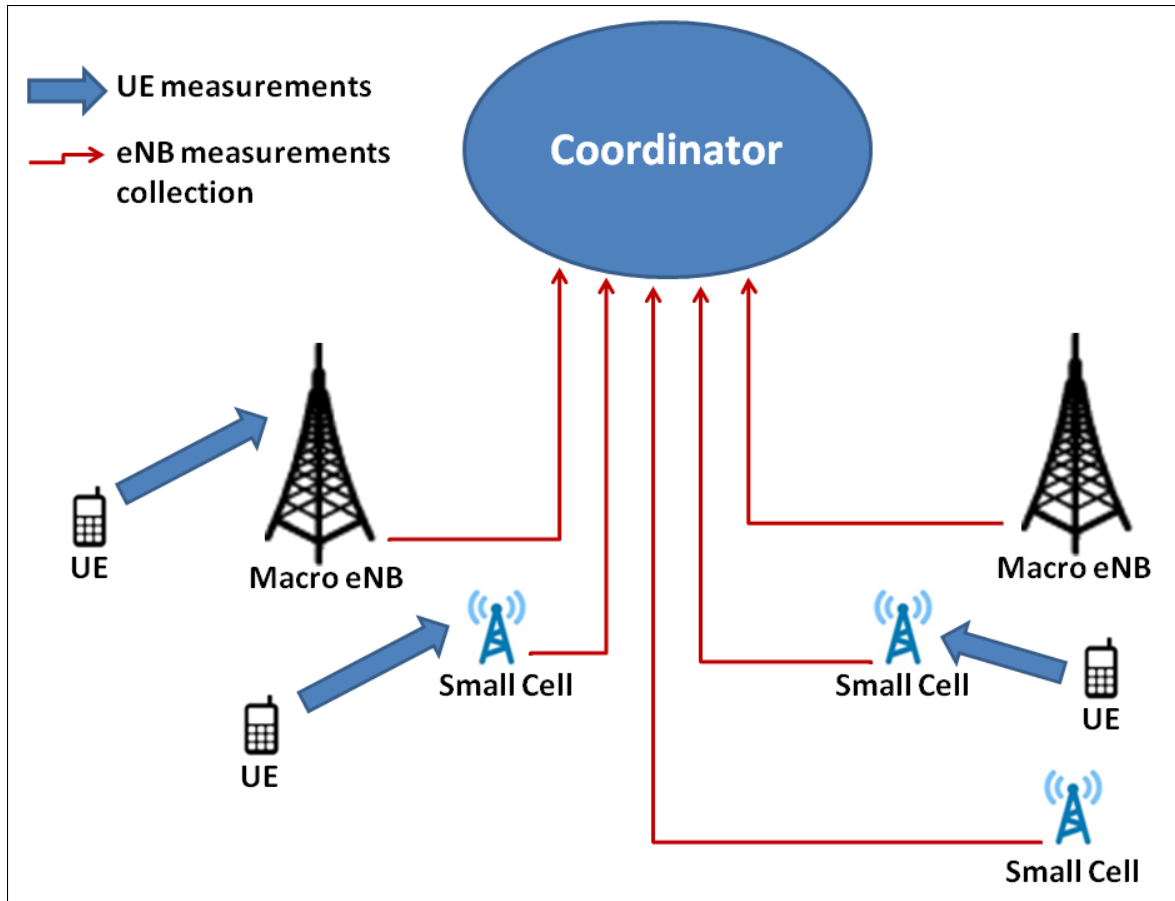

Figure 4.2: *Step 1: Data Collection.*

#### 4.2.1 Step 1 – Data Collection

Each UE reports to its serving eNB long term statistics, such as Channel Quality Indication and Reference Signal Received Power. These measurements are processed by the eNB to group the users in pools having similar channel quality, then they are sent via S1 protocol to the coordinator (See Figure 4.2). Various examples of UE grouping are presented in Figure. 4.3, for illustration.

- (A) Example of one ueGroup: includes all the users that are served by the cell.
- (B) Example of two ueGroups: one includes the cell edge UEs and the other one the cell center UEs. This classification can be done using RSRP measurements and a defined threshold.



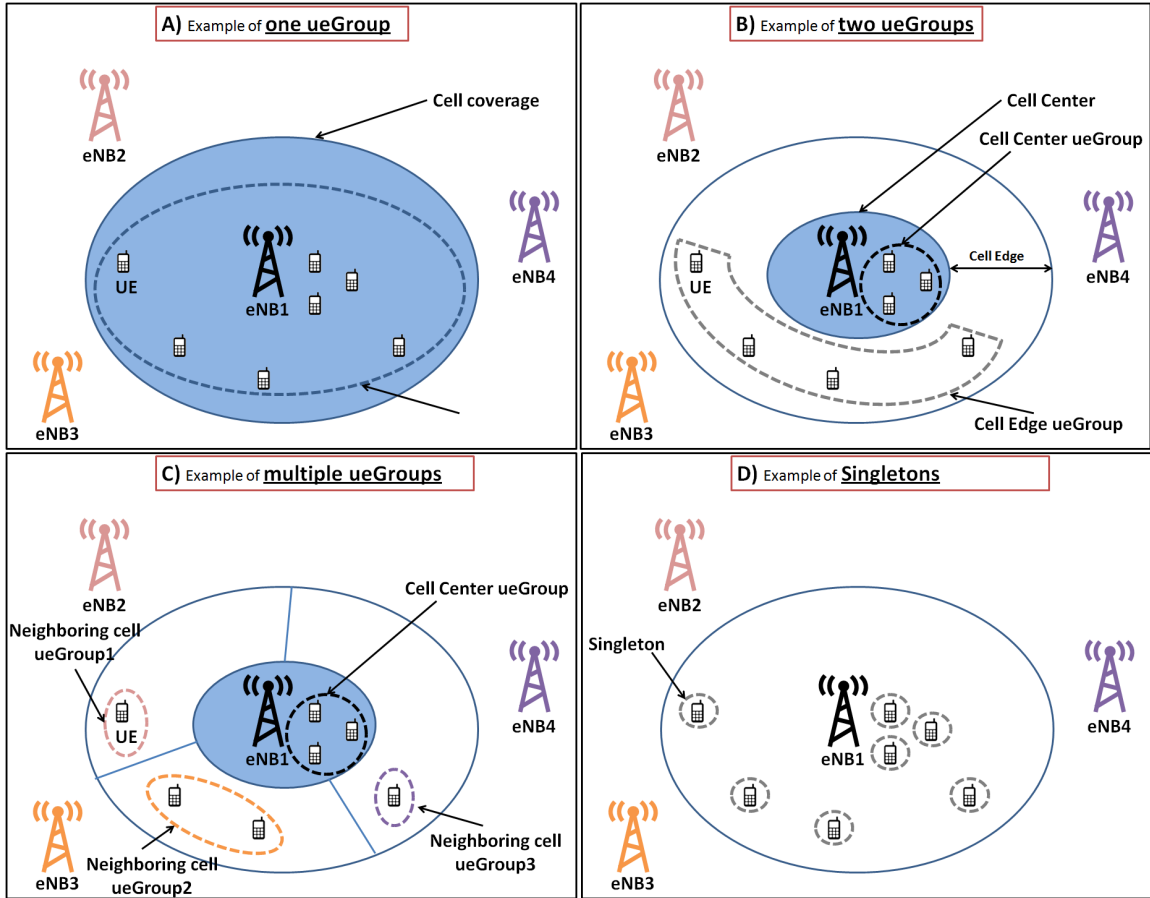

Figure 4.3: *Example of various UE grouping policies.*

- (C) Example of multiple ueGroups: one group made of the cell center UEs + neighboring cell ueGroups. A neighboring cell ueGroup  $k$  includes all the users that reported cell  $k$  as the most interfering neighbor.
- (D) Example of singletons: as many ueGroups as users.

UE grouping allows limiting the data exchange between the eNBs and the coordinator. This two-tier model enables a good balance between the local knowledge of the eNB that is precise and real time but limited in scope to its attached UEs, and the global knowledge of the coordinator that has access only to long-term statistics that are averaged both in spatial dimension (by UE grouping) and in time dimension (between two update messages) but with a system-wide scope. At the coordinator, the received measurements constitute a database that reflects the state of the network.

## 4.2.2 Step 2 – Optimization

Working on the database formed in *step 1*, the coordinator derives the optimal parameters: CIO values and transmission power pattern for each cell using an adapted algorithm. Fig. 4.1 shows the performed iterations.

### 4.2.2.1 Steps 2.1 & 2.2 – Choose a cell and store initial state

The coordinator picks up a cell randomly. It stores the initial network state, which refers to the CIO and power setting of each cell in the system. The coordinator computes the initial global utility which indicates the network performance.

### 4.2.2.2 Step 2.3 – Sampling

This step consists in sampling the couple  $(P_k, \bar{O}_k)$  for the selected cell. For each neighboring cell, we attribute a CIO value, which can be positive or negative. The total number of RBs depends on the system, e.g., given 5 MHz and 10 MHz, there will be 25 and 50 RBs, respectively. For simplicity and practical use, RBs are grouped into  $F$  equally sized sub-bands or approximately. Figure. 4.4 shows the details in the case of 10 MHz, where  $R = 50$  and  $F \in \{3, 4, 5, 6, 7\}$ . In the same manner, we regroup the  $S$  subframes into  $T$  equally sized slots. One resource element is defined by the couple of frequency sub-band and time slot. Sampling  $P_k$  consists on allocating a transmission power over each frequency sub-bands and time slot.

Note that the sampling of states is performed among the admissible combinations of power settings and CIO values. In practice, the sampling of states can be done in parallel. Given  $N_k$  neighboring cells and  $I$  possible offset values, we have  $I^{N_k}$  possible samples for  $\bar{O}_k$ . Given  $F$  frequency sub-bands,  $T$  time slots and  $Y$  power levels per RB, we have  $Y^{F \times T}$  samples for the power patterns. This implies that one will have  $I^{N_k} Y^{F \times T}$  cases to be sampled for the cell selected in *step 2.1*. However, some combinations can be easily discarded with respect to some constraints such as

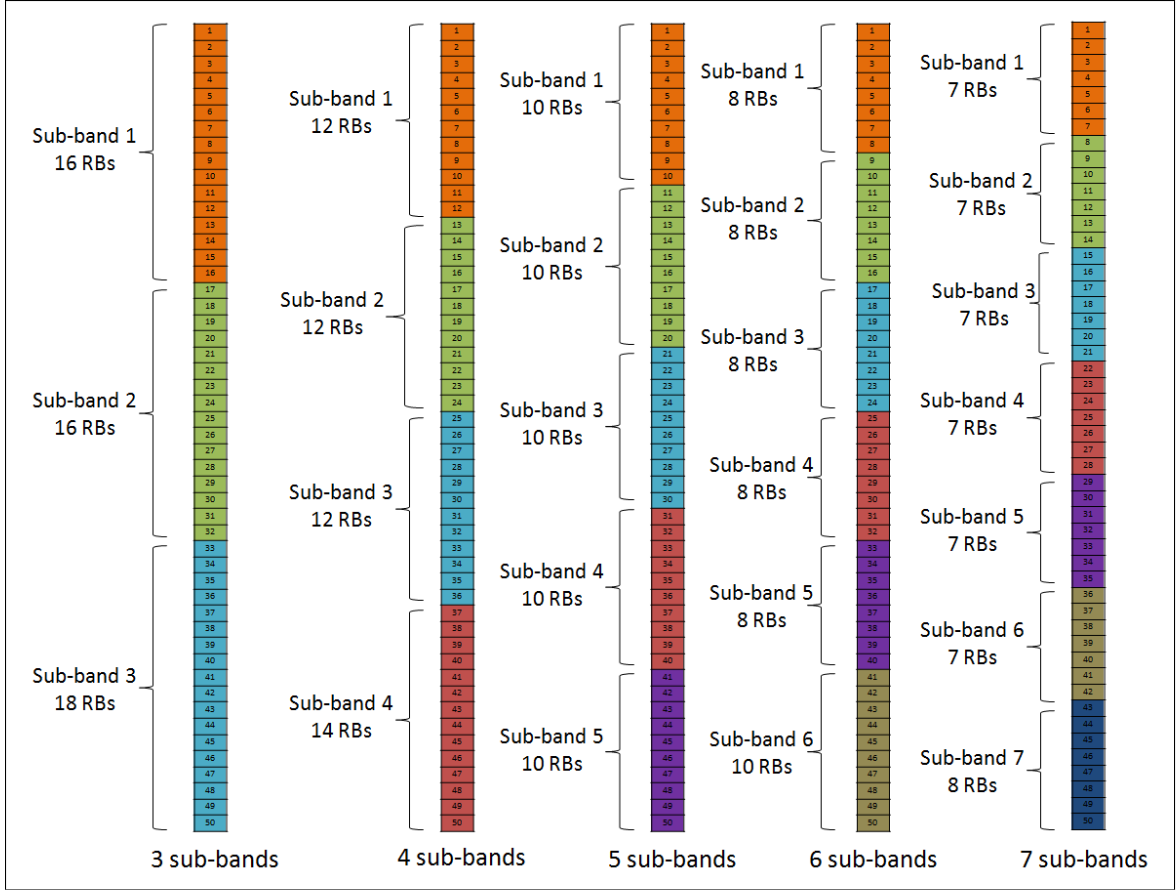

Figure 4.4: Resource blocks grouped into frequency sub-bands.

maximum power. As indicated in last chapter, performing disjoint optimization is also possible in our framework. The complexity of the sampling can be then reduced. For instance, in Almost Blank Sub-frames optimization, only macro cells are concerned with the muting.

#### 4.2.2.3 Step 2.4 – Virtual handover

For each sampled case where the CIO has been changed, we perform a virtual handover by calling the `ueGroupAttach` function. This function tests if the user group would make a handover to a neighboring cell due to the change in the CIO. It compares the RSRP measurements to the serving and neighboring cells after adding the new sampled CIO value, and virtually changes the user association accordingly.

Algorithm (4) describes the virtual handover procedure applied to base station  $k$ . Recall that  $\overline{O}_{k,k'}$  is the CIO value from cell  $k$  to its neighboring cell  $k'$ . Denote  $\overline{O}_{k,k'}^{current}$  and  $\overline{O}_{k,k'}^{sampled}$  as current CIO and sampled CIO respectively.

---

**Algorithm 4** Virtual Handover

---

```

for  $k' \in \mathcal{N}_k$  do
  if  $\overline{O}_{k,k'}^{sampled} > \overline{O}_{k,k'}^{current}$  then
    Check the RSRP of each UE attached to cell  $k$  to its neighbor  $k'$ 
    for  $u \in \mathcal{U}_k$  do
      if  $\overline{RSRP}_{u,k'} + \overline{O}_{k,k'}^{sampled} > \overline{RSRP}_{u,k}$  then
        Perform virtual handover of  $u$  from eNB  $k$  to  $k' \Rightarrow u \in \mathcal{U}'_k$ 
      end if
    end for
  else if  $\overline{O}_{k,k'}^{sampled} < \overline{O}_{k,k'}^{current}$  then
    Check the RSRP of each UE, attached to a neighbor cell of  $k$ , to
    eNB  $k$ 
    for  $j \in \mathcal{N}_k$  do
      for  $i \in \mathcal{U}_j$  do
        if  $\overline{RSRP}_{u,k} + \overline{O}_{k,k'}^{sampled} > \overline{RSRP}_{u,j}$  then
          Perform virtual handover of  $i$  from eNB  $j$  to  $k \Rightarrow i \in \mathcal{U}_k$ 
        end if
      end for
    end for
  end if
end for

```

---

#### 4.2.2.4 Steps 2.5 & 2.6 – Virtual scheduling & utility computation

For each sampled configuration, the optimizer calls the virtual scheduling function to render the scheduling performed by the eNB selected in *step 2.1* and its neighboring eNBs, in order to estimate the expected bit rates of attached users. Several options are available such as proportional fairness, absolute fairness (max-min), sum rate maximization, etc. The one adopted in the current approach is the well-known

**PFS** algorithm used in today’s LTE [82]: the **PFS** will serve a UE  $u_m$  when its instantaneous channel quality is the highest according to

$$u_m = \arg \max_{u \in \mathcal{U}_k} \frac{R_u(m, t)}{\bar{R}_u(t)} \quad (4.3)$$

where  $\bar{R}_u(t)$  denotes the experienced average throughput of user  $u$  at time  $t$  and  $R_u(m, t)$  is the achievable rate by user  $u$  if RB  $m$  is allocated to  $u$ .

After calling the virtual scheduling function for the selected cell and its neighboring cells, the coordinator computes the utility function based on the resulting achievable rates  $r_u$ ’s. Note that the proposed framework can support various optimization tools and utility definitions, depending on operator’s strategy. It is not limited to proportional fairness utility.

#### 4.2.2.5 Step 2.6 – Choosing optimal sample

After sampling all the possible states of the chosen cell and computing their corresponding utility values, the coordinator chooses one configuration according to an optimization policy, for instance best response, i.e. the best one is selected with the highest probability. As previously discussed, the best response update is guaranteed to converge to a local optimum (Nash equilibrium) through a finite number of iterations. Another policy considers introducing randomness in the selection of the sampled case using the Gibbs distribution. Under some cooling conditions, it is possible to prove the convergence towards a global optimum at the cost of more iterations. For a comparison between the Gibbs and best response, please refer to [85].

#### 4.2.3 Step 3 – Distribution & Execution

After the optimization, the coordinator sends the optimized setting to each eNB. The optimized CIO values are added to RSRP measurements to trigger possible han-

dovers. The local schedulers allocate their provided RBs with respect to their power level patterns over time and frequency dimension, as advised by the coordinator.

#### 4.2.4 Centralized vs Distributed

In the general case, the framework architecture may be centralized, distributed, or partially distributed. In this case, a computing element function  $C$  is defined such that  $C(k)$  gives the address of the element in charge of performing the optimization of eNB  $k$  settings. Let us revisit the possible options:

- In the centralized case  $C(k) = \text{centralized coordinator}$  for each eNB  $k \in \mathcal{K}$ .
- In the fully distributed case,  $C(k) = k$  for each eNB  $k \in \mathcal{K}$ .
- In a partially distributed case (or partially centralized), one possibility is to define:

$$C(k) = \begin{cases} k & \text{if } k \in \mathcal{M}, \\ M(k) & \text{otherwise.} \end{cases}$$

where  $M(k) \in \mathcal{M}$  and is the closest macro cell to small cell  $k$ .

A more general architecture for the partially distributed case is to define clusters composed of a certain number of macro and small cells. Each cluster has its own coordinator that manages dynamically the computation of CIO and power patterns for the eNBs in the cluster. Whenever a cell  $c1$  is selected, one has to check if there exist a cell  $c2 \in \mathcal{N}_{c2}$  such that  $C(c1) \neq C(c2)$ . If this is the case,  $C(c1)$  must give to  $C(c2)$  the new parameters selected at the end of the optimization. Otherwise, there is no exchange needed. Therefore a trade-off of the cluster size between the computing load on the cluster computing element and the level of message exchanges between two iterations is required. As an example shown in Figure. 4.5, we can see that whenever the small cell (1,2) gets updated during an iteration, its coordinator C1 must send its new parameters

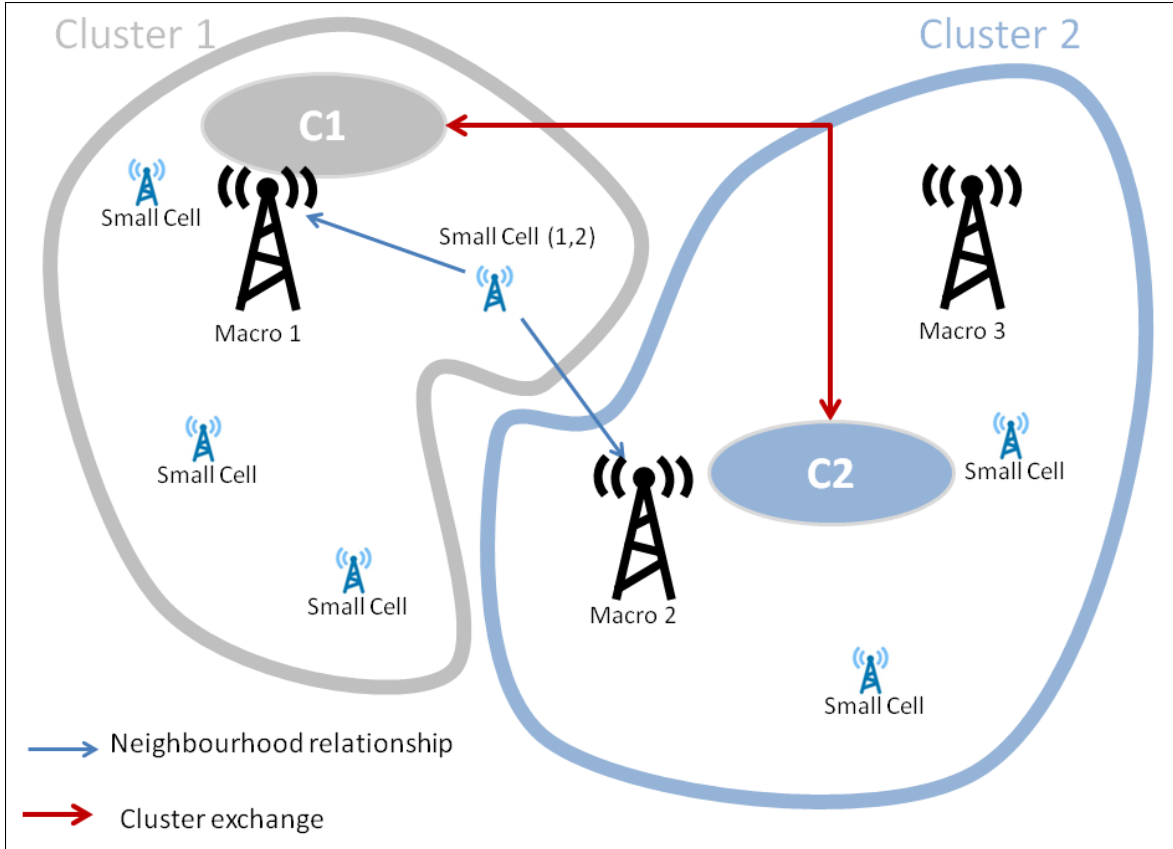

Figure 4.5: *Clustering.*

to the coordinator C2. Similarly, whenever the Macro (2) gets updated during iteration, the coordinator C2 must send its new parameters to the coordinator C1. But no exchange has to occur for all other cells.

### 4.3 Conclusion

Starting from a powerful mathematical approach based on game theory that suits the distributed case, we designed a flexible framework for addressing user association and resource allocation in both homogeneous and heterogeneous networks. In the next chapter, we provide simulation performance and describe the developed prototype.

## CHAPTER V

# Performance Evaluation

In this chapter, we present the simulation settings and performance results of different optimization configurations. We also provide a detailed description of the framework prototype.

### 5.1 Simulation setup & metrics

To emulate the **LTE** network, we used a MATLAB-based **LTE**-compliant simulator developed by the TU Wien's Institute of Telecommunications [63]. Globally, the simulator is structured in two main building blocks or layers: Link measurement model and link performance model (see Figure 5.1). This tool generates **eNBs**, local schedulers, pathloss and shadow fading model, UEs, etc. The simulation runs using a Region Of Interest (**ROI**) in which the eNodeBs and UEs are positioned and total simulation duration is expressed in Transmission Time Interval (**TTI**)s. As output, the simulator provides traces containing the main Key Performance Indicators (**KPIs**) such as throughput and error rates.

Table 5.1 gives the general simulation parameters. To evaluate the performance of the proposed framework, we measured:

- Average user throughput (**Avg-user-Th**) (kbps): mean value of all user rates in the system.



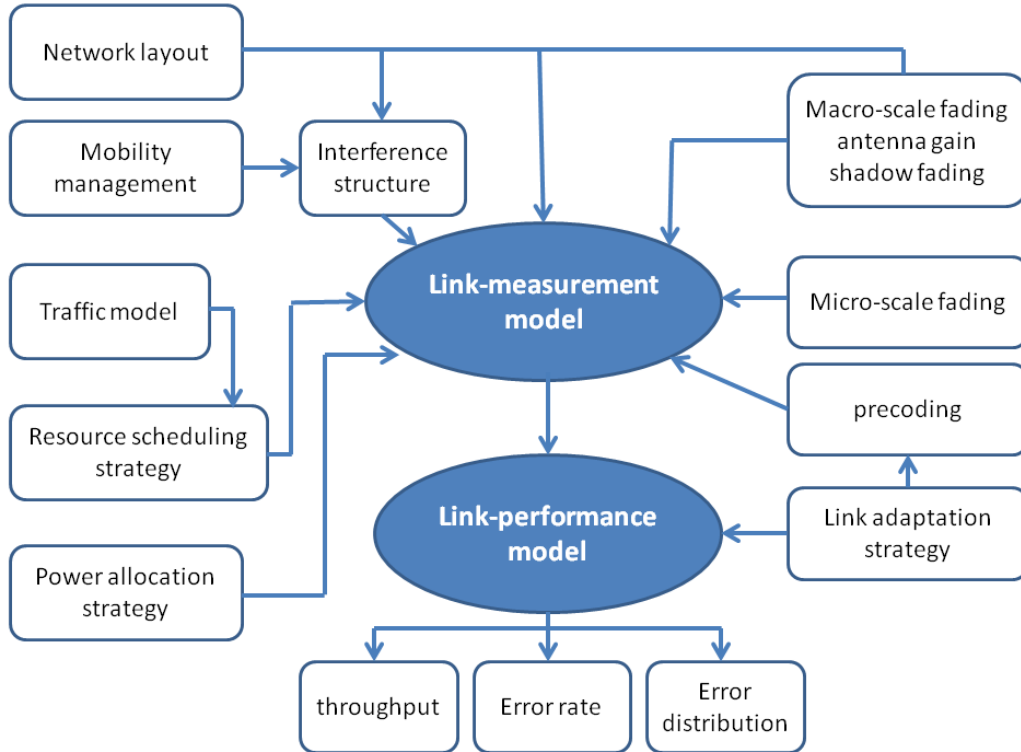

Figure 5.1: *LTE system level simulator.*

- Median throughput (**Median-Th**) (kbps): corresponds to the middle value of sorted throughputs, i.e., the 50th percentile point of the Cumulative Distribution Function (**CDF**) of user throughput.
- Cell edge throughput (**Cell-edge-Th**) (kbps): defined as the 5th percentile point of the **CDF** of user throughput. It represents the maximum throughput of the 5% users experiencing worst data rate in the network.
- Average energy efficiency (**Avg-EE**) (bits/joule): is the ratio of total amount data delivered to all the users and the total power consumed in the network.
- Cell edge energy efficiency (**Cell-edge-EE**) (bits/joule): defined as the ratio of bits delivered to cell edge users and the amount of power consumed to transmit these data.

In the following, the first scenario, called 'macros only' refers to the case where

<b>Radio</b>	LTE Rel. 8, Single Input Single Output ( <b>SISO</b> ), 10 MHz TS 36.942 recommended pathloss and shadow fading models [7]
<b>Topolgy</b>	<b>Macros:</b> Hexagonal 1 ring, Inter-Site Distance ( <b>ISD</b> ) 500m 3 cells/macro site, Antenna: Kathrein, Power max: 40W <b>Small Cells:</b> 30 <b>SC</b> at fixed location 0.5 ISD Antenna: Omnidirectional, Power max: 1W
<b>Mobile users</b>	Scenario 1: 25 users/MC, total of 525 users Scenario 2: 25 users/MC, 10 users/SC, total of 825 users No mobility, full buffer model

Table 5.1: *General simulation parameters*

we simulate 525 users that are initially attached to only macro cells. In the second scenario 'HetNets', besides the users in the coverage of macro cells as in first scenario, we simulate 300 more users that are initially associated to small cells. See Figure. 5.2 for an example of UEs' distribution, where blue dots refer to the users. Macro and small cells are in green and red respectively. We evaluate different sub optimization problems, as discussed in III. For each configuration, 20 simulation sets were run with different users distributions.

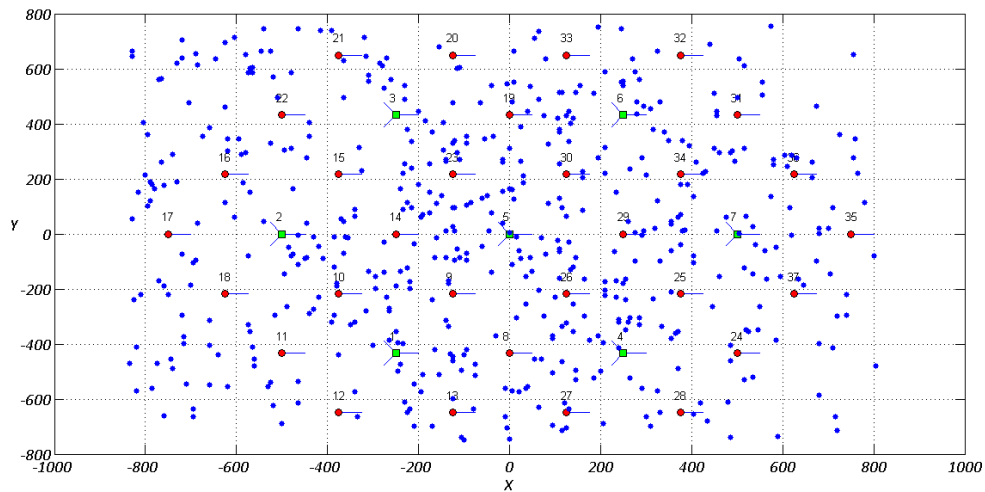

Figure 5.2: *Example of a users' distribution.*

## 5.2 Disjoint Frequency Sub-band Optimization

### 5.2.1 Specific optimization settings

As shown in Figure. 4.4, we consider frequency sub-bands with various possible size for two scenarios: (i) macros only and (ii) **HetNets**. Table. 5.2 defines the sampling parameters.

<b>Optimization sampling</b>	$F \in \{3, 4, 5, 6, 7\}, T = 1$ and $\bar{O}_{k,k'} = 0$ $\text{MC\_Power\_per\_RB} \in \{0, 0.8\}$ $\text{SC\_Power\_per\_RB} \in \{0, 0.02\}$
------------------------------	--

Table 5.2: *Frequency sub-bands optimization - sampling parameters*

### 5.2.2 Results

Results of frequency sub-bands optimization are presented in Tables 5.3 and 5.4. The gains are computed against the case of frequency reuse-1. Figures 5.3 and 5.4 depict the **CDF** statistics of average user throughput. Results show that:

- we obtain about 14% gain in average user throughput which increases from 301 kbps in the case of static reuse-1 to 345 kbps using the 7 sub-bands dynamic optimization in macros only scenario. In **HetNets**, the average throughput gain is around 25%, due to the presence of small cells in the coverage of macros. In general, we notice that the gains are increasing with the number of frequency sub-bands. For macros only scenario, the average throughput difference between each optimization configuration is less than 4%. From ( $F=6$ ) to ( $F=7$ ), the gain is almost the same, with less than 1% difference. For **HetNets** scenario, very good results are obtained since the 3 sub-bands optimization.
- compared to reuse-1, median throughput is increased by 36% and 45% in homogeneous et heterogenous networks, respectively with the 7 sub-bands dynamic

$T=1$	Static reuse-1	$F=3$	$F=4$	$F=5$	$F=6$	$F=7$
Avg-user-Th (kbps)	301.7	316.2	328.7	335.6	342.4	345.6
<b>Gain %</b>	–	<b>+4.8%</b>	<b>+9%</b>	<b>+11.2%</b>	<b>+13.5%</b>	<b>+14.6%</b>
Median-Th (kbps)	223.8	252.7	290.5	294.3	302.1	304.7
<b>Gain %</b>	–	<b>+12.9%</b>	<b>+29.8%</b>	<b>+31.5%</b>	<b>+35%</b>	<b>+36.1%</b>
Cell-edge-Th (kbps)	38.9	43.7	54.7	55	54.8	56
<b>Gain %</b>	–	<b>+12.4%</b>	<b>+40.8%</b>	<b>+41.5%</b>	<b>+41.1%</b>	<b>+44.4%</b>
Avg-EE (bits/joule)	190.7	228	263.2	258.4	258	258.7
<b>Gain %</b>	–	<b>+19.6%</b>	<b>+38%</b>	<b>+35.5%</b>	<b>+35.3%</b>	<b>+35.7%</b>
Cell-edge-EE (bits/joule)	20.5	25.7	32.2	30.1	29.5	30.2
<b>Gain %</b>	–	<b>+25%</b>	<b>+57%</b>	<b>+47%</b>	<b>+44%</b>	<b>+47%</b>

Table 5.3: *Disjoint frequency sub-bands optimization results - Only Macros*

optimization. In first scenario, we notice a significant gap from the 3 sub-bands to the 4 sub-bands case, then the median throughput gain slows down from the 4 sub-bands to the 7 sub-bands configurations. In **HetNets**, an improvement of more or less 5% from one optimization configuration to the next one.

- we reach about 40% gain in cell edge throughput for both macros and **HetNets** scenarios with our optimization algorithm. This significant improvement is due to a better inter-cell interference mitigation. Using a dynamic frequency sub-band pattern, neighboring cells schedule their users in different sub-bands which limits strongly the interference especially for cell edge users. In both scenarios, we observe similar performance in the gains obtained from our dynamic frequency sub-bands optimization as the gain significantly improves from ( $F=3$ ) to ( $F=4$ ) and then slightly increases in the remaining configurations.

$T=1$	Static reuse-1	$F=3$	$F=4$	$F=5$	$F=6$	$F=7$
Avg-user-Th (kbps)	381.4	458.4	464	462.4	474.3	477
<b>Gain %</b>	–	<b>+20.1%</b>	<b>+21.6%</b>	<b>+21.2%</b>	<b>+24.3%</b>	<b>+25%</b>
Median-Th (kbps)	243	314.9	330.3	335.8	347.3	351.7
<b>Gain %</b>	–	<b>+29.6%</b>	<b>+35.9%</b>	<b>+38.2%</b>	<b>+42.9%</b>	<b>+44.7%</b>
Cell-edge-Th (kbps)	40.4	49.5	54.5	55.4	57.9	58.5
<b>Gain %</b>	–	<b>+22.6%</b>	<b>+34.9%</b>	<b>+37%</b>	<b>+43.2%</b>	<b>+44.8%</b>
Avg-EE (bits/joule)	365.6	583.1	583.1	561.8	588.2	588.2
<b>Gain %</b>	–	<b>+59.5%</b>	<b>+59.5%</b>	<b>+53.6%</b>	<b>+60.9%</b>	<b>+60.9%</b>
Cell-edge-EE (bits/joule)	20.5	31.1	32.2	31.8	33.5	33.3
<b>Gain %</b>	–	<b>+51.2%</b>	<b>+56.7%</b>	<b>+54.7%</b>	<b>+63.2%</b>	<b>+62%</b>

Table 5.4: *Disjoint frequency sub-bands optimization result - HetNets*

This can be explained by the trade-off between throughput loss when muting some resources for one cell, and interference decrease for the neighboring cells which would improve the channel quality especially for cell edge users. In the case of the 3 sub-bands configuration, as a result of the optimization, at most only 1 sub-band of 16 or 18 RBs is muted per cell, which corresponds to a third of the available bandwidth. In the other sub-bands configuration, it could happen that 2 or even more sub-bands are muted for some cells. In general, the optimized size of muted sub-bands does not exceed the half of the bandwidth.

- average energy efficiency is improved by 35% and 60% for macros and **HetNets** scenarios, respectively. As we don't use power boosting in this frequency sub-bands optimization, the power transmission on one resource block is either zero or equal to the maximum power per RB (0.8 W for MC and 0.02 W for SC).

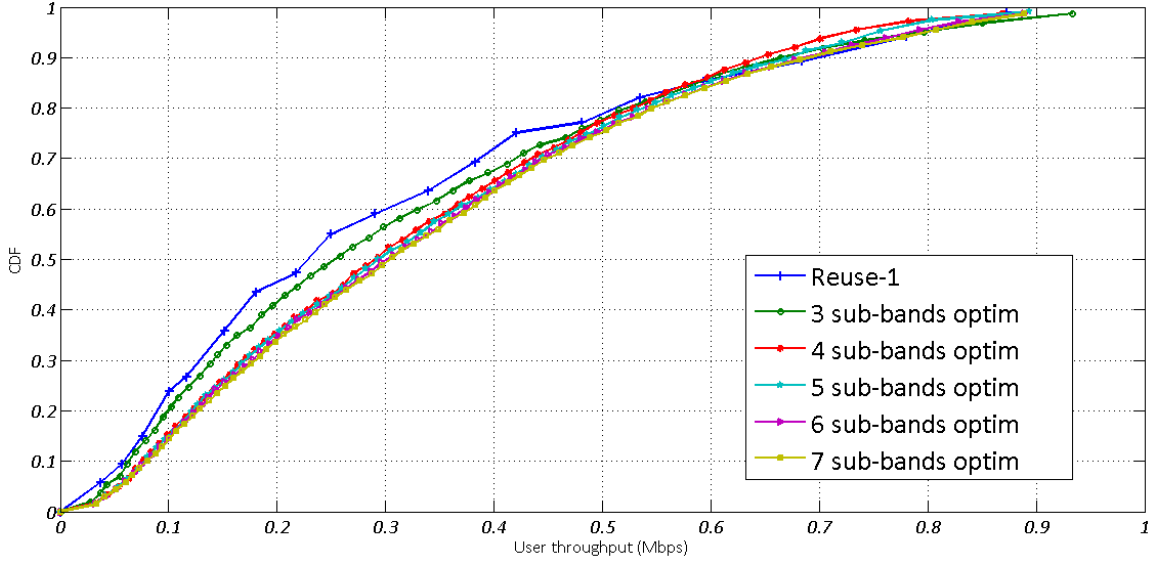

Figure 5.3: *CDF user throughput (Freq Optim vs Reuse-1)- Macros.*

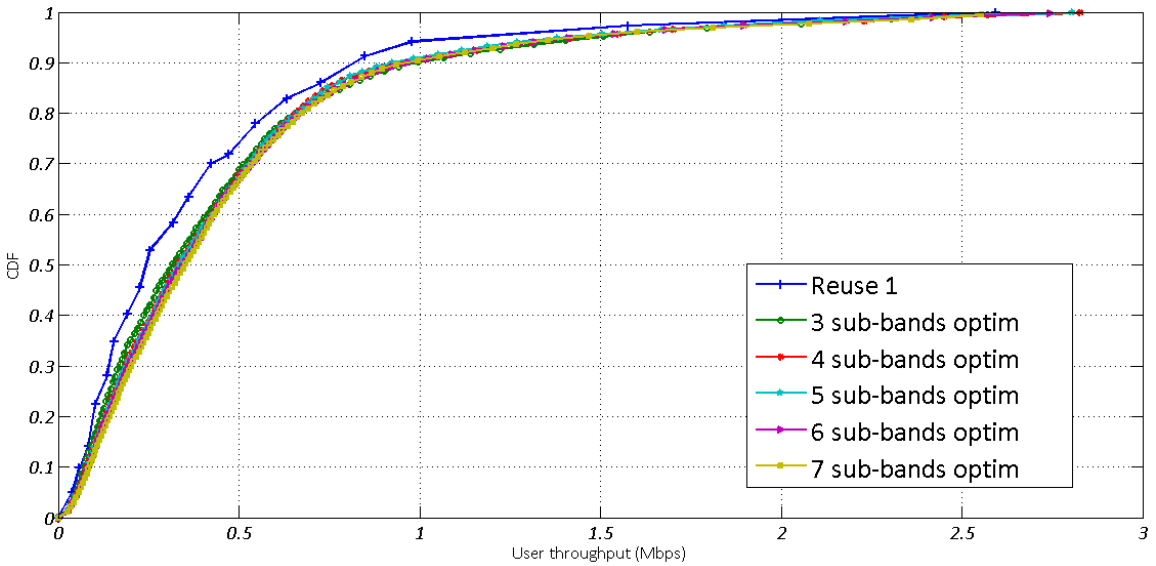

Figure 5.4: *CDF user throughput (Freq Optim vs Reuse-1)- HetNets.*

On one hand, when some sub-bands are muted, the sum of powers on all other sub-bands is inferior to the maximum of power of the cell, thus leads to energy saving. On the other hand, muting some resources on one cell permits its neighboring cells to have better spectral efficiency on the muted sub-band and then to transmit more data to their attached users. We also see the increase of the average energy efficiency from the macros only scenario to **HetNets** scenario.

- with proper frequency resource optimization, cell edge energy efficiency increases about 50% and 60% for macros and **HetNets** scenarios, respectively.

We can conclude that dynamic frequency sub-bands optimization always outperforms static frequency reuse-1 scheme in terms of user throughput and energy efficiency. The gains obtained using our proposed framework are increasing with the number of frequency sub-bands.

### 5.3 Disjoint Power Levels Optimization

#### 5.3.1 Specific optimization settings

Table. 5.10 defines the sampling parameters. We fix the number of sub-bands to 3 and study the impact of power optimization for both (i) macros only and (ii) **HetNets** scenarios. For each scenario, we have 3 configurations:

- 2 power levels per RB: 0 and 0.8 watts for macro cell and 0 and 0.02 watts for small cell.
- 4 power levels per RB: 0, 0.4, 0.8 and 1.2 watts for macro cell and 0, 0.01, 0.02 and 0.03 watts for small cell.
- 5 power levels per RB: 0, 0.4, 0.8, 1.2 and 1.6 watts for macro cell and 0, 0.01, 0.02, 0.03 and 0.04 watts for small cell.

<b>Optimization sampling</b>	$F = 3, T = 1$ and $\bar{O}_{k,k'} = 0$ MC_Power_per_RB $\in \{0, 0.4, 0.8, 1.2, 1.6\}$ SC_Power_per_RB $\in \{0, 0.01, 0.02, 0.03, 0.04\}$
------------------------------	---

Table 5.5: *Power levels optimization - sampling parameters*

$F=3, T=1$	2 power levels	4 power levels	5 power levels
avg-user-Th (kbps)	316.2	330	331.1
<b>Gain %</b>	<b>+4.8%</b>	<b>+9.4%</b>	<b>+9.8%</b>
Median-Th (kbps)	252.7	263.4	268.5
<b>Gain %</b>	<b>+12.9%</b>	<b>+17.7%</b>	<b>+20%</b>
cell-edge-Th (kbps)	43.7	55	61.3
<b>Gain %</b>	<b>+12.4%</b>	<b>+41.5%</b>	<b>+57.9%</b>
avg-EE (bits/joule)	228	217.2	218.1
<b>Gain %</b>	<b>+19.6%</b>	<b>+13.9%</b>	<b>+14.4%</b>
cell-edge-EE (bits/joule)	25.7	24.3	25.2
<b>Gain %</b>	<b>+25%</b>	<b>+18.4%</b>	<b>+23%</b>

Table 5.6: *Disjoint power levels optimization result - only Macros*

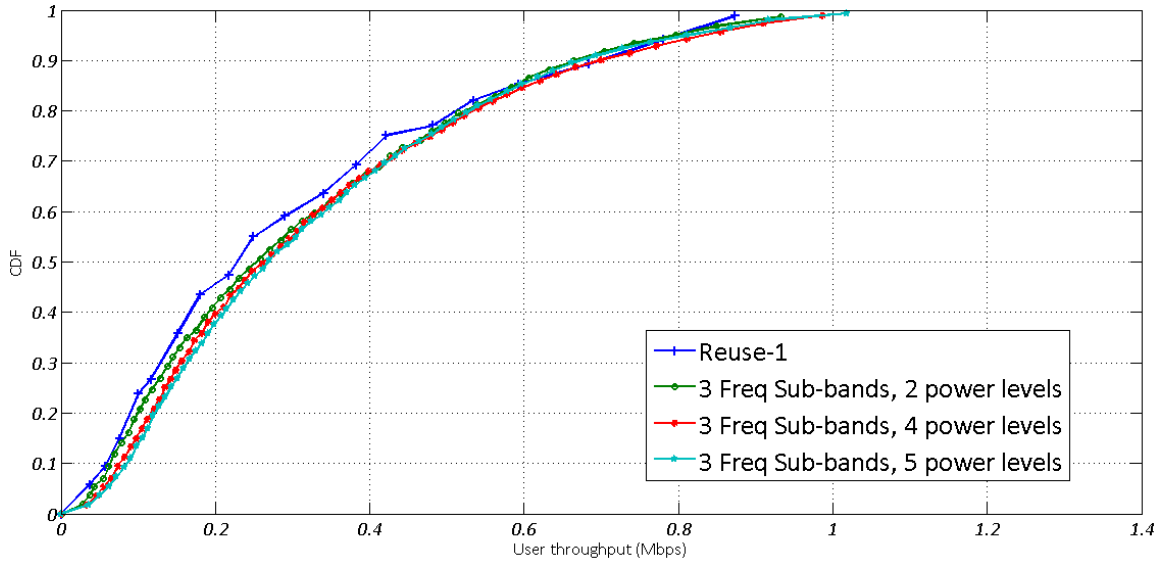

Figure 5.5: *CDF user throughput (Power levels optimization vs Reuse-1) - Macros.*

### 5.3.2 Results

The results are given in Table 5.6 and 5.7. The gains are computed in comparison to the frequency static reuse-1 configuration. Figures 5.5 and 5.6 depict the CDF statistics of average user throughput.



$F=3, T=1$	2 power levels	4 power levels	5 power levels
avg-user-Th (kbps)	458.4	458.6	465
<b>Gain %</b>	<b>+20.1%</b>	<b>+20.2%</b>	<b>+21.9%</b>
Median-Th (kbps)	314.9	311.4	320
<b>Gain %</b>	<b>+29.6%</b>	<b>+28.1%</b>	<b>+31.6%</b>
cell-edge-Th (kbps)	49.5	56.9	62
<b>Gain %</b>	<b>+22.6%</b>	<b>+40.9%</b>	<b>+53.6%</b>
avg-EE (bits/joule)	583.1	485.4	470.6
<b>Gain %</b>	<b>+59.5%</b>	<b>+32.8%</b>	<b>+28.7%</b>
cell-edge-EE (bits/joule)	31.1	28.3	27.3
<b>Gain %</b>	<b>+51.2%</b>	<b>+37.7%</b>	<b>+33%</b>

Table 5.7: Power levels optimization result - HetNets

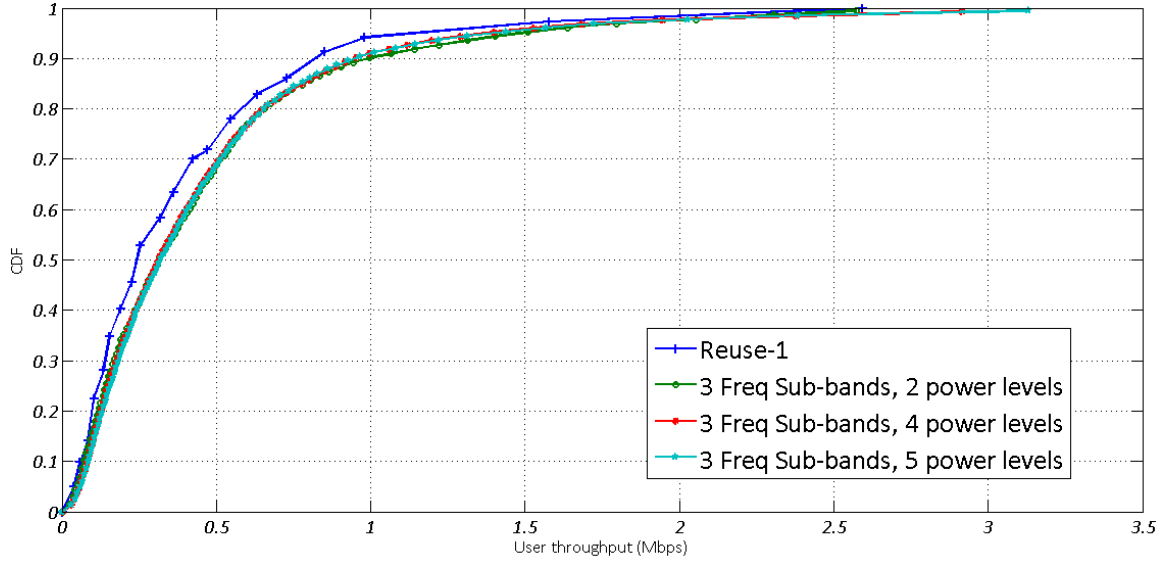

Figure 5.6: CDF user throughput (Power levels optimization vs Reuse-1) - Hetnets.

The simulation results show that:

- average and median throughputs are quite the same in the three different configurations for **HetNets** and slightly increase for macros only.
- power levels optimization further improves the cell edge user throughput. We notice that by moving from 2 to 5 power levels, we get 45% more gain in macros

only scenario and 30% more gain in **HetNets**.

- average and cell edge energy efficiencies are more or less decreasing when we increase the power levels. It means that the network is transmitting with more power than the case of only 2 power levels. Generally speaking, the optimal settings are either to boost the power on some sub-bands or to choose a low power level different from zero. As the average throughput is almost stable and the average energy efficiency is decreasing, we can say that the network is consuming more power but not transmitting more data in the system. However, the cell edge user throughput is increasing when using more power levels.

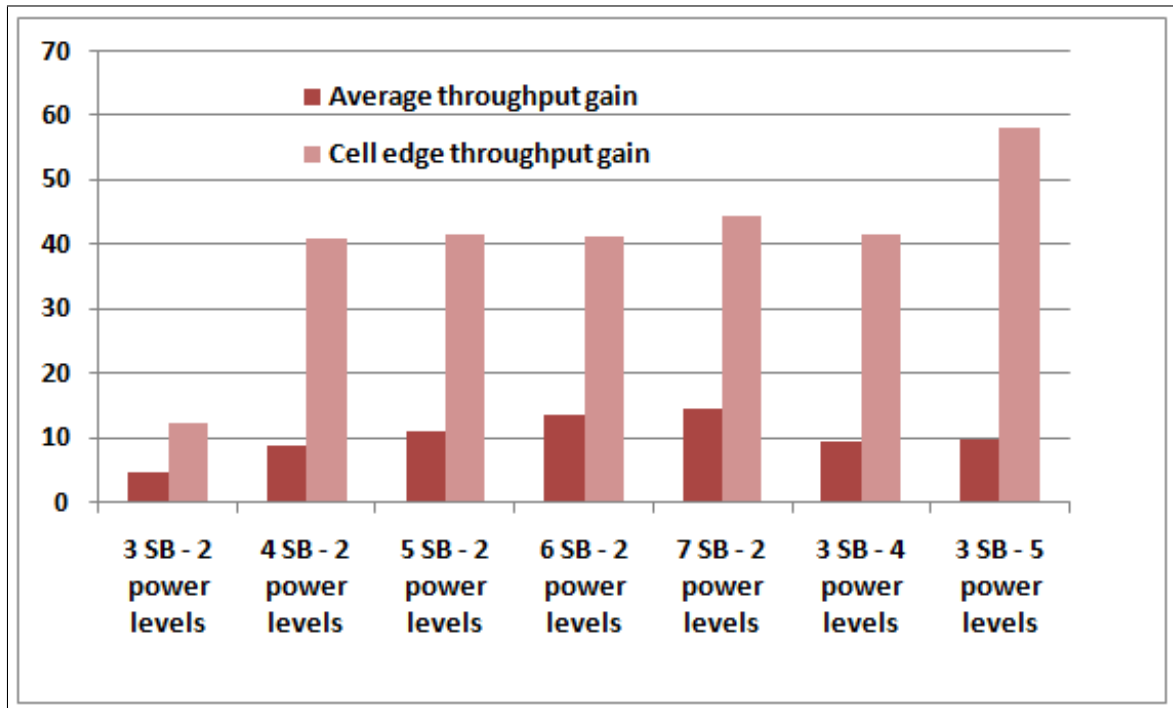

Figure 5.7: *Average and cell edge throughput gains - only Macro.*

Fig. 5.7 and Fig. 5.8 overview the average and cell edge throughput gains in the macros only and **HetNets** scenarios, respectively. We regroup all the frequency sub-bands and power levels optimization results for comparison. Generally speaking, we observe that our proposed algorithm outperforms the frequency reuse-1 scheme.

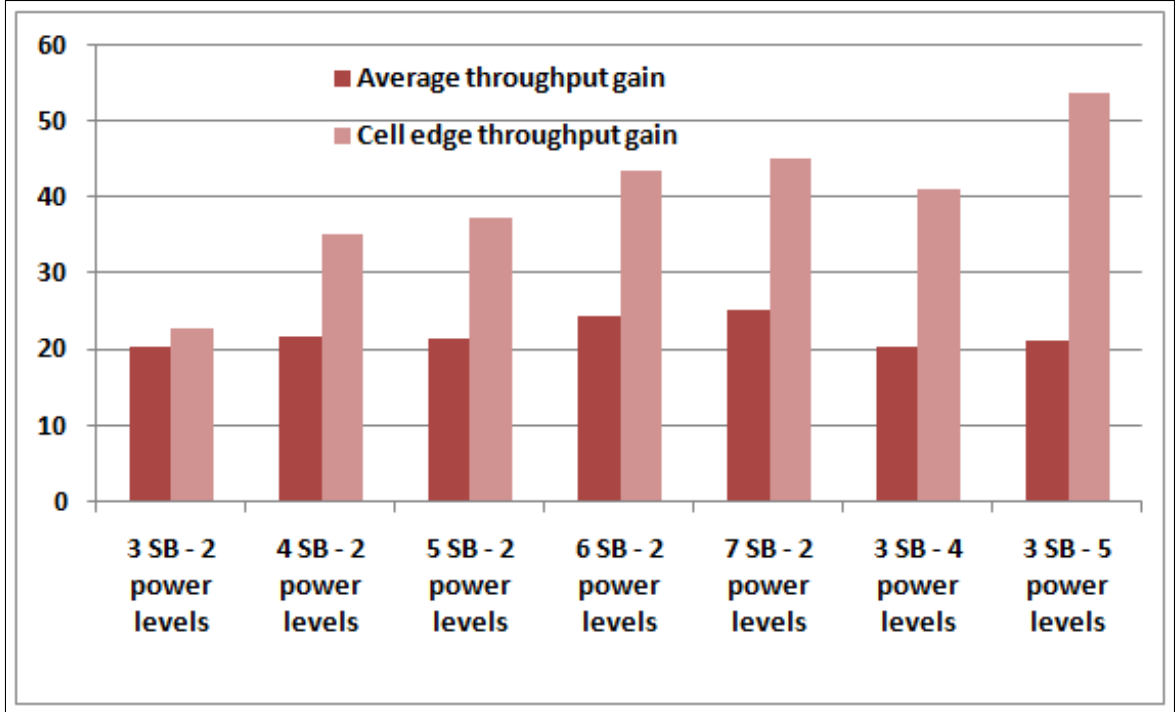

Figure 5.8: Average and cell edge throughput gains - HetNets.

The 7 sub-bands algorithm optimization results in the best average user throughput. The cell edge user throughput is maximized with the 5 power levels optimization algorithm. Further enhancement can be expected at the cost of higher computation complexity.

## 5.4 Almost Blank Sub-frames Optimization

### 5.4.1 Specific optimization settings

Time resource optimization via Almost Blank Sub-frames consists in defining for each macro cell a power pattern of 40 sub-frames over the whole bandwidth. In the muted sub-frames, i.e, when corresponding power patten equals to 0, the macro eNB is not allowed to send traffic channels. To limit the number of possible configurations, we regroup the sub-frames into equal sized slots: (i) 4 time slots, each containing 10 sub-frames, (ii) 8 time slots and each slot is composed of 5 sub-frames.

Table. 5.8 defines the sampling parameters.

<b>Optimization sampling</b>	$F = 1, T \in \{4, 8\}$ and $\bar{O}_{k,k'} = 0$ $MC\_Power\_per\_RB \in \{0, 0.8\}$ $SC\_Power\_per\_RB = 0.02,$
------------------------------	---

Table 5.8: *ABS optimization - sampling parameters*

#### 5.4.2 Results

The simulations results are summarized in Table 5.9 along with the case where is no **ABS** optimization. The **CDF** of average user throughput is presented in Figure. 5.9.

<b><math>F=1</math></b>	<b>No optim</b>	<b><math>T=4</math></b>	<b><math>T=8</math></b>
avg-user-Th (kbps)	381.4	442.3	461.3
<b>Gain %</b>	–	<b>+15.9%</b>	<b>+20.9%</b>
Median-Th (kbps)	243	302.2	330
<b>Gain %</b>	–	<b>+24.4%</b>	<b>+35.7%</b>
cell-edge-Th (kbps)	40.4	49.7	54.9
<b>Gain %</b>	–	<b>+22.9%</b>	<b>+35.9%</b>
avg-EE (bits/joule)	365.6	527.8	541.3
<b>Gain %</b>	–	<b>+44.3%</b>	<b>+48%</b>
cell-edge-EE (bits/joule)	20.5	29.6	31.5
<b>Gain %</b>	–	<b>+43.9%</b>	<b>+53.6%</b>

Table 5.9: *Disjoint ABS optimization result*

Disjoint **ABS** optimization enhances the network performance, as we obtain:

- gains of 16%, 24% and 23% in average, median and cell edge throughput respectively, using the 4 time slots optimization. This improvement is even more important with the second simulation configuration, i.e, using 8 time slots of 5 sub-frames. Choosing the optimal **ABS** for each macro cell, permits to mitigate the inter-cell interference and enhance user throughput. Muting certain

macro cells during some time slots, allows their neighboring SC to schedule their attached UEs, which are strongly interfered by the MC, in the protected sub-frames. The other UEs located at the cell center are scheduled over all sub-frames since the interference experienced from the macro eNBs is negligible compared to the signal of the SC.

- about 50% of gain in average and cell edge energy efficiency. The increase of transmitted bits per joule is much important than the throughput gains. This implies that with the ABS optimization, the cells are transmitting more data using lower power during the simulation. Muting some macro cells permits to decrease the power consumption but not at the cost of users throughput.

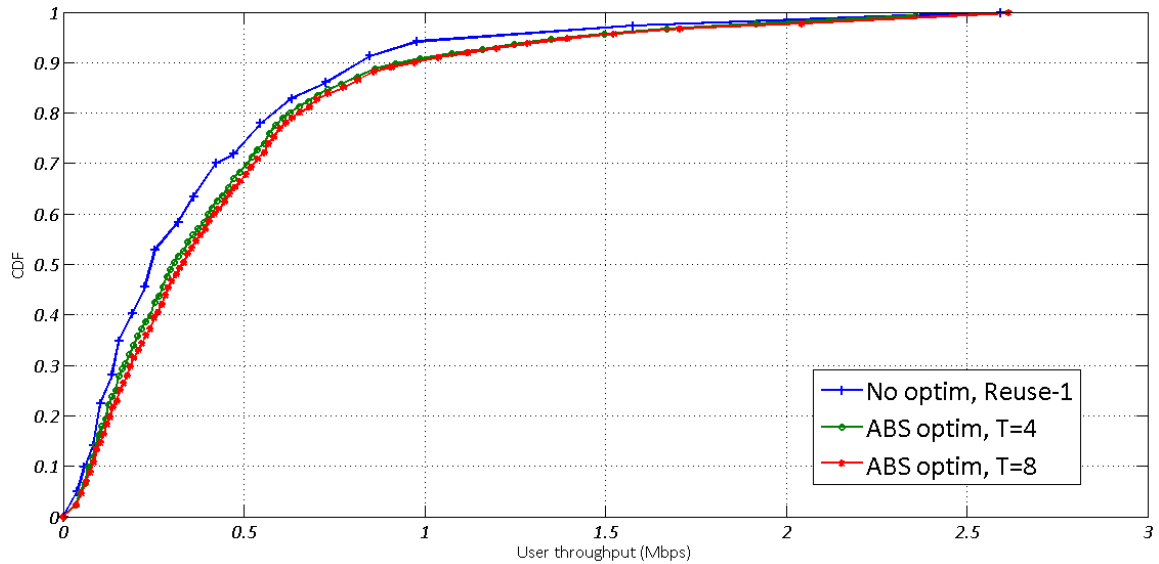

Figure 5.9: *CDF user throughput (ABS Optim vs Reuse-1)- HetNets.*

## 5.5 User Association & Resource Allocation Optimization

### 5.5.1 Specific optimization settings

To study the impact of user association using cell individual offset, we made multiple simulations using the first scenario, i.e, all the users are initially attached to macro cells.

<b>Optimization sampling</b>	$F \in \{1, 3, 4\}, T = 1$ and $\bar{O}_{k,k'} \in \{0, 5, -5\}$ $MC\_Power\_per\_RB \in \{0, 0.8\}$ $SC\_Power\_per\_RB \in \{0, 0.02\}$
------------------------------	---

Table 5.10: *CIO & Frequency sub-bands optimization - sampling parameters*

The results are presented in Table 5.11 for various configurations:

- Static reuse of 1 and no optimization is performed in the coordinator,
- Disjoint user association optimization using CIOs,
- Joint CIO optimization and Frequency sub-bands optimization.

### 5.5.2 Results

When performing disjoint CIO optimization, average and median throughputs increases slightly from 301 to 321 kbps and from 223 to 231 kbps, respectively. This is due to the change in CIO values and hence associating some UEs to SCs offering them higher bandwidth. However, the cell edge users remain highly interfered by MCs which continue to transmit with maximum power over the bandwidth as there is no interference mitigation in this case. This strong inter-cell interference is the reason behind the decrease of the cell edge throughput compared to the first configuration where is no CIO optimization.

The best performance are given by the joint optimization of CIO and frequency sub-bands optimization. We note that, using CIO and 4 frequency sub-bands optimization, the gains obtained in average and median throughput reach 20% and 37% respectively. Cell edge throughput is increased by 27%. Significant improvement in average and cell edge energy efficiency are also achieved. This optimization allows to offload traffic from MCs and to have an efficient distribution of the resources among the neighbouring cells which leads to better users experience.

$T=1$	Static reuse-1	CIO optim $F=1$	CIO optim $F=3$	CIO optim $F=4$
Avg-user-Th (kbps)	301.7	321.7	349.6	360
<b>Gain %</b>	–	<b>+6.7%</b>	<b>+15.9%</b>	<b>+19.4%</b>
Median-Th (kbps)	223.8	231.8	275.9	306.7
<b>Gain %</b>	–	<b>+3.6%</b>	<b>+23.3%</b>	<b>+37%</b>
Cell-edge-Th (kbps)	38.9	34.7	40.1	49.5
<b>Gain %</b>	–	<b>-10.7%</b>	<b>+3.3%</b>	<b>+27.4%</b>
Avg-EE (bits/joule)	190.7	200.7	255	282.1
<b>Gain %</b>	–	<b>+5.2%</b>	<b>+33.8%</b>	<b>+48%</b>
Cell-edge-EE (bits/joule)	20.5	18.9	23.4	27.5
<b>Gain %</b>	–	<b>-8.1%</b>	<b>+56.7%</b>	<b>+54.7%</b>

Table 5.11: *User association and resource allocation optimization result*

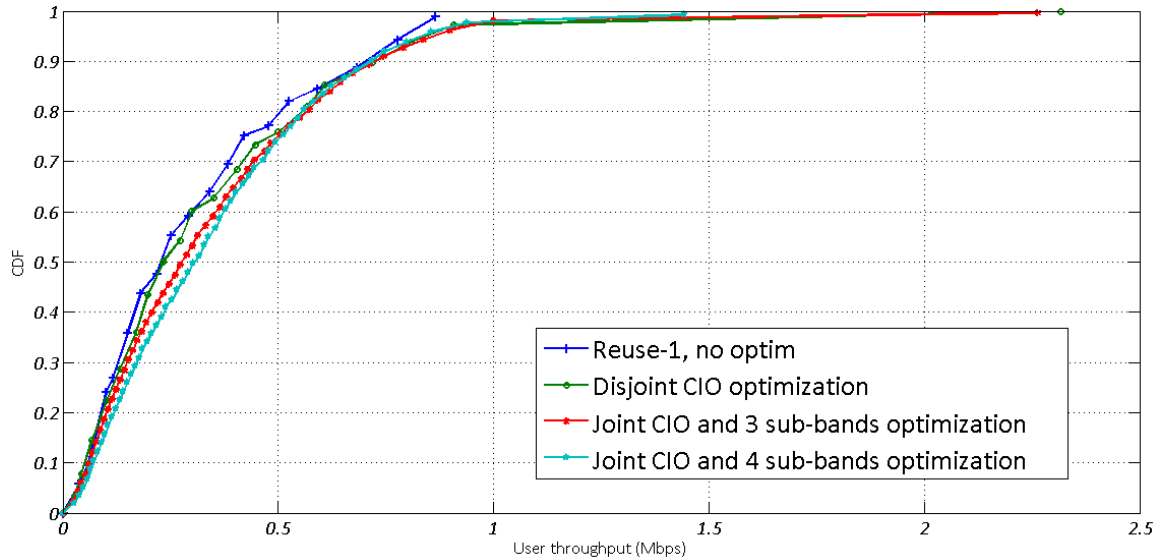

Figure 5.10: *CDF user throughput (CIO and Frequency Resource Optimization vs Reuse-1).*

## 5.6 From X2-Proxy to SDN Controller

Besides the validation of the proposed game theoretic framework through matlab simulations, we needed to demonstrate the feasibility of the approach and its performance with an actual prototype. In the following, we present the first prototype version called X2-proxy, then we describe second version within a **SDN** controller.

### 5.6.1 X2Proxy

X2-proxy presents itself as a virtual **eNB** without actual radio resources. It connects to all other **eNBs** via the standard X2 interface. It can then monitor the network and provide advanced functions to optimize network performance. X2-proxy processing consists of 4 phases:

- *initialization phase*: during this phase, X2-Proxy establishes X2 connections with all other **eNBs** using X2 signaling above Stream Control Transmission Protocol (**SCTP**). Then it sends X2 measurements requests to all connected base stations.
- *measurement phase*: each **eNB** sends regular X2 resource status updates to X2-Proxy. The latter stores collected data into its own database, which is kept updated. Generally, the information sent from the **eNBs** concern user association settings (**CIO** values, actual attachments, etc.), resource allocation (**ABS**, power pattern, frequency usage) and users measurements (**RSRP**, **CQI**).
- *optimization phase*: at some point in time, X2-proxy freezes its database and starts the optimization using the algorithm previously described. **CIO** vectors and power patterns are derived for each **eNB** connected to X2-Proxy.
- *emph execution phase*: in this final phase, the optimized settings are transmitted from X2-proxy to each **eNB** via X2 interface.



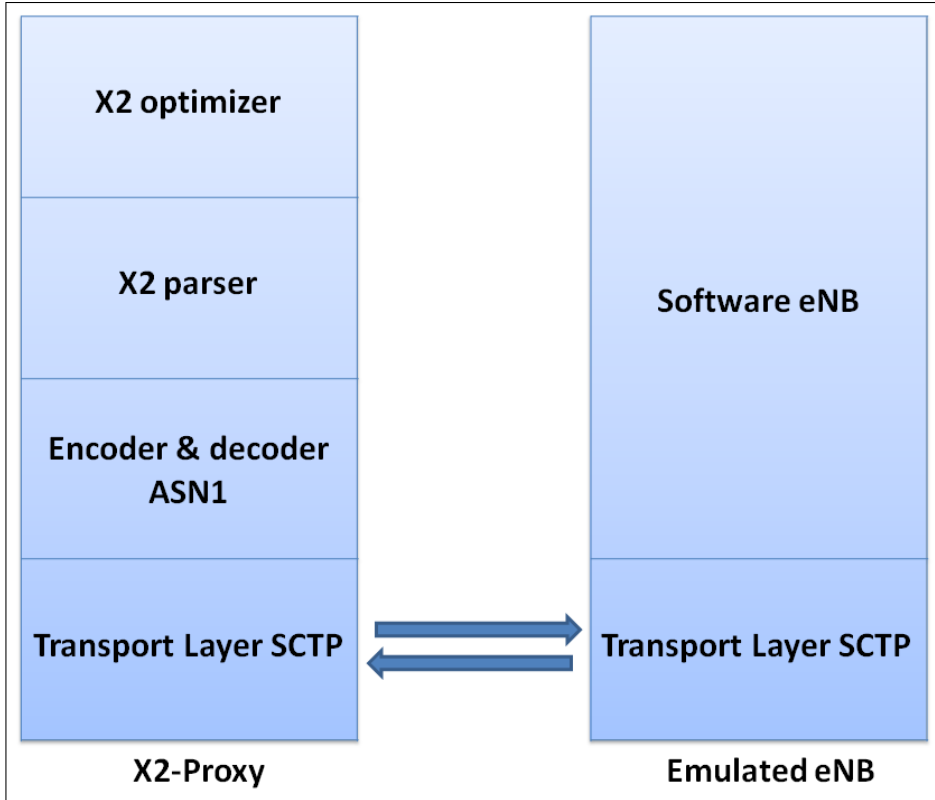

Figure 5.11: *X2-Proxy architecture.*

The internal architecture of X2-proxy is composed of 4 layers (See Figure. 5.11): Transport layer that is in charge of forwarding X2 messages. The second layer encodes or decodes X2 messages. X2 Parser creates X2 structure and fills in this structure with related information. The fourth layer of X2-proxy is the X2 optimizer which provides advanced optimization functions.

A proof of concept (X2-Proxy For eICIC : Enabling 4G Dense Network Optimization) has been showcased during the Bell Labs Open Days 2013. Refer to Appendix. B, Figure. B.1 for the poster.

### 5.6.2 SDN-based Prototype

Inspired by SDN and OpenDayLight (ODL) we build a prototype using ODL controller and emulated base stations. Our proposed optimization algorithm is then deployed as a North Bound (NB) application [36]. This architecture, illustrated by Fig-

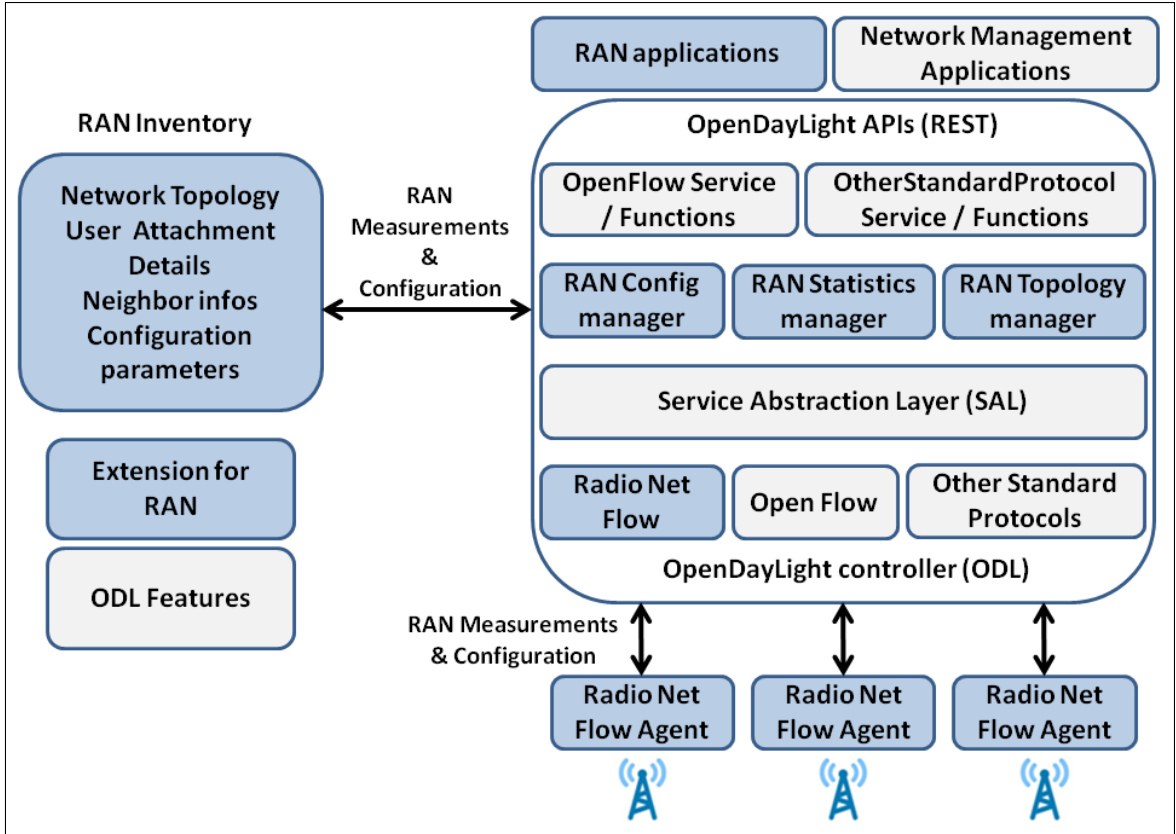

Figure 5.12: *SDN Platform for RAN architecture.*

ure. 5.12, closely follows the **SDN** paradigm by providing global network view using a logically centralized controller. Our optimizer can use the controller’s **NB** Application Programming Interface (**API**)s to discover existing network topology, retrieve **RAN** measurements and configuration parameters, and re-configure the **eNBs** using optimal settings. **SDN** controller uses Radio Net Flow (**RNF**) as a South Bound (**SB**) protocol. The corresponding protocol agent called Radio Net Flow Agent (**RNFA**) can be integrated into base stations to communicate with **SDN** controller. In the Service Abstraction Layer (**SAL**) of **ODL**, we can distinguish three principal service modules: **RAN** Configuration Manager, **RAN** Statistics Manager, and **RAN** Topology Manager. Through **RNF**, they can collect data and send configurations to the **eNBs**. We introduced **RAN** Inventory that is an external database to maintain long term network state history. The **RAN** Inventory is illustrated by Figure. 5.13. **RAN**

Network Topology
<pre>{ _id:&lt;objectid1&gt; Name: "RAN Topology" Attached eNodeBs: ["eNB-Id", " ", ...] Neighbour_eNB_Info: {eNB-Id: [Neighbour eNB-Id,..]} }</pre>
Interference and Config Info
<pre>{ _id:&lt;objectid2&gt; Name: "RAN Interference Info" eNBId: "eNB-Id" Neighbours: ["Neighbour eNB-Id",..] Attached_Users: [ "UE-Id", ..] ABS: "Current ABS Pattern in eNB" Optimized_ABS: "Optimized ABS from Optimizer" Pathloss: ["Neighbour eNB-Id": Pathloss-value, ..] Cio: ["Neighbour eNB-Id": CIO-value, ..] Optimized_CIO: ["Neighbour eNB-Id "CIO-value, ..] }</pre>

Figure 5.13: *RAN inventory in database.*

service modules are responsible of updating the **RAN** Inventory. The optimizer application, called **eICIC** optimizer can access the **RAN** Inventory to retrieve network informations via **NB REST APIs**.

This **SDN**-based prototype architecture (shown in Figure. 5.14) permits the separation of control decisions between the **SDN** controller and the **eNBs**, in order to facilitate flexible and dynamic network management and optimization.

To validate our proposed prototype, we use Matlab based LTE-compliant simulator to emulate the cellular networks. At some point, the simulator connects with the **eNBs** emulators via User Datagram Protocol (**UDP**) messages to exchange measurements and information. The IP addresses and ports of the emulated **eNBs** are known by the simulator. An initial connection is done to send the information of network topology, including a list of all cells in the cluster, their neighboring **eNBs**, and the maximum transmission power of each cell. During optimization iteration, the Matlab

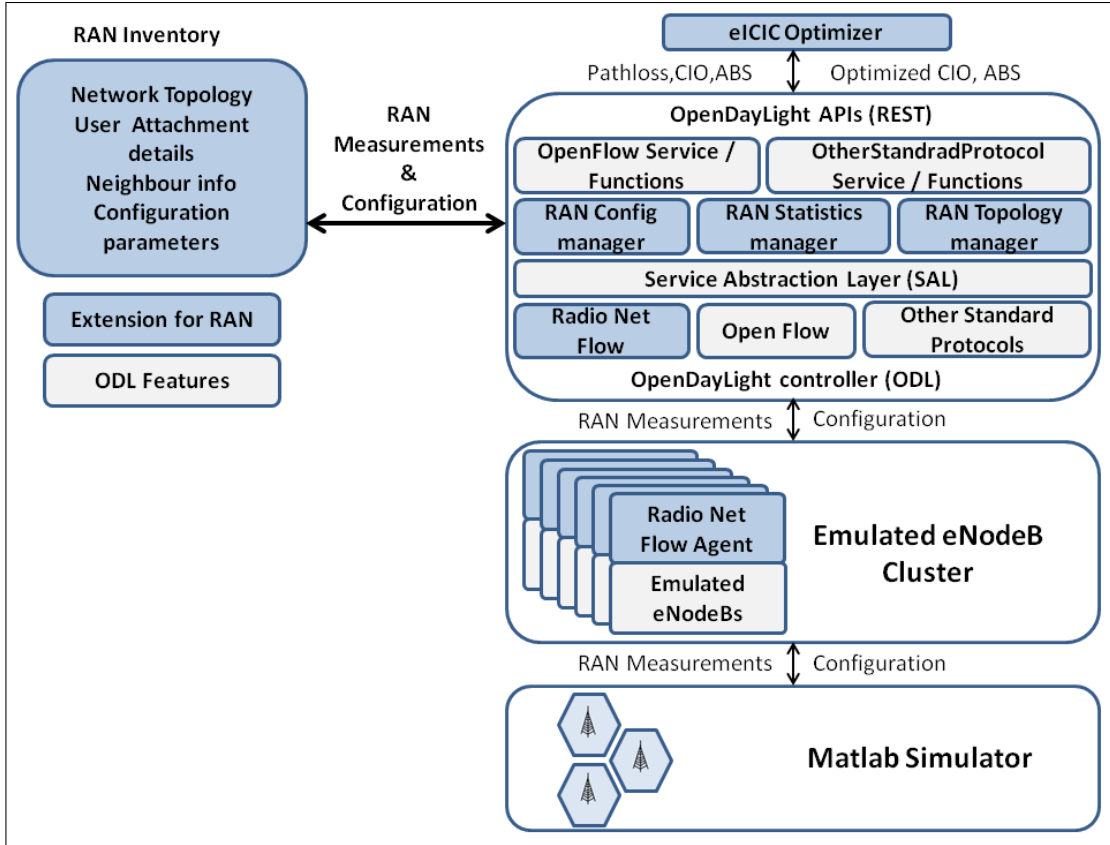

Figure 5.14: *Prototype for performance validation.*

simulator creates **UDP** socket and sends any updated messages for each **eNB**: the **CIO** values, the power patterns, the attachment of mobiles users, and the channel conditions. All these messages are then sent via **SCTP** from the **eNBs** to the **ODL** to be stored at the **RAN** Inventory. The optimizer therefore sends requests using **REST APIs** to retrieve the information needed to conduct optimization iterations. After computing the optimal settings, the optimizer sends them back to the **eNBs** via **SB** interface. For example, in the case of jointly **CIO** and **ABS** optimization, **CIO** re-configuration can trigger handovers and maintain a load balanced network. Optimized **ABS** ratio permits to coordinate the use of the available resource and mitigate inter-cell interference.

In the performance validation of the framework, we used a 16-core server to execute the **SDN** controller, **RAN** Inventory and the optimizer application. We measured

the latency between the control node and BSs. For 30 BSs, it takes about 2.7 ms to completely update the **RAN** Inventory for each cycle of updates from all the BSs and about 1.5 ms to send back the optimized parameters from the **SDN** controller to reach all the BSs after the optimization. In the validation scenario, we have time budget of 50 ms for applying optimal parameters to the BSs, so our **SDN** design can satisfy the time requirement for user association and resource allocation optimization. The latency increases steadily when the number of BSs increases which indicates that the proposed architecture is scalable.

A proof of concept (CLOUD RAN: Scalable and flexible cloud-driven Radio Access Network platform) has been showcased during the Bell Labs Future X Days 2015. Refer to Appendix. **B**, Figure. **B.2** for the poster.

## **5.7 Conclusion**

In this chapter, we presented the simulation settings and performance results of different optimization configurations. We also provided a detailed description of the framework prototype.

## CHAPTER VI

### Conclusion

Due to the exponential data traffic growth experienced in last decade, homogeneous LTE cellular networks face hard limits in terms of capacity and bandwidth and can no longer meet the users' requirement nor ensure higher quality services at a reasonable cost. To address this issue and cope with the limited amount of spectrum, small cells are currently deployed complementary to macro cells coverage layer. HetNets are seen as a promising approach to increase the network capacity via the higher spatial reuse of spectrum. However, two main challenges are facing HetNets: user association and Inter-cell Interference Management.

Generally speaking, current studies and solutions are often limited in their scope and don't handle the problem with high deployment flexibility.

Based on a potential game setup, we propose a practical solution to optimize the user-cell association and to coordinate inter-cell interference among multiple cells in LTE. The algorithm is based on a 2-tiers approach consisting of a logically centralized coordinator and local schedulers in the eNBs. Simulations results prove that this framework can provide optimal cell individual offsets and power settings over frequency and time resources for each cell to maximize a network utility. We observe that the proposed algorithm outperforms the frequency reuse-1 scheme and achieves substantial enhancement in user throughput and energy efficiency.

It should be noted that the method presented could be also useful for other resource allocation optimization problems and different criteria of similar systems.

As future work, we plan to:

- integrate the traffic profile of the users and consider user satisfaction. Some QoS parameters can be integrated to the virtual scheduler for example to take into account required minimum throughput for each user.
- study eNBs clusterization to distribute the computation tasks correspondingly. It is possible to have fully centralized, distributed or hybrid architectures, using the same optimization approach as described in this work. Obviously, there are trade-offs among the computational complexity in each cluster depending on its size, the amount of message exchanges, and the performance loss from a centralized to a fully distributed architecture.

## APPENDICES



## APPENDIX A

### Résumé de la Thèse

#### *1- Introduction*

Au cours de la dernière décennie, les services et applications mobiles sont devenus un élément essentiel de la vie des usagers. Le nombre d'abonnés mobiles a connu une croissance rapide et le trafic de données mobiles a presque doublé chaque année. Le rythme de croissance devrait se poursuivre au cours des prochaines années avec le lancement continu de nouvelles applications gourmandes en données. Comme la demande de plus de bande passante et de capacité ne cesse d'augmenter, les réseaux actuels sont entrain d'atteindre leurs limites. Les fournisseurs de service doivent trouver des solutions rentables et écologiques pour gérer ce niveau de croissance. Heureusement, il existe aujourd'hui plusieurs techniques que les opérateurs peuvent exploiter. Dans cette thèse, nous explorons l'une de ces solutions les plus populaires améliorant la capacité du réseau, c.à.d. les réseaux hétérogènes. L'introduction des petites cellules dans la couverture des macros permet d'utiliser efficacement le spectre disponible et d'augmenter ainsi la capacité du réseau. Cependant, ces réseaux hétérogènes sont confronté à deux principaux défis, à savoir l'association des mobiles aux stations de bases et gestion des interférences entre les différentes cellules.

## *2- Motivations*

Les réseaux cellulaires actuels sont généralement des réseaux homogènes constitués d'un ensemble de stations de bases appelées Macros ayant des caractéristiques similaires, tels que les niveaux de puissance d'émission, les modèles d'antenne, etc. Ces macros sont généralement placées dans un motif régulier sur une zone. Les stations de base sont soigneusement configurés pour maximiser la couverture, atténuer les interférences avec d'autres stations de base, et pour assurer un nombre à peu près équivalent de mobiles connectés à chaque cellule. Pourtant, les opérateurs sont aujourd'hui confronté à un défi technologique important avec le déluge de la consommation des données.

Jusqu'à ces dernières années, les réseaux homogènes ont réussi à optimiser la couverture et à gérer le trafic de données. La performance des réseaux LTE a été améliorée en termes de débit de données et de latence, grâce aux progrès dans l'interface de l'air, en utilisant des multi-antennes à l'émission et réception et grâce à une modulation et des schémas de codage plus efficace. Toutefois, en raison de l'augmentation exponentielle du nombre d'appareils connectés, de la croissance rapide du trafic de données et de la demande pour des débits plus élevés, les réseaux homogènes atteignent leurs limites.

Une des stratégies d'amélioration de capacité les plus connues est l'utilisation de cellules plus petites qui permet d'augmenter la réutilisation des fréquences. Le réseau des macros peut aussi être densifié en ajoutant plus de secteurs par site macro ou en déployant plus de stations de bases. Cependant, il devient plus difficile et coûteux de trouver de nouveaux sites de macro. Les réseaux cellulaires hétérogènes (HetNets) ont été proposées par la 3GPP pour augmenter l'efficacité spectrale. En général, dans les réseaux homogènes, le déploiement des macros est effectué de façon à minimiser les chevauchements entre les cellules et à assurer une couverture continue pour tous les utilisateurs du réseau. Les HetNets changent fondamentalement cette notion en

superposant la couche macro avec des stations de base à faible puissance tout en gardant des coûts d'infrastructure assez faible.

L'émergence des HetNets a donné lieu à essentiellement deux défis de gestion de réseaux.

Le premier concerne l'association des mobiles aux stations de bases. Dans les réseaux cellulaires traditionnels, l'utilisateur se connecte habituellement à la station qui émet le signal le plus fort. Dans les réseaux hétérogènes, avec des stations de bases émettant à des niveaux de puissance très différents, seuls quelques usagers seront servis par les petites cellules à faible puissance d'émission. L'attachement des mobiles aux stations ayant le signal le plus fort est souvent sous-optimal ou même négatif à la performance du système, puisque nous sous-utilisons les petites cellules. Une politique intelligente d'association d'utilisateurs et plus adaptée à cette nouvelle architecture, est donc nécessaire. Pour résoudre ce problème, on peut systématiquement élargir la zone desservie par les petites cellules. Ce mécanisme, illustré sur la figure 1.5 est appelé Extension de la couverture cellulaire. Pour associer plus de mobiles aux petites cellules, un offset est ajouté aux mesures RSRP reportés par les mobiles. Cela permet de forcer certains utilisateurs, en particulier ceux en bordure de cellule, à s'associer aux petites cellules les plus proches. Cela résulte en un réseau plus équilibré en termes de nombres de mobiles par cellule. Une question que nous allons aborder dans ce travail est l'optimisation des valeurs des offsets.

Le deuxième défi HetNets est la gestion des interférences afin d'améliorer la qualité des signaux. Contrairement à l'interférence intra-cellulaire qui est négligeable dans les réseaux LTE grâce à l'utilisation de OFDM et OFDMA, l'interférence inter-cellulaire est généralement sévère due à la réutilisation des bandes de fréquences entre les cellules voisines. Notez que l'utilisation de l'extension de la couverture cellulaire dans les HetNets pourrait également générer des interférences inter-cellulaire plus élevée, en particulier pour les utilisateurs qui changent leur attachement de macro à petites

cellules. Il est essentiel de veiller à ce que la réutilisation du spectre ne conduit pas à des scénarios élevés d'interférence dans les réseaux LTE. Pour atténuer l'interférence inter-cellules, la 3GPP a spécifié plusieurs techniques de gestion d'interférence comme l'ICIC et l'eICIC. En général, les techniques de ICIC sont limités au domaine de la fréquence et / ou de puissance, par exemple diviser la largeur de bande de fréquence en plusieurs sous-bandes pour les cellules adjacentes ou bien utiliser des niveaux de puissance différents. eICIC se concentre sur le domaine temporel par le biais de l'ABS. Cette technique a pour but d'interdire une macro d'émettre pendant des durées spécifiques de telle sorte que les petites cellules voisines puissent transmettre avec un minimum d'interférences.

Comme on peut le comprendre, l'association des utilisateurs et l'atténuation des interférences sont étroitement liées puisque les ressources disponibles pour chaque cellule sont liées au nombre d'utilisateurs réellement attachés à la cellule et leurs demandes de trafic. De meilleures stratégies de sélection des cellules et des techniques plus avancées pour la gestion des interférences et une coordination efficaces des ressources peuvent améliorer les débits des utilisateurs et l'efficacité spatiale dans les réseaux LTE.

### ***3- Contributions***

#### ***3.1- Formulation du Problème***

Nous considérons un réseau cellulaire LTE composé par  $K$  cellules :  $M$  macros cellules et  $N$  micros/petites cellules, où  $N \geq 0$  afin de modéliser les réseaux homogènes et hétérogènes. Chaque station de base  $k$  a  $S$  sous-trames dans le domaine temporel et  $R$  blocs de ressources fréquentielles. Les blocs de ressources fréquentielles sont groupés en  $F$  sous-bandes fréquentielles. De la même manière, nous organisons les  $S$  sous-trames en  $T$  tranches temporelles. Dans la formulation de ce problème, nous ne considérons que les transmissions descendantes, c'est à dire de la station de base vers le mobile. L'objectif est de maximiser l'utilité globale du réseau (par exemple,

la somme des logarithmes des débits des utilisateurs) en utilisant les variables de décisions suivantes.

- $\bar{O}_k := (\bar{O}_{k,1}, \bar{O}_{k,2}, \dots, \bar{O}_{k,N_k})$  : Vecteur d'offsets à ajouter aux mesures RSRP pour définir la règle d'attachement des utilisateurs aux stations de bases.
- $P_k = (P_{k,1,1}, P_{k,2,1}, \dots, P_{k,F,1}, P_{k,1,2}, \dots, P_{k,F,2}, \dots, P_{k,F,T})$  : Vecteur de puissance par tranche temporelle et sous-bande fréquentielle.

Nous proposons la formulation générale du problème d'optimisation :

---

### Algorithm 5 Problème d'optimisation général

---

L'objectif est de maximiser  $\sum_{u \in \mathcal{U}} \log(r_u(s))$

avec les conditions suivantes :

$$r_u = \sum_{k=1}^K q_{u,k} \frac{1}{S} \sum_{t=1}^T \sum_{f=1}^F \left[ \tau_{u,k,f,t} \times B \log\left(1 + \frac{P_{k,f,t} G_{u,k,f,t}}{\eta_u + \sum_{l \neq k} P_{l,f,t} G_{u,l,f,t}}\right) \right]$$

$$q_{u,k} = \begin{cases} 1 & \text{si } \forall k' \in N_k, \overline{RSRP}_{u,k} > \overline{RSRP}_{u,k'} + \bar{O}_{k,k'} \\ 0 & \text{sinon.} \end{cases}$$

$$\sum_{f=1}^F P_{k,f,t} \leq P_k^{\max}, \quad \forall t \in \{1, 2, \dots, T\}, \quad \forall k \in \mathcal{K}$$

$$P_{k,f,t} \leq R_f \times \frac{P_k^{\max}}{R}, \quad \forall t \in \{1, 2, \dots, T\}, \quad \forall f \in \{1, 2, \dots, F\}, \quad \forall k \in \mathcal{K}$$

$$\sum_{u \in \mathcal{U}_k} \tau_{u,k,f,t} \leq R_f \times S_t$$

---

A partir de cette formalisation générale du problème, nous pouvons spécifier des sous problèmes, en effectuant de simples modifications ou restrictions aux paramètres du problème général.

- Optimisation de l'allocation fréquentielle : Nous éliminons la dimension temporelle du problème général en prenant  $T$  égal à 1 et en considérant que chaque cellule suit un même schéma de puissance tout le temps. Aussi, nous limitons

les niveaux de puissance possible par sous-bande de fréquence à 2 valeurs uniquement : soit 0, soit la puissance maximale.

- Optimisation des niveaux de puissance : Nous éliminons la dimension temporelle et fixons la taille des sous-bandes fréquentielles. L'optimisation se fait en jouant avec les valeurs de puissance possibles par bloc de ressource.
- Optimisation de l'allocation des ressources temporelles : Nous définissons pour chaque cellule  $k$  un pattern binaire pour toute la largeur de bande qui détermine les trames durant laquelle la station a le droit d'émettre. Pour ce faire, nous effectuons des restrictions au problème originel : regrouper tous les RBS en une seule sous-bande de fréquence,  $F=1$ .
- Optimisation de l'attachement des utilisateurs : Il est possible d'appliquer des politiques déjà utilisées par l'opérateur (ou d'en définir d'autres en ajoutant des paramètres de mobilité, de vitesse, ou encore de classe d'utilisateurs) et d'utiliser le résultat de l'attachement dans le reste de l'optimisation. Le problème peut également être limité en imposant une valeur unique d'offset à appliquer vers tous les voisins d'une cellule donnée :  $\bar{O}_k = constant$ .
- Fonction d'utilité : L'utilisation de la somme logarithmique des débits est un exemple parmi tant d'autres. Aucune contrainte sur les caractéristiques de la fonction du coût à choisir. D'autres paramètres peuvent être pris en compte telles que la vitesse de l'utilisateur ou son trafic et le débit minimum requis.

### ***3.2- Modèle de la Solution Proposée***

Nous présentons une approche basée sur la théorie des jeux et utilisant un jeu de potentiel convergeant vers une solution optimale. Nous commençons donc par modéliser le problème formulé pour l'optimisation de l'attachement des mobiles et la coordinations de l'interférence inter-cellulaire comme un jeu non coopératif où les

stations de bases représentent les joueurs. La stratégie de chaque joueur est définie comme un couple de variables décisionnelles :  $\bar{O}_k$  and  $P_k$ . Nous montrons que la fonction  $U(.)$ , définie dans la partie précédente, est une fonction de potentiel et que le jeu non coopératif est un jeu de potentiel qui est connu d'avoir des propriétés intéressantes, i.e., l'existence d'un équilibre de Nash et la convergence de l'algorithme "Meilleure réponse" (Best Response) vers cet équilibre en un nombre fini d'itérations.

L'idée générale de l'algorithme d'optimisation que nous proposons est :

- on commence par un état d'initialisation arbitraire
- A chaque itération, les variables décisionnels sont choisis d'une façon jointe afin de maximiser une fonction d'utilité
- Après un nombre fini d'itérations, le système converge vers l'équilibre de Nash qui peut être une solution optimale localement.

Afin d'effectuer cette optimisation, nous définissons un modèle 2-tiers qui consiste essentiellement en 3 étapes :

- Chaque mobile renvoie ses mesures sur l'état du canal à sa station de base servante. Ces mesures peuvent être agrégées au niveau de l'eNB en regroupant les mesures similaires. Puis chaque station renvoie ces informations à un coordinateur qui effectuera l'optimisation. Ce coordinateur peut être une entité centrale avec une vue globale sur tout le réseau ou bien distribuée qui se rattache à une cellule (ou groupe de macro + les petites cellules en sa couverture).
- Le coordinateur utilise la base de données contenant l'état du système (ou du sous-système qu'il contrôle) afin d'optimiser les variables d'offsets et de puissance à allouer pour les ressources. Commencant par un état initial, le coordinateur sélectionne une cellule aléatoirement. Ensuite, il teste toutes les combinaisons possibles des 2 variables à optimiser, tout en respectant les conditions mentionnées dans la formulation du problème. Pour chaque combinaison,

le coordinateur vérifie si l'attachement des mobiles pourrait être virtuellement modifié à cause d'un changement d'offset. Aussi, il effectue une allocation des ressources virtuelle basée sur le choix du pattern de puissance. Ensuite, il calcule l'utilité. Après avoir testé toutes les combinaisons possibles, le coordinateur choisit la combinaison optimale : celle qui maximise l'utilité, ou bien en utilisant Gibbs (celle avec une certaine probabilité de distribution). Le coordinateur va réitérer ces actions en choisissant à chaque fois une nouvelle cellule jusqu'à ce que l'utilité globale du système converge vers l'équilibre.

- A la fin de l'optimisation, le coordinateur renvoie les paramètres optimisés aux stations de bases concernées. Les valeurs d'offset sont rajoutées aux RSRP pour initier de possibles changements d'attachement. Les ordonnanceurs locaux vont allouer leurs ressources tout en respectant les patterns de puissance envoyés par le coordinateur.

### ***3.3- Résultats***

Pour émuler le réseau LTE, nous avons utilisé un simulateur LTE sur MATLAB développé par l'Institut des Télécommunications de l'Université Technique de Vienne. Pour évaluer les performances de la solution proposée, nous avons effectué des simulations pour différents scénarios pour les réseaux homogènes et hétérogènes. :

- Scénario de base : attachement des mobiles à la station de base offrant le signal le plus fort et réutilisation des ressources avec facteur 1 entre les cellules.
- Optimisation disjointe de l'allocation des sous-bandes fréquentielles
- Optimisation disjointe des niveaux de puissance
- Optimisation disjointe des ressources temporelles
- Optimisation jointe de l'attachement des usagers et de l'allocation des ressources



Nous avons par la suite mesuré les débits moyens, les débits des utilisateurs en bordure de cellule, ainsi que l'efficacité énergétique. Les résultats obtenus sont récapitulés dans la suite.

- L'optimisation dynamique de l'utilisation des sous-bandes fréquentielles surpasse en terme de performance le scénario de base. Les gains en débit et énergie augmentent en fonction du nombre des sous-bandes. Pour les réseaux homogènes, nous obtenons des résultats presque optimaux à l'optimisation avec 4 sous-bandes. Alors que en Hetnets, il suffit d'utiliser 3 sous-bandes.
- L'optimisation des niveaux de puissance impacte particulièrement les débits en bordure de cellule. En passant de 2 niveaux à 5 niveaux de puissance, nous obtenons 45 % et 30 % de gains dans les réseaux homogènes et hétérogènes respectivement. Par contre, l'efficacité énergétique diminue légèrement en augmentant le nombre de niveaux de puissance.
- En configurant des patterns de tranches temporelles pour limiter les transmissions des macros, cela permet d'obtenir des gains supérieurs à 15 % et 22 % en débit moyen et en débit pour les utilisateurs en bordure de cellules. L'efficacité énergétique est améliorée d'environ 50 % ce qui signifie que les stations de bases transmettent plus de données en utilisant moins de puissance.
- L'optimisation disjointe des valeurs des offsets permet d'augmenter le débit utilisateur moyen. Toutefois, les mobiles en bordure de cellule, restent fortement interféré par les macros. Les meilleures performances sont obtenues par l'optimisation conjointe des CIO et de l'allocation des sous-bande de fréquences. Cette optimisation permet de balancer le trafic entre les macros et les petites cellules et d'avoir une distribution efficace des ressources fréquentielles entre les cellules voisines qui conduit à une meilleure expérience pour les utilisateurs.

### ***3.4- Prototype***

En plus de la validation de notre approche via les simulations matlab, nous avons développé un prototype afin de démontrer la faisabilité et la performance de la solution proposée.

La première version du prototype, nommée X2-proxy se présente comme une station de base virtuelle mais qui ne possède aucune ressource radio. X2-proxy se connecte aux autres nodes via l'interface X2 afin de contrôler le réseau et fournir des fonctionnalités d'optimisation avancées. L'architecture interne du X2 proxy est composée de 4 couches : la première couche est la couche transport responsable de l'envoi des messages X2. La deuxième couche se charge du codage et décodage des messages X2. X2 Parser crée les structures des messages X2 et les remplit avec les informations appropriées. La couche supérieure est celle de l'optimiseur.

Une deuxième version du prototype a été développée en se basant sur le modèle SDN. Notre optimiseur est en fait déployé comme une application du contrôleur SDN qui possède une vision globale du réseau. De ce fait, l'optimiseur peut utiliser les interfaces du coordinateur afin de découvrir le réseau et sa topologie, de collecter les mesures et paramètres de configuration, et pour reconfigurer les stations de bases en utilisant des paramètres optimisés. Nous avons introduit une base de données extérieure qui stocke les mesures et informations du réseau. Cette architecture permet la séparation des décisions de control entre le contrôleur et les eNBs afin de faciliter la gestion dynamique du réseau et rendre son optimisation plus flexible. Afin de valider ce prototype, nous avons utilisé un simulateur LTE sur matlab pour émuler la configuration d'un réseau cellulaire. A un moment donné, le simulateur se connecte aux simulateurs des stations de base via des messages UDP pour échanger les mesures et informations requises. Les adresses IP et ports des stations de bases émulées sont préalablement connus au niveau du simulateur. Une première connexion est faite pour envoyer la topologie du réseau, incluant une liste des cellules, leurs voisins et leurs

puissances d'émission. Ensuite, le simulateur crée des sockets UDP pour envoyer toute mise à jour de la part des eNBs, par exemple les valeurs des offsets pour l'attachement des usagers, ou bien les niveaux de puissance par ressource, les conditions du canal de transmission, etc. Tous ces messages sont envoyés via SCTP des stations de bases émulsés au contrôleur SDN pour être stockés dans la base de données. L'optimiseur envoie alors des requêtes en utilisant les REST API, pour retirer les données mises à jour et commencer l'optimisation.

#### ***4- Conclusion***

Basé sur un jeu de potentiel, nous proposons une solution générales pour optimiser l'association des mobiles aux stations de base et la coordination entre les cellules pour gérer les interférences dans les réseaux homogènes et hétérogènes. L'algorithme proposé fournit des paramètres optimaux d'offsets et de puissances alloués pour chaque cellule afin de maximiser l'utilité du réseau. Nous observons que l'algorithme proposé surpasse la réutilisation des fréquences avec facteur 1 et réalise plus de 50 % de gains en débits en bordures de cellules ainsi qu'une amélioration aussi importante pour le débit et l'efficacité énergiques moyens.

Les contributions de ce travail sont énumérés ci-dessous :

- Nous avons formulé le problème d'association mobile/cellule et de gestion d'interférence inter-cellules en utilisant un jeu de potentiel.
- nous avons proposé une solution dynamique optimisant les valeurs d'offsets et un pattern des puissance de transmission pour maximiser l'utilité du réseau.
- nous avons effectué des séries de simulation afin d'étudier les performances de notre solution. Les résultats de simulation ont montré une amélioration significative des débits ainsi que de l'efficacité énergétique.
- nous avons développé un prototype de l'optimisation qui se connecte à un contrôleur SDN.

## APPENDIX B

### Bell Labs Open Days Posters



# X2 PROXY FOR eICIC : ENABLING 4G DENSE NETWORK OPTIMIZATION

Increase your cellular network performance by cellular densification

## Challenge.....

Cellular networks follow an exponential development requiring strong densification of traditional macro cells by small cells (metro and picos). This densification induces interference issues -tight radio planning of small cells is not an option- and handover issues -standard user attachment favours most powerful eNB -macro- to the detriment of less powerful eNBs -metros, femtos-. How can we optimize these two parameters in a dynamic, efficient and scalable manner?

## Innovation.....

The innovative architecture introduces a new key element called the "X2 proxy", basically a server, that connects to all eNBs to collect data, process optimization task and return optimal parameters. The solution uses standardized X2 interface to collect statistics and report recommended parameters, offloads optimization processing from the eNBs and therefore enables a "fast track" deployment with limited interoperability tests.

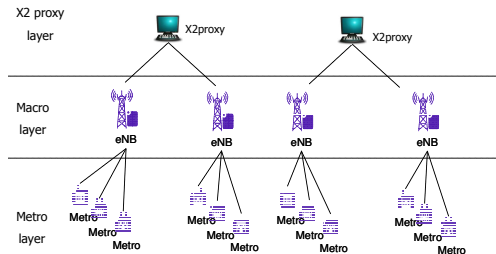

In addition to the X2 interoperability, the X2 brings nice features like: message frequency up to 1Hz and message extensibility via private information elements.

Although this approach could be used for many data collection and optimization scenarios, it is here proposed to solve a very hot problem: heterogeneous network densification via 3GPP release 10 time diversity "Almost Blank Subframe".

## Use case.....

The optimization algorithm is based on state of the art game theory and offers various performance points in convergence speed, global optimality and stability. Two cases are presented, one based on "best response algorithms" favouring fast convergence to local optimum and "stochastic relaxation" favouring global optimum with slower convergence.

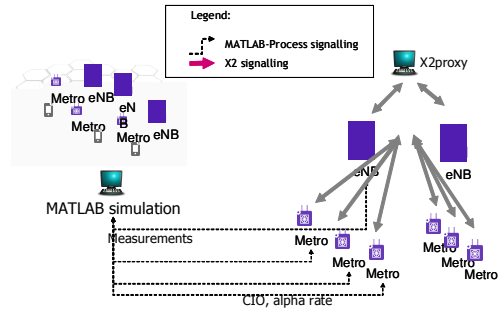

The demonstration will be showcased on an ultra-realistic heterogeneous network radio scenario located Paris down-town and modelled in Matlab while the messaging based on X2 and the optimization process of the main eICIC parameters (Cell Individual Offset and duty factor) will be run on discrete machines in real-time.

The demonstration will display the 3 main steps: (1) data collection via X2, (2) optimization search inside X2 proxy, (3) configuration execution via X2. Resulting performance gains in traffic and handover ratios are displayed on a separate GUI.

Contact(s) : [Laurent.Roulet@alcatel-lucent.com](mailto:Laurent.Roulet@alcatel-lucent.com)  
Alcatel-Lucent Bell Labs France

[YCorre@siradel.com](mailto:YCorre@siradel.com)  
Société SIRADEL

Figure B.1: X2-Proxy Poster - Bell Labs Open Days 2013.

# BELL LABS FUTURE X DAYS INVENTING THE NETWORK OF YOU

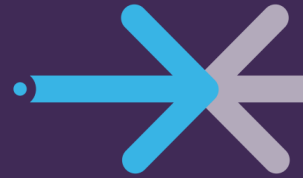

## CLOUD RAN

Scalable and flexible cloud-driven Radio Access Network platform

### Challenge . . . . .

Future radio networks will have to support many network configurations (macro, metro and femto, indoor, outdoor), various types of access waveforms (3G, 4G, 5G, wifi), a variety of devices (multimedia handsets, low rate high latency sensors, low latency machines), and very different types of communications from intensive video to sporadic small messaging, most of them probably not yet known. Radio networks will therefore need to be extremely scalable to the network size, and extremely reconfigurable to services and devices.

### Innovation . . . . .

The Cloud RAN vision is a disruptive cloud-driven wireless network architecture designed to support such flexibility in a sustainable way by "importing" several technologies from the IT industry and adapting them to the particular case of wireless networks (in terms of throughput, latency, topology):

- Software-Defined Network (OpenDayLight) is used for abstracting wireless control by introducing "network applications and services" like the X2 proxy coordinator;
- Virtualization (Docker containers and KVM virtual machines) is used for abstracting Radio Access Network and packet core functions from specialized telecom hardware and enabling telecom micro-services approach;
- IT hardware acceleration (GPU and APU) is used for offloading intensive signal processing functions (Fast Fourier Transform) to maximize energy efficiency and computing density;
- Orchestrator (Openstack) is used to dynamically map functions on IT resources;
- Shared Ethernet network is used to replace expensive point-to-point dedicated fronthaul Common Public Radio Interface links.

All resources are controlled by a "cloud manager".

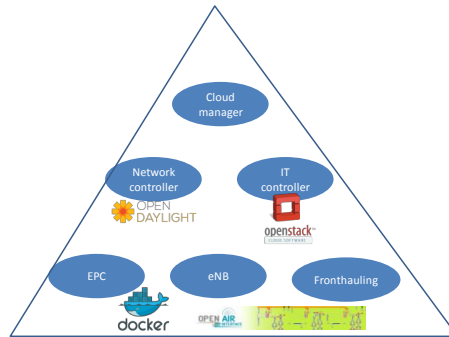

Figure 1: Cloud RAN hierarchical vision

### Usecase . . . . .

The Cloud RAN platform demonstrates several reference "radio as a service" use cases showing the elasticity of the solution: "RAN as a service", "EPC as a service" and "SDN as a service" demonstrated on inter and intra private cloud resources.

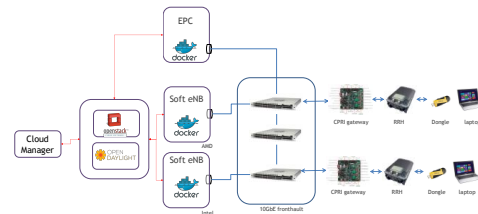

Figure 1: Cloud RAN architecture

**BENEFIT: Cloud RAN is the Bell Labs technological platform used for de-risking "cloudification" of the access network on the road to 5G. It is open for internal (BU) as well as external (start up, IRT, industry) collaborations.**

[laurent.roullet@alcatel-lucent.com](mailto:laurent.roullet@alcatel-lucent.com)  
[abdelkader.outtagarts@alcatel-lucent.com](mailto:abdelkader.outtagarts@alcatel-lucent.com) and Bell Labs  
 Software Defined Wireless Networks team

#### OUR PARTNERS

PLAN SOUVERAINTE TELECOMS (B-COM, INSTITUT MINES TELECOM, ORANGE, TDF, THALES, SYSTEMX)  
 XILINX - GREENFLOPS - EURECOM - OPEN SOURCE COMMUNITY



Figure B.2: SDN Controller Poster - Bell Labs Future X Days 2015.

## BIBLIOGRAPHY

## BIBLIOGRAPHY

- [1] 3GPP (2005), *R1-050841: Further Analysis of Soft Frequency Reuse Scheme.*, 3GPP.
- [2] 3GPP (2005), *R1-050507: Soft Frequency Reuse Scheme for UTRAN LTE.*, 3GPP.
- [3] 3GPP (2006), *R1-060135: Interference Mitigation by Partial Frequency Reuse.*, 3GPP.
- [4] 3GPP (2006), *R1-060291: OFDMA Downlink Inter-Cell Interference Mitigation.*, 3GPP.
- [5] 3GPP ETSI TS 36.300 version 10.11.0 (2013), *LTE; Evolved Universal Terrestrial Radio Access (E-UTRA) and Evolved Universal Terrestrial Radio Access Network (E-UTRAN); Overall description; Stage 2.*, 3GPP, 10 ed.
- [6] 3GPP Technical Specification Group Radio Access Network (2006), *TR 25.814: Physical layer aspects for evolved Universal Terrestrial Radio Access (eUTRA).*, 3GPP, 7 ed.
- [7] 3GPP Technical Specification Group Radio Access Network (2009), *TS 36.942: LTE; Evolved Universal Terrestrial Radio Access (E-UTRA); Radio Frequency (RF) system scenarios.*, 3GPP, 8 ed.
- [8] 3GPP TSG RAN WG1 (2010), *R1-104355: Potential performance of range expansion in macro-pico deployment*, 3GPP.
- [9] 3GPP TSG RAN WG1 (2010), *R1-103264: Performance of eICIC with control channel coverage limitation*, 3GPP.
- [10] Abaii, M., G. Auer, F. Bokhari, M. Bublin, E. Hardouin, O. Hrdlicka, G. Mange, M. Rahman, and P. Svac (2007), Winner ii deliverable d4.7.2: Interference avoidance concepts., *Tech. rep.*, Information Society Technologies.
- [11] Al-Rawi, M. (2012), A dynamic approach for cell range expansion in interference coordinated lte-advanced heterogeneous networks., in *IEEE International Conference on Communication Systems (ICCS)*, pp. 533–537, IEEE.



- [12] Andrews, J. G., S. Singh, Q. Ye, X. Lin, and H. S. Dhillon (2013), An overview of load balancing in hetnets: Old myths and open problems., *IEEE Wireless Communications*, 21(2), 18–25.
- [13] Bedekar, A. S., and R. Agrawal (2013), Optimal muting and load balancing for eicic., in *International Symposium on Ad Hoc and Wireless Networks. WiOpt*, pp. 280–287, IEEE.
- [14] Bendlin, R., T. Ekpenyong, and D. Greenstreet (2012), Paving the Path for Wireless Capacity Expansion., *White paper*, Texas Instruments.
- [15] Bonald, T., S. Borst, and A. Proutiere (2005), Inter-Cell Scheduling in Wireless Data Networks., in *European Wireless Conference*, pp. 1–7, IEEE.
- [16] Bosisio, R., and U. Spagnolini (2008), Interference Coordination Vs. Interference Randomization in Multicell 3GPP LTE System., in *Wireless Communications and Networking Conference WCNC*, pp. 824–829, IEEE.
- [17] Chen, C. S., and F. Baccelli (2012), Gibbsian method for the self-optimization of cellular networks., *EURASIP Journal on Wireless Communications and Networking*.
- [18] Chu, X., D. Lopez-Perez, Y. Yang, and F. Gunnarsson (2013), *Heterogeneous Cellular Networks: Theory, Simulation and Deployment.*, Cambridge University Press, New York, NY, USA.
- [19] Cicalo, S., V. Tralli, and A. I. Perez-Neira (2011), Centralized vs Distributed Resource Allocation in Multi-Cell OFDMA Systems., in *Vehicular Technology Conference VTC 2011-Spring*, pp. 1–6, IEEE.
- [20] Cierny, M., H. Wang, R. Wichman, Z. Ding, and C. Wijting (2013), On number of almost blank subframes in heterogeneous cellular networks., *IEEE Transactions on Wireless Communications*, 12(10), 5061–5073.
- [21] Cisco (2016), Cisco Visual Networking Index: Global Mobile Data Traffic Forecast Update, 2015–2020.
- [22] Corroy, S., L. Falconetti, and R. Mathar (2012), Dynamic cell association for downlink sum rate maximization in multi-cell heterogeneous networks., in *IEEE International Conference on Communications (ICC)*, pp. 2457–2461, IEEE.
- [23] Dahlman, E., S. Parkvall, J. Skold, and P. Beming (2008), *3G Evolution, Second Edition: HSPA and LTE for Mobile Broadband.*, 2 ed., Academic Press.
- [24] Das, S., H. Viswanathan, and G. Rittenhouse (2003), Dynamic load balancing through coordinated scheduling in packet data systems., in *INFOCOM*, pp. 786–796, IEEE.

- [25] Das, S. K., S. K. Sen, and R. Jayaram (1997), A Dynamic Load Balancing Strategy for Channel Assignment Using Selective Borrowing in Cellular Mobile Environment., *Wireless Networks*, 3(5), 333–347.
- [26] Das, S. K., S. K. Sen, and R. Jayaram (1997), CBWL: a new channel assignment and sharing method for cellular communication systems., *IEEE Transactions on Vehicular Technology*, 43(2), 313–322.
- [27] Deb, S., P. Monogioudis, J. Miernik, and J. P. Seymour (2014), Algorithms for Enhanced Inter Cell Interference Coordination (eICIC) in LTE HetNets., *IEEE/ACM Transactions on Networking*, 22(1), 137–150.
- [28] Dong, K., H. Tian, and Q. Sun (2010), A Distributed Inter-Cell Interference Coordination Scheme in Downlink Multicell OFDMA Systems., in *IEEE Consumer Communications and Networking Conf. CCNC*, pp. 1–5, IEEE.
- [29] Elayoubi, S. E., E. Altman, M. Haddad, and Z. Altman (2010), A Hybrid Decision Approach for the Association Problem in Heterogeneous Networks., in *INFOCOM*, pp. 1–5, IEEE.
- [30] Fodor, G., C. Koutsimanis, A. Rácz, N. Reider, A. Simonsson, and W. Müller (2009), Intercell Interference Coordination in OFDMA Networks and in the 3GPP Long Term Evolution System., *Journal of Communications*, 4(7), 445–453.
- [31] Fooladivanda, D., A. Al Daoud, and C. Rosenberg (2011), Joint channel allocation and user association for heterogeneous wireless cellular networks., in *International Symposium on Personal, Indoor and Mobile Radio Communications (PIMRC)*, pp. 384–390, IEEE.
- [32] Fraimis, I. G., V. D. Papoutsis, and S. A. Kotsopoulos (2010), A distributed radio resource allocation algorithm with interference coordination for multi-cell OFDMA systems., in *International Symposium on Personal Indoor and Mobile Radio Communications (PIMRC)*, pp. 1354–1359, IEEE.
- [33] Fudenberg, D. (1998), *The Theory of Learning in Games.*, MIT Press.
- [34] Fudenberg, D., and J. Tirole (1991), *Game Theory.*, MIT Press.
- [35] Gjendemsjo, A., D. Gesbert, G. E. Oien, and S. G. Kiani (2006), Optimal Power Allocation and Scheduling for Two-Cell Capacity Maximization., in *International Symposium on Modeling and Optimization in Mobile, Ad Hoc, and Wireless Networks*, pp. 1–6, IEEE.
- [36] Gopalasingham, A., L. Roullet, N. Trabelsi, C. S. Chen, A. Hebbbar, and E. Bizouarn (2016), Generalized Software Defined Network Platform for Radio Access Networks., in *IEEE Consumer Communications & Networking Conference (CCNC)*, pp. 626 – 629, IEEE.

- [37] Guvenc, I. (2011), Capacity and fairness analysis of heterogeneous networks with range expansion and interference coordination., *IEEE Communications Letters*, 15(10), 1084–1087.
- [38] Hamza, A. S., S. S. Khalifa, H. S. Hamza, and K. El-Sayed (2013), A Survey on Inter-Cell Interference Coordination Techniques in OFDMA-Based Cellular Networks., *IEEE Communications Surveys and Tutorials*, 15(4), 1642–1670.
- [39] Hanly, S. V. (1995), An algorithm for combined cell-site selection and power control to maximize cellular spread spectrum capacity., *IEEE Journal on Selected Areas in Communications*, 13(7), 1332 – 1340.
- [40] Jarraya, Y., T. Madi, and M. Debbabi (2014), A Survey and a Layered Taxonomy of Software-Defined Networking., *IEEE Communications Surveys and Tutorials*, 16(4), 1955–1980.
- [41] Jin, Y., and L. Qiu (2013), Joint user association and interference coordination in heterogeneous cellular networks., *IEEE Communications Letters*, 17(12), 2296–2299.
- [42] Jo, H.-S., Y. J. Sang, P. Xia, and J. G. Andrews (2012), Heterogeneous cellular networks with flexible cell association: A comprehensive downlink SINR analysis, *IEEE Transactions on Wireless Communications*, 11(2), 3484–3495.
- [43] Kamel, M., and K. Elsayed (2012), Performance Evaluation of a Coordinated Time-Domain eICIC Framework based on ABSF in Heterogeneous LTE-Advanced Networks., in *Global Telecommunications Conf. GLOBECOM*, IEEE.
- [44] Khan, Y., B. Sayraç, and E. Moulines (2013), Surrogate Based Centralized SON: Application to Interference Mitigation in LTE-A HetNets., in *Proceedings of the 77th IEEE Vehicular Technology Conference, VTC Spring 2013*, pp. 1–5.
- [45] Kikuchi, K., and H. Otsuka (2012), Proposal of adaptive control CRE in heterogeneous networks., in *International Symposium on Personal, Indoor and Mobile Radio Communications (PIMRC)*, pp. 910–914, IEEE.
- [46] Kim, H., G. de Veciana, X. Yang, and M. Venkatachalam (2012), Distributed  $\alpha$ -Optimal User Association and Cell Load Balancing in Wireless Networks., *IEEE/ACM Transactions on Networking*, 20(1), 177–190.
- [47] Kitagawa, K., T. Komine, T. Yamamoto, and S. Konishi (2012), Performance evaluation of handover in LTE-advanced systems with pico cell range expansion., in *International Symposium on Personal, Indoor and Mobile Radio Communications (PIMRC)*, pp. 1071–1076, IEEE.
- [48] Ko, S., H. Seo, H. Kwon, and B. G. Lee (2010), Distributed power allocation for efficient inter-cell interference management in multi-cell ofdma systems., in *Asia-Pacific Conference on Communications*, pp. 243–248, IEEE.

- [49] Kreutz, D., F. M. V. Ramos, P. Verissimo, C. E. Rothenberg, S. Azodolmolky, and S. Uhlig (2015), Software-Defined Networking: A Comprehensive Survey., *Proceedings of the IEEE*, 103(1), 14–76.
- [50] Kudo, T., and T. Ohtsuki (2013), Cell range expansion using distributed Q-learning in heterogeneous networks., *EURASIP Journal on Advances in Signal Processing*, 2013.
- [51] La, Q. D., Y. H. Chew, and B. H. Soong (2009), An Interference Minimization Game Theoretic Subcarrier Allocation Algorithm for OFDMA-Based Distributed Systems., in *Global Telecommunications Conf. GLOBECOM*, pp. 1–6, IEEE.
- [52] Lara, A., A. Kolasani, and B. Ramamurthy (2014), Network Innovation using OpenFlow: A Survey., *IEEE Communications Surveys and Tutorials*, 16(1), 493–512.
- [53] Li, G., and H. Liu (2006), Downlink Radio Resource Allocation for Multi-Cell OFDMA System., in *IEEE Transactions on Wireless Communications*, pp. 3451–3459, IEEE.
- [54] Lindbom, L., R. Love, S. Krishnamurthy, C. Yao, N. Miki, and V. Chandrasekhar (2011), Enhanced Inter-cell Interference Coordination for Heterogeneous Networks in LTE-Advanced: A Survey., *CoRR*, abs/1112.1344.
- [55] Liu, D., Y. Chen, K. K. Chai, and T. Zhang (2014), Nash bargaining solution based user association optimization in HetNets., in *IEEE Consumer Communications and Networking Conf. CCNC*, pp. 587–592, IEEE.
- [56] Liu, D., Y. Chen, K. K. Chai, T. Zhang, and E. M. (2014), Opportunistic User Association for Multi-Service HetNets Using Nash Bargaining Solution., *IEEE Communications Letters*, 18(3), 463–466.
- [57] Liu, D., L. Wang, Y. Chen, M. ElKashlan, K.-K. Wong, R. Schober, and L. Hanzo (2016), User association in 5G networks: A survey and an outlook., *IEEE Communications Surveys & Tutorials*, 18(2), 1018 – 1044.
- [58] Lopez-Perez, D., X. Chu, and I. Guvenc (2012), On the expanded region of picocells in heterogeneous networks., *IEEE Journal of Selected Topics in Signal Processing*, 6(3), 281–294.
- [59] López-Pérez, D., I. Güvenc, G. de la Roche, M. Kountouris, T. Q. S. Quek, and J. Zhang (2011), Enhanced intercell interference coordination challenges in heterogeneous networks., *IEEE Wireless Communications*, 18(3), 22–30.
- [60] MacDonald, V. H. (1979), Advanced Mobile Phone Service: The Cellular Concept., *Bell System Technical Journal*, 58(1), 15–41.

- [61] Madan, R., J. Borran, A. Sampath, N. Bhushan, A. Khandekar, and T. Ji (2010), Cell association and interference coordination in heterogeneous lte-a cellular networks., *IEEE Journal on Selected Areas in Communications*, 28(9), 1479–1489.
- [62] Mathar, R., and M. Schmeink (2002), Integrated optimal cell site selection and frequency allocation for cellular radio networks., *Telecommunications Systems*, 21(2-4), 339–347.
- [63] Mehlhruher, C., J. C. Ikuno, M. Simko, S. Schwarz, M. Wrulich, and M. Rupp (2011), The Vienna LTE Simulators - Enabling Reproducibility in Wireless Communications Research., *EURASIP Journal on Advances in Signal Processing*, 2011, 29.
- [64] Monderer, D., and L. S. Shapley (1996), Potential Games., *Games and Economic Behavior*, 14(1), 124–143.
- [65] Moon, S., B. Kim, S. Malik, C. You, H. Liu, J.-H. Kim, and I. Hwang (2015), Interference management with cell selection using cell range expansion and abs in the heterogeneous network based on lte-advanced, *Wireless Personal Communications*, 81(1), 151–160.
- [66] Nguyen, V.-G., T.-X. Do, and Y. Kim (2016), Sdn and virtualization-based lte mobile network architectures: A comprehensive survey., *Wireless Personal Communications*, 86(3), 1401–1438.
- [67] Nokia (2015), Technology Vision 2020, Executive Summary.
- [68] Nunes, B. A., M. Mendonca, X.-N. Nguyen, K. Obraczka, and T. Turetli (2014), A Survey of Software-Defined Networking: Past, Present, and Future of Programmable Networks., *IEEE Communications Surveys and Tutorials*, 16(3), 1617–1634.
- [69] Okino, K., C. Nakayama, H. Sato, and Y. Kusano (2011), Pico Cell Range Expansion with Interference Mitigation toward LTE-Advanced Heterogeneous Networks., in *IEEE International Conference on Communications Workshops (ICC)*, pp. 1–5, IEEE.
- [70] Ökvist, P., and A. Simonsson (2012), LTE HetNet trial - range expansion including micro/pico indoor coverage survey., in *Vehicular Technology Conference VTC 2012-Fall*, pp. 1–5, IEEE.
- [71] Open Networking Foundation (ONF) (2012), Software-defined networking: The new norm for networks. onf white paper.
- [72] Open Networking Foundation (ONF) (2013), Openflow-enabled mobile and wireless networks. onf solution brief.

- [73] Open Networking Foundation (ONF) (2013), Openflow specification version 1.4.0. onf specifications.
- [74] Pang, J., J. Wang, D. Wang, G. Shen, Q. Jiang, and J. Liu (2012), Optimized time-domain resource partitioning for enhanced inter-cell interference coordination in heterogeneous networks., in *Wireless Communications and Networking Conference WCNC*, pp. 1613–1617, IEEE.
- [75] Pateromichelakis, E., M. Shariat, A. ul Quddus, and R. Tafazolli (2012), On the Evolution of Multi-Cell Scheduling in 3GPP LTE/LTE-A., *IEEE Communications Surveys and Tutorials*, 15(2), 701–717.
- [76] Quek, T. Q., Z. Lei, and S. Sun (2009), Adaptive interference coordination in multi-cell OFDMA systems., in *International Symposium on Personal, Indoor and Mobile Radio Communications (PIMRC)*, pp. 2380–2384, IEEE.
- [77] Rahman, M., and H. Yanikomeroglu (2007), Multicell Downlink OFDM Sub-channel Allocations Using Dynamic Intercell Coordination., in *Global Telecommunications Conf. GLOBECOM*, pp. 5220–5225, IEEE.
- [78] Rahman, M., and H. Yanikomeroglu (2010), Enhancing Cell-edge Performance: a Downlink Dynamic Interference Avoidance Scheme with Inter-cell Coordination., in *IEEE Transactions on Wireless Communications*, pp. 1414–1425, IEEE.
- [79] Sang, A., M. Madihian, and R. D. Gitlin (2004), Coordinated load balancing, handoff/cell-site selection, and scheduling in multi-cell packet data systems., in *in Proc. of the 10th Annual International Conference on Mobile Computing and Networking (MOBICOM)*, pp. 302–314, ACM.
- [80] Sang, A., X. Wang, M. Madihian, and R. D. Gitlin (2004), A Load-aware handoff and cell-site selection scheme in multi-cell packet data systems., in *Global Telecommunications Conf. GLOBECOM*, p. 3931–3936, IEEE.
- [81] Sciancalepore, V., I. Filippini, V. Mancuso, A. Capone, and A. Banchs (2015), A semi-distributed mechanism for inter-cell interference coordination exploiting the absf paradigm., in *SECON*, pp. 193–201, IEEE.
- [82] Sesia, S., I. Toufik, and M. Baker (2011), *LTE - The UMTS Long Term Evolution: From Theory to Practice.*, Wiley.
- [83] Shen, K., and W. Yu (2014), Distributed pricing-based user association for downlink heterogeneous cellular networks., *IEEE Journal on Selected Areas in Communications*, 32(6), 1100–1113.
- [84] Shipon Ali, M. (2015), An overview on Interference Management in 3GPP LTE-advanced Heterogeneous Networks., *International Journal of Future Communication and Networking*, 8(1), 55–68.

- [85] Singh, C., C. S. Chen, P. Xia, and J. Andrews (2013), Distributed downlink resource allocation in cellular networks through spatial adaptive play., in *the 25th International Teletraffic Congress (ITC)*, pp. 1–9, IEEE.
- [86] Singh, S., H. S. Dhillon, and J. G. Andrews (2013), Offloading in heterogeneous networks: Modeling, analysis, and design insights., *JCM*, 12(5), 2484–2497.
- [87] Soret, B., H. Wang, K. I. Pedersen, and C. Rosa (2013), Multicell cooperation for lte-advanced heterogeneous network scenarios., *IEEE Wireless Communications*, 20(1), 27–34.
- [88] Sternad, M., T. Ottosson, A. Ahlén, and A. Svensson (2003), Attaining both Coverage and High Spectral Efficiency with Adaptive OFDM Downlinks., in *Vehicular Technology Conference VTC 2003-Fall*, pp. 2486–2490, IEEE.
- [89] Stolyar, A. L., and H. Viswanathan (2008), Self-organizing dynamic fractional frequency reuse in ofdma systems., in *in Proc. INFOCOM*, pp. 691–699, IEEE.
- [90] Stolyar, A. L., and H. Viswanathan (2009), Self-organizing dynamic fractional frequency reuse for best-effort traffic through distributed inter-cell coordination., in *in Proc. INFOCOM*, pp. 1287–1295, IEEE.
- [91] Sun, S.-. S., W. Liao, and W.-. T. Chen (2014), Traffic offloading with rate-based cell range expansion offsets in heterogeneous networks., in *Wireless Communications and Networking Conference WCNC*, pp. 2833–2838, IEEE.
- [92] Tall, A., Z. Altman, and E. Altman (2014), Self Organizing strategies for enhanced ICIC (eICIC)., in *International Symposium on Modeling and Optimization in Mobile, Ad Hoc, and Wireless Networks (WiOpt)*, pp. 318–325, IEEE.
- [93] Tian, P., H. Tian, J. Zhu, L. Chen, and X. She (2011), An adaptive bias configuration strategy for Range Extension in LTE-Advanced Heterogeneous Networks., in *IET International Conference on Communication Technology and Application (ICCTA)*, pp. 336–340, IEEE.
- [94] Tomovic, S., M. Pejanovic-Djurisic, and I. Radusinovic (2014), Sdn based mobile networks: Concepts and benefits, *Wireless Personal Communications*, 78(3), 1629–1644.
- [95] Trabelsi, N., L. Roullet, and A. Feki (2014), A Generic Framework for Dynamic eICIC Optimization in LTE Heterogeneous Networks., in *IEEE Vehicular Technology Conference (VTC)*, pp. 1–6, IEEE.
- [96] Trabelsi, N., C. S. Chen, L. Roullet, E. Altman, and R. El Azouzi (2016), Scheduling via Frequency and Power Allocation Optimization in LTE Cellular Networks., in *IEEE/IFIP Network Operations and Management Symposium (NOMS)*, pp. 44–51, IEEE.

- [97] Triki, A., and L. Nuaymi (2011), Intercell Interference Coordination Algorithm in OFDMA Wireless Systems., in *Vehicular Technology Conference VTC 2011-Spring*, pp. 1–6, IEEE.
- [98] Vasudevan, S., R. N. Pupala, and K. Sivanesan (2013), Dynamic eicic - a proactive strategy for improving spectral efficiencies of heterogeneous lte cellular networks by leveraging user mobility and traffic dynamics., *IEEE Trans. Wireless Communications*, 12(10), 4956–4969.
- [99] Wang, J., D. Wang, J. Pang, and G. Shen (2011), Optimized Fairness Cell Selection for 3GPP LTE-A Macro-Pico HetNets., in *Vehicular Technology Conference VTC 2011-Fall*, pp. 1–5, IEEE.
- [100] Yang, M., Y. Li, D. Jin, L. Zeng, X. Wu, and A. V. Vasilakos (2015), Software-defined and virtualized future mobile and wireless networks: A survey, *Mobile Networks and Applications*, 20(1), 4–18.
- [101] Yanmaz, E., and O. K. Tonguz (2004), Dynamic load balancing and sharing performance of integrated wireless networks., *IEEE Journal on Selected Areas in Communications*, 22(5), 862–872.
- [102] Yassin, M., M. A. AboulHassan, S. Lahoud, M. Ibrahim, D. Mezher, B. Cousin, and E. A. Sourour (2015), Survey of ICIC Techniques in LTE Networks under Various Mobile Environment Parameters, *Wireless Networks*, pp. 1–16.
- [103] Ye, Q., M. Al-Shalash, C. Caramanis, and J. G. Andrews (2013), On/off macrocells and load balancing in heterogeneous cellular networks., in *Global Telecommunications Conf. GLOBECOM*, p. 3814–3819, IEEE.
- [104] Ye, Q., B. Rong, Y. Chen, M. Shalash, C. Caramanis, and J. G. Andrews (2013), User association for load balancing in heterogeneous cellular networks., *IEEE Transactions on Wireless Communications*, 12(6), 2706 – 2716.
- [105] Zheng, S., H. Tian, Z. Hu, L. Chen, and J. Zhu (2010), QoS-Guaranteed Radio Resource Allocation with Distributed Inter-Cell Interference Coordination for Multi-Cell OFDMA Systems., in *Vehicular Technology Conference VTC 2010-Spring*, pp. 1–5, IEEE.