



HAL
open science

Développement de solutions associant solvants eutectiques profonds et cyclodextrines pour la solubilisation d'huiles essentielles et d'arômes

Lamia Nakhle

► **To cite this version:**

Lamia Nakhle. Développement de solutions associant solvants eutectiques profonds et cyclodextrines pour la solubilisation d'huiles essentielles et d'arômes. Autre. Université du Littoral Côte d'Opale; Université Libanaise, 2021. Français. NNT : 2021DUNK0611 . tel-04368885

HAL Id: tel-04368885

<https://theses.hal.science/tel-04368885>

Submitted on 2 Jan 2024

HAL is a multi-disciplinary open access archive for the deposit and dissemination of scientific research documents, whether they are published or not. The documents may come from teaching and research institutions in France or abroad, or from public or private research centers.

L'archive ouverte pluridisciplinaire **HAL**, est destinée au dépôt et à la diffusion de documents scientifiques de niveau recherche, publiés ou non, émanant des établissements d'enseignement et de recherche français ou étrangers, des laboratoires publics ou privés.



Thèse de Doctorat

Mention : Chimie

Spécialité : Chimie organique, minérale, industrielle

présentée à *l'Ecole Doctorale en Sciences Technologie et Santé (ED 585)*
de l'Université du Littoral Côte d'Opale

et

à *l'Ecole doctorale des Sciences et des Technologies (EDST)*
de l'Université Libanaise

par

Lamia Nakhle

pour obtenir le grade de Docteur de l'Université du Littoral Côte d'Opale et de
l'Université Libanaise

***Développement de solutions associant solvants eutectiques
profonds et cyclodextrines pour la solubilisation d'huiles
essentielles et d'arômes***

Soutenue le 17 décembre 2021, après avis des rapporteurs, devant le jury d'examen :

M^{me} Véronique Nardello-Rataj, Pr., Université de Lille, France
M. Joseph Saab, Pr., Université Saint-Esprit de Kaslik, Liban
M. Digambara Patra, Pr., Université Américaine de Beyrouth, Liban
M. Ahmad Rifai, Dr., Centre National de la Recherche Scientifique, Liban
M^{me} Hélène Greige- Gerges, Pr., Université Libanaise, Liban
M. David Landy, Pr., Université du Littoral Côte d'Opale, France
M^{me} Miriana Kfoury, Dr., Université du Littoral Côte d'Opale, France

Rapporteur
Rapporteur
Examinateur
Examinateur
Directeur de thèse
Directeur de thèse
Co-encadrante

Cette thèse entre dans le cadre d'une cotutelle entre l'Université du Littoral Côte d'Opale (ULCO) et l'Université Libanaise (UL). Elle a été financée par l'ULCO et par le Conseil National de la Recherche Scientifique-Libanais (CNRS-L).



National Council for Scientific Research

A mes parents Badawi et Badawié

A mes frères Marc et Elie

‘Car la connaissance appartient à l’humanité’

Louis Pasteur

Remerciements

Du début à la fin, j'ai eu la chance d'avoir à mes côtés des personnes qui m'ont aidé à pouvoir finir ces trois années de thèse avec succès et qui ont fait de cette aventure une très belle expérience. J'aimerais profiter de la chance pour les remercier.

Tout d'abord, je tiens à remercier tous les membres du jury Pr. Véronique Nardello-Rataj, Pr. Joseph Saab, Pr. Digambara Patra et Dr. Ahmad Rifai pour avoir pris le temps de lire et de juger ce manuscrit. Je tiens également à remercier les membres du comité de suivi individuel Pr. Pierre Villeneuve et Pr. Anissa Lounes-Hadj Sahraoui pour leurs commentaires et suggestions utiles.

Je souhaite remercier Pr. Stéphane Siffert, directeur de l'Unité de Chimie Environnementale et Interactions sur le Vivant (UCEIV) et Pr. Dominique Courcot, précédent directeur de l'UCEIV, de m'avoir accueilli parmi eux au sein de l'unité. Je remercie également Pr. Fawaz Ali El Omar, doyen de l'Ecole Doctorale des Sciences et des Technologies (EDST) à l'Université Libanaise (UL).

Je souhaite exprimer mes remerciements aussi à Dr. Tamara El Zein et toute l'équipe du CNRS-Libanais pour avoir contribué au financement de ce projet de thèse. De plus, je remercie la direction de l'Université du Littoral Côte d'Opale (ULCO) pour m'avoir attribué une bourse doctorale durant mon séjour en France.

J'ai eu la chance de pouvoir travailler dans deux laboratoires. L'équipe 'Chimie Supramoléculaire' (CS) à l'UCEIV-ULCO, dans laquelle je remercie mon directeur de thèse et le responsable actuel de l'équipe Pr. David Landy, sans lui la thèse n'aurait pas vu le jour. Un très grand merci pour toutes les discussions, pour votre orientation et vos conseils enrichissants. Vous m'avez aidé à développer mon esprit scientifique et surtout critique. Je remercie également Dr. Isabelle Mallard, ma co-encadrante, qui durant ma première année de thèse m'a accueilli et m'a aidé à réaliser de la synthèse organique ainsi que l'utilisation des techniques de caractérisation.

Je m'adresse ensuite à Pr. Hélène Greige-Gerges et Dr. Miriana Kfoury. Pr. Hélène, ce fut un honneur pour moi d'être l'une de vos étudiantes depuis les années de licence mais aussi durant ma deuxième année de master. En 2018, j'ai eu la chance de réaliser mon projet de master sous l'encadrement de Dr. Miriana, pour qui je tiens à remercier sincèrement pour l'accompagnement, le grand soutien et la gentillesse au Liban et en France. Vous deux, vous

vous êtes occupées de mon travail et vous m'avez fait confiance. Je vous remercie pour votre accueil durant tout mon travail au laboratoire 'Molécules Bioactives' à l'UL.

Je remercie également Pr. Sophie Fourmentin, précédente responsable de l'équipe CS à l'ULCO, d'avoir partagé avec moi ses qualités professionnelles et humaines.

Je remercie aussi tous les membres de l'équipe CS : Dr. Francine Cazier-dennin, Dr. Pierre-edouard Danjou et Dr. François Delattre. Je remercie spécifiquement Steven Ruellan pour son aide dans les expériences RMN.

J'exprime mes sincères remerciements à Amaury Kasprowiak, du département de chimie de l'ULCO, qui m'a apporté une aide précieuse lors de la réalisation des expériences de spectroscopie infrarouge.

Je tiens à exprimer toute ma gratitude à l'ensemble des membres du Centre Commun de Mesures. Merci Fabrice Cazier et Paul Genevray pour l'utilisation des divers appareils et pour votre aide quand les soucis techniques sont apparus.

Je remercie Tarek Moufawad, mon collègue d'équipe CS, de m'avoir guidé dans la réalisation des expériences en calorimétrie de titration isotherme. Tu étais présent pour m'aider à résoudre les problèmes où j'en avais le plus besoin, spécifiquement durant ma troisième année de thèse. Tout était beaucoup plus facile avec toi près de mes côtés.

Bien entendu, je tiens à remercier mes amis de l'équipe de CS : Tarek, Clémence, Nancy, Tracy, Sara, Pedro, Somenath, Corentin et Bastien pour les moments inestimables que nous avons partagés. Je ne peux pas oublier mes amis libanais : Eliane Bsaibess, Muriel, Rebecca, Myriam, Rita, Aida, Abir, Layla, Hamed, Nour, Maribelle et Michel, merci pour toutes les discussions que nous avons eues, les nuits et week-ends que nous avons passés à faire la fête. Merci à mes amis français : Margaux, Fred et Lilian. Vous avez tous participé au bon déroulement de ma thèse et vous avez rendu cette expérience si spéciale et mémorable.

Je remercie aussi le groupe de travail du laboratoire 'Molécules Bioactives' à l'UL qui sont avant tout des collègues très sympathiques : Sanaa, Ghenwa, Aline, Zahraa, Jad, Eliane Saliba et Carla. Je vous remercie pour l'ambiance, les discussions et les sorties.

En particulier je remercie Stéphanie et Mia, mes colocataires. Ça fait déjà trois ans que nous nous sommes lancées dans une aventure : la colocation. Ce n'est pas toujours facile, on n'avait pas toujours le parfait 'match'. Mais, je n'oublierai jamais nos tâches partagées, nos

fous rires dans le salon, nos soirées à parler de tout et de rien, nos moments de folie et nos moments de gourmandise. Faut dire qu'on a formé toute qu'une petite famille et une grande amitié.

Je remercie aussi mes amis au Liban en particulier Anthony, Maria, Alissa, Sandy et Jessica. Vous m'avez encouragé et m'avez attendu à chaque fois que je rentrais au Liban.

Enfin, je tiens à exprimer ma gratitude à mon partenaire, Marc, qui était présent pour moi toujours. Merci d'être mon support numéro un et de m'avoir poussé sans relâche à toujours faire de mon mieux et croire à moi-même. Ton appui indéfectible, ton enthousiasme et ta positivité contagieuse ont été mon système de soutien durant ces années. Aucun mot ne peut exprimer à quel point je suis reconnaissante pour ta confiance constante en moi.

Je finis par remercier ma famille, mes parents Badawi et Badawié et mes frères Marc et Elie. Vous avez réussi à me supporter que ça soit pendant les bons moments ainsi que pendant les moments parfois les plus difficiles. Cette thèse n'aurait pas été possible sans votre aide et vos prières. Votre fierté m'a poussé à donner le meilleur de moi-même. MERCI.

Table des matières

INTRODUCTION GENERALE	1
I. ETUDE BIBLIOGRAPHIQUE	4
Introduction.....	5
CHAPITRE 1: Utilisation des solvants eutectiques profonds pour la solubilisation des molécules naturelles.....	6
Introduction.....	7
Deep eutectic solvents for the solvation of natural molecules.....	8
CHAPITRE 2: Extraction des molécules naturelles dans les solvants eutectiques profonds	63
Introduction.....	64
Microextraction of bioactive compounds using deep eutectic solvents: a review	65
CHAPITRE 3: Application des solvants eutectiques profonds dans les techniques de microextraction des molécules naturelles	78
Introduction.....	79
Methods for extraction of bioactive compounds from plant and animal matter using deep eutectic solvents.....	80
CHAPITRE 4: Les propriétés d'inclusion des cyclodextrines <i>vis-à-vis</i> des huiles essentielles et des arômes.....	138
Introduction.....	139
Cyclodextrins and their inclusion properties towards essential oils and their components	140
II. EXPERIMENTATIONS ET RESULTATS	173
Introduction.....	174
CHAPITRE 5: Optimisation d'une formulation DES:eau:CD	175
Introduction.....	176
Choline chloride based-deep eutectic solvents:water:cyclodextrins mixtures for the entrapment and the solubilization of volatile molecules: application to <i>Eucalyptus citriodora</i> essential oil and citronellal	178
CHAPITRE 6: Influence de la polymérisation de cyclodextrines	207
Introduction.....	208
Cyclodextrins polymers in deep eutectic solvent:water mixture: Solubilization study of <i>Eucalyptus citriodora</i> essential oil	210
CHAPITRE 7: Application à la solubilisation d'une variété d'huiles essentielles et d'arômes.....	233
Introduction.....	234
Solubilization of a plethora of essential oils and aromas in choline chloride:urea deep eutectic solvent:cyclodextrins:water mixtures	235
CHAPITRE 8: Thermodynamique de la complexation dans les milieux DES:eau.....	269
Introduction.....	270
Thermodynamic investigations on host/guest interactions between β-cyclodextrin and adamantanol in deep eutectic solvent:water mixtures.....	272
CHAPITRE 9: Analyse et discussion.....	298
CONCLUSIONS GÉNÉRALES ET PERSPECTIVES	310
VALORISATION SCIENTIFIQUE.....	314
Références.....	317

Liste des abréviations

2-DOSY	Spectroscopie ordonnée par diffusion
2-ROESY	2-Spectroscopie d'amélioration d'Overhauser à cadre rotatif bidimensionnel
API	Principe actif pharmaceutique
But	Butane-1,3-diol
CD	Cyclodextrines
ChCl	Chlorure de choline
CRYSMEB	β -Cyclodextrine faiblement méthylée
DES	Solvants eutectiques profonds
DMSO	Diméthylsulfoxyde
EMA	Agence européenne des médicaments
E_{NR}	Paramètre de polarité
EO	Huile essentielle
FDA	Administration américaine des aliments et des médicaments
Fru	Fructose
FTIR	Spectroscopie infrarouge à transformée de fourier
Glu	Glucose
Gly	Glycérol
GRAS	Généralement identifié comme sûr
HBA	Accépteur de liaisons d'hydrogène
HBD	Donneur de liaison d'hydrogène
Hc	Constante de Henry
HMF	Hydroxyméthylfurfural
HP-α-CD	Hydroxypropyl- α -cyclodextrine
HP-β-CD	Hydroxypropyl- β -cyclodextrine
HP-γ-CD	Hydroxypropyl- γ -cyclodextrine
IL	Liquides ioniques
ITC	Calorimétrie de titration isotherme
JECFA	Comité mixte d'experts sur les additifs alimentaires
K	Coefficient de partage vapeur-liquide
K_f	Constante de formation
Lac	Acide lactique
Lev	Acide lévulinique
M_n	Masse moléculaire moyenne en nombre
M_w	Masse moléculaire moyenne en poids
NADES	Solvant eutectique profond naturel
NMR	Résonance magnétique nucléaire
NR	Rouge de Nil
PEDGE	Poly(éthylène glycol)-diglycidyl éther
PFA	Additifs alimentaires phytogéniques
Pro	Propane-1,3-diol
PRV	Méthode de variation du rapport de phase
RAMEA	α -Cyclodextrine méthylée au hasard
RAMEB	β -Cyclodextrine méthylée au hasard
SBE-β-CD	β -Cyclodextrine sulfobuthylée
SH-GC	Technique d'espace de tête-statique couplée à la chromatographie en phase gazeuse
Sor	Sorbitol

STMP	Sodium trimétaphosphate
SUPRADES	Solvant eutectique profond supramoléculaire
Tar	Acide tartrique
T CPP	Méso-tétra(4-carboxyphényl)porphine
THEDES	Solvant eutectique profond thérapeutique
THPP	5,10,15,20-Tetrakis(4-hydroxyphényl)porphyrine
UV-Vis	UV-Visible
VOC	Composé organique volatil
VPC	Méthode d'étalonnage en phase vapeur
ΔC_p	Variation de la capacité calorifique
ΔG	Variation d'énergie libre de Gibbs
ΔH	Variation d'enthalpie
ΔS	Variation d'entropie
λ_{\max}	Longueur d'onde maximale

INTRODUCTION GENERALE

Introduction générale

Depuis toujours, les huiles essentielles et les arômes ont été utilisés quotidiennement par l'Homme dans la cuisine, la parfumerie, la cosmétologie et la médecine. Actuellement, ces composés sont de plus en plus appréciés et reconnus pour leur origine naturelle et utilisés en tant qu'agents d'aromatisation mais également en tant qu'agents antioxydants et antimicrobiens dans différentes formulations pharmaceutiques, cosmétiques et alimentaires (de Cássia da Silveira e Sá et al., 2014). Cependant, leur application est limitée à cause de leur forte volatilité ainsi que leur faible solubilité et stabilité. Des formulations ont été développées dans le but d'améliorer leurs propriétés physico-chimiques, en utilisant des tensioactifs, des cosolvants organiques (éthanol, diméthylsulfoxyde...), des systèmes d'encapsulation (cyclodextrines (CDs), liposomes, dendrimères...), etc. (Fernández-Peña et al., 2019; Kfoury et al., 2019; Nakhle et al., 2020). Toutefois, l'utilisation de ces agents, particulièrement les solvants organiques, présentent des impacts négatifs pour l'environnement et la santé. De nouvelles stratégies pour le développement de formulations qualifiées de vertes, écologiques, biodégradables et durables sont actuellement recherchées.

Les solvants eutectiques profonds ou '*Deep eutectic solvents*' (DESs) sont des solvants qui ont été introduits pour la première fois en 2003 (Abbott et al., 2003). Les DESs sont définis comme un mélange de deux ou trois composés donnant un liquide clair et homogène ayant un point de fusion plus faible que ses constituants séparés. Ce phénomène de dépression du point de fusion est expliqué par l'établissement de liaisons d'hydrogènes intermoléculaires entre les composés (Abbott et al., 2003; Zhang et al., 2012). Ce sont des solvants facilement préparés à partir de matières premières largement accessibles, caractérisés par des propriétés physico-chimiques intéressantes (stabilité thermique, faible pression de vapeur, etc.). De plus, les DESs sont des solvants peu onéreux, modulables et biocompatibles pouvant apporter de nouvelles opportunités dans les domaines pharmaceutique, cosmétique, alimentaire, etc. (Mbous et al., 2017).

Les cyclodextrines (CDs) sont des oligosaccharides cycliques obtenues à partir de la dégradation enzymatique de l'amidon. Ces molécules hôtes possèdent une cavité hydrophobe pouvant accueillir des invités pour former ainsi des complexes d'inclusion. Les CDs ont été largement employées pour l'encapsulation des huiles essentielles et des arômes (Kfoury et al., 2015). Elles se sont avérées efficaces pour augmenter la solubilité et diminuer la volatilité de

ces derniers tout en préservant leurs activités biologiques (Ciobanu et al., 2013; Costa et al., 2015; Kfoury et al., 2016; Kfoury, et al., 2019).

De nouvelles formulations, combinant la capacité de solubilisation des DESs et la capacité de complexation des CDs pourraient être proposées. Ainsi, l'objectif de ce travail consiste à mettre en œuvre et optimiser de nouvelles formulations à base de différents DESs et CDs, permettant d'augmenter la rétention des huiles essentielles et des arômes et d'améliorer leur solubilité.

Ce travail s'articule autour de trois axes principaux. Le premier consiste à préparer et à étudier les propriétés physico-chimiques de nouvelles formulations associant les DESs et les CDs. Le deuxième axe vise à développer une formulation optimale (cela en étudiant l'influence de plusieurs paramètres : type de DES, composition du DES, présence d'eau, présence de CD et type de CD) et d'étudier sa capacité à réduire la volatilité et améliorer la solubilité d'un large panel d'huiles essentielles et d'arômes. Le troisième axe consiste à comprendre les mécanismes thermodynamiques de l'encapsulation dans les CDs dans ces milieux non conventionnels (DES:eau).

Ce manuscrit comprend deux parties constituées de neuf chapitres.

La première partie offre une étude bibliographique comportant quatre chapitres. Le premier consiste en une revue de la littérature sur la solubilisation de molécules naturelles dans les DESs. La classification des DESs, leurs méthodes de préparation et leurs propriétés physico-chimiques sont ainsi abordées avant d'évoquer la solvatisation des lipides (comme les terpènes), des sucres et leurs dérivés (comme les CDs), des acides aminés et des protéines, ainsi que des métabolites secondaires des plantes (comme les composés phénoliques et les alcaloïdes). Ce chapitre présente également un aperçu sur la combinaison des DESs et CDs pour l'augmentation de la solubilité des molécules naturelles.

Cette partie présente également un aperçu bibliographique sur l'utilisation des DESs en tant que solvants d'extraction de molécules naturelles faisant ainsi l'objet du deuxième chapitre publié sous forme d'un article dans '*Environmental Chemistry Letters*'.

Le troisième chapitre, portant sur l'application des DESs dans différentes techniques d'extraction de molécules naturelles, est également un chapitre publié dans l'ouvrage intitulé

'Deep Eutectic Solvents for Medicine, Gas Solubilization and Extraction of Natural Substances'.

Le quatrième chapitre présente une synthèse bibliographique sur les CDs et l'intérêt de leur utilisation pour l'encapsulation et l'amélioration des propriétés des huiles essentielles et des arômes.

La deuxième partie, comportant cinq chapitres, développe les expérimentations et les résultats obtenus. Le cinquième chapitre du manuscrit porte sur la préparation de différentes formulations DES:eau:CD, la caractérisation de ces formulations par des mesures de densité, de viscosité et de polarité et l'étude de leur capacité à réduire la volatilité de l'huile essentielle modèle *'Eucalyptus citriodora'* et de son composé majeur, le citronellal, par la technique d'espace de tête-statique couplée à la chromatographie en phase gazeuse, dans le but de trouver la formulation de solubilisation optimale.

Le sixième chapitre consiste à déterminer l'influence de la modification chimique des CDs, et en particulier de leur polymérisation, sur l'efficacité de solubilisation de la formulation optimale définie dans le chapitre précédent. Il couvre ainsi la synthèse et la caractérisation des polymères de CDs et l'étude de la solubilisation de l'huile essentielle *E. citriodora* dans des formulations DES:eau:polymères de CDs.

Le septième chapitre est dédié à l'investigation de la capacité de solubilisation de la formulation DES:eau:CD optimale *vis-à-vis* de vingt huiles essentielles et vingt-et-un de leurs constituants majeurs par la technique d'espace de tête-statique couplée à la chromatographie en phase gazeuse. Ce chapitre vise également à étudier le phénomène de complexation par les CDs dans le milieu DES:eau par la spectroscopie de résonance magnétique nucléaire et la calorimétrie de titration isotherme.

Le huitième chapitre présente une étude approfondie des mécanismes thermodynamiques de complexation au sein de formulations DES:eau:CD en utilisant une molécule modèle (l'adamantanol) par la calorimétrie de titration isotherme.

Le neuvième chapitre comporte une analyse et une discussion approfondie de l'ensemble des résultats obtenus. Finalement, le manuscrit s'achève par des conclusions générales de l'étude, accompagnée des perspectives de ce travail.

I. ETUDE BIBLIOGRAPHIQUE

Introduction

Le but principal du développement de nouvelles formulations alimentaires, cosmétiques, nutraceutiques ou pharmaceutiques est d'amener la molécule d'intérêt dans un état de solubilité maximale ou d'atteindre une concentration active. Dans ce cadre, divers systèmes peuvent être employés: la cosolvation, l'encapsulation (CDs, liposomes, nanoparticules à base de polymères...), l'émulsification etc. (Sebaaly et al., 2015; Kfoury et al., 2015; Fernández-Peña et al., 2019).

Les défauts de ces systèmes, particulièrement la toxicité des solvants organiques, ont favorisé l'émergence d'une nouvelle génération de solvants verts; les solvants eutectiques profonds (DESs) (Abbott et al., 2003). Depuis qu'ils ont été introduits pour la première fois en 2003, ces solvants ont pris un intérêt grandissant et ont fait l'objet d'études comme milieu privilégié pour la solubilisation et l'extraction des produits non solubles (Bi et al., 2013).

Les CDs sont des molécules hôtes naturelles possédant une cavité hydrophobe dans laquelle elles peuvent accueillir des invités pour former des complexes d'inclusion (Morin-Crini et al., 2020; Matencio et al., 2020). Elles permettent l'encapsulation sous forme dissoute ou sous forme solide (en poudre) des composés peu solubles. Ces molécules cages sont largement utilisées dans les procédés d'encapsulation classiques comme adjuvant de solubilisation, promoteurs d'absorption ou même des agents de protection. Les CDs naturelles sont considérées comme non toxiques et biodégradables et sont largement exploitées dans les secteurs alimentaire, pharmaceutique, cosmétique et environnemental (Crini, 2014).

L'objectif de ce travail est de développer de nouvelles formulations de solubilisation des composés naturels combinant les DESs et les CDs. La première partie est donc consacrée à une étude bibliographique divisée en quatre chapitres. Le premier chapitre offre une synthèse bibliographique portant sur l'utilisation des DESs pour la solvotation de différentes classes de molécules naturelles. Le deuxième et le troisième chapitres sont consacrés pour l'utilisation des DESs dans l'extraction des produits naturels. Le quatrième chapitre présente une analyse bibliographique sur l'utilisation des CDs comme agents d'encapsulation et de solubilisation des produits naturels.

CHAPITRE 1

Utilisation des solvants eutectiques profonds pour la solubilisation des molécules naturelles

Introduction

Au début des années 2000, les solvants DESs, une nouvelle classe de solvants ont fait leur apparition (Abbott et al., 2003). Les DESs sont facilement obtenus par simple chauffage d'un mélange de deux ou trois composés capables de s'associer entre eux par un réseau de liaisons d'hydrogènes. Ce mélange, appelé mélange eutectique, possède une température de fusion inférieure à celle de chacun de ses constituants (Martins et al., 2019). Par conséquent, la plupart des DESs sont liquides à la température ambiante ou proche de l'ambiante. Les DESs présentent généralement un faible impact environnemental et sont qualifiés de solvants verts et durables. Leur utilisation a été considérée comme une alternative pertinente aux solvants organiques (Leron et al., 2012; Zhang et al., 2012; AlOmar et al., 2016).

Ce chapitre présente une revue bibliographique sur l'utilisation des DESs pour la solvation de molécules naturelles. Il présente en premier lieu un aperçu sur la classification, la préparation et la caractérisation physico-chimique (densité, viscosité, polarité et conductivité thermique) des DESs. Cela met l'accent sur l'adaptabilité et la versatilité des propriétés physico-chimiques de ces solvants qui leur permettent de répondre à diverses applications dans plusieurs domaines et *vis-à-vis* de nombreux composés. Ce chapitre aborde par la suite la solubilisation de différentes classes de molécules naturelles (alcools, sucres, métabolites secondaires, acides aminés et protéines) dans les DESs. Il vise également à présenter l'intérêt de la combinaison des DESs et des CDs pour l'amélioration de la solubilité des composés peu solubles. Ce chapitre s'intéresse finalement à la compréhension de l'influence de différents paramètres tels que la nature des constituants du DES, leur rapport molaire dans un DES donné, la température à laquelle la solubilisation est effectuée et l'influence de la présence de l'eau sur la capacité de solubilisation de ces solvants.

Ainsi, ce chapitre présente la revue intitulée '*Deep eutectic solvents for the solvation of natural molecules*'.

Deep eutectic solvents for the solvation of natural molecules

Lamia Nakhle^{a,b}, Miriana Kfoury^{a,b,*}, Isabelle Mallard^a, H el ene Greige-Gerges^b, David Landy^a

^a *Unit e de Chimie Environnementale et Interactions sur le Vivant (UCEIV, UR 4492), SFR Condorcet FR CNRS 3417, Universit e du Littoral C ote d'Opale (ULCO), 145 Av. M. Schumann, F-59140 Dunkerque, France*

^b *Bioactive Molecules Research Laboratory, Faculty of Sciences, Lebanese University, 90656 Jdaidet el-Metn, Lebanon*

* Corresponding author at: miriana.kfoury@univ-littoral.fr

Abstract

A novel sustainable class of solvents, the deep eutectic solvents (DESs), emerged with great interest mainly due to their harmless environmental impact. These solvents are being applied in a broad spectrum of industries, mainly in pharmaceutical and nutraceutical fields. This review discusses the application of DESs in enhancing the solubility of natural molecules. In line with the findings, it was proved that DESs showed greater solvation potency for different classes of natural molecules in comparison to other solvents. The various factors affecting the solvation process such as the amount of water and the temperature are discussed. Also, this review focuses on providing deep understanding of the dissolution mechanisms. In the majority of the cases, it was found that the solvation process was favored by hydrogen bond interactions between the components of the solvent and the natural molecule. The use of DESs was proved to be an efficient strategy for overcoming many limitations associated with the poor aqueous solubility of naturally occurring molecules. Lastly, the DES/cyclodextrin (CD) combination showed even greater solubility of natural molecules since CDs can form inclusion complexes with these molecules.

Keywords: deep eutectic solvents; hydrogen bonding; natural molecules; solvation.

Contents

1. Introduction	11
2. Overview	13
2.1. Types of deep eutectic solvents.....	15
2.2. Preparation methods.....	16
2.3. Physico-chemical properties	17
3. Solvation of natural molecules by deep eutectic solvents	18
3.1. Alcohol- and sugar-based molecules.....	19
3.1.1. Native cyclodextrins	22
3.2. Terpenes	23
3.3. Phenolic compounds	25
3.3.1. Rutin.....	31
3.3.2. Curcumin.....	33
3.4. Alkaloids	34
3.5. Amino acids and proteins.....	36
3.6. Other natural molecules	38
3.7. Bioconversion.....	41
3.8. Combination of deep eutectic solvent with cyclodextrin.....	45
4. Summing-up on the solubility influencing parameters.....	48
5. Conclusion	49
Acknowledgements.....	49
References.....	50

List of abbreviations

API: Active pharmaceutical ingredient

CD: Cyclodextrin

DES: Deep eutectic solvent

DMSO: Dimethylsulfoxide

FDA: Food and drug administration

FF: Furfural

GRAS: Generally recognized as safe

HBA: Hydrogen bond acceptor

HBD: Hydrogen bond donor

HMF: 5-Hydroxymethylfurfural

IL: Ionic liquid

NADES: Natural deep eutectic solvent

SUPRADES: Supramolecular deep eutectic solvent

TCPP: Meso-tetra-(4-carboxyphenyl)-porphyrin

THEDES: Therapeutic deep eutectic solvent

THPP: 5,10,15,20-Tetrakis(4-hydroxyphenyl)-porphyrin

1. Introduction

Almost all chemistry and biochemistry processes need to be carried out in liquid solutions or solvents. Thus, solvents allow carrying out many synthesis and separation processes by dissolving and bringing together all the required compounds. Therefore, the solvent should have specific properties required for the chemical process (Marcus, 2002). Due to its presence in nearly all physiological and biochemical processes, water is considered to be the most common solvent in daily life (Carter, 2011). Nevertheless, water poorly dissolves, at ambient conditions many organic substances. Also, it can be highly reactive towards many solutes. Even if organic liquids have served for a long time in chemical processes, such solvents may be too volatile, toxic, flammable and detrimental to the human and to the environment, so that special precautions have to be undertaken in their uses (Clarke et al., 2018). Ionic Liquids (ILs), a new generation of solvents, have attracted interest in the area of green chemistry, mainly regarding the replacement of toxic organic solvents. ILs are composed of ions held together *via* ionic bonds and have melting points generally inferior to 100 °C (Huang et al., 2019). However, some studies have highlighted the drawbacks of ILs such as hazardous toxicity, poor biodegradability, non-biocompatibility, and high cost (Espino et al., 2016). Neoteric sustainable solvents derived from ILs, termed ‘Deep eutectic solvents’ (DESs) have emerged in the last two decades (Abbott et al., 2003). DESs have now become of growing interest both at academic and industrial levels and the number of publications dedicated to their use is rapidly increasing in the current literature (**Figure 1**). This further demonstrates the attractiveness of these solvents. **Figure 2** displays the number of articles devoted to DESs as a function of the application domain.

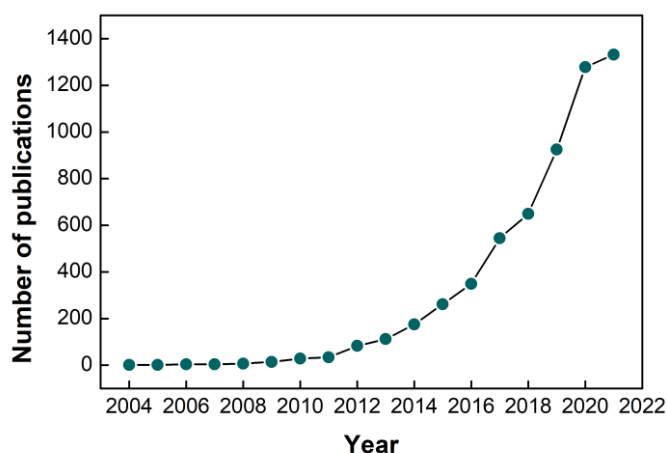

Figure 1: Number of articles on deep eutectic solvents per year. The query: (title-abstract-keyword ("Deep eutectic solvent")) was consulted in Scopus on October 04, 2021.

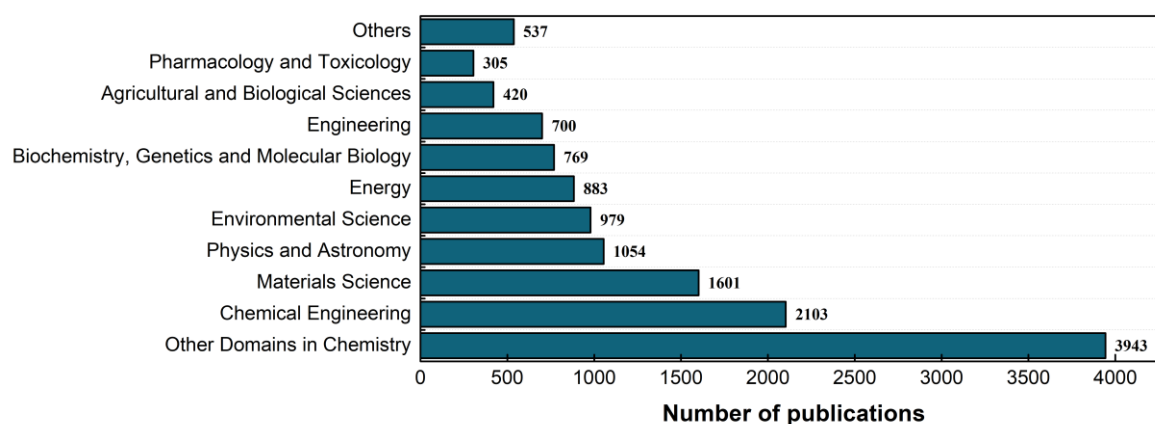

Figure 2: Number of articles devoted for each domain of application of deep eutectic solvents. The query: (title-abstract-keyword ("Deep eutectic solvent")) was consulted in Scopus on October 04, 2021.

Nowadays, growth has been taking place in the natural-products areas due to the increased consumer demand for these molecules in various sectors such as cosmetics, foods, pharmaceuticals, household products, etc. (Kfoury et al., 2019). However, most of the natural active molecules present a low aqueous solubility. Generally considered as safe solvents, numerous DESs have been tailored in order to ensure an increase in the solubility of a specific natural molecule (Álvarez & Zhang, 2019). Owing their dissolution ability, DESs have been applied for the extraction of natural molecules, for improving their bioavailability, and for enhancing their stability and their desired activity.

Efficient application of DESs in various fields requires adequate knowledge of their most important properties, i.e. the solvation potency of different molecules. More specifically, the solvation of many drugs in DESs was discussed in recent reviews (Álvarez & Zhang, 2019; Zainal-Abidin et al., 2019). Also, detailed analysis of the contribution of DESs to solubilize many polysaccharide-based macromolecules, i.e. cellulose and lignin, were published (Tang et al., 2017; Zdanowicz et al., 2018; Chen et al., 2019; Tan et al., 2020). Although the presence of the previously mentioned reviews, this paper focuses mainly on the solvation of different classes of natural molecules in DESs. The influence of different parameters, such as the presence of water and the temperature, on the solvation process is discussed. Also, examination of the contribution of the physico-chemical properties of DESs, mainly its viscosity, is also included herein. Additionally, the corresponding solvation mechanisms are outlined in details by the help of different spectroscopic techniques i.e. nuclear magnetic resonance (NMR) and infrared (IR).

2. Overview

DESs are solvents that can be easily prepared. They are composed of two or more starting materials that could be solid at room temperature when separated, however they become liquid when mixed together at a certain molar ratio and heated at a specific temperature (Abbott et al., 2003). This can be explained by the fact that one of the components is a hydrogen bond acceptor (HBA) such as a quaternary ammonium salt, while the other is a hydrogen bond donor (HBD) such as a carboxylic acid, an alcohol, etc. (Florindo et al., 2014; Cvjetko Bubalo et al., 2016). Thus, the liquid phase is obtained consecutively to several intermolecular hydrogen bonds between these two components (Abbott et al., 2004). As it can be explained from a thermodynamic point of view, the term eutectic is used to describe “a lower temperature of liquefaction than that given by any other proportion” (Martins et al., 2019). As a result, DESs are characterized by the decrease of the melting point of the mixture when compared to those of the parent pure components (Basar et al., 2020). In order to give a meaning to the term “deep”, Martins et al., defined a DES as a mixture of pure compounds for which the eutectic point temperature is below that of an ideal liquid mixture at a significantly different composition as presented in **Figure 3**. The temperature depression should be defined as the difference (ΔT_2) between the ideal ($T_{E,ideal}$) and the real (T_E) eutectic point and not as the difference (ΔT_1) between the linear combination of the melting points of the pure components and the real eutectic point (Martins et al., 2019).

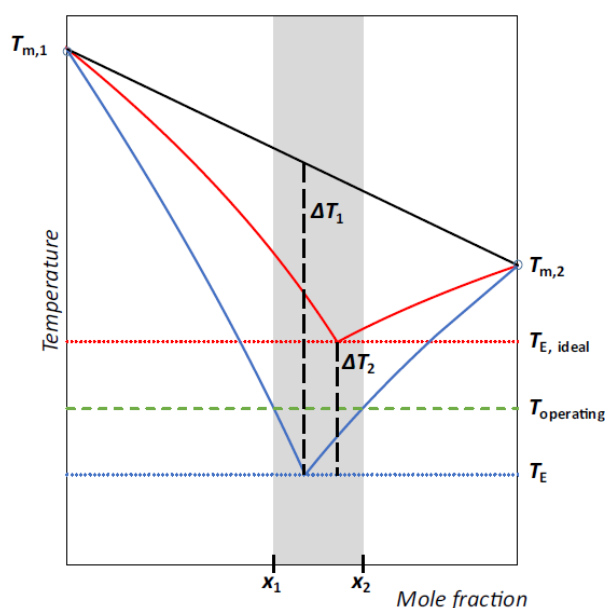

Figure 3: Schematic representation of the comparison of the solid-liquid equilibrium of a simple ideal eutectic mixture (red line) and a deep eutectic mixture (blue line). Figure reprinted with permission from Martins et al., 2019.

Choi et al., explored ‘Natural deep eutectic solvents’ (NADESs) that are DESs prepared from natural metabolites (Choi et al., 2011). These solvents are synthesized using simple molecules present in plant or human living cells such as urea, alcohols, organic acids, amines, amino acids, sugars and choline (Vanda et al., 2018). Most DESs and NADESs possess interesting properties such as low vapor pressure, non-flammability, high thermal stability and low thermal conductivity (Nam et al., 2015; Khataei et al., 2018). These solvents are tunable, sustainable, recyclable, and biocompatible; many are biodegradable and some of them can be stored conveniently at ambient temperature in enclosed glassware (AlOmar et al., 2016; Moura et al., 2017).

The strong association between the DESs components radically decreases their reactivity, making them inert solvents (Durand et al., 2013). Being interesting solvents in the chemical field, they are used in catalysis, bulk processing of metals, biodiesel purification, organic synthesis (i.e. polymer synthesis), co-solvency, dissolution and extraction processes, drug solubilization, biological transformations, electroplating, CO₂ absorption and even fabrication of novel metal surfaces and coatings (Leron et al., 2012; Zhang et al., 2012; AlOmar et al., 2016). In addition, DESs are used in the large-scale metals electrowinning from complex oxide matrices and stainless steel electropolishing (Abbott et al., 2006).

In order to be applied in different fields, these solvents should be proved as safe solvents with negligible or low toxicity adequate with green chemistry criteria. Also, the toxicological properties of the separate components and of the DESs should be well characterized (Mbous et al., 2017). Not all DESs have shown a clear toxicity profile due to the lack of related data and to the large number of available DESs.

Choline chloride, that constitutes the mostly used quaternary salt in DESs and NADESs, is a pro-vitamin B₄ extensively used in food and other consumer products (Mbous et al., 2017). Also, the concept of NADESs present in living organisms and playing important physiological and chemical roles was suggested by Choi et al., in 2011. Therefore, the natural origin of the components gives NADESs a great interest (Choi et al., 2011). This allowed them to be used in food and pharmaceutical industries to a certain level; for instance, a vanilla NADES solution suitable for flavoring was produced (Vanda et al., 2018). In addition, NADESs are used in the extraction process of active plant compounds, for example it is used in commercialized plant extracts named EutectysTM and supplied by Naturex (Martins et al., 2019). This product is used in face fluid, hydrating face oil, rejuvenating mask and in other skin care products i.e. a cherry blossom EutectysTM (Martins et al., 2019). Some NADESs are

FDA approved and generally recognized as safe (GRAS) i.e. fructose:glucose NADES. **Table 1** presents the structure of some commercial DESs (Marcus, 2019).

Table 1- Representative structures of commercial DESs.

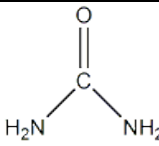
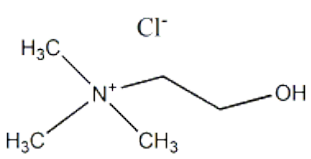
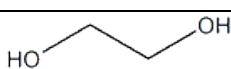
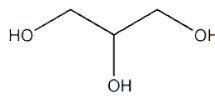
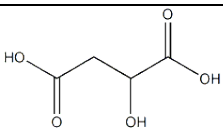
Hydrogen bond acceptor	Hydrogen bond donors	Commercial name
	 <p>Urea</p>	Reline
 <p>Choline chloride</p>	 <p>Ethylene glycol</p>	Ethaline
	 <p>Glycerol</p>	Glyceline
	 <p>Malic acid</p>	Maline

2.1. Types of deep eutectic solvents

In 2014, Smith and co-workers defined four types of DESs based on their chemical composition using the general formula Cat^+X^-zY (Smith et al., 2014):

Type I DES: $Y = MCl_x$

$M = Zn, Sn, Fe, Al, Ga, In$

Type II DES: $Y = MCl_x.yH_2O$

$M = Cr, Co, Cu, Ni, Fe$

Type III DES: $Y = RZ$

$Z = CONH_2, COOH, OH$

Type IV DES: $Y = MCl_x + RZ = MCl_{x-1}^+ \cdot RZ + MCl_{x+1}^-$

$M = Al, Zn$ and $Z = CONH_2, OH$

where Cat^+ is an ammonium, phosphonium, or sulfonium cation, and X is a Lewis base, generally a halide anion. The complex anionic species are formed between X^- and either a Lewis or Brønsted acid Y (z refers to the number of Y molecules). x is the number of Cl atoms; y is the number of H_2O molecules and R is an alkyl chain.

The first type of DESs consists of Cat^+ and a metal halide (i.e. $AlCl_3$); however this type presents the high disadvantage of possessing inherent hygroscopic character. The second type

is prepared using hydrated metal salts that are insensitive to moisture (Smith et al., 2014). A quaternary salt can also be mixed with a HBD compound that may comprise an alcohol, amine, sugar, amide, or a carboxylic acid to form type III DESs, some of them are liquid at room temperature (Shahbaz et al. 2016). The same group also defined a fourth type of DESs which is composed of metal chlorides (i.e. $ZnCl_2$) mixed with different HBDs such as urea, ethylene glycol, acetamide or hexanediol (Smith et al., 2014).

In some cases, a third component is required for the preparation of DESs. In this situation, the solvent is called a “ternary DES”. This was observed for example when mixing choline chloride with either suberic acid or gallic acid, where solid mixture is still observed after heating at 100 °C. However, the addition of glycerol, as a second HBD, led to the formation of DES with lower melting point (Maugeri & Domínguez de María, 2012).

Another interesting type of DESs is the ‘Therapeutic deep eutectic solvent’ (THEDES). These solvents have been defined as a bioactive eutectic system containing an active pharmaceutical ingredient (API) as one of the DES components i.e. the menthol:ibuprofen (3:1 molar ratio) THEDES (Duarte et al., 2017a).

Among the existing DESs, those based on bulk carbohydrates have been also described (Imperato et al., 2005). In this context, a new family of DESs based on dimethylurea and β -cyclodextrin at a weight ratio of 70:30 was proposed by Jérôme et al., 2014. In addition, Zhao et al., 2014 presented a low-melting mixture of β -cyclodextrin:N-methylurea (Zhao et al., 2014). In 2020, El Achkar et al., were the first to define supramolecular DESs, the SUPRADESs solvents composed of randomly-methylated β -cyclodextrin (RAMEB):levulinic acid DES (El Achkar et al. 2020). In SUPRADESs, cyclodextrins retained their supramolecular properties by forming inclusion complexes even when being a component of the solvent.

2.2. Preparation methods

DESs can be prepared by different methods without the need of any additional solvent, and without the formation of by-products (Cvjetko Bubalo et al., 2014; Cui et al., 2017). The general mode of preparation of DESs, if their ingredients are solids at ambient conditions, is to mix the components at a specific molar ratio and heat the mixture to a moderately elevated temperature (generally 60-100 °C), under stirring for a few hours until that the entire mass is converted to a homogeneous clear liquid. This method is called the heating method. If one of the ingredients is itself liquid at ambient conditions, the mixture can be possibly formed without heating, like the DES obtained using choline chloride and levulinic acid (1:2 molar

ratio) (Maugeri & Domínguez de María 2012). Another method is the grinding method. The compounds are mixed at room temperature and ground in a mortar with a pestle, until a clear liquid is formed. Another variant is to prepare a DES using both aqueous solutions of the individual counterparts. For instance, separated aqueous solutions of choline chloride and urea (or thiourea) are put together to form aqueous solutions of choline chloride:urea (or choline chloride:thiourea) with 1:2 molar ratio, having 5 wt% solute contents. After that, the water is vacuum-evaporated by a rotary evaporator or removed by freeze-drying. Then, the resulting viscous liquid DES is dried in a desiccator (Gutiérrez et al., 2009; Dai et al., 2013b; Craveiro et al., 2016).

2.3. Physico-chemical properties

Due to their large number of starting materials, the possibility to modify the HBA and HBD is almost infinite. This offers great combinations of DESs. These solvents possess diverse physico-chemical properties such as different freezing point, viscosity, density, acidity/basicity, and others. Therefore, task specific DESs can be obtained for a specific area of application (Durand et al., 2016). It can be stated that all physico-chemical properties of DESs are mainly affected by the chemical nature of the DESs components (type of the HBA and HBD), the strength of the hydrogen bonding between these components, the HBA:HBD molar ratio, the temperature and the water content (Zhang et al., 2012; El Achkar et al., 2019).

The eutectic point of DESs can be obtained in the solid-liquid phase diagrams by different methods such as differential scanning calorimetry (Morrison et al., 2009). For all reported DESs, their melting points are below 150 °C and most of them are liquids at temperature less than 70 °C (Zhang et al., 2012).

The development of DESs with low viscosities is highly desirable promoting their easier applications, mainly in the extraction processes. However, the presence of massive interactions between components results in DESs exhibiting relatively high viscosities (>100 cP) at room temperature, and as a consequence, a lower mobility of free species within the DESs is obtained (Zhang et al., 2012). Some exceptions might be found, such as choline chloride:ethylene glycol 1:4 molar ratio DES (viscosity: 19 cP at 20 °C).

Nearly all DESs present low ionic conductivities ($< 2\text{mS cm}^{-1}$ at room temperature) and high surface tension due to their high viscosity (Tang et al., 2014).

Most of them possess higher density values than water with levels ranging from $1.041\text{ g}\cdot\text{cm}^{-3}$ to $1.630\text{ g}\cdot\text{cm}^{-3}$ (Cunha & Fernandes, 2018). The density of DESs is higher than that of the

individual components and this can be explained by the fact that after mixing the components, the radius of the existing holes decreases. This is known by the “hole theory” (Tang et al., 2014).

Thermogravimetric analysis revealed that, in general, DESs have low but detectable vapor pressure, especially when one of their constituents is a non-volatile component (Shahbaz et al., 2016).

Most of the DESs are hydrophilic solvents, however hydrophobic DESs are gaining increasing attention in the extraction and the solubilization of hydrophobic compounds. The hydrophobic DESs were firstly prepared using decanoic acid and various quaternary ammonium salts (van Osch et al., 2015).

Most probably, the polarity of DESs is a key property mainly regarding the solubilizing capacity of the solvent. Solvatochromic values that have been reported for DESs are generally between those of methanol and water. This means that DESs are highly polar and have good hydrogen bond donation and acceptance abilities toward solutes (Marcus, 2019b). The nature of DESs components contribute significantly to the polarity of the solvent. As it was shown by Dwamena & Raynie, when increasing the alkyl chain length of HBD in carboxylic acid-based DESs, the polarity of DESs decreased (Dwamena & Raynie, 2020). Pandey & Pandey found that the polarity of choline chloride based-DESs with urea, glycerol or ethylene glycol was higher than with short alkyl chain-alcohols (Pandey & Pandey, 2014). The influence of the temperature on the polarity of DESs showed that the different measurement parameters of the polarity (solvent polarizability, solvent dipolarity, solvent acidity and solvent basicity), do not behave similarly (Valvi et al., 2017). The DESs components molar ratio contributes also to the polarity of the solvent as it was shown by Abbott et al., when varying the molar ratio of choline chloride:glycerol DES (Abbott et al., 2004).

3. Solvation of natural molecules by deep eutectic solvents

Since DESs components are connected through strong hydrogen bonding, it is assumed that solutes that are capable of forming hydrogen bonding will be soluble in these solvents. In this context, according to the ‘like dissolves like’ theory, the target compounds can be dissolved easily by solvents with similar polarity (Salehi et al., 2019). The research into the interactions between DESs components and solutes and the ways of dissolving them constitutes a large number of recent studies. Therefore, it is important to discuss the solvation of interesting natural molecules, mainly secondary plant metabolites, in DESs and NADESs.

Understanding the real mechanisms behind it is considered of great significance. In most of the presented studies, solubility measurements were done according to the saturation dissolved method (Cheng & Zhang, 2017). This is done by saturating a specified volume of DES or NADES with excess amount of the tested natural compound, followed by a possible ultrasonication (Shen et al., 2011). Then, the mixture is agitated at a given temperature and for a defined equilibrium time (varying from hours to days). After centrifugation, the supernatant, saturated with the highest solubilized amount of the compound, is filtered and analyzed by spectrophotometric or chromatographic methods (Dai et al., 2013a). Exactly same optimized experimental conditions (stirring velocity, time and temperature) were adopted for the solubility measurements in water and other organic solvents leading to efficient comparison (Faggian et al., 2016).

3.1. Alcohol- and sugar-based molecules

Recently, natural alcohol- and sugar-based molecules have received considerable attention, both as an energy source and as renewable raw materials. They are intermediates from which many other products can be obtained such as monomers for bioplastics. They are also important feedstock for the production of fuel, etc. (Dietz et al., 2017). Alcohol- and sugar-based molecules can be found in agricultural resources and residues from forest products (i.e. pine wood) and they are widely distributed in plant sources (i.e. rice, peppermint oil, tomatoes, tea, potatoes.). Many of these molecules have been dissolved in DESs and their solubilities were assessed and compared to water (**Table 2**).

Table 2- The representative application of DESs for the solvation of alcohol- and sugar-based natural molecules.

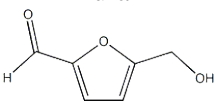
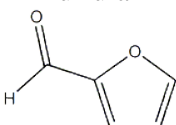
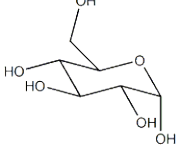
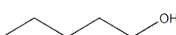
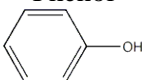
Compound	DESs				Solubility values in water ^a	Reference
	HBA	HBD	Molar ratio	Solubility in DES		
5-Hydroxymethylfurfural 	Imidazole	Acetic acid	1:1	Completely miscible ^c	7x10 ⁵ g/g	(Dietz et al., 2017)
	Betaine	Levulinic acid	1:2			
	Tetraethyl ammonium chloride	Glycolic acid	1:2			
	Tetraoctyl ammonium bromide	Decanoic acid	1:2			
	ChCl	Urea	1:2	0.80 g/g ^c		(Dietz et al., 2019)
	ChCl	Ethylene glycol	1:2	Completely miscible ^c		
	Tetraoctylammonium bromide	Decanoic acid	1:2	0.75 g/g ^d		
	Thymol	Decanoic acid	1:1	0.80 g/g ^d		
	Lidocaine	Thymol	1:2	0.85 g/g ^d		
Furfural 	Imidazole	Acetic acid	1:1	Completely miscible ^c	0.07 g/g	(Dietz et al., 2017)
	Betaine	Levulinic acid	1:2			
	Tetraethyl ammonium chloride	Glycolic acid	1:2			
	Tetraoctyl ammonium bromide	Decanoic acid	1:2			
	ChCl	Urea	1:2	0.80 g/g ^c		
ChCl	Ethylene glycol	1:2	0.95 g/g ^c			
Glucose 	ChCl	Ethylene glycol	1:2	0.10 g/g ^e	0.48 g/g ^b	(Häkkinen et al., 2019)
	Tetrabutylammonium bromide	Imidazole	1:2	0.13 mole fraction ^f		(Mohan et al., 2017)
	Tetrabutylammonium bromide	Ethylene glycol	1:4	0.02 mole fraction ^f		
	Tetrabutylammonium bromide	Glycerol	1:4	0.04 mole fraction ^f		
Pentanol 	ChCl	Ethylene glycol	1:2	<0.10 g/g ^e	0.02 g/g	(Häkkinen et al., 2019)
Phenol 					0.08 g/g	

ChCl: Choline Chloride; ^aSolubility values obtained from “PubChem Compound” at 25 °C; Solubility values at ^b20 °C or ^c30 °C or ^d29.85 °C or ^e24.85 °C or ^f26 °C.

Dietz et al., screened different DESs for 5-hydroxymethylfurfural (HMF), furfural (FF), glucose, fructose and other sugars solubilities. It was observed that the temperature does not have a significant influence on the solubility in the DESs, except for glucose and fructose, at high temperatures, which is related to the degradation/conversion of these sugars. Authors found that FF and HMF were completely miscible in all tested DESs except the DES containing choline chloride, where their solubilities are slightly lower. The hydrophobic DES tetraoctylammonium bromide:decanoic acid was shown to be the most interesting DES. This

is due to its water-immiscible character and because it presented the highest solvation ability for all sugar-derived components but not for the sugars themselves. Thus, this DES can be considered the most suited one for the extraction of FF and HMF from aqueous solutions. It was also found that the solubility of FF and HMF increased with increasing the amount of ethylene glycol in the choline chloride:ethylene glycol DES, revealing the influence of the HBA:HBD molar ratio on the solubility (Dietz et al., 2017). Dietz et al., 2019, also found that the solubility of HMF was very high in hydrophobic DESs. This accentuated their use for HMF removal from water in biorefinery processes (Dietz et al., 2019).

Hakkinen et al., 2019 explained the solvation mechanism of alcoholic solutes and glucose in choline chloride:ethylene glycol 1:2 molar ratio DES (known as ethaline). The authors were interested in the intermolecular forces between the solutes and the solvent. 10 wt% of glucose, pentanol and phenol were prepared in ethaline systems and the solvation behavior was assessed by viscosity and species diffusion measurements. It was shown that the solubility of glucose increased in DESs, thus inducing an increase in the viscosity of the system leading to lower mobility of all species. Also, dynamic light scattering results showed that a homogenous solution is obtained with glucose at two temperatures (25 and 50 °C). This indicated that, most probably, glucose forms hydrogen bonds with ethaline through its many hydroxyl groups and these solute-solvent interactions are stronger than the solute-solute or solvent-solvent interactions as shown in **Figure 4**.

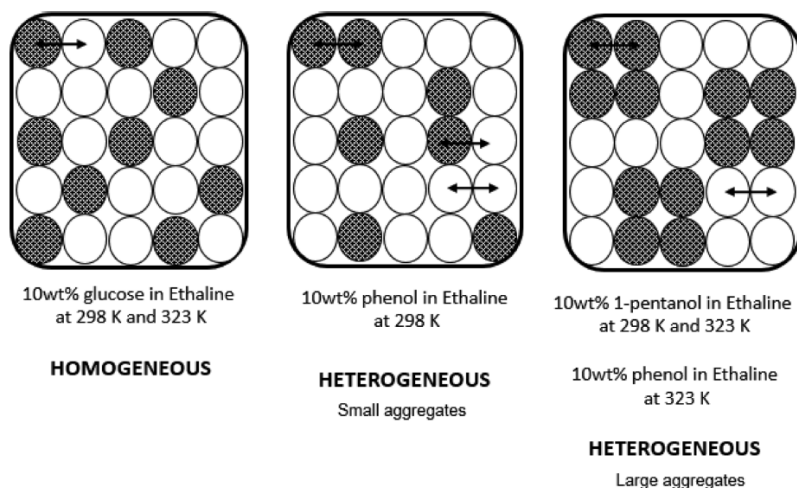

Figure 4: Phase behavior of 10 wt % glucose, pentanol, and phenol in ethaline at 25 and 50 °C. Figure reprinted with permission from Häkkinen et al., 2019. Dark circles present the solvent and white circles present the solute.

Figure 5 shows the interactions existing between glucose and ethaline that allow its solvation; these results are obtained by NMR analysis in deuterated dimethylsulfoxide (DMSO-d₆). The hydroxyl protons of glucose show exchange with the other hydroxyl

protons in the DESs. Even for the aliphatic protons, cross-peaks can be seen with the DESs hydroxyl protons, as a consequence of the proximity of both molecules (Häkkinen et al., 2019).

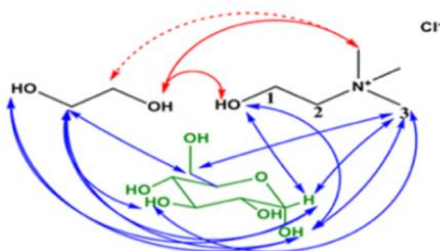

Figure 5: Interactions between ethylene glycol, choline chloride, and glucose when 10 wt % glucose is dissolved in ethaline. Figure reprinted with permission from Häkkinen et al., 2019.

The viscosity of 10 wt% pentanol and phenol in ethaline was less than in pure ethaline and in 10 wt% glucose in ethaline, indicating weaker interactions. Indeed, these molecules have only one hydroxyl group for hydrogen bond formation. Dynamic light scattering results suggested that below its melting point (40 °C), phenol is soluble in DESs; hence, there is an effective solvation by cholinium cation leading to a more homogenous mixture. However, above 40 °C, this interaction is weaker leading to an increase in the phenol-phenol interactions and to solute aggregation and formation of a heterogeneous media (Häkkinen et al., 2019).

Another work, done by Mohan et al., in 2017, measured the solubility of glucose in three DESs (**Table 2**). The tetrabutylammonium bromide:imidazole DES gave the highest solubility of glucose than others. This can be explained by the fact that the two other HBDs (ethylene glycol and glycerol) are assembled with the HBA by stronger interactions which led to a lower solubility of glucose. In addition, classical molecular dynamic simulations showed that the glucose-salt cation interaction are dominated by Van der Waals interactions while the electrostatic interaction, namely hydrogen bonds, dominates both the Glucose-[Br⁻] and Glucose-HBD interactions. Further, tetrabutylammonium bromide:imidazole DES can be used as an enhancer solvent for the dissolution of carbohydrate without thermal decomposition (Mohan et al., 2017).

3.1.1. Native cyclodextrins

Native cyclodextrines (CDs) known as α -CD, β -CD and γ -CD are naturally available oligosaccharides composed of six, seven and eight α -D-glucopyranose units, respectively, bounded by α -(1-4) linkages (Villiers, 1891).

In their work, McCune et al. dissolved the three native CDs in choline chloride:urea DES and obtained a solubility enhancement (>500 mg/mL for α -CD and >1000 mg/mL for β -CD and γ -CD) of more than 3 to 55-fold when compared to their solubility in water (129, 18 and 249 mg/mL for α -CD, β -CD and γ -CD, respectively) (McCune et al., 2017). In 2019, Moufawad et al., were able to solubilize 10 wt% of five CDs (including the natural α -CD, β -CD, γ -CD) in choline chloride:urea DES (Moufawad et al., 2019). Interestingly, no aggregation of the CDs was detected in the choline chloride:urea DES even at the highest tested concentration (800 mg/mL). The remarkable solvation ability of the DES toward CDs is attributed not only to the hydrogen bonding interaction between the DES moieties and the CDs hydroxyl groups but to the additional effect of urea which allowed the solvation of the interior hydrophobic walls of the CDs (Triolo et al., 2020).

3.2. Terpenes

Terpenes are a large class of compounds found in essential oils. These molecules are exploited worldwide in various applications, being the primary raw materials of the fragrance and flavor industries, also in cosmetic and medical fields (Kfoury et al., 2019).

Table 3 lists the terpenes that have been solubilized in DESs and displays their solubility values in DESs and in some reference solvents.

Terpenes can undergo oxidation, especially in the presence of a photosensitizer and oxygen (Rubulotta & Quadrelli, 2019). Accordingly, Ozturk et al., in 2018, relied on the difference in the solubility values of terpenes and oxygenated compounds present in citrus essential oils in DESs for essential oil deterpenation. Authors showed that, with the pure choline chloride:glycerol 1:2 molar ratio DES, the best separation of linalool from limonene was achieved because DES has higher affinity toward the target polar solute, being able to make intermolecular hydrogen bonding with the hydroxyl groups of this compound. The addition of water to the DES decreased the solvation ability of the solvent towards linalool. This is mainly due to the hydrogen bonds that occurred between the water molecules and linalool which alters the solvent polarity and results in lower solubility of the target molecule in DES (Ozturk et al., 2018).

Table 3- The representative application of DESs for terpenes solvation.

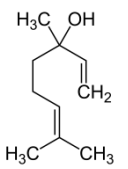
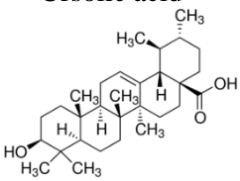
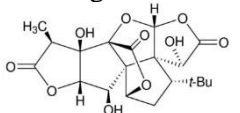
Compound	DESs				Solubility values in reference solvents	Reference
	HBA	HBD	Molar ratio	Solubility in DES		
Linalool ^b 	ChCl	Glycerol	1:2	0.02 < β < 0.15 in pure DES and 0.01 < β < 0.10 in DES/water (70/30, v/v)	β < 0.2 in ethylene glycol	(Ozturk et al., 2018)
	ChCl	Glycerol	1:3			
Ursolic acid ^c 	Menthol	Phenylpropionic acid	1:1	38 mg/g	~10 mg/g in limonene and γ -valerolactone, 37 mg/g in menthol and 50 mg/g in thymol	(Silva et al., 2020)
	Menthol	Thymol	1:1	28 mg/g		
	Menthol	Thymol	1:2	66 mg/g		
	Menthol	Thymol	2:1	27 mg/g		
Ginkgolide B ^d 	ChCl	Propane-1,2-diol	1:1:1 ^a	38.34 g/mole of DES	0.01 g/mole of water	(Dai et al., 2013a)
	ChCl	Glucose	5:2:5 ^a	6.51 g/mole of DES		
	Lactic acid	Glucose	5:1:3 ^a	2.49 g/mole of DES		
	ChCl	Xylitol	2:1:3 ^a	11.62 g/mole of DES		

ChCl: Choline Chloride; β : Solute distribution coefficient which is the ratio of a compound mass fraction (w) in two separated solvents (in this case *via* centrifugation) at equilibrium $\beta = \frac{w_{\text{solvent 1}}}{w_{\text{solvent 2}}}$;

^aThe molar ratio is presented as HBA:HBD:third component molar ratio in ternary DESs where water is the third component; Solubility values at ^b25 °C or ^c60 °C or ^d40 °C.

Another study, done by Silva et al., aimed to test several hydrophobic NADESs for the solvation of the most abundant compound in *Eucalyptus globulus* outer bark, ursolic acid. Overall, the solubility study was carried out in menthol:thymol NADES with different molar ratios and at different temperatures. The results, presented in **Figure 6**, showed that the solubility of this molecule is higher in the NADES with the higher thymol ratio (1:2) (Silva et al., 2020). The temperature had an influence on the solubility in contrary to what was observed with Dietz et al., in 2017. By increasing the temperature, an increase in the solubility of ursolic acid was obtained (Silva et al., 2020).

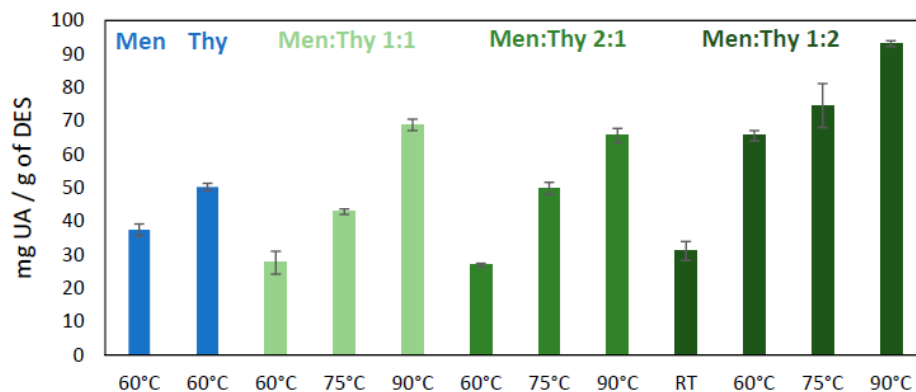
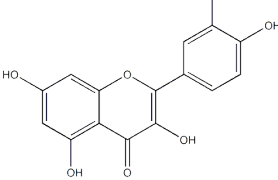
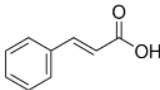
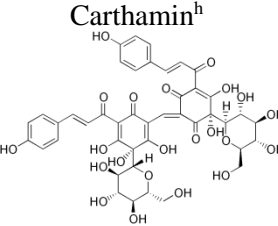
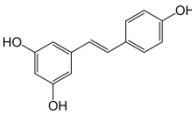
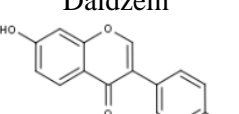
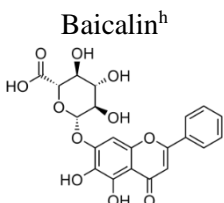

Figure 6: Solubility of ursolic acid (UA) in menthol (Men) and thymol (Thy) and in Men:Thy natural deep eutectic solvents (NADESs) in different proportions (1:1, 2:1, 1:2) at different temperatures including room temperature (RT). Figure reprinted with permission from Silva et al., 2020.

3.3. Phenolic compounds

Phenolic compounds are ubiquitously present in plants, herb species, fruits and vegetables. With the increasing evidence that phenolic compounds exert strong health-promoting effects, these molecules have a great potential to be used as nutraceutical supplements and pharmacological agents (Shamseddin et al., 2017; Schweiger et al., 2019). They can also be used as precursors for the synthesis of bio-based products (Schweiger et al., 2019). The results of solubility studies of phenols conducted in DESs are represented in **Table 4**.

Table 4- The representative application of DESs for the solvation of phenols.

Compound	DESs				Solubility values in reference solvents	Reference
	HBA	HBD	Molar ratio ^b	Solubility in DES at 313.15K		
<p>Quercetin^h</p> 	ChCl	Propane-1,2-diol	1:1:1 ^c	117.60 g/mole of DES	0.0004 g/mole of water (Dai et al., 2013a)	(Dai et al., 2013a)
	ChCl	Glucose	5:2:5 ^c	106.19 g/mole of DES		
	Lactic acid	Glucose	5:1:3 ^c	2.57 g/mole of DES		
	ChCl	Xylitol	2:1:3 ^c	166.95 g/mole of DES		
	ChCl	Propane-1,2-diol	1:1	~600 μmole/mL		(Dai et al., 2015)
	ChCl	Xylitol	2:1:3 ^c	$W_q=2.22 \cdot 10^{-2}$		
<p>Cinnamic acid^h</p> 	ChCl	Propane-1,2-diol	1:1:1 ^c	128.47 g/mole of DES	0.13 g/mole of water	(Dai et al., 2013a)
	ChCl	Glucose	5:2:5 ^c	40.54 g/mole of DES		
	Lactic acid	Glucose	5:1:3 ^c	124.60 g/mole of DES		
	ChCl	Xylitol	2:1:3 ^c	44.29 g/mole of DES		
<p>Carthamin^h</p> 	ChCl	Propane-1,2-diol	1:1:1 ^c	4.21 g/mole of DES	0.02 g/mole of water (Dai et al., 2013a)	(Dai et al., 2013a)
	ChCl	Glucose	5:2:5 ^c	2.77 g/mole of DES		
	Lactic acid	Glucose	5:1:3 ^c	0.41 g/mole of DES		
	ChCl	Xylitol	2:1:3 ^c	6.77 g/mole of DES		(Dai et al., 2015)
<p>Resveratrol^h</p> 	ChCl	Propane-1,2-diol	1:1:1 ^c	20 g/L	0.03 g/L ^{a,k} in water and 50 g/L ^{a,k} in DMSO and ethanol	
<p>Daidzein^h</p> 	Borneol	Menthol		~400 μg/mL	8.21 μg/mL in water and 7.85 μg/mL in acidic water	(Shen et al., 2011)
<p>Baicalin^h</p> 	Tetrabutylammonium chloride	Decanoic acid	2:1	19.73 mg/mL	0.08 mg/mL in water and 1.85 mg/mL in 70% ethanol (Wang et al., 2018a)	(Wang et al., 2018a)
	Tetrabutylammonium chloride	Decanoic acid	1:1	2.74 mg/mL		
	Tetrabutylammonium chloride	Decanoic acid	1:2	2.23 mg/mL		
	Methyltriethylammonium chloride	Decanoic acid	2:1	1.77 mg/mL		
	Methyltriethylammonium chloride	Decanoic acid	1:2	1.17 mg/mL		

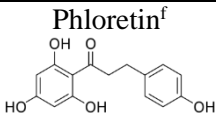
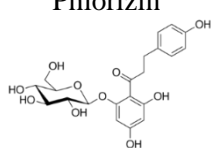
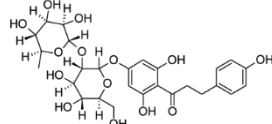
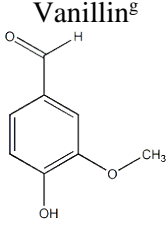
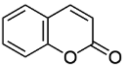
	Methyltriocetyl ammonium bromide	Decanoic acid	1:2	1.30 mg/mL		(Wang et al., 2018)
	Tetraoctyl ammonium bromide	Decanoic acid	1:2	1.28 mg/mL		
	ChCl	Lactic acid	1:1	22.70 mg/g		
	ChCl	Glucose	1:1	18.20 mg/g		
	ChCl	Glycerol	1:1	12.35 mg/g		
	ChCl	Butane-1,4-diol	1:1	2.25 mg/g		
Phloretin^f 	Citric acid	Glucose	1:1:12 ^c	$10^3x = 5,13 \times 10^{-3}$	0.12 g/L ^a in water	
	ChCl	Citric acid	1:1:11 ^c	$10^3x = 0.18$		
	ChCl	Sucrose	1:1:10 ^c	$10^3x = 3.34$		
Phlorizin^f 	Citric acid	Glucose	1:1:12 ^c	$10^3x = 0.51$	1 g/L ^{ai} in water	(Tang et al., 2016)
	ChCl	Citric acid	1:1:11 ^c	$10^3x = 2.57$		
	ChCl	Glucose	1:1:11 ^c	$10^3x = 1.61$		
Naringin dihydrochalcone^f 	Citric acid	Glucose	1:1:12 ^c	$10^3x = 0.38$	~30 g/L ^j in ethanol and DMSO and dimethyl formamide	
	ChCl	Citric acid	1:1:11 ^c	$10^3x = 1.53$		
	ChCl	Glucose	1:1:11 ^c	$10^3x = 1.62$		
Vanillin^g 	ChCl	Citric acid	1:1:6 ^c	90 mg/mL	375.81 mg/mL in ethanol, 632.94 mg/mL in methanol and 30 mg/mL in water	(González et al., 2018)
	ChCl	Malic acid	1:1:6 ^c	90 mg/mL		
	ChCl	Glycerol	1:1	270 mg/mL		
	Fructose	Glucose	1:1:6 ^c	30 mg/mL		
	Malic acid	Glucose	1:1:6 ^c	30 mg/mL		
	Betaine	Sucrose	2:1:6 ^c	30 mg/mL		
	Betaine	Citric acid	1:1:6 ^c	60 mg/mL		
	Betaine	Malic acid	1:1:1:9 ^d	30 mg/mL		
	Citric acid	Fructose	1:1:1:9 ^d	30 mg/mL		
	Malic acid	Glucose	1:1:1:9 ^e	30 mg/mL		
	L-Serine	Malic acid	1:1:6 ^c	30 mg/mL		
	β-Alanine	Citric acid	1:1:6 ^c	30 mg/mL		
	Lactic acid	Propane-1,2-diol	1:1	620 mg/mL		
Lactic acid	Fructose	5:1	320 mg/mL			
Coumarin^h 	ChCl	Propionic acid	1:2	$x = 1708.542$	$x = 4.393$ in water	(Khorsandi et al., 2020)
	ChCl	Acetic acid	1:2	$x = 970.398$		
	ChCl	Lactic acid	1:2	$x = 558.461$		

ChCl: Choline Chloride; W_q : mass fraction; x : mole fraction; ^aSolubility values obtained from “PubChem Compound”; ^bThe molar ratio is presented as HBA:HBD:third component molar ratio in ternary DESs where ^cwater or ^dglucose/ water or ^efructose/ water are the third component; Solubility values at ^f25 °C or ^g50 °C or ^h40 °C or ⁱ22 °C; ^jSolubility value obtained from Cayman Chemical *item No. 2779*; ^kTemperature not mentioned.

It was shown that the solubility of some poorly water-soluble natural molecules (quercetin, cinnamic acid and carthamin) in NADESs was strongly affected by the temperature; the change of temperature from 40 °C to 50 °C resulted in a 2.3-fold increase of the solubility of quercetin (Dai et al., 2014). Similar findings were obtained by Silva et al., in 2020. Also, the solubility was greatly higher in NADESs than in water or 40% ethanol/water (Dai et al., 2014). The same results were obtained later on, when López et al., measured the solubility of quercetin in water and in two DESs: choline chloride:xylitol:water (2:1:3 molar ratio) and choline chloride:citric acid:water (1:1:6 molar ratio) (López et al., 2020). Quercetin was remarkably more soluble in the studied DESs than in pure water (5 and 3 orders of magnitude, respectively). In 2013, Dai et al., reported a mass fraction value of $W_q=0.608$ indicating higher quercetin solubility at higher temperature (40 °C) for the same DES (Dai et al., 2013a). Authors also concluded that the interactions of choline chloride with xylitol were stronger than with citric acid because the solubility value was 3-fold higher in choline chloride:xylitol:water DES (López et al., 2020). In order to gain more insight into the solubilizing mechanism of NADESs, Dai et al., used high-resolution magic angle spinning NMR to analyze a saturated solution of quercetin in choline chloride:xylitol:water (2:1:3 molar ratio). Obvious cross peaks between quercetin and NADES, shown in **Figure 7**, were observed indicating that the high solvation capacity of NADES is explained by hydrogen bonding between NADES molecules and the solute (Dai et al., 2013a).

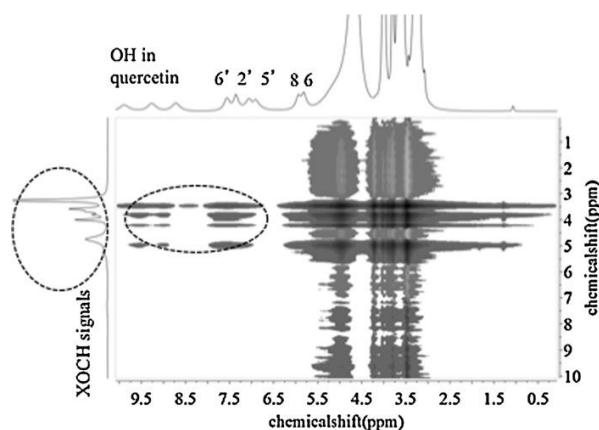

Figure 7: ^1H - ^1H -nuclear overhauser enhancement spectroscopy of correlation between quercetin and choline chloride:xylitol:water (2:1:3 molar ratio) (XoCH) by high-resolution magic angle spinning (HR-MAS) NMR. Figure reprinted with permission from Dai et al., 2013a.

Afterwards, Dai et al., got deeper understandings how the physico-chemical characteristics of NADESs with different water contents are useful to predict its solvation capacity. The water content can be optimized depending on the compound (**Figure 8**).

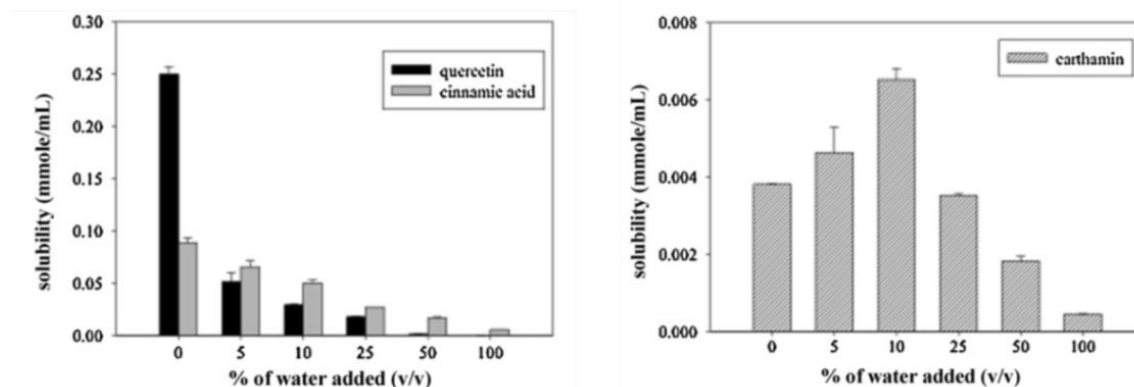

Figure 8: Solubility of quercetin, cinnamic acid and carthamin in choline chloride:glucose:water (5:2:5 molar ratio) diluted with different percentage of water. Figure reprinted partially with permission from Dai et al., 2013a.

Furthermore, the optimal water content is correlated with the viscosity of NADESs. For example, carthamin has the highest solubility in choline chloride:propane-1,2-diol with 5% (v/v) water and in choline chloride:glucose with 10% (v/v) water although the latter is more polar, however more viscous. This points to an extensive hydrogen bonding structure in glucose:choline chloride NADES which results in a high viscosity where there is no space for dissolving various solutes and more water is needed to achieve a good solvation ability. Notably, quercetin was highly soluble in choline chloride:propane-1,2-diol NADES with 10% (v/v) water while carthamin was most soluble in this NADES with 5% (v/v) water. This solvent has a low polarity and the dilution leads to an increase in its polarity to a value close to that of water. It was then stated that apolar compounds have the highest solubility in pure NADES while a 5-10 v% of water dilution allows the highest solubility of medium polar compounds (Dai et al., 2015). Also, López et al., in 2020 stated that water can play an important role in the solute-solvent interaction, possibly by favoring an environment rich in hydrogen bonds (López et al., 2020). When evaluating the extraction of flavonoids (myricetin and amentoflavone) using alcohol-based DESs, Bi et al., suggested that flavonoids can be considered as a type of HBD, which can interact competitively to alcohol-based HBDs with a chloride anion, thus becoming more soluble (Bi et al., 2013). Other findings showed also the possibility to dissolve resveratrol, a stilbenoid, in NADESs. From eighteen tested NADESs, resveratrol solubilized in choline chloride:propane-1,2-diol:water NADES exhibited a strong increased enzyme-inhibitory activity of matrix metalloprotease-9, at least 10-fold, higher than resveratrol dissolved in dimethylsulfoxide. Also, *in-vitro* studies showed that resveratrol dissolved in dimethylsulfoxide precipitated faster as compared with NADESs (Shamseddin et al., 2017).

Daidzein, a water-insoluble isoflavone, was solubilized in a borneol:menthol DES. For all tested ratios, the solubility of this molecule was higher in DESs than in water or acidic water. Its solubility varied with various concentrations of borneol in the DESs. The highest solubility was observed at the borneol:menthol ratio of 25:75 (**Figure 9**), improving its bioavailability when orally administrated to rats (Shen et al., 2011).

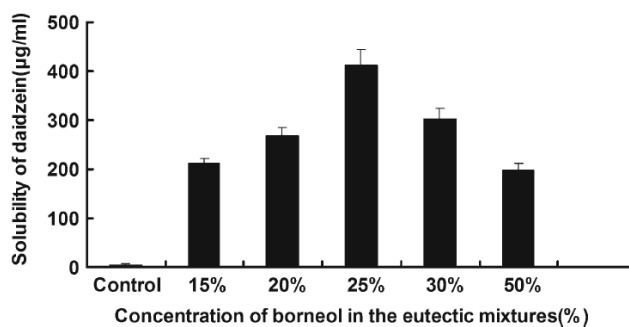

Figure 9: Solubility of daidzein in various concentrations of borneol in a eutectic mixture. Figure reprinted with permission from Shen *et al.*, 2011.

Similar results were obtained by Wang et al., when dissolving baicalin from *Scutellaria baicalensis* Georgi in hydrophobic decanoic acid-based DESs. The equilibrium solubility of baicalin was the highest in tetrabutylammonium chloride:decanoic acid 2:1 molar ratio which was approximately 240-times the solubility of baicalin in water and 10-times its solubility in 70% ethanol. Authors speculate that decanoic acid can form strong intermolecular hydrogen bonding with tetrabutylammonium chloride, thus acquiring similar polarity with baicalin, which is responsible for the high dissolution. It was shown that along with the increase in the length of the HBA alkyl chain, lower polarity and higher viscosity were obtained, thus, decreased solubility of baicalin was observed (Wang, et al., 2018b). The same group showed later that the equilibrium solubility of baicalin in choline chloride:lactic acid 1:1 molar ratio DES was also high, approximately 200-fold higher than in water and 20-fold higher than in 70% ethanol. This could be due to the low viscosity of the DES (Wang, et al., 2018). Identically, the solubilities of three flavonoids (phloretin, phlorizin and naringin dihydrochalcone) were remarkably improved in NADESs compared to water at the temperature range from 15 to 55 °C. According to the authors, the solubilities of phlorizin and naringin dihydrochalcone in choline chloride: citric acid: water NADES were approximately the same as in choline chloride: glucose: water NADES, and they were higher than in citric acid: glucose: water NADES. So the component choline chloride contributed efficiently to the solubility of flavonoids in NADESs (Tang et al., 2016). In addition, González et al., tested the solubility of vanillin in fourteen different NADESs at 50 °C where

a lower viscosity of DESs is observed. The solubility of vanillin was higher or similar than in methanol, ethanol or water (**Table 4**) (González et al., 2018).

In the same context, using the tailoring properties of DESs, the insoluble caffeic acid was added into a ternary choline chloride:caffeic acid:ethylene glycol DES, which was employed as a template to prepare molecularly imprinted polymers. Synthesized polymers showed increasing adsorption ability for polyphenols (caffeic acid, protocatechuic acid, catechin and epicatechin) with the highest adsorbed amount and recognition specificity for caffeic acid. In addition, this result showed that this preparation in DESs has the potential to be used in purification, analysis and drug delivery of poorly soluble bioactive compounds (Fu et al., 2017).

The solubility of coumarin, another essential pharmaceutical compound, have been investigated in three pure DESs and aqueous solutions of choline chloride-based acidic DESs (propionic acid, lactic acid or acetic acid as HBDs). As the result, coumarin dissolution was increased by increasing the temperature from 25 to 40 °C. The solubility values were more than 100-fold higher in pure DESs than in pure water for each temperature. It was found that increasing the acidity properties of propionic acid, acetic acid and lactic acid, the solubility of coumarin have been increased due to the favoring hydrogen bonding interactions between coumarin and DESs (Khorsandi et al., 2020).

3.3.1. Rutin

Rutin is a common dietary glycosylated flavonoid found in fruits, vegetables and many plant-derived beverages such as tea and wine. It is used in pharmaceutical and nutraceutical products mainly because of its anti-inflammatory, anti-bacterial, cancer chemopreventive and anti-depressive activities (Dai et al., 2013a; Faggian et al., 2016). Almost all solubility studies of rutin in DESs and NADESs showed increasing solubility of this molecule compared to reference solvents (water: 90 µg/mL and methanol: 97000 µg/mL) (Dai et al., 2013a; Faggian et al., 2016; Huang et al., 2017). This solubility increment, which varied significantly with the type of NADESs, is due to the hydrogen bonding between rutin and this solvent.

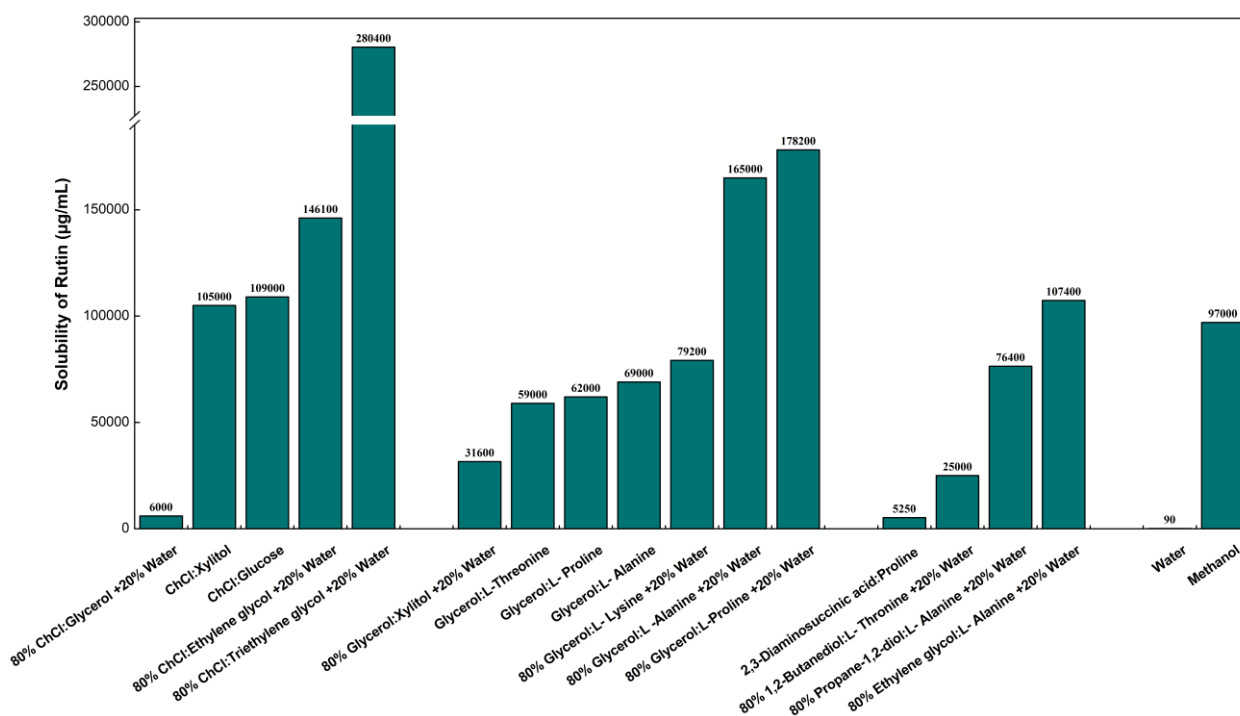

Figure 10: Solubility values of rutin in different NADESs, water and methanol at 40 °C (Huang et al., 2017; Zang et al., 2020). ChCl: Choline Chloride.

As can be seen from **Figure 10**, which focuses on the most efficient tested DESs and NADESs, the solubility of rutin in choline chloride-based NADESs was higher than in glycerol-based NADESs. The highest solubility value was obtained in 80% choline chloride:triethylene glycol (1:4 molar ratio)+ 20% water (0.28 g/mL). This solvent has the highest polarity. The lowest solubility value was observed in choline chloride:glycerol (1:1 molar ratio)+ 20% water (6 mg/mL). This is due to the high viscosity of this solvent (Zang et al., 2020). This indicated that the solvation capacity of NADESs can be increased by the addition of small quantity of water (20%). However, according to Huang et al., in 2017, the presence of too much water (>20%, w/w) in the solvent resulted in a decrease of rutin solubility, which may be attributed to the disrupted interactions between the solute and NADESs (Huang et al., 2017). Following this, Jeliński & Cysewski found that the number, position(s) and type(s) of functional groups affect the solvation potency of the NADESs. Using a computational screening methodology, the best solubilizing NADESs for rutin was the 2,3-diaminosuccinic acid:proline NADES. It was also concluded that the solubility of rutin, a weak acid, is enhanced by the presence of basic amino groups with heterocyclic structure present in DESs. Likewise, DESs composed of carboxylic acids with two unsubstituted amino groups attached to their alkyl chain (composed of two methylene groups), were proved to be the best (Jeliński & Cysewski, 2018).

3.3.2. Curcumin

Curcumin is a hydrophobic polyphenol present in Rhizomes of the herb *Curcuma longa* L. It shows anti-oxidant, anti-inflammatory, anti-tumor, etc. activities (Wikene et al., 2015b). In 2015, Wikene et al., attempted to solubilize curcumin, in different NADESs. The highest curcumin concentration was achieved in D-(+)-glucose:sucrose 1:1 molar ratio and choline chloride:malic acid 3:1 molar ratio. Storage of the curcumin-NADESs solutions in airtight tubes for one month induced an increase of curcumin solubility: 29 ± 4 % and 16 ± 9 % in these two NADESs, respectively, compared to the starting time (Wikene et al., 2015b). Samples of curcumin in these NADESs diluted 10-50 times in water showed a rapid precipitation of curcumin due to the disruption of curcumin-NADESs network, which was similarly obtained with Ozturk et al., in 2018. The increase in curcumin solubility was almost similar to other solubilizers like aqueous solutions of CDs and surfactants, and aqueous solutions of alginate or gelatin (Wikene et al., 2015b). However, NADESs presented higher hydrolytic and/or photolytic stability of curcumin, mainly because this solvent seemed to lock curcumin in its colorless diketo conformer. Choline chloride:malic acid NADES containing curcumin photoinactivated *Escherichia coli* at a lower curcumin concentration ($1.25 \mu\text{M}$) than many other preparations of curcumin (i.e. dimethylsulfoxide, CDs, liposomes, surfactants and others) (Wikene et al., 2015b). Curcumin was also better solubilized in acidic type of NADESs such malic acid:sucrose:water (1:1:11 molar ratio) and citric acid:sucrose:water (1:2:15 molar ratio) compared to water and ethanol. The dilution of NADESs with water decreased its solubilizing capacity, considering that curcumin has very low solubility in water at $1 < \text{pH} < 7$. Comparing the structure of citric acid and malic acid, the presence of extra hydroxyl or carboxyl groups in citric acid allowing more hydrogen bond to be formed, increased the stability of curcumin in citric acid-based NADESs (Rachmaniah et al., 2018). Jeliński et al., 2019 tested the solubility of curcumin in twenty-one NADESs and all of them showed a significant increase of curcumin solubility compared to water (**Figure 11**) (Jeliński et al., 2019).

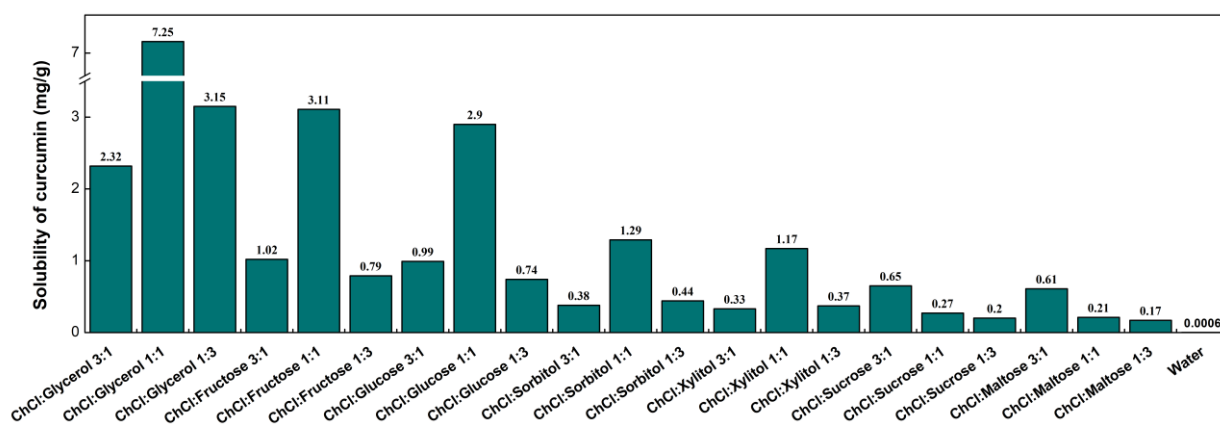

Figure 11: Solubility values of curcumin in different NADESs and water at 20 °C (Jeliński et al., 2019). ChCl: Choline chloride.

Choline chloride:glycerol NADES (1:1 molar ratio) gave a 12000-fold higher curcumin solubility than in water and presented higher advantage than methanol because of the increased stability of the dissolved curcumin (Jeliński et al., 2019). Similar results were observed by Wikene et al., 2015. In addition, based on *in-vitro* studies, a significant gain in curcumin solubility is observed, when dissolved in NADESs, in the gastrointestinal fluids. Therefore, it was concluded that using choline chloride:glycerol NADES as an agent for curcumin delivery offers an advantage over administrating curcumin in the powder form (Jeliński et al., 2019). Both studies showed that the solubilizing effect of the NADESs is most probably related to the formation of intermolecular hydrogen bonds between curcumin with at least one of NADESs components (Wikene et al., 2015b; Jeliński et al., 2019).

3.4. Alkaloids

Alkaloids are organic nitrogen-containing compounds that can be found with diverse structures in plants. They can be used in medicine due to their potential biological activities (Sut et al., 2017). **Table 5** displays the solubility studies conducted for some N-containing natural molecules in DESs.

Table 5- The representative application of DESs for the solvation of some alkaloids.

Compound	DESs				Solubility values in reference solvents	Reference
	HBA	HBD	Molar ratio ^b	Solubility in DES		
Berberine ^h	Proline	Urea	1:1	15.0 mg/mL	2.10 mg/mL in water and 2.75 mg/mL in	(Sut et al., 2017)
	Proline	Urea	2:1	12.30 mg/mL		
	Citric acid	Glucose	1:1	0.54 mg/mL		
	Proline	Malic acid	1:1	2.50 mg/mL		
	Proline	Malic acid	1:2	2.80 mg/mL		

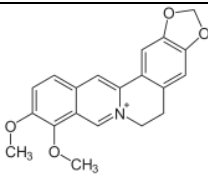
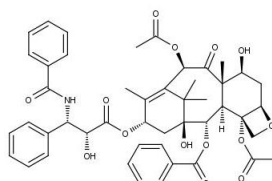
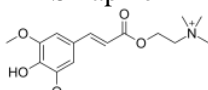
	Proline	Malic acid	1:3	6.0 mg/mL	ethanol	
	Proline	Malic acid	1:2:3 ^c	1.57 mg/mL		
	Proline	Malic acid	1:2:6 ^c	0.74 mg/mL		
	Proline	Citric acid	1:1	1.82 mg/mL		
	Proline	Citric acid	1:2	2.45 mg/mL		
	Proline	Tartaric acid	1:1:1 ^d	1.75 mg/mL		
	Proline	Glutamic acid	1:1	0.45 mg/mL		
	Proline	Glutamic acid	1:2	0.78 mg/mL		
	Proline	Malic acid	1:0.2:0.3:0.5 ^e	25 mg/mL		
	Proline	ChCl	1:1	1.24 mg/mL		
	Proline	ChCl	1:2	1.05 mg/mL		
	Proline	ChCl	2:1	0.80 mg/mL		
	ChCl	Malic acid	1:1	0.30 mg/mL		
	ChCl	Malic acid	1:2	1.35 mg/mL		
	ChCl	Malic acid	1:3	1.56 mg/mL		
	ChCl	Malic acid	2:1	1.42 mg/mL		
	ChCl	Malic acid	3:1	0.87 mg/mL		
	ChCl	Citric acid	2:1	0.75 mg/mL		
	ChCl	Citric acid	3:1	0.64 mg/mL		
	Carnitine	ChCl	1:1	0.41 mg/mL		
	Acetylcarnitine	ChCl	1:1	0.89 mg/mL		
	Carnitine	Proline	1:1	1.07 mg/mL		
	Acetylcarnitine	Proline	1:1	0.85 mg/mL		
	Carnitine	Proline	1:1	1.48 mg/mL		
	Carnitine	Sorbitole	1:1	0.35 mg/mL		
	Acetylcarnitine	Sorbitole	1:1	0.27 mg/mL		
	Carnitine	Xylitol	1:1	0.38 mg/mL		
	Acetylcarnitine	Xylitol	1:1	0.25 mg/mL		
	Acetylcarnitine	Proline	1:1:2 ^g	1.24 mg/mL		
	Acetylcarnitine	Proline	1:1:2 ^d	1.36 mg/mL		
Lactic acid			9 mg/mL			
Lactic acid	Water	1:1:0.1 ^d	10 mg/mL			
Lactic acid	Water	1:1:0.1 ^f	10 mg/mL			
Taxolⁱ 	ChCl	Propane-1,2-diol	1:1:1 ^c	2.95 g/mole of DES	0.0002 g/mole of water	(Dai et al., 2013a)
	ChCl	Glucose	5:2:5 ^c	0.46 g/mole of DES		
	Lactic acid	Glucose	5:1:3 ^c	3.45 g/mole of DES		
ChCl	Xylitol	2:1:3 ^c	0.13 g/mole of DES			
Sinapine^a 	ChCl	Propane-1,2-diol	1:1:1 ^c	0.02 mM	805.52 mM ^j in DMSO	(Duran et al., 2017)

ChCl: Choline Chloride; ^aTemperature not mentioned; ^bThe molar ratio is presented as HBA:HBD:third component molar ratio in ternary DESs where ^cwater or ^dcitric acid or ^elactic acid/water or ^foxalic acid or ^glactic acid are the third component; Solubility values at ^h22 °C or ⁱ40 °C; ^jSolubility value obtained from “Biocrick science solution specialist” with CAS# 18696-26-9.

In 2017, Sut et al., studied the solvation of berberine in different NADESs. Compared with water or ethanol, it was observed that a large number of NADESs that solubilized rutin, were not able to increase berberine solubility i.e. choline chloride-based NADESs. Only, three NADESs were able to solubilize berberine significantly higher than the reference solvents. The solubility of berberine in lactic acid-based NADESs was greater than 9 mg/mL. Also, in urea-based NADESs, berberine solubility was higher than 12 mg/mL, mainly due to the presence of the basic compound (urea). The best berberine solubility result (25 mg/mL) was obtained in proline:malic acid:lactic acid:water 1:0.2:0.3:0.5 molar ratio. This was explained by the fact that malic acid may form soluble berberine malate. Furthermore, the presence of a small amount of water strongly increased the solubility of berberine compared to DESs without water or with large amount of water, because excess dilution with water weakened the hydrogen-bonding interactions which was similarly obtained with Ozturk et al., 2018 and Wikene et al., 2015b. The administration by gavage to mice showed an increase in the bioavailability of berberine dissolved in this DES 8-fold higher than berberine in water suspension. On the basis of the prepared solvents, authors concluded that a tailor-made NADES for the berberine solubilization requires the combination of an organic acid (lactic or malic acid), amino acids and water (Sut et al., 2017).

Durand et al., were able to solubilize 25 μ M of sinapine, a natural antioxidant, in choline chloride:propane-1,2-diol:water (1:1:1 molar ratio) NADES. This formulation improved significantly sinapine relative antioxidant activity (~360% higher) as compared to sinapine dissolved in organic solvents (dimethylsulfoxide or ethanol) (Durand et al., 2017).

3.5. Amino acids and proteins

Amino acids and proteins are crucial for virtually all biological processes. They can be found in seeds, soy products, beans, fruits and vegetables. These molecules can be used in the manufacture of food and drink products and can be sold as nutritional supplements (Cardellini et al., 2014; Parnica & Antalík, 2014).

Table 6 presents the solubility studies conducted for some amino acids and proteins in DESs.

Table 6- Solvation of amino acids and proteins in DESs.

Compound	DESs				Solubility values in water	Reference
	HBA	HBD	Molar ratio ^b	Solubility in DES		
Phenylalanine ^d	Trimethylglycine	Glycolic acid	2:1	4.37 g/100g	2.20 g/100g	(Cardellini et al., 2014)
Tryptophan ^d				2.49 g/100g	1 g/100g	
Tyrosine ^d				1.05 g/100g	0.01 g/100g	
Leucine ^d				0.54 g/100g	1.76 g/100g	
Glutamic acid ^d				0.20 g/100g	2.20 g/100g	
Aspartic acid ^d				0.15 g/100g	2.10 g/100g	
L-Arginine ^e	Citric Acid	L-Arginine	1:1:6 ^c	102.17 mg/mL	99.35 mg/mL in phosphate buffered saline	(Santos et al., 2018)
	Citric Acid	L-Arginine	1:1:7 ^c	106.05 mg/mL		
	Citric Acid	L-Arginine	2:1:7 ^c	105.89 mg/mL		
	Citric Acid	L-Arginine	2:1:8 ^c	106.77 mg/mL		
	Citric Acid	L-Arginine	2:1:9 ^c	107.86 mg/mL		
Bovine serum albumin ^a	Ionic guanidine hydrochloride	Urea	1:2	260 mg/mL	40 mg/mL ^f	(Parnica & Antalík, 2014)
	Guanidine thiocyanate	Urea	1:2			
Cytochrome c ^a	Ionic guanidine hydrochloride	Urea	1:2	18 mg/mL	100 mg/mL ^g	
	Guanidine thiocyanate	Urea	1:2			

^aTemperature not mentioned; ^bThe molar ratio is presented as HBA:HBD:third component molar ratio in ternary DESs where ^cwater is the third component; Solubility values at ^d50 °C or ^e37 °C; ^fSolubility value obtained from “Sigma Aldrich” with CAS number 9048-46-8; ^gSolubility value obtained from “Merck” with CAS number 9007-43-6.

The solvation ability of a zwitterionic DES composed of trimethylglycine:glycolic acid 1:2 molar ratio, for α -L-amino acids was tested (Cardellini et al., 2014). Authors stated that the aromatic amino acids (phenylalanine, tryptophan and tyrosine) showed higher solubility in DES than in water. The solubility of apolar amino acids (such as leucine) in the DES was a bit lower than in water, whereas polar amino acids (glutamic acid and aspartic acid) showed much lower solubility in DES than in water. Most importantly, the DES showed good solubilizing capability of amino acids compared to typical ILs that could be due to the presence of a zwitterion in its structure (Cardellini et al., 2014). Santos et al., in 2018, proposed a strategy consisting of the preparation of THEDES that incorporates L-arginine. Particularly, the solubility of L-arginine was evaluated in phosphate buffered saline and it was slightly increased in THEDES (108 mg/mL) compared to the pure L-arginine (99 mg/mL) (Santos et al., 2018).

Some NADESs may contain compounds that can break down proteins structure (Vanda et al., 2018). Guanidine-based compounds and urea are well known denaturing agents and are used extensively in protein chemistry. Parnica & Antalík reported the ability of two DESs composed of these compounds to dissolve significant amounts of two purified proteins: bovine serum albumin and cytochrome c with, respectively, 6.5 and 1.8-fold higher solubility in both DESs than in water. Circular dichroism measurements showed that these DESs

present an effective tool to store soluble protein in its denatured form for a long time at room temperature (Parnica & Antalík, 2014).

3.6. Other natural molecules

Besides, other molecules such as porphyrins, fatty acids, aromatic molecules, active pharmaceutical ingredients (APIs), carboxylic acids, etc. are natural molecules used as food additives or in the treatment of many diseases (Morrison et al., 2009; Duarte et al., 2017). The results of the solvation studies in DESs and in reference solvents are presented in **Table 7**. All the molecules displayed later on, were more soluble in DESs than in the reference solvents.

Table 7- The representative application of DESs for the solvation of diverse natural molecules.

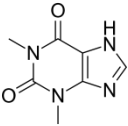
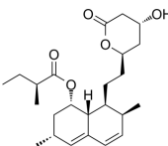
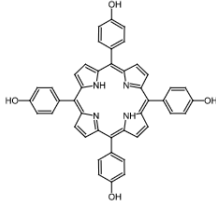
Compound	DESs				Solubility values in reference solvents	Reference
	HBA	HBD	Molar ratio ^a	Solubility in DES		
Theophylline ^d 	ChCl	Urea	1:2	2.20 mg/g	6.40 mg/g in water, 0.81 mg/g in ethanol, 1.66 mg/g in glycerol and 1.23 mg/g in polyethylene glycol 300	(Palmelund et al., 2019)
	ChCl	Glycerol	1:2	0.28 mg/g		
	ChCl	Lactic acid	1:0.9:0.6 ^b	4.10 mg/g		
	Betaine	Glycerol	1:2:1 ^b	3.42 mg/g		
	ChCl	Glucose	1:0.4:1 ^b	63.50 mg/g		
	Lactic acid	Glucose	1:0.2:1.2 ^b	1.08 mg/g		
Lovastatin ^e 	Lovastatin	Benzoic acid	0.19:0.81	194 µg/mL	49 µg/mL in sodium lauryl sulphate 0.25%/ water (w/v)	(Arya-Sibaja et al., 2019)
	Lovastatin	Salicylic acid	0.40:0.60	259 µg/mL		
	Lovastatin	Cinnamic acid	0.14:0.86	187 µg/mL		
5,10,15,20-tetrakis(4-hydroxyphenyl)porphyrin (THPP) ^f 	Citric acid	Sucrose	1:1	0.09 mg/mL		(Wikene et al., 2015a)
	ChCl	Maleic acid	1:1	0.01 mg/mL		
	D-(+)-glucose	DL-malic acid	1:1	1.04 mg/mL		
Meso-tetra-(4-carboxyphenyl)-porphyrin (TCPP) ^f	Citric acid	Sucrose	1:1	0.01 mg/mL	0.006 mg/ml in MilliQ-water and 0.6 x 10 ⁻³ mg/ml in 2.7 M citric acid	(Wikene et al., 2016)
	ChCl	Citric acid	2:1	0.12 mg/mL		
	ChCl	Maleic acid	2:1	0.07 mg/mL		
	ChCl	Xylitol	5:2	0.04 mg/mL		
	Citric acid	Xylitol	1:1	0.05 mg/mL		

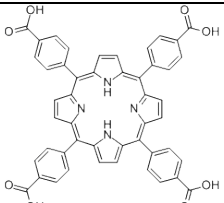
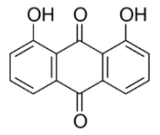
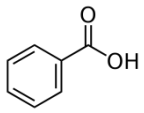
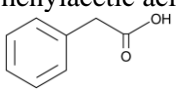
	DL-Malic acid	D-(-)-Fructose	1:1:1 ^c	0.04 mg/mL	solution	
	ChCl	Propane-1,2-diol	1:1:1 ^b	0.12 g/mole of DES	0 g/mole of water	(Dai et al., 2013a)
	ChCl	Glucos	5:2:5 ^b	0.26 g/mole of DES		
	Lactic acid	Glucose	5:1:3 ^b	0.41 g/mole of DES		
	ChCl	Xylitol	2:1:3 ^b	0.14 g/mole of DES		
	Betaine	Glycerol	1:8	DC = 0.52 (g.L ⁻¹)(g.L ⁻¹) ⁻¹		
	Betaine	Propylene glycol	1:8	DC = 0.97 (g.L ⁻¹)(g.L ⁻¹) ⁻¹		
	ChCl	Urea	1:2	229 mg/mL ^d	3 mg/mL ^d in water (Morrison et al., 2009) and 105mg/mL ^h in PBS buffer (Duarte et al., 2017b)	(Morrison et al., 2009)
	ChCl	Malic acid	1:1	35 mg/mL ^d		(Aroso et al., 2016)
	Menthol	Benzoic acid	3:1	DE = 87% ^d		(Duarte et al., 2017b)
	Menthol	Benzoic acid	3:1	218.70 mg/mL ^h		
	ChCl	Phenylacetic acid	1:1	DE = 67% ^d	18.40 mg/mL ^h in PBS buffer (Duarte et al., 2017b)	(Aroso et al., 2016)
	Menthol	Phenylacetic acid	2:1	DE = 78% ^d		
	Menthol	Phenylacetic acid	3:1	DE = 81% ^d		
	Menthol	Phenylacetic acid	2:1	22.50 mg/mL ^h		
	Menthol	Phenylacetic acid	3:1	16.10 mg/mL ^h		

ChCl: Choline Chloride; DC: Distribution coefficient; DE: Dissolution efficiency; ^aThe molar ratio is presented as HBA:HBD:third component molar ratio in ternary DESs where ^bwater or ^cD-(+)-Glucose are the third component; Solubility values at ^droom temperature or ^e37.45 °C or ^f22 °C or ^g40 °C or ^h20 °C.

In 2019, Palmelund et al., studied the solubility of eleven APIs, including “theophylline”, in six different DESs (**Table 7**). This molecule was 1.8-fold more soluble in the liquid component lactic acid than in the corresponding DESs. This result was not observed with the other DESs mainly due to the hydrophilic nature of the individual components of these DESs (Palmelund et al., 2019).

Araya-Sibaja et al., were able to detect an increase in the solubility of a natural lactone ‘lovastatin’ in sodium lauryl sulphate 0.25%:water (w/v), when it was used as a component in the DES formation. Three lovastatin-based DESs were formed with benzoic acid, salicylic

acid and cinnamic acid. The increment in lovastatin solubility was found to be 5-fold for the lovastatin-salicylic acid system and around 4-fold for the other two systems compared to pure lovastatin dissolved in sodium lauryl sulphate 0.25%:water (w/v) (Araya-Sibaja et al., 2019). A study conducted by Wikene et al., in 2015, had the purpose to develop novel hydrophilic formulations to dissolve the hydrophobic neutral ‘5,10,15,20-tetrakis(4-hydroxyphenyl) porphyrin’ (THPP). The prepared NADESs appeared more polar than methanol and water, yet solubilized THPP well. Two NADESs: citric acid:sucrose 1:1 molar ratio and D-(+)-glucose:DL-malic acid 1:1 molar ratio demonstrated superior solubilizing properties of THPP probably due to intermolecular hydrogen bonding and proton donor-acceptor interactions. Also, results indicated the formation of the protonated form of THPP in NADESs. Thus, the assertion that NADESs may act like a protic solvent was suggested. In addition, the photostability of THPP was higher in NADESs than in methanol at equal concentration and findings support that the solubilization power became more pronounced during storage for several weeks. Only nanomolar amounts of THPP in NADESs were needed for a complete photoinactivation of *E. coli* (Wikene et al., 2015a). One year later, the same group solubilized another porphyrin ‘meso-tetra-(4-carboxyphenyl)-porphyrin’ (TCPP) in different NADESs. Similar results, concerning the increased solubility and activity of the molecule, were obtained (Wikene et al., 2016).

Vegetable oil refining is a molecular fractionation process for the production of more ‘heart-healthy’ nutritional products. This process depends on the physico-chemical properties of the oil molecules i.e. their polarity. For fatty acids removal from oil, a deacidification process is a must while preserving the antioxidant components of the oil. Zahrina et al., in 2018, supposed that the palmitic acid, a well-known fatty acid in the palm oil, having the lowest polarity can be soluble in the NADESs; oppositely to non-polar long-chain oil components (α -tocopherol and β -carotene). Betaine monohydrate-based NADESs provided higher distribution coefficients of palmitic acid than those of the pure polyol (glycerol or propylene glycol). The betaine monohydrate:glycerol NADES at a molar ratio of 1:8 had the highest selectivity, with a high distribution coefficient of palmitic acid, and the lowest distribution coefficient of the studied antioxidants. Using IR spectroscopy, the obtained shifting of the hydroxyl and carbonyl groups stretching bands indicated the presence of hydrogen bonding between palmitic acid and the NADESs components. Further, the strong intra-molecular hydrogen bond in the α -tocopherol and the absence of hydroxyl groups in β -carotene explains why these two molecules were not soluble in this NADES (Zahrina et al., 2018).

The first study on the solubility of benzoic acid in DESs was that of Morrison et al., in 2009. The solubilization potential of the choline chloride:urea and choline chloride:malonic acid pure DESs were found to be 5 to 22,000-folds more than that in water, respectively, and significantly higher than in the individual components aqueous solutions. Thus, the optimum solubilization required the presence of both components in the DESs and is not simply due to the complexation of drugs with either one of the DESs components (Morrison et al., 2009). Aroso et al., developed new THEDESs based on choline chloride and menthol, combined with APIs: benzoic acid and phenylacetic acid. The authors proved significant increase in the dissolution rate profiles for the APIs when present as a component of THEDESs compared to the pure APIs dissolved in buffer solution. Same results were obtained with Duarte et al., 2017. Furthermore, the increase in the dissolution rate was particularly noticeable for menthol-based THEDESs. Hence, it was possible to modify the dissolution rate by selecting the appropriate HBA. The obtained data, indicating that THEDESs retained the antibacterial capacity of benzoic acid and phenylacetic acid, confirming that the THEDES is an effective strategy for their fast delivery (Aroso et al., 2016). NMR spectroscopy demonstrated the presence of hydrogen bonding between these APIs and menthol (Duarte et al., 2017b).

3.7. Bioconversion

To pave the way for many biocatalytic processes in DESs, the solubilization of various substrates was studied (**Table 8**), together with the enzymatic stability/activity.

When urea was used as HBD, no enzymatic activities can be detected suggesting the unfolding of the enzyme (Weiz et al., 2016; Schweiger et al., 2019). This was obtained with Weiz et al., in 2016, who were interested in the deglycosylation of hesperidin. The choline chloride-based DESs displayed excellent solubilizing capabilities for hesperidin, dissolving it up to 90 mM. Choline chloride, tested separately, led to a deleterious effect for the glycosidase even at low concentration. Oppositely to urea, ethylene glycol and glycerol that exhibited unexpected improvements of the enzymatic activity showing high stabilizing effect. Results suggested that an enhancement of hesperidin solubility would favor the catalysis when DES has a lower viscosity than its single components (Weiz et al., 2016). This was also obtained with Schweiger et al., in 2019, who were interested in the enzymatic activity of phenolic acid decarboxylase that converts several *p*-hydroxycinnamic acid derivatives, such as coumaric acid, ferulic acid, caffeic acid and sinapinic acid, into the corresponding *p*-hydroxystyrenes in DESs and DES:water mixtures. While being inactive in DESs containing

urea, this enzyme was shown to tolerate other choline chloride-based DESs with 0–50% water content. A set of coumaric acid derivatives was efficiently decarboxylated in a DES:water mixture 1:1 (w/w) at substrate loadings as high as 300 mM (Schweiger et al., 2019).

Table 8- The representative application of DESs for the solvation of diverse substrates for biocatalytic reactions.

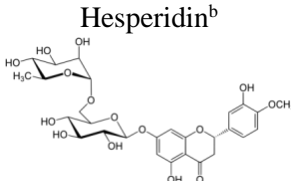
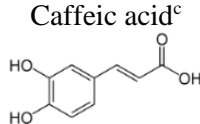
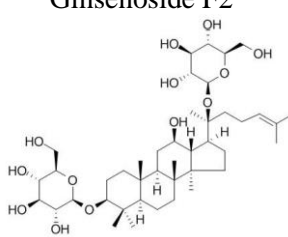
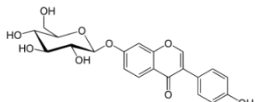
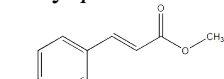
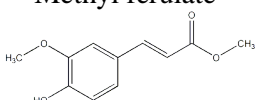
Compound	DESs			Solubility in DES	Solubility values in reference solvents	Reference
	HBA	HBD	Molar ratio			
 Hesperidin ^b	ChCl	Glycerol	1:2	Up to 54.95 mg/mL	5 mg/mL ^{a,d} in DMSO and 3 mg/mL ^{a,d} in dimethyl formamide	(Weiz et al., 2016)
	ChCl	Ethylene glycol	1:2			
	ChCl	Urea	1:2			
 Caffeic acid ^c	ChCl	Urea	1:2	1.80 mg/mL in DES/ water 1:1 molar ratio	~7 mg/mL ^{a,e} in ethanol, DMSO and dimethyl formamide	(Schweiger et al., 2019)
	ChCl	Sorbitol	1:1	72.06 mg/mL in DES/ water 1:1 molar ratio		
	ChCl	Glycerol	1:2	18.02 mg/mL in DES/ water 4:1 molar ratio or in pure DES		
 Ginsenoside F2 ^b	ChCl	Ethylene glycol	1:1, 1:2, 2:1	0.78 mg/mL in choline chloride/ ethylene glycol 2:1	0.35 mg/mL in acetate buffer	(Ma et al., 2020)
	ChCl	Glycerol	1:1, 1:2, 2:1			
 Daidzin ^b	ChCl	Ethylene glycol	2:1	556.70 µg/mL	383.20 µg/mL in phosphate buffer	(Cheng & Zhang, 2017)
 Methyl <i>p</i> -coumarate ^b  Methyl ferulate ^b	ChCl	Urea	1:2	7.12 mg/mL for methyl <i>p</i> -coumarate and 8.32 mg/mL for methyl ferulate	Methyl <i>p</i> -coumarate: 0.98 mg/mL ^{a,f} in water Methyl ferulate: 0.61 mg/mL ^{a,g} in water	(Duran et al., 2013)
	ChCl	Glycerol	1:2			

ChCl: Choline Chloride; ^aT: Temperature not mentioned; Solubility values at ^b60 °C or ^c30 °C; ^dSolubility values obtained from “Cayman Chemical” with *item No.* 18646; ^eSolubility value obtained from “Cayman Chemical” with *item No.* 70602; ^fSolubility value obtained from “Food Database” with the primary ID FDB001825; ^gSolubility value obtained from “Food Database” with the primary ID FDB001823.

In 2020, Ma et al., solubilized terpenes (ginsenoside Rd and F2) in DESs. In summary, the equilibrium solubility of ginsenoside F2 in 70% DES (choline chloride:ethylene glycol 2:1 molar ratio) + 30% acetate buffer was 2.2-fold higher than that of acetate buffer. β -glucosidase showed higher thermal stability and higher ginsenoside compound K (CK) yield in DESs than in acetate buffer. The hydrogen bonding formed by DESs increased the rigid structure of the enzyme and prevented its destruction. The equilibrium solubility of ginsenoside Rd and F2 was increased (>2 times higher) in DESs when increasing the temperature from 20 to 70 °C (Ma et al., 2020). Same result was also obtained by Cheng & Zhang, who evaluated the tremendous capacity of DESs in conducting the hydrolysis of daidzin to generate daidzein by β -D-glucosidase. Overall, according to **Figure 12**, the solubility of daidzin in four DESs increased obviously with the enhancement of the temperature, and the saturation concentration in choline chloride:ethylene glycol (2:1 molar ratio) + 30% v/v buffer reached 556.7 $\mu\text{g/mL}$ at 60 °C, while it was only 383.2 $\mu\text{g/mL}$ in DES-free buffer. The reasonable existence of small solubility differences between the polyols-based DESs presented in **Figure 12** may be due to the differences in hydrogen bonding intermolecular interactions or the physical properties of the solvent (Cheng & Zhang, 2017).

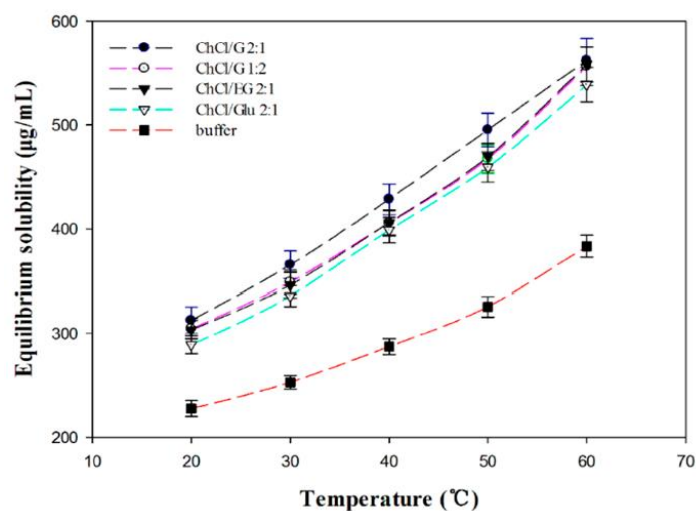

Figure 12: The equilibrium solubility of daidzin in the four DESs (ChCl:G 2:1; ChCl:G 1:2; ChCl:EG 2:1 and ChCl:Glu 2:1) and in buffer at different temperatures. Figure reprinted with permission from Cheng & Zhang, 2017. ChCl: Choline Chloride; G: Glycerol; EG: Ethylene Glycol; Glu: Glucose.

In 2020, Grabner et al., synthesized (E)-4-hydroxy-stilbene by decarboxylation of *p*-coumaric acid, in choline chloride-based DESs, using phenolic acid decarboxylase. An identical result regarding the increase of the substrate solubility was also obtained (4-fold higher in DESs than in buffer) (Grabner et al., 2020). Another study, conducted by Durand et al., in 2013, on

the lipophilisation of phenolic acids (methyl *p*-coumarate and methyl ferulate) by *Candida Antarctica* lipase B in DESs also showed an increase in the substrate solubility but no enzymatic activity was observed. Durand et al., used DESs as the reaction media in order to have good solubilities for both polar (phenolic compounds) and apolar (1-octanol: long-chain alcohol that is going to bring the aliphatic chain for grafting) substrates, at least partially. Almost no conversion (<2%) was observed in the studied DESs (choline chloride:urea and choline chloride:glycerol) although that the phenolic acids were perfectly dissolved by strong hydrogen bonding. The authors supposed that, the substrate is barely available for the reaction. Hence, they studied some DES:water mixtures in order to make the substrate more available for reacting. This resulted in a significant increase in the conversion rate, which reached 100% at the apparent equilibrium for water contents higher than 8% (Durand et al., 2013). A similar result was obtained with Papadopoulou et al., in 2013. Authors developed a lipase-catalyzed molecular hybridization of hydrophobic α -lipoic acid with other hydrophilic natural bioactive compounds pyridoxine, tyrosol and tyramine performed in choline chloride:urea 1:2 molar ratio DES. A reverse correlation between the solubility of pyridoxine or tyramine and the conversion yield of their enzymatic acylation was observed (Papadopoulou et al., 2013).

Recently, Knudsen et al., confirmed the proposed role of NADESs in biological systems by Choi et al., (Choi et al., 2011). Using the enzymes catalyzing the biosynthesis of the defense compound dhurrin as an experimental model system, authors were able to display the long-term stability and activity of these enzymes in glucose:tartrate NADES compared with aqueous buffer solutions. For better explanation, authors suggest that NADES may have an *in vivo* function by establishing structurally confined high-density NADESs-based biocondensates, in which the biosynthetic enzymes are stored in a soluble form. Also, in contrast to the normal process of protein denaturation and precipitation, the formation of NADESs and the presence of sequestered water molecules may provide an environment in which proteins can maintain solubility and intramolecular structures when dehydration of cells occurs (Knudsen et al., 2020).

In summary, for bioconversion reactions, both substrate and enzymes should be dissolved in DESs. A maintained activity and stability of the enzyme is necessary too. However, a strong interaction between the substrate and the media can prevent the reaction. In other words, low solubility of the substrate leads to a weak interaction between the substrate and the solvent, increasing therefore the availability of the substrates to bind to the enzyme and react (Durand et al., 2013; Papadopoulou et al., 2013).

3.8. Combination of deep eutectic solvent with cyclodextrin

Since studies showed that CDs can be solubilized in DESs, these molecules began to be potentially applied in combination with DESs for the investigation of their beneficial properties (i.e. more pronounced solubility enhancement), and to explore their applications in several domains (McCune et al., 2017). This combination could be produced either by solubilizing CDs in preformed DESs, or by using CDs as a component in the DES network due to its ability to form hydrogen bonding (because of the presence of hydroxyl groups). In both cases, CD/guest inclusion complexes could be formed in DESs as it will be explained later on.

β -CD:N-methylurea (3:7 mass ratio) was the first CD-based mixture, obtained with a melting point of 80 °C and was used as a reaction medium for Suzuki-Miyaura and Heck cross-coupling reactions (Zhao et al., 2014). Later, Jérôme and coworkers used native CDs or CDs derivatives and N,N'-dimethylurea to prepare melting mixtures characterized by a melting point around 90 °C, high catalytic activities for hydroformylation and Tsuji-Trost reactions and high recycling recoveries (Jérôme et al., 2014; Ferreira et al., 2015). The melting point was not affected by the size or the chemical modification of the CDs but, lower viscosities were obtained with modified CDs, which also led to higher 1-decene conversion. In 2015, Ferreira et al., evaluated the potentiality of CDs derivatives:N,N'-dimethylurea DESs to perform rhodium-catalyzed hydroformylation of 1-decene.

Table 9 presents the increase of 1-decene solubility in DESs compared to water, which induced an increase in the reaction yield.

The authors declared that the catalytic activity is generally connected to the solubility of 1-decene in the catalytic layer. There appeared to be an overall increase in the conversion when the 1-decene solubility increased and when the viscosity of the solvent decreased. Indeed, in aqueous biphasic hydroformylation reaction, CDs are known to play the role of mass transfer agents by forming inclusion complexes with hydrophobic substrates at the interface; however no correlation between the formation of inclusion complexes and the increased solubility of the substrate was stated by the authors (Ferreira et al., 2015).

Table 9- Composition of the studied DESs with solubility results of 1-decene compared to its solubility in water.

Studied DESs				Solubility in water
First component	Second component	Molar ratio	Solubility (g/100g)*	
N,N'-dimethylurea	α -CD	1:26	12	1.15 x10 ⁻³ g/100g at 25 °C
	β -CD	1:30	10	
	γ -CD	1:35	9	
	HyP- α -CD	1:31	3	
	HP- β -CD	1:37	10	
	HP- γ -CD	1:49	15	
	TRIME- β -CD	1:32	-	
	TRIAC- β -CD	1:55	-	
	CRYSME- β -CD	1:32	8	
	RAME- β -CD	1:36	25	
	β -CD	1:52	-	
	β -CD	1:13	2	
	β -CD	1:6	-	
	CRYSME- β -CD	1:55	-	
	CRYSME- β -CD	1:14	3	
	CRYSME- β -CD	1:6	1	
	CRYSME- β -CD	1:3	-	
	RAME- β -CD	1:61	-	
	RAME- β -CD	1:15	10	
	RAME- β -CD	1:6	3	
RAME- β -CD	1:4	-		
α -D-MeGluPyr	1:5	5		

*Solubility of 1-decene at 90 °C (Ferreira et al., 2015).

Athanasiadis et al, carried out a study with the purpose of testing the efficiency of polyphenol extraction from *Olea europaea* leafs, using a combination of methyl β -CD with a glycerol:glycine:water 7:1:3 molar ratio DES. The polyphenol yields attained with DES:CD was by 5.3% higher than that achieved with the DES and 19.3% higher than that with 60% (v/v) aqueous ethanol. This finding pointed clearly to a boosting of the solubility triggered by the addition of the CDs in the DES. Authors claimed that such a phenomenon may be attributed to the CDs that may have increased solubility of the less polar polyphenols through entrapment by strong hydrogen bonds formation. On the other hand, polyphenols may behave as HBDs and interact with glycine of the DES. However, none of these assumptions were proved (Athanasiadis et al., 2018a, 2018b). Other researchers added β -CD to the aqueous solution of lactic acid-based DESs to extract polyphenols. As a result, β -CD showed positive and sometimes negative contribution to polyphenols solubilization (Georgantzi et al., 2017; Chakroun et al., 2019). On the other hand, the same group proved that methyl- β -CD acted as

a booster by enhancing the polyphenol extraction yield and by delaying the chemical degradation of the extracts, such as hydrolysis and oxidation, when added to glycine:glycerol:water mixture. On another note, the chiral separation of threonine enantiomers was achieved *via* the biphasic recognition chiral extraction technique while using hydrophilic and hydrophobic DESs for the two-phase formation and HP- β -CD as one of two chiral selectors. The enantio-separation effect was evaluated by varying different conditions such as the type of DES and the water content of the hydrophilic DES (Wang et al., 2019). In another study, the effect of the addition of ChCl-based DESs to the β -CD acting as a chiral selector in a buffer solution was investigated in an attempt of separation of chiral drugs. The presence of choline chloride:urea DES (at a concentration of 1% (v/v)) improved the separation efficiency when compared to β -CD alone, thus suggesting a synergy between β -CD and the DES (Mu et al., 2019).

Nonetheless, CDs solubilized in DESs with retained inclusion complexation ability were proved by Moufawad et al., in 2019. This solubilization results from the ability of the hydroxyl groups on the exterior of the CDs to interact with the hydrogen-bonded network of the DES. UV-visible spectroscopy and static headspace-gas chromatography (SH-GC) demonstrated that higher solubilization capacities of different volatile organic compounds (VOCs), one of them is the limonene, were obtained in CD:DES solutions compared to water (Moufawad et al., 2019). A recent study tested the addition of water to choline chloride:urea with β -CD mixture. It was revealed that water interacts first with CDs hydroxyl groups while preserving the DES supramolecular network to some extent (Dugoni et al., 2019). Likewise, the same group once again proved the maintenance of β -CD host-guest properties in pure and hydrated choline chloride:urea by forming inclusion complexes with VOCs: aniline and toluene (Di Pietro et al., 2019).

For the first time, El Achkar et al., in 2019 tested the solubility of *trans*-anethole in randomly methylated β -CD:levulinic acid SUPRADES. Using SH-GC, they observed a 1300-fold increase in *trans*-anethole solubility when compared to water or CDs aqueous solutions. 2D ROESY NMR correlations indicated that the phenyl ring of *trans*-anethole is located inside the CD cavity. Therefore, the solvation mechanism was suggested to be due to inclusion complexes in the CD cavity although CD being used as a component of the solvent and not as a solute (El Achkar et al., 2020). Similar results were obtained by the same research group later on, where new levulinic acid-based SUPRADES with different β -CD derivatives (hydroxypropyl- β -cyclodextrin, randomly methylated β -cyclodextrin, low methylated β -

cyclodextrin and sulfobutylether- β -cyclodextrin) were prepared. Their ability to solubilize *trans*-anethole was evaluated by determining the vapor-liquid partition coefficient of *trans*-anethole as well as the percentage of *trans*-anethole retention. Also, authors studied the solvation of star anise and fennel essential oils in which *trans*-anethole is the major component. More than 99% of *trans*-anethole were retained by all the studied mixtures, while CDs aqueous solutions were able to reduce *trans*-anethole volatility only up to 92%. All the tested mixtures showed higher retention ability ($\geq 98.9\%$) toward star anise and fennel essential oils when compared to water, reflecting its higher solvation capacity (El Achkar et al., 2020).

4. Summing-up on the solubility influencing parameters

It was observed that the temperature has a significant influence on the solubility of natural molecules in DESs mainly by favoring it. Apparently, several physico-chemical properties of DESs such as the type of DESs components, etc. influence its solvation capacity. Choline chloride may contribute efficiently to the solubility; however, sometimes it can disfavor it (Dietz et al., 2017; López et al., 2020). In addition, the HBA:HBD molar ratio influences the solvation of the molecules, therefore it should be optimized (Dietz et al., 2017; Silva et al., 2020). Also, an extensive hydrogen bonding structure of the DESs can induce a higher viscosity of the media where there is no space for dissolving the solutes (Dai et al., 2015). Thus, the presence of water influences also on the solubility: in some cases it decreases the viscosity of the media, resulting in a better solvation (Dai et al., 2015). Also, López et al., stated that water can play an important role in the solute-solvent interaction, possibly by favoring an environment rich in hydrogen bonds (López et al., 2020). In other cases, water decreases the solubility of the molecule when it competes strongly with the target molecule to make hydrogen bonds with the DESs components (Ozturk et al., 2018). Water can alter the solvent polarity; therefore it should be optimized in a way of reaching a polarity range similar to that of the target compound, while preserving the structure of the DESs (Ozturk et al., 2018). It was then stated that nonpolar compounds have the highest solubility in pure NADESs while $<10\text{v}\%$ of water dilution allows the highest solubility of medium polar compounds (Dai et al., 2015). Also, storage of the natural molecules in DESs can induce a slight increase in its solubility (Wikene et al., 2015b; Wikene et al., 2016). The combination of DESs with an encapsulating agent such as CDs, can enhance even more the solubility of natural molecules, where CDs can form inclusion complexes with the target molecules.

5. Conclusion

This review provides a general insight into the solvation of natural molecules, mainly plant secondary metabolites, by DESs. Studies showed the ability of these solvents to enhance the solubility of the molecules comparing to water and other organic solvents. Also, the solubility of substrates necessary for an enzyme activity was increased while conserving the enzyme structure and stability. In general, the solubility of the molecules depends on diverse parameters such as water content, temperature, etc. Also, the type of DESs components, their molar ratio as well as their bonding strength can affect the physico-chemical properties of the solvent (i.e. its viscosity), thus influencing its solvation capability. Almost all solubility studies indicated the formation of hydrogen bonding between DESs components and the molecule; this constitutes the general mechanism of dissolution. In addition, studies showed that the combination of DES:CD presented a gain in the solubility of natural molecules compared to the use of DESs or CDs alone. In this sense, all these conclusions could lead to continuous expansion in finding novel applications of DESs.

Acknowledgements

Lamia Nakhle has received a scholarship from Université du Littoral Côte d'Opale (ULCO) and from the Lebanese National Council for Scientific Research (CNRS-L).

References

- Abbott, A. P., Boothby, D., Capper, G., Davies, D. L., & Rasheed, R. K. (2004). Deep Eutectic Solvents Formed between Choline Chloride and Carboxylic Acids: Versatile Alternatives to Ionic Liquids. *Journal of the American Chemical Society*, *126*(29), 9142–9147. <https://doi.org/10.1021/ja048266j>
- Abbott, A. P., Capper, G., Davies, D. L., & Rasheed, R. K. (2004). Ionic Liquid Analogues Formed from Hydrated Metal Salts. *Chemistry - A European Journal*, *10*(15), 3769–3774. <https://doi.org/10.1002/chem.200400127>
- Abbott, A. P., Capper, G., Davies, D. L., Rasheed, R. K., & Tambyrajah, V. (2003). Novel solvent properties of choline chloride/urea mixtures Electronic supplementary information (ESI) available: Spectroscopic data. See <http://www.rsc.org/suppdata/cc/b2/b210714g/>. *Chemical Communications*, *1*, 70–71. <https://doi.org/10.1039/b210714g>
- Abbott, A. P., Capper, G., McKenzie, K. J., & Ryder, K. S. (2006). Voltammetric and impedance studies of the electropolishing of type 316 stainless steel in a choline chloride based ionic liquid. *Electrochimica Acta*, *51*(21), 4420–4425. <https://doi.org/10.1016/j.electacta.2005.12.030>
- AlOmar, M. K., Hayyan, M., Alsaadi, M. A., Akib, S., Hayyan, A., & Hashim, M. A. (2016). Glycerol-based deep eutectic solvents: Physical properties. *Journal of Molecular Liquids*, *215*, 98–103. <https://doi.org/10.1016/j.molliq.2015.11.032>
- Álvarez, M. S., & Zhang, Y. (2019). Sketching neoteric solvents for boosting drugs bioavailability. *Journal of Controlled Release*, *311–312*, 225–232. <https://doi.org/10.1016/j.jconrel.2019.09.008>
- Araya-Sibaja, A., Vega-Baudrit, J., Guillén-Girón, T., Navarro-Hoyos, M., & Cuffini, S. (2019). Drug Solubility Enhancement through the Preparation of Multicomponent Organic Materials: Eutectics of Lovastatin with Carboxylic Acids. *Pharmaceutics*, *11*(3), 112. <https://doi.org/10.3390/pharmaceutics11030112>
- Aroso, I. M., Silva, J. C., Mano, F., Ferreira, A. S. D., Dionísio, M., Sá-Nogueira, I., Barreiros, S., Reis, R. L., Paiva, A., & Duarte, A. R. C. (2016). Dissolution enhancement of active pharmaceutical ingredients by therapeutic deep eutectic systems. *European Journal of Pharmaceutics and Biopharmaceutics*, *98*, 57–66. <https://doi.org/10.1016/j.ejpb.2015.11.002>

- Athanasiadis, V., Grigorakis, S., Lalas, S., & Makris, D. P. (2018a). Methyl β -cyclodextrin as a booster for the extraction of *Olea europaea* leaf polyphenols with a bio-based deep eutectic solvent. *Biomass Conversion and Biorefinery*, 8(2), 345–355. <https://doi.org/10.1007/s13399-017-0283-5>
- Athanasiadis, V., Grigorakis, S., Lalas, S., & Makris, D. P. (2018b). Stability effects of methyl β -cyclodextrin on *Olea europaea* leaf extracts in a natural deep eutectic solvent. *European Food Research and Technology*, 244(10), 1783–1792. <https://doi.org/10.1007/s00217-018-3090-8>
- Basar, A. O., Prieto, C., Durand, E., Villeneuve, P., Sasmazel, H. T., & Lagaron, J. (2020). Encapsulation of β -Carotene by Emulsion Electrospraying Using Deep Eutectic Solvents. *Molecules*, 25(4), 981. <https://doi.org/10.3390/molecules25040981>
- Bi, W., Tian, M., & Row, K. H. (2013). Evaluation of alcohol-based deep eutectic solvent in extraction and determination of flavonoids with response surface methodology optimization. *Journal of Chromatography A*, 1285, 22–30. <https://doi.org/10.1016/j.chroma.2013.02.041>
- Cardellini, F., Tiecco, M., Germani, R., Cardinali, G., Corte, L., Roscini, L., & Spreti, N. (2014). Novel zwitterionic deep eutectic solvents from trimethylglycine and carboxylic acids: Characterization of their properties and their toxicity. *RSC Adv.*, 4(99), 55990–56002. <https://doi.org/10.1039/C4RA10628H>
- Carter, R. E. (Ed.). (2011). *Organic solvents: Properties, toxicity, and industrial effects*. Nova Science Publisher's.
- Chakroun, D., Grigorakis, S., Loupassaki, S., & Makris, D. P. (2019). Enhanced-performance extraction of olive (*Olea europaea*) leaf polyphenols using L-lactic acid/ammonium acetate deep eutectic solvent combined with β -cyclodextrin: Screening, optimisation, temperature effects and stability. *Biomass Conversion and Biorefinery*. <https://doi.org/10.1007/s13399-019-00521-2>
- Chen, Y.-L., Zhang, X., You, T.-T., & Xu, F. (2019). Deep eutectic solvents (DESs) for cellulose dissolution: A mini-review. *Cellulose*, 26(1), 205–213. <https://doi.org/10.1007/s10570-018-2130-7>
- Cheng, Q.-B., & Zhang, L.-W. (2017). Highly Efficient Enzymatic Preparation of Daidzein in Deep Eutectic Solvents. *Molecules*, 22(1), 186. <https://doi.org/10.3390/molecules22010186>
- Choi, Y. H., van Spronsen, J., Dai, Y., Verberne, M., Hollmann, F., Arends, I. W. C. E., Witkamp, G.-J., & Verpoorte, R. (2011). Are Natural Deep Eutectic Solvents the

- Missing Link in Understanding Cellular Metabolism and Physiology? *Plant Physiology*, 156(4), 1701–1705. <https://doi.org/10.1104/pp.111.178426>
- Clarke, C. J., Tu, W.-C., Levers, O., Bröhl, A., & Hallett, J. P. (2018). Green and Sustainable Solvents in Chemical Processes. *Chemical Reviews*, 118(2), 747–800. <https://doi.org/10.1021/acs.chemrev.7b00571>
- Craveiro, R., Aroso, I., Flammia, V., Carvalho, T., Viciosa, M. T., Dionísio, M., Barreiros, S., Reis, R. L., Duarte, A. R. C., & Paiva, A. (2016). Properties and thermal behavior of natural deep eutectic solvents. *Journal of Molecular Liquids*, 215, 534–540. <https://doi.org/10.1016/j.molliq.2016.01.038>
- Cui, Y., Li, C., Yin, J., Li, S., Jia, Y., & Bao, M. (2017). Design, synthesis and properties of acidic deep eutectic solvents based on choline chloride. *Journal of Molecular Liquids*, 236, 338–343. <https://doi.org/10.1016/j.molliq.2017.04.052>
- Cunha, S. C., & Fernandes, J. O. (2018). Extraction techniques with deep eutectic solvents. *TrAC Trends in Analytical Chemistry*, 105, 225–239. <https://doi.org/10.1016/j.trac.2018.05.001>
- Cvjetko Bubalo, M., Čurko, N., Tomašević, M., Kovačević Ganić, K., & Radojčić Redovniković, I. (2016). Green extraction of grape skin phenolics by using deep eutectic solvents. *Food Chemistry*, 200, 159–166. <https://doi.org/10.1016/j.foodchem.2016.01.040>
- Cvjetko Bubalo, M., Radošević, K., Radojčić Redovniković, I., Halambek, J., & Gaurina Srček, V. (2014). A brief overview of the potential environmental hazards of ionic liquids. *Ecotoxicology and Environmental Safety*, 99, 1–12. <https://doi.org/10.1016/j.ecoenv.2013.10.019>
- Dai, Y., van Spronsen, J., Witkamp, G.-J., Verpoorte, R., & Choi, Y. H. (2013a). Natural deep eutectic solvents as new potential media for green technology. *Analytica Chimica Acta*, 766, 61–68. <https://doi.org/10.1016/j.aca.2012.12.019>
- Dai, Y., van Spronsen, J., Witkamp, G.-J., Verpoorte, R., & Choi, Y. H. (2013b). Ionic Liquids and Deep Eutectic Solvents in Natural Products Research: Mixtures of Solids as Extraction Solvents. *Journal of Natural Products*, 76(11), 2162–2173. <https://doi.org/10.1021/np400051w>
- Dai, Y., Verpoorte, R., & Choi, Y. H. (2014). Natural deep eutectic solvents providing enhanced stability of natural colorants from safflower (*Carthamus tinctorius*). *Food Chemistry*, 159, 116–121. <https://doi.org/10.1016/j.foodchem.2014.02.155>

- Dai, Y., Witkamp, G.-J., Verpoorte, R., & Choi, Y. H. (2015). Tailoring properties of natural deep eutectic solvents with water to facilitate their applications. *Food Chemistry*, 187, 14–19. <https://doi.org/10.1016/j.foodchem.2015.03.123>
- Di Pietro, M. E., Colombo Dugoni, G., Ferro, M., Mannu, A., Castiglione, F., Costa Gomes, M., Fourmentin, S., & Mele, A. (2019). Do Cyclodextrins Encapsulate Volatiles in Deep Eutectic Systems? *ACS Sustainable Chemistry & Engineering*, 7(20), 17397–17405. <https://doi.org/10.1021/acssuschemeng.9b04526>
- Dietz, C. H. J. T., Erve, A., Kroon, M. C., van Sint Annaland, M., Gallucci, F., & Held, C. (2019). Thermodynamic properties of hydrophobic deep eutectic solvents and solubility of water and HMF in them: Measurements and PC-SAFT modeling. *Fluid Phase Equilibria*, 489, 75–82. <https://doi.org/10.1016/j.fluid.2019.02.010>
- Dietz, C. H. J. T., Kroon, M. C., van Sint Annaland, M., & Gallucci, F. (2017). Thermophysical Properties and Solubility of Different Sugar-Derived Molecules in Deep Eutectic Solvents. *Journal of Chemical & Engineering Data*, 62(11), 3633–3641. <https://doi.org/10.1021/acs.jced.7b00184>
- Duarte, A. R. C., Ferreira, A. S. D., Barreiros, S., Cabrita, E., Reis, R. L., & Paiva, A. (2017a). A comparison between pure active pharmaceutical ingredients and therapeutic deep eutectic solvents: Solubility and permeability studies. *European Journal of Pharmaceutics and Biopharmaceutics*, 114, 296–304. <https://doi.org/10.1016/j.ejpb.2017.02.003>
- Duarte, A. R. C., Ferreira, A. S. D., Barreiros, S., Cabrita, E., Reis, R. L., & Paiva, A. (2017b). A comparison between pure active pharmaceutical ingredients and therapeutic deep eutectic solvents: Solubility and permeability studies. *European Journal of Pharmaceutics and Biopharmaceutics*, 114, 296–304. <https://doi.org/10.1016/j.ejpb.2017.02.003>
- Dugoni, G. C., Di Pietro, M. E., Ferro, M., Castiglione, F., Ruellan, S., Moufawad, T., Moura, L., Costa Gomes, M. F., Fourmentin, S., & Mele, A. (2019). Effect of Water on Deep Eutectic Solvent/ β -Cyclodextrin Systems. *ACS Sustainable Chemistry & Engineering*, 7(7), 7277–7285. <https://doi.org/10.1021/acssuschemeng.9b00315>
- Durand, E., Lecomte, J., Baréa, B., Dubreucq, E., Lortie, R., & Villeneuve, P. (2013). Evaluation of deep eutectic solvent–water binary mixtures for lipase-catalyzed lipophilization of phenolic acids. *Green Chemistry*, 15(8), 2275. <https://doi.org/10.1039/c3gc40899j>

- Durand, E., Lecomte, J., Upasani, R., Chabi, B., Bayrasy, C., Baréa, B., Jublanc, E., Clarke, M. J., Moore, D. J., Crowther, J., Wrutniak-Cabello, C., & Villeneuve, P. (2017). Evaluation of the ROS Inhibiting Activity and Mitochondrial Targeting of Phenolic Compounds in Fibroblast Cells Model System and Enhancement of Efficiency by Natural Deep Eutectic Solvent (NADES) Formulation. *Pharmaceutical Research*, 34(5), 1134–1146. <https://doi.org/10.1007/s11095-017-2124-4>
- Durand, E., Lecomte, J., & Villeneuve, P. (2016). From green chemistry to nature: The versatile role of low transition temperature mixtures. *Biochimie*, 120, 119–123. <https://doi.org/10.1016/j.biochi.2015.09.019>
- Dwamena, A. K., & Raynie, D. E. (2020). Solvatochromic Parameters of Deep Eutectic Solvents: Effect of Different Carboxylic Acids as Hydrogen Bond Donor. *Journal of Chemical & Engineering Data*, 65(2), 640–646. <https://doi.org/10.1021/acs.jced.9b00872>
- El Achkar, T., Fourmentin, S., & Greige-Gerges, H. (2019). Deep eutectic solvents: An overview on their interactions with water and biochemical compounds. *Journal of Molecular Liquids*, 288, 111028. <https://doi.org/10.1016/j.molliq.2019.111028>
- El Achkar, T., Moufawad, T., Ruellan, S., Landy, D., Greige-Gerges, H., & Fourmentin, S. (2020). Cyclodextrins: From solute to solvent. *Chemical Communications*, 56(23), 3385–3388. <https://doi.org/10.1039/D0CC00460J>
- El Achkar, T., Moura, L., Moufawad, T., Ruellan, S., Panda, S., Longuemart, S., Legrand, F.-X., Costa Gomes, M., Landy, D., Greige-Gerges, H., & Fourmentin, S. (2020). New generation of supramolecular mixtures: Characterization and solubilization studies. *International Journal of Pharmaceutics*, 119443. <https://doi.org/10.1016/j.ijpharm.2020.119443>
- Espino, M., de los Ángeles Fernández, M., Gomez, F. J. V., & Silva, M. F. (2016). Natural designer solvents for greening analytical chemistry. *TrAC Trends in Analytical Chemistry*, 76, 126–136. <https://doi.org/10.1016/j.trac.2015.11.006>
- Faggian, M., Sut, S., Perissutti, B., Baldan, V., Grabnar, I., & Dall'Acqua, S. (2016). Natural Deep Eutectic Solvents (NADES) as a Tool for Bioavailability Improvement: Pharmacokinetics of Rutin Dissolved in Proline/Glycine after Oral Administration in Rats: Possible Application in Nutraceuticals. *Molecules*, 21(11), 1531. <https://doi.org/10.3390/molecules21111531>
- Ferreira, M., Jérôme, F., Bricout, H., Manuel, S., Landy, D., Fourmentin, S., Tilloy, S., & Monflier, E. (2015). Rhodium catalyzed hydroformylation of 1-decene in low melting

- mixtures based on various cyclodextrins and N,N'-dimethylurea. *Catalysis Communications*, 63, 62–65. <https://doi.org/10.1016/j.catcom.2014.11.001>
- Florindo, C., Oliveira, F. S., Rebelo, L. P. N., Fernandes, A. M., & Marrucho, I. M. (2014). Insights into the Synthesis and Properties of Deep Eutectic Solvents Based on Cholinium Chloride and Carboxylic Acids. *ACS Sustainable Chemistry & Engineering*, 2(10), 2416–2425. <https://doi.org/10.1021/sc500439w>
- Fu, N., Li, L., Liu, X., Fu, N., Zhang, C., Hu, L., Li, D., Tang, B., & Zhu, T. (2017). Specific recognition of polyphenols by molecularly imprinted polymers based on a ternary deep eutectic solvent. *Journal of Chromatography A*, 1530, 23–34. <https://doi.org/10.1016/j.chroma.2017.11.011>
- Georgantzi, C., Lioliou, A.-E., Paterakis, N., & Makris, D. (2017). Combination of Lactic Acid-Based Deep Eutectic Solvents (DES) with β -Cyclodextrin: Performance Screening Using Ultrasound-Assisted Extraction of Polyphenols from Selected Native Greek Medicinal Plants. *Agronomy*, 7(3), 54. <https://doi.org/10.3390/agronomy7030054>
- González, C. G., Mustafa, N. R., Wilson, E. G., Verpoorte, R., & Choi, Y. H. (2018). Application of natural deep eutectic solvents for the “green” extraction of vanillin from vanilla pods. *Flavour and Fragrance Journal*, 33(1), 91–96. <https://doi.org/10.1002/ffj.3425>
- Grabner, B., Schweiger, A. K., Gavric, K., Kourist, R., & Gruber-Woelfler, H. (2020). A chemo-enzymatic tandem reaction in a mixture of deep eutectic solvent and water in continuous flow. *Reaction Chemistry & Engineering*, 5(2), 263–269. <https://doi.org/10.1039/C9RE00467J>
- Gutiérrez, M. C., Ferrer, M. L., Mateo, C. R., & del Monte, F. (2009). Freeze-Drying of Aqueous Solutions of Deep Eutectic Solvents: A Suitable Approach to Deep Eutectic Suspensions of Self-Assembled Structures. *Langmuir*, 25(10), 5509–5515. <https://doi.org/10.1021/la900552b>
- Häkkinen, R., Alshammari, O., Timmermann, V., D'Agostino, C., & Abbott, A. (2019). Nanoscale Clustering of Alcoholic Solutes in Deep Eutectic Solvents Studied by Nuclear Magnetic Resonance and Dynamic Light Scattering. *ACS Sustainable Chemistry & Engineering*, 7(17), 15086–15092. <https://doi.org/10.1021/acssuschemeng.9b03771>

- Huang, W., Wu, X., Qi, J., Zhu, Q., Wu, W., Lu, Y., & Chen, Z. (2019). Ionic liquids: Green and tailor-made solvents in drug delivery. *Drug Discovery Today*. <https://doi.org/10.1016/j.drudis.2019.09.018>
- Huang, Y., Feng, F., Jiang, J., Qiao, Y., Wu, T., Voglmeir, J., & Chen, Z.-G. (2017). Green and efficient extraction of rutin from tartary buckwheat hull by using natural deep eutectic solvents. *Food Chemistry*, 221, 1400–1405. <https://doi.org/10.1016/j.foodchem.2016.11.013>
- Imperato, G., Eibler, E., Niedermaier, J., & König, B. (2005). Low-melting sugar–urea–salt mixtures as solvents for Diels–Alder reactions. *Chem. Commun.*, 9, 1170–1172. <https://doi.org/10.1039/B414515A>
- Jeliński, T., & Cysewski, P. (2018). Application of a computational model of natural deep eutectic solvents utilizing the COSMO-RS approach for screening of solvents with high solubility of rutin. *Journal of Molecular Modeling*, 24(7). <https://doi.org/10.1007/s00894-018-3700-1>
- Jeliński, T., Przybyłek, M., & Cysewski, P. (2019). Natural Deep Eutectic Solvents as Agents for Improving Solubility, Stability and Delivery of Curcumin. *Pharmaceutical Research*, 36(8). <https://doi.org/10.1007/s11095-019-2643-2>
- Jérôme, F., Ferreira, M., Bricout, H., Menuel, S., Monflier, E., & Tilloy, S. (2014). Low melting mixtures based on β -cyclodextrin derivatives and N,N'-dimethylurea as solvents for sustainable catalytic processes. *Green Chem.*, 16(8), 3876–3880. <https://doi.org/10.1039/C4GC00591K>
- Kfoury, M., Auezova, L., Greige-Gerges, H., & Fourmentin, S. (2019). Encapsulation in cyclodextrins to widen the applications of essential oils. *Environmental Chemistry Letters*, 17(1), 129–143. <https://doi.org/10.1007/s10311-018-0783-y>
- Khataei, M. M., Yamini, Y., Nazaripour, A., & Karimi, M. (2018). Novel generation of deep eutectic solvent as an acceptor phase in three-phase hollow fiber liquid phase microextraction for extraction and preconcentration of steroidal hormones from biological fluids. *Talanta*, 178, 473–480. <https://doi.org/10.1016/j.talanta.2017.09.068>
- Khorsandi, M., Shekaari, H., & Mokhtarpour, M. (2020). Measurement and correlation of coumarin solubility in aqueous solution of acidic deep eutectic solvents based on choline chloride. *Fluid Phase Equilibria*, 524, 112788. <https://doi.org/10.1016/j.fluid.2020.112788>
- Knudsen, C., Bavishi, K., Viborg, K. M., Drew, D. P., Simonsen, H. T., Motawia, M. S., Møller, B. L., & Laursen, T. (2020). Stabilization of dhurrin biosynthetic enzymes

- from Sorghum bicolor using a natural deep eutectic solvent. *Phytochemistry*, 170, 112214. <https://doi.org/10.1016/j.phytochem.2019.112214>
- Leron, R. B., Soriano, A. N., & Li, M.-H. (2012). Densities and refractive indices of the deep eutectic solvents (choline chloride+ethylene glycol or glycerol) and their aqueous mixtures at the temperature ranging from 298.15 to 333.15K. *Journal of the Taiwan Institute of Chemical Engineers*, 43(4), 551–557. <https://doi.org/10.1016/j.jtice.2012.01.007>
- López, N., Delso, I., Matute, D., Lafuente, C., & Artal, M. (2020). Characterization of xylitol or citric acid:choline chloride:water mixtures: Structure, thermophysical properties, and quercetin solubility. *Food Chemistry*, 306, 125610. <https://doi.org/10.1016/j.foodchem.2019.125610>
- Ma, Z., Mi, Y., Han, X., Li, H., Tian, M., Duan, Z., Fan, D., & Ma, P. (2020). Transformation of ginsenoside via deep eutectic solvents based on choline chloride as an enzymatic reaction medium. *Bioprocess and Biosystems Engineering*. <https://doi.org/10.1007/s00449-020-02314-8>
- Marcus, Y. (2002). *Solvent mixtures: Properties and selective solvation*. Marcel Dekker, Inc.
- Marcus, Y. (2019a). Applications of Deep Eutectic Solvents. In Y. Marcus, *Deep Eutectic Solvents* (pp. 111–151). Springer International Publishing. https://doi.org/10.1007/978-3-030-00608-2_4
- Marcus, Y. (2019b). Properties of Deep Eutectic Solvents. In Y. Marcus, *Deep Eutectic Solvents* (pp. 45–110). Springer International Publishing. https://doi.org/10.1007/978-3-030-00608-2_3
- Martins, M. A. R., Pinho, S. P., & Coutinho, J. A. P. (2019). Insights into the Nature of Eutectic and Deep Eutectic Mixtures. *Journal of Solution Chemistry*, 48(7), 962–982. <https://doi.org/10.1007/s10953-018-0793-1>
- Maugeri, Z., & Domínguez de María, P. (2012). Novel choline-chloride-based deep-eutectic-solvents with renewable hydrogen bond donors: Levulinic acid and sugar-based polyols. *RSC Adv.*, 2(2), 421–425. <https://doi.org/10.1039/C1RA00630D>
- Mbous, Y. P., Hayyan, M., Hayyan, A., Wong, W. F., Hashim, M. A., & Looi, C. Y. (2017). Applications of deep eutectic solvents in biotechnology and bioengineering— Promises and challenges. *Biotechnology Advances*, 35(2), 105–134. <https://doi.org/10.1016/j.biotechadv.2016.11.006>

- McCune, J. A., Kunz, S., Olesińska, M., & Scherman, O. A. (2017). DESolution of CD and CB Macrocycles. *Chemistry - A European Journal*, 23(36), 8601–8604. <https://doi.org/10.1002/chem.201701275>
- Mohan, M., Naik, P. K., Banerjee, T., Goud, V. V., & Paul, S. (2017). Solubility of glucose in tetrabutylammonium bromide based deep eutectic solvents: Experimental and molecular dynamic simulations. *Fluid Phase Equilibria*, 448, 168–177. <https://doi.org/10.1016/j.fluid.2017.05.024>
- Morrison, H. G., Sun, C. C., & Neervannan, S. (2009). Characterization of thermal behavior of deep eutectic solvents and their potential as drug solubilization vehicles. *International Journal of Pharmaceutics*, 378(1–2), 136–139. <https://doi.org/10.1016/j.ijpharm.2009.05.039>
- Moufawad, T., Moura, L., Ferreira, M., Bricout, H., Tilloy, S., Monflie, E., Costa Gomes, M., Landy, D., & Fourmentin, S. (2019). First Evidence of Cyclodextrin Inclusion Complexes in a Deep Eutectic Solvent. *ACS Sustainable Chemistry & Engineering*, 7(6), 6345–6351. <https://doi.org/10.1021/acssuschemeng.9b00044>
- Moura, L., Moufawad, T., Ferreira, M., Bricout, H., Tilloy, S., Monflie, E., Costa Gomes, M. F., Landy, D., & Fourmentin, S. (2017). Deep eutectic solvents as green absorbents of volatile organic pollutants. *Environmental Chemistry Letters*, 15(4), 747–753. <https://doi.org/10.1007/s10311-017-0654-y>
- Mu, Y., Wu, X., Huang, Y., & Liu, Z. (2019). Investigation of deep eutectic solvents as additives to β -CD for enantiomeric separations of Zopiclone, Salbutamol, and Amlodipine by CE. *ELECTROPHORESIS*. <https://doi.org/10.1002/elps.201900067>
- Nam, M. W., Zhao, J., Lee, M. S., Jeong, J. H., & Lee, J. (2015). Enhanced extraction of bioactive natural products using tailor-made deep eutectic solvents: Application to flavonoid extraction from Flos sophorae. *Green Chemistry*, 17(3), 1718–1727. <https://doi.org/10.1039/C4GC01556H>
- Ozturk, B., Esteban, J., & Gonzalez-Miquel, M. (2018). Deterpenation of Citrus Essential Oils Using Glycerol-Based Deep Eutectic Solvents. *Journal of Chemical & Engineering Data*, 63(7), 2384–2393. <https://doi.org/10.1021/acs.jced.7b00944>
- Palmelund, H., Andersson, M. P., Asgreen, C. J., Boyd, B. J., Rantanen, J., & Löbmann, K. (2019). Tailor-made solvents for pharmaceutical use? Experimental and computational approach for determining solubility in deep eutectic solvents (DES). *International Journal of Pharmaceutics: X*, 1, 100034. <https://doi.org/10.1016/j.ijpx.2019.100034>

- Pandey, A., & Pandey, S. (2014). Solvatochromic Probe Behavior within Choline Chloride-Based Deep Eutectic Solvents: Effect of Temperature and Water. *The Journal of Physical Chemistry B*, 118(50), 14652–14661. <https://doi.org/10.1021/jp510420h>
- Papadopoulou, A. A., Katsoura, M. H., Chatzikonstantinou, A., Kyriakou, E., Polydera, A. C., Tzakos, A. G., & Stamatis, H. (2013). Enzymatic hybridization of α -lipoic acid with bioactive compounds in ionic solvents. *Bioresource Technology*, 136, 41–48. <https://doi.org/10.1016/j.biortech.2013.02.067>
- Parnica, J., & Antalík, M. (2014). Urea and guanidine salts as novel components for deep eutectic solvents. *Journal of Molecular Liquids*, 197, 23–26. <https://doi.org/10.1016/j.molliq.2014.04.016>
- Rachmaniah, O., Jumiati Fazriyah, L., Hesti Seftiyani, N., & Rachimoellah, M. (2018). Tailoring Properties of Acidic Types of Natural Deep Eutectics Solvents (NADES): Enhanced Solubility of Curcuminoids from *Curcuma zedoaria*. *MATEC Web of Conferences*, 156, 01011. <https://doi.org/10.1051/mateconf/201815601011>
- Rubulotta, G., & Quadrelli, E. A. (2019). Terpenes: A Valuable Family of Compounds for the Production of Fine Chemicals. In *Studies in Surface Science and Catalysis* (Vol. 178, pp. 215–229). Elsevier. <https://doi.org/10.1016/B978-0-444-64127-4.00011-2>
- Salehi, H. S., Ramdin, M., Moulton, O. A., & Vlugt, T. J. H. (2019). Computing solubility parameters of deep eutectic solvents from Molecular Dynamics simulations. *Fluid Phase Equilibria*, 497, 10–18. <https://doi.org/10.1016/j.fluid.2019.05.022>
- Santos, F., P.S. Leitão, M., & C. Duarte, A. (2018). Properties of Therapeutic Deep Eutectic Solvents of L-Arginine and Ethambutol for Tuberculosis Treatment. *Molecules*, 24(1), 55. <https://doi.org/10.3390/molecules24010055>
- Schweiger, A. K., Ríos-Lombardía, N., Winkler, C. K., Schmidt, S., Morís, F., Kroutil, W., González-Sabín, J., & Kourist, R. (2019). Using Deep Eutectic Solvents to Overcome Limited Substrate Solubility in the Enzymatic Decarboxylation of Bio-Based Phenolic Acids. *ACS Sustainable Chemistry & Engineering*, 7(19), 16364–16370. <https://doi.org/10.1021/acssuschemeng.9b03455>
- Shahbaz, K., Mjalli, F. S., Vakili-Nezhaad, G., AlNashef, I. M., Asadov, A., & Farid, M. M. (2016). Thermogravimetric measurement of deep eutectic solvents vapor pressure. *Journal of Molecular Liquids*, 222, 61–66. <https://doi.org/10.1016/j.molliq.2016.06.106>
- Shamseddin, A., Crauste, C., Durand, E., Villeneuve, P., Dubois, G., Durand, T., Vercauteren, J., & Veas, F. (2017). Resveratrol formulated with a natural deep

- eutectic solvent inhibits active matrix metalloprotease-9 in hormetic conditions: Resveratrol NADES formulation and hormesis. *European Journal of Lipid Science and Technology*, 119(11), 1700171. <https://doi.org/10.1002/ejlt.201700171>
- Shen, Q., Li, X., Li, W., & Zhao, X. (2011). Enhanced Intestinal Absorption of Daidzein by Borneol/Menthol Eutectic Mixture and Microemulsion. *AAPS PharmSciTech*, 12(4), 1044–1049. <https://doi.org/10.1208/s12249-011-9672-4>
- Silva, N. H. C. S., Morais, E. S., Freire, C. S. R., Freire, M. G., & Silvestre, A. J. D. (2020). Extraction of High Value Triterpenic Acids from Eucalyptus globulus Biomass Using Hydrophobic Deep Eutectic Solvents. *Molecules*, 25(1), 210. <https://doi.org/10.3390/molecules25010210>
- Smith, E. L., Abbott, A. P., & Ryder, K. S. (2014). Deep Eutectic Solvents (DESs) and Their Applications. *Chemical Reviews*, 114(21), 11060–11082. <https://doi.org/10.1021/cr300162p>
- Sut, S., Faggian, M., Baldan, V., Poloniato, G., Castagliuolo, I., Grabnar, I., Perissutti, B., Brun, P., Maggi, F., Voinovich, D., Peron, G., & Dall'Acqua, S. (2017). Natural Deep Eutectic Solvents (NADES) to Enhance Berberine Absorption: An In Vivo Pharmacokinetic Study. *Molecules*, 22(11), 1921. <https://doi.org/10.3390/molecules22111921>
- Tan, Y. T., Chua, A. S. M., & Ngoh, G. C. (2020). Deep eutectic solvent for lignocellulosic biomass fractionation and the subsequent conversion to bio-based products – A review. *Bioresource Technology*, 297, 122522. <https://doi.org/10.1016/j.biortech.2019.122522>
- Tang, B., Bi, W., Zhang, H., & Row, K. H. (2014). Deep Eutectic Solvent-Based HS-SME Coupled with GC for the Analysis of Bioactive Terpenoids in *Chamaecyparis obtusa* Leaves. *Chromatographia*, 77(3–4), 373–377. <https://doi.org/10.1007/s10337-013-2607-3>
- Tang, N., Zhong, J., & Yan, W. (2016). Solubilities of Three Flavonoids in Different Natural Deep Eutectic Solvents at $T = (288.15 \text{ to } 328.15) \text{ K}$. *Journal of Chemical & Engineering Data*, 61(12), 4203–4208. <https://doi.org/10.1021/acs.jced.6b00552>
- Tang, X., Zuo, M., Li, Z., Liu, H., Xiong, C., Zeng, X., Sun, Y., Hu, L., Liu, S., Lei, T., & Lin, L. (2017). Green Processing of Lignocellulosic Biomass and Its Derivatives in Deep Eutectic Solvents. *ChemSusChem*, 10(13), 2696–2706. <https://doi.org/10.1002/cssc.201700457>

- Triolo, A., Lo Celso, F., & Russina, O. (2020). Structural Features of β -Cyclodextrin Solvation in the Deep Eutectic Solvent, Reline. *The Journal of Physical Chemistry B*, 124(13), 2652–2660. <https://doi.org/10.1021/acs.jpcc.0c00876>
- Valvi, A., Dutta, J., & Tiwari, S. (2017). Temperature-Dependent Empirical Parameters for Polarity in Choline Chloride Based Deep Eutectic Solvents. *The Journal of Physical Chemistry B*, 121(50), 11356–11366. <https://doi.org/10.1021/acs.jpcc.7b07754>
- van Osch, D. J. G. P., Zubeir, L. F., van den Bruinhorst, A., Rocha, M. A. A., & Kroon, M. C. (2015). Hydrophobic deep eutectic solvents as water-immiscible extractants. *Green Chemistry*, 17(9), 4518–4521. <https://doi.org/10.1039/C5GC01451D>
- Vanda, H., Dai, Y., Wilson, E. G., Verpoorte, R., & Choi, Y. H. (2018). Green solvents from ionic liquids and deep eutectic solvents to natural deep eutectic solvents. *Comptes Rendus Chimie*, 21(6), 628–638. <https://doi.org/10.1016/j.crci.2018.04.002>
- Villiers, A. (1891). Sur la fermentation de la fécule par l'action du ferment butyrique. *C. R. Acad. Sci.*, 112. Scopus.
- Wang, H., Ma, X., Cheng, Q., Wang, L., & Zhang, L. (2018). Deep Eutectic Solvent-Based Ultrahigh Pressure Extraction of Baicalin from *Scutellaria baicalensis* Georgi. *Molecules*, 23(12), 3233. <https://doi.org/10.3390/molecules23123233>
- Wang, H., Ma, X., Cheng, Q., Xi, X., & Zhang, L. (2018a). Deep Eutectic Solvent-Based Microwave-Assisted Extraction of Baicalin from *Scutellaria baicalensis* Georgi. *Journal of Chemistry*, 2018, 1–10. <https://doi.org/10.1155/2018/9579872>
- Wang, H., Ma, X., Cheng, Q., Xi, X., & Zhang, L. (2018b). Deep Eutectic Solvent-Based Microwave-Assisted Extraction of Baicalin from *Scutellaria baicalensis* Georgi. *Journal of Chemistry*, 2018, 1–10. <https://doi.org/10.1155/2018/9579872>
- Wang, R., Sun, D., Wang, C., Liu, L., Li, F., & Tan, Z. (2019). Biphasic recognition chiral extraction of threonine enantiomers in a two-phase system formed by hydrophobic and hydrophilic deep-eutectic solvents. *Separation and Purification Technology*, 215, 102–107. <https://doi.org/10.1016/j.seppur.2019.01.022>
- Weiz, G., Braun, L., Lopez, R., de María, P. D., & Breccia, J. D. (2016). Enzymatic deglycosylation of flavonoids in deep eutectic solvents-aqueous mixtures: Paving the way for sustainable flavonoid chemistry. *Journal of Molecular Catalysis B: Enzymatic*, 130, 70–73. <https://doi.org/10.1016/j.molcatb.2016.04.010>
- Wikene, K. O., Bruzell, E., & Tønnesen, H. H. (2015a). Improved antibacterial phototoxicity of a neutral porphyrin in natural deep eutectic solvents. *Journal of Photochemistry*

- and Photobiology B: Biology*, 148, 188–196.
<https://doi.org/10.1016/j.jphotobiol.2015.04.022>
- Wikene, K. O., Bruzell, E., & Tønnesen, H. H. (2015b). Characterization and antimicrobial phototoxicity of curcumin dissolved in natural deep eutectic solvents. *European Journal of Pharmaceutical Sciences*, 80, 26–32.
<https://doi.org/10.1016/j.ejps.2015.09.013>
- Wikene, K. O., Rukke, H. V., Bruzell, E., & Tønnesen, H. H. (2016). Physicochemical characterisation and antimicrobial phototoxicity of an anionic porphyrin in natural deep eutectic solvents. *European Journal of Pharmaceutics and Biopharmaceutics*, 105, 75–84. <https://doi.org/10.1016/j.ejpb.2016.06.001>
- Zahrina, I., Nasikin, M., Krisanti, E., & Mulia, K. (2018). Deacidification of palm oil using betaine monohydrate-based natural deep eutectic solvents. *Food Chemistry*, 240, 490–495. <https://doi.org/10.1016/j.foodchem.2017.07.132>
- Zainal-Abidin, M. H., Hayyan, M., Ngoh, G. C., Wong, W. F., & Looi, C. Y. (2019). Emerging frontiers of deep eutectic solvents in drug discovery and drug delivery systems. *Journal of Controlled Release*, 316, 168–195.
<https://doi.org/10.1016/j.jconrel.2019.09.019>
- Zang, Y.-Y., Yang, X., Chen, Z.-G., & Wu, T. (2020). One-pot preparation of quercetin using natural deep eutectic solvents. *Process Biochemistry*, 89, 193–198.
<https://doi.org/10.1016/j.procbio.2019.10.019>
- Zdanowicz, M., Wilpiszewska, K., & Spychaj, T. (2018). Deep eutectic solvents for polysaccharides processing. A review. *Carbohydrate Polymers*, 200, 361–380.
<https://doi.org/10.1016/j.carbpol.2018.07.078>
- Zhang, Q., De Oliveira Vigier, K., Royer, S., & Jérôme, F. (2012). Deep eutectic solvents: Syntheses, properties and applications. *Chemical Society Reviews*, 41(21), 7108.
<https://doi.org/10.1039/c2cs35178a>
- Zhao, X., Liu, X., & Lu, M. (2014). β -cyclodextrin-capped palladium nanoparticle-catalyzed ligand-free Suzuki and Heck couplings in low-melting β -cyclodextrin/NMU mixtures: Suzuki and Heck couplings in low-melting CD/NMU mixtures. *Applied Organometallic Chemistry*, 28(8), 635–640. <https://doi.org/10.1002/aoc.3173>

CHAPITRE 2

Extraction des molécules naturelles dans les solvants eutectiques
profonds

Introduction

L'extraction des huiles essentielles par de nouveaux solvants est l'une des applications les plus recherchées pour la valorisation et la protection de ces molécules (Aziz et al., 2018). Ce chapitre, qui fait suite aux mécanismes de solubilisation des molécules naturelles dans les DESs présentés dans le chapitre 1, vise à faire un état des lieux sur l'utilisation des DESs pour l'extraction de molécules naturelles.

Une extraction est un procédé qui permet de faire migrer une ou plusieurs molécules présentes dans un milieu vers un autre milieu. L'efficacité des procédés d'extraction en phase liquide est principalement contrôlée par les mécanismes de solubilisation des molécules cibles dans le solvant utilisé (Fernández et al. 2018).

Comme les DESs sont caractérisés par une faible pression de vapeur, une inflammabilité, une haute stabilité thermique et une faible conductivité thermique, ils peuvent constituer des solvants potentiels pour l'extraction de molécules d'intérêt, en fonction de leur capacité à solubiliser ces molécules (Zhang et al., 2012).

Les molécules naturelles explorées dans la littérature pour leur extraction par les DESs appartiennent aux classes des terpénoïdes, composés phénoliques, hydrocarbures volatiles, flavonoïdes, isoflavones, anthocyanines, pro-anthocyanidines, stéroïdes, polysaccharides, xanthones, acides aminés, protéines et pigments.

En complément, cette revue a pour but de fournir des informations sur l'influence des propriétés physico-chimiques des DESs sur l'efficacité de solubilisation et d'extraction de molécules naturelles. Cette efficacité dépend à la fois des propriétés physico-chimiques de chaque composant du DES et de l'interaction entre les deux constituants. Les propriétés des DESs discutées dans cette revue regroupent la température de fusion, la densité, la viscosité, la compatibilité avec les instruments de détection, la tension de surface, la polarité, le pH ainsi que l'interaction du DES et de ses constituants avec les systèmes biologiques (cellules).

Ainsi, ce chapitre présente la revue publiée intitulée '*Microextraction of bioactive compounds using deep eutectic solvents: a review*'.



Microextraction of bioactive compounds using deep eutectic solvents: a review

Lamia Nakhle^{1,2} · Miriana Kfoury¹ · Isabelle Mallard² · David Landy² · H el ene Greige-Gerges¹

Received: 30 April 2021 / Accepted: 11 May 2021
  The Author(s), under exclusive licence to Springer Nature Switzerland AG 2021

Abstract

Analytical scientists are actually developing sustainable methods for the analysis of environmental samples. In particular, replacing classical, toxic solvents by safer solvents is a principle of green chemistry. For instance, deep eutectic solvents, formed by mixing two or more components by hydrogen bonding, appear promising. Here, we review the use of deep eutectic solvents for liquid–liquid, liquid–solid and combined extractions. We compare the use of deep eutectic solvents with conventional organic solvents for extraction. Overall, deep eutectic solvents showed better extraction efficiency and higher recovery compared to water and conventional organic solvents. In particular, deep eutectic solvents showed about 93–99% efficiency for protein extraction. The extraction efficiency often depends on the physicochemical properties of deep eutectic solvents.

Keywords Bioactive compounds · Combined extraction techniques · Deep eutectic solvents · Green chemistry · Liquid–liquid-phase microextraction · Physicochemical properties · Proteins · Solid-phase microextraction

Abbreviations

DES	Deep eutectic solvent
DI-SDME	Direct immersion single-drop microextraction technique
HS-SDME	Headspace single-drop microextraction technique
TDES-MIP	Ternary deep eutectic solvent molecularly imprinted polymer

Introduction

In the past decades, pharmaceutical industries revived the interest of plant-derived natural products in drug discovery (de C assia da Silveira e S a et al. 2014). In addition to their pharmaceutical applications, natural bioactive molecules are also used in the production of agrochemicals, nutraceuticals, cosmetics, etc. (Azmir et al. 2013). On another note, extraction and purification of proteins has become very interesting for biotechnology industry and for research and pharmaceutical applications (Huang et al. 2015). Extracting these valuable compounds from their original matrix into an adequate solvent is very challenging because the extraction method should follow the principles of the green chemistry while being time-saving, cheap and revealing a high yield (Rezaee et al. 2006; Anastas and Eghbali, 2010).

Conventional separation techniques, such as liquid–liquid extraction, solid-phase extraction, coprecipitation, as well as many exhaustive extraction methods (maceration, steam or hydro-distillation, pressing, decoction, infusion, percolation and Soxhlet extraction), were long considered for extraction-related applications before being described as expensive, labor-intensive and time-consuming techniques (Chemat et al. 2012). Consequently, new extraction methodologies have arisen such as solid-phase microextraction and liquid-phase microextraction (Hawthorne et al. 1992; Pedersen-Bjerggaard and Rasmussen, 1999). These techniques

  H el ene Greige-Gerges
hgreige@ul.edu.lb

Lamia Nakhle
lamia.nakhle@univ-littoral.fr

Miriana Kfoury
mirianakfoury@hotmail.com

Isabelle Mallard
isabelle.mallard@univ-littoral.fr

David Landy
david.landy@univ-littoral.fr

¹ Bioactive Molecules Research Laboratory, Doctoral School of Sciences and Technologies, Faculty of Sciences, Lebanese University, B.P. 90656, Jdaidet el-Matn, Lebanon

² Unit e de Chimie Environnementale et Interactions sur le Vivant (UCEIV, EA 4492), SFR Condorcet FR CNRS 3417, Universit  du Littoral C te d'Opale (ULCO), 145 Av. M. Schumann, 59140 Dunkerque, France

are characterized by using low amounts of sample matrices and small volumes of organic solvents. They are recently recommended because they offer many advantages such as increased concentration and minimized extraction time and energy consumption (Aydin et al. 2018). However, using toxic organic solvents in these extraction techniques is still a controversial subject (Mohebbi et al. 2018).

Deep eutectic solvents were first described by Abbott et al. in the early 2000's (Abbott et al. 2003). These solvents are prepared by mixing two or more components that can form hydrogen bonds (Moura et al. 2017). Due to different interactions (Van der Waals and hydrogen bonds), these solvents have much lower melting point than that of their individual components (Abbott et al. 2004). Natural deep eutectic solvents are formed by natural metabolites produced from cells such as urea, alcohols, organic acids, amines, amino acids, sugars and choline (Vanda et al. 2018). Deep eutectic solvents and natural deep eutectic solvents are characterized by a low vapor pressure, nonflammability, a high thermal stability and a low thermal conductivity (Nam et al. 2015; Radošević et al. 2016; Khataei et al. 2018). The first hydrophobic deep eutectic solvents were synthesized from decanoic acid and quaternary ammonium salts and used for the extraction of volatile fatty acids from aqueous solutions (van Osch et al. 2015). Deep eutectic solvents are considered "green," and excellent alternatives to conventional and nonconventional organic solvents, being effective to extract hydrophilic and hydrophobic compounds (Tang et al. 2014).

This review presents an emphasis on the microextraction techniques that used deep eutectic solvents as extraction solvents. Also, the effects of these solvents properties on the extraction efficiency are discussed. In addition, this review examines the advantages and drawbacks of each extraction method, used alone or in combination with a second extraction technique. A brief variation of a single method parameter (such as temperature and extraction time) can affect the extraction efficiency. However, given the large number of parameters as well as the microextraction techniques, little information regarding the method parameters is described in this review. A more comprehensive and extensive bibliography can be found in the corresponding book chapter. This review is an abridged version of the book chapter by Nakhle et al. (2021).

Microextraction techniques

Liquid-phase microextraction

Different liquid-phase microextraction techniques exist such as single-drop microextraction, hollow-fiber liquid-phase microextraction and dispersive liquid-liquid microextraction.

Single-drop microextraction

Headspace single-drop microextraction (Fig. 1) is applied for the extraction of volatile or semi-volatile compounds from a complex matrix because the suspended solvent drop is exposed only to the headspace of the sample. Tang et al. (2014) applied this method to extract terpenoids using the optimal deep eutectic solvent choline chloride/ethylene glycol (1:4 molar ratio), which showed the best extraction efficiency. A pronounced advantage was observed compared to other conventional methods (ultrasonication and heat reflux extraction) using methanol as extraction solvent (Tang et al. 2014). Also, Yousefi et al. (2018) validated the efficacy of this method in the extraction of aromatic hydrocarbons using a hydrophobic deep eutectic solvent-magnetic bucky gel. The solvent drop was formed by mixing the optimal deep eutectic solvent (choline chloride/chlorophenol 1:2 molar ratio) with magnetic multiwalled carbon nanotubes. This mixture made the solvent drop more stable. It was then demonstrated that heating and increasing the stirring rate decreased the extraction time (Yousefi et al. 2018).

Direct immersion single-drop microextraction (Fig. 1) is applied for the extraction of nonvolatile compounds and polar analytes. Gu et al. (2014) used this method for the extraction of phenolic compounds (phenol, *p*-cresol and

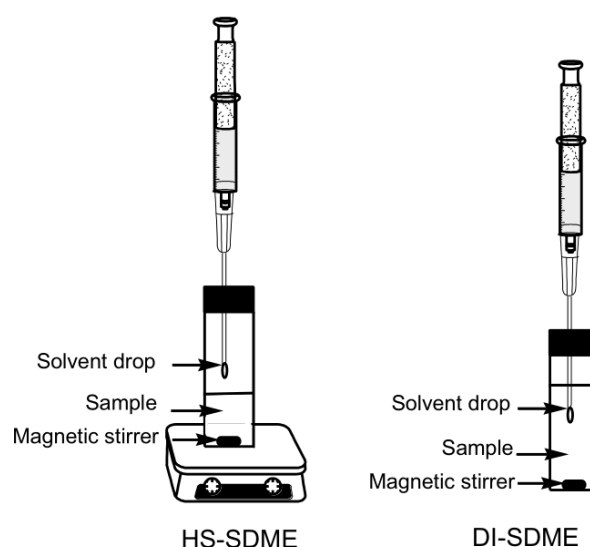

Fig. 1 Headspace single-drop microextraction technique (HS-SDME) and direct immersion single-drop microextraction technique (DI-SDME). In HS-SDME, the solvent drop is exposed to the headspace of the sample and is not in direct contact with the matrix. The solvent drop adsorbs the target compounds volatilized from the sample matrix heated and stirred for a specific time. In DI-SDME, the solvent drop is immersed directly in the sample phase. Herein, the acceptor solvent should be immiscible with the donor phase as the solvent drop is immersed in it. After extraction, the solvent drop is retracted back into the microsyringe and analyzed

β -naphthol) from crude oils with 10 μL of choline chloride/ethylene glycol (1:3 molar ratio) deep eutectic solvent. Ultrasonication was also applied for obtaining a better yield because polar compounds are being extracted from nonpolar solutions. According to authors, this solvent exhibited a better extraction efficiency than water or than the solutions of the individual components of the deep eutectic solvent (Gu et al. 2014).

Hollow-fiber liquid-phase microextraction

This microextraction method can be used for the extraction of components from complicated biological fluids. Interestingly, this technique prevented the diffusion of large molecules from the donor phase to the acceptor phase (Khataei et al. 2018), as a consequence of the use of a porous polypropylene hollow-fiber membrane (Fig. 2).

This method was used by Khataei et al. (2018) for the extraction of steroidal hormones (dydrogesterone and cyproterone acetate) from urine and plasma samples using methyltriphenylphosphonium iodide ($\text{Me}(\text{Ph})_3\text{PI}$)/ethylene glycol (1:4 molar ratio) plus 20% v/w methanol. Compared to other extraction techniques defined later on, such as hybrid solid-phase extraction, solid-phase extraction, hollow-fiber liquid–liquid microextraction, this technique has the lowest

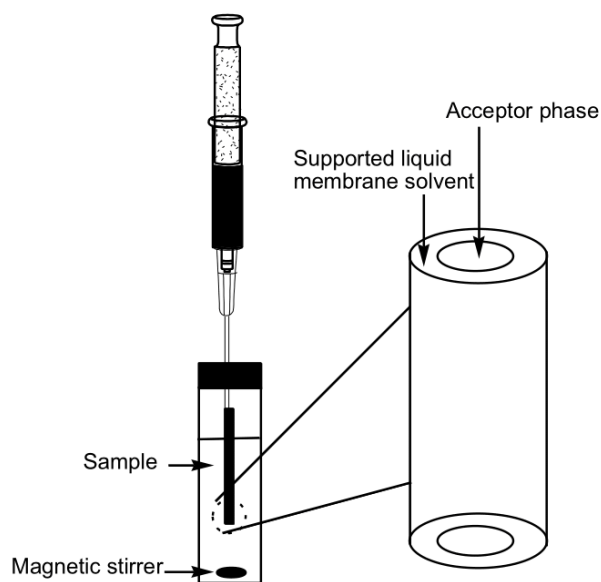

Fig. 2 Hollow-fiber liquid-phase microextraction technique. Three phases are present: the first one is the biological sample or the donor phase containing the target analytes; this phase is stirred in a sample vial. The acceptor phase is the second phase located in the lumen of the membrane. The third phase separates the two other phases: a supported liquid membrane solvent (immiscible with the two other phases) designated as the extraction phase; it is located inside the pores of the fiber membrane

limit of detection and a wider linear range in both plasma and urine matrices. In addition, clear chromatograms were obtained via this method (Khataei et al. 2018).

Dispersive liquid–liquid microextraction methods

Such techniques are based on the formation of small droplets of extraction solvent which are dispersed throughout the aqueous phase. In this way, the contact surface between both immiscible phases is increased (Fig. 3) (Ribeiro et al. 2015).

When extracting benzoylureas, the binary solvents-dispersive liquid–liquid microextraction method was tested using low hydrophilic deep eutectic solvent as extraction solvent (Zeng et al., 2017). Exceptionally, there was no need for a dispersive solvent and this method presented the advantage of lower minimum detection value and higher enrichment factor than various other techniques (Zeng et al. 2017). Also, the linear ranges of the air-assisted dispersive liquid-phase microextraction method, when extracting nine pesticides using deep eutectic solvent, were equivalent or wider than other extraction methods. Higher extraction efficiencies were also observed (Farajzadeh et al. 2017). In addition, Moghadam et al. (2018) developed a similar microextraction procedure: air-agitated emulsification microextraction based on a low-density deep eutectic solvent for the extraction of antidepressant drugs from human plasma samples and pharmaceutical wastewater samples by three types of deep eutectic solvents. Compared to other conventional techniques, this method proved its ability for accurate analysis of trace levels of drugs close to the therapeutic/toxic ranges (Moghadam et al. 2018). For the extraction of rhodamine B, recoveries experiments showed a minimal efficacy of this method using the optimal deep eutectic solvent consisted of tetrabutyl ammonium chloride/decanoic acid (1:2 molar ratio) (97% extraction efficacy) compared to other extraction methods (Yilmaz and Soylak, 2018).

Deep eutectic solvent-based subcritical water extraction

Saravana et al. (2018a) proved that the extraction yield of polysaccharides obtained using the optimal deep eutectic solvent (70% water plus choline chloride/glycerol in 1:2 molar ratio) was at least twice of that obtained from a solution of HCl/water mixture, usually used to extract polysaccharides (Saravana et al. 2018a). Through adding 10–30% citric acid/alanine (1:1 molar ratio) deep eutectic solvent to water media, Machmudah et al. (2018) proved the efficacy of the resulting subcritical water extraction method to extract xanthones. Accordingly, scanning electron microscope images showed the disruption of the surface of the pericarps of mangosteen after treatment by this method at high temperature. The formation of pores was obviously observed via the pronounced cleavage

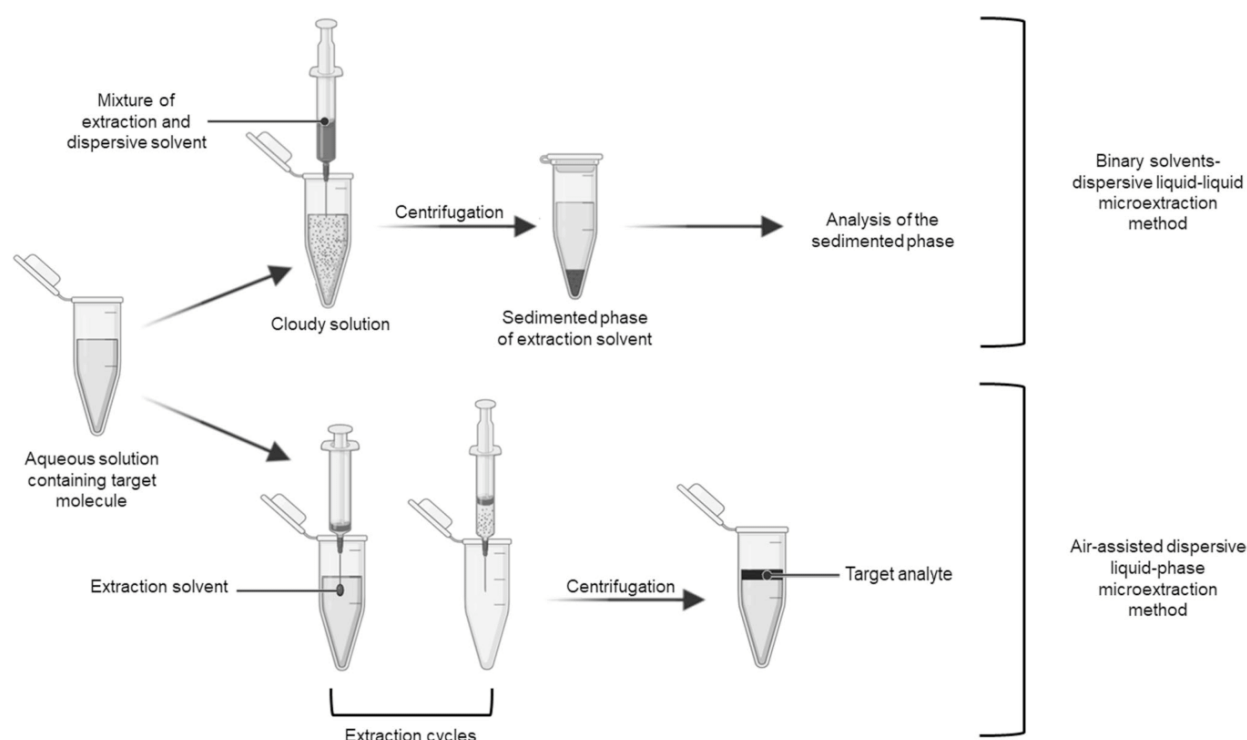

Fig. 3 Dispersive liquid–liquid microextraction techniques. In Binary solvents-dispersive liquid–liquid microextraction method, the dispersion of the solvent droplets is done by the help of a dispersive solvent that is miscible in both aqueous and extraction phases. The extraction solvent phase is analyzed after centrifugation. In the gas-associated dispersive liquid-phase microextraction, the dispersing solvent is

replaced by a gas. With air as gas, the method is called air-assisted dispersive liquid-phase microextraction. This method consists on multiple sucking and injecting processes via a syringe. At this stage, the target analytes are extracted into the fine droplets of the extraction solvent. Figure created with BioRender.com

of intermolecular and intramolecular bonds in and/or between lignin, cellulose, and hemicellulose by deep eutectic solvent (Machmudah et al. 2018).

Deep eutectic solvent-based aqueous two-phase system

This technique is widely used to extract proteins from biological fluids, as it prevents their denaturation and preserves their biological activity (Du et al., 2007; Li et al., 2016; Xu

et al., 2015; Zeng et al., 2014). The detailed process of the aqueous two-phase system is illustrated in Fig. 4.

The presence of relatively high salt concentration resulted in a competition between the salt ions and bovine serum albumin for water molecules. Due to the decrease in the amount of water required for the solubilization of the protein, the solubility of bovine serum albumin in the salt phase was tremendously decreased, resulting in the increase in its concentration in the deep eutectic solvent

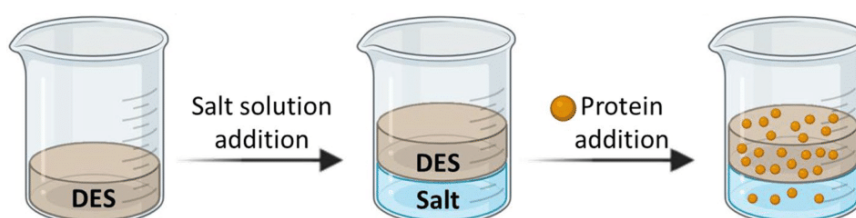

Fig. 4 Deep eutectic solvent (DES)-based aqueous two-phase system extraction method. Two aqueous phases are present in this technique: the DES-rich aqueous phase and the salt-rich aqueous phase. When these phases components are mixed above a certain salt critical con-

centration, they are separated into two unambiguous aqueous phases. It is then where the proteins present in the sample are partitioned between these two phases with a higher affinity for the DES-rich aqueous phase. Figure created with BioRender.com

phase. UV–visible, Fourier-transform infrared spectroscopy and circular dichroism experiments showed no interference between all deep eutectic solvents and bovine serum albumin and that the conformation of the protein was maintained during extraction. The extraction process is mainly due to the aggregation of protein molecules that are expected to be surrounded by deep eutectic solvent (Xu et al. 2015).

Li et al. (2016) used six betaine-based deep eutectic solvents differing by their hydrophilic property, viscosity and density for the extraction of bovine serum albumin, trypsin and ovalbumin proteins from calf blood sample. The extraction efficiency using the optimal deep eutectic solvent was higher than 99% as the bovine serum albumin band (66 kD), obtained by SDS-PAGE analysis, was present in the deep eutectic solvent-rich top phase but was not detectable in the bottom phase. This method was validated for accuracy, repeatability and environment stability (Li et al. 2016).

Compared to polypropylene glycol-based aqueous biphasic system, the extraction efficiency of three hydrophobic dyes was enhanced with tetrabutylammonium bromide/polypropylene glycol 400 (1:2 molar ratio) deep eutectic solvent. It was found that the more hydrophobic the pigment is, the more it is extracted in the deep eutectic solvent-rich phase (Zhang et al. 2018).

Ultrasound microextraction

This technique involves a low volume of deep eutectic solvent (<500 μ L) and a short time of extraction (< 15 min) (Khezeli et al. 2016; Mouratoglou et al. 2016). Similar or larger amounts of flavonoids were extracted from *Chamaecyparis obtusa* leaves using this method with deep eutectic solvent with relatively low cost, low vapor pressure and low toxicity compared to other extraction method (heating and stirring) using conventional organic solvents (Bi et al. 2013). Also, higher extraction yield of polysaccharides was obtained with optimized conditions, in comparison with hot water extraction and water-based ultrasound extraction (Zhang and Wang 2017). Bajkacz et al. (2017) used natural deep eutectic solvent-based ultrasound microextraction procedure that provided high accuracy, sensitivity and high extraction efficiency for the simultaneous analysis of four isoflavones. This method was faster and showed higher recoveries with lower relative standard deviation in comparison with the Soxhlet extraction and microwave extraction methods (Bajkacz and Adamek, 2017). In addition, the extraction yield of wine lees anthocyanins was improved in comparison with alternative methods (stirring, heating, or heating and stirring) and with the extraction using conventional solvents (water, methanol, ethanol, 70% methanol, 70% ethanol) (Jeong et al. 2017).

Microwave extraction

Microwave extraction is known for many advantages: homogeneous heating, high speed and high heat efficiency, which may produce a high extraction efficiency at a short extraction time (Cui et al. 2015; Wang et al. 2018). Comparing to other conventional techniques, microwave extraction is faster and allows the automation of the extraction, but it is more costly and demands cleanup steps (Chen et al. 2016). Higher extraction efficiency was observed using deep eutectic solvent than other conventional solvents. The maximum extraction yield of baicalin using deep eutectic solvent-based microwave extraction was slightly higher than the extraction by 70% ethanol (vol) -based hot reflux-assisted extraction and higher than the ultrasound extraction (Cvjetko Bubalo et al. 2016; Chanioti and Tzia, 2018).

Vortex extraction

The suspension, composed of the extractant phase and the donor phase, is subjected to mechanical vortex stirring, leading to the extraction of the analytes in a tiny droplets form. Subsequently, the suspension is centrifuged (González et al. 2018; Ojeda and Rojas, 2018).

This process was pursued by García et al. (2016) for the extraction of phenolic compounds. An increase in the extraction yield of oleacein and oleocanthal of 20–33% and approximately 68%, was proved by extraction with choline chloride/xylitol and choline chloride/1,2-propanediol deep eutectic solvents, respectively, compared to the conventional solvent (80% methanol/water (v/v)) (García et al. 2016). Wang et al. (2017) explored the potency of choline chloride/ethylene glycol deep eutectic solvent to extract and quantify rhodamine B present in Chili oil. Its recovery value using deep eutectic solvent was 75% higher than in control experiments using water (10% recovery). Compared to methanol, deep eutectic solvent showed high selectivity for rhodamine B; however, other dyes were extracted also with methanol (Wang et al. 2017). Cao et al. (2018) applied a vortex extraction method for the extraction of proanthocyanidin. Sixteen different deep eutectic solvents were tested, and it was concluded that organic acid-based deep eutectic solvents were better than alcohol-based ones and this was related to the higher polarity of the organic acid-based ones suitable for the extraction of the hydrophilic proanthocyanidin. Extraction yield with choline chloride/malonic acid deep eutectic solvent (1:2 molar ratio) with 55wt% of water (22.19 ± 0.71 mg/g solvent) was much higher than those with conventional organic solvents (70% methanol (7.87 ± 0.21 mg/g solvent), 70% ethanol (7.84 ± 0.10 mg/g solvent) and 70% acetone (13.26 ± 0.54 mg/g solvent)) (Cao et al. 2018).

Heating and stirring

Such method is based on the solubilization of the target analytes in the deep eutectic solvent under heating and stirring conditions that are optimized depending on the target compound (Das et al. 2016; Bağda et al. 2017).

Dai et al. (2016) used natural deep eutectic solvent to extract anthocyanins from purple and orange petals of *Catharanthus roseus*. This method was compared with ultrasound extraction and ultrasound extraction with heating. The best extraction yield was obtained by heating and stirring at 40 °C, and it was 35–55% greater than that obtained with sonication at 25 °C (Dai et al. 2016). Also, Peng et al. (2018) obtained an improved yield of extracted rutin using deep eutectic solvent and water (18.1%) compared with the methanol–water solution or ethanol–water solution (60% water). The yellow rutin powder was obtained with a yield of 62.7% with purity higher than 95% and an excellent antioxidant activity (Peng et al. 2018).

Solid-phase microextraction

Solid-phase microextraction is based on the partition of the analytes between a liquid solution (sample phase) and a viscous liquid (deep eutectic solvent) immobilized on a solid support (sorbent phase) via absorption/adsorption mechanism (Okenicová et al., 2016). This technique is considered better than liquid–liquid microextraction because it reduces and even eliminates the use of toxic and inflammable solvents, thus becoming more environmentally friendly (Picó et al., 2007; Ince et al., 2010). Some of the commercially available cartridges present some limitations such as single adsorption mechanism and low special selectivity, which limit their further application (Li et al. 2017). Hence, scientists are working on the development of new selective sorbents via the application of deep eutectic solvents to increase their selectivity and capacity (Gan et al. 2016).

Ball mill-assisted extraction method

Ball-mill extraction method can provide a special, optimized motion to disrupt cells through the multi-directional, simultaneous beating of specialized beads on the sample to achieve full release of the target molecules into the solvent (Wang et al. 2016). Comparing to other extraction methods (methanol-based ultrasound extraction and heat reflux extraction), the ball mill-assisted extraction method, developed by Wang et al. in (2016), was faster with higher extraction capacity of tanshinones and lower consumption of solvents. Also, in comparison with conventional solvents (n-hexane, ethanol, methanol, acetonitrile, acetone, and ethyl acetate), it was demonstrated that with deep eutectic solvents (six different choline chloride-based deep eutectic solvents)

higher extraction efficiencies were obtained likely because of multiple interactions between deep eutectic solvent and the target molecules. Extracted compounds were quite stable in deep eutectic solvents (Wang et al. 2016).

Magnetic solid-phase extraction method

This method has the same principle as the classical solid-phase microextraction, but it is mainly related to the magnetic sorbents facilitating the extraction process by applying an external magnetic field (Oller-Ruiz et al. 2018). Furthermore, these sorbents do not necessary need to be packed into cartridge and can be recycled and reused; also the centrifugation and the filtration could be avoided (Xu et al. 2016a, b). Huang et al. (2015) synthesized magnetic graphene oxide impregnated with deep eutectic solvent; the latter showed increased water solubility and improved proteins extraction efficiency than graphene oxide alone (Huang et al. 2015). The same method was used by Xu et al. (2016a, b) to extract proteins, without modification of their conformation. Also, Xu et al. (2016b) introduced a new type of polymer-immobilized magnetic silica materials with high thermal stability, extraction and recycling capacity for the extraction of trypsin (Xu et al. 2016b). Four choline chloride-based deep eutectic solvents-magnetic graphene oxide sorbent gave the best extraction efficiencies compared to magnetic graphene oxide and $\text{Fe}_3\text{O}_4\text{-NH}_2$ sorbents. This was linked to the numerous oxygen-containing functional groups existing on the surface of graphene oxide in addition to the hydroxyl groups of deep eutectic solvents that strengthen the interactions between proteins and deep eutectic solvents. In addition, the extraction efficiency was the best at a certain pH where opposite charges between magnetic microspheres and proteins exist. Another parameter related to the extraction capacity was the molecular weight of the proteins: the smaller the protein, the easier was its extraction (Xu et al. 2016a, b).

Li et al. (2017) developed a C_8 -amino-bifunctionalized ordered mesoporous organosilica sorbent for the extraction of triazine herbicides from watermelon samples. Deep eutectic solvent composed of choline chloride/ethylene glycol 1:2 molar ratio was used as the extraction solvent. This method demonstrated high recoveries and lower limits of detection and relative standard deviations values than other methods (pressurized liquid extraction, nonaqueous cavitation extraction, molecular-imprinted polymer-based solid-phase microextraction, cloud point extraction and matrix solid-phase dispersion). These sorbents present many advantages such as large surface area, regular and uniform pore size, hydrothermal stability, and the availability of two functional groups combining hydrophobic and hydrophilic characters (octyl chains and amino groups, respectively), which improved the adsorption selectivity (Li et al., 2017).

Mini-solid-phase microextraction or pipette-tip solid-phase extraction method

The needle of the syringe system is suitable to be used as a meticulous mini-solid-phase microextraction cartridge because of its special miniconical shape (Li and Row, 2018).

This technique was applied by Li and Row in (2018) for the extraction of 3,4-dihydroxybenzoic acid from *Ilex Chinensis Sims* leaves using molecular-imprinted polymers as shown in Fig. 5. Ternary deep eutectic solvent was used by mixing choline chloride, ethylene glycol and 3, 4-dihydroxybenzoic acid. Compared to deep eutectic solvent-modified non-imprinted polymers (without template), a molecular-imprinted polymer (without deep eutectic solvent) and non-imprinted polymer (without deep eutectic solvent and without template); ternary deep eutectic solvent molecularly imprinted polymer demonstrated the best extraction efficiency. This technique presents an additional advantage than the other solid-phase extraction techniques since lower amounts of sorbent mass were used (Li and Row, 2018).

Combined extraction techniques

Deep eutectic solvent-based negative-pressure cavitation-assisted extraction method combined with macroporous resin enrichment

In this method, millions of tiny vapor bubbles are formed in the liquid by the help of a machine that induces pressure (for example pumps, turbines and propellers). The deep eutectic solvent extraction solution flowed through the column packed with macroporous resins. Deep eutectic solvent showed better extractability than 80% ethanol

solvent. Moreover, deep eutectic solvent negative-pressure cavitation-assisted extraction yields were higher than that of deep eutectic solvent-based ultrasound extraction method (Qi et al. 2015). This method, which is performed at room temperature, can be widely used for the thermolabile compounds. Additionally, the oxidation of these compounds is avoided as air is excluded in the extraction process (Liu et al. 2009).

Microwave extraction and solid-phase extraction

Wei et al. (2015) used the microwave extraction method for the extraction of four flavonoids from *Radix Scutellariae*. Among the thirteen tested natural deep eutectic solvents, the choline chloride/lactic acid (1:2 molar ratio) + 20% water (v/v) mixture was selected because it was the most suitable for the simultaneous extraction of these compounds. A solid-phase extraction method was also applied where the natural deep eutectic solvent extraction solution was flowed through the column packed with ME-2 macroporous resin for the separation of the flavonoids (baicalin, wogonoside, baicalein and wogonin) from the natural deep eutectic solvent, with high recovery yields (Wei et al. 2015).

Biological and deep eutectic solvent pretreatments

The combination of the biological treatment and deep eutectic solvent was tested by Dai et al. (2017) for the removal of lignin and hemicellulose from bamboo shoot shell waste in order to enhance the biomass conversion into fermentable sugars for the producing of biofuel.

In this study, bamboo shoot shell was subjected to biological treatment with *Galactomyces* sp. CCZU11-1 used

Fig. 5 Pipette-tip solid-phase extraction method. In this method, the sorbent is packed inside the end of the syringe (in this case, the sorbent is the ternary deep eutectic solvent molecularly imprinted polymer (TDES-MIP)). Each time the solution was sucked up into and out of micropipette type of the needle containing the adsorbent by pulling and pushing the syringe, respectively. The extraction complex retained on the adsorbent was washed, eluted and subjected to analysis

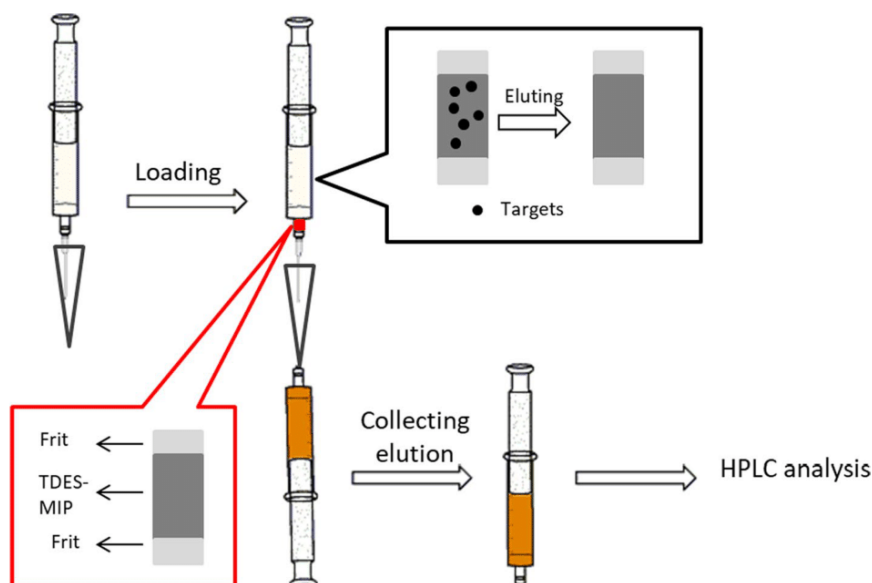

to produce cellulases. After fermentation, the residues of bamboo shoot shell were treated by deep eutectic solvent. Notably, choline chloride/oxalic acid (1:2 molar ratio) was found to be the best solvent for pretreating bamboo shoot shell with the highest xylan removal (53%) and delignification (48%). After deep eutectic solvent addition, more surface areas in the pretreated bamboo shoot shell were formed which allowed cellulases to further attack cellulose and residual hemicellulose. Thus, enzymatic saccharification of bamboo shoot shell was increased after deep eutectic solvent pretreatment. The reducing sugars yield from the enzymatic hydrolysis of 50 g/L deep eutectic solvent bamboo shoot shell was maximal (90%). Furthermore, it was found that the combination pretreatment was better than one step pretreatment and it effectively removed xylan and lignin after treatment with deep eutectic solvent (Dai et al. 2017).

Deep eutectic solvent-based vortex extraction combined with emulsification liquid–liquid microextraction

Aydin et al. (2018) developed a new technique using deep eutectic solvent (choline chloride/phenol 1:4 molar ratio) as a water-miscible extraction solvent for the extraction of curcumin. Recoveries of curcumin using different deep eutectic solvents were above 96% (Aydin et al. 2018).

Dispersive solid-phase extraction in combination with deep eutectic solvent-based air-assisted liquid–liquid microextraction

The process started with dispersive solid-phase extraction method. Then, air-assisted liquid–liquid microextraction method was applied. In the proposed method, the synthesized deep eutectic solvent was used as an elution/extraction solvent of tricyclic antidepressant drugs (amitriptyline, nortriptyline, desipramine, clomipramine and imipramine) from plasma and urine samples. Results showed many advantages such as good repeatability, high enrichment factors and extraction recoveries, low limits of detection and limits of quantification, and simplicity of operation. According to Mohebi et al. (2018), this method can be used for the routine analysis of many drugs in the pharmaceutical and clinical laboratories with no harm on human health and environment (Mohebbi et al. 2018).

Ultrasound extraction and solid-phase extraction

Liu et al. (2018) proposed a combined technique for the extraction of different classes of natural products (phenolics, terpenoids and phenolic acids) from *G. biloba* leaves and ginsenosides from *P. ginseng* leaves. Six different natural deep eutectic solvents were tested. The presence of

natural deep eutectic solvent caused severe tailing of spots in high-performance thin-layer chromatography analysis; therefore, it was important to recover the analytes from natural deep eutectic solvent before analysis. Hence, solid-phase extraction method was employed using polymeric reversed-phase sorbent cartridges. Among the natural deep eutectic solvents, choline chloride/malic acid (1:1 molar ratio) and glycerol/proline/sucrose (1:1:1 molar ratio) were the best for *G. biloba* leaves, and choline chloride/malic acid (1:1 molar ratio) and glucose/malic acid (1:1 molar ratio) for *P. ginseng* leaves showing the highest yields of the target compounds. The addition of water to natural deep eutectic solvent affected the extraction and maximum yields. The latter were obtained with approximately 20% water (w/w). Results showed that the yield of analytes obtained with the natural deep eutectic solvent is similar to that of methanol. A high advantage of the use of natural deep eutectic solvent is their incapability to extract ginkgolic acids (considered very toxic to human) due to their low polarity and low dissolution in natural deep eutectic solvents. This method proved to be able to deliver reproducible chemical profiles from the natural deep eutectic solvent extracts (Liu et al. 2018).

Influence of deep eutectic solvent properties on the extraction efficiency

The properties of deep eutectic solvent highly influence the extraction efficiency (Tang et al. 2014). These properties depend both on the physico-chemical properties of each deep eutectic solvent component and on the interactions between the two constituents. The extraction efficiency is also influenced by the deep eutectic solvent solubilizing capacities and eventually its cell structures disruption ability. The water content, which is generally present in the extraction media when targeting bioactive compounds, also influences the extraction efficiency. In fact, the properties of deep eutectic solvent can be heavily modulated by the presence of water (El Achkar et al. 2019).

Melting point

As it was mentioned above, deep eutectic solvents are characterized by a lower melting point than that of any of its individual components (Zhang et al. 2012). Nevertheless, not all deep eutectic solvents are liquid at ambient temperature, and therefore the melting temperature is the first criteria to consider when choosing a given deep eutectic solvent for an extraction procedure.

Density

The difference in density values of deep eutectic solvents, which ranges from 1.041 to 1.63 g.cm⁻³, is explained by their molecular organization and packing (Zhang et al. 2012). Deep eutectic solvent's density is a highly important property when separating phases in the extraction process especially in dispersive liquid–liquid microextraction techniques because most of the separation processes are based on the density differences between the two phases. Deep eutectic solvent's density decreases linearly when the temperature is increased as it was shown by Florindo et al. (2014). The molar ratio of the deep eutectic solvent components also heavily influences the density values (Wahaibi et al. 2019).

Viscosity

Most of the deep eutectic solvents possess high viscosity values (> 100 Cp) at room temperature (Zhang et al. 2012). This high viscosity is attributed to the presence of an extensive hydrogen-bonding network, Van der Waals and/or electrostatic interactions between the compounds that restricts the mobility of the free species inside deep eutectic solvent and restricts the dispersion of deep eutectic solvent in the extraction medium during the extraction process (Zhang et al. 2012; Habibollahi et al. 2018). Whereas high viscosity may be considered as favorable for the prevention of entrapped agents from vaporization, it hampers the mass transfer and thus produces lower extraction efficiency. Therefore, this problem can be solved by increasing the temperature, thus leading to a better penetration of the solvents in the sample; this is known as Arrhenius-like behavior (Bubalo et al. 2018). Also, adding a certain percentage of water to a deep eutectic solvent, at which the deep eutectic solvent's network is still maintained, is another way to decrease deep eutectic solvent's viscosity (Qi et al. 2015; Fernández et al. 2018). However, the addition of water can alter the hydrogen bonds between deep eutectic solvent and the target compound (Bajkacz and Adamek, 2017). Water-added deep eutectic solvents are more suitable for the extraction of polar compounds, whereas deep eutectic solvents with low water content are better for the extraction of nonpolar compounds (Dai et al. 2013a, b). Obviously, the nature of deep eutectic solvent components and the molar ratio also strongly influence the viscosity of a deep eutectic solvent (Abbott et al. 2011; Bi et al. 2013; Cao et al. 2018). Deep eutectic solvent with high viscosity may be selected for the single-drop microextraction techniques, because they facilitate the suspension of the drop at the end of the needle of a microsyringe.

Compatibility with instrumental detection systems

A high advantage of using deep eutectic solvent in the extraction techniques is the absence of interference generally observed for these solvents and their constituents with the detection methods. Many deep eutectic solvents showed a high compatibility with various instrumental detection systems such as mass spectrometry, flame ionization detector, UV–visible spectroscopy, diode-array-detector, graphite furnace atomic absorption spectroscopy, Fourier-transform infrared spectroscopy and fluorescence spectroscopy. Therefore, new combinations with advanced separation techniques like high-performance liquid chromatography, gas chromatography and thin-layer chromatography are ongoing, for example by using a certain percentage of deep eutectic solvent in the mobile phase (Tan et al. 2016).

Surface tension

Surface tension depends on the strength of intermolecular interaction of deep eutectic solvent and on temperature (Tang et al. 2014). Generally, most of the deep eutectic solvents have higher surface tension than conventional solvents. Deep eutectic solvent with low surface tension can be applied as an adhesive or wetting agent in the extraction techniques (Li and Row 2016).

Polarity and solubilizing properties

Deep eutectic solvent's polarity is an important parameter regarding its miscibility in other solvents or either in the sample solution, and regarding its solubilizing efficiency toward target analytes (Dai et al. 2013a, b). Deep eutectic solvents are known to have good solubilizing properties for polar and weak-polar compounds, including drugs, pharmaceutical ingredients, metal oxides, carbon dioxide, and elemental species such as lead, mercury and cadmium. (Aroso et al. 2016). Also, deep eutectic solvent proved better solubilizing effect, therefore better extractability compared to conventional solvents (Fernández et al. 2018). These properties may be rationalized, at least partially, by the “like dissolves like” theory, thus helping the choice of the adequate deep eutectic solvent regarding its polarity. Recently, deep eutectic solvents have been tailored to be target-specific via the selection of specific individual components based on the analytes via *in silico* methods. Unique interactions between the deep eutectic solvents with target analytes make it possible to selectively separate trace of this analyte from complex matrices (Fernández et al. 2018). It has to be mentioned that increasing the temperature generally leads to a decrease in the polarity of deep eutectic solvent because of the reduction in the hydrogen-bond donating acidity of the solvent, as observed

with choline chloride/glycerol deep eutectic solvent (Tang et al. 2014). A linear correlation has also been underlined between the choline chloride proportion and the polarity of the resulting deep eutectic solvent.

pH

The pH of deep eutectic solvent can affect the charge of the bioactive compounds subjected to extraction, and thus the extraction efficiency. In their neutral forms, analytes are generally much easier to be extracted by weakly polar solvents. Therefore, the pH of the extraction procedure should be higher than or near to the pK_a values of the studied analytes (Mohebbi et al. 2018). The pH of different deep eutectic solvent changes differently with temperature, and their acidity is highly affected by the type of hydrogen bond donor (Tang et al. 2014). The highly polar molecules demand an acidic environment for a better extraction; therefore, organic acid-based deep eutectic solvents or some natural deep eutectic solvents are often the best choice. This was observed with organic acid-based natural deep eutectic solvents that showed the best extraction results for anthocyanin (polar compounds), while sugar-based natural deep eutectic solvents were a better choice for other phenolic compounds (Radošević et al. 2016). Finally, due to their amphoteric properties, the extraction of proteins is highly influenced by the pH, and accordingly their isoelectric point should be taken into consideration (Li et al. 2016).

Cell disruption ability

There is no doubt that some extraction techniques, such as ultrasonication, microwave extraction, as well as hot reflux extraction and others, cause cell disruption. However, the solvent used has an additional impact on the cell disruption. Using different extraction techniques followed by scanning electron microscope analysis, it was proved that deep eutectic solvents cause cell rupture more efficiently than conventional extraction solvents such as methanol and ethanol. This leads to the full release of the target analyte and its subsequent dissolution in the deep eutectic solvent (Chen et al. 2016; Jeong et al. 2017; Zhou et al. 2018; Wang et al. 2018).

Conclusion

Owing their low cost, easy synthesis, eco-friendly behavior and solubilizing capacities, deep eutectic solvents may be considered as suitable extraction solvents in the newly developed microextraction techniques. The use of deep eutectic

solvent in many extraction techniques, either alone or mixed with a certain percentage of water, gives many advantages compared to the toxic conventional organic solvents. This was mainly proved by the enhanced extraction efficiency of different kind of molecules and macromolecules specially proteins and plant secondary metabolites. In addition, deep eutectic solvent properties, such as melting point, density, viscosity, compatibility with instrumental detection systems, surface tension, polarity and solubilizing properties, pH and cell disruption ability, should be considered for a maximum extraction efficiency. Consequently, these early twentieth century arisen solvents were immensely applied in the domains of chemistry given their special criteria; and as the selected publications in this review underlines, these solvents guarantee further progress in the domain of extraction.

Acknowledgements Lamia Nakhle has received a scholarship from Université du Littoral Côte d'Opale (ULCO) and from the Lebanese National Council for Scientific Research (CNRS-L).

References

- Abbott AP, Boothby D, Capper G, Davies DL, Rasheed RK (2004) Deep eutectic solvents formed between choline chloride and carboxylic acids: versatile alternatives to ionic liquids. *J Am Chem Soc* 126(29):9142–9147. <https://doi.org/10.1021/ja048266j>
- Abbott AP, Capper G, Davies DL, Rasheed RK, Tambyrajah V (2003) Novel solvent properties of choline chloride/urea mixtures. Electronic supplementary information (ESI) available: Spectroscopic data. *Chem Commun* 1:70–71. <https://doi.org/10.1039/b210714g>
- Abbott AP, Harris RC, Ryder KS, D'Agostino C, Gladden LF, Mantle MD (2011) Glycerol eutectics as sustainable solvent systems. *Green Chem* 13(1):82–90. <https://doi.org/10.1039/C0GC00395F>
- Anastas P, Eghbali N (2010) Green chemistry: principles and practice. *Chem Soc Rev* 39(1):301–312. <https://doi.org/10.1039/B918763B>
- Aroso IM, Silva JC, Mano F, Ferreira ASD, Dionísio M, Sá-Nogueira I, Barreiros S, Reis RL, Paiva A, Duarte ARC (2016) Dissolution enhancement of active pharmaceutical ingredients by therapeutic deep eutectic systems. *Eur J Pharm Biopharm* 98:57–66. <https://doi.org/10.1016/j.ejpb.2015.11.002>
- Aydin F, Yilmaz E, Soylak M (2018) Vortex assisted deep eutectic solvent (DES)-emulsification liquid-liquid microextraction of trace curcumin in food and herbal tea samples. *Food Chem* 243:442–447. <https://doi.org/10.1016/j.foodchem.2017.09.154>
- Azmir J, Zaidul ISM, Rahman MM, Sharif KM, Mohamed A, Sahena F, Jahurul MHA, Ghafoor K, Norulaini NAN, Omar AKM (2013) Techniques for extraction of bioactive compounds from plant materials: a review. *J Food Eng* 117(4):426–436. <https://doi.org/10.1016/j.jfoodeng.2013.01.014>
- Bağda E, Altundağ H, Soylak M (2017) Highly simple deep eutectic solvent extraction of manganese in vegetable samples prior to Its ICP-OES analysis. *Biol Trace Elem Res* 179(2):334–339. <https://doi.org/10.1007/s12011-017-0967-5>
- Bajkacz S, Adamek J (2017) Evaluation of new natural deep eutectic solvents for the extraction of isoflavones from soy products. *Talanta* 168:329–335. <https://doi.org/10.1016/j.talanta.2017.02.065>
- Bi W, Tian M, Row KH (2013) Evaluation of alcohol-based deep eutectic solvent in extraction and determination of flavonoids

- with response surface methodology optimization. *J Chromatogr A* 1285:22–30. <https://doi.org/10.1016/j.chroma.2013.02.041>
- Cao J, Chen L, Li M, Cao F, Zhao L, Su E (2018) Efficient extraction of proanthocyanidin from Ginkgo biloba leaves employing rationally designed deep eutectic solvent-water mixture and evaluation of the antioxidant activity. *J Pharm Biomed Anal* 158:317–326. <https://doi.org/10.1016/j.jpba.2018.06.007>
- Chanioti S, Tzia C (2018) Extraction of phenolic compounds from olive pomace by using natural deep eutectic solvents and innovative extraction techniques. *Innov Food Sci Emerg Technol* 48:228–239. <https://doi.org/10.1016/j.ifset.2018.07.001>
- Chemat F, Vian MA, Cravotto G (2012) Green extraction of natural products: concept and principles. *Int J Mol Sci* 13(7):8615–8627. <https://doi.org/10.3390/ijms13078615>
- Chen J, Liu M, Wang Q, Du H, Zhang L (2016) Deep eutectic solvent-based microwave-assisted method for extraction of hydrophilic and hydrophobic components from radix salviae miltiorrhizae. *Molecules* 21(10):1383. <https://doi.org/10.3390/molecules21101383>
- Cui Q, Peng X, Yao X-H, Wei Z-F, Luo M, Wang W, Zhao C-J, Fu Y-J, Zu Y-G (2015) Deep eutectic solvent-based microwave-assisted extraction of genistin, genistein and apigenin from pigeon pea roots. *Sep Purif Technol* 150:63–72. <https://doi.org/10.1016/j.seppur.2015.06.026>
- Cvjetko Bubalo M, Čurko N, Tomašević M, Kovačević Ganić K, Radojčić Redovniković I (2016) Green extraction of grape skin phenolics by using deep eutectic solvents. *Food Chem* 200:159–166. <https://doi.org/10.1016/j.foodchem.2016.01.040>
- Cvjetko Bubalo M, Vidović S, Radojčić Redovniković I, Jokić S (2018) New perspective in extraction of plant biologically active compounds by green solvents. *Food Bioprod Process* 109:52–73. <https://doi.org/10.1016/j.fbp.2018.03.001>
- Dai Yong, Zhang H-S, Huan B, He Y (2017) Enhancing the enzymatic saccharification of bamboo shoot shell by sequential biological pretreatment with *Galactomyces* sp. CCZU11–1 and deep eutectic solvent extraction. *Bioprocess Biosyst Eng* 40(9):1427–1436. <https://doi.org/10.1007/s00449-017-1800-4>
- Dai Y, Rozema E, Verpoorte R, Choi YH (2016) Application of natural deep eutectic solvents to the extraction of anthocyanins from *Catharanthus roseus* with high extractability and stability replacing conventional organic solvents. *J Chromatogr A* 1434:50–56. <https://doi.org/10.1016/j.chroma.2016.01.037>
- Dai Y, Witkamp G-J, Verpoorte R, Choi YH (2013) Natural deep eutectic solvents as a new extraction media for phenolic metabolites in *Carthamus tinctorius* L. *Anal Chem* 85(13):6272–6278. <https://doi.org/10.1021/ac400432p>
- Das AK, Sharma M, Mondal D, Prasad K (2016) Deep eutectic solvents as efficient solvent system for the extraction of κ -carrageenan from *Kappaphycus alvarezii*. *Carbohydr Polym* 136:930–935. <https://doi.org/10.1016/j.carbpol.2015.09.114>
- Andrade L, Barreto Dos Reis, de Oliveira R, de Sousa D (2014) A review on anti-inflammatory activity of phenylpropanoids found in essential oils. *Molecules* 19(2):1459–1480. <https://doi.org/10.3390/molecules19021459>
- Du Z, Yu Y-L, Wang J-H (2007) Extraction of proteins from biological fluids by use of an ionic liquid/aqueous two-phase system. *Chem Eur J* 13(7):2130–2137. <https://doi.org/10.1002/chem.200601234>
- El Achkar T, Fourmentin S, Greige-Gerges H (2019) Deep eutectic solvents: an overview on their interactions with water and biochemical compounds. *J Mol Liq* 288:111028. <https://doi.org/10.1016/j.molliq.2019.111028>
- Farajzadeh MA, Sattari Dabbagh M, Yadeghari A (2017) Deep eutectic solvent based gas-assisted dispersive liquid-phase microextraction combined with gas chromatography and flame ionization detection for the determination of some pesticide residues in fruit and vegetable samples. *J Sep Sci* 40(10):2253–2260. <https://doi.org/10.1002/jssc.201700052>
- Fernández M, de Los Á, Espino M, Gomez FJV, Silva MF (2018) Novel approaches mediated by tailor-made green solvents for the extraction of phenolic compounds from agro-food industrial by-products. *Food Chem* 239:671–678. <https://doi.org/10.1016/j.foodchem.2017.06.150>
- Florindo C, Oliveira FS, Rebelo LPN, Fernandes AM, Marrucho IM (2014) Insights into the synthesis and properties of deep eutectic solvents based on cholinium chloride and carboxylic acids. *ACS Sustain Chem Eng* 2(10):2416–2425. <https://doi.org/10.1021/sc500439w>
- Gan K, Tang W, Zhu T, Li W, Wang H, Liu X (2016) Enhanced extraction of cleistanthol from *Phyllanthus flexuosus* by deep eutectic solvent-modified anion-exchange resin. *J Liq Chromatogr Relat Technol* 39(19–20):882–888. <https://doi.org/10.1080/10826076.2017.1278609>
- García A, Rodríguez-Juan E, Rodríguez-Gutiérrez G, Rios JJ, Fernández-Bolaños J (2016) Extraction of phenolic compounds from virgin olive oil by deep eutectic solvents (DESs). *Food Chem* 197:554–561. <https://doi.org/10.1016/j.foodchem.2015.10.131>
- González CG, Mustafa NR, Wilson EG, Verpoorte R, Choi YH (2018) Application of natural deep eutectic solvents for the “green” extraction of vanillin from vanilla pods. *Flavour Fragr J* 33(1):91–96. <https://doi.org/10.1002/ffj.3425>
- Gu T, Zhang M, Tan T, Chen J, Li Z, Zhang Q, Qiu H (2014) Deep eutectic solvents as novel extraction media for phenolic compounds from model oil. *Chem Commun* 50(79):11749–11752. <https://doi.org/10.1039/C4CC04661G>
- Habibollahi MH, Karimyan K, Arfaeina H, Mirzaei N, Safari Y, Akramipour R, Sharafi H, Fattahi N (2018) Extraction and determination of heavy metals in soil and vegetables irrigated with treated municipal wastewater using new mode of dispersive liquid-liquid microextraction based on the solidified deep eutectic solvent followed by GFAAS: extraction of heavy metals using dispersive liquid-liquid microextraction. *J Sci Food Agric*. <https://doi.org/10.1002/jsfa.9230>
- Hawthorne SB, Miller DJ, Pawliszyn J, Arthur CL (1992) Solventless determination of caffeine in beverages using solid-phase microextraction with fused-silica fibers. *J Chromatogr A* 603(1–2):185–191. [https://doi.org/10.1016/0021-9673\(92\)85360-6](https://doi.org/10.1016/0021-9673(92)85360-6)
- Huang Y, Wang Y, Pan Q, Wang Y, Ding X, Xu K, Li N, Wen Q (2015) Magnetic graphene oxide modified with choline chloride-based deep eutectic solvent for the solid-phase extraction of protein. *Anal Chim Acta* 877:90–99. <https://doi.org/10.1016/j.aca.2015.03.048>
- Ince M, Kaya G, Yaman M (2010) Solid phase extraction and preconcentration of cobalt in mineral waters with PAR-loaded Amberlite XAD-7 and flame atomic absorption spectrometry. *Environ Chem Lett* 8(3):283–288. <https://doi.org/10.1007/s10311-009-0218-x>
- Jeong KM, Ko J, Zhao J, Jin Y, Yoo DE, Han SY, Lee J (2017) Multi-functioning deep eutectic solvents as extraction and storage media for bioactive natural products that are readily applicable to cosmetic products. *J Clean Prod* 151:87–95. <https://doi.org/10.1016/j.jclepro.2017.03.038>
- Khataei MM, Yamini Y, Nazarpour A, Karimi M (2018) Novel generation of deep eutectic solvent as an acceptor phase in three-phase hollow fiber liquid phase microextraction for extraction and preconcentration of steroidal hormones from biological fluids. *Talanta* 178:473–480. <https://doi.org/10.1016/j.talanta.2017.09.068>
- Khezeli T, Daneshfar A, Sahraei R (2016) A green ultrasonic-assisted liquid-liquid microextraction based on deep eutectic solvent for the HPLC-UV determination of ferulic, caffeic and cinnamic acid

- from olive, almond, sesame and cinnamon oil. *Talanta* 150:577–585. <https://doi.org/10.1016/j.talanta.2015.12.077>
- Li G, Row KH (2018) Selective extraction of 3,4-dihydroxybenzoic acid in *Ilex chinensis* Sims by meticulous mini-solid-phase microextraction using ternary deep eutectic solvent-based molecularly imprinted polymers. *Anal Bioanal Chem* 410(30):7849–7858. <https://doi.org/10.1007/s00216-018-1406-y>
- Li N, Wang Y, Xu K, Huang Y, Wen Q, Ding X (2016) Development of green betaine-based deep eutectic solvent aqueous two-phase system for the extraction of protein. *Talanta* 152:23–32. <https://doi.org/10.1016/j.talanta.2016.01.042>
- Li X, Row KH (2016) Development of deep eutectic solvents applied in extraction and separation: liquid chromatography. *J Sep Sci* 39(18):3505–3520. <https://doi.org/10.1002/jssc.201600633>
- Li Z, Jia J, Wang M, Zhang H, Yan H, Qiao F (2017) Bifunctionalized ordered mesoporous organosilica synthesized in deep eutectic solvent for extraction of triazine herbicides from watermelon. *J Chromatogr A* 1529:50–56. <https://doi.org/10.1016/j.chroma.2017.10.074>
- Liu W, Fu Y, Zu Y, Kong Y, Zhang L, Zu B, Efferth T (2009) Negative-pressure cavitation extraction for the determination of flavonoids in pigeon pea leaves by liquid chromatography–tandem mass spectrometry. *J Chromatogr A* 1216(18):3841–3850. <https://doi.org/10.1016/j.chroma.2009.02.073>
- Liu X, Ahlgren S, Korthout HAAJ, Salomé-Abarca LF, Bayona LM, Verpoorte R, Choi YH (2018) Broad range chemical profiling of natural deep eutectic solvent extracts using a high performance thin layer chromatography–based method. *J Chromatogr A* 1532:198–207. <https://doi.org/10.1016/j.chroma.2017.12.009>
- Machmudah S, Lestari SD, Widiyastuti W, Kanda H, Winardi S, Goto M (2018) Subcritical water extraction enhancement by adding deep eutectic solvent for extracting xanthone from mangosteen pericarps. *J Supercrit Fluids* 133:615–624. <https://doi.org/10.1016/j.supflu.2017.06.012>
- Moghadam AG, Rajabi M, Asghari A (2018) Efficient and relatively safe emulsification microextraction using a deep eutectic solvent for influential enrichment of trace main anti-depressant drugs from complicated samples. *J Chromatogr B* 1072:50–59. <https://doi.org/10.1016/j.jchromb.2017.09.042>
- Mohebbi A, Yaripour S, Farajzadeh MA, Afshar Mogaddam MR (2018) Combination of dispersive solid phase extraction and deep eutectic solvent–based air–assisted liquid–liquid microextraction followed by gas chromatography–mass spectrometry as an efficient analytical method for the quantification of some tricyclic antidepressant drugs in biological fluids. *J Chromatogr A* 1571:84–93. <https://doi.org/10.1016/j.chroma.2018.08.022>
- Moura L, Moufawad T, Ferreira M, Bricout H, Tilloy S, Monflier E, Costa Gomes MF, Landy D, Fourmentin S (2017) Deep eutectic solvents as green absorbents of volatile organic pollutants. *Environ Chem Lett* 15(4):747–753. <https://doi.org/10.1007/s10311-017-0654-y>
- Mouratoglou E, Malliou V, Makris DP (2016) Novel glycerol-based natural eutectic mixtures and their efficiency in the ultrasound-assisted extraction of antioxidant polyphenols from agri-food waste biomass. *Waste Biomass Valoriz* 7(6):1377–1387. <https://doi.org/10.1007/s12649-016-9539-8>
- Nakhle L, Kfoury M, Mallard I, Landy D, Greige-Gerges H (2021) Methods for extraction of bioactive compounds from plant and animal matter using deep eutectic solvents. In: Fourmentin S, Costa Gomes M, Lichtfouse E (eds) *Deep eutectic solvents for medicine gas solubilization and extraction of natural substances*. Springer, Cham, pp 183–240
- Nam MW, Zhao J, Lee MS, Jeong JH, Lee J (2015) Enhanced extraction of bioactive natural products using tailor-made deep eutectic solvents: application to flavonoid extraction from *Flos sophorae*. *Green Chem* 17(3):1718–1727. <https://doi.org/10.1039/C4GC01556H>
- Ojeda CB, Rojas FS (2018) Vortex-assisted liquid–liquid microextraction (VALLME): the latest applications. *Chromatographia* 81(1):89–103. <https://doi.org/10.1007/s10337-017-3403-2>
- Okenicová L, Žemberyová M, Procházková S (2016) Biosorbents for solid-phase extraction of toxic elements in waters. *Environ Chem Lett* 14(1):67–77. <https://doi.org/10.1007/s10311-015-0539-x>
- Oller-Ruiz A, Garrido I, Viñas P, Campillo N, Fenoll J, Hernández-Córdoba M (2018) Reliable analysis of chlorophenoxy herbicides in soil and water by magnetic solid phase extraction and liquid chromatography. *Environ Chem Lett* 16(3):1077–1082. <https://doi.org/10.1007/s10311-018-0725-8>
- Pedersen-Bjergaard S, Rasmussen KE (1999) Liquid–liquid–liquid microextraction for sample preparation of biological fluids prior to capillary electrophoresis. *Anal Chem* 71(14):2650–2656. <https://doi.org/10.1021/ac990055n>
- Peng F, Xu P, Zhao B-Y, Zong M-H, Lou W-Y (2018) The application of deep eutectic solvent on the extraction and in vitro antioxidant activity of rutin from *Sophora japonica* bud. *J Food Sci Technol* 55(6):2326–2333. <https://doi.org/10.1007/s13197-018-3151-9>
- Picó Y, Fernández M, Ruiz MJ, Font G (2007) Current trends in solid-phase-based extraction techniques for the determination of pesticides in food and environment. *J Biochem Biophys Methods* 70(2):117–131. <https://doi.org/10.1016/j.jbbm.2006.10.010>
- Qi X-L, Peng X, Huang Y-Y, Li L, Wei Z-F, Zu Y-G, Fu Y-J (2015) Green and efficient extraction of bioactive flavonoids from *Equisetum palustre* L. by deep eutectic solvents-based negative pressure cavitation method combined with macroporous resin enrichment. *Ind Crops Prod* 70:142–148. <https://doi.org/10.1016/j.indcrop.2015.03.026>
- Radošević K, Čurko N, Gaurina Srček V, Cvjetko Bubalo M, Tomašević M, Kovačević Ganić K, Radojčić Redovniković I (2016) Natural deep eutectic solvents as beneficial extractants for enhancement of plant extracts bioactivity. *LWT* 73:45–51. <https://doi.org/10.1016/j.lwt.2016.05.037>
- Rezaee M, Assadi Y, Milani Hosseini M-R, Aghaee E, Ahmadi F, Berijani S (2006) Determination of organic compounds in water using dispersive liquid–liquid microextraction. *J Chromatogr A* 1116(1–2):1–9. <https://doi.org/10.1016/j.chroma.2006.03.007>
- Ribeiro AR, Gonçalves VMF, Maia AS, Ribeiro C, Castro PML, Tiritan ME (2015) Dispersive liquid–liquid microextraction and HPLC to analyse fluoxetine and metoprolol enantiomers in wastewaters. *Environ Chem Lett* 13(2):203–210. <https://doi.org/10.1007/s10311-015-0498-2>
- Saravana PS, Cho Y-N, Woo H-C, Chun B-S (2018) Green and efficient extraction of polysaccharides from brown seaweed by adding deep eutectic solvent in subcritical water hydrolysis. *J Clean Prod* 198:1474–1484. <https://doi.org/10.1016/j.jclepro.2018.07.151>
- Tan T, Zhang M, Wan Y, Qiu H (2016) Utilization of deep eutectic solvents as novel mobile phase additives for improving the separation of bioactive quaternary alkaloids. *Talanta* 149:85–90. <https://doi.org/10.1016/j.talanta.2015.11.041>
- Tang B, Bi W, Zhang H, Row KH (2014) Deep eutectic solvent-based HS-SME coupled with GC for the analysis of bioactive terpenoids in *Chamaecyparis obtusa* leaves. *Chromatographia* 77(3–4):373–377. <https://doi.org/10.1007/s10337-013-2607-3>
- van Osch DJGP, Zubeir LF, van den Bruinhorst A, Rocha MAA, Kroon MC (2015) Hydrophobic deep eutectic solvents as water-immiscible extractants. *Green Chem* 17(9):4518–4521. <https://doi.org/10.1039/C5GC01451D>
- Vanda H, Dai Y, Wilson EG, Verpoorte R, Choi YH (2018) Green solvents from ionic liquids and deep eutectic solvents to natural deep eutectic solvents. *C R Chim* 21(6):628–638. <https://doi.org/10.1016/j.crci.2018.04.002>

- Wahaibi IA, Wahaibi YA, Hajri RA, Jibril B, Shuwa S (2019) The novel use of malonic acid-based deep eutectic solvents for enhancing heavy oil recovery. *Int J Oil Gas Coal Technol* 20(1):31. <https://doi.org/10.1504/IJOGCT.2019.096493>
- Wang H, Ma X, Cheng Q, Xi X, Zhang L (2018) Deep eutectic solvent-based microwave-assisted extraction of baicalin from *Scutellaria baicalensis* Georgi. *J Chem* 2018:1–10. <https://doi.org/10.1155/2018/9579872>
- Wang M, Wang J, Zhang Y, Xia Q, Bi W, Yang X, Chen DDY (2016) Fast environment-friendly ball mill-assisted deep eutectic solvent-based extraction of natural products. *J Chromatogr A* 1443:262–266. <https://doi.org/10.1016/j.chroma.2016.03.061>
- Wang W, Du Y, Xiao Z, Li Y, Li B, Yang G (2017) Determination of trace Rhodamine B in chili oil by deep eutectic solvent extraction and an ultra high-performance liquid chromatograph equipped with a fluorescence detector. *Anal Sci* 33(6):715–717. <https://doi.org/10.2116/analsci.33.715>
- Wei Z-F, Wang X-Q, Peng X, Wang W, Zhao C-J, Zu Y-G, Fu Y-J (2015) Fast and green extraction and separation of main bioactive flavonoids from *Radix Scutellariae*. *Ind Crops Prod* 63:175–181. <https://doi.org/10.1016/j.indcrop.2014.10.013>
- Xu K, Wang Y, Ding X, Huang Y, Li N, Wen Q (2016a) Magnetic solid-phase extraction of protein with deep eutectic solvent immobilized magnetic graphene oxide nanoparticles. *Talanta* 148:153–162. <https://doi.org/10.1016/j.talanta.2015.10.079>
- Xu K, Wang Y, Huang Y, Li N, Wen Q (2015) A green deep eutectic solvent-based aqueous two-phase system for protein extracting. *Anal Chim Acta* 864:9–20. <https://doi.org/10.1016/j.aca.2015.01.026>
- Xu K, Wang Y, Li Y, Lin Y, Zhang H, Zhou Y (2016b) A novel poly(deep eutectic solvent)-based magnetic silica composite for solid-phase extraction of trypsin. *Anal Chim Acta* 946:64–72. <https://doi.org/10.1016/j.aca.2016.10.021>
- Yilmaz E, Soylak M (2018) A novel and simple deep eutectic solvent based liquid phase microextraction method for rhodamine B in cosmetic products and water samples prior to its spectrophotometric determination. *Spectrochim Acta Part A Mol Biomol Spectrosc* 202:81–86. <https://doi.org/10.1016/j.saa.2018.04.073>
- Yousefi SM, Shemirani F, Ghorbanian SA (2018) Enhanced headspace single drop microextraction method using deep eutectic solvent based magnetic bucky gels: application to the determination of volatile aromatic hydrocarbons in water and urine samples. *J Sep Sci* 41(4):966–974. <https://doi.org/10.1002/jssc.201700807>
- Zeng H, Qiao K, Li X, Yang M, Zhang S, Lu R, Li J, Gao H, Zhou W (2017) Dispersive liquid-liquid microextraction based on the solidification of deep eutectic solvent for the determination of benzoylureas in environmental water samples. *J Sep Sci* 40(23):4563–4570. <https://doi.org/10.1002/jssc.201700890>
- Zeng Q, Wang Y, Huang Y, Ding X, Chen J, Xu K (2014) Deep eutectic solvents as novel extraction media for protein partitioning. *Analyst* 139(10):2565. <https://doi.org/10.1039/c3an02235h>
- Zhang H, Wang Y, Zhou Y, Chen J, Wei X, Xu P (2018) Aqueous biphasic systems formed by deep eutectic solvent and new-type salts for the high-performance extraction of pigments. *Talanta* 181:210–216. <https://doi.org/10.1016/j.talanta.2018.01.014>
- Zhang L, Wang M (2017) Optimization of deep eutectic solvent-based ultrasound-assisted extraction of polysaccharides from *Dioscorea opposita* Thunb. *Int J Biol Macromol* 95:675–681. <https://doi.org/10.1016/j.ijbiomac.2016.11.096>
- Zhang Q, De Oliveira Vigier K, Royer S, Jérôme F (2012) Deep eutectic solvents: syntheses, properties and applications. *Chem Soc Rev* 41(21):7108. <https://doi.org/10.1039/c2cs35178a>
- Zhou P, Wang X, Liu P, Huang J, Wang C, Pan M, Kuang Z (2018) Enhanced phenolic compounds extraction from *Morus alba* L. leaves by deep eutectic solvents combined with ultrasonic-assisted extraction. *Ind Crops Prod* 120:147–154. <https://doi.org/10.1016/j.indcrop.2018.04.071>

Publisher's Note Springer Nature remains neutral with regard to jurisdictional claims in published maps and institutional affiliations.

CHAPITRE 3

Application des solvants eutectiques profonds dans les techniques de microextraction des molécules naturelles

Introduction

Notre étude bibliographique sur les extractions des molécules naturelles par les DESs a été plus largement développée dans un chapitre publié dans '*Environmental chemistry for a Sustainable world*', et intitulé '*Methods for extraction of bioactive compounds from plant and animal matter using deep eutectic solvents*'.

Ce chapitre met l'accent sur les différentes techniques de microextraction qui utilisent les DESs comme solvants d'extraction de molécules naturelles, principalement les méthodes de microextraction en phase liquide-liquide (microextraction sur une goutte, microextraction liquide-liquide assistée par fibre creuse, microextraction dispersive liquide-liquide, microextraction en eau subcritique, microextraction à deux phases aqueuses, etc.), les méthodes de microextraction ultrasonique, les méthodes de microextraction assistées par micro-ondes, les méthodes de microextraction par vortex, les méthodes de microextraction par chauffage et sous agitation et les méthodes de microextraction en phase solide (microextraction assistée par broyeur à boulets, microextraction magnétique en phase solide, microextraction en phase solide par pointes de micropipette, etc.). De plus, les combinaisons récentes de différentes techniques de microextraction utilisant les DESs dans les procédés d'extraction sont également passées en revue. Ce chapitre examine également les avantages et les inconvénients de ces méthodes de microextraction en les comparant aux méthodes d'extraction conventionnelles. De plus, les avantages et inconvénients de l'utilisation des DESs par rapport aux solvants organiques conventionnels sont discutés.

Aussi, les effets des propriétés physico-chimiques des DESs sur l'efficacité d'extraction ont été discutés en détail. L'influence des paramètres de la méthode de microextraction choisie y compris le type du DES, le rapport volumique de l'échantillon par rapport au DES (v/v), l'effet des ions de la matrice, le type d'agent émulsifiant, la température, la durée d'extraction et l'agitation sur les capacités d'extraction ont été reportés.

Ce chapitre révèle le potentiel applicatif des DESs dans les techniques d'extraction : applications qui pourraient faire suite à la mise en évidence du pouvoir de solubilisation des solutions DES:eau:CD formulées dans cette thèse.

Chapter 6

Methods for Extraction of Bioactive Compounds from Plant and Animal Matter Using Deep Eutectic Solvents



Lamia Nakhle, Miriana Kfoury, Isabelle Mallard, David Landy,
and H el ene Greige-Gerges

Contents

6.1	Introduction.....	184
6.2	Microextraction Techniques: Description and Application with Deep Eutectic Solvents.....	186
6.2.1	Liquid-Phase Microextraction.....	187
6.2.2	Ultrasound Microextraction.....	197
6.2.3	Microwave Extraction.....	198
6.2.4	Vortex Extraction.....	199
6.2.5	Heating and Stirring.....	204
6.2.6	Solid-Phase Microextraction.....	205
6.2.7	Combined Extraction Techniques.....	216
6.3	Influence of Deep Eutectic Solvent Properties on the Extraction Efficiency.....	224
6.3.1	Melting Point.....	224
6.3.2	Density.....	224
6.3.3	Viscosity.....	225
6.3.4	Compatibility with Instrumental Detection Systems.....	227
6.3.5	Surface Tension.....	227

L. Nakhle

Bioactive Molecules Research Laboratory, Faculty of Sciences, Lebanese University,
Jdaidet el-Matn, Lebanon

Unit  de Chimie Environnementale et Interactions sur le Vivant (UCEIV, UR 4492), SFR
Condorcet FR CNRS 3417, Universit  du Littoral C te d'Opale (ULCO), Dunkerque, France
e-mail: lamia.nakhle@univ-littoral.fr

M. Kfoury · H. Greige-Gerges (✉)

Bioactive Molecules Research Laboratory, Faculty of Sciences, Lebanese University,
Jdaidet el-Matn, Lebanon
e-mail: hgreige@ul.edu.lb

I. Mallard · D. Landy

Unit  de Chimie Environnementale et Interactions sur le Vivant (UCEIV, UR 4492), SFR
Condorcet FR CNRS 3417, Universit  du Littoral C te d'Opale (ULCO), Dunkerque, France
e-mail: isabelle.mallard@univ-littoral.fr; david.landy@univ-littoral.fr

  The Editor(s) (if applicable) and The Author(s), under exclusive license to
Springer Nature Switzerland AG 2021

S. Fourmentin et al. (eds.), *Deep Eutectic Solvents for Medicine, Gas Solubilization and Extraction of Natural Substances*, Environmental Chemistry for a Sustainable World 56, https://doi.org/10.1007/978-3-030-53069-3_6

183

6.3.6	Polarity and Solubilizing Properties.....	228
6.3.7	pH.....	229
6.3.8	Cell Disruption Ability.....	229
6.4	Optimization of Extraction Parameters.....	230
6.4.1	Type of Extraction Solvent.....	230
6.4.2	Sample to Deep Eutectic Solvent Volume Ratio (V/V) Optimization.....	230
6.4.3	Matrix Ions.....	230
6.4.4	Type of Emulsifier Agent.....	232
6.4.5	Temperature.....	232
6.4.6	Time.....	232
6.4.7	Agitation or Vortexing.....	233
6.5	Conclusion.....	233
	References.....	233

Abstract Nowadays, scientists are going through developing more eco-friendly analysis methods of simple and complex samples that follow the principles of “green chemistry.” One of the followed strategies is by replacing the toxic conventional organic solvents used in the extraction by a new generation of solvents called “deep eutectic solvent” or “natural deep eutectic solvent.” These solvents are formed between two or more cheap nontoxic components via hydrogen bonds. This review presents the various extraction methods that use deep eutectic solvents as extraction solvents, mainly the liquid-liquid-phase microextraction methods, solid-phase microextraction methods, and the newly combined techniques. In addition, the advantages and drawbacks of using these green solvents in comparison to the conventional organic solvents used in conventional extraction methods are discussed. It was observed that, with all reported extractions, deep eutectic solvents showed better extraction efficiency and higher recovery values for the studied natural target analytes compared to water and lots of conventional organic solvents. For the protein extraction, these solvents showed around 93–99% extraction efficiency. In addition, new types of deep eutectic solvents, like the ternary deep eutectic solvent molecularly imprinted polymer, were synthesized, improving the solvent characteristics; therefore, lower volume of the solvent was used with shorter extraction time.

Keywords Bioactive compounds · Combined extraction techniques · Deep eutectic solvents · Green chemistry · Imprinted polymer · Liquid-liquid-phase microextraction · Optimization · Physicochemical properties · Proteins · Solid-phase microextraction

6.1 Introduction

Nowadays, pharmaceutical industries intend to replace the synthesized chemo-based or semi-chemo-based active molecules used in the drug formulations with bio-based active molecules present in environmental and biological matrices in order to reduce undesirable side effects (de Cássia da Silveira e Sá et al. 2014).

Regardless of their pharmaceutical applications, natural bioactive molecules are also used in the production of agrochemicals, nutraceuticals, cosmetics, etc. They are mainly found in plant materials as secondary metabolites (Azmir et al. 2013).

On the other hand, proteins are important biomacromolecules because they are considered as multifunctional biomaterials. Therefore, extraction and purification of proteins became very interesting for biotechnology industry and for proteins applications in fields of research and pharmaceuticals (Huang et al. 2015; Xu et al. 2016a, b).

At the same time, direct determination of the analytes in drug and food formulations, or in blood and urine samples, is difficult because of the complexity of the sample and their presence in very small quantity (Yilmaz and Soylak 2018). Therefore, developing an extraction method, for the valuable compounds, from their original matrix into an adequate solvent is the first critical step in the analytical method because it prepares this sample for a further sensitive and selective quantitative analysis (Rezaee et al. 2006). Hence, it is necessary that the developed extraction method follows the 12 principles of the green chemistry (Anastas and Eghbali 2010). In addition, the extraction method should be time-saving, cheap, and reveal a high yield.

Several conventional separation techniques are available such as liquid-liquid extraction, solid-phase extraction, coprecipitation, as well as many exhaustive extraction methods (maceration, steam or hydro-distillation, pressing, decoction, infusion, percolation, and Soxhlet extraction) (Chemat et al. 2012; Yilmaz and Soylak 2018). Despite being expensive, labor-intensive, and time-consuming, these techniques were always associated with a certain degree of toxicity due to the large volume of toxic organic solvents used (Alfonsi et al. 2008; Zhuang et al. 2017; Mohebbi et al. 2018).

Since 1998, ionic liquids have gained much attention to be used as alternative to organic solvents due to their low vapor pressure and variable viscosities (Khataei et al. 2018). However, compared to organic solvents, most ionic liquids are more costly and difficult to prepare. Also they could have a toxic impact on the environment (Gu et al. 2014).

New solvents, so-called deep eutectic solvents, were developed by Abbott since 2003 (Abbott et al. 2003). These solvents are composed of two or more cheap non-toxic components, one of them with the capacity to be a hydrogen bond acceptor, while the other possesses the properties of a hydrogen bond donor (Florindo et al. 2014; Cvjetko et al. 2016; Moura et al. 2017). Due to the formation of intramolecular hydrogen bonds and Van der Waals interactions, these solvents have much lower melting point than that of its individual components (Abbott et al. 2004; Moura et al. 2017).

Natural deep eutectic solvents are prepared from natural metabolites produced by cell metabolism; therefore, they have been synthesized using simple molecules present in living cells such as urea, alcohols, organic acids, amines, amino acids, sugars, choline, and even water (Vanda et al. 2018). Normally, the hydrogen bond acceptor is an ammonium chloride or an amino acid, while the hydrogen bond donor is an organic acid or a carbohydrate (Choi et al. 2011; Dai et al. 2014).

Deep eutectic solvents and natural deep eutectic solvents are known for their various properties: low vapor pressure, nonflammability, high thermal stability, and low thermal conductivity (Nam et al. 2015; Radošević et al. 2016; Ruesgas-Ramón et al. 2017; Moura et al. 2017; Khataei et al. 2018). Deep eutectic solvents are generally hydrophilic; the first hydrophobic one, synthesized from decanoic acid and quaternary ammonium salts, was used for the extraction of volatile fatty acids from aqueous solutions (van Osch et al. 2015). These solvents are considered “green” and excellent alternatives to conventional and nonconventional organic solvents, being effective to extract hydrophilic and hydrophobic compounds (Tang et al. 2014).

New techniques miniaturizing solid-phase extraction or liquid-liquid extraction have arisen such as solid-phase microextraction and liquid-phase microextraction, respectively (Hawthorne et al. 1992; Pedersen-Bjergaard and Rasmussen 1999). These techniques are characterized by using low amounts of sample matrices and small volumes of organic solvents. They are recently recommended because they offer many advantages such as high degree of concentration and minimized extraction time and energy consumption (Aydin et al. 2018). The application of these solvents in these techniques will be discussed later on.

This chapter presents an emphasis on the extraction techniques that used deep eutectic solvents as extraction solvents. Also, the effects of their properties and of the method parameters on the extraction efficiency are discussed. This review examines additionally the advantages and drawbacks of each extraction method. Moreover, the recent combinations of different extraction techniques using deep eutectic solvents in extraction processes are also reviewed.

6.2 Microextraction Techniques: Description and Application with Deep Eutectic Solvents

Liquid-liquid extraction and solid-phase extraction techniques were first introduced in the early 1970s. Liquid-liquid extraction involves adding a solvent to the sample that is immiscible, followed by a selective partitioning of analytes between the two phases. Solid-phase extraction technique consists on passing aqueous samples through a solid sorbent where the analytes will be retained (Okenicová et al. 2016). Therefore, the selection of an appropriate sorbent is very important. This technique is considered better than liquid-liquid extraction because it reduces and even eliminates the use of toxic and inflammable solvents, thus becoming more environmentally friendly (Picó et al. 2007; Ince et al. 2010).

Since then, extraction techniques trends in analytical chemistry have been focusing toward less organic solvent consumption, faster extraction time, automation, and improved quantification, which includes higher recoveries, better reproducibility, and lower method detection limits. That led to the invention of small-scale miniaturizing versions of liquid-liquid extraction and solid-phase extraction techniques: the liquid-phase microextraction and solid-phase microextraction techniques, respectively (Raynie 2004). In this part of the chapter, different types of

liquid-phase microextraction and solid-phase microextraction techniques will be described, and their applications using deep eutectic solvents as extraction solvents will be presented.

6.2.1 *Liquid-Phase Microextraction*

In the liquid-phase microextraction techniques, the sample solution containing the target analyte is designated as the donor phase and the extraction solvent as the acceptor phase. These techniques consist on adding few microliters of the solvent into the aqueous sample followed by the collection of the extraction solvent containing the target analytes (Yilmaz and Soylak 2018). Different liquid-phase microextraction techniques exist such as single-drop microextraction, hollow-fiber liquid-phase microextraction, and dispersive liquid-liquid microextraction.

Single-Drop Microextraction

This method consists of a solvent drop suspended at the end of the needle of a microsyringe. Single-drop microextraction can be distinguished in two different techniques: headspace single-drop microextraction or direct immersion single-drop microextraction. Figure 6.1 presents schematically these two techniques.

Headspace single-drop microextraction is applied for the extraction of volatile or semi-volatile compounds from a complex matrix because the suspended solvent drop is exposed only to the headspace of the sample. Table 6.1 presents examples of extractions processes via the headspace single-drop microextraction technique using deep eutectic solvents as extraction solvents.

Tang et al. (2014) applied headspace single-drop microextraction method to extract terpenoids using the optimal deep eutectic solvent choline chloride/ethylene glycol (1:4 molar ratio) because it showed the best extraction efficiency. This method showed a pronounced advantage compared to other conventional methods (ultrasonication and heat reflux extraction) using methanol as extraction solvent (Tang et al. 2014). Also, Yousefi et al. (2018) validated the efficacy of this method in the extraction of aromatic hydrocarbons using a new type of hydrophobic deep eutectic solvent-magnetic bucky gel. The solvent drop was formed by mixing the optimal deep eutectic solvent (choline chloride/chlorophenol 1:2 molar ratio) with magnetic multiwalled carbon nanotubes. This mixture made the solvent drop more stable. Therefore, the heating temperature and the stirring rates were increased, which allowed to decrease the extraction time (Yousefi et al. 2018).

Direct immersion single-drop microextraction is applied for the extraction of nonvolatile compounds and polar analytes. Herein, the acceptor solvent should be immiscible with the donor phase as the solvent drop is immersed in it. Gu et al. (2014) used this method for the extraction of phenolic compounds (phenol, *p*-cresol, and β -naphthol) from crude oils with 10 μ L of choline chloride/ethylene glycol (1:3

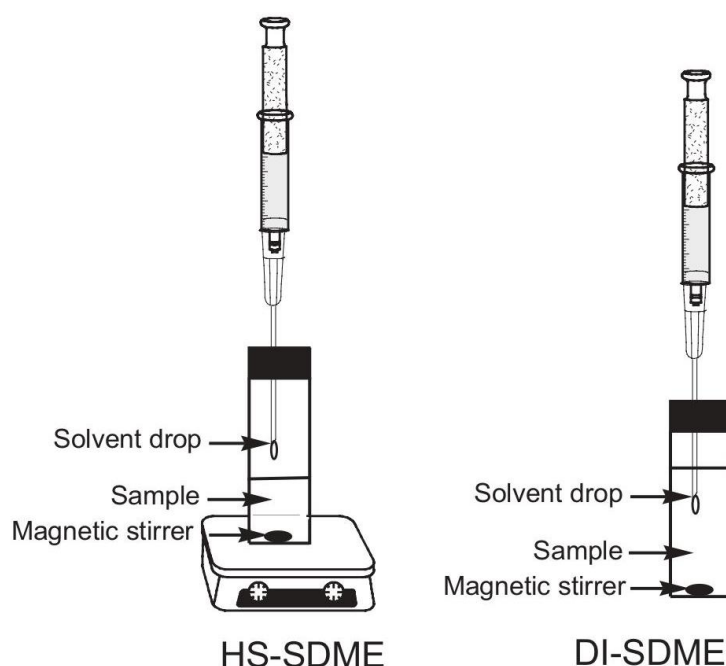

Fig. 6.1 Headspace single-drop microextraction technique (HS-SDME), where the solvent drop is exposed to the headspace of the sample and is not in direct contact with the matrix. The solvent drop adsorbs the target compounds volatilized from the sample matrix heated and stirred for a specific time. Direct immersion single-drop microextraction technique (DI-SDME), where the solvent drop is immersed directly in the sample phase. After extraction, the solvent drop is retracted back into the microsyringe and analyzed

Table 6.1 Examples of the application of the headspace single-drop microextraction technique with deep eutectic solvents as extraction solvents

Extraction medium	Target compounds	DES: HBA/HBD (molar ratio)	References
<i>Chamaecyparis obtusa</i> leaves	Terpenoids: linalool, terpineol, and terpinyl acetate	Choline chloride/ethylene glycol (1:2, 1:3, 1:4, 1:5)	Tang et al. (2014)
Water samples close to gas station spots Morning urine samples from healthy gas station workers	Volatile aromatic hydrocarbons: benzene, toluene, ethylbenzene, and xylene isomers	Hydrophobic magnetic bucky gel formed by mixing each DES: choline chloride/phenol (1:2); choline chloride/chlorophenol (1:2), and choline chloride/resorcinol (1:2) with magnetic multiwalled carbon nanotubes	Yousefi et al. (2018)

DES deep eutectic solvent, HBA hydrogen bond acceptor, HBD hydrogen bond donor

molar ratio) deep eutectic solvent. Ultrasonication was also applied for obtaining a better yield because polar compounds are being extracted from nonpolar solutions. According to the authors, this solvent exhibited a better extraction than water or than the solutions of the individual components of the deep eutectic solvent (Gu et al. 2014).

Fig. 6.2 Hollow-fiber liquid-phase microextraction technique. Three phases are present: the first one is the biological sample or the donor phase containing the target analytes; this phase is stirred in a sample vial. The acceptor phase is the second phase located in the lumen of the membrane. The third phase separates the other two phases: a supported liquid membrane solvent (immiscible with the two other phases) designated as the extraction phase; it is located inside the pores of the fiber membrane

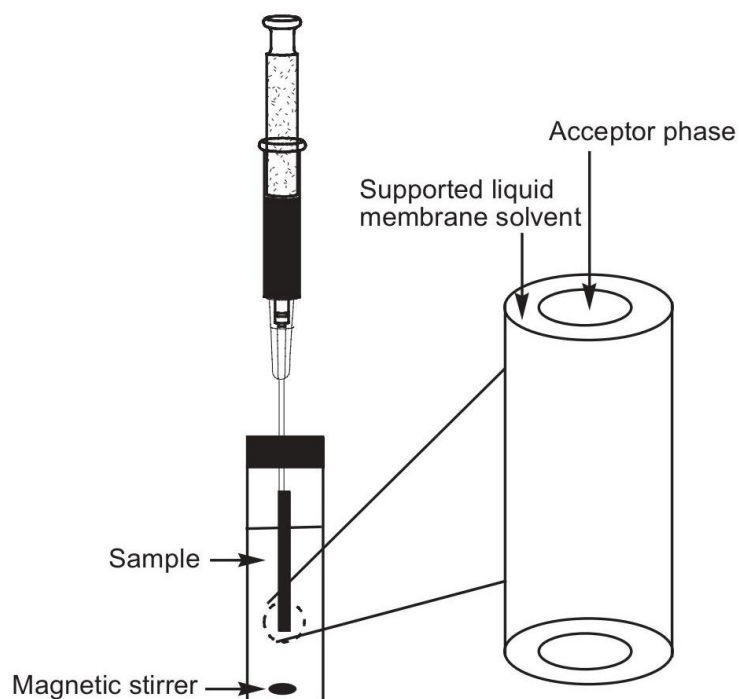

Hollow-Fiber Liquid-Phase Microextraction

Hollow-fiber liquid-phase microextraction constitutes another selective method, which can be used for the extraction of components from complicated biological fluids. Interestingly, this technique prevents the diffusion of large molecules from the donor to the acceptor phase (Khataei et al. 2018). This is due to the use of a porous polypropylene hollow-fiber membrane. The hollow-fiber liquid-phase microextraction consists of three phases presented in Fig. 6.2.

Hollow-fiber liquid-phase microextraction was used by Khataei et al. (2018) for the extraction of steroidal hormones (dydrogesterone and cyproterone acetate) from urine and plasma samples using methyltriphenylphosphonium iodide ($\text{Me}(\text{Ph})_3\text{PI}$)/ethylene glycol (1:4 molar ratio) plus 20% v/w methanol. n-Dodecane was used as the supported liquid membrane hydrophobic solvent. Compared to other extraction techniques defined later on such as hybrid solid-phase extraction, solid-phase extraction, and hollow-fiber liquid-liquid-liquid microextraction, this technique has the simplest detection instrument, good limit of detection, and wider linear range in both plasma and urine matrices. In addition, clear chromatograms were obtained via this method (Khataei et al. 2018).

Dispersive Liquid-Liquid Microextraction Methods

Dispersive liquid-liquid microextractions are extraction techniques where small droplets of extraction solvent are formed and dispersed throughout the aqueous phase. In this way, the contact surface between both immiscible phases is increased.

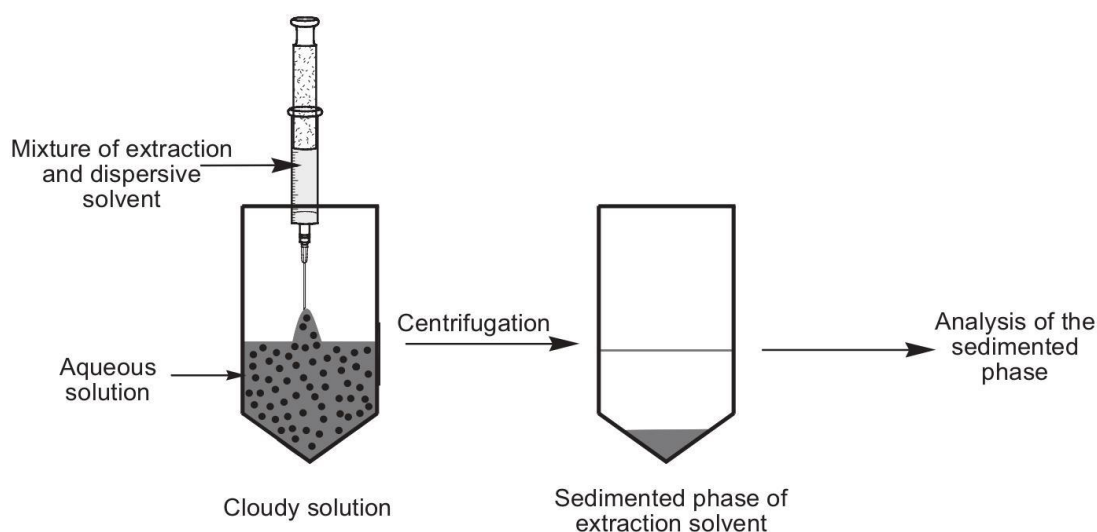

Fig. 6.3 Binary solvents-dispersive liquid-liquid microextraction method. The dispersion of the solvent droplets is done by the help of a dispersive solvent that is miscible in both aqueous and extraction phases. The extraction solvent phase is analyzed after centrifugation. (Figure modified from Jain et al. 2015)

After centrifugation, the deep eutectic solvent can be found in either the upper or the bottom phase of the tube depending on its density. Being simple, fast, and cheap, this method has been highly used (Ribeiro et al. 2015).

Figure 6.3 shows a schematic representation of binary solvents-dispersive liquid-liquid microextraction method where a dispersive solvent is used in order to disperse the solvent drops. When extracting benzoylureas, this method was tested using solidified deep eutectic solvent as extraction solvent (Zeng et al. 2017). Exceptionally, there was no need for a dispersive solvent, and this method presented the advantage of lower minimum detection value and higher enrichment factor than other techniques (dispersive liquid-liquid microextraction using ionic liquids or solidified ionic liquids, ultrasound-assisted hybrid ionic liquid-dispersive liquid-liquid microextraction, and solid-phase extraction using acetonitrile as extraction solvent) (Zeng et al. 2017).

In the gas-associated dispersive liquid-phase microextraction, the dispersing solvent is replaced by a gas. With air as gas, the method is called air-assisted dispersive liquid-phase microextraction or air-assisted emulsification liquid-liquid microextraction (Lamei et al. 2017; Ge et al. 2018). Figure 6.4 explains this technique schematically.

Table 6.2 presents examples of the application of dispersive liquid-liquid microextraction techniques with deep eutectic solvents as extraction solvents.

The linear ranges of this method, when extracting nine pesticides using deep eutectic solvent, were equivalent or wider than other extraction methods (solid-phase microextraction, vortex-assisted low-density solvent liquid-liquid microextraction, and salt-induced demulsification and sequential dispersive liquid-liquid microextraction). Also, higher extraction efficiencies were also observed (Farajzadeh et al. 2017).

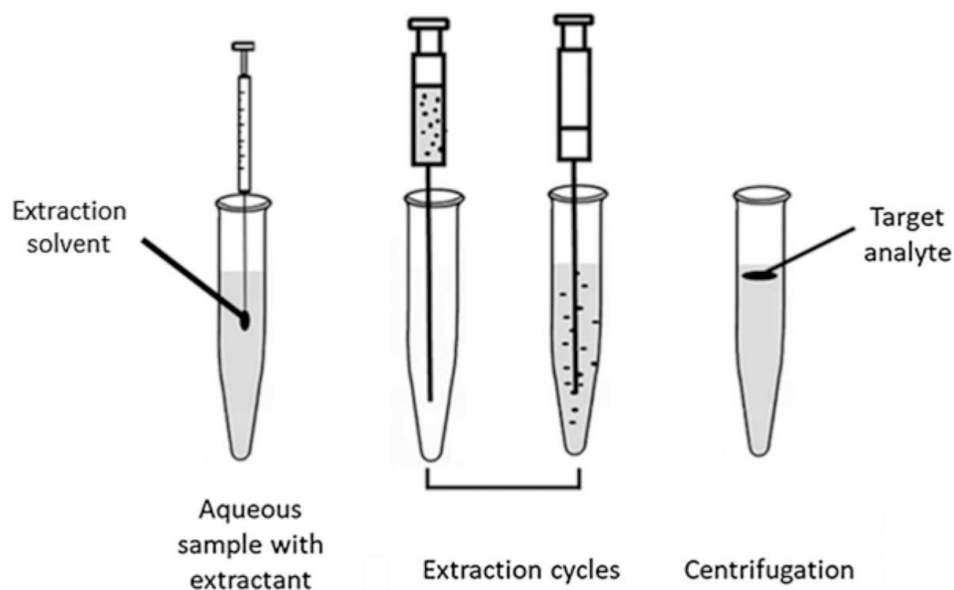

Fig. 6.4 Air-assisted dispersive liquid-phase microextraction method. This technique consists on multiple sucking and injecting processes via a syringe. At this stage, the target analytes are extracted into the fine droplets of the extraction solvent. (Figure modified from Yang et al. 2015)

Also, Moghadam et al. (2018) developed a similar microextraction procedure, air-agitated emulsification microextraction, based on a low-density deep eutectic solvent for the extraction of antidepressant drugs from human plasma samples and pharmaceutical wastewater samples by three types of deep eutectic solvents. Compared to other conventional techniques, this method proved its ability for accurate analysis of trace levels of drugs close to the therapeutic/toxic ranges (Moghadam et al. 2018).

For the extraction of rhodamine B, recoveries experiments showed a minimal efficacy of this method using the optimal deep eutectic solvent (97% extraction efficacy) compared to solid-phase extraction, magnetic solid-phase extraction methods, and magnetic stirring-assisted dispersive liquid-liquid microextraction using 1-octanol as extraction solvent (Yilmaz and Soylak 2018).

Dispersive liquid-liquid microextraction based on the solidified deep eutectic solvent method developed by Habibollahi et al. (2018) consists on the rapid addition of deep eutectic solvent (50 μL): 1-octyl-3-methylimidazolium chloride/1-undecanol (1:2 molar ratio) to the sample solution; this forms an emulsion. Next, NaCl was added to break the emulsion. After vortexing and centrifuging, the fine droplets of deep eutectic solvent were extracted from the upper phase and subjected finally to a graphite furnace atomic absorption spectrophotometry analysis. Compared to other techniques (wet digestion extraction, solid-phase extraction, cloud point extraction, persistent sample circulation microextraction, continuous sample drop flow-based microextraction, and dispersive liquid-liquid microextraction using solidified 1-undecanol organic solvent drop), this method, when extracting metals, offers a higher advantage because no disperser solvents are necessary, which prevents a decrease in the partition coefficients of the metals into the

Table 6.2 Examples of the application of dispersive liquid-liquid microextraction techniques with deep eutectic solvents as extraction solvents

Extraction medium	Target compounds	DES:HBA/HBD (molar ratio)	Remarks	References
Environmental waters	Benzoylureas: diflubenzuron, triflumuron, hexaflumuron, flufenoxuron, and lufenuron	1-octyl-2,3-dimethylimidazolium chloride/1-dodecanol (1:2), 1-decyl-3-methylimidazolium chloride/1-dodecanol (1:2), 1-decyl-2,3-dimethylimidazolium chloride/1-dodecanol (1:2), and 1-dodecyl-3-methylimidazolium chloride/1-dodecanol (1:2)	The optimal DES was 1-decyl-3-methylimidazolium chloride/1-dodecanol (1:2).	Zeng et al. (2017)
Vegetable oils: olive, soy, peanuts, corn, and sunflower oils	Oxypropylated phenylpropanoids: ferulic acid, umbelliferone, boropinic acid, 7-isopentenylloxycoumarin, 4'-geranylloxyferulic acid, and auraptene	Betaine/glycolic acid (1:2), betaine/phenylacetic acid (1:2), betaine/2-furoic acid (1:2), and betaine/S-(+)-mandelic acid (1:1)	Betaine/phenylacetic acid (1:2) was the selected DES. Isopropanol was used as dispersive solvent.	Ferrone et al. (2018)
Urine and blood samples	Methadone	Choline chloride/5,6,7,8-tetrahydro-5,5,8,8-tetramethylnaphthalen-2-ol (1:1, 1:2, and 1:3)	Optimal molar ratio of DES was 1:2. Tetrahydrofuran: emulsifier agent	Lamei et al. (2017)
Fruit and vegetable juices	Pesticides residues: penconazole, tebuconazole, diazinon, haloxyfop-R-methyl, hexaconazole, diniconazole, clodinafop-propargyl, bromopropylate, and fenazaquin	Choline chloride/4-chlorophenol (1:2)	Air was used as the dispersive agent.	Farajzadeh et al. (2017)
Environmental water samples	6-benzophenones	DL-menthol/octanoic acid (2:1, 1:1, and 1:2), DL-menthol/decanoic acid (2:1, 1:1, and 1:2), DL-menthol/dodecanoic acid (2:1, 1:1, and 1:2), tetrabutylammonium bromide/octanoic acid (1:1), tetrabutylammonium bromide/decanoic acid (1:1), tetrabutylammonium bromide/dodecanoic acid (1:1), tetrabutylammonium chloride/octanoic acid (1:1), tetrabutylammonium chloride/decanoic acid (1:1), and tetrabutylammonium chloride/dodecanoic acid (1:1)	DL-menthol/decanoic acid (1:1) was the best extraction solvent. Air was used to disperse DES in the solution.	Ge et al. (2018)

Human plasma and pharmaceutical wastewater samples	Antidepressant drugs: escitalopram, desipramine, and imipramine	Choline chloride/phenol (1:4), choline chloride/ethylene glycol (1:2), and choline chloride/urea (1:2)	Choline chloride/phenol (1:4) was the selected DES. Tetrahydrofuran was used to disperse DES in the solution.	Moghadam et al. (2018)
Cosmetic products (lipsticks, cologne, and acetone cleaning solution of nail polish samples), sea, and river water samples	Rhodamine B	Choline chloride/phenol (1:2), methyltriethylammonium chloride/decanoic acid (1:2), and tetrabutylammonium chloride/decanoic acid (1:2, 1:3, and 1:4)	Tetrabutylammonium chloride/decanoic acid (1:2) was the optimal DES. Tetrahydrofuran was used to disperse DES in the solution.	Yilmaz and Soy lak (2018)
Soil and vegetables: <i>Raphanus sativus</i> , <i>Spinacia oleracea</i> , <i>Coriandrum sativum</i> , and <i>Daucus carota</i>	Heavy metals: Pb, cd, and hg	1-decyl-2,3-dimethylimidazoliumchloride/1-undecanol (1:1, 1:2, 1:3, 2:5, 3:7), 1-octyl-2,3-dimethylimidazolium chloride/1-undecanol (1:1, 1:2, 1:3, 2:5, 3:7), 1-octyl-3-methylimidazolium chloride/1-undecanol (1:1, 1:2, 1:3, 2:5, 3:7), 1-dodecyl-3-methylimidazolium chloride/1-undecanol (1:1, 1:2, 1:3, 2:5, 3:7), and 1-decyl-3-methylimidazolium chloride/1-undecanol (1:1, 1:2, 1:3, 2:5, 3:7)	1-octyl-3-methylimidazolium chloride/1-undecanol (1:2) was the best DES. Diethyldithiophosphoric acid was used as a chelating agent.	Habibollah-i et al. (2018)

DES deep eutectic solvent, HBA hydrogen bond acceptor, HBD hydrogen bond donor

extraction solvent, hence reducing the environmental pollution. In addition, the used deep eutectic solvent showed high stability, low density, and a melting point near room temperature (Habibollahi et al. 2018).

Deep Eutectic Solvent-Based Subcritical Water Extraction

When increasing the temperature of water above its boiling point (between 100 and 374 °C) but keeping the pressure tuned for liquid state, subcritical water is obtained. At these conditions, water acts like an organic solvent that can dissolve a wide range of analytes of low polarities, hence presenting the advantage of using only water as the extraction solvent. New approaches on using deep eutectic solvent in a certain percentage with subcritical water are being reported. Nevertheless, one should underline the high amount of water added to the deep eutectic solvent (generally superior to 50% volume), thus questioning the remaining structure of the deep eutectic solvent. For example, Machmudah et al. (2018) tested the effect of the addition of 10–30% volume of deep eutectic solvent to pure water on the extraction of xanthone (Machmudah et al. 2018). Table 6.3 presents some examples of the application of subcritical water extraction technique with deep eutectic solvents as extraction solvents.

Saravana et al. (2018a, b) proved that the yield of polysaccharides obtained using the optimal deep eutectic solvent (choline chloride/glycerol (1:2 molar ratio) + 70% water) was at least twice of that obtained from a solution of HCl/water mixture, usually used to extract polysaccharides (Saravana et al. 2018a, b). Through adding 10–30% citric acid/alanine (1:1 molar ratio) deep eutectic solvent to water media, Machmudah et al. (2018) proved the efficacy of the resulting subcritical water extraction method to extract xanthenes. Accordingly, scanning electron microscope images showed the disruption of the surface of the pericarps of mangosteen after treatment by this method at high temperature. The formation of pores was obviously observed via the pronounced cleavage of intermolecular and intramolecular bonds in and/or between lignin, cellulose, and hemicellulose by deep eutectic solvent (Machmudah et al. 2018).

Deep Eutectic Solvent-Based Aqueous Two-Phase System

Such system is formed when two polymers, one polymer, and one salt or two salts are mixed in the presence of water, forming two distinct aqueous phases. K_2HPO_4 is the frequently used salt because it demonstrated a better phase-forming ability than other salts (for example, Na_2HPO_4 and KH_2PO_4) (Li et al. 2016). This technique is widely used to extract proteins. It prevents proteins denaturation and preserves their biological activity. Also, it is used for the extraction of genetic materials, drugs, cells, and organelles (Zeng et al. 2014; Li et al. 2016). The detailed process of the aqueous two-phase system is illustrated in Fig. 6.5.

Bovine serum albumin was chosen as a model protein. All tested deep eutectic solvent showed around 93–99% extraction efficiency of this protein (Li et al. 2016). In addition, the presence of relatively high salt concentration resulted in a competition between the salt ions and bovine serum albumin for water molecules. Due to the decrease of the amount of water required for the solubilization of the protein, the solubility of bovine serum albumin in the salt phase was tremendously decreased; this results in the increase of its concentration in the deep eutectic solvent phase. UV-Vis, FT-IR, and circular dichroism experiments showed no interaction and no interference between all deep eutectic solvents and bovine serum albumin and that the conformation of bovine serum albumin was maintained during extraction. The extraction process is mainly due to the aggregation of protein molecules that are expected to be surrounded by deep eutectic solvent. Dynamic light scattering experiments showed that before extraction, the particle sizes in deep eutectic solvent solution were around 615 nm and those of bovine serum albumin aqueous protein solution were around 4 nm, 18 nm, and 255 nm. After extraction, the size of the observed particles became about 5560 nm. Apparently, the size of this newly formed aggregate was greater than that of deep eutectic solvent particles and protein particles. Therefore, deep eutectic solvent-protein aggregate could be formed (Xu et al. 2015). Examples of the application of aqueous two-phase system technique with deep eutectic solvents as extraction solvents are presented in Table 6.4.

Li et al. (2016) used six betaine-based deep eutectic solvents differing by their hydrophilic property, viscosity, and density for the extraction of proteins. The extraction efficiency using the optimal deep eutectic solvent was higher than 99% as the bovine serum albumin band (66 kD), obtained by SDS-PAGE analysis, was present in the deep eutectic solvent-rich top phase but was not detectable in the bottom phase. This method was validated for accuracy, repeatability, and environment stability experiments investigated under the following optimized conditions

Table 6.3 Examples of the application of subcritical water extraction technique with deep eutectic solvents as extraction solvents

Extraction medium	Target compounds	DES: HBA/HBD (molar ratio)	References
Brown seaweed from <i>Saccharina japonica</i>	Polysaccharides: alginate and fucoidan	Choline chloride/1,2-propanediol (1:2), choline chloride/glycerol (1:2), choline chloride/ethylene glycol (1:2), choline chloride/1,3-butanediol (1:2), choline chloride/1,4-butanediol (1:2), choline chloride/urea (1:2), and choline chloride/propanedioic acid (1:2)	Saravana et al. (2018a, b)
Pericarps of mangosteen (<i>Garcinia mangostana</i> Linn)	Xanthones	Citric acid/alanine (1:1)	Machmudah et al. (2018)

DES deep eutectic solvent, HBA hydrogen bond acceptor, HBD hydrogen bond donor

(betaine/urea deep eutectic solvent (1.4 g)/K₂HPO₄ (0.75 g mL⁻¹, 2.0 mL)/bovine serum albumin (15 mg) and the separation time: 12 min).

Compared to polypropylene glycol-based aqueous biphasic system, the extraction efficiency of three hydrophobic dyes was enhanced with deep eutectic solvent. It was found that the more hydrophobic the pigment is, the more it is extracted in the deep eutectic solvent-rich phase (Zhang et al. 2018).

Deep Eutectic Solvent-Based Flow Method Liquid-Liquid Extraction: Stepwise Injection Analysis System

It is an automated extraction technique developed by Nugbienyo et al. (2017) (Fig. 6.6). The authors reported the extraction of antiarrhythmic agent procainamide from human saliva using choline chloride/glycerol at a 1:2 molar ratio. Acetonitrile, which will extract the other components present in the human saliva, is added because the deep eutectic solvent is water-miscible but insoluble in acetonitrile; therefore, separation of the two phases occurs at room temperature.

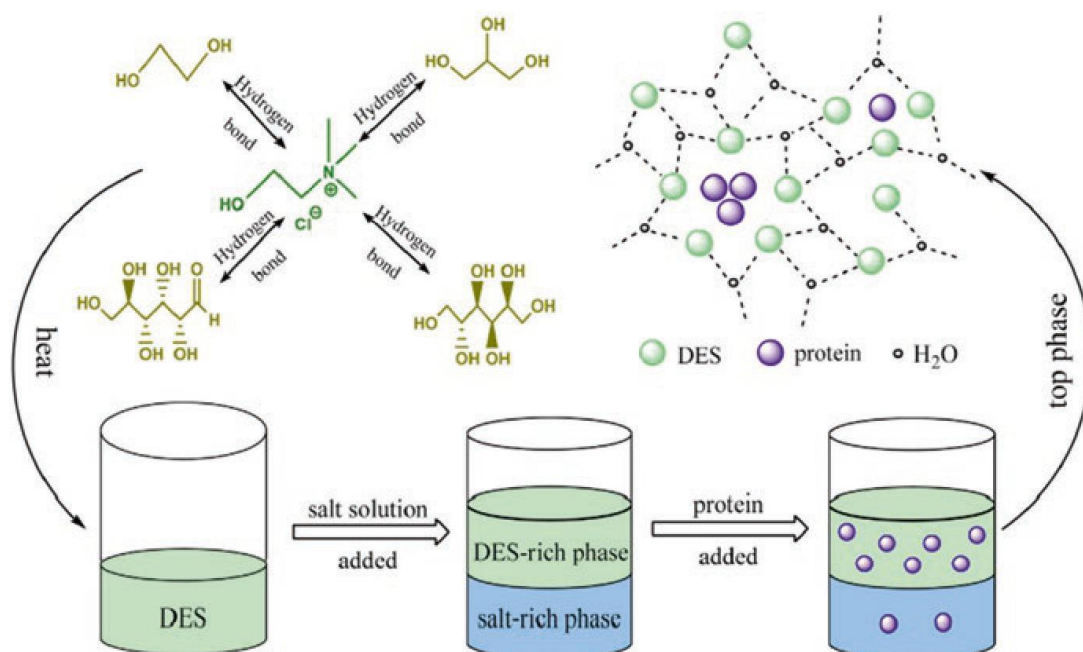

Fig. 6.5 Deep eutectic solvent (DES)-based aqueous two-phase system extraction method. Two aqueous phases are present in this technique: the DES-rich aqueous phase and the salt-rich aqueous phase. When these phase components are mixed above a certain salt critical concentration, they are separated into two unambiguous aqueous phases. It is then where the proteins present in the sample are partitioned between these two phases with a higher affinity for the DES-rich aqueous phase. (Figure reprinted with permission from Xu et al. 2015)

6.2.2 Ultrasound Microextraction

Ultrasound microextraction technique is performed under ultrasonic energy that increases the contact between the sample and the extraction solvent (Fig. 6.7).

Ultrasounds radiation can be applied via water baths or ultrasonic probes. Mainly, cavitation phenomenon is observed with the generation of bubbles, leading to increase in pressure and temperature. This allows the disruption of the cell walls, facilitating solvent penetration into the material and allowing the release of the target compounds (Chanioti and Tzia 2018). The extraction efficiency depends on different factors like ultrasonic conditions (temperature, amplitude, time) and sample features (matrix, amount, particle size) (Yilmaz and Soylak 2015; Huang et al. 2017; Bosiljkov et al. 2017; Zhou et al. 2018). Advantageously, no dispersive solvent is needed. This technique involves lower volume of deep eutectic solvent (<500 μ L) and shorter time of extraction (<15 min) than liquid-phase microextraction techniques (Bakirtzi et al. 2016; Khezeli et al. 2016; Mouratoglou et al. 2016). Examples of the application of ultrasound microextraction technique with deep eutectic solvents as extraction solvents are summarized in Table 6.5.

Similar or larger amounts of flavonoids were extracted using this method with deep eutectic solvent with relatively low cost, low vapor pressure, and low toxicity compared to other extraction methods (heating and stirring) using conventional organic solvents (Bi et al. 2013). Also, higher extraction yield of polysaccharides was obtained using this method in the optimized conditions in comparison to hot

Table 6.4 Examples of the application of aqueous two-phase system technique with deep eutectic solvents as extraction solvents

Extraction medium	Target compounds	DES:HBA/HBD (molar ratio)	Selected DES	References
Proteins mixture	Bovine serum albumin	Choline chloride/urea (1:2), tetramethylammonium chloride/urea (1:2), tetrapropylammonium bromide/urea (1:2), and choline chloride/methylurea (1:2)	Choline chloride/urea (1:2)	Zeng et al. (2014)
Proteins mixture	Bovine serum albumin	Choline chloride/ethylene glycol (1:2), choline chloride/glycerol (1:1), choline chloride/D-glucose (2:1), and choline chloride/D-sorbitol (1:1)	Choline chloride/glycerol (1:1)	Xu et al. (2015)
Proteins mixture and calf blood	Bovine serum albumin, tyrosine, and ovalbumin	Betaine/urea/water (1:2:1), betaine/methylurea/water (1:3:1), betaine/D-(+)-glucose/water (1:1:2), betaine/D-sorbitol/water (1:2:1), betaine/ethylene glycol (1:2), and betaine/glycerol (1:1)	Betaine/urea/water (1:2:1)	Li et al. (2016)
Three dyes	Amaranth, sunset yellow FCF, and Sudan III	Tetrabutylammonium bromide/polypropylene glycol 400 (1:2)		Zhang et al. (2018)

DES deep eutectic solvent, HBA hydrogen bond acceptor, HBD hydrogen bond donor

water extraction and water-based ultrasound extraction (Zhang and Wang 2017). Bajkacz and Adamek (2017) used natural deep eutectic solvent-based ultrasound microextraction procedure that provided high accuracy, sensitivity, and high extraction efficiency for the simultaneous analysis of four isoflavones. This method was faster in the addition of higher recoveries with lower relative standard deviation in comparison with the Soxhlet extraction and microwave extraction methods (Bajkacz and Adamek 2017). In addition, the extraction yield of wine lees anthocyanins was improved in comparison to alternative methods (stirring, heating, and heating+stirring) and to the extraction with conventional solvents (water, methanol, ethanol, 70% methanol, 70% ethanol) (Jeong et al. 2017).

6.2.3 Microwave Extraction

This technique uses the non-ionized electromagnetic irradiation in a frequency range of 0.3–300 GHz in order to heat both solvent and samples by movements of ions and rotation of molecular and atomic dipoles, leading to an increase in the extraction kinetics (Fig. 6.8). In addition to the method parameters, the extraction efficiency depends on the pressure, the radiation power and the sample composition. This method is known for many advantages: homogeneous heating, high speed, and high heat efficiency, which may be responsible for a high extraction efficiency and short extraction time (Cui et al. 2015; Peng et al. 2016; Wang et al. 2018). Examples

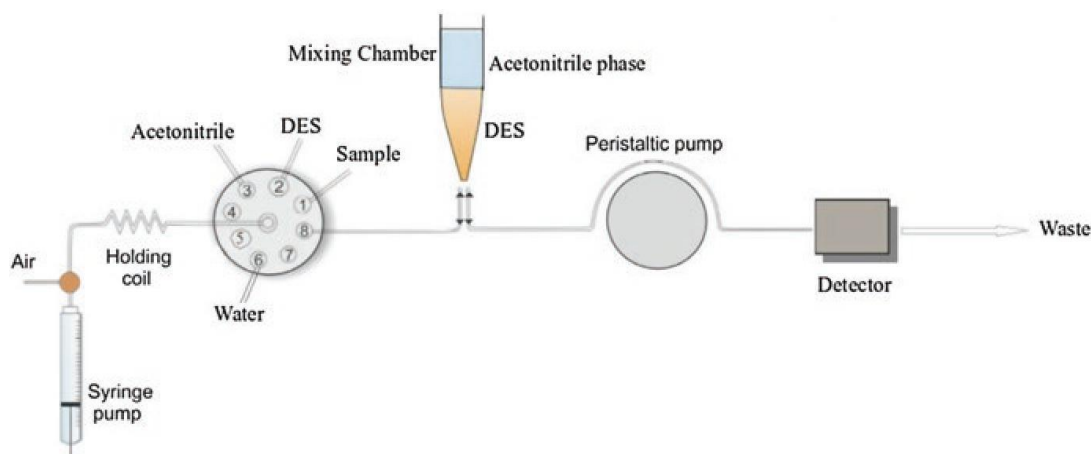

Fig. 6.6 The stepwise injection analysis manifold for the determination of procainamide in saliva. This method involves several steps: the first one includes the addition of a specific deep eutectic solvent (DES) to a sample (saliva, for instance), followed by formation of a homogeneous solution. The second step is the separation of the DES phase by the addition of acetonitrile at room temperature. In this step, the analyte is extracted into the DES phase, using air-bubbling to promote the extraction process and phase separation. All these steps are controlled by the movement of the syringe that introduces the different solutions. Finally, the bottom DES phase was moved into the flow cell for analysis. (Figure reprinted with permission from Nugbienyo et al. 2017)

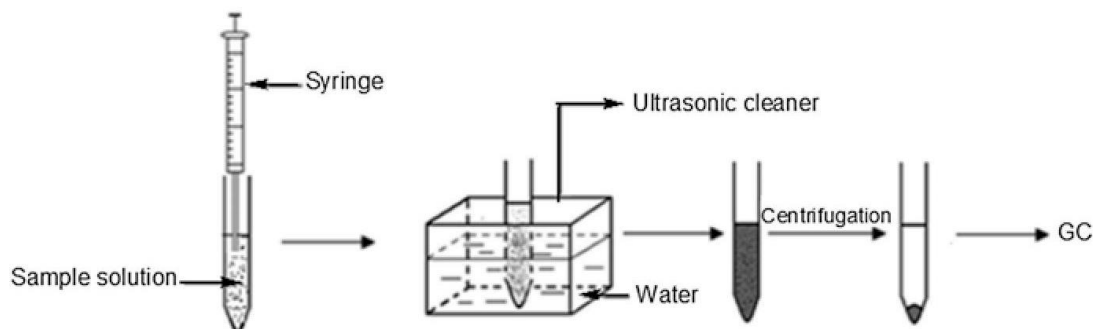

Fig. 6.7 Ultrasound microextraction method. Deep eutectic solvent is added to the powdered sample; the mixture is subjected to ultrasound in a bath followed by centrifugation, and then the deep eutectic solvent-rich phase is analyzed by gas chromatography (GC). (Figure modified from Yan et al. 2011)

of the application of microwave extraction technique with deep eutectic solvents as extraction solvents are listed in Table 6.6.

Comparing to other conventional techniques, microwave extraction was faster and allows the automation of the extraction, but it is more costly and demand cleanup steps (Chen et al. 2016). Also, it shows higher extraction efficiency using deep eutectic solvent than other conventional solvents. The maximum extraction yield of baicalin using deep eutectic solvent-based microwave extraction was slightly higher than the extraction by 70 vol% ethanol-based hot reflux-assisted extraction and higher than ultrasound extraction (Cvjetko Bubalo et al. 2016; Chanioti and Tzia 2018; Wang et al. 2018).

6.2.4 Vortex Extraction

This technique is a rapid microextraction technique. The suspension is subjected to mechanical stirring by a vortex stirrer, which further favors the dispersion of the donor phase in the aqueous phase. In this way, the analytes are extracted in the tiny droplets formed. Subsequently, the suspension is centrifuged to separate the two phases (González et al. 2018; Ojeda and Rojas 2018). This leads to a greater efficiency of the extraction procedure. Table 6.7 displays some examples of the application of vortex extraction technique with deep eutectic solvents as extraction solvents.

This process was pursued by García et al. (2016) for the extraction of phenolic compounds. An increase in the extraction yield of oleacein and oleocanthal of 20–33% and approximately 68%, respectively, was proved by extraction with the deep eutectic solvent with respect to the conventional solvent (80% methanol:water (v/v)) (García et al. 2016). Wang et al. (2017) explored the potency of deep eutectic solvent to extract and quantify rhodamine B. Its recovery value using deep eutectic solvent was 75% higher than in control experiments using water (10% recovery). Compared to methanol, deep eutectic solvent showed high selectivity for rhodamine

Table 6.5 Examples of the application of the ultrasound microextraction technique with deep eutectic solvents as extraction solvents

Extraction medium/ target compounds	DES:HBA/HBD (molar ratio)	Selected DES	References
Leave plants of <i>Chamaecyparis obtusa</i> / flavonoids: myricetin and amentoflavone	Choline chloride/ethylene glycol (1:2), choline chloride/glycerol (1:2), choline chloride/1,2-butanediol (1:2), choline chloride/1,3-butanediol (1:2), choline chloride/1,4-butanediol (1:2), choline chloride/2,3-butanediol (1:2), and choline chloride/1,6-hexanediol (1:2)	Choline chloride/1,4-butanediol (1:5) with 35 vol % of water	Bi et al. (2013)
Sheep, bovine, and chicken liver samples/ iron	Choline chloride/oxalic acid (1:1), choline chloride/ethylene glycol (1:1), choline chloride/glycerol (1:1), and choline chloride/lactic acid (1:1, 1:2, 1:1.5, 2:1)	Choline chloride/lactic acid (1:1) DES led to the best recovery (>95%) compared to the other DES.	Yilmaz and Soylak (2015)
Vegetable oil samples: olive, almond, sesame, and cinnamon/phenolic acids: ferulic, caffeic, and cinnamic acids	Choline chloride/ethylene glycol (1:2) and choline chloride/glycerol (1:2)	Choline chloride/ethylene glycol (1:2)	Khezeli et al. (2016)
Greek medicinal plants (dittany, fennel, marjoram, mint, and sage)/polyphenols	Choline chloride/L-lactic acid (1:3), sodium acetate/L-lactic acid (1:3), ammonium acetate/L-lactic acid (1:3), glycine/L-lactic acid (1:3), and water/glycine/L-lactic acid (3:1:3)	Natural deep eutectic solvent with 80% (v/v) water was better than natural deep eutectic solvent without water	Bakirtzi et al. (2016)
Agri-food waste biomass (lemon peels, olive leaves, onion solid wastes, red grape pomace, spent filter coffee, and wheat bran)/ polyphenols	Choline chloride/glycerol (1:3), sodium acetate/glycerol (1:3), and sodium potassium tartrate/glycerol/water (4:1:5 and 3:1:5)	Natural deep eutectic solvent tested was as 90% (v/v) in water	Mouratoglou et al. (2016)

(continued)

Table 6.5 (continued)

Extraction medium/ target compounds	DES:HBA/HBD (molar ratio)	Selected DES	References
Wine lees/anthocyanins	Choline chloride/citric acid, choline chloride/oxalic acid, choline chloride/malic acid, choline chloride/glucose, choline chloride/fructose, choline chloride/xylose, and choline chloride/glycerol (n.m.)	Choline chloride/malic acid. Also, it provided more effective extraction than ethanol	Bosiljkov et al. (2017)
Tartary buckwheat hull/ rutin	Choline chloride/1,2-propanediol (1:1), choline chloride/glycerol (1:1), choline chloride/glucose (2:5), choline chloride/sucrose (1:1), choline chloride/xylitol (1:2), choline chloride/sorbitol (2:5), glycerol/L-proline (3:1), glycerol/L-alanine (3:1), glycerol/glycine (3:1), glycerol/L-histidine (3:1), glycerol/L-threonine (3:1), glycerol/L-lysine (4.5:1), and glycerol/L-arginine (4.5:1)	Choline chloride/glycerol (1:1) (highest extraction efficiency 95%). Natural deep eutectic solvent exhibited 660–1577 times higher solubilization efficiency for rutin compared to water; the solubility of rutin in choline chloride-based natural deep eutectic solvent was higher than in glycerol-based natural deep eutectic solvent.	Huang et al. (2017)
Platycladi Cacumen: Chinese herbal medicine/flavonoids glycosides (myricetin and quercetin), and aglycones (amentoflavone and hinokiflavone)	Choline chloride/levulinic acid (1:2), choline chloride/ethylene glycol (1:2), choline chloride/dimethylurea (1:1), choline chloride/glucose (1:1), betaine/levulinic acid (1:2), betaine/ethylene glycol (1:2), betaine/methylurea (1:1), betaine/glucose (1:1), proline/levulinic acid (1:2), proline/glycerol (1:2.5), proline/acetamide (1:1), and proline/glucose (1:1)	Choline chloride/levulinic acid in 75% water	Zhuang et al. (2017)
<i>Dioscorea opposita</i> Thunb (Chinese yam) / polysaccharides	Choline chloride/ethylene glycol, choline chloride/glycerol, choline chloride/1,4-butanediol, and choline chloride/1,6-hexanediol (n.m.)	Choline chloride/1,4-butanediol (1:4 molar ratio) with 30% (v/v) water	Zhang and Wang (2017)

(continued)

Table 6.5 (continued)

Extraction medium/ target compounds	DES:HBA/HBD (molar ratio)	Selected DES	References
Soy-food products (soybeans, flour, pasta, breakfast cereals, cutlets, tripe, soy drink, soy nuts, soy cubes, and three different dietary supplements)/ isoflavones: daidzin, genistin, genistein, and daidzein	Choline chloride/D(+)-glucose (2:1), choline chloride/L(+)-tartaric acid (1:1), choline chloride/citric acid (1:1, 2:1, and 1:2), choline chloride/saccharose (2:1), choline chloride/glycerine (1:1 and 2:1), choline chloride/D(+)-xylose (2:1), choline chloride/urea (1:1), citric acid/urea (1:2), L(+)-tartaric acid/urea (1:2), L(+)-tartaric acid/glycerine (1:2), D(+)-glucose/glycerine (1:2), citric acid/glycerine (1:2), and choline chloride/citric acid/glycerine (1:1:1 and 2:2:1) with 10, 15, 20, 25, 30, 40, 50, and 75% of deionized water	Choline chloride/citric acid (1:1) in 30% (w/w) water	Bajkacz and Adamek (2017)

(continued)

Table 6.5 (continued)

Extraction medium/ target compounds	DES:HBA/HBD (molar ratio)	Selected DES	References
Green tea (<i>Camellia sinensis</i>)/catechins: epigallocatechin-3-gallate (EGCG)	Betaine/sucrose (4:1), citric acid/sucrose (1:1), glycerol/sucrose (3:1), betaine/glycerol/maltitol (4:4:1), betaine/glycerol/glucose (4:4:1, 4: 5:1, 4:10:1, 4:15:1, and 4:20:1), betaine/sorbitol (2:1), citric acid/sorbitol (1:1), glycerol/sorbitol (2:1), betaine/glycerol/maltose (4:4:1), betaine/maltose (4:1), citric acid/maltose (2:1), glycerol/maltose (3:1), betaine/glycerol/urea (1:1:2), betaine/glucose (4:1), citric acid/glucose (1:1), glycerol/glucose (3:1), betaine/glycerol/citric acid (1:1:1), betaine/maltitol (4:1), citric acid/maltitol (2:1), glycerol/maltitol (3:1), betaine/xylitol (4:1), citric acid/xylitol (1:1), glycerol/xylitol (2:1), citric acid/glycerol/maltitol (2:4:1), betaine/urea (1:2), citric acid/fructose (1:1), glycerol/fructose (3:1), citric acid/glycerol/maltose (2:4:1), betaine/glycerol (1:1), citric acid/glycerol (1:2), glycerol/galactose (3:1), citric acid/glycerol/glucose (1:2:1), betaine/citric acid (1:1), glycerol/urea (1:1), urea/glycerol/maltose (3:3:1), urea/glycerol/maltitol (3:3:1), and urea/glycerol/glucose (2:2:1)	81% betaine/glycerol/D-glucose (4:20:1) is the best as an extraction and stabilizer solvent.	Jeong et al. (2017)

(continued)

Table 6.5 (continued)

Extraction medium/ target compounds	DES:HBA/HBD (molar ratio)	Selected DES	References
Morus alba leaves/ phenolic compounds	Choline chloride/urea (1:2), choline chloride/ethylene glycol (1:2), choline chloride/glycerol (1:2), choline chloride/citric acid (2:1), choline chloride/DL-malic acid (1:1), betaine/levulinic acid (1:2), betaine/DL-lactic acid (1:1), betaine/glycerol (1:2), L-proline/DL-malic acid (1:1), L-proline/glycerol (2:5), L-proline/levulinic acid (1:2), and L-proline/lactic acid (1:1)	Choline chloride/citric acid (2:1)	Zhou et al. (2018)
Edible oils/ tert-butylhydroquinone	Choline chloride/ascorbic acid (1.2:1, 2:1, 2.5:1, 1:1.6, 1:2, and 1:2.5)	Choline chloride/ascorbic acid (1:2) was chosen because it has the highest thermal stability.	Liu et al. (2018)

DES deep eutectic solvent, HBA hydrogen bond acceptor, HBD hydrogen bond donor; *n.m.* not mentioned

B; however, other dyes were extracted also with methanol (Wang et al. 2017). Cao et al. (2018) applied a vortex extraction method for the extraction of proanthocyanidin. Sixteen different deep eutectic solvents were tested, and it was concluded that organic acid-based deep eutectic solvents were better than alcohol-based ones, and this was related to the higher polarity of the organic acid-based ones suitable for the extraction of the hydrophilic proanthocyanidin. Extraction yield with deep eutectic solvent (22.19 ± 0.71 mg/g) was much higher than those with conventional organic solvents (70% methanol (7.87 ± 0.21 mg/g), 70% ethanol (7.84 ± 0.10 mg/g), and 70% acetone (13.26 ± 0.54 mg/g)) (Cao et al. 2018).

6.2.5 Heating and Stirring

The heating and stirring method is the simplest one. It is based on the solubilization of the target analytes in the deep eutectic solvent under heating and stirring conditions (Guo et al. 2013; Das et al. 2016; Bağda et al. 2017; Saravana et al. 2018a, b). The latter are optimized depending on the target compound (Ribeiro et al. 2013; Helalat-Nezhad et al. 2015; Athanasiadis et al. 2018). Centrifugation and filtration steps can be used to separate the deep eutectic solvent phase from the sample solution. Table 6.8 presents examples of the application of heating and stirring extraction technique with deep eutectic solvents as extraction solvents.

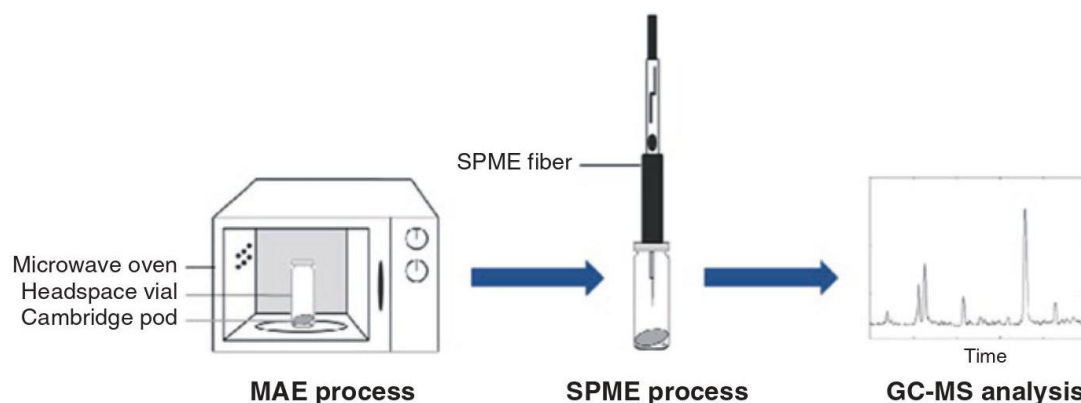

Fig. 6.8 Microwave extraction (MAE) method. Deep eutectic solvent is added to the sample in a test tube which is immersed in a microwave flask and then in a microwave extractor. The solutions are then filtrated via a solid-phase microextraction (SPME) process and then analyzed by gas chromatography-mass spectrometry (GC-MS). (Figure reprinted with permission from Sha et al. 2013)

Dai et al. (2016) used natural deep eutectic solvent to extract anthocyanins from purple and orange petals of *Catharanthus roseus*. This method was compared with ultrasound extraction and ultrasound extraction with heating. Among these three methods, the least efficient one was the ultrasound extraction method at 25 °C. But with ultrasound extraction with heating, an improvement of the yield of 2–20% was observed. The best extraction yield was obtained by heating and stirring at 40 °C, and it was 35–55% greater than that obtained with sonication at 25 °C (Dai et al. 2016). Also, Peng et al. (2018) obtained an improved yield of extracted rutin using deep eutectic solvent and water (18.1%) compared with the methanol-water solution or ethanol-water solution (60% water). The yellow rutin powder was obtained with a yield of 62.7% with purity higher than 95%. The extracted rutin has an excellent antioxidant activity (Peng et al. 2018).

6.2.6 Solid-Phase Microextraction

Solid-phase microextraction is based on the partition of the analytes between a liquid solution (sample matrix or extract) and a viscous liquid immobilized on a solid support (sorbent phase). Different types of sorbents are used for the extraction of a wide range of volatile compounds, via absorption/adsorption mechanism. The choice of the sorbent depends on the target analytes and the type of interactions. It should have large surface area, high purity, and chemical stability in the conditions of extraction. This technique is rapid, simple, safe, efficient with good recoveries, and reproducible, and it combines the extraction and the preconcentration steps into a single step (Karimi et al. 2017). It can be automated and the solvent can be reused. The solid-phase microextraction is limited for a specific number of commercially available cartridges, used as sorbents, that are expensive and demand a

Table 6.6 Examples of the application of microwave extraction technique with deep eutectic solvents as extraction solvents

Extraction medium	Target compounds	DES:HBA/HBD (molar ratio)	Selected DES	References
Pigeon pea roots	Genistin, genistein, and apigenin	Choline chloride/sucrose (1:1), choline chloride/1,2-propanediol (1:1), choline chloride/glucose (1:1), choline chloride/sorbitol (1:1), choline chloride/glycol (1:1), choline chloride/glycerol (1:1), choline chloride/1,3-butanediol (1:1), choline chloride/1,4-butanediol (1:1), glucose/L-proline (1:1), glucose/lactic acid (1:1), and choline chloride/1,6-hexanediol (1:1, 2:1, 3:1, 4:1, 5:1, 6:1, 7:1, 8:1)	Choline chloride/1,6-hexanediol (7:1)	Cui et al. (2015)
<i>Lonicera japonica</i> Flos	Phenolic acids: chlorogenic acid, caffeic acid, 3,5-dicaffeoylquinic acid, 3,4-dicaffeoylquinic acid, and 4,5-dicaffeoylquinic acid	Choline chloride/1,2-propanediol (1:2), glycerol (1:2), choline chloride/ethylene glycol (1:2), choline chloride/1-3 butanediol (1:2), choline chloride/1-4 butanediol (1:2), choline chloride/urea (1:2), propanedioic acid (1:2), choline chloride/glucose (1:2), choline chloride/sorbitol (1:2), oxalic acid/sucrose (1:2), lactic acid/sucrose (1:2), and lactic acid/glucose (1:2)	Choline chloride/1,3-butanediol (6:1) proved the highest extraction ability.	Peng et al. (2016)
Radix Salviae Miltiorrhizae	Hydrophilic and hydrophobic components: rosmarinic acid, lithospermic acid, salvianolic acid B, salvianolic acid A, and tanshinone 2 A	Choline chloride/ethylene glycol (1:2), choline chloride/1,2-propanediol (1:1, 1:2, and 1:3), choline chloride/glycerol (1:1, 1:2, 1:3, and 1:4), choline chloride/1,4-butanediol (1:2 and 1:4), choline chloride/oxalic acid (2:1 and 1:1), choline chloride/succinic acid (2:1 and 1:1), choline chloride/lactic acid (1:1), choline chloride/malonic acid (1:1 and 1:2), choline chloride/malic acid (1:1), choline chloride/citric acid (2:1), choline chloride/maltose (1:1), choline chloride/fructose (2:1), choline chloride/glucose (2:1), and choline chloride/urea (1:1, 2:1, and 1:2)	Choline chloride/1,2-propanediol (1:1) in 20 vol% of water	Chen et al. (2016)
Red grape skin	Phenolic compounds	Choline chloride/glycerol (1:2), choline chloride/oxalic acid (1:1), choline chloride/malic acid (1.5:1), choline chloride/sorboside (1:1), and choline chloride/proline/malic acid (1:1:1). 10%, 25%, and 50% w/w DES/water were tested.	Choline chloride/oxalic acid (1:1) in 25% water	Cvjetko et al. (2016)

Olive pomace	Phenolic compounds	Choline chloride/citric acid (1:2), choline chloride/lactic acid (1:2), choline chloride/maltose (1:2), and choline chloride/glycerol (1:2)	Choline chloride-based organic acids natural deep eutectic solvent (citric acid and lactic acid) with the addition of 20% v/v water	Chanioti and Tzia (2018)
<i>Scutellaria baicalensis</i> Georgi (Chinese herbal medicine)	Baicalin	Tetrabutylammonium chloride/decanoic acid (2:1, 1:1, and 1:2), tetraoctylammonium bromide/decanoic acid (1:2), methyltrioctylammonium chloride/decanoic acid (2:1, 1:1, and 1:2), and methyltrioctylammonium bromide/decanoic acid (1:2 and 1:1)	Tetrabutylammonium chloride/decanoic acid (2:1) in 30% vol/vol water. It increased the baicalin solubility (240 and 10 times in comparison with water and 70% ethanol, respectively). This was mainly related to the polarity and the physical properties of the solvent.	Wang et al. (2018)

DES deep eutectic solvent, HBA hydrogen bond acceptor, HBD hydrogen bond donor

Table 6.7 Examples of the application of vortex extraction technique with deep eutectic solvents as extraction solvents

Extraction medium	Target compounds	DES:HBA/HBD (molar ratio)	Selected DES	References
Virgin olive oil	Phenolic compounds	Choline chloride/glycerol (1:2), choline chloride/lactic acid (1:2), choline chloride/urea (1:2), choline chloride/sucrose (1:1 and 4:1), choline chloride/1,4-butanediol (1:5), choline chloride/xylitol (2:1), choline chloride/1,2-propanediol (1:1), choline chloride/malonic acid (1:1), choline chloride/urea/glycerol (1:1:1), and D-fructose/D-glucose/sucrose (1:1:1)	Choline chloride/xylitol (2:1) and choline chloride/1,2-propanediol (1:1)	García et al. (2016)
Chili oil	Rhodamine B	Choline chloride/ethylene glycol (1:3)	Choline chloride/ethylene glycol (1:3); the extraction process requires only 1 min of vortexing.	Wang et al. (2017)
<i>Ginkgo biloba</i> leaves	Polymer polyphenol compound: proanthocyanidin	Choline chloride/glycerol (1:2), choline chloride/ethylene glycol (1:2), choline chloride/propylene glycol (1:2), choline chloride/1,3-butanediol (1:3), choline chloride/D-sorbitol (1:1), choline chloride/xylitol (1:1), choline chloride/1,5-pentanediol (1:1), choline chloride/glycolic acid (1:1), choline chloride/malonic acid (1:1), choline chloride/DL-malic acid (1:1), choline chloride/levulinic acid (1:1), choline chloride/lactic acid (1:2), choline chloride/citric acid (1:1), choline chloride/L-(+)-tartaric acid (1:1), choline chloride/urea (2:1), and choline chloride/oxalic (1:1)	Choline chloride/malonic acid (1:2) with 55% (w/w) water	Cao et al. (2018)

(continued)

Table 6.7 (continued)

Extraction medium	Target compounds	DES:HBA/HBD (molar ratio)	Selected DES	References
Vanilla pods	Vanillin	Choline chloride/malic acid/water (1:1:6), choline chloride/citric acid/water (1:1:6), choline chloride/glycerol (1:1), malic acid/glucose/fructose/water (1:1:1:9), citric acid/fructose/glucose/water (1:1:1:9), fructose/glucose/water (1:1:6), malic acid/glucose/water (1:1:6), betaine/sucrose/water (2:1:6), betaine/malic acid/glucose/water (1:1:1:9), betaine/citric acid/water (1:1:6), β -alanine/citric acid/water (1:1:6), L-serine/malic acid/water (1:1:6), lactic acid/1,2-propanediol (1:1), and lactic acid/fructose (5:1)		González et al. (2018)

DES deep eutectic solvent, HBA hydrogen bond acceptor, HBD hydrogen bond donor

time-consuming pretreatment (Mohebbi et al. 2018). Several types of sorbents are used such as carbon nanotube, SiO₂, C₁₈, and NH₂. However, these sorbents present some limitations such as single adsorption mechanism and low special selectivity, which limit their further application (Li et al. 2017). Hence, scientists are working on the development of new selective sorbents via the applications of deep eutectic solvent to increase their selectivity and capacity (Gan et al. 2016). All upcoming examples of the application of solid-phase microextraction techniques with deep eutectic solvents as extraction solvents are listed in Table 6.9.

Deep eutectic solvent-modified sorbents exhibited higher extraction efficiency and recovery values than tested sorbents using conventional organic solvents with a remarkable affinity and selectivity toward the target molecule; this was observed in all presented cases.

Ball Mill-Assisted Extraction

This method was developed by Wang et al. in 2016. Compared to other extraction methods (methanol-based ultrasound extraction and heat reflux extraction), the ball mill-assisted extraction was faster with higher extraction capacity of “tanshinones” and lower consumption of solvents. Also, in comparison with conventional solvents (n-hexane, ethanol, methanol, acetonitrile, acetone, and ethyl acetate), it was demonstrated that with deep eutectic solvent (six different choline chloride-based deep eutectic solvents), higher extraction efficiencies were obtained likely because of

Table 6.8 Examples of the application of heating and stirring extraction technique with deep eutectic solvents as extraction solvents

Extraction medium	Target compounds	DES:HBA/HBD (molar ratio)	References
Toluene oil	Phenol	The quaternary ammonium salts studied include tetramethylammonium chloride, tetramethylammonium bromide, tetraethylammonium chloride, methyltriethylammonium chloride, tetraethylammonium bromide, tetrapropylammonium chloride, tetrabutylammonium chloride, ammonium chloride, and choline bromide; the HBD was phenol.	Guo et al. (2013)
Plant species: Juá (<i>Ziziphus joazeiro</i>) and sisal (<i>Agave sisalana</i>)	Saponins, triterpenic, or steroidal glycosides	Choline chloride/urea (1:2), choline chloride/glycerol (1:2), choline chloride/ethylene glycol (1:2), choline chloride/acetic acid (1:2), choline chloride/propionic acid (1:2), choline chloride/lactic acid (1:2), choline chloride/malonic acid (1:2), choline chloride/oxalic acid (1:2), and choline chloride/phenylacetic acid (1:2)	Ribeiro et al. (2013)
Safflower: <i>Carthamus tinctorius</i> L. (Asteraceae)	Phenolic compounds	Choline chloride/glucose (5:2), choline chloride/sucrose (4:1), malic acid/proline (1:1); glucose/lactic acid (1:5), and choline chloride/xylitol (4:1)	Dai et al. (2014)
Fish and macroalgae samples and an uncontaminated Hamour fish sample	PAHs: phenanthrene, anthracene, fluoranthene, pyrene, benz[a]anthracene, chrysene, benzo[e]pyrene, and benzo[a]pyrene	Choline chloride/oxalic acid (1:1, 1:2, and 1:3)	Helalat-Nezhad et al. (2015)
Seaweed: <i>Kappaphycus alvarezii</i>	k-Carrageenan	Choline chloride/urea (1:2), choline chloride/ethylene glycol (1:2), and choline chloride/glycerol (1:2)	Das et al. (2016)
Purple and orange petals of the flower <i>Catharanthus roseus</i>	Anthocyanins	Choline chloride/1, 2-propanediol/water (1:1:1), glucose/lactic acid/water (1:5:3), malic acid/proline/water (1:1:3), choline chloride/malic acid/water (1:1:2), choline chloride/glucose/water (5:2:5), and malic acid/ β -alanine/water (1:1:3)	Dai et al. (2016)

(continued)

Table 6.8 (continued)

Extraction medium	Target compounds	DES:HBA/HBD (molar ratio)	References
Vegetable samples: basil herb, spinach, dill, and cucumber barks	Manganese	Choline chloride/tartaric acid (1:1), choline chloride/oxalic acid (1:1), and choline chloride/citric acid (1:1)	Bağda et al. (2017)
<i>Sophora japonica</i> bud	Rutin	Choline chloride/triethylene glycol (1:4) + 18.1% water	Peng et al. (2018)
Shrimp shells (<i>Marsupenaeus japonicus</i>)	Chitin and chitin films	Choline chloride/lactic acid (1:2), choline chloride/1,4-butanediol (1:2), choline chloride/ethylene glycol (1:2), choline chloride/urea (1:2), choline chloride/1,6-hexanediol (1:2), choline chloride/glycerol (1:2), choline chloride/oxalic acid (1:2), choline chloride/malonic acid (1:2), choline chloride/citric acid (1:2), choline chloride/malic acid (1:2), choline chloride/propylene glycol (1:2), choline chloride/L-tartaric acid (1:2), choline chloride/maleic anhydride (1:2), and choline chloride/thiourea (1:2). Choline chloride/malonic acid (1:2) was the best extraction solvent.	Saravana et al. (2018a, b)
<i>Olea europaea</i> Leaves	Polyphenols	Glycerol/glycine/water (7:1:3)	Athanasiadis et al. (2018)

DES deep eutectic solvent, HBA hydrogen bond acceptor, HBD hydrogen bond donor

multiple interactions, such as hydrogen bonding, electrostatic, and Van der Waals interactions, between deep eutectic solvent and the target molecules. Extracted compounds were quite stable in deep eutectic solvent (Wang et al. 2016). This method is described by a scheme in Fig. 6.9.

Magnetic Solid-Phase Extraction

This method gained much attention in recent years. It has the same principle as the classical solid-phase microextraction, but it is mainly related to the magnetic sorbents facilitating the extraction process by applying an external magnetic field (Oller-Ruiz et al. 2018). Furthermore, these sorbents do not necessarily need to be packed into cartridge and can be recycled and reused; also, the centrifugation and the filtration could be avoided (Huang et al. 2015; Xu et al. 2016a, b).

Huang et al. (2015) synthesized magnetic graphene oxide impregnated with deep eutectic solvent (Fe₃O₄@GO-DES); the latter showed increased water solubility and improved proteins extraction efficiency than graphene oxide alone. Figure 6.10 illustrates the extraction process (Huang et al. 2015).

The same method was used by Xu et al. (2016a, b) to extract proteins. The adsorbed proteins on the $\text{Fe}_3\text{O}_4\text{-NH}_2\text{@GO@DES}$ nanoparticles were eluted with no modification of their conformation. Also, Xu et al. (2016a, b) introduced a new type of polymer-immobilized magnetic silica materials with high thermal stability, long lifetime, and good durability for the extraction of trypsin. This sorbent can be recycled six times without significant loss of its extraction capacity and retained a high extraction capacity after eight cycles (Xu et al. 2016a, b). The new synthesized $\text{Fe}_3\text{O}_4\text{-NH}_2\text{@GO@DES}$ sorbent gave the best extraction efficiency compared to $\text{Fe}_3\text{O}_4\text{-NH}_2\text{@graphene oxide}$ and $\text{Fe}_3\text{O}_4\text{-NH}_2$ sorbents. This was linked to the numerous oxygen-containing functional groups existing on the surface of graphene oxide in addition to the hydroxyl groups of deep eutectic solvent that strengthen the interactions between proteins and deep eutectic solvent. In addition, the extraction efficiency was the best at a certain pH where opposite charges between magnetic microspheres and proteins exist. Another parameter related to the extraction capacity was the molecular weight of the proteins: the smaller the protein, the easier is its extraction (Xu et al. 2016a, b).

Li et al. (2017) developed a new synthesized sorbent C_8 -amino-bifunctionalized ordered mesoporous organosilica for the extraction of triazine herbicides from watermelon samples. The synthesis of these new sorbents is illustrated in Fig. 6.11. Deep eutectic solvent composed of choline chloride/ethylene glycol 1:2 molar ratio was used as the extraction solvent. This method demonstrated lower limits of detection and relative standard deviations values in addition to high recoveries than other methods (pressurized liquid extraction, nonaqueous cavitation extraction, molecular-imprinted polymer-based solid-phase microextraction, cloud point extraction, matrix solid-phase dispersion). These sorbents present many advantages such as large surface area, regular and uniform pore size, and hydrothermal stability. In addition, these sorbents have two functional groups: C_8 and amino (the octyl chains gave the hydrophobic character, while the amino groups gave the hydrophilic one simultaneously), which improved the adsorption selectivity of C_8 -amino-bifunctionalized ordered mesoporous organosilica. The latter has a good stability and reusability.

Online-Flow-Injection-Flame Atomic Absorption Spectrometry Solid-Phase Extraction

Karimi et al. (2017) extracted copper and nickel metal ions from water and biological samples (human serum and urine) by synthesizing deep eutectic solvent of choline chloride/urea (1:2 molar ratio) immobilized on cotton fibers. Desorption of the ions on deep eutectic solvent was due to the formation of a complex between nitrogen donor moieties of urea in the deep eutectic solvent and the analyte ions. This method is characterized by its rapidity, high sampling rate, simplicity, low reagent consumption, high accuracy, and freedom from contamination. Additionally, it presents a high advantage because it includes a natural cheap abundant renewable

Table 6.9 Examples of the application of solid-phase microextraction techniques with deep eutectic solvents as extraction solvents

Extraction medium	Target compounds	DES:HBA/HBD (molar ratio)	Sorbent type	References
Grape juice and mineralized drinking water	Organic acids: benzoic acid, <i>p</i> -anisic acid, salicylic acid, and cinnamic acid	Choline chloride/urea (1:2)	Silica cartridge was prepared in DES to obtain nitro-substituted tris(indolyl) methane-modified silica	Wang et al. (2016)
<i>Phyllanthus flexuosus</i> (dried plant materials)	Cleistanthol	Choline chloride/glycerol (1:2)	DES-modified anion exchange resin. Positive choline groups of DES can make electrostatic interactions with the negatively charged analyte.	Gan et al. (2016)
<i>Salvia miltiorrhiza Bunge</i>	Tanshinones: cryptotanshinone, tanshinone I, and tanshinone IIA	Choline chloride/ethylene glycol (1:3), choline chloride/glycerol (1:3), choline chloride/1,2-butanediol (1:4), choline chloride/1,3-butanediol (1:4), choline chloride/1,4-butanediol (1:4), and choline chloride/2,3-butanediol (1:4)	Beads	Wang et al. (2016)
Proteins	Bovine serum albumin, ovalbumin, lysozyme, and bovine hemoglobin	Choline chloride/urea (1:1), choline chloride/D (+)-glucose (1:1), choline chloride/ethylene glycol (1:2), and choline chloride/glycerol (1:1)	Magnetic graphene oxide impregnated with DES (Fe ₃ O ₄ @GO-DES); optimal DES: choline chloride/D-(+)-glucose (1:1)	Huang et al. (2015)
Bovine whole blood	Bovine serum albumin, ovalbumin, lysozyme, and bovine hemoglobin	Choline chloride/glycerol (1:1), choline chloride/ethylene glycol (1:2), choline chloride/D-glucose (2:1), and choline chloride/D-sorbitol (1:1)	Fe ₃ O ₄ -NH ₂ @GO@DES magnetic nanoparticles using choline chloride/glycerol (1:1) as the best DES	Xu et al. (2016a, b)

(continued)

Table 6.9 (continued)

Extraction medium	Target compounds	DES:HBA/HBD (molar ratio)	Sorbent type	References
Crude bovine pancreas extract	Trypsin	Choline chloride/ itaconic acid (n.m.)	Poly(DES)-grafted silica-coated magnetic microspheres (Fe ₃ O ₄ @SiO ₂ -MPS@PDES)	Xu et al. (2016a, b)
Watermelon	Triazine herbicides	Choline chloride/ ethylene glycol (1:2)	C8-amino-bifunctionalized ordered mesoporous organosilica in DES	Li et al. (2017)
Water (spring water, tap water, and seawater) and biological samples (human serum samples and urine samples)	Metal ions: copper and nickel	Choline chloride/urea (1:2)	DES immobilized on cotton fibers	Karimi et al. (2017)
Milk samples from China	Chloramphenicol	Choline chloride/ ethylene glycol (1:1), choline chloride/ glycerol (1:1), and choline chloride/ propylene glycol (1:1)	Ternary DES molecularly imprinted polymer	Tang et al. (2017)
<i>Ilex chinensis Sims</i> leaves	3,4-dihydroxybenzoic acid	Ternary DES of choline chloride/3, 4-dihydroxybenzoic acid and ethylene glycol (1:1:1, 1:1:2, and 1:1:3)	Ternary DES molecularly imprinted polymer	Li and Row (2018)

DES deep eutectic solvent, HBA hydrogen bond acceptor, HBD hydrogen bond donor; n.m. not mentioned

biopolymer sorbent, with increased selectivity by immobilization of deep eutectic solvent (Karimi et al. 2017).

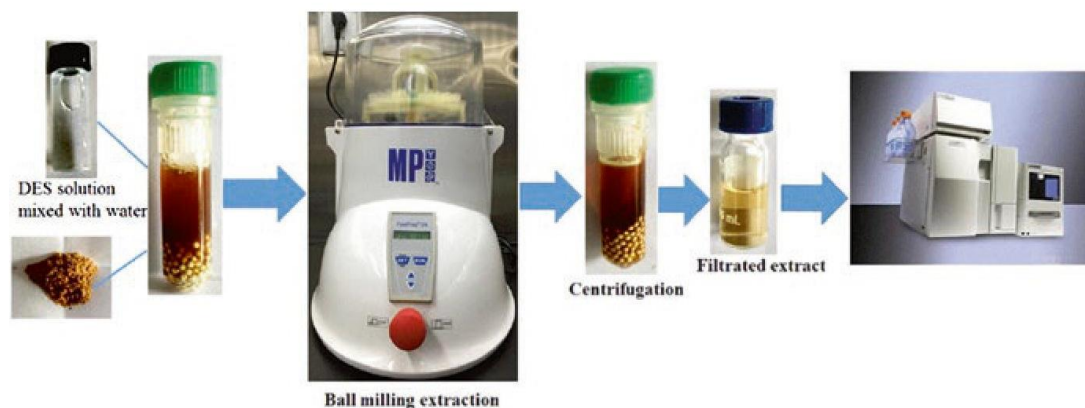

Fig. 6.9 Ball mill-assisted deep eutectic solvent-based extraction of tanshinones from *Salvia miltiorrhiza Bunge*. This method can induce an optimized motion to disrupt cells through the multidirectional, simultaneous beating of specialized beads on the sample. This leads to a full release of intracellular products into the deep eutectic solvent (DES). (Figure reprinted with permission from Wang et al. 2016)

Mini-Solid-Phase Microextraction or Pipette-Tip Solid-Phase Extraction Method

The needle of the syringe system is suitable to be used as a meticulous mini-solid-phase microextraction cartridge because of its special miniconical shape with different diameters in the two ends where a certain amount of adsorbent can be packed, for example, molecular-imprinted polymer adsorbent. Compared to the conventional solid-phase extraction cartridges, extraction, using this technique, can be carried out faster and with facilitated sample-loading procedure (Li and Row 2018). Molecular-imprinted polymers are used as sorbents for purifying complex samples with numerous advantages such as high-recognition ability, mechanical stability, and resistance to a wide range of pH (Hu et al. 2012; Tang et al. 2017).

This technique was also applied by Li and Row in 2018 for the extraction of 3,4-dihydroxybenzoic acid from *Ilex chinensis Sims* leaves as shown in Fig. 6.12. Ternary deep eutectic solvent was used by mixing choline chloride, ethylene glycol, and 3, 4-dihydroxybenzoic acid. Compared to deep eutectic solvent-modified non-imprinted polymers (without template), a molecular-imprinted polymer (without deep eutectic solvent), and NIP (without deep eutectic solvent and without template), ternary deep eutectic solvent molecularly imprinted polymer demonstrated the best extraction efficiency. This technique presents an additional advantage than the other solid-phase extraction techniques since lower amounts of sorbent mass are used (Li and Row 2018).

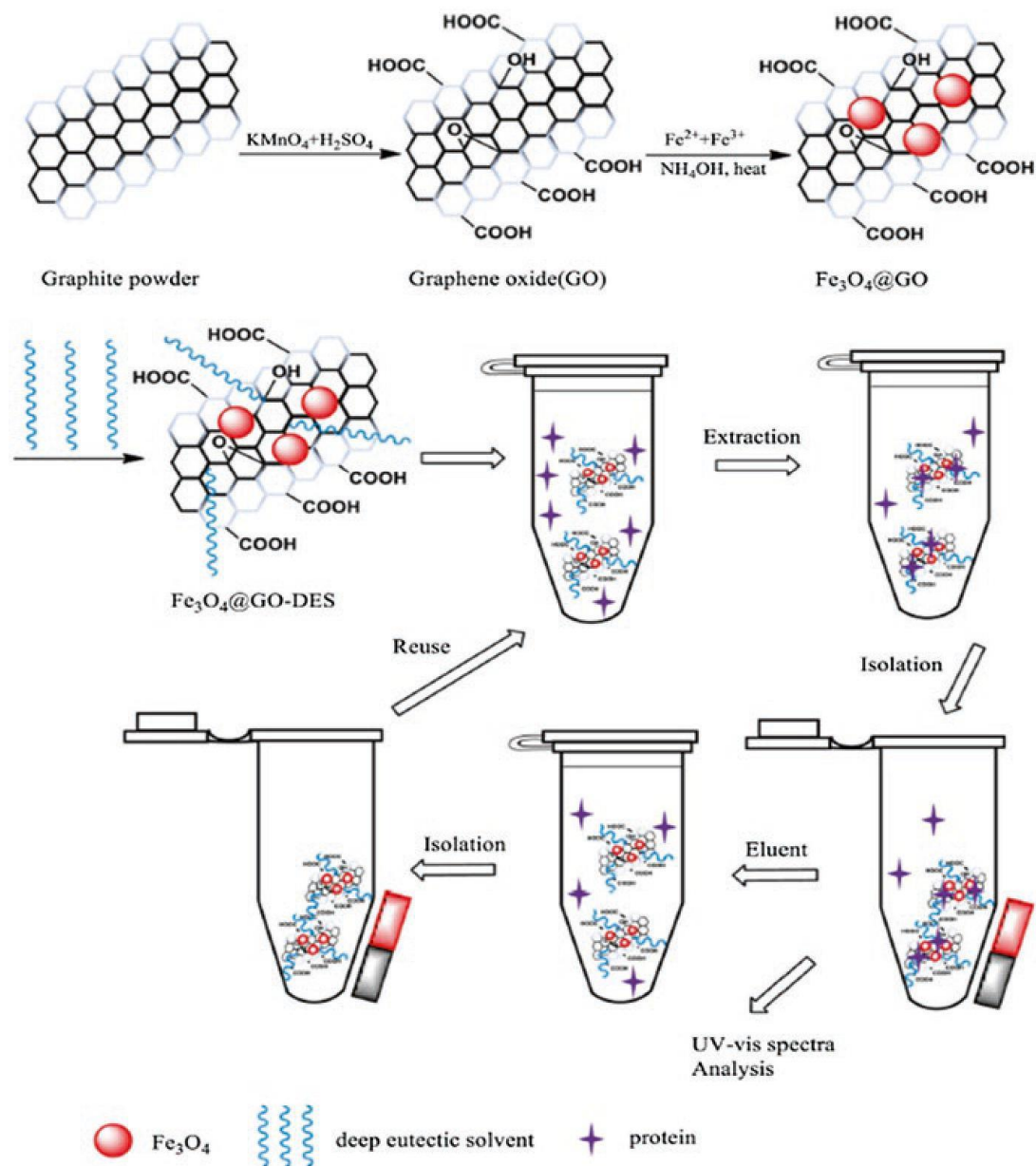

Fig. 6.10 Preparation of $\text{Fe}_3\text{O}_4@GO$ magnetic sorbent impregnated with deep eutectic solvent and its application for the magnetic solid-phase extraction of protein. These sorbents are recovered via an external magnetic field. (Figure reprinted with permission from Yanhua Huang et al. 2015)

6.2.7 Combined Extraction Techniques

Extraction of target molecules has been also studied via application of combined techniques. Examples of these applications with deep eutectic solvents as extraction solvents are explained in this paragraph and presented in Table 6.10.

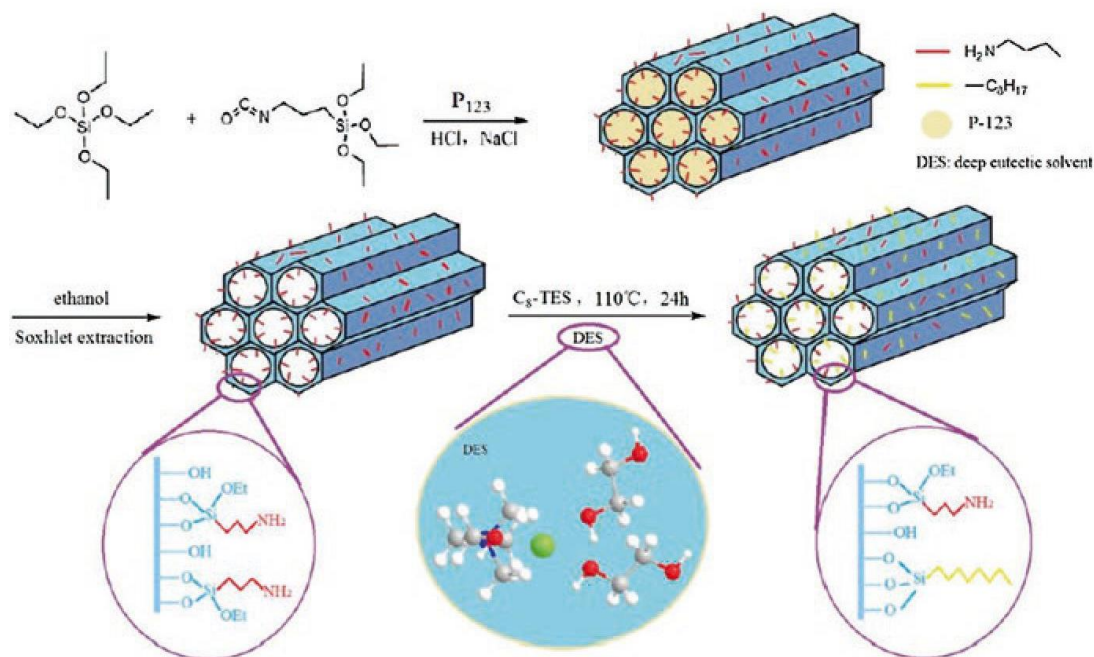

Fig. 6.11 Synthetic protocol of C_8 -amino-bifunctionalized ordered mesoporous organosilica. Coating the sorbent with the deep eutectic solvent (DES) is also presented. (Figure reprinted with permission from Li et al. 2017)

Deep Eutectic Solvent-Based Negative-Pressure Cavitation-Assisted Extraction Method Combined with Macroporous Resin Enrichment

In this method (Fig. 6.13), millions of tiny vapor bubbles (voids) are formed in the liquid by the help of a machine that induces pressure (for example, pumps, turbines, and propellers). Firstly, the heating system of the negative-pressure cavitation-assisted extraction is turned on, and the water is heated. The sample is then introduced. After adding the deep eutectic solvent, this device is connected to the vacuum pump during all the extraction time. The deep eutectic solvent extraction solution obtained under optimized extraction conditions flowed through the column packed with macroporous resins at a constant flow rate. The adsorbed analytes were washed with deionized water and then eluted with 95% aqueous ethanol (v/v). The ethanolic fraction was collected and analyzed. Deep eutectic solvent showed better extractability than tested 80% ethanol solvent with the same technique. Moreover, deep eutectic solvent negative-pressure cavitation-assisted extraction yields were higher than that of deep eutectic solvent-based ultrasound extraction method (Qi et al. 2015). This method can be highly used for the thermolabile compounds because negative-pressure cavitation-assisted extraction is performed at room temperature. Additionally, the oxidation of these compounds is avoided as air is excluded in the extraction process (Liu et al. 2009).

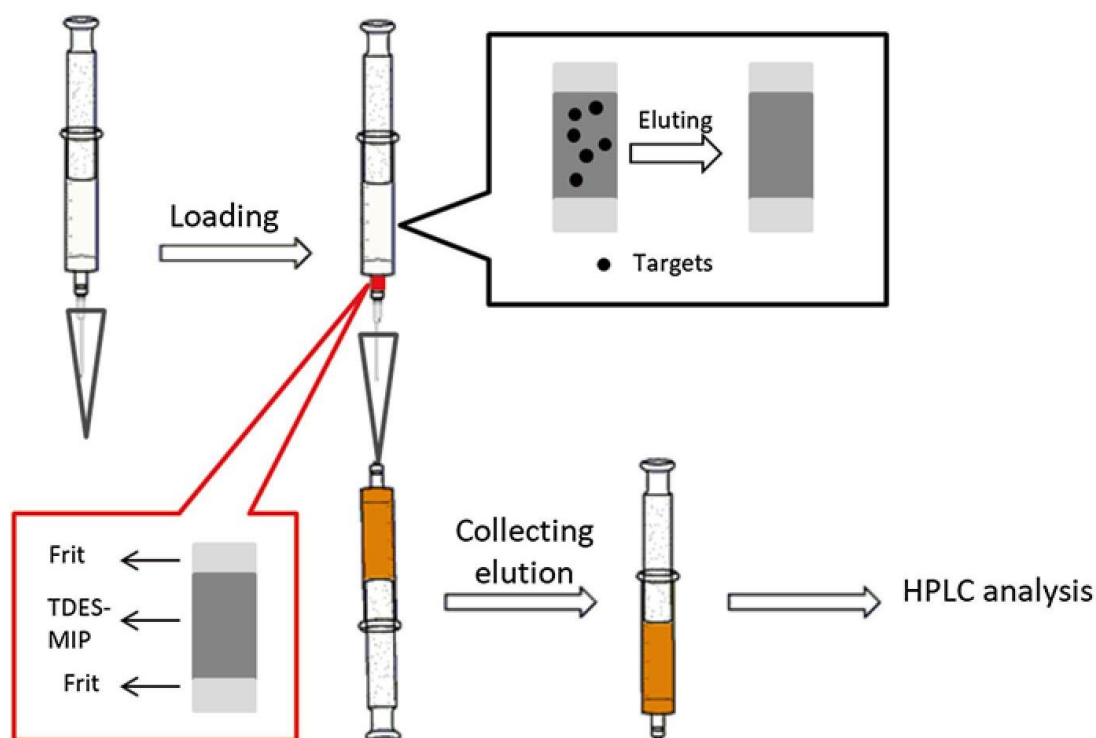

Fig. 6.12 Pipette-tip solid-phase extraction method where the sorbent is packed inside the end of the syringe (in this case, the sorbent is the ternary deep eutectic solvent molecularly imprinted polymer (TDES-MIP)). Each time the solution was sucked up into and out of micropipette type of the needle containing the adsorbent by pulling and pushing the syringe, respectively. The extraction complex retained on the adsorbent was washed, eluted, and subjected to analysis

Microwave Extraction and Solid-Phase Extraction

Wei et al. (2015) used the microwave extraction method for the extraction of four flavonoids from *Radix Scutellariae*, and their extraction yields were 33, 9, 9, and 2 mg/g, respectively. Thirteen natural deep eutectic solvents were tested; choline chloride/lactic acid (1:2 molar ratio) + 20% water (v/v) was selected because it was the most suitable one for the simultaneous extraction of these compounds. Aqueous ethanol 60% (v/v) was selected as reference extraction solvent. A solid-phase extraction method was also applied where the natural deep eutectic solvent extraction solution was flowed through the column packed with ME-2 macroporous resin for the separation of the flavonoids from the natural deep eutectic solvent solution. Recovery yields of baicalin, wogonoside, baicalein, and wogonin were 84%, 80%, 85%, and 82%, respectively (Wei et al. 2015).

Table 6.10 Examples of the application of combined extraction techniques with deep eutectic solvents as extraction solvents

Extraction medium	Target compounds	DES:HBA/HBD (molar ratio)	Extraction method	References
<i>Equisetum palustre L.</i>	Flavonoids	Choline chloride/glycerol, betaine hydrochloride/glycerol, choline chloride/1,4-butanediol, betaine hydrochloride/1,4-butanediol, choline chloride/1,3-butanediol, betaine hydrochloride/1,3-butanediol, choline chloride/ethylene glycol, betaine hydrochloride/ethylene glycol, and choline chloride/betaine hydrochloride/ethylene glycol (n.m.). Choline chloride/betaine hydrochloride/ethylene glycol (1:1:2) was the optimal DES.	DES-based negative-pressure cavitation-assisted extraction method coupled to macroporous resin enrichment	Qi et al. (2015)
Radix Scutellariae	Flavonoids: baicalin, wogonoside, baicalein, and wogonin	Choline chloride/1,4-butanediol (1:2), choline chloride/glycerol (1:2), choline chloride/ethylene glycol (1:2), choline chloride/citric acid (1:2), choline chloride/malic acid (1:2), choline chloride/lactic acid (1:2, 3:1, 2:1, 1:1, 1:3, 1:4), choline chloride/glucose (1:2), choline chloride/sorbitol (1:2), choline chloride/sucrose (1:2), choline chloride/maltose (1:2), citric acid/sucrose (1:2), citric acid/glucose (1:2), and lactic acid/sucrose (1:2)	Natural deep eutectic solvent-based microwave extraction coupled to direct macroporous resin adsorption and desorption process	Wei et al. (2015)
Bamboo shoot shell	Lignin and xylan	Choline chloride/organic acid (1:2), choline chloride/ethylene glycol (1:2), and choline chloride/glycerol (1:2)	Biological treatment based on microorganisms coupled to DES pretreatment	Dai et al. (2017)

(continued)

Table 6.10 (continued)

Extraction medium	Target compounds	DES:HBA/HBD (molar ratio)	Extraction method	References
Food and herbal tea samples: turmeric liquid supplement, herbal tea, turmeric drug or powder, and root herbal tea	Curcumin	Choline chloride/phenol (1:4)	DES-based vortex extraction combined to emulsification liquid-liquid microextraction	Aydin et al. (2018)
Human urine and plasma samples	Tricyclic antidepressant drugs: amitriptyline, nortriptyline, desipramine, clomipramine, and imipramine	Choline chloride/4-chlorophenol DES formed by mixing 1.39 g choline chloride with 2.58 g 4-chlorophenol	Dispersive solid-phase extraction coupled to DES-based air-assisted liquid-liquid microextraction	Mohebbi et al. (2018)
<i>Ginkgo biloba</i> and <i>Panax ginseng</i>	Phenolics, phenolic acids, and terpenoids from <i>G. biloba</i> leaves and ginsenosides from <i>P. ginseng</i> leaves	Choline chloride/malic acid/(1:1), glucose/malic acid (1:1), choline chloride/glucose (5:2), proline/malic acid (1:1), sucrose/fructose/glucose (1:1:1), and sucrose/proline/glycerol (1:4:9). All of the prepared NADES were mixed with 10% (w/w) water.	Ultrasound extraction combined with solid-phase extraction	Liu et al. (2018)

DES deep eutectic solvent, HBA hydrogen bond acceptor, HBD hydrogen bond donor; *n.m.* not mentioned

Biological and Deep Eutectic Solvent Pretreatments

Dai et al. (2017) highlighted the importance of biodiesel production from microbial lipids obtained from the fermentation of low-cost carbon sources by microorganisms. Waste biomass could be treated and used as one of those carbon sources (hydrolysates). Bamboo shoot shell, highly agricultural waste produced in China, is treated; it is mainly composed of cellulose, hemicellulose, and lignin. The combination of the biological treatment and deep eutectic solvent was tested for the removal of lignin and hemicellulose from bamboo shoot shell in order to enhance the biomass conversion into fermentable sugars for producing biofuel.

In this study, untreated bamboo shoot shell was subjected to biological pretreatment with *Galactomyces* sp. CCZU11-1 and used to produce cellulases. After 3 days, maximum amount of xylan and lignin were removed and compared to untreated bamboo shoot shell. After fermentation, the residues of bamboo shoot shell were pretreated by deep eutectic solvent. Notably, choline chloride/oxalic acid

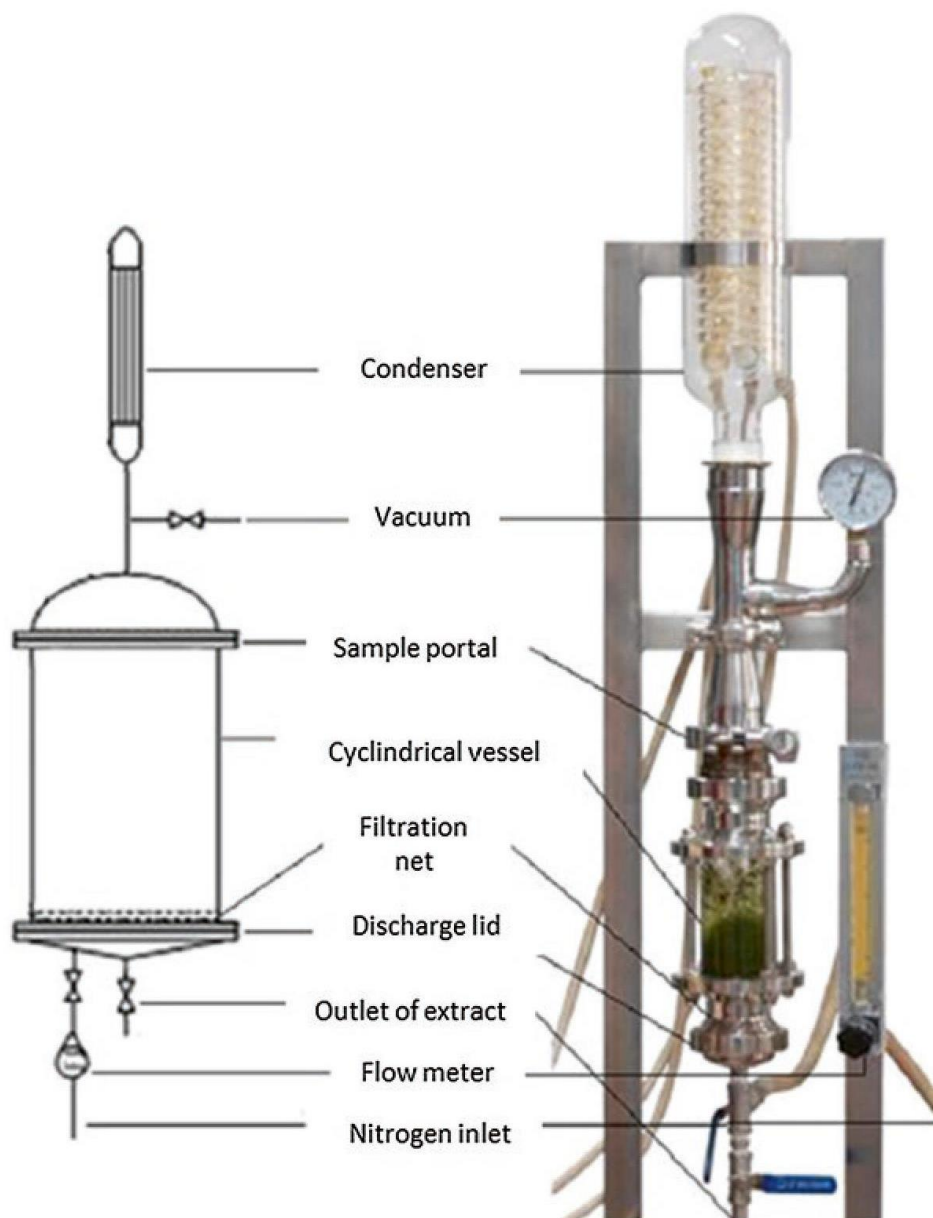

Fig. 6.13 Schematic representation of the negative-pressure cavitation-assisted extraction device and the actual negative-pressure cavitation-assisted extraction device. (Figure reprinted with permission from Liu et al. 2009)

(1:2 molar ratio) was found to be the best solvent for pretreating bamboo shoot shell with the highest xylan removal (53%) and delignification (48%). After deep eutectic solvent addition, more surface areas in the pretreated bamboo shoot shell were formed which allowed cellulases to further attack cellulose and residual hemicellulose. Thus, enzymatic saccharification of bamboo shoot shell was increased after deep eutectic solvent pretreatment. The reducing sugars yield from the enzymatic hydrolysis of 50 g/L deep eutectic solvent bamboo shoot shell was maximal (90%). Furthermore, it was found that combination pretreatment was better than one-step pretreatment, and it effectively removed xylan and lignin after treatment with deep eutectic solvent (Dai et al. 2017).

Deep Eutectic Solvent-Based Vortex Extraction Combined with Emulsification Liquid-Liquid Microextraction

Aydin et al. (2018) developed a new technique using deep eutectic solvent (choline chloride/phenol 1:4 molar ratio) as a water-miscible extraction solvent for the extraction of curcumin (Fig. 6.14). Recoveries of curcumin using different deep eutectic solvent were above 96% (Aydin et al. 2018).

Dispersive Solid-Phase Extraction in Combination with Deep Eutectic Solvent-Based Air-Assisted Liquid-Liquid Microextraction

The proposed method is represented in Fig. 6.15. The process started with dispersive solid-phase extraction method. Then air-assisted liquid-liquid microextraction method was applied. In the proposed method, the synthesized deep eutectic solvent was used as an elution/extraction solvent. Results showed many advantages such as good repeatability, high enrichment factors and extraction recoveries, low limits of detection and limits of quantification, and simplicity of operation. According to Mohebbi et al. (2018), this method can be used for the routine analysis of many drugs in the pharmaceutical and clinical laboratories with no harm on human health and environment (Mohebbi et al. 2018).

Ultrasound Extraction and Solid-Phase Extraction

Liu et al. (2018) proposed a combined technique for the extraction of different classes of natural products (phenolics, terpenoids, and phenolic acids) from *G. biloba* leaves and ginsenosides from *P. ginseng* leaves. Six different natural deep eutectic solvents were tested (Table 6.10). The presence of natural deep eutectic solvent caused severe tailing of spots in high-performance thin-layer chromatography analysis; therefore, it was important to recover the analytes from natural deep eutectic solvent before analysis. Hence, solid-phase extraction method was employed using polymeric reversed-phase sorbent cartridges. Of the natural deep eutectic solvents, choline chloride/malic acid (1:1 molar ratio) and glycerol/proline/sucrose (1:1:1 molar ratio) were the best for *G. biloba* leaves, and choline chloride/malic acid (1:1 molar ratio) and glucose/malic acid (1:1 molar ratio) for *P. ginseng* leaves showing the highest yields of the target compounds. The addition of water to natural deep eutectic solvent affected the extraction and maximum yields. The latter were obtained with approximately 20% water (w/w). Results showed that the yield of analytes obtained with the natural deep eutectic solvent is similar to that of methanol. A high advantage of the usage of natural deep eutectic solvent is their incapability to extract ginkgolic acids (considered very toxic to human) due to their low polarity and low dissolution in natural deep eutectic solvents. This method proved to be able to deliver reproducible chemical profiles from the natural deep eutectic solvent extracts (Liu et al. 2018).

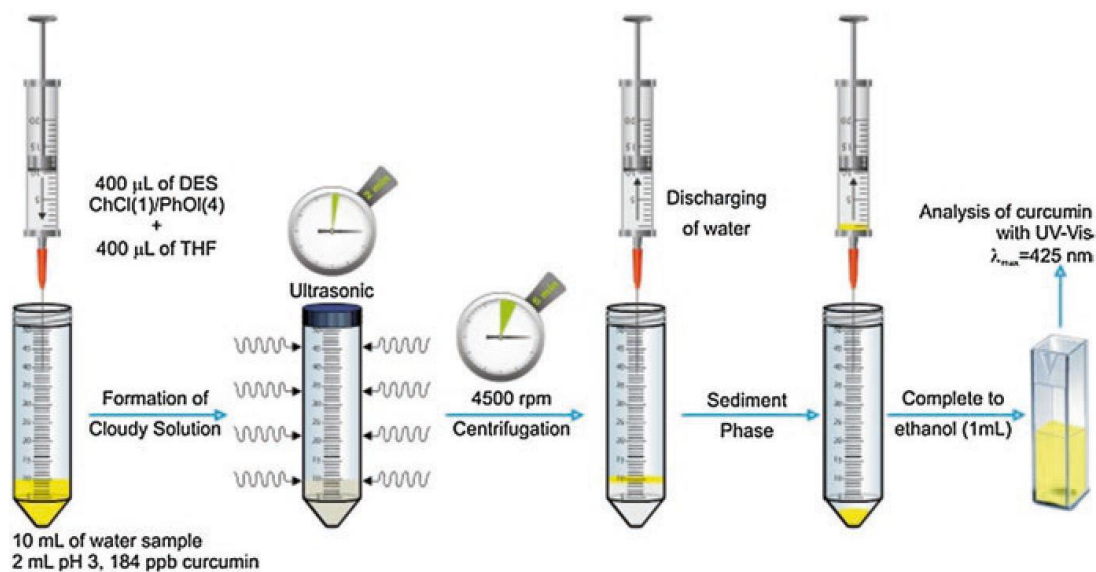

Fig. 6.14 Deep eutectic solvent-based vortex extraction combined with emulsification liquid-liquid microextraction. Deep eutectic solvent (DES) was injected rapidly to the sample solution with tetrahydrofuran as an emulsifier agent. This leads to the formation of a cloudy solution due to insoluble self-aggregation of DES droplets. The cloudy solution was subjected to ultrasonication. Then centrifugation was applied to separate the DES phase from the aqueous solution. The DES phase containing curcumin was subjected to UV-Vis analysis. (Figure reprinted with permission from Aydin et al. 2018)

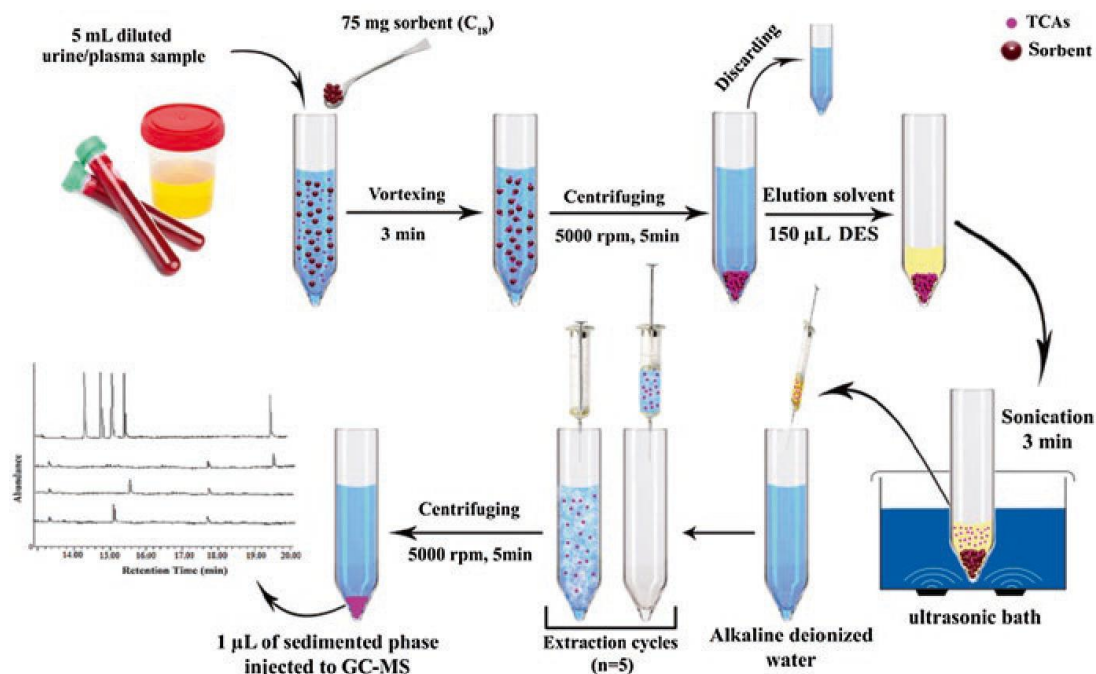

Fig. 6.15 Dispersive solid-phase extraction in combination with deep eutectic solvent (DES)-based air-assisted liquid-liquid microextraction preconcentration procedure. The process started with diluted urine or plasma samples transferred into a glass test tube in the presence of sorbent. The tube was then vortexed. Then, the adsorbed analytes were subsequently eluted with DES under sonication. The supernatant solution obtained from the previous step was removed and then subjected to five aspiration/dispersion cycles. A cloudy solution was formed. After centrifugation, DES phase was analyzed. (Figure reprinted with permission from Mohebbi et al. 2018)

6.3 Influence of Deep Eutectic Solvent Properties on the Extraction Efficiency

The properties of deep eutectic solvent highly influence the extraction efficiency of the analytes (Tang et al. 2014). These properties depend both on the physicochemical properties of each component and on the interactions between the two constituents of the deep eutectic solvent. While deep eutectic solvent melting point, density, viscosity, and compatibility with instrumental detection systems may control the extraction process feasibility, the extraction efficiency is mainly influenced by the deep eutectic solvent solubilizing capacities and by its cell structures disruption ability. Since the majority of the bioactive compounds are being extracted from a medium containing large amount of water, deep eutectic solvent properties can be influenced by the presence of water. Accordingly, El Achkar et al. (2019) discussed, in a recent review, the effect of water on the main physicochemical properties of deep eutectic solvents; the water content should be considered in the analysis of the extraction efficiency by deep eutectic solvent (El Achkar et al. 2019).

6.3.1 Melting Point

As it was mentioned above, deep eutectic solvents are characterized by a lower melting point than that of any of its individual components. For example, choline chloride has a melting point of 302 °C and urea 113 °C; when mixing these two compounds, a eutectic mixture with a melting point of 12 °C is obtained (Zhang et al. 2012). This melting point depression is due to an interaction between the halide anion Cl⁻ and urea via hydrogen bonds, and consequently charge delocalization occurs. This indicates that the melting point is dependent on the nature of hydrogen bond acceptor and hydrogen bond donor and is highly in correlation with the hydrogen bond strength. The molar ratio of the deep eutectic solvent components also affects the melting point (Zhang et al. 2012). So it is considered when choosing the temperature in the extraction procedure.

6.3.2 Density

Most of deep eutectic solvents possess higher density values than water, with levels ranging from 1.041 to 1.63 g.cm⁻³. Density differences between deep eutectic solvents are explained by their molecular organization and packing (Zhang et al. 2012). Deep eutectic solvent density is higher than the individual components densities because of the “hole theory”: the radius of the existing holes decreases after mixing. Deep eutectic solvent’s density is a highly important property when separating phases in the extraction process especially in dispersive liquid-liquid

microextraction techniques because most of the separation processes are based on the density differences between the two phases. Deep eutectic solvent's density decreases linearly when the temperature is increased as it was shown by Florindo et al. (2014) and as presented in Fig. 6.16. Also, it is highly influenced by the deep eutectic solvent components molar ratio. For example, it was seen by Wahaibi et al. (2019) that the densities of the deep eutectic solvent choline chloride/malonic acid with 1:0.5 molar ratio are slightly higher than the same solvent with 1:1 molar ratio at all temperatures. As it was explained by the authors, that this is due to the presence of high amount of choline chloride in the first solvent because, as a general rule, the bulkier the cation is, the lower the density is (Wahaibi et al. 2019). Another reference proved also a similar result that is presented in Fig. 6.17 (Abbott et al. 2011).

6.3.3 Viscosity

The range of deep eutectic solvent's viscosity values are around 20–1000 times higher than that of water at room temperature (Dai et al. 2013a, b). Most of the deep eutectic solvents possess high viscosity values (>100 Cp) at room temperature (Zhang et al. 2012). The choline chloride/ethylene glycol (1:4 molar ratio) deep eutectic solvent possesses the lowest viscosity (Zhang et al. 2012). Mainly, the viscosity depends on the ion size, the void volume, the temperature, and the water content (Smith et al. 2014; Tang et al. 2014). The possible high viscosity of deep eutectic solvents is attributed to the presence of an extensive hydrogen-bonding network, Van der Waals, and/or electrostatic interactions between the compounds that restrict the mobility of the free species inside deep eutectic solvent and restrict the dispersion of deep eutectic solvent in the extraction medium during the extraction process (Zhang et al. 2012; Habibollahi et al. 2018). The high viscosity is good for the prevention of entrapped agents from vaporization, but it hampers the mass transfer and thus produces lower extraction efficiency. Therefore, this problem can be solved by increasing the temperature, thus leading to a better penetration of the solvents in the sample; this is known as Arrhenius-like behavior (Bubalo et al. 2018). Also, adding a certain percentage of water to a deep eutectic solvent, at which the deep eutectic solvent's network is still maintained, is another way to decrease deep eutectic solvent's viscosity (Qi et al. 2015; Fernández et al. 2018). However, Dai et al. (2015) showed that the addition of water above 50% can dissolve the deep eutectic solvent components in water (Dai et al. 2015). Also, the addition of water can alter the hydrogen bonds between deep eutectic solvent and the target compound (Bajkacz and Adamek 2017). Water-added deep eutectic solvents are more suitable for the extraction of polar compounds, whereas deep eutectic solvents with low water content are better for the extraction of nonpolar compounds (Dai et al. 2013a, b). Other parameters that may influence the viscosity of the deep eutectic solvent are the type of its components and the molar ratio. Cao et al. (2018) showed that the extraction yield of proanthocyanidin was decreased

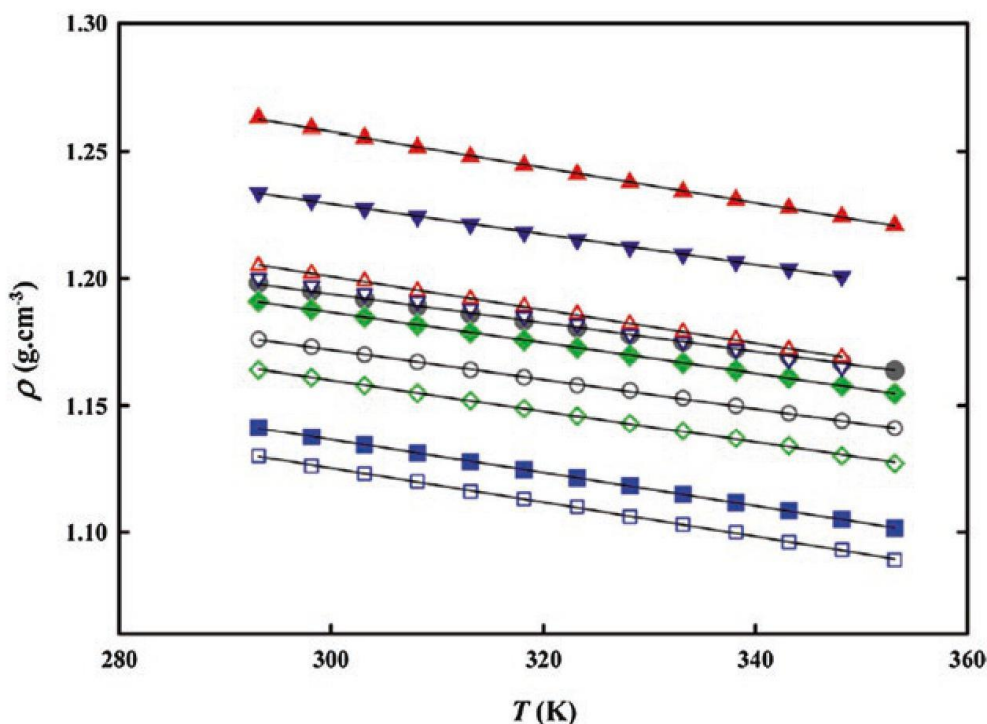

Fig. 6.16 Experimental densities (ρ) of some dried and water-saturated deep eutectic solvents as a function of temperature: choline chloride/oxalic acid (\blacktriangle), choline chloride/malonic acid (\blacktriangledown), choline chloride/glycerol (\bullet), choline chloride/glutaric acid (\blacklozenge), and choline chloride/levulinic acid (\blacksquare). The filled symbols correspond to the dried solvents, and the empty symbols correspond to the water-saturated solvents. When comparing the values obtained for the densities of the dried and the water-saturated solvents, it can be observed that the latter are lower, as expected. As observed, the density decreases linearly with temperature for all deep eutectic solvents (dried and water saturated) in the whole temperature range studied. (Figure reprinted with permission from Florindo et al. 2014)

when using deep eutectic solvent containing xylitol compared to those containing other alcohols because of the high viscosity of the first one. According to the authors, viscosities of deep eutectic solvents prepared with solid hydrogen bond donors were higher than those prepared with liquid hydrogen bond donors (Cao et al. 2018). Bi et al. (2013) showed that the amounts of the flavonoids extracted increased with decreasing choline chloride/hydrogen bond donor ratio from 1/1 to 1/5 (mol/mol) due to a decrease in viscosity (Bi et al. 2013). That means that the viscosity decreases when decreasing choline chloride concentration. However, Abbott et al. (2011) found the opposite result with choline chloride/glycerol deep eutectic solvent (Fig. 6.18). For example, at 20 °C, viscosities of this solvent with a choline chloride/glycerol molar ratio of 1:4, 1:3, and 1:2 were 503, 450, and 376 cP, respectively. This drastic decrease of the glycerol viscosity upon addition of choline chloride was attributed to the partial rupture of the intermolecular hydrogen bond network of glycerol (Abbott et al. 2011). Deep eutectic solvents with a high viscosity are good for the single-drop microextraction techniques because they facilitate the suspension of the drop at the end of the needle of a microsyringe.

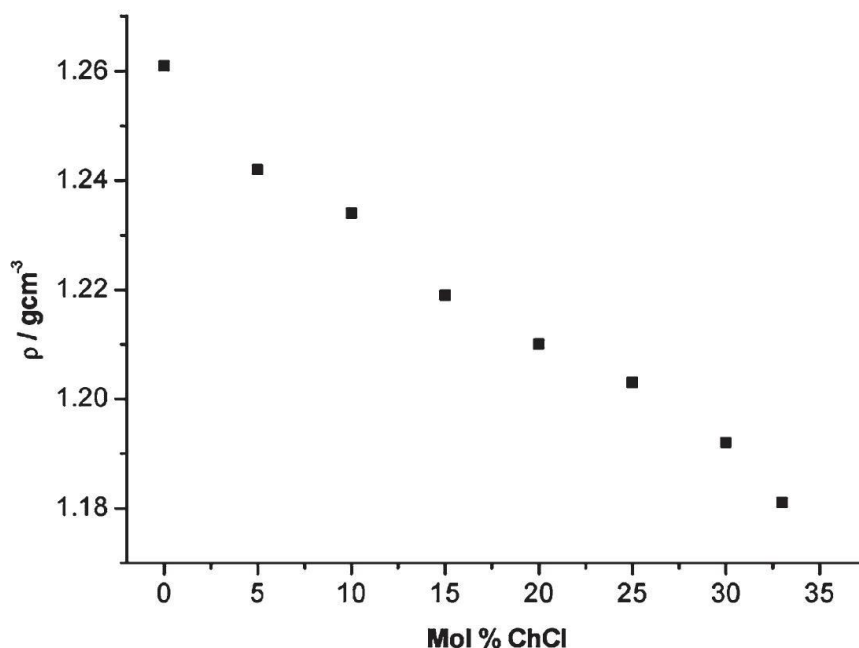

Fig. 6.17 Density (ρ) of the choline chloride/glycerol deep eutectic solvent as a function of choline chloride (ChCl) percentage. Addition of ChCl to glycerol results in a decrease of the deep eutectic solvent density. (Figure reprinted with permission from Abbott et al. 2011)

6.3.4 Compatibility with Instrumental Detection Systems

An extraction technique is useless without an appropriate detection method for the target compound. Therefore, a high advantage of using deep eutectic solvent in the extraction techniques is the absence of interference generally observed for these solvents with the detection methods. They showed a high compatibility with various instrumental detection systems such as mass spectrometry, flame ionization detector, UV-Vis spectroscopy, inductively coupled plasma-optical emission spectrometry, diode array detector, graphite furnace atomic absorption spectroscopy, Fourier transform infrared spectroscopy, and fluorescence; therefore, new combinations with advanced separation techniques like high-performance liquid chromatography, gas chromatography, and thin-layer chromatography are ongoing, for example, by using a certain percentage of deep eutectic solvent in the mobile phase (Tan et al. 2016).

6.3.5 Surface Tension

Surface tension depends on the strength of intermolecular interaction of deep eutectic solvent and on temperature (Tang et al. 2014). Therefore, it is positively dependent on the viscosity. Some deep eutectic solvent (for example, choline chloride/glycerol) showed a linear correlation between the surface tension and the

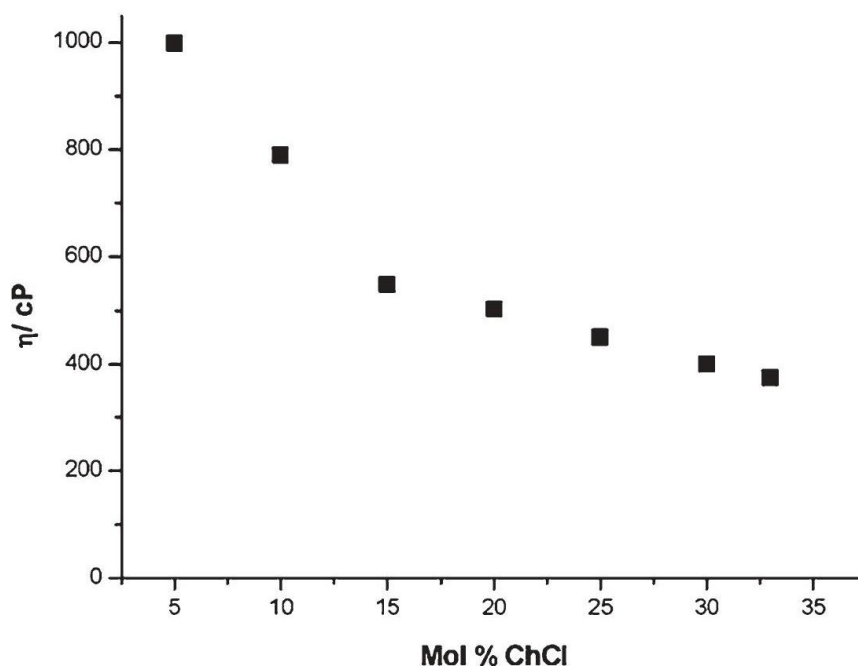

Fig. 6.18 Plot of the viscosity (η) of the choline chloride/glycerol deep eutectic solvent as a function of the choline chloride (ChCl) molar composition at 298 K. It can be seen that the viscosity decreases as the salt concentration increases. (Figure reprinted with permission from Abbott et al. 2011)

temperature but reciprocally with the choline chloride concentration. Generally, most of the deep eutectic solvents have higher surface tension than conventional solvents. Deep eutectic solvent with low surface tension can be applied as an adhesive or wetting agent in the extraction techniques (Li and Row 2016).

6.3.6 Polarity and Solubilizing Properties

Deep eutectic solvent's polarity is an important parameter regarding the miscibility of the deep eutectic solvent in other solvents or either in the sample solution (Dai et al. 2013a, b). Increasing the temperature leads to a decrease in the polarity of deep eutectic solvent because of the reduction of the hydrogen bond donating acidity of deep eutectic solvent, as observed with choline chloride/glycerol deep eutectic solvent (Tang et al. 2014). Also, a linear correlation exists between the polarity of deep eutectic solvent and the choline chloride concentration.

Deep eutectic solvents are known to have good solubilizing properties for polar and weak polar compounds, including drugs, pharmaceutical ingredients, metal oxides, carbon dioxide, and elemental species such as lead, mercury, cadmium, etc. (Aroso et al. 2016). Also, deep eutectic solvent proved better solubilizing effect, therefore better extractability compared to conventional solvents (Fernández et al. 2018). These properties may be rationalized, at least partially, by the "like dissolves

like” theory, thus helping the choice of the adequate deep eutectic solvent regarding its polarity. Due to the high number of starting components, different combinations can lead to various deep eutectic solvent with different properties. Recently, deep eutectic solvents have been tailored to be target-specific via the selection of specific individual components based on the analytes via *in silico* methods (Fernández et al. 2018). Unique interactions between the deep eutectic solvents with target analytes make it possible to selectively separate trace of this analyte from complex matrices (Fernández et al. 2018).

6.3.7 pH

Since this parameter determines the state of the analytes, the pH of deep eutectic solvent can affect the structures of the bioactive compounds subjected to extraction and thus the extraction efficiency. In their neutral forms, analytes are generally much easier to be extracted by weakly polar solvents. However, in their ionic forms, they have fewer tendencies to be extracted. Therefore, the pH of the extraction procedure should be higher than or near to the pKa values of the studied analytes (Mohebbi et al. 2018). The pH of different deep eutectic solvent changes differently with temperature, and the acidity of deep eutectic solvent is highly affected by the type of hydrogen bond donor (Tang et al. 2014). The highly polar molecules demand an acidic environment for a better extraction; therefore, organic acid-based deep eutectic solvents or natural deep eutectic solvents are the best choice. This was observed by organic acid-based natural deep eutectic solvent that showed the best extraction results for anthocyanin (polar compounds), while sugar-based natural deep eutectic solvents were a better choice for other phenolic compounds (Radošević et al. 2016). Finally, due to their amphoteric properties, the extraction of proteins is highly influenced by the pH (Li et al. 2016). The isoelectric point of the protein should be taken into consideration (Li et al. 2016). pH contributes as well for the reduction of the matrix interference (Karimi et al. 2017).

6.3.8 Cell Disruption Ability

Cell disruption plays an important role in the extraction of analytes; therefore, it is considered as a revealed parameter for the extraction efficiency. There is no doubt that some extraction techniques cause cell disruption such as ultrasonication, microwave extraction, as well as hot reflux extraction and others. However, the solvent used have an additional impact on the cell disruption. Using different extraction techniques followed by scanning electron microscope analysis, it was proved that deep eutectic solvents cause cell rupture more efficiently than water or other conventional extraction solvents (Table 6.11). This leads to the full release of the target analyte and its subsequent dissolution in deep eutectic solvent.

6.4 Optimization of Extraction Parameters

An extraction method can be selective for a specific analyte by monitoring the process parameters like temperature, pressure, flow, or power.

6.4.1 Type of Extraction Solvent

Being applied in the extraction methods as alternatives to conventional solvents, deep eutectic solvent should have high affinity for the target analytes (Yousefi et al. 2018). They should possess low solubility in supported liquid membrane solvent and high stability in the lumen of the used membrane in the case of hollow-fiber liquid-phase microextraction method (Khataei et al. 2018). Extraction process is affected not only by the type of hydrogen bond donor but also by the proportion of functional groups. For example, in contrast to the aqueous two-phase system extraction method, Yanhua et al. (2015) declared that hydrogen bonding interactions could be the main driving force in protein extraction; the OH groups can form hydrogen bonds with proteins more than the NH₂ groups because the electronegativity of oxygen is greater than that of nitrogen (Yanhua Huang et al. 2015).

6.4.2 Sample to Deep Eutectic Solvent Volume Ratio (V/V) Optimization

The volume of deep eutectic solvent should be sufficient for the solubilization of the analytes and for a fast extraction but as low as possible in order to avoid waste and environmental toxicity and to get a final volume of deep eutectic solvent adequate for the chromatographic analysis (Khataei et al. 2018; Mohebbi et al. 2018). On the other hand, a high volume of deep eutectic solvent leads to decreasing the extraction efficiency, and this is related to the dilution effect when freeze-drying cannot be performed (Mohebbi et al. 2018).

6.4.3 Matrix Ions

Coexisting ions can enter in competition with the target analytes, thus reducing the recoveries values, and the extraction efficiency of the method (Karimi et al. 2017). This parameter reveals the selectivity of the method (Aydin et al. 2018). Salt can act as an effective dehydrating agent for more hydrophilic analytes, also called salting-out effect, in which the solubility of the analytes in the aqueous solution decreases, leading to a better extraction and, subsequently, a good-phase separation. However,

Table 6.11 Extraction techniques that proved the cell disruption ability of deep eutectic solvents

Extraction medium	Target compounds	Selected DES HBA/HBD (molar ratio)	Extraction technique	Disruption degree order	References
Radix Salviae Miltiorrhizae	Rosmarinic acid, lithospermic acid, salvianolic acid B, salvianolic acid A, tanshinone 2 A	Choline chloride/1,2-propanediol (1:1) + 20 vol% of water	Microwave extraction	DES > 75% methanol > water	Chen et al. (2016)
Green tea (<i>Camellia sinensis</i>)	Catechins: epigallocatechin-3-gallate	81% betaine/glycerol/D-glucose (4:20:1)	Ultrasound microextraction	81% DES > methanol or 70% methanol	Jeong et al. (2017)
Morus alba leaves	Phenolic compounds	Choline chloride/citric acid (2:1)	Ultrasound microextraction	DES > 75% methanol > water	Zhou et al. (2018)
<i>Scutellaria baicalensis</i> Georgi (Chinese herbal medicine)	Baicalin	Decanoic acid/tetrabutylammonium chloride (1: 2) + 30% v/v water	Microwave extraction or ultrasound extraction or hot reflux extraction	Microwave extraction > ultrasound extraction > hot reflux extraction. Also, DES > 70 vol% ethanol	Wang et al. (2018)

DES deep eutectic solvent, HBA hydrogen bond acceptor, HBD hydrogen bond donor

at higher concentrations, the solution viscosity can significantly increase due to the salting-in phenomena, leading to a noticeable reduction in the diffusion rate of the target analytes into the extraction liquid phase, thus reducing the extraction efficiency (Khataei et al. 2018; Moghadam et al. 2018; Mohebbi et al. 2018).

6.4.4 Type of Emulsifier Agent

Some microextraction techniques require a nonmiscibility of the deep eutectic solvent in the aqueous solution, for example, emulsification microextraction. Therefore, it is important to use an emulsifier agent or an aprotic solvent in order to release the bonding of water-miscible deep eutectic solvent from the water molecules. This leads to a self-aggregation of deep eutectic solvent molecules. Many aprotic solvents are used: tetrahydrofuran, acetone, 1,4-dioxane, dichloromethane, and others (Moghadam et al. 2018).

6.4.5 Temperature

As mentioned earlier, this parameter positively affects the viscosity of deep eutectic solvent, and therefore, it can affect the diffusivity of analytes to deep eutectic solvent; however, it should be optimized in the extraction of thermolabile analytes in order to prevent their decomposition (Li et al. 2016). When using sorbents coated by deep eutectic solvent, increasing the temperature can desorb the deep eutectic solvent molecules from the sorbents, thus diminishing the extraction capacity (Huang et al. 2015). For the extraction of volatile compounds, temperature is a critical parameter that should be controlled. At high temperature, they are rapidly volatilized which leads to a higher extraction efficiency (Tang et al. 2014). However, increasing temperature for the extraction of nonvolatile compounds enhances their desorption from the matrix and their solubilization in deep eutectic solvent (Qi et al. 2015; Huang et al. 2015). In the case of proteins, attention should be paid to the temperature for it won't cause proteins denaturation (Li et al. 2016).

6.4.6 Time

An optimal time should be chosen for the best diffusion of the analytes from the original sample to the deep eutectic solvent. This parameter should be well controlled especially when having an adsorption/desorption process because in liquid-phase microextraction methods, the extraction should reach an equilibrium (Tang et al. 2014). Also, long extraction time can cause high risk of losing solvents and formation of air bubbles (Khataei et al. 2018).

6.4.7 Agitation or Vortexing

It is important to accelerate the extraction; however, it is necessary to disperse the best media in order to get a good contact between the analytes and the extraction solvent. So the vortex apparatus type and the vortex time are very important parameters (Aydin et al. 2018). Ultrasonication can be also applied. It increases the mass transfer of target compounds, and it decreases the extraction time (Gu et al. 2014).

6.5 Conclusion

Extensive studies have been conducted on the different applications of deep eutectic solvents. Their low cost, their ease of synthesis, and their eco-friendly behavior make them suitable extraction solvents in the newly developed microextraction techniques. This review confirmed that the use of deep eutectic solvent in many extraction techniques, either alone or mixed in a certain percentage of water, has given many advantages compared to the highly toxic conventional organic solvents. Mainly, this was proved by the enhanced extraction efficiency for different kind of molecules and macromolecules especially drugs, proteins, and plants secondary metabolites. In addition, deep eutectic solvent properties, such as melting point, density, viscosity, compatibility with instrumental detection systems, surface tension, polarity and solubilizing properties, pH, and cell disruption ability, should be considered for a maximum extraction efficiency. Extraction method parameters including type of deep eutectic solvent, sample to deep eutectic solvent volume ratio (v/v), effect of matrix ions, type of emulsifier agent, temperature, time, and agitation should be optimized. Future studies should be carried for the extraction of other important bio-based compounds and for the development of new extraction techniques that could be even greener. Also, the application of these solvents in the industrial large-scale extraction techniques should be investigated later on.

Acknowledgments Lamia Nakhle has received a scholarship from Université du Littoral Côte d'Opale (ULCO) and from the Lebanese National Council for Scientific Research (CNRS-L).

References

- Abbott AP, Capper G, Davies DL, Rasheed RK, Tambyrajah V (2003) Novel solvent properties of choline chloride/urea mixtures Electronic supplementary information (ESI) available: spectroscopic data. See <http://www.rsc.org/suppdata/cc/b2/b210714g/>. Chem Commun 1:70–71. <https://doi.org/10.1039/b210714g>
- Abbott AP, Boothby D, Capper G, Davies DL, Rasheed RK (2004) Deep eutectic solvents formed between choline chloride and carboxylic acids: versatile alternatives to ionic liquids. J Am Chem Soc 126(29):9142–9147. <https://doi.org/10.1021/ja048266j>

- Abbott AP, Harris RC, Ryder KS, D'Agostino C, Gladden LF, Mantle MD (2011) Glycerol eutectics as sustainable solvent systems. *Green Chem* 13(1):82–90. <https://doi.org/10.1039/C0GC00395F>
- Alfonsi K, Colberg J, Dunn PJ, Fevig T, Jennings S, Johnson TA, Kleine HP, Knight C, Nagy MA, Perry DA, Stefaniak M (2008) Green chemistry tools to influence a medicinal chemistry and research chemistry based organisation. *Green Chem* 10(1):31–36. <https://doi.org/10.1039/B711717E>
- Anastas P, Eghbali N (2010) Green chemistry: principles and practice. *Chem Soc Rev* 39(1):301–312. <https://doi.org/10.1039/B918763B>
- Aroso IM, Silva JC, Mano F, Ferreira ASD, Dionísio M, Sá-Nogueira I, Barreiros S, Reis RL, Paiva A, Duarte ARC (2016) Dissolution enhancement of active pharmaceutical ingredients by therapeutic deep eutectic systems. *Eur J Pharm Biopharm* 98:57–66. <https://doi.org/10.1016/j.ejpb.2015.11.002>
- Athanasiadis V, Grigorakis S, Lalas S, Makris DP (2018) Highly efficient extraction of antioxidant polyphenols from *Olea europaea* leaves using an eco-friendly glycerol/glycine deep eutectic solvent. *Waste Biomass Valoriz* 9(11):1985–1992. <https://doi.org/10.1007/s12649-017-9997-7>
- Aydin F, Yilmaz E, Soylak M (2018) Vortex assisted deep eutectic solvent (DES)-emulsification liquid-liquid microextraction of trace curcumin in food and herbal tea samples. *Food Chem* 243:442–447. <https://doi.org/10.1016/j.foodchem.2017.09.154>
- Azmir J, Zaidul ISM, Rahman MM, Sharif KM, Mohamed A, Sahena F, Jahurul MHA, Ghafoor K, Norulaini NAN, Omar AKM (2013) Techniques for extraction of bioactive compounds from plant materials: a review. *J Food Eng* 117(4):426–436. <https://doi.org/10.1016/j.jfoodeng.2013.01.014>
- Bağda E, Altundağ H, Soylak M (2017) Highly simple deep eutectic solvent extraction of manganese in vegetable samples prior to its ICP-OES analysis. *Biol Trace Elem Res* 179(2):334–339. <https://doi.org/10.1007/s12011-017-0967-5>
- Bajkacz S, Adamek J (2017) Evaluation of new natural deep eutectic solvents for the extraction of isoflavones from soy products. *Talanta* 168:329–335. <https://doi.org/10.1016/j.talanta.2017.02.065>
- Bakirtzi C, Triantafyllidou K, Makris DP (2016) Novel lactic acid-based natural deep eutectic solvents: efficiency in the ultrasound-assisted extraction of antioxidant polyphenols from common native Greek medicinal plants. *J Appl Res Med Aromat Plants* 3(3):120–127. <https://doi.org/10.1016/j.jarmap.2016.03.003>
- Bi W, Tian M, Row KH (2013) Evaluation of alcohol-based deep eutectic solvent in extraction and determination of flavonoids with response surface methodology optimization. *J Chromatogr A* 1285:22–30. <https://doi.org/10.1016/j.chroma.2013.02.041>
- Bosiljkov T, Dujmić F, Cvjetko Bubalo M, Hribar J, Vidrih R, Brnčić M, Zlatic E, Radojčić Redovniković I, Jokić S (2017) Natural deep eutectic solvents and ultrasound-assisted extraction: green approaches for extraction of wine lees anthocyanins. *Food Bioprod Process* 102:195–203. <https://doi.org/10.1016/j.fbp.2016.12.005>
- Cao J, Chen L, Li M, Cao F, Zhao L, Su E (2018) Efficient extraction of proanthocyanidin from *Ginkgo biloba* leaves employing rationally designed deep eutectic solvent-water mixture and evaluation of the antioxidant activity. *J Pharm Biomed Anal* 158:317–326. <https://doi.org/10.1016/j.jpba.2018.06.007>
- Chanioti S, Tzia C (2018) Extraction of phenolic compounds from olive pomace by using natural deep eutectic solvents and innovative extraction techniques. *Innovative Food Sci Emerg Technol* 48:228–239. <https://doi.org/10.1016/j.ifset.2018.07.001>
- Chemat F, Vian MA, Cravotto G (2012) Green extraction of natural products: concept and principles. *Int J Mol Sci* 13(7):8615–8627. <https://doi.org/10.3390/ijms13078615>
- Chen J, Liu M, Wang Q, Du H, Zhang L (2016) Deep eutectic solvent-based microwave-assisted method for extraction of hydrophilic and hydrophobic components from radix *salviae miltiorrhizae*. *Molecules* 21(10):1383. <https://doi.org/10.3390/molecules21101383>

- Choi YH, van Spronsen J, Dai Y, Verberne M, Hollmann F, Arends IWCE, Witkamp G-J, Verpoorte R (2011) Are natural deep eutectic solvents the missing link in understanding cellular metabolism and physiology? *Plant Physiol* 156(4):1701–1705. <https://doi.org/10.1104/pp.111.178426>
- Cui Q, Peng X, Yao X-H, Wei Z-F, Luo M, Wang W, Zhao C-J, Fu Y-J, Zu Y-G (2015) Deep eutectic solvent-based microwave-assisted extraction of genistin, genistein and apigenin from pigeon pea roots. *Sep Purif Technol* 150:63–72. <https://doi.org/10.1016/j.seppur.2015.06.026>
- Cvjetko Bubalo M, Ćurko N, Tomašević M, Kovačević Ganić K, Radojčić Redovniković I (2016) Green extraction of grape skin phenolics by using deep eutectic solvents. *Food Chem* 200:159–166. <https://doi.org/10.1016/j.foodchem.2016.01.040>
- Cvjetko Bubalo M, Vidović S, Radojčić Redovniković I, Jokić S (2018) New perspective in extraction of plant biologically active compounds by green solvents. *Food Bioprod Process* 109:52–73. <https://doi.org/10.1016/j.fbp.2018.03.001>
- Dai Y, Witkamp G-J, Verpoorte R, Choi YH (2013a) Natural deep eutectic solvents as a new extraction media for phenolic metabolites in *Carthamus tinctorius* L. *Anal Chem* 85(13):6272–6278. <https://doi.org/10.1021/ac400432p>
- Dai Y, van Spronsen J, Witkamp G-J, Verpoorte R, Choi YH (2013b) Ionic liquids and deep eutectic solvents in natural products research: mixtures of solids as extraction solvents. *J Nat Prod* 76(11):2162–2173. <https://doi.org/10.1021/np400051w>
- Dai Y, Verpoorte R, Choi YH (2014) Natural deep eutectic solvents providing enhanced stability of natural colorants from safflower (*Carthamus tinctorius*). *Food Chem* 159:116–121. <https://doi.org/10.1016/j.foodchem.2014.02.155>
- Dai Y, Witkamp G-J, Verpoorte R, Choi YH (2015) Tailoring properties of natural deep eutectic solvents with water to facilitate their applications. *Food Chem* 187:14–19. <https://doi.org/10.1016/j.foodchem.2015.03.123>
- Dai Y, Rozema E, Verpoorte R, Choi YH (2016) Application of natural deep eutectic solvents to the extraction of anthocyanins from *Catharanthus roseus* with high extractability and stability replacing conventional organic solvents. *J Chromatogr A* 1434:50–56. <https://doi.org/10.1016/j.chroma.2016.01.037>
- Dai Y, Zhang H-S, Huan B, He Y (2017) Enhancing the enzymatic saccharification of bamboo shoot shell by sequential biological pretreatment with *Galactomyces* sp. CCZU11-1 and deep eutectic solvent extraction. *Bioprocess Biosyst Eng* 40(9):1427–1436. <https://doi.org/10.1007/s00449-017-1800-4>
- Das AK, Sharma M, Mondal D, Prasad K (2016) Deep eutectic solvents as efficient solvent system for the extraction of κ -carrageenan from *Kappaphycus alvarezii*. *Carbohydr Polym* 136:930–935. <https://doi.org/10.1016/j.carbpol.2015.09.114>
- de Cássia da Silveira e Sá R, Andrade L, dos Reis Barreto de Oliveira R, de Sousa D (2014) A review on anti-inflammatory activity of phenylpropanoids found in essential oils. *Molecules* 19(2):1459–1480. <https://doi.org/10.3390/molecules19021459>
- El Achkar T, Fourmentin S, Greige-Gerges H (2019) Deep eutectic solvents: an overview on their interactions with water and biochemical compounds. *J Mol Liq* 288:111028. <https://doi.org/10.1016/j.molliq.2019.111028>
- Farajzadeh MA, Sattari Dabbagh M, Yadeghari A (2017) Deep eutectic solvent based gas-assisted dispersive liquid-phase microextraction combined with gas chromatography and flame ionization detection for the determination of some pesticide residues in fruit and vegetable samples. *J Sep Sci* 40(10):2253–2260. <https://doi.org/10.1002/jssc.201700052>
- Fernández M d l Á, Espino M, Gomez FJV, Silva MF (2018) Novel approaches mediated by tailor-made green solvents for the extraction of phenolic compounds from agro-food industrial by-products. *Food Chem* 239:671–678. <https://doi.org/10.1016/j.foodchem.2017.06.150>
- Ferrone V, Genovese S, Carlucci M, Tiecco M, Germani R, Preziuso F, Epifano F, Carlucci G, Taddeo VA, (2018) A green deep eutectic solvent dispersive liquid-liquid micro-extraction (DES-DLLME) for the UHPLC-PDA determination of oxyprenylated phenylpropanoids in olive, soy, peanuts, corn, and sunflower oil. *Food Chemistry* 245:578–585

- Florindo C, Oliveira FS, Rebelo LPN, Fernandes AM, Marrucho IM (2014) Insights into the synthesis and properties of deep eutectic solvents based on cholinium chloride and carboxylic acids. *ACS Sustain Chem Eng* 2(10):2416–2425. <https://doi.org/10.1021/sc500439w>
- Gan K, Tang W, Zhu T, Li W, Wang H, Liu X (2016) Enhanced extraction of cleistanthol from *Phyllanthus flexuosus* by deep eutectic solvent-modified anion-exchange resin. *J Liq Chromatogr Relat Technol* 39(19–20):882–888. <https://doi.org/10.1080/10826076.2017.1278609>
- García A, Rodríguez-Juan E, Rodríguez-Gutiérrez G, Rios JJ, Fernández-Bolaños J (2016) Extraction of phenolic compounds from virgin olive oil by deep eutectic solvents (DESs). *Food Chem* 197:554–561. <https://doi.org/10.1016/j.foodchem.2015.10.131>
- Ge D, Zhang Y, Dai Y, Yang S (2018) Air-assisted dispersive liquid-liquid microextraction based on a new hydrophobic deep eutectic solvent for the preconcentration of benzophenone-type UV filters from aqueous samples. *J Sep Sci* 41(7):1635–1643. <https://doi.org/10.1002/jssc.201701282>
- González CG, Mustafa NR, Wilson EG, Verpoorte R, Choi YH (2018) Application of natural deep eutectic solvents for the “green” extraction of vanillin from vanilla pods. *Flavour Fragr J* 33(1):91–96. <https://doi.org/10.1002/ffj.3425>
- Gu T, Zhang M, Tan T, Chen J, Li Z, Zhang Q, Qiu H (2014) Deep eutectic solvents as novel extraction media for phenolic compounds from model oil. *Chem Commun* 50(79):11749–11752. <https://doi.org/10.1039/C4CC04661G>
- Guo W, Hou Y, Wu W, Ren S, Tian S, Marsh KN (2013) Separation of phenol from model oils with quaternary ammonium salts via forming deep eutectic solvents. *Green Chem* 15(1):226–229. <https://doi.org/10.1039/C2GC36602A>
- Habibollahi MH, Karimyan K, Arfaenia H, Mirzaei N, Safari Y, Akramipour R, Sharafi H, Fattahi N (2018) Extraction and determination of heavy metals in soil and vegetables irrigated with treated municipal wastewater using new mode of dispersive liquid-liquid microextraction based on the solidified deep eutectic solvent followed by GFAAS: extraction of heavy metals using dispersive liquid-liquid microextraction. *J Sci Food Agric* 99(2):656–665. <https://doi.org/10.1002/jsfa.9230>
- Hawthorne SB, Miller DJ, Pawliszyn J, Arthur CL (1992) Solventless determination of caffeine in beverages using solid-phase microextraction with fused-silica fibers. *J Chromatogr A* 603(1–2):185–191. [https://doi.org/10.1016/0021-9673\(92\)85360-6](https://doi.org/10.1016/0021-9673(92)85360-6)
- Helalat-Nezhad Z, Ghanemi K, Fallah-Mehrjardi M (2015) Dissolution of biological samples in deep eutectic solvents: an approach for extraction of polycyclic aromatic hydrocarbons followed by liquid chromatography-fluorescence detection. *J Chromatogr A* 1394:46–53. <https://doi.org/10.1016/j.chroma.2015.03.053>
- Hu Y, Hu R, Zhu Q, Zhan J, Liu H, Yao B (2012) Improved selective extraction of 3,3'-dichlorobenzidine by molecularly imprinted polysiloxane microspheres. *Environ Chem Lett* 10(3):275–280. <https://doi.org/10.1007/s10311-011-0350-2>
- Huang Y, Wang Y, Pan Q, Wang Y, Ding X, Xu K, Li N, Wen Q (2015) Magnetic graphene oxide modified with choline chloride-based deep eutectic solvent for the solid-phase extraction of protein. *Anal Chim Acta* 877:90–99. <https://doi.org/10.1016/j.aca.2015.03.048>
- Huang Y, Feng F, Jiang J, Qiao Y, Wu T, Voglmeir J, Chen Z-G (2017) Green and efficient extraction of rutin from tartary buckwheat hull by using natural deep eutectic solvents. *Food Chem* 221:1400–1405. <https://doi.org/10.1016/j.foodchem.2016.11.013>
- Ince M, Kaya G, Yaman M (2010) Solid phase extraction and preconcentration of cobalt in mineral waters with PAR-loaded Amberlite XAD-7 and flame atomic absorption spectrometry. *Environ Chem Lett* 8(3):283–288. <https://doi.org/10.1007/s10311-009-0218-x>
- Jain R, Kumar A, Shukla Y, Mudiam MKR (2015) Dispersive liquid-liquid microextraction-injector port silylation: a viable option for the analysis of polar analytes using gas chromatography-mass spectrometry. *Austin J Anal Pharm Chem* 2(3):4
- Jeong KM, Ko J, Zhao J, Jin Y, Yoo DE, Han SY, Lee J (2017) Multi-functioning deep eutectic solvents as extraction and storage media for bioactive natural products that are readily applicable to cosmetic products. *J Clean Prod* 151:87–95. <https://doi.org/10.1016/j.jclepro.2017.03.038>

- Karimi M, Dadfarnia S, Shabani AMH (2017) Application of deep eutectic solvent modified cotton as a sorbent for online solid-phase extraction and determination of trace amounts of copper and nickel in water and biological samples. *Biol Trace Elem Res* 176(1):207–215. <https://doi.org/10.1007/s12011-016-0814-0>
- Khataei MM, Yamini Y, Nazaripour A, Karimi M (2018) Novel generation of deep eutectic solvent as an acceptor phase in three-phase hollow fiber liquid phase microextraction for extraction and preconcentration of steroidal hormones from biological fluids. *Talanta* 178:473–480. <https://doi.org/10.1016/j.talanta.2017.09.068>
- Khezeli T, Daneshfar A, Sahraei R (2016) A green ultrasonic-assisted liquid–liquid microextraction based on deep eutectic solvent for the HPLC-UV determination of ferulic, caffeic and cinnamic acid from olive, almond, sesame and cinnamon oil. *Talanta* 150:577–585. <https://doi.org/10.1016/j.talanta.2015.12.077>
- Lamei N, Ezoddin M, Abdi K (2017) Air assisted emulsification liquid-liquid microextraction based on deep eutectic solvent for preconcentration of methadone in water and biological samples. *Talanta* 165:176–181. <https://doi.org/10.1016/j.talanta.2016.11.036>
- Li X, Row KH (2016) Development of deep eutectic solvents applied in extraction and separation: liquid chromatography. *J Sep Sci* 39(18):3505–3520. <https://doi.org/10.1002/jssc.201600633>
- Li G, Row KH (2018) Selective extraction of 3,4-dihydroxybenzoic acid in *Ilex chinensis* Sims by meticulous mini-solid-phase microextraction using ternary deep eutectic solvent-based molecularly imprinted polymers. *Anal Bioanal Chem* 410(30):7849–7858. <https://doi.org/10.1007/s00216-018-1406-y>
- Li N, Wang Y, Xu K, Huang Y, Wen Q, Ding X (2016) Development of green betaine-based deep eutectic solvent aqueous two-phase system for the extraction of protein. *Talanta* 152:23–32. <https://doi.org/10.1016/j.talanta.2016.01.042>
- Li Z, Jia J, Wang M, Zhang H, Yan H, Qiao F (2017) Bifunctionalized ordered mesoporous organosilica synthesized in deep eutectic solvent for extraction of triazine herbicides from watermelon. *J Chromatogr A* 1529:50–56. <https://doi.org/10.1016/j.chroma.2017.10.074>
- Liu W, Fu Y, Zu Y, Kong Y, Zhang L, Zu B, Efferth T (2009) Negative-pressure cavitation extraction for the determination of flavonoids in pigeon pea leaves by liquid chromatography–tandem mass spectrometry. *J Chromatogr A* 1216(18):3841–3850. <https://doi.org/10.1016/j.chroma.2009.02.073>
- Liu X, Ahlgren S, Korthout HAAJ, Salomé-Abarca LF, Bayona LM, Verpoorte R, Choi YH (2018) Broad range chemical profiling of natural deep eutectic solvent extracts using a high performance thin layer chromatography–based method. *J Chromatogr A* 1532:198–207. <https://doi.org/10.1016/j.chroma.2017.12.009>
- Machmudah S, Lestari SD, Widiyastuti W, Kanda H, Winardi S, Goto M (2018) Subcritical water extraction enhancement by adding deep eutectic solvent for extracting xanthone from mango-steen pericarps. *J Supercrit Fluids* 133:615–624. <https://doi.org/10.1016/j.supflu.2017.06.012>
- Moghadam AG, Rajabi M, Asghari A (2018) Efficient and relatively safe emulsification microextraction using a deep eutectic solvent for influential enrichment of trace main anti-depressant drugs from complicated samples. *J Chromatogr B* 1072:50–59. <https://doi.org/10.1016/j.jchromb.2017.09.042>
- Mohebbi A, Yaripour S, Farajzadeh MA, Afshar Mogaddam MR (2018) Combination of dispersive solid phase extraction and deep eutectic solvent–based air–assisted liquid–liquid microextraction followed by gas chromatography–mass spectrometry as an efficient analytical method for the quantification of some tricyclic antidepressant drugs in biological fluids. *J Chromatogr A* 1571:84–93. <https://doi.org/10.1016/j.chroma.2018.08.022>
- Moura L, Moufawad T, Ferreira M, Bricout H, Tilloy S, Monflier E, Costa Gomes MF, Landy D, Fourmentin S (2017) Deep eutectic solvents as green absorbents of volatile organic pollutants. *Environ Chem Lett* 15(4):747–753. <https://doi.org/10.1007/s10311-017-0654-y>
- Mouratoglou E, Malliou V, Makris DP (2016) Novel glycerol-based natural eutectic mixtures and their efficiency in the ultrasound-assisted extraction of antioxidant polyphenols from

- agri-food waste biomass. *Waste Biomass Valoriz* 7(6):1377–1387. <https://doi.org/10.1007/s12649-016-9539-8>
- Nam MW, Zhao J, Lee MS, Jeong JH, Lee J (2015) Enhanced extraction of bioactive natural products using tailor-made deep eutectic solvents: application to flavonoid extraction from *Flos sophorae*. *Green Chem* 17(3):1718–1727. <https://doi.org/10.1039/C4GC01556H>
- Nugbienyo L, Shishov A, Garmonov S, Moskvina L, Andruch V, Bulatov A (2017) Flow method based on liquid-liquid extraction using deep eutectic solvent for the spectrofluorimetric determination of procainamide in human saliva. *Talanta* 168:307–312. <https://doi.org/10.1016/j.talanta.2017.03.057>
- Ojeda CB, Rojas FS (2018) Vortex-assisted liquid-liquid microextraction (VALLME): the latest applications. *Chromatographia* 81(1):89–103. <https://doi.org/10.1007/s10337-017-3403-2>
- Okenicová L, Žemberyová M, Procházková S (2016) Biosorbents for solid-phase extraction of toxic elements in waters. *Environ Chem Lett* 14(1):67–77. <https://doi.org/10.1007/s10311-015-0539-x>
- Oller-Ruiz A, Garrido I, Viñas P, Campillo N, Fenoll J, Hernández-Córdoba M (2018) Reliable analysis of chlorophenoxy herbicides in soil and water by magnetic solid phase extraction and liquid chromatography. *Environ Chem Lett* 16(3):1077–1082. <https://doi.org/10.1007/s10311-018-0725-8>
- Pedersen-Bjergaard S, Rasmussen KE (1999) Liquid-liquid-liquid microextraction for sample preparation of biological fluids prior to capillary electrophoresis. *Anal Chem* 71(14):2650–2656. <https://doi.org/10.1021/ac990055n>
- Peng X, Duan M-H, Yao X-H, Zhang Y-H, Zhao C-J, Zu Y-G, Fu Y-J (2016) Green extraction of five target phenolic acids from *Lonicera japonica* Flos with deep eutectic solvent. *Sep Purif Technol* 157:249–257. <https://doi.org/10.1016/j.seppur.2015.10.065>
- Peng F, Xu P, Zhao B-Y, Zong M-H, Lou W-Y (2018) The application of deep eutectic solvent on the extraction and in vitro antioxidant activity of rutin from *Sophora japonica* bud. *J Food Sci Technol* 55(6):2326–2333. <https://doi.org/10.1007/s13197-018-3151-9>
- Picó Y, Fernández M, Ruiz MJ, Font G (2007) Current trends in solid-phase-based extraction techniques for the determination of pesticides in food and environment. *J Biochem Biophys Methods* 70(2):117–131. <https://doi.org/10.1016/j.jbbm.2006.10.010>
- Qi X-L, Peng X, Huang Y-Y, Li L, Wei Z-F, Zu Y-G, Fu Y-J (2015) Green and efficient extraction of bioactive flavonoids from *Equisetum palustre* L. by deep eutectic solvents-based negative pressure cavitation method combined with macroporous resin enrichment. *Ind Crop Prod* 70:142–148. <https://doi.org/10.1016/j.indcrop.2015.03.026>
- Radošević K, Čurko N, Gaurina Srček V, Cvjetko Bubalo M, Tomašević M, Kovačević Ganić K, Radojčić Redovniković I (2016) Natural deep eutectic solvents as beneficial extractants for enhancement of plant extracts bioactivity. *LWT* 73:45–51. <https://doi.org/10.1016/j.lwt.2016.05.037>
- Raynie DE (2004) Modern extraction techniques. *Anal Chem* 76(16):4659–4664. <https://doi.org/10.1021/ac040117w>
- Rezaee M, Assadi Y, Milani Hosseini M-R, Aghaee E, Ahmadi F, Berijani S (2006) Determination of organic compounds in water using dispersive liquid-liquid microextraction. *J Chromatogr A* 1116(1–2):1–9. <https://doi.org/10.1016/j.chroma.2006.03.007>
- Ribeiro BD, Coelho MAZ, Marrucho IM (2013) Extraction of saponins from sisal (*Agave sisalana*) and juá (*Ziziphus joazeiro*) with cholinium-based ionic liquids and deep eutectic solvents. *Eur Food Res Technol* 237(6):965–975. <https://doi.org/10.1007/s00217-013-2068-9>
- Ribeiro AR, Gonçalves VMF, Maia AS, Ribeiro C, Castro PML, Tiritan ME (2015) Dispersive liquid-liquid microextraction and HPLC to analyse fluoxetine and metoprolol enantiomers in wastewaters. *Environ Chem Lett* 13(2):203–210. <https://doi.org/10.1007/s10311-015-0498-2>
- Ruesgas-Ramón M, Figueroa-Espinoza MC, Durand E (2017) Application of deep eutectic solvents (DES) for phenolic compounds extraction: overview, challenges, and opportunities. *J Agric Food Chem* 65(18):3591–3601. <https://doi.org/10.1021/acs.jafc.7b01054>

- Saravana PS, Cho Y-N, Woo H-C, Chun B-S (2018a) Green and efficient extraction of polysaccharides from brown seaweed by adding deep eutectic solvent in subcritical water hydrolysis. *J Clean Prod* 198:1474–1484. <https://doi.org/10.1016/j.jclepro.2018.07.151>
- Saravana PS, Ho TC, Chae S-J, Cho Y-J, Park J-S, Lee H-J, Chun B-S (2018b) Deep eutectic solvent-based extraction and fabrication of chitin films from crustacean waste. *Carbohydr Polym* 195:622–630. <https://doi.org/10.1016/j.carbpol.2018.05.018>
- Sha Y, Huang D, Zheng S, Liu B, Deng C (2013) Development of microwave-assisted headspace solid-phase microextraction followed by gas chromatography-mass spectrometry for the analysis of phenol in a cigarette pad. *Anal Methods* 5(18):4655. <https://doi.org/10.1039/c3ay40273h>
- Smith EL, Abbott AP, Ryder KS (2014) Deep eutectic solvents (DESs) and their applications. *Chem Rev* 114(21):11060–11082. <https://doi.org/10.1021/cr300162p>
- Tan T, Zhang M, Wan Y, Qiu H (2016) Utilization of deep eutectic solvents as novel mobile phase additives for improving the separation of bioactive quaternary alkaloids. *Talanta* 149:85–90. <https://doi.org/10.1016/j.talanta.2015.11.041>
- Tang B, Bi W, Zhang H, Row KH (2014) Deep eutectic solvent-based HS-SME coupled with GC for the analysis of bioactive terpenoids in *Chamaecyparis obtusa* leaves. *Chromatographia* 77(3–4):373–377. <https://doi.org/10.1007/s10337-013-2607-3>
- Tang W, Gao F, Duan Y, Zhu T, Ho Row K (2017) Exploration of deep eutectic solvent-based molecularly imprinted polymers as solid-phase extraction sorbents for screening chloramphenicol in milk. *J Chromatogr Sci* 55(6):654–661. <https://doi.org/10.1093/chromsci/bmx011>
- van Osch DJGP, Zubeir LF, van den Bruinhorst A, Rocha MAA, Kroon MC (2015) Hydrophobic deep eutectic solvents as water-immiscible extractants. *Green Chem* 17(9):4518–4521. <https://doi.org/10.1039/C5GC01451D>
- Vanda H, Dai Y, Wilson EG, Verpoorte R, Choi YH (2018) Green solvents from ionic liquids and deep eutectic solvents to natural deep eutectic solvents. *C R Chim* 21(6):628–638. <https://doi.org/10.1016/j.crci.2018.04.002>
- Wahaibi IA, Wahaibi YA, Hajri RA, Jibril B, Shuwa S (2019) The novel use of malonic acid-based deep eutectic solvents for enhancing heavy oil recovery. *Int J Oil Gas Coal Technol* 20(1):31. <https://doi.org/10.1504/IJOGCT.2019.096493>
- Wang M, Wang J, Zhang Y, Xia Q, Bi W, Yang X, Chen DDY (2016) Fast environment-friendly ball mill-assisted deep eutectic solvent-based extraction of natural products. *J Chromatogr A* 1443:262–266. <https://doi.org/10.1016/j.chroma.2016.03.061>
- Wang W, Du Y, Xiao Z, Li Y, Li B, Yang G (2017) Determination of trace rhodamine B in chili oil by deep eutectic solvent extraction and an ultra high-performance liquid chromatograph equipped with a fluorescence detector. *Anal Sci* 33(6):715–717. <https://doi.org/10.2116/analsci.33.715>
- Wang H, Ma X, Cheng Q, Xi X, Zhang L (2018) Deep eutectic solvent-based microwave-assisted extraction of baicalin from *Scutellaria baicalensis* Georgi. *J Chem* 2018:1–10. <https://doi.org/10.1155/2018/9579872>
- Wei Z-F, Wang X-Q, Peng X, Wang W, Zhao C-J, Zu Y-G, Fu Y-J (2015) Fast and green extraction and separation of main bioactive flavonoids from *Radix Scutellariae*. *Ind Crop Prod* 63:175–181. <https://doi.org/10.1016/j.indcrop.2014.10.013>
- Xu K, Wang Y, Huang Y, Li N, Wen Q (2015) A green deep eutectic solvent-based aqueous two-phase system for protein extracting. *Anal Chim Acta* 864:9–20. <https://doi.org/10.1016/j.aca.2015.01.026>
- Xu K, Wang Y, Ding X, Huang Y, Li N, Wen Q (2016a) Magnetic solid-phase extraction of protein with deep eutectic solvent immobilized magnetic graphene oxide nanoparticles. *Talanta* 148:153–162. <https://doi.org/10.1016/j.talanta.2015.10.079>
- Xu K, Wang Y, Li Y, Lin Y, Zhang H, Zhou Y (2016b) A novel poly(deep eutectic solvent)-based magnetic silica composite for solid-phase extraction of trypsin. *Anal Chim Acta* 946:64–72. <https://doi.org/10.1016/j.aca.2016.10.021>
- Yan H, Wang H, Qin X, Liu B, Du J (2011) Ultrasound-assisted dispersive liquid–liquid microextraction for determination of fluoroquinolones in pharmaceutical wastewater. *J Pharm Biomed Anal* 54(1):53–57. <https://doi.org/10.1016/j.jpba.2010.08.007>

- Yang M, Xi X, Yang X, Bai L, Lu R, Zhou W, Zhang S, Gao H (2015) Determination of benzoylurea insecticides in environmental water and honey samples using ionic-liquid-mingled air-assisted liquid–liquid microextraction based on solidification of floating organic droplets. *RSC Adv* 5(32):25572–25580. <https://doi.org/10.1039/C5RA00140D>
- Yilmaz E, Soylak M (2015) Ultrasound assisted-deep eutectic solvent extraction of iron from sheep, bovine and chicken liver samples. This study is a part of PhD thesis of Erkan Yilmaz. *Talanta* 136:170–173. <https://doi.org/10.1016/j.talanta.2014.12.034>
- Yilmaz E, Soylak M (2018) A novel and simple deep eutectic solvent based liquid phase microextraction method for rhodamine B in cosmetic products and water samples prior to its spectrophotometric determination. *Spectrochim Acta A Mol Biomol Spectrosc* 202:81–86. <https://doi.org/10.1016/j.saa.2018.04.073>
- Yousefi SM, Shemirani F, Ghorbanian SA (2018) Enhanced headspace single drop microextraction method using deep eutectic solvent based magnetic bucky gels: application to the determination of volatile aromatic hydrocarbons in water and urine samples. *J Sep Sci* 41(4):966–974. <https://doi.org/10.1002/jssc.201700807>
- Zeng Q, Wang Y, Huang Y, Ding X, Chen J, Xu K (2014) Deep eutectic solvents as novel extraction media for protein partitioning. *Analyst* 139(10):2565. <https://doi.org/10.1039/c3an02235h>
- Zeng H, Qiao K, Li X, Yang M, Zhang S, Lu R, Li J, Gao H, Zhou W (2017) Dispersive liquid-liquid microextraction based on the solidification of deep eutectic solvent for the determination of benzoylureas in environmental water samples. *J Sep Sci* 40(23):4563–4570. <https://doi.org/10.1002/jssc.201700890>
- Zhang L, Wang M (2017) Optimization of deep eutectic solvent-based ultrasound-assisted extraction of polysaccharides from *Dioscorea opposita* Thunb. *Int J Biol Macromol* 95:675–681. <https://doi.org/10.1016/j.ijbiomac.2016.11.096>
- Zhang Q, De Oliveira Vigier K, Royer S, Jérôme F (2012) Deep eutectic solvents: syntheses, properties and applications. *Chem Soc Rev* 41(21):7108. <https://doi.org/10.1039/c2cs35178a>
- Zhang H, Wang Y, Zhou Y, Chen J, Wei X, Xu P (2018) Aqueous biphasic systems formed by deep eutectic solvent and new-type salts for the high-performance extraction of pigments. *Talanta* 181:210–216. <https://doi.org/10.1016/j.talanta.2018.01.014>
- Zhou P, Wang X, Liu P, Huang J, Wang C, Pan M, Kuang Z (2018) Enhanced phenolic compounds extraction from *Morus alba* L. leaves by deep eutectic solvents combined with ultrasonic-assisted extraction. *Ind Crop Prod* 120:147–154. <https://doi.org/10.1016/j.indcrop.2018.04.071>
- Zhuang B, Dou L-L, Li P, Liu E-H (2017) Deep eutectic solvents as green media for extraction of flavonoid glycosides and aglycones from *Platycladi Cacumen*. *J Pharm Biomed Anal* 134:214–219. <https://doi.org/10.1016/j.jpba.2016.11.049>

CHAPITRE 4

Les propriétés d'inclusion des cyclodextrines *vis-à-vis* des huiles essentielles et des arômes

Introduction

Les CDs sont des composés qui suscitent de plus en plus d'intérêt compte tenu de leurs utilisations multiples. Ceci est la conséquence de leur capacité à encapsuler des molécules faiblement solubles dans l'eau dans leur cavité hydrophobe, augmentant ainsi la solubilité de molécules invitées (Crini, 2014). L'utilisation des CDs pour l'encapsulation des huiles essentielles et des arômes a augmenté dans les dernières décennies (Kfoury, et al., 2019).

Ce chapitre est donc dédié à une étude bibliographique sur les CDs et leur application pour la solubilisation des huiles essentielles et des arômes. Après un bref historique et une description des CDs natives et modifiées (notamment polymérisées), et de leur relative innocuité, nous décrirons quelques approches de caractérisation qui peuvent être employées pour l'étude des complexes CD/huile essentielle et CD/arôme. La technique d'espace de tête-statique couplée à la chromatographie en phase gazeuse, la calorimétrie de titration isotherme et la résonance magnétique nucléaire seront plus spécifiquement développées. La technique d'espace de tête-statique couplée à la chromatographie en phase gazeuse est une méthode analytique utilisée lorsqu'une molécule volatile a été répartie en équilibre entre une phase liquide ou une matrice solide et une phase gazeuse dans un flacon fermé (Kolb & Ettore, 2006). La calorimétrie de titration isotherme est une technique polyvalente ayant l'avantage de mesurer directement la chaleur produite ou consommée après des interactions moléculaires entre CDs et l'invité (Bertaut & Landy, 2014). La résonance magnétique nucléaire permet la révélation de la structure du complexe en mesurant les différences de l'environnement magnétique de CDs et des invités (Pirnau et al., 2014). Cette revue s'attarde enfin sur l'importance de la solubilisation et de l'encapsulation des huiles essentielles et des arômes par les CDs, ce qui constitue le but majeur de notre étude.

Ainsi, ce chapitre présente la revue intitulée '*Cyclodextrins and their inclusion properties towards essential oils and their components*'.

Cyclodextrins and their inclusion properties towards essential oils and their components

Lamia Nakhle^{a,b}, Miriana Kfoury^{a,b,*}, Hélène Greige-Gerges^b, David Landy^a

^a *Unité de Chimie Environnementale et Interactions sur le Vivant (UCEIV, UR 4492), SFR Condorcet FR CNRS 3417, Université du Littoral Côte d'Opale (ULCO), 145 Av. M. Schumann, F-59140 Dunkerque, France*

^b *Bioactive Molecules Research Laboratory, Faculty of Sciences, Lebanese University, 90656 Jdaidet el-Metn, Lebanon*

* Corresponding author at: miriana.kfoury@univ-littoral.fr

Abstract

Discovered more than 130 years ago, cyclodextrins (CDs) are naturally occurring cyclic oligosaccharides resulting from the enzymatic degradation of starch. If native and modified CDs are commercially accessible, CDs polymers can be synthesized. The significant roles of CDs in the construction of supramolecular systems made of them the come-to-mind molecules when it comes to resolve problems encountered with lipophilic guests. This property enabled CDs to be potentially used in various fields, especially in the aroma and essential oils (EOs) fields, mainly for its capability to increase their solubility. For this reason, this review presents an in-depth evaluation of EOs and aromas loaded CD-inclusion complexes. This, by the mean of specific characterization methods notably: the static headspace-gas chromatography (SH-GC), the isothermal titration calorimetry (ITC) and the nuclear magnetic resonance spectroscopy (NMR) methods. Subsequently, the number of studies considering the use of CDs for such purposes is recently increasing.

Keywords: aromas; cyclodextrins; deep eutectic solvents; essential oils; organic solvents; solvation

Contents

1. Introduction	143
2. Overview	145
2.2. Modified cyclodextrins	146
2.2. Toxicity and safety	151
2.3. Applications	152
3. Encapsulation of essential oils and aromas in cyclodextrins.....	153
3.1. Analytical methods for the evaluation of the complexation phenomena	154
3.1.1. Static headspace- gas chromatography	154
3.1.2. Isothermal titration calorimetry	156
3.1.3. Nuclear magnetic resonance	158
4. Conclusion	160
Acknowledgments.....	160
References.....	161

List of abbreviations

2-DOSY: 2-Dimensional diffusion ordered spectroscopy

2-ROESY: 2-Dimensional rotating frame overhauser enhancement spectroscopy

CD: Cyclodextrin

CRYSMEB: Low methylated- β -CD

EMA: European medicines agency

EO: Essential oil

FDA: Food and drug administration

GRAS: Generally recognized as safe

HP- α -CD: Hydroxypropylated- α -CD

HP- β -CD: Hydroxypropylated- β -CD

HP- γ -CD: Hydroxypropylated- γ -CD

ITC: Isothermal titration calorimetry

JECFA: Joint expert committee on food additives

NMR: Nuclear magnetic resonance

RAMEA: Randomly methylated- α -CD

RAMEB: Randomly methylated- β -CD

SBE- β -CD: Sulfobutylated- β -CD

SH-GC: Static headspace-gas chromatography

VOC: Volatile organic compound

1. Introduction

Supramolecular chemistry is a discipline at the interface of chemistry, physics and biology. Jean-Marie Lehn defines supramolecular chemistry as ‘the chemistry of assemblies of molecules and intermolecular bonds’ or ‘chemistry beyond the individual molecule’ (Lehn, 1988). Generally, supramolecular assemblies consist of a large host molecule (enzymes, cyclic compounds, etc.) capable of entrap or stabilize a guest (ranging from an atom to a macromolecule) (Beer et al., 1999). The different components of the complex arrange each other in structures stabilized by intermolecular forces (Cram, 1986). Since its conception, supramolecular chemistry has not stopped expanding and diversifying into various fields such as biomimetics, physics and materials science. In 1987, supramolecular chemistry has definitively obtained its ‘letters of nobility’ when J. M. Lehn, D. J. Cram and C. J. Pedersen received the Nobel prize in chemistry for their respective work on cryptates (Lehn, 1985), spherands (Cram, 1986), and crown ethers (Pedersen, 1988) which are molecules with highly specific and selective interactions. Although discovered about a hundred years ago in France, cyclodextrins (CDs) are cage-like compounds that still fascinate researchers in the domain of supramolecular chemistry (Villiers, 1891). CDs are among the most remarkable macrocyclic molecules of major theoretical and practical achievements in chemistry, biology, biochemistry, health science and agriculture. CDs-related investigations have broken frontiers between many different disciplines and, as a result, scientists work together to disclose new concepts and applications. Thus, these macromolecules are present in our daily-used products: a whooping cough vaccine, a hair loss solution, a stop smoking aid, toothpastes, shampoo, colognes, a deodorant toilet, razors, a butter, a mayonnaise, fish sausages, modified steaks, a horseradish powder, mustard sauces, a sweetener, honey, a cinnamon extract, green tea without bitterness, vanilla coffee, clarified fruit juices, chewing gums, biopesticides, cosmeo-textiles, an ink, a detergent, a bioflocculant for swimming pool, or a bioadsorbent for water treatment (Morin-Crini et al., 2020). The unique feature of CDs is their ability to form inclusion complexes with various molecules by host/guest interactions. Due to this variety, only CDs inclusion complexes will be presented in this bibliographic review. CDs have become of growing interest both at academic and industrial levels and the number of publications dedicated to their use is rapidly increasing in the literature (**Figure 1**). This further demonstrates the attractiveness of these supramolecules. **Figure 2** displays the number of articles devoted to CDs as a function of the domain of application.

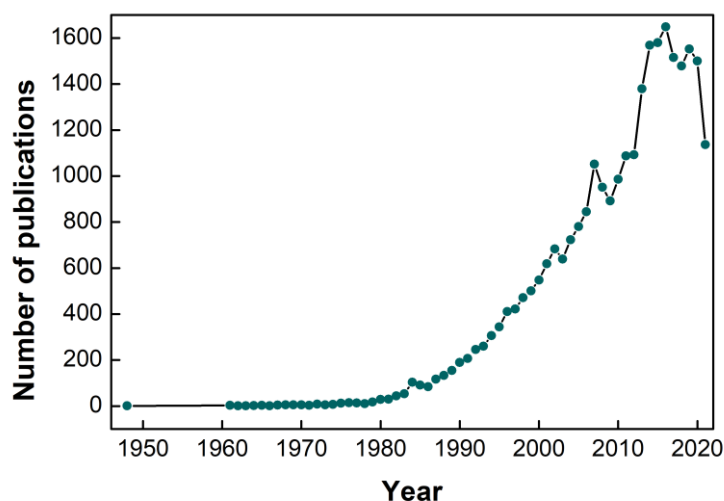

Figure 1: Number of articles on cyclodextrins per year. The query: (title-abstract-keyword ("cyclodextrin")) was consulted in Scopus on October 04, 2021.

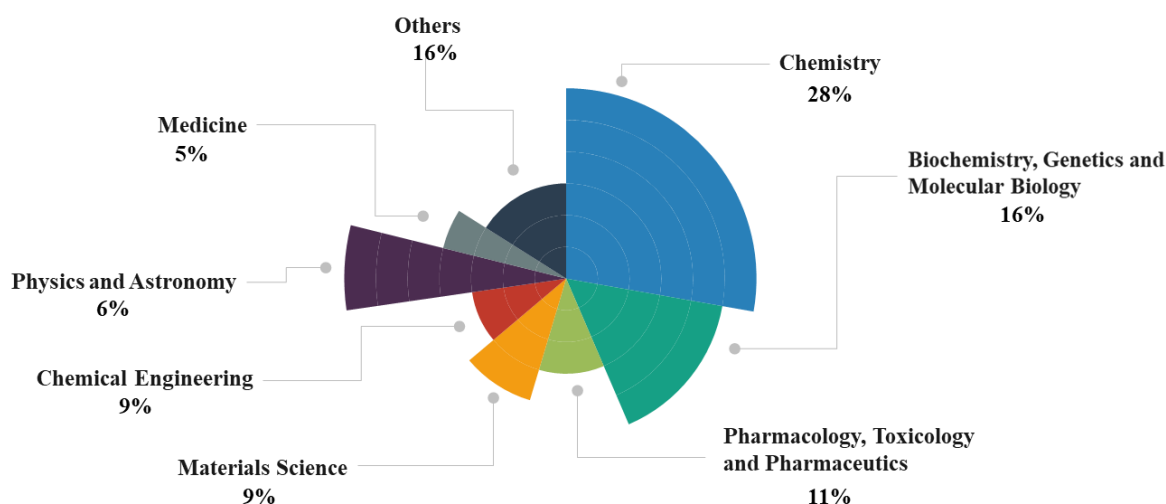

Figure 2: Number of articles devoted for each domain of application of cyclodextrins. The query: (title-abstract-keyword ("cyclodextrin")) was consulted in Scopus on October 04, 2021.

This paper focuses mainly on the evaluation of CD/essential oils (EOs) and CD/aromas inclusion complexes explaining how their characterization can be done using specifically the static headspace-gas chromatography (SH-GC), the isothermal titration calorimetry (ITC) and the nuclear magnetic resonance spectroscopy (NMR) methods.

2. Overview

CDs, first described by Villiers in 1891 (Villiers, 1891), are obtained from the digestion of starch by *Bacillus amylobacter* bacteria (Bonnet et al., 2015). The chemical structures of native CDs (α -CD, β -CD and γ -CD) were elucidated by Freudenberg and Cramer (Freudenberg & Cramer, 1948) and were shown to be cyclic oligosaccharides composed of six, seven and eight α -D-glucopyranose units, respectively, bounded by α -(1-4) linkages, without any reductive extremities (**Figure 3**). The chair conformation of the glucose units gives the CDs a truncated tridimensional cone shape open at both ends. CDs present a hydrophobic cavity formed from the hydrocarbons and the ethereal oxygens of the glucose residues. In addition, they possess a hydrophilic external surface formed from the primary hydroxyl groups (located at the narrower rim of the cone), and the secondary hydroxyl groups (found at the wider rim of the cone) (**Figure 3**) (Loftsson & Brewster, 1996; Szejtli, 2004).

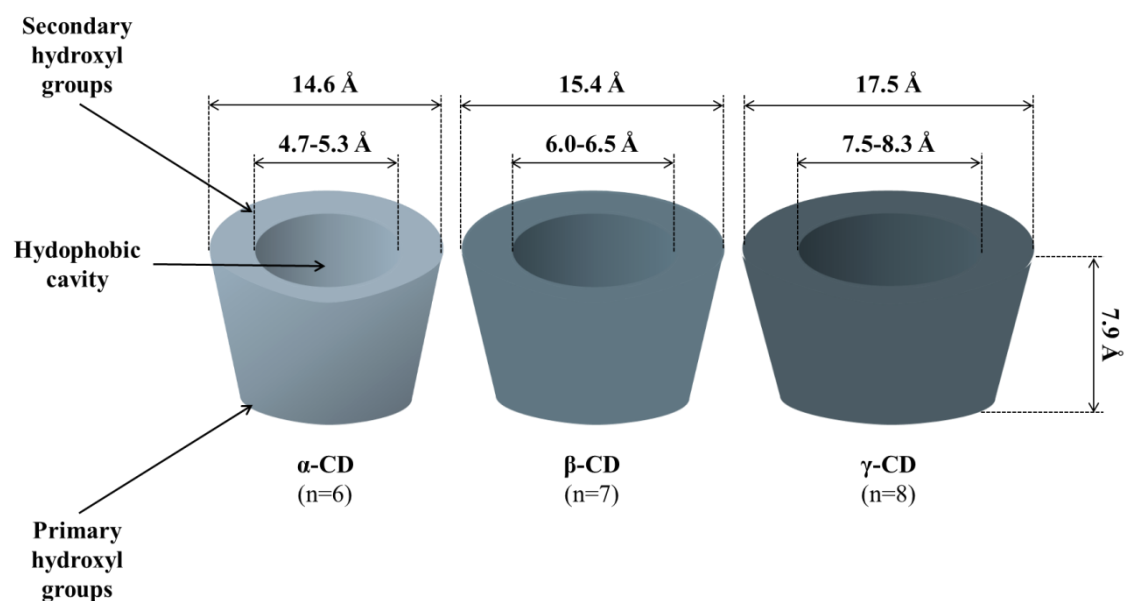

Figure 3: Schematic structure of the native cyclodextrins.

Later on, Cramer and co-workers described the ability of CDs to form inclusion complexes with lipophilic guests in aqueous solutions *via* association/dissociation equilibrium through non-covalent bonds (Crini, 2014). It is generally accepted that during this interaction, water molecules located within the lipophilic central cavity of CDs are replaced by the lipophilic molecule or its lipophilic moiety(ies), thus the system is found in the most thermodynamically stable state (Kurkov & Loftsson, 2013). The formation of inclusion complexes in solid state was carried out afterwards (Fenyvesi et al., 1999). Further, the CD/guest stoichiometry of the complex can be varied depending on the CD and the guest.

The CD/guest 1/1 stoichiometry constitutes the most common one, meaning that one molecule of the guest is trapped in one molecule of CD. However, higher order CD/guest stoichiometries also exist such as 2/1, 1/2, and 2/2 (**Figure 4**). CD/guest 2/1 is the second most common stoichiometry where an additional CD molecule forms a complex with an existing 1/1 complex (Loftsson et al., 2005).

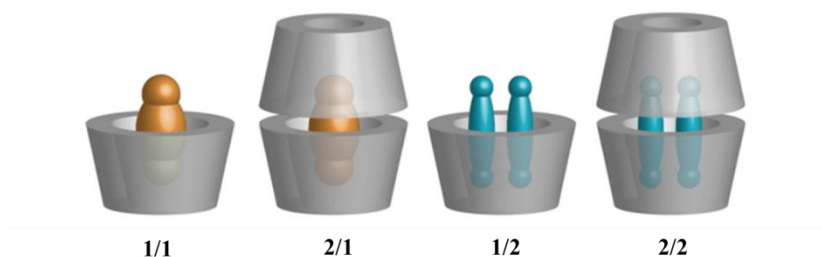

Figure 4: Schematic illustration of the different CD/guest stoichiometries.

The complexation equilibrium can be expressed as follow for a CD/guest 1/1 inclusion complex (1) and for a 2/1 stoichiometry (2) (Landy, 2018):



k_f presents the binding constant or the formation constant that describes the strength and the stability of the CD/G interaction, expressed as follows:

$$K_{f1/1} = \frac{[CD/G]}{[CD][G]} \quad (3) \quad K_{f2/1} = \frac{[CD_2/G]}{[CD][CD/G]} \quad (4)$$

$$\beta_{2/1} = \frac{[CD_2/G]}{[CD]^2 [G]} = K_{f1/1} \times K_{f2/1} \quad (5)$$

with $[CD/G]$, $[CD]$, and $[G]$ the concentrations of the inclusion complex, free CD and the free guest, respectively.

K_f can be determined experimentally by measuring the changes in the physical properties while changing the guest and/or the CD concentration. In previous reported models, it was demonstrated that the free energy of complexation is related to the lipophilicity descriptors such as the logP of guests, the steric descriptors such as the molecular volume and surface, as well as to other descriptors that may involve dipole-dipole interactions and hydrogen bonding (Rao & Stella, 2003).

2.1. Modified cyclodextrins

The reactivity difference between the primary and secondary hydroxyl groups of CDs units allows selective functionalization on the primary and secondary rims of CDs. Consequently, a

variety of modified CDs has been developed and employed to improve the formation of inclusion complexes and to promote the aqueous solubility of CDs (Kfoury et al., 2016). Native β -CD is proven to be the most suitable CD for the encapsulation of the majority of lipophilic guests due to its appropriate cavity size; however it presents a poor solubility in water due to the intramolecular hydrogen bonds taking place between the hydroxyl groups of the adjacent glucose molecules (Blach et al., 2008). For this reason, most of the modified CDs are synthesized from β -CD. **Table 1** presents some chemically modified CDs.

Table 1- Structures and acronyms of some reported modified CDs.

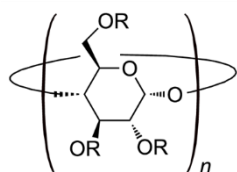

n	Residue	Abbreviation	DS	MW	Aqueous solubility (mg.mL ⁻¹)
7	R = H or -CH ₃	RAMEB	12	1303	>500
6		RAMEA	11	1127	>500
7	R = H or -CH ₃	CRYSMEB	4.9	1312	>500
7	R = H or -CH ₂ CH(OH)CH ₃	HP- β -CD	4.5	1400	>600
6			5.6	1460	>600
6		HP- α -CD	4.5	1180	~500
8		HP- γ -CD	4.5	1576	>500
7	R = H or -(CH ₂) ₄ SO ₃ Na	SBE- β -CD	4	1768	>500
			6.5	2163	>500

RAMEB: randomly methylated- β -CD; RAMEA: randomly methylated- α -CD; CRYSMEB: low methylated- β -CD; HP- β -CD: hydroxypropylated- β -CD; HP- α -CD: hydroxypropylated- α -CD; HP- γ -CD: hydroxypropylated- γ -CD; SBE- β -CD: sulfobutylated- β -CD; DS: degree of substitution (mean number of hydroxyl groups substituted per a molecule of CD); MW: molecular weight.

Besides, CDs were basic materials for the synthesis of derivatives and polymers that started to appear in the 1960s. Since, alkylated and acylated CDs, nitrogen- and sulfur-containing CDs and halogenated products were introduced. The cross-linking procedure is considered as the first landmark in the field of CDs polymers and is the most adapted synthesis since then. The starting point belongs to the work of Solms and Egli in 1965 (Solms & Egli, 1965). In that patent, the authors used epichlorohydrin as the cross-linker in an alkaline bulk reaction, and since then, this polymer has been the most abundant one in the literature (Gidwani &

Vyas, 2014; Crini, 2020). In this type of reaction, CDs are covalently attached by a cross-linking agent to originate more complex structures including soluble or insoluble polymers, hydrogels and others. Materials containing more than two covalently linked CDs units are known as CDs polymers (Petitjean et al., 2020). Consequently, different classes of crosslinking agents were used including carboxylic acids and phosphore-based crosslinking agents (Wintgens et al. 2013; Wintgens et al. 2015; Ghorpade et al. 2016). CDs polymers can be also obtained using grafting reactions (Crini & Morcellet, 2002), by linkage to a polymeric backbone through covalent bonding or by means of physical entrapment in different polymeric chains (Fenyvesi, 1988; Mocanu et al., 2001; Li, 2009), etc. **Table 2** presents some reported CD-based polymers synthesized through cross-linking reaction.

CDs derivatives and polymers could be more advantageous when compared to the native CDs if they demonstrate one of the following properties: a) increased aqueous solubility; b) increased complexation ability; c) increased guest affinity and specificity; d) facilitated complexation due to the addition of specific groups e) reduced damage caused to cell membrane level; f) validated regeneration and reuse (Shaw and Buslig 1986; Wagner et al. 1988; Ansari et al. 2011; Ciobanu et al. 2012). Given this, they can be widely applied in the food and pharmaceutical areas (Petitjean et al. 2020), being used in smoke filters for example (Szejtli, 1982).

Table 2- Some reported CD- based polymers synthesized through cross-linking reaction along with their potential applications.

Cyclodextrin	Cross-linking agent	Observations	Applications	Reference
β -CD	Epichlorohydrin	Soluble and insoluble polymers were obtained	Detoxification of wastewater, removal of dyes, retention of aroma compounds and essential oils and adsorption of pesticides from water	(Crini, 2003; Liu et al., 2011; Ciobanu et al., 2012, 2013; Morin-Crini & Crini, 2013; Morin-Crini et al., 2018)
CRYSMEB	Epichlorohydrin	First results showing polymers as efficient absorbents for volatile organic compounds	Removal of toxic pollutants found in gaseous effluents for the prevention of air-pollution	(Mallard Favier et al., 2011)
β -CD	Sodium trimetaphosphate	Non-reticulated polymers with molecular weights $M_w > 10^4$ g.mol ⁻¹ were obtained with significant rise of the swelling ratio	Selective chelation of calcium ions in the biomedical field	(Wintgens et al., 2013, 2015; Morin-Crini et al., 2018)
β -CD	Nitrated cross-linking agents (triethylene glycol diglycidyl ether and poly(ethylene glycol) diglycidyl ethers)	Lower glass transition temperatures were achieved (-20 °C), with increased polymers solubility in acetone and tetrahydrofuran	Preparation of energetic formulations with improved mechanical properties and protection from environmental degradation	(Luppi et al., 2018)
β -CD	Polyethylene glycol diglycidyl ether and ethylene diglycidyl ether	The synthesis was environmentally friendly. Obtained polymers possess good adsorption capacities of methylene blue; and they can be easily regenerated	Adsorption of dyes for the environment decontamination in printing, leather, textile finishing, pharmaceutical companies and plastic industries	(Mallard et al., 2020)
β -CD	Adipic acid	Changes in the original morphology with increased	Potential cholesterol removal and highly efficient recycling	(Han et al., 2007; Chang et al., 2010;

		particle size of the raw material	rate in cream cheese, ice cream, squid and cod liver oil	(Kwak et al., 2011)
β -CD	Itaconic acid	Polymer formed <i>via</i> an esterification reaction, and the presence of a vinyl group was found to be useful for producing a new reactive CD	Reinforcing performance of cotton fabric	(Nazi et al., 2012a, b)
γ -CD	Citric acid	The formation of a 1:1 and 1:2 polymer:drug complexes	Drug delivery in vascular prosthesis and bone implants	(Anand et al., 2013)
β -CD	Epichlorohydrin, succinyl chloride and two diisocyanates	When compared with other typical sorbents used to extract phenol from water (activated carbon, the macroporous resin Lewatit OC 1064, and calcium alginate), CD polymers showed high sorption capacities	Application in plywood, construction, automotive, and appliance industries	(Romo et al., 2008)
β -CD	Epichlorohydrin, diphenyl carbonate, hexamethylene diisocyanate and 1,3-bis(azidomethyl)benzene	Soluble and insoluble-polymers were obtained	Usage as debittering agents by adsorption of naringin, limonin and caffeine	(Binello et al., 2008)
α -CD, β -CD, γ -CD, RAMEB and HP- β -CD	Citric acid, 1,2,3,4-butanetetracarboxylic acid and poly(acrylic acid)	High reaction temperatures, high crosslinking agent/CD molar ratios and long reaction times preferably yielded insoluble gels, whereas softer conditions resulted in very soluble polymers	Usage in the durable press finishing of cotton	(Martel et al., 2005)

2.2. Toxicity and safety

In 1923, the first conducted biological tests were done to determine whether the dextrins were physiologically available either to plants or animals (Hoesslin & Pringsheim, 1923). Szejtli demonstrated the nontoxicity of CDs after oral administration (Szejtli, 1984). It was then stated that CDs improve the bioavailability of drugs. Orally administered CD-complexes dissociate in the gastro-intestinal tract, releasing the drug that undergoes absorption. CD molecules are hydrolyzed to glucose units in the intestinal tract (Irie & Uekama, 1997). The limited aqueous solubility of parent CDs as well as their hydrophobic derivatives (RAMEB for example) imparts toxicity by absorbing through lipophilic biological membranes (Hammoud et al., 2019). Indeed, α -CD and β -CD tend to solubilize phospholipids and cholesterol, respectively, whereas γ -CD is generally less lipid extracting (Kilsdonk et al., 1995). In contrast, the hydrophilic character of other CD derivatives retains them extracellularly and prevents their absorption through lipophilic biological membrane but in limited cases, they can only pass through transporter proteins (Chaudhari et al., 2019). Detailed studies on toxicity, mutagenicity, teratogenicity, and oncogenicity of CDs and some of their derivatives have been realized. These results indicated that CDs can be harmful to the human body only at very high concentrations (Shityakov et al., 2016; Waalkens-Berendsen et al., 1998). Although a dosage of about 200 mg/kg/day of CDs is generally recommended by the European Medicines Agency (EMA) for oral uses in pharma, this value depends on the type of CD used; a dosage of 8000 mg/day, for instance, in the case of HP- β -CD (Matencio et al., 2020). The first drug product consisting on prostaglandin E2/ β -CD Prostarmon E™ sublingual tablet, was marketed in Japan (Ono Co.) (Hirayama et al., 1980). Nowadays, HP- β -CD is the most versatile excipient among the cyclic oligosaccharides (Malanga et al., 2016). It can be used in oral, rectal, dermal, ocular, and parenteral formulations, and several pharmaceutical products are marketed, e.g., Indocid® (eye drop), Vorzu® (tablet for fungal infection), Strepfen® (oromucosal spray with flurbiprofen), Vibativ® (infusion with telavancin), and Lubion® (injection with progesterone). In addition, the development of a new excipient: sulfobutylether- β -CD (CAPTISOL®) was reported (Katdare & Chaubal, 2006). As regards for the use of CDs for supplementing food products, only natural CDs are considered food additives and “generally recognized as safe” (GRAS). The recommendation of the Joint Expert Committee on Food Additives (JECFA) established a maximum level of β -CD in foods of 5 mg/kg/day (Cravotto et al., 2006).

2.3. Applications

In the field of pharmaceuticals, CDs are being applied with the aim of targeting many purposes such as: the improvement of drugs bioavailability, the decrease of its side effects, the stomach protection, the reduction of the drug bitterness, the transport of the drug to its target (vectors), the controlled release of the drug and the solubility and stability increase of the drug (Challa et al., 2005; Szejtli & Szenté, 2005; Loftsson & Duchene, 2007; Loftsson & Brewster, 2010; Salústio et al., 2011; Yin et al., 2013).

In cosmetics, the use of CDs aims to protect the flavors and vitamins during storage; to increase the solubility of hydrophobic products; to protect against degradation, oxidation, hydrolysis and evaporation; to reduce skin irritations; to increase dermal absorption; to reduce interactions between constituents of the same product; to stabilize emulsions and suspensions; to reduce unpleasant odors; to improve foaming ability, to deodorize hygiene products and to increase solubility and stability of fragrances (Marques, 2010; Bilensoy, 2011; Hougeir & Kircik, 2012).

Food industries take the use of CDs seriously in their protocols. This manner has the objective of encapsulation and controlled release of aromas; protection against oxidation, degradation by heat and light and hydrolysis for labile compounds; elimination of unpleasant tastes and odors; prolongation of taste duration; sequestration of cholesterol; conservation of food; prolongation of the action time of herbicides, fungicides and pheromones and reduction of the toxicity (Del Valle, 2004; Szejtli, 2004; Szenté & Szejtli, 2004; Szejtli & Szenté, 2005; Alonso et al., 2009; Astray et al., 2009; Loftsson & Brewster, 2010; Marques, 2010).

In the field of textiles, CDs helped masking unwanted odors or reinforcing the absorption of dyes through the fabric and therefore reducing their loss during rinsing. In addition, CDs allowed recover of the dyes present in the washing water of the factories (Hedges, 1998; Martel et al., 2002).

Environmental applications of CDs are also encountered. CDs are mainly used to extract and reduce the volatility of pollutants atmospheric organic substances as well as those found in soils or water. CDs are used in particular to trap polycyclic aromatic hydrocarbons, pesticides, nitrosamine and naphthalene (Wang et al., 2004; Sayo O. Fakayode et al., 2007; Blach et al., 2008; Dou et al., 2011; Landy et al., 2012; Sun et al., 2013).

3. Encapsulation of essential oils and aromas in cyclodextrins

More than 3000 types of EOs are currently known, of which 300 are of commercial interest (Kfoury et al., 2018). Attention has always been attached to the retention of EOs and aromas, in a way of increasing their solubility for food, pharmaceutical or environmental purposes. Aromas belong to different chemical classes (hydrocarbons, phenylpropanoids, terpenes, terpenoids and their derivatives) that are responsible for the biological properties of EOs, relevant to human use. CDs were extensively applied in this manner by virtue of their ease of availability and their ability to entrap guest moieties. This led to the improvement of the poor solubility, high volatility and sensitivity of aromas to environmental factors (Wadhwa et al., 2017). The success of this approach for EOs is exemplified by the commercialized β -CD/garlic oil products, available under the trade names Xund, Tegra, Allidex and Garlessence®. It was reported that the encapsulation of aromas in CDs depends on many factors. The binding efficiency could be classified as very weak, weak, moderate, strong and very strong when formation constant values are in the following ranges: 0-500, 500-1000, 1000-5000, 5000-20,000 and greater than 20,000 M^{-1} , respectively (Carrier et al., 2007). The stability constants of many aroma compounds are usually lower for α - and γ -CD than that for β -CD (Ciobanu et al., 2013). Another study explained that the greater inclusion complexes stability of β -CD/aromas versus α -CD/aromas would be related to the larger cavity of β -CD, which can locate more comfortably the guest molecule. Nevertheless, there are exceptions to this rule; for example, the large cavities (γ -CD) were more suitable for the inclusion of citral (Phunpee et al., 2017). The importance of the steric effect is also confirmed when isomers are not likewise recognized by CDs; examples include α - and β -pinene, thymol and carvacrol, trans-anethole and estragole, eugenol and isoeugenol, *cis*-ocimene and *trans*-ocimene and others (Bethanis et al., 2013; Ciobanu, Landy, et al., 2013; Miron et al., 2012; Rungsardthong Ruktanonchai et al., 2011). In addition, the hydrophobicity of aromas ($\log P$) and their binding constants (K_f) with α -CD and β -CD were proved to be perfectly correlated (Astray et al., 2010). It was also established, *via* a relationship between the molar volume of each aroma and its binding constants, that the geometry of the substrates play also a prominent role in the formation and stability of these inclusion complexes (Astray et al., 2010). On the other hand, the presence of substituents can affect the binding affinity; for example, the presence of methyl groups can affect the cavity size of CDs, making the formation constants of menthol, menthone, pulegone and eucalyptol with randomly methylated- β -CD and low methylated- β -CD higher than with natural β -CD (Ciobanu, et al., 2013). For instance, the cavity size of

CDs affects the binding constant (Astray et al., 2010). The stoichiometric ratio of CDs and aroma compounds is usually 1/1 (Ciobanu, et al., 2013); however, this is not the only possible ratio (Landy et al., 2007; Piñeiro et al., 2007). It was previously proved that native α -CD forms predominantly a 2/1 inclusion stoichiometry with (1R)-(+)-camphor in water (Dodziuk et al., 1999, 2003; Bernatowicz et al., 2006).

3.1. Analytical methods for the evaluation of the complexation phenomena

The inclusion complex formation is characterized by several parameters such as the stoichiometry of the complex, the formation constants (K_f) and the thermodynamic parameters (inclusion enthalpy (ΔH), inclusion entropy (ΔS), heat capacity variation (ΔC_p)). We present, in the following paragraph, the importance of these parameters in the characterization of CD/EOs and CD/aromas inclusion complexes. Despite the wide variety of methods used for the determination of K_f (Mura, 2014), the main techniques applied in the case of EOs and aromas are HPLC (Moeder et al., 1996), ITC (Y. Liu et al., 2004), UV-visible spectroscopy (Decock et al., 2006), the solubility method (Nakhle et al., 2020), fluorescence (Kfoury et al., 2014), NMR spectroscopy (Landy, 2018) or even the SH-GC (Decock et al. 2008; Ciobanu et al. 2012; Ciobanu et al. 2013; Ciobanu et al. 2013; Kfoury et al. 2018). We will focus herein on SH-GC, ITC and NMR methods.

3.1.1. Static headspace- gas chromatography

Headspace technology is an analytical method used when a volatile molecule has been partitioned in equilibrium between a liquid phase or a solid matrix with a gaseous phase in a closed vial (Kolb & Ettre, 2006). It is generally coupled to a subsequent gas chromatography analysis. This allows the separation of the volatile compounds due to the separation efficiency of the chromatographic column and therefore, allows the simultaneous analysis of various volatile compounds. The headspace analysis can be carried out either as a one-step extraction (static or equilibrium headspace) or as a continuous extraction (dynamic headspace) (Kolb, 1999). The static headspace gas chromatography (SH-GC) is gaining an increasing interest for the study of CDs inclusion complexes with aromas. In this part of the review, focus will be given on the characterization of the inclusion complexes via the SH-GC. This technique allows to determine the formation constant (K_f) value, to evaluate the retention capacity of CDs, to follow the release of aromas from CD/aroma complexes, and to study the effect of encapsulation on the physicochemical properties of the guest (solubility and volatility). The first paper that reported the application of the SH-GC in the CDs field

appeared at the end of the 1980s (Hall et al., 1986). **Figure 5** presents the principle of this method.

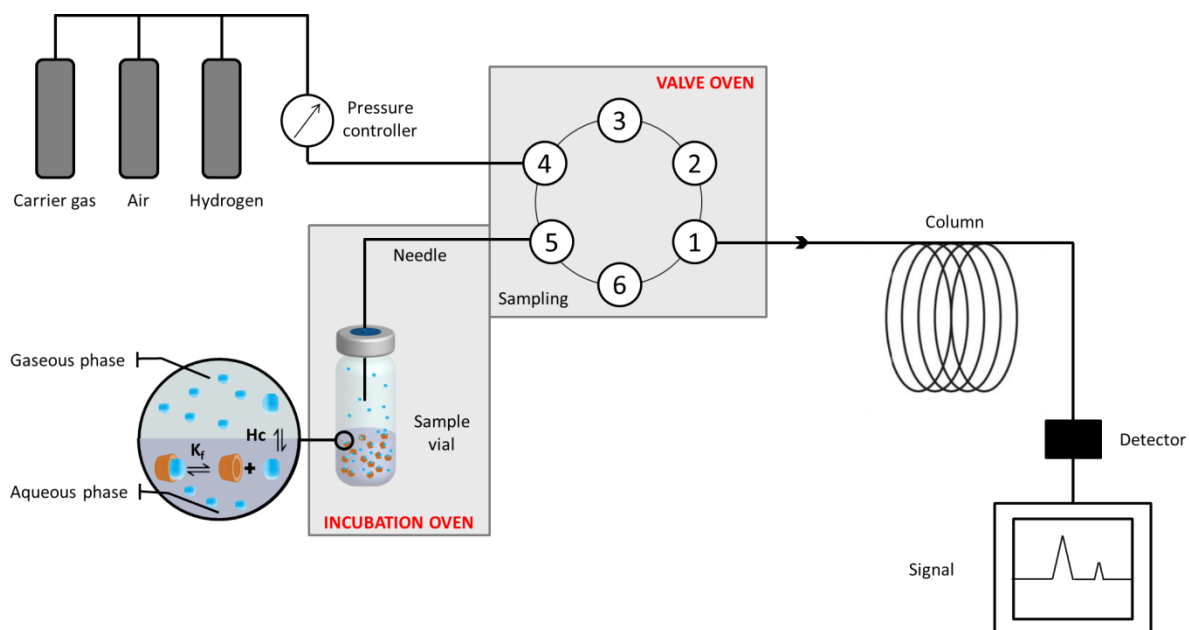

Figure 5: Schematic illustration of the principle of the static headspace- gas chromatography. First, the sample is placed in a vial, sealed and thermostated. The volatile compound present in the sample will vaporize from this sample to the gaseous phase. Subsequently, equilibrium will be reached. This equilibrium is driven by the Henry law constant H_c (also called vapor-liquid partition coefficient and sometimes referred to as K) of the compound. After sample equilibrium, a needle penetrates the septum of the glass vial and an inert carrier gas pressurizes the vial. An aliquot of the vapor phase (headspace) is then injected in the column and analyzed. In the case of CDs inclusion complexes, the non-volatile matrix may be either an aqueous solution of CDs, solid CDs or solid inclusion complexes. Indeed, the presence of CDs has an impact on the equilibrium and therefore on the partition coefficient of the aroma. This will result mostly in an increase of the solubility of the volatile compound and therefore in a decrease of the chromatographic peak area depending on the strength of the K_f and H_c values (Kfoury et al. 2019). In 2007, Landy and coworkers have developed a method, that did not necessitate any calibration curve, for calculating K_f value using a constant concentration of the volatile guest and various concentrations of CDs (Landy et al., 2000). Interestingly, an algorithmic treatment is applied to evaluate the K_f values using the following equation (6):

$$[CD/G] = -\frac{1}{2} \sqrt{\left[\left(\frac{1}{K_f} + [CD]_T + [G]_T\right)^2 - 4[CD]_T[G]_T\right]} + \frac{1}{2} \left(\frac{1}{K_f} + [CD]_T + [G]_T\right) \quad (6)$$

where [CD/G] is the concentration of the inclusion complex, [CD]_T and [G]_T are the initial concentrations of CD and the volatile guest, respectively.

Even more, a more simple and rapid approach has been developed by Fourmentin and coworkers, called the “one shot” method. It presents the advantage of the possible determination of K_f values, simultaneously, for several volatile guests directly present in a complex mixture, for example in benzene/toluene/ethylbenzene/xylene (BTEX) mixture, pollutants, EOs, solvents, etc. (Fourmentin et al., 2013).

In addition, this method allows the determination of vapor-liquid partition coefficient K of volatile organic compounds (VOCs) in different solvents, even in the presence of CDs. The PRV method (phase ratio variation method) was used to determine the K value of VOCs in water. This method consists of adding the same amount of VOC to vials containing different volumes of aqueous solution in order to vary the liquid/gas ratio. To determine the values of K in other solvents, like deep eutectic solvents, the PRV method could not be used because it presents limitations for very low values of K , in contrary to the VPC method (vapor phase calibration method). The latter consists of adding different amounts of VOCs to vials containing the same amount of solvent. In all cases, the peak area of the resulting VOC makes it possible to return to the concentration in the gas phase (C_G) and in the liquid phase (C_L) by the law of conservation of masses; the K value could then be calculated using the following equation:

$$K = \frac{C_G}{C_L} \quad (7)$$

3.1.2. Isothermal titration calorimetry

ITC is a versatile technique with the advantage to directly measure the heat produced or consumed (depending if the process is exothermic or endothermic, respectively) during a reaction or an interaction, like the case of CD/aroma complexation. It helps to determine, in addition to the K_f value, the thermodynamic parameters of the complex including the inclusion enthalpy ΔH , the inclusion entropy ΔS , the heat capacity variation ΔC_p as well as the stoichiometry of the complex using equations (8) and (9) (Bertaut & Landy, 2014):

$$\Delta G = -RT \ln K \quad (8)$$

$$\Delta G = \Delta H - T\Delta S \quad (9)$$

Unlike other techniques, ITC have been designed and developed specifically for the characterization of molecular interactions (Bouchemal & Mazzaferro, 2012). In 1978, Komiyama and Bender were the first to observe that the inclusion of a guest in a host molecule was accompanied by increased enthalpy and loss of entropy (Komiyama & Bender, 1978). The more the guest is non-polar, the more it enters the cavity of the CD, the more important the stability of the complex is, and thus the higher is the enthalpy variation. In 1982, Szejtli explains the gain in enthalpy by the spontaneous arrival of the guest in the cavity of the CD, thus pushing the water molecules out of the cavity; Van der Waals and hydrogen bonds also playing a major role in the complexation (Szejtli, 1988).

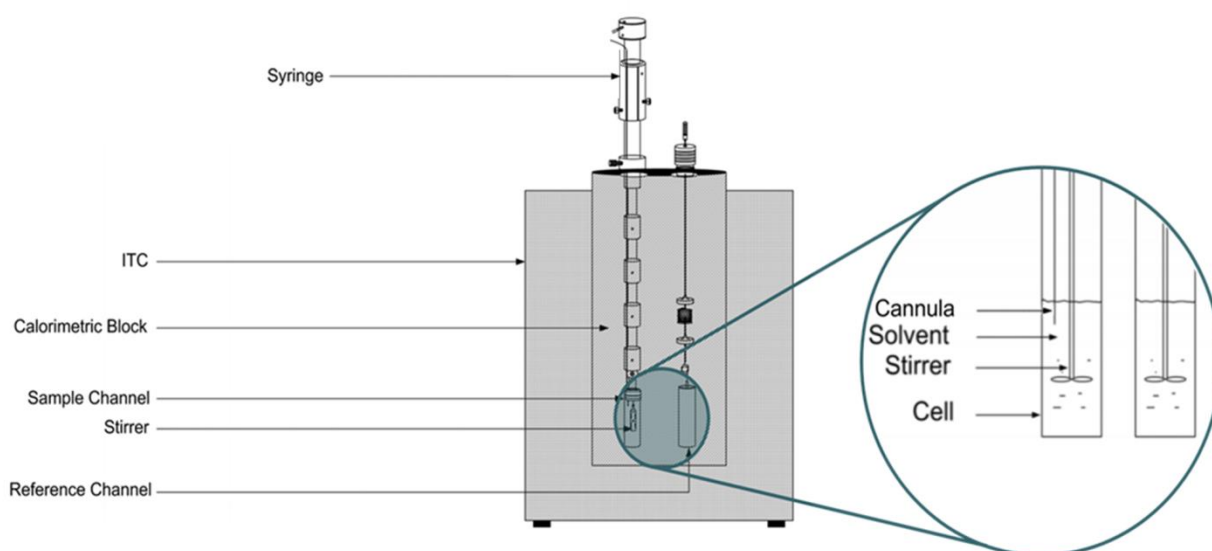

Figure 6: Schematic illustration of the principle of the isothermal titration calorimetry technique (Figure adapted from ITC manual).

On a methodological point of view, multiple ITC protocols exist. Among them, the conventional titration protocol is the most employed experiment: one partner of the studied phenomenon, called titrand (guest, specially aroma) is placed inside the cell, while the second partner, called titrant (CDs, generally), is contained in the syringe of the ITC device (**Figure 6**). If the experiment is also carried out in the other direction (injection of guest solution within host solution), it is then called reversed titration (Liang, 2008). Each injection of one partner on the other induces the formation of supramolecules, thus releasing an amount of heat which is proportional to the binding enthalpy and to the amount of complexes formed during this addition. As CD complexes are often characterized by negative inclusion enthalpy, negative peaks are observed. On the other hand, one of the non-conventional

methods is the release experiment, first introduced by Heerklotz (Heerklotz et al. 1999). Herein, the complex is already formed outside the device and is placed inside the syringe of the ITC and being injected unto the cell containing the solvent. Positive peaks are obtained in this case, consecutively to the dissociation of the pre-formed complexes.

For all experiments, the thermogram is obtained by recording differential power as a function of time. Before data treatment, it is then time to subtract heat of blanks experiments, that is to say of confronting each partner of the interaction with a solution containing only the buffer or the solvent used. This implies keeping the same parameters as during titration or release experiment (number of injections, volumes and time). Plotting the integrated heats at each injection as function of the number of injections (or of partners molar ratio or concentrations), results in an isotherm, which should present a sigmoidal shape for strong complexation. At this stage, a fitting procedure between experimental and theoretical data allows the evaluation of the various thermodynamic parameters (Bertaut & Landy, 2014). When we compare the two protocols, it was established that the release experiments are more suited to weak affinities, while the titration procedures are more efficient for stronger complexes. As demonstrated, the coupling of titration and release experiments proved to be systematically more accurate than the analysis of two titration experiments, or at least as accurate (Bertaut & Landy, 2014). However, there are some circumstances under which the direct ITC protocols fail to characterize the CDs complexes, and then competitive methods may be of valuable aid. This kind of behavior was observed when the studied inclusion complex is nearly athermic, with inclusion enthalpy close to 0 cal.mol^{-1} (Bertaut & Landy, 2014).

3.1.3. Nuclear magnetic resonance

Nuclear Magnetic Resonance (NMR) helps getting deeper in the determination of the structure of the complex. The magnetic environment of atoms molecules (CDs or aroma) involved in the complexation process is modified. Those changes can be measured by NMR spectrometry (Lis-Cieplak et al., 2014). Indeed, the variation of the resonant frequency of the protons of the CD cavity coupled to that of aroma protons highlights the formation of a complex but allows also proposing the complex geometry. The two-dimensional rotating frame overhauser enhancement spectroscopy (2D-ROESY) technique is applied to observe the dipolar interactions of protons close in space ($<4 \text{ \AA}$). The interactions between the protons of the CDs cavity (mainly H3 and H5 that are located inside the CDs cavity) and aroma

confirm the presence of an inclusion complex. Generally, this technique is complementary to the $^1\text{H-NMR}$ which makes it possible to confirm that the variations in chemical shifts are indeed due to a real inclusion and do not result from simple interactions of area. Consequently, it makes it possible to propose the complex geometry (Pirnau et al., 2014). In addition, following encapsulation in the CDs cavity, the mobility of the guest is reduced; therefore, a complementary two-dimensional diffusion ordered spectroscopy (2D-DOSY) NMR which allows track of the variation of the diffusion coefficients (D) of the involved compounds can be very useful. Decreased D coefficient of aroma can reflect the complexation phenomena. This coefficient depends on physical parameters such as the size and shape of the molecule, temperature and viscosity of the medium. Assuming the molecule has a spherical shape with radius r, the diffusion coefficient is given by the Stokes-Einstein equation (Leite et al., 2003):

$$D = \frac{KT}{6\pi\eta r} \quad (10)$$

with K Boltzmann constant (J.K^{-1}), T the temperature (K), η the viscosity of the medium (Pa.s) and r the radius of the molecule.

4. Conclusion

In this review, we described the different types of CDs (native, modified and polymerized CDs); their toxicity and the different fields in which they are used are also revised. Specific investigations were given for CD/EO and CD/aroma inclusion complexes. The use of CDs enhanced the solubility of EOs and aromas *via* the formation of inclusion complexes. It was shown that they can be characterized by SH-GC where the formation constants could be determined and their contribution on the partition coefficients can be deduced. Also, ITC technique constitutes a precise way to assign the thermodynamic parameters related to the complexation. While, by determining the diffusion coefficients of CDs and of aromas and by attributing the dipolar interactions of protons by the mean of NMR techniques, the CD/aroma complexes can be well characterized and the complex geometry can be established.

Acknowledgments

Lamia Nakhle has received a scholarship from Université du Littoral Côte d'Opale (ULCO) and from the Lebanese National Council for Scientific Research (CNRS-L).

References

- Alonso, L., Cuesta, P., Fontecha, J., Juarez, M., & Gilliland, S. E. (2009). Use of β -cyclodextrin to decrease the level of cholesterol in milk fat. *Journal of Dairy Science*, 92(3), 863–869. <https://doi.org/10.3168/jds.2008-1452>
- Anand, R., Malanga, M., Manet, I., Manoli, F., Tuza, K., Aykaç, A., Ladavière, C., Fenyvesi, E., Vargas-Berenguel, A., Gref, R., & Monti, S. (2013). Citric acid- γ -cyclodextrin crosslinked oligomers as carriers for doxorubicin delivery. *Photochemical & Photobiological Sciences*, 12(10), 1841. <https://doi.org/10.1039/c3pp50169h>
- Ansari, K. A., Vavia, P. R., Trotta, F., & Cavalli, R. (2011). Cyclodextrin-Based Nanosponges for Delivery of Resveratrol: In Vitro Characterisation, Stability, Cytotoxicity and Permeation Study. *AAPS PharmSciTech*, 12(1), 279–286. <https://doi.org/10.1208/s12249-011-9584-3>
- Astray, G., Gonzalez-Barreiro, C., Mejuto, J. C., Rial-Otero, R., & Simal-Gándara, J. (2009). A review on the use of cyclodextrins in foods. *Food Hydrocolloids*, 23(7), 1631–1640. <https://doi.org/10.1016/j.foodhyd.2009.01.001>
- Astray, G., Mejuto, J. C., Morales, J., Rial-Otero, R., & Simal-Gándara, J. (2010). Factors controlling flavors binding constants to cyclodextrins and their applications in foods. *Food Research International*, 43(4), 1212–1218. <https://doi.org/10.1016/j.foodres.2010.02.017>
- Beer, P. D., Gale, P. A., & Smith, D. K. (1999). *Supramolecular chemistry*. Oxford University Press.
- Bernatowicz, P., Nowakowski, M., Dodziuk, H., & Ejchart, A. (2006). Determination of association constants at moderately fast chemical exchange: Complexation of camphor enantiomers by α -cyclodextrin. *Journal of Magnetic Resonance*, 181(2), 304–309. <https://doi.org/10.1016/j.jmr.2006.06.001>
- Bertaut, E., & Landy, D. (2014). Improving ITC studies of cyclodextrin inclusion compounds by global analysis of conventional and non-conventional experiments. *Beilstein Journal of Organic Chemistry*, 10, 2630–2641. <https://doi.org/10.3762/bjoc.10.275>
- Bethanis, K., Tzamalís, P., Tsorteki, F., Kokkinou, A., Christoforides, E., & Mentzafos, D. (2013). Structural study of the inclusion compounds of thymol, carvacrol and eugenol in β -cyclodextrin by X-ray crystallography. *Journal of Inclusion Phenomena and Macrocyclic Chemistry*, 77(1–4), 163–173. <https://doi.org/10.1007/s10847-012-0230-9>

- Bilensoy, E. (Ed.). (2011). *Cyclodextrins in pharmaceuticals, cosmetics, and biomedicine: Current and future industrial applications*. Wiley.
- Binello, A., Robaldo, B., Barge, A., Cavalli, R., & Cravotto, G. (2008). Synthesis of cyclodextrin-based polymers and their use as debittering agents. *Journal of Applied Polymer Science*, *107*(4), 2549–2557. <https://doi.org/10.1002/app.27249>
- Blach, P., Fourmentin, S., Landy, D., Cazier, F., & Surpateanu, G. (2008). Cyclodextrins: A new efficient absorbent to treat waste gas streams. *Chemosphere*, *70*(3), 374–380. <https://doi.org/10.1016/j.chemosphere.2007.07.018>
- Bonnet, V., Gervaise, C., Djedaïni-Pilard, F., Furlan, A., & Sarazin, C. (2015). Cyclodextrin nanoassemblies: A promising tool for drug delivery. *Drug Discovery Today*, *20*(9), 1120–1126. <https://doi.org/10.1016/j.drudis.2015.05.008>
- Bouchemal, K., & Mazzaferro, S. (2012). How to conduct and interpret ITC experiments accurately for cyclodextrin–guest interactions. *Drug Discovery Today*, *17*(11–12), 623–629. <https://doi.org/10.1016/j.drudis.2012.01.023>
- Carrier, R. L., Miller, L. A., & Ahmed, I. (2007). The utility of cyclodextrins for enhancing oral bioavailability. *Journal of Controlled Release*, *123*(2), 78–99. <https://doi.org/10.1016/j.jconrel.2007.07.018>
- Challa, R., Ahuja, A., Ali, J., & Khar, R. K. (2005). Cyclodextrins in drug delivery: An updated review. *AAPS PharmSciTech*, *6*(2), E329–E357. <https://doi.org/10.1208/pt060243>
- Chang, Y. H., Lee, J. E., & Kwak, H.-S. (2010). Optimization of the Conditions for Removing Cholesterol from Cod Liver Oil by β -Cyclodextrin Crosslinked with Adipic Acid. *Journal of the American Oil Chemists' Society*, *87*(7), 803–808. <https://doi.org/10.1007/s11746-010-1555-4>
- Chaudhari, P., Ghate, V. M., & Lewis, S. A. (2019). Supramolecular cyclodextrin complex: Diversity, safety, and applications in ocular therapeutics. *Experimental Eye Research*, *189*, 107829. <https://doi.org/10.1016/j.exer.2019.107829>
- Ciobanu, A., Landy, D., & Fourmentin, S. (2013). Complexation efficiency of cyclodextrins for volatile flavor compounds. *Food Research International*, *53*(1), 110–114. <https://doi.org/10.1016/j.foodres.2013.03.048>
- Ciobanu, A., Mallard, I., Landy, D., Brabie, G., Nistor, D., & Fourmentin, S. (2012). Inclusion interactions of cyclodextrins and crosslinked cyclodextrin polymers with linalool and camphor in *Lavandula angustifolia* essential oil. *Carbohydrate Polymers*, *87*(3), 1963–1970. <https://doi.org/10.1016/j.carbpol.2011.10.005>

- Ciobanu, A., Mallard, I., Landy, D., Brabie, G., Nistor, D., & Fourmentin, S. (2013). Retention of aroma compounds from *Mentha piperita* essential oil by cyclodextrins and crosslinked cyclodextrin polymers. *Food Chemistry*, 138(1), 291–297. <https://doi.org/10.1016/j.foodchem.2012.10.106>
- Cram, D. J. (1986). Preorganization? From Solvents to Spherands. *Angewandte Chemie International Edition in English*, 25(12), 1039–1057. <https://doi.org/10.1002/anie.198610393>
- Cravotto, G., Binello, A., Baranelli, E., Carraro, P., & Trotta, F. (2006). Cyclodextrins as Food Additives and in Food Processing. *Current Nutrition & Food Science*, 2(4), 343–350. <https://doi.org/10.2174/157340106778699485>
- Crini, G. (2003). Studies on adsorption of dyes on beta-cyclodextrin polymer. *Bioresource Technology*, 90(2), 193–198. [https://doi.org/10.1016/S0960-8524\(03\)00111-1](https://doi.org/10.1016/S0960-8524(03)00111-1)
- Crini, G. (2014). Review: A History of Cyclodextrins. *Chemical Reviews*, 114(21), 10940–10975. <https://doi.org/10.1021/cr500081p>
- Crini, G. (2020). Water-Insoluble Cyclodextrin-Epichlorohydrin Polymers. In G. Crini, S. Fourmentin, & E. Lichtfouse (Eds.), *The History of Cyclodextrins* (Vol. 52, pp. 345–394). Springer International Publishing. https://doi.org/10.1007/978-3-030-49308-0_8
- Crini, G., & Morcellet, M. (2002). Synthesis and applications of adsorbents containing cyclodextrins. *Journal of Separation Science*, 25(13), 789–813. Scopus. [https://doi.org/10.1002/1615-9314\(20020901\)25:13<789::AID-JSSC789>3.0.CO;2-J](https://doi.org/10.1002/1615-9314(20020901)25:13<789::AID-JSSC789>3.0.CO;2-J)
- Decock, G., Fourmentin, S., Surpateanu, G. G., Landy, D., Decock, P., & Surpateanu, G. (2006). Experimental and Theoretical Study on the Inclusion Compounds of Aroma Components with β -Cyclodextrins. *Supramolecular Chemistry*, 18(6), 477–482. <https://doi.org/10.1080/10610270600665749>
- Decock, G., Landy, D., Surpateanu, G., & Fourmentin, S. (2008). Study of the retention of aroma components by cyclodextrins by static headspace gas chromatography. *Journal of Inclusion Phenomena and Macrocyclic Chemistry*, 62(3–4), 297–302. <https://doi.org/10.1007/s10847-008-9471-z>
- Del Valle, E. M. M. (2004). Cyclodextrins and their uses: A review. *Process Biochemistry*, 39(9), 1033–1046. [https://doi.org/10.1016/S0032-9592\(03\)00258-9](https://doi.org/10.1016/S0032-9592(03)00258-9)
- Dodziuk, H., Ejchart, A., Lukin, O., & Vysotsky, M. O. (1999). ¹H and ¹³C NMR and Molecular Dynamics Study of Chiral Recognition of Camphor Enantiomers by α -Cyclodextrin. *The Journal of Organic Chemistry*, 64(5), 1503–1507. <https://doi.org/10.1021/jo981937+>

- Dodziuk, H., Nowinski, K. S., Kozminski, W., & Dolgonos, G. (2003). On the impossibility of determination of stepwise binding constants for the 1 : 2 complex of (+)-camphor with α -cyclodextrin. *Organic & Biomolecular Chemistry*, 1(3), 581–584. <https://doi.org/10.1039/b209272g>
- Dou, J., Li, S., Cheng, L., Ding, A., Liu, X., & Yun, Y. (2011). The Enhancement of Naphthalene Degradation in Soil by Hydroxypropyl- β -Cyclodextrin. *Procedia Environmental Sciences*, 10, 26–31. <https://doi.org/10.1016/j.proenv.2011.09.006>
- Fenyvesi, E., Jicsinszky, L., Szejtli, J., & Schwarzenbach, R. (1999). Inclusion Complexes of UV Filters in Solution and in Solid State. In J. J. T. Labandeira & J. L. Vila-Jato (Eds.), *Proceedings of the Ninth International Symposium on Cyclodextrins* (pp. 639–643). Springer Netherlands. https://doi.org/10.1007/978-94-011-4681-4_151
- Fenyvesi, E. (1988). Cyclodextrin polymers in the pharmaceutical industry. *Journal of Inclusion Phenomena*, 6(5), 537–545. <https://doi.org/10.1007/BF00660751>
- Fourmentin, S., Ciobanu, A., Landy, D., & Wenz, G. (2013). Space filling of β -cyclodextrin and β -cyclodextrin derivatives by volatile hydrophobic guests. *Beilstein Journal of Organic Chemistry*, 9, 1185–1191. <https://doi.org/10.3762/bjoc.9.133>
- Freudenberg, K., & Cramer, F. (1948). Notizen: Die Konstitution der Schardinger-Dextrine α , β und γ . *Zeitschrift Für Naturforschung B*, 3(11–12), 464–466. <https://doi.org/10.1515/znb-1948-11-1211>
- Ghorpade, V. S., Yadav, A. V., & Dias, R. J. (2016). Citric acid crosslinked cyclodextrin/hydroxypropylmethylcellulose hydrogel films for hydrophobic drug delivery. *International Journal of Biological Macromolecules*, 93, 75–86. <https://doi.org/10.1016/j.ijbiomac.2016.08.072>
- Gidwani, B., & Vyas, A. (2014). Synthesis, characterization and application of Epichlorohydrin- β -cyclodextrin polymer. *Colloids and Surfaces B: Biointerfaces*, 114, 130–137. <https://doi.org/10.1016/j.colsurfb.2013.09.035>
- Hall, D., Bloor, D., Tawarah, K., & Wyn-Jones, E. (1986). Kinetic and equilibrium studies associated with the formation of inclusion compounds involving n-butanol and n-pentanol in aqueous cyclodextrin solutions. *Journal of the Chemical Society, Faraday Transactions 1: Physical Chemistry in Condensed Phases*, 82(7), 2111. <https://doi.org/10.1039/f19868202111>
- Hammoud, Z., Khreich, N., Auezova, L., Fourmentin, S., Elaissari, A., & Greige-Gerges, H. (2019). Cyclodextrin-membrane interaction in drug delivery and membrane structure

- maintenance. *International Journal of Pharmaceutics*, 564, 59–76.
<https://doi.org/10.1016/j.ijpharm.2019.03.063>
- Han, E.-M., Kim, S.-H., Ahn, J., & Kwak, H.-S. (2007). Optimizing cholesterol removal from cream using γ -cyclodextrin cross-linked with adipic acid. *International Journal of Dairy Technology*, 60(1), 31–36. <https://doi.org/10.1111/j.1471-0307.2007.00296.x>
- Hedges, A. R. (1998). Industrial Applications of Cyclodextrins. *Chemical Reviews*, 98(5), 2035–2044. <https://doi.org/10.1021/cr970014w>
- Heerklotz, H. H., Binder, H., & Eppard, R. M. (1999). A “Release” Protocol for Isothermal Titration Calorimetry. *Biophysical Journal*, 76(5), 2606–2613. [https://doi.org/10.1016/S0006-3495\(99\)77413-8](https://doi.org/10.1016/S0006-3495(99)77413-8)
- Hirayama, F., Uekama, K., & Koinuma, H. (1980). Molecular dynamics of prostaglandin F₂ALPHA.-cyclodextrin complexes in aqueous solution. *Chemical and Pharmaceutical Bulletin*, 28(7), 1975–1980. <https://doi.org/10.1248/cpb.28.1975>
- Hoesslin, H., & Pringsheim, H. (1923). Zur Physiologie der Polyamylosen. II. (Glykogenbildung und tierische Verbrennung.). *Hoppe-Seyler's Zeitschrift Für Physiologische Chemie*, 131(1–3), 168–176. <https://doi.org/10.1515/bchm2.1923.131.1-3.168>
- Hougeir, F. G., & Kircik, L. (2012). A review of delivery systems in cosmetics: A review of delivery systems in cosmetics. *Dermatologic Therapy*, 25(3), 234–237. <https://doi.org/10.1111/j.1529-8019.2012.01501.x>
- Irie, T., & Uekama, K. (1997). Pharmaceutical Applications of Cyclodextrins. III. Toxicological Issues and Safety Evaluation. *Journal of Pharmaceutical Sciences*, 86(2), 147–162. <https://doi.org/10.1021/js960213f>
- Katdare, A., & Chaubal, M. (Eds.). (2006). *Excipient Development for Pharmaceutical, Biotechnology, and Drug Delivery Systems* (0 ed.). CRC Press. <https://doi.org/10.1201/9781420004137>
- Kfoury, M., Auezova, L., Fourmentin, S., & Greige-Gerges, H. (2014). Investigation of monoterpenes complexation with hydroxypropyl- β -cyclodextrin. *Journal of Inclusion Phenomena and Macrocyclic Chemistry*, 80(1–2), 51–60. <https://doi.org/10.1007/s10847-014-0385-7>
- Kfoury, M., Auezova, L., Greige-Gerges, H., & Fourmentin, S. (2018). Cyclodextrins for Essential Oils Applications. In S. Fourmentin, G. Crini, & E. Lichtfouse (Eds.), *Cyclodextrin Applications in Medicine, Food, Environment and Liquid Crystals* (Vol.

- 17, pp. 81–123). Springer International Publishing. https://doi.org/10.1007/978-3-319-76162-6_4
- Kfoury, M., Hădărugă, N. G., Hădărugă, D. I., & Fourmentin, S. (2016). Cyclodextrins as encapsulation material for flavors and aroma. In *Encapsulations* (pp. 127–192). Elsevier. <https://doi.org/10.1016/B978-0-12-804307-3.00004-1>
- Kfoury, M., Landy, D., & Fourmentin, S. (2018). Characterization of Cyclodextrin/Volatile Inclusion Complexes: A Review. *Molecules*, 23(5), 1204. <https://doi.org/10.3390/molecules23051204>
- Kfoury, M., Landy, D., & Fourmentin, S. (2019). Contribution of headspace to the analysis of cyclodextrin inclusion complexes. *Journal of Inclusion Phenomena and Macroscopic Chemistry*, 93(1–2), 19–32. <https://doi.org/10.1007/s10847-018-0818-9>
- Kilsdonk, E. P. C., Yancey, P. G., Stoudt, G. W., Bangerter, F. W., Johnson, W. J., Phillips, M. C., & Rothblat, G. H. (1995). Cellular Cholesterol Efflux Mediated by Cyclodextrins. *Journal of Biological Chemistry*, 270(29), 17250–17256. <https://doi.org/10.1074/jbc.270.29.17250>
- Kolb, B. (1999). Headspace sampling with capillary columns. *Journal of Chromatography A*, 842(1–2), 163–205. [https://doi.org/10.1016/S0021-9673\(99\)00073-4](https://doi.org/10.1016/S0021-9673(99)00073-4)
- Kolb, B., & Ettre, L. S. (2006). *Static headspace-gas chromatography: Theory and practice* (2nd ed). Wiley.
- Komiyama, M., & Bender, M. L. (1978). Thermodynamic studies of the cyclodextrin-accelerated cleavage of phenyl esters. *Journal of the American Chemical Society*, 100(14), 4576–4579. <https://doi.org/10.1021/ja00482a042>
- Kurkov, S. V., & Loftsson, T. (2013). Cyclodextrins. *International Journal of Pharmaceutics*, 453(1), 167–180. <https://doi.org/10.1016/j.ijpharm.2012.06.055>
- Kwak, H.-S., Lee, J. E., & Chang, Y. H. (2011). Structural characterisation of β -cyclodextrin crosslinked by adipic acid: Structural characterisation of β -cyclodextrin. *International Journal of Food Science & Technology*, 46(6), 1323–1328. <https://doi.org/10.1111/j.1365-2621.2011.02594.x>
- Landy, D. (2018). Measuring Binding Constants of Cyclodextrin Inclusion Compounds. In S. Fourmentin, G. Crini, & E. Lichtfouse (Eds.), *Cyclodextrin Fundamentals, Reactivity and Analysis* (Vol. 16, pp. 223–255). Springer International Publishing. https://doi.org/10.1007/978-3-319-76159-6_5
- Landy, D., Fourmentin, S., Salome, M., & Surpateanu, G. (2000). Analytical Improvement in Measuring Formation Constants of Inclusion Complexes between β -Cyclodextrin and

- Phenolic Compounds. *Journal of Inclusion Phenomena and Macrocyclic Chemistry*, 38(1/4), 187–198. <https://doi.org/10.1023/A:1008156110999>
- Landy, D., Mallard, I., Ponchel, A., Monflier, E., & Fourmentin, S. (2012). Remediation technologies using cyclodextrins: An overview. *Environmental Chemistry Letters*, 10(3), 225–237. <https://doi.org/10.1007/s10311-011-0351-1>
- Landy, D., Tetart, F., Truant, E., Blach, P., Fourmentin, S., & Surpateanu, G. (2007). Development of a competitive continuous variation plot for the determination of inclusion compounds stoichiometry. *Journal of Inclusion Phenomena and Macrocyclic Chemistry*, 57(1–4), 409–413. <https://doi.org/10.1007/s10847-006-9226-7>
- Lehn, J.-M. (1985). Supramolecular Chemistry: Receptors, Catalysts, and Carriers. *Science*, 227(4689), 849–856. <https://doi.org/10.1126/science.227.4689.849>
- Lehn, J.-M. (1988). Supramolecular Chemistry—Scope and Perspectives Molecules, Supramolecules, and Molecular Devices(Nobel Lecture). *Angewandte Chemie International Edition in English*, 27(1), 89–112. <https://doi.org/10.1002/anie.198800891>
- Leite, R. A., Lino, A. C. S., & Takahata, Y. (2003). Inclusion compounds between α -, β - and γ -cyclodextrins: Iron II lactate: a theoretical and experimental study using diffusion coefficients and molecular mechanics. *Journal of Molecular Structure*, 644(1–3), 49–53. [https://doi.org/10.1016/S0022-2860\(02\)00479-9](https://doi.org/10.1016/S0022-2860(02)00479-9)
- Li, J. (2009). Cyclodextrin Inclusion Polymers Forming Hydrogels. In G. Wenz (Ed.), *Inclusion Polymers* (Vol. 222, pp. 175–203). Springer Berlin Heidelberg. https://doi.org/10.1007/12_2008_9
- Liang, Y. (2008). Applications of isothermal titration calorimetry in protein science. *Acta Biochimica et Biophysica Sinica*, 40(7), 565–576. <https://doi.org/10.1111/j.1745-7270.2008.00437.x>
- Lis-Cieplak, A., Sitkowski, J., & Kolodziejcki, W. (2014). Comparative Proton Nuclear Magnetic Resonance Studies of Amantadine Complexes Formed in Aqueous Solutions with Three Major Cyclodextrins. *Journal of Pharmaceutical Sciences*, 103(1), 274–282. <https://doi.org/10.1002/jps.23802>
- Liu, H., Cai, X., Wang, Y., & Chen, J. (2011). Adsorption mechanism-based screening of cyclodextrin polymers for adsorption and separation of pesticides from water. *Water Research*, 45(11), 3499–3511. <https://doi.org/10.1016/j.watres.2011.04.004>

- Liu, Y., Li, L., Zhang, H.-Y., Yang, Y.-W., & Ding, F. (2004). Correlation between Thermodynamic Behavior and Structure in the Complexation of Modified β -Cyclodextrins and Bile Salts. *Supramolecular Chemistry*, 16(5), 371–379. <https://doi.org/10.1080/10610270410001713295>
- Loftsson, T., & Brewster, M. E. (1996). Pharmaceutical Applications of Cyclodextrins. 1. Drug Solubilization and Stabilization. *Journal of Pharmaceutical Sciences*, 85(10), 1017–1025. <https://doi.org/10.1021/js950534b>
- Loftsson, T., & Brewster, M. E. (2010). Pharmaceutical applications of cyclodextrins: Basic science and product development. *Journal of Pharmacy and Pharmacology*, 62(11), 1607–1621. <https://doi.org/10.1111/j.2042-7158.2010.01030.x>
- Loftsson, T., & Duchene, D. (2007). Cyclodextrins and their pharmaceutical applications. *International Journal of Pharmaceutics*, 329(1–2), 1–11. <https://doi.org/10.1016/j.ijpharm.2006.10.044>
- Loftsson, T., Jarho, P., Másson, M., & Järvinen, T. (2005). Cyclodextrins in drug delivery. *Expert Opinion on Drug Delivery*, 2(2), 335–351. <https://doi.org/10.1517/17425247.2.1.335>
- Luppi, F., Cavaye, H., & Dossi, E. (2018). Nitrated Cross-linked β -Cyclodextrin Binders Exhibiting Low Glass Transition Temperatures. *Propellants, Explosives, Pyrotechnics*, 43(10), 1023–1031. <https://doi.org/10.1002/prop.201800137>
- Malanga, M., Szemán, J., Fenyvesi, É., Puskás, I., Csabai, K., Gyémánt, G., Fenyvesi, F., & Szente, L. (2016). “Back to the Future”: A New Look at Hydroxypropyl Beta-Cyclodextrins. *Journal of Pharmaceutical Sciences*, 105(9), 2921–2931. <https://doi.org/10.1016/j.xphs.2016.04.034>
- Mallard Favier, I., Baudalet, D., & Fourmentin, S. (2011). VOC trapping by new crosslinked cyclodextrin polymers. *Journal of Inclusion Phenomena and Macrocyclic Chemistry*, 69(3–4), 433–437. <https://doi.org/10.1007/s10847-010-9776-6>
- Mallard, I., Landy, D., & Fourmentin, S. (2020). Evaluation of Polyethylene Glycol Crosslinked β -CD Polymers for the Removal of Methylene Blue. *Applied Sciences*, 10(13), 4679. <https://doi.org/10.3390/app10134679>
- Marques, H. M. C. (2010). A review on cyclodextrin encapsulation of essential oils and volatiles. *Flavour and Fragrance Journal*, 25(5), 313–326. <https://doi.org/10.1002/ffj.2019>
- Martel, B., Morcellet, M., Ruffin, D., Vinet, F., & Weltrowski, L. (2002). Capture and Controlled Release of Fragrances by CD Finished Textiles. *Journal of Inclusion*

- Phenomena and Macrocyclic Chemistry*, 44(1/4), 439–442.
<https://doi.org/10.1023/A:1023028105012>
- Matencio, A., Caldera, F., Cecone, C., López-Nicolás, J. M., & Trotta, F. (2020). Cyclic Oligosaccharides as Active Drugs, an Updated Review. *Pharmaceuticals*, 13(10), 281. <https://doi.org/10.3390/ph13100281>
- Miron, D., Battisti, F., Schwengber Ten Caten, C., Mayorga, P., & Eva Scherman Schapoval, E. (2012). Spectrophotometric Simultaneous Determination of Citral Isomers in Cyclodextrin Complexes with Partial Least Squares Supported Approach. *Current Pharmaceutical Analysis*, 8(4), 401–408.
<https://doi.org/10.2174/157341212803341735>
- Mocanu, G., Vizitiu, D., & Carpov, A. (2001). Cyclodextrin Polymers. *Journal of Bioactive and Compatible Polymers*, 16(4), 315–342. <https://doi.org/10.1106/JJUV-8F2K-JGYF-HNGF>
- Moeder, C., O'Brien, T., Thompson, R., & Bicker, G. (1996). Determination of stoichiometric coefficients and apparent formation constants for α - and β -CD complexes of terpenes using reversed-phase liquid chromatography. *Journal of Chromatography A*, 736(1–2), 1–9. [https://doi.org/10.1016/0021-9673\(95\)01276-1](https://doi.org/10.1016/0021-9673(95)01276-1)
- Morin-Crini, N., & Crini, G. (2013). Environmental applications of water-insoluble β -cyclodextrin–epichlorohydrin polymers. *Progress in Polymer Science*, 38(2), 344–368. <https://doi.org/10.1016/j.progpolymsci.2012.06.005>
- Morin-Crini, N., Fourmentin, S., Fenyvesi, É., Lichtfouse, E., Torri, G., Fourmentin, M., & Crini, G. (2020). History of Cyclodextrins. In G. Crini, S. Fourmentin, & E. Lichtfouse (Eds.), *The History of Cyclodextrins* (Vol. 52, pp. 1–93). Springer International Publishing. https://doi.org/10.1007/978-3-030-49308-0_1
- Morin-Crini, N., Winterton, P., Fourmentin, S., Wilson, L. D., Fenyvesi, É., & Crini, G. (2018). Water-insoluble β -cyclodextrin–epichlorohydrin polymers for removal of pollutants from aqueous solutions by sorption processes using batch studies: A review of inclusion mechanisms. *Progress in Polymer Science*, 78, 1–23. <https://doi.org/10.1016/j.progpolymsci.2017.07.004>
- Mura, P. (2014). Analytical techniques for characterization of cyclodextrin complexes in aqueous solution: A review. *Journal of Pharmaceutical and Biomedical Analysis*, 101, 238–250. <https://doi.org/10.1016/j.jpba.2014.02.022>
- Nakhle, L., Kfoury, M., Greige-Gerges, H., & Fourmentin, S. (2020). Effect of dimethylsulfoxide, ethanol, α - and β -cyclodextrins and their association on the

- solubility of natural bioactive compounds. *Journal of Molecular Liquids*, 310, 113156. <https://doi.org/10.1016/j.molliq.2020.113156>
- Nazi, M., Malek, R. M. A., & Kotek, R. (2012). Modification of β -cyclodextrin with itaconic acid and application of the new derivative to cotton fabrics. *Carbohydrate Polymers*, 88(3), 950–958. <https://doi.org/10.1016/j.carbpol.2012.01.047>
- Nazi, M., Malek, R. M. A., & Moghadam, M. B. (2012). Effect of processing conditions on producing a reactive derivative from β -cyclodextrin with itaconic acid. *Starch - Stärke*, 64(10), 794–802. <https://doi.org/10.1002/star.201100182>
- Pedersen, C. J. (1988). The Discovery of Crown Ethers. *Science*, 241(4865), 536–540. <https://doi.org/10.1126/science.241.4865.536>
- Petitjean, M., García-Zubiri, I. X., & Isasi, J. R. (2020). Cyclodextrin-Based Polymers for Food and Pharmaceutical Applications: A Historical Review. In G. Crini, S. Fourmentin, & E. Lichtfouse (Eds.), *The History of Cyclodextrins* (Vol. 52, pp. 281–304). Springer International Publishing. https://doi.org/10.1007/978-3-030-49308-0_6
- Phunpee, S., Ruktanonchai, U. R., Yoshii, H., Assabumrungrat, S., & Soottitantawat, A. (2017). Encapsulation of lemongrass oil with cyclodextrins by spray drying and its controlled release characteristics. *Bioscience, Biotechnology, and Biochemistry*, 81(4), 718–723. <https://doi.org/10.1080/09168451.2016.1277942>
- Piñero, Á., Banquy, X., Pérez-Casas, S., Tovar, E., García, A., Villa, A., Amigo, A., Mark, A. E., & Costas, M. (2007). On the Characterization of Host–Guest Complexes: Surface Tension, Calorimetry, and Molecular Dynamics of Cyclodextrins with a Non-ionic Surfactant. *The Journal of Physical Chemistry B*, 111(17), 4383–4392. <https://doi.org/10.1021/jp0688815>
- Pirna, A., Floare, C. G., & Bogdan, M. (2014). The complexation of flurbiprofen with β -cyclodextrin: A NMR study in aqueous solution. *Journal of Inclusion Phenomena and Macrocyclic Chemistry*, 78(1–4), 113–120. <https://doi.org/10.1007/s10847-012-0277-7>
- Rao, V. M., & Stella, V. J. (2003). When can cyclodextrins be considered for solubilization purposes? *Journal of Pharmaceutical Sciences*, 92(5), 927–932. <https://doi.org/10.1002/jps.10341>
- Romo, A., Peñas, F. J., Isasi, J. R., García-Zubiri, I. X., & González-Gaitano, G. (2008). Extraction of phenols from aqueous solutions by β -cyclodextrin polymers. Comparison of sorptive capacities with other sorbents. *Reactive and Functional Polymers*, 68(1), 406–413. <https://doi.org/10.1016/j.reactfunctpolym.2007.07.005>

- Rungsardthong Ruktanonchai, U., Srinuanchai, W., Saesoo, S., Sramala, I., Puttipipatkachorn, S., & Soottitantawat, A. (2011). Encapsulation of Citral Isomers in Extracted Lemongrass Oil with Cyclodextrins: Molecular Modeling and Physicochemical Characterizations. *Bioscience, Biotechnology, and Biochemistry*, 75(12), 2340–2345. <https://doi.org/10.1271/bbb.110523>
- Salústio, P. J., Pontes, P., Conduto, C., Sanches, I., Carvalho, C., Arrais, J., & Marques, H. M. C. (2011). Advanced Technologies for Oral Controlled Release: Cyclodextrins for Oral Controlled Release. *AAPS PharmSciTech*, 12(4), 1276–1292. <https://doi.org/10.1208/s12249-011-9690-2>
- Sayo O. Fakayode, Mark Lowry, Kristin A. Fletcher, Xiaodong Huang, Aleeta M. Powe, & Isiah M. Warner. (2007). Cyclodextrins Host- Guest Chemistry in Analytical and Environmental Chemistry. *Current Analytical Chemistry*, 3(3), 171–181. <https://doi.org/10.2174/157341107781023811>
- Shaw, P. E., & Buslig, B. S. (1986). Selective removal of bitter compounds from grapefruit juice and from aqueous solution with cyclodextrin polymers and with Amberlite XAD-4. *Journal of Agricultural and Food Chemistry*, 34(5), 837–840. <https://doi.org/10.1021/jf00071a018>
- Shityakov, S., Salmas, R. E., Salvador, E., Roewer, N., Broscheit, J., & Förster, C. (2016). Evaluation of the potential toxicity of unmodified and modified cyclodextrins on murine blood-brain barrier endothelial cells. *The Journal of Toxicological Sciences*, 41(2), 175–184. <https://doi.org/10.2131/jts.41.175>
- Solms, J., & Egli, R. H. (1965). Harze mit Einschlu shohlräumen von Cyclodextrin-Struktur. *Helvetica Chimica Acta*, 48(6), 1225–1228. <https://doi.org/10.1002/hlca.19650480603>
- Sun, M.-M., Teng, Y., Luo, Y.-M., Li, Z.-G., Jia, Z.-J., & Zhang, M.-Y. (2013). [Ex-situ remediation of PAHs contaminated site by successive methyl-beta-cyclodextrin enhanced soil washing]. *Huan Jing Ke Xue*, 34(6), 2428–2435. PubMed.
- Szejtli, J. (1982). Cyclodextrins in Food, Cosmetics and Toiletries. *Starch - Stärke*, 34(11), 379–385. <https://doi.org/10.1002/star.19820341106>
- Szejtli, J. (1984). Limits of cyclodextrin application in oral drug preparations. *Journal of Inclusion Phenomena*, 2(3–4), 487–501. <https://doi.org/10.1007/BF00662215>
- Szejtli, J. (1988). *Cyclodextrin Technology*. /z-wcorg/. <http://www.vlebooks.com/vleweb/product/openreader?id=none&isbn=978940157797>

- Szejtli, J. (2004). Past, present and future of cyclodextrin research. *Pure and Applied Chemistry*, 76(10), 1825–1845. <https://doi.org/10.1351/pac200476101825>
- Szejtli, J., & Szente, L. (2005). Elimination of bitter, disgusting tastes of drugs and foods by cyclodextrins. *European Journal of Pharmaceutics and Biopharmaceutics*, 61(3), 115–125. <https://doi.org/10.1016/j.ejpb.2005.05.006>
- Szente, L., & Szejtli, J. (2004). Cyclodextrins as food ingredients. *Trends in Food Science & Technology*, 15(3–4), 137–142. <https://doi.org/10.1016/j.tifs.2003.09.019>
- Villiers, A. (1891). Sur la fermentation de la fécule par l'action du ferment butyrique. *C. R. Acad. Sci.*, 112. Scopus.
- Waalkens-Berendsen, D. H., Verhagen, F. J. J., & Bär, A. (1998). Embryotoxicity and Teratogenicity Study with γ -Cyclodextrin in Rats. *Regulatory Toxicology and Pharmacology*, 27(2), 166–171. <https://doi.org/10.1006/rtp.1998.1221>
- Wadhwa, G., Kumar, S., Chhabra, L., Mahant, S., & Rao, R. (2017). Essential oil–cyclodextrin complexes: An updated review. *Journal of Inclusion Phenomena and Macrocyclic Chemistry*, 89(1–2), 39–58. <https://doi.org/10.1007/s10847-017-0744-2>
- Wagner, C. J., Wilson, C. W., & Shaw, P. E. (1988). Reduction of Grapefruit Bitter Components in a Fluidized β -Cyclodextrin Polymer Bed. *Journal of Food Science*, 53(2), 516–518. <https://doi.org/10.1111/j.1365-2621.1988.tb07745.x>
- Wang, Y., Zhou, S., Xia, J., Xue, J., Xu, J., & Zhu, J. (2004). Trapping and degradation of volatile nitrosamines on cyclodextrin and zeolites. *Microporous and Mesoporous Materials*, 75(3), 247–254. <https://doi.org/10.1016/j.micromeso.2004.07.025>
- Wintgens, V., Dalmas, F., Sébille, B., & Amiel, C. (2013). Novel phosphorus-containing cyclodextrin polymers and their affinity for calcium cations and hydroxyapatite. *Carbohydrate Polymers*, 98(1), 896–904. <https://doi.org/10.1016/j.carbpol.2013.06.073>
- Wintgens, V., Lorthioir, C., Dubot, P., Sébille, B., & Amiel, C. (2015). Cyclodextrin/dextran based hydrogels prepared by cross-linking with sodium trimetaphosphate. *Carbohydrate Polymers*, 132, 80–88. <https://doi.org/10.1016/j.carbpol.2015.06.038>
- Yin, J.-J., Zhou, Z.-W., & Zhou, S.-F. (2013). Cyclodextrin-based targeting strategies for tumor treatment. *Drug Delivery and Translational Research*, 3(4), 364–374. <https://doi.org/10.1007/s13346-013-0140-4>

II. EXPERIMENTATIONS ET RESULTATS

Introduction

De nos jours, l'utilisation des huiles essentielles et des arômes comme alternatifs aux agents antimicrobiens, antioxydants et anti-inflammatoires de synthèse pour leur incorporation dans la formulation des produits alimentaires et pharmaceutiques constitue une tendance de fond. Toutefois, les huiles essentielles et les arômes souffrent d'une faible solubilité dans les phases aqueuses. De plus, ces composés sont volatils et sensibles à la dégradation (Kfoury et al., 2016). Le développement de nouvelles formulations améliorant leurs propriétés est par conséquent considéré comme de haute importance.

Durant les dernières années, des études ont été menées au sein de nos équipes de recherche portant sur l'étude du pouvoir de solubilisation des CDs au sein des DESs *vis-à-vis* des molécules hydrophobes et peu solubles. Les résultats ont démontré que la co-présence des DESs avec les CDs permet d'améliorer la solubilité des molécules naturelles (El Achkar et al., 2020). Toutefois, des études plus poussées sont considérées essentielles pour déterminer l'influence de plusieurs facteurs sur le pouvoir de solubilisation d'une telle combinaison.

Ce projet de thèse fait suite à ce constat et vise à répondre aux questions suivantes :

1. Est-ce qu'une combinaison DES:eau:CD peut améliorer le piégeage et la solubilité d'une huile essentielle modèle ? Quelles sont les paramètres influençant cette capacité de solubilisation ? Quel est l'apport éventuel de la complexation dans ces formulations ?
2. Etant donnée la grande diversité qui peut être induite par la modification chimique des CDs (Partie I- Chapitre 4), la polymérisation de CDs peut-elle influencer la capacité de solubilisation de l'huile modèle dans une telle combinaison ?
3. Une formulation DES:eau:CD définie dans le cas d'une huile modèle peut-elle s'avérer optimale pour une large gamme d'huiles essentielles et d'arômes ? Peut-on expliquer cette versatilité éventuelle sur la base des constituants individuels composant les huiles essentielles ? Peut-on rationaliser ces constats par la mise en évidence de phénomènes de complexation dans de telles formulations ?
4. Plus précisément, serait-il possible de déterminer les paramètres thermodynamiques des phénomènes de complexation se déroulant au sein de ces formulations ?

Les chapitres 5 à 8 de la partie II répondent ainsi respectivement à ces quatre axes de questions.

CHAPITRE 5

Optimisation d'une formulation DES:eau:CD

Introduction

Récemment, il a été montré que les DESs pouvaient présenter des capacités de solubilisation plus élevées que l'eau dans le cas des molécules naturelles, et ce avec un apport parfois positif de la présence d'eau dans les DESs (Shamseddin et al., 2017; Moufawad et al., 2019). De plus, il a été révélé que la combinaison DES:CD peut augmenter davantage la solubilité des molécules naturelles (El Achkar et al., 2020).

Afin de développer de nouvelles formulations combinant les DESs et les CDs dans le but d'augmenter la solubilité des huiles essentielles, nous nous sommes tout d'abord focalisés sur une étude d'optimisation de la solubilisation de l'huile essentielle *Eucalyptus citriodora* en tant qu'une huile modèle. *E. citriodora* est formée d'une grande variété de molécules volatiles de classes chimiques diverses, notamment des carbonyles (citronnellal, menthone), des alcools (citronellol, isopulégol, néoisopulégol, linalol, α -terpinéol, géraniol, safrole, eugénol, nérol), des esters (citronnellate de citronnellyle, acétate de citronnellyle), des éthers (1,8-cinéole) et des hydrocarbures (α -pinène, β -pinène, *p*-cymène, limonène, ϵ -cadinène, β -caryophyllène, δ -cadinène). Même si la composition et les concentrations des composants varient d'une huile à une autre, l'hypothèse formulée ici est de considérer qu'une telle diversité peut constituer une base de travail pour la définition d'une formulation relativement universelle.

Dans cette étude, le suivi de la solubilisation d'*E. citriodora* est réalisé de manière indirecte en déterminant la réduction de sa volatilité par rapport à une solution aqueuse. Ces mesures de volatilité sont exécutées par la technique d'espace de tête-statique couplée à la chromatographie en phase gazeuse.

En préalable à ces études de volatilité, les différentes formulations DES:eau:CD ont été préparées et caractérisées. En particulier, des mesures de densité, viscosité et polarité ont été réalisées.

Les DESs explorés dans cette étude sont obtenus à partir d'un accepteur de liaisons d'hydrogènes largement utilisé dans la littérature, le chlorure de choline. Ce dernier est notamment employé dans le domaine de l'alimentation animale (pro-vitamine B₄), ce qui en fait un constituant de base largement accessible.

Comme le DES le plus couramment étudié est celui qui associe le chlorure de choline à l'urée, nos investigations en termes de formulations se sont tout d'abord basées sur cette association. Dans un premier temps, nous avons ainsi étudié l'influence de la variation de la quantité d'eau dans les DESs sur la volatilité de l'huile essentielle, en présence et en l'absence de CDs dans la formulation.

Sur la base des informations obtenues, nous nous sommes ensuite intéressés à l'influence de la nature du donneur de liaison hydrogène (acide lévulinique, acide tartrique, acide lactique, glycérol, xylitol, sorbitol, butane-1,3-diol, propane-1,3-diol, glucose et fructose).

Dans un troisième temps, nous avons exploré l'impact de la variation du ratio molaire chlorure de choline:urée pour la définition de la formulation optimale, puisqu'il existe des études qui ont montré que le ratio molaire du DES influe sur son pouvoir de solubilisation (Dietz et al., 2017; Silva et al., 2020).

Le citronellal constitue le composé majeur de l'huile essentielle *E. citriodora*. Par conséquent, des études plus spécifiques ont été menées pour caractériser les éventuels complexes d'inclusion CD/citronellal pouvant exister au sein d'un mélange DES:eau. En particulier, l'affinité des systèmes β -CD/citronellal et HP- β -CD/citronellal dans la nouvelle formulation a été évaluée en comparaison avec l'eau. Enfin, le coefficient de partage du citronellal entre la formulation DES:eau:CD et la phase gazeuse a également été déterminé afin de quantifier la réduction de volatilité du citronellal dans la formulation proposée.

Ces investigations ont été rassemblées dans l'article intitulé '*Choline chloride based-deep eutectic solvents:water:cyclodextrins mixtures for the entrapment and the solubilization of volatile molecules: application to Eucalyptus citriodora essential oil and citronellal*', et qui est en phase de soumission.

Choline chloride based-deep eutectic solvents:water:cyclodextrins mixtures for the entrapment and the solubilization of volatile molecules: application to *Eucalyptus citriodora* essential oil and citronellal

Lamia Nakhle^{a,b}, Miriana Kfoury^{a,b,*}, Isabelle Mallard^b, H el ene Greige-Gerges^a, David Landy^b

^a *Bioactive Molecules Research Laboratory, Faculty of Sciences, Lebanese University, 90656 Jdeidet el-Metn, Lebanon*

^b *Unit e de Chimie Environnementale et Interactions sur le Vivant (UCEIV, EA 4492), SFR Condorcet FR CNRS 3417, Universit e du Littoral C ote d'Opale (ULCO), 145 Av. M. Schumann, F-59140 Dunkerque, France*

* Corresponding author: miriana.kfoury@univ-littoral.fr

Abstract

This study examined, for the first time, the combination of deep eutectic solvents (DESs), water and cyclodextrins (CDs) for the retention and solubilization of *Eucalyptus Citriodora* essential oil and its major component, citronellal. The density, viscosity and polarity of the newly prepared mixtures were measured. The solubilization ability of different ChCl based-DESs, CDs and the combined DES:water:CD was studied using static headspace-gas chromatography. The influence of water content, DES type and composition as well as CD type and concentration was investigated. The formation constants of CD/citronellal inclusion complexes and the vapor-liquid partition coefficients of citronellal were determined in choline chloride:urea (ChCl:U) DES:water 70:30 wt%. Results showed that the combined mixtures presented higher solubilization capacity than the separated systems. Adding water (30 wt%) to DES:CD mixtures was required to fully benefit from the inclusion phenomenon. Therefore, ChCl:U (1:2 molar ratio) DES:water(70:30 wt%):CD was shown to be the best solubilizer among all.

Keywords: citronellal, cyclodextrins, deep eutectic solvents, essential oil, solubility.

1. Introduction

Essential oils (EOs) are natural multicomponent mixtures that have been widely used since ancient times due to their beneficial effects on humans and animals. They represent a major group of phytochemical feed additives (PFA) due to their various antibiotic, antioxidant, anti-quorum sensing, anti-inflammatory as well as digestive fluids stimulating activities (Stevanovic et al., 2018). *Eucalyptus* EO ranks as the world's first traded oil and *Eucalyptus citriodora* EO is the major *Eucalyptus* oil with respect to the trade volume (Dhakad et al., 2018). It possesses a wide variety of bioactivities (antimicrobial, antiviral, fungicidal, insecticidal and herbicidal). However, incorporating EOs in different formulations remains a challenge due to their low aqueous solubility, low stability and high volatility. This thereby restricts their broad utilization (Kfoury et al., 2016).

Recent strategy for enhancing EO solubility is the use of deep eutectic solvents (DESs) (El Achkar et al., 2020). DESs are generally defined as mixtures of two or more pure compounds, at specific composition, that are able to associate mainly *via* hydrogen bonds (Abbott et al., 2003). This interaction causes a great depression in the melting point of the mixture compared to its constituents. More precisely, the eutectic point temperature of a DES is below that of its ideal liquid mixture (Martins et al., 2019) and DESs are generally liquid at room temperature. These solvents are considered as environmentally friendly alternative for toxic organic solvents. They consequently present an effective way to design systems with greener aspects (Fernández et al., 2018). DESs have been introduced to replace water and organic solvents for the solvation of different active agents such as volatile organic compounds (Moura et al., 2017), curcumin (Jeliński et al., 2019), *trans*-anethole as well as star anise and fennel EOs (El Achkar et al., 2020).

Another approach to overcome such problems is the use of cyclodextrins (CDs), oligosaccharides obtained from the enzymatic degradation of starch. The most common native CDs are α -CD, β -CD, and γ -CD, made up of six, seven or eight (α -1,4)-linked α -D-glucopyranose units, respectively (Loftsson & Brewster, 2012). These CDs can be safely used in food. They are included in the GRAS list and their assigned E-numbers are E457, E459, and E458, respectively. CDs possess a hydrophilic outer surface allowing them to be soluble in water. Also, they have a hydrophobic interior cavity making them able to form inclusion complexes with lipophilic guests through non-covalent interactions (Crini, 2014). This usually results in an improvement of the physico-chemical properties of guests, mainly their aqueous solubility. CDs contain several hydroxyl groups that are used for selective

functionalization in order to obtain CDs derivatives with enhanced solubility and encapsulation capability, like the hydroxypropylated- β -CD (HP- β -CD) (Kfoury et al., 2016). Many studies were focused on using native CDs as well as their derivatives to improve the solubility of EOs and their components (Ciobanu et al., 2012, 2013; Kfoury et al., 2015, 2018; Nakhle et al., 2020).

Interestingly, it was shown that poorly-soluble native β -CD can be solubilized in choline chloride:urea (ChCl:U) DES up to 1 g.mL^{-1} compared to its solubility in water of 0.018 g.mL^{-1} (McCune et al., 2017). Molecular dynamics simulations showed the presence of hydrophilic and hydrophobic interactions between CDs and the DESs components, leading to energetically favorable CDs solvation (Triolo et al., 2020). Also, it was recently demonstrated that CDs retain their encapsulation capacity in DESs (Moufawad et al., 2019). Thus, the combination of DESs and CDs could give rise to formulations with higher potency of solubilization taking advantage of the complementary features of the two systems, as CDs can encapsulate hydrophobic molecules and DESs can dissolve them in the bulk medium. The aim of the present study is to develop new mixtures using CDs and ChCl, a vitamin and substitute supplement in animal feed additives, based-DESs to retain and solubilize *E. citriodora* EO and its major component, citronellal. The density, viscosity and polarity of the new prepared mixtures were determined. Then, the retention and the solubilization potential of different DESs, CDs and the combined DES:water:CD mixtures were studied using static headspace-gas chromatography (SH-GC). Additionally, the influence of water content, DESs type, DESs composition and CDs content on the volatility of the EO and citronellal were assessed. Finally, the formation constant (K_f) values of CD/citronellal inclusion complexes and the vapor-liquid partition coefficients of citronellal were determined in the new studied mixtures.

2. Experimental section

2.1. Materials

Choline chloride (ChCl, 98%) was purchased from Sigma-Aldrich, China. Urea (U, 99%) and lactic acid were purchased from Sigma-Aldrich, USA. Levulinic acid was purchased from Sigma-Aldrich, France. Citronellal was provided by Merck group, Germany. Propane-1,3-diol, L-(+)-tartaric acid, glycerol, D(-)-sorbitol, D(-)-fructose and D(+)-glucose anhydrous were provided by VWR Chemicals, Belgium. Xylitol and (\pm)-butane-1,3-diol were provided by Alfa Aesar, Germany. Nile red was provided by Acros, Belgium. β -CD was provided by Wacker-Chemie, Lyon, France. Hydroxypropyl- β -CD (HP- β -CD, MS=0.65) was provided by Roquette Frères, Lestrem, France. *E. citriodora* EO was provided by Herbes et Traditions, Comines, France. The constituents (with percentage of presence > 1%) of the EO are: citronellal (74.77%), citronnellol (4.84%), isopulegol (4.30%), neoisopulegol (2.17%), citronnellate of citronnellyle isomers (2.07%), citronnellyle acetate (1.26%), α -pinene (1.32%), β -pinene (1.04%) and ϵ -cadinene (1.22%) (data provided by Herbes et Traditions). ChCl was dried at 60 °C for at least 2 weeks before use. All other compounds were used as received. Distilled water was used throughout this work.

2.2. Preparation of deep eutectic solvents

DESs were prepared using the heating method by mixing ChCl as the hydrogen bond acceptor (HBA) and different hydrogen bond donors (HBDs) in a specific molar ratio under stirring until the formation of a clear and homogenous liquid (**Table 1**). The water content of all the prepared DESs were determined using the Karl Fisher titration method (Mettler Toledo DL31).

Table 1- Composition of the studied deep eutectic solvents.

DES (HBA:HBD)	Abbreviation	Molar ratio	Heating temperature (°C)	Water content (%)
ChCl:Urea	ChCl:U	1:2	60	0.05
ChCl:Levulinic acid	ChCl:Lev	1:2	RT	0.31
ChCl:Tartaric acid	ChCl:Tar	1:1	80	0.16
ChCl:Lactic acid	ChCl:Lac	1:2	RT	8.07
ChCl:Glycerol	ChCl:Gly	1:2	RT	0.20
ChCl:Xylitol	ChCl:Xyl	1:2	80	0.07
ChCl:Sorbitol	ChCl:Sor	1:1	80	0.36
ChCl:Butane-1,3-diol	ChCl:But	1:2	40	0.08
ChCl:Propane-1,3-diol	ChCl:Pro	1:1	80	0.21
ChCl:Glucose	ChCl:Glu	2:1	80	0.26
ChCl:Fructose	ChCl:Fru	2:1	80	2.15

ChCl: Choline chloride; DES: Deep eutectic solvent; HBA: Hydrogen bond acceptor; HBD: Hydrogen bond donor; RT: Room temperature

2.3. Density measurements

Density (ρ) measurements of the studied mixtures were carried out using a U-shaped vibrating tube densimeter (Anton Paar, model SVM 3001) operating in a static mode at atmospheric pressure at 30 °C or 60 °C. The factory calibration was used and verified before and after each measurement with air. The densimeter performs an analysis with an estimated uncertainty in density and temperature of $\pm 0.0001 \text{ g.cm}^{-3}$ and $\pm 0.005 \text{ °C}$, respectively. For ChCl:U DES:water mixtures at low DES wt%, density values were fitted using a linear equation (1):

$$\rho = b + (a \times w) \quad (1)$$

With w representing the wt% of ChCl:U DES, a and b representing the fitting parameters of the equation (listed in **Table S1**).

2.4. Viscosity measurements

The viscosity (η) of the studied mixtures was determined using a Stabinger viscometer (Anton Paar, model SVM 3001) at atmospheric pressure at 30 °C or 60 °C. The temperature was controlled to within 0.005 °C. The overall uncertainty on the viscosity was estimated to be 2 %. For ChCl:U DES:water mixtures at low DES wt%, the results are fitted following an exponential equation (2), with a Chi-square up to 0.09.

$$\eta = \left(A_1 \times e^{\frac{w}{t_1}} \right) + \left(A_2 \times e^{\frac{w}{t_2}} \right) + y_0 \quad (2)$$

With w representing the wt% of ChCl:U DES, y_0 , A_1 , t_1 , A_2 and t_2 representing the fitting parameters of the equation (listed in **Table S2**).

2.5. Polarity measurements

Polarity measurements were carried out for various ChCl:U DES:water mixtures and for the different ChCl-based DES:water mixtures (70:30 wt%). A stock solution of Nile Red (NR) was prepared in ethanol with a concentration of 10^{-4} mol.L⁻¹. A volume of 30 μ L of NR solution was added to 1470 μ L of mixture placed in vials. The same concentration of ethanol was kept in all mixtures (2 vol% of ethanol) to prevent any influence of ethanol on the polarity of the mixture (Ray et al., 2019). Then, solutions were stirred at 20 °C for a few minutes, to ensure the solubilization of the probe. UV-Vis spectra were recorded with a PerkinElmer Lambda 2S spectrophotometer, between 400 and 700 nm. The wavelength, at which the maximum visible-light absorption of NR occurred (λ_{max}), was determined for each mixture, and the NR polar parameter E_{NR} (in kcal.mol⁻¹) was calculated using equation (3).

$$E_{NR} = \frac{28591.44}{\lambda_{max} (nm)} \quad (3)$$

2.6. Solubility studies

The solubilization ability of different DESs, CDs and the combined DES:water:CD mixtures towards *E. citriodora* EO and citronellal was evaluated using SH-GC.

2.6.1. Preparation of different mixtures

2.6.1.1. Influence of water content

ChCl:U DES:water mixtures were prepared in various water wt% ranging from 0 to 100 wt% in the absence or presence of 10 wt% HP- β -CD (previously weighted in vials).

2.6.1.2. Influence of DES composition

Screening of different DESs

DES:water (70:30 wt%) mixtures were prepared using different ChCl-based DESs in the absence and presence of 10 wt% HP- β -CD. The studied DESs are listed in **Table 1**.

Influence of the mass fraction of DES components

30 wt% of water and 70 wt% of ChCl:U DES components were mixed using different ChCl and U mass fractions (0, 0.1, 0.2, 0.3, 0.4, 0.5, 0.6, 0.7, 0.8, 0.9 and 1 ChCl/U) in the absence and presence of 10 wt% HP- β -CD.

2.6.1.3. Chromatographic conditions

In all experiments, prepared mixtures (3 mL) were placed in 22 mL vials. Then, appropriate amounts of an ethanolic solution of EO or citronellal were added. Vials were subsequently sealed using silicone septa and aluminium foil and thermostated at 30 °C (or 60 °C when varying the mass fractions of DES components) for 24 hours under stirring to reach the equilibrium between liquid and gas phases. Then, 1 mL of the headspace was withdrawn from the vial and injected in the chromatographic system for analysis *via* a heated transfer line (250 °C). Measurements were carried out with a Varian Genesis headspace sampler coupled with a Perkin Elmer Autosystem XL gas chromatography (GC) equipped with a flame ionization detector and a DB624 column using nitrogen as carrier gas. The GC column temperature conditions were set as follows: initial temperature of 50 °C for 2 min, increased to 200 °C at 5 °C.min⁻¹, then hold for 2 min, giving a total runtime of 34 min.

Results for EO were expressed as:

$$\text{Normalized area (\%)} = \frac{\sum A_m}{\sum A_0} \times 100 \quad (4)$$

where $\sum A_m$ and $\sum A_0$ stand for the sum of peak areas of the EO components in the presence of the studied mixture and the corresponding reference, respectively.

Results for citronellal were expressed as:

$$\text{Normalized area (\%)} = \frac{A_m}{A_0} \times 100 \quad (5)$$

where A_m and A_0 stand for the peak area of citronellal in the presence of the studied mixture and the corresponding reference, respectively.

2.6.2. Determination of formation constants

The formation constant (k_f) of the complexes were determined using a SH-GC titration method developed in our laboratory for volatile organic compounds and using an algorithmic calculation (Blach et al., 2008; Decock et al., 2008). Increasing concentrations of CDs (β -CD

or HP- β -CD) ranging from 0 to 10 wt% of CDs were added to ChCl:U DES:water 70:30 wt% mixtures. Then, 40 μ L of the ethanol solutions of EO (0.02 g.mL⁻¹) or citronellal (0.015 g.mL⁻¹) were then added to all mixtures. Vials, equilibrated at 30 °C, were then subjected to SH-GC analysis. The chromatographic conditions were set as in 2.6.1.3.

2.6.3. Determination of vapor-liquid partition coefficients of citronellal

The vapor-liquid partition coefficient (K) is the ratio of the concentration of the volatile compound in the vapor phase to its concentration in the liquid phase, when the equilibrium is reached, expressed as (Kolb & Ettre, 2006):

$$K = \frac{C_G}{C_L} \quad (6)$$

Where C_G and C_L are the concentrations of the volatile compound in the gas phase and the liquid phase at equilibrium, respectively.

K of citronellal was determined in water and in ChCl:U DES:water 70:30 wt% mixture prepared in the absence or the presence of 10 wt% HP- β -CD or 2 wt% β -CD at 30 °C by using the phase ratio variation (PRV) method in water and the vapor phase calibration (VPC) method in the other mixtures as reported earlier (Moura et al., 2017).

In water, several headspace vials were prepared containing different volumes of water to which the same amount of citronellal (10 μ L of 0.005 g.mL⁻¹) was added. The values of K were determined by the relationship between the reciprocal chromatographic peak areas and the vapor-liquid volumetric ratio (V_G/V_L , with V_G and V_L being the gas volume and the liquid volume, respectively):

$$\frac{1}{AV_L} = \frac{1}{\alpha} \frac{V_G}{V_L} + \frac{1}{\alpha K} \quad (7)$$

where A is the chromatographic peak area of citronellal and α is a constant incorporating several parameters.

Using the previously determined K value in water, the concentration of citronellal in the gas phase was calculated and the response coefficient R in each vial was determined as follows:

$$R = \frac{A}{C_G} \quad (8)$$

where A stands for the experimental chromatographic peak area.

Next, the average of the obtained R values was calculated. This parameter will help calculating the concentration of citronellal in the gas phase in the following experiments.

In DES:water mixtures, the VPC method was used. Different amounts of citronellal (0.1 g.mL^{-1}) were added to vials containing the same volume of ChCl:U DES:water 70:30 wt% mixture (3 mL) in the absence or presence of 10 wt% HP- β -CD or 2 wt% β -CD (precipitation was observed when using higher amounts of β -CD). A higher concentration of citronellal was used in order to obtain chromatographic peak areas in the same order as in water for a higher precision. The experimental chromatographic peak areas (A) allowed the determination of C_G using equation (8). C_L was then calculated from the mass balance. K of citronellal in these mixtures was subsequently calculated using equation (6).

3. Results

This study was performed to evaluate the effects of the combination of DESs, CDs and water on the entrapment and the solubilization of *E. citriodora* EO and its major component, citronellal. Different formulations were prepared by varying water content, DESs type and composition as well as CDs content. All formulations were then subjected to physico-chemical characterization. Solubility studies were carried out using SH-GC. When a decrease in the peak areas is observed, this corresponds to a decrease in the volatility of the EO or citronellal and in other terms an increase in their solubility in the studied mixture.

3.1. Characterization of the prepared mixtures

3.1.1. Density measurements

Different wt% of water were added to ChCl:U DES in the absence and presence of 10 wt% HP- β -CD. All solutions were homogeneous, and DES was completely miscible in water. These solutions were characterized first by measuring their densities (**Figure S1**). The density of ChCl:U DES decreases linearly when increasing the amount of water in the media in the absence and the presence of CDs. Results are coherent with those found in literature with other DESs (ChCl:Glu, ChCl:sucrose, and ChCl:propane-1,2-diol) (Dai et al., 2015).

The influence of ChCl mass fraction variation in ChCl:U DES:water 70:30 wt% was also studied. Results proved that decreasing the ChCl mass fraction in the mixture, meaning increasing the U mass fraction, led to the increase in the density of the mixture (**Table S3**).

Further, preparing different types of DESs can give rise to solvents with different properties including their densities (Cunha & Fernandes, 2018). The obtained results (**Table S4**) confirmed that the density of the different types of DES:water 70:30 wt% depended on the nature of the HBD of the DESs, in agreement with literature (Zhang et al., 2012).

For all studied formulations, the presence of 10 wt% of HP- β -CD led to an increase in the density of the mixture compared to CDs-free formulations. Additionally, the density increased when increasing the wt% of CDs (either HP- β -CD or β -CD) (**Table S5**). Hence, the increase in the density in the presence of CDs can be attributed to the large hydrodynamic volume of CDs.

3.1.2. Viscosity measurements

The viscosity (η) of all formulations was then measured. A dramatic decrease in the viscosity was observed upon the addition of a small percentage of water to ChCl:U DES either in the

absence or the presence of CDs (**Figure S2**), which is in agreement with the literature where authors showed a decrease in the viscosity of ChCl:glucose:water mixture when increasing the vol% of water (Dai et al., 2013). This proved the interest of using water to obtain solutions with appropriate viscosity for different applications. In addition, the viscosity of the solutions was higher in the presence of 10 wt% HP- β -CD than in its absence. This could be due to the presence of additional hydrogen bonds in the presence of CDs leading to a higher viscosity of the mixture (Wu et al., 2020).

Similar tendencies as observed with the density of the different ChCl-based DES:water 70:30 wt% were noticed with the viscosity (**Table S4**). The viscosity of these different mixtures was affected by the HBD type of DES, which was always higher in the presence of CDs.

3.1.3. Polarity measurements

For a better understanding of the mechanism of solubilization, polarity measurements were conducted for the prepared formulations starting by the different ChCl:U DES:water mixtures. Because of the aggregation phenomena of the Nile red probe in water, the polarity of only 100, 90, 80, 70, 60, 50 and 40 wt% ChCl:U DES in water mixtures was measured. λ_{\max} and E_{NR} values are depicted in **Table S6**. Besides disrupting the hydrogen bond network of the DES, polarity values showed that adding water to the media led to the increase in the polarity of the mixture as indicated by the red-shift of the λ_{\max} , in agreement with the literature (Cao et al., 2020).

In addition, polarity measurements of the different synthesized ChCl-based DES:water 70:30 wt% mixtures were done (**Table S7**). It was shown that the least polar mixture was with ChCl:But, however, the most polar one was with ChCl:Tar. This can be explained by the fact that butane-1,3-diol possess a long hydrocarbon chain which explains its lower polarity, while adding alcoholic and acidic functional groups increase the polarity of the solvent (Florindo et al., 2018). Most of the organic acid-based DESs have been known to be the most polar, followed by sugar-based and amino-based DESs (Dai et al., 2013).

3.2. Solubilization studies

3.2.1. Influence of water content

Firstly, the influence of water addition on ChCl:U DES on the volatility of the *E. citriodora* EO was studied. **Figure S3**, shows the overlapping chromatograms obtained with water and pure ChCl:U DES. Clearly, the peaks corresponding to the volatile compounds found in the

EO are visible in water but they almost disappeared in the pure DES in accordance with literature (El Achkar et al., 2020). This was obviously observed for the major compound of the EO, citronellal that was eluted at 21 min approximately.

Figure 1 depicts the evolution of the total area of the EO when increasing the DES wt% in the mixture in the absence and the presence of 10 wt% HP- β -CD.

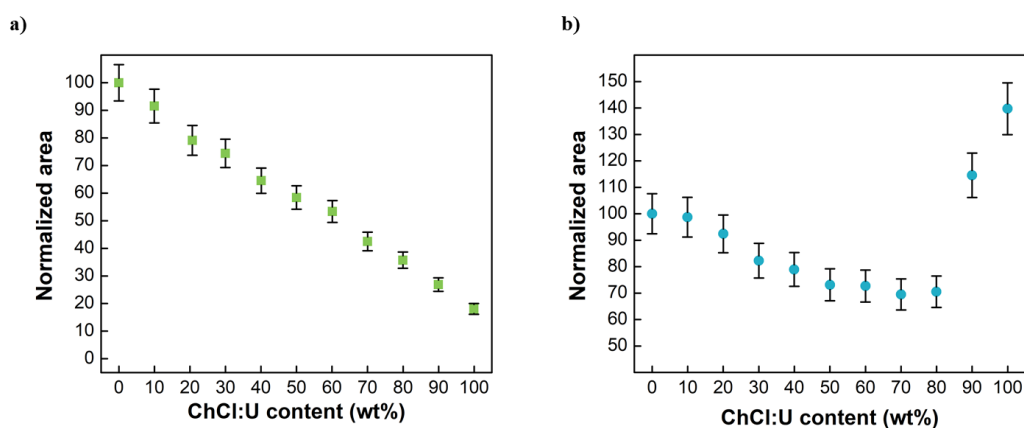

Figure 1: Plots of the EO normalized area, obtained from SH-GC analysis, as a function of the ChCl:U DES content (wt%) in water, a) in the absence of CD where the reference mixture was water and b) in the presence of 10 wt% of HP- β -CD where the reference mixture was the water containing 10 wt% HP- β -CD, at 30 °C.

In the absence of HP- β -CD (**Figure 1a**), a linear decrease in the total area was observed when increasing the wt% of DES, which indicated a decrease in the volatility of EO due to its increased solubilization. It should be noted that in **Figure 1a**, the total areas are normalized to those obtained with water. The same tendency was observed in literature, where the increase of water content led to a relatively linear decrease in the solubility of four phytochemicals in Natural deep eutectic solvents (NADESs) (Cao et al., 2020). A correlation between the polarity of ChCl:U DES:water mixtures and the total EO areas was observed (**Figure S4**). As can be seen from this Figure, decreasing DES content, meaning adding water to the mixture, led concomitantly to the increase in the polarity of the mixture and to an increase in the volatility of the EO. This indicated that increasing the polarity of the mixture led to a decrease in the solubility of the EO in accordance with the literature (Cao et al., 2020). Therefore, it can be confirmed that the polarity constituted the fundamental solubilization mechanism. In a recent paper, authors discussed the impact of adding water to ChCl:propane-1,2-diol:water (molar ratio, 1:1:1) DES and pointed out that in water content above 50 wt%, the DES can be transformed to an aqueous solution of DES components with decreased solubilizing ability (Dai et al., 2015). However, the continuous linear trend observed in

Figure 1a does not support the existence of a clear transition from “Water in DES” to “DES in Water” solutions.

As the addition of HP- β -CD to DES:water mixtures resulted in a dramatic decrease in the total chromatographic area of the EO, a higher concentration of the EO (0.1 g.mL^{-1} EO instead of 0.0065 g.mL^{-1}) was used to have chromatographic peak areas of the same order as in the absence of HP- β -CD. In the presence of 10 wt% HP- β -CD (**Figure 1b**), a relatively linear decrease in the total chromatographic peak area was observed by increasing the wt% of ChCl:U DES in water between 0 and 80 wt%. Surprisingly, an increase in the EO volatility was observed above DES:water 80:20 wt%. When comparing the volatility of EO in water in the absence and the presence of CDs, almost a 33-times higher retention of the EO was obtained when adding CDs. Thus, the effect of CDs alone (33-times) was higher than the effect of DESs (5-times) (when comparing water and pure ChCl:U DES in **Figure 1a**). The lowest EO volatility, meaning the highest solubilization was obtained in DES:water:CD mixture, which means that the solubilization in this medium depended on two mechanisms including the polarity of the mixture and the complexation ability of CDs with a higher influence for the complexation mechanism. Above DES:water 80:20 wt%, the complexation phenomenon still exists, however the solubilization of the EO was lower in the presence of CDs compared to the aqueous solution of CDs (**Figure 1b**). So, given the lower polarity of DES compared to water, we can hypothesize that the solvation of the volatile molecules by the DES lowers their affinity for the cavity of the CDs. In brief, increasing the DES content at a constant CD concentration would lead simultaneously to a decrease in polarity and in the CD complexation ability. The relative balance between these two opposite effects was shown to be positive in terms of volatility reduction up to 70 wt% of DES and then negative above 80 wt% of DES. In a recent study, authors were able to study the complexation of piroxicam in β -CD (10 wt%) solubilized in ChCl:U DES by NMR (Dugoni et al., 2019). Upon addition of 25 wt% of water to the DES, they concluded that water molecules tend to interact firstly with the hydroxyl groups of the CDs through hydrogen bonding, increasing therefore the molecular rotational motion of the CDs, where the CDs experienced an aqueous-like environment capable of maintaining its encapsulation capacity (Dugoni et al., 2019). This suggested that the contribution of CDs required a minimum presence of water in order to fully benefit from the inclusion driven by the hydrophobic forces. From this perspective, the presence of water allowed obtaining a compromise in terms of convenience of preparation

and use of solvents, since water effectively reduces the high viscosity generally observed for DESs, while improving the solubilization efficiency when using CDs.

As 60- 80 wt% of ChCl:U DES:water mixtures was the optimal range (**Figure 1b**), and as a strong increase of volatility was observed above 80 wt%, the ChCl:U DES:water 70:30 wt% was chosen in the following investigations.

3.2.2. Influence of DES composition

3.2.2.1. Screening of different DESs

The temperature range used in the literature to prepare DESs was found to be between 60 and 80 °C (Bi et al., 2013; Dai et al., 2015; Saravana et al., 2018). However, heating DESs for a long time can cause the esterification of ChCl (Rodriguez Rodriguez et al., 2019). For this reason, some of the prepared DESs, presenting a liquid HBD, were kept stirring at room temperature, while for the others a minimal heating time and temperature was applied to avoid the esterification process (**Table 1**).

The solubilization capacity of different ChCl-based DES:water 70:30 wt%, in the absence and presence of 10 wt% HP- β -CD, was studied. Results are illustrated in **Figure 2**.

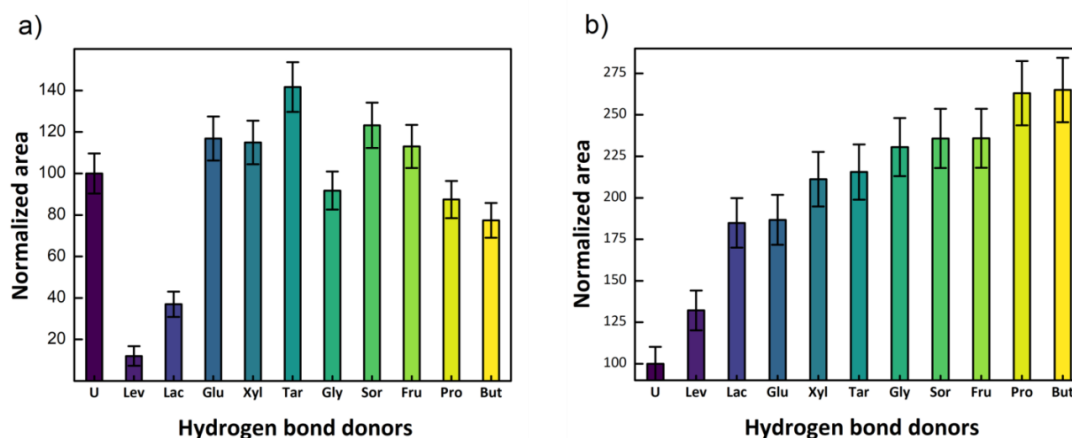

Figure 2: EO normalized area, obtained from SH-GC, for different ChCl-based DES:water 70:30 wt% mixtures a) in the absence of CDs where the reference mixture was ChCl:U DES:water 70:30 wt%, and b) in the presence of 10 wt% HP- β -CD where the reference mixture was ChCl:U DES:water 70:30 wt% containing 10 wt% HP- β -CD at 30 °C.

Figure 2a shows the total chromatographic peak areas normalized to those obtained with ChCl:U DES:water 70:30 wt% in the absence of CDs. From this Figure, it can be shown that, in the absence of CDs, the lowest EO volatilities were obtained with ChCl:Lev and ChCl:Lac DESs. One can hypothesize that these results are highly affected by the acidity of such

solvents, which might convert some EO components into their ionic forms, thus increasing their solubility. Nevertheless, their acidic nature can therefore limit their applications.

When excluding acid-basic effect and thus the three acid-based DESs, a better understanding of the influence of the polarity on the volatility results can be obtained. A correlation was observed between the polarity of the DES:water 70:30 wt% mixtures and the obtained EO chromatographic area for each mixture (**Figure S5**). It can be seen, that when increasing the polarity (a red shift of the λ_{\max}), a higher volatility of the EO was observed, which indicated a decrease in the solubility.

Figure 2b shows the EO volatility in the different ChCl-based DES in the presence of 10 wt% HP- β -CD. In this Figure, the total areas are normalized to those obtained with ChCl:U DES:water 70:30 wt% in the presence of 10 wt% HP- β -CD. It can be seen that ChCl:U has the best solubilizing ability because it presented the lowest EO volatility. This suggests that this system affects the less the complexation phenomena comparing to the other DESs. Thus, this optimal mixture ChCl:U DES:water 70:30 wt% was used in the following investigations.

3.2.2.2. Influence of the mass fraction of DES components

The influence of the ChCl mass fraction in the ChCl:U DES on the volatility of EO in DES:water 70:30 wt% mixtures was studied in the absence and in the presence of 10 wt% HP- β -CD. **Figure 3** shows the evolution of the EO volatility as a function of the ChCl mass fraction in the DES.

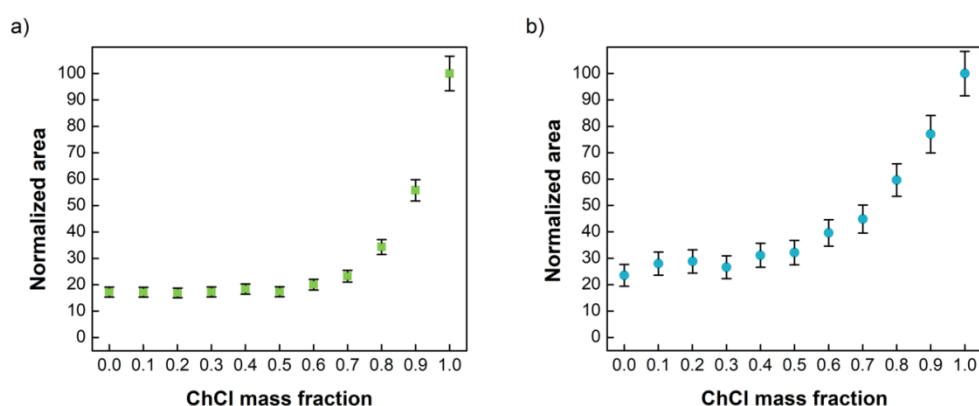

Figure 3: Plots of the EO normalized area, obtained from SH-GC, as a function of the ChCl mass fraction in ChCl:U DES:water 70:30 wt% a) in the absence of CDs where the reference mixture was water containing 1 ChCl mass fraction and b) in the presence of 10 wt% of HP- β -CD where the reference mixture was water containing 1 ChCl mass fraction and 10 wt% HP- β -CD at 60 °C.

In **Figure 3a** and **Figure 3b**, the total chromatographic peak areas were normalized to those obtained with 1.0 ChCl mass fraction in the absence and in the presence of 10 wt% of HP- β -CD, respectively. It should be noted that the ChCl mass fraction equal to 0.5 roughly corresponds to the eutectic point 1:2 molar ratio (Abbott et al., 2003). Increasing the ChCl mass fraction from 0 to 0.7 (from ChCl:U 0:1 to 1:1 molar ratio, respectively) led to insignificant volatility variation. Then, above 0.7 ChCl mass fraction, a gradual increase in the EO volatility was observed. The same tendency was observed in the presence of 10 wt% HP- β -CD, even if a slightly higher slope was obtained between 0.0- 0.7 ChCl mass fraction range. As the eutectic point is close to optimal efficiency both in the absence and presence of CDs, such composition was chosen in the following experiments.

3.2.3. Determination of formation constants

Different concentrations of native β -CD and HP- β -CD were added to ChCl:U (1:2) DES:water 70:30 wt%. The evolution of volatility of *E. citriodora* EO and its major component citronellal in the different mixtures are illustrated in **Figure 4**. In all the Figures, the total areas are normalized to those obtained with ChCl:U (1:2) DES:water 70:30 wt% in the absence of CDs.

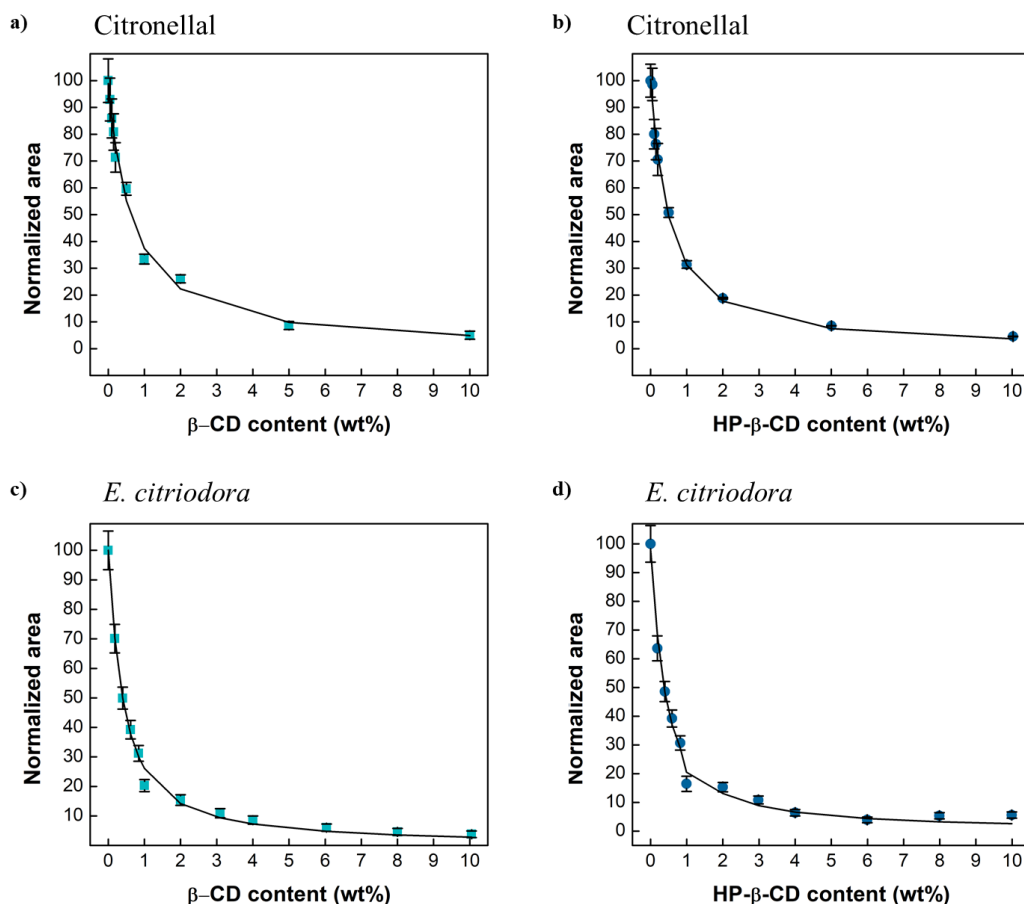

Figure 4: Complexation curves of a) β -CD/citronellal, b) HP- β -CD/citronellal, c) β -CD/*E. citriodora* and d) HP- β -CD/*E. citriodora* in ChCl:U (1:2) DES:water 70:30 wt% at 30 °C. In all these plots, the reference mixture was ChCl:U DES:water 70:30 wt% in the absence of CDs.

An exponential decrease in the volatility of citronellal and EO was observed when increasing the wt% of both CDs. 2 wt% of CDs was sufficient to have an almost maximum retention capacity of the EO. Such an isothermal curve is typical of a complexation phenomenon (Landy et al., 2000; Saokham et al., 2018). This variation is in agreement with a 1:1 inclusion complex between citronellal and CDs dissolved in ChCl:U (1:2) DES:water 70:30 wt%. Formation constants (K_f) values for β -CD/citronellal and HP- β -CD/citronellal inclusion complexes were calculated using an algorithmic treatment developed in our laboratory (Blach et al., 2008; Decock et al., 2008) and were equal to $177 \pm 15 \text{ M}^{-1}$ and $303 \pm 28 \text{ M}^{-1}$, respectively. The obtained K_f in DES:water 70:30 wt% were lower than those obtained in water; 1523 M^{-1} and 815 M^{-1} for β -CD/citronellal and HP- β -CD/citronellal, respectively, at 25 °C (Kfoury et al., 2015). The same tendency was observed in a previous article that showed the decrease of the CD/methyl orange K_f in the pure ChCl:U DES compared to water (Moufawad et al., 2019). This confirms the early stated hypothesis that the solubilization of

guests in DESs lowers their affinity for the hydrophobic cavity of CDs, therefore lowers their encapsulation efficiency.

Then, the affinity of CDs towards the whole EO was evaluated. Given that the EO is a mixture of different volatile components, one way to calculate an apparent molar concentration of the EO is to use the percentage of citronellal in the EO (74.77%) and its molar concentration in the vials. Thus, the apparent molar concentration of the EO was calculated by dividing the concentration of citronellal by 0.7477. Apparent K_f of the EO were then determined and were equal to $320 \pm 18 \text{ M}^{-1}$ and $433 \pm 33 \text{ M}^{-1}$ with β -CD and HP- β -CD, respectively.

3.2.4. Determination of vapor-liquid partition coefficients of citronellal

As citronellal constitutes the major component of the studied EO, its vapor-liquid partition coefficient (K) in water and in the other mixtures (DES:water and DES:water:CD) was determined at 30 °C *via* the PRV and VPC methods, respectively. The corresponding K values are presented in **Table 2**. The lower the K value, the higher is the absorption or solubilization capacity of the mixture.

Table 2- Citronellal vapor-liquid partition coefficients (K) measured at 30 °C in water and other mixtures.

K	Water	ChCl:U DES:water 70:30 wt%	ChCl:U DES:water 70:30 wt% with 2 wt% β -CD	ChCl:U DES:water 70:30 wt% with 10 wt% HP- β -CD
Citronellal	3.59E-02 $\pm 0.18\text{E-}02$	1.05E-02 $\pm 0.07\text{E-}02$	3.93E-04 $\pm 0.43\text{E-}04$	2.54E-04 $\pm 0.08\text{E-}04$

It can be seen from **Table 2** that K value in ChCl:U DES:water 70:30 wt% was approximately 3-times lower than in water, which was similarly obtained in another study for other volatile compounds (Moura et al., 2017). This proved the higher solubilization of citronellal in the mixture. Besides, significantly lower apparent K values were obtained upon the addition of CDs to DES:water mixture, as a consequence of the higher retention of citronellal because of its encapsulation in the CDs. K values were 27 and 41-times lower in the presence of 2 wt% of β -CD and 10 wt% of HP- β -CD, respectively, compared to the DES:water mixture in the absence of CDs.

4. Conclusion

With the aim of improving the solubility of *E. citriodora* EO and its major constituent, citronellal, new DES:water:CD mixtures were prepared and characterized by measuring their densities, viscosities and polarities. Solubility studies were conducted by SH-GC for different type of DESs, DES compositions in the presence of different water and CD contents. It was shown that the presence of a minimal amount of water was highly favorable when combining DESs and CDs in the mixture providing the highest solubilization ability compared to the use of each system separately. ChCl:U DES:water 70:30 wt% was shown to be the most efficient mixture for the solubilization of the EO among different ChCl-based DES:water mixtures, when CDs was present. Also, the eutectic point of ChCl:U 1:2 molar ratio may be considered as one of the optimal ratios for solubilization purposes. The complexation of the EO and citronellal with β -CD and HP- β -CD was proved in ChCl:U (1:2) DES:water 70:30 wt%. Even if the K_f values of citronellal were lower in DES:water than in water, the contribution of CDs in DESs mixtures was proved to be highly favorable. Lastly, the vapor-liquid partition coefficients of citronellal were determined in ChCl:U (1:2) DES:water 70:30 wt% in the absence and the presence of CDs and were significantly lower compared to water. All these results proved that DES:water:CD mixtures could be efficiently used to solubilize volatile guests. These new formulations should be taken into consideration for further research implications in different domains given the interesting obtained results in enhancing the EO solubility.

Acknowledgements

The authors would like to acknowledge the National Council for Scientific Research of Lebanon (CNRS-L) and Université du Littoral Côte d'Opale (ULCO) for granting a doctoral fellowship to Lamia Nakhle.

References

- Abbott, A. P., Capper, G., Davies, D. L., Rasheed, R. K., & Tambyrajah, V. (2003). Novel solvent properties of choline chloride/urea mixtures. Electronic supplementary information (ESI) available: Spectroscopic data. See <http://www.rsc.org/suppdata/cc/b2/b210714g/>. *Chemical Communications*, 1, 70–71. <https://doi.org/10.1039/b210714g>
- Bi, W., Tian, M., & Row, K. H. (2013). Evaluation of alcohol-based deep eutectic solvent in extraction and determination of flavonoids with response surface methodology optimization. *Journal of Chromatography A*, 1285, 22–30. <https://doi.org/10.1016/j.chroma.2013.02.041>
- Blach, P., Fourmentin, S., Landy, D., Cazier, F., & Surpateanu, G. (2008). Cyclodextrins: A new efficient absorbent to treat waste gas streams. *Chemosphere*, 70(3), 374–380. <https://doi.org/10.1016/j.chemosphere.2007.07.018>
- Cao, J., Cao, J., Wang, H., Chen, L., Cao, F., & Su, E. (2020). Solubility improvement of phytochemicals using (natural) deep eutectic solvents and their bioactivity evaluation. *Journal of Molecular Liquids*, 318, 113997. <https://doi.org/10.1016/j.molliq.2020.113997>
- Crini, G. (2014). Review: A History of Cyclodextrins. *Chemical Reviews*, 114(21), 10940–10975. <https://doi.org/10.1021/cr500081p>
- Cunha, S. C., & Fernandes, J. O. (2018). Extraction techniques with deep eutectic solvents. *TrAC Trends in Analytical Chemistry*, 105, 225–239. <https://doi.org/10.1016/j.trac.2018.05.001>
- Dai, Y., van Spronsen, J., Witkamp, G.-J., Verpoorte, R., & Choi, Y. H. (2013). Natural deep eutectic solvents as new potential media for green technology. *Analytica Chimica Acta*, 766, 61–68. <https://doi.org/10.1016/j.aca.2012.12.019>
- Dai, Y., Witkamp, G.-J., Verpoorte, R., & Choi, Y. H. (2015). Tailoring properties of natural deep eutectic solvents with water to facilitate their applications. *Food Chemistry*, 187, 14–19. <https://doi.org/10.1016/j.foodchem.2015.03.123>
- Decock, G., Landy, D., Surpateanu, G., & Fourmentin, S. (2008). Study of the retention of aroma components by cyclodextrins by static headspace gas chromatography. *Journal of Inclusion Phenomena and Macrocyclic Chemistry*, 62(3–4), 297–302. <https://doi.org/10.1007/s10847-008-9471-z>

- Dhakad, A. K., Pandey, V. V., Beg, S., Rawat, J. M., & Singh, A. (2018). Biological, medicinal and toxicological significance of *Eucalyptus* leaf essential oil: A review: Biological, medicinal and toxicological significance of *Eucalyptus* leaf essential oil. *Journal of the Science of Food and Agriculture*, 98(3), 833–848. <https://doi.org/10.1002/jsfa.8600>
- Dugoni, G. C., Di Pietro, M. E., Ferro, M., Castiglione, F., Ruellan, S., Moufawad, T., Moura, L., Costa Gomes, M. F., Fourmentin, S., & Mele, A. (2019). Effect of Water on Deep Eutectic Solvent/ β -Cyclodextrin Systems. *ACS Sustainable Chemistry & Engineering*, 7(7), 7277–7285. <https://doi.org/10.1021/acssuschemeng.9b00315>
- El Achkar, T., Moufawad, T., Ruellan, S., Landy, D., Greige-Gerges, H., & Fourmentin, S. (2020). Cyclodextrins: From solute to solvent. *Chemical Communications*, 56(23), 3385–3388. <https://doi.org/10.1039/D0CC00460J>
- El Achkar, T., Moura, L., Moufawad, T., Ruellan, S., Panda, S., Longuemart, S., Legrand, F.-X., Costa Gomes, M., Landy, D., Greige-Gerges, H., & Fourmentin, S. (2020). New generation of supramolecular mixtures: Characterization and solubilization studies. *International Journal of Pharmaceutics*, 119443. <https://doi.org/10.1016/j.ijpharm.2020.119443>
- Fernández, M. de los Á., Espino, M., Gomez, F. J. V., & Silva, M. F. (2018). Novel approaches mediated by tailor-made green solvents for the extraction of phenolic compounds from agro-food industrial by-products. *Food Chemistry*, 239, 671–678. <https://doi.org/10.1016/j.foodchem.2017.06.150>
- Florindo, C., McIntosh, A. J. S., Welton, T., Branco, L. C., & Marrucho, I. M. (2018). A closer look into deep eutectic solvents: Exploring intermolecular interactions using solvatochromic probes. *Physical Chemistry Chemical Physics*, 20(1), 206–213. <https://doi.org/10.1039/C7CP06471C>
- Jeliński, T., Przybyłek, M., & Cysewski, P. (2019). Natural Deep Eutectic Solvents as Agents for Improving Solubility, Stability and Delivery of Curcumin. *Pharmaceutical Research*, 36(8). <https://doi.org/10.1007/s11095-019-2643-2>
- Kfoury, M., Auezova, L., Greige-Gerges, H., & Fourmentin, S. (2015). Promising applications of cyclodextrins in food: Improvement of essential oils retention, controlled release and antiradical activity. *Carbohydrate Polymers*, 131, 264–272. <https://doi.org/10.1016/j.carbpol.2015.06.014>
- Kfoury, M., Auezova, L., Ruellan, S., Greige-Gerges, H., & Fourmentin, S. (2015). Complexation of estragole as pure compound and as main component of basil and

- tarragon essential oils with cyclodextrins. *Carbohydrate Polymers*, 118, 156–164. <https://doi.org/10.1016/j.carbpol.2014.10.073>
- Kfoury, M., Hădărugă, N. G., Hădărugă, D. I., & Fourmentin, S. (2016). Cyclodextrins as encapsulation material for flavors and aroma. In *Encapsulations* (pp. 127–192). Elsevier. <https://doi.org/10.1016/B978-0-12-804307-3.00004-1>
- Kfoury, M., Landy, D., & Fourmentin, S. (2018). Characterization of Cyclodextrin/Volatile Inclusion Complexes: A Review. *Molecules*, 23(5), 1204. <https://doi.org/10.3390/molecules23051204>
- Kolb, B., & Ettre, L. S. (2006). *Static headspace-gas chromatography: Theory and practice* (2nd ed). Wiley.
- Landy, D., Fourmentin, S., Salome, M., & Surpateanu, G. (2000). [No title found]. *Journal of Inclusion Phenomena and Macrocyclic Chemistry*, 38(1/4), 187–198. <https://doi.org/10.1023/A:1008156110999>
- Loftsson, T., & Brewster, M. E. (2012). Cyclodextrins as Functional Excipients: Methods to Enhance Complexation Efficiency. *Journal of Pharmaceutical Sciences*, 101(9), 3019–3032. <https://doi.org/10.1002/jps.23077>
- Martins, M. A. R., Pinho, S. P., & Coutinho, J. A. P. (2019). Insights into the Nature of Eutectic and Deep Eutectic Mixtures. *Journal of Solution Chemistry*, 48(7), 962–982. <https://doi.org/10.1007/s10953-018-0793-1>
- McCune, J. A., Kunz, S., Olesińska, M., & Scherman, O. A. (2017). DESolution of CD and CB Macrocycles. *Chemistry - A European Journal*, 23(36), 8601–8604. <https://doi.org/10.1002/chem.201701275>
- Moufawad, T., Moura, L., Ferreira, M., Bricout, H., Tilloy, S., Monflier, E., Costa Gomes, M., Landy, D., & Fourmentin, S. (2019). First Evidence of Cyclodextrin Inclusion Complexes in a Deep Eutectic Solvent. *ACS Sustainable Chemistry & Engineering*, 7(6), 6345–6351. <https://doi.org/10.1021/acssuschemeng.9b00044>
- Moura, L., Moufawad, T., Ferreira, M., Bricout, H., Tilloy, S., Monflier, E., Costa Gomes, M. F., Landy, D., & Fourmentin, S. (2017). Deep eutectic solvents as green absorbents of volatile organic pollutants. *Environmental Chemistry Letters*, 15(4), 747–753. <https://doi.org/10.1007/s10311-017-0654-y>
- Nakhle, L., Kfoury, M., Greige-Gerges, H., & Fourmentin, S. (2020). Effect of dimethylsulfoxide, ethanol, α - and β -cyclodextrins and their association on the solubility of natural bioactive compounds. *Journal of Molecular Liquids*, 310, 113156. <https://doi.org/10.1016/j.molliq.2020.113156>

- Rasheed, D. M., Serag, A., Abdel Shakour, Z. T., & Farag, M. (2021). Novel trends and applications of multidimensional chromatography in the analysis of food, cosmetics and medicine bearing essential oils. *Talanta*, 223, 121710. <https://doi.org/10.1016/j.talanta.2020.121710>
- Ray, A., Das, S., & Chattopadhyay, N. (2019). Aggregation of Nile Red in Water: Prevention through Encapsulation in β -Cyclodextrin. *ACS Omega*, 4(1), 15–24. <https://doi.org/10.1021/acsomega.8b02503>
- Rodriguez Rodriguez, N., van den Bruinhorst, A., Kollau, L. J. B. M., Kroon, M. C., & Binnemans, K. (2019). Degradation of Deep-Eutectic Solvents Based on Choline Chloride and Carboxylic Acids. *ACS Sustainable Chemistry & Engineering*, 7(13), 11521–11528. <https://doi.org/10.1021/acssuschemeng.9b01378>
- Saokham, P., Muankaew, C., Jansook, P., & Loftsson, T. (2018). Solubility of Cyclodextrins and Drug/Cyclodextrin Complexes. *Molecules*, 23(5), 1161. <https://doi.org/10.3390/molecules23051161>
- Saravana, P. S., Cho, Y.-N., Woo, H.-C., & Chun, B.-S. (2018). Green and efficient extraction of polysaccharides from brown seaweed by adding deep eutectic solvent in subcritical water hydrolysis. *Journal of Cleaner Production*, 198, 1474–1484. <https://doi.org/10.1016/j.jclepro.2018.07.151>
- Stevanović, Z. D., Bošnjak-Neumüller, J., Pajić-Lijaković, I., Raj, J., & Vasiljević, M. (2018). Essential Oils as Feed Additives—Future Perspectives. *Molecules*, 23(7), 1717. <https://dx.doi.org/10.3390%2Fmolecules23071717>
- Triolo, A., Lo Celso, F., & Russina, O. (2020). Structural Features of β -Cyclodextrin Solvation in the Deep Eutectic Solvent, Reline. *The Journal of Physical Chemistry B*, 124(13), 2652–2660. <https://doi.org/10.1021/acs.jpcc.0c00876>
- Wu, S., Cai, C., Li, F., Tan, Z., & Dong, S. (2020). Deep Eutectic Supramolecular Polymers: Bulk Supramolecular Materials. *Angewandte Chemie International Edition*, 59(29), 11871–11875. <https://doi.org/10.1002/anie.202004104>
- Zhang, Q., De Oliveira Vigier, K., Royer, S., & Jérôme, F. (2012). Deep eutectic solvents: Syntheses, properties and applications. *Chemical Society Reviews*, 41(21), 7108. <https://doi.org/10.1039/c2cs35178a>

Supplementary data for

Choline chloride based-deep eutectic solvents:water:cyclodextrins mixtures for the entrapment and the solubilization of volatile molecules: application to *Eucalyptus citriodora* essential oil and citronellal

Lamia Nakhle^{a,b}, Miriana Kfoury^{a,b,*}, Isabelle Mallard^b, H  l  ne Greige-Gerges^a, David Landy^b

^a *Bioactive Molecules Research Laboratory, Faculty of Sciences, Lebanese University, 90656 Jdeidet el-Metn, Lebanon*

^b *Unit   de Chimie Environnementale et Interactions sur le Vivant (UCEIV, EA 4492), SFR Condorcet FR CNRS 3417, Universit   du Littoral C  te d'Opale (ULCO), 145 Av. M. Schumann, F-59140 Dunkerque, France*

* Corresponding author: miriana.kfoury@univ-littoral.fr

Table S1- Linear fitting parameters (a and b) and the average absolute deviation (AAD%) of the experimental values of density as a function of the wt% of ChCl:U DES in water at 30   C in the absence and presence of 10 wt% of HP-  -CD in the total mixture.

	a	b	AAD (%)
Without CDs	989.93	2.0311	0.0294
With 10 wt% HP-��-CD	1019.20	1.9129	0.0315

Table S2- The equation parameters (y_0 , A_1 , t_1 , A_2 and t_2) and the chi-square values of the fitted exponential curve of the experimental values of viscosity (η) as a function of the wt% of ChCl:U DES in water at 30   C in the absence and presence of 10 wt% of HP-  -CD in the total mixture.

	y_0	A_1	t_1	A_2	t_2	Chi- square
Without CDs	0.8199	3.43E-2	14.448	3.97E-14	2.6660	0.0262
With 10 wt% HP-��-CD	1.3052	5.60E-12	3.0551	3.36E-2	13.208	0.0934

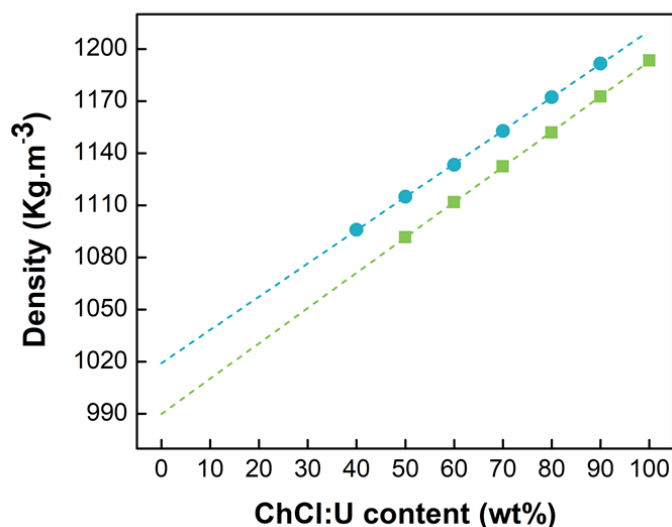

Figure S1: Density variation as a function of the ChCl:U DES content (wt%) in water ■ in the absence and ● the presence of 10 wt% of HP-β-CD, at 30 °C. The dashed curves are the fitted curves obtained from the experimental values.

Table S3- Density (ρ) values of different choline chloride (ChCl) and urea (U) mass fractions mixed with 30 wt% of water at 60 °C under atmospheric pressure, in the absence and the presence of 10 wt% HP-β-CD.

ChCl mass fraction	ChCl:U molar ratio	ρ (g.cm ⁻³)	
		Without HP-β-CD	10 wt% HP-β-CD
1.0	1:0.00	1.0735	1.0944
0.9	1:0.26	1.0814	1.1048
0.8	1:0.58	1.0906	1.1129
0.7	1:1.00	1.1001	1.1220
0.6	1:1.55	1.1097	1.1315
0.5	1:2.32	1.1210	1.1410
0.4	1:3.49	1.1316	1.1512
0.3	1:5.42	1.1425	1.1620
0.2	1:9.30	1.1560	1.1718
0.1	1:20.92	1.1577	1.1827
0.0	0:1.00	1.1671	1.1878

Table S4- Density (ρ) and viscosity (η) values of different ChCl-based DES:water 70:30 wt% mixtures at 30 °C under atmospheric pressure, in the absence and the presence of 10 wt% HP- β -CD.

HBD	ρ (g.cm ⁻³)		η (mPa.s)	
	Without HP- β -CD	10 wt% HP- β -CD	Without HP- β -CD	10 wt% HP- β -CD
Levulinic acid	1.0992	1.1215	7.1663	11.0220
Butane-1,3-diol	1.0482	1.0733	11.2820	16.8890
Propane-1,3-diol	1.0725	1.0962	8.5572	12.8790
Lactic acid	1.1247	1.1465	9.3914	15.2430
Glycerol	1.1332	1.1539	9.7785	15.1150
Sorbitol	1.1892	1.2071	19.9050	33.5370
Fructose	1.1665	1.1939	17.6040	42.7270
Xylitol	1.2023	1.2194	20.3290	33.9070
Tartaric acid	1.2231	1.2415	21.9880	40.4770
D-glucose	1.1684	1.1922	18.0560	46.2030
Urea	1.1324	1.1528	5.0561	7.7858

HBD: Hydrogen bond donor.

Table S5- Density (ρ) values of ChCl:U DES:water 70:30 wt% in the presence of different wt% of HP- β -CD or β -CD at 30 °C under atmospheric pressure.

CDs (wt%)	ρ (g.cm ⁻³)	
	HP- β -CD	β -CD
0.0	1.1324	1.1324
0.2	1.1328	1.1328
0.4	1.1332	1.1333
0.6	1.1336	1.1338
0.8	1.1340	1.1343
1.0	1.1344	1.1354
2.0	1.1365	1.1373
3.0	1.1385	1.1397
4.0	1.1406	1.1428
6.0	1.1446	1.1477
8.0	1.1487	1.1536
10.0	1.1528	1.1554

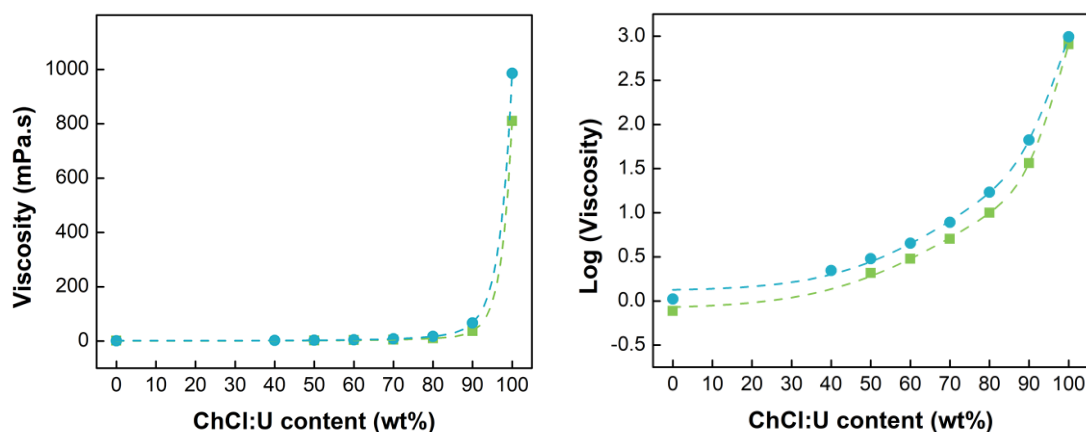

Figure S2: Viscosity variation as function of the ChCl:U DES content (wt%) in water ■ in the absence and ● the presence of 10 wt% of HP- β -CD, at 30 °C. The dashed curves are the fitted curves obtained from the experimental values.

Table S6- Maximum wavelength (λ_{\max}) and the transition energy (E_{NR}) of nile red probe obtained for different wt% of ChCl:U DES in water at 20 °C.

ChCl:U DES (wt%)	λ_{\max} (nm)	E_{NR} (Kcal.mol ⁻¹)
100	566.50	50.52
90	577.19	49.43
80	582.08	49.12
70	587.93	48.62
60	591.50	48.32
50	594.84	48.01
40	599.80	47.67

Table S7- Maximum wavelength (λ_{\max}) and the transition energy (E_{NR}) of different ChCl-based DES:water 70:30 wt% mixtures, obtained with nile red probe, at 20 °C.

HBD	λ_{\max} (nm)	E_{NR} (Kcal.mol ⁻¹)
Butane-1,3-diol	582.21	49.11
Propane-1,3-diol	583.64	48.99
Urea	588.05	48.62
Glycerol	589.17	48.53
Levulinic acid	589.29	48.52
Fructose	589.77	48.48
D-glucose	590.38	48.43
Xylitol	591.50	48.34
Sorbitol	593.19	48.20
Lactic acid	595.50	48.01
Tartaric acid	598.11	47.80

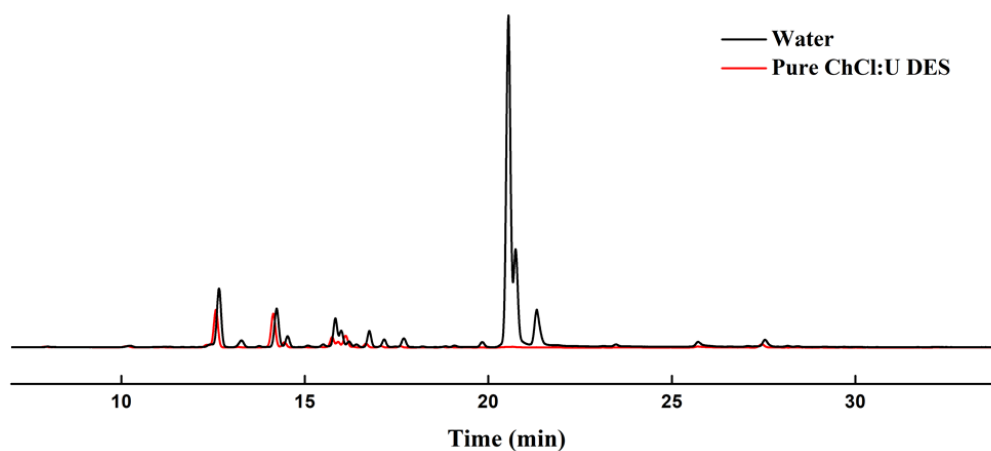

Figure S3: Overlap of *E. citriodora* EO chromatograms obtained with water and pure ChCl:U DES.

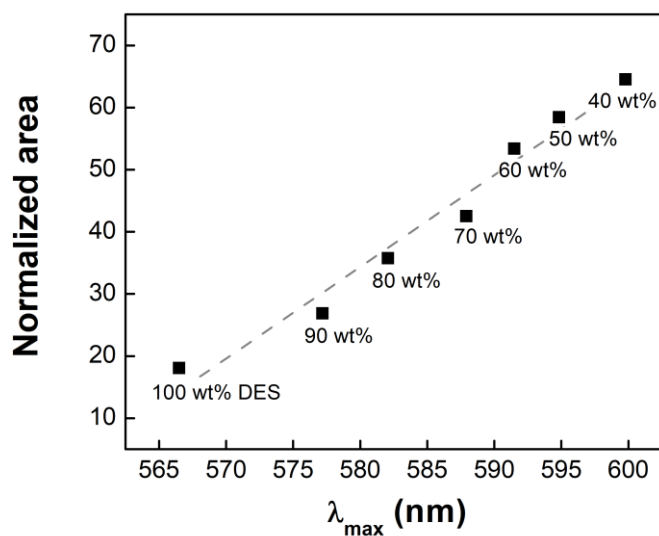

Figure S4: Correlation between the EO normalized area, using water as reference, obtained from SH-GC analysis, and the maximum wavelength (λ_{\max}) of Nile red probe in the corresponding ChCl:U DES content (wt%).

These data follow the normality test and possess a correlation coefficient of 0.9857 with p -value < 0.01 .

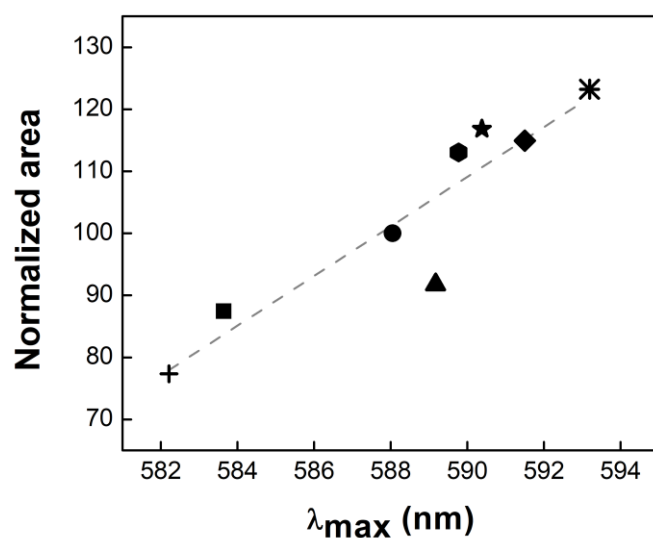

Figure S5: Correlation between the EO normalized area, obtained from SH-GC analysis, and the maximum wavelength (λ_{\max}) of Nile red probe in the different DES:water 70:30 wt% mixtures. The reference solvent was the ChCl:U DES:water 70:30 wt%. These data follow the normality test and possess a correlation coefficient of 0.8521 with p -value < 0.01 .

† ChCl:But, ■ ChCl:Pro, ▲ ChCl:Gly, ● ChCl:U, ● ChCl:Fru, ★ ChCl:Glu, ◆ ChCl:Xyl, * ChCl:Sor

CHAPITRE 6

Influence de la polymérisation de cyclodextrines

Introduction

Dans l'étude d'optimisation d'une formulation DES:eau:CD pour la solubilisation de l'huile essentielle modèle *E. citriodora* (chapitre 5), plusieurs paramètres ont été évalués (proportion d'eau, type de DESs, ratio molaire des constituants de DES, quantité de CDs).

Toutefois, la nature de la CD pourrait constituer un champ d'étude large. De nombreux dérivés et polymères, possédant des propriétés physico-chimiques et capacités de complexation différentes, peuvent être obtenus à partir des CDs naturelles. Ce chapitre consiste, par conséquent, à étudier l'impact de l'utilisation des polymères des CDs sur la capacité de solubilisation des formulations développées.

La première étape consiste à synthétiser différents polymères de CDs et procéder par la suite à leur caractérisation. Notre choix de CD s'est porté sur la β -CD native, en raison de la versatilité de ses capacités d'inclusion par rapport aux autres CDs natives α -CD et γ -CD, ainsi que sur l'HP- β -CD (2-hydroxypropyl- β -CD) et la CRYSMEB (dérivé méthylé de la β -CD) parce qu'elles ont démontré, selon des études précédentes menées au sein de notre laboratoire, une meilleure capacité de solubilisation des huiles essentielles en comparaison avec la β -CD native dans l'eau (Kfoury et al., 2018).

Différents agents de réticulation ont été utilisés dans la synthèse des polymères de CDs. Ils ont été principalement sélectionnés en raison de leur caractère non-toxique. La première classe d'agents réticulants renferme des polyacides carboxyliques, et en particulier les diacides et triacides carboxyliques (acide citrique, acide malonique, acide glutarique et acide itaconique). Ces différents acides sont déjà exploités comme agent réticulant dans la synthèse de polymères de CDs, permettant ainsi leur utilisation comme agents de vectorisation (Anand et al., 2013), en profitant ainsi de l'augmentation des constantes de complexation *vis-à-vis* de certains principes actifs (Danel et al., 2013). Un second agent réticulant à base de phosphore a été évalué (le sodium trimétaphosphate). Les polymères à base de phosphore ont l'avantage, en tant qu'agent de vectorisation de principes actifs, d'être généralement biodégradables et hémocompatibles. Il a d'ailleurs été montré que les polymères à base de CDs et de phosphates permettent une libération contrôlée de principes actifs (Wintgens et al., 2015). Enfin, un dérivé de polyéthylène glycol a également été utilisé comme agent de réticulation.

Les polymères de CDs obtenus par synthèse thermique, ont été purifiés puis caractérisés par résonance magnétique nucléaire, spectroscopie infrarouge à transformée de fourrier et chromatographie d'exclusion stérique.

Ensuite, les polymères synthétisés sont introduits dans la formulation chlorure de choline:urée DES:eau 70:30 % (m/m). La capacité de solubilisation de ces nouvelles formulations *vis-à-vis* de l'huile essentielle *E. citriodora* est étudiée, par la technique d'espace de tête-statique couplée à la chromatographie en phase gazeuse. Les résultats ont fait l'objet d'une comparaison systématique entre les nouveaux polymères de CDs synthétisés, les dérivés de CDs et les CDs natives.

La préparation et la caractérisation des polymères de CDs et l'étude de leur capacité de solubilisation de l'huile modèle *E. citriodora* sont ainsi développées dans l'article intitulé '*Cyclodextrins polymers in deep eutectic solvent:water mixture: Solubilization study of Eucalyptus citriodora essential oil*'.

Cyclodextrins polymers in deep eutectic solvent:water mixture: Solubilization study of *Eucalyptus citriodora* essential oil

Lamia Nakhle^{a,b}, Miriana Kfoury^{a,b,*}, Isabelle Mallard^a, Hélène Greige-Gerges^b, David Landy^b

^a *Unité de Chimie Environnementale et Interactions sur le Vivant (UCEIV, UR 4492), SFR Condorcet FR CNRS 3417, Université du Littoral Côte d'Opale (ULCO), 145 Av. M. Schumann, F-59140 Dunkerque, France*

^b *Bioactive Molecules Research Laboratory, Faculty of Sciences, Lebanese University, 90656 Jdeidet el-Metn, Lebanon*

* Corresponding author: miriana.kfoury@univ-littoral.fr

Abstract

The use of cyclodextrins (CDs) polymers in combination with choline chloride:urea deep eutectic solvent:water 70:30 wt% mixture for the solubilization of *Eucalyptus citriodora* essential oil (*E. citriodora* EO), chosen as a model of EO, is investigated in the present work. CDs polymers were synthesized using either β -CD, hydroxypropylated- β -CD (HP- β -CD) or low methylated- β -CD (CRYSMEB) crosslinked with either carboxylic acid (malonic acid, citric acid, glutaric acid and itaconic acid), poly(ethylene glycol) diglycidyl ether-640 or sodium trimetaphosphate. CDs polymers showed inclusion capacity for the EO in the DES:water mixture, some of them presenting higher EO retention compared to the native β -CD while others were not advantageous. In all cases, the use of native β -CD was considered more beneficial from an economic point of view.

Keywords: cyclodextrins polymers, deep eutectic solvents, *Eucalyptus citriodora*, essential oil, solubility.

1. Introduction

Cyclodextrins (CDs) are edible and biocompatible natural cyclic oligosaccharides possessing a truncated tridimensional cone shape characterized by an amphiphilic character: a hydrophilic external surface and a hydrophobic cavity (Crini, 2014). The latter constitutes the bonding site of different lipophilic guests through non-covalent interactions providing therefore an efficient way to increase their aqueous solubility (Crini et al., 2018). β -CD is found to be the most interesting native CD because it is the most accessible, the lowest-priced and it has the most suitable cavity size for the inclusion of the majority of non-polar molecules (Blach et al., 2008; Gidwani & Vyas, 2014). Native CDs can undergo many modifications in their primary and secondary hydroxyl groups in order to obtain various CD derivatives with improved aqueous solubility, complexation capacity, affinity towards a specific guest and safety (Kfoury et al., 2016). The hydroxypropylated- β -CD (HP- β -CD) and the low methylated- β -CD (CRYSMEB) are the most studied CD derivatives in literature. In addition, CDs can be cross-linked by direct reaction between its hydroxyl groups with a coupling agent to form water-soluble or insoluble CDs polymers (Ciobanu et al., 2012). The CD polymers emerged in literature with considerable attention for their possible enhancement of the apparent aqueous solubility of different hydrophobic molecules. One of the first and the most studied CD polymer is the β -CD/epichlorohydrin polymer which was applied in buccal, topical and parenteral drug delivery (Gidwani & Vyas, 2014). Up until now, CDs polymers-based technologies are constantly growing in the various domains: pharmaceuticals, cosmetics, food, textiles and others (Liu et al., 2021; Martel et al., 2005a). Ciobanu et al. studied the inclusion of aroma compounds of essential oils (EOs) (*Lavandula angustifolia* and *Mentha piperita* EOs) by CDs polymers in aqueous medium and showed an increase in the EOs solubility compared to native CDs (α -CD and γ -CD) (Ciobanu et al., 2012, 2013).

Deep eutectic solvents (DESs) are neoteric class of green solvents defined as a mixture of two or more compounds that are solid at room temperature, but when mixed at a particular molar ratio, the mixture becomes liquid (Shishov et al., 2017; El Achkar et al., 2021). The first and most studied DES is composed of choline chloride (ChCl) and urea (U) mixed at a 1:2 molar ratio (Abbott et al., 2003). DESs are characterized by a low volatility, non-flammability and biocompatibility (Smith et al., 2014). Limited number of scientists worked on the solubilization of EOs in DESs, and a recent study showed an increase in the solubility of *trans*-anethole, as well as star anise and fennel EOs in DESs compared to water (El Achkar et al., 2020).

Recent studies underlined the beneficial effect of combining CDs and DESs in order to improve the solubility of polyphenols and volatile molecules (El Achkar et al., 2020; Georgantzi et al., 2017). Thereafter, we investigated in a recent study this combination towards the solubilization of *Eucalyptus citriodora* (*E. citriodora*) EO (Nakhle et al., 2021). In the presence of 10 wt% of HP- β -CD, it was shown that ChCl:U DES:water 70:30 wt% was the optimal wt% ratio giving the highest solubility of *E. citriodora* EO when compared to water, pure ChCl:U DES and aqueous solutions of ChCl:U DES components. In addition, the solubilization of *E. citriodora* EO in different ChCl-based DESs in DES:water 70:30 wt% mixture in the presence of 10 wt% HP- β -CD was done. The results demonstrated that ChCl:U DES:water 70:30 wt% was the most efficient solubilizer among others, hypothesizing that this mixture insures the best compromise between inclusion efficiency and polarity of the medium (Nakhle et al., 2021). To the best of our knowledge, no solubilization studies of aromas and EOs conducted with CDs polymers in DESs have been done yet. In this regard, the present study aims to synthesize, *via* the cross-linking method, β -CD, HP- β -CD and CRYSMEB based/polymers. Various non-toxic crosslinking agents were used including four carboxylic acids (malonic acid, citric acid, glutaric acid and itaconic acid), poly(ethylene glycol) diglycidyl ether-640 (PEGDGE) and sodium trimetaphosphate (STMP), in order to obtain different types of CDs polymers. After characterization of the polymers, the solubilization capacity of ChCl:U (1:2 molar ratio) DES:water 70:30 wt% containing 2 wt% of CDs polymers towards *E. citriodora* EO was evaluated. The solubilizing effect was compared to the same mixture in the absence and presence of 2 wt% of native β -CD or modified CDs (HP- β -CD and CRYSMEB).

2. Experimental section

2.1. Materials

Choline chloride (98%), glutaric acid and trisodium trimetaphosphate were purchased from Sigma-Aldrich, China. Urea (99%) and poly(ethylene glycol) diglycidyl ether (Mn 640) were purchased from Sigma-Aldrich, USA. Citric acid and sodium hydroxide were purchased from Sigma-Aldrich, France. Itaconic acid was purchased from Sigma-Aldrich, Germany. Malonic acid was provided by Merck group, Germany. β -CD was provided by Wacker-Chemie, Lyon, France. CRYSMEB (DS = 4.9) and HP- β -CD (DS = 5.6) were provided by Roquette Frères, Lestrem, France. *E. citriodora* EO was provided by Herbes et Traditions, Comines, France. Choline chloride was dried at 60°C for at least 2 weeks before use. All other compounds were used as received. Distilled water was used throughout this work.

2.2. Preparation of deep eutectic solvent

DES was prepared by heating ChCl and U in a 1:2 molar ratio under stirring at 60 °C until the formation of a clear liquid. DES:water 70:30 wt% mixture was used throughout this work.

2.3. Cyclodextrins polymers preparation and purification

Preparation

The polymers have been prepared by reticulation of either β -CD, HP- β -CD or CRYSMEB using several crosslinking agents.

Four acids (malonic acid, citric acid, glutaric acid and itaconic acid) were used at first following the synthetic procedure as previously reported by Martel et al., 2005. The aqueous solutions were prepared by the solubilization of the catalyst (KH_2PO_4), the CD, and the carboxylic acid with respective concentrations of 0.2, 0.09, and 0.45 mol.L⁻¹ in 50 mL of distilled water. These solutions were then concentrated by evaporation (at 50 °C and at 5 mbar), and the resulting dried mixture underwent a treatment at 140 °C for 30 min. This step was carried out under reduced atmospheric pressure in a system connected to a suction pump. The polymer was recovered after the addition of 50 mL of distilled water to the flask. The flask was kept under agitation overnight to solubilize the reaction products. The fraction was then filtered off using sintered glass funnel (membrane porosity: 40 μm). Only trace amounts of insoluble products were obtained so these insoluble fractions were discarded. The structure of these polymers is illustrated in **Figure S1**.

Another crosslinking agent was also tested: the poly(ethylene glycol) diglycidyl ether-640 (PEGDGE) according to the previously described procedure by Luppi et al., 2018. The CD (3.6-4.4 mmol) was dissolved in 21 mL NaOH (1.38-1.46 mol.L⁻¹) and stirred mechanically for 16 hours at room temperature. 17.4 mL of PEGDGE (10.8-13.2 mmol) was then added dropwise during 20 min with vigorous stirring. The reaction mixture was heated to 30 °C for 5 hours with vigorous stirring. After cooling for 20 min, the mixture was neutralized with HCl solution (6 mol.L⁻¹). The volume of the solvent was reduced by evaporation and then precipitated in acetone three times and one time in ether. The solid was then collected and dissolved in distilled water.

The sodium trimetaphosphate (STMP) linker was also used according to Wintgens et al., 2013. Typically, 5-6.6 g of CD were dissolved in 10 mL of a NaOH solution (2.5 mol.L⁻¹), under mechanical stirring (300 rpm) at 30 °C. After 210 min, the temperature was raised to 50 °C, and the desired amount of STMP (0.5, 3, 5 or 10 g with identifying codes of STMP1, STMP2, STMP3 or STMP4, respectively) was added to the solution under vigorous stirring (600 rpm). After 90 min, 50 mL of water were added, and the pH was neutralized by HCl addition (6 mol.L⁻¹).

Purification

The soluble fractions obtained with malonic, citric and glutaric acids were purified by several passages on a Sephadex gel column (SephadexTM G-25 Medium) using water as eluent. Only polymers with itaconic acid, PEGDGE and STMP were purified by dialysis three times using a Spectra/Por[®] Standard grade regenerated cellulose membrane (molecular weight cut-off of 1 KDa). After water evaporation by rotary evaporator, all polymer fractions were dried under reduced pressure overnight to obtain the powders.

The polymer purification process was followed by different characterization techniques including nuclear magnetic resonance spectroscopy (NMR), fourier-transform infrared spectroscopy (FTIR) and gel permeation chromatography.

By integrating the respective protons in the ¹H-NMR spectra, we were able to find the number of linker molecules (n) for 1 molecule of CD (**Table 1**). After that, the wt% of CDs in the polymer fraction was calculated using the following equation:

$$CD \text{ (wt\%)} = \frac{MW_{CD}}{MW_{CD} + (n \times MW_{linker})} \times 100 \quad (1)$$

with MW_{CD} and MW_{linker} corresponding to the molecular weight of the used CD and the linker, respectively.

The molar concentration of the CDs was then calculated from the mass used in the vials in 3 mL of the mixture present (Table 1).

It is noteworthy to mention that β -CD/malonic acid, HP- β -CD/glutaric acid, HP- β -CD/itaconic acid, HP- β -CD/PEGDGE, HP- β -CD/STMP and all CRYSMEB-based polymers in this paper are, to the best of our knowledge, newly synthesized CDs polymers. While the others have been previously synthesized in literature such as β -CD/citric acid (Bednarz et al., 2011; Garcia-Fernandez et al., 2016), HP- β -CD/citric acid (Martel et al., 2005b), β -CD/itaconic acid (Nazi et al., 2012), β -CD/PEGDGE (Luppi et al., 2018) and β -CD/STMP (Wintgens et al., 2013) polymers. Only one CD polymer was previously synthesized based on CRYSMEB using epichlorohydrin as the crosslinking agent (Mallard Favier et al., 2011).

2.4. Characterization of cyclodextrins polymers

2.4.1. Infrared spectroscopy

Nicolet iS5 (Thermo Scientific) spectrophotometer was used to obtain the fourier transform infrared (FTIR) spectra of all compounds in the range of 600-4000 cm^{-1} using attenuated total reflection (iD7 ATR) diamond accessory. The spectra are the results of 16 scans with a resolution of 0.482 cm^{-1} . Before performing the FTIR measurements on the compounds, background and reference scans were carefully filtered.

2.4.2. Gel permeation chromatography

Gel permeation chromatography (PL-GPC50 Plus, Agilent Technologies, Polymer Laboratories, A Varian Inc. Company) was carried out with PL-aquagel-OH 40 column at 40 °C and the flow rate was 1 $\text{mL}\cdot\text{min}^{-1}$. Detection was conducted with a refractive index detector. Ultrapure water was used as eluent. The pressure during the analysis was set to 5.69 MPa. Calibration was made using standard pullulan polysaccharide samples from molecular weight: 180 to 708000. Samples were used with concentration of 0.01 % and filtered with a 0.2 mm Agilent captiva filter-syringe prior to use.

2.4.3. Nuclear magnetic resonance spectroscopy

Nuclear Magnetic Resonance (NMR) spectra were recorded at 25 °C in D₂O using a Bruker Avance III spectrometer, equipped with a multinuclear z-gradient BBFO probe head, operating at 400 MHz, 100 MHz and 161 MHz for ¹H, ¹³C and ³¹P NMR (when using STMP as the linker), respectively. Standard 5 mm NMR tubes were used for the experiments.

2.5. Solubility study

3 mL of ChCl:U (1:2 molar ratio) DES:water 70:30 wt% mixed with 2 wt% of CDs or CDs polymers were placed in 22 mL headspace vials. After the addition of 40 µL of 0.02 g.mL⁻¹ of *E. citriodora* EO (prepared in ethanol), all vials were sealed using silicone septa and aluminium foil and thermostated at 30 °C for 24 hours under stirring to reach the equilibrium between liquid and gas phases. Subsequently, 1 mL of the headspace was withdrawn from the vial and injected in the chromatographic system for analysis *via* a heated transfer line (250 °C). Measurements were carried out with a Varian Genesis headspace sampler coupled with a Perkin Elmer Autosystem XL gas chromatography (GC) equipped with a flame ionization detector and a DB624 column using nitrogen as carrier gas. The GC column temperature conditions were set as follows: initial temperature of 50 °C for 2 min, increased to 200 °C at 5 °C.min⁻¹, then hold for 2 min, giving a total runtime of 34 min. Results are expressed as:

$$\text{Normalized area (\%)} = \frac{\sum A_m}{\sum A_0} \times 100 \quad (2)$$

where $\sum A_m$ and $\sum A_0$ stand for the sum of peak areas of the EO components in the DES:water 70:30 wt% + 2 wt% of CDs or CDs polymers and in the DES:water 70:30 wt% + 2 wt% of β -CD, respectively.

3. Results and discussion

3.1. Characterization of cyclodextrins polymers

In order to complete our previous study (Nakhle et al., 2021), and to fully exploit the solubility of an EO in DES:water:CD mixture, it was essential to study the influence of the type of CDs used. As mentioned above, the polymerization of CDs dealing with covalent crosslinking agents was adopted and is presented in **Table 1**.

As can be seen from $^1\text{H-NMR}$ results (**Figures S2, S3 and S4**), changes in peaks forms and in the chemical shifts (δ) of the CDs corresponding peaks indicate the modification of the CDs. Broad signals confirmed the loss of the macrocycle symmetry as a result of the modification of the CDs (Anand et al., 2013). In addition, this was also confirmed for the linkers corresponding peaks. From $^{13}\text{C-NMR}$ results (**Figures S2, S3 and S4**) and in some cases, it can be noticed the appearance of a peak at approximately 170 ppm, which corresponds to the ester group. From $^{31}\text{P-NMR}$ results (**Figure S5**), it can be seen that as the polymers were extensively washed and dried before NMR measurements, inorganic phosphates (or unreacted STMP) usually located at -21 ppm, were not detected in polymers spectra (Wintgens et al., 2013). Based on previous investigations (Wintgens et al., 2015), peaks located between 2 and 5 ppm are assigned to grafted monophosphate groups, and those located between -2 and 2 ppm correspond to the monophosphate linkages. Peaks located between -6 and -10 ppm, or between -20 to -22 ppm correspond to grafted tripolyphosphates and pyrophosphates. The structure of these polymers is illustrated in **Figure S5**.

An analysis of the IR spectra in **Figure S6** showed the conversion of the carbonyl groups of the carboxylic acids into esters functions (sharp peaks around 1700 cm^{-1} appeared which was not present in the starting materials, that is a typical absorption for the carbonyl stretching of an ester moiety) (Li et al., 2015). **Figure S7** presents an example of an overlap of the newly synthesized CRYSMEB/citric acid polymer IR spectrum with spectra of its starting materials. It can be seen how the ester peak was only present in the polymer. Two strong peaks at $3550\text{-}3450\text{ cm}^{-1}$ are assigned to OH stretching vibrations of free hydroxyl groups in CDs. Finally, the presence of CDs in the polymers was also revealed by the C-OH vibration (2900 cm^{-1}) and COO of the ether groups (1000 cm^{-1}) (Martel et al., 2005a).

Table 1- Synthesized CDs polymers along with their molecular weights (M_n and M_w) obtained from the gel permeation chromatography. The number of linkers per a CD molecule and the molar concentration of CDs in the headspace vials were calculated.

	Polymer	Linker	Number of linker/CD molecule	[CD] in 2 wt% of polymer in 3 mL of the mixture (mM)	M_n (g.mol ⁻¹)*	M_w (g.mol ⁻¹)*
β-CD	-	-	-	16.19	-	-
	P1	Citric acid	2	14.94	264374	365761
	P2	Itaconic acid	2	16.08	555165 71503	765004 85262
	P3	PEGDGE	0.5	15.45	658972 184768	680090 201198
	P4	STMP1	-	-	291595 33952	391439 35884
	P5	STMP2	-	-	541635	665746
	P6	STMP3	-	-	609464	818420
	P7	STMP4	-	-	645417 105030	821485 105867
HP-β-CD	-	-	-	16.19	-	-
	P8	Citric acid	3	11.44	267358 64032	387353 65853
	P9	Glutaric acid	2	13.56	1009500 24073 12635 4223	1184790 28312 12849 5449
	P10	Itaconic acid	3	12.71	835106 168464	1430067 185510
	P11	PEGDGE	0.3	16.02	820854 230618	837640 250664
	P12	STMP1	-	-	175756 45301	247123 47253
	P13	STMP2	-	-	334029	424047

					130886	139516
	P14	STMP3	-	-	234171	345950
	P15	STMP4	-	-	64313	143712
CRYSMEB	-	-	-	18.89	-	-
	P16	Citric acid	3	12.67	347898	525474
	P17	PEGDGE	0.3	14.19	761298	787684
	P18	STMP1	-	-	182285	201146
	P19	STMP2	-	-	142162	179150
					170800	249697
					59355	60148
					268290	369613
	P20	STMP3	-	-	110195	113413
					67834	68667
					46451	47103
	P21	STMP4	-	-	97585	183745

*Gel permeation chromatogram can present one or more peaks for each polymer and each peak is characterized by M_n and M_w parameters; M_n is the major molecular weight present in the material and M_w is the average molecular weight of all the macromolecules. These parameters are indicators of the polydispersity of the synthesized polymers.

Gel permeation chromatography analysis was carried out to determine the macromolecular nature of the soluble polymers. The chromatograms revealed that the sample displayed heterogeneous composition of the polymers, which can be explained by the multiple peaks, each peak characterized by M_n and M_w obtained with different eluting time, as can be seen from **Table 1**. An example of gel permeation chromatogram of the HP- β -CD/glutaric acid polymer is presented in **Figure S8**. It can be seen that five peaks are obtained which indicates that the obtained product appeared highly polydispersed. Peak number 5 corresponds to the remaining non-reacted HP- β -CD in the media.

3.2. Solubility Study

The CDs polymers, as well as the native CD (β -CD) and the CD derivatives (CRYSMEB and HP- β -CD), were screened for their ability to entrap and solubilize the EO. In our previous study, when using different wt% of β -CD or HP- β -CD in ChCl:U DES:water 70:30 wt% for the solubilization of *E. citriodora* EO, 2 wt% of CDs was sufficient to have an almost maximum capacity of solubilization (Nakhle et al., 2021). For this reason, 2 wt% of the different CDs and CDs polymers were dissolved in 3 mL of ChCl:U DES:water 70:30 wt%. The entrapment and solubilization of EO was evaluated by measurement of the volatility reduction *via* the static headspace-gas chromatography (SH-GC) technique. The total area associated with the different peaks of the EO components was used as an indicator of the overall volatility of the EO. The decrease in the total area indicated an increase in the EO solubility. **Figure 1** presents the obtained results where the total areas were normalized to the area obtained when using the native β -CD.

Since all CDs and CDs polymers presented a decrease in the volatility of the EO compared to DES:water mixture in the absence of CDs, it can be stated that all CDs retained at least partially their inclusion capacities in this mixture reflecting the complexation of EO components aroma in CDs and CDs polymers. The majority of the CDs polymers presented a higher volatility of the EO compared to the native β -CD, and for the rest, no dramatic reduction of the EO volatility was observed.

One can hypothesize that bearing high number of linkers (as example 3 carboxylic acids for HP- β -CD/citric acid polymer), meaning low CD concentration, the volatility of the EO increased compared to CDs polymers bearing low number of linkers (as example 2 carboxylic acids for HP- β -CD/glutaric acid polymer), meaning high CD concentration. In

order to better understand these results, a comparison between the real CD concentration present in the vials (**Table 1**) and the EO volatility when using the CDs polymers (**Figure 1**) should be settled. For this comparison, the STMP/based polymers will not be taken into consideration because the real molar concentration of these polymers was not calculated due to the non-appearance of the STMP peaks neither in $^1\text{H-NMR}$ nor the $^{13}\text{C-NMR}$ spectra. Focusing first on the β -CD/based polymers, the least efficient solubilizer of the EO, meaning the one presenting the highest EO volatility is the β -CD/PEDGE polymer (with a real concentration of 15.45 mM and a normalized area of 304%). While the most efficient solubilizer, meaning the one presenting the lowest EO volatility was the β -CD/itaconic acid polymer (with a real concentration of 16.08 mM and a normalized area of 79%). This very slight difference in concentrations is unable really to engender this huge difference in the solubility of the EO. For this reason, we tried to do the same comparison with HP- β -CD/based polymers and CRYSMEB/based polymers. For the HP- β -CD/based polymers, the least efficient solubilizer was the HP- β -CD/PEDGE polymer (with a real concentration of 16.02 mM and a normalized area of 223%) while the most efficient solubilizer was the HP- β -CD/glutaric acid polymer (with a real concentration of 13.56 mM and a normalized area of 85%), which is in contrary to what was obtained previously with β -CD/based polymers. For the CRYSMEB/based polymers, the least efficient solubilizer was the CRYSMEB/PEDGE polymer (with a real concentration of 14.19 mM and a normalized area of 205%) while the most efficient solubilizer was the CRYSMEB/citric acid polymer (with a real concentration of 12.17 mM and a normalized area of 99%). Therefore, these results can assure that no definitive correlation was found between the real CD concentration in the polymer and the obtained EO volatility.

Another explanation could be given related to the EO volatility differences. This can be due to the presence of additional groups, or the highly-branched architecture of CDs polymers, that can hinder the CDs cavity and lower their encapsulation efficiency unlike the native β -CDs where there are no steric groups present (Morin-Crini et al., 2018). Since the PEDGGE/based CDs polymers presented almost the highest volatility of the EO, this could be explained by the fact that this cross-linker presents a really long chain.

In summary, the use of these CDs polymers does not seem relevant, regarding both the small benefit in EO solubility compared to native β -CD and on the economic point of view.

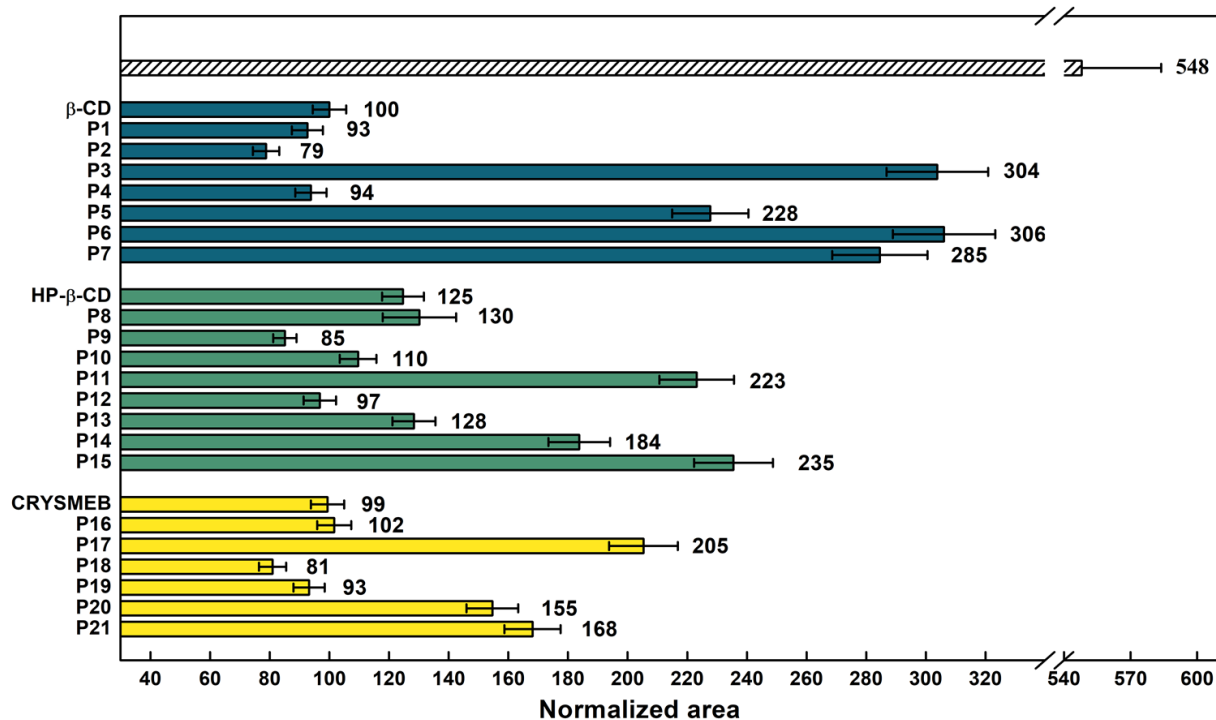

Figure 1: *E. citriodora* EO normalized area, obtained from SH-GC analysis, as function of the CDs polymers (2 wt%) in ChCl:U DES:water 70:30 wt%, at 30 °C, where the reference mixture was the ChCl:U DES:water 70:30 wt% + 2 wt% of β -CD. The dashed histogram corresponds to the volatility of the EO (normalized) in ChCl:U DES:water 70:30 wt% in the absence of CDs.

4. Conclusion

Although CDs polymers have long been considered as very promising materials targeting different applications including drug carriers, organic pollutants remedies and others in aqueous solutions, this study showed no systematic advantageous interest in the use of CD polymers for the solubilization of EO compared to the native β -CD when using DES:water mixture, a non-conventional media. However, similar studies in the same mixture should be done with other natural molecules and/or CDs polymers for the investigation of possible solubility enhancement.

Acknowledgements

The authors would like to acknowledge the National Council for Scientific Research of Lebanon (CNRS-L) and Université du Littoral Côte d'Opale (ULCO) for granting a doctoral fellowship to Lamia Nakhle.

References

- Abbott, A. P., Capper, G., Davies, D. L., Rasheed, R. K., & Tambyrajah, V. (2003). Novel solvent properties of choline chloride/urea mixtures. Electronic supplementary information (ESI) available: Spectroscopic data. See <http://www.rsc.org/suppdata/cc/b2/b210714g/>. *Chemical Communications*, 1, 70–71. <https://doi.org/10.1039/b210714g>
- Anand, R., Malanga, M., Manet, I., Manoli, F., Tuza, K., Aykaç, A., Ladavière, C., Fenyvesi, E., Vargas-Berenguel, A., Gref, R., & Monti, S. (2013). Citric acid- γ -cyclodextrin crosslinked oligomers as carriers for doxorubicin delivery. *Photochemical & Photobiological Sciences*, 12(10), 1841. <https://doi.org/10.1039/c3pp50169h>
- Bednarz, S., Lukaszewicz, M., Mazela, W., Pajda, M., & Kasprzyk, W. (2011). Chemical structure of poly(β -cyclodextrin-co-citric acid). *Journal of Applied Polymer Science*, 119(6), 3511–3520. <https://doi.org/10.1002/app.33002>
- Ciobanu, A., Mallard, I., Landy, D., Brabie, G., Nistor, D., & Fourmentin, S. (2012). Inclusion interactions of cyclodextrins and crosslinked cyclodextrin polymers with linalool and camphor in *Lavandula angustifolia* essential oil. *Carbohydrate Polymers*, 87(3), 1963–1970. <https://doi.org/10.1016/j.carbpol.2011.10.005>
- Ciobanu, A., Mallard, I., Landy, D., Brabie, G., Nistor, D., & Fourmentin, S. (2013). Retention of aroma compounds from *Mentha piperita* essential oil by cyclodextrins and crosslinked cyclodextrin polymers. *Food Chemistry*, 138(1), 291–297. <https://doi.org/10.1016/j.foodchem.2012.10.106>
- Crini, G. (2014). Review: A History of Cyclodextrins. *Chemical Reviews*, 114(21), 10940–10975. <https://doi.org/10.1021/cr500081p>
- Crini, G., Fourmentin, S., Fenyvesi, É., Torri, G., Fourmentin, M., & Morin-Crini, N. (2018). Cyclodextrins, from molecules to applications. *Environmental Chemistry Letters*, 16(4), 1361–1375. <https://doi.org/10.1007/s10311-018-0763-2>
- El Achkar, T., Greige-Gerges, H., & Fourmentin, S. (2021). Basics and properties of deep eutectic solvents: A review. *Environmental Chemistry Letters*. <https://doi.org/10.1007/s10311-021-01225-8>
- El Achkar, T., Moufawad, T., Ruellan, S., Landy, D., Greige-Gerges, H., & Fourmentin, S. (2020). Cyclodextrins: From solute to solvent. *Chemical Communications*, 56(23), 3385–3388. <https://doi.org/10.1039/D0CC00460J>

- El Achkar, T., Moura, L., Moufawad, T., Ruellan, S., Panda, S., Longuemart, S., Legrand, F.-X., Costa Gomes, M., Landy, D., Greige-Gerges, H., & Fourmentin, S. (2020). New generation of supramolecular mixtures: Characterization and solubilization studies. *International Journal of Pharmaceutics*, 584, 119443. <https://doi.org/10.1016/j.ijpharm.2020.119443>
- Garcia-Fernandez, M. J., Tabary, N., Chai, F., Cazaux, F., Blanchemain, N., Flament, M.-P., & Martel, B. (2016). New multifunctional pharmaceutical excipient in tablet formulation based on citric acid-cyclodextrin polymer. *International Journal of Pharmaceutics*, 511(2), 913–920. <https://doi.org/10.1016/j.ijpharm.2016.07.059>
- Georgantzi, C., Lioliou, A.-E., Paterakis, N., & Makris, D. (2017). Combination of Lactic Acid-Based Deep Eutectic Solvents (DES) with β -Cyclodextrin: Performance Screening Using Ultrasound-Assisted Extraction of Polyphenols from Selected Native Greek Medicinal Plants. *Agronomy*, 7(3), 54. <https://doi.org/10.3390/agronomy7030054>
- Gidwani, B., & Vyas, A. (2014). Synthesis, characterization and application of Epichlorohydrin- β -cyclodextrin polymer. *Colloids and Surfaces B: Biointerfaces*, 114, 130–137. <https://doi.org/10.1016/j.colsurfb.2013.09.035>
- Kfoury, M., Hădărugă, N. G., Hădărugă, D. I., & Fourmentin, S. (2016). Cyclodextrins as encapsulation material for flavors and aroma. In *Encapsulations* (pp. 127–192). Elsevier. <https://doi.org/10.1016/B978-0-12-804307-3.00004-1>
- Li, Y.-F., Ha, Y.-M., Guo, Q., & Li, Q.-P. (2015). Synthesis of two β -cyclodextrin derivatives containing a vinyl group. *Carbohydrate Research*, 404, 55–62. <https://doi.org/10.1016/j.carres.2014.11.012>
- Liu, Y., Lin, T., Cheng, C., Wang, Q., Lin, S., Liu, C., & Han, X. (2021). Research Progress on Synthesis and Application of Cyclodextrin Polymers. *Molecules*, 26(4), 1090. <https://doi.org/10.3390/molecules26041090>
- Luppi, F., Cavaye, H., & Dossi, E. (2018). Nitrated Cross-linked β -Cyclodextrin Binders Exhibiting Low Glass Transition Temperatures. *Propellants, Explosives, Pyrotechnics*, 43(10), 1023–1031. <https://doi.org/10.1002/prop.201800137>
- Mallard Favier, I., Baudalet, D., & Fourmentin, S. (2011). VOC trapping by new crosslinked cyclodextrin polymers. *Journal of Inclusion Phenomena and Macrocyclic Chemistry*, 69(3–4), 433–437. <https://doi.org/10.1007/s10847-010-9776-6>
- Martel, B., Ruffin, D., Weltrowski, M., Lekchiri, Y., & Morcellet, M. (2005a). Water-soluble polymers and gels from the polycondensation between cyclodextrins and

- poly(carboxylic acid)s: A study of the preparation parameters. *Journal of Applied Polymer Science*, 97(2), 433–442. <https://doi.org/10.1002/app.21391>
- Martel, B., Ruffin, D., Weltrowski, M., Lekchiri, Y., & Morcellet, M. (2005b). Water-soluble polymers and gels from the polycondensation between cyclodextrins and poly(carboxylic acid)s: A study of the preparation parameters. *Journal of Applied Polymer Science*, 97(2), 433–442. <https://doi.org/10.1002/app.21391>
- Morin-Crini, N., Winterton, P., Fourmentin, S., Wilson, L. D., Fenyvesi, É., & Crini, G. (2018). Water-insoluble β -cyclodextrin–epichlorohydrin polymers for removal of pollutants from aqueous solutions by sorption processes using batch studies: A review of inclusion mechanisms. *Progress in Polymer Science*, 78, 1–23. <https://doi.org/10.1016/j.progpolymsci.2017.07.004>
- Nakhle, L., Kfoury, M., Mallard, I., Greige-Gerges, H & Landy, D. (2021). Choline chloride based- deep eutectic solvents:water:cyclodextrins mixtures for the entrapment and the solubilization of volatile molecules: application to *Eucalyptus citriodora* essential oil and citronellal.
- Nazi, M., Malek, R. M. A., & Kotek, R. (2012). Modification of β -cyclodextrin with itaconic acid and application of the new derivative to cotton fabrics. *Carbohydrate Polymers*, 88(3), 950–958. <https://doi.org/10.1016/j.carbpol.2012.01.047>
- Shishov, A., Bulatov, A., Locatelli, M., Carradori, S., & Andruch, V. (2017). Application of deep eutectic solvents in analytical chemistry. A review. *Microchemical Journal*, 135, 33–38. <https://doi.org/10.1016/j.microc.2017.07.015>
- Smith, E. L., Abbott, A. P., & Ryder, K. S. (2014). Deep Eutectic Solvents (DESs) and Their Applications. *Chemical Reviews*, 114(21), 11060–11082. <https://doi.org/10.1021/cr300162p>
- Wintgens, V., Dalmás, F., Sébille, B., & Amiel, C. (2013). Novel phosphorus-containing cyclodextrin polymers and their affinity for calcium cations and hydroxyapatite. *Carbohydrate Polymers*, 98(1), 896–904. <https://doi.org/10.1016/j.carbpol.2013.06.073>
- Wintgens, V., Lorthioir, C., Dubot, P., Sébille, B., & Amiel, C. (2015). Cyclodextrin/dextran based hydrogels prepared by cross-linking with sodium trimetaphosphate. *Carbohydrate Polymers*, 132, 80–88. <https://doi.org/10.1016/j.carbpol.2015.06.038>

Supplementary data for

Cyclodextrins polymers in deep eutectic solvent:water mixture: Solubilization study of *Eucalyptus citriodora* essential oil

Lamia Nakhle^{a,b}, Miriana Kfoury^{a,b,*}, Isabelle Mallard^a, H el ene Greige-Gerges^b, David Landy^b

^a *Unit e de Chimie Environnementale et Interactions sur le Vivant (UCEIV, UR 4492), SFR Condorcet FR CNRS 3417, Universit e du Littoral C te d'Opale (ULCO), 145 Av. M. Schumann, F-59140 Dunkerque, France*

^b *Bioactive Molecules Research Laboratory, Faculty of Sciences, Lebanese University, 90656 Jdeidet el-Metn, Lebanon*

* Corresponding author: miriana.kfoury@univ-littoral.fr

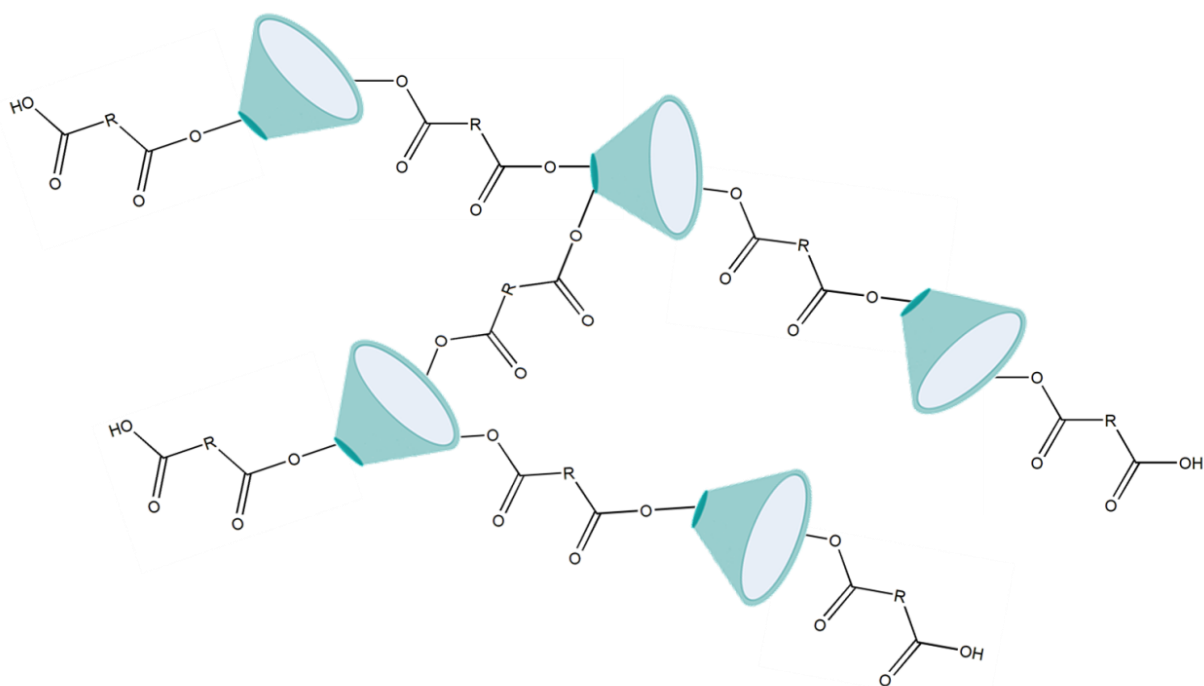

Figure S1: Illustration of carboxylic acid/based CD polymer. Figure adapted from Anand et al., 2013 and Danel et al., 2013.

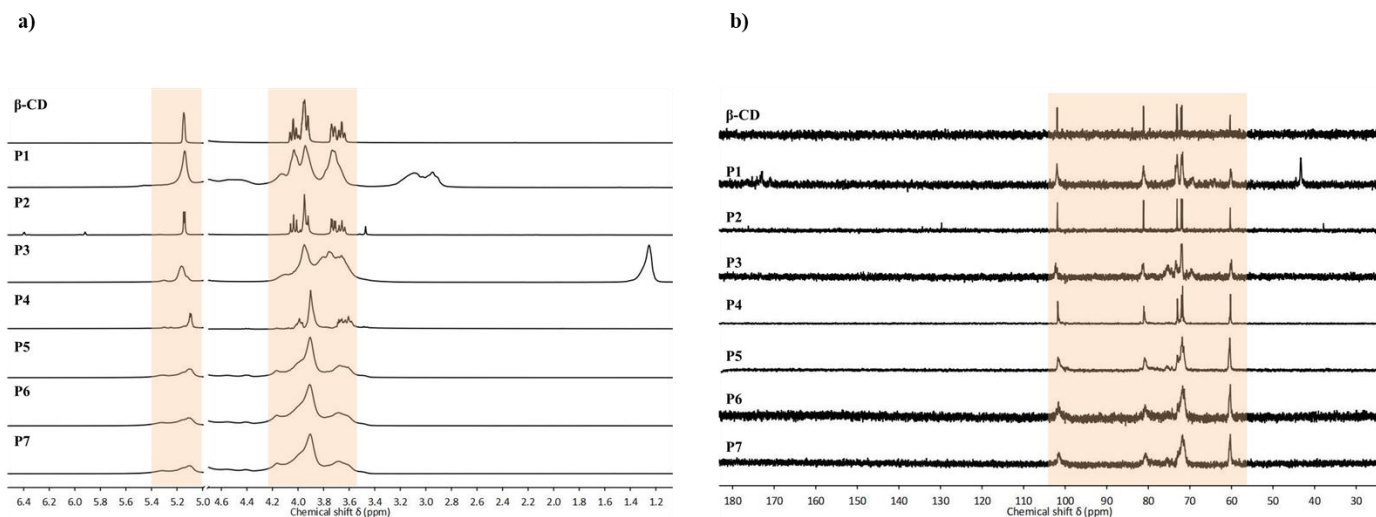

Figure S2: Superposition of ^1H -NMR spectra (a) and ^{13}C -NMR spectra (b) of β -CD synthesized polymers. Highlighted areas correspond to the CD peaks.

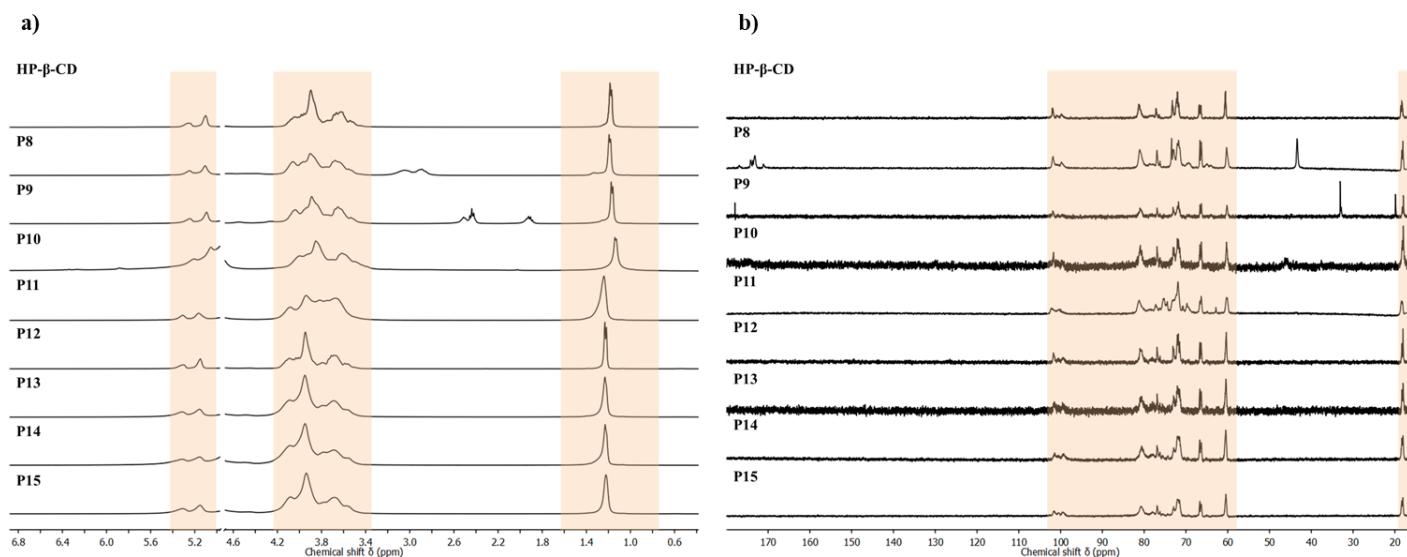

Figure S3: Superposition of ^1H -NMR spectra (a) and ^{13}C -NMR spectra (b) of HP- β -CD synthesized polymers. Highlighted areas correspond to the CD peaks.

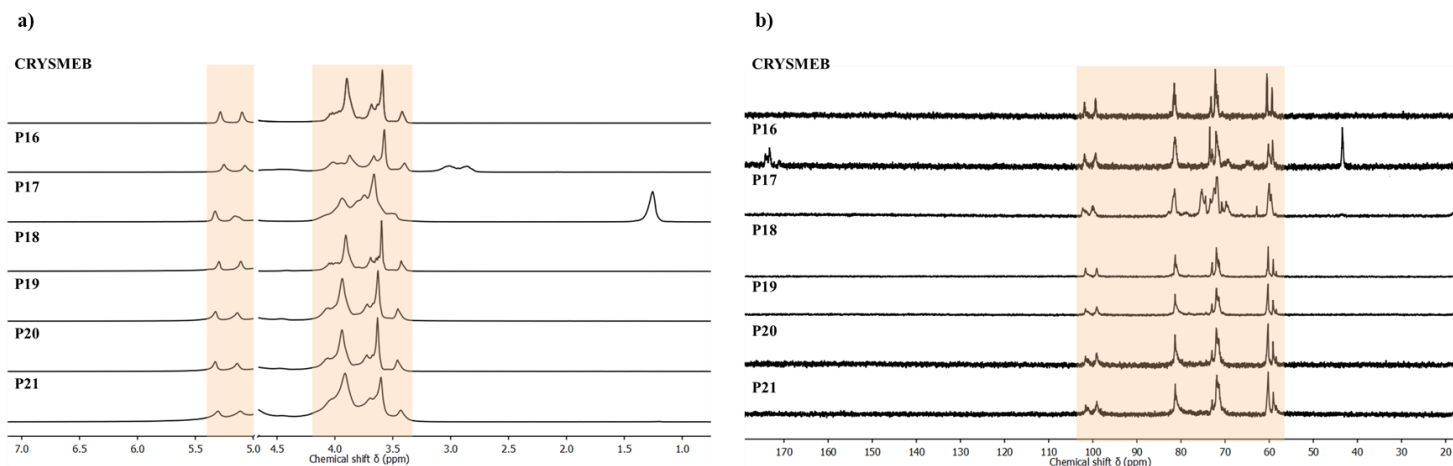

Figure S4: Superposition of ^1H -NMR spectra (a) and ^{13}C -NMR spectra (b) of CRYSMEB synthesized polymers. Highlighted areas correspond to the CD peaks.

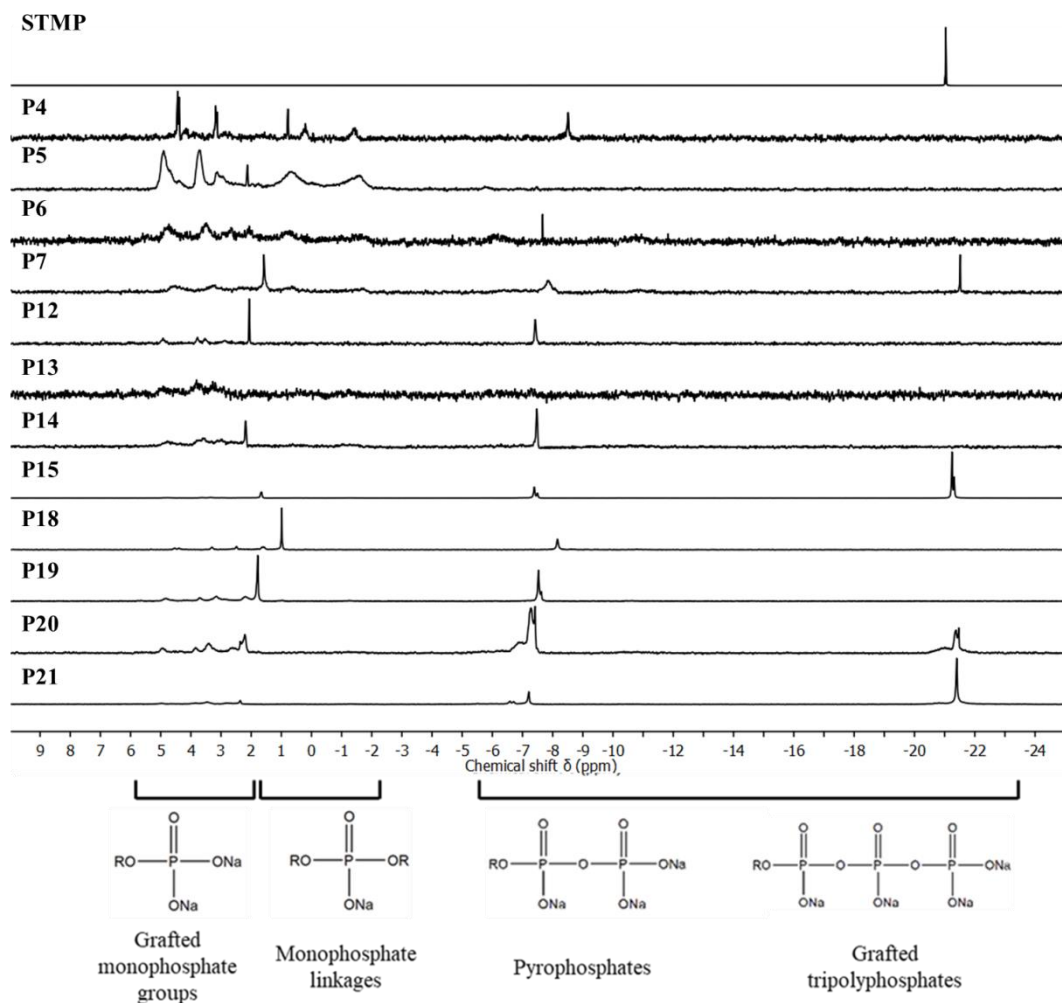

Figure S5: Superposition of ^{13}P -NMR spectra all CD synthesized polymers when using STMP linker. Illustration of possible structure of these polymers is also presented with R referring to CD molecule.

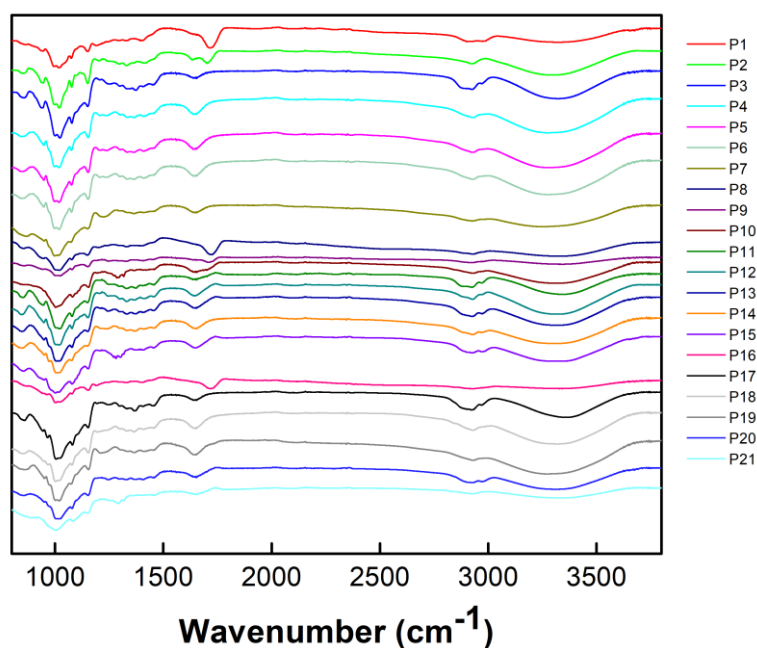

Figure S6: Superposition of infrared spectra of all the synthesized CDs polymers.

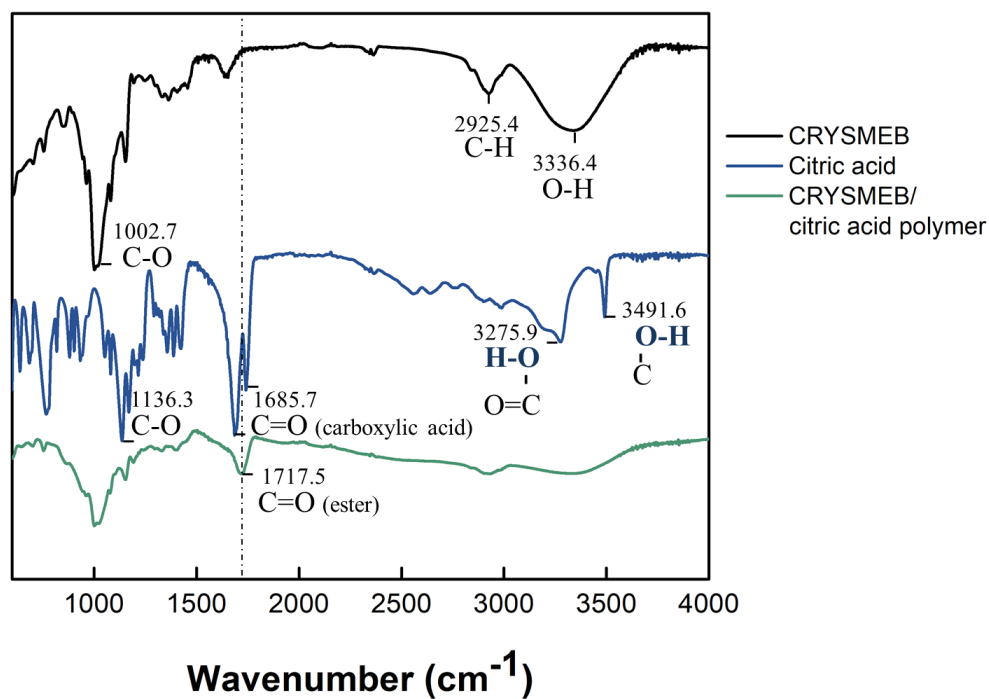

Figure S7: Superposition of infrared spectrum of CRYSMEB/citric acid polymer with the spectra of its starting materials.

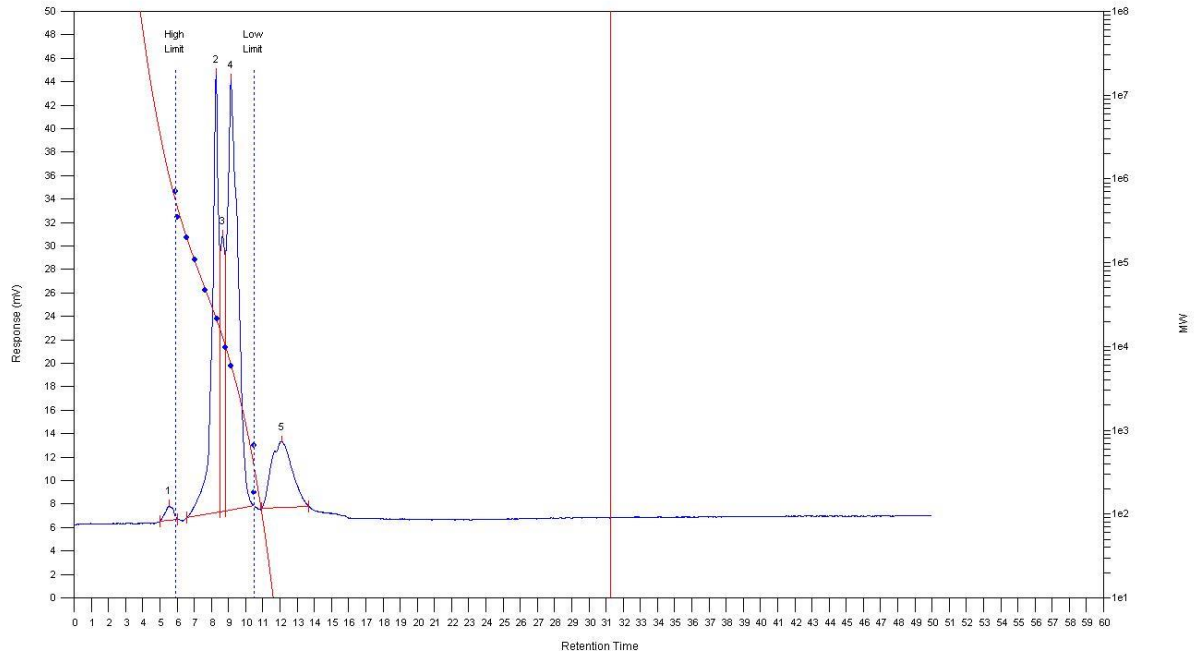

Figure S8: Gel permeation chromatogram of the HP- β -CD/glutaric acid polymer.

References

- Anand, R., Malanga, M., Manet, I., Manoli, F., Tuza, K., Aykaç, A., Ladavière, C., Fenyvesi, E., Vargas-Berenguel, A., Gref, R., & Monti, S. (2013). Citric acid- γ -cyclodextrin crosslinked oligomers as carriers for doxorubicin delivery. *Photochemical & Photobiological Sciences*, 12(10), 1841. <https://doi.org/10.1039/c3pp50169h>
- Danel, C., Azaroual, N., Chavaria, C., Odou, P., Martel, B., & Vaccher, C. (2013). Comparative study of the complex forming ability and enantioselectivity of cyclodextrin polymers by CE and ^1H NMR. *Carbohydrate Polymers*, 92(2), 2282–2292. <https://doi.org/10.1016/j.carbpol.2012.11.095>

CHAPITRE 7

Application à la solubilisation d'une variété d'huiles essentielles et
d'arômes

Introduction

Dans les chapitres précédents, nous avons optimisé la formulation menant à une solubilisation efficace de l'huile essentielle *E. citriodora* (CD native ajouté au chlorure de choline:urée DES:eau 70:30 % (m/m)). Le chapitre présent se focalise sur la potentielle versatilité de la formulation optimale *vis-à-vis* d'une large gamme d'huiles essentielles, en s'appuyant sur l'utilisation principalement de la β -CD, et occasionnellement de son dérivé l'HP- β -CD.

Afin de confirmer le potentiel de solubilisation de la formulation chlorure de choline:urée DES:eau 70:30 % (m/m), le travail présent consiste à évaluer en premier lieu la transférabilité des résultats obtenus pour *E. citriodora*, vers une autre huile essentielle *Rosmarinus officinalis L.* (dans laquelle la (R)-(+)-verbénone est le constituant majeur) par la technique d'espace de tête-statique couplée à la chromatographie en phase gazeuse. Afin de souligner l'existence du phénomène d'inclusion au sein du milieu DES:eau et son importance dans les mécanismes de solubilisation d'un mélange complexe tel qu'une huile essentielle dans son ensemble, nous avons étudié l'inclusion des constituants individuels des huiles essentielles. Le complexe d'inclusion β -CD/(R)-(+)-verbénone a été étudié dans la formulation chlorure de choline:urée DES:eau 70:30 % (m/m) par différentes techniques : la RMN (2D ROESY et 2D DOSY), la calorimétrie de titration isotherme ainsi que par l'espace de tête-statique couplée à la chromatographie en phase gazeuse pour effectuer des mesures de réduction de volatilité et détermination du coefficient de partage.

Par la suite, la réduction de la volatilité de vingt huiles essentielles et vingt-et-un arômes, constituants majeurs des huiles essentielles étudiées, a été évaluée dans la formulation DES:eau:CD par l'espace de tête-statique couplée à la chromatographie en phase gazeuse. De plus, les valeurs des constantes de formation (K_f) des complexes CD/arômes ont été déterminées. La variété des molécules étudiées permettra de vérifier le caractère majoritaire de la stœchiométrie d'inclusion de type 1/1, et éventuellement de mettre en évidence l'existence ponctuelle d'édifices plus élaborés.

La versatilité du concept DES:eau:CD est ainsi explorée dans l'article intitulé '*Solubilization of a plethora of essential oils and aromas in choline chloride:urea deep eutectic solvent:cyclodextrins:water mixtures*'.

Solubilization of a plethora of essential oils and aromas in choline chloride:urea deep eutectic solvent:cyclodextrins:water mixtures

Lamia Nakhle^{a,b}, Steven Ruellan^a, Miriana Kfoury^{a,b,*}, Hélène Greige-Gerges^b, David Landy^a

^a *Unité de Chimie Environnementale et Interactions sur le Vivant (UCEIV, UR 4492), SFR Condorcet FR CNRS 3417, Université du Littoral Côte d'Opale (ULCO), 145 Av. M. Schumann, F-59140 Dunkerque, France*

^b *Bioactive Molecules Research Laboratory, Faculty of Sciences, Lebanese University, 90656 Jdeidet el-Metn, Lebanon*

* Email of the corresponding author: miriana.kfoury@univ-littoral.fr

Abstract

Essential oils (EOs) and aromas have long been used in the perfume, cosmetic, pharmaceutical and food industries. Yet, their low aqueous solubility limits their applications. Deep eutectic solvents (DESs) have emerged recently with attractive properties for the solubilization of compounds of various chemical classes. On another hand, cyclodextrins (CDs) are known to form inclusion complexes with poorly-water soluble molecules. Taking advantage of these properties, new formulations could be prepared with higher solubilizing ability when combining DESs and CDs. This study examines the solubilization of 20 EOs and 21 aromas in choline chloride:urea (ChCl:U) DES in combination with CDs and water by the use of static headspace-gas chromatography. The complexation phenomena of (R)-(-)-verbenone, the major constituent of *Rosmainus officinalis L.* EO, in DES:water mixture was first investigated by NMR, isothermal titration calorimetry (ITC) and measurements of vapor-liquid partition coefficients. Formation constants (K_f) of CD/aromas inclusion complexes were determined afterwards in ChCl:U DES:water 70:30 wt%. In addition, a stoichiometry of 2/1 was proved for the first time for the α -CD/(1R)-(+)-camphor inclusion complex in DES:water mixture.

Keywords: aromas, camphor, cyclodextrins, deep eutectic solvents, essential oils, solubility, verbenone.

1. Introduction

Solubility enhancement of poorly-water soluble bioactive molecules is a frequently encountered subject. A considerable attention should be given for essential oils (EOs) and aromas since they present a large spectrum of important biological properties (antiviral, antibacterial, antimycotic, antitoxigenic, antiparasitic, and insecticidal properties) that are being altered due to their low aqueous solubility, chemical instability and high volatility (Kfoury et al., 2015).

Organic solvents, being applied alone or as co-solvents, have been considered for increasing aromas solubility (Nakhle et al., 2020). However, there was no escape from their unsafe and harmful impacts (Joshi & Adhikari, 2019). Deep eutectic solvents (DESs) have been discovered in 2003. These solvents are frequently defined as safe binary or ternary mixtures of compounds that are able to associate mainly *via* hydrogen bonds (Abbott et al., 2003). At a certain molar ratio of compounds, an eutectic mixture could be obtained at which the melting temperature of the solvent is lower than its starting compounds (Abbott et al., 2004). In order to give meaning of the word 'deep', Martins et al. attributed a more specific definition for DES: 'a mixture of two or more pure compounds for which the eutectic point temperature is below that of an ideal liquid mixture, presenting significant negative deviations from ideality (Martins et al., 2019). Being the first discovered and the most studied DES, choline chloride:urea (ChCl:U) with 1:2 molar ratio DES displays a freezing point of 12 °C (Abbott et al., 2003). Recently, DESs are being extensively used for the solubilization and extraction of natural molecules owing to the advantages they provide given the low vapor pressure, non-flammability, high thermal stability and low thermal conductivity of its starting compounds (Nakhle et al., 2021). Lately, they have been used to solubilize EOs and aromas (El Achkar et al., 2020). It was also proven that introducing water to DES, in a considered content, can maximize the extraction and the solvation of proteins and polysaccharides (Dai et al., 2013; Lores et al., 2017).

Since their discovery in 1891, cyclodextrins (CDs) are found to be at the forefront of the supramolecular chemistry field (Crini et al., 2018). They are cyclic oligosaccharides that display a unique structure including an inner hydrophobic cavity and two rims on their outer hydrophilic sides (Loftsson & Brewster, 2012). These molecules own the capacity to form inclusion complexes with poorly soluble guests held together by intermolecular forces (Kfoury et al., 2018). Native CDs are known as α , β and γ - composed of six, seven and eight

glucose units, respectively. CD derivatives have also been explored, notably the hydroxypropylated- β -CD (HP- β -CD). Given their exclusive properties, CDs have been remarkably used for the solubilization of EOs and aromas in aqueous solution or in organic solvents (Ciobanu et al., 2013; Decock et al., 2008; Kfoury et al., 2015; Kfoury et al., 2019; Nakhle et al., 2020). Many techniques have been used to study the interactions of aromas with CDs like static headspace-gas chromatography (SH-GC), nuclear magnetic resonance (NMR) and isothermal titration calorimetry (ITC) (Kfoury et al., 2018).

Recently, CDs were added to DESs to improve the extraction of polyphenols (Athanasiadis et al., 2018) and to increase the solvation of volatile organic compounds (Di Pietro et al., 2019; Moufawad et al., 2019). In addition, the incorporation of CDs in the DES network, being one of its components, was recently introduced, which led to the discover of SUPRADES (supramolecular deep eutectic solvent) (El Achkar et al., 2020a). However, to the best of our knowledge no such combination was applied for the solvation of a large number of EOs and aromas except two recent studies that proved the higher solubilization ability of these formulations towards *trans*-anethole, star anise EO, fennel EO and *Eucalyptus citriodora* EO as compared to water (El Achkar et al., 2020b; Nakhle et al., 2021).

In a previous study, we were able to show that ChCl:U DES:water 70:30 wt% containing CDs was the optimal mixture, providing the highest *E. citriodora* EO solubilization (Nakhle et al., 2021). Therefore, ChCl:U DES:water 70:30 wt% containing CDs was adopted in this study to improve the solubilization of 20 EOs and 21 aromas, found in the chosen EOs. The aromas belong to various chemical classes (hydrocarbons, alcohols, aldehydes, ketones, oxides, esters, phenols and ethers). The CD/aromas inclusion complexes were characterized by NMR, ITC and SH-GC. The determination of the diffusion coefficients of β -CD/(R)-(-)-verbenone in DES:water 70:30 wt% was done through NMR experiments. Further, ITC experiments are conducted herein for the first time in DES:water mixture with β -CD/(R)-(-)-verbenone and α -CD/(1R)-(+)-camphor complexes. SH-GC experiments were also performed to determine the formation constants (K_f) of the β -CD/aromas and HP- β -CD/aromas in ChCl:U DES:water 70:30 wt%.

2. Experimental section

2.1. Materials

Choline chloride (98%) was purchased from Sigma-Aldrich, China. Urea (99%) was purchased from Sigma-Aldrich, USA. Citronellal was provided by Merck group, Germany. β -CD and α -CD were provided by Wacker-Chemie, Lyon, France. Hydroxypropyl- β -CD (HP- β -CD, MS = 0.65) was provided by Roquette Frères, Lestrem, France. All EOs were provided by Herbes et Traditions, Comines, France. The composition of the various EOs is provided in **Table S1** (data provided by Herbes et Traditions). (-)-Terpinene-4-ol, *trans*-anethole, p-cymene and (R)-(+)-verbenone were purchased from Acros Organics, France. Geraniol, (+)-limonene, linalool, (1,8) cineole, (1S)-(-)- α -pinene and (1S)-(-)- β -pinene were provided by Aldrich-Chemie, France. β -Citronellol, γ -terpinene, carvacrol, estragole, α -terpinene, citral (mixture of neral and geranial) and (1R)-(+)-camphor were purchased from Sigma-Aldrich, France. (S)-(+)-Carvone and geranyl acetate were provided by Alfa Aesar, France. Choline chloride was dried at 60 °C for at least 2 weeks before use. All other compounds were used as received. Distilled water was used throughout this work.

2.2. Preparation of deep eutectic solvent

DES was prepared using the heating method by mixing ChCl and U in a 1:2 molar ratio under stirring at 60 °C until the formation of a clear and homogenous liquid. The water content of DES was determined using the Karl Fisher titration method (Mettler Toledo DL31) and was of 0.049 %. When studying the influence of water content in DES:water:CD mixture, different DES:water mixtures were prepared ranging from 0 to 100 wt%. For all the rest experiments, pure DES and DES:water 70:30 wt% mixture were used.

2.3. Solubilization studies

The solubilization ability of water, aqueous solutions of CDs, DES, and their combinations towards 20 EOs and 21 aromas was evaluated using SH-GC. EOs and aromas solutions were prepared in ethanol (the concentrations are mentioned between brackets for each experiment). All prepared headspace vials were sealed after the addition of 30 μ L of the ethanolic solutions of the EOs or aromas to 3 mL of DES:CD, DES:water or DES:water:CD mixtures, and thermostated at 30 °C under stirring for 24 hours to reach equilibrium between liquid and gas phases. Subsequently, 1 mL of the headspace was withdrawn from the vial and injected in the chromatographic system for analysis *via* a heated transfer line (250 °C). All measurements

were carried out with a Thermo Scientific™ TriPlus™ 500 Headspace Sampler coupled to TRACE™ 1300 Series GC equipped with a flame ionization detector and P/N 260E113P column (TR-5; 7 m long; 0.32 mm ID; 0.25 mm film thickness) using nitrogen as carrier gas. The GC column temperature conditions were set as follows: initial temperature of 50 °C for 2 min, increased to 200 °C at 5 °C.min⁻¹, then hold for 2 min, giving a total runtime of 34 min. Each experiment was repeated 3 times.

Results for EOs were expressed as:

$$\text{Normalized area (\%)} = \frac{\sum A_m}{\sum A_0} \times 100 \quad (1)$$

where $\sum A_m$ and $\sum A_0$ stand for the sum of peak areas of the EOs components in the presence of the studied mixture and the corresponding reference, respectively.

And results for aromas were expressed as:

$$\text{Normalized area (\%)} = \frac{A_m}{A_0} \times 100 \quad (2)$$

where A_m and A_0 stand for the peak area of each aroma in the presence of the studied mixture and water, respectively.

2.3.1. Influence of water content in DES:water:CD mixtures on the solubilization of EOs

ChCl:U DES:water mixtures were prepared using various DES wt% ranging from 0 to 100 wt%. HP- β -CD was introduced first in the vials. Then, precise amount of the different DES:water wt% mixtures were added. 10 wt% of HP- β -CD was present in the final mixtures. *Rosmainus officinalis L.* EO (30 μ L of 0.01 g.mL⁻¹) was then added in all vials. After equilibrium, the vials were subjected to SH-GC analysis. For the other EOs (30 μ L of 0.01 g.mL⁻¹), experiments were done only with pure ChCl:U DES ChCl:U DES:water 70:30 wt%, both in the presence of 10 wt% of HP- β -CD.

2.3.2. Solubilization of various EOs and aromas in combined mixtures

Water containing or not 10 wt% HP- β -CD or 1 wt% β -CD were prepared. Similarly, ChCl:U DES:water 70:30 wt% containing or not 10 wt% HP- β -CD or 10 wt% β -CD were also formulated. Vials containing 3 mL of these mixtures were prepared. The same amount of EO

(30 μL of 0.01 $\text{g}\cdot\text{mL}^{-1}$) was added to the vials followed by equilibrium. Same procedure was done with the 21 aromas found in the EOs (using 30 μL of 0.005 $\text{g}\cdot\text{mL}^{-1}$ aromas).

2.4. Characterization of CD/aromas complexes

2.4.1. Nuclear magnetic resonance spectroscopy

All NMR experiments have been recorded on a Bruker Avance III spectrometer operating at 400 MHz for the proton nucleus, equipped with a multinuclear z-gradient BBFO probe head. In all experiments, the probe temperature was maintained at 30 °C and standard 5 mm NMR tubes with D_2O inserts were used. In order to investigate the interactions between the CDs cavity and the volatile molecule, a 2D ROESY NMR was adopted with a mixing time of 500 ms during spin-lock, using off resonance pulse program troesyph, and States-TPPI method with a 2048 K time domain in F2 and 256 experiments in F1 with 256 scans. This NMR method was followed by a complementary 2D DOSY NMR which allows tracking of the variation of the diffusion coefficients D of the involved compounds. It has been performed using the bipolar longitudinal eddy current delay (BPPLIED-Bipolar Pulsed Field Gradient Longitudinal Eddy Delay) pulse sequence. In each DOSY experiment, a series of 16 spectra with 20 K points were collected, with 16 scans. The pulse gradients have been incremented in 16 steps from 2 to 98 % of the maximum gradient strength in a linear ramp. Diffusion times (Δ) and gradient pulse durations (δ) were optimized for each experiment in order to achieve a 95 % decrease in resonance intensity at the largest gradient amplitude; typically, δ between 2.5 and 3.5 ms, Δ has been set at 125 ms. After fourier transformation, phase and baseline correction, the diffusion dimension of the 2D-DOSY spectra was processed by means of MestRenova software (version 11.0.2). The diffusion constants were calculated by Peak Heights Fit method with 128 points in diffusion dimension.

β -CD/(R)-(-)-verbenone complex was characterized by NMR. First, the determination of the diffusion coefficients (D) of DES components were determined in $\text{ChCl}:\text{U DES}:\text{D}_2\text{O}$ 70:30 wt% mixture. Then, D values of β -CD (99.8 mM), R(-)-verbenone (31.6 mM) and the mixtures of β -CD and R(-)-verbenone (99.8 and 31.6 mM, respectively, and 24.98 and 21.96 mM, respectively) in $\text{ChCl}:\text{U DES}:\text{D}_2\text{O}$ 70:30 wt% were determined.

2.4.2. Isothermal titration calorimetry

An isothermal calorimeter (VP-ITC, MicroCal Inc., USA) was used to determine the formation constant and the inclusion enthalpy of the complex at 25 °C. The experiments were

realized in water or in ChCl:U DES:water 70:30 wt%. Two types of experiments were conducted: the titration and the release experiments.

For the titration experiment, CDs and guests were dissolved in water or in ChCl:U DES:water 70:30 wt%. β -CD (10 mM) or α -CD (5 or 10 mM) is loaded in the syringe and added progressively to the (R)-(-)-verbenone (1 mM) or (1R)-(+)-camphor (0.5 mM) solutions respectively, present in the sample cell. The titration experiment for α -CD/(1R)-(+)-camphor in water was done only with 5 mM α -CD and 0.5 mM (1R)-(+)-camphor.

For the release experiment, the complex was prepared by mixing β -CD (6.67 mM) with (R)-(-)-verbenone (6.67 mM), or α -CD (2.5 or 5 mM) with (1R)-(+)-camphor (2.5 mM) in water or ChCl:U DES:water 70:30 wt%. The complex was loaded in the syringe and then added to the sample cell filled with water or with ChCl:U DES:water 70:30 wt%.

After the addition of an initial aliquot of 25 μ L, 10 aliquots of 25 μ L of the syringe solution were delivered (over 50 s for each injection) under agitation. The time interval between two consecutive injections was chosen in a way to reach the equilibrium before every injection. The resulting heat flow was recorded as a function of time. In addition, the heat of dilution (for each partner) was eliminated by subtracting the raw signal obtained for the corresponding blank titrations (only one partner in cell or syringe, the other compartment being filled with water or with ChCl:U DES:water 70:30 wt%). The peak area following each addition was obtained by integration of the resulting signal and was expressed as the heat effect per injection. Formation constants and inclusion enthalpies were determined by simultaneous nonlinear regression analysis of all binding isotherms by means of a dedicated homemade program, providing also the uncertainties (Bertaut & Landy, 2014).

2.4.3. Determination of the CD/aromas formation constants by static headspace-gas chromatography

The formation constants (k_f) of the CD/aromas complexes were determined using a SH-GC titration method developed in our laboratory for volatile organic compounds and using an algorithmic calculation (Blach et al., 2008; Decock et al., 2008). 30 μ L of aromas (0.05 g.mL⁻¹) were added to 3 mL of ChCl:U DES:water 70:30 wt% with increasing wt% of CDs (β -CD or HP- β -CD) (0, 0.1, 0.5 and 1 wt%) at 30 °C.

For the α -CD/(1R)-(+)-camphor complex, 30 μL of (1R)-(+)-camphor ($0.05 \text{ g}\cdot\text{mL}^{-1}$) were added to 3 mL of CDs aqueous solutions or CDs dissolved in DES:water 70:30 wt%. The CDs contents in the mixtures were 0, 0.1, 0.2, 0.5, 0.8, 1, 2, 5 and 10 wt%.

2.5. Determination of vapor-liquid partition coefficient of (R)-(-)-verbenone in DES:water:CD formulations

The vapor-liquid partition coefficient (K) is the ratio of the concentration of (R)-(-)-verbenone in the vapor phase to its concentration in the liquid phase, when the equilibrium is reached, expressed as (Kolb & Ettre, 2006):

$$K = \frac{C_G}{C_L} \quad (3)$$

Where C_G and C_L are the concentration of (R)-(-)-verbenone in the vapor phase and the liquid phase at equilibrium, respectively.

K of (R)-(-)-verbenone was determined in water and in ChCl:U DES:water 70:30 wt% mixture prepared in the absence or in the presence of 10 wt% HP- β -CD or β -CD at 30 °C by using the phase ratio variation (PRV) method in water and the vapor phase calibration (VPC) method in the other mixtures as reported earlier (Moura et al., 2017).

Several headspace vials were prepared containing different amounts of water to which the same amount of (R)-(-)-verbenone (10 μL of $0.005 \text{ g}\cdot\text{mL}^{-1}$) was added. The values of K were determined by the relationship between the reciprocal chromatographic peak areas and the vapor-liquid volumetric ratio (V_G/V_L , with V_G and V_L being the vapor volume and the liquid volume, respectively):

$$\frac{1}{AV_L} = \frac{1}{\alpha} \frac{V_G}{V_L} + \frac{1}{\alpha K} \quad (4)$$

where A is the peak area, α is a constant incorporating several parameters.

Using the previously determined K value in water, we calculated the concentration of (R)-(-)-verbenone in the vapor phase and determined the response coefficient R of (R)-(-)-verbenone in each vial:

$$R = \frac{\text{Area}}{C_G} \quad (5)$$

Next, the mean of the different obtained R values was calculated. This parameter will help us calculate the gaseous concentration of (R)-(-)-verbenone in the following experiments.

For the study of (R)-(-)-verbenone in ChCl:U DES:water 70:30 wt%, the VPC method was used. Different amounts of (R)-(-)-verbenone ($0.005 \text{ g}\cdot\text{mL}^{-1}$) were added to vials containing the same solvent amount (3 mL). The experimental chromatographic peak areas allowed the determination of C_G using equation (5); C_L , being calculated from the mass balance. The vapor-liquid partition coefficient of (R)-(-)-verbenone was then calculated using equation (3). The same procedure was adopted with ChCl:U DES:water 70:30 wt% in the presence of 10 wt% HP- β -CD or 10 wt% β -CD. In the presence of CDs, a higher concentration of (R)-(-)-verbenone ($0.05 \text{ g}\cdot\text{mL}^{-1}$) was used in order to obtain chromatographic areas in the same order as in water for a higher precision.

3. Results and Discussion

This study was performed to evaluate the effects of ChCl:U DES, CDs, water and their combination on the solubilization of 20 EOs and 21 aromas. Volatility studies were carried out using SH-GC where the peak areas of the volatile compounds could be determined. A decrease in the peak areas corresponds to a decrease in the volatility of the EOs or aromas, meaning an increase in their solubility. All the aromas used in this study are presented in **Table S1**, along with their relative percentage of presence in the used EOs, their octanol/water partition coefficients (logP values) as well as their solubility in water (S_0 values).

Dugoni et al. proved that upon addition of 25 wt% of water to the ChCl:U DES, water molecules tends to interact with the hydroxyl groups of the CDs through hydrogen bonding, increasing therefore the molecular rotational motion of the CDs, where the CDs experiences an aqueous-like environment capable of maintaining its encapsulation capacity (Dugoni et al., 2019).

Recently, we were also able to prove the beneficial impact on the DES solubilizing capacity when adding small amount of water. We studied the solubilization of *E. citriodora* EO in various DES:water:CD mixtures, the results demonstrated that DES:water 70:30 wt% containing 10 wt% HP- β -CD was the optimal solubilizing mixture (Nakhle et al., 2021). This suggests that the contribution of CDs requires a minimum presence of water in order to fully benefit from the inclusion induced by the hydrophobic effects. From this perspective, the presence of water will aim to obtain a compromise in terms of convenience of preparation and use of solvent, since water effectively reduces the high viscosity generally observed for DES, while improving the solubilization efficiency when using CDs (Nakhle et al., 2021). It is essential to mention that *E. citriodora* EO is majorly composed of citronellal, having high logP value of 3.53 and low S_0 value of 0.9 mM. The same experiment was performed herein with *Rosmainus officinalis* L. EO containing (R)-(+)-verbenone as a major constituent. (R)-(+)-verbenone is among the most water-soluble volatiles included in this study, with a low logP value of 2.23 and the highest S_0 value of 46.53 mM. Indeed, the influence of water addition to ChCl:U DES in the presence of 10 wt% HP- β -CD on the volatility of *Rosmainus officinalis* L. EO is presented in **Figure S1**. The total areas are normalized to the one obtained with aqueous solution of 10 wt% HP- β -CD. A relatively linear decrease of the volatility was observed by increasing the wt% of ChCl:U DES between 0 and 60 wt% of DES. An increase

of the volatility is obtained above DES:water 70:30 wt%, but without reaching the level observed in the absence of DES.

At DES wt% higher than 70 wt%, the complexation phenomenon still exists. However, relying on the results obtained in our previous study with *E. citriodora* EO containing hydrophobic constituent (citronellal) (Nakhle et al., 2021); and the results obtained herein for *Rosmainus officinalis* L. containing constituent with lower hydrophobicity ((R)-(+)-verbenone), we can hypothesize that given the lower polarity of DES compared to water, the solvation of the EO aromas by the DES lowers their affinity for the cavity of the CDs, which is observed at 80, 90 and 100 wt% DES, leading to their volatility increase. **Figure S1** shows that ChCl:U DES:water 70:30 wt% seems to be close to the optimal ratio, giving the highest solubility of both relatively water-soluble molecule like (R)-(+)-verbenone and poorly water-soluble ones like citronellal (the major component of *E. citriodora* EO) (Nakhle et al., 2021). Further, according to a previous work using randomly methylated β -CD (RAMEB):levulinic acid DES, the “water-in-DES” system was prevailed above 72 wt% (± 2 wt%) DES and below it the “DES-in-water” system was the most prominent (El Achkar et al., 2020). For this reason, the ChCl:U DES:water 70:30 wt% mixture was chosen in the following investigations, where the DES structure could be always maintained with highest solubilization capability.

3.1. β -CD/(R)-(+)-verbenone complex in DES:water mixture

The CD/aromas complexes in DES:water mixture were characterized and the first investigations were done with β -CD/(R)-(+)-verbenone in DES:water 70:30 wt% mixture. As mentioned above, (R)-(+)-verbenone was chosen because it presents the highest aqueous solubility among others (see S_0 values in **Table S1**), thus allowing clear and visible peaks in the NMR spectra as well as higher heat release/consumption in ITC experiments.

Figure 1 shows a section of the contour plot of the ROESY spectrum of R-(-)-verbenone and β -CD in ChCl:U DES:D₂O 70:30 wt% mixture. Significant correlation was observed between H5 and H6 of R-(-)-verbenone and the different protons of β -CD, most importantly with the protons being located inside the CD cavity (H3 and H5). Such correlation proved that β -CD was able to form inclusion complex with R-(-)-verbenone in this mixture. A previous study proved the randomly methylated β -CD/*trans*-anethole inclusion complex formation in pure randomly methylated β -CD/levulinic acid DES using also 2D ROESY NMR experiment (El Achkar et al., 2020b).

Generally, hydrogen atoms of CDs and guests are affected by the inclusion resulting in the displacement of their chemical shifts (δ) and diffusion coefficients (D) (Kfoury et al., 2018). For this, we followed the diffusion coefficients of R-(-)-verbenone and β -CD solubilized in ChCl:U DES:D₂O 70:30 wt% (the diffusion of each compound alone in this mixture was also determined) (**Table 1**). The presence of β -CD weakly decreased the D values of the DES components, according probably to the resulting increase of density and viscosity making the components less able to diffuse in the mixture (Nakhle et al., 2021). As we can see, the diffusion coefficient of R-(-)-verbenone decreased significantly to a value approximately equal to the value of the CDs when the latter was added. Thus, the formation of a stable inclusion complex β -CD/R-(-)-verbenone in this mixture is proven, with up to 95% of total complexation of the molecule. In order to evaluate the formation constant K_f of this complex with satisfying accuracy, another experiment was prepared in a way to obtain almost 50% of total complexation of R-(-)-verbenone in β -CD, meaning varying the host/guest concentration ratio (**Table 1**). The resulting D value permitted to evaluate the K_f value of β -CD/R-(-)-verbenone inclusion complex in ChCl:U DES:D₂O 70:30 wt%, which was 320 M⁻¹. K_f being calculated as described previously (Kfoury et al., 2016).

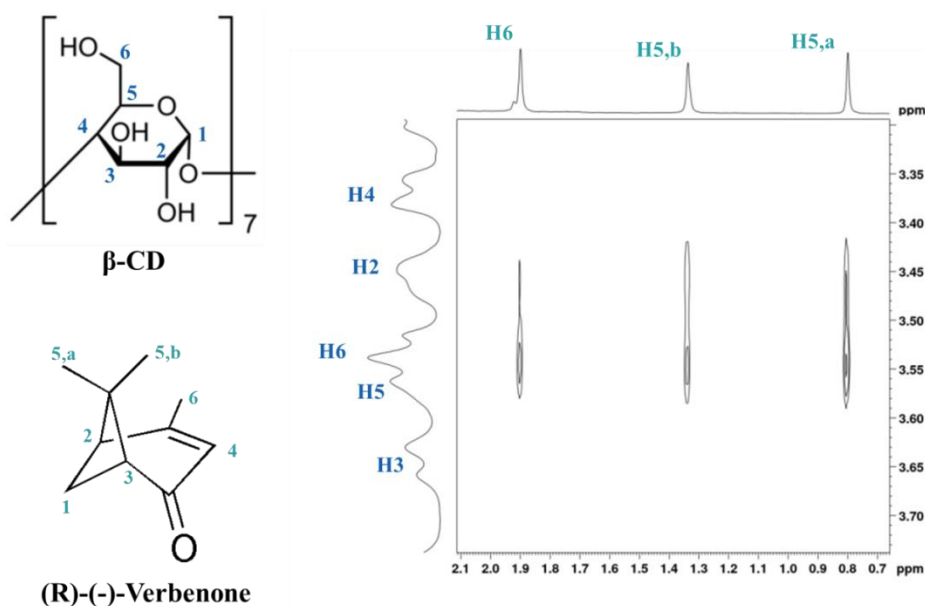

Figure 1: ROESY spectrum of β -CD/(R)-(-)-verbenone inclusion complex in ChCl:U DES:D₂O 70:30 wt% (recorded with a D₂O insert).

Table 1- Diffusion coefficients (D) of R-(-)-verbenone and β -CD in ChCl:U DES:D₂O 70:30 wt%.

D (10 ⁻⁷ m ² /s)	ChCl	U	β -CD	R-(-)-Verbenone
-	18.50	28.60	-	-
R-(-)-verbenone (31.6 mM)	17.90	29.70	-	13.90
β -CD (99.8 mM)	13.90	26.10	3.43	-
β -CD (99.8 mM) + R-(-)-verbenone (31.6 mM)	13.90	26.10	3.43	3.90
β -CD (24.98 mM) + R-(-)-verbenone (21.96 mM)	17.17	29.70	5.05	7.35

ChCl: Choline Chloride; U: Urea

On another level, it was previously shown, *via* the SH-GC experiments, that the formation constants are lower in pure ChCl:U DES compared to water (Moufawad et al., 2019).

ITC experiments were then developed to assess the formation constant of β -CD/(R)-(-)-verbenone complex and to determine the various thermodynamic parameters in water and in ChCl:U DES:water 70:30 wt%. It was previously mentioned that the release experiments were more suited to weak affinities between the guests and the CDs, while the titration procedures were more efficient for stronger complexes. Further, it was seen that coupling titration and release experiments is systematically the best approach since a high uncertainty obtained by titration in the case of problematic complexes might be reduced by this coupling strategy (Bertaut & Landy, 2014). It is worthy to mention that in this paper, ITC studies are realized for the first time in DES:water mixture. ITC results are presented in **Figure 2** for ChCl:U DES:water mixture and in **Figure S2** for water alone. In **Figure 2a**, the classical titration thermogram is presented. Each injection induces the formation of β -CD/(R)-(-)-verbenone complexes, thus releasing an amount of heat which is proportional to the binding enthalpy and to the amount of complexes formed during this addition. As the concentration of free (R)-(-)-verbenone molecules in the cell are decreasing after each injection, heat is diminishing all along the titration, since less and less complexes are formed. In **Figure 2c**, the release thermogram is presented. It implies the injection of the β -CD/(R)-(-)-verbenone complex into the solvent mixture. As each injection induced a dilution of the syringe content within the cell, the complex initially formed in the mixture partially dissociates in the cell, resulting in heat consumption and positive peaks. As the inclusion compound concentration is increasing in the cell, the dissociation is diminishing injection after injection. The fitting process was done simultaneously for titration and release experiments for the same mixture in the same excel program sheet; this is called a global analysis. The formation constant and the

inclusion enthalpy of β -CD/(R)-(-)-verbenone complex in ChCl:U DES:water 70:30 wt% were evaluated to $253 \pm 28 \text{ M}^{-1}$ and to $-3343 \pm 239 \text{ cal}$, respectively. The calculated K_f value was nearly equal to the one calculated by the NMR experiments (320 M^{-1}). The formation constant was weaker in the DES:water 70:30 wt% mixture than K_f in water, determined in this study which was of $1096 \pm 24 \text{ M}^{-1}$. A moderate decrease of the inclusion enthalpy ($-4406 \pm 54 \text{ cal}$) was also observed in water.

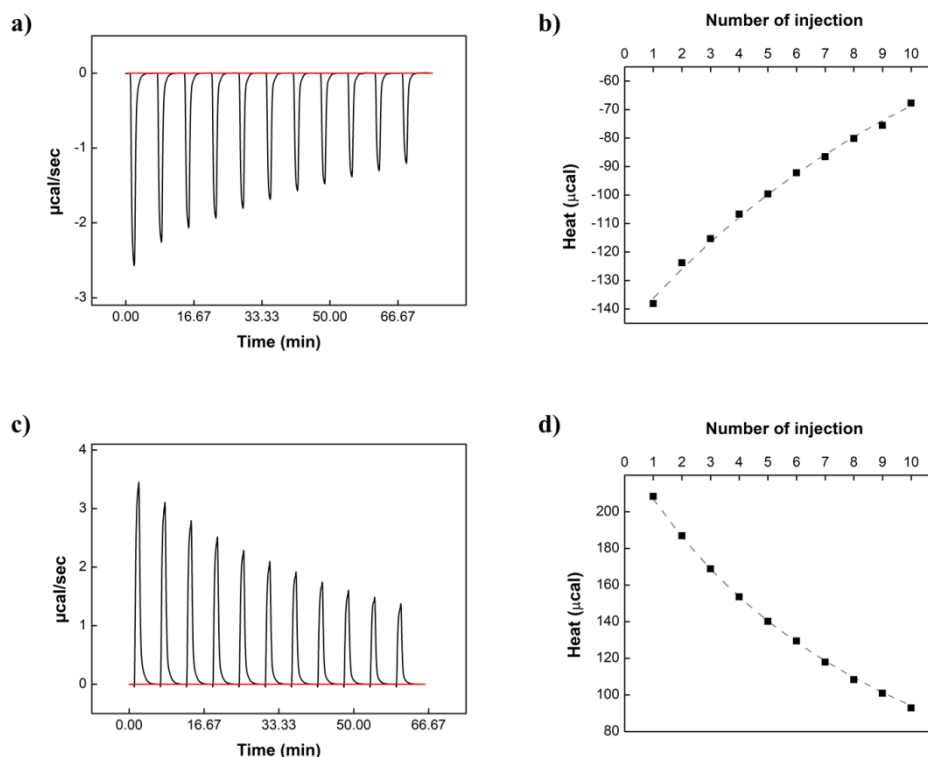

Figure 2: ITC thermograms obtained from the a) titration study and c) the release study of β -CD/R(-)-verbenone inclusion complex in ChCl:U DES:water 70:30 wt% and ITC isotherms obtained from the b) titration study and d) the release study of β -CD/R(-)-verbenone inclusion complex in ChCl:U DES:water 70:30 wt%. The dashed curves correspond to the theoretical curve.

Next, the influence of DES:water:CD formulations on the vapor-liquid partition coefficient (K) of (R)-(-)-verbenone was investigated in water and in DES:water 70:30 wt% mixture via PRV and VPC methods, respectively, at $30 \text{ }^\circ\text{C}$ by SH-GC.

The corresponding K values are presented in **Table 2**. The lower the K value, the higher is the absorption capacity of the mixture, meaning the higher is the solubilization capacity of the respective mixture. It can be seen from this Table that K value in ChCl:U DES:water 70:30 wt% was approximately in the same order as in water, which suggests that this mixture had a little impact on (R)-(-)-verbenone solubility. Besides, the addition of CDs to this mixture

decreased more the K value compared to water and to ChCl:U DES:water 70:30 wt% without CDs. This decrease is due to the higher retention of (R)-(-)-verbenone because of its complexation in CDs cavities. K value was 14 and 16-times lower in the presence of 10 wt% of HP- β -CD and 10 wt% of β -CD, respectively, compared to the absence of CDs. Similar results were previously obtained with citronellal in almost the same mixtures (Nakhle et al., 2021).

Table 2- Vapor-liquid partition coefficients (K) measured at 30 °C for R(-)-verbenone in water and other mixtures.

K	Water	ChCl:U DES:water 70:30 wt%	ChCl:U DES:water 70:30 wt% with 10 wt% HP- β -CD	ChCl:U DES:water 70:30 wt% with 10 wt% β -CD
(R)-(-)- verbenone	8.83E-03 \pm 0.44E-03	9.84E-03 \pm 2.23E-03	6.15E-04 \pm 0.40E-04	5.63E-04 \pm 1.25E-04

3.2. Solubilization of the different aromas in DES:water:CD mixtures

The solubilization of 21 aromas was done in water and in ChCl:U DES:water 70:30 wt% in the absence and in the presence of CDs (**Figure 3**). The total areas are normalized to the areas obtained in water alone. Due to the low aqueous solubility of β -CD (Torri et al., 2020), 1 wt% β -CD was prepared in aqueous solution, and showed a decrease in the volatility of all the aromas compared to water. This decrease in the volatility refers to an increase in the solubility that is related to the inclusion complex formation of the different aromas in the CDs cavities as obtained previously (Kfoury et al., 2019) and as proved above with β -CD/(R)-(-)-verbenone complex. As the derived CD, HP- β -CD, possess a higher aqueous solubility compared to the native CD, 10 wt% of HP- β -CD were prepared in water and gave a higher volatility reduction compared to aqueous solution of 1 wt% β -CD as more CDs cavities are available. Compared to water, lower volatility of aromas was obtained in ChCl:U DES:water 70:30 wt%. This decrease is due to the lower polarity of the DES:water mixture compared to water, that is translated by higher aromas solubility in DES:water mixture. However, this decrease is less pronounced than the decrease induced by the addition of CDs to water. Further, this suggests that the inclusion phenomena influence more on the aromas' volatility than the polarity of the mixture.

Since a higher amount of native β -CD could be dissolved in ChCl:U DES:water 70:30 wt% than in water (McCune et al., 2017), 10 wt% of β -CD were dissolved in such mixture. For a similar CD content (10 wt%), the use of water with HP- β -CD or ChCl:U DES:water 70:30

wt% with β -CD or HP- β -CD led to similar aromas volatilities. Accordingly, one can infer that high CD/aroma ratios tend to lower the influence of both mixture polarity and CDs chemical modification on the aromas solubilization.

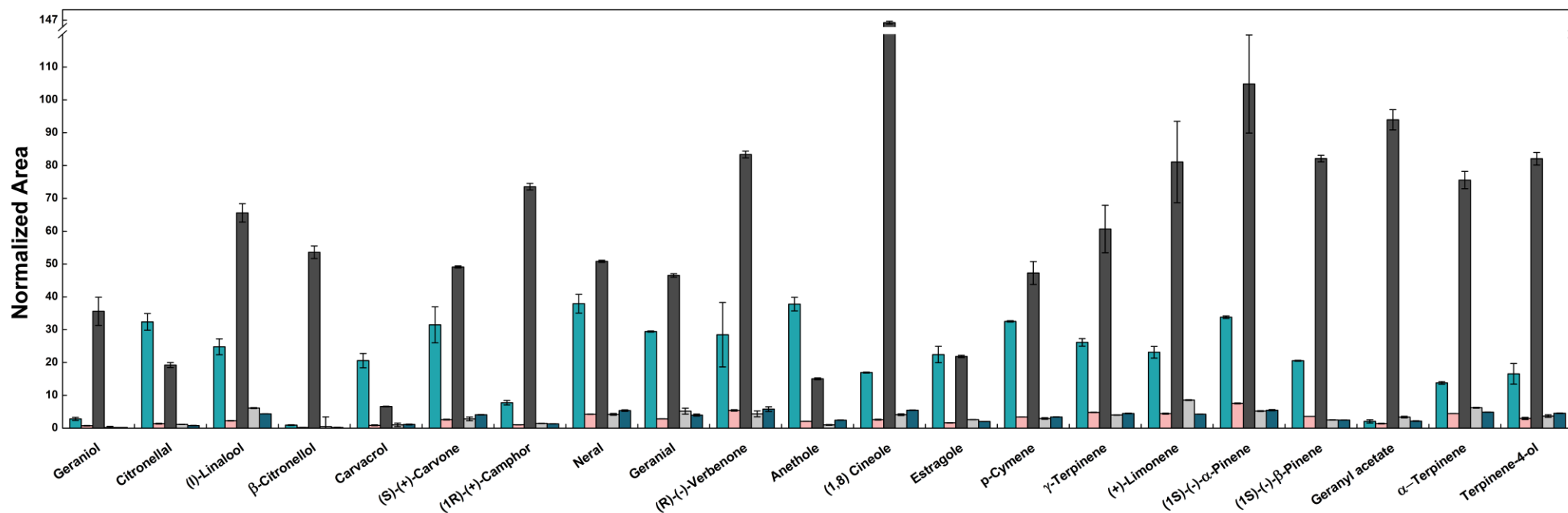

Figure 3: Normalized areas of the major aromas, obtained from SH-GC analysis, in five different formulations, with ■ water with 1 wt% β-CD, ■ water with 10 wt% HP-β-CD, ■ ChCl:U DES:water 70:30 wt%, ■ ChCl:U DES:water 70:30 wt% with 10 wt% β-CD and ■ ChCl:U DES:water 70:30 wt% with 10 wt% HP-β-CD, at 30 °C. The water was the reference solvent.

As NMR and ITC studies demonstrated the occurrence of inclusion phenomena in DES:water mixture, the formation constants of various CD/aromas were assessed by SH-GC. The resulting K_f for the studied β -CD/aromas and HP- β -CD/aromas complexes determined in ChCl:U DES:water 70:30 wt% are compared to the values obtained in water in literature studies (**Table 3**). Lower K_f values were obtained in the DES:water mixture compared to water. This decrease is mostly due to the lower polarity of the DES compared to water, inducing the solubilization of the aromas in the solvent rather than its encapsulation in the CDs cavities. Similar tendencies were observed in a previous study where the authors showed a decrease of the CD/methyl orange formation constant in the pure ChCl:U DES compared to the K_f value determined in water (Moufawad et al., 2019). The calculated K_f value for β -CD/(R)-(-)-verbenone complex in ChCl:U DES:water mixture (177 M^{-1}) was nearly equal to the K_f value calculated by the NMR experiments (320 M^{-1}) and ITC experiments (253 M^{-1}).

Table 3- Formation constants (M^{-1}) values of β -CD/components and HP- β -CD/components inclusion complexes in ChCl:U DES:water 70:30 wt% obtained at $30 \text{ }^\circ\text{C}$, and in water obtained from literature.

Components	ChCl:U DES:water 70:30 wt%		Water	
	β -CD	HP- β -CD	β -CD	HP- β -CD
<i>trans</i> - Anethole	39	67	630 ^c	1042 ^c
(1R)-(+)-Camphor	1120	837	2058 ^c	1280 ^c
Carvacrol	63	165	2620 ^b	2154 ^b
(S)-(+)-Carvone	110	148	180 ^b	-
(1,8) Cineole	361	329	615 ^b	334 ^b
Citronellal	111	223	1523 ^a	815 ^a
β -Citronellol	716	1497	3141 ^b	2578 ^b
p-Cymene	116	167	2525 ^a	2230 ^a
Estragole	46	120	987 ^d	1508 ^d
Geranial	61	50	-	1560 ^b
Geraniol	313	635	528 ^b	712 ^b
Geranyl acetate	689	794	-	-
(+)-Limonene	244	478	2605 ^a	3076 ^a
Linalool	176	196	1058 ^a	675 ^a
Neral	75	86	-	1560 ^b
(1S)-(-)- α -Pinene	257	267	2540 ^a	1361 ^a
(1S)-(-)- β -Pinene	394	551	4646 ^a	1742 ^a
α -Terpinene	102	218	-	-
γ -Terpinene	155	360	1640 ^a	1554 ^a
(-)-Terpinene-4-ol	314	385	-	-
(R)-(-)-Verbenone	177	229	-	-

^aKfoury et al., 2015a; ^bKfoury et al., 2018; ^cCiobanu et al., 2013; ^dKfoury et al., 2015b.

Moreover, the complexation curve variation of all the CD/aromas complexes in DES:water 70:30 wt% mixture in this study were in agreement with a 1/1 inclusion stoichiometry. As it is known that native α -CD forms predominantly a 2/1 inclusion stoichiometry with (1R)-(+)-camphor in water (Dodziuk et al., 1999, 2003; Bernatowicz et al., 2006), SH-GC experiments were done with this system in DES:water mixture. Interestingly, the volatility studies of (1R)-(+)-camphor in water and in ChCl:U DES:water 70:30 wt% with α -CD, presented in **Figure S3**, showed similar results. The variation was in agreement with a CD/guest 2/1 (or 2/1 and 1/1) inclusion complexes in water and in DES:water 70:30 wt%, with formation constants values of $91045 \pm 12403 \text{ M}^{-2}$ and $5718 \pm 311 \text{ M}^{-2}$, respectively.

ITC experiments were also done for the α -CD/(1R)-(+)-camphor in ChCl:U DES:water 70:30 wt%. According to the literature, it was difficult to study the cooperativity of 1/1 and 2/1 complexes formation. Detailed analysis revealed that the partitioning cannot be carried out unequivocally (2/1 being the major complex found) (Dodziuk et al., 1999, 2003; Bernatowicz et al., 2006). Therefore, and for more simplicity, our analysis were based on the hypothesis of an exclusive 2/1 α -CD/(1R)-(+)-camphor complex.

The results of the titration and release experiments are presented in **Figure 4** and **Figure S4**, for ChCl:U DES:water mixture and water, respectively. Interestingly, analogous isotherms shapes were obtained in water and ChCl:U DES:water 70:30 wt%, thus showing that similar stoichiometries were involved in both media. According to a model implementing exclusively 2/1 complexes, the global analysis of the titration-release coupling approach lead to α -CD/(1R)-(+)-camphor 2/1 formation constants equal to $840623 \pm 8028 \text{ M}^{-2}$ and $13770 \pm 1185 \text{ M}^{-2}$, in water and ChCl:U DES:water 70:30 wt%, respectively. The formation constant in water was close to that obtained in the literature of 515000 M^{-2} (Dodziuk et al., 2003). Even if a decrease of affinity is again observed when moving from water to ChCl:U DES:water as previously observed by SH-GC experiments, this result constitutes the first example of a 2/1 CD complexation in mixture containing DES.

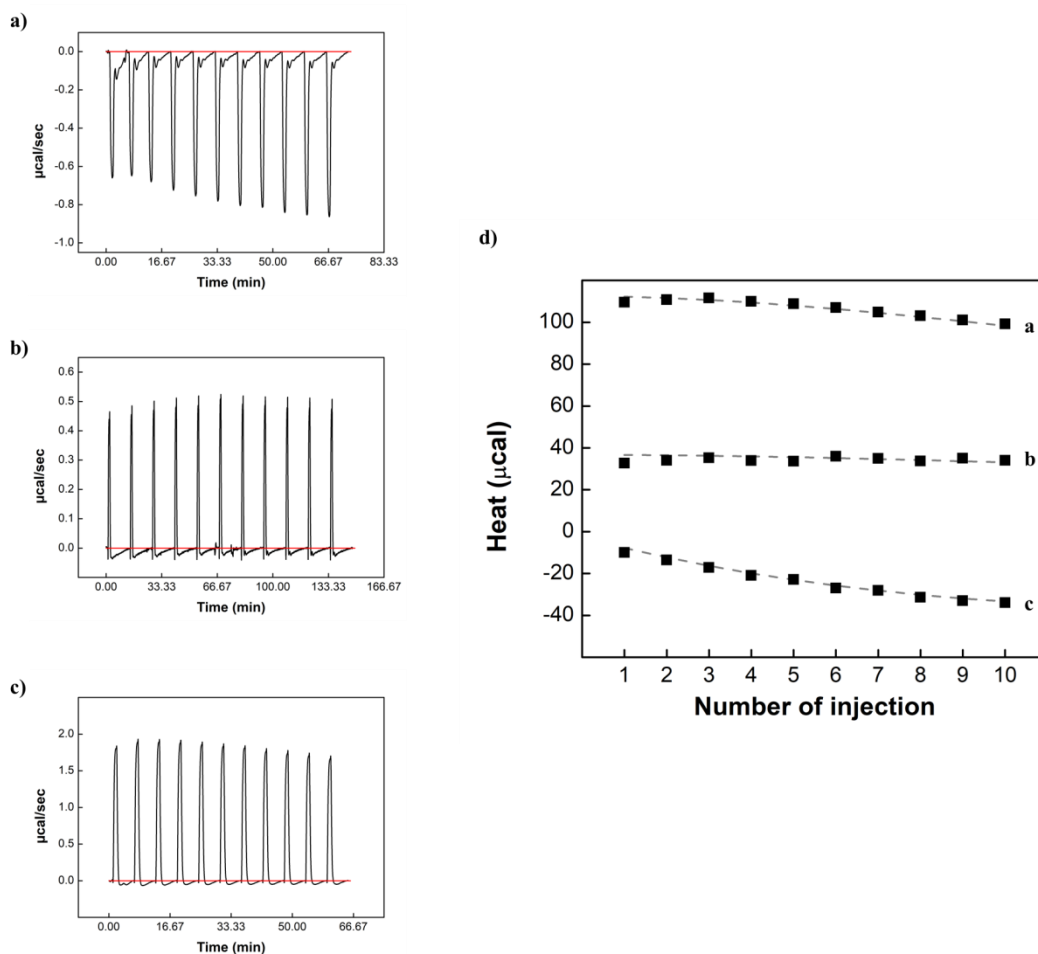

Figure 4: ITC thermograms obtained from the a) titration study, b) and c) the release studies of α -CD/(1R)-(+)-camphor inclusion complex in ChCl:U DES:water 70:30 wt% along with d) their ITC isotherms. The dashed curves correspond to the theoretical curve.

3.3. Solubilization of the different EOs

Since positive influence of adding water to DES on the solubility of both *Rosmainus officinalis L.* and *E. citriodora* EOs in DES:water:CD mixtures was previously proved, the solubility of 20 EOs was determined in pure DES and in ChCl:U DES:water 70:30 wt%, both containing 10 wt% HP- β -CD in order to confirm such tendency on the EOs solubility (**Figure 5**). In this Figure, the areas are normalized to the area obtained with pure ChCl:U DES in the presence of 10 wt% HP- β -CD. It can be noticed that all the EOs exhibited a weaker volatility in ChCl:U DES:water 70:30 wt% compared to pure DES (area normalized to 100%), thus confirming the positive effect of the presence of 30 wt% water when CDs is employed, as previously observed with *Rosmainus officinalis L.* EO.

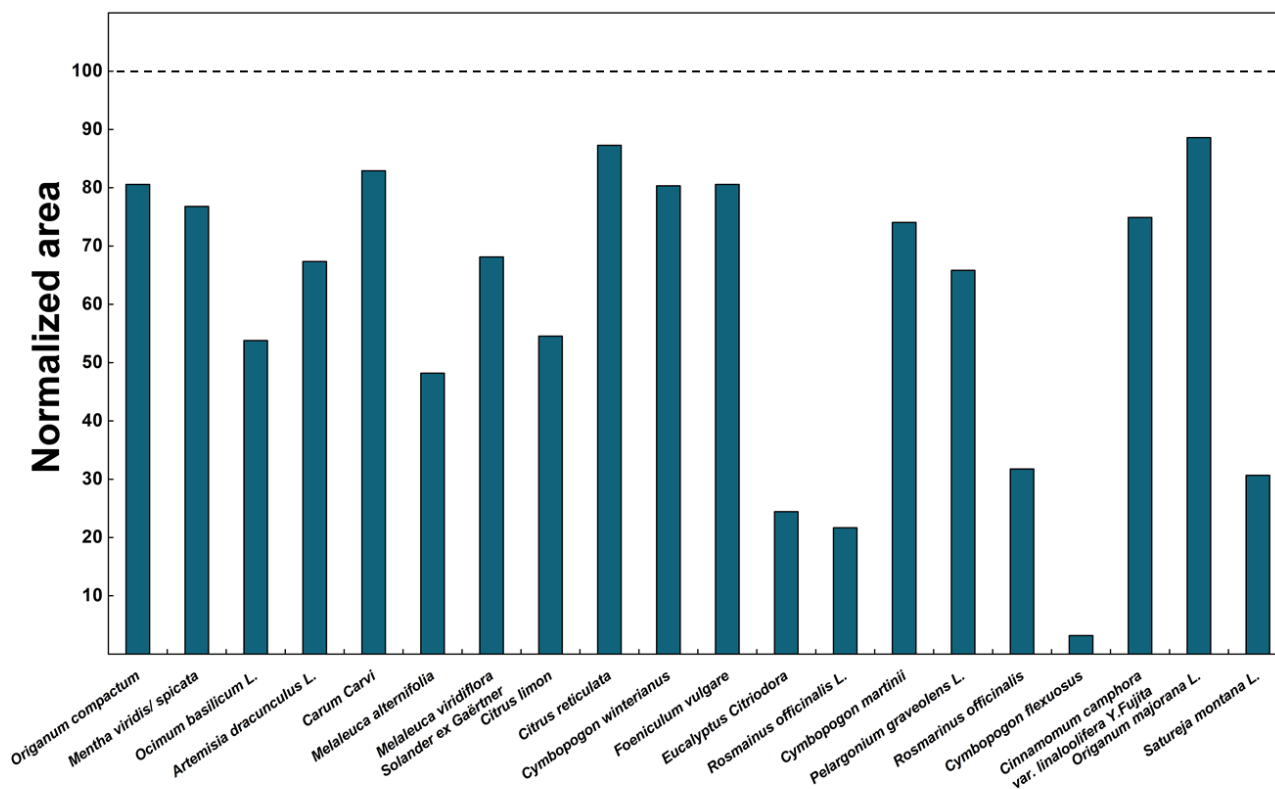

Figure 5: Normalized areas of EOs, obtained from SH-GC analysis, in ChCl:U DES:water 70:30 wt% with 10 wt% HP- β -CD, at 30 °C. The pure ChCl:U DES with the presence of 10 wt% HP- β -CD was the reference mixture.

Next, volatility studies of the 20 EOs were done in water and in ChCl:U DES:water 70:30 wt% in the absence or the presence of CDs (**Figure 6**). The total areas are normalized to the areas obtained in water alone. Similar tendencies, as observed in all the mixtures with the aromas, are observed herein. As expected from the previous results, the use of high CDs content leads to negligible volatility for each EO, whatever the solvent used (water or DES:water 70:30 wt%) and whatever the CD used (β -CD or HP- β -CD). The volatility of the EOs depended on the volatility of the aromas found in each EO. Meaning that, it should be kept in mind, the ability of molecules to form hydrogen bonds with the DES structure, this ability influences highly on the solubility of the molecules. The higher their ability to form hydrogen bonds, the higher is their solubility, which was obtained for example with glucose solubilized in ChCl:ethylene glycol DES (Häkkinen et al., 2019). In addition, it should be noted that the encapsulation of guests in the CD cavity depends not only on the hydrophobicity of the molecules (LogP values), but also on their molecular volume that should fit the CD cavity (Kfoury et al., 2015). Normally, hydrocarbons present high CD/guest formation complex (K_f) in comparison to other classes of organic molecules in water (Kfoury

et al., 2015a). When plotting the aromas areas obtained in ChCl:U DES:water 70:30 wt% as function of their areas obtained in water, an interesting correlation was obtained (**Figure S5**). From this correlation, it can be concluded that the most entrapped aroma in water was also the same in ChCl:U DES:water 70:30 wt%. In the presence of CDs, complexation phenomena seems to be similar in ChCl:U DES:water 70:30 wt% as in water, even if lower affinities were obtained in DES:water mixture compared to water.

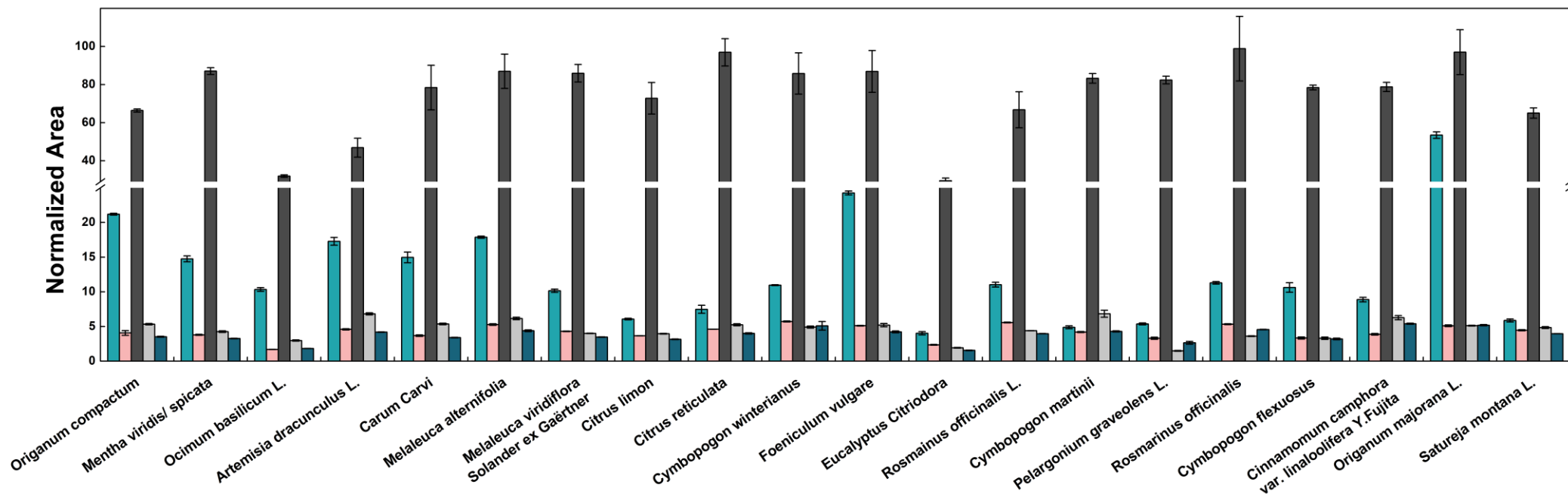

Figure 6: Normalized areas of EOs, obtained from SH-GC analysis, in five different formulations, with ■ water with 1 wt% β -CD, ■ water with 10 wt% HP- β -CD, ■ ChCl:U DES:water 70:30 wt%, ■ ChCl:U DES:water 70:30 wt% with 10 wt% β -CD and ■ ChCl:U DES:water 70:30 wt% with 10 wt% HP- β -CD, at 30 °C. Water was the reference solvent.

4. Conclusion

In this paper, compared to water, DES and aqueous solutions of CDs tested separately, the use of CDs in ChCl:U DES:water 70:30 wt% mixture proved higher solubilization ability of 20 EOs and 21 aromas, the latter characterized by different polarities. The solubilization process was mainly influenced by the complexation phenomenon that occurs to be controlled by the same factors in water as in DES:water 70:30 wt%. On one hand, the formation of β -CD/(R)-(-)-verbenone inclusion complex in DES:water mixture was proved *via* NMR and ITC experiments. The vapor-liquid partition coefficients of (R)-(-)-verbenone in ChCl:U DES:water 70:30 wt% in the presence of 10 wt% HP- β -CD or β -CD were lower than in the absence of CDs. Notably, the formation constants of 21 CD/aromas inclusion complexes were determined in ChCl:U DES:water 70:30 wt% and were lower compared to water, proving the formation of 1/1 complexes. On the other hand, the SH-GC experimental data obtained from the complexation between (1R)-(+)-camphor and α -CD followed the theoretical fitted curve for combined CD/guest 2/1 and 1/1 inclusion complexes, which was proved for the first time in systems containing DES. With the help of ITC experiments done with α -CD/(1R)-(+)-camphor, the formation constant in ChCl:U DES:water was determined and was lower compared to the one obtained in water. These results will certainly contribute to further exploration of DES:water:CD combinations in different domains.

Acknowledgments

The authors would like to acknowledge the National Council for Scientific Research of Lebanon (CNRS-L) and Université du Littoral Côte d'Opale (ULCO) for granting a doctoral fellowship to Lamia Nakhle.

References

- Abbott, A. P., Boothby, D., Capper, G., Davies, D. L., & Rasheed, R. K. (2004). Deep Eutectic Solvents Formed between Choline Chloride and Carboxylic Acids: Versatile Alternatives to Ionic Liquids. *Journal of the American Chemical Society*, *126*(29), 9142–9147. <https://doi.org/10.1021/ja048266j>
- Abbott, A. P., Capper, G., Davies, D. L., Rasheed, R. K., & Tambyrajah, V. (2003). Novel solvent properties of choline chloride/urea mixtures. Electronic supplementary information (ESI) available: Spectroscopic data. See <http://www.rsc.org/suppdata/cc/b2/b210714g/>. *Chemical Communications*, *1*, 70–71. <https://doi.org/10.1039/b210714g>
- Athanasiadis, V., Grigorakis, S., Lalas, S., & Makris, D. P. (2018). Methyl β -cyclodextrin as a booster for the extraction of *Olea europaea* leaf polyphenols with a bio-based deep eutectic solvent. *Biomass Conversion and Biorefinery*, *8*(2), 345–355. <https://doi.org/10.1007/s13399-017-0283-5>
- Bernatowicz, P., Nowakowski, M., Dodziuk, H., & Ejchart, A. (2006). Determination of association constants at moderately fast chemical exchange: Complexation of camphor enantiomers by α -cyclodextrin. *Journal of Magnetic Resonance*, *181*(2), 304–309. <https://doi.org/10.1016/j.jmr.2006.06.001>
- Bertaut, E., & Landy, D. (2014). Improving ITC studies of cyclodextrin inclusion compounds by global analysis of conventional and non-conventional experiments. *Beilstein Journal of Organic Chemistry*, *10*, 2630–2641. <https://doi.org/10.3762/bjoc.10.275>
- Ciobanu, A., Landy, D., & Fourmentin, S. (2013). Complexation efficiency of cyclodextrins for volatile flavor compounds. *Food Research International*, *53*(1), 110–114. <https://doi.org/10.1016/j.foodres.2013.03.048>
- Crini, G., Fourmentin, S., Fenyvesi, É., Torri, G., Fourmentin, M., & Morin-Crini, N. (2018). Cyclodextrins, from molecules to applications. *Environmental Chemistry Letters*, *16*(4), 1361–1375. <https://doi.org/10.1007/s10311-018-0763-2>
- Dai, Y., van Spronsen, J., Witkamp, G.-J., Verpoorte, R., & Choi, Y. H. (2013). Natural deep eutectic solvents as new potential media for green technology. *Analytica Chimica Acta*, *766*, 61–68. <https://doi.org/10.1016/j.aca.2012.12.019>
- Decock, G., Landy, D., Surpateanu, G., & Fourmentin, S. (2008). Study of the retention of aroma components by cyclodextrins by static headspace gas chromatography. *Journal*

- of Inclusion Phenomena and Macrocyclic Chemistry*, 62(3–4), 297–302. <https://doi.org/10.1007/s10847-008-9471-z>
- Di Pietro, M. E., Colombo Dugoni, G., Ferro, M., Mannu, A., Castiglione, F., Costa Gomes, M., Fourmentin, S., & Mele, A. (2019). Do Cyclodextrins Encapsulate Volatiles in Deep Eutectic Systems? *ACS Sustainable Chemistry & Engineering*, 7(20), 17397–17405. <https://doi.org/10.1021/acssuschemeng.9b04526>
- Dodziuk, H., Ejchart, A., Lukin, O., & Vysotsky, M. O. (1999). ¹H and ¹³C NMR and Molecular Dynamics Study of Chiral Recognition of Camphor Enantiomers by α -Cyclodextrin. *The Journal of Organic Chemistry*, 64(5), 1503–1507. <https://doi.org/10.1021/jo981937+>
- Dodziuk, H., Nowinski, K. S., Kozminski, W., & Dolgonos, G. (2003). On the impossibility of determination of stepwise binding constants for the 1 : 2 complex of (+)-camphor with α -cyclodextrin. *Organic & Biomolecular Chemistry*, 1(3), 581–584. <https://doi.org/10.1039/b209272g>
- Dugoni, G. C., Di Pietro, M. E., Ferro, M., Castiglione, F., Ruellan, S., Moufawad, T., Moura, L., Costa Gomes, M. F., Fourmentin, S., & Mele, A. (2019). Effect of Water on Deep Eutectic Solvent/ β -Cyclodextrin Systems. *ACS Sustainable Chemistry & Engineering*, 7(7), 7277–7285. <https://doi.org/10.1021/acssuschemeng.9b00315>
- El Achkar, T., Fourmentin, S., & Greige-Gerges, H. (2019). Deep eutectic solvents: An overview on their interactions with water and biochemical compounds. *Journal of Molecular Liquids*, 288, 111028. <https://doi.org/10.1016/j.molliq.2019.111028>
- El Achkar, T., Moufawad, T., Ruellan, S., Landy, D., Greige-Gerges, H., & Fourmentin, S. (2020a). Cyclodextrins: From solute to solvent. *Chemical Communications*, 56(23), 3385–3388. <https://doi.org/10.1039/D0CC00460J>
- El Achkar, T., Moufawad, T., Ruellan, S., Landy, D., Greige-Gerges, H., & Fourmentin, S. (2020b). Cyclodextrins: From solute to solvent. *Chemical Communications*, 56(23), 3385–3388. <https://doi.org/10.1039/D0CC00460J>
- El Achkar, T., Moura, L., Moufawad, T., Ruellan, S., Panda, S., Longuemart, S., Legrand, F.-X., Costa Gomes, M., Landy, D., Greige-Gerges, H., & Fourmentin, S. (2020). New generation of supramolecular mixtures: Characterization and solubilization studies. *International Journal of Pharmaceutics*, 119443. <https://doi.org/10.1016/j.ijpharm.2020.119443>

- Joshi, D. R., & Adhikari, N. (2019). An Overview on Common Organic Solvents and Their Toxicity. *Journal of Pharmaceutical Research International*, 1–18. <https://doi.org/10.9734/jpri/2019/v28i330203>
- Kfoury, M., Auezova, L., Greige-Gerges, H., & Fourmentin, S. (2015). Promising applications of cyclodextrins in food: Improvement of essential oils retention, controlled release and antiradical activity. *Carbohydrate Polymers*, 131, 264–272. <https://doi.org/10.1016/j.carbpol.2015.06.014>
- Kfoury, M., Auezova, L., Greige-Gerges, H., & Fourmentin, S. (2019). Encapsulation in cyclodextrins to widen the applications of essential oils. *Environmental Chemistry Letters*, 17(1), 129–143. <https://doi.org/10.1007/s10311-018-0783-y>
- Kfoury, M., Auezova, L., Ruellan, S., Greige-Gerges, H., & Fourmentin, S. (2015). Complexation of estragole as pure compound and as main component of basil and tarragon essential oils with cyclodextrins. *Carbohydrate Polymers*, 118, 156–164. <https://doi.org/10.1016/j.carbpol.2014.10.073>
- Kfoury, M., Landy, D., & Fourmentin, S. (2018). Characterization of Cyclodextrin/Volatile Inclusion Complexes: A Review. *Molecules*, 23(5), 1204. <https://doi.org/10.3390/molecules23051204>
- Kfoury, M., Landy, D., Ruellan, S., Auezova, L., Greige-Gerges, H., & Fourmentin, S. (2016). Determination of formation constants and structural characterization of cyclodextrin inclusion complexes with two phenolic isomers: Carvacrol and thymol. *Beilstein Journal of Organic Chemistry*, 12, 29–42. <https://doi.org/10.3762/bjoc.12.5>
- Kolb, B., & Ettre, L. S. (2006). *Static headspace-gas chromatography: Theory and practice* (2nd ed). Wiley.
- Loftsson, T., & Brewster, M. E. (2012). Cyclodextrins as Functional Excipients: Methods to Enhance Complexation Efficiency. *Journal of Pharmaceutical Sciences*, 101(9), 3019–3032. <https://doi.org/10.1002/jps.23077>
- Lores, H., Romero, V., Costas, I., Bendicho, C., & Lavilla, I. (2017). Natural deep eutectic solvents in combination with ultrasonic energy as a green approach for solubilisation of proteins: Application to gluten determination by immunoassay. *Talanta*, 162, 453–459. <https://doi.org/10.1016/j.talanta.2016.10.078>
- Martins, M. A. R., Pinho, S. P., & Coutinho, J. A. P. (2019). Insights into the Nature of Eutectic and Deep Eutectic Mixtures. *Journal of Solution Chemistry*, 48(7), 962–982. <https://doi.org/10.1007/s10953-018-0793-1>

- McCune, J. A., Kunz, S., Olesińska, M., & Scherman, O. A. (2017). DESolution of CD and CB Macrocycles. *Chemistry - A European Journal*, 23(36), 8601–8604. <https://doi.org/10.1002/chem.201701275>
- Moufawad, T., Moura, L., Ferreira, M., Bricout, H., Tilloy, S., Monflier, E., Costa Gomes, M., Landy, D., & Fourmentin, S. (2019). First Evidence of Cyclodextrin Inclusion Complexes in a Deep Eutectic Solvent. *ACS Sustainable Chemistry & Engineering*, 7(6), 6345–6351. <https://doi.org/10.1021/acssuschemeng.9b00044>
- Moura, L., Moufawad, T., Ferreira, M., Bricout, H., Tilloy, S., Monflier, E., Costa Gomes, M. F., Landy, D., & Fourmentin, S. (2017). Deep eutectic solvents as green absorbents of volatile organic pollutants. *Environmental Chemistry Letters*, 15(4), 747–753. <https://doi.org/10.1007/s10311-017-0654-y>
- Nakhle, L., Kfoury, M., Greige-Gerges, H., & Fourmentin, S. (2020). Effect of dimethylsulfoxide, ethanol, α - and β -cyclodextrins and their association on the solubility of natural bioactive compounds. *Journal of Molecular Liquids*, 310, 113156. <https://doi.org/10.1016/j.molliq.2020.113156>
- Nakhle, L., Kfoury, M., Mallard, I., Landy, D., & Greige-Gerges, H. (2021). Microextraction of bioactive compounds using deep eutectic solvents: A review. *Environmental Chemistry Letters*. <https://doi.org/10.1007/s10311-021-01255-2>
- Nakhle, L., Kfoury, M., Mallard, I., Greige-Gerges, H & Landy, D. (2021). Choline chloride based- deep eutectic solvents:water:cyclodextrins mixtures for the entrapment and the solubilization of volatile molecules: application to *Eucalyptus citriodora* essential oil and citronellal.
- Torri, G., Naggi, A., & Crini, G. (2020). Professor Casu and Cyclodextrins. In G. Crini, S. Fourmentin, & E. Lichtfouse (Eds.), *The History of Cyclodextrins* (Vol. 52, pp. 157–179). Springer International Publishing. https://doi.org/10.1007/978-3-030-49308-0_3

Supplementary data for

Solubilization of a plethora of essential oils and aromas in choline chloride:urea deep eutectic solvent:cyclodextrins:water mixtures

Lamia Nakhle^{a,b}, Steven Ruellan^a, Miriana Kfoury^{a,b,*}, Hélène Greige-Gerges^b, David Landy^a

^a *Unité de Chimie Environnementale et Interactions sur le Vivant (UCEIV, UR 4492), SFR Condorcet FR CNRS 3417, Université du Littoral Côte d'Opale (ULCO), 145 Av. M. Schumann, F-59140 Dunkerque, France*

^b *Bioactive Molecules Research Laboratory, Faculty of Sciences, Lebanese University, 90656 Jdeidet el-Metn, Lebanon*

* Email of the corresponding author: miriana.kfoury@univ-littoral.fr

Table S1- Chemical structures of the studied aromas, their LogP, S₀ and relative percentage in the studied EOs.

Aromas*	Hydrocarbons						Alcohols				Aldehydes			Ketones			Oxide	Ester	Phenol	Ethers	
	(+)-Limonene	(1S)-(-)- α -Pinene	(1S)-(-)- β -Pinene	p-Cymene	α -Terpinene	γ -Terpinene	β -Citronellol	Geraniol	(D)-Linalool	(-)-Terpinene-4-ol	Citronellal	Neral	Geranial	(R)-(-)-Verbenone	(S)-(+)-Carvone	(1R)-(+)-Camphor	(1,8) Cineole	Geranyl acetate	Carvacrol	trans-Anethole	Estragole
LogP^a	4.57	4.42	4.49	4.10	4.25	4.50	3.91	3.56	2.97	3.26	3.53	2.76	2.76	2.23	1.27	2.38	2.74	4.04	3.49	3.11	3.47
S₀ (mM)	0.09 ^b	0.02 ^c	0.23 ^b	0.38 ^d	0.10 ^b	0.06 ^c	10.41 ^d	7.72 ^d	18.45 ^d	8.82 ^b	0.90 ^e	3.80 ^e	3.80 ^e	46.53 ^b	10.20 ^e	3.61 ^b	2.15 ^b	0.09 ^b	8.60 ^d	0.22 ^f	0.32 ^e
<i>Mentha viridis/spicata</i>	19.95	-	-	-	-	-	-	-	-	-	-	-	-	61.82	-	-	-	-	-	-	-
<i>Citrus reticulata</i>	68.85	2.20	1.60	-	-	19.42	-	-	0.15	-	-	-	-	-	-	-	-	-	-	-	-
<i>Carum carvi</i>	19.71	0.01	-	-	-	-	-	-	-	-	-	-	-	79.72	-	-	-	-	-	-	-
<i>Citrus limon</i>	66.44	1.87	12.16	-	-	8.93	-	-	-	-	-	1.49	-	-	-	-	-	-	-	-	-
<i>Rosmarinus officinalis</i>	2.19	10.37	9.01	0.74	-	1.28	-	-	0.72	-	-	-	-	-	8.83	47.05	-	-	-	-	-
<i>Rosmarinus officinalis L.</i>	4.08	20.09	1.84	1.06	-	1.31	-	-	1.52	-	-	-	10.47	-	14.48	8.16	-	-	-	-	-
<i>Satureja montana L.</i>	-	-	-	11.28	1.74	11.58	-	-	-	-	-	-	-	-	-	-	-	-	52.05	-	-
<i>Melaleuca alternifolia</i>	1.15	2.42	-	2.02	10.53	21.49	-	-	-	41.51	-	-	-	-	-	-	3.99	-	-	-	-
<i>Origanum compactum</i>	-	-	-	5.19	1.72	14.60	-	-	1.08	-	-	-	-	-	-	-	-	-	61.40	-	-
<i>Origanum majorana L.</i>	1.09	-	-	2.71	5.97	11.76	-	-	2.11	13.15	-	-	-	-	-	-	-	-	13.72	-	-
<i>Pelargonium graveolens</i>	-	-	-	-	-	-	34.19	13.11	4.63	-	-	-	-	-	-	-	-	-	-	-	-

II. Chapitre 7: Application à la solubilisation d'une variété d'huiles essentielles et d'arômes

<i>L'Hér.</i>																						
<i>Cymbopogon winterianus</i>	3.24	-	-	-	-	-	10.59	21.81	-	-	-	-	-	-	-	-	-	-	2.82	-	-	-
<i>Melaleuca viridiflora Solander ex Gaertner</i>	7.69	8.65	2.33	-	-	1.86	-	-	-	-	-	-	-	-	-	-	-	57.22	-	-	-	-
<i>Cymbopogon martinii</i>	0.18	-	-	-	-	-	-	80.85	1.88	-	-	0.23	0.46	-	-	-	-	-	11.22	-	-	-
<i>Eucalyptus citriodora</i>	0.45	1.32	1.04	0.83	-	-	4.84	0.09	0.29	-	74.77	-	-	-	-	-	-	0.38	-	-	-	-
<i>Cymbopogon flexuosus</i>	0.29	-	-	-	-	-	-	5.88	1.21	-	-	32.06	41.42	-	-	-	-	-	-	-	-	-
<i>Cinnamomum camphora var. linaloolifera Y.Fujita</i>	-	-	-	-	-	-	-	-	99.25	-	-	-	-	-	-	-	-	-	-	-	-	-
<i>Ocimum basilicum L.</i>	0.05	-	-	-	-	-	-	0.05	18.12	-	-	0.50	0.50	-	-	-	-	0.14	-	-	-	75.92
<i>Artemisia dracunculus L.</i>	4.12	-	-	-	-	-	-	-	-	-	-	-	-	-	-	-	-	-	-	-	-	79.22
<i>Foeniculum vulgare</i>	-	-	-	-	-	-	-	-	-	-	-	-	-	-	-	-	-	-	-	-	75.30	3.10

^aLogP values are provided by 'PubChem Compound' database from 'National Center for Biotechnology Information' (NCBI); ^bWeidenhamer et al., 1993; ^cLi et al., 1998; ^dMartins et al., 2017; ^eAjisaka et al., 2000; ^fNakhle et al., 2020;*

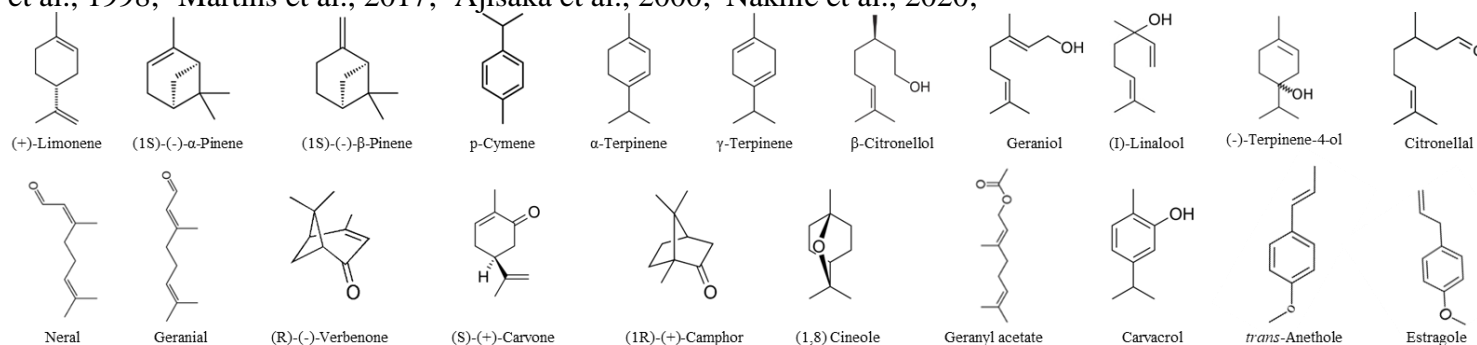

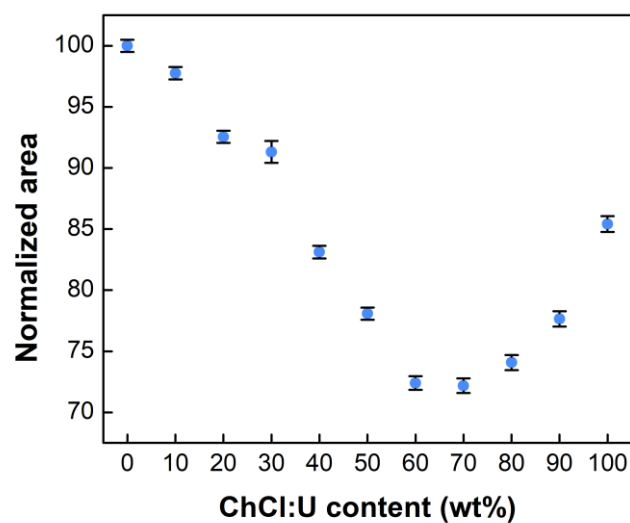

Figure S1: Normalized area of *Rosmainus officinalis* L. EO, obtained from SH-GC analysis, as a function of the ChCl:U DES content (wt%) in the presence of 10 wt% of HP- β -CD, at 30 °C. Herein, the water containing 10 wt% HP- β -CD is the reference solvent.

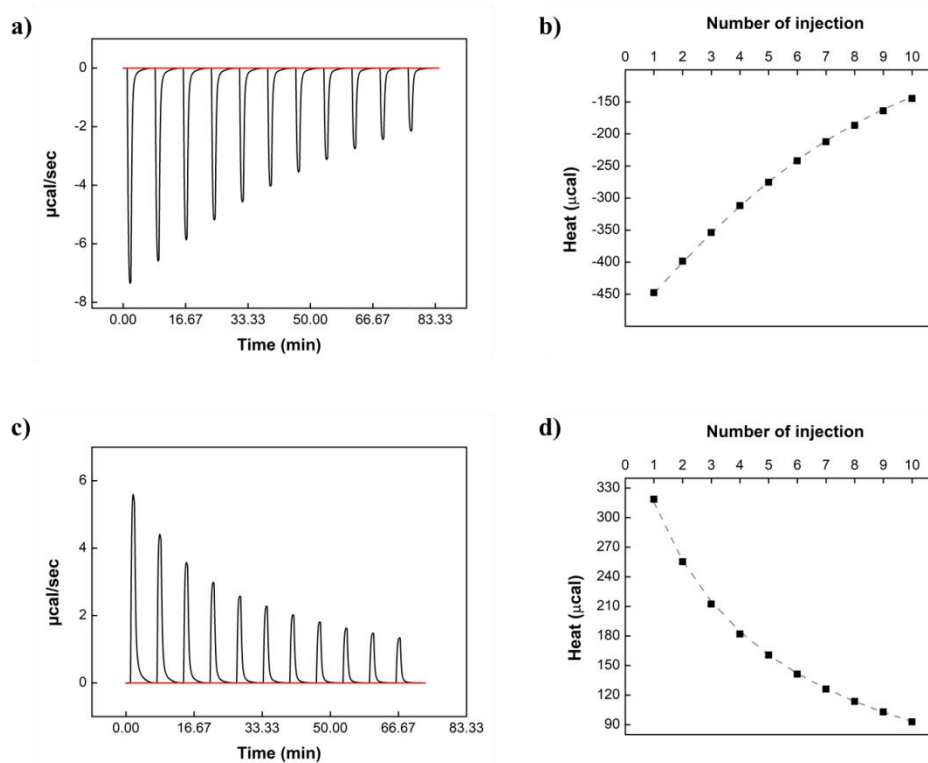

Figure S2: ITC thermograms obtained from the a) titration study and c) the release study of β -CD/R(-)-verbenone inclusion complex in water and ITC isotherms obtained from the b) titration study and d) the release study of β -CD/R(-)-verbenone inclusion complex in water. The dashed curves correspond to the theoretical curve.

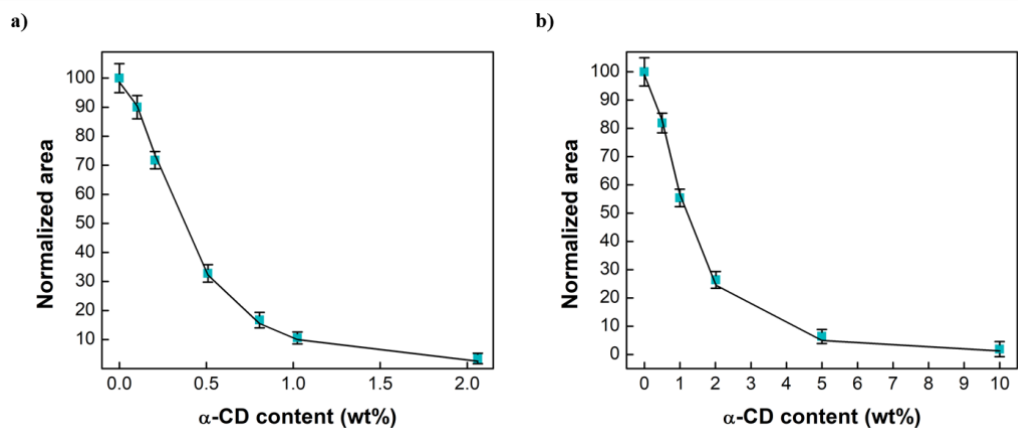

Figure S3: Plots of the (1R)-(+)-camphor normalized area, obtained from SH-GC analysis, as function as the α -CD content (wt%) in a) water, b) ChCl:U DES:water 70:30 wt% along with the theoretical fitted curves (full line), at 30 °C. The corresponding mixture in the absence of CDs was considered as the reference solvent in each graph.

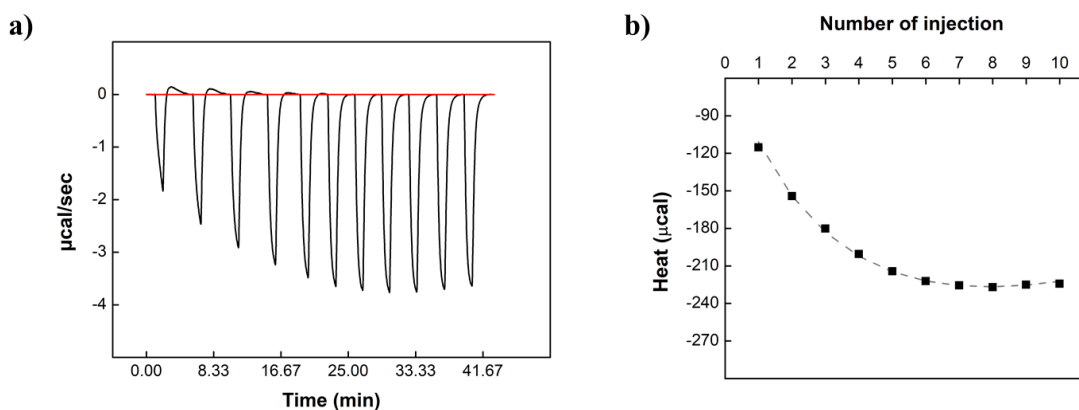

Figure S4: a) ITC thermogram and b) ITC isotherm obtained from the titration study of α -CD/(1R)-(+)-camphor inclusion complex in water. The dashed curve corresponds to the theoretical curve.

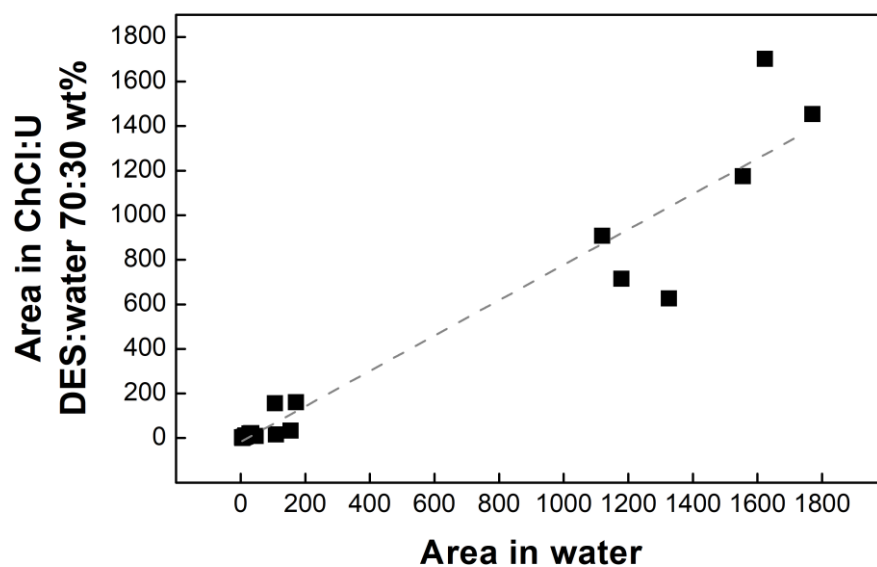

Figure S5: Correlation between the aromas areas in ChCl:U DES:water 70:30 wt% as function of the aromas areas in water, obtained from SH-GC analysis. These data are not normally distributed, and possess a correlation coefficient of 0.96104 with $p < 0.01$.

CHAPITRE 8

Thermodynamique de la complexation dans les milieux DES:eau

Introduction

La calorimétrie de titration isotherme occupe une place prépondérante dans le cadre de la caractérisation des phénomènes d'interactions moléculaires, particulièrement les complexes d'inclusion de CDs. Son principal avantage est sa capacité de fournir une description thermodynamique complète du phénomène de complexation (Illapakurthy et al., 2005; Liang, 2008). Elle permet en effet de mesurer directement l'enthalpie de l'interaction (ΔH) ainsi que la constante de formation du complexe d'inclusion (K_f) à une température donnée. Ce qui permet d'accéder par la suite à l'énergie libre de Gibbs (ΔG) et à l'entropie (ΔS) de l'interaction. De plus, la réalisation des expériences à différentes températures permet dans un second temps la description de l'évolution des enthalpies et entropies d'interaction, ce qui aboutit à la détermination de la variation des capacités calorifiques (ΔC_p) lors de la complexation (Bertaut & Landy, 2014).

Les précédents chapitres de cette thèse ont montré que les CDs permettent une amélioration de la solubilité des huiles essentielles au sein des formulations DES:eau, et que cette amélioration pouvait être attribuée à leur capacité d'inclusion. Ce dernier chapitre s'attache donc à exploiter la thermodynamique de ces phénomènes, afin de disposer d'une meilleure compréhension de leurs mécanismes au sein des formulations DES:eau. Une étude de calorimétrie de titration isotherme est donc menée sur un système de complexation modèle dans différents mélanges DES:eau (différents DESs et différentes proportions d'eau).

Le système modèle étudié consiste en la β -CD et l'adamantanol. Ce complexe β -CD/adamantanol a été choisi car il présente, dans l'eau, une forte valeur de constante de formation (K_f , de l'ordre de $3 \cdot 10^4 \text{ M}^{-1}$) et d'enthalpie d'inclusion (de l'ordre de -5 kcal/mol) (Carrazana et al., 2005). Ses caractéristiques thermodynamiques en solution aqueuse peuvent être donc obtenues avec une précision importante. Cela permet d'envisager une caractérisation satisfaisante au sein d'autres solvants, même en cas de diminution relative de l'affinité et de l'enthalpie d'inclusion.

Afin de garantir d'autant plus la fiabilité des résultats, notre approche méthodologique tire parti du concept d'analyse global. Cela consiste à réaliser plusieurs expériences (différentes températures, différents protocoles expérimentaux) et de réaliser l'ajustement entre les études théoriques et expérimentales sur l'ensemble des résultats à l'aide d'un seul jeu de paramètres thermodynamiques (constante de formation (K_f) et enthalpie (ΔH) d'inclusion et variation des

capacités calorifiques). Une telle approche permet d'une part de vérifier la robustesse du modèle envisagé (notamment en termes d'équilibres chimiques) et d'autre part d'accroître la précision obtenue sur chaque paramètre. Des expériences différenciées contiennent plus d'informations que la répétition d'expériences identiques.

Cette approche a donc été appliquée à différents mélanges DES:eau ainsi qu'aux entités individuelles des constituants de DES (chlorure de choline, urée, glycérol, xylitol, sorbitol, butane-1,3-diol, propane-1,3-diol, glucose et fructose). La complexation entre la β -CD et l'adamantanol au sein des mélanges DES:eau à proportions de 25:75, 50:50 et 70:30 % (m/m) a ainsi été étudiée. La viscosité des milieux constitue un paramètre limitant pour ce type d'étude. Une très forte viscosité empêche le bon déroulement de la manipulation dans la cellule du calorimètre, ce qui conduit à l'obtention de résultats biaisés. Ce constat justifie l'usage de proportions maximales de DES limitées à 70 % (m/m), proportion correspondant néanmoins à la formulation optimale constatée précédemment pour la solubilisation des huiles essentielles. La complexation au sein des mélanges éthanol:eau 25:75, 50:50 et 70:30 % (m/m) a également été caractérisée afin de disposer d'une référence en termes de solvant organique.

Les différentes proportions DES:eau permettent de juger de l'influence de la présence du DES non seulement en tant que compétiteur au sein de la cavité, mais également en tant que solvant des différentes espèces libres et complexées. L'article '*Thermodynamic investigations on host/guest interactions between β -cyclodextrin and adamantanol in deep eutectic solvent:water mixtures*' développe les résultats obtenus dans ce travail.

**Thermodynamic investigations on host/guest interactions
between β -cyclodextrin and adamantanol in deep eutectic solvent:water mixtures**

Lamia Nakhle^{a,b}, Miriana Kfoury^{a,b}, H el ene Greige-Gerges^b, David Landy^{a,*}

^a *Unit e de Chimie Environnementale et Interactions sur le Vivant (UCEIV, UR 4492), SFR Condorcet
FR CNRS 3417, Universit e du Littoral C ote d'Opale (ULCO), 145 Av. M. Schumann, F-59140
Dunkerque, France*

^b *Bioactive Molecules Research Laboratory, Faculty of Sciences, Lebanese University, 90656 Jdeidet
el-Metn, Lebanon*

* Email of the corresponding author: david.landy@univ-littoral.fr

Abstract

Cyclodextrins (CDs) are cage molecules that can form inclusion complexes with a variety of guests, improving therefore their physico-chemical properties. On the other hand, new green solvents emerged in the early 2000's, called 'Deep eutectic solvents' (DESs), were proved to retain the CD/guest complex formation. This study examines the β -CD/adamantanol interactions, using isothermal titration calorimetry, in different DES:water mixtures. Eight choline chloride (ChCl)-based DESs were incorporated in DES:water mixtures of 25:75, 50:50 and sometimes up to 70:30 wt%, depending on the viscosity of the resulting mixture. The formation constant (K_f), enthalpy (ΔH) and entropy (ΔS) of the complexation were determined in each mixture at different temperatures and were compared to the results obtained in water, in ethanol:water mixtures and in 25 wt% of the aqueous solutions of DESs' components. The data revealed that the inclusion is mainly driven by enthalpy within DES:water mixtures, similarly to pure aqueous solutions. Among the studied guests, it was proved that only ChCl:propane-1,3-diol and ChCl:butane-1,3-diol at DES:water 25:75 wt%, were identified as competitive DESs. For the higher DESs wt%, lower K_f and ΔG values were observed compared to water. The analysis of the heat capacity variation (ΔC_p) values confirmed that the influence of solvophobic contribution to the complex formation was found in a smaller extent in DES:water mixtures compared to water. However, the weak competitive behavior of these DESs is far less unfavorable to inclusion phenomena than what is observed with organic solvent such as ethanol.

Keywords: adamantanol, cyclodextrins, deep eutectic solvents, inclusion thermodynamics, isothermal titration calorimetry.

1. Introduction

For many years, cyclodextrins (CDs) have been the center of attention in supramolecular chemistry for their capability of improving the stability, solubility and bioavailability of numerous molecules of interest, including drugs and nutraceuticals (Crini, 2014). This can be attributed to the formation of inclusion complexes between the hydrophobic cavity of CDs and the guest through non-covalent forces (Connors, 1997). Thus, the thermodynamic study of the inclusion complexes using CDs is of great importance. Isothermal titration calorimetry (ITC) presents a unique analytical technique that allows a complete thermodynamic description of the inclusion phenomena on a molecular level. Measurement of the heat flow by ITC allows for accurate determination of binding constant (K_f), reaction stoichiometry (n), enthalpy (ΔH), entropy (ΔS) and heat capacity variation (ΔC_p) (Illapakurthy et al., 2005; Liang, 2008). On a methodological point of view, different protocols may be employed. Most ITC studies are based on the classical titration protocol. While one partner of the studied phenomenon, called titrand, is placed inside the cell, the second partner, called titrant, is contained in the syringe of the ITC device. Each injection of one partner on the other induces the formation of supramolecules, thus releasing an amount of heat which is proportional to the binding enthalpy and to the amount of complexes formed during this addition. The binding isotherm is then obtained by recording heats for all injections. At this stage, a fitting procedure between experimental and theoretical data allows the evaluation of the various thermodynamic parameters (Bertaut & Landy, 2014). One of the non-conventional methods is the release experiment first introduced by Heerklotz (Heerklotz et al., 1999). Herein, the complex is already formed outside the device and is placed inside the syringe of the ITC and being injected unto the cell containing the solvent, consuming an amount of heat at each injection.

Although a high number of ITC studies have been conducted investigating the thermodynamic aspects of CDs inclusion complexes in water solutions, with different pH, at different temperatures and in some organic solvents (Illapakurthy et al., 2005; Zheng et al., 2014; Usacheva et al., 2019), no study was done yet in deep eutectic solvents (DESs). DESs are green solvents referred to a mixture, at a specific molar ratio, of two or more starting materials with high melting points that often form a liquid with lower melting temperature than the initial compounds (Abbott et al., 2003). Mainly, hydrogen bond interactions constitute the leading forces between the hydrogen bond donor (HBD) (first component) and the hydrogen bond acceptor (HBA) (second component), which leads to lowering the

entropic differences of the phase transitions and allows decreasing the melting point (Martins et al., 2019). The nature of the components as well as the presence of water to a specific extent could modulate the different physico-chemical properties of DESs (viscosity, density, polarity...) (El Achkar et al., 2019). Recently, it was proved that CDs retained some ability to form inclusion complexes in DESs (Moufawad et al., 2019). Formation constants of CD/guest complexes were determined in DES:water mixtures by static headspace-gas chromatography and were proved to be lower than in water (Nakhle et al., 2021).

In order to gain better insights in the molecular mechanism of these inclusion phenomena within DES:water mixtures, this paper investigates the thermodynamic parameters of the CDs inclusion complexes in DES:water mixtures, for the first time in literature, to the best of our knowledge. The complexation of adamantane derivatives with β -CD has been the subject of numerous studies (Rüdiger et al., 1996; Granadero et al., 2010). Adamantane derivatives form usually strong complexes with β -CD, with ΔG close to -30 kJ mol^{-1} in water (Mavromoustakos et al., 1998; Carrazana et al., 2005). This was explained by the fact that adamantyl residue fits perfectly inside the β -CD cavity and water molecules do not have room inside the cavity. The diameter of the adamantyl group is about 7 \AA and fits well into the 7.8 \AA cavity of β -CD (Vashi et al., 2001). For this purpose, this study aims to determine the thermodynamic parameters (ΔG , ΔH , ΔC_p and $-T\Delta S$) of β -CD/adamantanol complex in eight ChCl-based DESs in different DES:water mixtures and at different temperatures. The formation constants of β -CD/adamantanol complex were also determined in each mixture. The influence of DESs type and of the water content on the thermodynamic parameters and on the formation constants were discussed and compared to water, ethanol:water mixtures, but also to aqueous solutions of DESs individual components.

2. Experimental section

2.1. Materials

Choline chloride (98%) was purchased from Sigma-Aldrich, China. Urea (99%) was purchased from Sigma-Aldrich, USA. Propane-1,3-diol, glycerol, D(-)-sorbitol, D(-)-fructose and D(+)-glucose anhydrous were provided by VWR Chemicals, Belgium. Xylitol and (±)-butane-1,3-diol were provided by Alfa Aesar, Germany. β-CD was provided by Wacker-Chemie, Lyon, France. 1-Adamantanol was purchased from Acros, Belgium. Choline chloride was dried at 60 °C for at least 2 weeks before use. All other compounds were used as received. Distilled water was used throughout this work.

2.2. Preparation of deep eutectic solvents

DESs were prepared using the heating method by mixing choline chloride (ChCl) as the HBA and different HBDs in a specific molar ratio under stirring until the formation of a clear and homogenous liquid (**Table 1**). The water content of all the prepared DESs were determined using the Karl Fisher titration method (Mettler Toledo DL31).

Table 1- Composition of the studied deep eutectic solvents.

DES (HBA:HBD)	Abbreviation	Molar Ratio	Heating temperature (°C)	Water content (%)	E _{NR} * (Kcal.mol ⁻¹)
ChCl:Urea	ChCl:U	1:2	60	0.05	48.62
ChCl:Glycerol	ChCl:Gly	1:2	RT	0.20	48.53
ChCl:Xylitol	ChCl:Xyl	1:2	80	0.07	48.34
ChCl:Sorbitol	ChCl:Sor	1:1	80	0.36	48.20
ChCl:Butane- 1,3-diol	ChCl:But	1:2	40	0.08	49.11
ChCl:Propane- 1,3-diol	ChCl:Pro	1:1	80	0.21	48.99
ChCl:Glucose	ChCl:Glu	2:1	80	0.26	48.43
ChCl:Fructose	ChCl:Fru	2:1	80	2.15	48.48

ChCl: Choline chloride; DES: Deep eutectic solvent; HBA: Hydrogen bond acceptor; HBD: Hydrogen bond donor; RT: Room temperature; *E_{NR} (NR: Nile red probe): polarity parameter obtained for the DES:water 70:30 wt% mixtures using this equation $E_{NR} = \frac{28591.44}{\lambda_{max}(nm)}$ (Nakhle et al., 2021).

2.3. Isothermal titration calorimetry

An isothermal calorimeter (VP-ITC, MicroCal Inc., USA) was used to determine simultaneously the formation constants and the inclusion enthalpy of the β-CD/adamantanol complex first in water. Experiments were also done with the different ChCl-based DESs at DES:water 25, 50 and 70 wt% for ChCl:U, ChCl:Gly, ChCl:But and ChCl:Pro, or at

DES:water 25 and 50 wt% for ChCl:Xyl, ChCl:Sor, ChCl:Glu and ChCl:Fru. In addition, experiments were done with 25 wt% of DESs components and 25, 50 and 70 wt% of ethanol in water. For each experiment, the solvent was used in both cells (reference and sample cells) and syringe and experiments were done at 15, 25 and 35 °C. Titration experiments were done where β -CD (5 mM) is loaded in the syringe and added progressively to adamantanol (0.5 mM) present in the sample cell. β -CD and the guest were both dissolved in the tested mixture. After the addition of an initial aliquot of 25 μ L, 10 other aliquots of 25 μ L of the syringe solution were delivered (over 50 s for each injection) under agitation. The time interval between two consecutive injections was chosen in a way to reach the equilibrium before every injection. The resulting heat flow was recorded as a function of time. In addition, the heat of dilution (for each partner) was eliminated by subtracting the raw signal obtained for the corresponding blank titrations (only one partner in cell or syringe, the other compartment being filled with the tested mixture). The peak area following each addition was obtained by integration of the resulting signal and was expressed as the heat effect per injection. Binding constants and thermodynamic parameters were determined by nonlinear regression analysis of the binding isotherms by means of a dedicated homemade program (Excel spreadsheet). The data treatment consists of the postulation of values for formation constants and inclusion enthalpies, and then the simulation of the heat obtained for each injection, followed by the minimization of the difference between experimental and simulated heats by varying the initial thermodynamic parameters. Finally, uncertainties on the thermodynamic parameters are determined by using the a priori variance–covariance matrix V as described previously (Bertaut & Landy, 2014).

Only for ChCl:But DES:water 70:30 wt%, a release experiment was conducted at all temperatures, along with the titration experiment in order to increase the accuracy of the determined thermodynamic parameters. The complex was previously formed by mixing 5 mM of β -CD with 5 mM of adamantanol in this mixture and was loaded in the syringe and being added in the same way as described above to the sample cell filled with the mixture.

Since the experiments are carried out at different temperatures (T_i), the binding enthalpies (ΔH^{T_i}) are optimized for each temperature, while the affinity is fitted on the basis of only one formation constant at a reference temperature T_0 (K^{T_0}). The association constants for the other temperatures are then calculated by trapezoidal numerical integration of the van't Hoff expression according to Freiburger et al., 2011:

$$\ln K^{T_j} = \ln K^{T_0} + \sum_{i=1}^j \frac{T_i - T_{i-1}}{2R} \left(\frac{\Delta H^{T_{i-1}}}{(T_{i-1})^2} + \frac{\Delta H^{T_i}}{(T_i)^2} \right) \quad (3)$$

When all binding enthalpies are known, the heat capacity variation may be estimated by linear least square using the following equation:

$$\Delta H^{T_i} = \Delta H^{T_0} + \Delta C_p^{T_i - T_0} \quad (4)$$

where R is the universal gas constant of 8.314 J.K⁻¹.mol⁻¹, T is the absolute temperature expressed in Kelvin, K is the formation constant, ΔH is the enthalpy change and ΔC_p is the heat capacity variation.

3. Results and discussion

ITC experiments have been performed for β -CD/adamantanol complex in water, and in different ChCl-based DES:water, DES components:water and ethanol:water mixtures. To ensure the accuracy of the derived thermodynamic parameters and to check the influence of the temperature on the complexation, experiments were carried out at 15, 25 and 35 °C and treated simultaneously with a single set of thermodynamic temperatures (global analysis principle). We were interested in studying the competitive and the solvation contributions of DES:water and ethanol:water mixtures on the β -CD/adamantanol system. Therefore, experiments were done first at low DES or ethanol content in water (DES:water or ethanol:water 25:75 wt%) and then we gradually increased the DES or the ethanol content in the mixture (DES:water or ethanol:water 50:50 and 70:30 wt%).

Figure 1 illustrates an example of ITC titration experiments obtained in ChCl:U DES:water 25:75 wt% at 25 °C. The fitting of the experimental data obtained in all ITC experiments in this study was successfully done using a simple 1/1 host/guest complex model, confirming the general observation that β -CD/adamantanol is known to form 1/1 inclusion complex (Becuwe et al., 2008).

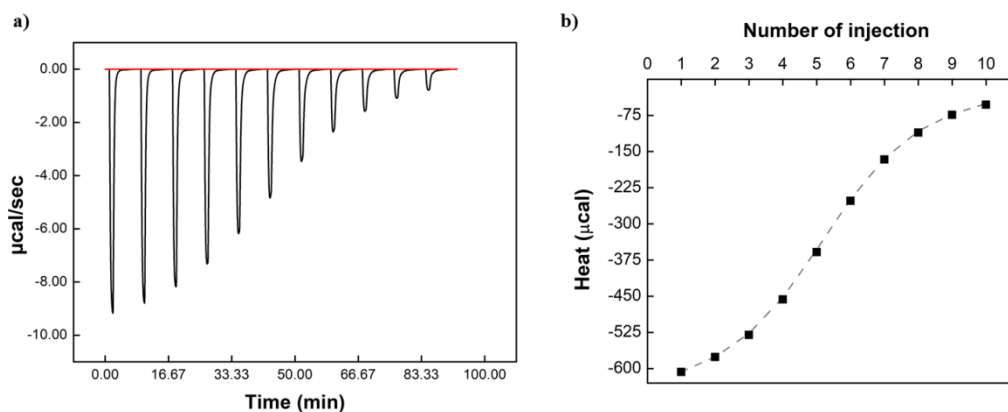

Figure 1: Typical isothermal titration calorimetry data obtained for the binding interaction of β -CD and adamantanol in ChCl:U DES:water 25:75 wt% at 25 °C with a) the thermogram presenting the exothermic heat releases upon injection of CD into adamantanol and b) the isotherm presenting the integrated heat data, giving a differential binding curve; the dashed curve corresponds to the theoretical curve.

The classical titration thermogram is presented in **Figure 1a**. Each injection induces the formation of β -CD/adamantanol supramolecules, thus releasing an amount of heat which is proportional to the binding enthalpy and to the amount of complexes formed during this addition (Bouchemal & Mazzaferro, 2012). As the concentration of free adamantanol molecules in the cell is decreasing after each injection, heat is diminishing all along the

titration, since less and less complexes are formed. In **Figure 1b**, the titration isotherm is presented showing the adjustment between experimental and theoretical data. After the appropriate data treatment, the thermodynamic parameters were determined at all temperatures in water and in the other DES:water and ethanol:water mixtures. Results obtained at 25 °C are presented in **Table 2**, whereas the results obtained at 15 and 35 °C are presented in **Tables S1 and S2**, respectively. The obtained formation constant of β -CD/adamantanol at 25 °C in water (29694 M^{-1}) was similar to that determined previously in literature at 25 °C, which was of 45919 M^{-1} (Leko et al., 2020).

Table 2- Thermodynamic parameters determined in water, in the different DES:water mixtures as well as in ethanol:water mixtures at 25 °C.

K (M ⁻¹)			ΔH (KJ.mol ⁻¹)			-TΔS (KJ.mol ⁻¹)			ΔG (KJ.mol ⁻¹)			
Water	29694 ± 390		-22.42 ± 0.05			-3.09 ± 0.08			-25.52 ± 0.10			
Mixture	25 wt%	50 wt%	70 wt%	25 wt%	50 wt%	70 wt%	25 wt%	50 wt%	70 wt%	25 wt%	50 wt%	70 wt%
ChCl:U	29636 ± 1521	20801 ± 989	12101 ± 678	-24.86 ± 0.87	-27.05 ± 0.84	-27.28 ± 0.99	-0.66 ± 1.00	2.41 ± 0.96	3.98 ± 1.13	-25.51 ± 0.20	-24.64 ± 0.20	-23.29 ± 0.20
ChCl:Gly	20695 ± 1249	10549 ± 603	5580 ± 342	-23.99 ± 0.95	-26.67 ± 0.95	-30.11 ± 1.01	-0.64 ± 1.10	3.72 ± 1.10	8.70 ± 1.16	-24.63 ± 0.20	-22.95 ± 0.20	-21.41 ± 0.20
ChCl:Xyl	28068 ± 1551	17012 ± 977	-	-24.14 ± 0.91	-24.93 ± 0.95	-	-1.24 ± 1.05	0.78 ± 1.09	-	-25.38 ± 0.20	-24.15 ± 0.20	-
ChCl:Sor	30621 ± 1599	18786 ± 1089	-	-24.76 ± 0.88	-24.39 ± 0.94	-	-0.83 ± 1.01	0.01 ± 1.09	-	-25.59 ± 0.20	-24.38 ± 0.20	-
ChCl:But	4334 ± 507	1466 ± 338	534 ± 18	-21.68 ± 1.59	-25.30 ± 2.41	-27.28 ± 0.57	0.93 ± 1.88	7.23 ± 2.99	11.72 ± 0.65	-20.75 ± 0.30	-18.06 ± 0.60	-15.56 ± 0.10
ChCl:Pro	10114 ± 820	4337 ± 432	2611 ± 359	-21.75 ± 1.17	-23.84 ± 1.39	-24.32 ± 1.68	-1.10 ± 1.37	3.08 ± 1.64	4.82 ± 2.02	-22.85 ± 0.30	-20.76 ± 0.30	-19.50 ± 0.40
ChCl:Glu	30860 ± 1878	15183 ± 1163	-	-22.45 ± 0.97	-21.21 ± 1.14	-	-3.17 ± 1.12	-2.66 ± 1.33	-	-25.62 ± 0.20	-23.86 ± 0.20	-
ChCl:Fru	25844 ± 1772	12476 ± 112	-	-21.89 ± 0.24	-20.79 ± 0.04	-	-3.34 ± 0.41	-2.64 ± 0.06	-	-25.23 ± 0.20	-23.43 ± 0.10	-
Ethanol	1690 ± 133	1762 ± 362	132 ± 8*	-55.66 ± 1.12	-43.47 ± 2.01	-12.85 ± 5.56*	37.24 ± 1.32	24.95 ± 2.53	0.75 ± 5.71*	-18.42 ± 0.20	-18.52 ± 0.60	-12.10 ± 0.20*

*The uncertainties were calculated after considering that there was no uncertainty in the CD and adamantanol concentrations.

Figure 2 displays the different thermodynamic parameters in the different DES:water and ethanol:water 25:75 wt% at 25 °C.

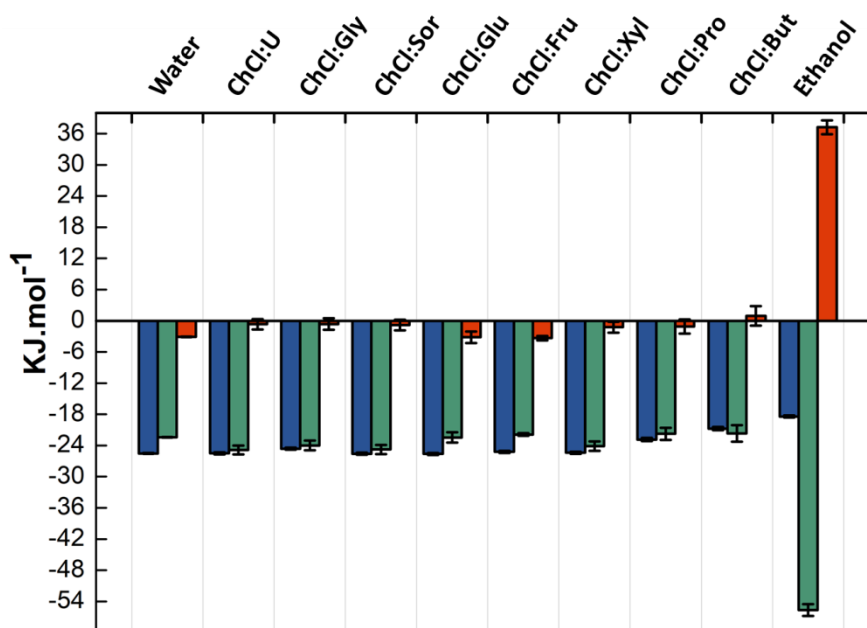

Figure 2: Evolution of the ΔG , ΔH and $-T\Delta S$ obtained with water and the different ChCl-based DESs in DES:water 25:75 wt% and with ethanol:water 25:75 wt%, at 25 °C.

The negative values of ΔG (**Figure 2**) resulting from the contribution of ΔH and $-T\Delta S$ indicated that the formation of the β -CD/adamantanol in water and in the other DES:water and ethanol:water 25:75 wt% is a spontaneous process. Hence, the inclusion phenomenon is associated with a high-energy loss and could result from hydrophobic or Van der Waals forces (Eid et al., 2011).

The entropy effect ($-T\Delta S$) of the β -CD/adamantanol complex was essentially close to zero over the studied temperature range. Accordingly, the entropy effect makes a minor contribution to the negative values of standard Gibbs energy (ΔG), to the contrary of the enthalpic term. The observed entropy variation may be due to the compensation between the release of water molecules from the cavity, which has positive contribution to entropy (Sun et al., 2006; Wszelaka-Rylik & Gierycz, 2013) and the β -CD/adamantanol complex formation, which has negative contribution to entropy. Indeed, once adamantanol is encapsulated in the cavity of the CD, it resulted in a substantial loss in the degree of reagents freedom what, in consequence, causes the entropy lost ($\Delta S < 0$, $-T\Delta S > 0$) (Cooper, 1999).

Such host-guest combinations, with absolute value of enthalpy that was greater than the absolute value of the product of temperature and entropy ($|\Delta H| > |-T\Delta S|$), are classified as complexation primarily driven by enthalpy with entropic assistance (Cooper et al., 2001).

At DES:water 25:75 wt%, six DESs presented ΔG , ΔH and $-T\Delta S$ values with negligible difference to the one obtained in water, which underlines that complexation mechanisms are analogous in the absence or the presence of 25 wt% of these DESs in water. Thus, one can hypothesize that DES:water 25:75 wt% corresponds to a ‘DES in water system’, in which DES components can be considered as solute species. This applies for the six DESs ChCl:U, ChCl:Gly, ChCl:Sor, ChCl:Glu, ChCl:Fru and ChCl:Xyl, in DES:water 25:75 wt%, demonstrating that no competition phenomena was observed between the DESs components and adamantanol for the cavity of CDs. However, for ChCl:Pro and ChCl:But DES:water 25:75 wt%, small yet significant difference in the ΔG values were obtained with less negative values compared to the values obtained in water. In this case, both DESs are designated as weak competitive DESs.

In order to confirm the observed tendencies, titration experiments were carried out with 25 wt% of DESs’ components in water. The obtained thermodynamic parameters are presented in **Table S3**. As can be seen, the ΔG value obtained with the presence of ChCl, the main HBA used in our study, was almost similar to the one obtained in water. Thus, ChCl presented no competition behavior. Therefore, one can say that the type of HBD can influence the ΔG values. Same result was obtained for the six HBDs (U, Gly, Sor, Glu, Fru and Xyl) for which the corresponding DES:water 25:75 wt% systems didn’t show any competition phenomena with adamantanol, while results obtained with 25 wt% aqueous solution of Pro and But confirmed the competitive behavior of their respective DES:water 25:75 wt% observed previously since significant variation in ΔG values was observed compared to water. Giving this correlation, one can infer the competitive behavior of a specific DES:water mixture by testing the competitive behavior of the aqueous solutions of DES’ components. As an example, the lowest K_f value obtained in DES:water 25:75 wt% was in the case of ChCl:But DES (**Table 2** and **Tables S1 and S2**), the same HBD (But) presented the lowest K_f value compared to the other HBDs (**Table S3**).

The less negative ΔG value was obtained when using ethanol indicating its very strong competitive behavior for the CD cavity, thus underlining that the nature and driving forces of CD complexation in organic solvents may differ significantly from those in water and in

DES:water mixtures. Compared to water and DES:water 25:75 wt%, the entropic term strongly disfavors β -CD/adamantanol complexation in ethanol. Such unfavorable behavior of organic solvent for CD inclusion was also obtained in the case of the complexation of aliphatic amines with α -CD in N,N-dimethylformamide compared to water (Spencer et al., 1996). Other studies showed that increasing ethanol molar fraction in water was able to effectively solvate the guest molecules (quercetin for instance), by subtracting them from the complexation, and competing for occupation of hydroxypropylated- β -CD (HP- β -CD) cavities or filling the residual empty space of the CD cavities (Usacheva et al., 2019). In this latter, no HP- β -CD/quercetin complex formation was noticed in ethanol:water mixture when ethanol volume fraction exceeded 0.2 at neutral and alkaline pH, and exceeded 0.1 at acidic pH (Usacheva et al., 2019). In another study, similar results showed that the presence of ethanol:water mixture affected the formation of CD/caffeic acid inclusion complex and no CD/caffeic acid inclusion complex was observed at ethanol:water 45% v/v (Kfoury et al., 2019). Many studies proved also that the guest molecule and most probably the organic solvent, used as cosolvent, compete for the formation of the complex with the CDs (García-Río et al., 2006; Horský & Walterová, 2003; Yoshikiyo et al., 2012).

Titration experiments with DES:water mixtures and ethanol:water mixtures at 50:50 wt% and 70:30 wt% were also done. However, with ChCl:But DES:water 70:30 wt%, release experiments were done additionally because significant but low heats were obtained in the titration experiment. Therefore, coupling this titration experiment with a release experiment was crucial to obtain higher accuracy for the thermodynamic parameters in this case. The corresponding thermograms and isotherm are presented in **Figure S1**. One can see how the curve of the titration isotherm lost its sigmoidal shape in ChCl:But DES:water 70:30 wt% (almost disappeared). The release experiment implies the injection of the β -CD/adamantanol complex into the mixture. As each injection induced a dilution of the syringe content within the cell, the complex initially formed in the mixture partially dissociates in the cell, resulting in heat consumption and positive peaks (endothermic process of dissociation). As the inclusion compound concentration is increasing in the cell, the dissociation is diminishing injection after injection. The appearance of double peaks in the titration experiment with ChCl:But DES:water 70:30 wt%, is due to the high viscosity of the mixtures. Consequently, for some of the DESs, experiments at DES:water 70:30 wt% were hard to conduct because of the high viscosities of the resulting mixture. **Figure S2** presents the viscosities of the different DES:water mixtures at 30 °C. The viscosities of the mixtures increased

exponentially after increasing the DESs content. Due to the limitations of the ITC instrument and to the lack of agitation that could result, all the DES:water 70:30 wt% mixtures presenting viscosities higher than ChCl:But DES:water 70:30 wt% even at high temperature (30 °C) were not studied in DES:water 70:30 wt%. In these cases, ITC experiments were done only at 25:75 and 50:50 DES:water wt% mixtures.

Table 2 and **Tables S1 and S2** assemble the thermodynamic parameters obtained for the higher DES:water wt% and ethanol:water wt%. All these mixtures displayed lower K_f values compared to water. Same tendency was observed when increasing the temperature for the same DES:water wt%, as a consequence of the exothermic character of the β -CD/adamantanol inclusion complex formation, favored by the release of water molecules from the hydrophobic cavity of a completely hydrated β -CD to the bulk aqueous phase (Sun et al., 2006). A recent work led to estimate the release of 15-25 water molecules from the CD cavity upon adamantane binding to β -CD (Cameron et al., 2010). Accordingly, the changes in K_f and ΔG with temperature variation are generally weak since the entropy variation often compensates to cancel out a substantial part of enthalpic variation. For example, in the case of the β -CD/adamantanol system in aqueous solution, ΔG was even stable when increasing the temperature (**Table 2**).

Increasing the DES content up to DES:water 70:30 wt% at a given temperature induced the decrease of the enthalpy, the decrease of K_f , the increase of $-T\Delta S$, and most importantly the increase of the ΔG values. As no competitive behavior was observed for some of the DES at DES:water 25:75 wt%, such variation is necessarily induced by an additional phenomenon related to the external solvation of CDs and adamantanol. In fact, when moving from pure water to DES, the solvent molecules surrounding β -CD and adamantanol experiment more favorable interactions, which in turn disfavor the complex formation. Therefore, the solvatophobic forces are quantitatively found in the following order: water > DES:water 50:50 wt% > DES:water 70:30 wt%. The negative heat capacity (ΔC_p) values can confirm this statement because they are usually considered to be evidence of significant hydrophobic interactions in the binding process. In water, ΔC_p was found to be negative (-95 J.K^{-1}), which is typical of macromolecular associations in water (Dam et al., 1998; Lopez & Makhatadze, 1998). Adding DES to water induced the increase of ΔC_p value as function of the DES:water wt%. For example, ChCl:U DES:water 25:75 wt% displayed a ΔC_p value of -71 J.K^{-1} , this value increased to -30 J.K^{-1} in ChCl:U DES:water 50:50 wt% and -18 J.K^{-1} in ChCl:U DES:water 70:30 wt%. This confirms the early stated hypothesis of the involvement of

solvatophobic forces in the complex formation. In addition, the more pronounced is the increase of ΔC_p value, the more pronounced is the decrease in K_f value. As example, the ΔC_p value in ChCl:But 25:75 wt% was found to be -30 J.K^{-1} which is much higher than in the case of ChCl:U DES:water 25:75 wt%. This example implies one competitive DES (ChCl:But, which induced the pronounced decrease of K_f) and one non-competitive DES (ChCl:U, which slightly induced the decrease of K_f). Since excellent correlations between the polarity of different types of DES:water 70:30 wt% mixtures and the solubility of *Eucalyptus citriodora* essential oil in the mixture were found previously (Nakhle et al. 2021), and according to the E_{NR} values obtained for the different DES:water 70:30 wt% mixtures (**Table 1**), we can hypothesize that ChCl:But DES:water 70:30 wt% presenting the lowest polarity (since it has the longest hydrocarbon chain and presenting the highest E_{NR} value) among the other DESs, thus solubilizing, in a more pronounced way, adamantanol in the mixture rather than inducing the β -CD/adamantanol complex formation, lowering therefore the K_f value.

At high ethanol content (ethanol:water 50:50% and and 70:30 wt%), the competitive behavior of ethanol was also accompanied by external solvation effect, but with an opposite thermodynamic signature. The compensation between high values of enthalpy and entropy observed at ethanol:water 25:75% gradually evolved to a compensation involving much smaller contributions. While external solvation effect was related to an unfavorable entropy variation in the case of DES:water systems, a reduction of such unfavorable entropy was observed in the case of ethanol, again underlining the strong difference of solvation mechanisms between the two kind of solutions. However, these solvation mechanisms still induce a decrease of ΔG in the presence of ethanol, thus reducing the affinity of adamantanol for β -CD.

These results are emphasized in **Figure 3** which presents the evolution of ΔH and $-T\Delta S$ values for ChCl:U, ChCl:But and ethanol as function of their content. We can observe that the evolution of both ΔH and $-T\Delta S$ is less significant for non-competitive DES (ChCl:U), than for the weakly competitive DES (ChCl:But) and was highly significant for ethanol giving the pronounced competitive behavior of this solvent.

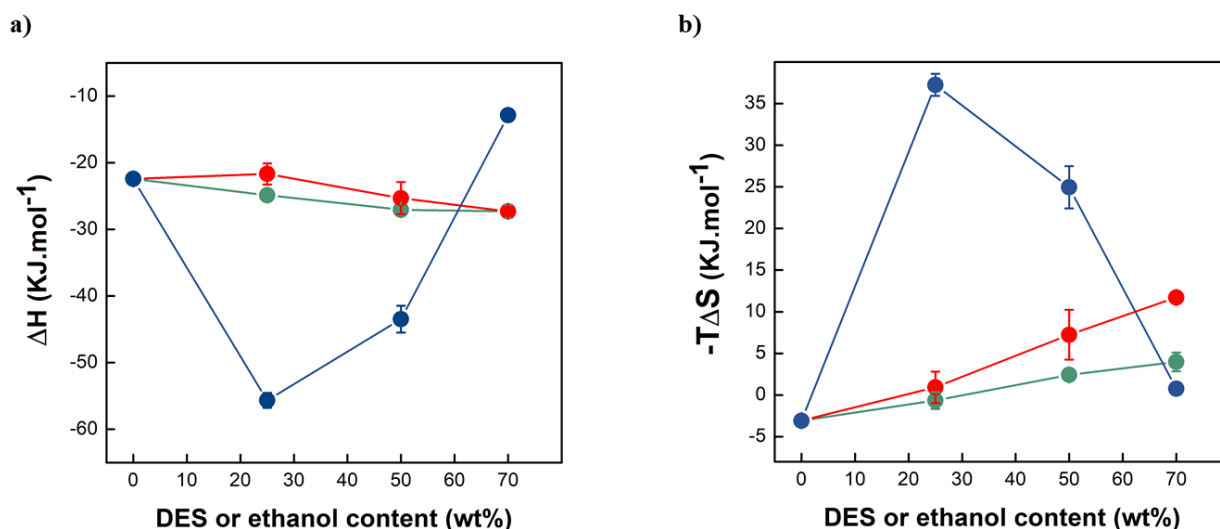

Figure 3: Evolution of the a) ΔH and b) $-T\Delta S$ with increasing the wt% of ● ChCl:U and ● ChCl:But DESs and ● ethanol in water at 25 °C.

By plotting $T\Delta S$ as function of ΔH for all DES:water and ethanol:water mixtures at 25 °C (**Figure 4**), linear relationships were observed, thus confirming the previously stated enthalpy-entropy compensation, which was also observed in a wide variety of reactions and equilibria (Rekharsky & Inoue, 1998, 2002; Illapakurthy et al., 2005). Regression of enthalpy-entropy compensation was done separately for ethanol:water mixtures and DES:water mixtures due to the different behavior both types of mixtures can report. Enthalpy-entropy compensation was reported in literature when water was progressively replaced by an organic solvent (Danil de Namor et al., 1990; Irwin et al., 1996). For some authors, this could result from the interactions between the solvent and the CDs. For example, the presence of hydrogen bonds between the guest molecule and the solvent results in more rigid structure of the inclusion complex and, in turn, decreases the entropy of the interaction (Hamai, 1992; Spencer et al., 1996).

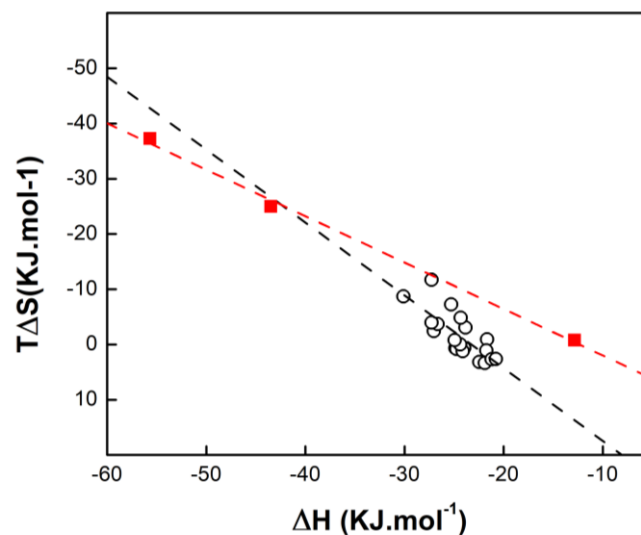

Figure 4: Enthalpy-entropy relationship for β -CD/adamantanol complex from values obtained in the different \bigcirc DES:water mixtures and \blacksquare ethanol:water mixtures at 25 °C. The dashed curves correspond to the fitted linear curves.

4. Conclusion

In this study, we were able to evaluate the β -CD/adamantanol inclusion complex in aqueous solutions of eight different ChCl-based DESs (DES:water 25:75, 50:50 and sometimes 70:30 wt%), with comparison to water and ethanol:water mixtures at three different temperatures. The data revealed that the inclusion is mainly driven by enthalpy with weak contribution of entropy within DES:water mixtures, similarly to pure aqueous solutions. At low DES content, the results demonstrated that various DESs (ChCl:U, ChCl:Gly, ChCl:Sor, ChCl:Glu, ChCl:Fru, ChCl:Xyl) do not behave as competitive species; only ChCl:Pro and ChCl:But at DES:water 25:75 wt%, were identified as competitive DESs. These data were correlated with results obtained with 25 wt% of DESs individual components in water. For higher DESs wt% (50%, 70%), lower K_f and ΔG values were observed compared to water. Analysis of the heat capacity variation (ΔC_p) values confirmed the influence of solvatophobic contribution to the complex formation, which are found in a smaller extent in DES:water mixtures compared to water. The lowest affinity was obtained in ChCl:But DES:water mixtures, while the highest one was obtained with ChCl:U DES:water mixtures. This can be due to the lowest polarity of ChCl:But DES, facilitating both internal solvation of CD and external solvation of adamantanol and therefore diminishing host-guest affinity. Compensatory enthalpy-entropy mechanism was observed throughout the studied mixtures. This study demonstrated that the use of DESs compared to organic solvent like ethanol was advantageous, as a result of strongly differentiated thermodynamic solvation signatures.

Acknowledgements

The authors would like to acknowledge the National Council for Scientific Research of Lebanon (CNRS-L) and Université du Littoral Côte d'Opale (ULCO) for granting a doctoral fellowship to Lamia Nakhle.

References

- Abbott, A. P., Capper, G., Davies, D. L., Rasheed, R. K., & Tambyrajah, V. (2003). Novel solvent properties of choline chloride/urea mixtures. Electronic supplementary information (ESI) available: Spectroscopic data. See <http://www.rsc.org/suppdata/cc/b2/b210714g/>. *Chemical Communications*, 1, 70–71. <https://doi.org/10.1039/b210714g>
- Becuwe, M., Landy, D., Delattre, F., Cazier, F., & Fourmentin, S. (2008). Fluorescent Indolizine- β -Cyclodextrin Derivatives for the Detection of Volatile Organic Compounds. *Sensors*, 8(6), 3689–3705. <https://doi.org/10.3390/s8063689>
- Bertaut, E., & Landy, D. (2014). Improving ITC studies of cyclodextrin inclusion compounds by global analysis of conventional and non-conventional experiments. *Beilstein Journal of Organic Chemistry*, 10, 2630–2641. <https://doi.org/10.3762/bjoc.10.275>
- Bouchemal, K., & Mazzaferro, S. (2012). How to conduct and interpret ITC experiments accurately for cyclodextrin–guest interactions. *Drug Discovery Today*, 17(11–12), 623–629. <https://doi.org/10.1016/j.drudis.2012.01.023>
- Cameron, D. L., Jakus, J., Pauleta, S. R., Pettigrew, G. W., & Cooper, A. (2010). Pressure Perturbation Calorimetry and the Thermodynamics of Noncovalent Interactions in Water: Comparison of Protein–Protein, Protein–Ligand, and Cyclodextrin–Adamantane Complexes. *The Journal of Physical Chemistry B*, 114(49), 16228–16235. <https://doi.org/10.1021/jp107110t>
- Carrazana, J., Jover, A., Meijide, F., Soto, V. H., & Vázquez Tato, J. (2005). Complexation of Adamantyl Compounds by β -Cyclodextrin and Monoaminoderivatives. *The Journal of Physical Chemistry B*, 109(19), 9719–9726. <https://doi.org/10.1021/jp0505781>
- Chatjigakis, A. K., Donze, C., Coleman, A. W., & Cardot, P. (1992). Solubility behavior of β -cyclodextrin in water/cosolvent mixtures. *Analytical Chemistry*, 64(14), 1632–1634. <https://doi.org/10.1021/ac00038a022>
- Connors, K. A. (1997). The Stability of Cyclodextrin Complexes in Solution. *Chemical Reviews*, 97(5), 1325–1358. <https://doi.org/10.1021/cr960371r>
- Cooper, A. (1999). Thermodynamic analysis of biomolecular interactions. *Current Opinion in Chemical Biology*, 3(5), 557–563. [https://doi.org/10.1016/S1367-5931\(99\)00008-3](https://doi.org/10.1016/S1367-5931(99)00008-3)
- Cooper, A., Johnson, C. M., Lakey, J. H., & Nöllmann, M. (2001). Heat does not come in different colours: Entropy–enthalpy compensation, free energy windows, quantum

- confinement, pressure perturbation calorimetry, solvation and the multiple causes of heat capacity effects in biomolecular interactions. *Biophysical Chemistry*, 93(2–3), 215–230. [https://doi.org/10.1016/S0301-4622\(01\)00222-8](https://doi.org/10.1016/S0301-4622(01)00222-8)
- Crini, G. (2014). Review: A History of Cyclodextrins. *Chemical Reviews*, 114(21), 10940–10975. <https://doi.org/10.1021/cr500081p>
- Dam, T. K., Oscarson, S., & Brewer, C. F. (1998). Thermodynamics of Binding of the Core Trimannoside of Asparagine-linked Carbohydrates and Deoxy Analogs to Dioclea grandiflora Lectin. *Journal of Biological Chemistry*, 273(49), 32812–32817. <https://doi.org/10.1074/jbc.273.49.32812>
- Daniil de Namor, A. F., Traboulssi, R., & Lewis, D. F. V. (1990). Host properties of cyclodextrins towards anion constituents of antigenic determinants. A thermodynamic study in water and in N,N-dimethylformamide. *Journal of the American Chemical Society*, 112(23), 8442–8447. <https://doi.org/10.1021/ja00179a031>
- Eid, E. E. M., Abdul, A. B., Suliman, F. E. O., Sukari, M. A., Rasedee, A., & Fatah, S. S. (2011). Characterization of the inclusion complex of zerumbone with hydroxypropyl- β -cyclodextrin. *Carbohydrate Polymers*, 83(4), 1707–1714. <https://doi.org/10.1016/j.carbpol.2010.10.033>
- El Achkar, T., Fourmentin, S., & Greige-Gerges, H. (2019). Deep eutectic solvents: An overview on their interactions with water and biochemical compounds. *Journal of Molecular Liquids*, 288, 111028. <https://doi.org/10.1016/j.molliq.2019.111028>
- Freiburger, L. A., Baettig, O. M., Sprules, T., Berghuis, A. M., Auclair, K., & Mittermaier, A. K. (2011). Competing allosteric mechanisms modulate substrate binding in a dimeric enzyme. *Nature Structural & Molecular Biology*, 18(3), 288–294. <https://doi.org/10.1038/nsmb.1978>
- García-Río, L., Hervés, P., Leis, J. R., Mejuto, J. C., Pérez-Juste, J., & Rodríguez-Dafonte, P. (2006). Evidence for complexes of different stoichiometries between organic solvents and cyclodextrins. *Organic & Biomolecular Chemistry*, 4(6), 1038. <https://doi.org/10.1039/b513214b>
- Granadero, D., Bordello, J., Pérez-Alvite, M. J., Novo, M., & Al-Soufi, W. (2010). Host-Guest Complexation Studied by Fluorescence Correlation Spectroscopy: Adamantane–Cyclodextrin Inclusion. *International Journal of Molecular Sciences*, 11(1), 173–188. <https://doi.org/10.3390/ijms11010173>

- Hamai, S. (1992). Hydrogen Bonding in Inclusion Complexes of Heptakis(2,3,6-tri- *O* -methyl)- β -cyclodextrin with Chlorophenols in Organic Solvents. *Bulletin of the Chemical Society of Japan*, 65(9), 2323–2327. <https://doi.org/10.1246/bcsj.65.2323>
- Heerklotz, H. H., Binder, H., & Eppard, R. M. (1999). A “Release” Protocol for Isothermal Titration Calorimetry. *Biophysical Journal*, 76(5), 2606–2613. [https://doi.org/10.1016/S0006-3495\(99\)77413-8](https://doi.org/10.1016/S0006-3495(99)77413-8)
- Horský, J., & Walterová, Z. (2003). Formation of poly(ethylene glycol) inclusion complexes in aqueous solutions of mixed cyclodextrins. *Macromolecular Symposia*, 203(1), 259–264. <https://doi.org/10.1002/masy.200351327>
- Illapakurthy, A., Wyandt, C., & Stodghill, S. (2005). Isothermal titration calorimetry method for determination of cyclodextrin complexation thermodynamics between artemisinin and naproxen under varying environmental conditions. *European Journal of Pharmaceutics and Biopharmaceutics*, 59(2), 325–332. <https://doi.org/10.1016/j.ejpb.2004.08.006>
- Irwin, P. L., King, G., & Hicks, K. B. (1996). Polymerized cyclomaltoheptaose (β -cyclodextrin, β -CDn) inclusion complex formation with chlorogenic acid: Solvent effects on thermochemistry and enthalpy-entropy compensation. *Carbohydrate Research*, 282(1), 65–79. [https://doi.org/10.1016/0008-6215\(95\)00377-0](https://doi.org/10.1016/0008-6215(95)00377-0)
- Kfoury, M., Geagea, C., Ruellan, S., Greige-Gerges, H., & Fourmentin, S. (2019). Effect of cyclodextrin and cosolvent on the solubility and antioxidant activity of caffeic acid. *Food Chemistry*, 278, 163–169. <https://doi.org/10.1016/j.foodchem.2018.11.055>
- Leko, K., Hanževački, M., Brkljača, Z., Pičuljan, K., Ribić, R., & Požar, J. (2020). Solvophobicity Driven Complexation of Adamantyl Mannoside with β -Cyclodextrin in Water and Structured Organic Solvents. *Chemistry – A European Journal*, 26(23), 5208–5219. <https://doi.org/10.1002/chem.202000282>
- Liang, Y. (2008). Applications of isothermal titration calorimetry in protein science. *Acta Biochimica et Biophysica Sinica*, 40(7), 565–576. <https://doi.org/10.1111/j.1745-7270.2008.00437.x>
- Lopez, M. M., & Makhatadze, G. I. (1998). Solvent isotope effect on thermodynamics of hydration. *Biophysical Chemistry*, 74(2), 117–125. [https://doi.org/10.1016/S0301-4622\(98\)00173-2](https://doi.org/10.1016/S0301-4622(98)00173-2)
- Martins, M. A. R., Pinho, S. P., & Coutinho, J. A. P. (2019). Insights into the Nature of Eutectic and Deep Eutectic Mixtures. *Journal of Solution Chemistry*, 48(7), 962–982. <https://doi.org/10.1007/s10953-018-0793-1>

- Mavromoustakos, T., Papadopoulos, A., Theodoropoulou, E., Dimitriou, C., & Antoniadou-Vyza, E. (1998). Thermal properties of adamantanol derivatives and their β -cyclodextrin complexes in phosphatidylcholine bilayers. *Life Sciences*, 62(20), 1901–1910. [https://doi.org/10.1016/S0024-3205\(98\)00155-6](https://doi.org/10.1016/S0024-3205(98)00155-6)
- McCune, J. A., Kunz, S., Olesińska, M., & Scherman, O. A. (2017). DESolution of CD and CB Macrocycles. *Chemistry - A European Journal*, 23(36), 8601–8604. <https://doi.org/10.1002/chem.201701275>
- Moufawad, T., Moura, L., Ferreira, M., Bricout, H., Tilloy, S., Monflier, E., Costa Gomes, M., Landy, D., & Fourmentin, S. (2019). First Evidence of Cyclodextrin Inclusion Complexes in a Deep Eutectic Solvent. *ACS Sustainable Chemistry & Engineering*, 7(6), 6345–6351. <https://doi.org/10.1021/acssuschemeng.9b00044>
- Rekharsky, M. V., & Inoue, Y. (1998). Complexation Thermodynamics of Cyclodextrins. *Chemical Reviews*, 98(5), 1875–1918. <https://doi.org/10.1021/cr970015o>
- Rekharsky, M. V., & Inoue, Y. (2002). Complexation and Chiral Recognition Thermodynamics of 6-Amino-6-deoxy- β -cyclodextrin with Anionic, Cationic, and Neutral Chiral Guests: Counterbalance between van der Waals and Coulombic Interactions. *Journal of the American Chemical Society*, 124(5), 813–826. <https://doi.org/10.1021/ja010889z>
- Rüdiger, V., Eliseev, A., Simova, S., Schneider, H.-J., Blandamer, M. J., Cullis, P. M., & Meyer, A. J. (1996). Conformational, calorimetric and NMR spectroscopic studies on inclusion complexes of cyclodextrins with substituted phenyl and adamantane derivatives. *J. Chem. Soc., Perkin Trans. 2*, 10, 2119–2123. <https://doi.org/10.1039/P29960002119>
- Spencer, J. N., Mihalick, J. E., Paul, I. M., Petigara, B., Wu, Z., Chen, S., & Yoder, C. H. (1996). Complex formation between β -cyclodextrin and amines in water and DMF solvents. *Journal of Solution Chemistry*, 25(8), 747–756. <https://doi.org/10.1007/BF00973782>
- Sun, D.-Z., Li, L., Qiu, X.-M., Liu, F., & Yin, B.-L. (2006). Isothermal titration calorimetry and ¹H NMR studies on host–guest interaction of paeonol and two of its isomers with β -cyclodextrin. *International Journal of Pharmaceutics*, 316(1–2), 7–13. <https://doi.org/10.1016/j.ijpharm.2006.02.020>
- Usacheva, T., Kabirov, D., Beregova, D., Gamov, G., Sharnin, V., Biondi, M., Mayol, L., D’Aria, F., & Giancola, C. (2019). Thermodynamics of complex formation between hydroxypropyl- β -cyclodextrin and quercetin in water–ethanol solvents at T = 298.15

- K. *Journal of Thermal Analysis and Calorimetry*, 138(1), 417–424. <https://doi.org/10.1007/s10973-019-08136-5>
- Vashi, P. R., Cukrowski, I., & Havel, J. (2001). Stability constants of the inclusion complexes of β -cyclodextrin with various adamantane derivatives. A UV-Vis study. *South African Journal of Chemistry*, 54, 84–101.
- Wszelaka-Rylik, M., & Gierycz, P. (2013). Isothermal titration calorimetry (ITC) study of natural cyclodextrins inclusion complexes with drugs. *Journal of Thermal Analysis and Calorimetry*, 111(3), 2029–2035. <https://doi.org/10.1007/s10973-012-2251-4>
- Yoshikiyo, K., Matsui, Y., & Yamamoto, T. (2012). Determination of Binding Constants for Inclusion Complexes of Cyclodextrins with Organic Solvents, Ethylene Glycol, and Its Related Compounds by Means of ^1H NMR Spectroscopy. *Bulletin of the Chemical Society of Japan*, 85(11), 1206–1209. <https://doi.org/10.1246/bcsj.20120140>
- Zheng, Y., Dong, L.-N., Liu, M., Chen, A., Feng, S., Wang, B., & Sun, D. (2014). Effect of pH on the Complexation of Kaempferol-4'-glucoside with Three β -Cyclodextrin Derivatives: Isothermal Titration Calorimetry and Spectroscopy Study. *Journal of Agricultural and Food Chemistry*, 62(1), 244–250. <https://doi.org/10.1021/jf404320w>

Supplementary data for

Thermodynamic investigations on host/guest interactions between β -cyclodextrin and adamantanol in deep eutectic solvent:water mixtures

Lamia Nakhle^{a,b}, Miriana Kfoury^b, H  l  ne Greige-Gerges^b, David Landy^{a,*}

^a *Unit   de Chimie Environnementale et Interactions sur le Vivant (UCEIV, UR 4492), SFR Condorcet
FR CNRS 3417, Universit   du Littoral C  te d'Opale (ULCO), 145 Av. M. Schumann, F-59140
Dunkerque, France*

^b *Bioactive Molecules Research Laboratory, Faculty of Sciences, Lebanese University, 90656 Jdeidet
el-Metn, Lebanon*

* Email of the corresponding author: david.landy@univ-littoral.fr

Table S1- Thermodynamic parameters determined in water, in the different DES:water mixtures as well as in ethanol:water mixtures at 15 °C.

K (M⁻¹)		ΔH (KJ.mol⁻¹)			-TΔS (KJ.mol⁻¹)			ΔG (KJ.mol⁻¹)				
Water	39094 ± 514			-18.62 ± 0.06			-6.73 ± 0.09			-25.36 ± 0.10		
Mixture	25 wt%	50 wt%	70 wt%	25 wt%	50 wt%	70 wt%	25 wt%	50 wt%	70 wt%	25 wt%	50 wt%	70 wt%
ChCl:U	40715 ± 2089	29781 ± 1416	17241 ± 966	-21.99 ± 0.74	-25.82 ± 0.76	-26.58 ± 0.91	-3.46 ± 0.86	1.12 ± 0.88	3.17 ± 1.04	-25.44 ± 0.20	-24.7 ± 0.20	-23.41 ± 0.20
ChCl:Gly	28009 ± 1690	14979 ± 857	8336 ± 511	-21.16 ± 0.81	-25.54 ± 0.86	-27.98 ± 0.86	-3.41 ± 0.95	2.48 ± 1.00	6.32 ± 1.01	-24.57 ± 0.20	-23.06 ± 0.20	-21.66 ± 0.20
ChCl:Xyl	37931 ± 2096	23414 ± 1344	-	-21.25 ± 0.77	-23.20 ± 0.84	-	-4.04 ± 0.91	-0.94 ± 0.98	-	-25.29 ± 0.20	-24.14 ± 0.20	-
ChCl:Sor	41796 ± 2183	25685 ± 1489	-	-21.63 ± 0.74	-22.22 ± 1.19	-	-3.88 ± 0.87	-2.13 ± 0.96	-	-25.52 ± 0.20	-24.35 ± 0.20	-
ChCl:But	5751 ± 673	2060 ± 475	768 ± 26	-20.47 ± 1.39	-25.85 ± 2.18	-26.08 ± 0.52	-0.29 ± 1.67	7.54 ± 2.74	10.15 ± 0.60	-20.76 ± 0.30	-18.30 ± 0.60	-15.93 ± 0.10
ChCl:Pro	13286 ± 1077	5904 ± 589	3604 ± 495	-18.93 ± 0.97	-22.15 ± 1.19	-23.68 ± 1.48	-3.84 ± 1.17	1.32 ± 1.43	4.04 ± 1.81	-22.77 ± 0.20	-20.83 ± 0.30	-19.65 ± 0.40
ChCl:Glu	40866 ± 2487	19870 ± 1522	-	-19.46 ± 0.82	-19.35 ± 1.00	-	-6.02 ± 0.96	-4.40 ± 1.18	-	-25.47 ± 0.20	-23.75 ± 0.20	-
ChCl:Fru	33940 ± 2327	15960 ± 143	-	-17.69 ± 0.83	-15.44 ± 0.09	-	-7.36 ± 0.99	-7.81 ± 0.11	-	-25.04 ± 0.20	-23.25 ± 0.10	-
Ethanol	3235 ± 254	3194 ± 383	151 ± 9*	-42.39 ± 0.75	-45.19 ± 2.84	-7.63 ± 2.91*	23.00 ± 0.93	25.84 ± 3.13	-4.41 ± 3.06*	-19.39 ± 0.20	-19.36 ± 0.30	-12.04 ± 0.20*

*The uncertainties were calculated after considering that there was no uncertainty in the CD and adamantanol concentrations.

Table S2- Thermodynamic parameters determined in water, in the different DES:water mixtures as well as in ethanol:water mixtures at 35 °C.

K (M⁻¹)		ΔH (KJ.mol⁻¹)			-TΔS (KJ.mol⁻¹)			ΔG (KJ.mol⁻¹)				
Water	21582 ± 284			-26.39 ± 0.06			0.83 ± 0.10			-25.56 ± 0.10		
Mixture	25 wt%	50 wt%	70 wt%	25 wt%	50 wt%	70 wt%	25 wt%	50 wt%	70 wt%	25 wt%	50 wt%	70 wt%
ChCl:U	20996 ± 1077	14474 ± 688	8423 ± 472	-27.81 ± 1.03	-28.32 ± 0.94	-28.02 ± 1.11	2.33 ± 1.16	3.78 ± 1.06	4.87 ± 1.25	-25.49 ± 0.20	-24.53 ± 0.20	-23.15 ± 0.20
ChCl:Gly	14884 ± 898	7355 ± 421	3774 ± 232	-26.91 ± 1.14	-27.86 ± 1.09	-32.17 ± 1.23	2.30 ± 1.30	5.05 ± 1.24	11.08 ± 1.38	-24.61 ± 0.20	-22.81 ± 0.20	-21.09 ± 0.20
ChCl:Xyl	20063 ± 1109	12172 ± 699	-	-27.18 ± 1.08	-26.73 ± 1.09	-	1.81 ± 1.23	2.64 ± 1.24	-	-25.37 ± 0.20	-24.09 ± 0.20	-
ChCl:Sor	21680 ± 1132	13449 ± 780	-	-28.02 ± 1.05	-26.66 ± 1.10	-	2.45 ± 1.18	2.31 ± 1.25	-	-25.57 ± 0.20	-24.35 ± 0.20	-
ChCl:But	3236 ± 378	1056 ± 243	371 ± 13	-22.93 ± 1.85	-24.72 ± 2.77	-28.52 ± 0.64	2.23 ± 2.16	6.89 ± 3.37	13.37 ± 0.73	-20.70 ± 0.40	-17.83 ± 0.70	-15.15 ± 0.10
ChCl:Pro	7441 ± 603	3138 ± 313	1891 ± 260	-24.72 ± 1.44	-25.61 ± 1.67	-24.98 ± 1.97	1.88 ± 1.64	4.98 ± 1.92	5.65 ± 2.33	-22.84 ± 0.30	-20.63 ± 0.30	-19.33 ± 0.40
ChCl:Glu	22616 ± 1376	11391 ± 872	-	-25.55 ± 1.16	-23.15 ± 1.32	-	-0.13 ± 1.32	-0.77 ± 1.52	-	-25.68 ± 0.20	-23.92 ± 0.20	-
ChCl:Fru	19279 ± 1322	9402 ± 84	-	-25.89 ± 0.26	-25.87 ± 0.04	-	0.62 ± 0.44	2.44 ± 0.06	-	-25.27 ± 0.20	-23.43 ± 0.10	-
Ethanol	746 ± 59	875 ± 180	108 ± 6*	-69.62 ± 2.16	-63.97 ± 1.91	-18.34 ± 9.62*	52.68 ± 2.36	46.62 ± 2.44	6.35 ± 9.76*	-16.94 ± 0.30	-17.35 ± 0.60	-11.99 ± 0.20*

*The uncertainties were calculated after considering that there was no uncertainty in the CD and adamantanol concentrations.

Table S3- Thermodynamic parameters determined in the different components:water 25:75 wt% at 15, 25 and 35 °C.

	K (M ⁻¹)			ΔH (KJ.mol ⁻¹)			$-T\Delta S$ (KJ.mol ⁻¹)			ΔG (KJ.mol ⁻¹)		
	15 °C	25 °C	35 °C	15 °C	25 °C	35 °C	15 °C	25 °C	35 °C	15 °C	25 °C	35 °C
ChCl	29640 ± 2303	23243 ± 1806	17564 ± 1365	-17.13 ± 0.94	-19.93 ± 1.13	-22.90 ± 1.36	-7.58 ± 1.13	-4.98 ± 1.32	-2.13 ± 1.56	-24.71 ± 0.20	-24.91 ± 0.20	-25.03 ± 0.20
U	40657 ± 1852	28898 ± 1316	20029 ± 912	-25.02 ± 0.72	-26.96 ± 0.81	-29.03 ± 0.93	-0.45 ± 0.83	1.51 ± 0.93	3.66 ± 1.05	-25.47 ± 0.20	-25.45 ± 0.20	-25.37 ± 0.20
Gly	23362 ± 1245	16777 ± 894	11640 ± 620	-23.23 ± 0.75	-26.13 ± 0.89	-29.19 ± 1.07	-0.89 ± 0.88	2.03 ± 1.02	5.21 ± 1.21	-24.12 ± 0.20	-24.10 ± 0.20	-23.98 ± 0.20
Xyl	32893 ± 1689	23639 ± 1214	16687 ± 857	-23.01 ± 0.75	-25.77 ± 0.14	-28.56 ± 0.17	-1.94 ± 0.87	0.80 ± 0.27	3.66 ± 0.30	-24.95 ± 0.20	-24.97 ± 0.20	-24.90 ± 0.20
Sor	46775 ± 2176	33553 ± 1561	23473 ± 1092	-23.40 ± 0.71	-26.15 ± 0.82	-29.00 ± 0.96	-2.40 ± 0.82	0.32 ± 0.94	3.22 ± 0.94	-25.80 ± 0.20	-25.83 ± 0.20	-25.77 ± 0.20
But	2894 ± 445	2048 ± 315	1415 ± 218	-24.92 ± 1.46	-27.11 ± 1.77	-29.41 ± 2.26	5.80 ± 1.83	8.22 ± 2.16	10.83 ± 2.66	-19.12 ± 0.40	-18.89 ± 0.40	-18.58 ± 0.40
Pro	5219 ± 555	3834 ± 407	2749 ± 292	-21.70 ± 1.19	-24.33 ± 1.45	-27.04 ± 1.82	1.16 ± 1.45	3.87 ± 1.71	6.76 ± 2.09	-20.53 ± 0.30	-20.45 ± 0.30	-20.28 ± 0.30
Glu	64115 ± 2451	44359 ± 1696	30117 ± 1151	-25.40 ± 0.63	-28.38 ± 0.72	-31.40 ± 0.84	-1.13 ± 0.72	1.86 ± 0.82	4.99 ± 0.94	-26.53 ± 0.10	-26.52 ± 0.10	-26.41 ± 0.10
Fru	35133 ± 2235	26549 ± 1689	19459 ± 1238	-18.94 ± 0.81	-22.47 ± 0.20	-26.04 ± 0.23	-6.17 ± 0.97	-2.79 ± 0.35	0.74 ± 0.39	-25.11 ± 0.20	-25.26 ± 0.20	-25.29 ± 0.20

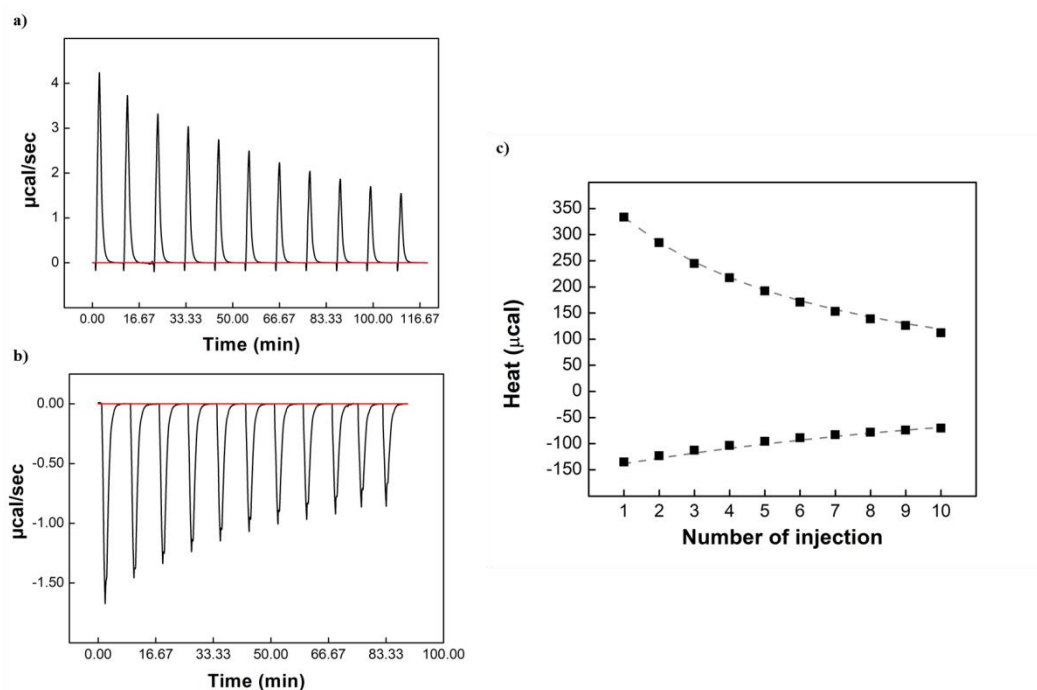

Figure S1: Typical isothermal titration calorimetry data obtained for the binding interaction of β -CD and adamantanol in ChCl:But DES:water 70:30 wt% at 25 °C with a) the thermogram presenting the endothermic heat consumed upon injection of mixture on the complex (release experiment) and b) the thermogram presenting the exothermic heat releases upon injection of CD unto adamantanol (titration experiment) and c) the isotherms presenting the integrated heat data; the dashed curves corresponds to the theoretical curves.

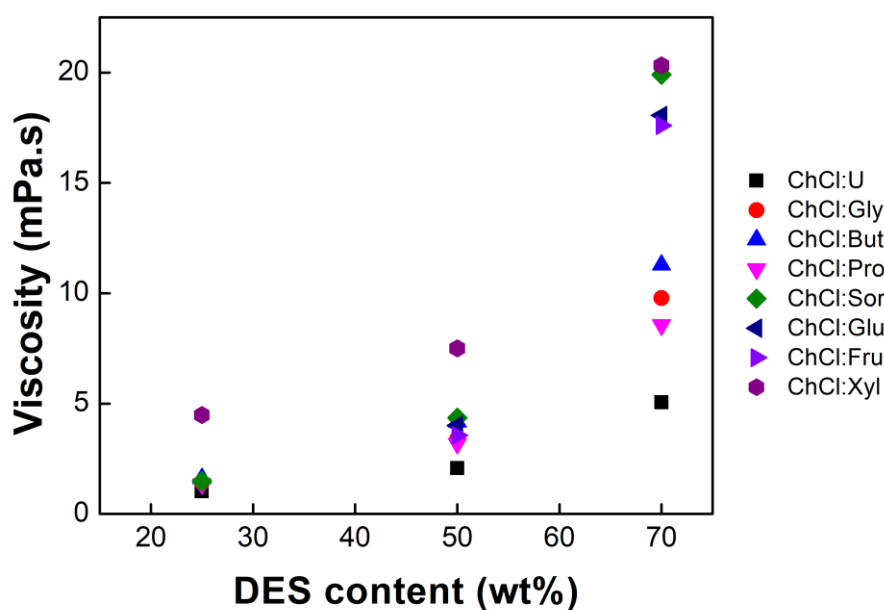

Figure S2: Viscosity variation as function of the different DESs content (wt%) in water, at 30 °C.

CHAPITRE 9

Analyse et discussion

Analyse et discussion

Dans l'objectif de trouver de nouvelles formulations pour la solubilisation de molécules naturelles qui respectent les principes de la chimie verte, nous avons choisi de combiner les DESs, l'eau et les CDs et d'évaluer leur potentiel *vis-à-vis* d'huiles essentielles et d'arômes.

Les chapitres 5 à 8 ont ainsi présenté nos méthodologies et résultats, sous la forme de quatre articles.

Le chapitre 5 avait pour but de trouver une formulation optimale combinant DES, eau et CDs pour la solubilisation de l'huile essentielle *E. citriodora*, choisie comme modèle dans ce projet de thèse. Les caractérisations physico-chimiques et les résultats de volatilité obtenus pour cet article sont illustrés dans la **Figure 1**.

L'objectif du chapitre 6 était d'explorer l'influence de modifications chimiques des CDs sur la solubilisation de l'huile essentielle modèle, en s'appuyant sur la formulation optimale obtenue au chapitre 5. Ce travail s'articule notamment autour de la synthèse et de la caractérisation des polymères de CDs ainsi que de l'étude de leur capacité de solubilisation de l'huile essentielle *E. citriodora* au sein de la formulation définie. Les résultats obtenus sont résumés dans la **Figure 2**.

Le but du chapitre 7 était d'utiliser la formulation optimale pour étudier la solubilité de vingt-et-un arômes et de vingt huiles essentielles, en insistant sur la mise en évidence et la caractérisation de la complexation par les CDs des arômes individuels constituant les huiles essentielles. La **Figure 3** synthétise l'ensemble des résultats obtenus.

En dernier lieu, le chapitre 8 visait à mieux comprendre ces mécanismes de complexation, par l'étude thermodynamique de l'interaction du système β -CD/adamantanol, en tant que complexe modèle, au sein de ces nouvelles formulations. Les principales conclusions sont rassemblées dans la **Figure 4**.

I. Caractérisation physico-chimique

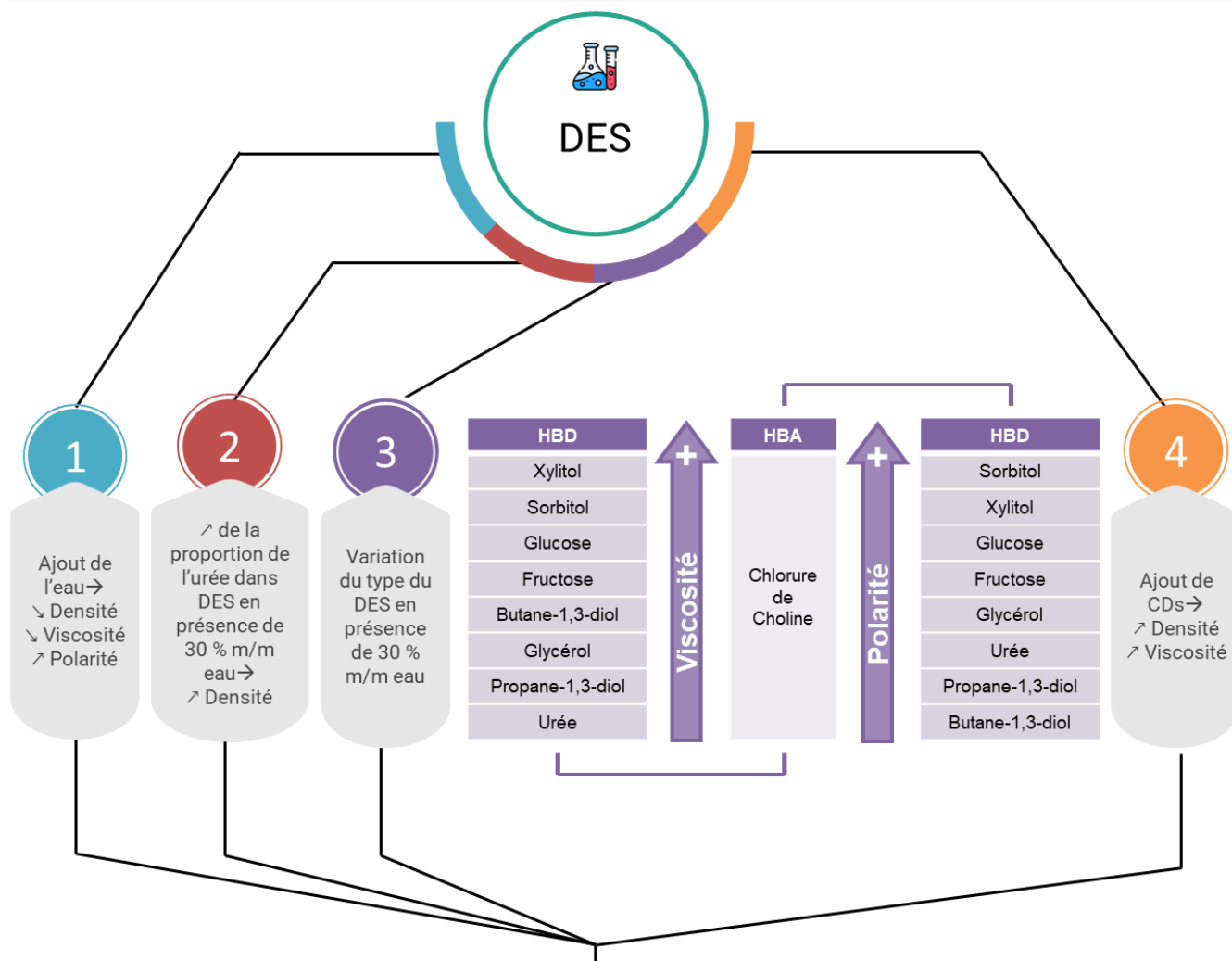

II. Espace de tête-statique - chromatographie en phase gazeuse

Mesure de la volatilité d'E. *citriodora* Détermination du K_f et K du citronellal

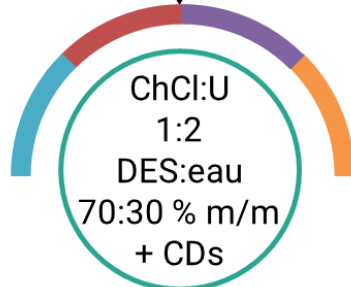

Formulation optimale

→ Volatilité réduite
45x par rapport à l'eau

Figure 1: Résumé des résultats obtenus dans l'article : 'Choline chloride based-deep eutectic solvents:water:cyclodextrins mixtures for the entrapment and the solubilization of volatile molecules: application to *Eucalyptus citriodora* essential oil and citronellal'.

➤ Synthèse et caractérisation des polymères de CDs

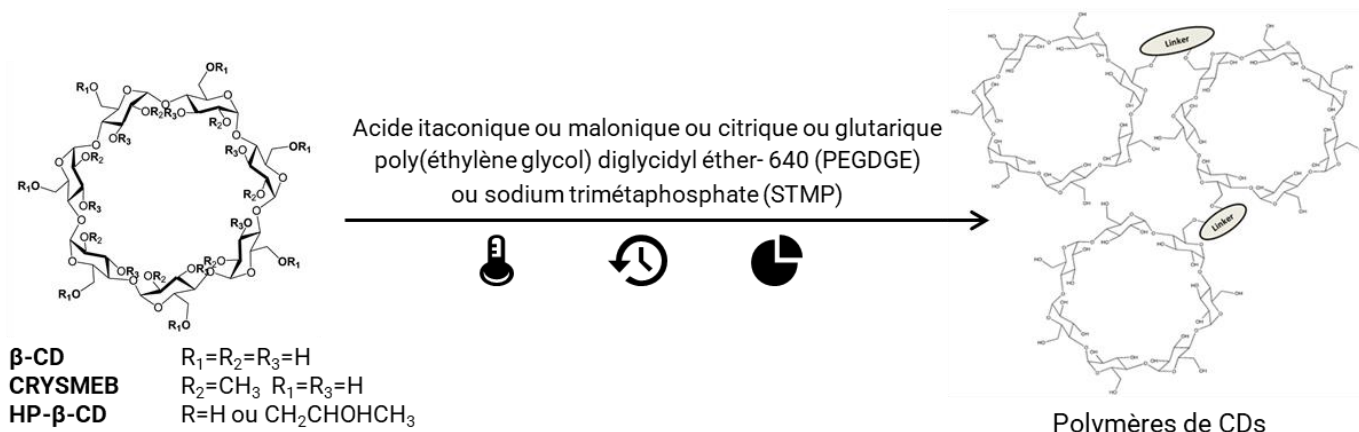

- Preuve d'obtention de polymères**
1. 1H -RMN → signaux élargis → perte de la symétrie de CDs
 2. ^{13}C -RMN → pic à 170 ppm → fonction ester
 3. ^{13}P -RMN → pas de pic à -21 ppm caractéristique de Pi
 4. IR → pics à 1700 cm^{-1} → bande d'étirement d'ester
 5. Chromatographie par perméation de gel → hétérogénéité des polymères

➤ Mesure de la volatilité d'*E. citriodora*

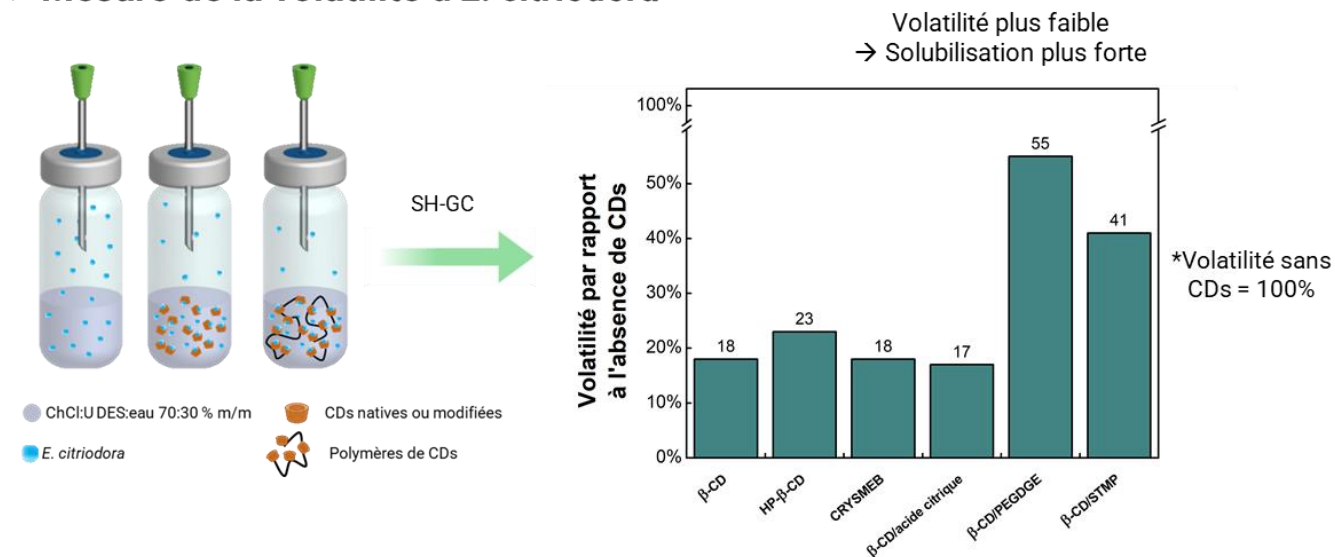

Pas d'amélioration significative de la capacité de complexation des polymères par rapport à la β-CD

Figure 2: Représentation résumant les résultats obtenus pour l'article : 'Cyclodextrins polymers in deep eutectic solvent:water mixture: Solubilization study of Eucalyptus citriodora essential oil'.

1 CD/arômes

β-CD/(R)-(-)-verbénone

ROESY et DOSY RMN

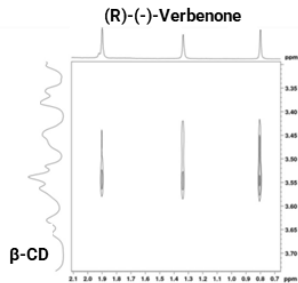

Corrélations entre H de verbénone et H de β-CD

Coefficients de diffusion après complexation

SH-GC

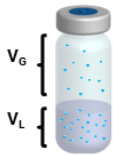

Eau ou ChCl:U DES:eau 70:30 % m/m ± CDs

Coefficients de partage: $K_{DES+CD} < K_{DES} < K_{eau}$

α-CD/camphre

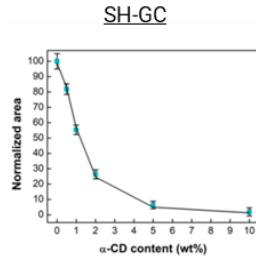
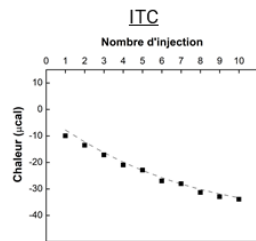

Preuve de formation d'un complexe 2/1

Vingt arômes

SH-GC



Différents [CDs] dans ChCl:U DES:eau 70:30 % m/m + arômes

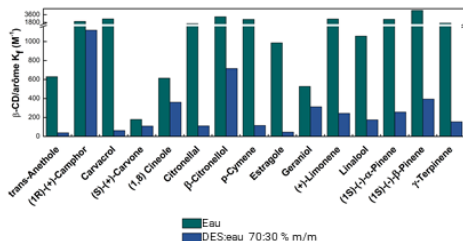

Formation systématique de complexes $K_{f(DES:eau)} < K_{f(eau)}$

2 CD/huiles essentielles

SH-GC

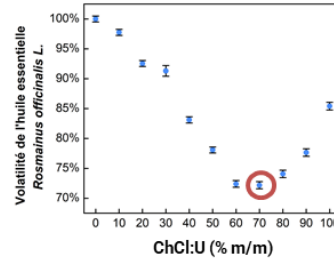

Formulation optimale pour la solubilisation d'une huile essentielle modèle

20 huiles essentielles

ChCl:U DES pure + 10 % m/m HP-β-CD

ChCl:U DES:eau 70:30 % m/m + 10 % m/m HP-β-CD

Volatilité

>

Volatilité

DES:eau 70:30 % m/m + CDs est plus efficace

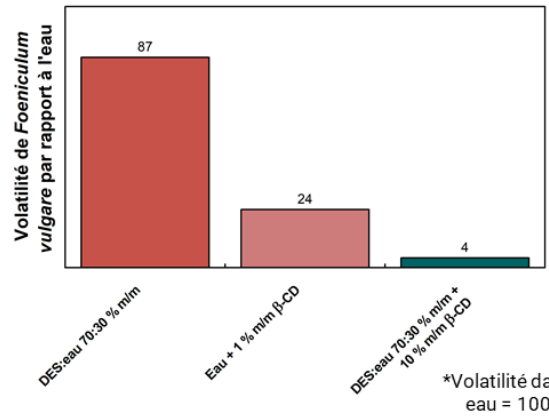

Solubilité plus élevée de β-CD dans la formulation DES:eau que dans l'eau

Réduction typique de la volatilité des huiles essentielles dans les différents milieux → Avantage d'utiliser DES:eau:CD

Figure 3: Représentation résumant les résultats obtenus dans l'article : 'Solubilization of a plethora of essential oils and aromas in choline chloride:urea deep eutectic solvent:cyclodextrins:water mixtures'.

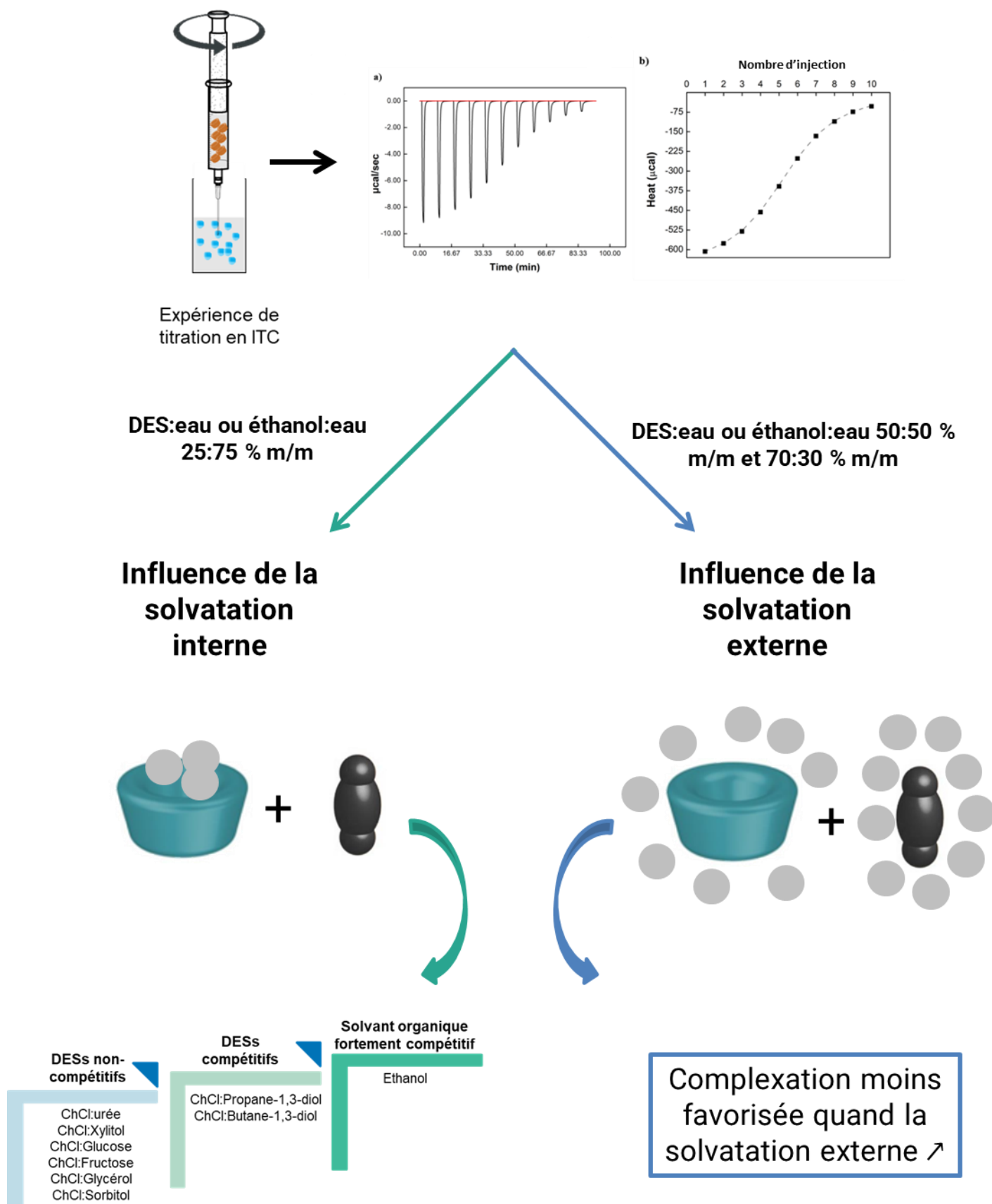

Figure 4: Représentation résumant les résultats obtenus dans l'article : *'Thermodynamic investigations on host/guest interactions between β -cyclodextrin and adamantanol in deep eutectic solvent:water mixtures'*.

Le point de départ de notre travail était de préparer un vaste panel de formulations DES:eau en faisant varier la proportion d'eau, le ratio molaire des constituants du DES et la nature du donneur de liaison hydrogène, et ce en l'absence et en la présence de CDs.

La caractérisation physico-chimique des formulations a été étudiée. En fait, la viscosité, la densité et la polarité varient en fonction de la composition chimique de la formulation (chapitre 5). Ainsi, l'augmentation de la proportion de l'eau dans des formulations de chlorure de choline:urée DES:eau a induit la diminution de la densité et de la viscosité de la formulation tout en augmentant sa polarité, ce qui a été rapporté dans la littérature d'une façon similaire (Dai et al., 2013, 2015). De même, l'augmentation de la proportion de l'urée dans le DES en présence d'une certaine quantité de l'eau a abouti à l'augmentation de la densité. De plus, la préparation de différents types de DES dans la proportion DES:eau 70:30 % (m/m) nous a amené à obtenir des mélanges avec des propriétés physico-chimiques différentes dépendantes de la nature du donneur de liaison hydrogène utilisé, y compris leurs viscosités et leurs polarités, en accord avec la littérature (Zhang et al., 2012; Cunha & Fernandes, 2018). L'ajout de CDs aux formulations augmente la densité et la viscosité de ces dernières (chapitre 5).

Le pouvoir solubilisant de ces formulations a ensuite été évalué pour les huiles essentielles modèles *E. citriodora* (chapitre 5) et *R. officinalis* (chapitre 7), en l'absence et en la présence d'HP- β -CD. La première information recueillie est que la présence de CDs améliore considérablement la solubilisation de ces huiles modèles. Cela a été révélé par des mesures de volatilité *via* la technique d'espace de tête-statique couplée à la chromatographie en phase gazeuse.

Il a par ailleurs été montré qu'en présence de CDs, l'apport d'une certaine proportion d'eau (30 % (m/m)) permet une rétention optimale de ces huiles essentielles (volatilité d'*E. citriodora* 45 fois moins importante dans la formulation DES:eau:CD optimale que dans l'eau en absence de CDs). Le pouvoir de solubilisation résulte ainsi à la fois de la polarité des formulations DES:eau et de la force de complexation des CDs. La diminution de la polarité du mélange entraîne en effet une diminution de la volatilité des huiles essentielles, conformément à la littérature (Cao et al., 2020). L'accroissement du phénomène de complexation conduit également à une réduction de la volatilité de l'huile essentielle. Néanmoins, la réduction de la polarité du milieu s'accompagnant plutôt d'une réduction des

capacités d'inclusion des CDs, nous observons donc une compensation entre ces deux mécanismes, résultant en la nécessité de la présence d'une proportion optimale d'eau.

Dans ce cadre, la réduction de la volatilité a par ailleurs été quantifiée par des mesures de coefficients de partage (K) du citronellal (composant majeur d'*E. citriodora*) (chapitre 5) et de la verbénone (composant majeur de *R. officinalis*) (chapitre 7). La valeur K du citronellal dans le mélange chlorure de choline:urée DES:eau 70:30 % (m/m) est environ 3 fois plus faible que dans l'eau, ce qui confirme la tendance observée dans la littérature pour d'autres composés volatils (Moura et al., 2017). En présence de 2 % (m/m) de β -CD et de 10 % (m/m) d'HP- β -CD, respectivement, les valeurs de K deviennent de 27 et 41 fois inférieures par rapport au même mélange chlorure de choline:urée DES:eau 70:30 % (m/m) en absence de CDs.

L'importance de l'ajout de l'eau a été généralisée pour une large gamme d'huiles essentielles, en comparant leur volatilité dans le DES pur incorporant 10 % (m/m) d'HP- β -CD et dans la formulation chlorure de choline:urée DES:eau 70:30 % (m/m) en présence de la même quantité de CDs (chapitre 7). Le fait d'observer une réduction de la volatilité en présence de 30 % (m/m) d'eau confirme ainsi l'effet positif de la présence d'eau dans le DES lorsque les CDs sont employées.

Il est important de noter que l'ajout d'un faible pourcentage d'eau au DES choline:urée DES s'accompagne également d'une diminution spectaculaire de la viscosité de la formulation (chapitre 5). Ceci est en accord avec la littérature où les auteurs ont montré une diminution de la viscosité d'autres DESs lors de l'augmentation de la quantité d'eau (Dai et al., 2013). Cette réduction de viscosité nous a permis de mener des expériences de calorimétrie de titration isotherme sur les complexes, en milieu DES:eau (chapitre 8), ce qui aurait été impossible en milieu DES en l'absence d'eau. L'apport de l'eau, dans le cadre d'une application potentielle d'une telle formulation, doit donc aussi être évalué en fonction du bénéfice éventuellement apporté par la réduction de viscosité.

La variation du type de DES, *via* l'association de différents donneurs de liaison hydrogène au chlorure de choline, a constitué un deuxième paramètre dont nous avons évalué l'influence sur la solubilisation de l'huile essentielle *E. citriodora*, (chapitre 5). Si certains donneurs de liaison hydrogène ont conduit à une réduction de la polarité du solvant DES:eau en l'absence de CDs avec une influence favorable sur le pouvoir de solubilisation, le chlorure de

choline:urée DES:eau 70:30 % (m/m) a démontré un pouvoir de solubilisation maximale en présence de 10 % (m/m) d'HP- β -CD (notamment un pouvoir de solubilisation 3 fois plus élevé qu'en utilisant le butane-1,3-diol à la place d'urée). Ce constat a pu être rationalisé par les mesures en calorimétrie de titration isotherme (chapitre 8), qui ont montré que le DES chlorure de choline:urée était le DES affectant le moins la formation des complexes d'inclusion parmi les DES étudiés, sur la base de la complexation modèle β -CD/adamantanol.

Le troisième paramètre de la formulation qui a été évalué pour son influence sur le pouvoir de solubilisation d'*E. citriodora* est le ratio molaire chlorure de choline/urée en présence de 30 % (m/m) d'eau (chapitre 5). Il a été démontré que le ratio molaire eutectique chlorure de choline:urée 1:2 était situé dans la zone de solubilisation optimale, celle-ci étant néanmoins assez large, puisque toute proportion d'urée supérieure à l'eutectique conduit à une réduction de volatilité satisfaisante. L'idée selon laquelle les forces impliquées dans la formation de l'eutectique pourrait s'opposer à la solvataion des solutés n'est donc ici pas démontrée (il faut toutefois garder en tête que la présence d'eau écarte le mélange du concept de composition eutectique).

L'influence du type de CD utilisée dans la formulation a également été explorée, notamment avec la préparation de différents polymères de CD native (β -CD) et de CDs modifiées (HP- β -CD et CRYSMEB), avec divers agents réticulants (acide citrique, acide malonique, acide glutarique, acide itaconique, sodium trimétaphosphate et polyéthylène glycol diglycidyl éther). Si toutes les CDs étudiées ont un impact positif sur le pouvoir solubilisant de la formulation *vis-à-vis* d'*E. citriodora*, nous n'avons pas constaté d'amélioration significative dans le cas des CDs polymérisées par rapport aux CDs monomériques, lors de l'emploi de concentrations élevées en CDs (chapitre 6). Les différences entre CDs monomériques sont également limitées ; néanmoins, l'efficacité d'une CD au sein d'une formulation à base de DES reste conditionnée par la solubilité de la CD elle-même, et les modifications chimiques de ces macrocycles peuvent alors constituer un avantage.

Comme cela a été évoqué lors de la variation des paramètres eau, nature du DES et ratio molaire des deux partenaires du DES, la présence de CDs présente un impact considérable et positif sur la volatilité observée, impact d'ailleurs plus important que pour les trois premiers paramètres. La mise en évidence et la caractérisation des phénomènes d'inclusion a donc constitué un volet important de cette thèse.

Une première preuve de ces phénomènes de complexation a été apportée par la diminution exponentielle de la volatilité d'*E. citriodora* et de son constituant principal, le citronellal, lors de la variation de la proportion en β -CD et d'HP- β -CD dans un mélange chlorure de choline:urée (1:2) DES:eau 70:30 % (m/m) (chapitre 5). L'analyse des données a en effet montré que cette variation était compatible avec un modèle de complexation de stœchiométrie 1/1. Il a également été constaté que la présence de 2 % (m/m) en CDs était suffisante pour avoir une complexation totale des composants de l'huile, dans les conditions de l'expérience.

Des preuves de complexation ont par ailleurs été apportées par la mise en œuvre d'expériences en RMN ROESY, avec l'observation notamment de proximités spatiales entre les protons de la verbénone et les protons de la β -CD dans le milieu chlorure de choline:urée DES:eau 70:30 % (m/m) de manière semblable à ce qui est obtenu avec un DES pur (El Achkar et al., 2020) (chapitre 7). La détermination de la constante de formation du complexe a d'ailleurs pu être déterminée suite à des expériences RMN DOSY, sur la base de la variation des coefficients de diffusion de la verbénone et de la CD (chapitre 7).

Le phénomène d'inclusion dans des formulations DES:eau a enfin été souligné sous un angle thermodynamique par le biais d'expériences de calorimétrie de titration isotherme, dans le cas des arômes verbénone et camphre avec la β -CD (chapitre 7) et de la complexation modèle β -CD/adamantanol (chapitre 8).

Si une stœchiométrie 1/1 a été majoritairement observée pour les arômes constituant les huiles essentielles, l'obtention d'un complexe 2/1 pour le camphre au sein d'un mélange DES:eau constitue une première dans la littérature (chapitre 7).

Au-delà de la stœchiométrie, la détermination des constantes de formation des complexes est un élément central d'appréciation des mécanismes qui se mettent en place au sein des formulations, et l'on retrouve donc ces déterminations d'affinité dans l'ensemble de notre travail. Sur un plan méthodologique, les méthodes employées semblent donner des résultats robustes, puisque l'utilisation de la RMN, de la calorimétrie de titration isotherme et de la technique d'espace de tête-couplée à une chromatographie gazeuse, a donné des valeurs similaires pour la constante de formation du complexe β -CD/verbénone au sein de la formulation optimale (320, 253 et 177 M⁻¹, respectivement) (chapitre 7). En conséquence, des constantes de formation ont pu être évaluées pour un large panel d'arômes (vingt-et-un) avec

la β -CD et l'HP- β -CD (chapitres 5 et 7). Le système modèle β -CD/adamantanol a également permis d'évaluer l'évolution des affinités en fonction de la nature et de la proportion des DESs employées dans les formulations (chapitre 8). L'ensemble des résultats a montré l'existence systématique d'une affinité hôte/invité dans les divers mélanges DES:eau, mais avec une tendance à la diminution quand on compare à l'eau seule, et qui est dépendante des constituants du DES. L'aptitude à la complexation est donc préservée au sein des milieux DES:eau, tout en étant moins intense.

Partant de ce constat, nous avons décidé d'étudier les mécanismes thermodynamiques impliqués dans différents DESs, en utilisant la variation de la proportion DES:eau pour décomposer les différents phénomènes, à partir de la complexation modèle β -CD/adamantanol (chapitre 8). Ainsi, les résultats obtenus (ΔG) pour une proportion DES:eau 25:75 % (m/m) conduisent à des résultats analogues à l'eau pour six différents DESs (à base de chlorure de choline associée à: urée, glycérol, xylitol, sorbitol, glucose et fructose). Nous pouvons donc en conclure que de tels mélanges ne constituent que des solutions 'DESs dans l'eau' sans interférence des constituants du DES avec la cavité des CDs. Plus précisément, l'interaction des constituants du DES avec l'intérieur de la cavité semble ne pas être significativement différente de l'interaction eau-cavité, pour ces six DESs que l'on peut qualifier de non-compétitifs. Au contraire, les deux formulations à base de 25 % (m/m) de chlorure de choline:butane-1,3-diol ou de chlorure de choline:propane-1,3-diol ont conduit à une diminution de l'affinité, ce qui laisse penser que le propane-1,3-diol et le butane-1,3-diol interagissent avec la cavité (faiblement mais significativement plus que l'eau). Les deux DESs correspondants sont donc catégorisés en tant que DESs compétitifs. A titre de comparaison, une très large variation de tous les paramètres thermodynamiques a été observée pour l'introduction de 25 % (m/m) d'éthanol dans l'eau, avec une réduction drastique de l'affinité du système modèle (une valeur de constante de formation 18 fois plus réduite en présence de 25 % (m/m) d'éthanol qu'avec l'eau pure à 25 °C). Un tel solvant organique peut donc être considéré comme hautement compétitif *vis-à-vis* de l'intérieur du macrocycle, conformément à ce qui a été prouvé dans la littérature (Horský & Walterová, 2003; García-Río et al., 2006; Yoshikiyo et al., 2012).

L'augmentation de la proportion en DES vers des valeurs de 50 et 70 % (m/m) nous a ensuite permis de juger des phénomènes apparaissant lorsque l'on évolue vers un milieu du type 'eau dans DESs'. A ce stade, les constituants du DES commencent à se comporter en tant que

solvant, de fait impliqué dans la solvataion externe des solutés (β -CD et adamantanol). Tous les DESs étudiés ont conduit à une diminution de l'affinité entre les partenaires d'interaction, cette tendance augmentant avec la proportion de DES.

Ce phénomène s'accompagne d'une origine de la complexation qui reste par contre largement enthalpique : l'adamantanol étant parfaitement encapsulé dans la cavité de la CD, on observe de manière concomitante une forte interaction hôte/invité et une perte substantielle de degré de liberté entre les partenaires. La compensation enthalpie-entropie se retrouve d'ailleurs très largement dans l'évolution de $T\Delta S$ en fonction de ΔH sur l'ensemble des formulations et températures étudiées.

Au-delà de ce mécanisme de compensation, on observe qu'avec l'augmentation de la proportion de DES, l'entropie s'oppose de plus en plus à l'inclusion, et que la variation des capacités calorifiques se rapproche de plus en plus d'une valeur nulle (alors qu'elle est fortement négative dans l'eau pure). Ces tendances observées pour les termes ΔS et ΔC_p sont typiques d'un apport moindre des forces solvatophobes aux phénomènes d'interaction. Nous pouvons donc en conclure que la solvataion plus favorable des espèces par le DES, et notamment de la molécule invitée (ce qui avait été observé indirectement par la réduction de volatilité des arômes dans un milieu DES:eau par rapport à l'eau seule), se traduit par une moindre propension des partenaires à interagir entre eux.

A contrario, la très forte opposition constatée à 25 % (m/m) en éthanol, entre les contributions enthalpique et entropique, s'atténue considérablement avec le passage à 50 et 70 % (m/m), confirmant ainsi la nécessité de distinguer solvataion interne de la CD et solvataion externe des deux partenaires, en termes d'influence sur la complexation. En ce sens, l'eau présente une plus grande similitude thermodynamique avec les différents DESs étudiés dans ce travail, qu'avec des solvants organiques tels que l'éthanol. Ce constat pourrait expliquer le principal résultat de cette thèse, à savoir un caractère général de la capacité d'inclusion des CDs au sein de systèmes à base de DESs, alors qu'au contraire les phénomènes d'inclusion les impliquant sont excessivement rares au sein des solvants organiques.

CONCLUSIONS GÉNÉRALES ET PERSPECTIVES

Conclusions générales et perspectives

L'objectif de cette thèse était d'explorer les propriétés de solubilisation de solutions combinant DESs, eau et CDs. Diverses formulations ont ainsi été préparées à partir de chlorure de choline associée à un panel de différents donneurs de liaison hydrogène, en faisant varier le ratio entre les partenaires du DES, la teneur en eau, ainsi que la teneur et la nature des CDs. Les préparations, d'abord caractérisées en termes de viscosité, densité et polarité, ont ensuite été testées pour leur capacité à réduire la volatilité d'une large gamme d'huiles essentielles et d'arômes les composant. Ces mesures ont été réalisées par le biais de la technique d'espace de tête-statique couplée à la chromatographie en phase gazeuse. Des expériences de résonance magnétique nucléaire ainsi que de calorimétrie de titration isotherme ont complétés les mesures chromatographiques.

Parmi les différents paramètres étudiés, cette étude a confirmé que le levier le plus important en termes de solubilisation réside dans l'utilisation de CDs au sein de la formulation.

Si l'apport de ces macrocycles pour solubiliser des molécules hydrophobes est connu pour être effectif avec l'immense majorité des molécules organiques en solution aqueuse, à contrario, l'observation de complexes de CDs dans d'autres milieux reste exceptionnelle, l'inclusion du cholestérol au sein de CDs dans le diméthylsulfoxyde faisant ainsi quasiment figure d'exception. Les expériences de calorimétrie de titration isotherme menées dans cette thèse sur le système β -CD/adamantanol ont en outre montré qu'un solvant comme l'éthanol vient solvater de manière préférentielle, relativement à l'eau, l'intérieur de la cavité. Ce phénomène, défavorable à des mécanismes de complexation et que l'on peut observer isolément à basse teneur en éthanol, se voit complété à forte teneur en solvant organique par la meilleure solvation des molécules invitées potentielles, par rapport à celle observée dans l'eau.

A l'opposé, nos investigations menées dans le cas des DESs montrent que certains peuvent se révéler à la fois parfaitement neutre *vis-à-vis* de la cavité (constituants non ou peu compétitifs) et moyennement solvantant *vis-à-vis* des molécules invitées. Ce constat explique pourquoi toutes les molécules organiques testées au sein de DESs, dans notre équipe de recherche et notamment au cours de cette thèse, ont pu bénéficier de mécanismes de complexation. Après l'eau, les DESs constituent donc une nouvelle classe de solvants

conduisant à des capacités d'inclusion relativement universelles pour les CDs. La signature thermodynamique de la complexation reste d'ailleurs majoritairement enthalpique dans ces milieux.

Cette versatilité des cavités de CDs au sein de solutions de DESs a ainsi été vérifiée pour vingt-et-un arômes. La stœchiométrie des complexes observée dans l'eau y est par ailleurs conservée dans ces milieux. Notamment, l'association quasi exclusive d'une molécule de camphre avec deux molécules d' α -CD a en effet été confirmée en présence de chlorure de choline:urée, ce qui constitue, à notre connaissance, la première observation d'une stœchiométrie supérieure à 1/1 dans ce type de milieu.

Comme la solubilisation d'une huile essentielle peut s'expliquer sur la base de celle de ces constituants, le caractère universel de la complexation par les CDs *vis-à-vis* des arômes au sein des DESs conduit mécaniquement à la versatilité de la solubilisation des huiles dans ces mêmes milieux, ce que nous avons pu confirmer pour vingt huiles essentielles.

Néanmoins, nous avons également pu constater que les DESs utilisés seuls conduisent de manière générale à une solvataion plus efficace des molécules invitées potentielles, ce qui contribue simultanément à une réduction de la volatilité des espèces de manière directe mais également à une réduction de la force de complexation des CDs *vis-à-vis* de ces molécules. La formulation DES:eau est donc le siège de deux mécanismes qui s'opposent, expliquant de fait que les résultats optimaux sont obtenus pour une teneur en eau non nulle, de l'ordre de 30 % (m/m) dans le cadre des expériences menées dans cette thèse.

Nos études ont également montré que la composition eutectique n'était ni favorable ni défavorable au processus de solubilisation, et que ce sont principalement les caractéristiques individuelles des constituants du DES qui gouvernent l'efficacité de la formulation pour une teneur en eau et CDs donnée. Des donneurs de liaison hydrogène tels que le butane-1,3-diol ou le propane-1,3-diol ont ainsi présenté des mécanismes compétitifs les rendant moins efficaces au sein de nos formulations. Des composés comme le glucose ont par ailleurs donné des résultats bien plus satisfaisants. Enfin, l'urée s'est révélée être le meilleur partenaire du chlorure de choline lors de nos investigations.

La concentration en CDs s'est évidemment avérée un paramètre essentiel pour accroître le pouvoir solubilisant de nos formulations, ce qui était parfaitement attendu de par les mécanismes de complexation mis en évidence et de par ce qui avait déjà été observé dans

l'eau seule. A concentration élevée en CDs, la nature de la CD a par contre peu d'influence, y compris pour un large panel de polymères de CDs que nous avons synthétisés dans le cadre de ce travail.

En résumé, cette thèse a pu montrer qu'une formulation associant 70 % de DES de type chlorure de choline:urée à 30 % d'eau (m/m), en présence de β -CD native ou modifiée aléatoirement, constituait une solution optimale en termes de réduction de volatilité de l'huile essentielle *E. citriodora*. Cette formulation peut en outre s'appliquer avec tout autant d'efficacité pour une large gamme d'huiles essentielles. De par le caractère général des mécanismes d'inclusion que nous avons pu mettre en exergue, nous pouvons penser qu'une telle formulation pourrait donner des résultats satisfaisants pour la plupart des problématiques de molécules hydrophobes.

Enfin, comme le caractère optimal de la formulation présente néanmoins une dépendance modérée à la teneur en eau (de par la compensation des phénomènes d'inclusion et de solvation) et que divers constituants de DESs ont montré une efficacité encourageante, l'un des enseignements forts de cette thèse est qu'il sera également possible de moduler les propriétés physico-chimiques (viscosité, densité, ...) de ce type de formulation pour la rendre compatible avec les diverses applications qui pourraient être envisagées.

Sur la base de ce travail, des investigations futures peuvent être proposées :

- Etude des capacités de complexation et de relargage des CDs pour un large panel de principes actifs (notamment des médicaments comme les anti-inflammatoires...) au sein des formulations DES:eau.
- Investigation des efficacités d'encapsulation d'autres classes d'agent encapsulant (liposomes, dendrimères...) pour des molécules d'intérêts dans des formulations de type DES:eau.
- Poursuite des études fondamentales de calorimétrie de titration isotherme sur la thermodynamique des mécanismes d'inclusion dans les systèmes DES:eau, en passant d'une molécule invitée modérément polaire comme l'adamantanol à des molécules apolaires (tert-butylbenzène) ou ioniques (ibuprofène).

VALORISATION SCIENTIFIQUE

Valorisation scientifique

Liste des publications

Chapitre d'ouvrage

1. Nakhle Lamia, Kfoury Miriana, Mallard Isabelle, Landy David, & Greige-Gerges H el ene. *Methods for Extraction of Bioactive Compounds from Plant and Animal Matter Using Deep Eutectic Solvents*. Environmental Chemistry for a Sustainable World, 56, 183-240, 2021a. https://doi.org/10.1007/978-3-030-53069-3_6

Articles

2. Nakhle Lamia, Kfoury Miriana, Mallard Isabelle, Landy David, & Greige-Gerges H el ene. *Microextraction of bioactive compounds using deep eutectic solvents: A review*. Environmental Chemistry Letters, 2021b. <https://doi.org/10.1007/s10311-021-01255-2>

3. Nakhle Lamia, Kfoury Miriana, Mallard Isabelle, Greige-Gerges H el ene, Landy David. *Deep eutectic solvents for the solvation of natural molecules. (  soumettre)*

4. Nakhle Lamia, Kfoury Miriana, Mallard Isabelle, Greige-Gerges H el ene, Landy David. *Encapsulation of essential oils and their components in cyclodextrins. (  soumettre)*

5. Nakhle Lamia, Kfoury Miriana, Mallard Isabelle, Greige-Gerges H el ene, Landy David. *Choline chloride based-deep eutectic solvents:water:cyclodextrins mixtures for the entrapment and the solubilization of volatile molecules: application to Eucalyptus citriodora essential oil and citronellal. (soumis au journal 'Food Chemistry')*

6. Nakhle Lamia, Kfoury Miriana, Mallard Isabelle, Greige-Gerges H el ene, Landy David. *Cyclodextrins polymers in deep eutectic solvent:water mixture: Solubilization study of Eucalyptus citriodora essential oil. (  soumettre)*

7. Nakhle Lamia, Ruellan Steven, Kfoury Miriana, Greige-Gerges H el ene, Landy David. *Solubilization of a plethora of essential oils and aromas in choline chloride:urea deep eutectic solvent:cyclodextrins:water mixtures. (  soumettre)*

8. Nakhle Lamia, Kfoury Miriana, Greige-Gerges H el ene, Landy David. *Thermodynamic investigations on host/guest interactions between β -cyclodextrin and adamantanol in deep eutectic solvent:water mixtures.* (** a soumettre**)

Liste des communications orales

1. Nakhle Lamia, Kfoury Miriana, Mallard Isabelle, Greige-Gerges H el ene and Landy David. *Solubilization of Eucalyptus citriodora essential oil in formulations based on deep eutectic solvents and cyclodextrins.* Scientific meeting of the GDR solvate, 25-26 Novembre, 2020. (en ligne)

2. Nakhle Lamia, Kfoury Miriana, Mallard Isabelle, Greige-Gerges H el ene and Landy David. *Combinaison de solvants eutectiques profonds et de cyclodextrines pour la solubilisation de l'huile essentielle Eucalyptus citriodora.* Journ ees SFR Condorcet, 14-15 Janvier, 2021. (en ligne)

3. Nakhle Lamia, Kfoury Miriana, Mallard Isabelle, Greige-Gerges H el ene and Landy David. *Enhanced solubilization of essential oils by combining deep eutectic solvent, cyclodextrins and water.* Second International Meeting on Deep Eutectic Systems, 15-16-17 Juin, 2021. (en ligne)

Liste des communications par affiche

1. Nakhle Lamia, Kfoury Miriana, Mallard Isabelle, Greige-Gerges H el ene and Landy David. *Combinaison de deep eutectic solvents and cyclodextrins for the solubilization of Eucalyptus citriodora essential oil.* RSC Poster Twitter Conference, 2 Mars, 2021. (en ligne)

Références

Les références citées ci-dessous concernent les citations mentionnées dans l'introduction générale, les introductions des chapitres ainsi que dans le chapitre 9 du manuscrit.

- Abbott, A. P., Capper, G., Davies, D. L., Rasheed, R. K., & Tambyrajah, V. (2003). Novel solvent properties of choline chloride/urea mixtures. Electronic supplementary information (ESI) available: Spectroscopic data. See <http://www.rsc.org/suppdata/cc/b2/b210714g/>. *Chemical Communications*, 1, 70–71. <https://doi.org/10.1039/b210714g>
- AlOmar, M. K., Hayyan, M., Alsaadi, M. A., Akib, S., Hayyan, A., & Hashim, M. A. (2016). Glycerol-based deep eutectic solvents: Physical properties. *Journal of Molecular Liquids*, 215, 98–103. <https://doi.org/10.1016/j.molliq.2015.11.032>
- Anand, R., Malanga, M., Manet, I., Manoli, F., Tuza, K., Aykaç, A., Ladavière, C., Fenyvesi, E., Vargas-Berenguel, A., Gref, R., & Monti, S. (2013). Citric acid- γ -cyclodextrin crosslinked oligomers as carriers for doxorubicin delivery. *Photochemical & Photobiological Sciences*, 12(10), 1841. <https://doi.org/10.1039/c3pp50169h>
- Aziz, Z. A. A., Ahmad, A., Setapar, S. H. M., Karakucuk, A., Azim, M. M., Lokhat, D., Rafatullah, Mohd., Ganash, M., Kamal, M. A., & Ashraf, G. M. (2018). Essential Oils: Extraction Techniques, Pharmaceutical And Therapeutic Potential - A Review. *Current Drug Metabolism*, 19(13), 1100–1110. <https://doi.org/10.2174/1389200219666180723144850>
- Bertaut, E., & Landy, D. (2014). Improving ITC studies of cyclodextrin inclusion compounds by global analysis of conventional and non-conventional experiments. *Beilstein Journal of Organic Chemistry*, 10, 2630–2641. <https://doi.org/10.3762/bjoc.10.275>
- Bi, W., Tian, M., & Row, K. H. (2013). Evaluation of alcohol-based deep eutectic solvent in extraction and determination of flavonoids with response surface methodology optimization. *Journal of Chromatography A*, 1285, 22–30. <https://doi.org/10.1016/j.chroma.2013.02.041>
- Cao, J., Cao, J., Wang, H., Chen, L., Cao, F., & Su, E. (2020). Solubility improvement of phytochemicals using (natural) deep eutectic solvents and their bioactivity evaluation. *Journal of Molecular Liquids*, 318, 113997. <https://doi.org/10.1016/j.molliq.2020.113997>

- Carrazana, J., Jover, A., Meijide, F., Soto, V. H., & Vázquez Tato, J. (2005). Complexation of Adamantyl Compounds by β -Cyclodextrin and Monoaminoderivatives. *The Journal of Physical Chemistry B*, *109*(19), 9719–9726. <https://doi.org/10.1021/jp0505781>
- Ciobanu, A., Mallard, I., Landy, D., Brabie, G., Nistor, D., & Fourmentin, S. (2013). Retention of aroma compounds from *Mentha piperita* essential oil by cyclodextrins and crosslinked cyclodextrin polymers. *Food Chemistry*, *138*(1), 291–297. <https://doi.org/10.1016/j.foodchem.2012.10.106>
- Costa, P., Medronho, B., Gonçalves, S., & Romano, A. (2015). Cyclodextrins enhance the antioxidant activity of essential oils from three Lamiaceae species. *Industrial Crops and Products*, *70*, 341–346. <https://doi.org/10.1016/j.indcrop.2015.03.065>
- Crini, G. (2014). Review: A History of Cyclodextrins. *Chemical Reviews*, *114*(21), 10940–10975. <https://doi.org/10.1021/cr500081p>
- Cunha, S. C., & Fernandes, J. O. (2018). Extraction techniques with deep eutectic solvents. *TrAC Trends in Analytical Chemistry*, *105*, 225–239. <https://doi.org/10.1016/j.trac.2018.05.001>
- Dai, Y., Witkamp, G.-J., Verpoorte, R., & Choi, Y. H. (2013). Natural Deep Eutectic Solvents as a New Extraction Media for Phenolic Metabolites in *Carthamus tinctorius* L. *Analytical Chemistry*, *85*(13), 6272–6278. <https://doi.org/10.1021/ac400432p>
- Dai, Y., Witkamp, G.-J., Verpoorte, R., & Choi, Y. H. (2015). Tailoring properties of natural deep eutectic solvents with water to facilitate their applications. *Food Chemistry*, *187*, 14–19. <https://doi.org/10.1016/j.foodchem.2015.03.123>
- Danel, C., Azaroual, N., Chavaria, C., Odou, P., Martel, B., & Vaccher, C. (2013). Comparative study of the complex forming ability and enantioselectivity of cyclodextrin polymers by CE and ^1H NMR. *Carbohydrate Polymers*, *92*(2), 2282–2292. <https://doi.org/10.1016/j.carbpol.2012.11.095>
- de Cássia da Silveira e Sá, R., Andrade, L., dos Reis Barreto de Oliveira, R., & de Sousa, D. (2014). A Review on Anti-Inflammatory Activity of Phenylpropanoids Found in Essential Oils. *Molecules*, *19*(2), 1459–1480. <https://doi.org/10.3390/molecules19021459>
- El Achkar, T., Moufawad, T., Ruellan, S., Landy, D., Greige-Gerges, H., & Fourmentin, S. (2020). Cyclodextrins: From solute to solvent. *Chemical Communications*, *56*(23), 3385–3388. <https://doi.org/10.1039/D0CC00460J>

- El Achkar, T., Moura, L., Moufawad, T., Ruellan, S., Panda, S., Longuemart, S., Legrand, F.-X., Costa Gomes, M., Landy, D., Greige-Gerges, H., & Fourmentin, S. (2020). New generation of supramolecular mixtures: Characterization and solubilization studies. *International Journal of Pharmaceutics*, 119443. <https://doi.org/10.1016/j.ijpharm.2020.119443>
- Fernández, M. de los Á., Espino, M., Gomez, F. J. V., & Silva, M. F. (2018). Novel approaches mediated by tailor-made green solvents for the extraction of phenolic compounds from agro-food industrial by-products. *Food Chemistry*, 239, 671–678. <https://doi.org/10.1016/j.foodchem.2017.06.150>
- Fernández-Peña, L., Gutiérrez-Muro, S., Guzmán, E., Lucia, A., Ortega, F., & G. Rubio, R. (2019). Oil-In-Water Microemulsions for Thymol Solubilization. *Colloids and Interfaces*, 3(4), 64. <https://doi.org/10.3390/colloids3040064>
- García-Río, L., Hervés, P., Leis, J. R., Mejuto, J. C., Pérez-Juste, J., & Rodríguez-Dafonte, P. (2006). Evidence for complexes of different stoichiometries between organic solvents and cyclodextrins. *Organic & Biomolecular Chemistry*, 4(6), 1038. <https://doi.org/10.1039/b513214b>
- Horský, J., & Walterová, Z. (2003). Formation of poly(ethylene glycol) inclusion complexes in aqueous solutions of mixed cyclodextrins. *Macromolecular Symposia*, 203(1), 259–264. <https://doi.org/10.1002/masy.200351327>
- Kfoury, M., Auezova, L., Greige-Gerges, H., & Fourmentin, S. (2015). Promising applications of cyclodextrins in food: Improvement of essential oils retention, controlled release and antiradical activity. *Carbohydrate Polymers*, 131, 264–272. <https://doi.org/10.1016/j.carbpol.2015.06.014>
- Kfoury, M., Auezova, L., Greige-Gerges, H., & Fourmentin, S. (2019). Encapsulation in cyclodextrins to widen the applications of essential oils. *Environmental Chemistry Letters*, 17(1), 129–143. <https://doi.org/10.1007/s10311-018-0783-y>
- Kfoury, M., Geagea, C., Ruellan, S., Greige-Gerges, H., & Fourmentin, S. (2019). Effect of cyclodextrin and cosolvent on the solubility and antioxidant activity of caffeic acid. *Food Chemistry*, 278, 163–169. <https://doi.org/10.1016/j.foodchem.2018.11.055>
- Kfoury, M., Hădărugă, N. G., Hădărugă, D. I., & Fourmentin, S. (2016). Cyclodextrins as encapsulation material for flavors and aroma. In *Encapsulations* (pp. 127–192). Elsevier. <https://doi.org/10.1016/B978-0-12-804307-3.00004-1>

- Kfoury, M., Landy, D., & Fourmentin, S. (2018). Characterization of Cyclodextrin/Volatile Inclusion Complexes: A Review. *Molecules*, 23(5), 1204. <https://doi.org/10.3390/molecules23051204>
- Kfoury, M., Lounès-Hadj Sahraoui, A., Bourdon, N., Laruelle, F., Fontaine, J., Auezova, L., Greige-Gerges, H., & Fourmentin, S. (2016). Solubility, photostability and antifungal activity of phenylpropanoids encapsulated in cyclodextrins. *Food Chemistry*, 196, 518–525. <https://doi.org/10.1016/j.foodchem.2015.09.078>
- Kolb, B., & Ettre, L. S. (2006). *Static headspace-gas chromatography: Theory and practice* (2nd ed). Wiley.
- Leron, R. B., Soriano, A. N., & Li, M.-H. (2012). Densities and refractive indices of the deep eutectic solvents (choline chloride+ethylene glycol or glycerol) and their aqueous mixtures at the temperature ranging from 298.15 to 333.15K. *Journal of the Taiwan Institute of Chemical Engineers*, 43(4), 551–557. <https://doi.org/10.1016/j.jtice.2012.01.007>
- Liang, Y. (2008). Applications of isothermal titration calorimetry in protein science. *Acta Biochimica et Biophysica Sinica*, 40(7), 565–576. <https://doi.org/10.1111/j.1745-7270.2008.00437.x>
- Martins, M. A. R., Pinho, S. P., & Coutinho, J. A. P. (2019). Insights into the Nature of Eutectic and Deep Eutectic Mixtures. *Journal of Solution Chemistry*, 48(7), 962–982. <https://doi.org/10.1007/s10953-018-0793-1>
- Matencio, A., Navarro-Orcajada, S., García-Carmona, F., & López-Nicolás, J. M. (2020). Applications of cyclodextrins in food science. A review. *Trends in Food Science & Technology*, 104, 132–143. <https://doi.org/10.1016/j.tifs.2020.08.009>
- Mbous, Y. P., Hayyan, M., Hayyan, A., Wong, W. F., Hashim, M. A., & Looi, C. Y. (2017). Applications of deep eutectic solvents in biotechnology and bioengineering—Promises and challenges. *Biotechnology Advances*, 35(2), 105–134. <https://doi.org/10.1016/j.biotechadv.2016.11.006>
- Morin-Crini, N., Fourmentin, S., Fenyvesi, É., Lichtfouse, E., Torri, G., Fourmentin, M., & Crini, G. (2020). History of Cyclodextrins. In G. Crini, S. Fourmentin, & E. Lichtfouse (Eds.), *The History of Cyclodextrins* (Vol. 52, pp. 1–93). Springer International Publishing. https://doi.org/10.1007/978-3-030-49308-0_1
- Moufawad, T., Moura, L., Ferreira, M., Bricout, H., Tilloy, S., Monflier, E., Costa Gomes, M., Landy, D., & Fourmentin, S. (2019). First Evidence of Cyclodextrin Inclusion

- Complexes in a Deep Eutectic Solvent. *ACS Sustainable Chemistry & Engineering*, 7(6), 6345–6351. <https://doi.org/10.1021/acssuschemeng.9b00044>
- Moura, L., Moufawad, T., Ferreira, M., Bricout, H., Tilloy, S., Monflier, E., Costa Gomes, M. F., Landy, D., & Fourmentin, S. (2017). Deep eutectic solvents as green absorbents of volatile organic pollutants. *Environmental Chemistry Letters*, 15(4), 747–753. <https://doi.org/10.1007/s10311-017-0654-y>
- Nakhle, L., Kfoury, M., Greige-Gerges, H., & Fourmentin, S. (2020). Effect of dimethylsulfoxide, ethanol, α - and β -cyclodextrins and their association on the solubility of natural bioactive compounds. *Journal of Molecular Liquids*, 310, 113156. <https://doi.org/10.1016/j.molliq.2020.113156>
- Pirna, A., Floare, C. G., & Bogdan, M. (2014). The complexation of flurbiprofen with β -cyclodextrin: A NMR study in aqueous solution. *Journal of Inclusion Phenomena and Macrocyclic Chemistry*, 78(1–4), 113–120. <https://doi.org/10.1007/s10847-012-0277-7>
- Sebaaly, C., Jraij, A., Fessi, H., Charcosset, C., & Greige-Gerges, H. (2015). Preparation and characterization of clove essential oil-loaded liposomes. *Food Chemistry*, 178, 52–62. <https://doi.org/10.1016/j.foodchem.2015.01.067>
- Shamseddin, A., Crauste, C., Durand, E., Villeneuve, P., Dubois, G., Durand, T., Vercauteren, J., & Veas, F. (2017). Resveratrol formulated with a natural deep eutectic solvent inhibits active matrix metalloprotease-9 in hormetic conditions: Resveratrol NADES formulation and hormesis. *European Journal of Lipid Science and Technology*, 119(11), 1700171. <https://doi.org/10.1002/ejlt.201700171>
- Wintgens, V., Lorthioir, C., Dubot, P., Sébille, B., & Amiel, C. (2015). Cyclodextrin/dextran based hydrogels prepared by cross-linking with sodium trimetaphosphate. *Carbohydrate Polymers*, 132, 80–88. <https://doi.org/10.1016/j.carbpol.2015.06.038>
- Yoshikiyo, K., Matsui, Y., & Yamamoto, T. (2012). Determination of Binding Constants for Inclusion Complexes of Cyclodextrins with Organic Solvents, Ethylene Glycol, and Its Related Compounds by Means of ^1H NMR Spectroscopy. *Bulletin of the Chemical Society of Japan*, 85(11), 1206–1209. <https://doi.org/10.1246/bcsj.20120140>
- Zhang, Q., De Oliveira Vigier, K., Royer, S., & Jérôme, F. (2012). Deep eutectic solvents: Syntheses, properties and applications. *Chemical Society Reviews*, 41(21), 7108. <https://doi.org/10.1039/c2cs35178a>

Résumé

Les huiles essentielles et les arômes sont des molécules d'origine naturelle largement utilisées dans différentes industries en raison de leurs activités biologiques diverses. Cependant, leur faible solubilité et forte volatilité limitent parfois leur application. Les solvants eutectiques profonds (*Deep eutectic solvents*, DESs) sont des solvants verts présentant un fort potentiel en tant qu'alternative aux solvants organiques pour la solubilisation des molécules hydrophobes. Les cyclodextrines (CDs) sont des molécules cages naturelles largement employées pour l'amélioration de la solubilité aqueuse de molécules encapsulées. Ce travail vise à développer de nouvelles formulations combinant DESs, eau et CDs, en variant la teneur en eau, le type de DES, le ratio molaire des constituants du DES, ainsi que la nature de la CD (native, modifiée ou polymère de CDs). Ces formulations ont été caractérisées par des mesures de densité, viscosité et polarité. Leur capacité de solubilisation a été évaluée en mesurant la réduction de la volatilité d'une huile essentielle modèle *E. citriodora*. Les résultats ont permis de définir une formulation optimale, chlorure de choline:urée DES:eau 70:30 % (m/m) en présence de CDs, qui a été utilisée pour la solubilisation de vingt huiles essentielles et vingt-et-un arômes. De plus, les complexes CD/arôme ont été caractérisés dans cette formulation par différentes techniques analytiques (espace de tête-statique couplée à la chromatographie en phase gazeuse, résonance magnétique nucléaire et calorimétrie de titration isotherme). Des études de calorimétrie de titration isotherme menées sur un système de complexation modèle β -CD/adamantanol ont permis de caractériser les propriétés thermodynamiques du phénomène de complexation au sein d'une formulation DES:eau. Les résultats de ce travail montrent que ces nouvelles formulations possèdent des performances prometteuses dans la solubilisation des composés hydrophobes.

Mots-clés : cyclodextrines, solvants eutectiques profonds, huiles essentielles, arômes, technique d'espace de tête, calorimétrie de titration isotherme.

Abstract

Essential oils and aromas are natural molecules that are widely used in different industries due to their diverse biological activities. However, their low solubility and high volatility limit sometimes their application. Deep eutectic solvents (DESs) are green solvents with great potential as an alternative to organic solvents for the solubilization of hydrophobic molecules. Cyclodextrins (CDs) are natural cage molecules widely used for the improvement of the aqueous solubility of encapsulated guests. This work aims to develop new formulations by combining DESs, water and CDs, by varying the water content, the type of DES, the molar ratio of the DES constituents, as well as the nature of the CD (native, modified or polymer of CDs). These formulations were characterized by density, viscosity and polarity measurements. Their solubilization capacity was evaluated by measuring the volatility reduction of a model essential oil *E. citriodora*. The results allowed to define an optimal formulation, choline chloride:urea DES:water 70:30 wt% in the presence of CDs, which was used for the solubilization of twenty essential oils and twenty-one aromas. In addition, the CD/aroma complexes were characterized in this formulation by different analytical techniques (headspace static-gas chromatography, nuclear magnetic resonance and isothermal titration calorimetry). Isothermal titration calorimetry studies conducted on a model inclusion complex system β -CD/adamantanol have allowed the characterization of the thermodynamic properties of the complexation phenomenon within a DES:water formulation. The results of this work show that these new formulations possess promising performance in the solubilization of hydrophobic compounds.

Keywords: cyclodextrins, deep eutectic solvents, essential oils, aromas, headspace technique, isothermal titration calorimetry.