



**HAL**  
open science

# Advanced monitoring in I4.0 era : people, environment, and data

Annarita Tedesco

► **To cite this version:**

Annarita Tedesco. Advanced monitoring in I4.0 era : people, environment, and data. Automatic Control Engineering. Université de Bordeaux; Università del Salento, 2022. English. NNT : 2022BORD0331 . tel-04368926

**HAL Id: tel-04368926**

**<https://theses.hal.science/tel-04368926>**

Submitted on 2 Jan 2024

**HAL** is a multi-disciplinary open access archive for the deposit and dissemination of scientific research documents, whether they are published or not. The documents may come from teaching and research institutions in France or abroad, or from public or private research centers.

L'archive ouverte pluridisciplinaire **HAL**, est destinée au dépôt et à la diffusion de documents scientifiques de niveau recherche, publiés ou non, émanant des établissements d'enseignement et de recherche français ou étrangers, des laboratoires publics ou privés.

CO-SUPERVISED THESIS PRESENTED  
TO OBTAIN THE QUALIFICATION OF

**DOCTEUR DE  
L'UNIVERSITÉ DE BORDEAUX  
AND OF THE  
UNIVERSITA' DEL SALENTO**

SCIENCES PHYSIQUES ET DE L'INGÉNIEUR  
AUTOMATIQUE, PRODUCTIQUE, SIGNAL ET IMAGE, INGÉNIERIE COGNITIVE  
INGEGNERIA DEI SISTEMI COMPLESSI

By Annarita TEDESCO

**ADVANCED MONITORING IN THE I4.0 ERA:  
PEOPLE, ENVIRONMENT, AND DATA**

Under the supervision of Dominique DALLET  
and Andrea CATALDO

Viva on 02 December 2022

Members of the examination panel:

Mr. CORONATO, Antonio	Full Professor	Univ. Telematica "G. FORTUNATO"	Président
M. PITTELLA, Erika	Assistant Professor	Sapienza University of Rome	Reviewer
M. RABAH, Hassan	Full Professor	University of Lorraine	Reviewer
M. DALLET, Dominique	Full Professor	Université de Bordeaux	Supervisor
Mr. CATALDO, Andrea	Associate Professor	Università del Salento	Supervisor

**Titre :** Surveillance avancée dans l'ère I4.0 : Personnes, environnement et données  
**Résumé :** [4000 caractères maximum, espaces compris]  
**Mots clés :** [3 minimum]

---

**Title :** Advanced Monitoring in I4.0 Era: People, Environment, and Data  
**Abstract :** [4000 caractères maximum]

The advanced technologies introduced by the Industry 4.0 paradigm are permeating several other application contexts, enabling the fusion of physical and virtual worlds through cyber-physical systems (CPSs), which represent the most effective expression of this new “4.0 Era”. For CPSs, Measurement and Monitoring Systems (MMSs) are considered a crucial, but subordinate element: they provide source of information for the CPS (i.e., Connection to the physical world), but do not participate in any higher-level actions of the CPS (i.e., Conversion, Cyber, Cognition, Configuration). However, a deeper analysis shows that there are strong similarities between MMSs and CPSs, and that the suitable adoption of the enabling technologies can reshape the role of MMSs in the 4.0 Era. This requires a fundamental change of perspective, in which the 4.0 technologies stop being employed as external superstructures for MMSs, and become embedded solutions, intrinsically present in the architecture of the monitoring system, and fully effective through an adequate metrological configuration. This approach emphasizes the holistic nature of monitoring, and paves the way for “4.0 transition-driven monitoring systems”. Through the wise adoption of the 4.0 technologies, MMSs evolve into self-aware, self-conscious, self-maintained entities, able to generate highly-valued insights, just like CPSs. MMSs can evolve into Cyber-Physical Measurement Systems (CPMSs), thus becoming pro-active expression of the 4.0 Era, strengthening not only the role of measurement (which becomes directly involved in the decision-making process of CPS), but the performance of the overall 4.0 ecosystem.

Starting from these considerations, the major goal of this research work was to demonstrate that, through the suitable introduction of 4.0 technologies into MMSs, and applying the methodological approach typical of the Measurement Science, it is possible to exploit the intrinsic potential of MMSs, and make them evolve in CPMS. Another goal of the thesis is to show how, by improving the perceptive layer of 4.0 applications, it is possible to enrich all kinds of applications with monitoring capabilities at a very minimum cost (if any at all).

The thesis is organized in five chapters. Chapter 1, titled “*Industrial revolution and 4.0 Era*”, introduces to the Industry 4.0 paradigm and provides an overview of the most prominent technologies that enable its implementation.

Chapter 2, titled “*The 4.0 transition-driven monitoring system*”, provides an overview of the

evolution of MMSs. It is shown how the architectures of modern MMSs is similar to that of 4.0 systems (structurally based on the Internet-of-Things platform, and articulated on the well known 5C architecture). A broad taxonomic analysis of MMSs in some relevant application sectors is also provided.

Chapter 3, titled *"Development and Implementation of 4.0 Transition-Driven Measurement Systems: Human-centered approach"* summarizes the results of the research related to the development of 4.0 MMSs designed with user-centered approach. More specifically, innovative sensing solutions for sensing skin hydration in a wearable fashion are presented. Additionally, the adoption of brain computer interface for monitoring worker's stress is also presented. Chapter 4, titled *"Development and Implementation of 4.0 Transition-Driven Measurement Systems: Industry-oriented applications"*, is focused on 4.0-enhanced MMSs for industrial monitoring applications. The first application relates to the adoption of augmented reality for assisting assembly operation in industrial application. Another application relates to the development of soft growing robots for remote measurement task in confined and/or constrained environment. The experience matured from the research presented in Chapter 3 and Chapter 4 lead to the definition of a new methodological approach to design a fully-native CPMS. In this regard, Chapter 5, titled *"Towards a native Cyber-Physical Measurement System: a Case-Study"* is dedicated to provide practical evidence of the effectiveness of this new methodological approach. To this purpose, a practical example for achieving the first full-round example of a CPMS is presented, focusing onn the CPMS-oriented evolution of a "traditional" microwave reflectometry-based MMS for leak localization in underground pipes.

---

#### **Unité de recherche**

Laboratoire de l'Intégration du Matériau au Système - UMR 5218 IMS,  
351 Cours de la libération, 33405 Talence cedex, France.

# Table of contents

<b>I</b>	<b>Background</b>	<b>1</b>
<b>1</b>	<b>Industrial revolution and 4.0 Era</b>	<b>2</b>
1.1	Introduction . . . . .	2
1.2	Industry 4.0 . . . . .	3
1.3	The enabling technologies . . . . .	6
1.3.1	Big data analytics . . . . .	6
1.3.2	Autonomous robots . . . . .	6
1.3.3	Simulation . . . . .	7
1.3.4	Horizontal and vertical system integration . . . . .	7
1.3.5	Internet of things . . . . .	7
1.3.6	Cyber security . . . . .	8
1.3.7	Cloud computing . . . . .	8
1.3.8	Additive manufacturing . . . . .	8
1.3.9	Augmented reality . . . . .	8
1.4	The evolution of Industry in the 4.0 Era . . . . .	9
1.5	Cross-cutting technologies of 4.0 Era . . . . .	10
1.6	The CPS concept . . . . .	11
1.6.1	CPS basics . . . . .	11
1.6.2	Industrial CPSs vs measurement and networking issues . . . . .	13
1.6.3	Industrial CPS self-awareness: measurement challenges . . . . .	15
1.7	Transversal Technology: Internet of Things . . . . .	16
1.7.1	IoT architecture . . . . .	16
<b>2</b>	<b>The 4.0 transition-driven monitoring system</b>	<b>20</b>
2.1	Traditional monitoring systems . . . . .	22
2.2	Components of a monitoring system . . . . .	23
2.2.1	Metrics, thresholds and alerts . . . . .	25
2.3	Evolution of the monitoring model . . . . .	26
2.4	4.0 Architectures . . . . .	33
2.5	Taxonomy of monitoring systems: before and during 4.0 era . . . . .	38

---

2.6	Comparison between monitoring and 4.0 architectures . . . . .	41
<b>II</b>	<b>Proposal and Experimentation</b>	<b>48</b>
<b>3</b>	<b>Development and implementation of 4.0 transition-driven measurement systems: human-centered approach</b>	<b>49</b>
3.1	Introduction . . . . .	49
3.2	A wearable EEG instrument for monitoring worker stress . . . . .	51
3.2.1	Background . . . . .	52
3.2.2	Brain Computer Interface . . . . .	55
3.2.3	Design . . . . .	58
3.2.4	Implementation . . . . .	60
3.2.5	Metrological characterization . . . . .	61
3.2.6	Discussion . . . . .	66
3.3	Microwave-based system for skin sensing . . . . .	67
3.3.1	The application context . . . . .	67
3.3.2	Theoretical background . . . . .	68
3.3.3	The proposed sensing system . . . . .	68
3.3.4	Design and manufacturing of the flexible sensing element . . . . .	69
3.3.5	Experimental validation and discussion of results . . . . .	71
3.4	Fully-textile humidity sensors for wearable applications . . . . .	74
3.4.1	The context . . . . .	74
3.4.2	Design and fabrication of the sensing device prototype . . . . .	75
3.4.3	Experimental setup . . . . .	75
3.4.4	Experimental results and discussion . . . . .	76
3.4.5	Conclusion . . . . .	76
<b>4</b>	<b>Development and implementation of 4.0 transition-driven measurement systems: industry-oriented applications</b>	<b>87</b>
4.1	Introduction . . . . .	87
4.2	Augmented Reality for assembly in Industry 4.0 . . . . .	87
4.2.1	The context . . . . .	87
4.2.2	Case study: Lego prototype assembly operation . . . . .	89
4.2.3	Methods . . . . .	89
4.2.4	Experimental tests and discussion . . . . .	91
4.2.5	Conclusion . . . . .	94
4.3	Soft continuum robots for remote measurements . . . . .	95
4.3.1	Soft continuum robots . . . . .	95

---

4.3.2	Preliminary experimental steps of soft growing robot for remote measurement tasks in confined and constrained environments . . . . .	100
4.3.3	Using a soft growing robot as a sensor delivery system in remote environments: A practical case study . . . . .	107
4.3.4	Materials and methods: The soft growing robot . . . . .	108
4.3.5	Experimental setup and sensing task . . . . .	109
4.3.6	Results and discussion . . . . .	110
<b>III</b>	<b>Ongoing work: Towards Cyber-physical measurement systems</b>	<b>113</b>
<b>5</b>	<b>Towards a native Cyber-Physical Measurement System: a case-study</b>	<b>114</b>
5.1	Introduction . . . . .	114
5.2	The case study: the “traditional” microwave reflectometric system for leak localization in underground pipes . . . . .	116
5.2.1	TDR theoretical background . . . . .	116
5.2.2	TDR-based system for localization of leaks in underground pipes . . . . .	117
5.3	A 4.0-driven evolution of the traditional MR-based monitoring system into a native CPMS: The design . . . . .	120
5.3.1	Phase 1 – Design and implementation of the physical part of the CPMS . . . . .	121
5.3.2	Phase 2 – Design, implementation and testing of the Cyber part of the CPMS . . . . .	123
5.3.3	Phase 3 – Design, implementation and testing of AI into the CPMS . . . . .	124
5.3.4	Phase 4 – Integration and validation of the CPMS . . . . .	126
<b>6</b>	<b>Conclusions</b>	<b>129</b>
	<b>References</b>	<b>134</b>

**Part I**

**Background**



# Chapter 1

## Industrial revolution and 4.0 Era

### 1.1 Introduction

The history of mankind is the synthesis of the elements that have allowed him to progress over time. Starting from the invention of the wheel, humanity has used its wits to develop multiple technologies in order to imitate the functionalities of human body. Producing tools that replaced physical functionality is the evolutionary engine that led humanity in the Third Millennium. Human evolution occurs in a competition between genetic, individual and group transformations. Each evolutionary phase requires energy and information. indeed, humanity evolves with its genes and with the evolution of the environment in which it lives. Scientific progress insinuates itself, for this reason, into every aspect of everyday life, varying and improving the way people work, live and think. New technologies bring usually great changes, sometimes even revolutionary ones, first of all in the productive sector and then in the social fabric and habits. The main evolutionary milestone of the contemporary era are indicated by the first three industrial revolutions. The First Industrial Revolution in the second half of the Seventeenth Century produced the first developments in the technological-economic (and also social) field, which involved different sectors from agriculture, transport, trade and industry. Factories were the main protagonist of the Second Industrial Revolution, introducing the mass industry concept. At the end of the Second World War the Third Industrial Revolution began. In that period new economic theories such as post-Fordism and Toyotism were developed, and moreover the advancement of technological progress introduced the automation in the production processes. With the use of automation, technology has not only represented an extension of man's physical abilities, but also an extension of his brain. According to this, automation technology exercises the first functions of control and integration. In this same time foundations for the great change were laid, taking place in these decades, with the birth and development of Communications Networks. With the first three industrial revolutions, historians have schematized the basic steps that have transformed proto-industrial society into today's post-industrialized one [1].

Industry is currently involved in a new change that historians, sociologists and economists agree to define as the "Fourth Industrial Revolution". The term "Industry 4.0" was used for the first time in 2011 during the Technology Fair in Hanover, where a German group of scientists and entrepreneurs

presented the report entitled «Industrie 4.0: mit dem Internet der Dinge auf dem Weg zur 4 industriellen Revolution» («Industry 4.0: with the Internet of Things on the way to the fourth Industrial Revolution»). In this report the possible new applications of advanced technologies in the industrial sector were illustrated.

Among them is the use of Internet-connected machines, devices and sensors enabling the collection, management and analysis of large amounts of data in any business process. The ways in which data is stored and processed create new information, influence decision-making processes and business processes themselves, in some cases enabling automation and making business operations more efficient, flexible and faster. As an example of technology implemented in the industry, the report mentioned "product memory." This is a micro device that, when applied to each individual physical product, is capable of collecting and storing a lot of information. When used in an interconnected system of machinery and appropriate sensors, this device allows the product to communicate data about its status to other instruments; in this way "the product becomes simultaneously an actor and an observer of its production process." Following the Industry 4.0 report, the German government continued studies to implement advanced technologies in the manufacturing sector and in 2013 presented "Zukunftsprojekt Industrie 4.0" ("Project for Industry of the Future 4.0"). This was the first world program of measures, incentives and investments to foster the development of the industry with a 4.0 view. The Fourth Industrial Revolution with its digitization and networking of machines is truly changing our lives. These new technologies are allowing the physical and virtual worlds to come into manufacturing and logistics to merge to form Cyber Physical Systems (CPS).

## 1.2 Industry 4.0

Since 2011, industrial developments have been collectively referred to as Industry 4.0. Machines have the ability to communicate with one another autonomously, thereby optimizing process flows. Industry 4.0 clearly relates to networking in the industrial sector. Each entity connected to network plays a very important role in the value creation chain in this environment. The prerequisite for communication is in fact an abundance of information to deliver, process and transform. Industry 4.0 can be defined as the process of digitalization and intelligent automation of company production systems, its aim is linked to processes and product innovations.

Industry 4.0 paradigm is based on Cyber-Physical Systems (CPS), that is on computer systems able to interact with the physical ones systems in which they operate, and it previews the interconnection between all the components of the chain of the value, making business processes more efficient, flexible, fast and accurate [2].

The paradigms of Industry 4.0 can be applied by any enterprise, regardless of its size or the sector in which it operates. In order to better implement them, we need technologies capable of collecting and managing large amounts of information, enabling automation and digitization of business processes [3]. These enabling technologies are grouped in the following four macro-categories.

- **Data, computational power and connectivity**

Data are the basis of the Fourth Industrial Revolution, so the devices and platforms that allow their collection, storage, management and analysis are essential. In this context new technologies such as Cloud Computing, Big Data Analytic and Internet of Things become fundamental. Cloud computing is a set of resources both hardware and software that can store and process huge amounts of complex digital information (Big Data) at low cost. The collection and the communication of the data, instead, is entrusted to particular devices connected to Internet, called Internet of things (IoT), that render the entire productive apparatus interconnected.

- **Analytics and intelligence**

The analysis and processing of the collected data leads to the implementation of cognitive systems, that are software and machineries that, through appropriate algorithms, are able to learn instructions to decide and act independently. This is made possible by the development of studies on artificial intelligence and machine learning. Machine learning is a subset of the discipline of artificial intelligence and allows the device to learn without having been explicitly programmed. These tools enable the complete automation not only of production processes, for example through robots, but also of administrative, accounting and relational processes.

- **Human-machine interaction**

In addition to process automation, the industry 4.0 paradigm pays attention to the interaction between man and machine. Equipment with touch interfaces, augmented reality and/or virtual reality make the use of technology more intuitive moreover for men. The term augmented reality (augmented reality, AR) refers to the different perception of reality.

- **Digital-to-physical conversion**

All those machines that allow the physical production of the good from a digital model belong to this category. These are automated robots and additive manufacturing technologies such as the 3D printer. The latter are able to make the finished product using additive production or layered production techniques. Additive production is opposed to the more traditional subtractive production. While the first involves the manufacture of the product through the union of several raw materials, the subtractive production is carried out by removing material from a single block until the desired product is obtained.

The mere use of these enabling technologies does not guarantee the transition to a productive reality 4.0. In fact, Industry 4.0 is not determined by the simple use of certain revolutionary technologies, but depends on the combined use of the various instruments listed above [4].

In the industrial and manufacturing sector designated by Industry 4.0, there are four key features [5]:

- **Digitalization**

Thanks to the large amount of information available and the technologies with high computing

power able to manage and process them, it is possible to replicate the real situation in a digital dimension (digital twin). The combination of digital twin and physical elements, such as equipment and machinery, creates a cyber-physical apparatus in which information is easily available and fully usable in the production cycle. Digital twins are also functional for strategic planning as they can simulate processes in any condition and thus support decisions.

- **Interconnection**

Thanks to IoT technologies, which allow the automatic collection and exchange of data, the production system is interconnected at several levels. Indeed there is a greater coordination not only between the resources inside of a same enterprise but also between the various subjects present in the value chain: it is possible to integrate the processes of the entire chain of the value, optimizing the relationships between suppliers, customers and partner.

- **Remote Interaction**

The production systems can be controlled remotely: it is possible to access the individual devices remotely in order to monitor the processes and to issue directives. In addition, remote assistance or maintenance of the machinery can be provided in order to increase productivity.

- **Real Time**

The information about the production phases are immediately accessible and computable, thus allowing the company not only to constantly monitor the state of the various processes, but also to react promptly to new market stimuli. In this way the enterprise is able to take decisions and to optimise their resources.

The use of new technologies in the 4.0 paradigm, therefore, disrupts traditional production methods by involving process innovations (Fig. 1.1). Production systems are digital, interconnected, flexible and fast in responding to external stimuli. Manufacturing processes tend to be modular, in order to achieve customised and at the same time massive production at low cost, pursuing a market strategy oriented towards the final consumer while at the same time benefiting economies of scale. There is also an improvement in all business processes in terms of efficiency that is reflected in increased productivity. The waste of raw materials is reduced and production and maintenance times are shortened. Saving time and cost does not bring enterprises to the detriment of the quality of the final product, because the collaboration between men and machinery increases the reliability of the processes, reducing errors and defects in production.

This reality 4.0 necessarily pays attention to the issues of safety and sustainability: technologies are aimed at improving safety and ergonomics in the workplace, assisting workers in their jobs and, as a result, reducing the risk of accidents and increasing their quality of life. In addition, by optimizing resources, companies reduce energy consumption and emissions.

### Digitization of the manufacturing sector – Industry 4.0

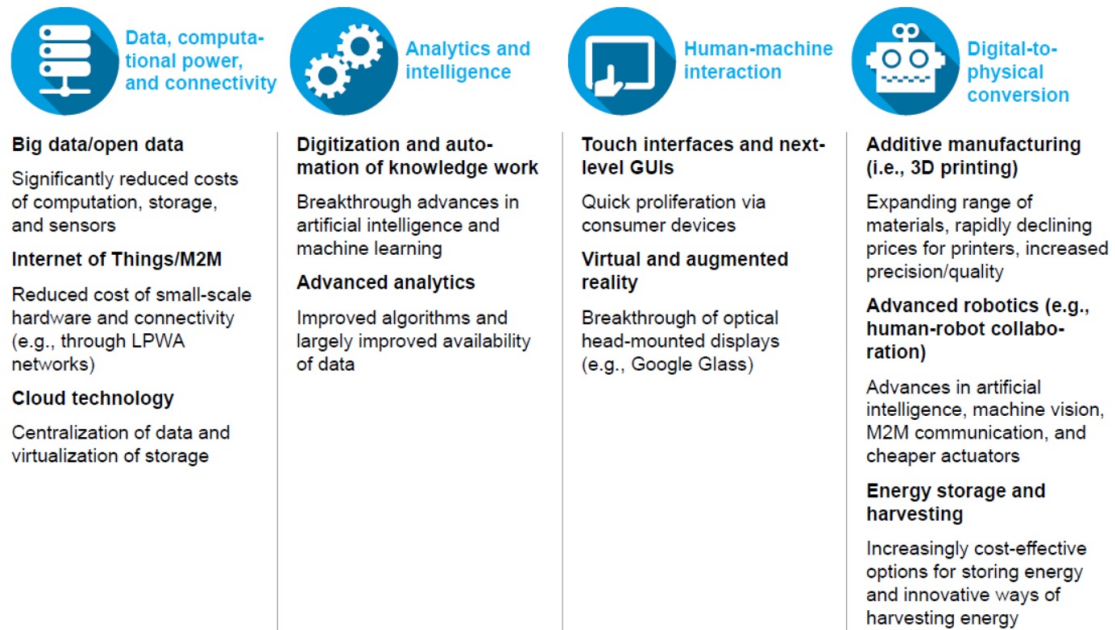


Fig. 1.1 Enabling technologies [6]

## 1.3 The enabling technologies

Nine enabling technologies are the driving force of Industry 4.0 Revolution. The digital transformation that they involve blurs the boundaries between the physical and digital world and the internet one. The technologies are briefly described below.

### 1.3.1 Big data analytics

The big data analytics represents a process of collection and processing of a large amount of data that are produced daily on our planet; such data come mainly from online activities, communications, photos and videos, sensor data and the Internet of things. In fact, almost all the actions that we carry out on a daily basis always leave a digital track (date) that businesses and institutions can use to their advantage. Precisely through the analysis of these data put into the net by users, companies can optimize their production processes, understand the behaviors of potential customers, intuit market changes and anticipate competition, thus transforming a set of simple data into added value.

### 1.3.2 Autonomous robots

Autonomous Robots are machines that perform tasks or behaviours even very complex with a high degree of autonomy, a characteristic that is particularly desirable in areas such as space flights, domestic maintenance, waste water treatment or provision of goods and services. Autonomous Robots support

the 4.0 paradigm for factories in the transition from the mass production industry to the customized one. The robots are essential to reach the flexibility need in many human and industrial activities.

### **1.3.3 Simulation**

The term simulation refers to that process that through the 3D simulation, makes it possible to visualize the workflows before adjusting the production line, allowing therefore to preview and to establish a priori the parameters of the production process. In this way it is possible to set up the machines correctly reducing the time to setup them. Simulations for staff training can also be used to increase the safety of workers in the company. The computer simulation is becoming a technology which help to understand the dynamics of business systems. Simulation allows experiments for the validation of products, processes or systems design and configuration. Simulation modelling helps on cost reduction, decrease development cycles and increase product quality.

### **1.3.4 Horizontal and vertical system integration**

System Integration is defined in the engineering field as the process of coordinating all subsystems, components of a single large system, so that they collaborate, and the global system is able to provide a general functionality. An example of this is the process of linking computer systems and software, which are physically and functionally different, but which can nevertheless act as a coordinated whole. The integration can be of two types, vertical and horizontal. The Vertical System Integration is the process of integrating subsystems according to their functionality. The horizontal integrated system or Enterprise Service Bus (ESB) is an integration method in which a specialized subsystem is dedicated to communication between other subsystems. This reduces the number of connections (interfaces) to a single subsystem that will connect directly to BSE. BSE can translate the interface into another interface. By this way integration costs are cut off and the whole system acquires extreme flexibility. Real-time data sharing is enabled by these two types of integration.

### **1.3.5 Internet of things**

The Internet of Things (IoT) was defined by Kevin Ashton (1999) as the extension of the Internet to the world of objects and concrete places and represents a fundamental part of the news concerning Information Technology. One simple definition of IoT described is: "IoT allows people and things to be connected anytime, anyplace, with anything and anyone, ideally using any path/network and any service".

In general, it distinguishes between the Internet of things for consumers (IoT) and the Internet of things for companies (Industrial Internet of things - IIoT). In the consumer-oriented concept (IoT) the focal points are people, home applications, electronic devices, automobiles, computers and many other everyday objects. IIoT creates opportunities for companies, production plants or entire sensor networks.

### **1.3.6 Cyber security**

With the advent of IIoT and the increase of information on the web, it becomes necessary to implement a solution to the cyber security problems (Cyber Security) in industrial control systems to guarantee the protection of sensitive data. The complexity of the IIoT requires that cybernetic safety needs to be predicted from the design stage of the components that make up the automation system. The digital transformation of production processes, the use of cloud systems by companies, but also the use of currency encryption, has greatly increased the surface of hacker's attack on businesses and institutions, intensifying de facto exposure to cyber crime.

### **1.3.7 Cloud computing**

In computer science the word Cloud Computing indicates a paradigm of distribution of computer resources, such as storage, processing or transmission of data, characterized by on-demand availability through the Internet from a set of existing and configurable resources. According to the NIST (National Institute of Standards and Technology) Cloud computing is a model that allows from anywhere and in a convenient way access on demand via network, to a set of shared and configurable computing resources (e.g. networks, servers, storage, applications and services). Cloud computing, therefore, provides data and resources to computers or other devices, thus offering many useful benefits to improve the capabilities of robots by increasing the efficiency of the services offered.

### **1.3.8 Additive manufacturing**

Additive Manufacturing (AM) is the identifying name of manufacturing techniques and technologies in which the finished product is formed without the need to melt the material into moulds or remove it from a crude form. The most famous industrial version is the "3D printing", the technique of building objects three-dimensional materials, adding one on the other ultra-thin layers of material.

3D printing can be used in all sectors: in the field of building engineering the first cases have already been printed in 3D, in the medical field it will be possible in the next years to print organs for transplantation, in the aerospace and defence sector is still used for the production of complex components. These are just a few examples of how new 3D printers can make production more efficient and of better quality.

### **1.3.9 Augmented reality**

Augmented Reality is a technology that increases human performances and capabilities.

Augmented Reality is reality, as perceived sensorially and intellectually by the individual, enriched with data in digital format. In essence, an enhancement - through high-tech devices - of the possibilities provided by the 5 senses and intellect. Not a virtual world, then, but an integration between physical reality and the digital world, through common devices such as smartphones, or more sophisticated ones such as 'smart glasses', or hi-tech bracelets for the remote control of robotic / electronic equipment.

AR technology increase reality operator's perception by making use of artificial information about the environment, where the real world is fulfilled by its objects. The principle of AR is the combination of two scenarios: 1) digitally processed reality with 2) digitally added artificial objects that could be 2D flat objects, or by other definitions that only considers 3D objects within the scene. AR main system features as:

1. the ability on combining real and virtual objects on a real environment,
2. the ability on align each other the real and the virtual objects
3. the ability on running inter-actively, in 3D, and on real-time.

## **1.4 The evolution of Industry in the 4.0 Era**

The innovation introduced by 4.0 technologies have had a radical impact on industries. Enabling technologies have entered organizational and production processes by subverting previous planning techniques and radically changing communication logics. Industries have become increasingly intercommunicating and interfacing thanks to enabling technologies and this requires new architectural standards that meet the need for interoperability of technologies in complex environments and heterogeneous sectors. In the new Industry 4.0, production management and control must coexist in the same logical process. The 4.0 paradigm has endowed conventional industrial automation techniques with development capabilities aimed at improving working conditions, creating new business models, increasing plant productivity and improving product quality. Decision-making processes supported by the availability of data and distributed logic allow the generation of new business models. In Industry 4.0 Vision: the intelligent product controls its own production through self-configuration and self-optimization of systems, up to a complete self-organization. In order to capitalize on this innovation scenario, the need has emerged for data transmission through the Industrial Internet, in combination with the Internet of Things, Services, Organizations, People and Machines, to also underpin the development of specific applications pertaining to the domain of artificial intelligence. The introduction of the 4.0 paradigm imposes logical and physical system adjustments for all components, subsystems and solutions, with the primary objective of creating a socio-technological ecosystem in which devices/subsystems are interoperable and transparent, radically simplifying the development process and the functional management of industries, understood as systems themselves, embedded in an integrated eco-system. It became necessary to formulate a reference model aimed, by definition, at representing the complexity of systems and their interaction with each other and the world around them. The model of Industry 4.0 promotes a reference architecture to break down functions, services, and processes into components that are more easily manipulated. This model must be able to take into account the peculiarities and risks of digital scenarios for which along the value chain increase the complexity and instability of systems. In fact, the interconnection and integration are the central elements in the vision for Industry 4.0. that need to govern a constant flow of data and information within the individual industries and between companies



and along the value chain. It is necessary to have architectures of reference flexible in all the directions and able to make a model fulfill its task if it proposes a general description shared within a well circumscribed domain, through the definition of a finite set of specific and measurable parameters. These parameters must be representative of the functionalities belonging to the domain that the same model wants to describe, and include the impact of the model with respect to its application, the determination of the boundaries of the represented system, and the definition of the interfaces that the model must have in order to interact with other reference models. "Industry 4.0" can be considered as a specialization of the Internet of Things and services that, jointly, go to place within the domain "production-product system". In fact, it gathers the intimate relationship existing between the engineering of production tools, product characteristics and corresponding services. Therefore, a standardization model is needed to link the pre-existing regulations with a sustainable method for the realization of an overall integrated system, which is able to bring together the Internet world, the digital transformation, and the simple apparatus-apparatus interaction in the workshop. A high-performance reference model was found to be RAMI 4.0 (Reference Architectural Model Industry 4.0). RAMI 4.0 defines a Service Oriented architecture that is independent of the type of industry from its customers or vendors. The actors of this architecture are the components that provide services to other components that talk to each other through protocols thus becoming interconnected on the Internet in a de-localized way.

The two areas of greatest attention to be standardized are the Interoperability between the interfaces of the commercial solutions of the different producers on the market and the definition of open standards. The risk is that proprietary solutions will emerge and establish themselves as a de facto standard leading to a technological lock-in. Open standards can be set and adopted quickly, but are less supported because they are difficult to exploit for commercial gain. The large number of subjects in the standardisation initiative makes it clear how to outline a complex panorama with multiple standards, both highly specialised and generic.

## **1.5 Cross-cutting technologies of 4.0 Era**

In the previous chapter were illustrated the enabling technologies of industry 4.0 paradigm. They are nine fundamental pillars to support the revolutionary digital transformation of these recent decades. However some of them have higher potential thanks their cross cutting applicability. These principal technologies are Cyber Physical Systems (CPS) and Internet of Things (IoT). They represent correlation, cps logical and IoT physical, between the real world and the digital once. Their implementation and architectural principles are essential for the analysis of monitoring systems 4.0 developed in the continuation of the thesis, therefore the following sections briefly illustrate the main characteristics of these two cross-cutting technologies.

## 1.6 The CPS concept

Cyber-Physical Systems (CPSs) are the key players of 4.0 Industrial Revolution [2]. Cyber-Physical Systems are engineered solutions obtained through the seamless integration of computational algorithms and physical components. Nowadays, they are entitled to drive innovation and competition in different fields such as agriculture, building design and automation, energy, healthcare, transportation and, above all, industrial manufacturing.

Among CPS technologies, measurement and networking ones play a fundamental role, being enrolled as the natural bridge between the cyber and physical components of a CPS. A number of interconnected sensors and transducers are claimed to give inner and outer, local measurement data that, once processed through suitable algorithms and analytics, have to provide reliable information about the effectiveness of the whole CPS and its interaction with the external world, as well as its health status for maintenance and troubleshooting purposes. So, great attention has to be paid to network models and architectures, to sensor forms and functions, in order to make CPSs properly integrate the continuous and the discrete, compounded by the uncertainty of open environments.

Each technological system has a dual physical and computational identity. The combination of these two identities has undergone a deep evolution in the last years, which has led to the total revolution of physical systems and to how people interact with them. From the beginning, management and control electronics have been forged with the aim of optimizing the performance of physical systems in the same way that physical systems have been adapted to the requirements of electronics and automation in terms of design, materials and mechanics. This process has generated hybrid systems with access windows to the electronics, to the structure, and to the logic of mechanical operations, called Cyber Physical Systems (CPSs). The term cyber defines the modernity of machines, not only intelligent thanks to cybernetics but characterized by a virtual nature and the ability of interfacing with data networks, i.e. Internet. Intelligence of CPSs does not reside in their ability to exchange information with the surrounding world but in their nature of sensitive, open and active machines, capable of real-time learning from external information the way to improve their functioning and to develop optimal criteria to be pursued.

To fit a CPS for a specific production context (industrial CPS for a smart factory), it is necessary to abstract the representation of the factory into a model of interactions between components, machines and production systems.

### 1.6.1 CPS basics

CPSs represent the real revolution for social systems and industrial systems. The potential of CPSs is enormous and invests a number of domains that are different and transversal to production and organizational activities, and therefore require multidisciplinary knowledge to be defined and developed. Particularly, there is a need for new descriptive formalisms that allow a simultaneous description of a system that is both physical and cyber. No more and not just equations and network models.

Many research results available in literature try to define a general framework for describing the reference architecture of a CPS. All of them converge on the need to develop integration methods of:

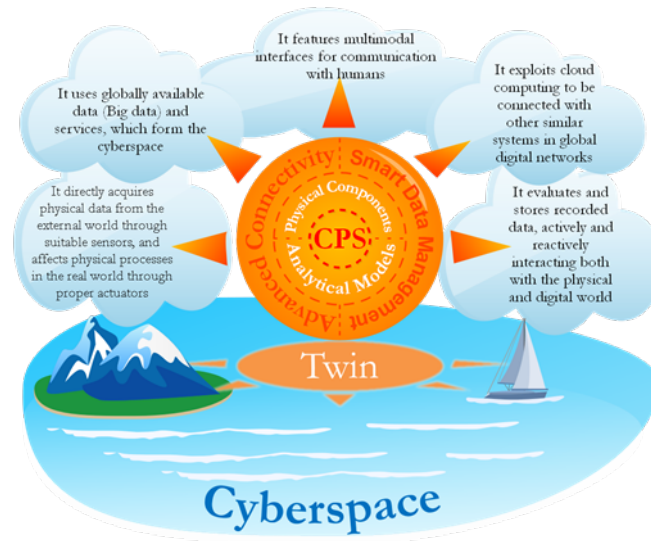


Fig. 1.2 Cyberspace complexity.

- control systems;
- communication systems;
- computing systems.

Differently from real-time systems, CPSs need not only to translate a continuous world into a discrete one but also to define co-operation requirements and methods to interface both logically (decision support) and physically (event driven) heterogeneous systems operating on different spatial and time scales. CPSs should not only be interfaceable, interoperable and modular, but also multifunctional. The best reference models are the brain or the capability of living in an animal or human community. The complexity of CPSs imposes the development of a new science, built on consciences of neuroscience, biology, social sciences and all branches of engineering, as shown in Fig. 1.2.

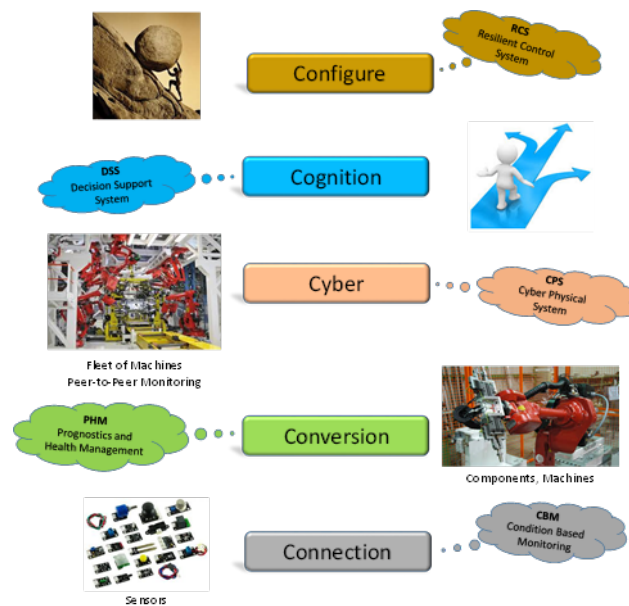
As shown in Fig. 1.3, major actors in this model are components, machines and systems of production.

#### 1. Smart Connection Level

This is the level of data acquisition and transmission. Specific sensors and communication protocols are crucial to ensure seamless and free data acquisition and transmission.

#### 2. Data-to-Information Conversion Level

At this level, information is extracted from the data. Specific prognostics and health-management tools and methods are used, with the aim of evaluating operative parameters of the machines or predicting degradation and performance. This level gives self-awareness to the machines.



**Fig. 1.3** CPS layer architecture.

### 3. Cyber Level

At this level, the cyber twin of each machine or component is generated and made visible to the network. This is the communication hub of cyber representations of all machines and components.

### 4. Cognition Level

At this level the data on the status of the CPS are visible to the human.

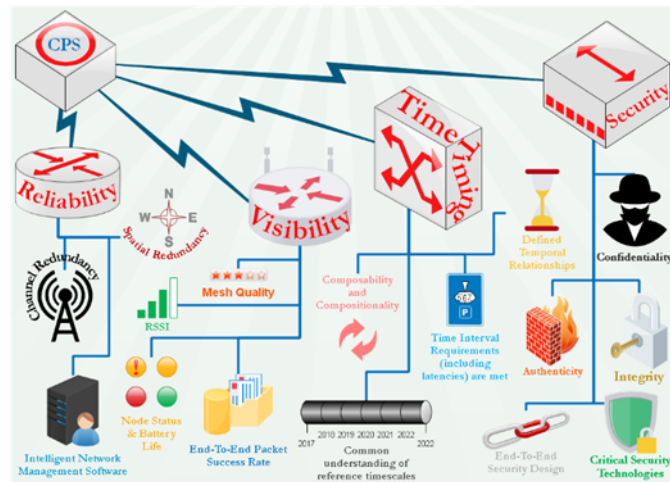
5. Configuration Level This is the resilience level. At this level, in fact, the CPS is self-configurable and self-adaptable, taking advantage of feedbacks from the cyberspace and the ability to control the monitored system through the network.

## 1.6.2 Industrial CPSs vs measurement and networking issues

Thanks to the use of CPSs in industrial processes, intelligent production processes and intelligent industries are emerging, providing completely innovative and renewable product and service management. In a smart industry, machines have the ability to know their operating status and can record the surrounding environment, keep the memory of the history of network operation in which they are immersed and make decisions as a result of inferential processes. All these skills change the nature, duration and management of planning processes and lifecycle as well as the management of supply chain and maintenance processes. The scenarios that sequentially make a smart factory effective are:

- a) generation and acquisition of data;
- b) computing and sharing of acquired data;
- c) support for decision making.

All sectors where CPS systems will be used are characterized by communication networks deployed at



**Fig. 1.4** CPS network requirement.

different levels, from field sensors properly networked to data transmission networks. In order to ensure, in particular, the evolution of CPS-based industries, it is essential that such communication networks meet vital requirements (Fig. 1.4).

Reliability of the networking system that supports a CPS imposes pressing requirements to all architectural levels:

- communication level reliability, assured through communication channel reliability;
- computational level reliability, assured through software reliability;
- connection level reliability, assured through link redundancy and topological robustness.

To satisfy these requirements, the aforementioned networking system has to be designed and managed taking into account the following items:

- Spatial Redundancy
- Channel Redundancy
- Intelligent Network Management Software

To ensure the security of data exchanged by the network system the following conditions must be satisfied:

- Confidentiality: data transmitted through the network system must not be read by anyone other than the recipient;
- Integrity: every received message must be exactly the same as the transmitted message, without adding, deleting or modifying the content;

- **Authenticity:** source warranty and protection from recording and copy;
- **Robustness:** in the presence of wireless sensor networks, it is necessary they feature robust encryption methods, i.e. robust keys as well as robust systems for their management;
- **End-to-end security:** unsafe gateway connections must be avoided.

Network monitoring and control is a business critical element, which directly influences the basic cost of producing a good. The punctuality of the data is crucial, therefore ensuring a uninterrupted temporal reference and a unique time measurement within interconnected heterogeneous systems is crucial. The re-routing capabilities that ensure transmission reliability can generate networks with low latency, but with a disordered and unmanageable traffic density. It is indispensable for each node to have a time reference to reconstruct the signals and to locate them correctly.

It is imperative to use trusted and unique network parameter management metrics that are also visible. Visibility is a requirement that gives intrinsic robustness to a network and allows locally to solve routing or loss issues and optimize the overall network operation. Visibility must be provided at least guaranteed for the following parameters:

- wireless connection quality, measured through signal strength (RSSI);
- success rate of sending end-to-end packages;
- network quality, highlighting nodes that do not have sufficient alternative pathways to maintain high reliability;
- node status and “battery life”.

### 1.6.3 Industrial CPS self-awareness: measurement challenges

The disruptive force of CPSs depends on their ability to create a virtual world in which each object is represented not only by its characteristics but also by its "conscious" membership in the context in which it operates. This ability enables to deploy a knowledge of the production system that is simultaneously global and precise, making it available all the information necessary to reach high levels of machine reliability and availability and increase production efficiency.

From a measurement and networking point of view, to realize industrial self-aware systems many open challenges arise, some of them are listed below according to the enabling technology they refer to:

- **Sensors** - a new concept of sensor should be introduced, in which the traditional sensing and processing functions are complemented with a special form of intelligence that makes it a self-standing CPS (a little CPS within a greater CPS). This new kind of sensor is thus capable of providing both rough (measurement data) and structured information (operating status efficiency and reliability, adaptive maintenance and prognostics), key elements to assure self-awareness and self-consciousness to the overall CPS. New metrological features have to be added or integrated

into traditional ones, and new procedures for their assessment and characterization have to be defined and implemented;

- **Cloud computing** - capacity, available bandwidth, latency and timing at each layer of the protocol stack of the communication network have to be assessed and real-time monitored. Cross-layer measurement approaches are needed to make self-awareness viable;
- **Internet-of-Things technology** – due to the diversity of machines and devices connected through the communication network, new measurement models are required, which are claimed to take into account both rough (physical) measurement data and structured (virtual) measurement information. These models can identify virtual smart transducers, i.e. transducers not physically on hand but capable of measuring quantities or parameters without human intervention;
- **Big data and Analytics** – a great deal of rough and unformed measurement data is expected to be available in a CPS system. Data integration and data mining methods and techniques are thus necessary to gain structured and helpful information.

## 1.7 Transversal Technology: Internet of Things

Kevin Ashton of the Massachusetts Institute of Technology (MIT) is credited with coining the phrase “the Internet of Things” in 1999 as part of a presentation about RFID tags.

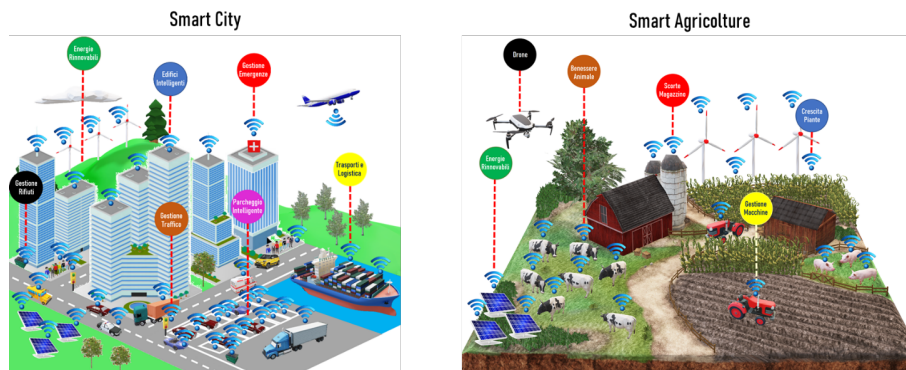
At that time, a “thing” on the Internet of Things (IoT) was imagined as something that could be counted. Current visions for the IoT space have taken on a broader perspective, with more emphasis on post-processing of accumulated data. This has led to the need to connect individual applications to cloud storage and enable remote control via the Internet. The scale of the required network is potentially mind-boggling—and making this scenario a reality depends on absolutely reliable connectivity, designed in from the start and well tested all along the product lifecycle.

The information is collected thanks to the use of the ‘smart sensors’ (intelligent sensors), able to detect physical size, to transform them into information and to transmit them in the form of electrical signals to the central processing unit of the smart thing, responsible for the elaboration of the same and for the formulation of possible decisions.

### 1.7.1 IoT architecture

The technological development of smart sensors, the rapid spread of smart things and the performance improvement of communication protocols enable completely new scenarios, even on a large scale, such as Smart City, Smart Agriculture and Smart Factory, aimed at the intelligent and digitised management of very complex systems such as cities, agri-food production and factories for the production of goods and services (Fig. 1.5).

Developing the architecture of IoT systems is complex due to the fragmentary nature of this technology. The architecture must be based on two key aspects in the Internet of Things: Things (devices) and



**Fig. 1.5** Example of new scenarios as enabled by the technological development of smart sensors, combined with the spread of smart things and the performance improvement of communication protocols: Smart City (*left*), Smart Agriculture (*right*).

Server-Side Architecture (support for devices). It has to implement a real server-side support and not refer to the Internet generically because very often are need one or more other architectural elements, which act as a bridge between the sensory devices (which are almost always low-power entities that are not able to expose themselves independently on the web) and the real Server that allows the connection to the Internet.

Several architectural stacks have been proposed in the literature to give a global vision for an Iot software system: find a reference configuration will, as already expressed, an enabling road for the future definition of technological standards and winning solutions in the application market of these technologies.

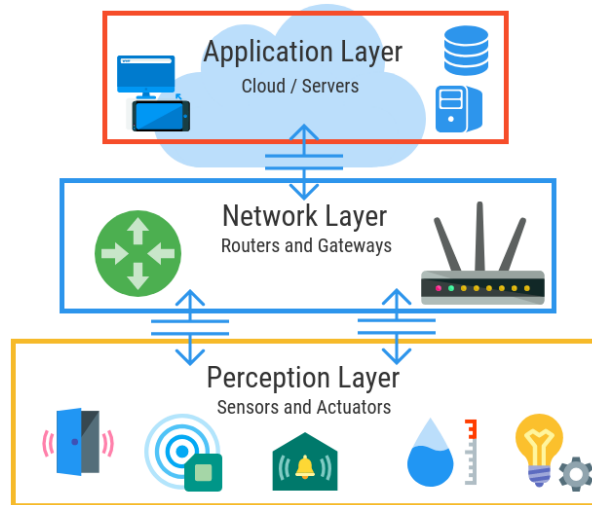
In particular, it generally considers an Iot stack to three levels, as shown in Fig. 1.6: Application, Network and Perception.

- Application means the application level, that is where the software offering a service (for example in a Web environment) is actually implemented;
- Network means the level of communication of the network, where objects are actually connected for an Iot service, and therefore becomes of fundamental importance to consider;
- Perception means the physical level of the objects connected to the network (the objects themselves).

The architecture can get more and more complicated: there could be another level of business that goes to manage a further abstraction towards the end user, for example to integrate data into an analytical decision (Business Intelligence, Business Analysis and Big Data); or, intermediate abstraction levels can be inserted. Generally, however, reference is made to this vertical architecture, and therefore to the possible attacks that may occur in this specific configuration.

The architecture can be further specialized, it could be introduced an additional level of business able to handle a further abstraction towards the end user, for example to integrate data into an analytical decision





**Fig. 1.6** Levels of the IoT stack [7]

(Business Intelligence, Business Analysis and Big Data); or by inserting an intermediate abstraction levels [8] as shown in Fig. 1.7.

Generally, however, reference is made to three layers architecture to describe all the potentials and vulnerabilities of IoT technology. Several technological challenges invest IoT architecture. They depend on the possible applications and the necessity of interfacing with other technologies. Main opened issues are:

**Connectivity & Scalability:**

Connecting a huge number of devices is one of the most important challenges for the Iot. Today we rely very often on centralized architectures, server/client nodes, but already in many solutions (and in the future, with billions of devices to manage) the primacy will be obtained by those who manage to offer an efficient and totally decentralized architecture: we are talking about, for example, fog computing, peer-to-peer, and in general solutions that in turn have challenges, one of all security;

**Compatibility and standard:**

You need to be fully aware that there is neither a single architecture nor of course a single standard for Iot solutions: as already expressed, the Iot grows in different directions, And since there are no standard protocols for M2M interaction, we will have differences both in the firmware of the devices and in the network protocols. Many challenges are also due to the fact that the data of the devices fall almost completely in the sphere of Big Data, or data described in order of 5 V (Velocity, Veracity, Volume, Variety, Value) totally different from relational data and therefore new models and architectures are needed for their processing/storage (Data Warehouse, Hadoop, Spark);

**Intelligent Analysis & Actions:** Extracting behavioral aspects and information from data for analysis, or a real intelligent analytics of data that comes from IOT devices, is an aspect that determines the true nature of the Iot application field but at the same time full of challenges, for example in the

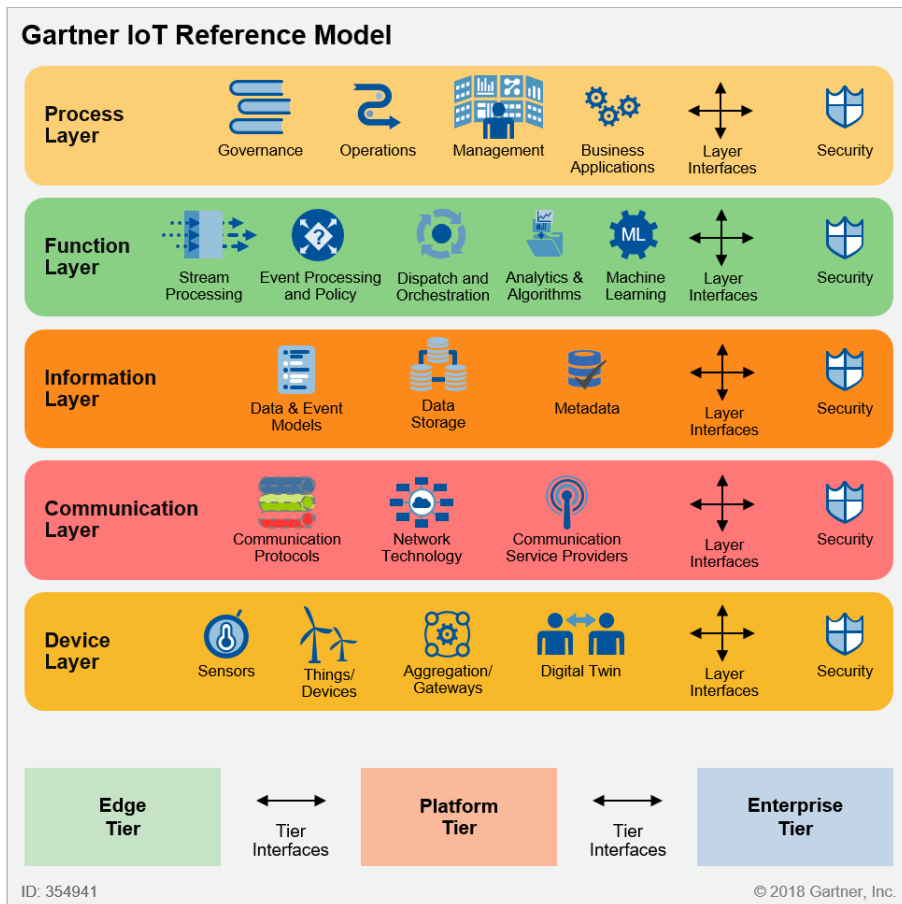


Fig. 1.7 Gartner IoT reference model [8].

real-time management of a large volume of data, passing from a 'batch analysis' to a 'streaming analysis' also in relation to the management of interoperability between the various devices and, once again, in terms of information security and privacy.

## Chapter 2

# The 4.0 transition-driven monitoring system

According to its Latin etymology, *monere* is a verb that means to predict, to preannounce.

A monitoring system is a system capable of detecting information on the characteristics and status of the elements intended to be observed, whether they are simple or complex. Monitoring means to identify the descriptive quantities of a phenomenon, to select the appropriate technique to measure this information in relation to their peculiar characteristics and to those of the context and measuring these quantities. For complex systems, the monitoring operation requires the correlation of different quantities in order to observe the evolution of complex phenomena and to evaluate the impact of possible changes on the evolution of the observation system

The main purpose of a monitoring system is to observe the temporal evolution of quantities, systems or infrastructures in order to assess the status of the system. Monitoring systems allow auscultation of ongoing phenomena and are essential, first, to characterise the phenomena themselves, to acquire historical series of data on the systems states and subsequently to validate their evolution through comparison with the expected states, or to prevent the propagation of malfunctions.

Monitoring systems have been indispensable for progress in various development fields from health to engineering, from agriculture to the economy. In fact, the evolutionary stages of industrial history have been marked by the evolution of monitoring techniques and the development of increasingly sophisticated monitoring systems. The simplest and oldest monitoring systems allowed observing the evolution of phenomena and processes over time exclusively with real-time techniques. Subsequently, the techniques of analysis and processing of the information acquired through the observations allowed to develop methods and systems of control and regulation at the base of the theory of the automation and, therefore, of the industrial automation processes.

The introduction of storage systems in the second half of the 20th century marked a profound evolution of monitoring systems, enabling the delayed processing of information and the implementation of data aggregation techniques necessary to develop prediction and early-warning techniques for the observation of strategic systems. At the same time, the evolution of data acquisition technologies, the implementation

---

of simulation systems, the introduction of graphical languages able to virtualize measuring instruments and the increment of the ability to calculation and elaboration is hardware and software has favoured the possibility to implement systems of monitoring, dedicated or generalist, usable in any application field. Since ancient times, the natural need for monitoring in all the disciplines has been expressed by constant activities of observation. Although the monitoring of most quantities has developed thanks to electrical and electronic measurement techniques and instrumentation, before the beginnings of digital instrumentation, monitoring activities were carried out with instantaneous observations, which required the operator's physical presence and an additional (i.e., external to the monitoring instrumentation) capability of recording results. The first revolution of monitoring systems was marked by the advent of numerical tools and their storage of data, which offered the possibility of processing both offline and in real time. A significant increase in performances was observed with the advent of interfacing protocols between personal computers and electronic instrumentation and the simultaneous development of graphic programming languages. The implementation of graphic languages has established the introduction of the concept of virtuality in the measurement field. These languages offered an innovative possibility of writing programs through links between icons representing functions and interfaces with physical systems, in order to reproduce visually and logically the flow of data to be processed.

The sequence of instructions and their syntax, which transformed an algorithm thought by a human logic into a process that could be understood by a machine, was subverted by a language that enslaved the machine to the mapping of the logical sequence of thoughts and connections. Programmable software tools with graphical languages generate programs called Virtual Tools, in conjunction with the possibility to measure and process any physical size by simulating the availability of the measurement tool ad hoc. Through graphic languages, the centrality of measurement information in the evolution of both civil and industrial processes has been clearly established. The rationale of these languages has been to build a bridge between direct and visible connections of the measurement information obtainable from the real world and its impact on the activities of control, regulation and monitoring of the processes. Not only do these languages allow reproducing virtual measurement stations, but they also ensure the possibility of following the evolution in a process along logical paths and blocks that are not necessarily consecutive, thus implementing multithreading techniques underpinning industrial automation processes. Graphic languages have represented a revolution not only because of their potential to simulate a measurement environment without having to bear the costs, but above all for the simplicity with which they allow to modify the operating scenario emulating the flexibility of human thought. Preserving the traditional systems of input and output of computers, keyboard, mouse, monitor, graphical programming languages have allowed software systems to develop structured data flows that have simultaneously amplified the potential for action of both software simulation systems and representation models of the data flows. The graphical languages represented not only the point of contact between these two philosophies, but the method to achieve local and sequential control and automation systems and to anticipate the most modern monitoring technologies, distributed management and control implemented from the distributed geographic networks to the landing place at the Internet of things and the big data.

In modern times, and particularly following the spread of telecommunications networks and digital

technologies (enabling technologies), the ability to find, collect, process and share information has become one of the engines of the global economy. Therefore, monitoring principles and techniques are a cornerstone of both material and intangible processing and processing of goods and services.

In the present global world understanding the state of infrastructure and systems is essential for ensuring the reliability and stability of services. Information about the health and performance of deployments not only helps to react to issues, it also gives the security to make changes with confidence. One of the best ways to gain this insight is with a robust monitoring system that gathers metrics, visualizes data, and alerts operators when things appear to be broken. The disproportionate amplification of information produced by the 4.0 paradigm requires further evolution of monitoring systems in the holistic sense, by anticipating the overcoming of existing barriers between data and metadata from different sensor networks. Invoked, necessarily, as pervasive by the smart Communities paradigm, the simultaneous monitoring systems shall lead to overcome existing barriers between data gathered from sensor networks having different characteristics and physical/geographical placement.

Despite the fact that monitoring practices are ubiquitous and are the source of data that drives the development of data science, the nature of monitoring has been neglected theoretically. What is the nature and purpose of monitoring? Do the diverse and apparently disparate monitoring systems have anything in common?

We attempt to answer these questions by proposing an abstract approach to monitoring that can explore the common structure of many different monitoring systems. The scope of monitoring is colossal. Monitoring examples abound in science, engineering, commerce, manufacturing, infrastructure, healthcare, management, security, and services.

## 2.1 Traditional monitoring systems

A monitoring system is a system capable of detecting information on the characteristics and status of the elements intended to be observed, whether they are simple or complex. Monitoring means to identify the descriptive quantities of a phenomenon, to select the appropriate technique to measure this information in relation to their peculiar characteristics and to those of the context and measuring these quantities. For complex systems, the monitoring operation requires the correlation of different quantities in order to observe the evolution of complex phenomena and to evaluate the impact of possible changes on the evolution of the observation system.

The main purpose of a monitoring system is to observe the temporal evolution of quantities, systems or infrastructures in order to assess the status of the system. Monitoring systems allow auscultation of ongoing phenomena and are essential, first, to characterise the phenomena themselves, to acquire historical series of data on the systems states and subsequently to validate their evolution through comparison with the expected states, or to prevent the propagation of malfunctions.

Monitoring systems have been indispensable for progress in various development fields from health to engineering, from agriculture to the economy. In fact, the evolutionary stages of industrial history illustrated in the previous chapter have been marked by the evolution of monitoring techniques and the

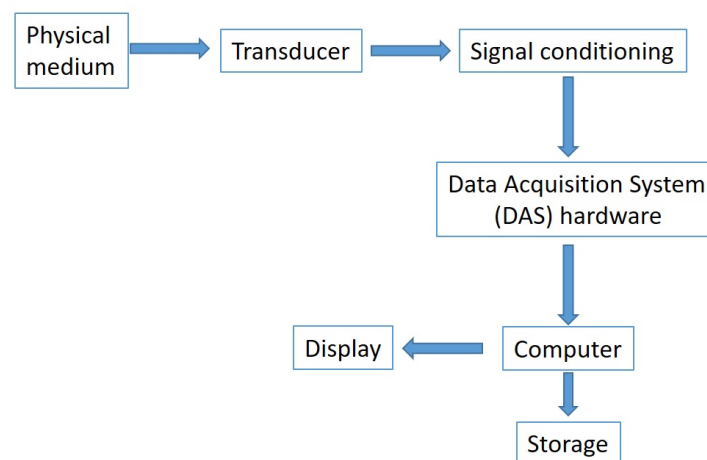
development of increasingly sophisticated monitoring systems. The simplest and oldest monitoring systems allowed observing the evolution of phenomena and processes over time exclusively with real-time techniques. Subsequently, the techniques of analysis and processing of the information acquired through the observations allowed to develop methods and systems of control and regulation at the base of the theory of the automation and, therefore, of the industrial automation processes.

This chapter describes main characteristics of monitoring systems, with a brief description of the fundamental elements such sensors, data acquisition systems, processing methods.

## 2.2 Components of a monitoring system

Providing a general definition of a monitoring system is a very difficult task, mostly because the expression “monitoring system” (MS) is so broad that it encompasses a number of possible declinations, each with its unique peculiarity and dignity. In general, monitoring means to select physical parameters associated to a specific phenomenon and to detect them, measuring the value assumed in the temporal spatial domains, recording and correlating them with others to obtain useful data to develop control system of prediction and prevention.

The simplest and oldest monitoring systems allowed observing the evolution of phenomena and processes over time exclusively with real-time techniques (Fig. 2.1).

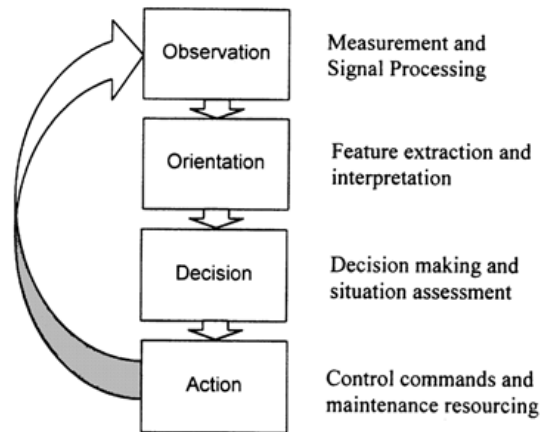


**Fig. 2.1** Real-time monitoring.

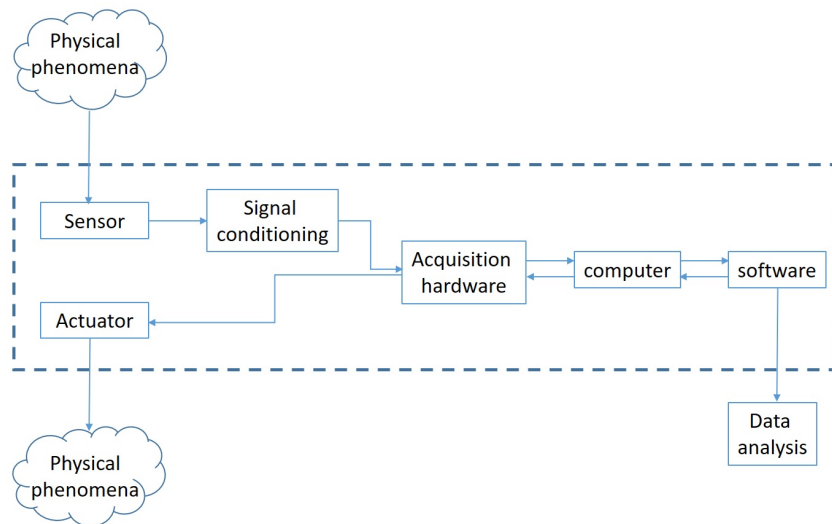
Subsequently, the techniques of analysis and processing of the information acquired through the observations allowed to develop methods and systems of control (Fig. 2.2).

Control and regulation methods are fundamental for automation theory and, therefore, of the industrial automation processes according to the schema in Fig. 2.3.

The conceptual framework of a monitoring system in Fig. 2.3 formalises the idea that monitoring is a process that observes properties of the behaviour of people and objects in a context. Data acquisition



**Fig. 2.2** Monitoring support to decision making.



**Fig. 2.3** Monitoring system block diagram.

is the heart of monitoring systems and is key in very diverse fields such as health sciences research, civil engineering, industry, etc. All these sectors bet on a technology of this type because it brings them many advantages.

Data acquisition provides greater control over an organization's processes and faster response to failures that may occur. The procedures are optimized to the maximum to obtain products and services of quality that maximize the result of the company and increase its efficiency.

A monitoring system basically consists of a series of main units:

- measuring instruments with related sensors;
- the data transfer system from the point of acquisition to the point of use;
- the data processing and archiving system.

Monitoring a context begins by choosing attributes to be observed. The contexts are represented by abstract data types and the observation attributes by logical languages.

The correct functioning of a monitoring system is based on the choice and use of the hardware and software components and systems which must meet some fundamental requirements that will be listed below.

The choice of the tools to be used and the relative installation procedures represents a particularly important aspect for the possibility of successful monitoring; in fact, the quality of the measurements depends predominantly on them.

### **2.2.1 Metrics, thresholds and alerts**

Thanks to the performing characteristics of the technologies metrics, monitoring, and alerting have become interrelated concepts and together form the basis of a monitoring system. The chain of accurate metrics, reliable monitoring methods and robust instruments, and accurate trigger allow to provide visibility into the health of monitored systems, to help in the understanding trends in usage or behavior, and to forecast the impact of changes you make.

Metrics represent the quantitative evaluation of the attributes of a system, they are raw measurements that can be collected throughout observation of system activity. Metrics outline the input of monitoring systems, therefore it is necessary to choose appropriate indicators of system and suitable metrics to implement an optimal monitoring system. Some metrics are presented in relation to a total capacity, while others are represented as a rate that indicates the “busyness” of a component. Metrics are useful because they provide insight into the behavior and health of your systems, especially when analyzed in aggregate. They are necessary to build a holistic view of your environment, automate responses to changes, and alert human beings when required. Metrics are the basic values used to understand historic trends, correlate diverse factors, and measure changes in your performance, consumption, or error rates. Monitoring is the process of collecting, aggregating, and analyzing measured values of metrics to improve awareness of components’ characteristics and behavior. The data from various parts of environment are collected into a monitoring system that is responsible for storage, aggregation, visualization, and initiating automated responses when the values meet specific requirements [9].

In general, the difference between metrics and monitoring mirrors the difference between data and information. Data is composed of raw, unprocessed facts, while information is produced by analyzing and organizing data to build context that provides value. Monitoring takes metrics data, aggregates it, and presents it in various ways that allow humans to extract insights from the collection of individual pieces.

Monitoring systems typically provide visualizations of data. While metrics can be displayed and understood as individual values or tables, humans are much better at recognizing trends and understanding how components fit together when information is organized in a visually meaningful way. Monitoring systems usually represent the components they measure with configurable graphs and dashboards. This makes it possible to understand the interaction of complex variables or changes within a system by



glancing at a display.

An additional function that monitoring systems provide is organizing and correlating data from various inputs. For the metrics to be useful, administrators need to be able to recognize patterns between different resources and across groups of servers.

Finally, monitoring systems are typically used as a platform for defining and activating alerts, which are useful output of monitoring systems to prevent the propagation of dangerous in a badly functioning system. Alerting, indeed, is the responsive component of a monitoring system that performs actions based on changes in metric values. Alerts definitions are composed of two components: a metrics-based condition or threshold, and an action to perform when the values fall outside of the acceptable conditions. Thanks to alerts is possible to distinguish two form of monitoring one active and other one passive. Alerts allow, indeed, to define and recognize situations that have to actively manage, while relying on the passive monitoring to observe for changing and evolution of conditions.

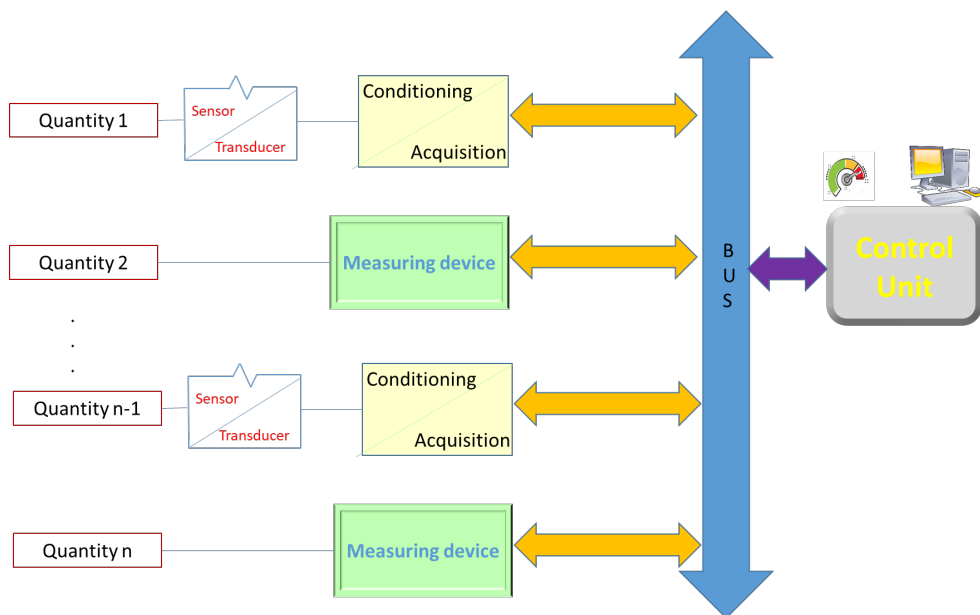
While notifying responsible parties is the most common action for alerting, some programmatic responses can be triggered based on threshold violations as well, and many automatic protections can be activated. However, the main purpose of alerting is still to bring human attention to bear on the current status of your systems. Automating responses is an important mechanism for ensuring that notifications are only triggered for situations that require consideration from a knowledgeable human being. The alert itself should contain information about what is wrong and where to go to find additional information. The individual responding to the alert can then use the monitoring system and associated (tooling like log files) to investigate the cause of the problem and implementing a mitigation strategy.

## **2.3 Evolution of Monitoring Systems: from Data Acquisition Systems to “4.0 Monitoring”**

The evolution of monitoring systems has seen them change from simple data acquisition systems to true expressions of the 4.0 paradigm. The primary task of a monitoring system is to obtain, in an appropriate form, the temporal evolution of the measurement information relating to the physical quantities describing the behaviour of the phenomenon, of the body, of the substance, of the generic system, subject to the monitoring itself.

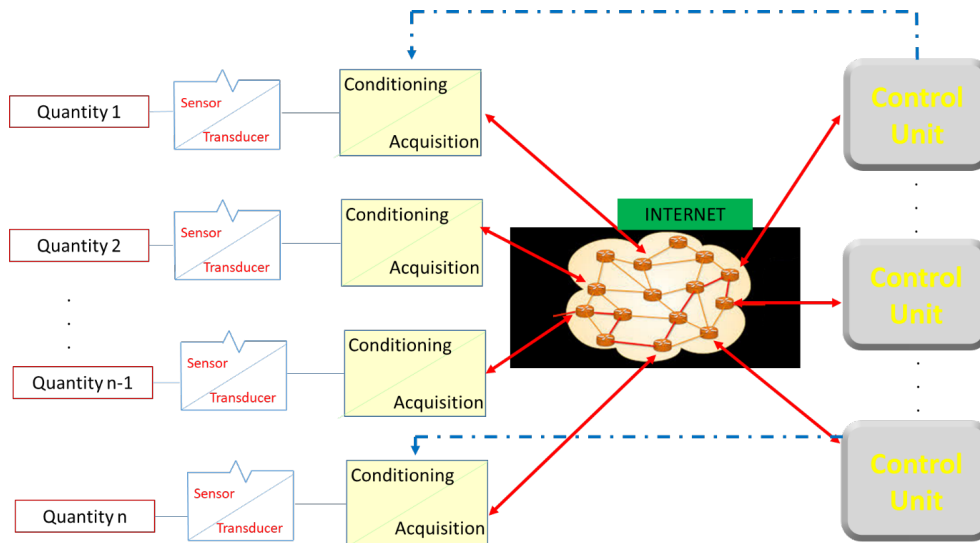
The classic architecture of a monitoring system coincided substantially with that of a locally distributed measuring system and referred to the possibility of acquiring measurement data from sensors/transducers, sometimes stand-alone measuring instruments, and to carry out local processing on the central unit to extract structured information. The information or data generated required one or more levels of conditioning to be presented to the external observer in the form of indication or recording. The entire measurement process could also take place automatically thanks to an appropriate processing and control software, developed ad-hoc to implement the measurement procedure and executed by the central unit. The simplest block representation of this model is shown in the following Fig. 2.4.

About sensors and transducers, the following considerations apply.



**Fig. 2.4** Classic architecture of a monitoring system.

- Sensors are used to convert a parameter of interest to a form that is more convenient to use. The most familiar sensors provide an electrical output, but many other kinds of mappings are possible. This broader definition includes devices whose purpose is not measurement but rather to provide a binary output when a specific “event” occurs. Examples are glass-breakage detectors and fire detectors. Their purpose is not measurement of an analog variable, but rather is the detection of an event and the initiation of an alarm signal (or the inflation of an airbag) if an event is detected. Such devices are considered as sensor products in the sensor marketplace and are thus included in our definition of sensors.
- Sensors are part of transducers, when a processing section is added.
- Sensors are the doors through which the world enters the monitoring system. Sensor information must have two attributes to be useful: (1) it must describe a measurable attribute of the physical world external to the monitoring system, and (2) it must be distinguishable from noise (random signals). Thus, it is possible to define sensor information as the useful signal (describing an attribute of a measurand) that is distinguishable from a noise background.
- The term *information transducer* is an inclusive term that covers any mapping, any transformation of information from one form to another. It is a much broader term and labels a concept essential to discuss the transducer process and analyze its mechanisms. Information transducers generally transform information in only one direction, i.e., have a specified input and output.
- With this definition, sensors are simply a subset of the larger set of information transducers. There are three categories of information transducers – input transducers, information processors



**Fig. 2.5** Geographically distributed monitoring systems.

and output transducers, depending on where the transducer is in the information chain. Input transducers include sensors but also include other types of information transducer that are not usually considered sensors – in the marketplace or in the literature. “Sensors” refers to input transducers that measure some attribute of the physical world.

Concerning data processing, its stage is implemented in the control unit and may have different degrees of complexity. In the simplest situation, the processing can consist only in the documentation of the evolution of the phenomenon for example through the visualization on a display of the variation of a certain magnitude in the time.

The subsequent refinement of sampling and digitisation techniques, the evolution of communication protocols dedicated to measuring instruments, the development of networking systems to operate with the Internet and the simultaneous increase in computing power have made monitoring systems applicable to all industrial, productive and service sectors. The monitoring model has, therefore, been configured as a system that, thanks to a suitable section of data acquisition, distributed also geographically, becomes able to send information to external units, more or less complex, for processing, decision and control (Fig. 2.5).

By increasing the complexity of these systems, processing leads to specific control and regulation actions that affect the dynamics of the process and alter its evolution. In fact, based on the data collected by the control and regulation system and the logic of regulation and feedback, the regulator processes the signal to be applied to the actuator allowing the monitoring system to enter the architecture of the decision systems.

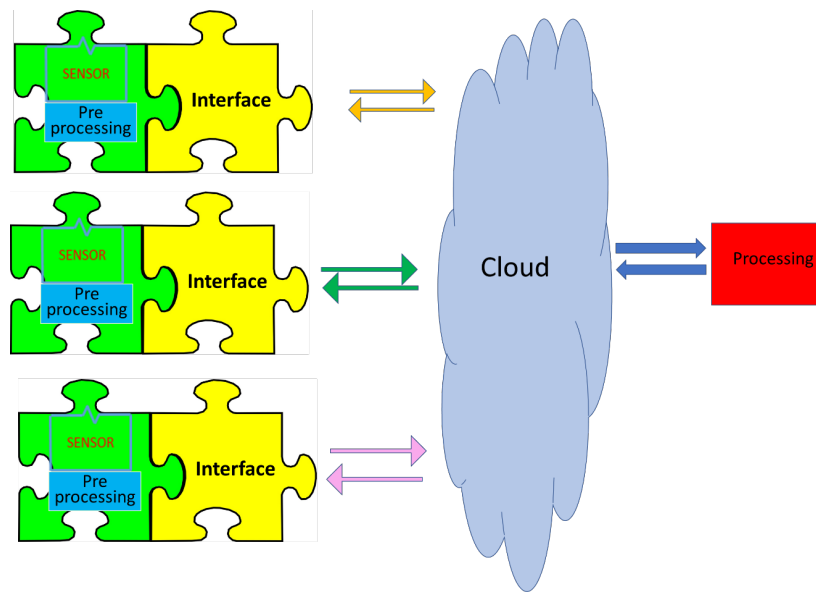
Subsequently, the portentous diffusion of monitoring models was possible thanks to the possibility to centralise data distributed geographically and temporally. At this stage, the transmission units between sensors and processing units met the precise characteristics of the communication interfaces, which

could be different for the different sizes acquired, while processing and decision/control units began to develop intelligence across systems.

The next step in this evolutionary scale is marked by sensors networks. A sensor network is a network of spatially distributed autonomous sensors for monitoring physical quantities. Each node of the network carries out only sensing, acquisition and data transmission with centralized control and processing. Therefore, the difference between sensor networks and distributed measuring systems is related to the centralization or distribution of the control and data processing. Distributed systems represent multi-node networks, where each node integrates locally sensing, data acquisition, and transmission, with specific processing and control modules (intelligent node). Differently, sensor networks are still considered as distributed systems for the measurement, but with centralized control and processing. In other terms, each node of the network carries out only sensing, acquisition and data transmission. About hardware, distributed systems have complex/intelligent nodes (sensing, data acquisition, processing, control, and transmission modules) with a central unit for supervision. Sensor networks present nodes (sensing, data acquisition, and transmission module) less complex than in the previous case. About software aspects, both the systems present a centralized software for control (data management); the main difference is the possibility for distributed systems to have software installed locally (on the nodes), implementing different functions.

Wireless sensor networks (WSNs) technology represents the key technology for the future coverage of the Internet and the expansion of computing. WSNs technology has received widespread attention from society and academia, and it has great application value for the national economy, social development, and defense. Because the sensor nodes are limited by their volume, weight, power consumption, cost, the deployment environment, external interference, and limited energy, they are prone to malfunction, energy exhaustion, environmental damage, and other issues. Moreover, the data collected by some sensor nodes are inaccurate and can suffer from node failure, network instability, or collapse, which affects the stability and the reliability of the network and under the worst conditions, the entire sensor network may fail or stop working. Therefore, the reliability of the network must be considered in the design of hardware device for WSNs, the process of data transmission, and the maintenance of WSNs system (Fig. 2.6). The reliability of WSNs is one of the most important indices in the evaluation of the performance of WSNs. Due to the rapid development and application of mobile terminal technology and mobile Internet technology, MWSNs have become a new trend in the evolution of WSNs and a popular research focus in the field of WSNs. The difference between MWSNs and WSNs is to the mobility of the nodes, which improves the coverage and connectivity, the network scalability, and the reliability of the network. At the same time, MWSNs balance the energy consumption and prolong the network's lifetime. Due to the complexity of the industrial environment and the dynamic changes in the topological structure, especially during data acquisition and data transmission, the performance of the MWSNs is easily affected and may lead to failure of network.

At this stage an evolution sensor and transducer have changed their concept, it become mandatory to make a connection between sensors and information. In fact, "sensors" refers non only to input



**Fig. 2.6** Sensor network-based monitoring systems.

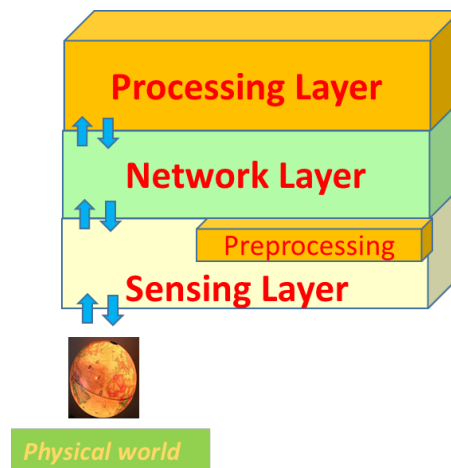
transducers that measure some attribute of the physical world, but also to information input transducers that make use of different information transduction mechanisms and can produce new meaning.

Since information can come in many forms (electrical, optical, chemical, etc.) and types (binary, digital or analog), information transducers can come in many combinations. Input transducers devices generate electrical output signals compatible with today's information processing and control systems. The concepts of information and information transduction are much broader, and they evolve as fast as knowledge evolves. Perhaps, future sensors and information transducers will be even more diverse, making use of optical data processing, quantum computation or even neurotransmitter receptors.

More modern networks are wireless and bidirectional, also to enable control systems, and are used in many industrial and consumer applications, such as health monitoring, industrial process, machine control, and so on. They depend strongly on the field application, and on the case study. For this reason, the related software can be considered as specific and case study oriented.

The revolution due to the miniaturisation of electronic tools and the increase in computing capabilities and the implementation of increasingly general interfaces and communication systems, has allowed to insert in a system of distributed acquisition specialized sensing units on the different quantities to acquire, able to locally pre-analyze the data and to use protocols transportable from any means of transmission.

At the same time, the development of flexible and interoperable interfaces has allowed the transformation of the monitoring architecture from a dedicated architecture into a stack architecture that has in its founding idea the principle of independence of each level, operational specialization and the very high functional abstraction of each level and the great transparency of implementation. Therefore, the activity of monitoring, peculiarities of customized measurement applications, transits in the paradigm open source in which the architecture of the system is shaped (driven) by the technologies and not from the logic of implementation (Fig. 2.7).



**Fig. 2.7** Protocol stack of modern monitoring systems.

The framework is established by considering sensing processes as forms of information processing that include the transduction of information. To the aim, to exploit all the potential of this architecture it is necessary to underline some characteristics of the sensing layer:

- information comes from outside the system. It is meaningful only when it represents some attribute of the physical world outside the information system. (An exception is information that originates within the system, e.g., for self-diagnosis);
- sensing is an information transduction process; signals from outside the system are transformed into electrical signals that can be processed by a data or signal processing system;
- sensing process is (non-electronic) information processing that takes place when some attribute of the physical world is converted to an electronic signal;
- to understand sensing mechanisms, it is important to consider the entire sensing or transduction process that may include processes occurring outside the “sensor” or the information system;
- to understand sensing mechanisms, it is important to consider the entire sensing or transduction process that may include processes occurring outside the “sensor” or the information system;
- sensing cannot add information but can only reduce the amount of information available (by adding noise or distortion or by limiting bandwidth).

The stack architectures have the peculiarity of quickly transposing technological innovations and are inherently scalable, so they minimize market times. For these characteristics, today, the diffusion of proprietary protocols and customized architectures have been reduced.

Thanks to its modularity, the stack architecture meets the needs of modern industrial and societal systems. That requires the combination of a multitude of data sources and the application of different analytical techniques. Traditionally, scientific and applicative sectors worked according to well-defined

and compartmentalized sectors in using and applying their data and analytical tools. The stack model is a framework that allows a more comprehensive analysis and a more reliable decision-making process through the management of a large amount of data.

The stack architecture is the answer to the demand of semantic interoperability at the lower levels of the abstract framework of data processing and analysis. The stack meets emerging trends changes of broadening policy and decision contexts, which push the “science & knowledge” domain more and more towards multidisciplinary and interdisciplinary. According to the velocity and globalization of the industrial world, the attention of applicative tools has turned to open data as public good resource, therefore cross-sectional monitoring systems have become indispensable. The amount of data, also, has grown enormously in the recent time driven by technology developments such as open access repositories, the advance of mobile devices and the increase of computational resources. The availability of more data and higher connectivity offers, in principle, opportunities to support larger, faster and more complex data intensive processing and analysis across disciplines as required for monitoring systems to support evidence-based decision making. The basic idea of this kind of monitoring systems is that decision making process needs real-time, reliable data for monitoring and taking evidence-based decisions. Therefore, the transformation of an entity at a lower level in the stack hierarchy, e.g. raw data, to an entity at the higher level in the stack, e.g. information, is the most pressing goal of monitoring systems.

However, for stack architectures characterized by high flexibility to be used as monitoring architectures, it is essential that each level exhibits the prerogatives of a measurement system:

- adequate design of sensing equipment;
- measuring data processing capacity;
- capability of manipulating the quality of measurement information.

These prerogatives, however, are no longer intrinsically fulfilled by the architectural model. In fact, unlike previous monitoring models where the design of architecture and data processing units was entirely and exclusively dedicated to the practical measurement and designed according to the specificities of the application, in the stack model the functionality of each level is not customized for the application. The successful elements of the stack architectures, flexibility and interoperability, are therefore, key factors for modern monitoring applications that can only be governed by the appropriate measurement expertise.

This conceptualization is a consequence of the evolutionary process that has made the amount of available data enormous. The raw data have become manifold and have gradually lost their informative power to the advantage of techniques aimed at meaning attributing that can be used by the end user, or to the benefit of information that can be immediately used for decision making processes.

The availability of cheap and fast integration and processing systems on the one hand, and the chimera of operational autonomy of the operators in the various application sectors on the other hand,

have implicitly increased confidence in structured data. Big data are implicitly perceived as the most appropriate source of data according to their final use.

In this scenario, the integrity and accuracy of the data and their sources has become a substitute for the amount of data and the complexity of their relationships and mutual influences.

However, rigorous procedures and accurate techniques that preserve the integrity and accuracy of the data are essential to make the use of big data truly advantageous both in precision applications and in cross-application domains.

These monitoring models require an effort to harmonize the bottom-up approach imposed by the metrological requirements of the monitoring systems with the top-down approach imposed by the heterogeneity requirements of the data distributed in support of modern decision-making processes, thus emphasizing the common practice of quantifying information in terms of information capacity rather than meaningful information.

## 2.4 4.0 Architectures

The general architecture of the 4.0 paradigm-based systems is represented by a stack architecture that includes the functionalities made available by the enabling technologies, illustrated in Section 1.3, and by the operational logics of the CPS illustrated in Section 1.6.

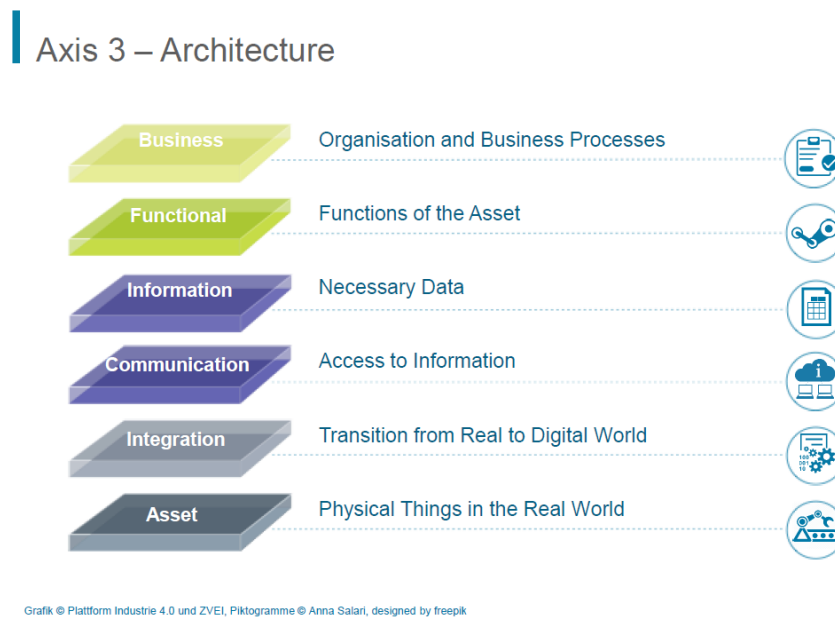
One of the first architectural models to provide such a perspective is referred to as “reference architectural model” for I4.0 (RAMI 4.0)”. This tridimensional architecture was first introduced by a group of collaborators (from different European enterprises and R&D Institutions), whose goal was to lay the foundation for a common base around the I4.0. Their major purpose was to group and represent the different aspects of the industry in a common model, i.e., vertical integration, end-to-end engineering and horizontal integration [10]. One major strength of RAMI 4.0 is that its structure is compatible with the approach of “modern” monitoring systems, and it has paved the way for the recent hierarchical (stack) architecture [11].

The RAMI 4.0 focuses on a structured description of a distributed Industrie 4.0 system in order to identify standardization gaps and to achieve a common understanding of what standards and use cases are required for I4.0. In general, the RAMI 4.0 provides a “basic reference architecture” for an I4.0 [12]. In particular, the so-called Layer axis represents the pillar of the architecture. These layers describe the decomposition of machines and physical entities in a way to enable its virtual mapping. The layers are used to represent perspectives, such as data maps, functional descriptions, communications behaviour, hardware/assets or business processes [Adolphs], i.e., they define a structure of ICT representing the I4.0.

RAMI 4.0 is an adaptation and expansion from the Smart Grid Architecture Model (SGAM) to meet the requirements of I4.0 [13]. As reported in [14], RAMI 4.0 is a basic reference architecture for I4.0 systems; therefore, it is important to describe briefly the RAMI 4.0 and, in particular, its so-called “layer” axis.

In the Layer axis of the RAMI 4.0, the functional elements are aggregated into six abstract interoperability

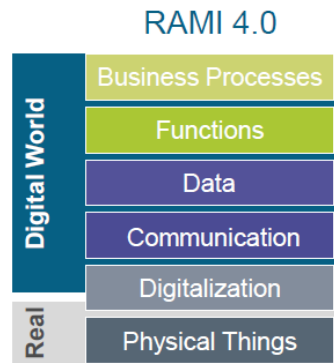




**Fig. 2.8** RAMI 4.0 Architectural model [15].

layers, as shown in Fig. 2.8. In this model, the first two levels correspond to the physical world and the level of acquisition of the necessary data to create the digital consideration of the real world. The next two levels are related to the transport and transmission of information functionalities. The last 2 levels are logical decision levels and applications. Let us examine more in detail each level.

- **Business Layer:** The business layer represents the business view on the information exchange related to industrial processes. RAMI 4.0 can be used to map regulatory and economic (market) structures and policies, business models, business portfolios (products & services) of market parties involved. Also business capabilities and business processes can be represented in this layer. In this way it supports business executives in decision making related to (new) business models and specific business projects (business case) as well as regulators in defining new market models.
- **Function Layer:** The function layer describes functions and services including their relationships from an architectural viewpoint. The functions are represented independent from actors and physical implementations in applications, systems and components. The functions are derived by extracting the use case functionality which is independent from actors.
- **Information Layer:** The information layer describes the information that is being used and exchanged between functions, services and components. It contains information objects and the underlying canonical data models. It oversees the I4.0 compatible data representation and access.
- **Communication Layer:** The emphasis of the communication layer is to describe protocols and mechanisms for the interoperable exchange of information between components in the context of the underlying use case, function or service and related information objects or data models.



**Fig. 2.9** View of RAMI 4.0 Architectural model [15].

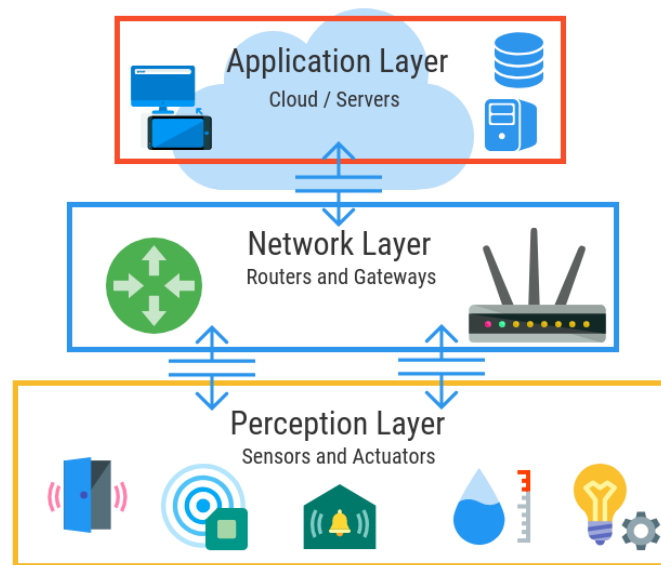
- **Integration Layer:** The integration layers' main purpose is to provide all physical assets to the other layers in order to create events in the form of so-called administration shells. To show the context of each asset, the integration layer also provides the usage and integration of network components. Hence, this layer can be considered as a link between the physical and digital worlds. From a practical point of view, the Integration layer may include system drivers, HMI devices, bridge wires, switches, hubs. It may as well include other tools like barcodes and QR-codes sensor readers to identify and connect the elements of the underlying Asset Layer.
- **Asset Layer:** The emphasis of the component layer is the physical distribution of all participating components in the smart grid context. This includes system actors, applications, physical components as well as documents, ideas and human beings (e.g. sensor, actuator, mechanical parts, documents, IP, etc.).

This architecture summarizes the main characteristics of paradigm 4.0:

- flexible machine and systems;
- functions distributed throughout the network;
- participants interact across hierarchy levels;
- communication among all participants; and
- product and data are part of the network.

A more intuitive representation of the architecture is shown in Fig. 2.9.

This figure shows how the real world generically becomes the world of things, in which all physical actors, machines, men, sensors and systems have the opportunity to access the world 4.0 through the Internet of things paradigm. It is therefore clear that in the field of enabling technologies IoT becomes an enabling technology for each of the other technologies, resulting the basic architecture on which to



**Fig. 2.10** Layers of the architecture for conceptual IoT systems [7].

develop the applications and potentialities of other technologies, just as cloud computing is networking technology for the entire panorama of 4.0 applications. The transversality of IoT technology transforms its paradigm into the metaphor of paradigm 4.0, allowing to consider the model of architecture proposed in literature for IoT systems as the reference architecture for the panorama of 4.0 applications in the different versions scanned by the enabling technologies [16, 17].

The functions of three-layer architecture for our conceptual IoT systems are described below [18].

- **Application Layer:** The layer consists of functional modules for application systems and users which consume the real-world data for analysis, computation, and for a real-world action.
  1. **End Users / Applications:** The application layer consists of systems or users or machines or an environment for consuming/ using the data sensed by the real-world object or situation. The application functional modules will be specific to application domain which consume data received from lower layers representing the real situation for required functions.
  2. **IoT data specific modules:** It includes the functions like optimization of duplicate and redundant data from field devices, functions of storing/retrieval of data for historic references, and retrieval of data for adaptive and dynamic decisions etc.

Some of these components are distributable between application and perception layers for achieving effective QoS.

- **Network Layer:** The network layer will be responsible for routing the data from lower layer to upper layer and vice versa. The functional components and modules of this layer would include:

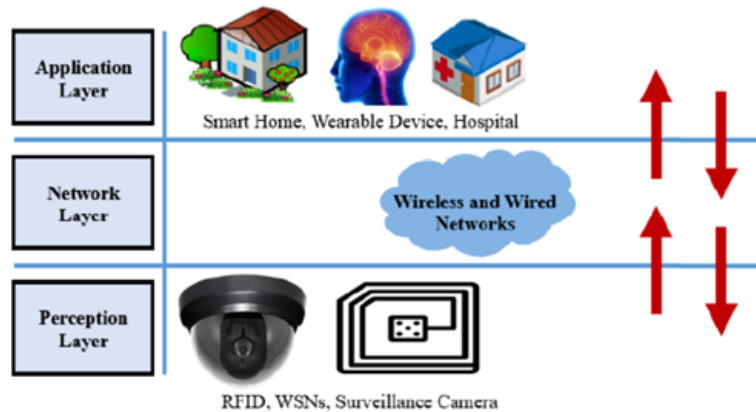


Fig. 2.11 Example of a three-layer 4.0 monitoring application [19].

1. All kinds of access networks, protocols
  2. Communication devices for connectivity and communication.
  3. Routing functions/modules
- **Perception Layer:** The main task of the perception layer is to perceive (measure) the physical properties of “things” or the environment. This process of perception is based on several sensing technologies. The sensing layer functional modules will include the essential data sensing/data gathering from real world objects which would include all the real-world objects, machines and people. The perception layer is the physical layer with environmental information sensors. In the environment, some physical parameters are sensed, or other intelligent objects are identified. Also, the functions may include controlling of field devices/actions based on sensed data and control commands received by upper layers and application systems/users of the domain.
    1. Edge Nodes: these are smart embedded devices (System on Chip - SoCs, Microcontrollers etc) having the minimum computing, storage and communication capabilities
    2. Field Devices: these are the devices for sensing the real world data with or with-out any intelligence and are capable of sensing data/information for a specific application/purpose, example sensors, RFID, ECP, actuator and other objects accessible directly or indirectly and providing the field data in the IoT environment by enabling IoT application for actions with real world data/situation (can also include devices, machines and objects with computing capabilities and participating in IoT data).

For the sake of example, Fig. 2.11 shows an example of the three layer of a 4.0 monitoring system/application.

## 2.5 Taxonomy of monitoring systems: before and during 4.0 era

Monitoring is fundamental in human and technological sciences such as in social and engineering systems, where methods and instruments are created to observe phenomena inside and outside the laboratory.

In industrial world, monitoring became essential for the proper functioning of manufacturing plant in factories, and of the infrastructures of energy, transport, communications and information. However, monitoring is by no means confined to science and engineering. Accounting, insurance and other financial services, with equally long histories, have developed theories and methods to monitor money algebra that began in the service of commerce [20]. Therefore, monitoring activity is part of knowledge of each specific field.

Monitoring cries out for a taxonomy system. While every other engineering discipline relies on rigid classification, “monitoring” has become a catchall for a wide range of tools and activities. Monitoring is useful to collect measurements or process them, on the basis of where the information to monitor is. Scientific literature exhibits many papers focused on monitoring, applied in the most disparate sectors of research and human activities.

To this aim, a wide-ranging analysis of the papers on monitoring topics published in relevant international journals or included in the proceedings of relevant international congresses has been conducted. The temporal period of the analysis has been chosen according to the breakthrough of Industry 4.0. The 4.0 paradigm, indeed, has had revolutionary effects also in the field of monitoring systems. So, a comparison between the main criteria adopted in some application sectors relevant for monitoring systems in the period prior to the current 4.0 era and those developed after the introduction of the so-called 4.0 enabling technologies is drawn.

A two-dimensional taxonomy has been arranged, according both to the application sector and the considered pillar of the monitoring system. Sectors considered significant for their heterogeneity have been selected, such as: Transportation, Industrial, Social & Economy, Healthcare, Environment, Agriculture, Energy, and Network while three major pillars of monitoring systems have been pointed out:

- Data
- Information
- Processing and application

These pillars do not represent single subsystems inside monitoring systems, rather they are conceptual monitoring implementation phases, founding and unchanged along the history of monitoring. Indeed, Data refers to the sensing stage used to collect raw data. Information refers to several intermediate aspects between raw data and their use through applications, i.e. acquisition system, transmission, formatting, pre-processing. Processing and application refer to the way to use monitoring outcomes. All details of the analysis are given in Table 2.1 and Table 2.2.

**Table 2.1** Taxonomy of monitoring systems before 4.0 Era.

	<b>Sensors/Data</b>	<b>Information</b>	<b>Processing &amp; Application</b>
Transportation	[21, 22]	[21, 23, 24]	[21, 23–25]
Industrial	[26–30]	[26, 28–32]	[28, 31, 33]
Social & Economy	–	[34–38]	[35–40]
Healthcare	[41–47]	[41–48]	[41–48]
Environment	[49–51]	[50–52]	[50–53]
Agriculture	[54–57]	[55–60]	[54, 55, 58–60]
Energy	[61, 62]	[61, 63, 64]	[62, 63]
Network	[65–67]	[65–68]	[67–69]

It can be observed that the papers cover quite equally both the different considered sectors and the three selected pillars. From the analysis of all papers the following general considerations can be drawn.

- Several examples of monitoring methods specialized for each field are available in literature: models, metrics, infrastructures and algorithms, with the aim of monitoring quantities of interest and their evolution, detecting warnings, alerts and supporting decision strategies.
- The role of monitoring practice and systems is leveraged as the optimal way to inform management. It is highlighted the need to stress the investments on monitoring systems before committing resources to the design and implementation of every kind of system or application.
- Monitoring systems comprise a mixture of attributes and competences not found in typical or specific scientific activity of investigation
- Monitoring effectiveness is only be possible if the monitoring system is itself effective.
- Monitoring practice has evolved with technology and has always been distinctive for each sector, both for the characteristics of the quantities to be observed and for the peculiarities of the processing of the information acquired. Once pin down the requirements, monitoring systems and commercial tools are available for different categories of use.
- Advances in monitoring systems had been driven by commercial demands for improvements in productivity, quality, inventory control, and expenditure on plant and machinery. As a result, today technological advances take place gradually as new scientific discoveries are made, accepted and applied to monitoring systems.
- Thanks to monitoring practice, technological advances include improved knowledge of material failure mechanisms, advancements in failure forecasting techniques, advancements in monitoring and sensor devices, advancements in diagnostic and prognostic software, acceptance of communication protocols, developments in maintenance software applications and computer networking technologies.

**Table 2.2** Taxonomy monitoring systems during 4.0 Era.

	<b>Sensors 4.0/Data</b>	<b>Information</b>	<b>Processing &amp; Application</b>
Transportation	[70–72]	[70–72]	[70, 72]
Industrial	[73–77]	[73–78]	[73–75, 78]
Social & Economy	[79, 80]	[37, 79–82]	[37, 79, 81, 82]
Healthcare	[83–90]	[83–91]	[86–90]
Environment	[92–98]	[92–96, 98]	[96, 97]
Agriculture	[99–105]	[101–104]	[99–104]
Energy	[75, 106–109]	[75, 106–108]	[75, 106, 107, 109]
Network	[110–112]	[110, 112, 113]	[111–115]

- As for the healthcare field, several kinds of monitoring and diagnostic instrumentation have been developed, that have become indispensable. Relevant families of sensors have enriched human knowledge and improved life quality.

With special regard to the papers concerning monitoring solutions in the 4.0 era still in progress, it can be observed that the evolution induced by the 4.0 paradigm has pushed a cross-sectorial, interdisciplinary combination, integration of vertical competences on rough data, structured information, measurement, communication and processing. As a matter of fact, in the pre-4.0 era these competences were independent and research was invested by the effort to develop, assembly and interface them for each application purpose. The experienced evolution is strictly related to the evolution the monitoring concept has had thanks to the current 4.0 era. This is the read thread of Table 2.2.

Specific comments on the papers listed in Table 2.2 are as follows.

- The rise of cyber-physical systems, networks of sensors, activators and processors is transforming industry and its products.
- Monitoring has become one of the fundamental techniques for the proper functioning of all types of systems, simple and complex, local and distributed, material and intangible. No field of application and decision can disregard the information derived from the acquisition and processing of data, and consequently, from pervasive deployment of monitoring systems.
- Commercial, social, professional and personal lives are mediated by software, and so they are also subject to monitoring. Data is available about all aspects of our everyday life as individuals, or members of groups, organisations and societies, to be collected, analysed, and compared for all sorts of reasons.
- In the current 4.0 era, monitoring solutions aim at reducing the need of installing sensors on each of the individual components of the system under observation (non-intrusive approach), as opposed to traditional monitoring fully relying on intrusive techniques.
- It is possible to exploit the data acquired and used by a 4.0 application as “sensing” ones, capable of providing additional information useful both to the application itself and to third parties systems, thanks to the intrinsic measurement skills and dedicated processing.

- Successful large-scale urban and industrial management relies on the efficient sensing and acquisition of data about more and more extended areas for right decision and proper policy making.
- It is highlighted the view that monitoring systems in the 4.0 era comprise an unusual mixture of attributes not found in typical scientific activity. These attributes are a mix of biophysical, social and institutional attributes.
- Monitoring has made surveillance and privacy an international public concern.
- Monitoring sustainability will only be possible if the monitoring system is itself sustainable.
- It cannot be expected that monitoring systems should be designed to answer a single question and even more it cannot be assumed that the question will not change over time. Moreover, the strength of a monitoring system may be reduced if an attempt is made to address too many questions or if a single question is posed too broadly.

## 2.6 Comparison between the monitoring architectures and the 4.0 architectures

Considering what described in the previous sections, a comparison is drawn between the current, typical architecture of a monitoring system and that characterizing an ordinary 4.0 system, with specific reference to an IoT system. At a first glance, it is quickly evident that similar stack models characterized by the same number of levels (three levels, in the specific case) can be associated to both architectures. Indeed, a careful deepening could uncover a similarity that goes far beyond what the stack models can reveal. To this aim, further considerations concerning IoT systems are preliminary given.

The Internet of Things (IoT) is taking worldwide industrial and commercial sectors by storm. According to the 2019 IoT report by PwC [116], 93% of surveyed executives believe the benefits of IoT outweigh its risks and 70% reported to have planned or ongoing IoT initiatives in place. IoT refers to vast networks of physical objects that can autonomously communicate information about their current status and surroundings. By uncovering asset, process and workforce insights at unprecedented granularity, IoT empowers businesses of all sizes to pinpoint previously invisible bottlenecks and optimize their operations in numerous ways. The central value around IoT is the unprecedented visibility into existing processes, equipment and production environment that empowers strategic decision-making. Think of applications used for asset maintenance, facility management and worker safety.

Therefore, in an IoT application multiple tasks need to be performed to deliver a message from an end device to the cloud. There are various tasks involved including transporting, addressing, routing, error reporting, integrity and reliability management. Different IoT protocols are responsible for handling a specific set of networking tasks. That's why we need, not a single, but a stack of IoT protocols, each of which is responsible for a set of tasks. The Open Systems Interconnection (OSI) and Transmission Control Protocol/Internet Protocol (TCP/IP) networking models are the most common frameworks to



encapsulate networking tasks in the form of multiple layers. Widely adopted IoT protocols can be mapped to these two models. For an IoT network to function effectively, protocols at different layers must be interoperable with each other [117].

This is also true for industrial IoT (IIoT), even though the protocol landscape can be confusing with a vast assortment of available Operational Technology - OT and Information Technology – IT [118, 119]. Note that OT stands for the hardware and software dedicated to detecting or causing changes in physical processes through direct monitoring and/or control of physical devices (such as valves, pumps, etc.), a sort of monitoring system addressed to a specific industrial scenario.

As a matter of fact, while OT protocols have been the backbone of industrial controls and automation, IT protocols have been newly integrated to enable cloud-based connectivity and IIoT applications. It is worth underlining that IT and OT protocols do not always work with each other and the IoT protocol stack may not always be applied to the OT architecture. Typically, network and transport layers are often skipped either because older OT ethernet protocols do not support TCP/IP suite or because time-sensitive, millisecond low-latency data exchange is strictly required. To close the OT/IT gap and enable data exchange from automation systems to the Internet, major industry efforts have been made to promote interoperability between IT and OT protocols, thus accelerating the pace towards a fully IoT-based industrial monitoring paradigm (IIoT).

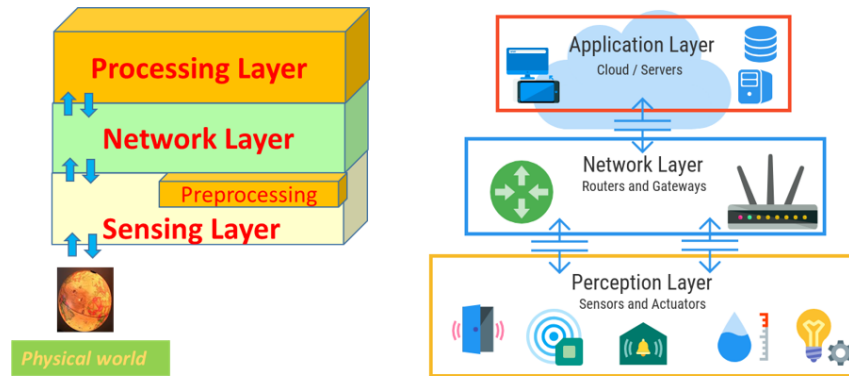
The above considerations clearly demonstrate a natural process of convergence of the current monitoring systems towards systems that respond to the 4.0 paradigm, with specific regard to IoT systems. The widespread and pervasive nature of the enabling 4.0 technologies in many economic, productive and social sectors is creating the conditions for an almost immediate availability of more or less explicit solutions for the acquisition, registration, transmission, routing and processing of information associated with quantities and/or parameters that characterize the behaviour and evolution of the systems in which the technologies are inserted.

Each IoT system can exhibit more or less explicit monitoring capabilities, in relation to the specific features that characterize the configuration of the different levels of its stack model. Monitoring systems therefore evolve towards IoT systems, given the high availability of this technology, its ease of configuration, its flexibility in application and modularity of use.

In contrast, IoT systems offer intrinsic monitoring capability, which can be exploited in a more or less optimal way. Operating with an IoT system also means potentially having an operational monitoring capability, which is substantiated through a specialization in measurement terms of the three levels of its stack model, and in particular of the "perception layer" or the sensors and transducers of which it is endowed.

Based on the foregoing considerations it is possible to state that:

1. a monitoring system designed and implemented today responds to rules attributable to IoT systems in the 4.0 paradigm;
2. an IoT system can intrinsically operate also as a monitoring system.



**Fig. 2.12** Modern monitoring system stack model vs IoT stack model.

This circumstance, although evidenced by the close similarity of the two stack models, is corroborated by numerous application cases promoted by major international technological players.

The similarity of these architectures allows the monitoring systems to operate assessing the environmental impacts of their equipment and their procedures mutuating the high level of development of green IoT architectures.

Valuable examples of the perfect symbiosis between IoT systems and current monitoring systems are given by the company Behertech, awarded as the “2019 Startup of the Year” in Germany, in relevant application fields, such as Manufacturing, Oil & Gas, Mining, Utilities, Smart Buildings [120]. Strengths and goals of the proposed solutions are highlighted below.

### Manufacturing

- **Condition Monitoring & Predictive Maintenance.** Tracking and communicating key metrics like pressure, vibration, temperature, humidity, and voltage of numerous machines and equipment across the whole industry complex. Proactively predicting impending issues and schedule demand-based inspection and repairation.
- **Environmental Monitoring.** Remotely monitoring and controlling optimal environments for various, factory-wide processes. Maintaining ideal air pressure to prevent dust infiltration, setting optimal humidity levels or monitoring temperature of processing and storage facilities to ensures product safety.
- **Remote Surveillance of Storage Tanks & Pipelines.** Monitoring the structural health of widely distributed tanks and pipelines round the clock, while decreasing manual checks. Identifying potential spills, leaks or ruptures to avoid disasters and receive notifications on material tank levels for timely refills.

- **Worker Safety Wearables.** Tracking workers' health and environment in real-time such as temperature, humidity, radiation, noise and gas levels. Notifying managers of fatigue, exhaustion, and "out-of-tolerance" incidents and ensuring workers receive timely warnings of potential hazards. Triggering alarms when environments become dangerous and executing timely evacuation and rescue activities.
- **Power Consumption Reporting.** Enabling seamless multi-level energy consumption tracking from plant, process unit to machinery-level. Analyzing energy flows, consumption patterns, and usage behavior across multiple sites for effective production planning, identifying power waste sources and improving energy efficiency.
- **Plant Facility Management.** Monitoring the battery, health or "alive" status of critical plant facilities like elevators, smoke detectors, fire alarms and other facilities across the entire factory. Cutting down time spent on manual inspection and quickly responding to any incurred issues.

### **Oil & Gas**

- **Remote Monitoring of Disparate Field Equipment.** Increasing visibility and integrity of your critical assets from pumps and compressors, to pipes and tanks. Monitoring key factors like remote pressure, temperature, flow rate, corrosion, ruptures and leakage. Getting notified of anomalies to prevent hazards and production loss and proactively schedule maintenance. Identifying potential threats of fuel theft and spillage.
- **Predictive Machinery Maintenance.** Gaining real-time insights into the status of your machinery and its operating condition (e.g. electric motors, turbines, valves, ventilators). Identifying causes of past failures and future error probability to effectively schedule maintenance and minimize costly production downtime.
- **Energy Consumption Monitoring.** Tracking multi-level energy consumption from plant, process unit to machinery-level. Analyzing energy flows, consumption patterns and usage behavior across multiple sites to effectively plan production, identify power waste sources and improve energy efficiency.
- **Worker Safety Wearables.** Tracking workers' health and activity parameters in real-time such as pulse, fall detection emergency distress indicators and GPS and trigger emergency signals when an accident or "out-of-tolerance" incident occurs. Monitor environmental conditions such as air quality or gas concentration level to alert workers of potential hazards and ensure timely evacuation of endangered zones.

### **Mining**

- **Real-time Asset Tracking, Remote Diagnostics & Predictive Maintenance.** Enabling real-time remote diagnostics, troubleshooting and asset tracking across the entire mine. Planning corrective

maintenance and procurement of spare parts to prevent asset downtime and stay ahead of expensive production losses.

- **Emission and Groundwater Level Monitoring.** Controlling emission levels and threshold limit values to sustain a secure working environment that complies with safety standards. Monitoring changes in groundwater levels in real-time and performing timely and effective pumping to prevent excessive inflows, avoiding contamination and underground flooding.
- **After-blast & Environmental Monitoring.** Instantly informing operators and miners of environmental safety conditions and hazards. Reducing unnecessary wait times and enabling quick turnaround after blasts to increase productivity.
- **Worker Safety Wearables & Rock Bolt Monitoring.** Tracking workers' health and environment in real-time such as temperature, humidity, radiation, noise and gas levels. Notifying managers of fatigue, exhaustion, and "out-of-tolerance" incidents and ensuring miners receive timely warnings of potential hazards. Installing rock bolt sensors to assess integrity and reduce fatal risk of ground falls.
- **Ventilation-on-Demand (VoD).** Continuously monitoring air quality and air flows in different areas of the mine and adjusting fan speed as necessary. Ensuring ventilation is only activated in active work zones to reduce operational costs and environmental footprint.

### **Utilities**

- **Fault Detection & Location.** Cost-effectively and reliably connecting all of your distribution lines and devices, even the ones underground or in the most inaccessible locations, for remote monitoring. Detecting and locating faults quickly, saving substantial repair time and minimizing breakdown duration.
- **Transmission Line and Tower Surveillance.** Measuring conductor temperature, current, and tension, as well as meteorological data along overhead transmission lines. Retaining a more accurate sag evaluation and predicting potential line damages caused by extreme weather conditions. Empowering immediate, preventive maintenance to avoid serious failures, improving safety and stability of the transmission lines.
- **Remote Monitoring & Predictive Maintenance.** Cost-effectively monitoring operations and the health status of critical assets on a massive scale like power generation plants, solar farms or wind farms. Optimizing equipment operations and energy production and receiving alerts of abnormalities for proactive maintenance and to avoid costly downtime

### Smart building

- **Power Consumption Monitoring.** Gaining real-time insight into the energy consumption of individual assets and multiple building zones. Analyzing usage behavior to identify waste sources and improve energy efficiency.
- **Intelligent HVAC Control.** Measuring temperature, humidity and air quality in remote building areas for decentralized, granular control of the HVAC (Humidity, Ventilation and Air Conditioning) system. Getting advanced analytics and development of an optimal thermal model based on occupants' inputs. Helping building operators considerably reduce utility costs and carbon footprint, while maximizing tenants' comfort and productivity.
- **Occupancy Sensing.** Gaining real-time visibility into space usage and occupancy rates. Pinpointing under-utilized areas and unnecessary and wasteful maintenance and energy expenses such as lighting, heating and cooling.
- **Intelligent Parking.** Providing data on parking space availability to the control center and updating digital signs, indicator lights or API-fed user apps to improve customer satisfaction, decreasing parking congestion and associated ventilation costs.
- **Digital Management of Critical Facilities.** Simplifying the management and service life of facilities such as elevators, escalators and HVAC equipment. Diagnosing abnormalities and schedule proactive condition-based maintenance.
- **Access Control & Interconnected Alarm Networks.** Interconnecting your entire alarm system from smoke detectors to open window/door detectors. Triggering alerts upon intrusive and dangerous incidents. Sending regular reports on battery life and enabling access systems for employees and visitors.
- **Asset Tracking.** Combating theft of your critical assets like fire extinguishers and defibrillation units. Using motion sensors to immediately alert building managers when unauthorized and suspect movement is detected.
- **Waste Management.** Monitoring the fill-levels of waste containers and optimizing pick-up routes and disposal schedules of different waste types to reduce financial and environmental impact.

The red thread that runs through the drawn comparison is that the monitoring architecture is addressed in technology-based systems as opposed to nature-based systems, and that “information” is something that can be sensed, communicated and stored, and that can take many forms. Anyway, the postulate of the present thesis is that all the information on which a monitoring system has to work in the 4.0 era is provided by sensing systems.

Since signals can come in several forms and can be stored and utilized in several ways, it is clear that “information” is an even broader concept in 4.0 era. The monitoring system considers information

as a sensor-based phenomenon. The bridge between the two architecture is information. Information, in fact, must enter a monitoring system through a sensor or sensor-like input device. By understanding sensing mechanisms more deeply and broadly, it may be possible to gain a better understanding of the nature of information and of its meaning.

In conclusion, also considering the results of the previous taxonomic analysis, a widespread use of monitoring methods implemented according to the architecture of 4.0 systems, and in particular of IoT systems, thanks to their pervasiveness and their high application possibilities, is irrefutable. However, often the simplicity of implementation risks sacrificing the measurement expertise underlying each monitoring operation. This is a warning to always be alerted so as not to compromise the quality of structured information and the reliability of the decisions made starting from it.

## **Part II**

# **Proposal and Experimentation**

## **Chapter 3**

# **Development and implementation of 4.0 transition-driven measurement systems: human-centered approach**

### **3.1 Introduction**

In the previous chapter, an evolutionary analysis of the monitoring systems and related architectures has been developed. A taxonomy declined on some important technological, economic, social and industrial application sectors has been presented to compare the architectures of the monitoring systems implemented in the period preceding and following the diffusion of the technologies of the industry 4.0 paradigm, respectively. In the final paragraph of the previous chapter, the perfect overlap of the monitoring architectures with those of the IoT systems has been postulated. The fundamental levels of the IoT systems: Perception, Network and Application, useful for ensuring the implementation of the 4.0 paradigm in the CPS logic, are capable of completely carrying out the functions of the fundamental levels of a monitoring architecture. However, this functional overlap does not correspond to a logical overlap due to the marked orientation of the information of the IoT architectures for the governance of 4.0 applications. IoT architectures are at the service of CPS, with a cross-sector and cross-discipline approach. The evolution of the data over time and its availability bring to the CPS much more knowledge of its own value. In 4.0 era the heterogeneity of the sources represents an indispensable wealth to be able to develop transversal applications even if this conflicts with the measurement accuracy requirements of a monitoring system.

The internet of things (IoT) has contributed in boosting the pervasiveness of sensors in every field. Nowadays, however, the challenge is not only to monitor a physical quantity, but also to facilitate and make more effective the User's fruition of the information made available by the sensors. An analysis of the operating context suggests the importance of adopting a user-centered approach, to improve usability and user experience in the 4.0 Era applications. Especially, in Industry 4.0 applications,



humans are becoming a composite factor in a highly automated system. Therefore, to improve the collaboration between men and the surrounding 4.0 Era context, there is the need of enhancing the human-machine interaction. This is particularly important not only in industrial sector, but also in the social and medical once, in fact, in all scenarios, the overall effectiveness of any 4.0 process is intrinsically related to the performance of the human actor involved.

The 4.0 Era technologies enable new types of interactions not only between digital and physical worlds, but also between humans and cyber-physical systems (CPSs). This has led to the definition of User 4.0 [121–123], which is based on the concept of human-cyber-physical systems (H-CPSs): these are systems that are intrinsically designed to facilitate cooperation between humans and machines, by making humans part of the system [124–127]. As detailed in the following sections, several enabling technologies (e.g., IoT, Augmented reality, machine learning) have been combined for the design, implementation and validation of measurement-driven 4.0 applications.

The first application case describes a correlated work stress monitoring application through a Brain Computer Interface (BCI) system. In this application, it is shown how a 4.0 technology operates natively as a monitoring system.

The second application relates to the development of innovative wearable-oriented sensing solutions for monitoring skin hydration. In particular, the design, fabrication and test of a microwave reflectometry-based portable sensing system for real-time monitoring of skin hydration level was presented. The new flexible sensing device was miniaturized and fabricated on a flexible substrate to ensure better wearability and adherence to the skin. The system was preliminarily validated through a numerical analysis. Successively, experimental tests were carried out through a low-cost portable vector network analyzer (VNA). The obtained results, although preliminary, demonstrate the feasibility of employing a portable VNA and a wearable, flexible SE to sense variation of skin hydration.

Finally, the third application relates to an innovative fully-textile sensor, with a case study also on monitoring humidity. A completely-textile two-resonator device, to be used as a wearable sensor for humidity measurements was presented and experimentally characterized. The operating mechanism relies on sensing the variation of the resonant frequency values of the two resonators (both operating in the ISM frequency band) when the dielectric jeans substrate moistens with the humidity. To achieve full integration with clothes, the prototype was implemented using jeans as a substrate, and self-adhesive non-woven fabric for the conducting parts of the device. The sensing device was characterized experimentally in a climate chamber, for pre-established RH levels, from 30% to 90% (in steps of 10%). The proposed textile device represents an interesting solution for smart garments, especially useful in 4.0 application contexts.

### 3.2 A wearable EEG instrument for real-time frontal asymmetry monitoring in worker stress analysis

Stress is a psycho-physical pathological response to emotional, cognitive, or social tasks, perceived as excessive by an individual. Many stimuli of different nature (physical, toxic, emotional), external to individuals, could disturb their homeostasis and psychological well-being, bringing to an adaptive or non-adaptive response [128]. In industrial work, stress has negative impact on safety, on the quality of the outcome and, thus, on the cost of the production process as a whole [129]. Technological innovation, indeed, has introduced new sources of stress (*stress 4.0*). Intelligent automated systems in their various configurations, robots or cobots in collaborative meaning [130], interact continuously with individuals in a constant relationship of cooperation and, at the same time, of unconscious competition.

In the literature, different indicators of stress status are proposed, arising from products of neuroendocrine reactions affecting sympathetic and parasympathetic nervous systems [131]. Some biochemical and biophysical markers are measured usually by invasive methods: (i) Cortisol Concentration in blood or saliva; (ii) Galvanic Skin Response; (iii) Heart Rate; and (iv) Brain Activity.

Cortisol is a hormone produced by the adrenal glands with the aim of preserving homeostasis in all conditions tending to alter the normal body balance. Cortisol concentration in blood has been used as the first index of the individual's response to stress. It is measured through repeated blood samples, or through saliva samples, by means of less invasive methods but with less significance [129].

Skin conductance is a further parameter associated to the activation of the sympathetic nervous system and, therefore, to stress. Stress induces an increase in the epidermis moisture and, therefore, a reduction in skin resistance.

Furthermore, stress generates peripheral vasoconstriction that causes a decrease in wave amplitudes of electrocardiogram (ECG) and an increase in the heart rate [131].

Brain activity produces electrical signals as a response to all kind of internal and external stimuli. The signals are recorded either through functional Magnetic Resonance Imaging, Positron Emission Tomography, or electroencephalography (EEG). All these techniques detect brain activity changes in the limbic system and frontal regions.

EEG is the most widely used because it is easy to implement and little intrusive; moreover, EEG signals can be classified effectively through a frequency analysis. Some use cases of stress recognition based on EEG are given in the literature [132, 133]. Significant is a wearable EEG device for construction workers [134]. High vulnerability characterizes the activities on-site of the workers during a construction process; so, they suffer from load stress. By including an EEG device into their protective helmet, brain waves are monitored and analyzed along the activity, by highlighting possible emotional states and, therefore, actual attention levels [135]. However, state-of-the-art solutions exhibit at least one of the following weaknesses: (i) limitations for daily on-field use, e.g. due to a large number of wet electrodes and use of wired systems; (ii) accuracy less than 90%, even in case of simultaneous ECG and EEG measurements [136]; and (iii) high cost, up to thousands of dollars [137].

In this research activity, a highly-wearable single-channel instrument, conceived with off-the-shelf components and dry electrodes, for human stress real-time detection based on EEG, is presented. The single-channel differential measurement aims at analyzing the Frontal Asymmetry, a well-claimed EEG feature for stress assessment. The differential channel, in fact, acquires two signal from symmetric regions of the scalp and calculates the difference [136]. The instrument exploit EEG robustness to movement artifacts compared to other stress assessment biosignals. In particular, in Section 3.2.1, concepts related to biosignals and stress, EEG for stress assessment, and frontal EEG asymmetry are recalled. Instrument architecture and operation are illustrated in Section 3.2.3. Hardware, firmware, and software are described in Section 3.2.4. In Section 3.2.5, the experimental psychological validation of the stressors effectiveness, a Principal Component Analysis, and a noise robustness assessment are reported.

### 3.2.1 Background

#### EEG for Stress Assessment

Several methods for stress assessment, like self-assessment scale, or questionnaires, follow a psychological approach [138]. As an example, in human-robot interaction, questionnaires to analyze the psychological effect of cycle time on operators [139] highlighted frustration, effort, and a dissatisfaction feeling about own performance.

As more direct and objective tools for stress detection, biosignals have been proposed in several studies [140]. Physiological parameters, as EEG signals, blood volume pulse (BVP), electro-oculogram (EOG), salivary cortisol level (SCL) [141], heart rate variability (HRV) [142], galvanic skin response (GSR), or electromyography (EMG) are assessed [131].

Compared to other biosignals, EEG proved better latency and robustness to artifacts due to physical activity [133] [143]. In Industry I4.0 scenarios, EEG has been widely applied to assess individuals' stress in workplace in order to improve workers' safety, health, well-being, and productivity [134][144]. Thanks to the ease of application and removal, dry electrodes are increasingly used to reliably search human cognitive states in real-life conditions. They guarantee the quality of the EEG signal which approaches the wet sensors, as demonstrated in [145, 146]. Beside that, EEG is regarded as one of the most reliable and effective techniques for identifying fatigue and monitoring stress level in drivers [147, 148, 132]. Different classification methods try to face the main problems of EEG signals, including the low signal-to-noise ratio, their non stationarity over time within or between users, and the limited amount of training data typically available to calibrate the classifiers[149].

A large number of informative and measurable properties (features) of EEG signals, can be used both in time and frequency domains. Their accurate selection is crucial for the accuracy and the computational cost of classification [150]. Both types of features reap the benefit from being extracted after spatial filtering. Independent Component Analysis and Canonical Correlation Analysis are useful methods for muscle artifact removal in EEG data [151, 152]. Several supervised learning algorithms could be exploited to assess workers stress by using subjects' EEG signals. The classification can be assisted by:

linear classifiers, neural networks, non-linear Bayesian classifiers, nearest neighbour classifiers, random forest, naive bayes, and decision tree [153][154]. Linear classifiers are the most popular algorithms for Brain Computer Interface (BCI) applications, such as, Linear Discriminant Analysis (LDA) and Support Vector Machine (SVM). The LDA is used to assess mental fatigue in [155], it divides the data into hyperplanes representing the different classes, with very-low computational burden. A discrimination based on hyperplanes was also used in SVM, with recognition rate of 75.2% to identify three different level of stress out of four, using EEG features and six statistical features in [156]. Meanwhile a better prediction accuracy of 90.5% and 92%, combining different acquired signals, were reported in [147, 148] for drivers.

Various supervised machine learning algorithms, using sliding and fixed windowing procedures, were tested in [134]: k-Nearest Neighbors, Gaussian Discriminant Analysis, SVM with different similarity functions (linear, Gaussian, cubic, and quadratic).

Among the state-of-the-art classifiers, the SVM yielded the highest classification accuracy of 90.1% [157], using a single-channel EEG. As well as the highest accuracy of 88.0% was reached by SVM in [158], where individuals' stress was recognized by exploiting only EEG signal as input of the classifier. Table 3.1 summarizes the reported accuracy of different classifiers, including the numbers and type of EEG electrodes, without reference electrodes, the numbers of different classes according to the acquired bio-signals used as model input.

### Frontal EEG asymmetry

Systematic alterations in frontal EEG asymmetry, in response to specific emotional stimuli, can be exploited to analyze emotional response [161].

In particular, EEG asymmetry proved to be capable of predicting state-related emotional changes and responses. For example, a greater self-reported happiness or positively-valued stimuli might be expected to be associated with greater relative left frontal activity. Therefore, greater relative right frontal activity would be expected in response to negative stimuli [162, 163]. However, fear or happiness response to stimuli may either be attenuated or amplified according to any given individual's trait pattern of frontal EEG asymmetry [162].

Different models were presented: Baron and Kenney linear model may predict individual's response to fear relevant stimuli. According to the relative difference between the left and right hemisphere, the EEG asymmetry may serve both to amplify and attenuate the effect of the fear relevant stimuli. Some individuals show the increase of relative right versus left sided activity in response to negative cues and the increase of left versus right sided activity to positive cues [164]. Coan and Allen [165] presented another linear model to predict emotional experience using emotion type and trait frontal EEG asymmetry. The frontal EEG asymmetry may serve as a useful liability marker also for depression and anxiety [166]. Many works, using EEG caps with a limited number of electrodes, demonstrated that stress causes changes in regions of prefrontal and frontal areas [133, 141, 162].

Table 3.1 State of art of stress classification

Classifier	Reference	Reported Accuracy%	Acquired Signals	Classes	n° Electrodes	n° Subjects
Artificial Neural Network (ANN)	[147]	76.0%	EEG,ECG,GSR	2 no-stress/stress	14 Wet	22
	[154]	79.2%	EEG,SCL,BVP,PPG	2 levels of stress	5 Wet	15
Cellular Neural Network (CNN)	[147]	92.0%	EEG,ECG,GSR	2 no-stress/stress	14 Wet	22
Decision Tree	[147]	84.0%	EEG,ECG,GSR	2 no-stress/stress	14 Wet	22
Fisher linear discriminant analysis (FLDA)	[148]	90.5%	EEG,EOG	2 alert and fatigue states	32 Wet	8
Gaussian Discriminant Analysis (GDA)	[134]	74.9%	EEG,GSR	2 high or low stress level	14 Wet	11
K-Nearest Neighbors (k-NN)	[134]	65.8%	EEG,GSR	2 high or low stress level	14 Wet	11
Linear discriminant analysis (LDA)	[156]	76.7%	EEG	2 levels of stress	14 Wet	9
	[155]	77.5%	EEG	3 low, medium, high mental fatigue	16 Wet	10
Naive Bayes (NB)	[133]	86.0%	EEG,ECG,EMG,GSR	3 stress,relax,and neutral	4 Wet	10
	[147]	77.0%	EEG,ECG,GSR	2 no-stress/stress	14 Wet	22
Random Forest (RF)	[158]	69.7%	EEG,ECG,GSR	2 mental workload and stress	2 Wet	9
	[159]	79.6%	EEG,EMG,ECG,GSR	4 cognitive states	8 Wet	12
	[153]	84.3%	EEG,ECG,BVP	3 mental stress states	14 Wet	17
	[156]	75.2%	EEG	3 levels of stress	14 Wet	9
	[134]	80.3%	EEG, SCL	2 high or low stress level	14 Wet	11
Support vector machine (SVM)	[160]	85.4%	EEG	2 positive or negative emotion	14 Wet	11
	[136]	87.5%	EEG,ECG,HRV	2 stress and rest	2 Wet	7
	[157]	88.0%	EEG	2 levels of stress	14 Wet	10
	[158]	90.1%	EEG,ECG,GSR	2 mental workload and stress	2 Wet	9

### 3.2.2 Brain Computer Interface

The electrical activity of the brain was first recorded in 1929 by Berger through a rudimentary electroencephalograph (EEG), able to detect the massive activity of neurons. Thanks to the improvement of technology, nowadays this device records the difference in electrical potential between pairs of electrodes placed on the head at different areas of the surface of the brain (cerebral cortex) This activity produces electric waves that have different frequencies in conditions of well-being or in the presence of brain alterations. Each area is specialized for particular tasks, but concurrent tasks can be processed by the same area, and many tasks are processed in multiple areas [167].

Since then, studies on the voluntary and involuntary nervous system combined with the evolution of electroencephalographic techniques have allowed to introduce, in 1973, a new technology of investigation and interaction with the brain called Brain Computer Interface [168].

Brain-Computer Interface allows direct communication between the brain and an external world. This technology relies on measurements of brain activity, induced both involuntarily or voluntarily from the subject. This technology is based on the ability to read neuronal activity, to process the signals and send commands to the outside world, without depending on the normal brain output channels, i.e. nerves and peripheral muscles.

A general purpose BCI scheme is shown in Fig. 3.1. Signals are typically acquired from the user's brain by electrodes, and then are processed to obtain a command for the application of interest. Thanks the brain computer interface the brain electrical signals are transformed in a source of control signal for external devices. Brain Computer Interface (BCI) has the potential to become the "ultimate interface", through which thoughts can become acts [169]. The signal processing is divided in two stages: (i) features extraction derives proper parameters describing the signals synthetically, and (ii) features translation interprets them producing an output command. A feedback is finally given to the user depending on the application.

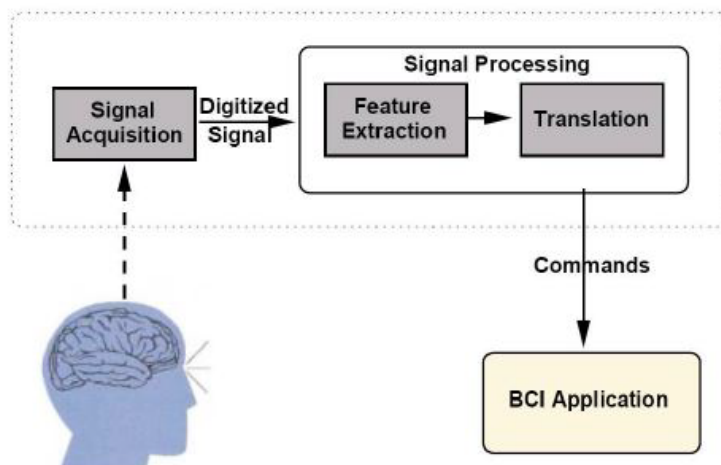


Fig. 3.1 Scheme of a Brain Computer Interface.

The choice of a proper algorithm for signal processing depends on the kind of brain signals to analyze literature. The literature proposes algorithms of varying complexity for the analysis of specific signal types.

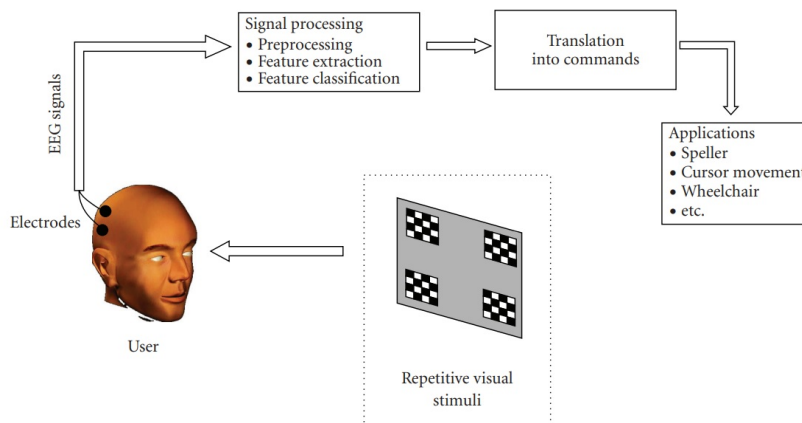
BCI systems can also be classified according to the type of neural activity used for brain-machine communication [170]. The types that can be used are:

- Spontaneous: these signals are generated by the brain independently of external stimuli. For example, they occur when the user decide to perform or simply he images to perform a motor action.
- Evoked: these signals are generated as response to a light or auditory signal.

Depending on the type of signals chosen, the technologies to be used in the interface and the amount of training necessary for the user to be able to control the BCI will be determined.

### SSVEP-based Brain Computer Interfaces

A particular type of BCI system is based on Steady State Visually Evoked Potential (SSVEP). An SSVEP-based BCI, Fig. 3.2, enables the user to select among several commands that depend on the application, such as moving a cursor on a computer screen. Each command is associated with a repetitive visual stimulus (RVS) that has distinctive properties (e.g., frequency or phase) [171].



**Fig. 3.2** Functional model of a SSVEP-based BCI [171].

The stimuli are simultaneously presented to the user who selects a command by focusing his/her attention on the corresponding stimulus. When the user focuses his/her attention on an RVS, an SSVEP is elicited, manifesting oscillatory components in the user's EEG, especially in the signals from the primary visual cortex, matching the frequency or harmonics of that RVS. SSVEPs can be elicited by repetitive visual stimuli at frequencies in the 6 to 70 Hz range. They can be automatically detected through a series of signal processing steps including pre-processing (e.g., band-pass filtering), artifact detection/correction, feature extraction (e.g., spectral content at the stimulation frequencies), and feature

classification. From these characteristics it is highlighted the user's will, that is traduced in command. A visually evoked potential is a potential that reflects the electro physiological mechanisms of the visual information being processed in the brain. Unlike spontaneous potentials, these occur only in the presence of external stimulation and always in the same timing and modality. Thanks to these characteristics, they are excellent candidates for a brain-computer interface. SSVEP signals are generated in response to trains of repeated stimuli. They are easier to observe in the frequency domain and they appear as power peaks corresponding to the stimulus frequency and its higher order harmonics. A practical demonstration is shown in Fig. 3.3. Their stability characteristic makes these evoked potentials very useful for engineering applications.

In fact, they are easily identifiable, do not vary significantly from subject to subject and demonstrate a moderate immunity to muscular artifacts.

Finally, another important feature is that, in case of simultaneous visual stimuli with different flickering frequencies, the main component in analyzing the signal spectrum will correspond to the stimulus at which the user is starring at.

### **Generation of SSVEP signal**

To generate a Steady-State Visually Evoked Potential, it is necessary to stimulate the user through a repetitive visual stimulus. This stimulus can be of various kinds: LED, liquid crystal display, or cathode ray tube. Three main categories of repetitive visual stimuli exist:

- Light stimuli are rendered using light sources such as LEDs, fluorescent lights, and Xe-lights, which are modulated at a specified frequency. These devices are generally driven by dedicated electronic circuitry which enables them to accurately render any illumination sequence or waveform;
- Single graphics stimuli (e.g., rectangle, square, or arrow) are rendered on a computer screen and appear from and disappear into the background at a specified rate (Fig. 3.4(a));
- Pattern reversal stimuli are rendered on a computer screen by oscillatory alternation of graphical patterns, for example, checkerboards. They consist of at least two patterns that are alternated at a specified number of alternations per second. Frequently used patterns include checkerboards and lineboxes

Real pattern reversal stimuli elicit an SSVEP response at the frequency of one alternation.

The goal is to generate a light stimulus that flickers at a fixed frequency included in a range of about 6 to 70 Hz. This range can be divided into three classes: low frequencies (6-20) Hz, medium frequencies (21-30) Hz, high frequencies (31-70) Hz.

Despite the stimulation of these evoked visual potentials has a wide range of frequencies to use, the most appropriate choice is the use of a range of low frequencies. Furthermore, visual stimulations at frequencies above 30 Hz could induce epileptic seizures to the stimulated subject. In general, subjecting



the user to the vision of an icon, or of a bright LED, which flickers at a sufficiently high frequency ( $f > 20$  Hz), can be annoying and tiring for the sight and, therefore, not very useful for practical applications. Finally choose, for the generation of SSVEP signals, a stimulus that oscillates at a “low” frequency seems to be the most suitable solution to realize a BCI, which uses this type of signal.

### 3.2.3 Design

This section addresses the *Basic Ideas*; the *Architecture*; the *Operation*; and the *Feature Extraction and Classification* of the instrument.

#### Basic Ideas

The concept design of the real-time stress monitoring instrument was based on the following main basic ideas.

- *High wearability*: a single differential channel allows the use of only two frontal electrodes in the area FP1 e FP2 according to the EEG International 10–20 system for placement of EEG electrodes on the scalp. The reference electrode is applied to the earlobe. These positions have been used in reports of successful studies on stress [158]. Active dry electrodes avoid the inconvenient of electrolytic gel. A wireless module allows the user to carry out work activity during the EEG acquisition.
- *High accuracy and low latency*: Despite the use of a single differential acquisition channel, a time-domain based machine learning algorithm brings to an accuracy of  $98.3 \pm 0.4$  in stress detection. A time window of 512 samples guarantees a latency of 2 s.
- *Off-the-shelf components*: The measurement of frontal asymmetry by EEG at very-low density (single channel) allows high wearability, maximum accuracy, and low latency by exploiting the lowest cost hardware on the market ( $< 200$  \$) [137].

#### Architecture

The architecture of the proposed instrument is highlighted in Fig. 3.5, in an example of interaction with a cobot. Prefrontal asymmetry is measured by two *Electrodes* as the difference of brainwaves from position FP1 and FP2, according to 10/20 system. The differential signal is referred to the earlobe. Analog signal is digitized by the *Acquisition Unit* and is sent, via wires, to the *Wi-Fi Transmission Unit*. Digital data arrives at the *Processing Unit* through wireless communication for real-time elaboration. Suitable *features* are extracted from each EEG record to compress data and increase significance. A *Classifier* receives the feature arrays, detects the stress condition, and assess its level. The measured stress is sent to the Cobot.

### Operation

The instrument allows to detect the onset and to assess the level of the stress arising from the concurrence of high mental load and negative emotional conditions, during the interaction with a Cobot. Once the worker fixes the electrodes on the forehead and on the earlobe, the Processing Unit interface allows to check signal quality both in time and in frequency domain. Subsequently, the stress measurement starts and the acquired data are sent in real time to the Processing Unit, by updating the user condition assessment every 2 s. Measurement results are sent to the Cobot in order to adapt its behavior to the worker stress conditions.

### Feature extraction and classification

Preliminary experiments in frequency domain highlighted poor accuracy results. Therefore, data analysis was carried out in the time domain. According to the state of the art [164], a EEG time window of 2 s was chosen as the optimal solution considering the trade-off accuracy vs latency. In time domain, EEG tracks are divided into 2-s records of 512 samples. In this way, raw data are composed of 512 features, i.e. each feature corresponds to just one sample. Feature Extraction was carried out by a standard machine learning technique, the Principal Component Analysis (PCA). This allows to compress data [173] and to approximate signals as a linear combination of a restricted number of orthogonal components. Therefore, data variance is most efficiently explained. Accordingly, a multi-variable signal can be represented as a smaller number of coefficients of the linear combination of the components. PCA also performs a filter function, because it highlights the components with maximum variance (information) of the data. Therefore, selecting only the components with the greatest variability improves signal-to-noise ratio.

For the classifier design, a linear separability test of the data was carried out by an euclidean distance-based K-means algorithm with low computational burden [174]. If a problem is linearly separable, a nonlinear classifier complicates the model unnecessarily and makes the correct learning of the classifier parameters less effective [175]. K-means algorithm estimates k means (centroids) in order to partition data into k clusters where each observation belongs to the cluster with the nearest mean. Then, in case of few outliers, a linear classifier is justified. Therefore, a preliminary analysis was realized.

### Preliminary Analysis

Ten subjects were divided into two classes with different stress level: (i) *control group*, only cognitive load, and (ii) *experimental group*, cognitive load but with negative emotions. Data were recorded during all the tests with a differential single-channel digitizer, sampling at 256 sample/s. The signal was elaborated in time domain and without artifact filtering according to [160]. For each volunteer, two EEG tracks of 20 s were processed and divided into 2-s records of 512 samples. The resulting matrix 200x512 was divided in two clusters using the standard K-means algorithm with  $K = 2$ . In Fig. 3.6, the result of the clustering algorithm is reported. The two experimental groups were separated by K-means almost cleanly: on the first five rows, the arrays of the experimental group records, and on the other

rows, the ones of the control group. These results suggested that also a linear classifier can be used to discriminate the points of the two groups adequately.

### 3.2.4 Implementation

#### Hardware

**Data Acquisition Unit** It is based on the differential single-channel 10-bit digitizer EEG-SMT by Olimex, with maximum sampling rate of 256 sample/s, an EEG amplifier, and an Atmel ATmega16 Alf and Vegard Reduced Instruction Set Computer processor microcontroller. The gain of the analog-to-digital converter (ADC) of the transducer was set to be 6427 V/V. A right-leg driver [driven rightled (circuit) (DRL)] signal increases the common-mode noise rejection. Universal serial bus is used for both data communication and powering. Moreover, the EEG-SMT has an analog three stages pass-band filter from 0.16 to 59.00 Hz. A previous work proved its suitability for wearable, low-cost, and non-invasive brain activity monitoring, by means of a single differential channel [137].

**Dry Electrodes** Brain signals are acquired by two dry active electrodes (Olimex EEG-AE), coated with a thin layer of silver chloride to guarantee the best contact impedance. The contact surface is extended by pins of conductive material. In this way, the quality of the acquired signal is preserved even with the electrode on a thick layer of hair. The reference passive dry electrode (Olimex EEG-PE) was applied to the earlobe. The electrodes on the user's forehead are fixed with a tight headband. The electrode on the earlobe is fixed with a clip, to ensure electrical connection.

**Transmission unit** A Wi-Fi communication channel was implemented to enhance wearability, throughout a Raspberry Pi 3 single-board computer, used as server, connected via UART to the EEG-SMT. The Raspberry Pi 3 uses a BCM43438 wireless chip and operates at ISM frequency bands (2.4 GHz).

#### Signal processing and classification

In time domain, EEG tracks are divided into 2-s records of 512 samples. In this way, raw data are composed of 512 features, i.e. each feature corresponds to just one sample. Then, a feature reduction process is realized by PCA. The first four Principal Components are considered as input in the successive classification step. As emerged in a previous exploratory experimental campaign, the first 4 components guarantee at the same time high accuracy as well as low uncertainty and computational burden. The mean of accuracy obtained by the first four Principal Components resulted significantly greater than that of the first three Principal Components, with a confidence level of 93.0% (one-tailed t test). machine learning classifier distinguishes records of a stressed or no stressed subject. The results of the preliminary experiments (Fig. 3.6) show that the two groups are separated from the K-means quite clearly. These results suggested that also a linear classifier can be used to discriminate data of the two groups adequately. The length of records determines the latency of 2 s.

## Software

**Raspberry** The EEG signals, digitized by the EEG-SMT Olimex, are acquired by the Raspberry via UART by means of a dedicate software in C and installed on the Raspberry Pi 3. The baud rate is set to 57600 bit/s, with packet size 8, without parity bit. The Raspberry Pi 3 acts also as a Wi-Fi server, receiving from the EEG-SMT the command of start of the acquisition, and sending to the computer station the acquired data. This allows the users to freely move during real life. In view of a stand-alone device release, the computational power guaranteed by the raspberry allows processing to be carried out directly on board.

**Processing Unit** A specifically designed Matlab graphical user interface (GUI) allows easy interaction with Olimex EEG-SMT, through graphical icons and visual indicators. Moreover, by observing the display windows, EEG signal can be monitored both in time and frequency domain. Meanwhile, Matlab scripts implement the machine learning classifiers.

### 3.2.5 Metrological characterization

#### Experimental Setup

Seventeen volunteers underwent an initial screening test administered by the psychologist. Seven participants were excluded from the experiment owing to excess in smoke, high score in anxiety and depression at questionnaires, and low performance at short memory tests. Therefore, ten healthy young volunteers (average age 25 years) of whom five women and five men, participated in the study. The informed consent, containing all the information about the experiment, was provided and signed by the subjects. The protocol was explained by the psychologist. Participants were divided equally into control and experimental groups, to complete a task, which induces mental load, together with (experimental group) or without (control group) negative social feedback. In particular, the Stroop Color and Word Test (SCWT) [176], a neuropsychological test extensively used for both experimental and clinical purposes, aimed to challenge subject using a complex cognitive task. In this test, subjects are required to read as fast as possible color-words printed in an inconsistent color ink, and to name the color of the ink instead of reading the word. This is to be done in a limited time punctuated by the psychologist who also gave information about errors during the performance. Environment was specifically designed in order to stress participants, by means of an attractive prize and an extremely out of range performance. Before and after the Stroop Test, subjects were required to complete two questionnaires: (i) STAI State form [177], to evaluate current anxiety state, and (ii) Rosemberg inventory [178], to assess participants' self-esteem. In them, they had to reflect their emotions in the specific moments during their exercise. Moreover, at the end of experimental tests, participants filled a rating of the experience in the Likert scale. The two groups, experimental and control, were subjected to the same protocols, but only the experimental group was stressed emotionally. During the experiment, the device did not annoy or distract the subject. After each trial, the psychologist asked for feedbacks in order to ensure the safety of

participants. They did not experience any discomfort related to the electrode band; after a few minutes, they no longer noticed the device. The most significant 40 s were extracted from each individual test of 180 s. The initial and concluding stages are potentially the most inhomogeneous among them, that is, the most challenging in order to find a regularity, intra individual and even more intra group.

The first 10 s of the test, regarded as cognitive warm up, were excluded. Therefore, only the later 20 s were deemed.

The final 10 s were discarded, due to observations of the psychologist. The specialist noticed that some subjects showed a renouncing attitude, once realized the impossibility to complete the task.

Hence, the previous 20 s were considered. Subsequently, for each subject, the two 20-s EEG tracks were divided in 2-s records. Each record is characterized by 512 time domain features, i.e. the 512 samples contained in 2 s. The total number of records were 200, namely 20 records for 10 subjects of 2 s each. Five subjects were taken from control group and five from experimental (stressed) group. In this way, the total EEG-samples from each group were 51,200. A matrix with 200 records on the rows was obtained by placing the first 100 records referred to the initial and final 20 s stress of control group and subsequently 100 records related to initial and final 20 s of experimental group.

### Psychological validation

A unique stress index was estimated as sum of normalized indexes to assess the general stress induced to participants. The indexes of performance, anxiety, self-esteem, perceived stress, and motivation, were obtained from parametric STAI and Rosemberg tests, as well as from task performance. One-way ANOVA was used to evaluate stress and motivation indexes on groups with a significance level  $\alpha=0.05$ . The experimental group was more stressed compared to the control group, as evidenced by the One-way ANOVA ( $F=7.49$ ;  $p=0.026$ ). Instead, any significant difference between gender was noticed. A relevant difference in motivation between groups ( $F=14.52$ ;  $p=0.005$ ) showed that control group was more motivated than experimental group at the end of the experiment. Table 3.2 shows that, once arranged the stress index in decreasing order, the experimental group is more stressed than control one.

**Table 3.2** Stress index distribution (descending sort)

Subject	Stress Index	Group
1	1,68	Experimental
2	1,66	Experimental
3	1,52	Experimental
4	1,38	Control
5	1,21	Experimental
6	0,77	Experimental
7	0,69	Control
8	0,54	Control
9	0,14	Control
10	-0,06	Control

**Table 3.3** Classifier optimized iperparameters and range of variation [172].

Classifier	Iperparameter	Variation range
SVM	Cost parameter (C)	[0.1, 10.1] step = 1.0
Random Forest	n_estimators	{90, 180, 270, 360, 450}
k-NN	n_neighbors	[5, 15] step = 2
ANN	number of internal node	{25, 50, 100, 200}

### Stress Classification

Four different machine learning classifiers were used for validating the proposed method, by distinguishing stressed subject signals from no-stressed subject signals: (i) SVM (linear Kernel), (ii) k-nearest neighbors ( $n\_neighbors = 9$ ), (iii) Random Forest (criterion = 'gini',  $max\_depth = 118$ ,  $min\_samples\_split = 49$ ), and (iv) ANN (one hidden layer, activation function for hidden node = hyperbolic tangent, loss function = cross entropy cost, post processing = soft max, training algorithm = Resilient Propagation). In tab 3.3 the optimized iperparameters for each classifier are reported.

The behavior of each classifier was also evaluated when the input was pre-processed by PCA.

Importantly, a subject-wise leave-two-out cross-validation evaluation was uniformly conducted in all the experiments in order to build a model capable of generalizing to new subjects. In case of small dataset according to [179], the Leave-p-out cross-validation (LPOCV) guarantees better statistical significance with respect to Leave-one-out cross-validation (LOOCV). Applying LOOCV to our dataset, the cross-validation process is repeated for  $k = 10$  times, i.e.  $k = n$  (the number of subjects in the original sample). Instead, LPOCV requires training and validating the model  $C_p^n$  times, where  $C_p^n$  is the binomial coefficient,  $n$  the number of subjects in the original sample, and  $p$  is the number of subjects reserved only for the test. In our case (leave-two-out) the two subjects always belong to different groups (experimental vs control). In this way, a higher statistical significance was obtained ( $k = 25$ ), by keeping training and test datasets balanced concerning the two classes. Therefore, for each iteration, one subject for group was left out from training set and used in the test set.

### PCA analysis

Each classifier was fed with both raw data (2-s EEG epoch) and PCA pre-processed data. In particular, for each iteration of the LPOCV method [179] the first  $p$  principal components were computed on the training set. Then both training and test set were projected on them. Finally, the reduced representations of both data sets were input to the classifiers. The number of principal components  $p$  was varied:  $p \in \{0, 1, 2, \dots, 9\}$ , where  $p = 0$  corresponds to consider original data without PCA. The cumulative explained variance by the first nine components is greater than 99%, when PCA is applied on the dataset as a whole (Fig. 3.7). Therefore, this result highlights an intrinsic dimensionality of the data actually equal to no more than 9 (with respect to 512) and, in this case, the use of PCA for features extraction is validated. The results of the cross-validation strategy are shown in Table 3.4, as mean and uncertainty, with and without PCA. The lowest average accuracy for data without PCA is obtained by SVM and is

**Table 3.4** Classifiers accuracy (mean and uncertainty percentage) in Original Data (O.D.) and Principal Components Hyperplanes [172].

	SVM	Random Forest	k-NN	ANN
O.D.	97.5 ± 0.6	98.5 ± 0.3	98.5 ± 0.4	99.2 ± 3.1
PC1	90.5 ± 5.3	98.6 ± 0.3	98.9 ± 0.3	98.5 ± 3.8
PC2	78.5 ± 7.1	98.8 ± 0.2	98.0 ± 0.5	98.8 ± 3.9
PC3	93.2 ± 3.4	98.4 ± 0.5	98.5 ± 0.4	98.7 ± 4.3
PC4	98.3 ± 0.4	98.9 ± 0.3	98.5 ± 0.4	99.1 ± 2.4
PC5	97.8 ± 0.4	98.8 ± 0.5	98.5 ± 0.4	99.2 ± 2.8
PC6	97.4 ± 0.6	98.4 ± 0.5	98.5 ± 0.4	98.9 ± 3.3
PC7	97.8 ± 0.5	99.0 ± 0.4	98.5 ± 0.4	98.9 ± 3.6
PC8	97.4 ± 0.6	98.6 ± 0.5	98.5 ± 0.4	99.0 ± 3.5
PC9	97.9 ± 0.5	98.9 ± 0.5	98.5 ± 0.4	98.9 ± 4.1

**Table 3.5** F-measure test results for SVM (mean and uncertainty percentage) [172].

	Precision (%)	Recall (%)
O.D. Hyperplane	96.5 ± 1.0	98.4 ± 0.7
PC1	89.2 ± 5.1	92.2 ± 5.3
PC2	81.1 ± 6.2	81.1 ± 6.7
PC3	96.4 ± 1.5	93.6 ± 3.1
PC4	98.2 ± 0.5	98.5 ± 0.7
P.C. Hyperplanes PC5	97.2 ± 0.5	98.5 ± 0.7
PC6	96.4 ± 1.1	98.5 ± 0.7
PC7	97.2 ± 0.8	98.5 ± 0.7
PC8	96.4 ± 1.1	98.5 ± 0.7
PC9	97.2 ± 0.8	98.7 ± 0.6

equal to 97.5%. An F-measure test was carried out to assess the classification performance of the worst classifier (SVM). Results are reported in Table 3.5.

SVM classification output when  $p=2$  is shown in Fig. 3.8 in PCs space. The PCs plot shows vectors distribution with respect to Support Vector. In that, the diamonds are associated to the control group, while the circles represent the experimental group.

Even with a temporal resolution of 2 s, satisfying results can be obtained in discriminating stress conditions. Generally PCA allows to obtain comparable or better average accuracy when  $p > 3$  and, correspondingly, a lower uncertainty. This last result suggests a better noise robustness with PCA.

In bi-dimensional case, PCA highlights that the variance of the control group is lower. Among the two groups, a significant difference in dispersion around the mean value as well as amplitudes comes out.

Results confirm the data separability, even using only the first principal component, capable of explaining almost the 90% of variance. The good correlation between psychometric data and the exposure to different experimental set up (emotionally stressful and not) founds the experimental set up reliability in conditioning participants with regard to the study variable. The high accuracy level suggests that the

**Table 3.6** Accuracy (mean and uncertainty) in Original Data (O.D.) and Principal Components Hyperplanes at varying amplitude of random gaussian noise [172].

	Noise $\sigma$ percentage value				
	4	8	12	16	20
O. D.	97.9 $\pm$ 0.5	97.0 $\pm$ 0.7	96.1 $\pm$ 0.8	95.2 $\pm$ 0.9	92.2 $\pm$ 1.2
PC1	90.1 $\pm$ 5.3	89.7 $\pm$ 5.2	88.2 $\pm$ 5.2	86.4 $\pm$ 5.1	84.1 $\pm$ 4.8
PC2	79.0 $\pm$ 7.0	77.9 $\pm$ 7.1	77.5 $\pm$ 6.7	74.7 $\pm$ 6.6	74.5 $\pm$ 6.5
PC3	93.2 $\pm$ 3.4	92.4 $\pm$ 3.5	88.7 $\pm$ 3.4	85.7 $\pm$ 3.3	84.4 $\pm$ 3.4
PC4	98.2 $\pm$ 0.4	97.1 $\pm$ 0.7	95.9 $\pm$ 0.7	92.7 $\pm$ 0.9	90.8 $\pm$ 1.1
PC5	97.6 $\pm$ 0.4	97.2 $\pm$ 0.5	94.6 $\pm$ 0.7	91.6 $\pm$ 0.1	89.9 $\pm$ 0.1
PC6	97.7 $\pm$ 0.6	96.6 $\pm$ 0.7	95.1 $\pm$ 1.0	93.3 $\pm$ 1.0	90.4 $\pm$ 1.1
PC7	97.9 $\pm$ 0.5	96.8 $\pm$ 0.7	96.2 $\pm$ 0.8	93.7 $\pm$ 0.9	91.6 $\pm$ 0.1
PC8	97.5 $\pm$ 0.6	96.8 $\pm$ 0.6	96.3 $\pm$ 0.7	93.5 $\pm$ 0.1	90.5 $\pm$ 0.1
PC9	98.1 $\pm$ 0.5	97.2 $\pm$ 0.6	96.6 $\pm$ 0.6	93.7 $\pm$ 0.9	91.9 $\pm$ 0.1

**Table 3.7** Accuracy (mean and uncertainty) in Original Data (O.D.) and Principal Components Hyperplanes at varying amplitude of homogeneous noise

	Noise Percentage value				
	4	8	12	16	20
O. D.	97.4 $\pm$ 0.6	97.4 $\pm$ 0.6	97.1 $\pm$ 0.7	92.6 $\pm$ 2.2	88.7 $\pm$ 3.3
PC1	90.7 $\pm$ 5.3	90.8 $\pm$ 5.2	90.5 $\pm$ 5.3	89.9 $\pm$ 5.4	88.0 $\pm$ 5.6
PC2	78.0 $\pm$ 7.2	77.4 $\pm$ 7.2	76.0 $\pm$ 7.4	73.4 $\pm$ 7.2	68.9 $\pm$ 7.0
PC3	93.0 $\pm$ 3.6	90.8 $\pm$ 3.8	85.1 $\pm$ 4.5	81.8 $\pm$ 4.5	72.0 $\pm$ 4.5
PC4	98.2 $\pm$ 0.4	97.4 $\pm$ 0.7	94.2 $\pm$ 1.8	89.7 $\pm$ 3.2	85.2 $\pm$ 3.2
PC5	97.5 $\pm$ 0.4	97.6 $\pm$ 0.4	93.5 $\pm$ 1.8	88.8 $\pm$ 3.1	85.3 $\pm$ 3.3
PC6	97.4 $\pm$ 0.6	97.8 $\pm$ 0.5	95.6 $\pm$ 0.1	91.1 $\pm$ 3.2	87.6 $\pm$ 3.4
PC7	97.8 $\pm$ 0.5	97.8 $\pm$ 0.5	95.4 $\pm$ 1.5	91.1 $\pm$ 3.1	87.6 $\pm$ 3.4
PC8	97.5 $\pm$ 0.6	97.4 $\pm$ 0.6	94.9 $\pm$ 1.5	89.9 $\pm$ 3.0	86.7 $\pm$ 3.4
PC9	97.8 $\pm$ 0.5	97.5 $\pm$ 0.5	94.9 $\pm$ 1.54	90.9 $\pm$ 2.9	88.1 $\pm$ 3.3

signal acquired through a single channel preserves the information concerning the frontal asymmetry elicited from an emotional stress condition.

**Noise and Bias Robustness** Noise robustness was tested on the worst classifier (SVM) in order to assess the robustness of the proposed method. The subject-wise leave-two-out cross-validation strategy was repeated but with a further noise parameter, both (i) to make more generic the proposed method, and (ii) to verify the occurrence of possible bias during acquisition. The second evaluation is aimed to test the noise robustness of classification accuracy after PCA. In particular, two different kinds of noise were considered. In the first test, aimed at generalization, a random Gaussian noise with zero-mean and  $\sigma \in \{0.04, 0.08, 0.12, 0.16, 0.20\}$ , multiplied by the absolute value of the data maximum, was added. Results are reported in Table 3.6.

In the second test, aimed to verify bias, a constant value was added to each subject signal of the test sets. In this way, the signal of each subject was treated with a different random bias. Bias levels were chosen randomly within intervals of increasing amplitude ( $\sigma \in [0.04 - 0.20]$ , step = 0.04). For this reason, the global effect on the entire data set is noise. Results are reported in Table 3.7.



In both the cases, the instrument shows good noise robustness. The classifier with PCA performs better if the noise level is less than 12% of absolute value of the maximum of data. Performance degrades in any case with higher noise levels. In this study, the differential channel and the PCA are exploited to face the problem of artifacts. A differential channel intrinsically rejects the common mode noise. PCA on the differential channel EEG acts like a pass band filter owing to its intrinsic reduction of the signal dimensionality in the PC domain. The combined effect of this two filtering effects improves the signal-to-noise ratio significantly. The experimental analysis of noise robustness validated, ex post, the proposed method.

### 3.2.6 Discussion

A method to assess stress condition in real time through a high-wearable EEG-based device has been proposed. EEG signal amplitudes variations between prefrontal right and left zone were acquired through a single differential channel. The induced stress status was verified by a psychologist through (i) questionnaires administered before and after the stress test, and (ii) performance assessment. Time domain features were used in the classification procedure. Four standard machine learning classifiers (SVM, k-NN, Random Forest, and ANN) reached more than 90% accuracy in distinguishing each 2-s epoch of EEG. Generally, PCA allows to obtain a better noise robustness. The results show the adequacy of the proposed solution based on a single-acquisition channel and time domain-based feature selection. In the worst case, the SVM Linear -Kernel classifier succeeded in discriminating stress conditions with an accuracy of  $97.5 \pm 0.6\%$  and a latency of 2 s. For latency above 4 s the accuracy reaches 100%. Noise robustness was tested in order to exclude the impact of bias during signal acquisition and to empower generality to the results. The proposed method gives a new way to detect prefrontal asymmetry traditionally associated to emotional stress condition. Further future experimental activity with a larger number of subjects are necessary to consolidate the statistical significance of these preliminary results. ). Electrode scalp locations used in this study, FP1 and FP2, are considered as sensitive to ocular artifacts. However, our experiments did not highlight this problem. In any case, further experimental campaigns will be carried out on new areas of the scalp. In this way, the impact on the classifier of the information produced by both the EEG signals and the eye movements will be deepened. Alternative classifiers and strategies for the feature extraction such as sparse dictionary learning will be implemented.

### 3.3 Microwave-based system for skin sensing

#### 3.3.1 The application context

Wearable sensing technologies offer a convenient means of monitoring physiological parameters [180–184]. While there are numerous wearable solutions for real-time monitoring of many important biomedical parameters (e.g., oxygen saturation, blood pressure, heart rate), monitoring skin hydration still remains a challenging task. In fact, the state-of-the-art solutions are inadequate to obtain continuous real-monitoring, especially in a wearable-oriented perspective. Monitoring skin hydration is particularly relevant in presence of superficial diseases that cannot be detected from an estimation of total body water, as with the bioimpedance method [185–188]. In these cases, a wearable skin hydration sensor can be particularly useful for the continuous monitoring of the effects of medical treatments. Another application field regards workers in hostile environments [189]; in fact, the skin suffers from prolonged exposure to cold, wind, UV rays, dryness or pollution. Also hormonal changes may cause skin dehydration [190]. Skin hydration is also an indicator for alcohol abuse [191], and cosmetology [192]. Another important application field is sports: athletes who need to monitor their surface hydration status need a device that is miniaturized and made of comfortable materials for use over long periods of time.

Several types of skin monitoring sensors are reported in the literature; a taxonomy of the state-of-the-art skin hydration measuring techniques is shown in Figure 3.9. However, most of these skin-hydration sensing systems require benchtop instrumentation; hence, they are not viable in view of wearable applications. In addition, sensors for such applications should be made of flexible and comfortable materials, to adapt well to the body.

In this work of thesis, we have investigated the possibility of adopting microwave reflectometry (MR) technique (in combination with a wearable SE) to monitor in real time skin hydration. MR allows to relate the dielectric permittivity variations of the skin to the state of hydration. From the estimation of the values of dielectric permittivity, it would be possible to retrieve important information on the skin health. In particular, in [193], a preliminary validation was carried out using a planar SE. The system proposed in [193] successfully related skin humidity to MR measurements. However, the SE was manufactured on a FR4 substrate; hence, its rigidity hardly adapts to the skin curvature. Additionally, the measuring instrument adopted in [193], although accurate and portable, has dimensions that remains unsuitable in view of fully-wearable applications. Starting from these results, a new SE was designed and manufactured (with different configuration and materials with respect to [193]): the goal was to make the device flexible and more compact, thus improving adherence to the skin and comfort for the user. In addition, the performance of the device was improved and through full-wave simulations, its sensitivity to skin hydration was verified in terms of variation of the reflection scattering parameter,  $S_{11}(f)$ . With this new SE, measurements for different skin hydration states were carried out employing, as a further innovative element, a low-cost portable VNA that can be powered through a battery. This configuration is particularly useful in view of practical applications, because it overcomes the wearability limitations typically associated with skin sensing systems.

### 3.3.2 Theoretical background

A MR-based monitoring system consists of three major components [195]:

- a probe or SE;
- a reflectometric measuring instrument (which may be operating either in time domain or in frequency domain);
- an elaboration unit for acquiring and real-time processing of the measurement data.

Figure 3.10 shows a schematization of a typical experimental setup, in which the SE is a trifilar, planar device. The working principle for monitoring skin hydration relies on measuring the reflection scattering parameter,  $S_{11}(f)$ , of the SE when this is placed in contact with the skin, and in relating it to the skin hydration condition. In fact, when the skin is more hydrated, its effective relative dielectric permittivity,  $\epsilon_r$ , increases (since water has a relative dielectric permittivity considerably higher than dry tissues). This, in turn, leads to a shift in frequency and amplitude of the  $|S_{11}(f)|$  curve. Hence, by monitoring the shift of resonance frequency and the amplitude of the  $|S_{11}(f)|$  curve, it is possible to appreciate the different hydration states. The  $S_{11}(f)$  can be measured starting from time-domain measurements or directly in the frequency domain.

In time-domain reflectometry (TDR) measurements, the electromagnetic (EM) test-signal (often, a step-like voltage signal) is propagated along the SE and interacts with the system under test [196–199]. The direct output of TDR measurements is a reflectogram, which shows the time-domain reflection coefficient as a function of time:

$$\rho(t) = \frac{v_{refl}(t)}{v_{inc}(t)} \quad (3.1)$$

where  $-1 \leq \rho(t) \leq 1$ . The corresponding  $S_{11}(f)$  can be calculated as the ratio between the discrete Fourier transform (DFT) of the reflected signal and that of the input signal:

$$S_{11}(f) = \frac{DFT[\rho(t)]}{DFT[\rho_i(t)]}, \quad (3.2)$$

where  $\rho_i(t)$  is the time-domain reflection coefficient measured when the SE is not connected to the TDR measuring instrument.

As well known, the  $S_{11}(f)$  can be measured directly in the frequency domain through VNAs. These are generally bulky and costly instruments, often employed for laboratory measurements. The costs of these pieces of equipment are often prohibitive for practical applications; however, recently, some compact, portable VNA are available: for basic measurements, in relatively low frequency ranges, the cost/performance ratio may be particularly advantageous.

### 3.3.3 The proposed sensing system

The SE was redesigned with different configurations and using different materials. The first goal was to improve wearability, sensitivity, and patient's comfort in using the device. In particular, the

device was miniaturized and fabricated on a flexible rubber substrate with a layer of Kapton, to ensure simultaneously better wearability and adherence to the skin. In this way, in fact, the new flexible SE can adhere better to different body parts, even in correspondence of joints. This was not feasible with the SE proposed in [200], which employed a rigid FR4 substrate. FR4 was chosen because of its low cost, optimal strength and water resistance (features that have favoured the widespread adoption of this material for electrical applications).

Additionally, as a further innovative element, a low-cost portable VNA was used as a reflectometric unit to carry out measurements on volunteer subjects. In particular, a low-cost portable VNA, namely the NanoVNA (HCXQS-OwOComm) was used for the  $|S_{11}(f)|$  measurements. Being a low-cost measurement instrument, the NanoVNA has the potential to replace bulky and expensive tools and to pave the way for wearable VNA measurements [201]. The NanoVNA works in the 50 kHz - 3 GHz frequency range, and costs approximately 100 Euros. This device has approximate dimensions of 8 cm  $\times$  2 cm  $\times$  5 cm, and it can be powered through a USB port. The used VNA can be powered through a battery and is particularly convenient for allowing fully-wearable applications.

In the following sections, the design, manufacturing and experimental validation of the proposed flexible SE are described in detail.

### 3.3.4 Design and manufacturing of the flexible sensing element

The flexible SE was designed through EM simulations performed through the CST Microwave Studio software. Also in this case, a planar trifilar configuration was considered. Simulations were carried out considering different types of flexible substrates (mainly made up of ultra-thin glass, metal foil, and plastic films) and with different parameter settings (dimensions such as width of the electrodes, spacing, etc.) until the optimal configuration in terms of sensitivity was obtained.

Figure 3.11 shows a sketch of the SE. The overall dimensions are 50 mm  $\times$  90 mm. The fingers are made of adhesive aluminum, with a width of 2 mm and a spacing of 1 mm, and they are applied on a 2 mm-thick rubber substrate with a layer of adhesive kapton.

It should be mentioned that the area near the connector is particularly delicate, with the consequent presence of possible spurious phenomena. To solve this problem, an aluminum shielding was used to cover this portion of SE; insulating tape was used to insulate the shielding from the strips. Figure 3.12 shows a picture of the SE as manufactured.

**Numerical analysis and calibration curves** After the identification of the optimal configuration of the SE, simulations of the SE in contact with human skin with different degrees of humidity (using data available from the literature) were also performed. The simulation results were used to obtain specific calibration curves that relate the scattering parameter  $S_{11}(f)$  to the skin moisture level. This step allowed (along with the successive experimental measurements carried out with a portable NanoVNA), to validate the method and the metrological performance of the system.

To carry out the analysis of the sensitivity performance, a set of full-wave simulations was carried out

**Table 3.8** Simulation results for different hydration levels. Reference values of the dielectric permittivity ( $\epsilon_r$ ) are also reported [194].

Simulated condition	$\epsilon_r$	Frequency [MHz]	$ S_{11} $
Dry skin	43.07	360	0.165
n1	44.55	354	0.176
n2	46.04	348	0.187
n3	47.52	346	0.197
n4	49.00	341	0.207
n5	50.48	335	0.216
n6	51.97	330	0.225
n7	53.45	324	0.235
n8	54.98	319	0.243
n9	56.32	318	0.252
n10	57.80	313	0.260
Wet skin	59.28	307	0.268

through CST Microwave Studio. Simulations were carried out considering the SE in contact with a human phantom with different skin hydration levels; this allowed to identify a calibration curve that relates the simulations results (and, subsequently, measurement results) to dielectric permittivity of the skin.

In the CST software, a group of seven human model voxel data sets created from seven persons of different gender, age and stature is available. However, human tissues exhibit a significantly dispersive dielectric behavior in frequency. Therefore, to accurately model different hydration status of the human phantom in CST, it is essential to know the trend of permittivity and conductivity of dry and wet skin as a function of frequency. To this purpose, the average in-vivo electrical properties of skin determined by Gabriel and Gabriel [202] in the range 10 Hz – 20 GHz were considered. To model different levels of skin hydration, the skin properties of the phantoms were varied according to the EM parameters available from [202]. In particular, in order to take into account the dispersive behavior of human tissues, the database from [202] was used to set in CST the values of the EM parameters of the skin at different frequency values.

In this way, different skin hydration conditions were simulated by setting appropriate values of the EM parameters of the skin in a specific frequency range. Consequently, for each simulation, the EM parameters of the skin were modified, while the dielectric properties of the remaining tissues (blood, bone average, cartilage, fat, muscle) were left unchanged.

Twelve conditions were simulated with the SE placed on the phantom's forearm. In particular, the parameters of "dry" and "wet" skin from [202] were considered as the minimum and maximum values of healthy skin hydration, and ten other intermediate conditions were considered (from n1 to n10). In this way, considering as input values the reference data available in [202] which are related to the healthy skin hydration values, the corresponding values related to the intermediate dielectric levels can be retrieved and analyzed to assess the system performance in terms of detectivity limitation.

Figure 3.13 shows the magnitude of the reflection scattering parameter  $|S_{11}(f)|$  in the 200–550 MHz frequency range, which is the range where the changes in the  $|S_{11}(f)|$  behavior are more evident. It

can be seen that an increase in water in the skin leads to a shift of  $|S_{11}(f)|$  minimum towards lower frequencies. This phenomenon is due to changes in the dielectric permittivity of the skin at different hydration states. In particular, starting from *dry* condition until the *wet* condition, the minimum of  $|S_{11}(f)|$  move to lower frequencies and the magnitude of  $|S_{11}(f)|$  increases.

Table 3.8 summarizes the values of the frequency where the  $|S_{11}(f)|$  minimum occurs and the corresponding values of  $|S_{11}(f)|$  at the resonant peak. In Table 3.8, the reference values of  $\epsilon_r$  for each simulation in the frequency range of interest are also reported. In terms of resolution, from Table 3.8 and Fig. 3.13, it is possible to notice that the device is able to discriminate variations of the dielectric constant as low as about 1.5.

It can be noticed that the SE is sensitive to changes in hydration not only through the increase in  $|S_{11}(f)|$  but also in the shift in the resonant frequency. Consequently, it is possible to identify a relation that relates these parameters to the hydration level. This result suggests that it could be of interest to relate the values of  $\epsilon_r$  to the magnitude of the  $|S_{11}(f)|$  at the frequency of resonance and to the resonant frequency value,  $f_r$ , as shown in Figure 3.14(b): the  $(\epsilon_r, |S_{11}(f)|)$  points were fitted through a linear regression. It can be seen that there is a distinct proportionality between the  $\epsilon_r$  values and the  $|S_{11}(f)|$  and the resonant frequency value corresponding to the minimum. These results, which translate into specific calibration curves, constitute the practical way for successfully identifying the skin hydration status. A check on both quantities (i.e.,  $f_r$  and  $|S_{11}(f)|_{@res}$ ) allows to improve the accuracy in the estimation of  $\epsilon_r$  and therefore of the degree of hydration.

### 3.3.5 Experimental validation and discussion of results

#### Preliminary experimental validation

For verifying the performance of the NanoVNA, first, comparative measurements were carried out through the NanoVNA and through a benchtop VNA, namely the VNA R&S ZLV6, a very accurate and more expensive instrument. Measurements were carried out on dry skin of different subjects. In particular, the measurements were carried out in two areas of the body: forearm and leg, both in dry condition. The SE was placed in an elastic band to keep it adherent to the body.

Figure 3.15 shows a picture of the experimental session with the NanoVNA. For the sake of example, Figure 3.16 shows the  $|S_{11}(f)|$  results, for subject #2, obtained through the two VNAs. It can be noticed that there is a good agreement between the results obtained from the two VNAs. The root mean square error (*RMSE*) was considered as a figure of merit to assess the agreement between the two VNAs; the resulting *RMSE* was 0.013.

To verify repeatability, measurements were repeated in all the considered conditions, for both the subjects. For the sake of example, Figure 3.17 shows the measurement results for the repetitions carried out on the dry forearm of Subject #2. Also in this case, the *RMSE* between the curves of the repetitions was considered as a figure of merit to assess repeatability. The obtained values are  $RMSE_{(r1-r2)} = 0.008$ ;  $RMSE_{(r1-r3)} = 0.016$ ;  $RMSE_{(r2-r3)} = 0.010$ .

Considering the good agreement between the measurements on dry skin performed with NanoVNA and with VNA, measurements were made with different degrees skin humidity states using the NanoVNA only (which is of lower cost, compactness and portability for wearable configuration).

### Experimental validation for different hydration conditions

Based on the results obtained with the preliminary characterization, the analysis was carried out through the NanoVNA, in the frequency range within 600 MHz. Three different skin hydration conditions were considered:

- dry skin;
- skin with hydrating lotion;
- wet skin.

Figure 3.18(a) and Figure 3.18(b) show the results obtained for subjects #1 and #2, respectively. It can be noticed that, for both subjects, there is a consistent trend of the variation of the resonance frequency of the device. In particular, as the hydration increases, there is a shift of the resonant frequency towards lowers values. These results, although preliminary, demonstrate the feasibility of employing a portable VNA and a wearable, flexible SE to sense variation of skin hydration.

For validation purposes, it is useful to compare the measured and the simulated results obtained for  $|S_{11}(f)|$ : Figure 3.19 shows the comparison. By considering the two extreme conditions of dry and wet skin, a good agreement between measurements and simulations can be observed.

Table 3.9 shows a comparison of the values of  $|S_{11}(f)|$  at the resonance peak,  $f_r$ , for the measurements and for the simulations. It is important to emphasize that this good agreement between measurements and simulations is crucial to validate the method and the metrological performance of the system. In fact, the difficulty in obtaining a precise tuning of the actual skin dielectric parameters (useful to perform measurements at every small dielectric variations), is overcome by the simulations, which well match the measurements in extreme dry and wet conditions. In fact, through the simulations with the Gabriel's dielectric parameters [202] and the resulting calibration curves, it is possible to retrieve an accurate quantification of the level of humidification of a skin portion on which the measurement was carried out, thus enabling the early warning of aggravating pathological conditions.

Finally, in terms of accuracy, there is a deviation between the  $|S_{11}(f)|$  and the resonant frequency value between the simulated curve and the measured curve of less than 2%, which is the same order of magnitude as the instrumental uncertainty of the portable NanoVNA.

### Discussion

This activity addressed the design, fabrication and test of a microwave reflectometry-based portable sensing system for real-time monitoring of skin hydration level. In particular, the new SE device was

**Table 3.9** Comparison of the  $|S_{11}|$  and frequency values at the resonance peak,  $f_r$ , for the measurements (M.) and simulations (S.) [194].

Condition	$\epsilon_r$	$f_r$ [MHz] (M.)	$f_r$ [MHz] (S.)	$ S_{11} $ (M.)	$ S_{11} $ (S.)
Dry skin	43.07	369	366	0.154	0.165
Wet skin	59.28	302	307	0.270	0.268

miniaturized and fabricated on a flexible rubber substrate with a layer of Kapton, to ensure simultaneously a better wearability and surface adherence to the skin. First, the system was preliminarily validated through a numerical analysis, which allowed to identify specific calibration curves. In this regard, it is important to emphasise that the accuracy of the device was improved: employing the proposed SE, it is possible to take advantage also from the frequency shift of the resonance peak of  $S_{11}$  in addition to the information obtained from its magnitude. Monitoring the variation of both  $f_r$  and  $|S_{11}|$  allows to improve the accuracy in the estimation of  $\epsilon$  and, therefore, of the degree of hydration. Successively, experimental tests were carried out through a low-cost portable VNA. The obtained results, although preliminary, demonstrate the feasibility of employing a portable VNA and a wearable, flexible SE to sense variation of skin hydration.

Further work will be dedicated to improve and systematically characterize the proposed system (for example by employing solutions for data acquisition managed via Bluetooth interface and local processing), and to miniaturize the NanoVNA, removing the LCD screen in order to make it fully wearable.



## 3.4 Fully-textile humidity sensors for wearable applications

### 3.4.1 The context

Thanks to the continuous technological progress in the integration of electronics into textiles, innovative solutions are constantly emerging for monitoring the human environment and human-machine interactions [203–206].

The recent literature confirms the trend of Industry 4.0 in this direction. For example, in [204], a sensor shirt (employing inertial sensors and wireless connectivity) for recording the movement and position of the upper body for occupational health and ergonomics was presented. Also, in [207], a smart-maintenance jacket for industrial applications was proposed: the jacket was equipped with sensors, actuators and microcontroller and was implemented using electronic textiles. Additionally, in [208], a smart-fabric based wireless Body Area Sensor Network for assessing psychological and physiological work risk levels was addressed: the system combined smart-sensing fabrics, high electronic miniaturization and machine learning to assess the risk level of the worker.

However, in spite of the widespread adoption of smart garments and their constant increase in popularity, one of the aspects that limit the development of smart clothing for fully-wearable applications is the presence of electronic parts and the necessity of soldering, which make operations such as washing and ironing difficult if not impossible [209]. The exploitation of fully-textile chipless sensors allows to overcome all these issues [210, 211].

Starting from these considerations, this work addresses the development, fabrication and preliminary experimental characterization of a fully-textile, wearable chipless device for humidity sensing purposes. The proposed device is a 50  $\Omega$  microstrip line loaded by two chipless resonators.

For guaranteeing full integration with clothes, the proposed device was designed using jeans as a substrate, which also enables the humidity sensing capability of the device. In fact, in the literature, it is largely reported that there is a direct relation between the dielectric permittivity of textile materials and the environmental conditions [212, 213]. Because of their porosity, textiles absorb water from the environment; as a result, both the relative dielectric permittivity  $\epsilon_r$  and the loss tangent  $\tan \delta$  of the textile substrate increase as the relative humidity (RH) increases [212]. Hence, the basic idea is to exploit the variation of  $\epsilon_r$  of the textile substrate caused by variation of RH. The humidity information can be then related to the magnitude of the transmission scattering parameter,  $|S_{21}|$ , of the microstrip line. In particular, the variation of humidity leads to a change of the resonance frequency values of the chipless resonators.

It is worth mentioning that the proposed multi-resonator device can be used for different sensing purposes. However, humidity sensing was considered as a case study because humidity and sweat are related to physiological parameters, and the literature shows a growing interest on such applications [214–220].

In Section 3.4.2, the design and fabrication of the proposed two-resonator device is described in detail. Section 3.4.3 describes the experimental setup employed for the characterization of the device for humidity monitoring applications. In Section 3.4.4, the results of the experimental characterization of

**Table 3.10** Dimensions of the two-Resonator chipless device [221].

Parameter	[mm]
$W_{feed}$	3.7
$W_{1st,res}$	19.1
$L_{1st,res}$	18.3
$S_{1st,res}$	1.2
$W_{2nd,res}$	16.7
$L_{2nd,res}$	16.1
$S_{2nd,res}$	1.1

the sensing device (carried out in a climate chamber) for different values of RH is reported and discussed. Finally, in Section 3.4.5 conclusions are drawn.

### 3.4.2 Design and fabrication of the sensing device prototype

The geometry of a 50  $\Omega$  microstrip line loaded by two resonators is shown in Figure 3.20. A 5 mm-thick jeans layer was used as a substrate. The conductive parts were made using a 0.11 mm-thick self-adhesive non-woven conductive fabric (electrical conductivity equal to  $2.27 \times 10^5$  S/m). The dimensions of the device (and, hence, of the resonating structures) were chosen so that the device would work in the ISM frequency band.

The device was designed through full-wave electromagnetic simulations, using CST Microwave Studio software. The dimensions of the device, after optimization, are summarized in Table 3.10. The overall area of the prototype is 60 mm  $\times$  40 mm. Additional information on the geometry of the resonators can be found in [222], where the device was characterized as a chipless RFID tag.

After the design optimization, the device was fabricated by shaping the conductive parts using a cutting plotter: this procedure expedites fabrication and is potentially suitable to be used for large-scale production [223–225, 181]. Fig. 3.21(a) and Fig. 3.21(b) show the front view and the back view of the two-resonator device, respectively.

### 3.4.3 Experimental setup

For carrying out the characterization in a controlled-humidity and temperature environment, the jeans prototype was tested in a climate chamber, Challenge CH250. This climate chamber allows to control the temperature and the relative humidity of the chamber. The temperature was set at 20  $^{\circ}$ C. The RH value was varied from 30% to 90%, in steps of 10%. From specifications, the maximum uncertainty in RH is 3%. Two cycles were carried out: one increasing the RH value and the other decreasing the RH value, so as to appreciate possible hysteresis effect.

Measurements of the transmission scattering parameter,  $|S_{21}|$ , were carried out through a vector network analyzer (VNA), VNA R&S ZVA50. A short-open-load-thru (SOLT) calibration was performed before carrying out the experiments.

During the tests, the device was inside the climate chamber. The VNA was outside the chamber. An access port plug on one side of the climate chamber allowed the pass through of cables and the connection to the device.

### 3.4.4 Experimental results and discussion

First, the prototype was characterized out of the climate chamber, through VNA measurements. Fig. 3.22 shows the comparison between numerical and experimental results (during measurements, the ambient relative humidity was approximately 55%). The quantities  $f_{r1}$  and  $f_{r2}$  indicate the resonant frequencies of the two resonators. A good agreement can be observed between simulation and measurement.

Successively, the jeans prototype was characterized in the climate chamber, varying the relative humidity of the chamber between 30% and 90%.

As known from theory, each resonator exhibits an amplitude minimum of the  $|S_{21}|$  parameter of the microstrip line. The frequency values of the minima depend on the  $\epsilon_r$  value of the substrate, which depends on the humidity content. Therefore, it is possible to associate the variations of the frequencies of the minima of the  $|S_{21}|$  to the RH value.

Fig. 3.23 shows the results of the climate chamber tests. In particular, Fig. 3.23(a) shows the variation of the  $|S_{21}|$  curve as the RH value is increased. It can be noticed that, as RH increases, there is a steady shift of the two resonances towards lower frequency values. In particular, the value of the first resonance peak,  $f_{r1}$ , shifts from 1.820 GHz (for RH = 30%) to 1.749 GHz (for RH= 90%). On the other hand, the resonance peak  $f_{r2}$  shifts from 2.046 GHz (for RH = 30%) to 1.991 GHz (for RH = 90%).

To verify possible hysteresis effects, the tests were repeated by decreasing the RH level inside the chamber. Fig. 3.23(b) shows the  $|S_{21}|$  results when decreasing the RH. The obtained results are consistent with the results obtained in the first measurement cycle. In fact, the peaks of the resonances shifted towards higher frequency values as the RH decreased. In particular, the first resonance peak  $f_{r1}$  shifts from 1.750 GHz (for RH=90%) to 1.822 GHz (for RH=30%). Also  $f_{r2}$  shifts from 2.021 GHz (for RH = 90%) to 2.048 GHz (for RH = 30%).

Results showed that there is distinct relationship between the variation of the resonant frequency and the value of RH. However, some hysteresis effect could be observed. In this regard, Fig. 3.24(a) shows the variation of the low-frequency resonance peak ( $f_{r1}$ ) as a function of the RH, for the two measurement cycles. Similarly, Fig. 3.24(b) shows the variation of the resonant frequency for the higher-frequency peak,  $f_{r2}$ . While the behavior is coherent with the lower-frequency peak, it can be noticed that for the  $f_{r2}$ , the two cycles exhibit considerable differences in terms of frequency value. This can be attributed to the fact that the peaks of the second resonance are less pronounced, as can be seen from Fig. 3.23, which shows that the  $|S_{21}|$  curve in correspondence of  $f_{r2}$  are flatter.

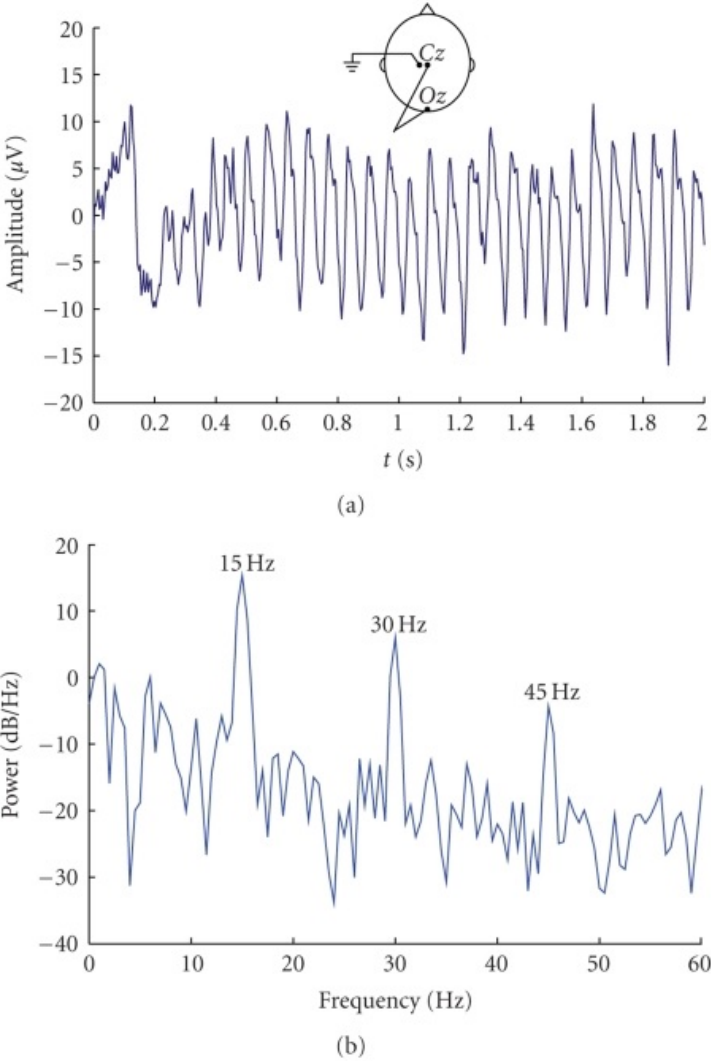
### 3.4.5 Conclusion

A fully-textile two-resonator device, to be used as a wearable sensor for humidity measurements was presented and experimentally characterized. The operating mechanism relies on sensing the variation of

the resonant frequency values of the two resonators (both operating in the ISM frequency band) when the dielectric jeans substrate moistens with the humidity.

To achieve full integration with clothes, the prototype was implemented using jeans as a substrate, and self-adhesive non-woven fabric for the conducting parts of the device. The experimental characterization was carried out in a climate chamber, for pre-established RH levels, from 30% to 90% (in steps of 10%): first increasing and then decreasing the RH value, in the considered range. Results demonstrated a distinct relationship between the variation of the resonant frequency of the resonators and the value of RH. In particular, the analysis of results suggests that employing a resonator with a more pronounced minimum of the  $|S_{21}|$  should be preferred in order to emphasize the direct relation between the resonance frequency variation and the RH value.

The proposed textile device represents an interesting solution for smart garments, especially useful in 4.0 application contexts. To this end, further work will be dedicated to fine-tune the multi-resonator structure design and to the systematic experimental characterization of the  $f_{r1}$ -RH calibration curve. Also, in view of practical use of these type of devices, it is envisaged to include fully-textile receiving and transmitting antennas. Employing two planar monopoles as radiating elements [226] should allow an easier integration of the device as a whole (i.e., resonators and antennas).



**Fig. 3.3** Typical waveform of an EEG signal (Oz-Cz) acquired during visual light stimulation with a frequency of 15 Hz: (a) in time domain and (b) in frequency domain [171].

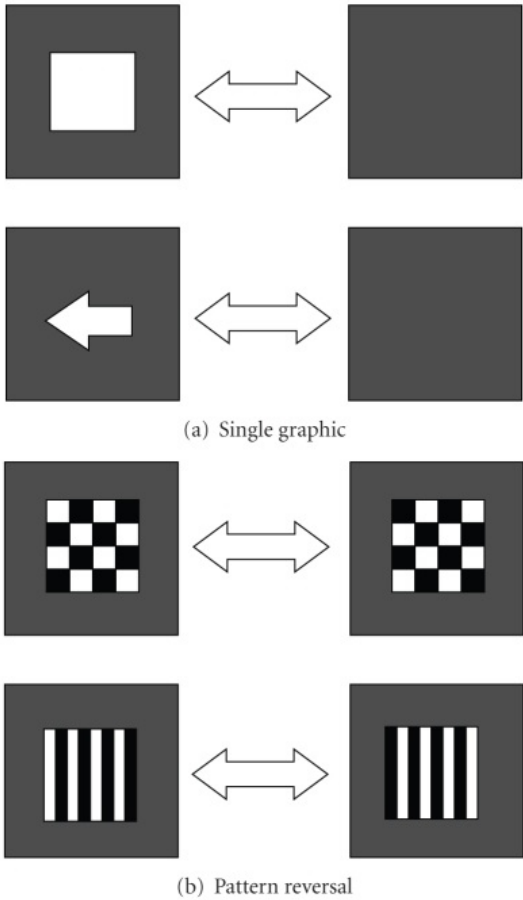


Fig. 3.4 Repetitive visual stimuli: (a) Single graphic stimuli. (b) Pattern reversal stimuli [171].

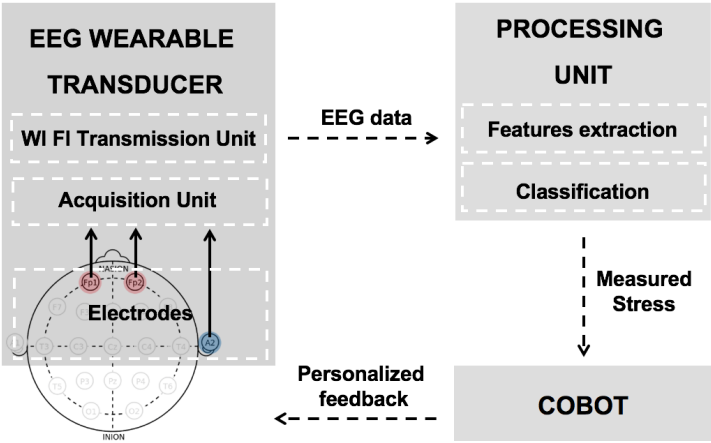
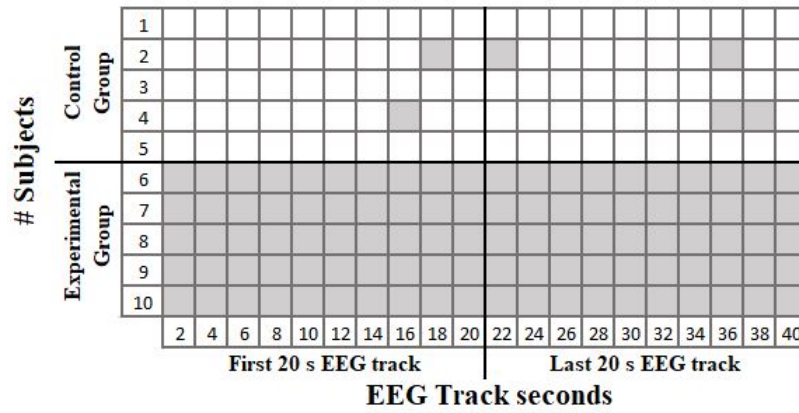
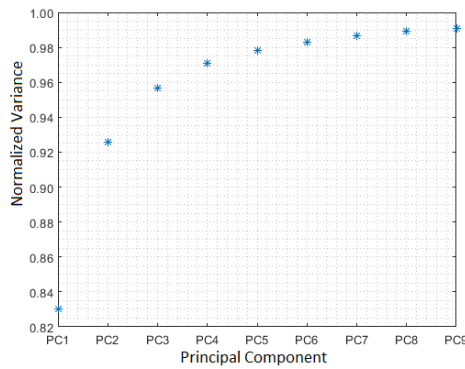


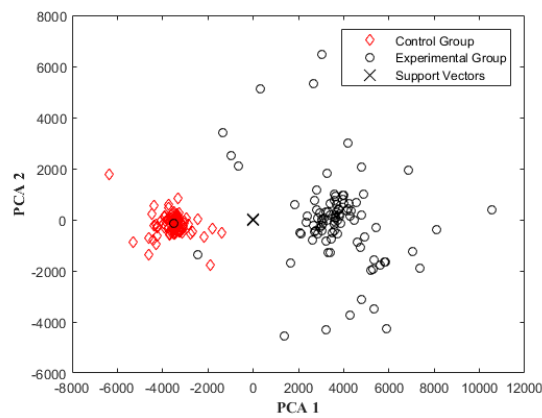
Fig. 3.5 Architecture of the real-time stress monitoring instrument in Cobot interaction [172].



**Fig. 3.6** K-means classification (white: class 1; black: class 2) among the 2 different time phases according to subjects belonging group [172].



**Fig. 3.7** Cumulative Explained Variance in the PCA [172].



**Fig. 3.8** SVM data distribution in PCs space,  $p=2$ , 92,6% of explained variance [172].

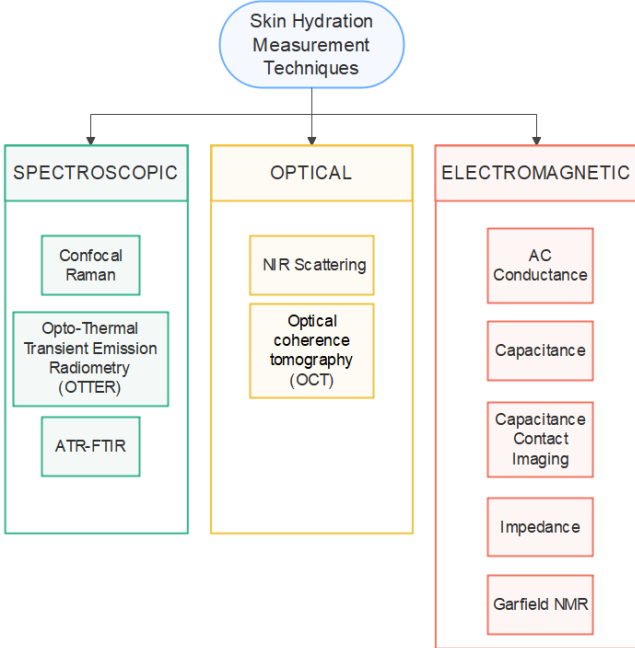


Fig. 3.9 Taxonomy of state-of-the-art skin hydration measuring techniques [194].

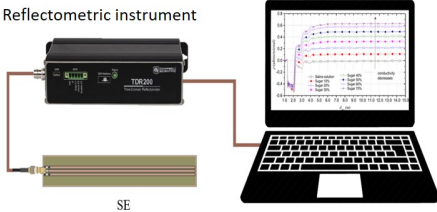


Fig. 3.10 Schematization of a microwave reflectometry-based measuring system [194].



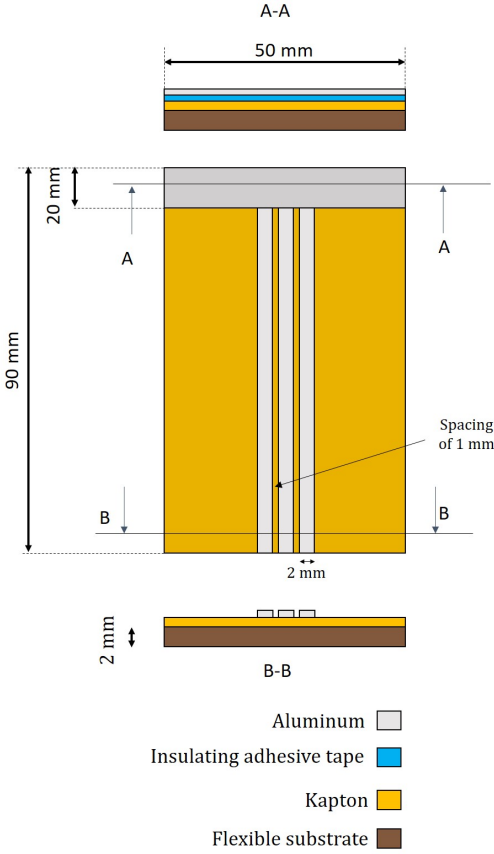
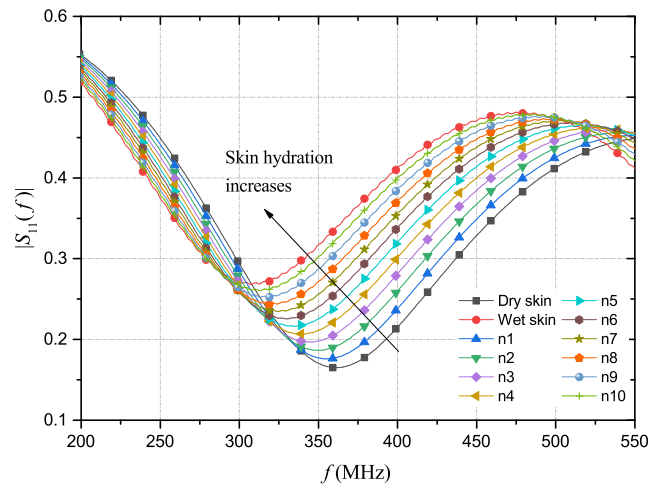


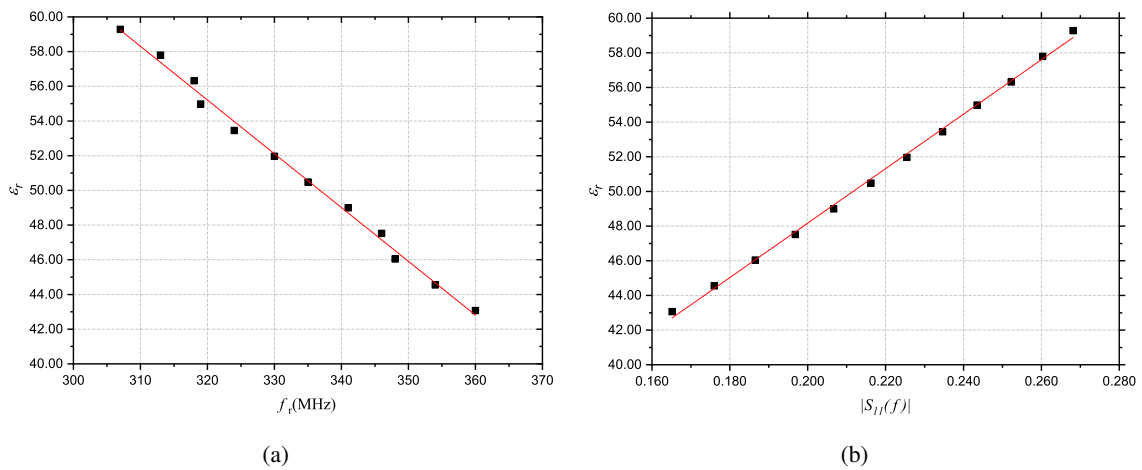
Fig. 3.11 Sketch of the flexible SE: top view and cross sections (A – A) and (B – B) [194].



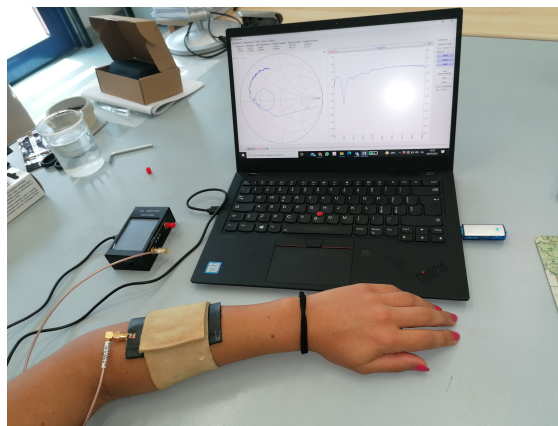
Fig. 3.12 Picture of the flexible SE [194].



**Fig. 3.13** Simulation results for the  $|S_{11}(f)|$  of the SE for 12 skin hydration states (different permittivity). The trend is highlighted [194].



**Fig. 3.14** Linear fit of  $\epsilon_r$  values as a function of the resonant frequency (a). Magnitude of  $S_{11}$  (b) [194].



**Fig. 3.15** Picture of the experimental session when using the SE and the NanoVNA [194].

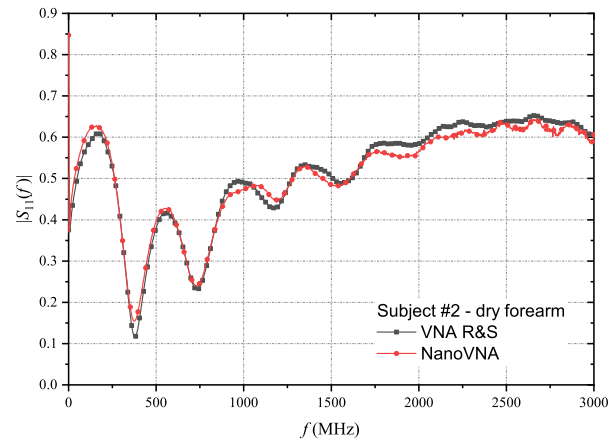


Fig. 3.16 Comparison of measurements carried out through the two VNAs on subject #2 [194].

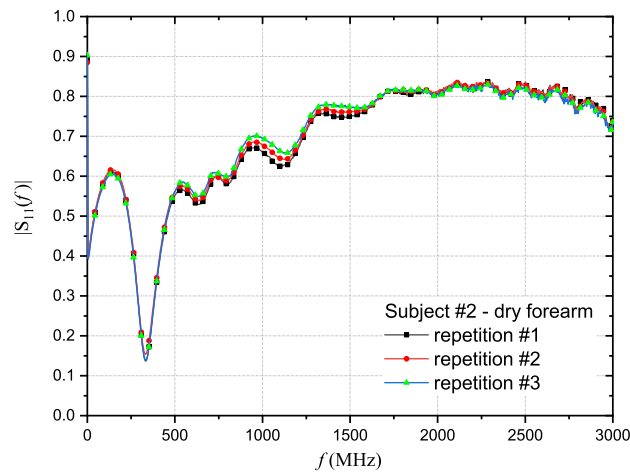


Fig. 3.17 Subject #2 forearm: results of the repeated measured in the dry-forearm condition [194].

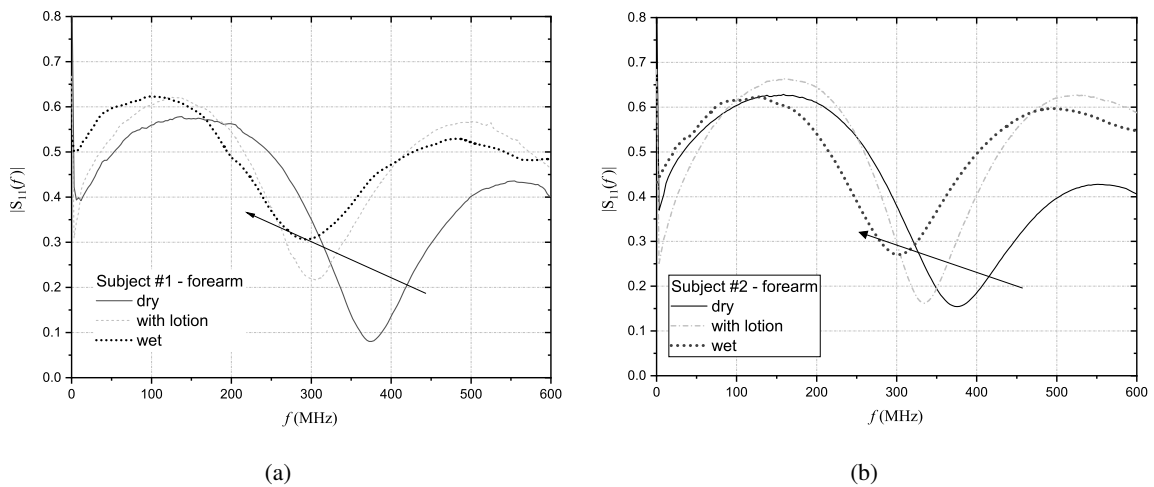
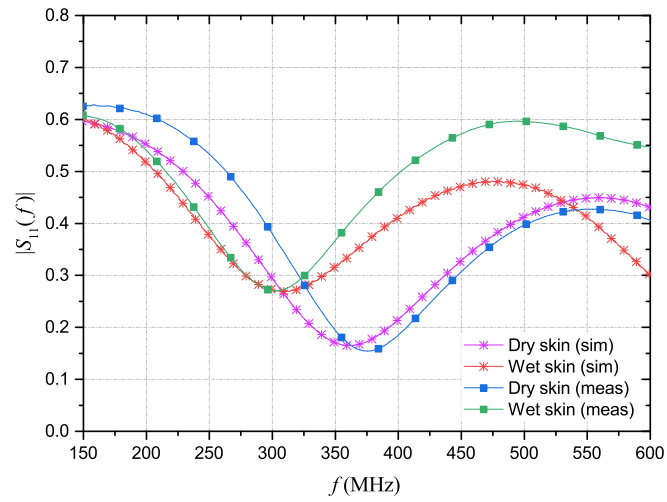
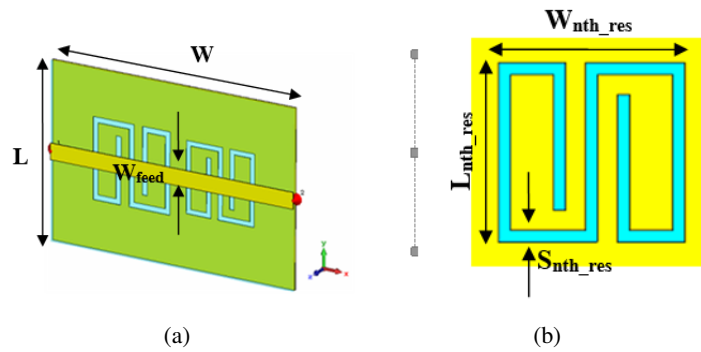


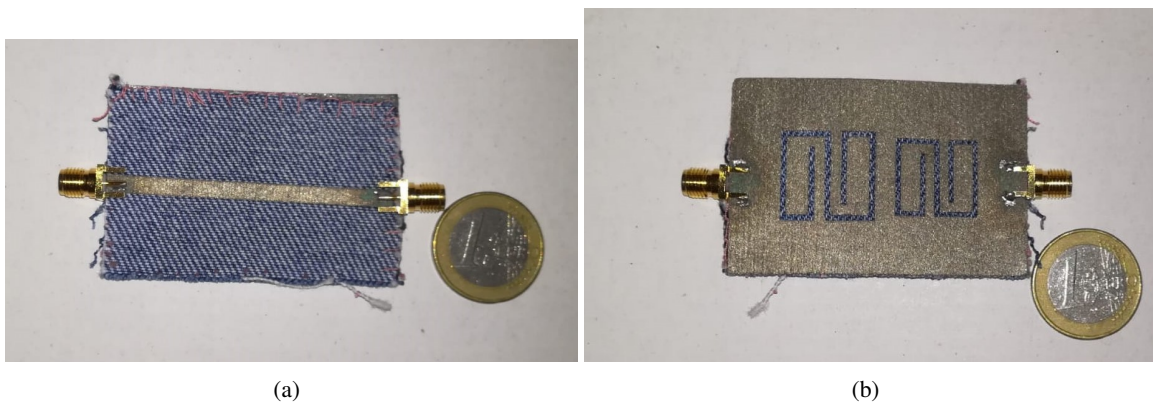
Fig. 3.18 Different hydration conditions for forearm: Subject #1 (a); Subject #2 (b) [194].



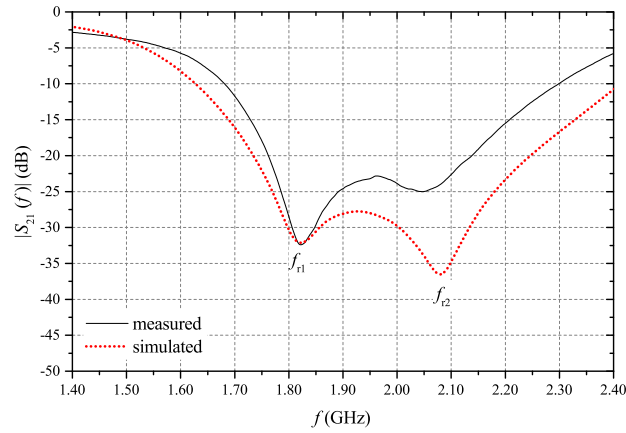
**Fig. 3.19** Comparison between  $S_{11}$  of measurements (lines) and that of CST simulations (lines+stars), for the SE [194].



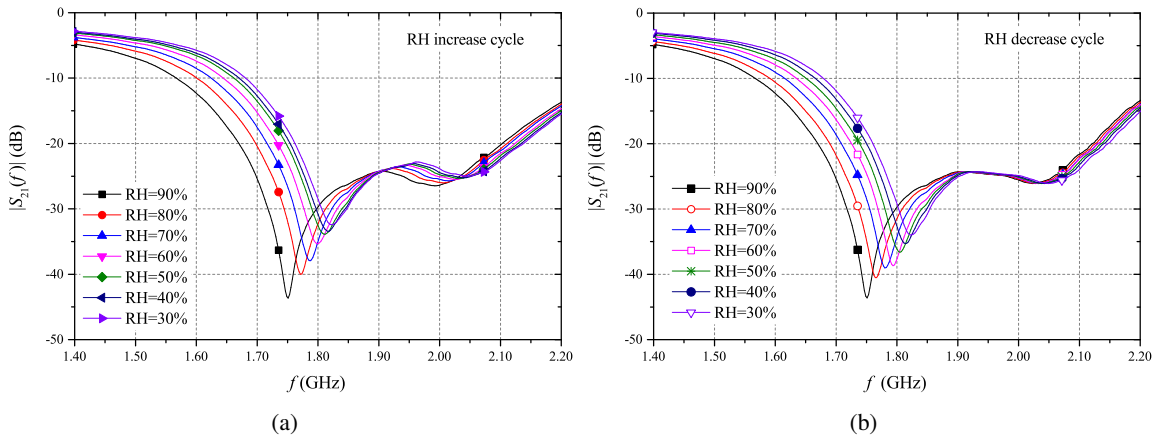
**Fig. 3.20** Design of the two-resonator humidity sensor: (a) perspective view; (b) details of the single resonator [221].



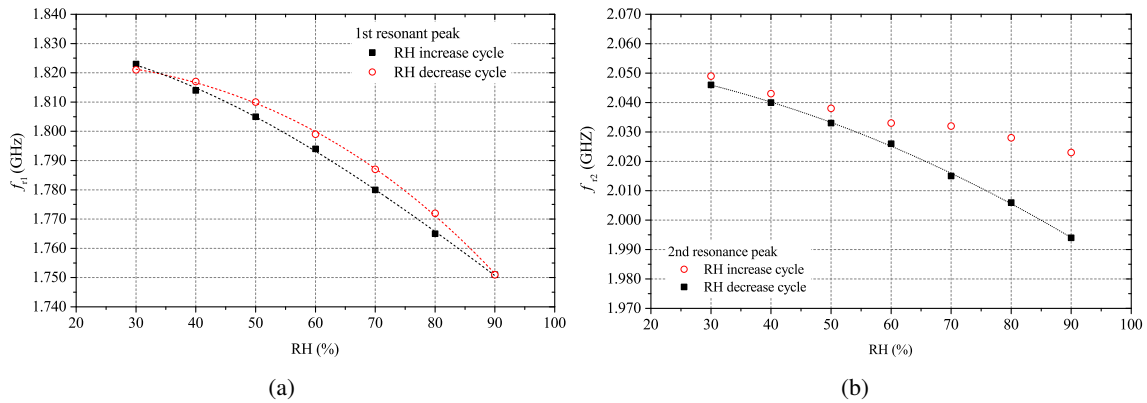
**Fig. 3.21** Pictures of the prototype of the chipless humidity sensor: (a) front, (b) back [221].



**Fig. 3.22** Comparison between the measured  $|S_{21}|$  and the simulated  $|S_{21}|$  [221].



**Fig. 3.23** Amplitude of the  $|S_{21}|$  parameter measured for different RH values: increase cycle (a), decrease cycle (b) [221].



**Fig. 3.24** Relationship between the frequency of the first resonance peak of the device and the RH value, obtained for increasing and decreasing RH levels (a); Relationship between the frequency of the second resonance peak of the device and the RH value, obtained for increasing and decreasing RH levels (b) [221].

## **Chapter 4**

# **Development and implementation of 4.0 transition-driven measurement systems: industry-oriented applications**

### **4.1 Introduction**

In the previous chapter, the research focus was dedicated on the design, development and implementation of innovative MMSs designed with user-centered approach. The goal was to demonstrate how taking into account the person in the development of MMS can improve the effectiveness of the monitoring.

In this chapter, the focus is on 4.0 transition driven MMSs, for the industrial application field.

The first case study describes an Augmented Reality (AR) system developed to support industrial assembly operations. The goal is to show how an application developed with 4.0 technologies can perform additional monitoring functions.

The second case study describes the use of the innovative soft robot continuum technology that offers the possibility of jointly implementing 4.0 and monitoring applications for the inspection of hostile environments. In this thesis, these two technologies have been employed with a metrology-oriented approach, crucial for measurement-driven 4.0 applications.

### **4.2 Augmented Reality for assembly in Industry 4.0**

#### **4.2.1 The context**

AR has become an integral part of the Industry 4.0, as it is considered as one of the enabling technologies with the largest potential to improve the way in which modern factories operate [227, 228]. AR can support workers in carrying out tasks such as assembly [229, 230], maintenance and repair [231, 232], design and manufacturing applications [233], warehouse management operations [234, 235], etc. The implementation of AR technologies in the Industry 4.0 can also facilitate the collaboration between

humans and robots [236, 237]. Indeed, AR is useful not only to increase the operators' throughput, but also as a support for cognitively impaired workers [238]. A recent trend is also to pair up AR with another cutting-edge technology, namely brain computer interface (BCI). For example, in [239], a wearable monitoring system using BCI in place of traditional input interface of AR platforms was proposed.

However, as with all emerging technologies, there are still some aspects that hinder the widespread adoption of AR in industrial contexts, especially with regard to the acceptance factors and usability [240]. The tasks supported by AR are expected to be more efficient in terms of time to complete the task and in terms of error rate; nevertheless, the increase in AR performance often depends on the nature and complexity of the task. Some studies have shown that the performance enhancement brought by the AR system also depends on the workers' experience [241]. For example, in [242], it was observed that AR-aided training reduced the error rate, but took longer than the paper instructions, and this could be caused by the unfamiliarity of the participants with the AR. Also, excessive reliance on displays and signals generated in AR can negatively affect the operator's performance as they can distract him from the task at hand. On such bases, it is evident that a major limitation for the AR employment in Industry 4.0 is the general lack of a rigorous characterization of the impact of AR technology on the worker's performance. In the literature, some studies have focused on using objective indicators to assess AR's effectiveness in manufacturing activities (such as time and error rate), while basic usability factors (such as operator's acceptance, possible stress, perceived usefulness or engagement) and technical problems (for example display and tracking technology, calibration techniques and interfaces with machines) have not yet been sufficiently considered [243].

To fill this gap, this work addresses this aspect by considering quantitative parameters to describe the worker's performance enhancement, but also including a characterization of the task and of the operating workflow that could enhance usability. In particular, to verify the effectiveness of AR assistance, comparative experimental tests were carried out on two groups of volunteers who were given a specific assembly task. One group was asked to follow paper instructions, while the other group was administered assembly instructions through an AR application. Two figures of merits were used to measure the working performance of the volunteers: the processing time required to complete the task and the number of mistakes made.

As aforementioned, the operating workflow of the assembly was established with the intention to reduce the operator's cognitive effort and improve usability, by rendering AR systems as natural as possible. Finally, for the experimental tests, particular care was taken in order to recreate operating conditions similar to those of a real industrial context.

The present section is organized as follows. First, the case study is described in detail. Then, the description of the experimental settings and of the developed AR application are addressed. Successively, the results of the experimental tests are presented.

### 4.2.2 Case study: Lego prototype assembly operation

A specific case study was developed to measure the workers' performance in carrying out an AR-assisted assembly process. The case study consists of an assembly task using Lego Mindstorm. The Legos are used to recreate an assembly station in Industry 4.0 framework, similarly to [244]. In particular, the proposed task requires that the operator assemble a prototype (made with Legos), for which the assembly instructions are available either in paper or virtual-aided forms. The bricks used for the prototype are made of different materials (e.g. plastic or rubber objects), different colours and of pieces that show some similarities (e.g. similar shape but different colour, similar colour but different size).

For the experiments, eight volunteers were recruited: four males and four females; average age 24.8. The participants were engineering students; hence, they all had some technical university education. However, none of them was familiar with AR. The volunteers were divided randomly in two groups of four persons. One group (*Group A*) had to assemble the prototype using paper instructions. The other group (*Group B*) had to assemble the proposed prototype following instructions provided through AR. To evaluate the working performance of the volunteers, each of them was asked to assemble the prototype in the shortest possible time, for five consecutive times. The objective was to highlight the learning process that manifests itself with the two approaches under analysis.

It should be mentioned that, as in most areas, the characteristics of the operators (for example, possessing a technical background and education degree) may influence their performance. Also, for the specific assembly task, other practical aspects (such as familiarity with Legos and length of the Operator's nails) may affect the operator's performance, either with AR instructions or paper instructions. In the experimental tests reported herein, however, these differences in the considered groups of volunteers were levelled.

### 4.2.3 Methods

#### Experimental Settings

In setting up the scenario and the AR application, particular attention was dedicated to make the operating conditions as close as possible to a real assembly environment. First of all, the volunteers (operators) worked on a standard assembly table. The operator has to assemble the prototype using parts that were provided in an assembly tray (AT) positioned on the right side of the table. The AT was organized in cavities, and each cavity contained a specific assembly part.

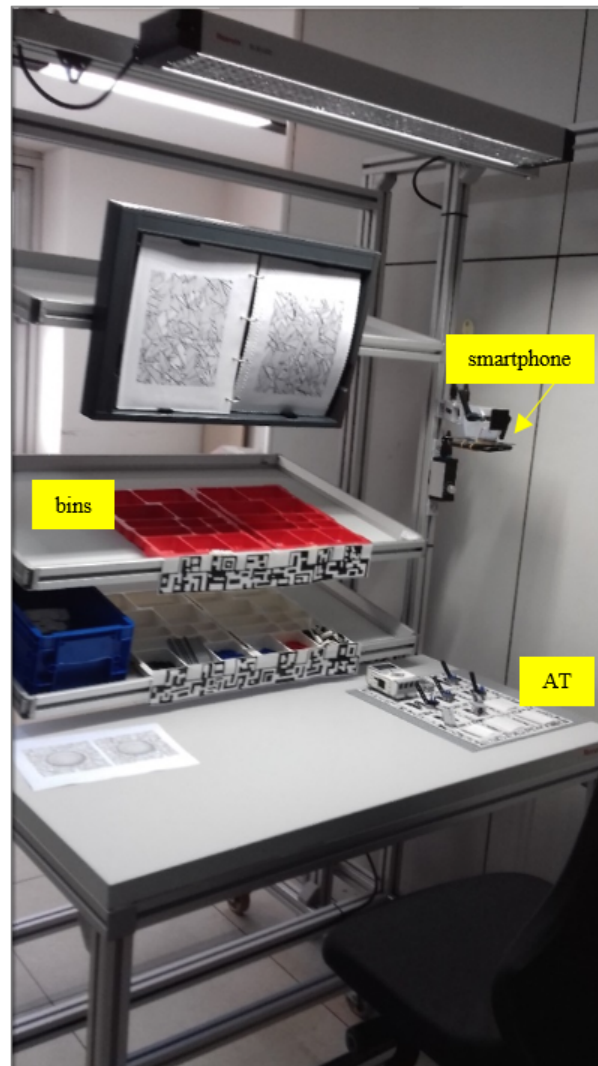
As in an actual assembly station, the operator had also to pick some components (such as screws, bolts, etc.) which were placed in bins on the shelves of the assembly table.

Figure 4.1 shows a picture of how the assembly station was organized

To automate the use of the AR system and to improve its usability, two separate but intercommunicating AR applications were implemented, each running on an Android-based device.

The reason behind this strategy is that, in an actual assembly line, operators usually keep the product that is being assembled before themselves, while the AT is on their side (as shown in Fig. 4.1). Hence,





**Fig. 4.1** Picture of how the assembly table was organized [124].

if only one AR device was to be used (i.e, an head-mounted display, HMD), then the operators would have to move their head and look sideways. In this way, the HMD camera could point at the AT and the application could identify the parts that are being taken.

To avoid this stressing condition, the AR assistance was implemented through two separate, but mutually interacting, applications. One application runs on an HMD and shows the AR assembly instructions to the operator. The second application runs on an Android smartphone, whose camera points at the AT. The smartphone AR application monitors the parts that are being picked from the AT, so that the proper instructions are administered through the HMD.

In these experiments, the EPSON Moverio BT-350 smart glasses were used as HMD. The BT-350 is an affordable and robust device, and therefore suitable also for large-scale, AR applications. It has optical see-through glasses, equipped with a camera that records the scene in front of the operator, and

allows the interaction of the application with the AR content.

As shown in Fig. 4.1, the smartphone (Samsung A3) is mounted and fixed so that its camera always points at the AT. The applications on the two devices communicate and interact with each other via bluetooth.

The AR applications were developed under Unity3d environment [245]. Unity3d is a multi-platform graphic engine used for developing video games and other interactive contents, such as architectural visualizations or 3D animations in real time. Unity3d was chosen because of its versatility in the development of Android applications and, most importantly, for the perfect integration with the Vuforia AR tool.

### **Description of the applications and of the operating workflow**

In industrial applications, the challenge is to limit the workload on employees by designing efficient assembly processes with high process capacity [246]. Therefore, another requirement that was established for the experiment was to avoid interaction between the operator and the applications so that the operator can use the AR applications hands-free. Clearly, this is a crucial aspect, not only in the manufacturing industry, but also in several other application contexts. For this reason, the applications were designed so that they would proceed automatically, as the assembly procedure unfolds. In particular, frame markers were used to automatically identify the AT, as shown in Fig. 4.2(a). Also, to let the applications follow the operator actions, virtual buttons were used as shown in Fig. 4.2(b).

On the bases of the aforementioned requirements, the AR-assisted workflow was as follows:

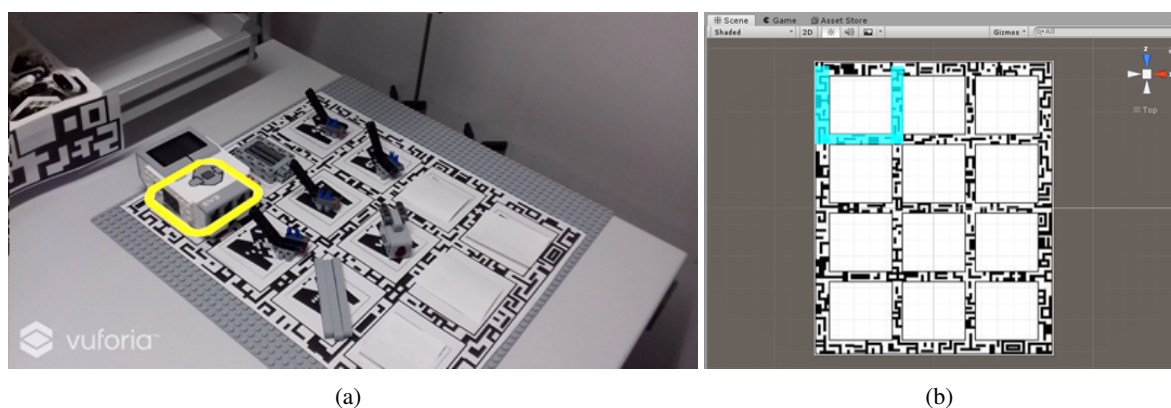
1. The operator picks the first assembly part from the AT. When the hand of the operator reaches for a component in the AT, the corresponding virtual button (Fig. 4.2(b)) is activated.
2. The application on the smartphone detects this event; it recognizes the part that has been picked, and it communicates it to the application on the HMD.
3. Based on the received information, the HMD will show the relevant instruction on how to assemble the component that has been picked.

The HMD application also shows information about which and how many parts should be picked from the bins. Figure 4.3 shows an example of the augmented information that appears to the operator.

Once the first set of instructions has been carried out, the operator picks another assembly part from the second cavity of the AT. This sequence repeats for the successive parts until the assembly is completed. The assembly instructions administered through the HMD were created by using pictures of the different phases of the assembly procedure.

#### **4.2.4 Experimental tests and discussion**

As mentioned in Section 4.2.2, each volunteer repeated the assembly task five consecutive times. For each repetition, the processing time (i.e time to complete the task) was measured. This was done both



**Fig. 4.2** Frame-marker for the assembly tray (a). Image of the design of the virtual buttons (b) [124].



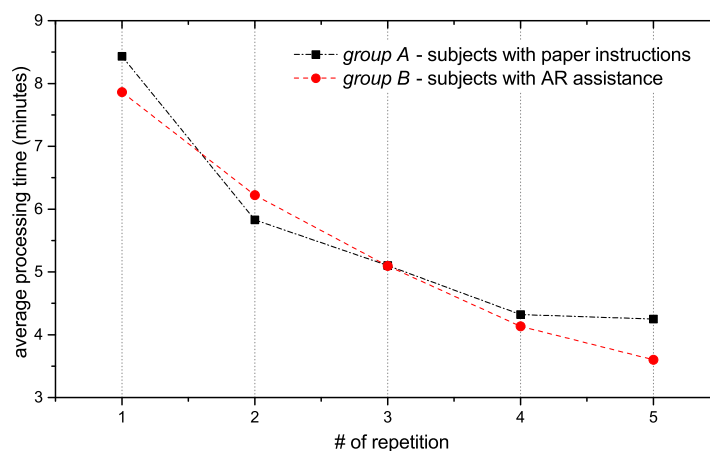
**Fig. 4.3** Example of the images that appear on the HMD to the operator, when he/she looks at the bins [124].

for *Group A* and *Group B*.

Figure 4.4 shows the obtained results in terms of average processing time as a function of the number of repetition. The average processing time was obtained as the mean value of the processing times of all the volunteer of the same Group, for the same repetition.

It can be observed that the average processing times for the two groups are similar; however, a slight but distinct tendency to lower processing time values for *Group B* can be observed. In fact, the group who used AR showed a marked improvement as the task was repeated. The explanation is that, after overcoming the initial unfamiliarity of a new technology, AR instructions became more effective for the volunteers, and *Group B* outperformed the volunteers who used paper instructions.

Another important aspect that is important to underline is that the number of mistakes of *Group B* was nearly zero for all the participants. On the other hand, the operators who used the paper instructions made a few mistakes, as summarized in Table 4.1. The reason is attributable to the fact that the volunteers of *Group A* relied on their memory rather than on the paper instructions that they were given (as confirmed by the interviews after the tests). This strategy eventually proved counterproductive because of the complexity of the proposed prototype: in fact, this was designed with the intention to have similar



**Fig. 4.4** Measured average workers' performance - Paper Instruction (*Group A*) vs AR-aided system (*Group B*) [124].

**Table 4.1** Registered Worker Error - Paper Instruction (*Group A*) vs AR-aided system (*Group B*) [124].

Volunteer	#1	#2	#3	#4	#5	average (errors/repetition)
A1	1	0	1	0	0	0.4
A2	2	0	1	0	1	0.8
A3	0	1	0	0	0	0.2
A4	1	0	0	1	1	0.6
B1	0	0	0	0	0	0.0
B2	0	1	0	0	0	0.2
B3	0	0	0	0	0	0.0
B4	0	0	0	0	0	0.0

parts to be assembled, as in many real manufacturing contexts. On the other hand, operators with AR instructions declared that they followed instructions throughout the tests.

As a general consideration, more complex tasks would increase the need to resort to instructions; and, hence, the difference in the operators' throughput with AR or paper instructions would become more apparent.

Overall, the obtained results demonstrate that, after an activity of training for use and tuning of technology, AR can represent an effective aid to improve the quality of the operations to be carried out. This is of the utmost importance in industrial applications. In fact, reducing mistakes in an industrial procedure avoids the propagation of mistakes in the successive procedures along the production line.

In this activity, the effect of the adoption of AR on the worker's performance in an Industry 4.0 context was addressed. Comparative tests were carried out between two groups of people who were given the same assembly task. Results showed a slight but distinct improvement of the processing time

for the volunteers who were administered AR instructions. In addition to this, it was observed is that the volunteers who used AR made almost no mistake during the assembly.

As a more general observation, the experimental tests (although carried out on a limited number of volunteers) showed that AR is a mature technology implementation-wise, but less in terms of usability in daily activities. In particular, the results obtained in this work showed that AR requires 1) to characterize the application to be supported and 2) some initial training to accustom the operators to AR.

The obtained results motivate the need to further develop a method to evaluate systematically the most suitable implementation and interfacing criteria that could lead to the effective inclusion of AR technology in a wide range of human activities. The lack of this type of characterization prevents the exploitation of the enormous potential of AR technology in activities other than gaming or tutorials.

As demonstrated by the small sample of observation of the experimentation, after an activity of training for use and tuning of technology, AR represents an effective aid to improve the quality of the operations to be carried out. A rigorous characterization of the use of AR could be carried out, for example, through the analysis of the learning curves of operators busy in performing repetitive tasks. This would be beneficial not only for practical applications scenarios as in the manufacturing context, but also for investigation purposes, for example, in learning exercises for patients with brain damage or with learning disabilities.

#### **4.2.5 Conclusion**

The goal of this research activity was to assess objectively the effects introduced by the adoption of AR. To this end, two figures of merit were considered in the measurement: 1) the overall processing time for the operator to accomplish the task; 2) the number of mistakes the operator made during the execution of the task.

The most notable observation, however, is that this application has been designed for industrial aims to evaluate operators' learning curves, but in addition it has inside several monitoring capabilities. In particular embedded in data processing there are

1. information on critical activities in the workers operations useful to prevent mistake and “production waste”
2. information on global quality of the whole process and intermediate steps,
3. information to characterize the specific activity inside productive cycle,
4. information useful to assess the occurrence and prevent potential accidents.

The present case study is a proof of the overlap between IoT application and monitoring activities allowed by an adequate ability to process and to interpret the data.

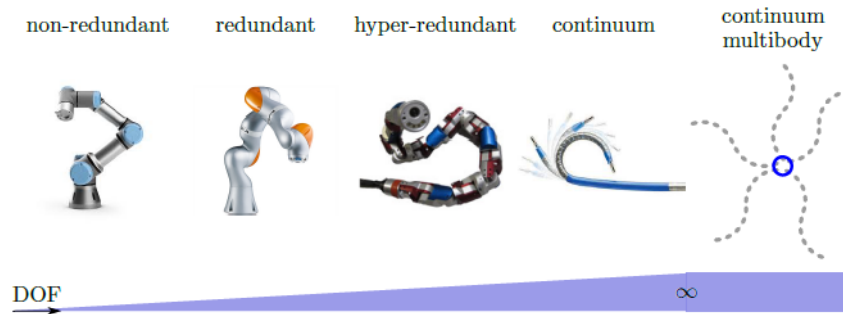


Fig. 4.5 Robot degrees of freedom

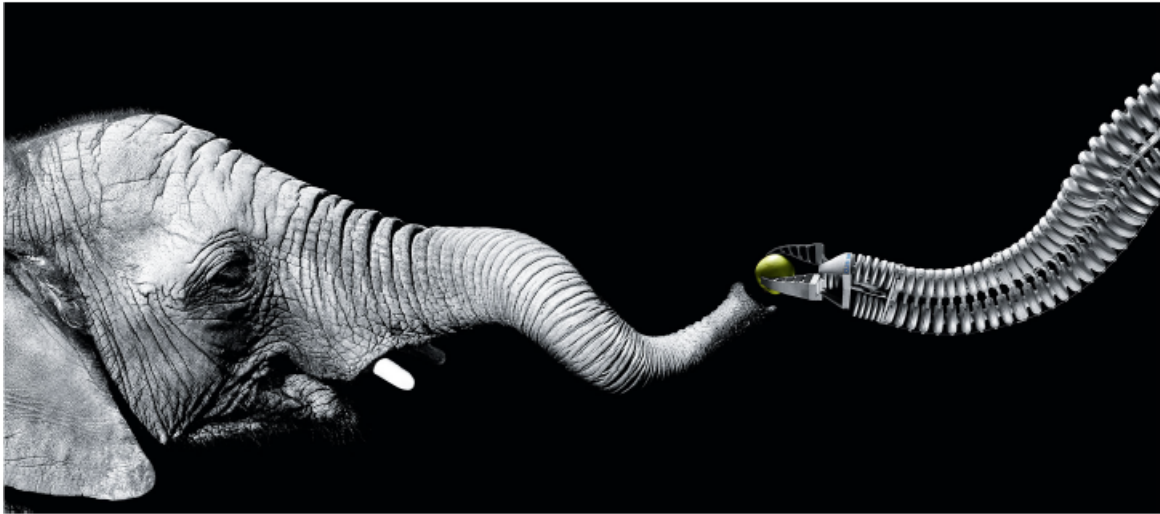
## 4.3 Soft continuum robots for remote measurement tasks in constrained environments

### 4.3.1 Soft continuum robots

Soft robots refer to robotic systems which exhibit an inherent compliant behavior. Their key component is represented by the continuously deformable mechanical structure, which provides them new capabilities relative to traditional robots. The most commonly used traditional robots are kinematically non-redundant. They have been used since many years to repetitively perform a prescribed motion in well-known environments. When a robot has more degrees of freedom (DOF) than the necessary to execute a task (e.g., a 7-DOF arm with a 6-DOF task space) it is said to be redundant, or, in extreme cases, hyper-redundant. Hyper-redundant robots have a large number of links and joints; they have the potential to work in unstructured environments and provide high dexterity. When the number of DOF approaches infinity, the robot approaches what is known as a continuum robot. The shape of a continuum robot is defined by an infinite-DOF elastic member.

Since an elastic structure has a distributed deformation and it is inherently compliant, we use the term soft robots to indicate a infinite-DOF compliant robotic manipulator. When multiple infinite-DOF elastic structures are connected through joints in a generic kinematic chain, the soft robot approaches the continuum multibody structure. When multiple infinite-DOF elastic structures are connected through joints in a generic kinematic chain, the soft robot approaches the continuum multibody structure. A qualitative picture on classification of robots based on the DOF is shown in Fig. 4.5. The configuration space of soft robots is theoretically infinite: the robot tip (tips) can reach every point (points) in the three-dimensional workspace with an infinite number of robot configurations.

Exploiting large strain deformation, soft robots can adapt their shape to nonlinear path and squeeze through openings smaller than their nominal dimensions. All these features enable soft robots to perform delicate tasks in cluttered and/or unstructured environments, as well as to investigate novel grasping and manipulation possibilities. Further, the compliance of their underlying material makes them ideal for applications which require a safer physical human-robot interaction.



**Fig. 4.6** Geometrical description of reference of curve for continuum arm [248].

As a matter of fact, soft continuum robots have demonstrated their capabilities in several robotic fields, such as minimally invasive robotic surgery, robotic rehabilitation, autonomous remote maintenance and inspection in industrial and space environments, and physical human–robot interaction [247].

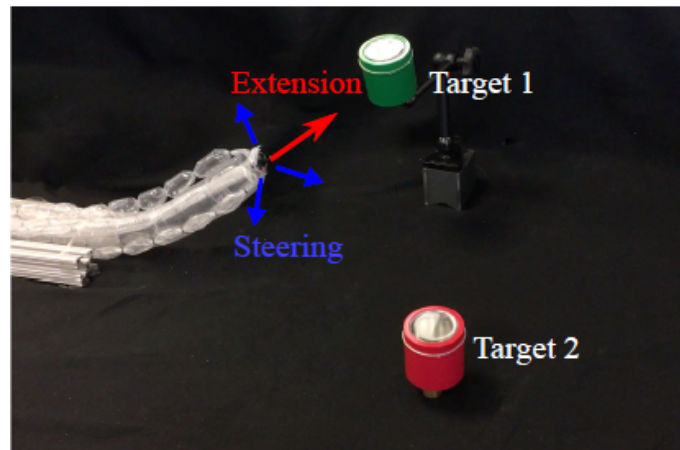
The mathematical considerations, not reported here for the sake of brevity, lead to develop continuously deformable robots with an elastic structure such as the example shown in Fig. 4.6.

### Models

Real-time model-based analysis, simulation, planning, and control of soft robotic manipulators are complicated by the lack of dynamic models that are at the same time accurate and computationally efficient. Therefore, our overall goal is to derive a soft robots dynamic formulation able to handle geometric nonlinearities, which is:

- accurate, using a geometrically exact approach for large deformations;
- computationally efficient, using a finite element spatial integration and a geometric time integration.

Currently, the most adopted practice in the soft robotics community is to approximate the robot's shape as a series of mutually tangent circular arcs, which are described by only three parameters, namely the radius of curvature, angle of the arc, and bending plane. This is known as the constant curvature kinematic assumption. This approximation has been verified experimentally in many continuum robots. However, when extreme loading conditions lead to complicated robot's shape, variable curvature kinematic frameworks combined with elasticity theories for slender objects are preferable.



**Fig. 4.7** Demonstration of soft continuum robot with novel Extension degree of freedom

### Vine Robots

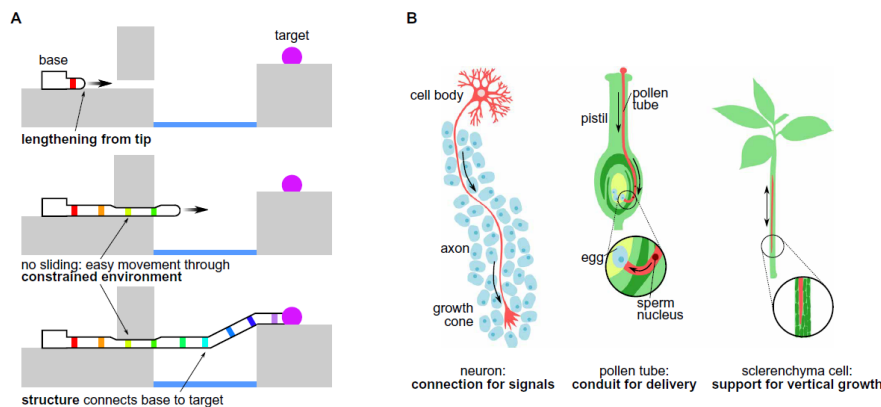
A new class of continuum robots has recently been explored, characterized by tip extension, significant length change, and directional control. Here, we call this class of robots “vine robots,” due to their similar behavior to plants with the growth habit of trailing. Due to their growth-based movement, vine robots are well suited for navigation and exploration in cluttered environments. Portability of these robots and steerability at length scales relevant for navigation are key to field applications. In addition, intuitive human-in-the-loop tele-operation enables movement in unknown and dynamic environments. Vine robot system can be teleoperated using a custom designed flexible joystick and camera system, long enough for use in navigation tasks, and portable for use in the field. The robot tip successfully moved past the obstacles and through the tunnels, demonstrating the capability of vine robots to achieve navigation and exploration tasks in the field [249].

Unlike continuum robots that lengthen by extending modules that move relative to the environment until fully emitted vine robots emit new material only at the very tip, which enables lengthening without relative movement between the emitted robot body material and the environment [250].

Extension in this way also enables enormous length change, limited only by the amount of material that can be transported to the tip. A novel extension degree-of-freedom enables movement of robot in a direction that is always tangent to the robot’s backbone, independent of environmental contacts is shown in Fig. 4.7.

Growth as a method for navigating the environment is found in fungal hyphae with diameters as small as a few micrometers as well as in vines with girths as large as a meter. These organisms grow from their tips, increase length hundreds of times, and continually control growth direction based on environmental stimuli. Because lengthening from the tip, or apical extension, involves no relative movement of the body with respect to the environment, the body can lengthen along constrained paths without friction from sliding against the environment (Fig. 4.8 (a)).





**Fig. 4.8** Substantial lengthening from the tip with directional control enables a body to pass through a constrained environment and create a structure along its path of growth.

Furthermore, because each movement of the tip results in a directionally controlled lengthening of the body, the body forms into a three-dimensional (3D) structure along the path of the tip. These capabilities enable natural cells and organisms to grow through tightly packed tissue or abiotic materials and form structures with functions ranging from signal pathways to conduits for delivery (Fig. 4.8(b)).

### Discussion and future directions

Soft continuum robots have shown great potentials for measurement applications where humans and traditional means can not access due to constraints given by the environment. Some application examples of soft continuum robots for remote *measurement tasks* are shown in Fig. 4.9 and include the following areas: space [251–255]; airplane industry [256–258]; nuclear reactors [259–264]; marine environments [265–268]; and medicine [269–276].

In these contexts, such systems act as tools transporting sensors for data acquisition, environment monitoring, visual inspection, diagnostics. However, none of these works is specifically focused on *measurement applications* enabled by soft continuum robots in constrained environments.

Continuum robots used as measurement systems can indeed provide fundamental information to perform critical tasks, as the location and characterization of a damaged blade in a gas engine for a blending procedure or the visualization of anatomy for a surgical operation.

Since most of current robotic systems working in hazardous domains are not fully autonomous (they either share a certain level of autonomy with humans, or they are full teleoperated), continuum measurement systems can be seen as tools for augmenting the human sensory system. As a matter of fact, in real applications, the environmental data that they provide are used by humans to take informed decisions and perform the remote task with a greater awareness. However, as data provided especially by continuum-like instrumentation lack of information, human experience still matters a lot in performing critical tasks. As an example in robotic surgery, flexible endoscopes, although being introduced since many years, still offer poor image resolution, if compared to rigid endoscopes.

In the application scenarios analysed in this work, soft continuum robots have already started in demonstrating their capabilities as remote measurement systems, despite the observed limitations. However, soft continuum robots could be used in many other applications of interest by the measurements community, where there is not yet a relevant scientific evidence of their use. Future applications might include: (i) power line inspection; (ii) remote power quality analysis [277]; (iii) monitoring of infrastructure sites which are difficult to access; (iv) structural health monitoring [278]; (v) in-situ diagnosis of electronic circuits; (vi) in-situ measuring of thin structures [279]; (vii) inspection of electrical cabinets and/or data center racks; (viii) remote ultrasonic-based nondestructive testing [280]; (ix) urban disaster operations, as they can bring sensors in a priori unknown and cluttered environment.

Another limitation of the soft continuum robots analysed in this work is that, in most of cases, they are robots with a fixed base. Therefore, despite their unique capabilities of going inside narrow spaces and adapt their shape to curvilinear path, they offer a limited workspace. To limit this problem, their design can be improved by using telescopic sections; however, even in this case, the workspace is limited, especially for such tasks that require inspection of large environments. There are two possible solutions to this problem:

- (1) coupling the continuum robot with a mobile or aerial robot;
- (2) giving locomotion and climbing capabilities to the continuum robot.

In the first case, the mobile or aerial robot is used to bring the continuum robot in the inspection site, with the latter performing the measurement task. With the aim of enhancing the operational capabilities of traditional flying robots, two European projects have been recently funded for the developed of a robotic platform where a flying robot is coupled with a rigid articulated manipulator (AEROARMS, <https://aeroarms-project.eu/>) and a rigid hyper-redundant long reach manipulator (HYFLIERS, <https://www.oulu.fi/hyfliers/>). Despite these recent progresses, aerial manipulation and measurement tasks are still performed coupling a rigid manipulator to the drone [281]. Coupling a soft manipulator to the flying robot could be a possibility for future works in this domain.

In the second solution, a continuum robot is endowed with internal locomotion and/or climbing. With this respect, there is an on-going research on different paradigms for soft robot locomotion, inspired by the locomotion of snakes and caterpillars [282]. On the other side, soft robots able to climb on different surfaces are inspired by geckos [283]. As an example, these robots can provide an alternative solution to drones for in-situ inspection of power distribution lines. In this context, it has been underlined that a robot able to climb along the conductor and overcome various obstacles on the power line might provide high inspection accuracy with respect to flying robots [284].

Another important aspect of soft robots is that they can exploit internal energy as additional source of actuation for locomotion/climbing purposes. Thus, soft robots designed considering this aspect can be more energy efficient, overcoming the current autonomy problem of traditional aerial robots. They could eventually become permanent residents of many sites, for their continuous monitoring.

In summary, in this preliminary work we have emphasized the features of soft continuum robots which are interesting for their use in remote measurement tasks. This first analysis underlines that soft continuum robots have been used as remote measurement systems mainly in the following environments:

space, aerospace, nuclear, marine, surgical. However, their capabilities might benefit many other applications which are worth to be investigated in the future.

The successful execution of remote measurement tasks in environments which are difficult to reach by humans requires the use of robotics technologies. A class of robotic systems which is suitable for remote measurement applications is represented by flying robots. Indeed, by embedding sensors on drones, it is possible to convert the flying robot in a remote measurement system [285]. To date, drones have successfully demonstrated their use in a wide range of measurement applications: aerial photogrammetry, agriculture, monitoring of buildings, inspection of power lines [286]. However, reaching remote sites through constrained and small-scale spaces using drones is highly challenging as they require accurate and reliable sensing systems for navigation; indeed, developing methods for efficient navigation of drones in GPS-denied environments as indoor spaces is still an open issue. Furthermore, drones can not be used in such contexts which also require safe interaction with the surrounding environment (i.e. surgery).

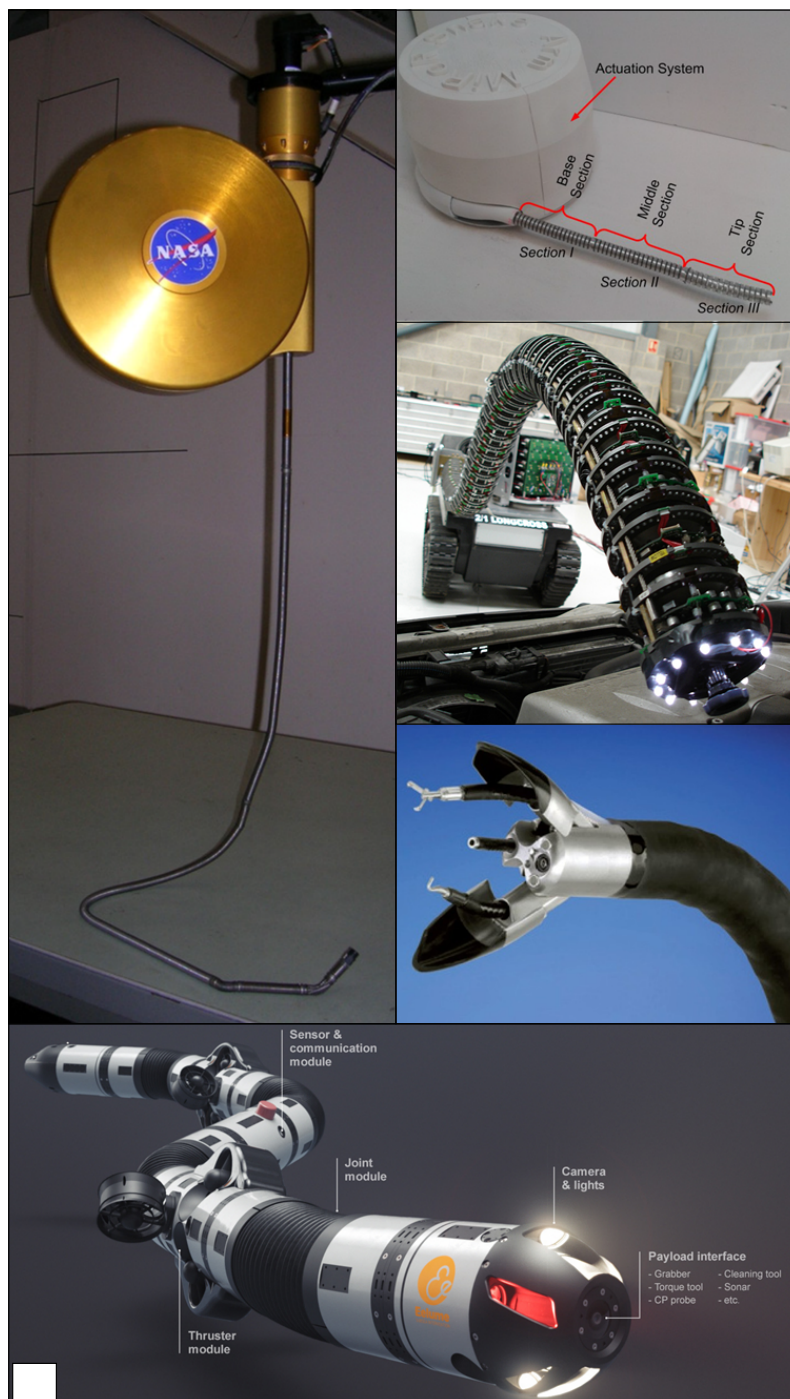
One possible technological solution for enabling remote measurement tasks in constrained and high-risk environments is represented by soft continuum robots [287], namely robots with a continuously deformable mechanical structure. Their inherently compliant structure enhance the operational capabilities of traditional robots by offering the possibility to traverse cluttered spaces and conform their shape to nonlinear paths, while guaranteeing, at the same time, a compliant interaction with the environment. Furthermore, they can also be used to manipulate objects in complex environments; this is relevant as sensing the environment is often required for remote on-line execution of manipulation tasks. Therefore, having the same robotic platform which can be used as both measurement and manipulation system could be a great advantage.

The design of soft robots takes inspiration from continuum biological structures, as climbing plants, snakes, trunks of elephants and tentacles of octopuses. In order to replicate the motion of their natural counterparts, soft continuum robots are basically composed by one or more elastic elements, which can be actuated by intrinsic sources (as fluids) or by external motors which transmit forces to the robotic structure through transmission mechanisms (as tendons/cables). Despite more complex models are needed to describe and control their shapes [247, 288–290], soft robots are relatively easy to fabricate.

In the literature, existing review papers on soft continuum robots have focused on: continuum robots in general [291]; bioinspired soft robots [292, 287]; design and fabrication of soft robots [293]; design and kinematic modeling of constant curvature robots [294]; medical continuum robots [269]; shape sensing techniques for medical continuum robots [295]; force sensing using fiber optic sensors [296].

### **4.3.2 Preliminary experimental steps of soft growing robot for remote measurement tasks in confined and constrained environments**

**Background and rationale** Enabling remote measurement tasks in confined and constrained spaces is a technological problem that cannot be solved using classical robotic systems. Inspired by biological trunks and tentacles, soft continuum robots [247] constitute a possible solution to this problem, given their



**Fig. 4.9** Soft continuum robots used in measurement applications. (a) Tendril robot for in-space inspection developed by NASA's Johnson Space Center [251]. (b) Slender continuum for on-wing inspection of gas turbine engines developed by Rolls-Royce University Technology Center (UTC) at University of Nottingham [256]. (c) Snake-arm robot for nuclear applications developed by OC Robotics [263] (<http://www.ocrobotics.com/>). (d) Eel-like robot for subsea inspection developed by Eelume, a spin-off company from Norwegian University of Science and Technology [266] (<https://eelume.com/>). (e) ANUBISCOPE, a flexible endoscope prototype developed by Karl-Storz/IRCAD [297].

ability to traverse confined spaces and conform their shape to nonlinear curvilinear paths. Furthermore, their inherently compliant structure allows a safe interaction with the external environment. This means that the safe contact interaction with the environment can also be exploited on purpose for effective navigation in highly constrained environments.

There are several measurement-oriented applications where the use of soft continuum robots has been considered to be effective [298]. The major limitation of the current available design solutions for soft continuum robots is their limited workspace: this is a problem for tasks which require inspection and exploration of large environments. To overcome this issue, soft continuum robots can be endowed with locomotion capabilities, by using tethered/untethered fluidic or cable-driven actuators, taking inspiration from the animal movements (snake, earthworms, caterpillars) [299]. However, this solution requires a relative movement between the robot and the environment, and thus high sliding friction to move, lowering the energy efficiency of the robot. Indeed, a recent design of soft continuum robots achieves enhanced mobility through growth (rather than locomotion), taking inspiration from the growing process of plants and vines [249]. These robots, referred to as *soft growing robots*, achieve mobility by emitting new material at the tip: this enables lengthening without relative movements between the robot's body and environment. With this solution, the inspection/exploration length of remote environments is therefore limited only by the amount of robot's body material that can be transported on the field, to enable the real tasks. Although different mechanisms have been used to enable this form of apical extension [300], recently pneumatically-driven solutions are attracting much attention from the robotics community; we call these solutions *pneumatically everting soft growing robots* [301]. The process of pneumatic eversion involves the use of a pressurized fluid to enable the forward growth of the robot's body through lengthening at the tip. While it is growing, the robot's body can be curved/steered using suitable additional actuators distributed along its body.

Overall, the use of pneumatically everting soft growing robots brings the following advantages for effective execution of remote inspection/exploration tasks in confined and constrained environments:

- Ability to access in remote sites through small-scale cross sections (below 50 mm).
- Ability to move in remote sites through a pneumatically-driven growth process, which does not involve sliding, and thus friction, with the environment.
- High inspection/exploration length (also several meters).
- Intrinsic safety if coming into contact with the environment.
- Environment-driven navigation/exploration (the reaction force resulting from the safe contact with the environment can be used as "additional" source of actuation, i.e. for allowing curving/steering).
- Transportability, since the robot body can be "rolled up" around a spool and "rolled out" in a controlled manner on the field.
- Low costs of fabrication.

Because of all these advantages, the pneumatically everting technology has been chosen for the experimentation of soft growing robot. This technology brings relatively low implementation costs, even though the resulting robot will be difficult to model, sense and control.

**Design of the soft growing robot** The soft growing robot has been developed considering the features and requirements listed in Table 4.2. The requirements follow the need for portability of the system, ability to access in remote sites through small-scale cross sections, ability to inspect/explore large sites while not causing damages of the external environment. Table 4.2 also summarizes possible design solutions to implement the desired features, and thus system specifications.

**Table 4.2** Requirements and system specifications for the soft growing robot

Features and requirements	Solutions and system specifications
Small-scale cross section (below 100 mm)	IF sensors at tip THEN access section = body diameter; IF no sensors at tip THEN access section < body diameter
High inspection/exploration length (5 to 10 m) while maintaining portability	Robot body material stored on a reel in a suitable portable robot base
Growth by eversion	Lengthening at the tip by pressurizing the pressure vessel where the robot's body material is rolled. The robot material should be flexible, not stretchable, and airtight.
Controllable growth	Balance between the air pressure for pressurization of the vessel and the rotation of the spool for unrolling of the robot's body material
Retraction without buckling	Models for buckling prediction and development of suitable retraction devices for the material
Steering/curving control	Models for shape prediction and development of suitable soft pneumatic actuators distributed on the body for effective steering/curving
Environment-driven navigation	Planning algorithms for exploiting the contact interaction forces for navigation
Human situation awareness/sensing the environment	Camera (or sensors) to be mounted within a suitable case mounted at tip, which has to be developed taking into consideration that this device should always remain at tip when the robot grows/retracts.

The resulting architecture of the soft growing robot is illustrated in Fig. 4.10. The system is divided into the following main hardware components:

1. soft robot body
2. robot base
3. electronic control board

Let us discuss more in detail these subsystems.

1. **Soft robot body** - The main body of the soft growing robot is made of an airtight tube which is flexible but not stretchable. For the preliminary experimental platform, a low-density polyethylene film was chosen as material. In the first experiments, it was noticed that, when pressurized, this

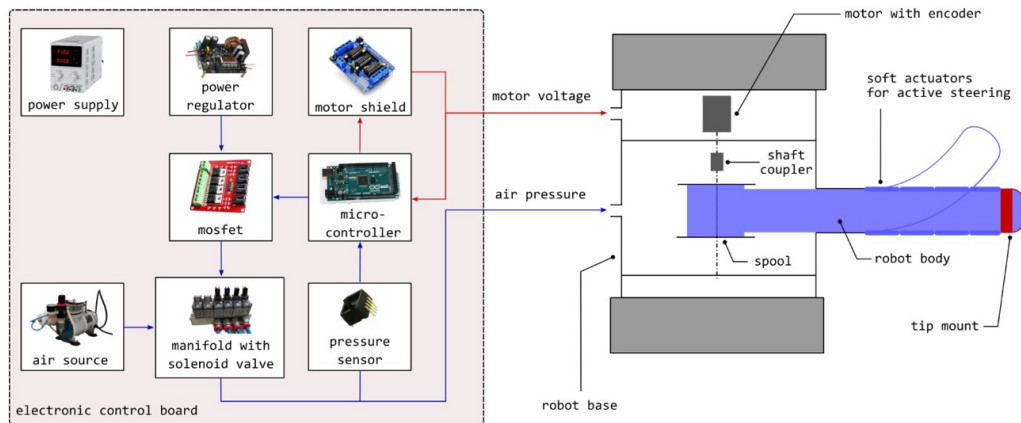


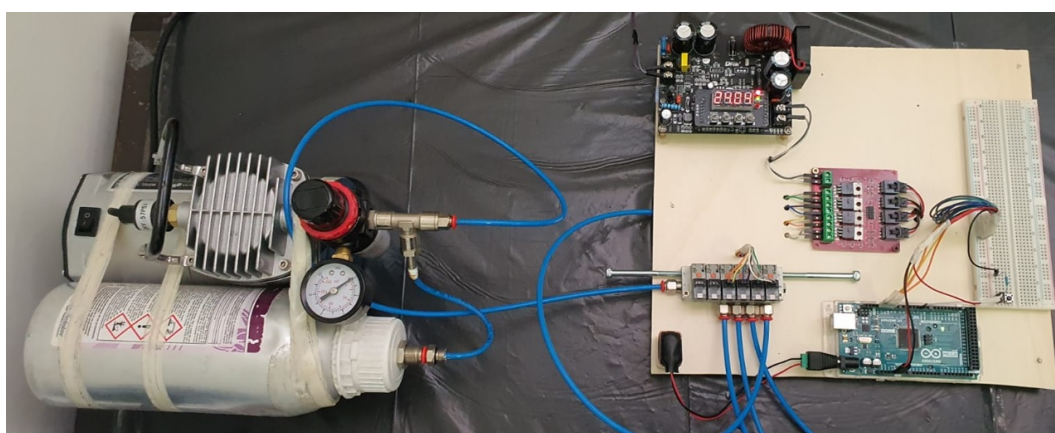
Fig. 4.10 Architecture of the soft growing robot [302]

material slides with non-negligible friction during the eversion process. As this is not desirable, we have planning on employing a different material, namely a double side silicon-coated ripstop nylon (Rockywoods Fabric LLC, Loveland, CO): this fabric material should guarantee an almost zero friction in the eversion process as well as major durability to be used for field applications. The soft robot body is rolled up and fixed from one hand around a spool inside the pressure vessel: when pressurized, the material everts outside the robot base through an opening. The forward growth is controllable by finding a suitable balance between the desired air pressure to pressurize the vessel and the desired spool rotation, and thus, motor angular velocity along the axis of the spool. For guaranteeing a reversible steering/curving of the robot body, soft pneumatic actuators (made of the same material of the robot's body) should be placed along the entire length of the robot: the steering/curving control is guaranteed by a suitable pressurization of these additional actuators, considering models of curvature/deformations of the robot's shape. During the retraction process of the robot's body, in order to avoid structural buckling, suitable mechanisms to drive the retraction should be developed.

2. **Soft robot base** - The robot base is the container of the unfolded robot and represents the pressurized vessel when the robot is in operation. It is formed by an acrylic cylinder with two end caps (QC-108 Qwik cap, Fernco Inc., Davison, MI). The spool for rolling out the robot material is driven by a DC motor (6408K27, McMaster-Carr Inc., Douglasville, GA) with a magnetic encoder which allow for growth/retraction of the robot body.
3. **Electronic control board** - The electronic control board is composed by two sub-systems: one for generating the desired air pressure for pressurization of the vessel, and one for generating the necessary voltage for the DC motor for growth/retraction of the robot body. The pneumatic circuit regulates the air pressure by pulse-width modulation (PWM), which involves the controlled timing of the opening and closing of solenoid valves (SY114-5LOU, SMC) through a mosfet board (based on IRF540 mosfets, STMicroelectronics), with pressure sensors (ASDXAVX100PGAA5,

Honeywell) providing feedback. The pneumatic circuit is an essential component of the robot, as it is responsible for the growth process (one pneumatic tube for the main tube of the robot body) and the steering capability of the robot body (one pneumatic tube for each of the serial soft actuators placed along the robot body). This PWM-based pneumatic circuit was fabricated in the laboratory, and it replaces more expensive solutions based on professional closed-loop pressure regulators.

The experimental setup of the pneumatic circuit is shown in Fig. 4.11.



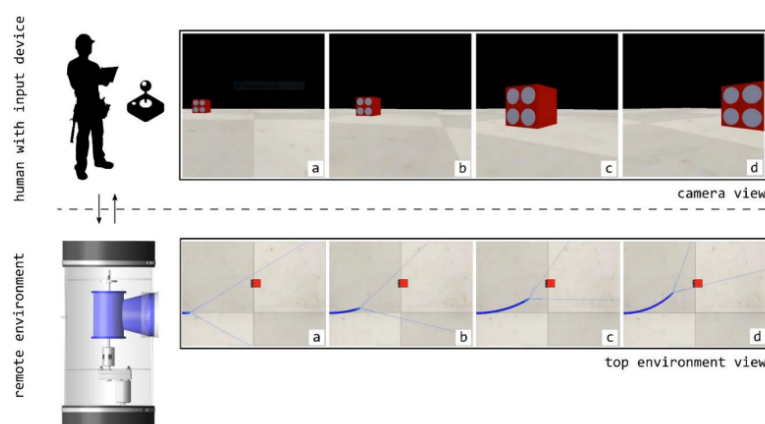
**Fig. 4.11** The pneumatic circuit and pneumatic control board [302].

**Current activities and next actions** To summarize, as of the date of writing, the following activities have been completed in relation to the first prototype of the soft growing robot:

- definition of requirements and specifications;
- detailed system architecture;
- testing of the hardware components;
- testing of materials for the eversion process;
- development of the pneumatic circuit and pneumatic control board;
- identification of hardware and software solutions for endowing the soft growing robot with the following capabilities: growth control, retraction without buckling, steering/curving control, environment-driven navigation, human situation awareness and sensing of remote environments.

The development of the soft growing robot will follow a modular approach, in the sense that each capability will be added during the development process in a consecutive manner. Indeed, some capabilities (retraction without buckling, sensing of remote environments) require not only the development of ad-hoc software solutions, but also the design and fabrication of ad-hoc mechanisms.

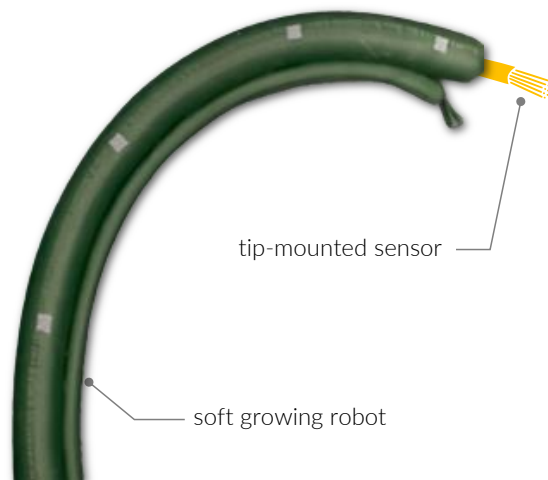




**Fig. 4.12** Example scenario for remote inspection through the proposed soft growing robot. By using a suitable input device, the human operator drives the growth and steering of the robotic system in the remote environment, accessed through an access section which is slightly larger than the diameter of the robot's body. The human operator sees the remote environment through the tip-mounted camera [302].

The soft growing robot is intended as a novel robotic platform that will allow novel research activities regarding modeling, sensing, and control of pneumatically everting soft growing robots, also considering the development of more application-oriented activities, for example related to possible inspection of large infrastructures and non-destructive exploration of archaeological sites.

**Example of a practical measurement scenario** The practical measurement scenario consists of a human operator performing visual inspection in a remote site through the proposed soft growing robot, endowed with a tip-mounted camera. An input device is used by the human operator to impart growing/steering commands. A digital twin of the measurement system is built in V-REP including the model of the robot (modelled as a growing constant curvature robot), the model of the cameras as well as the model of the environment. The constant curvature assumption is reasonable when artificial pneumatic muscles are used to steer the robot. Snapshots of the measurement scenario are shown in Fig. 4.12, where we can see the remotely operated soft growing robot approaching and inspecting a target (red box) within the simulated remote site. The soft growing robotic platform represents a novel technology for the inspection of confined and constrained remote environments that are not accessible by current technologies. Furthermore, it represents a suitable platform for enabling measurement applications in large, GPS-denied environments. In addition to industrial inspections, this robotic platform may be used for exploration purposes or even for search and rescue applications after accidents, earthquakes, and collapses of buildings. Finally, an additional application is the sensor delivery in difficult-to-reach remote sites.



**Fig. 4.13** Soft growing robot with a tip-mounted sensor as a sensor delivery system in confined environments.

### 4.3.3 Using a soft growing robot as a sensor delivery system in remote environments: A practical case study

Another interesting approach is represented by the adoption of *Soft continuum robots* (also called *soft growing robots*), namely robots composed of a continuously deformable mechanical structures [303, 304]. They are ideal candidates for the successful execution of these tasks, due to their possibility to traverse cluttered spaces and conform their shape to nonlinear paths, while guaranteeing a compliant and safe interaction with the surrounding environment. In the literature, there are several examples of soft continuum robots for remote measurement applications, in both industrial and medical scenarios, as reported in [298].

Soft continuum robots are particularly appealing in the case of delivery sensors in long-to-be-reached remote targets, accessible only by small-scaled entrance sections. Applications include reaching long-distance targets within known environments, as within the assembly phase of large structures (as in airplane manufacturing) or collecting data in unstructured environments, as example for scientific studies or explorations. For these cases, a recent design solution referred to as soft growing robots can be of particular interest [249], with multiple benefits in remote measurement and monitoring applications [126, 127]. Soft growing robots take inspiration from the growth process of plants and vines [305]. Apart from being inherently soft, another great advantage is that they can navigate without sliding through constrained environments [306].

In this activity, we used a soft growing robot as a system to deliver sensors in confined and constrained spaces. As a proof of concept, a wired temperature sensor is connected to the tip of the soft growing robot in such a way that both the wire of the sensor and the body of the robot evert simultaneously, till reaching the remote measurement target.

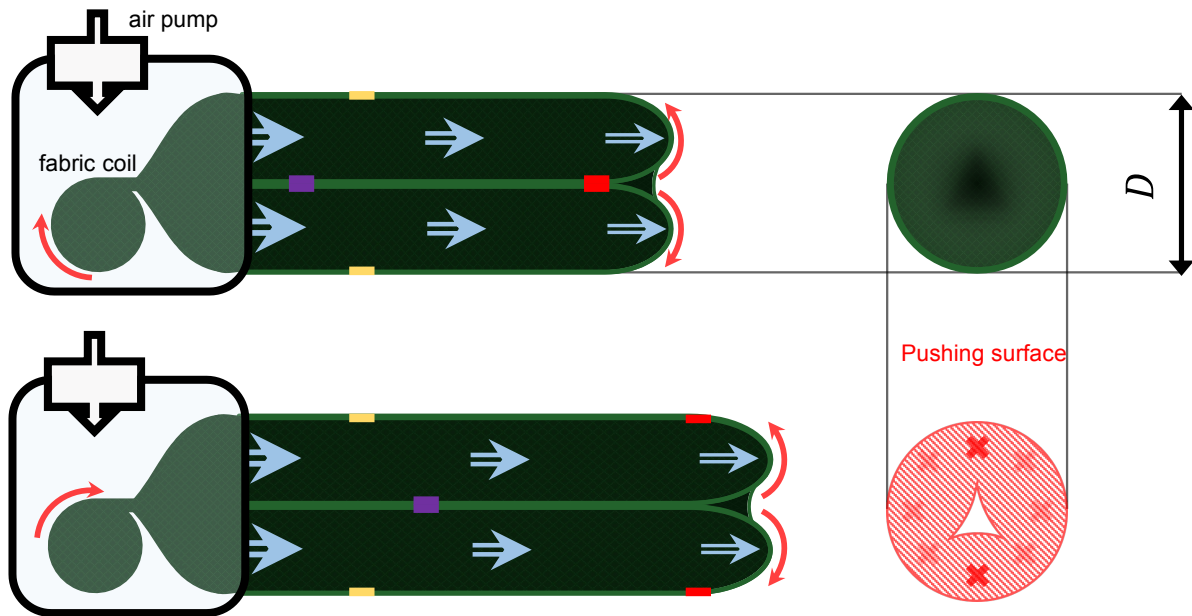


Fig. 4.14 Eversion mechanism of the soft growing robot.

#### 4.3.4 Materials and methods: The soft growing robot

The soft growing robot considered in this work is made up of an everting backbone and two fabric pneumatic artificial muscles (fPAM) glued to its diametrically opposite sides. The backbone is inverted such that when pressurized it pulls new material out from its tip causing the robot body to extend by growing (see Fig. 4.14). When pressurized, the laterally attached fPAM contracts and cause a shortening of the backbone side, thus making this to deform and thus steer its tip (see Fig. 4.15). The material of the backbone and the fPAM is a double side silicon-coated ripstop nylon, which guarantees negligible friction during the eversion process. The rip-stop pattern of the material is simply a plain weave with thicker, reinforcing strands at regular intervals in both the warp and weft direction. The key to the operation of the presented fPAM is fabric bias. Indeed, the fabric is inextensible along the major thread lines, but is fairly elastic along the fabric bias at a  $45^\circ$  angle to these threads. This means that a tube of bias-cut fabric will be elastic, while a tube with a straight or cross grain cut will not. As a result, when the tube is pressurized it expands radially while contracting lengthwise. When this tube is attached to a backbone, it causes bending motion to the overall system.

An important feature of this kind of system is that it is possible to attach at its tip a tethered sensor, in such a way that the eversion of the robot's body and of the sensor's cable acts simultaneously. Another option is to design ad-hoc magnetic caps to be placed at the tip of the robot, to allow the mounting of sensor systems that in this case should be wireless.

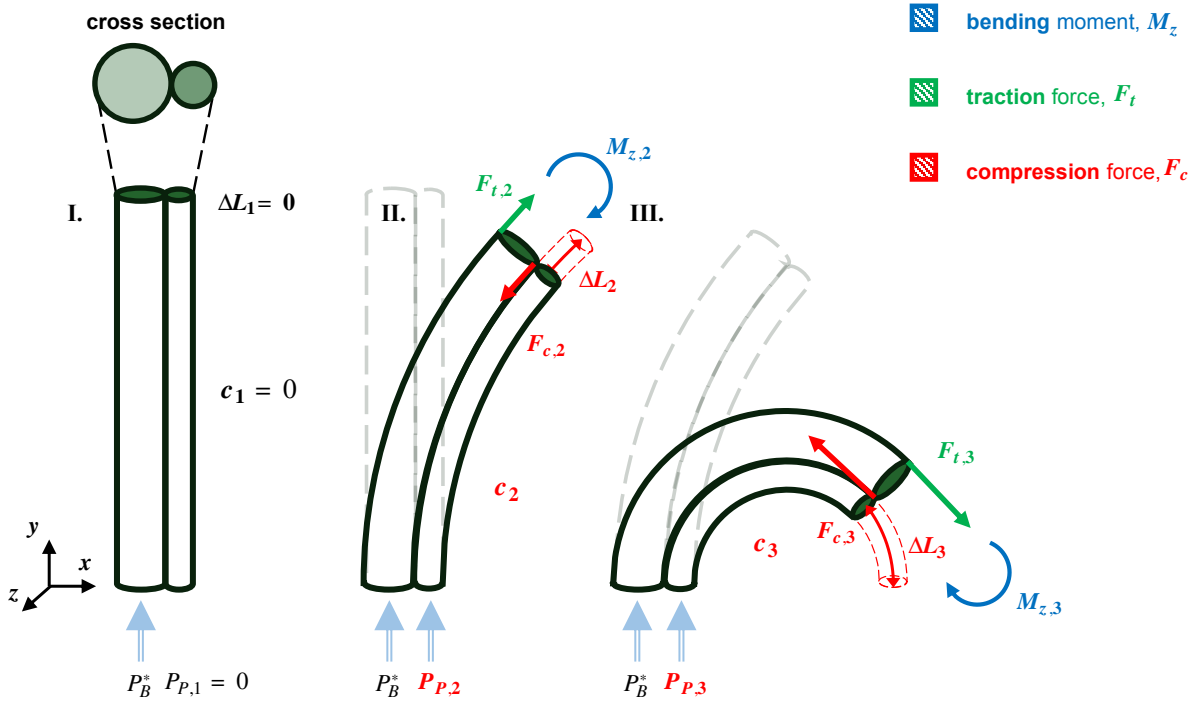


Fig. 4.15 Bending motion of the soft growing robot caused by a fPAM laterally attached to the backbone.

### 4.3.5 Experimental setup and sensing task

As a case study, we considered a thermocouple wire directly attached to the tip of the soft growing robot. The task considered in this work consists of actuating the soft growing robot with a tip-mounted thermocouple until reaching a *target location* represented as a hot source, and here collecting the temperature measurement.

The experimental setup is illustrated in Fig. 4.16. It includes the following elements:

- A hot source at a temperature  $T_{nom}$  (assumed as free of uncertainty contributions).
- A custom-built soft growing robot with a backbone and a laterally attached fPAM.
- Two type K thermocouple wires (*U1180A*, Agilent Technologies, Santa Clara, CA, USA), one attached to the robot and one attached to the hot source.
- Two digital multimeters (*U1253B*, Keysight Technologies, Santa Rosa, CA, USA) connected to the thermocouple wires for the temperature measurements.

One of the thermocouple wire is preliminarily attached to the tip of the robot in the inverted configuration. A second thermocouple is attached at the target location: this acts as a reference for the temperature measurement  $T_{ref}$ .

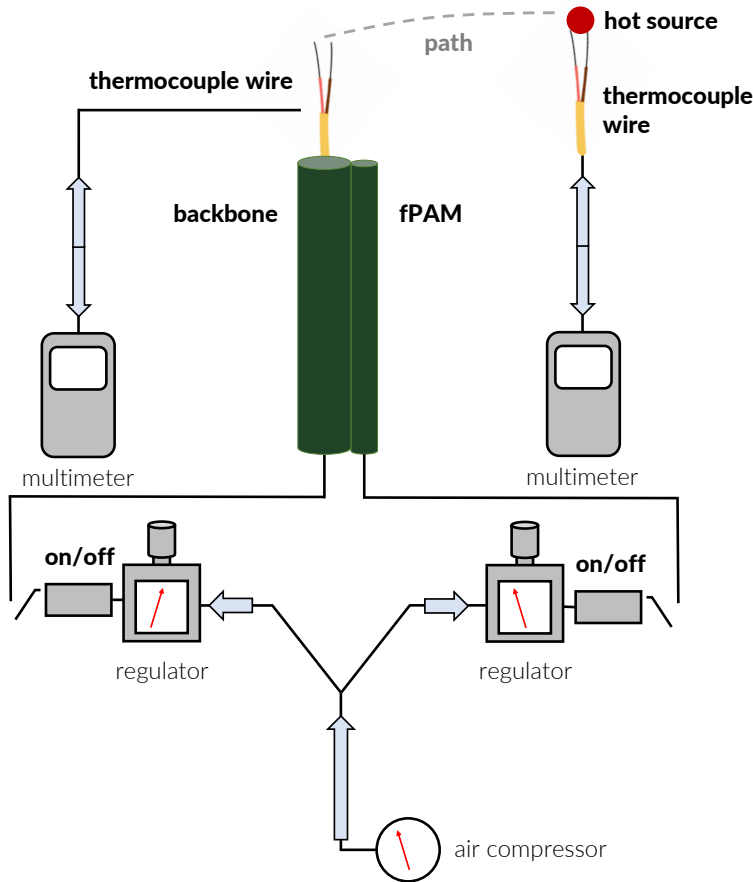


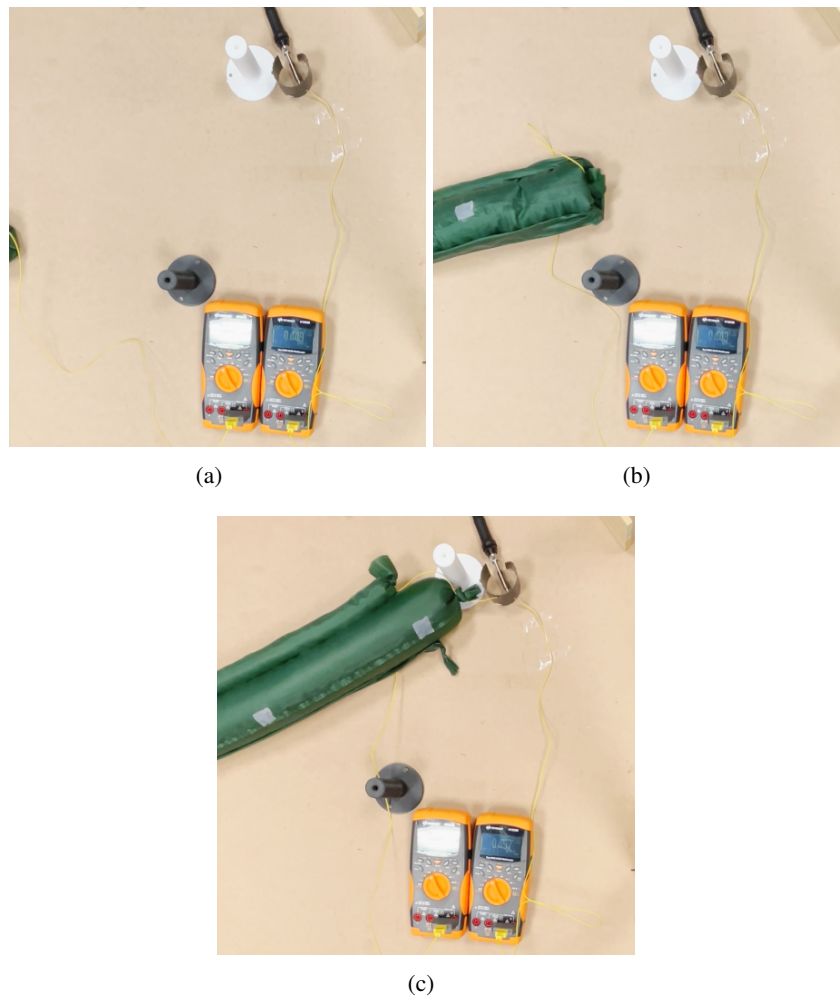
Fig. 4.16 Sketch of the experimental setup used for considered case study.

### 4.3.6 Results and discussion

Figure 4.17 shows a series of snapshots of the sensor delivery system which is moving towards the *target location*. The yellow cables are the thermocouple wires, one being connected to the robot and one being connected directly to the hot source.

As aforementioned, during the movement, the thermocouple wire everts together with the robot's body. Fig. 4.17(a) shows the beginning of the experiment ( $t = 0$  s). Then, the robot everts to reach the target location, at  $t = 12$  s. Fig. 4.17(b) shows the robot while it is everting toward the target location. Finally, Fig. 4.17(c) shows the robot when it has reached the target location at  $t = 36$  s. It can be noticed that when the robot reaches the target location, the two output from the multimeters  $T_{meas}$  and  $T_{ref}$  are comparable with each other as shown in Table 4.3, where also the type-B standard uncertainty is reported.

This simple task is just a proof of concept for use cases related to the delivery of sensors in remote locations. For the sake of example, further applications can involve (i) the real-time monitoring of multiple measurement points, or (ii) the extraction of a spatial temperature profile from a starting point to an end point, by means of the adoption of wireless sensors attached to the tip of the robot.



**Fig. 4.17** Snapshots of the experimental test at different time instants while the robot was everting:  $t = 0$  s (a),  $t = 12$  s (b), and  $t = 36$  s (c).

**Table 4.3** Temperature measurement at  $t = 36$  s.

$T_{nom}$ (°C)	$T_{ref}$ (°C)	$T_{meas}$ (°C)
$50.0 \pm 0.0$	$49.5 \pm 1.1$	$49.4 \pm 1.1$

To get closer to a full definition of CPMS, future work will be dedicated to embedding additional 4.0 enabling technologies (e.g., artificial intelligence algorithms) in the CMPS, for endowing monitoring system with autonomous planning/navigation capabilities. Also, effort will be dedicated to motion analysis and control in highly constrained situations. Additionally, a set of practical applications cases will be identified, to experiment the system and assess its metrological performance. Finally, suitable sensing technologies and processing strategies will be developed to enhance the metrological performance of the system (e.g., in terms of resolution, reliability and accuracy of interaction with the environment). The ultimate goal is to achieve a self-adapting, fully autonomous system for remote monitoring operations to be used reliably and safely for the inspection of unknown and/or constrained and confined environments.

## **Part III**

# **Ongoing work: Towards Cyber-physical measurement systems**



## Chapter 5

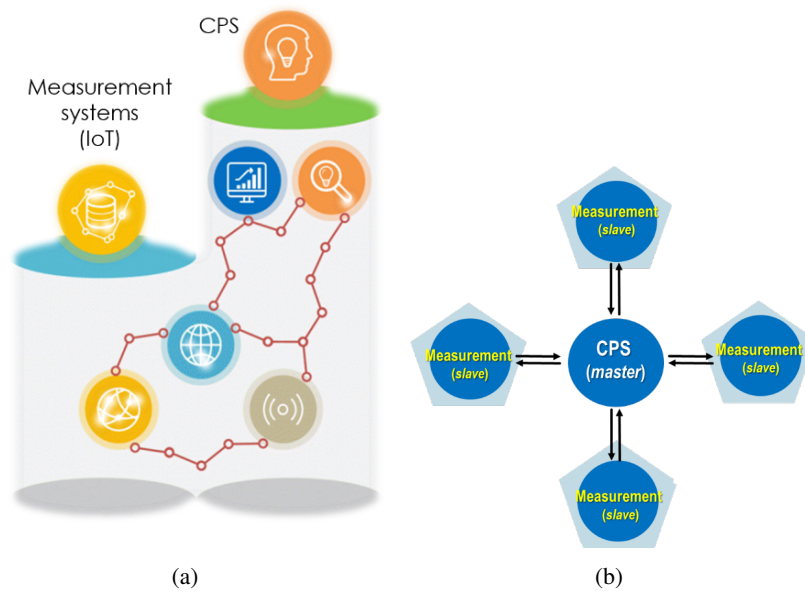
# Towards a native Cyber-Physical Measurement System: a case-study

### 5.1 Introduction

Monitoring systems represent a key enabler of the 4.0 Era, crucial not only for guaranteeing the optimal functioning of the monitored systems but also for timely intervening in case of failures. As a result, the combination of the internet of things (IoT) and of sensing networks has become an irreplaceable tool for achieving a ubiquitous monitoring in the 4.0 ecosystem.

In a CPS, measurement and monitoring systems (MMS) and actuators are crucial to interact with the physical world. While the former provide source of information (as they are responsible for sensing the conditions from the physical environment), the latter execute control commands. With sensors and actuators, any changes in physical process (e.g., behavior, conditions, or performance) cause changes in the cyber world, and vice versa. Therefore, measurement systems, sensors and actuators are crucial elements for CPSs. Because MMS are crucial for CPSs, they have consequently benefitted from 4.0 technologies. In particular, measurements in the 4.0 framework have taken advantage from the IoT technologies and from the associated standardized approach (5C). As a result, measurement systems in CPS are implemented through IoT. In the current 4.0 ecosystem, IoT is generally considered a synonym for MMS and vice versa. In the traditional concept of CPS, Measurement & Monitoring Systems are considered a crucial element of CPSs. They are realized through IoT technologies; nevertheless, their role is still considered marginal. Drawing a comparison with the Master/Slave architecture, we could say that MMSs represent the slaves (mostly dedicated to the collection of data) to a Master (the CPS), as depicted in Figure 5.1.

But, Is the role of Measurement really that limited? Can Measurement offer anything more valuable except for the simple indication of a physical quantity or status? The first question should address what is the real difference between a Measurement System and a CPS. Both of them are connected to a network, Internet and heavily rely on sensors and data to form the overall system. However, CPSs can resort to advanced analytic tools to convert data into knowledge, then into insights based on historical



**Fig. 5.1** (a) Relation between Measurement and CPS. (b) Mutual role of CPS and measurement systems in the 4.0 ecosystem.

data analysis. On the other hand, Measurement Systems do not play a pro-active role in running the network; they are not allowed to operate any reasoning and to participate in any decision-making process. However, Measurement Systems could actually carry out these tasks. In fact, Measurement Systems hold an unexplored potential that can allow them to become self-aware, self-conscious, self-maintained entities able to generate high-valued insights, just like CPSs. This evolution relies on the combined and integrated use of all the key technologies of the 4.0 paradigm. The idea here is to apply the 4.0 Vision to MMSs themselves, making them “intelligent instruments” in a 4.0 fashion. In this way, measurement and monitoring systems evolve into cyber-physical measurement systems (CPMSs) and become relevant players in the 4.0 ecosystem. This means that Measurement Systems will become a CPS among CPSs. The current “master-to-slave” relationship between Measurement Systems and CPSs will turn into a “peer-to-peer” cooperation (Fig. 5.2). MMSs can become pro-active elements in the 4.0 ecosystem, directly involved in the decision-making process of CPS.

Starting from the considerations reported in this thesis, the major goal of the ongoing research activity is to demonstrate that, through the suitable introduction of 4.0 technologies into measurement and monitoring systems (MMSs), and applying the methodological approach typical of the Measurement Science, it is possible to exploit the intrinsic potential of MMSs, and make them evolve into CPMSs. For providing tangible evidence of the effectiveness of this new methodological approach, a practical example for achieving the first full-round example of a CPMS is presented. In particular, we focus on a specific case study, related to the adoption of microwave reflectometry (MR) for leak localization in underground pipes (which is a consolidated expertise at the University of Salento).

The objective is to achieve a first practical example of how the transition from MMS to CPMS can

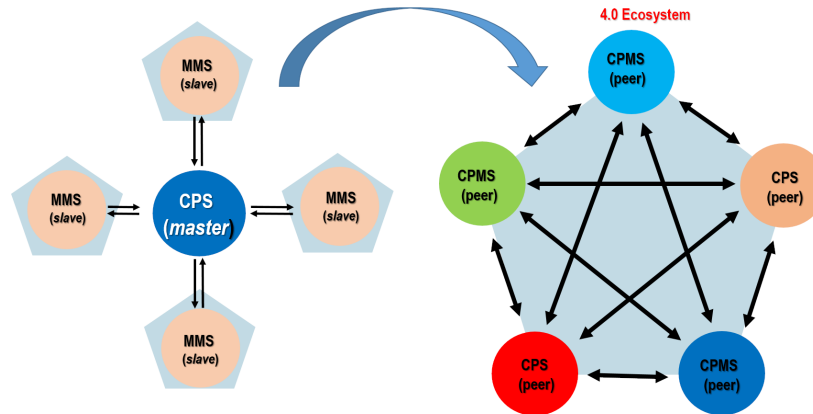


Fig. 5.2 The evolution of the “traditional” MMS into a CPMS

be successfully accomplished. As detailed in the following, specific enabling technologies (e.g., IoT, machine learning, system integration, simulation and modeling of processes, etc.) will “populate” the different levels of the stack architecture of the MR-based monitoring systems. The goal is to provide a round view of the transition towards CPMS, by addressing all the aspects underlying this concept.

## 5.2 The case study: the “traditional” microwave reflectometric system for leak localization in underground pipes

### 5.2.1 TDR theoretical background

MR is a well-established electromagnetic (EM) measurement technique. Thanks to its versatility, in terms of adaptability to the specific operating conditions, this technique has been employed for applications in diverse fields: from fault location in electric cables to moisture monitoring in soil, dielectric characterization of materials, structural health monitoring, leak localization in underground pipes. A MR-based monitoring system consists of three major elements:

- A (portable) measuring instrument which generates a low-power EM test signal and acquires the reflected EM signal;
- a sensing element (SE) inserted in the system to be monitored, and responsible for the interaction between the EM signal and the system under test (SUT);
- An algorithm to process the acquired data and retrieve the desired information on the SUT.

In MR measurements, the EM test signal is usually a step-like voltage signal (or a pulse signal) that propagates along the SE. The signal travels along the SE, and it is partially reflected by impedance

changes along the line and/or by dielectric permittivity variations. Through the analysis of the reflected signal, it is possible to retrieve the desired information on the SUT. Generally, in TDR measurements, the direct measurement output is the time-domain reflection coefficient ( $\rho$ ) is expressed as:

$$\rho = \frac{(v_{refl}(t))}{(v_{inc}(t))} \quad (5.1)$$

where,  $v_{refl}(t)$  is the amplitude of the reflected signal and  $v_{inc}(t)$  is the amplitude of the incident signal. The value of  $\rho$  is represented as a reflectogram, which shows  $\rho$  as a function of the travelled apparent distance,  $d_{app}$ . As well known, the quantity  $d_{app}$  is related to the actual distance,  $d_{real}$ , by the following equation:

$$d_{app} = d_{real} \times \sqrt{\epsilon_{app}} = (c \times t) / 2\sqrt{\epsilon_{app}} \quad (5.2)$$

where  $\epsilon_{app}$  is the effective dielectric permittivity of the propagating medium (which describes the interaction between the electromagnetic signal and the SUT);  $c$  is the velocity of light in free space; and  $t$  is the travel time, which is the time that it takes for the EM signal to travel back and forth.

The propagation velocity of the signal inside the medium depends on the dielectric properties of the material (i.e.,  $\epsilon_{app}$ ). If the EM signal propagated in vacuum, then  $\epsilon_{app} \cong \epsilon_{r,air} \cong 1$ . On the other hand, if the SE is inserted in a material other than air, then the propagating EM signal will propagate more slowly.

From a physical point of view, MR senses variation of electrical impedance related to the dielectric properties of the material in which the SE is inserted (the soil, in the considered case). In particular, the variations in electrical impedance encountered by the EM signal along its "path" will cause the reflection of part of the signal itself. The analysis of the reflected signal allows to obtain information on the dielectric/electrical characteristics of the monitored system. Finally, through an appropriate data processing, it is possible to obtain further information (not necessarily electric, but related to malfunctioning, anomalies, etc.) on the investigated system.

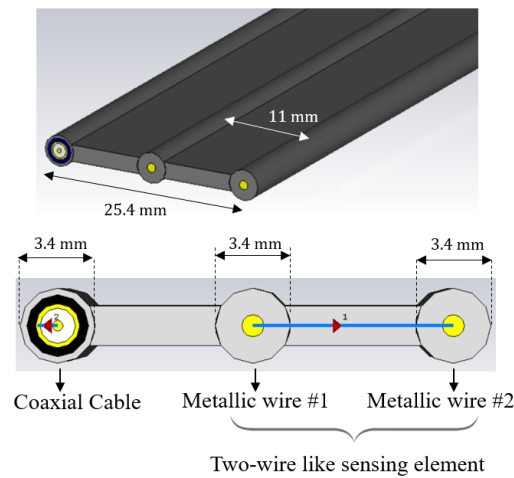
The effective dielectric constant of the material in which the SE is inserted through the estimation of the apparent length ( $d_{app}$ ) evaluated from the reflectogram.

$$\epsilon_{app} = \left(\frac{d_{app}}{d_{real}}\right)^2 \quad (5.3)$$

Based on these considerations, from the TDR reflectogram, it is possible to estimate the dielectric characteristics of the propagating medium and/or to localize when these dielectric variations occurs.

### 5.2.2 TDR-based system for localization of leaks in underground pipes

In the leak-localization application, the dielectric permittivity profile is used to detect and localize the presence of leaks.

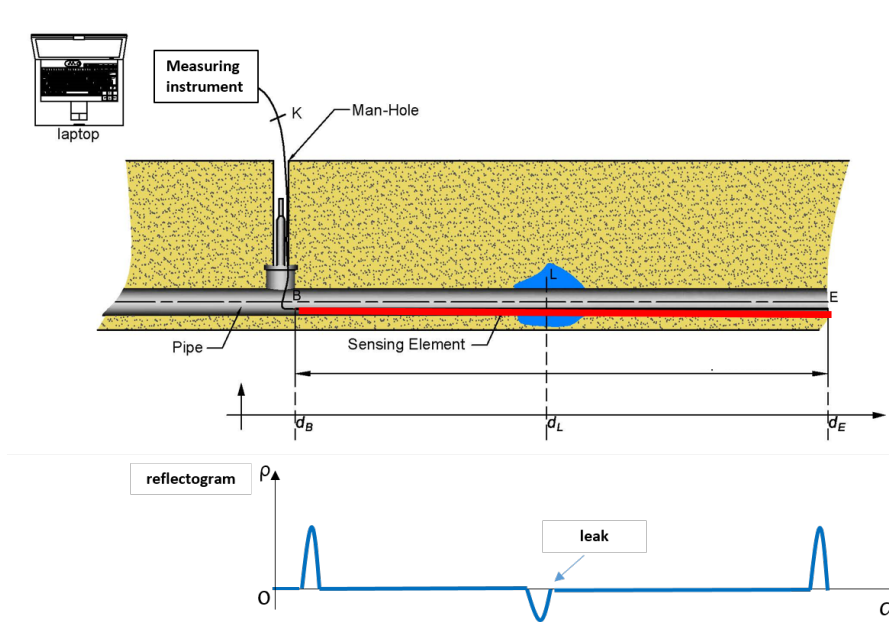


**Fig. 5.3** Diffuse sensing element: two wire-like conductors and a coaxial cable.

**Diffused sensing element** At the state of the art, most sensor or monitoring systems are characterized by point-type sensory information; hence, to monitor large areas, it is necessary to employ a multitude of probes. This drawback can be overcome by using diffused sensing elements that could be able to satisfy many applications [10] where the use of point sensors is not recommended. Recently, a new generation of elongated wire-like SEs has started to be used for MR applications: these SEs can be permanently incorporated into infrastructures (such as buildings, bridges, pipe networks) at the time of construction. This allows the monitoring over the entire life cycle, with very cost-effective approach [198, 307, 308].

The configuration of the d-SE is shown in Figure 5.3: it consists of a coaxial cable and two conductors that run parallel to each other and are mutually insulated through a plastic jacket. The figure also shows the cross section dimensions of the SE. The SE is placed along the direction of the electrical impedance profile under test so as to provide a diffused monitoring of the STBM. The EM signal propagation in fact, occurs between the two conductors and is influenced by the dielectric characteristics of the surrounding material: this aspect is exploited to identify in the reflectogram the area in which dielectric variations are observed. The coaxial cable has the same length as the sensitive portion and was integrated with SE in order to calibrate the apparent distance in real distance. In fact, because the dielectric characteristics of the coaxial cable are known, by propagating the TDR signal along the coaxial cable, it is possible to evaluate the actual distance of the SE from (3). This aspect, is especially important in practical applications in which the length of the embedded SEs is not necessarily known in advance.

**TDR-based leak localization** Figure 5.4 shows a typical application scenario of MR, i.e. the localization of leaks in underground pipe networks. The elongated SE is permanently buried with the system to be monitored; the SE runs parallel to the pipe that need monitoring). The EM test signal is propagated, through the buried SE. During the installation phase, the d-SE is placed along the pipeline to be inspected and the connection to the measuring system is ensured through an access point.



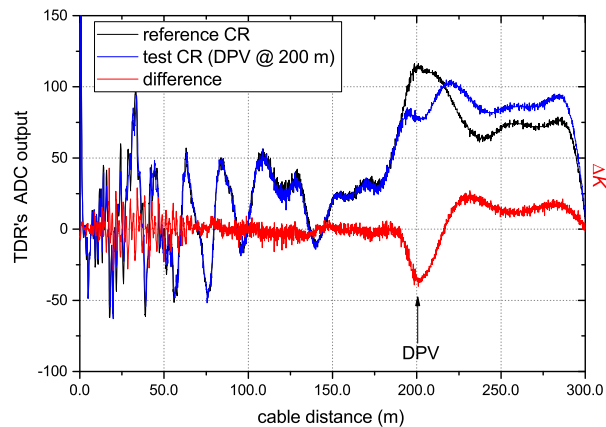
**Fig. 5.4** Schematization of the typical MMS for TDR-based localization of leaks in underground pipes (dimensions not to scale): the wire-like SE runs parallel to the buried pipe (top). Corresponding output reflectograms of the MMS (bottom): the presence of the leak provokes a distinct reflection in the reflectogram.

Points  $B$  and  $E$  indicate the beginning and the ending of the SE, while  $L$  indicates the position of a leak. It can be seen that there is a section of cable which “runs” vertically through the man-hole, to allow the connection of the SE to the measuring instrument.<sup>1</sup>

A large set of experiments has been carried out with the "traditional" TDR-based leak localization system. For the sake of clarity, in this chapter, a practical example is reported. For these measurements, the TDR RI-307USBm was used.

Figure 5.5 shows the measurement results obtained for a leak at  $d_L = 200$  m. First, the reference reflectogram was acquired, i.e. when there is no leak (red curve). Then, the reflectogram in presence of the emulated leak was acquired. It can be noticed that, in presence of the leak, there is a distinct variation of the output reflectogram. The position of the leak is estimated by applying (2) to the different portions of the reflectogram, for identifying the abscissa of the minimum in correspondence of the leak. It is also interesting to analyze the detection of a leak (or a dielectric permittivity variations DPV) at long distances (i.e. 200 m), in which case the use of the aforementioned algorithm becomes of essential

<sup>1</sup>Variations of dielectric permittivity that may occur along this “vertical” SE section are not of interest for the leak localization. To overcome this issue, this portion of SE is electromagnetically shielded (by means of a metal shield). In this way, the sensing portion starts from point  $B$ . This approach allows easier identification of the interface relative to the start point of the sensing element relative to the buried pipeline, excluding the portion of the connection section from the measured data. Another advantage is that, thanks to this shielding, the vertical portion can be of any length as it does not influence the localization of the leak (hence, it is not necessary to know a priori the burial depth of the pipe).



**Fig. 5.5** Localization of DPV: reference reflectogram is superimposed to the reference reflectogram. The difference between the two reflectograms is also shown (red curve).

importance. Figure 5.5 shows the TDR curves that are automatically processed: the difference between the test reflectogram and the one in the presence of a DPV allows to localize the DPV <sup>2</sup>.

### 5.3 A 4.0-driven evolution of the traditional MR-based monitoring system into a native CPMS: The design

In the previous sections, the basic principle behind the TDR-based system for leak localization was presented. The principle is intuitive and the obtained results are extremely good; in fact, this system is being already adopted on a large scale by water companies in Southern Italy. However, there are still some factors that limit the exploitation of the full potential that it may offer. For example, because of the complexity of the materials/systems under test and of the surrounding material, it is not trivial to accurately retrieve the profile that matches the exact conditions of the monitored system and to compensate for the non-idealities. In particular, it is difficult to discriminate the variations due to the non-idealities from possible parameter changes significant in terms of information to be monitored. By implementing a “simulation and modeling” approach in the 4.0 perspective, it would be possible to obtain accurate EM models describing the materials and the measurement system.

Another issue relates to the analysis of the MR measurement output. In fact, it is often necessary that the operator analyzes the measurement output to retrieve the desired information. In fact, although data acquisition and processing can be automated, an “expert eye” is generally required to analyze the measurement result. The introduction of a suitable artificial intelligence can overcome these limitations, and facilitate the automatic analysis of the measurement output, thus reducing and supporting human intervention.

<sup>2</sup>In applying (2), an assumption of “constant” permittivity of the soil along the SE is made. This assumption is acceptable considering that, generally, the variation of permittivity caused by leakages is significantly higher than the natural variation of permittivity of the soil (which, on the other hand, may be due to some temperature variations or to slightly different soil compaction in different areas).

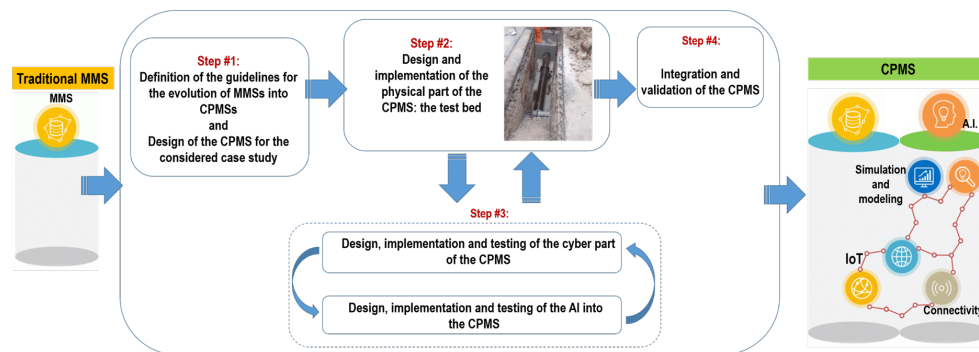


Fig. 5.6 The evolution of the “traditional” MMS into a CPMS.

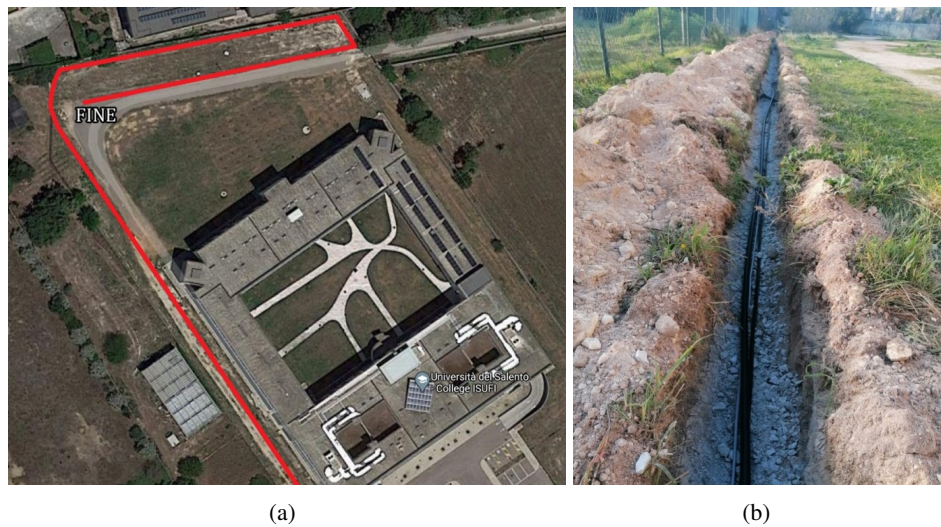
Finally, the introduction of IoT and of suitable communication protocols is a very logical step, permitting the continuous acquisition and processing of large amount of data.

Endowing the TDR-based monitoring system with these features would allow it to evolve towards a system with self-awareness and self-comparison capabilities, able to assess its own condition (e.g., automatically confirm the presence and the position of a leak) and take the need actions. For this reason, the current research activity foresees four major phases, which will allow the transition of this MMS into a CPMS. Figure 5.6 summarizes the methodology that will be implemented, while the following subsections provide a brief description of all the steps that are planned to achieve the first implementation of a native CPMS, with its *cyber* and *physical* parts.

### 5.3.1 Phase 1 – Design and implementation of the physical part of the CPMS

- *Step #1.1 - Design of the test bed for emulating large-scale, practical application scenarios*  
The very first step for the validation of the evolution from a “traditional” monitoring system into a CPMS requires an intensive *modeling* and *experimental* campaign intended to provide the proof of concept of the methodological approach. To this purpose, a test-bed for emulating large-scale practical applications of the CPMS is needed, taking into account all the operating requirements of large-scale applications.
- *Step #1.2 - Identification of the operating requirements of the HW and acquisition of the HW components for the test-bed*  
As mentioned earlier, a MR-based MMS requires a measuring instrument and the SEs. These two “components” of the system will be selected from those available in the market, based on the operating requirements. For example, the identification of the measuring instrument will consider the frequency range of the test signal (which is related to the achievable spatial resolution). Conversely, the choice of the SE will be based, for example, on sensitivity requirements but also on the robustness for a long lifetime. Clearly, also the implementation cost will be considered, taking into account that the importance of monitoring critical infrastructures may outweigh the cost limitation. This step also relates to the identification of the communication protocols and





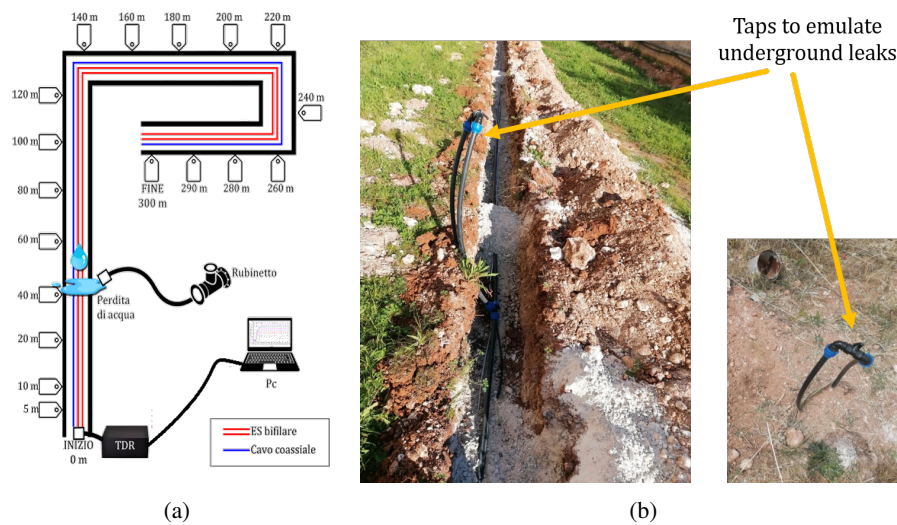
**Fig. 5.7** PHASE 1: **(a)** Test-bed for emulating pipe leaks in controlled conditions. The red line indicates the path of the buried sensing element. **(b)** Picture of the sensing element before burial.

networking technologies, for the implementation of the IoT paradigm and a robust connectivity technology, so as to ensure a continuous remote communications and networking and a reliable means for the acquisition and transmission of large amount of measurement data.

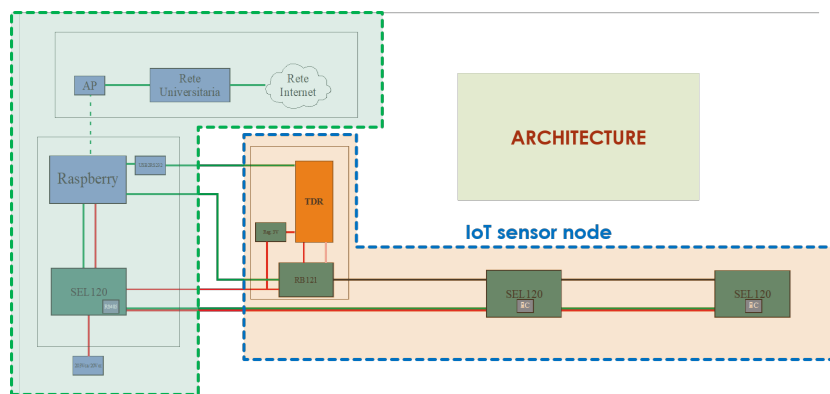
- *Step #1.3 – Implementation of the test bed for emulating large-scale, practical application scenarios*

This test-bed represents the “physical part” of the CPMS. This step is crucial for the practical implementation of the monitoring systems for the considered application scenario. In particular, the SEs and all the relevant hardware equipment (including the measuring instruments, the IoT equipment, the materials to emulate the SUT) will be installed at a selected site. The test bed has been implemented at the University of Salento’s premises. This task will also address the development and implementation of the software for data acquisition and collection. Fig. 5.7(a) shows the outline of the path of a pipe used for emulating pipe leaks in controlled conditions. The red line indicates the path of the buried sensing element. Fig. 5.7(b) shows a section of the pipe before burial. The presence of pipe leaks at different positions is emulated through the opening and closing of valves, which lets water out of the pipe. Figure 5.8(a) shows a sketch of the layout. The arrows indicate the different position of the emulated leaks. Figure 5.8(b) shows the installation of the tap that allows to emulate the presence of the underground leakage.

In order to be able to monitor the pipe, control the system and collect the data, we have implemented the architecture depicted in Fig. 5.9. We have the «IoT sensor node»: with the sensing element and with the IoT measuring instrument. We also included the «connection level» which allows the remote data acquisition through the internet.



**Fig. 5.8 PHASE 1:** (a) Sketch of the layout. The arrows indicate the different position of the emulated leaks. (b) Installation of the tap that allows to emulate the presence of the underground leakage.



**Fig. 5.9 PHASE 1:** Architecture for the implementation of the connection level.

### 5.3.2 Phase 2 – Design, implementation and testing of the Cyber part of the CPMS

Under the CPMS paradigm, the cyber part is a simulation of the physical process that produces the observable quantities for given measurands in class. In the example, the observable quantities are the measured reflectograms, and the measurands are profiles. The cyber part is built with actual physical experiments, mathematical modeling, and parameters identification; comparisons between the physical and the cyber part trigger modifications of equations and parameters. A final working cyber part is not only necessary for constructing the whole measurement system: it is also embedded in its operations. The major steps of this phase are summarized in Fig. 5.10.

- *Step #2.1 - Identification and development of the EM models for the description of the dielectric properties of materials*

This task will relate to the development and validation of frequency-dispersive dielectric permittiv-

ity models of complex materials, for describing the properties and/or composition of the materials that constitute the system under investigation, taking into account the volume fraction of the inclusions and their mutual interactions. With regard to the considered application scenarios (i.e., leak localization and structural health monitoring), the most suitable models will be identified and declined for the specific application contexts. Furthermore, also the influence of additional physical parameters (e.g. temperature) will be considered to enhance the performance of the models.

- *Step #2.2 - Laboratory tests for preliminary validating the dielectric models*

Through laboratory spectroscopic measurements, the EM properties of the involved materials are determined, as functions of the parameter to be monitored (e.g., humidity) as well as of influence or "nuisance" parameters (e.g. temperature). It will be then necessary to preliminarily verify the validity and reliability of the proposed models, also in presence of complex materials. To this purpose, a large number of experimental tests on homogeneous materials, mixtures and high-loss materials will be carried out.

- *Step #2.3 – Validation of the dielectric models for the test-bed*

This activity address the validation of the dielectric models directly for sample materials used in the test-bed emulating the application scenarios. Considering the difference between the laboratory material and the test-bed materials, particular attention will be dedicated to the scalability, to the non-idealities, dispersion and dissipative effects, and the uncertainty contribution associated to all of them.

- *Step #2.4 - Identification and development of the full-wave EM models of the sensing element*

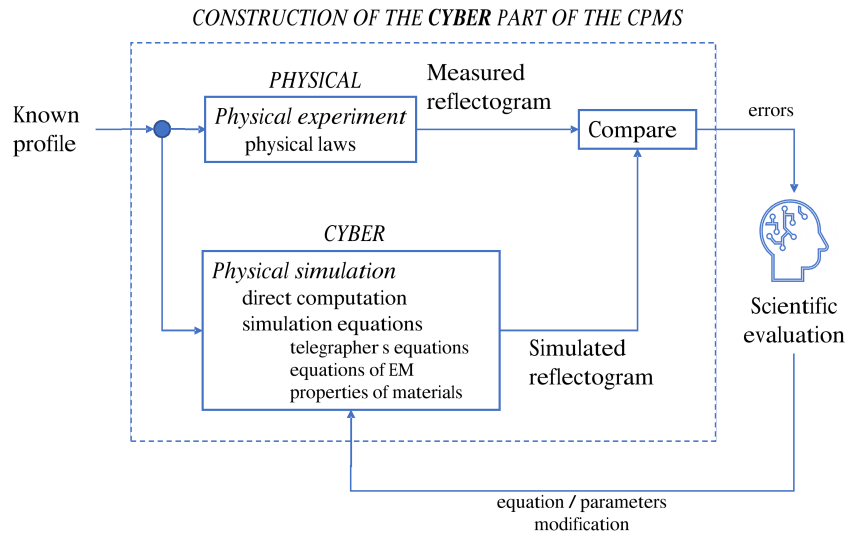
This activity relates to the development of the full-wave EM model of the measurement system. This model (which will be developed using commercial software) will represent the modality of interaction between the SUT and the SE. The goal is to compute the parameters of the SE, seen as a transmission line, when it is surrounded by a given material in given physical conditions.

- *Step #2.5 - Integration of the models, validation in the test-bed and metrological assessment*

With this step, the developed dielectric model will be integrated with the transmission line model developed in the Step #3.4, and the validity of the overall model will be validated through experimental tests on the test-bed in the considered case scenarios. Through dedicated optimization procedures, this preliminary validation will allow to fine tune the model based on the measurement data.

### **5.3.3 Phase 3 – Design, implementation and testing of AI into the CPMS**

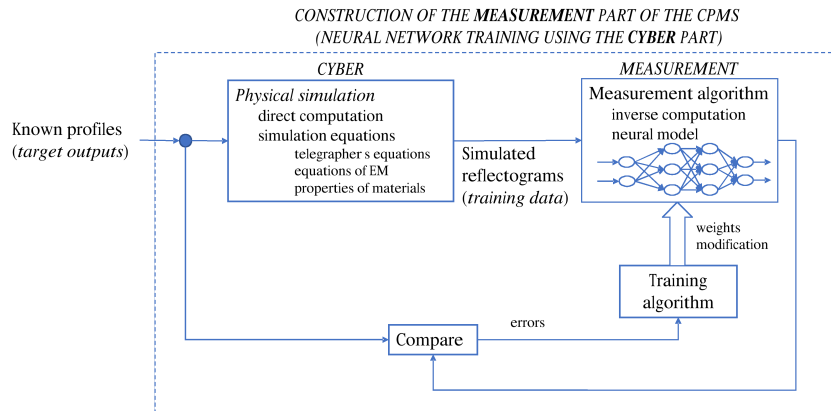
This relates to the construction of the neural measurement part of the CPMS. This is the standard training of a neural network, with just one important aspect: training data are provided by the cyber part of the CPMS. It would be impossible, indeed, to obtain only from physical experiments the big amount of data



**Fig. 5.10** Construction of the cyber part of the CPMS.

needed for the training. The process relies on the accuracy of the mathematical model, i.e. on the quality of the cyber part. It is worth noting that also in this case the comparison (between actual and target outputs) is crucial.

- *Step #3.1 - Implementation of a circuit MR simulator (CMS) using the developed EM models*  
The CMS will be used to produce simulated reflectograms with a transmission line (TL) circuit model of the SE. The TL parameters (primary/secondary) are profiles, i.e. functions of the spatial position. The simulator will have to perform two separate computations: -From a given physical situation, compute the TL parameter profiles, using the mathematical models developed for the SEs and the surrounding material. -From given TL parameters profiles (computed in the previous step), compute the reflectogram generated by a given input waveform.
- *Step #3.2 - Tuning and validation of the CPMS*  
This task relates to adjusting the parameters of the simulation in order to have consistency between simulated reflectograms of the CMS and reflectograms coming from three different sources: 1)Experimental reflectograms obtained in laboratory (in accurately known and controlled conditions); 2)Experimental reflectograms obtained in the test bed (in less accurately known and controlled conditions); 3)Simulated reflectograms obtained with more accurate and already validated full-wave simulators.
- *Step #3.3 - Identification of the neural architecture for MR inversion*  
In this activity various options will be examined (e.g. convolutional, recurrent, or recursive neural network; different ways of coding the input and the output, etc.). Final choices will be made to develop a working neural MR inversion.



**Fig. 5.11** Graphical illustration of the construction of the measurement part of the CPMS.

- *Step #3.4 - Identification of a class of physical situations and associated TL parameters profiles; Production of simulated reflectograms for neural network training and validation; neural network training and validation*

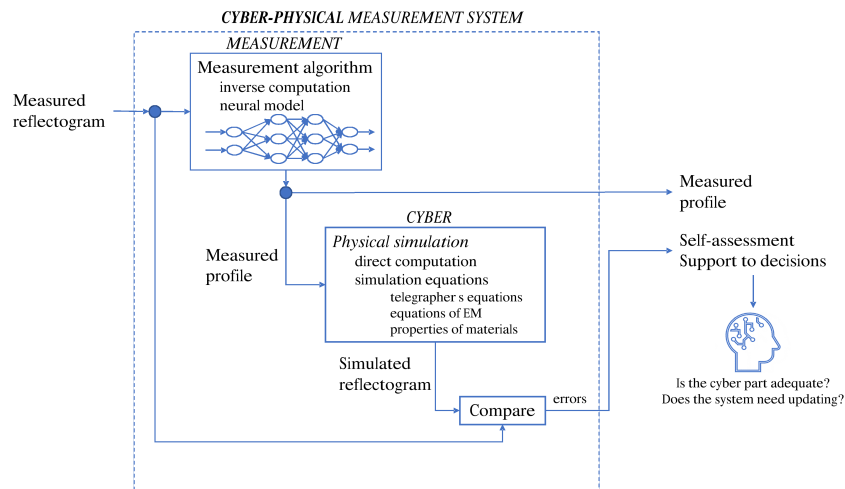
The training and validation of the neural networks will require a set of “labeled” reflectograms (reflectograms generated by the CMS with associated “true” TL profiles and physical conditions). The physical conditions must be chosen in a general but realistic way. A class of profiles is chosen taking into account the manageability of the generated data set, and considering realistic physical situations. The production of a large number (hundreds of thousands) of simulated reflectograms with associated “labels” will be allowed by the availability of a fast and validated CMS.

- *Step #3.5 - Test of the neural MR inversion using reflectograms from laboratory and from the test bed and metrological validation*

This activity consists in using the neural inversion on “new” (i.e., not the ones employed during training and validation) and experimental reflectograms acquired in accurately known conditions (laboratory) and in approximately known conditions (test bed). The results are used for fine-tuning. The inversion will be tailored according to the specific monitoring parameters of the selected application scenarios. For example, for leak-localization application, the neural MR inversion will be used to infer the position of the leak. Also in this case, the inversion technique will be characterized metrologically, in order to assess the performance (Fig. 5.11).

### 5.3.4 Phase 4 – Integration and validation of the CPMS

In this phase, first, it is necessary to validate the final CPMS and implement the self-awareness capability. This will provide a proof of concept of the developed CPMS; in particular, in this phase, it should be verified the robustness of the CPMS in terms of accuracy and consistency of the outcome (i.e., the dielectric profiles). For example, the dielectric profiles obtained from the neural inversion should be given as an input for the CMS; and the output of the CMS should then be compared to the measured



**Fig. 5.12** Graphical illustration of some core operations of the CPMS, embedding self-awareness and support to decisions.

reflectogram that was fed to the neural network. This aspect is depicted in Figure 5.12.

This comparison will highlight a “degree of similarity” used as metric for the CPMS. Basically, if the similarity is too low, the user of the monitoring system knows that it is working in a situation that has not been correctly modeled, or that the physical system is not performing in the expected way. In a robust CPMS, the cyber and physical sides will be strictly intertwined: hence, a low similarity value will highlight possible deviations from the expected results (this may require either to correct the digital twin or to adjust the physical part, which is not working as expected).

The key operation, again, is a comparison, in this case between the observed quantity feeding the measurement algorithm, and the cyber version of the same quantity, as produced by the system. The comparison would be trivial for an elementary cyber part and, consequently, an elementary inverse computation. For a complex measurement problem, it is instead non-trivial and an essential part of the measurement system, which is able to warn the user if there is too much difference between the inner digital twin and the outer physical world. If this is the case, the cyber part of the system must be updated, with the processes in Fig. 5.10 (new experiments) and Fig. 5.11 (new training).

The successive step should regard the integration between cyber and physical systems. This will concern the integration of the different components of the system into the final CPMS and integrating the “cyber” and the “physical” systems developed in the previous phases. The integration will focus not only on the separate physical and computational components, but also on their interaction.

Concurrently, it is necessary to address the metrological assessment of the CPMS. This will be dedicated to the metrological assessment of the CPMS as a whole, in terms of reliability of dielectric models and accuracy of measurement methods and inversion techniques. This will allow the evaluation of the measurement uncertainty and, as a consequence, the estimation of the confidence intervals of the

estimated parameters. Such a metrological assessment is crucial to conclusively demonstrate whether the developed methodology is feasible for application in the given areas.

Finally, the validation of the 4.0 methodological approach to monitoring systems should be addressed.

## Chapter 6

# Conclusions

The title of this thesis is “Advanced monitoring in industry 4.0 Era: people, environment and data” and writing it has been a long journey inside the new Industry 4.0 paradigm, inside its technologies, inside its complexity and its rationales, with the aim of reaching a key point: monitoring is the foundation of the 4.0 philosophy, and industry 4.0 is an expression of modern monitoring systems. We are in the era of transitions from analog to digital, from fossil to renewable, from atoms to bits and all these transitions are driven directly and indirectly by monitoring systems. The monitoring systems are responsible for the alignment between the real and virtual world, so that this constant play of mirrors does not deceive the physical world through the immateriality of the cyber world. Monitoring systems are therefore powerful and essential in the 4.0 era.

The first characteristic of this revolution is globalization: for the first time in history, an industrial transformation is taking place simultaneously on a global scale. The second key-factor is the word ecosystem: unlike the first three industrial revolutions (steam engine, electricity and computers) over the past few years, no technologies nor machines were invented anew, but we understood how to keep together different technological platforms by using the same language (bit). With the advent of Industry 4.0, nothing new appeared in the technological scenario. Certainly, some old technologies have matured, but none of those that characterize this new revolution is truly innovative, as it was in the case of steam and electricity or information technology for previous revolutions. In fact, many of the technologies that are considered 4.0 today have been invented and used intensively in the Third Industrial Revolution, if not even at the end of the Second.

The fourth industrial revolution is the only one to have been baptized the moment it was born, in Germany, in the heart of Europe. The original title of the document that introduced it was “Industrie 4.0: Mit dem Internet der Dinge auf dem Weg zur 4. industriellen Revolution”. 4.0 revolution 4 is a response to the collapse of the social and economic paradigms that characterized the second half of the twentieth century and which began to falter at the beginning of the twenty-first century under their own weight. In the title of this document, the complexity of the idea of Industry 4.0 is already evident. However, this new model needs all the technologies that make up its paradigm in order to be fully defined. First, the technological platform of the Internet-of-Things, which represents itself a cultural as



well as a technological revolution.

Internet-of-Things is an immaterial technology that takes shape as a design and communication language for all objects that have an IP address. Thanks to the Internet-of-Things, it is possible to populate the cyber world of virtual twins of real entities, and at the same time only through the Internet-of-things there is a physical world that responds to the laws of the 4.0 paradigm.

As said, however, to be completely described, Industry 4.0 needs, as in a large matryoshka family, many of the enabling technologies that it introduces. Objects communicate through connections and generate a huge amount of data (big data), that is large quantities of often unrelated and unorganized data that are collected in databases in the cloud and that must be organized in such a way that they can provide predictive models on the various phenomena of interest. The physical objects themselves are born directly from the world of data and files through digital printing technologies, associating data value with the forms and raw materials with which they are produced. Furthermore, the interconnection between physical and digital worlds cannot disregard the technologies that associate intelligence with objects and their relationships through interface data. Industry 4.0 therefore needs the Internet of Things to be defined and the Internet of Things needs other technologies, but above all it needs data. The matryoshka family relies, therefore, on data, which lack of semantics that need to be given meaning, and because they have meaning they must be monitored during their evolution and in the same time they are generated. Therefore, the relationship between monitoring techniques and 4.0 data is the same as that existing between the signifier and meaning.

Industry 4.0 has established a bridge between the virtual world (cyberspace) and tangible reality, allowing a fine synchronization between the digital models of devices and physical reality through cyber physical systems. Production systems as well as everyday products through the introduction of integrated memories, communication capabilities, wireless sensors, integrated actuators and intelligent software, are an active part of industrial processes. In this transformation process, the evolution of more intelligent monitoring systems determines the complete change of the industrial paradigm allowing to control the entire value chain practically in real-time, intervening on decision-making and optimization processes. In this new model, for the first time the product takes an active role: it is no longer subject to centralized control, but operates as a semi-finished product capable of communicating, capable of suggesting the manipulations to which it should be subjected in the various processing stages, controlling the manufacturing process of itself, monitoring the relevant environmental parameters by means of integrated sensors and implementing the appropriate corrective actions in the presence of disturbances. The potential of the fourth industrial revolution therefore relies on the ability that each element has to consolidate the information concerning it, completely disrupting the previous logic of centralization and control. In this vision, monitoring systems are the cornerstone of information generated in the 4.0 era. This new era has the potential to develop new services for a broad spectrum of applications, as smart products that are “aware” of their status offer intelligent services themselves. This new generation of products can autonomously exchange information, undertake initiatives and control each other through the Internet by means of Machine to Machine (M2M) communication methods. The interoperability of the services will be implemented through the use of semantic technologies based on the concept of

CPS, to guarantee open control of the devices. This distributed and global control capacity made of connections, intertwining, relationships and adaptations places 4.0 systems in perfect analogy with the brain / human body model and marks the transition from complicated to complex systems. Complicated systems have characterized the scientific and technological evolution to date, allowing the breakdown of all types of problems into increasingly elementary, or simplified, problems in order to arrive at a unique and certain solution, valid under defined conditions. However, diseases, climate, financial systems are some of the best-known examples of systems that cannot be broken down or approximated with simpler problems, because their complexity constitutes the problem sense itself. In these cases, knowledge and the ability to produce awareness from data analysis is the only weapon to dominate the scenarios. Therefore monitoring systems and methods are the cornerstone of complex problem solving systems. When the physicist Tim Berners Lee proposed the World Wide Web project at CERN in Geneva he was judged "vague but exciting". Industry 4.0, as an extension of the World Wide Web to physical objects is the realm of vagueness in which the certain, univocal and predetermined solution is definitively put apart at the advantage of the solution adapted to the present moment and the global state. Industry 4.0 is an extremely exciting paradigm in that it favours the relationship between entities and phenomena over the deterministic ones of cause and effect. In this scenario, participation in the decision-making and predictive processes of each individual entity is an expression of monitoring itself and therefore the effectiveness of paradigm 4.0 depends on the skill with which the monitoring is performed

The thesis can be framed in this context, and it has analyzed the characteristics of the monitoring models in the 4.0 era through the comparison between ordinary monitoring architectures and 4.0 architectures, with special regard to Internet-of-Things architectures.

Thanks to the study of the evolution of monitoring systems starting from data acquisition systems up to wireless sensor networks distributed on the cloud, the architecture of modern monitoring systems has been illustrated, structured in a stack model divided into three essential levels: sensing layer, network layer and processing layer. The stack model is a modern framework because allows a more comprehensive analysis and a more reliable decision-making process through the management of a large amount of data useful in cross sectors. Therefore, thanks to its modularity, the stack architecture meets the needs of modern industrial and societal systems. The stack meets emerging trends changes of broadening policy and decision contexts, which push the "science & knowledge" domain more and more towards multidisciplinary and interdisciplinary. According to the velocity and globalization of the industrial world, the attention of applicative tools has turned to open data as public good resource, therefore cross-sectional monitoring systems have become indispensable.

This architecture has been compared both for its functional and logical aspects with the architectures of modern 4.0 systems structurally based on the Internet-of-Things platform, also articulated on three main levels: perception layer, network layer and application layer. The comparison has been conducted through a broad taxonomic analysis of the monitoring systems in some relevant application sectors from social & economy to health, from agriculture to transport.

The vastness of the sectors investigated and their heterogeneity corroborates the significant conclusions postulated within the thesis. The comparative analysis has, in fact, shown how 4.0 architectures

---

intrinsically perform monitoring activities in their operations and, likewise, as in 4.0 era, monitoring systems can be implemented exhaustively through 4.0 architectures. The widespread and pervasive nature of the enabling 4.0 technologies in many economic, productive and social sectors is creating the conditions for an almost immediate availability of more or less explicit solutions for the acquisition, registration, transmission, routing and processing of information associated with quantities and/or parameters that characterize the behaviour and evolution of the systems in which the technologies are inserted. However, in the stack model the functionality of each level is not customized for the application and this could compromise the metrological peculiarities and effectiveness of the monitoring systems. The successful elements of the stack architectures, flexibility and interoperability, are therefore, key factors for modern monitoring applications that can only be governed by the appropriate measurement expertise. The evolutionary process that has made the amount of available data enormous. The raw data have become manifold and have gradually lost their informative power to the advantage of techniques aimed at meaning attributing that can be used by the end user, or to the benefit of information that can be immediately used for decision making processes. The availability of cheap and fast integration and processing systems on the one hand, and the chimera of operational autonomy of the operators in the various application sectors on the other hand, have implicitly increased confidence in structured data. Big data are implicitly perceived as the most appropriate source of data according to their finale use. In this scenario, the integrity and accuracy of the data and their sources has become a substitute for the amount of data and the complexity of their relationships and mutual influences.

With the aim of showing the validity of the composite conclusion that a monitoring system can be fully implemented by adequately enhancing the metrological characteristics of the lower layers of the architectural stack of the IoT paradigm, three application cases have been studied in this thesis. The three proposed examples present a decreasing degree of overlap of the technologies with monitoring methods and they show an increasing level of logical and functional interoperability between 4.0 applications and monitoring applications.

The case studies highlight the naturalness with which this transposition can become both logical and functional and exhibit the potential that derives from elevating 4.0 architectures to express monitoring functions with the necessary metrological accuracy. The case studies use enabling technologies with a growing degree of both technological and application innovation and show the versatility of the results of the union between 4.0 applications and monitoring activities. In the first experiment, the Brain Computer Interface technology has been specialized to monitor brain response to stressogenic stimuli. In the second experiment, from the processing of information produced by an Augmented Reality application to support an industrial process, some figures of merit useful for monitoring the process itself have been defined. In the third experiment, it was shown through an extremely innovative technology such as the Soft Robot Continuum how it is possible with adequate skills to design 4.0 applications capable of simultaneously meeting the requirements of the monitoring systems.

Based on the foregoing and the considerations developed through the experiments, it is possible to conclude that in the 4.0 era the monitoring systems and 4.0 architectures, in particular thanks to the Internet-of-Things platform, are indistinguishable and essential from each other. To implement a

monitoring system, it is necessary to use measurement skills together with 4.0 technologies, just as a native 4.0 application can express monitoring functionality. Therefore, monitoring affects the semantics of information in 4.0 era.

However, rigorous procedures and accurate techniques that preserve the integrity and accuracy of the data are essential to make the use of big data truly advantageous both in precision applications and in cross-application domains.

These monitoring models require an effort to harmonize the bottom-up approach imposed by the metrological requirements of the monitoring systems with the top-down approach imposed by the heterogeneity requirements of the data distributed in support of modern decision-making processes, thus emphasizing the common practice of quantifying information in terms of information capacity rather than meaningful information.

The high availability of technology and the spread of artificial intelligence applications seem to have led us into a world that decides and proceeds automatically and independently of the human will, however no technology is fully useful if not enslaved to the project of man and the practice and the management of monitoring operations represent the transduction point of human knowledge in technological usability in the 4.0 era.

# References

- [1] D. Stark, “Manuel castells, the rise of the network society,” *CONTEMPORARY SOCIOLOGY*, vol. 26, pp. 725–725, 1997.
- [2] A. Tedesco, M. Gallo, and A. Tufano, “A preliminary discussion of measurement and networking issues in cyber physical systems for industrial manufacturing,” in *2017 IEEE International Workshop on Measurement and Networking (M&N)*, pp. 1–6, IEEE, 2017.
- [3] P.-S. Jang, “Davos forum: Our strategy for the upcoming fourth industrial revolution,”” *Science & Technology Policy*, vol. 26, no. 2, pp. 12–15, 2016.
- [4] M. Rüßmann, M. Lorenz, P. Gerbert, M. Waldner, J. Justus, P. Engel, and M. Harnisch, “Industry 4.0: The future of productivity and growth in manufacturing industries,” *Boston Consulting Group*, vol. 9, no. 1, pp. 54–89, 2015.
- [5] D. Wee, R. Kelly, J. Cattel, and M. Breunig, “Industry 4.0-how to navigate digitization of the manufacturing sector,” *McKinsey & Company*, vol. 58, 2015.
- [6] A. Baums, “How to navigate digitization of the manufacturing sector,” *McKinsey Digital*, 2014.
- [7] S. Vimal, A. Suresh, P. Subbulakshmi, S. Pradeepa, and M. Kaliappan, “Edge computing-based intrusion detection system for smart cities development using iot in urban areas,” in *Internet of Things in Smart Technologies for Sustainable Urban Development*, pp. 219–237, Springer, 2020.
- [8] P. DeBeasi, “Designing an iot reference architecture.” <https://www.gartner.com/en/documents/3970299/designing-an-iot-reference-architecture>, 2019. Accessed: April 01, 2022.
- [9] “Monitoring architecture.” <https://developer.lightbend.com/guides/monitoring-at-scale/monitoring-architecture/architecture.html>. Accessed: April 01, 2022.
- [10] P. Adolphs *et al.*, “Reference architecture model industrie 4.0 (rami4. 0),” *ZVEI and VDI, Status report*, 2015.
- [11] M. A. Pisching *et al.*, “An architecture based on rami 4.0 to discover equipment to process operations required by products,” *Computers & Industrial Engineering*, vol. 125, pp. 574–591, 2018.

- [12] T. Bangemann *et al.*, “Industrie 4.0—technical assets: basic terminology concepts life cycles and administration models,” *VDI/VDE and ZVEI*, 2016.
- [13] L. Adolph, T. Anlahr, and H. Bedenbender, “German standardization roadmap: Industry 4.0,” in *Version 4. Berlin: DIN eV*, DIN e. V., 2020.
- [14] R. Langmann and L. F. Rojas-Peña, “A plc as an industry 4.0 component,” in *2016 13th International Conference on Remote Engineering and Virtual Instrumentation (REV)*, pp. 10–15, IEEE, 2016.
- [15] K. Schweichhart, “Reference architectural model industrie 4.0 (rami 4.0),” *An Introduction. Available online: [https://www.plattform-i40.de I](https://www.plattform-i40.de/I)*, vol. 40, 2016.
- [16] H. Boyes, B. Hallaq, J. Cunningham, and T. Watson, “The industrial internet of things (iiot): An analysis framework,” *Computers in Industry*, vol. 101, pp. 1–12, 2018.
- [17] P. Radanliev, D. De Roure, R. Nicolescu, and M. Huth, “A reference architecture for integrating the industrial internet of things in the industry 4.0,” *arXiv preprint arXiv:1903.04369*, 2019.
- [18] A. Calihman, “Architectures in the iot civilization.” <https://www.netburner.com/learn/architectural-frameworks-in-the-iot-civilization/>, 2020. Accessed: April 01, 2022.
- [19] M. Burhan, R. A. Rehman, B. Khan, and B.-S. Kim, “Iot elements, layered architectures and security issues: a comprehensive survey,” *Sensors*, vol. 18, no. 9, p. 2796, 2018.
- [20] K. Johnson, J. V. Tucker, and V. Wang, “Monitoring and intervention: Concepts and formal models,” *arXiv preprint arXiv:1701.07484*, 2017.
- [21] F. Flammini, A. Gaglione, F. Ottello, A. Pappalardo, C. Pragliola, and A. Tedesco, “Towards wireless sensor networks for railway infrastructure monitoring,” in *Electrical Systems for Aircraft, Railway and Ship Propulsion*, pp. 1–6, IEEE, 2010.
- [22] W. Staszewski, C. Boller, and G. R. Tomlinson, *Health monitoring of aerospace structures: smart sensor technologies and signal processing*. John Wiley & Sons, 2004.
- [23] Y.-Y. Chen, Y.-Y. Tu, C.-H. Chiu, and Y.-S. Chen, “An embedded system for vehicle surrounding monitoring,” in *2009 2nd International Conference on Power Electronics and Intelligent Transportation System (PEITS)*, vol. 2, pp. 92–95, IEEE, 2009.
- [24] T. G. Reynolds and R. J. Hansman, “Conformance monitoring approaches in current and future air traffic control environments,” in *Proceedings. The 21st Digital Avionics Systems Conference*, vol. 2, pp. 7C1–7C1, IEEE, 2002.
- [25] S. King, P. Bannister, D. Clifton, and L. Tarassenko, “Probabilistic approach to the condition monitoring of aerospace engines,” *Proceedings of the Institution of Mechanical Engineers, Part G: Journal of Aerospace Engineering*, vol. 223, no. 5, pp. 533–541, 2009.

- [26] L. Ruiz-Garcia, P. Barreiro, and J. Robla, "Performance of zigbee-based wireless sensor nodes for real-time monitoring of fruit logistics," *Journal of Food Engineering*, vol. 87, no. 3, pp. 405–415, 2008.
- [27] G. S. Lorite *et al.*, "Novel, smart and rfid assisted critical temperature indicator for supply chain monitoring," *Journal of Food Engineering*, vol. 193, pp. 20–28, 2017.
- [28] J. P. Lynch *et al.*, "The design of a wireless sensing unit for structural health monitoring," in *Proceedings of the 3rd International Workshop on Structural Health Monitoring*, pp. 12–14, Stanford University Stanford, CA, 2001.
- [29] J. P. Lynch *et al.*, "Design of piezoresistive mems-based accelerometer for integration with wireless sensing unit for structural monitoring," *Journal of Aerospace Engineering*, vol. 16, no. 3, pp. 108–114, 2003.
- [30] W.-T. Sung and Y.-C. Hsu, "Designing an industrial real-time measurement and monitoring system based on embedded system and zigbee," *Expert Systems with Applications*, vol. 38, no. 4, pp. 4522–4529, 2011.
- [31] P. Higgs *et al.*, "A survey on condition monitoring systems in industry," in *ASME 7th Biennial Conference on Engineering Systems Design and Analysis*, pp. 163–178, American Society of Mechanical Engineers Digital Collection, 2004.
- [32] M. Greiffenhagen, D. Comaniciu, H. Niemann, and V. Ramesh, "Design, analysis, and engineering of video monitoring systems: an approach and a case study," *Proceedings of the IEEE*, vol. 89, no. 10, pp. 1498–1517, 2001.
- [33] T. Stone and R. H. Hollier, "Electronic data capture and operational performance monitoring: a supply chain perspective," *International Journal of Logistics*, vol. 3, no. 3, pp. 213–226, 2000.
- [34] W. Zachary, J. Ryder, L. Ross, and M. Z. Weiland, "Intelligent computer-human interaction in real-time, multi-tasking process control and monitoring systems," *Human factors in design for manufacturability*, pp. 377–401, 1992.
- [35] R. Cadima *et al.*, "Promoting social network awareness: A social network monitoring system," *Computers & Education*, vol. 54, no. 4, pp. 1233–1240, 2010.
- [36] L. Sarycheva, "Using gmdh in ecological and socio-economical monitoring problems," *Systems Analysis Modelling Simulation*, vol. 43, no. 10, pp. 1409–1414, 2003.
- [37] A. Polyakova, M. Loginov, A. Serebrennikova, and E. Thalassinos, "Design of a socio-economic processes monitoring system based on network analysis and big data," *International Journal of Economics and Business Administration*, 2019.

- [38] H. Wang, J. Mylopoulos, and S. Liao, "Intelligent agents and financial risk monitoring systems," *Communications of the ACM*, vol. 45, no. 3, pp. 83–88, 2002.
- [39] J. D. Willms, *Monitoring school performance: A guide for educators*. Routledge, 2003.
- [40] R. Baubinas, D. Burneika, and V. Daugirdas, "The social–economical monitoring of problem regions for sustainable development: methodological aspects," *Environmental research, engineering and management*, vol. 4, no. 26, pp. 21–26, 2003.
- [41] A. Pantelopoulos and N. G. Bourbakis, "A survey on wearable sensor-based systems for health monitoring and prognosis," *IEEE Transactions on Systems, Man, and Cybernetics, Part C (Applications and Reviews)*, vol. 40, no. 1, pp. 1–12, 2009.
- [42] M. Trincavelli, S. Coradeschi, and A. Loutfi, "Odour classification system for continuous monitoring applications," *Sensors and Actuators B: Chemical*, vol. 139, no. 2, pp. 265–273, 2009.
- [43] J. L. Gehrich *et al.*, "Optical fluorescence and its application to an intravascular blood gas monitoring system," *IEEE transactions on biomedical engineering*, no. 2, pp. 117–132, 1986.
- [44] J. Cairns Jr and W. Van der Schalie, "Biological monitoring part i—early warning systems," *Water Research*, vol. 14, no. 9, pp. 1179–1196, 1980.
- [45] W.-Y. Chung, Y.-D. Lee, and S.-J. Jung, "A wireless sensor network compatible wearable u-healthcare monitoring system using integrated ecg, accelerometer and spo 2," in *2008 30th Annual International Conference of the IEEE Engineering in Medicine and Biology Society*, pp. 1529–1532, IEEE, 2008.
- [46] M. Aminian and H. R. Naji, "A hospital healthcare monitoring system using wireless sensor networks," *J. Health Med. Inform*, vol. 4, no. 02, p. 121, 2013.
- [47] A. P. Abidoye, N. A. Azeez, A. O. Adesina, and K. K. Agbele, "Using wearable sensors for remote healthcare monitoring system," *Journal of Sensor Technology*, vol. 1, pp. 22–28, 2011.
- [48] B. H. Ginsberg, "Factors affecting blood glucose monitoring: sources of errors in measurement," *Journal of diabetes science and technology*, vol. 3, no. 4, pp. 903–913, 2009.
- [49] M. Sequeira, M. Bowden, E. Minogue, and D. Diamond, "Towards autonomous environmental monitoring systems," *Talanta*, vol. 56, no. 2, pp. 355–363, 2002.
- [50] G. FISKESJÖ, "The allium test as a standard in environmental monitoring," *Hereditas*, vol. 102, no. 1, pp. 99–112, 1985.
- [51] M. Karamouz, A. K. Nokhandan, R. Kerachian, and Č. Maksimovic, "Design of on-line river water quality monitoring systems using the entropy theory: a case study," *Environmental monitoring and assessment*, vol. 155, no. 1-4, p. 63, 2009.



- [52] I. Watson and P. Novelty, "Making the biodiversity monitoring system sustainable: design issues for large-scale monitoring systems," *Austral Ecology*, vol. 29, no. 1, pp. 16–30, 2004.
- [53] R. C. Ward, J. C. Loftis, and G. B. McBride, *Design of water quality monitoring systems*. John Wiley & Sons, 1990.
- [54] G. Pajares, A. Peruzzi, and P. Gonzalez-de Santos, "Sensors in agriculture and forestry," 2013.
- [55] T. Ojha, S. Misra, and N. S. Raghuwanshi, "Wireless sensor networks for agriculture: The state-of-the-art in practice and future challenges," *Computers and Electronics in Agriculture*, vol. 118, pp. 66–84, 2015.
- [56] L. Ruiz-Garcia and L. Lunadei, "The role of rfid in agriculture: Applications, limitations and challenges," *Computers and Electronics in Agriculture*, vol. 79, no. 1, pp. 42–50, 2011.
- [57] P. Andrade-Sanchez, F. J. Pierce, and T. V. Elliott, "Performance assessment of wireless sensor networks in agricultural settings," in *2007 ASAE Annual Meeting*, p. 1, American Society of Agricultural and Biological Engineers, 2007.
- [58] J. G. Van Der Vorst, "Performance measurement in agrifood supply chain networks: an overview," in *Quantifying the agri-food supply chain*, no. 15, pp. 13–24, Springer Science+ Business Media, 2005.
- [59] S. Duruz *et al.*, "A webgis platform for the monitoring of farm animal genetic resources (genmon)," *PloS one*, vol. 12, no. 4, 2017.
- [60] J. G. van der Vorst, O. van Kooten, and P. A. Luning, "Towards a diagnostic instrument to identify improvement opportunities for quality controlled logistics in agrifood supply chain networks," *International journal on food system dynamics*, vol. 2, no. 1, pp. 94–105, 2011.
- [61] J. Burgess and M. Nye, "Re-materialising energy use through transparent monitoring systems," *Energy policy*, vol. 36, no. 12, pp. 4454–4459, 2008.
- [62] M. Zima, M. Larsson, P. Korba, C. Rehtanz, and G. Andersson, "Design aspects for wide-area monitoring and control systems," *Proceedings of the IEEE*, vol. 93, no. 5, pp. 980–996, 2005.
- [63] J. Roos, I. Lane, E. Botha, and G. P. Hancke, "Using neural networks for non-intrusive monitoring of industrial electrical loads," in *Conference Proceedings. 10th Anniversary. IMTC/94. Advanced Technologies in I & M. 1994 IEEE Instrumentation and Measurement Technology Conference (Cat. No. 94CH3424-9)*, pp. 1115–1118, IEEE, 1994.
- [64] S. Chen, "Open design of networked power quality monitoring systems," *IEEE Transactions on Instrumentation and measurement*, vol. 53, no. 2, pp. 597–601, 2004.

- [65] C. Fraleigh *et al.*, “Design and deployment of a passive monitoring infrastructure,” in *Thyrrhenian Internatinal Workshop on Digital Communications*, pp. 556–575, Springer, 2001.
- [66] L. Angrisani, G. Ventre, L. Peluso, and A. Tedesco, “Measurement of processing and queuing delays introduced by an open-source router in a single-hop network,” *IEEE transactions on instrumentation and measurement*, vol. 55, no. 4, pp. 1065–1076, 2006.
- [67] S. Lee, K. Levanti, and H. S. Kim, “Network monitoring: Present and future,” *Computer Networks*, vol. 65, pp. 84–98, 2014.
- [68] A. Ramachandran, S. Seetharaman, N. Feamster, and V. Vazirani, “Fast monitoring of traffic subpopulations,” in *Proceedings of the 8th ACM SIGCOMM conference on Internet measurement*, pp. 257–270, 2008.
- [69] D. Gavalas, D. Greenwood, M. Ghanbari, and M. O’Mahony, “Advanced network monitoring applications based on mobile/intelligent agent technology,” *Computer communications*, vol. 23, no. 8, pp. 720–730, 2000.
- [70] J.-M. Bohli, A. Hessler, O. Ugus, and D. Westhoff, “A secure and resilient wsn roadside architecture for intelligent transport systems,” in *Proceedings of the first ACM conference on Wireless network security*, pp. 161–171, 2008.
- [71] Y. Qian, M. S. Dersch, Z. Gao, and J. R. Edwards, “Railroad infrastructure 4.0: development and application of an automatic ballast support condition assessment system,” *Transportation Geotechnics*, vol. 19, pp. 19–34, 2019.
- [72] M. S. Uddin, M. M. Ahmed, J. B. Alam, and M. Islam, “Smart anti-theft vehicle tracking system for bangladesh based on internet of things,” in *2017 4th International Conference on Advances in Electrical Engineering (ICAEE)*, pp. 624–628, IEEE, 2017.
- [73] A. Cachada *et al.*, “Maintenance 4.0: Intelligent and predictive maintenance system architecture,” in *2018 IEEE 23rd International Conference on Emerging Technologies and Factory Automation (ETFA)*, vol. 1, pp. 139–146, IEEE, 2018.
- [74] V. Román-Ibáñez, A. Jimeno-Morenilla, and F. A. Pujol-López, “Distributed monitoring of heterogeneous robotic cells. a proposal for the footwear industry 4.0,” *International Journal of Computer Integrated Manufacturing*, vol. 31, no. 12, pp. 1205–1219, 2018.
- [75] D. Zhang, C. C. Chan, and G. Y. Zhou, “Enabling industrial internet of things (iiot) towards an emerging smart energy system,” *Global Energy Interconnection*, vol. 1, no. 1, pp. 39–47, 2018.
- [76] M. Sony, “Industry 4.0 and lean management: a proposed integration model and research propositions,” *Production & Manufacturing Research*, vol. 6, no. 1, pp. 416–432, 2018.

- [77] J. Lee, H.-A. Kao, S. Yang, *et al.*, “Service innovation and smart analytics for industry 4.0 and big data environment,” *Procedia Cirp*, vol. 16, no. 1, pp. 3–8, 2014.
- [78] M. S. Reis and G. Gins, “Industrial process monitoring in the big data/industry 4.0 era: From detection, to diagnosis, to prognosis,” *Processes*, vol. 5, no. 3, p. 35, 2017.
- [79] R. Godina and J. C. Matias, “Quality control in the context of industry 4.0,” in *International Joint conference on Industrial Engineering and Operations Management*, pp. 177–187, Springer, 2018.
- [80] J. Von Lucke, “Smart government—the potential of intelligent networking in government and public administration,” in *2016 conference for e-democracy and open government (CeDEM)*, pp. 137–144, IEEE, 2016.
- [81] S. Fong and H. S. Meng, “A web-based performance monitoring system for e-government services,” in *Proceedings of the 3rd international conference on Theory and practice of electronic governance*, pp. 74–82, 2009.
- [82] T. V. Kumar and B. Dahiya, “Smart economy in smart cities,” in *Smart Economy in Smart Cities*, pp. 3–76, Springer, 2017.
- [83] C. Otto, A. Milenkovic, C. Sanders, and E. Jovanov, “System architecture of a wireless body area sensor network for ubiquitous health monitoring,” *Journal of mobile multimedia*, vol. 1, no. 4, pp. 307–326, 2006.
- [84] M. M. Baig and H. Gholamhosseini, “Smart health monitoring systems: an overview of design and modeling,” *Journal of medical systems*, vol. 37, no. 2, p. 9898, 2013.
- [85] T. Liang and Y. J. Yuan, “Wearable medical monitoring systems based on wireless networks: A review,” *IEEE Sensors Journal*, vol. 16, no. 23, pp. 8186–8199, 2016.
- [86] D. S. Rajput and R. Gour, “An iot framework for healthcare monitoring systems,” *International Journal of Computer Science and Information Security*, vol. 14, no. 5, p. 451, 2016.
- [87] G. Manogaran *et al.*, “A new architecture of internet of things and big data ecosystem for secured smart healthcare monitoring and alerting system,” *Future Generation Computer Systems*, vol. 82, pp. 375–387, 2018.
- [88] S. V. Zanjali and G. R. Talmale, “Medicine reminder and monitoring system for secure health using iot,” *Procedia Comput. Sci*, vol. 78, no. 3, pp. 471–476, 2016.
- [89] G. Sannino, I. De Falco, and G. De Pietro, “A continuous noninvasive arterial pressure (cnap) approach for health 4.0 systems,” *IEEE Transactions on Industrial Informatics*, vol. 15, no. 1, pp. 498–506, 2018.

- [90] M. S. Hossain and G. Muhammad, "Cloud-assisted speech and face recognition framework for health monitoring," *Mobile Networks and Applications*, vol. 20, no. 3, pp. 391–399, 2015.
- [91] H. Chi, W. Chow, K. Chui, K. Man, and G. P. Hancke, "A remote monitoring patient homecare gateway supporting streaming vital sign monitoring," in *IECON 2013-39th Annual Conference of the IEEE Industrial Electronics Society*, pp. 8415–8419, IEEE, 2013.
- [92] M. Chang and P. Bonnet, "Meeting ecologists' requirements with adaptive data acquisition," in *Proceedings of the 8th ACM Conference on Embedded Networked Sensor Systems*, pp. 141–154, 2010.
- [93] A. Ghobakhlou, S. Zandi, and P. Sallis, "Development of environmental monitoring system with wireless sensor networks," in *Proceedings of 19th International Congress on Modelling and Simulation*, 2011.
- [94] R. Huang *et al.*, "Real-world sensor network for long-term volcano monitoring: Design and findings," *IEEE Transactions on Parallel and Distributed Systems*, vol. 23, no. 2, pp. 321–329, 2011.
- [95] R. K. Grace and S. Manju, "A comprehensive review of wireless sensor networks based air pollution monitoring systems," *Wireless Personal Communications*, vol. 108, no. 4, pp. 2499–2515, 2019.
- [96] N. Sivaiah, K. P. S. SOWMYA, K. SUSMITHA, N. A. SAI, and N. SUMA, "Internet of things (iot) enabled water monitoring system," *FEB 2018 IRE Journals*, vol. 1, no. 8, 2018.
- [97] R. Valentini *et al.*, "New tree monitoring systems: from industry 4.0 to nature 4.0," *Annals of Silvicultural Research*, 2019.
- [98] J. Shah and B. Mishra, "Iot enabled environmental monitoring system for smart cities," in *2016 international conference on internet of things and applications (IOTA)*, pp. 383–388, IEEE, 2016.
- [99] S. Fritz *et al.*, "A comparison of global agricultural monitoring systems and current gaps," *Agricultural systems*, vol. 168, pp. 258–272, 2019.
- [100] E. P. R. da Fonseca *et al.*, "Agro 4.0: a data science-based information system for sustainable agroecosystem management," *Simulation Modelling Practice and Theory*, p. 102068, 2020.
- [101] I. Mohanraj, K. Ashokumar, and J. Naren, "Field monitoring and automation using iot in agriculture domain," *Procedia Computer Science*, vol. 93, pp. 931–939, 2016.
- [102] C.-R. Rad, O. Hancu, I.-A. Takacs, and G. Olteanu, "Smart monitoring of potato crop: a cyber-physical system architecture model in the field of precision agriculture," *Agriculture and Agricultural Science Procedia*, vol. 6, pp. 73–79, 2015.

- [103] J. Nie, R. Z. Sun, and X. H. Li, "A precision agriculture architecture with cyber-physical systems design technology," in *Applied Mechanics and Materials*, vol. 543, pp. 1567–1570, Trans Tech Publ, 2014.
- [104] J. Miranda, P. Ponce, A. Molina, and P. Wright, "Sensing, smart and sustainable technologies for agri-food 4.0," *Computers in Industry*, vol. 108, pp. 21–36, 2019.
- [105] N. Suma, S. R. Samson, S. Saranya, G. Shanmugapriya, and R. Subhashri, "Iot based smart agriculture monitoring system," *International Journal on Recent and Innovation Trends in computing and communication*, vol. 5, no. 2, pp. 177–181, 2017.
- [106] K. Friansa *et al.*, "Development of battery monitoring system in smart microgrid based on internet of things (iot)," *Procedia engineering*, vol. 170, pp. 482–487, 2017.
- [107] Q. M. Ashraf *et al.*, "Energy monitoring prototype for internet of things: Preliminary results," in *2015 IEEE 2nd World Forum on Internet of Things (WF-IoT)*, pp. 1–5, IEEE, 2015.
- [108] H. Luan and J. Leng, "Design of energy monitoring system based on iot," in *2016 Chinese Control and Decision Conference (CCDC)*, pp. 6785–6788, IEEE, 2016.
- [109] K. Akkaya, I. Guvenc, R. Aygun, N. Pala, and A. Kadri, "Iot-based occupancy monitoring techniques for energy-efficient smart buildings," in *2015 IEEE Wireless communications and networking conference workshops (WCNCW)*, pp. 58–63, IEEE, 2015.
- [110] T. Maksymyuk, S. Dumych, M. Brych, D. Satria, and M. Jo, "An iot based monitoring framework for software defined 5g mobile networks," in *Proceedings of the 11th international conference on ubiquitous information management and communication*, pp. 1–4, 2017.
- [111] U. Gupta, "Monitoring in iot enabled devices," *arXiv preprint arXiv:1507.03780*, 2015.
- [112] J. Subramaniam, Y. Ho, and S. Manickam, "Intelligent ipv6 based iot network monitoring and altering system on cooja framework," *Journal of Fundamental and Applied Sciences*, vol. 9, no. 6S, pp. 661–670, 2017.
- [113] A. Kos *et al.*, "Network monitoring applications based on iot system," in *Proceedings of the 2013 18th European Conference on Network and Optical Communications & 2013 8th Conference on Optical Cabling and Infrastructure (NOC-OC&I)*, pp. 69–74, IEEE, 2013.
- [114] Z. Hu, G. Xue, Y.-C. Chen, and M. Li, "Nb-iot network monitoring and diagnosing," in *2019 16th Annual IEEE International Conference on Sensing, Communication, and Networking (SECON)*, pp. 1–9, IEEE, 2019.
- [115] M. Brattstrom and P. Morreale, "Scalable agentless cloud network monitoring," in *2017 IEEE 4th International Conference on Cyber Security and Cloud Computing (CSCloud)*, pp. 171–176, IEEE, 2017.

- [116] “2019 iot survey: Speed operations, strengthen relationships and drive what’s next.” <https://www.pwc.com/us/en/services/consulting/technology/emerging-technology/iot-pov.html>. Accessed: April 01, 2022.
- [117] B. Lewis, “Iot interop across the osi model.” <https://www.embedded-computing.com/embedded-computing-design/iot-interop-across-the-osi-model>, 2020. Accessed: April 01, 2022.
- [118] S. Gupta and K. Bamezai, “The internet of things,” 2018.
- [119] “Fabbriche intelligenti e iot industriale.” [https://www.rohde-schwarz.com/it/soluzioni/test-and-measurement/wireless-communication/iot-m2m/smart-factories/overview/panoramica-fabbriche-intelligenti\\_233886.html?WT.mc\\_id=site\\_com\\_sea\\_143\\_google\\_19-04\\_i\\_iot-markets\\_industrial-iot\\_search\\_text-ad\\_r-eu\\_\\_&cid=site\\_com\\_sea\\_143\\_google\\_19-04\\_i\\_iot-markets\\_industrial-iot\\_search\\_text-ad\\_r-eu\\_\\_&kw=industrial%20iot](https://www.rohde-schwarz.com/it/soluzioni/test-and-measurement/wireless-communication/iot-m2m/smart-factories/overview/panoramica-fabbriche-intelligenti_233886.html?WT.mc_id=site_com_sea_143_google_19-04_i_iot-markets_industrial-iot_search_text-ad_r-eu__&cid=site_com_sea_143_google_19-04_i_iot-markets_industrial-iot_search_text-ad_r-eu__&kw=industrial%20iot). Accessed: April 01, 2022.
- [120] “Powering the future of advanced manufacturing.” <https://behrtech.com/>. Accessed: April 01, 2022.
- [121] D. Romero, P. Bernus, O. Noran, J. Stahre, and Å. Fast-Berglund, “The operator 4.0: Human cyber-physical systems & adaptive automation towards human-automation symbiosis work systems,” in *Advances in Production Management Systems. Initiatives for a Sustainable World* (I. Nääs, O. Vendrametto, J. Mendes Reis, R. F. Gonçalves, M. T. Silva, G. von Cieminski, and D. Kiritsis, eds.), (Cham), pp. 677–686, Springer International Publishing, 2016.
- [122] T. Ruppert, S. Jaskó, T. Holczinger, and J. Abonyi, “Enabling technologies for operator 4.0: A survey,” *Applied Sciences*, vol. 8, no. 9, 2018.
- [123] A. Bousdekis, D. Apostolou, and G. Mentzas, “A human cyber physical system framework for operator 4.0 – artificial intelligence symbiosis,” *Manufacturing Letters*, vol. 25, pp. 10–15, 2020.
- [124] P. Arpaia, D. Dallet, E. Erra, and A. Tedesco, “Reliability measurements of an augmented reality-based 4.0 system for supporting workmen in handmade assembly,” in *24th IMEKO TC4 International Symposium and 22nd International Workshop on ADC and DAC Modelling and Testing*, pp. 190–195, 2020.
- [125] P. D’Amore and A. Tedesco, “Technologies for the implementation of a security system on rail transportation infrastructures,” *Topics in Safety, Risk, Reliability and Quality*, vol. 27, pp. 123–141, 2015.
- [126] S. Grazioso, A. Tedesco, M. Selvaggio, S. Debei, S. Chiodini, Egidio De Benedetto, G. D. Gironimo, and A. Lanzotti, “Design of a soft growing robot as a practical example of cyber–physical measurement systems,” in *IEEE Metrology for Industry 4.0 and IoT Proceedings*, IEEE, 2021.

- [127] S. Grazioso, A. Tedesco, M. Selvaggio, S. Debei, and S. Chiodini, "Towards the development of cyber-physical measurement systems (CPMSs): case study of a bioinspired soft growing robot for remote measurement and monitoring applications," *ACTA IMEKO*, vol. 10, no. 2, pp. 103–109, 2021.
- [128] M. Poole and M. Warner, *The IEBM handbook of human resource management*. International Thomson Business, 1998.
- [129] J. Fischer, A. Calame, A. Dettling, H. Zeier, and S. Fanconi, "Objectifying psychomental stress in the workplace—an example," *International archives of occupational and environmental health*, vol. 73, no. 1, pp. S46–S52, 2000.
- [130] B. Siciliano and O. Khatib, *Springer handbook of robotics*. Springer, 2016.
- [131] N. Sharma and T. Gedeon, "Objective measures, sensors and computational techniques for stress recognition and classification: A survey," *Computer methods and programs in biomedicine*, vol. 108, no. 3, pp. 1287–1301, 2012.
- [132] M. Choi, G. Koo, M. Seo, and S. W. Kim, "Wearable device-based system to monitor a driver's stress, fatigue, and drowsiness," *IEEE Transactions on Instrumentation and Measurement*, vol. 67, no. 3, pp. 634–645, 2017.
- [133] J. Minguillon, E. Perez, M. Lopez-Gordo, F. Pelayo, and M. Sanchez-Carrion, "Portable System for Real-Time Detection of Stress Level," *Sensors*, vol. 18, no. 8, p. 2504, 2018.
- [134] H. Jebelli, S. Hwang, and S. Lee, "EEG-based workers' stress recognition at construction sites," *Automation in Construction*, vol. 93, pp. 315–324, 2018.
- [135] C. Setz *et al.*, "Discriminating stress from cognitive load using a wearable EDA device," *IEEE Transactions on information technology in biomedicine*, vol. 14, no. 2, pp. 410–417, 2009.
- [136] J. W. Ahn, Y. Ku, and H. C. Kim, "A Novel Wearable EEG and ECG Recording System for Stress Assessment," *Sensors*, vol. 19, no. 9, p. 1991, 2019.
- [137] L. Angrisani, P. Arpaia, D. Casinelli, and N. Moccaldi, "A Single-Channel SSVEP-Based Instrument With Off-the-Shelf Components for Trainingless Brain-Computer Interfaces," *IEEE Transactions on Instrumentation and Measurement*, 2018.
- [138] G. Matthews, L. Joyner, K. Gilliland, S. Campbell, S. Falconer, and J. Huggins, "Validation of a comprehensive stress state questionnaire: Towards a state big three," *Personality psychology in Europe*, vol. 7, pp. 335–350, 1999.
- [139] S. L. Müller-Abdelrazeq, S. Stiehm, M. Haberstroh, and F. Hees, "Perceived Effects of Cycle Time in Human-Robot-Interaction," in *2018 IEEE Workshop on Advanced Robotics and its Social Impacts (ARSO)*, pp. 25–30, IEEE, 2018.

- [140] J. Wijsman, B. Grundlehner, H. Liu, H. Hermens, and J. Penders, "Towards mental stress detection using wearable physiological sensors," in *2011 Annual International Conference of the IEEE Engineering in Medicine and Biology Society*, pp. 1798–1801, IEEE, 2011.
- [141] A.-M. Brouwer, M. A. Neerincx, V. Kallen, L. van der Leer, and M. ten Brinke, "EEG alpha asymmetry, heart rate variability and cortisol in response to virtual reality induced stress," *Journal of Cybertherapy & Rehabilitation*, vol. 4, no. 1, pp. 21–34, 2011.
- [142] S. GR *et al.*, "Development of four stress levels in group stroop colour word test using HRV analysis.," *Biomedical Research (0970-938X)*, vol. 28, no. 1, 2017.
- [143] A. Mohammed and L. Wang, "Brainwaves driven human-robot collaborative assembly," *CIRP annals*, vol. 67, no. 1, pp. 13–16, 2018.
- [144] B. Wallace, F. Knoefel, R. Goubran, R. A. L. Zunini, Z. Ren, and A. Maccosham, "EEG/ERP: within episodic assessment framework for cognition," *IEEE Transactions on Instrumentation and Measurement*, vol. 66, no. 10, pp. 2525–2534, 2017.
- [145] L.-D. Liao *et al.*, "A novel 16-channel wireless system for electroencephalography measurements with dry spring-loaded sensors," *IEEE Transactions on Instrumentation and Measurement*, vol. 63, no. 6, pp. 1545–1555, 2014.
- [146] Y.-C. Chen, B.-S. Lin, and J.-S. Pan, "Novel noncontact dry electrode with adaptive mechanical design for measuring EEG in a hairy site," *IEEE Transactions on Instrumentation and Measurement*, vol. 64, no. 12, pp. 3361–3368, 2015.
- [147] S. Mühlbacher-Karrer, A. H. Mosa, L.-M. Faller, M. Ali, R. Hamid, H. Zangl, and K. Kyamakya, "A driver state detection system—combining a capacitive hand detection sensor with physiological sensors," *IEEE Transactions on Instrumentation and Measurement*, vol. 66, no. 4, pp. 624–636, 2017.
- [148] Z. Gao, S. Li, Q. Cai, W. Dang, Y. Yang, C. Mu, and P. Hui, "Relative wavelet entropy complex network for improving EEG-based fatigue driving classification," *IEEE Transactions on Instrumentation and Measurement*, no. 99, pp. 1–7, 2018.
- [149] D. J. Krusienski *et al.*, "Critical issues in state-of-the-art brain–computer interface signal processing," *Journal of neural engineering*, vol. 8, no. 2, p. 025002, 2011.
- [150] F. Lotte *et al.*, "A review of classification algorithms for EEG-based brain–computer interfaces: a 10 year update," *Journal of neural engineering*, vol. 15, no. 3, p. 031005, 2018.
- [151] X. Chen, H. Peng, F. Yu, and K. Wang, "Independent vector analysis applied to remove muscle artifacts in EEG data," *IEEE Transactions on Instrumentation and Measurement*, vol. 66, no. 7, pp. 1770–1779, 2017.



- [152] X. Chen, X. Xu, A. Liu, M. J. McKeown, and Z. J. Wang, "The use of multivariate EMD and CCA for denoising muscle artifacts from few-channel EEG recordings," *IEEE transactions on instrumentation and measurement*, vol. 67, no. 2, pp. 359–370, 2017.
- [153] M. Zanetti, T. Mizumoto, L. Faes, A. Fornaser, M. De Cecco, L. Maule, M. Valente, and G. Nollo, "Multilevel assessment of mental stress via network physiology paradigm using consumer wearable devices," *Journal of Ambient Intelligence and Humanized Computing*, pp. 1–10, 2019.
- [154] S. A. Hosseini and M. A. Khalilzadeh, "Emotional stress recognition system using EEG and psychophysiological signals: Using new labelling process of EEG signals in emotional stress state," in *2010 international conference on biomedical engineering and computer science*, pp. 1–6, IEEE, 2010.
- [155] P. Zhang, X. Wang, X. Li, and P. Dai, "EEG feature selection based on weighted-normalized mutual information for mental fatigue classification," in *2016 IEEE International Instrumentation and Measurement Technology Conference Proceedings*, pp. 1–6, IEEE, 2016.
- [156] X. Hou *et al.*, "EEG based stress monitoring," in *2015 IEEE International Conference on Systems, Man, and Cybernetics*, pp. 3110–3115, IEEE, 2015.
- [157] G. Jun and K. G. Smitha, "EEG based stress level identification," in *2016 IEEE International Conference on Systems, Man, and Cybernetics (SMC)*, pp. 003270–003274, IEEE, 2016.
- [158] A. Secerbegovic, S. Ibric, J. Nisic, N. Suljanovic, and A. Mujcic, "Mental workload vs. stress differentiation using single-channel EEG," in *CMBEIH 2017*, pp. 511–515, Springer, 2017.
- [159] D. Bian, J. W. Wade, A. Swanson, Z. Warren, and N. Sarkar, "Physiology-based affect recognition during driving in virtual environment for autism intervention.," in *PhyCS*, pp. 137–145, 2015.
- [160] N. Jatupaiboon, S. Pan-ngum, and P. Israsena, "Emotion classification using minimal EEG channels and frequency bands," in *The 2013 10th International Joint Conference on Computer Science and Software Engineering (JCSSE)*, pp. 21–24, IEEE, 2013.
- [161] J. A. Coan and J. J. Allen, "Frontal EEG asymmetry as a moderator and mediator of emotion," *Biological psychology*, vol. 67, no. 1-2, pp. 7–50, 2004.
- [162] I. Papousek *et al.*, "Prefrontal EEG alpha asymmetry changes while observing disaster happening to other people: cardiac correlates and prediction of emotional impact," *Biological psychology*, vol. 103, pp. 184–194, 2014.
- [163] R. N. Goodman, J. C. Rietschel, L.-C. Lo, M. E. Costanzo, and B. D. Hatfield, "Stress, emotion regulation and cognitive performance: The predictive contributions of trait and state relative frontal EEG alpha asymmetry," *International Journal of Psychophysiology*, vol. 87, no. 2, pp. 115–123, 2013.

- [164] J. Minguillon, M. A. Lopez-Gordo, and F. Pelayo, "Stress assessment by prefrontal relative gamma," *Frontiers in computational neuroscience*, vol. 10, p. 101, 2016.
- [165] J. A. Coan and J. J. Allen, "Frontal EEG asymmetry and the behavioral activation and inhibition systems," *Psychophysiology*, vol. 40, no. 1, pp. 106–114, 2003.
- [166] R. J. Davidson, "Anterior electrophysiological asymmetries, emotion, and depression: Conceptual and methodological conundrums," *Psychophysiology*, vol. 35, no. 5, pp. 607–614, 1998.
- [167] D. Hagemann, E. Naumann, J. F. Thayer, and D. Bartussek, "Does resting electroencephalograph asymmetry reflect a trait? an application of latent state-trait theory.," *Journal of personality and social psychology*, vol. 82, no. 4, p. 619, 2002.
- [168] J. J. Vidal, "Toward direct brain-computer communication," *Annual review of Biophysics and Bioengineering*, vol. 2, no. 1, pp. 157–180, 1973.
- [169] A. M. Norcia *et al.*, "The steady-state visual evoked potential in vision research: a review," *Journal of vision*, vol. 15, no. 6, pp. 4–4, 2015.
- [170] Y.-J. Huang, C.-Y. Wu, A. M.-K. Wong, and B.-S. Lin, "Novel active comb-shaped dry electrode for eeg measurement in hairy site," *IEEE Transactions on Biomedical Engineering*, vol. 62, no. 1, pp. 256–263, 2014.
- [171] D. Zhu, J. Bieger, G. Garcia Molina, and R. M. Aarts, "A survey of stimulation methods used in ssvep-based bcis," *Computational intelligence and neuroscience*, vol. 2010, 2010.
- [172] P. Arpaia, N. Moccaldi, R. Prevede, I. Sannino, and A. Tedesco, "A wearable eeg instrument for real-time frontal asymmetry monitoring in worker stress analysis," *IEEE Transactions on Instrumentation and Measurement*, vol. 69, no. 10, pp. 8335–8343, 2020.
- [173] I. Jolliffe, *Principal component analysis*. Springer, 2011.
- [174] E.-C. Chang, S.-C. Huang, and H.-H. Wu, "Using k-means method and spectral clustering technique in an outfitter's value analysis," *Quality & Quantity*, vol. 44, no. 4, pp. 807–815, 2010.
- [175] C. M. Bishop *et al.*, *Neural networks for pattern recognition*. Oxford university press, 1995.
- [176] P. Renaud and J.-P. Blondin, "The stress of stroop performance: Physiological and emotional responses to color–word interference, task pacing, and pacing speed," *International Journal of Psychophysiology*, vol. 27, no. 2, pp. 87–97, 1997.
- [177] C. D. Spielberger, *Manual for the State-Trait Anxiety Inventory STAI (form Y)( " self-evaluation questionnaire" )*. Consulting Psychologists Press, Inc., 1983.
- [178] J. Blascovich and J. Tomaka, "Measures of self-esteem," *Measures of personality and social psychological attitudes*, vol. 1, pp. 115–160, 1991.

- [179] A. Celisse and S. Robin, "Nonparametric density estimation by exact leave-p-out cross-validation," *Computational Statistics & Data Analysis*, vol. 52, no. 5, pp. 2350–2368, 2008.
- [180] K. Arquilla, A. K. Webb, and A. P. Anderson, "Textile electrocardiogram (ecg) electrodes for wearable health monitoring," *Sensors*, vol. 20, no. 4, p. 1013, 2020.
- [181] L. Corchia *et al.*, "Fully-textile, wearable chipless tags for identification and tracking applications," *Sensors*, vol. 20, no. 2, p. 429, 2020.
- [182] N. Starliper *et al.*, "Activity-aware wearable system for power-efficient prediction of physiological responses," *Sensors*, vol. 19, no. 3, p. 441, 2019.
- [183] D. I. Townsend, M. Holtzman, R. Goubran, M. Frize, and F. Knoefel, "Measurement of torso movement with delay mapping using an unobtrusive pressure-sensor array," *IEEE Transactions on Instrumentation and Measurement*, vol. 60, no. 5, pp. 1751–1760, 2011.
- [184] T. W. Wang, W. X. Chen, H. W. Chu, and S. F. Lin, "Single-channel bioimpedance measurement for wearable continuous blood pressure monitoring," *IEEE Transactions on Instrumentation and Measurement*, vol. 70, pp. 1–9, 2021.
- [185] K. Das, T. Yuasa, T. Maeda, I. Nishidate, H. Funamizu, and Y. Aizu, "Simple detection of absorption change in skin tissue using simulated spectral reflectance database," *Measurement*, vol. 182, p. 109684, 2021.
- [186] V. Oji and H. Traupe, "Ichthyosis," *American journal of clinical dermatology*, vol. 10, no. 6, pp. 351–364, 2009.
- [187] U. M. Thorkar and S. T. Hamde, "Non invasive measurement of skin biophysical parameters in normal, psoriasis, vitiligo affected skin," *2015 International Conference on Industrial Instrumentation and Control (ICIC)*, pp. 811–815, 2015.
- [188] O. G. Martinsen *et al.*, "Gravimetric method for in vitro calibration of skin hydration measurements," *IEEE Transactions on Biomedical Engineering*, vol. 55, no. 2, pp. 728–732, 2008.
- [189] Y. Sunwoo, C. Chou, J. Takeshita, M. Murakami, and Y. Tochihara, "Physiological and subjective responses to low relative humidity," *Journal of physiological anthropology*, vol. 25, no. 1, pp. 7–14, 2006.
- [190] G. Hall and T. J. Phillips, "Estrogen and skin: the effects of estrogen, menopause, and hormone replacement therapy on the skin," *Journal of the American Academy of Dermatology*, vol. 53, no. 4, pp. 555–568, 2005.
- [191] N. Muizzuddin, K. Marenus, P. Vallon, and D. Maes, "Effect of cigarette smoke on skin," *Journal of the Society of Cosmetic Chemists*, vol. 48, no. 5, pp. 235–242, 1997.

- [192] J. Marty, “Nmf and cosmetology of cutaneous hydration,” in *Annales de Dermatologie et de Venereologie*, vol. 129, pp. 131–136, 2002.
- [193] R. Schiavoni, G. Monti, A. Tedesco, L. Tarricone, E. PiuZZi, E. De Benedetto, A. Masciullo, and A. Cataldo, “Microwave wearable system for sensing skin hydration,” in *2021 IEEE International Instrumentation and Measurement Technology Conference (I2MTC)*, pp. 1–6, 2021.
- [194] A. Cataldo, E. De Benedetto, R. Schiavoni, G. Monti, A. Tedesco, A. Masciullo, E. PiuZZi, and L. Tarricone, “Portable microwave reflectometry system for skin sensing,” *IEEE Transactions on Instrumentation and Measurement*, vol. 71, pp. 1–8, 2022.
- [195] A. Cataldo, E. De Benedetto, L. Angrisani, G. Cannazza, and E. PiuZZi, “A microwave measuring system for detecting and localizing anomalies in metallic pipelines,” *IEEE Transactions on Instrumentation and Measurement*, vol. 70, pp. 1–11, 2020.
- [196] A. Cataldo, E. De Benedetto, A. Masciullo, and G. Cannazza, “A new measurement algorithm for tdr-based localization of large dielectric permittivity variations in long-distance cable systems,” *Measurement*, vol. 174, p. 109066, 2021.
- [197] A. Cataldo *et al.*, “Combined punctual and diffused monitoring of concrete structures based on dielectric measurements,” *Sensors*, vol. 21, no. 14, 2021.
- [198] A. Cataldo, E. De Benedetto, R. Schiavoni, A. Tedesco, A. Masciullo, and G. Cannazza, “Microwave reflectometric systems and monitoring apparatus for diffused-sensing applications,” *ACTA IMEKO*, vol. 10, no. 3, pp. 202–208, 2021.
- [199] A. Cataldo *et al.*, “Large-scale implementation of a new TDR-based system for the monitoring of pipe leaks,” in *XXI IMEKO World Congress ‘Measurement in Research and Industry*, pp. 1174–1177, 2015.
- [200] R. Schiavoni, G. Monti, E. PiuZZi, L. Tarricone, A. Tedesco, E. De Benedetto, and A. Cataldo, “Feasibility of a wearable reflectometric system for sensing skin hydration,” *Sensors*, vol. 20, no. 10, 2020.
- [201] C. Schwärzler and M. Schwärzler, *A guide to the NanoVNA*. Self-published, 2021.
- [202] C. Gabriel, “Compilation of the dielectric properties of body tissues at rf and microwave frequencies,” tech. rep., King’s Coll London (United Kingdom) Dept of Physics, 1996.
- [203] T. Fernández-Caramés and P. Fraga-Lamas, “Towards the internet-of-smart-clothing: A review on iot wearables and garments for creating intelligent connected e-textiles,” *Electronics*, vol. 7, no. 12, 2018.

- [204] P. Petz, F. Eibensteiner, and J. Langer, "Sensor shirt as universal platform for real-time monitoring of posture and movements for occupational health and ergonomics," in *Procedia Computer Science*, vol. 180, pp. 200–207, 2021.
- [205] P. Arpaia, E. De Benedetto, and L. Duraccio, "Design, implementation, and metrological characterization of a wearable, integrated AR-BCI hands-free system for health 4.0 monitoring," *Measurement*, vol. 177, 2021.
- [206] P. Arpaia, E. De Benedetto, C. Dodaro, L. Duraccio, and G. Servillo, "Metrology-based design of a wearable augmented reality system for monitoring patient's vitals in real time," *IEEE Sensors Journal*, vol. 21, no. 9, pp. 11176–11183, 2021.
- [207] B. Greinke *et al.*, "Interactive workwear: Smart maintenance jacket," in *UbiComp 2016 Adjunct - Proceedings of the 2016 ACM International Joint Conference on Pervasive and Ubiquitous Computing*, pp. 470–475, 2016.
- [208] A. Lanata *et al.*, "A new smart-fabric based body area sensor network for work risk assessment," in *2020 IEEE International Workshop on Metrology for Industry 4.0 and IoT, MetroInd 4.0 and IoT 2020 - Proceedings*, pp. 187–190, 2020.
- [209] L. Corchia, G. Monti, and L. Tarricone, "Durability of wearable antennas based on nonwoven conductive fabrics: Experimental study on resistance to washing and ironing," *International Journal of Antennas and Propagation*, vol. 2018, 2018.
- [210] S. Genovesi, F. Costa, M. Borgese, A. F. Dicandia, G. Manara, S. Tedjini, and E. Perret, "Enhanced chipless rfid tags for sensors design," in *2016 IEEE International Symposium on Antennas and Propagation (APSURSI)*, pp. 1275–1276, 2016.
- [211] S. Genovesi, F. Costa, M. Borgese, F. A. Dicandia, A. Monorchio, and G. Manara, "Chipless rfid sensor for rotation monitoring," in *2017 IEEE International Conference on RFID Technology Application (RFID-TA)*, pp. 233–236, 2017.
- [212] P. Mukherjee, "Dielectric properties in textile materials: a theoretical study," *Journal of the Textile Institute*, vol. 110, no. 2, pp. 211–214, 2019.
- [213] C. Hertleer, A. Van Laere, H. Rogier, and L. Van Langenhove, "Influence of relative humidity on textile antenna performance," *Textile Research Journal*, vol. 80, no. 2, pp. 177–183, 2010.
- [214] T. Grethe, S. Borczyk, K. Plenkmann, M. Normann, M. Rabe, and A. Schwarz-Pfeiffer, "Textile humidity sensors," in *Symposium on Design, Test, Integration and Packaging of MEMS/MOEMS, DTIP 2018*, pp. 1–3, 2018.
- [215] C. Kutzner, R. Lucklum, R. Torah, S. Beeby, and J. Tudor, "Novel screen printed humidity sensor on textiles for smart textile applications," in *2013 Transducers and Eurosensors XXVII: The 17th*

- International Conference on Solid-State Sensors, Actuators and Microsystems, TRANSDUCERS and EUROSENSORS 2013*, pp. 282–285, 2013.
- [216] J. F. Salmerón *et al.*, “Wireless chipless system for humidity sensing,” *Sensors*, vol. 18, no. 7, 2018.
- [217] G. Zhou *et al.*, “Highly sensitive wearable textile-based humidity sensor made of high-strength, single-walled carbon nanotube/poly(vinyl alcohol) filaments,” *ACS Applied Materials and Interfaces*, vol. 9, no. 5, pp. 4788–4797, 2017.
- [218] X. Lin, B.-C. Seet, and F. Joseph, “Wearable humidity sensing antenna for ban applications over 5g networks,” in *2018 IEEE 19th Wireless and Microwave Technology Conference (WAMICON)*, pp. 1–4, 2018.
- [219] P. Salvo, A. Pingitore, A. Barbini, and F. Di Francesco, “A wearable sweat rate sensor to monitor the athletes’ performance during training [mise au point d’un capteur de mesure de la sudation durant l’entraînement],” *Science and Sports*, vol. 33, no. 2, pp. e51–e58, 2018.
- [220] J. Sim, S. Yoon, and Y.-H. Cho, “Wearable sweat rate sensors for human thermal comfort monitoring,” *Scientific Reports*, vol. 8, no. 1, 2018.
- [221] G. Monti, E. De Benedetto, A. Tedesco, D. Dallet, A. Cataldo, and L. Tarricone, “A textile humidity sensor for wearable applications in the 4.0 era,” in *2021 5th International Symposium on Instrumentation Systems, Circuits and Transducers (INSCIT)*, pp. 1–5, 2021.
- [222] L. Corchia, G. Monti, and L. Tarricone, “A frequency signature rfid chipless tag for wearable applications,” *Sensors*, vol. 19, no. 3, 2019.
- [223] G. Monti, L. Corchia, E. De Benedetto, and L. Tarricone, “A wearable wireless energy link for thin-film batteries charging,” *International Journal of Antennas and Propagation*, vol. 2016, pp. 1–9, 2016.
- [224] G. Monti, L. Corchia, and L. Tarricone, “Fabrication techniques for wearable antennas,” in *European Microwave Week 2013, EuMW 2013 - Conference Proceedings; EuMC 2013: 43rd European Microwave Conference*, pp. 1747–1750, 2013.
- [225] L. Corchia, E. De Benedetto, G. Monti, A. Cataldo, L. Angrisani, P. Arpaia, and L. Tarricone, “Radio-frequency identification based on textile, wearable, chipless tags for IoT applications,” in *2019 IEEE International Workshop on Metrology for Industry 4.0 and IoT, MetroInd 4.0 and IoT 2019 - Proceedings*, pp. 1–5, 2019.
- [226] G. Monti *et al.*, “Broadband compact planar monopole,” *Microwave and Optical Technology Letters*, vol. 53, no. 12, pp. 2838–2842, 2011.

- [227] T. M. Fernández-Caramés and P. Fraga-Lamas, “A review on the application of blockchain to the next generation of cybersecure industry 4.0 smart factories,” *IEEE Access*, vol. 7, pp. 45201–45218, 2019.
- [228] P. Fraga-Lamas, T. M. Fernández-Caramés, Ó. Blanco-Novoa, and M. A. Vilar-Montesinos, “A review on industrial augmented reality systems for the industry 4.0 shipyard,” *Ieee Access*, vol. 6, pp. 13358–13375, 2018.
- [229] S. Webel, U. Bockholt, T. Engelke, N. Gavish, M. Olbrich, and C. Preusche, “An augmented reality training platform for assembly and maintenance skills,” *Robotics and autonomous systems*, vol. 61, no. 4, pp. 398–403, 2013.
- [230] N. Gavish *et al.*, “Evaluating virtual reality and augmented reality training for industrial maintenance and assembly tasks,” *Interactive Learning Environments*, vol. 23, no. 6, pp. 778–798, 2015.
- [231] S. Henderson and S. Feiner, “Exploring the benefits of augmented reality documentation for maintenance and repair,” *IEEE transactions on visualization and computer graphics*, vol. 17, no. 10, pp. 1355–1368, 2010.
- [232] J. Zhu, S.-K. Ong, and A. Y. Nee, “A context-aware augmented reality assisted maintenance system,” *International Journal of Computer Integrated Manufacturing*, vol. 28, no. 2, pp. 213–225, 2015.
- [233] A. Y. Nee, S. Ong, G. Chryssolouris, and D. Mourtzis, “Augmented reality applications in design and manufacturing,” *CIRP annals*, vol. 61, no. 2, pp. 657–679, 2012.
- [234] B. Sarupuri, G. A. Lee, and M. Billinghamurst, “An augmented reality guide for assisting forklift operation,” in *2016 IEEE International Symposium on Mixed and Augmented Reality (ISMAR-Adjunct)*, pp. 59–60, IEEE, 2016.
- [235] A. Syberfeldt, O. Danielsson, and P. Gustavsson, “Augmented reality smart glasses in the smart factory: Product evaluation guidelines and review of available products,” *Ieee Access*, vol. 5, pp. 9118–9130, 2017.
- [236] S. A. Green, M. Billinghamurst, X. Chen, and J. G. Chase, “Human-robot collaboration: A literature review and augmented reality approach in design,” *International journal of advanced robotic systems*, vol. 5, no. 1, p. 1, 2008.
- [237] G. Avalle, F. De Pace, C. Fornaro, F. Manuri, and A. Sanna, “An augmented reality system to support fault visualization in industrial robotic tasks,” *IEEE Access*, vol. 7, pp. 132343–132359, 2019.
- [238] M. Funk and A. Schmidt, “Cognitive assistance in the workplace,” *IEEE Pervasive Computing*, vol. 14, no. 3, pp. 53–55, 2015.

- [239] L. Angrisani, P. Arpaia, A. Esposito, and N. Moccaldi, “A wearable brain-computer interface instrument for augmented reality-based inspection in industry 4.0,” *IEEE Transactions on Instrumentation and Measurement*, 2019.
- [240] A. Tang, C. Owen, F. Biocca, and W. Mou, “Comparative effectiveness of augmented reality in object assembly,” in *Proceedings of the SIGCHI conference on Human factors in computing systems*, pp. 73–80, 2003.
- [241] T. Masood and J. Egger, “Augmented reality in support of industry 4.0—implementation challenges and success factors,” *Robotics and Computer-Integrated Manufacturing*, vol. 58, pp. 181–195, 2019.
- [242] L. Daling, A. Abdelrazeq, C. Sauerborn, and F. Hees, “A comparative study of augmented reality assistant tools in assembly,” in *International Conference on Applied Human Factors and Ergonomics*, pp. 755–767, Springer, 2019.
- [243] D. Capriglione, M. Carratù, A. Pietrosanto, and P. Sommella, “Real-time implementation of an ifd scheme for motorcycle sensors,” in *2018 IEEE International Instrumentation and Measurement Technology Conference (I2MTC)*, pp. 1–6, IEEE, 2018.
- [244] L. J. De Vin and L. Jacobsson, “Karlstad lean factory: an instructional factory for game-based lean manufacturing training,” *Production & Manufacturing Research*, vol. 5, no. 1, pp. 268–283, 2017.
- [245] “Unity.” <https://unity.com/>. Accessed: April 01, 2022.
- [246] S. Bendzioch, D. Bläsing, and S. Hinrichsen, “Comparison of different assembly assistance systems under ergonomic and economic aspects,” in *International Conference on Human Systems Engineering and Design: Future Trends and Applications*, pp. 20–25, Springer, 2019.
- [247] S. Grazioso, G. Di Gironimo, and B. Siciliano, “A geometrically exact model for soft continuum robots: The finite element deformation space formulation,” *Soft robotics*, 2018.
- [248] “Wild-inspired robotic arms pbs learningmedia and nova.” <https://asknature.org/resource/wild-inspired-robotic-arms/>. Accessed: April 01, 2022.
- [249] E. W. Hawkes, L. H. Blumenschein, J. D. Greer, and A. M. Okamura, “A soft robot that navigates its environment through growth,” *Science Robotics*, vol. 2, no. 8, p. eaan3028, 2017.
- [250] J. D. Greer, T. K. Morimoto, A. M. Okamura, and E. W. Hawkes, “A soft, steerable continuum robot that grows via tip extension,” *Soft robotics*, vol. 6, no. 1, pp. 95–108, 2019.
- [251] J. S. Mehling, M. A. Diftler, M. Chu, and M. Valvo, “A minimally invasive tendril robot for in-space inspection,” in *IEEE/RAS-EMBS Int. Conf. on Biomedical Robotics and Biomechatronics*, pp. 690–695, 2006.



- [252] M. M. Tonapi, I. S. Godage, and I. D. Walker, "Next generation rope-like robot for in-space inspection," in *2014 IEEE Aerospace Conference*, pp. 1–13, IEEE, 2014.
- [253] M. M. Tonapi, I. S. Godage, A. Vijaykumar, and I. D. Walker, "A novel continuum robotic cable aimed at applications in space," *Advanced Robotics*, vol. 29, no. 13, pp. 861–875, 2015.
- [254] M. B. Wooten and I. D. Walker, "A novel vine-like robot for in-orbit inspection," in *45th Int. Conf. on Environmental Systems*, 2015.
- [255] D. Nahar, P. M. Yanik, and I. D. Walker, "Robot tendrils: Long, thin continuum robots for inspection in space operations," in *2017 IEEE Aerospace Conference*, pp. 1–8, IEEE, 2017.
- [256] X. Dong *et al.*, "Development of a slender continuum robotic system for on-wing inspection/repair of gas turbine engines," *Robotics and Computer-Integrated Manufacturing*, vol. 44, pp. 218–229, 2017.
- [257] M. Wang *et al.*, "Design and development of a slender dual-structure continuum robot for in-situ aeroengine repair," in *2018 IEEE/RSJ International Conference on Intelligent Robots and Systems (IROS)*, pp. 5648–5653, IEEE, 2018.
- [258] D. Axinte, X. Dong, D. Palmer, *et al.*, "Mirror—miniaturized robotic systems for holistic in situ repair and maintenance works in restrained and hazardous environments," *IEEE/ASME Trans. on Mechatronics*, vol. 23, pp. 978–981, 2018.
- [259] S. Grazioso, G. Di Gironimo, and B. Siciliano, "Modeling and vibration control of flexible mechanical systems for demo remote maintenance: Results from the flexarm project," *Fusion Engineering and Design*, 2019.
- [260] J. A. S. Rico, G. Endo, S. Hirose, and H. Yamada, "Development of an actuation system based on water jet propulsion for a slim long-reach robot," *Robomech Journal*, vol. 4, no. 1, p. 8, 2017.
- [261] K. Keogh *et al.*, "Laser cutting and welding tools for use in-bore on eu-demo service pipes," *Fusion Engineering and Design*, vol. 136, pp. 461–466, 2018.
- [262] J. Trevelyan, W. R. Hamel, and S.-C. Kang, "Robotics in hazardous applications," in *Springer handbook of robotics*, Springer, 2016.
- [263] R. Buckingham and A. Graham, "Nuclear snake-arm robots," *Industrial Robot: An International Journal*, vol. 39, no. 1, pp. 6–11, 2012.
- [264] R. Buckingham, V. Chitrakaran, R. Conkie, *et al.*, "Snake-arm robots: a new approach to aircraft assembly," tech. rep., SAE Technical Paper, 2007.
- [265] G. Antonelli, *Underwater robots*, vol. 3. Springer, 2014.

- [266] P. Liljebäck and R. Mills, “Eelume: A flexible and subsea resident imr vehicle,” in *Oceans 2017-Aberdeen*, pp. 1–4, IEEE, 2017.
- [267] C. Laschi *et al.*, “Soft robot arm inspired by the octopus,” *Advanced Robotics*, vol. 26, no. 7, pp. 709–727, 2012.
- [268] K. C. Galloway *et al.*, “Soft robotic grippers for biological sampling on deep reefs,” *Soft robotics*, vol. 3, no. 1, pp. 23–33, 2016.
- [269] J. Burgner-Kahrs, D. C. Rucker, and H. Choset, “Continuum robots for medical applications: A survey,” *IEEE Transactions on Robotics*, vol. 31, no. 6, pp. 1261–1280, 2015.
- [270] B. P. M. Yeung and T. Gourlay, “A technical review of flexible endoscopic multitasking platforms,” *International journal of surgery*, vol. 10, no. 7, pp. 345–354, 2012.
- [271] R. J. Hendrick, C. R. Mitchell, S. D. Herrell, and R. J. Webster III, “Hand-held transendoscopic robotic manipulators: A transurethral laser prostate surgery case study,” *The International journal of robotics research*, vol. 34, no. 13, pp. 1559–1572, 2015.
- [272] S. Can *et al.*, “Design, development and evaluation of a highly versatile robot platform for minimally invasive single-port surgery,” in *IEEE/RAS-EMBS Int. Conf. on Biomedical Robotics and Biomechatronics*, pp. 817–822, 2012.
- [273] L. Wu, S. Song, K. Wu, C. M. Lim, and H. Ren, “Development of a compact continuum tubular robotic system for nasopharyngeal biopsy,” *Medical & biological eng. & comp.*, vol. 55, no. 3, pp. 403–417, 2017.
- [274] H.-S. Yoon, H.-J. Cha, J. Chung, and B.-J. Yi, “Compact design of a dual master-slave system for maxillary sinus surgery,” in *2013 IEEE/RSJ International Conference on Intelligent Robots and Systems*, pp. 5027–5032, IEEE, 2013.
- [275] Y. Gao, K. Takagi, T. Kato, N. Shono, and N. Hata, “Continuum robot with follow the leader motion for endoscopic third ventriculostomy and tumor biopsy,” *IEEE Transactions on Biomedical Engineering*, 2019.
- [276] K. Xu and N. Simaan, “Intrinsic wrench estimation and its performance index for multisegment continuum robots,” *IEEE Transactions on Robotics*, vol. 26, no. 3, pp. 555–561, 2010.
- [277] L. Angrisani, P. Daponte, and M. D’Apuzzo, “A method based on wavelet networks for the detection and classification of transients,” in *Proceedings of the IEEE Instrumentation and Measurement Technology Conference (IMTC/98)*, vol. 2, pp. 903–908, IEEE, 1998.
- [278] L. Gallucci *et al.*, “An embedded wireless sensor network with wireless power transmission capability for the structural health monitoring of reinforced concrete structures,” *Sensors*, vol. 17, no. 11, p. 2566, 2017.

- [279] L. Angrisani and P. Daponte, “Thin thickness measurements by means of a wavelet transform-based method,” *Measurement*, vol. 20, no. 4, pp. 227–242, 1997.
- [280] L. Angrisani and R. S. L. Moriello, “Estimating ultrasonic time-of-flight through quadrature demodulation,” *IEEE transactions on instrumentation and measurement*, vol. 55, no. 1, pp. 54–62, 2006.
- [281] F. Ruggiero, V. Lippiello, and A. Ollero, “Aerial manipulation: A literature review,” *IEEE Robotics and Automation Letters*, vol. 3, no. 3, pp. 1957–1964, 2018.
- [282] I. H. Han, H. Yi, C.-W. Song, H. E. Jeong, and S.-Y. Lee, “A miniaturized wall-climbing segment robot inspired by caterpillar locomotion,” *Bioinspiration & biomimetics*, vol. 12, no. 4, p. 046003, 2017.
- [283] G. Gu, J. Zou, R. Zhao, X. Zhao, and X. Zhu, “Soft wall-climbing robots,” *Science Robotics*, vol. 3, no. 25, p. eaat2874, 2018.
- [284] J. Katrasnik, F. Pernus, and B. Likar, “A survey of mobile robots for distribution power line inspection,” *IEEE Transactions on power delivery*, vol. 25, no. 1, pp. 485–493, 2010.
- [285] K. P. Valavanis and G. J. Vachtsevanos, *Handbook of unmanned aerial vehicles*. Springer, 2015.
- [286] P. Daponte *et al.*, “Metrology for drone and drone for metrology: Measurement systems on small civilian drones,” in *2015 IEEE Metrology for Aerospace (MetroAeroSpace)*, pp. 306–311, IEEE, 2015.
- [287] S. Kim, C. Laschi, and B. Trimmer, “Soft robotics: a bioinspired evolution in robotics,” *Trends in biotechnology*, vol. 31, no. 5, pp. 287–294, 2013.
- [288] S. Grazioso, V. Sonneville, G. Di Gironimo, O. Bauchau, and B. Siciliano, “A nonlinear finite element formalism for modelling flexible and soft manipulators,” in *2016 IEEE Int. Conf. on Simulation, Modeling, and Programming for Autonomous Robots*, pp. 185–190, IEEE, 2016.
- [289] S. Grazioso, G. Di Gironimo, and B. Siciliano, “From differential geometry of curves to helical kinematics of continuum robots using exponential mapping,” in *International Symposium on Advances in Robot Kinematics*, pp. 319–326, Springer, 2018.
- [290] R. K. Katzschmann, C. Della Santina, Y. Toshimitsu, A. Bicchi, and D. Rus, “Dynamic motion control of multi-segment soft robots using piecewise constant curvature matched with an augmented rigid body model,” in *2019 2nd IEEE International Conference on Soft Robotics (RoboSoft)*, pp. 454–461, IEEE, 2019.
- [291] G. Robinson and J. B. C. Davies, “Continuum robots-a state of the art,” in *Proceedings 1999 IEEE International Conference on Robotics and Automation*, vol. 4, pp. 2849–2854, IEEE, 1999.

- [292] D. Trivedi, C. D. Rahn, W. M. Kier, and I. D. Walker, “Soft robotics: Biological inspiration, state of the art, and future research,” *Applied bionics and biomechanics*, vol. 5, no. 3, pp. 99–117, 2008.
- [293] D. Rus and M. T. Tolley, “Design, fabrication and control of soft robots,” *Nature*, vol. 521, no. 7553, p. 467, 2015.
- [294] R. J. Webster III and B. A. Jones, “Design and kinematic modeling of constant curvature continuum robots: A review,” *The International Journal of Robotics Research*, vol. 29, no. 13, pp. 1661–1683, 2010.
- [295] C. Shi *et al.*, “Shape sensing techniques for continuum robots in minimally invasive surgery: A survey,” *IEEE Transactions on Biomedical Engineering*, vol. 64, no. 8, pp. 1665–1678, 2017.
- [296] F. Taffoni, D. Formica, P. Saccomandi, G. Pino, and E. Schena, “Optical fiber-based mr-compatible sensors for medical applications: An overview,” *Sensors*, vol. 13, no. 10, pp. 14105–14120, 2013.
- [297] S. Perretta, B. Dallemagne, B. Barry, and J. Marescaux, “The anubiscope<sup>sup</sup> flexible platform ready for prime time: description of the first clinical case,” *Surgical endoscopy*, vol. 27, no. 7, p. 2630, 2013.
- [298] L. Angrisani, S. Grazioso, G. Di Gironimo, D. Panariello, and A. Tedesco, “On the use of soft continuum robots for remote measurement tasks in constrained environments: a brief overview of applications,” in *2019 IEEE International Symposium on Measurements & Networking (M&N)*, pp. 1–5, IEEE, 2019.
- [299] W. Hu, G. Z. Lum, M. Mastrangeli, and M. Sitti, “Small-scale soft-bodied robot with multimodal locomotion,” *Nature*, vol. 554, no. 7690, pp. 81–85, 2018.
- [300] A. Sadeghi, A. Mondini, and B. Mazzolai, “Toward self-growing soft robots inspired by plant roots and based on additive manufacturing technologies,” *Soft robotics*, vol. 4, no. 3, pp. 211–223, 2017.
- [301] M. M. Coad *et al.*, “Vine robots: Design, teleoperation, and deployment for navigation and exploration,” *arXiv preprint arXiv:1903.00069*, 2019.
- [302] S. Grazioso, A. Tedesco, M. Selvaggio, S. Debei, and S. Chiodini, “Towards the development of a cyber-physical measurement system (cpms): Case study of a bioinspired soft growing robot for remote measurement and monitoring applications,” *ACTA IMEKO*, vol. 10, no. 2, pp. 104–110, 2021.
- [303] C. Della Santina, M. G. Catalano, and A. Bicchi, “Soft robots,” *Encyclopedia of Robotics*, M. Ang, O. Khatib, and B. Siciliano, Eds. Springer, 2020.

- 
- [304] S. Grazioso, G. Di Gironimo, and B. Siciliano, “A geometrically exact model for soft continuum robots: The finite element deformation space formulation,” *Soft robotics*, vol. 6, no. 6, pp. 790–811, 2019.
- [305] E. W. Hawkes, L. H. Blumenschein, J. D. Greer, and A. M. Okamura, “A soft robot that navigates its environment through growth,” *Science Robotics*, vol. 2, no. 8, p. eaan3028, 2017.
- [306] J. D. Greer, L. H. Blumenschein, R. Alterovitz, E. W. Hawkes, and A. M. Okamura, “Robust navigation of a soft growing robot by exploiting contact with the environment,” *The International Journal of Robotics Research*, vol. 39, no. 14, pp. 1724–1738, 2020.
- [307] A. Cataldo, E. De Benedetto, G. Cannazza, N. Giaquinto, M. Savino, and F. Adamo, “Leak detection through microwave reflectometry: From laboratory to practical implementation,” *Measurement*, vol. 47, pp. 963–970, 2014.
- [308] A. Cataldo *et al.*, “Recent advances in the TDR-based leak detection system for pipeline inspection,” *Measurement*, vol. 98, pp. 347–354, 2017.