



HAL
open science

Caractérisation des effets bénéfiques de la microflore naturelle de l'huître du Pacifique *Crassostrea gigas* en vue d'applications en conchyliculture

Luc Dantan

► **To cite this version:**

Luc Dantan. Caractérisation des effets bénéfiques de la microflore naturelle de l'huître du Pacifique *Crassostrea gigas* en vue d'applications en conchyliculture. Biologie animale. Université de Perpignan, 2023. Français. NNT : 2023PERP0030 . tel-04382801

HAL Id: tel-04382801

<https://theses.hal.science/tel-04382801>

Submitted on 9 Jan 2024

HAL is a multi-disciplinary open access archive for the deposit and dissemination of scientific research documents, whether they are published or not. The documents may come from teaching and research institutions in France or abroad, or from public or private research centers.

L'archive ouverte pluridisciplinaire **HAL**, est destinée au dépôt et à la diffusion de documents scientifiques de niveau recherche, publiés ou non, émanant des établissements d'enseignement et de recherche français ou étrangers, des laboratoires publics ou privés.

THÈSE

Pour obtenir le grade de
Docteur



Délivré par
Université de Perpignan Via Domitia

Préparée au sein de l'école doctorale
ED305 Energie Environnement

Et de l'unité de recherche
**Interactions Hôtes Pathogènes Environnements
(IHPE) UMR 5244**

Spécialité : **Biologie**

Présentée par
Luc DANTAN

**Caractérisation des effets bénéfiques de la
microflore naturelle de l'huître du Pacifique
Crassostrea gigas en vue d'applications en
conchyliculture**

Soutenue le **09 octobre 2023**, devant le jury composé de

Mme Isabelle Arzul , Cadre de recherche, IFREMER La Tremblade	Rapporteur
Mme Christine Coustau Directrice de recherche, CNRS, INRAE Sophia Antipolis	Rapporteur
Mme Delphine Passerini Cadre de recherche, IFREMER centre Atlantique	Examinatrice
M Benjamin Gourbal Professeur des universités, Université de Perpignan Via Domitia	Examinateur
M Guillaume Mitta Directeur de recherche, Centre IFREMER du Pacifique	Examinateur
Mme Céline Cosseau Maître de conférences, Université de Perpignan Via Domitia	Directrice de thèse
Mme Eve Toulza Maître de conférences, Université de Perpignan Via Domitia	Co-directrice de thèse
M Yannick Gueguen Chargé de recherche, Station IFREMER de Sète	Co-directeur de thèse



Remerciements

Je tiens tout d'abord à remercier Madame Isabelle Arzul et Madame Christine Coustau d'avoir accepté d'être les rapporteurs de ma thèse et d'avoir pris le temps d'évaluer mon travail de recherche.

Je souhaite également remercier Madame Delphine Passerini, Monsieur Benjamin Gourbal et Monsieur Guillaume Mitta d'avoir accepté d'être les examinateurs de cette thèse.

Je remercie aussi les membres de mon CSI, Madame Lise Barthelmebs, Monsieur Fabrice Pernet, Monsieur Raphaël Lami, Monsieur Camille Clérissi, Monsieur Bruno Petton et Monsieur Yannick Fleury. Merci à vous tous pour vos nombreux conseils et les échanges très enrichissants.

Je souhaite remercier chaleureusement mes encadrants de thèse, Madame Céline Cosseau, Madame Eve Toulza et Monsieur Yannick Gueguen. Il est difficile de vous écrire des remerciements personnalisés tant vous partagez de nombreuses qualités.

Céline, un grand merci pour l'opportunité que tu m'as accordée. L'immense sincérité dont tu fais preuve au quotidien aura été d'un énorme soutien pour le déroulement de ma thèse. J'espère que de t'avoir côtoyé pendant quatre ans m'aura permis d'acquérir, grâce à la magie de l'épigénétique, un peu de ta bienveillance et de ta persévérance. En tout cas, j'ai déjà pris goût au carré de chocolat pendant les réunions de thèse.

Eve, merci pour ta gentillesse, ta bonne humeur à toute épreuve et ta disponibilité, même quand on te croise en train de courir dans les couloirs pour te rendre à une de tes nombreuses réunions ou heures de cours. Merci également de m'avoir guidé sur le chemin de la recherche (j'espère que ton sens de l'orientation ne se sera pas trompé 😊) et pour avoir su m'encourager lorsque j'en avais besoin.

Yannick, merci pour ta bienveillance et la patience dont tu as dû faire preuve pour m'aider dans les divers actes administratifs. Merci également d'avoir apporté à ma thèse ton expertise sur l'aquaculture.

Je remercie également tous les membres de l'IHPE pour contribuer à la bonne ambiance générale de ce laboratoire. Merci à tous les membres de l'équipe TReV, les échanges avec vous m'ont permis de faire évoluer et d'améliorer ma recherche.

Agnès, merci beaucoup pour ton aide et ton implication dans ma thèse.

Jérémie, je me rappellerai de cette petite escapade en bateau sur le bassin d'Arcachon. Elle fait sans aucun doute partie des moments les plus sympathiques de cette thèse. Merci également de m'avoir transmis de ton savoir, notamment pour les analyses de transcriptomiques.

David Duval, merci beaucoup pour les visites surprises dans le bureau des étudiants aux alentours de 18h. Ces échanges avec toi, heu vous, étaient à la fois enrichissants mais aussi des moments de détente agréables en fin de journée.

Benjamin, merci pour la découverte de cette boulangerie à Montpellier et surtout pour la découverte de la pâtisserie locale que même les Montpelliérains ne connaissent pas, le fameux pavé montpelliérain.

Jeff, merci pour toute l'aide technique que tu m'as apportée. Merci aussi de nous rendre la vie de laboratoire si agréable. Dès que tu pars, le chaos s'installe dans le laboratoire. Merci également pour la découverte du paddle. Juste après le rendu de la thèse, cela a été un très bon moyen de se défouler.

Gaëlle, Océane et Juliette, merci à vous pour l'aide que vous m'avez apportée. Les moments d'échanges que j'ai eus avec vous lors de mes séjours à Montpellier ont toujours été des moments agréables.

Diane et Camille, merci à vous pour votre aide incommensurable sur la gestion des ordres de mission et autres problèmes administratifs. Merci aussi à vous pour les discussions tantôt sérieuses tantôt à la rigolade lors de la pause-café.

Anne Modat, merci pour la patience dont tu fais preuve à notre égard. Nous courir après pour avoir toutes les informations que l'on doit normalement te transmettre ne doit pas être des plus simples et pourtant tu gardes toujours le sourire. Je te souhaite du bonheur dans ta nouvelle vie montpelliéraine.

Merci Richard pour m'avoir fourni un bureau neuf et climatisé. Un élément indispensable pour la réussite d'une thèse quand on est dans le sud.

À la soupe ! Merci à l'équipe du midi. Julien Portela, tu as toujours été là depuis le début. Ton humour m'a permis de m'intégrer et de me lâcher un peu, moi qui ne parlais pas beaucoup. Merci également à Olivier Portela et Damien pour votre bonne humeur et la convivialité que vous avez emmenée avec vous. Les pauses repas étaient, grâce à vous, de vraies coupures dans les journées de travail.

Bruno Petton, une rencontre que je ne suis pas près d'oublier. Merci beaucoup pour ton accueil chaleureux lors de mes séjours à Argenton et pour ton aide précieuse lors de mes premiers prélèvements d'huîtres.

Merci à toute l'équipe de l'IFREMER de La Tremblade pour m'avoir accueilli de nombreuses fois parmi vous. J'ai beaucoup appris grâce à vous, tant sur l'élevage larvaire des huîtres que sur les infections expérimentales.

Merci à la plateforme Bio2Mar de Banyuls et surtout merci à vous, Laurent, Raphaël, Mattea et Emilie, pour m'avoir accueilli parmi vous lors de ma première année de thèse.

Merci également à l'équipe du LBCM de Quimper pour l'accueil convivial autour d'une galette des rois presque tous les jours.

Un grand merci aux trois stagiaires que j'ai eu l'occasion d'encadrer au cours de ma thèse, Maïlys Combes, Prunelle Carcassonne et Laetitia Essomba. Sans vous, ma thèse ne serait pas ce qu'elle est aujourd'hui. Je vous souhaite de la réussite dans votre avenir, et pour toi, Prunelle, je t'envoie tout plein de bonnes ondes pour que ta fin de thèse et la rédaction de ton manuscrit se déroulent sous les meilleurs auspices. En tous cas, il reste un peu de temps, mais il me tarde de lire ton manuscrit.

SAMBA ! do Roscoff ! Sauvann, on s'était déjà rencontrés lors de nos stages de M2 respectifs sans trop avoir le temps de discuter. Le temps fait bien les choses et la formation métabarcoding aura permis de renouer le contact. Je te souhaite bien du bonheur dans ta future vie qui t'attend après ta thèse.

Merci à tous les doctorants du laboratoire IHPE. Nélia, ta gentillesse et la volonté que tu mets dans ton travail n'auront eu de cesse de m'impressionner. Chrystelle, le temps passé avec toi aura malheureusement été trop court, mais je garde de très bons souvenirs de moments de rigolade passés dans l'ancien bureau des doctorants. Pierre, l'aigle du labo. Le nombre de manip que tu réalises en simultané me surprend toujours. Bon courage pour la dernière ligne droite et n'oublie pas de te préserver. Manon, merci pour tous ces bons moments passés au cours de ces trois ans à partager nos joies et nos galères au cours de cette thèse. Philippe, mon confrère de café, à nous deux on en aura coulé et bu des litres de café. Cécile, j'ai apprécié nos échanges amicaux et scientifiques. Elodie, je garderai gravé en moi l'image de la soirée karaoké durant laquelle tu as enflammé la piste, garde cette énergie et cette bonne humeur. Mathilde, (ou 小面包) j'ai été très heureux de te rencontrer, et d'avoir la chance de pouvoir goûter à tes essais culinaires. Tes cookies sont vraiment une tuerie, c'était vraiment nul de devoir te partager avec ton équipe de Montpellier ! Léo, merci pour l'initiation à l'escalade, et merci pour l'organisation de la randonnée au Canigou, de toutes celles que j'ai faites je pense pouvoir dire sans me tromper que ça aura été la meilleure. Sarah, tu auras apporté joie et bonne humeur dans notre bureau. Merci également pour la recommandation des petits restaurants bien sympathiques à côté du Sphinx. Promis, maintenant que j'aurai un peu plus de temps, on ira boire un verre en ville. Amélie, merci de m'avoir rassuré, je sais maintenant qu'il est possible de manger des Kinder à la pause de 10 heures et manger fast-food au moins une fois par semaine sans prendre un kilo ! J'avais un camarade, de meilleur il n'en est pas, ... un grand MERCI à toi Rémi, sans toi, ces quatre années de thèse n'auraient pas été ce qu'elles sont. Tu es un ami précieux et tu as été un soutien important dans ma thèse. Quatre années de thèse avec toi auront été trop courtes. J'en profite également pour remercier l'œil de Moscou, Anaïs, c'est à contre cœur que je te laisse la garde exclusive de Rémi. Prends soin de lui dans votre nouvelle vie.

Je remercie également mes parents Gaëlle et David, ma sœur Mayane et mes grands-parents Marie-France, Régine, Jean-Marc et Monique pour m'avoir soutenu et apporté du réconfort durant ces longues années d'études. Merci également à toute ma belle-famille pour les agréables moments passés en Normandie (et ce n'est que le début).

Enfin, ces derniers remerciements reviennent à ma femme Margot. Ta présence et ton soutien inébranlable ont été essentiels pour moi. Je ne saurais jamais assez te remercier pour tout ce que tu as fait pour moi.



Table des matières

Remerciements	
Table des matières	
Liste des figures	
Liste des abréviations	
Introduction	1
I. L'ostréiculture en France.	1
II. L'huître du Pacifique <i>Crassostrea gigas</i>	3
1. Classification taxonomique.....	3
2. Cycle de vie.....	4
3. Anatomie et physiologie de l'huître.....	5
4. Le microbiote de <i>Crassostrea gigas</i>	5
5. Les agents pathogènes affectant l'huître <i>C. gigas</i>	7
a. Les Ostreid Herpes Virus.	8
b. <i>Vibrio aestuarianus</i>	10
6. La réponse immunitaire chez <i>C. gigas</i>	12
a. Le système immunitaire inné.	12
b. Les hémocytes.	14
c. Molécules de reconnaissance du non-soi	15
III. Les bactéries comme moyens de lutte contre les maladies infectieuses affectant l'huître <i>C. gigas</i>	17
1. Modes d'actions directs : Activités antibactériennes et Quorum Quenching.....	17
2. Modes d'actions indirects : modulation du système immunitaire de l'hôte.....	19
Publication 1	20
IV. Objectifs de la thèse.....	62
Chapitre 1 : Rôle de l'éducation microbienne dans le développement du système immunitaire de l'huître <i>Crassostrea gigas</i> à des fins de lutte contre les maladies infectieuses.....	64

I.	Contexte et objectifs.....	65	
II.	Matériel et méthodes	66	
III.	Résultats.....	67	
IV.	Discussion / Conclusion	69	
	Publication 2.....	71	
Chapitre 2 : Caractérisation des effets antagonistes de bactéries issues du microbiote de l'huître <i>Crassostrea gigas</i> dans la réponse face à la maladie du POMS et à la bactérie pathogène <i>Vibrio aestuarianus</i>			120
I.	Utilisation des activités antibactériennes de bactéries issues du microbiote de l'huître <i>C. gigas</i> comme moyen de lutte contre les infections à OsHV-1 μ Var et <i>V. aestuarianus</i>	121	
1.	Contexte et objectifs	121	
2.	Matériel et Méthodes	122	
3.	Résultats.....	123	
4.	Discussion / Conclusion.....	125	
	Publication 3.....	127	
II.	Caractérisation biochimique de composés à activités antibactériennes produits par des bactéries issues du microbiote de l'huître <i>Crassostrea gigas</i>	160	
1.	Introduction.....	160	
2.	Matériel et Méthode	160	
3.	Résultats	163	
4.	Discussion et Conclusion	169	
III.	Caractérisation des activités de Quorum Quenching de bactéries issues du microbiote naturel de l'huître <i>Crassostrea gigas</i>	171	
1.	Introduction.....	171	
2.	Matériel et Méthodes	171	
3.	Résultats.....	173	
4.	Discussion et Conclusion.....	175	
	Discussion générale et Perspectives	176	

Conclusion.....	184
Références bibliographiques	185
Annexes	202
Abstract	263
Résumé.....	265

Liste des figures

Figure 1 :	Production ostréicole en France de 1950 à 2020.....	2
Figure 2 :	Répartition et production ostréicole (en bleu) et mytilicole (en rose) en France (hors écloseries).....	3
Figure 3 :	Cycle de vie de l’huître du Pacifique <i>Crassostrea gigas</i>	4
Figure 4 :	Schéma de l’anatomie de l’huître du Pacifique issue de (Gay 2004).	5
Figure 5 :	Théorie de l'holobionte et de l'hologénome d'après Theis.....	6
Figure 6 :	Schéma reprenant les étapes clé de la maladie du POMS causée par OsHV-1 μ Var.....	9
Figure 7 :	Nombre de pays ayant rapporté la détection de <i>V. aestuarianus</i>	11
Figure 8 :	Schéma du mécanisme de virulence de <i>Vibrio aestuarianus subsp. francensis</i> 01/032	12
Figure 9 :	Représentation schématique des différents types de mémoire immunitaire innée chez différents invertébrés.....	13
Figure 10 :	Implications des hémocytes lors de la réponse immunitaire chez les invertébrés..	15
Figure 11 :	Représentation schématique du système de régulation Lux I/Lux R dépendant des N-Acyl Homosérine Lactone (AHL).....	18
Figure 12:	Overall experimental design for bacterial exposure and experimental infections performed with the NTA oyster population.....	136
Figure 13 :	Résultats des tests d'activités antibactériennes des fractions issue de la phase organique dirigés contre la souche <i>Marinomonas sp.</i> 12/107-2T2.....	164
Figure 14 :	Chromatogramme HPLC-DAD-DEDL de la phase organique (AE).	165
Figure 15 :	Chromatogramme obtenu par analyse LC-HRMS.	166
Figure 16 :	Spectres de fragmentation en LC-HRMS/MS (mode positif) des ions correspondant au (A) pic A1, (B) pic A2 et (C) pic B.....	167
Figure 17 :	Spectre RMN ion du proton de l’ion 314 dans CDCl ₃ à 303K pour la molécule correspondant au pic B.	168
Figure 18 :	Résultats du test d’activité antibactérienne de la N-Lauroyl-leucine dirigé contre la bactérie <i>Marinomonas sp.</i> 12/107-2T2.....	169
Figure 19 :	Principe de fonctionnement du biosenseur <i>Escherichia coli</i> MT102.....	172
Figure 20 :	Résultats des tests d'activité de quorum quenching.....	174

Figure 21 : Hypothèse émise à la suite d'une analyse protéomique sur les mécanismes moléculaires impliqués dans l'interaction entre le virus OsHV-1 et les cellules des huîtres sensibles (partie supérieure) et résistantes (partie inférieure). 178

Liste des abréviations

AHL :	N-Acyl Homosérine Lactone
DAD :	Détecteur Alliance à barrette de Diode
DEDL :	Détecteur à Diffusion de Lumière par Evaporation
HPLC :	High Performance Liquid Chromatography (Chromatographie en phase liquide à haute performance)
LC-HRMS :	Liquid Chromatography–High Resolution Mass Spectrometry (Chromatographie Liquide couplé à un spectromètre de masse haute résolution)
NSI :	Naissains standardisés Ifremer
OsHV-1 μ Var :	Ostreid Herpes Virus 1 variant μ Var
PAMP :	Pathogen-associated Molecular Patterns (Profils moléculaires associés aux agents pathogènes).
POMS :	Pacific Oyster Mortality Syndrome (Syndrome de mortalité de l’huitre du Pacifique)
PRR :	Pattern Recognition Receptors (Récepteurs de reconnaissance de motifs)
RMN :	Résonance Magnétique Nucléaire

Introduction

L'aquaculture est le secteur de production alimentaire à la croissance la plus rapide au monde, avec une production de 53,4 millions de tonnes de poissons, 17,5 millions de tonnes de mollusques et 9,4 millions de tonnes de crustacés pour l'année 2018 (Food and Agriculture Organization of the United Nations 2020). Les invertébrés marins constituent donc des groupes d'espèces majeurs apportant une contribution fondamentale à la source alimentaire de protéines animales et soutenant d'importantes industries aquacoles dans le monde. Compte tenu de l'importance socio-économique de ces espèces, un grand intérêt a été consacré à l'étude des maladies infectieuses qui affectent de manière récurrente ces productions, représentant une limitation principale pour l'expansion de l'aquaculture (Stentiford *et al.* 2012 ; Burge *et al.* 2014 ; Pernet *et al.* 2016). Des données de mortalités massives récurrentes se sont accumulées, démontrant le rôle dévastateur des maladies infectieuses sur les populations sauvages et cultivées. On retrouve parmi ces maladies infectieuses le « White Spot Syndrome Virus » (WSSV), pouvant induire jusqu'à 100 % de mortalité dans les élevages de crevettes (Sánchez-Paz 2010), le « withering syndrome » (WS) capable d'induire 99 % de mortalité chez l'ormeau *Haliotis cracherodii* aux États-Unis (Crosson and Friedman 2018) ou encore les infections à *Vibrio sp.* affectant de nombreuses espèces marines et notamment les huîtres (Travers *et al.* 2015 ; Destoumieux-Garzón *et al.* 2020).

I. L'ostréiculture en France.

En France, l'espèce endémique *Ostrea edulis*, aussi appelée huître plate, a atteint un pic de production en 1961 avec une production estimée à 29 400 tonnes, mais une succession d'épizooties entre 1977 et 1980, provoquées par les parasites *Marteilia refringens* (protozoaire extracellulaire parasite de l'appareil digestif (Grizel 1974; Le Roux *et al.* 2001)) et *Bonamia ostreae* (protozoaire parasite intracellulaire des hémocytes) (Pichot *et al.* 1981; Cochenec *et al.* 2000), ont conduit à une baisse de 90 % de sa production. En parallèle, l'huître portugaise *Crassostrea angulata* a vu sa production s'effondrer en 1970 à la suite d'une épizootie provoquée par un Irido-like virus. Ces épizooties ont conduit les ostréiculteurs français à introduire une nouvelle espèce, l'huître *Crassostrea gigas* (**Figure 1**).

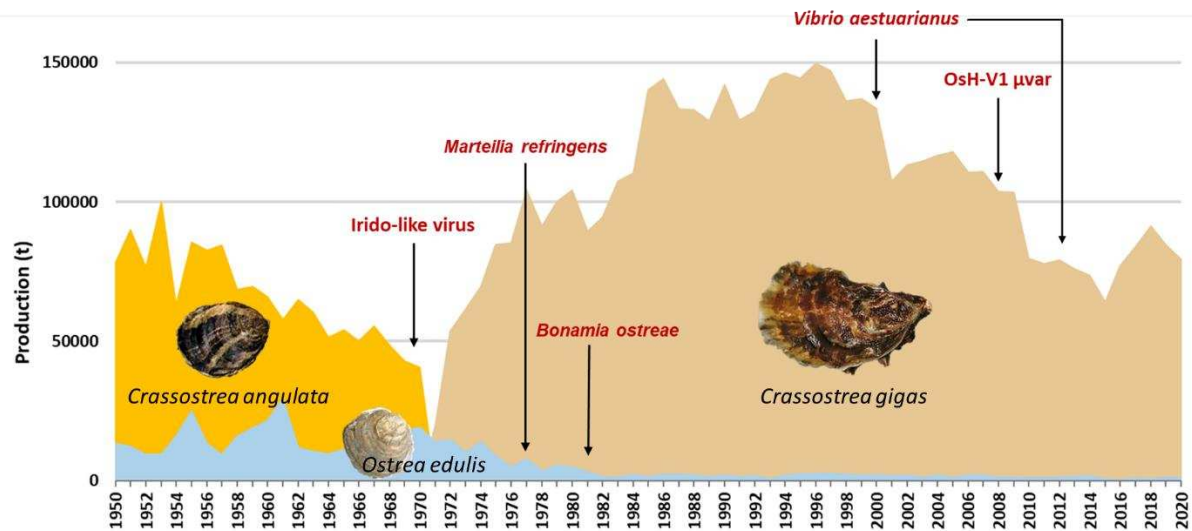

Figure 1 : Production ostréicole en France de 1950 à 2020. Bleu : huître plate *Ostrea edulis* ; Jaune : huître portugaise *Crassostrea angulata* ; Maron : huître du Pacifique *Crassostrea gigas*. Les noms en rouge correspondent aux principaux agents pathogènes des huîtres. D'après FishStatJ (www.fao.org/fishery/statistics/software/fishstatj/fr) et (Azéma *et al.* 2015).

L'huître *C. gigas*, aussi appelée huître du Pacifique ou huître creuse, a été importée du Japon et de Colombie-Britannique en France entre 1971 et 1975 (Grize and Héra 1991). Depuis, la France est devenue le premier producteur d'huîtres creuses en Europe, avec une production estimée à 81 000 tonnes en 2020 (Service de la Statistique et de la Prospective 2022). Les principales zones de production françaises sont le bassin Charentais (44,12 %), la région Bretagne (24,35 %), la région Normandie (12,05 %), la région Occitanie (6,12 %), la région Pays de la Loire (7,86 %) et le bassin d'Arcachon (5,49 %) (**Figure 2**) (Service de la Statistique et de la Prospective 2022). Néanmoins, cette huître est à son tour touchée par des épizooties provoquant d'importants épisodes de mortalité et menaçant de nouveau la filière ostréicole (**Figure 1**).

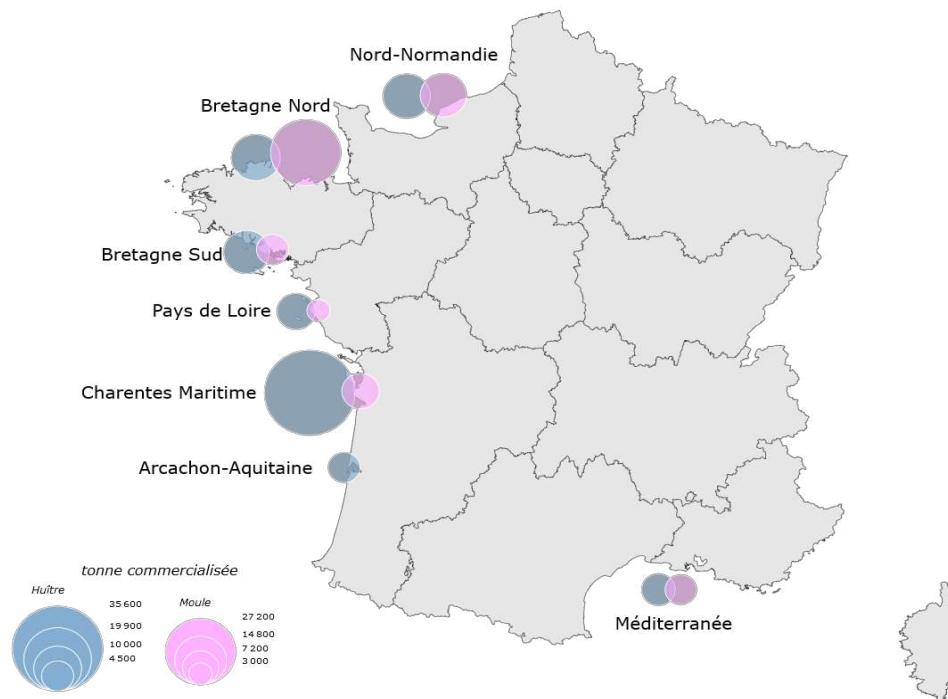

Figure 2 : Répartition et production ostréicole (en bleu) et mytilicole (en rose) en France (hors écloseries). Issue de (Service de la Statistique et de la Prospective 2022).

II. L'huître du Pacifique *Crassostrea gigas*.

1. Classification taxonomique

L'huître du Pacifique *Crassostrea gigas* est un mollusque bivalve de la famille des Ostreidae. Longtemps affiliée au genre *Crassostrea*, cette espèce a vu récemment sa classification évoluer. À la suite d'une étude phylogénétique basée sur un alignement de séquences de l'ITS2 (Internal Transcribed Spacer 2) des gènes de l'ARN ribosomiques (Salvi and Mariottini 2017), l'huître du Pacifique a été reclassifiée dans le genre *Magallana* et est devenue *Magallana gigas* (Salvi and Mariottini 2017). Néanmoins, cette nouvelle classification phylogénétique est controversée (Bayne *et al.* 2017), et les scientifiques ainsi que les professionnels du milieu continuent d'employer majoritairement la classification *Crassostrea gigas*. C'est pourquoi, le nom d'espèce *Crassostrea gigas* sera utilisé dans la suite de ce manuscrit.

2. Cycle de vie

L'huître du Pacifique est une espèce hermaphrodite successive à tendance protandre. La majorité des individus commence leur vie en tant que mâles et peuvent changer de sexe à chaque saison ou après l'émission des gamètes. La gamétogenèse est induite par une augmentation de la température de l'eau couplée à un fort apport en nutriments et à une photopériode adéquate (Fabioux *et al.* 2005). Les gamètes sont ensuite relargués dans la colonne d'eau où se produit la fécondation. Les premières phases de la vie de l'huître sont planctoniques. Environ 12 heures post-fécondation (hpf), les œufs vont se transformer en larves trochophores, puis à environ 24 hpf, une larve D va se former. Entre le 2^{ème} et le 14^{ème} jour de développement, les larves D vont se transformer en larves véligères. Enfin, entre les 15^{ème} et 25^{ème} jours, un pied va apparaître chez les larves qui seront alors des larves pédivéligères. Les larves pédivéligères vont ainsi se servir de leur pied afin de trouver un endroit où se fixer. Une fois fixée sur un substrat, la larve entame sa forme de vie sessile et l'huître sera alors appelée naissain. Les huîtres sont ensuite considérées comme adultes après leur première reproduction, soit un à deux ans après la fécondation (**Figure 3**).

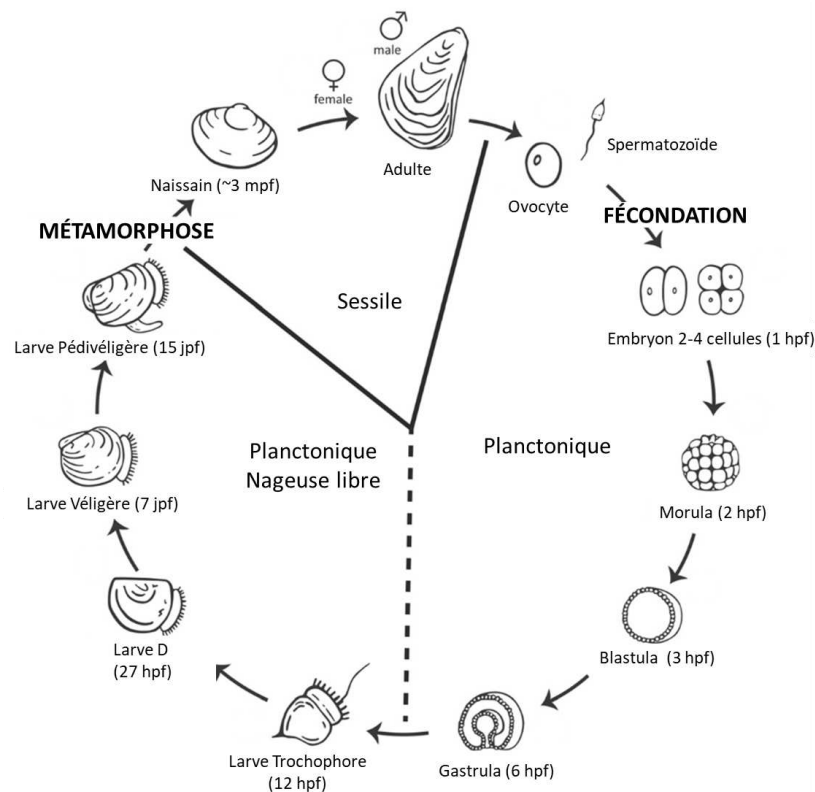

Figure 3 : Cycle de vie de l'huître du Pacifique *Crassostrea gigas*. hpf : heures post-fécondation ; jpf : jours post-fécondation ; mpf : mois post-fécondation. Modifié d'après (Vogeler *et al.* 2016).

3. Anatomie et physiologie de l'huître

L'huître est un mollusque bivalve. Son corps mou est protégé par une coquille bivalve asymétrique composée d'une valve plate et d'une valve creuse. Cette coquille est constituée de carbonate de calcium, et son ouverture et fermeture sont contrôlées par un muscle adducteur (**Figure 4**). L'huître est un animal filtreur. La nutrition est assurée en même temps que la respiration grâce au flux d'eau qui passe sur les branchies. Les branchies lamellaires vont filtrer les particules en suspension dans l'eau (~5-10 µm) qui seront par la suite acheminées vers les palpes labiaux grâce aux courants d'eau créés par les branchies et entreront dans le système digestif (**Figure 4**). La circulation de l'hémolymphe dans l'huître est assurée par un cœur constitué de deux oreillettes et un ventricule. Le système circulatoire de l'huître étant semi-ouvert, l'hémolymphe est propulsée par le cœur dans les tissus mais n'est pas reconduite au cœur par un système veineux. L'hémolymphe de l'huître n'est donc pas un environnement stérile et contient un mélange de plasma, d'hémocytes et de microorganismes.

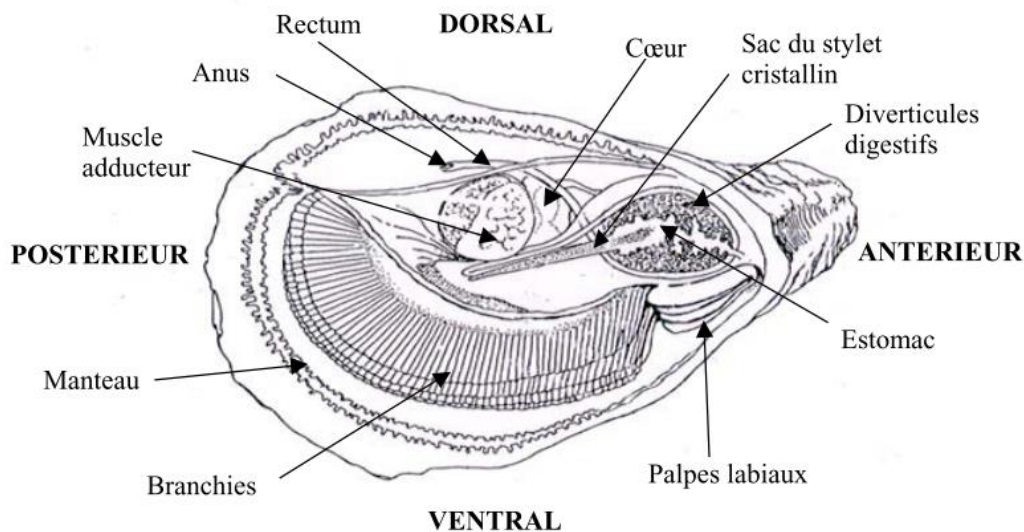

Figure 4 : Schéma de l'anatomie de l'huître du Pacifique issue de (Gay 2004).

4. Le microbiote de *Crassostrea gigas*

Le microbiote correspond à l'ensemble des microorganismes (bactéries, archées, virus, protistes et champignons) associés à un environnement, un organisme, ou même un organe donné. Il est composé de microorganismes commensaux, bénéfiques, ou pathogènes opportunistes. Cet ensemble de microorganismes joue un rôle important pour l'homéostasie, la survie, et le

développement des organismes (McFall-Ngai *et al.* 2013; Laukens *et al.* 2015). Néanmoins, un déséquilibre de la balance entre les microorganismes commensaux ou bénéfiques et les microorganismes pathogènes opportunistes peut entraîner une dégradation de la santé de l'hôte. Cette rupture de l'équilibre du microbiote est appelée la dysbiose.

Les nombreuses études portant sur les interactions entre un hôte et son microbiote ont fait naître les concepts de l'holobionte et de l'hologénome. Le concept de l'holobionte consiste à considérer les organismes non plus comme des individus isolés mais comme une communauté complexe de plusieurs espèces. Dans un premier temps, seules les interactions obligatoires et mutualistes entre un hôte et ses symbiotes étaient prises en compte (Rohwer *et al.* 2002), mais avec les avancées faites dans le domaine du séquençage du microbiote, le concept de l'holobionte s'est généralisé à l'hôte ainsi qu'à tous les microorganismes (bactéries, archées, virus et levures) qui lui sont associés (Bordenstein and Theis 2015). De ce concept, est née la théorie de l'hologénome comme théorie de l'évolution. Cette théorie considère que l'holobionte ainsi que l'hologénome (composé de toutes les unités génomiques qui composent l'holobionte) sont une seule unité évolutive. Ainsi, cette théorie suggère que l'hôte et ses symbiotes n'interagissent pas uniquement pour l'accès à la nourriture ou une niche écologique, mais qu'ils ont co-évolué ensemble en influant l'un sur l'autre sur leur composition génétique (Zilber-Rosenberg and Rosenberg 2008; Theis *et al.* 2016) (**Figure 5**). Ces théories ont permis de réévaluer les interactions entre un hôte et son microbiote.

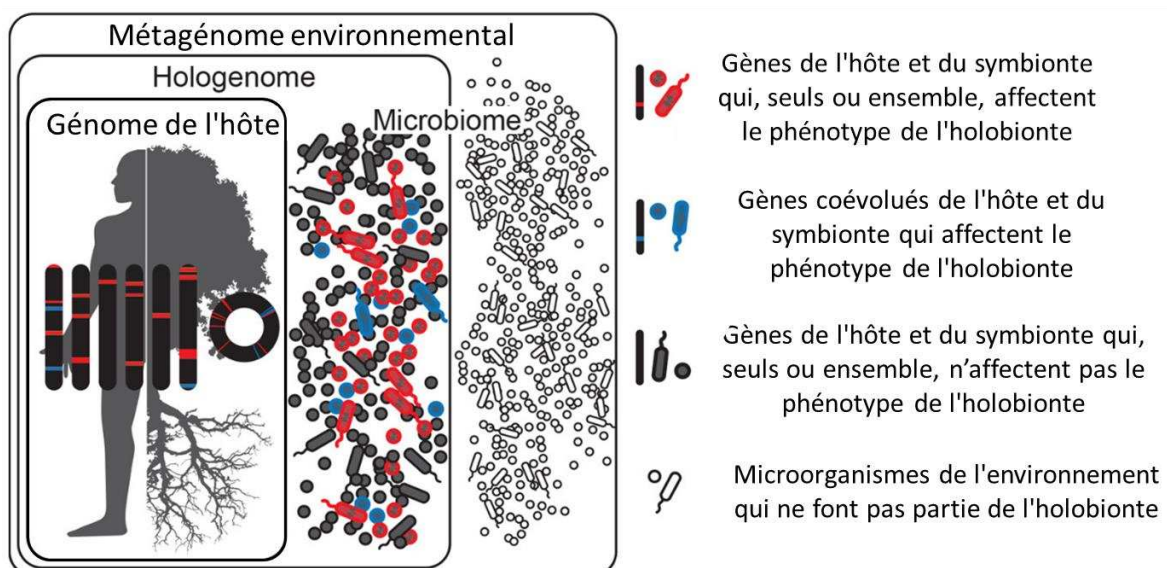

Figure 5 : Théorie de l'holobionte et de l'hologénome d'après Theis (modifié de Theis *et al.* 2016).

Les études portant sur les interactions hôte-microbiote chez des invertébrés marins ont permis de démontrer le rôle majeur que joue le microbiote pour la santé de son hôte, mais aussi pour sa croissance ou encore la qualité de sa coquille (Infante-Villamil *et al.* 2021; Rajeev *et al.* 2021; Paillard *et al.* 2022).

Les huîtres étant des animaux filtreurs, leur microbiote va être en partie composé des bactéries issues de leur environnement (Wright *et al.* 2018). Ce microbiote varie donc en fonction de différents paramètres tels que la localisation géographique (King *et al.* 2020) et de la température de l'eau (Shen *et al.* 2009). Malgré cette étroite relation avec les bactéries provenant de l'eau de mer, l'huître possède un microbiote qui lui est propre (Yeh *et al.* 2020; Dupont *et al.* 2020) et qui varie en fonction du type de tissu (King *et al.* 2020; Yeh *et al.* 2020) mais aussi au cours du temps en suivant les différents stades de vie de l'huître (Yeh *et al.* 2020; Unzueta-Martínez *et al.* 2022). Récemment, Unzueta-Martínez *et al.* (2022) ont démontré qu'une fraction du microbiote était également transmise par les parents.

Des études comparatives portant sur le microbiote d'huîtres résistantes ou sensibles à la maladie du POMS ont permis de mettre en évidence que la composition du microbiote jouait un rôle dans la résistance ou la sensibilité à la maladie (King *et al.* 2019; Clerissi *et al.* 2020; Fallet *et al.* 2022). Des bactéries appartenant à la famille des Sphingomonadaceae, des Halomonadaceae, ou aux genres *Cobetia* et *Neptunomonas* (Fallet *et al.* 2022) pour les stades larvaires ou à la famille des Colwelliaceae, des Cyanobacteria (Subsection III, family I) des Rhodobacteraceae (Clerissi *et al.* 2020), des Bradyrhizobiaceae au genre *Winogradskyella* (King *et al.* 2019) pour les huîtres juvéniles ont été identifiées comme étant préférentiellement associées aux huîtres résistantes à la maladie du POMS.

Bien que certains microorganismes jouent un rôle bénéfique pour la santé de *C. gigas* et sa résistance face à certains pathogènes, d'autres microorganismes sont identifiés comme étant pathogènes ou opportunistes pour l'huître *C. gigas*.

5. Les agents pathogènes affectant l'huître *C. gigas*.

L'huître du Pacifique est une espèce robuste, capable de supporter des écarts importants de température et de salinité. Néanmoins, son mode de vie sessile et les fortes densités de population dans les zones ostréicoles la rendent sensible à de nombreuses maladies provoquées par des virus, des bactéries, mais aussi des parasites.

Parmi les agents pathogènes, on trouve des parasites protozoaires tels que *Haplosporidium costale* (Arzul and Carnegie 2015; Arzul *et al.* 2022), des virus tels que les Ostreid Herpes Virus, ainsi que des bactéries appartenant aux genres *Nocardia*, *Roseovarius*, ou encore *Vibrio* (Travers *et al.* 2015). Ce dernier genre comprend de nombreuses espèces pathogènes qui affectent préférentiellement les huîtres aux stades larvaires (*V. coralliilyticus*, *V. tubiashii* et *V. splendidus*), juvéniles (*V. crassostreae*, *V. harveyi* et *V. tasmaniensis*), ou adultes (*V. aestuarianus*) (Faury *et al.* 2004; Travers *et al.* 2015; Destoumieux-Garzón *et al.* 2020).

Au cours de ce travail de thèse, deux agents pathogènes seront principalement étudiés : l'Ostreid Herpes Virus 1 μ Var (OsHV-1 μ Var), responsable du Pacific Oysters Mortality Syndrome (POMS) affectant principalement les huîtres juvéniles, et *Vibrio aestuarianus*, responsable de mortalités chez les huîtres adultes.

a. Les Ostreid Herpes Virus.

La présence d'un virus de type herpes a été associée à des épisodes de mortalité importante chez l'huître *C. gigas* dès 1992 (Hine *et al.* 1992). Ces mortalités ont touché aussi bien les stades larvaires (Hine *et al.* 1992; Renault *et al.* 1994, 2000) que les stades juvéniles (Renault *et al.* 1994). En France, des épisodes de mortalités massives (80-90 %) ont été rapportés pour la première fois en 1993 (Renault *et al.* 1994). Grâce à une identification moléculaire et à la purification de la capsid, une nouvelle espèce virale infectant les larves et les juvéniles d'huîtres a pu être définie et nommée ostreid herpes virus 1 (OsHV-1) (Le Deuff and Renault 1999; Davison *et al.* 2005).

Depuis 2008, des épisodes de mortalités massives ont été associés à un nouveau variant de l'OsHV-1, décrit pour la première fois en 2010 et appelé OsHV-1 μ Var (Segarra *et al.* 2010). À la suite de cette nouvelle identification, cette infection a été signalée initialement en France (Segarra *et al.* 2010) en 2008, puis en Irlande en 2009 (Peeler *et al.* 2012). La présence de ce variant a également été détectée aux USA (Friedman *et al.* 2005), en Australie (Paul-Pont *et al.* 2013), et au Japon (Shimahara *et al.* 2012). La maladie provoquée par cet agent infectieux a été appelée « Pacific Oyster Mortality Syndrome » (POMS). En Europe, cette maladie se produit lorsque la température de l'eau est comprise entre 16 et 24 °C (Pernet *et al.* 2012). De plus, les huîtres exposées à d'importantes concentrations de nourriture ou sélectionnées pour une croissance rapide s'avèrent être plus susceptibles à la maladie du POMS (Pernet *et al.* 2019).

Plus récemment, des études s'intéressant aux mécanismes de cette maladie ont permis de déterminer que cette maladie est une maladie polymicrobienne dont deux étapes majeures, une infection primaire par le virus suivie d'une infection secondaire par des bactéries, ont été décrites. En détail, la première étape consiste en l'infection de l'huître par OsHV-1 μ Var. Une réplication importante du virus est nécessaire au développement de la maladie. Le virus va alors cibler les hémocytes de l'huître et ainsi altérer leur physiologie, provoquant une baisse de la réponse immunitaire antibactérienne. Cette immunodéficience va provoquer une dysbiose du microbiote de l'huître et permettre à des bactéries opportunistes de proliférer, provoquant une bactériémie et une lyse des hémocytes qui aura pour conséquence la mort de l'huître (**Figure 6**) (de Lorgeril *et al.* 2018a; Petton *et al.* 2021).

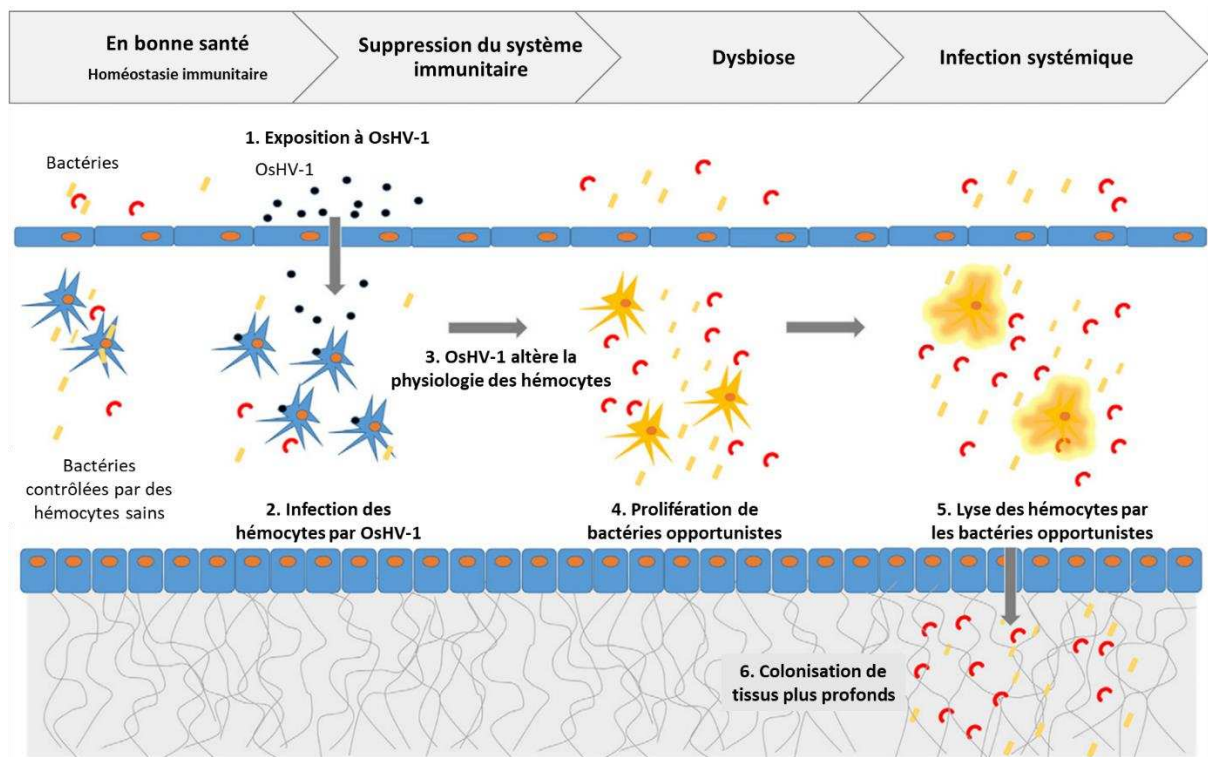

Figure 6 : Schéma reprenant les étapes clés de la maladie du POMS causée par OsHV-1 μ Var. À la suite d'une exposition de l'huître à OsHV-1 μ Var, le virus va infecter les hémocytes et altérer leur physiologie. Cela va conduire à une baisse de l'immunité de l'huître et permettre, dans un second temps, à des bactéries opportunistes de proliférer, ce qui provoquera une bactériémie entraînant la mort de l'huître. Modifié d'après (Petton *et al.* 2021).

Bien que l'implication du microbiote dans la maladie du POMS ait été démontrée, son rôle ainsi que les principales bactéries impliquées restent encore peu connus. Toutefois, de récentes études ont permis d'identifier que des bactéries du genre *Arcobacter*, *Marinomonas*, *Mycoplasma*, *Psychrobium*, *Psychromonas*, *Roseovarius*, *Streptococcus* et *Vibrio* étaient fortement surreprésentées lors des étapes de la dysbiose et de la bactériémie (de Lorgeril *et al.* 2018a ; King *et al.* 2019 ; Delisle *et al.* 2022). Néanmoins, ces études sont limitées du fait de l'utilisation de données de séquençage de l'ADNr 16S qui limite les informations obtenues au niveau du genre et non pas de l'espèce, ou encore du fait que le choix de la méthode d'extraction ou des régions de l'ADNr 16S ciblées induit un biais dans la quantification des bactéries par ces méthodes (Kumar *et al.* 2011 ; Abellan-Schneyder *et al.* 2021). De ce fait, il sera donc nécessaire de réaliser de nouvelles études afin de déterminer le rôle plus précis des bactéries dans la maladie du POMS.

b. *Vibrio aestuarianus*.

Les bactéries du genre *Vibrio* sont des bactéries hétérotrophes retrouvées dans le milieu marin. Ces bactéries sont Gram négatives et appartiennent à la classe des Gammaproteobacteria et à la famille des Vibrionaceae. Bien que toutes les bactéries du genre *Vibrio* ne soient pas des pathogènes, elles sont néanmoins fréquemment associées à différentes maladies touchant le domaine aquacole, notamment chez les huîtres.

V. aestuarianus a été isolé initialement à partir d'eau de mer et de coquillages en 1983 aux États-Unis (Tion and Seidler 1983). Depuis sa découverte, trois sous-espèces ont été décrites : *V. aestuarianus* subsp. *aestuarianus*, *V. aestuarianus* subsp. *francensis* (Garnier *et al.* 2008) et *V. aestuarianus* subsp. *cardii* (Garcia *et al.* 2021). *V. aestuarianus* infecte et induit des mortalités chez les huîtres adultes (Azéma *et al.* 2017 ; Dégremont *et al.* 2021). *V. aestuarianus* subsp. *francensis* est responsable de mortalités récurrentes chez les huîtres en France depuis 2001 (Garnier *et al.* 2008). Il a par la suite été détecté dans d'autres pays européens tels que l'Italie, l'Irlande et l'Espagne (Mesnil *et al.* 2022) (**Figure 7**). Depuis 2012, une augmentation de la fréquence de ces épisodes de mortalité a été observée en France (Goudenège *et al.* 2015).

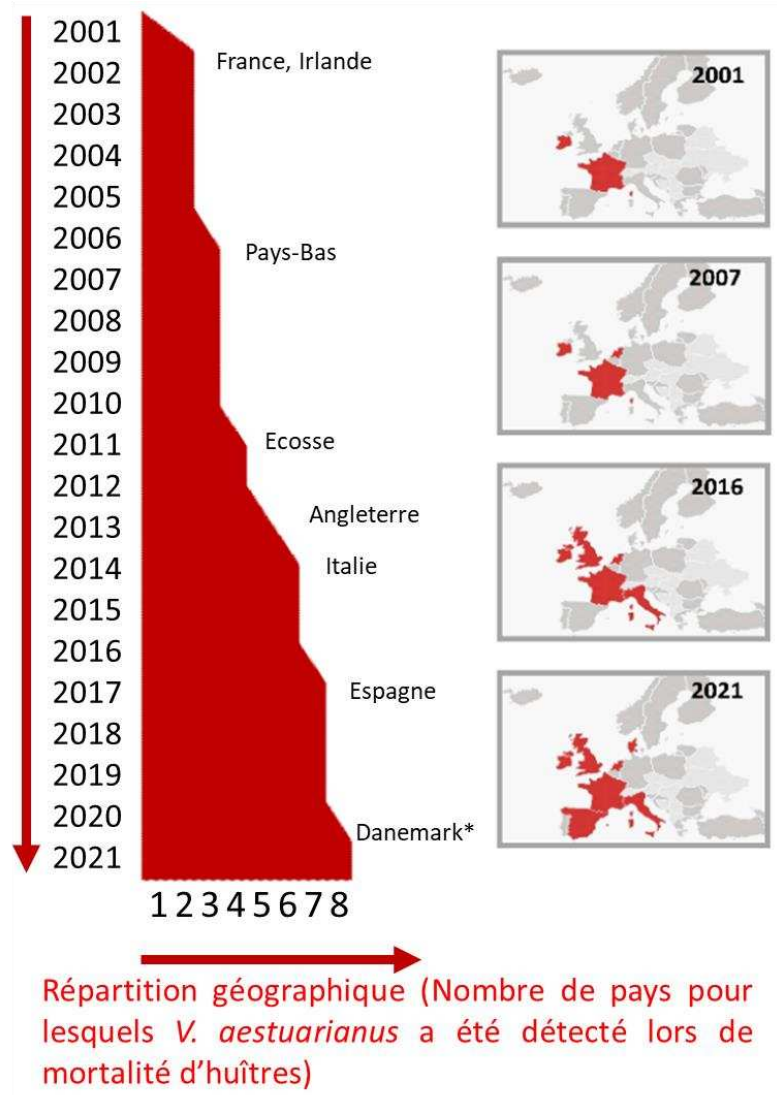

Figure 7 : Nombre de pays ayant rapporté la détection de *V. aestuarianus* à l'aide d'un questionnaire envoyé aux laboratoires nationaux de référence (LNR) européens. *Le rapport de cas du Danemark correspond à un cas suspect sans isolement bactérien. Modifié d'après (Mesnil *et al.* 2022).

Peu de choses sont connues quant aux mécanismes d'infection de *V. aestuarianus* chez l'huître. Il a été montré que la souche *V. aestuarianus subsp. francensis* 01/032 produisait des composés extracellulaires contenant un facteur de virulence, la métalloprotéase Vam (Labreuche *et al.* 2010). Il a également été démontré *in vitro* que ces composés extracellulaires avaient la capacité d'induire une immunosuppression des hémocytes de l'huître (altération de la phagocytose, de l'adhésion et de la production d'espèces réactives de l'oxygène (ROS) par les hémocytes de l'huître) (Labreuche *et al.* 2006, 2010). Cette immunosuppression favoriserait alors la colonisation de l'huître par *V. aestuarianus* (**Figure 8**). Cependant, les propriétés de cette

souche n'ont pu être généralisées à l'ensemble de la collection de *V. aestuarianus* francensis, et les mécanismes moléculaires de l'interaction entre *V. aestuarianus* francensis et les hémocytes d'huître restent incompris.

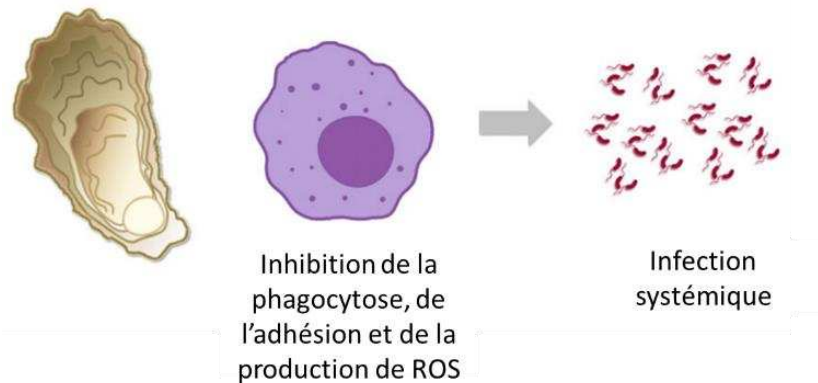

Figure 8 : Schéma du mécanisme de virulence de *Vibrio aestuarianus subsp. francensis* 01/032. *V. aestuarianus* secrète des composés extracellulaires qui vont venir inhiber la phagocytose, l'adhésion et la production de ROS des hémocytes de l'huître et permettre ainsi une prolifération bactérienne. Modifié d'après (Destoumieux-Garzón *et al.* 2020)

La contamination des huîtres par immersion dans l'eau de mer contaminée par une culture de *Vibrio* est plutôt inefficace (Le Roux *et al.* 2016). Cependant, il a été démontré récemment que le passage de *V. aestuarianus* dans une huître, notamment après une injection, permet l'excrétion par l'huître de bactéries hypervirulentes capables d'infecter les huîtres par voie naturelle (Parizadeh *et al.* 2018).

6. La réponse immunitaire chez *C. gigas*.

a. Le système immunitaire inné.

Comme tous les invertébrés, l'huître possède un système immunitaire inné permettant, par le biais des hémocytes, de divers récepteurs et cascades de transduction du signal, mais aussi par l'intermédiaire de différentes molécules, de se défendre contre les agressions extérieures (Wang *et al.* 2018). Bien que l'huître ne possède pas de système immunitaire dit adaptatif, il a pu être démontré récemment qu'une mémoire immunitaire existe chez les invertébrés, notamment chez l'huître. À ce jour, trois mécanismes de régulation de l'expression génétique expliquant l'acquisition d'une mémoire immunitaire ont été décrits (**Figure 9**) (Coustau *et al.* 2016 ; Melillo *et al.* 2018 ; Prigot-Maurice *et al.* 2022).

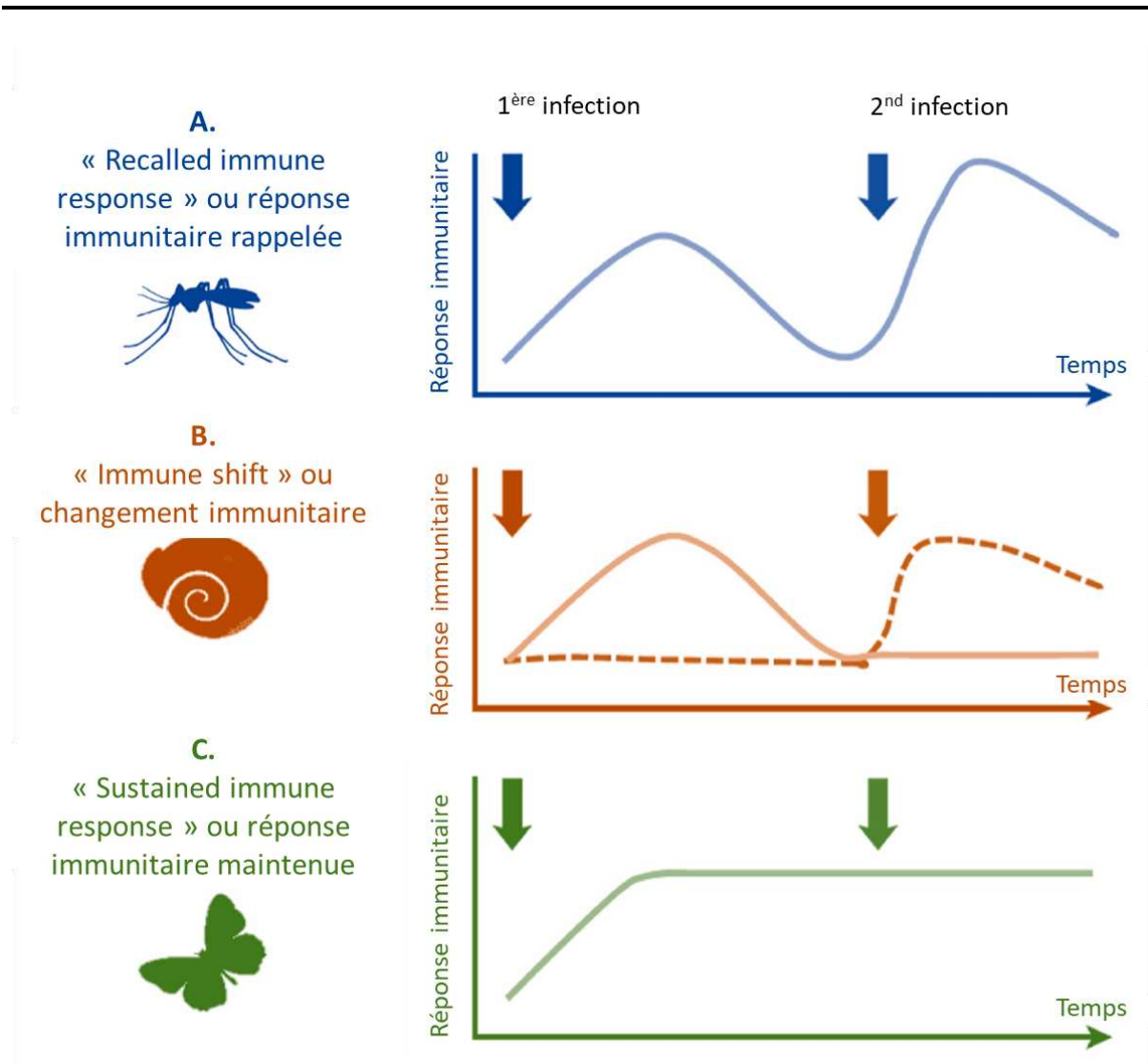

Figure 9 : Représentation schématique des différents types de mémoire immunitaire innée chez différents invertébrés. A) La réponse immunitaire rappelée implique une réponse immunitaire en deux temps qui implique les mêmes effecteurs immunitaires, avec un retour aux niveaux basaux entre la première et la deuxième infection. B) Le changement immunitaire est un passage d'effecteurs immunitaires lors de la première infection à d'autres effecteurs immunitaires lors de la deuxième infection. C) La réponse immunitaire maintenue est une réponse immunitaire durable, qui perdure jusqu'à la seconde infection avec le même effecteur immunitaire. Les infections sont illustrées par les flèches en gras. Modifié d'après Prigot-Maurice *et al.* 2022.

Chez l'huître, le mécanisme appelé "sustained immune response" ou réponse immunitaire maintenue (**Figure 9C**), correspondant à une réponse transcriptionnelle qui perdure tout au long de la vie de l'animal à la suite d'une stimulation primaire, a pu être observé récemment (Lafont *et al.* 2020). L'utilisation de poly(I:C), un analogue synthétique viral, a induit une protection de l'huître contre l'infection à OsHV-1 μ Var pendant plusieurs mois après son injection dans l'huître (Green *et al.* 2016 ; Lafont *et al.* 2017).

b. Les hémocytes.

Les hémocytes jouent un rôle majeur dans la réponse immunitaire de l'huître. Ce sont des cellules immunocompétentes circulant dans l'hémolymphe, mais également capables d'infiltrer les cavités, les tissus et l'épithélium des huîtres (Bachère *et al.* 2015). Lors d'une infection ou d'une lésion, les hémocytes vont s'agréger au niveau du site concerné et transporter les éléments essentiels à la réparation ou à la lutte contre l'infection (**Figure 10**). Ils sont capables de reconnaître des éléments étrangers à l'organisme par l'intermédiaire de récepteurs capables de reconnaître les motifs moléculaires associés aux pathogènes (Pathogen Associated Molecular Patterns ou PAMPs) ou d'opsonines leur permettant par la suite de déclencher la phagocytose et la sécrétion de composés antibactériens (espèces réactives de l'oxygène, peptides antimicrobiens ou enzymes hydrolytiques) (Bachère *et al.* 2015) (**Figure 10**). La phagocytose joue un rôle important dans l'élimination des agents pathogènes. Lors de la phagocytose, l'agent étranger (bactérie, virus ou parasite protozoaire) va être endocyté dans une vacuole cytoplasmique de l'hémocyte appelée phagosome. Ce phagosome va ensuite fusionner avec des vésicules lysosomales et devenir ainsi un phagolysosome. L'acidification couplée à la présence d'hydrolases, de protéases, de peptides antibactériens ainsi que d'espèces réactives de l'oxygène et de l'azote va provoquer la dégradation du corps étranger (Bachère *et al.* 2015).

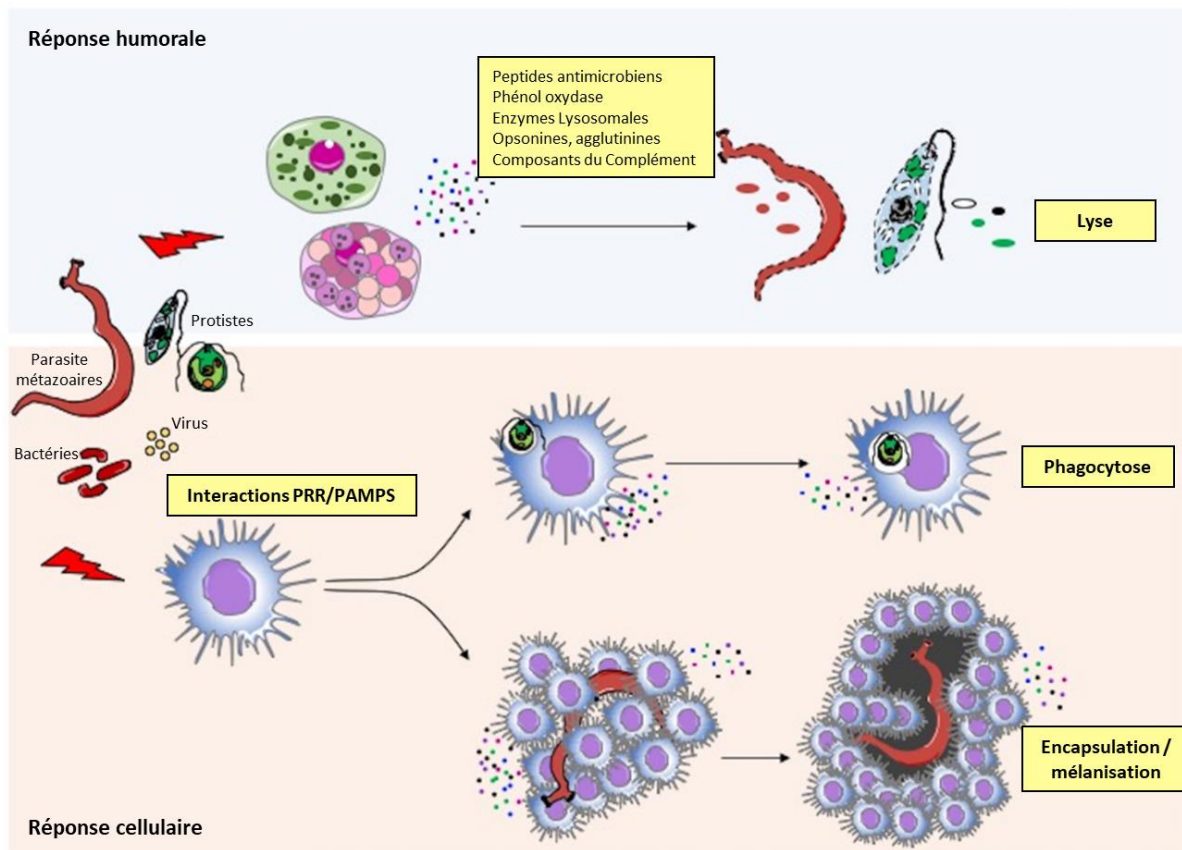

Figure 10 : Implications des hémocytes lors de la réponse immunitaire chez les invertébrés. Après la reconnaissance des motifs moléculaires associés aux pathogènes (PAMPs) ou d'autres molécules par les récepteurs de reconnaissance de motifs moléculaires (PRR), les hémocytes circulant dans l'hémolymphe vont neutraliser les éléments étrangers par phagocytose ou encapsulation/mélanisation. En parallèle, d'autres cellules immunitaires vont libérer des composés toxiques pour les pathogènes (peptides antimicrobiens, agglutinines, ...) ou participer à leur élimination (Composants du Complément, Phénol oxydase, Oponine, ...). Modifié d'après (Melillo *et al.* 2018).

c. Molécules de reconnaissance du non-soi

Pour induire une réponse efficace, le système immunitaire de l'huître doit être en mesure de différencier les molécules qui font partie de l'individu des molécules appartenant à des organismes externes (non-soi). Pour cela, les huîtres disposent de protéines leur permettant de reconnaître les agents externes (non-soi). Ces protéines sont des récepteurs de reconnaissance de motifs moléculaires (Pattern Recognition Receptor ou PRR) qui sont capables de reconnaître les structures conservées au cours de l'évolution des agents pathogènes (PAMPs) et ainsi déclencher les mécanismes de défense (Guo *et al.* 2015).

Les PRR sont classés en trois types suivant leurs fonctions. Les premiers sont des récepteurs présents à la surface des cellules jouant un rôle dans la reconnaissance et l'internalisation des

PAMPs. Les seconds sont des récepteurs de signalisation qui vont être responsables de la reconnaissance et de l'activation de voies de signalisation intracellulaire. Enfin, les troisièmes sont des molécules solubles qui assurent la liaison entre les PAMPs et les cellules (Jeannin *et al.* 2008 ; Liu *et al.* 2011 ; Wang *et al.* 2018). Parmi ces PRR, on retrouve notamment les Toll-like receptors (TLRs), les lectines ou encore le composant du complément 1q (C1q).

Les Toll-like receptors sont conservés au cours de l'évolution depuis les cnidaires jusqu'aux mammifères et jouent un rôle essentiel dans la défense de l'hôte. À ce jour, au moins sept TLRs participant à la réponse immunitaire ont été identifiés chez l'huître (Wang *et al.* 2018 ; de Lorgeril *et al.* 2020). Une surexpression du Toll-like receptor 13 a été retrouvée chez des huîtres résistantes à la maladie du POMS, suggérant que ce récepteur est capable de détecter l'ARN viral et bactérien et ainsi participer dans la voie de signalisation TLR/NF-KB (de Lorgeril *et al.* 2020).

Les lectines sont des protéines qui se lient aux glucides avec une grande affinité (Liener *et al.* 2012). Il existe sept types de lectines tels que les C-type, P-Type, F-type ou galectines (Wang *et al.* 2018). Les lectines de type C forment une grande famille de protéines pouvant se lier aux glucides de façon calcium-dépendante (Robinson *et al.* 2006). Les lectines de type C sont abondantes chez les huîtres et retrouvées dans plusieurs types de tissus. Au total, 266 lectines de type C sont annotées dans le génome de *C. gigas* et sept ont pu être caractérisées (Wang *et al.* 2018). Une surexpression des lectines de type C a été observée chez *C. gigas* en réponse à une infection par OsHV-1 μ Var (He *et al.* 2015). Il a également été montré que les lectines de type C pouvaient être associées aux galectines dans la reconnaissance des bactéries Gram-positives mais également pour renforcer l'activité de phagocytose (Li *et al.* 2015).

Le composant du complément 1q (C1q) est une protéine impliquée dans l'activation de la voie classique du complément. Chez les vertébrés, la voie classique est activée lorsque la protéine C1q se lie à des anticorps fixés à la surface de l'agent pathogène. En tant que PRR, la protéine C1q peut engager une large gamme de ligands via son domaine globulaire (gC1q) et moduler les cellules immunitaires (Bohlsón *et al.* 2007). Un total de 321 gènes codant pour des protéines contenant un domaine C1q ont pu être retrouvés dans le génome de l'huître (Gerdol *et al.* 2015).

III. Les bactéries comme moyens de lutte contre les maladies infectieuses affectant l'huître *C. gigas*

Les huîtres étant élevées en milieu ouvert, l'utilisation de méthodes telles que l'utilisation d'antibiotiques n'est possible que lors des étapes d'élevage larvaire qui ont lieu en milieu fermé dans les écloseries. De plus, l'utilisation d'antibiotiques a montré ses limites avec l'apparition de bactéries résistantes aux antibiotiques et pouvant être pathogènes pour les huîtres, mais aussi pour les humains (Cabello 2006 ; Hossain *et al.* 2022).

Une des alternatives à l'utilisation d'antibiotiques est le développement de probiotiques. Un probiotique est, d'après la définition de l'Organisation des Nations Unies pour l'alimentation et l'agriculture, "un ou des microorganismes vivants qui, lorsqu'ils sont consommés en quantités adéquates, confèrent un effet bénéfique pour la santé de l'hôte" (Food and Agriculture Organisation of the United Nations 2006). Les probiotiques ont des modes d'action variés qui ont fait l'objet de nombreuses études. Les effets contre des pathogènes peuvent résulter d'actions directes, telles que la compétition avec les pathogènes via des activités antibactériennes (Lim *et al.* 2011 ; Touraki *et al.* 2012 ; Offret *et al.* 2018) ou des activités de quorum quenching (Ghanei-Motlagh *et al.* 2021), ou par des actions indirectes, telles que la stimulation du système immunitaire de leur hôte (Tseng *et al.* 2009 ; Guzmán-Villanueva *et al.* 2014 ; Hao *et al.* 2014 ; Yan *et al.* 2014). Les probiotiques peuvent également être utilisés afin d'améliorer l'assimilation des nutriments ou la croissance de l'hôte (Aguilar-Macías *et al.* 2010 ; Hao *et al.* 2014 ; Yan *et al.* 2014 ; Wang *et al.* 2019). Enfin, certains probiotiques vont être utilisés afin de contrôler la qualité chimique et/ou microbiologique de l'eau d'élevage (Ma *et al.* 2009).

1. Modes d'actions directs : Activités antibactériennes et Quorum Quenching

Afin de lutter contre les pathogènes, de nombreuses études se sont penchées sur l'utilisation des activités antibactériennes de certaines bactéries. En effet, certaines bactéries ont la capacité de synthétiser des composés capables de provoquer la mort d'autres bactéries (effets bactéricides) ou d'empêcher leur multiplication (effets bactériostatiques). Certaines de ces bactéries ont déjà été testées pour leurs effets protecteurs contre des pathogènes en aquaculture. Parmi elles, nous pouvons citer les souches *Pseudoalteromonas sp.* hCg-51 et *Pseudoalteromonas sp.* hCg-6, isolées de l'hémolymphe de l'huître, qui présentent des effets antibactériens à l'encontre de

différents pathogènes marins tels que *V. splendidus*, *V. tapetis*, *V. harveyi* ORM4 ou encore *Aeromonas salmonicida* (Desriac *et al.* 2014 ; Offret *et al.* 2018) et qui, pour la souche *Pseudoalteromonas sp.* hCg-6, ont conféré un effet protecteur chez l'ormeau européen *Haliotis tuberculata* lors d'une infection à *V. harveyi* ORM4 (Offret *et al.* 2018). Un autre exemple d'utilisation de bactéries à activité antibactérienne est la bactérie *Bacillus subtilis* NCIMB 3610, qui présente des activités antibactériennes contre la bactérie *V. anguillarum* et qui a permis, lors d'essais *in vitro*, d'augmenter significativement la survie de larves de bar européen *Dicentrarchus labrax* lors d'une infection à *V. anguillarum* (Touraki *et al.* 2012).

Une autre possibilité consiste à exploiter les activités de quorum quenching des bactéries. En effet, certaines bactéries possèdent un mode de communication chimique inter- et intra-espèce : le quorum sensing (Kuramitsu *et al.* 2007 ; Li and Tian 2012). Ce phénomène est impliqué dans la formation des biofilms, l'émission de bioluminescence (Miller and Bassler 2001 ; Li and Tian 2012), mais aussi dans des mécanismes de virulence (Kiyimaci *et al.* 2018 ; Zhao *et al.* 2019). Le quorum sensing est basé sur la sécrétion et la perception de molécules auto-inductrices dont la plus étudiée est la N-Acyl Homosérine Lactone (AHL) (Figure 11) (Huang *et al.* 2016).

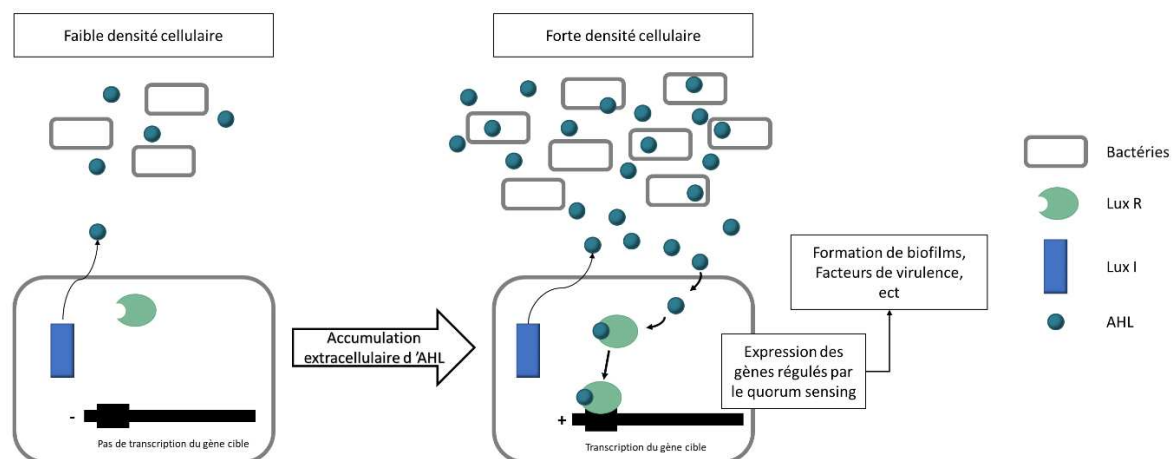

Figure 11 : Représentation schématique du système de régulation Lux I/Lux R dépendant des N-Acyl Homosérine Lactone (AHL). La protéine Lux I va synthétiser des AHL qui seront sécrétés dans le milieu jusqu'à ce qu'en présence d'une forte densité cellulaire, la quantité d'AHL dans le milieu devienne suffisante pour que des molécules pénètrent dans les bactéries. Une fois dans la bactérie, la protéine Lux R va fixer ces AHL et va se lier au promoteur, induisant la transcription de divers gènes pouvant être impliqués dans la formation de biofilms ou encore de facteurs de virulence. Adapté de (Huang *et al.* 2016)

Le quorum quenching, à l'inverse, est un mécanisme qui inhibe le quorum sensing. Cette inhibition peut se faire à différentes étapes de la communication bactérienne : en bloquant la génération ou la propagation des molécules de signal, ou encore en bloquant leur réception par les bactéries cibles. Ainsi, l'utilisation du quorum quenching pourrait permettre d'inhiber des mécanismes de virulence de pathogènes ou leur implantation durable dans des biofilms. À titre d'exemple, la bactérie *Phaeobacter inhibens* S4Sm a pu conférer un effet protecteur aux larves d'huîtres contre une infection à *V. coralliilyticus* RE22Sm (Karim *et al.* 2013). Il a par la suite été démontré que cette protection était liée à la sécrétion d'AHL responsable de la perturbation du quorum sensing de *V. coralliilyticus*, inhibant ainsi la transcription de facteurs de virulence tels que des protéases (Zhao *et al.* 2019).

2. Modes d'actions indirects : modulation du système immunitaire de l'hôte

Des bactéries peuvent également être utilisées en tant que probiotiques dans le but de stimuler le système immunitaire de leur hôte, lui permettant ainsi de combattre les infections par ses propres moyens. Le travail bibliographique présenté dans cette partie fait la synthèse des études portant sur l'utilisation de probiotiques à effets immunomodulants chez les mollusques d'intérêt aquacole. De plus, nous proposons dans cet article de revue une nouvelle approche basée sur les travaux de (Fallet *et al.* 2022) lors desquels une exposition de larves d'huîtres à un microbiote d'huître donneuse a permis d'induire une modulation de gènes de l'immunité ayant conduit à une meilleure survie lors d'une infection à OsHV-1 au stade juvénile. Ainsi, nous proposons d'utiliser le concept de l'éducation microbienne. Ce concept propose d'éduquer le système immunitaire de l'hôte en l'exposant à des microorganismes lors de l'ontogenèse du système immunitaire. Le fait de cibler cette étape clé du développement doit permettre d'induire des effets bénéfiques tout au long de la vie de l'animal et éventuellement de façon transgénérationnelle.

Publication 1

Microbial education for marine invertebrate disease prevention in aquaculture

Luc Dantan, Eve Toulza, Bruno Petton, Caroline Montagnani, Lionel Degremont, Benjamin Morga, Yannick Fleury, Guillaume Mitta, Yannick Gueguen, Jérémie Vidal-Dupiol, Céline Cosseau

Article soumis à "Review in aquaculture" en cours de révision

Microbial education for marine invertebrate disease prevention in aquaculture

Luc Dantan¹, Eve Toulza¹, Bruno Petton², Caroline Montagnani¹, Lionel Degremont³, Benjamin Morga³, Yannick Fleury⁴, Guillaume Mitta⁵, Yannick Gueguen⁶, Jérémie Vidal-Dupiol¹, Céline Cosseau^{1*}

¹ IHPE, Univ. Montpellier, CNRS, Ifremer, Univ. Perpignan Via Domitia, Perpignan France

² Ifremer, UBO CNRS IRD, LEMAR UMR 6539 Argenton, France

³ Ifremer, ASIM, F- 17390 La Tremblade, France

⁴ Laboratoire de Biotechnologie et Chimie Marine, EA3884, Université de Bretagne Occidentale, Université Bretagne Sud, 29334 Quimper, France

⁵ Ifremer, UMR 241 Écosystèmes Insulaires Océaniques, Labex Corail, Centre Ifremer du Pacifique, BP 49, 98725 Tahiti, Polynésie française

⁶ MARBEC, Univ Montpellier, CNRS, Ifremer, IRD, Sète, France

* Corresponding author

Celine.cosseau@univ-perp.fr

IHPE UMR 5244

Université de Perpignan Via Domitia

58 Avenue Paul Alduy Bât R

F-66860 Perpignan Cedex, France

Tel 33 (0)4.68.66.20.50

<http://ihpe.univ-perp.fr/>

Short running title: An early life microbial exposure educates the immune system of invertebrate species of interest to aquaculture

Abstract:

The holobiont theory expands the notion of individual multicellular organisms as a community composed of a host and all its associated microorganisms. This concept has been largely studied in the aquaculture field where increasing evidence has shown the importance of the host associated microorganisms in species fitness. Here, we focus our review on mollusc and crustacean species for which microbiota dysbiosis have been described recently in the context of various diseases leading to important economic losses. Influencing the holobiont structure through the use of probiotics is a potential strategy that could improve the fitness or the robustness of cultivated species. We discuss here the possibility of developing microbiome targeted prophylactic approaches by promoting (1) methods to identify host microbial community fostering a good health status and (2) early life microbial education to favour long term resistance to stress or disease. This review is expected to inform the aquaculture industry of new possible strategies in rearing practices to mitigate diseases and economic liabilities.

Keywords: mollusc, crustacean, holobiont, microbial education, probiotics

Introduction

Aquaculture production covers most of the increase in seafood needs since 1990 and has surpassed fisheries as a source of food for human consumption (Anderson *et al.* 2019). It has become the fastest growing food-producing sector in the world with a production of 57.5 million tonnes of finfish, 17.7 million tonnes of molluscs and 11.2 million tonnes of crustaceans for the year 2020 (Food and Agriculture Organisation 2022). For the aquaculture industry, disease emergences represent great risk and can induce huge economic losses. More worrying is the accumulation of evidence over the past decades that diseases affecting wild and cultivated animals have increased in frequency and severity in association with anthropogenic disturbances and global change (Harvell *et al.* 2002; Jones *et al.* 2008; Altizer *et al.* 2013; Burge *et al.* 2014; Kibenge 2019; Behringer and Duermit-Moreau 2021). As mentioned below, marine invertebrates constitute an important contribution to aquaculture production in the world. In these species, evidence for recurrent diseases inducing mass mortalities have accumulated, demonstrating the devastating impact of epizooties (Burge *et al.* 2014; Kibenge 2019). Diseases of farmed oysters, shrimp, abalone, and various fish cost billions of dollars each year to this industry (Lafferty *et al.* 2015). In some cases, these diseases are directly due to the emergence of viral, bacterial or parasitic pathogens (Soudant *et al.* 2013; Travers *et al.* 2015). As an example, the White Spot Syndrome Virus (WSSV) is the most prevalent viral pathogen in shrimps leading to massive mortalities (up to 100% within 3-10 days) that have impacted productions for decades (Sánchez-Paz 2010). This virus is highly virulent, infecting quickly infecting gills, stomach, haemocytes, hematopoietic tissues and antennal gland (Pradeep *et al.* 2012). Another worrying infection called acute hepatopancreatic necrosis disease (AHPDN) or Early Mortality Syndrome (EMS) has been reported in different shrimp species in Asia. It induces rapid and drastic mortalities causing losses of up to 90% of the livestock (Hong *et al.* 2016). This disease is due to the bacterial agent *Vibrio parahaemolyticus* that damages the hepatopancreas. In molluscs, the abalone withering syndrome (WS) is another infectious disease due to the bacteria *Xenohalotis californiensis* responsible for moderate to mass mortality events depending on the considered species. A mortality rate of up to 99% can be reached in some species such as the black abalone *Haliotis cracherodii* in USA (Crosson and Friedman 2018). Several bacterial diseases due to *Vibrio*, *Nocardia* and *Roseovarius* have also been reported in several bivalve species (Travers *et al.* 2015).

Other diseases which affect invertebrates of interest to aquaculture are multifactorial and polymicrobial: in this case, it involves a destabilisation of the microbiota due to an initial

harmful environmental pressure or to the presence of a pathogen. This dysbiosis eventually opens the door to development or colonization by opportunistic pathogens or may even lead to a shift from commensalism to opportunism/pathogenicity for some members of the microbiota. In shrimp species, the White Feces Syndrome (WFS) is a gastrointestinal disorder of cultivated penaeid shrimp, which causes severe production losses worldwide. Shrimps with WFS usually show a reduced feed consumption and growth rate, hepatopancreatic discoloration, and loose shells. Diseased shrimps have dramatically decreased microbial richness and diversity compared to control shrimps (Huang *et al.* 2020). In molluscs, many epizooties affecting shellfish are polymicrobial. One of the most striking examples is the case of the Pacific Oyster Mortality Syndrome (POMS) that emerged in 2008 and is still heavily impacting the Pacific oyster, *Crassostrea gigas*, production worldwide (Barbosa Solomieu *et al.* 2015; Petton *et al.* 2021). POMS is a multifactorial disease, with biotic and abiotic factors influencing the disease outbreak (Petton *et al.* 2015, 2021). The central role of a herpes-like virus, OsHV-1- μ Var, in POMS has been demonstrated; viral infection triggers an immune-compromised state that induces microbiota dysbiosis and subsequent bacteraemia caused by opportunistic bacteria, ultimately leading to oyster death (de Lorgeril *et al.* 2018). Other studies have shown that OsHV-1 infection leads to variations in the microbiota characterised by changes in the bacterial groups which are normally the most abundant and an increase of rare OTU belonging to the *Vibrio* genus including known opportunistic pathogens such as *V. harveyi* (King *et al.* 2019a) and *Arcobacter* (Lasa *et al.* 2019). Other works have shown that environmental factors such as pollutant exposure or warming temperatures are another possible cause of dysbiosis in molluscs which might be responsible for increased mortality rate that are reported in farms. Temperature stress in *C. gigas* (rapid increase from 20°C to 25°C) leads to change in the structure of bacterial composition of the microbiota towards dominance of opportunistic pathogens such as *Vibrionaceae* which correlates with increased in mortality (Green *et al.* 2019). Heat stress also leads to decreased stability of the haemolymph microbiota in the pacific oyster *C. gigas* (Lokmer and Wegner 2015) and induces lower diversity in the mussel *M. coruscus* (Li *et al.* 2019). These changes in the haemolymph microbiota participate in the increased mortality in these two bivalves in response to infections. Other studies performed in *Chamelea gallina* (Milan *et al.* 2019) and *Tegillarca granosa* (Liu *et al.* 2022) have shown that chemical pollution leads to microbiota shift associated with proliferation of opportunistic pathogens that could contribute to declining health of clams.

In order to fight these diseases threatening aquaculture activities, a series of approaches were developed. The use of probiotics, mutualist symbionts and bacteriophages (Pérez-Sánchez *et al.* 2018) are some strategies. These proposed approaches are based on the identification of beneficial microorganisms inducing direct benefit through their antagonistic effects against potential pathogens (production of antimicrobial compounds, quorum sensing interference or predatory effects) (Touraki *et al.* 2012; Kiyimaci *et al.* 2018; Offret *et al.* 2018; Zhao *et al.* 2019; Goh *et al.* 2022). Other strategies are based on changes in aquaculture practices through the application of methods which aims at managing the microbial community inside the rearing tanks. For example, the use of biofloc system increases the water quality (Kumar *et al.* 2021; Rajeev *et al.* 2021) and has been shown to favour a better host immune response. Diverse technologies aim at creating a K-selected microbial community which select against r-strategic opportunists. These microbial management strategies have led to better performance and increased viability of larvae (De Schryver *et al.* 2014; Bossier *et al.* 2016; Vadstein *et al.* 2018). Otherwise, in a broader context, several studies have evidenced the critical role of microbiota during the early developmental steps to educate and durably imprint the host innate immune system in mammals (Arrieta *et al.* 2014; Gensollen *et al.* 2016, Renz *et al.* 2017), in fish (Galindo-Villegas *et al.* 2012) in crustaceans (Ziaei-Nejad *et al.* 2006; Roy *et al.* 2020) and in molluscs (Yang *et al.* 2020; Fallet *et al.* 2022). Despite these evidence, antagonistic approaches toward microbial communities, such as water sterilization and antibiotic treatment, have been favoured so far (Eljaddi *et al.* 2021; Cordier *et al.* 2021).

In this review, we promote the possibility of applying natural microorganisms as treatment during the early developmental stage (larval/spat rearing) to shape and sustain lifelong innate immune competence in aquaculture. We first report recent works which emphasize the critical role played by the microbiota on molluscs and crustaceans of economic interest for the aquaculture field. We then discuss the possibility of using the growing amount of data describing the host associated microbiota to propose a better prediction of health promoting bacteria. Finally, we argue that a potential application of these new generation probiotics for a microbial education in early developmental steps (larval and post metamorphosis stages) could be a new strategy to induce long-term beneficial effects in aquaculture.

1. Host-microbiota interactions in health and disease of mollusc and crustacean species

a. Definition of the holobiont concept

Numerous studies have evidenced that host associated microbial communities can influence multiple facets of animal physiology from pathogen resistance and immunity, development, behaviour, but also ecological functions such as stress tolerance (Sharon *et al.* 2010; Heijtz *et al.* 2011; Webster *et al.* 2011; McFall-Ngai *et al.* 2013; Kostic *et al.* 2013; Gilbert *et al.* 2015; Schmidt *et al.* 2015; Kohl and Yahn 2016; Webster and Reusch 2017; Gould *et al.* 2018). These impacts imply that microbiota can profoundly influence animal performance, fitness and adaptation capacities in changing environmental conditions (Rosenberg *et al.* 2009; Webster and Reusch 2017). These observations fall into the now largely accepted holobiont concept considering multicellular organisms as a complex community of species. This concept initially took into account only the mutualistic obligate associations between the host and its symbionts (Rohwer *et al.* 2002) but, with the advent of sequencing methodologies and progress made on the microbiota, the concept of holobiont was generalized to the association between the host and all its associated microorganisms (bacteria, archaea, viruses and yeasts) (Bordenstein and Theis 2015). Building on the holobiont concept, the hologenome theory of evolution considers the holobiont with its hologenome (all genomic entities in interaction) as the unit of selection during evolution (Zilber-Rosenberg and Rosenberg 2008; Theis *et al.* 2016). This theory implies that the host and the symbiont do not interact only for food or ecological niche, but also constitute the true unit of selection, thus co-evolving together and shaping the genetic composition of each other. These concepts have made it possible to re-evaluate host-associated microorganisms beyond their association with diseases and allow us to consider their role in the host physiology (see Laukens *et al.* 2015). The influence of the microbiota on the host immunity is one of the best examples illustrating the contribution of associated microorganisms to host fitness. Interestingly, commensal microbiota has multiple ways to cooperate with the host immune system to prevent pathogen infection. This has been well described in model species, especially in mice where it is possible to do experiments on germ free animals. Commensal bacteria can boost the immune system either locally or systemically (e.g., in distant tissues) (Chung *et al.* 2012; Hooper *et al.* 2012; Abt and Artis 2013; Sommer and Bäckhed 2013). But commensals can also directly impact bacteria (either true pathogen or opportunistic ones) through interference with their entry and installation by direct competition or production of antimicrobial compounds. The cnidarian *Hydra vulgaris* is the aquatic invertebrate model

for which the beneficial effect of the microbiota has been largely addressed and a substantial number of works clearly shows that the mucosal innate immunity is shaped by host-microbiota interactions (Schröder and Bosch 2016).

b. Influence of the microbiota for health and disease outcomes in crustaceans and molluscs of aquaculture interests

Several studies on host-associated microbiota have highlighted the beneficial effects of the microorganisms for invertebrate species of aquaculture interest. Beneficial properties of the microbiota have been shown in several contexts relevant for aquaculture such as enhanced growth, feed efficiency, increased survival in early life stages, settlement, shell quality, size, or organoleptic quality (Infante-Villamil *et al.* 2021; Rajeev *et al.* 2021; Paillard *et al.* 2022; Yu *et al.* 2022). We have focused our review work on host-associated microorganisms which are beneficial in a context of health and infectious disease outcomes (**Table 1**). Several studies have shown that a higher microbiota diversity is correlated with the health status of the host in both crustaceans and molluscs (**Table 1, part 1**). This may result from the capacity of a highly diversified microbial community to provide a greater number of beneficial functions. This has been shown in different shrimp species where a higher diversity of metabolites with potential beneficial properties are produced by half of the core microbiota and likely contributes to their immune homeostasis (Zhang and Sun 2022). Otherwise, functional redundancy has been described in the more diverse microbial community of the yellow abalone compared to the blue abalone and this correlates with a lower prevalence of the Withering Syndrome disease (Cicala *et al.* 2018, 2022). All these aforementioned studies are correlative and only two of them have shown a direct causality between healthy or diseased microbiota and health status. In penaeid shrimp, intestinal microbiota transfer (IMT) from WFS diseased shrimp to healthy ones leads to symptoms like diseased ones (Huang *et al.* 2020). In *C. gigas*, a microbiota transfer from healthy juvenile donor oysters to healthy recipient larval oysters for ten days, leads to enhanced immune response at juvenile stages and greater capacity to prevent OsHV-1 viral proliferation and reduced mortality to the POMS disease (Fallet *et al.* 2022).

Beside the beneficial properties induced by a highly diversified microbial community, some microbiota-specific strains may also contribute to the health of their host by their direct antagonistic effect on pathogens (**Table 1, part 2**). The addition of Alterins producing *Pseudoalteromonas hCg-42* correlates with lower mortality in *Vibrio* challenged *C. gigas* (Defer *et al.* 2013; Desriac *et al.* 2020 and Dantan, personal communication). The injection of

BALOs (*BdelloVibrio*-like organisms) in lobster juveniles results in lower abundance of *Vibrio* compared to non-injected control group (Ooi *et al.* 2021). BALOs are a group of Gram-negative bacteria that prey on other Gram-negative bacteria and their presence have been reported in the haemolymph microbiota of diverse shrimp species and the spiny lobster *Panulirus ornatus*. Furthermore, in a broader sense, a substantial amount of correlation analysis has clearly highlighted that the presence or abundance of specific bacteria correlates with lower or higher prevalence of disease (King *et al.* 2019a; Clerissi *et al.* 2020; Infante-Villamil *et al.* 2021) The exact role of these bacteria to support host beneficial properties remains however to be defined.

In summary, there is evidence that the host associated microbiota contributes to the health of molluscs and crustaceans of interest to aquaculture and disruption of a healthy and diversified microbiota eventually leads to disease states. Understanding the dynamic crosstalk of this interaction in these species has become necessary to implement disease mitigation strategies.

c. Innate immune effectors are key players which shape the microbiota of molluscs and crustaceans of interest to aquaculture.

In many species, host-microbiota associations seem to be relatively stable within an individual and demonstrate a strong correlation between host phylogeny and microbiota that co-evolved for beneficial outcomes, a concept known as phyllosymbiosis (Lim and Bordenstein 2020). This concept implies that the host can selectively shape its microbiota, leading to convergence of host phylogeny and microbiota composition. Correlation between host genetic background and microbiota composition has been clearly evidenced in marine molluscs. In *C. gigas*, family's specific microbiota has been described and perfectly segregates with the oyster's genetic background (King *et al.* 2019b; Clerissi *et al.* 2020; Dupont *et al.* 2020).

In a broader context, evidence from invertebrate models reveals that immune systems can control microbial communities through diverse strategies from mechanical barriers provided by mucus layers, defence peptides, as well as a cellular defensive line (innate immune cells) (Rosenstiel *et al.* 2009; Chu and Mazmanian 2013; Broderick 2016; Dishaw *et al.* 2016). This is especially well described in the two noteworthy invertebrate aquatic models, the squid *Euprymna scolopes* (Heath-Heckman *et al.* 2016) and the cnidaria *Hydra vulgaris* (Fraune and Bosch 2007; Augustin *et al.* 2017). In molluscs of aquaculture interest, several studies have evidenced an indirect link between microbiota and host immunity, especially in the context of abiotic stresses (Auguste *et al.* 2019, 2020; Yang *et al.* 2020; Li *et al.* 2022; Liu *et al.* 2022;

Zhao *et al.* 2023; Dang *et al.* 2023) and disease-triggered dysbiosis (de Lorgeril *et al.* 2018; Milan *et al.* 2019). However, in these studies, whether the stress triggers a microbiota change which result in an immune shift or reversely, whether the stress triggers an immune shift which results in a change of microbiota structure remains to be determined. The few studies that addressed the direct influence of the host innate immunity on microbiota composition in molluscs and crustaceans are listed in the Table 2. A substantial number of studies have been performed in the kuruma shrimp *Marsupenaeus japonicus* and the king prawn *Litopenaeus vannamei* where RNAi invalidation has pointed to a causal link between innate immune effectors (reactive oxygen/nitrogen species (ROS and RNS and antimicrobial peptides) and the balance of the bacterial microbiome (**Table 2**). In *L. vannamei*, similar works involving inactivation of gene encoding for AMPs of the crustins family have shown that the type I and type II crustins were involved in the regulation of the host bacterial community (Lv *et al.* 2020b, a).

In molluscs, to our knowledge, studies have addressed the direct influence of the host innate immunity for microbiota composition in scallops and oysters. In the scallop *Argopecten purpuratus*, the big defensin ApBD1 and the bactericidal/permeability increasing protein ApLBP/BPI1 have been shown to regulate the proliferation of specific bacterial groups in the haemolymph (Muñoz *et al.* 2019; González *et al.* 2020). In the same species, a g-type lysozyme is shown to participate in the microbial homeostasis (González *et al.* 2022). In *C. gigas*, big defensins have the potential to shape oyster microbiota. *Cg-BigDef1* induced a significant shift in oyster microbiota β -diversity 6h and 24h after its injection into oyster tissues (de San Nicolas *et al.* 2022).

2. Toward the use of next generation probiotics for an optimised microbial education

a. Probiotic usage: definition and limitation for shellfish aquaculture

In this article, we reviewed recent works which emphasize the critical role played by the microbiota on health and disease resistance for marine invertebrates of economic interest. Increasing evidence is accumulating which points toward the beneficial advantage conferred by the microbiota for crustaceans and molluscs in an aquaculture context and how a fine-tuned setting is necessary to ensure an optimal host-microbiota balance. Disruption of this balance by external stress or pathogens induces a fitness decrease of the holobiont which eventually leads to death. In this sense, it is obvious that we should now consider each organism as an holobiont

where associated microorganisms not only confer a beneficial advantage in adverse conditions but are essential players of host health. Experimenting with the microbial part of the holobiont has been active for decades using probiotics. A probiotic is by the definition of the Food and Agriculture Organization (FAO), a “live microorganisms, which when consumed in adequate amounts, confers a health benefit on the host” (Food and Agriculture Organisation of the United Nation 2006). Probiotics have been successfully applied for decades in human health which has focussed attention on beneficial bacteria isolated from natural human microbiota. As an example, Lactic Acid Bacteria (LAB) have been widely studied for their beneficial properties (as reviewed by Mousavi Khaneghah *et al.* 2020) and were recently used to potential application to depuration in *C. gigas* (Sorée *et al.* 2020). This has led to several commercial applications with proved beneficial effect in human health and in agro-industries. The use of probiotic strains has further been extended to animal production and is considered a promising eco-responsible and prophylactic alternative to antibiotics (Getachew 2016). The extensive use of antibiotics has pointed to shrimp aquaculture as a major cause for emergence of antibiotic resistant pathogens (Thornber *et al.* 2020) and in this field, the application of probiotics has been used for decades as an environmentally friendly alternative strategy to fight pathogens (Akhter *et al.* 2015; Goh *et al.* 2022). The use of probiotics has also been successfully tested on oysters (Aguilar-Macías *et al.* 2010; Kesarcodi-Watson *et al.* 2012b; García-Bernal *et al.* 2019; Modak and Gomez-Chiarri 2020). The mode of action of probiotics and their beneficial effects for disease resistance and species performance in aquaculture have been extensively reviewed (Akhter *et al.* 2015; Yeh *et al.* 2020; Goh *et al.* 2022; Sumon *et al.* 2022). Several limitations have been reported in the literature which make that the application of probiotic is not always fully beneficial. One major limitation is that the probiotic strains do not settle down in the endogenous microbiota (**Table 3**). Addition of non-autochthonous strain (Bacteria isolated from another species) is a possible explanation considering the tight association which exist between the host and its microbiota as explained in the first part of this review. Regular addition of probiotics supplemented with prebiotics (compounds in food that induce the growth or activity of the probiotics) is a strategy which has been applied so far to maintain long term beneficial properties of the added strains, but such an approach increases the economic cost of the probiotic solution (Pérez-Sánchez *et al.* 2018). Another major limitation in the shellfish farms is that it is impossible to use probiotics in open culture at sea. In this sense, the probiotic usage in molluscs industry is restricted to hatcheries during larval rearing. Except for the work performed by Fallet *et al.* (2022), the literature on probiotics added during larval stages do not report long term beneficial effect for molluscs and crustacean health (**Table 3**). Several reason

might explain this potential caveat: (i) The long term beneficial properties have not been addressed in the published work mentioned in table 3 and the authors have missed the potential of their probiotics to confer long-term benefits to their host (ii) The author have added single probiotic strain and considering the importance of the microbial diversity for host fitness, the use of multi-strain probiotics (MSP) should lead to more beneficial effects. MSP consist of a mix of two or more strains, that have proven to give various beneficial effects for its host. The improved performance of MSP effect compared to single strains has been intensively described in fish (Puvanasundram *et al.* 2021; Padeniya *et al.* 2022) and is starting to be described in crustaceans and molluscs (Kesarcodi-Watson *et al.* 2012a; Grandiosa *et al.* 2020). As an example, the use of a mix of four different probiotics has improved the growth and the immune status of *L. vannamei* more efficiently in comparison with sigle use probiotics (Wang *et al.* 2019). The addition of MSP during the larval stages conferred a protective effect in Spiny Lobster (*P. ornatus*) larvae against *Vibrio owensii* infections (Goulden *et al.* 2012).

b. Next generation probiotics: emerging tools for a better prediction of health promoting bacteria

The recent advances on host-microbiota interactions have brought new insights which should broaden their use to the most updated strategies. A subsequent number of large-scale diversity analyses applied to diverse crustaceans (Holt *et al.* 2021) or mollusc species (Yeh *et al.* 2020) has led to multiple descriptions of bacteria associated with different tissues, at several life stages, related to different health status, in different locations. These datasets are tremendously valuable resources for prediction of stage and species-specific beneficial bacteria. Correlation studies that identify association between health status and microbiota composition should lead to decipher consortia of beneficial microorganisms. This has been applied to microbial communities associated with health and disease in shrimp in order to identify stage specific disease or bioindicators of health (Zheng *et al.* 2017). Based on a Linear Discriminant Analysis (LDA) Effect Size (*LEfSe*) (Segata *et al.* 2011), Zheng *et al.* identified that the genus *Meridianimaribacter* was enriched in healthy shrimp and with good water quality. In agreement with other culture dependent work (Zheng *et al.* 2016), this genus was identified as a beneficial bacterium for shrimp larvae and was suggested as a probiotic candidate for shrimp larval rearing. In the same manner, based on the similar *LEfSe method* applied to the bacterial community associated with POMS sensitive and resistant oysters, we identified stage specific bacterial taxa which are overrepresented in more resistant oysters during experimental infection

(Fallet *et al.* 2022)t. In another study, we performed a differential analysis of taxa abundance between conditions in microbiome and we have identified three bacterial families (*Colwelliaceae*, *Cyanobacteria* (Subsection III, family I), and *Rhodobacteraceae*) significantly associated with oysters resistant to POMS disease (Clerissi *et al.* 2020). Overall, we suggest that the predictive analysis based on correlation studies in combination with literature information should be an upstream step to identify putative beneficial bacteria that can be then isolated by culture-based approaches (**Figure 2**). We anticipate an improved benefice of the probiotics designed in such a way since this would consider the concept of the holobiont and the long co-evolutionary history between the host and the bacteria (**Box 1**). However, this is only a predictive strategy, and the beneficial effect of these probiotics requires to be validated in an experimental framework as we describe in Figure 2.

c. Microbial education during early stages: An opportunity to sustain long-term beneficial effects.

Another possibility that we discuss here is to educate the host immune system through the application of beneficial microorganisms during the course of the immune system ontogenesis. This “microbial education” plan is not just applying another probiotic strategy but is a real concept that meets its foundation on robust recent scientific works which are at the interface of several fields as summarised in the box 1 and figure 1: (1) the microbial community management in aquaculture (2) the holobiont theory (3) The biological embedding concept (4) the possibility to prime the innate immune system of invertebrate species to induce long term immune protection. The “microbial education” outline is to add host specific microorganisms during the larval development. This strategy aims at influencing the immune system toward better defence capacities. The possibility to influence the developmental trajectory of individual by environmental manipulation during early development has been previously discussed by others (Gavery and Roberts 2017; Eirin-Lopez and Putnam 2021). This strategy can be used to produce a desired phenotype and applied to critical issues in aquaculture with some benefits but also, some barriers as summarised in the Table 4. The possibility to educate the host immune system through a microbial education has been demonstrated in oysters by Fallet *et al.* (2022). In this work, we showed that it was possible to increase *C. gigas* immune competence until the juvenile stage four months after a 10 days natural microbial exposure during the larval stages. This work clearly highlighted that an interaction with a diversified and autochthonous microbiota during the early developmental stages has lifelong consequences (even

transgenerational impact) and could be instrumental to fight against the POMS disease. Such an approach remains to be investigated for the other pathogens commonly described from the larval to adult stages in *C. gigas* (Dégremont *et al.* 2021), and other oyster species (Dégremont *et al.* 2015). This early life microbial education is somewhat in contradiction with some hatchery current practices, which seek to limit the introduction of both non-pathogen and pathogen bacteria, viruses, and eukaryotes as well as to eliminate unwanted plankton and zooplankton in seawater from the conditioning of the broodstock to the larval and spat stages (Bourne *et al.* 1989; Helm *et al.* 2004; Eljaddi *et al.* 2021; Cordier *et al.* 2021). In addition, the depletion of bacteria in the rearing environment and in the farmed animals is often accentuated by the addition of antibiotics. This process was tested in response to the risk of mortality in livestock (Le Pennec *et al.* 1973; Bourne *et al.* 1989; Nicolas *et al.* 1992) and was quickly associated with the risk of selecting antibiotic-resistant bacteria (Martin and Mengus 1977; Bourne *et al.* 1989). Today, however, this use remains a common practice, mainly at the larval stage of rearing of various species of marine invertebrates as well as their broodstock.

Globally, research efforts remain to be performed for a microbial education to be applied during larval rearing. The microbial management plan is in line with our proposal. It aims at increasing the performance and viability of larvae by applying ecological theories and optimising the larvae-microbiota interactions (De Schryver and Vadstein 2014; De Schryver *et al.* 2014). Diverse methods (MMS: Microbially Matured Water System, BFT: Bio Flocc Technology, RAS: Recirculating Aquaculture System) allow for the stable presence of naturally K-selected microbial community into the rearing tanks. It clearly has long term beneficial impact and favours the production of high-quality juveniles (De Schryver and Vadstein 2014; De Schryver *et al.* 2014). The immunomodulatory properties and health benefits of such practices have been demonstrated (Kumar *et al.* 2021). However, using these methods, the added microflora is not controlled and not specific to the raised species and it is hazardous since it may contain pathogenic microorganisms. In perspective of this review, we propose a simple conceptual model to summarize the possible strategy which could be applied to perform the most appropriate early-stage microbial education (**Figure 2**). Full-scale trials will be necessary and should consider several parameters which could impact hatching and larval growth/survival. The parameters should include: the definition of the multi-strain bacterial mix to be applied, the way the bacterial mix should be administered, the most appropriate window to be targeted, the duration of the exposure, and the aquaculture rearing conditions. In Fallet *et al.* (2022), the microorganisms to which recipient oyster larvae were exposed came from healthy *C. gigas*

spats sampled in their natural environment and used as microbiota donors. Those donor oysters were held upstream the larval tanks but downstream the filter systems. This strategy allowed transferring the whole oyster associated microorganisms' community to recipient larvae and accordingly, the immunomodulatory potential of the overall microbial diversity (including viral, prokaryotic, eukaryotic and uncultivable microorganisms) was used. Such a strategy could be applied to hatcheries. However, a major limitation of such a practice should be considered: the microorganism community is not controlled and remains hazardous. A real health risk remains since donor oysters of microbiota may also carry pathogens although they appear to be healthy. In this sense, a controlled environment rich in microorganisms used during the larval rearing is recommended. This can be achieved using donor oysters of microbiota which were always kept in biosecured facilities (**Figure 2**). In this way, the oysters were shown to be devoid of the three main pathogens of *C. gigas* from larvae to juveniles (Azéma *et al.* 2017; Dégrement *et al.* 2021). Alternatively, a controlled culture based bacterial formulation, the multi-strain bacterial mix can be added during the larval rearing (**Figure 2**). For this purpose, it will be necessary to first build a collection of hosts associated bacteria and screen several bacterial cocktails for their ability to induce long term immunomodulatory effects. Early development is the preferential stage to be targeted to induce long lasting effects, as previously reported (Galindo-Villegas *et al.* 2012; Arrieta *et al.* 2014; Gensollen *et al.* 2016; Fallet *et al.* 2022). Targeting this stage also offers the possibility to treat millions of larvae at the same time.

Conclusions:

Diseases of farmed shellfish induce significant economic losses. To cope with these recurring threats, the search for alternative and environmentally friendly solutions has been investigated for a long time. We review here how host associated microorganisms are not just a great help to improving the fitness of their host but are part of a much more complex evolutionary unit called the holobiont. We discuss the possibility of implementing the most advanced techniques and the concept of the holobiont field as potential new strategies to mitigate, at least, farmed animal diseases. We suggest (i) using the increasingly growing amount of data which describes microbiota in diverse species as a tool to predict the most natural beneficial bacteria for their associated host (ii) applying an exposure of these predicted beneficial microorganisms during the larval rearing step in hatchery to benefit from the biological embedding. If properly applied, this microbial education is expected to induce lifelong protection and could be a natural and sustainable strategy for safeguarding aquaculture efforts from infectious disease.

List of abbreviations:

AHPDN: Acute Hepatopancreatic Necrosis Disease

BALOs: Bdello*Vibrio* and like organisms

BLIS: Bacteriocin-Like Inhibitory Substance

Cg-BigDef1: *C. gigas* Big Defensin 1

EMS: Early Mortality Syndrome

LAB: Lactic Acid Bacteria

LC_MS: liquid chromatography-coupled mass spectrometry

LEfSe: Linear discriminant analysis (LDA) Effect Size

MSP: multi-strain probiotics

OTU: Operational Taxonomic Unit

POMS: Pacific Oyster Mortality Syndrome

RNS: Reactive Nitrogen Species

ROS: Reactive Oxygen Species

TNF: Tail Fan Necrosis

WFS: White Feces Syndrome

WS: Withering Syndrome

WSSV: White Spot Syndrome Virus

Competing interests

The authors declare that they have no competing interests.

Acknowledgments

The authors are grateful to Yannick Fleury, Noémie De San Nicolas, Fabrice Pernet and Jim Harris for fruitful discussions. The present study was supported by the ANR projects DECIPHER (ANR-14-CE19-0023) and DECICOMP (ANR-19-CE20-0004). The present study was supported by the Ifremer project GT-huitre and by the Fond Européen pour les Affaires Maritimes et la Pêche (FEAMP, GESTINNOV project n°PFEA470020FA1000007), the project “Microval” of the Bonus Qualité Recherche program of the University of Perpignan, the project “gigantimic 1” from the federation de recherche of the university of Perpignan, the project “gigantimic 2” from the kim food and health foundation of MUSE. This study is set within the framework of the "Laboratoires d'Excellences (LABEX)": TULIP (ANR-10-LABX-41).and “CeMEB” (ANR-10-LABX-04-01). Luc Dantan is a recipient of a PhD grant from the Region Occitanie (Probiomic project) and the University of Perpignan Via Domitia graduate school ED305.

References

- Abt MC, Artis D (2013) The dynamic influence of commensal bacteria on the immune response to pathogens. *Curr Opin Microbiol* 16:4–9. doi: 10.1016/j.mib.2012.12.002
- Aguilar-Macías OL, Ojeda-Ramírez JJ, Campa-Córdova AI, Saucedo PE (2010) Evaluation of natural and commercial probiotics for improving growth and survival of the pearl oyster, *Pinctada mazatlanica*, during Late hatchery and early field culturing. *J World Aquac Soc* 41:447–454. doi: 10.1111/j.1749-7345.2010.00386.x
- Akhter N, Wu B, Memon AM, Mohsin M (2015) Probiotics and prebiotics associated with aquaculture: A review. *Fish Shellfish Immunol* 45:733–741. doi: 10.1016/j.fsi.2015.05.038
- Altizer S, Ostfeld RS, Johnson PTJ, Kutz S, Harvell CD (2013) Climate change and infectious diseases: From evidence to a predictive framework. *Science* (80-) 341:514–519. doi: 10.1126/science.1239401
- Anderson JL, Asche F, Garlock T (2019) Economics of Aquaculture Policy and Regulation. *Annu Rev Resour Econ* 11:101–123. doi: 10.1146/annurev-resource-100518-093750
- Aristizabal MJ, Anreiter I, Halldorsdottir T, Odgers CL, McDade TW, Goldenberg A, Mostafavi S, Kobor MS, Binder EB, Sokolowski MB, O'Donnell KJ (2020) Biological embedding of experience: A primer on epigenetics. *Proc Natl Acad Sci U S A* 117:23261–23269. doi: 10.1073/pnas.1820838116
- Arrieta MC, Stiemsma LT, Amenyogbe N, Brown E, Finlay B (2014) The intestinal microbiome in early life: Health and disease. *Front Immunol*. doi: 10.3389/fimmu.2014.00427
- Auguste M, Lasa A, Pallavicini A, Gualdi S, Vezzulli L, Canesi L (2019) Exposure to TiO₂ nanoparticles induces shifts in the microbiota composition of *Mytilus galloprovincialis* hemolymph. *Sci Total Environ* 670:129–137. doi: 10.1016/j.scitotenv.2019.03.133
- Auguste M, Lasa A, Balbi T, Pallavicini A, Vezzulli L, Canesi L (2020) Impact of nanoplastics on hemolymph immune parameters and microbiota composition in *Mytilus galloprovincialis*. *Mar Environ Res*. doi: 10.1016/j.marenvres.2020.105017
- Augustin R, Schröder K, Rincón APM, Fraune S, Anton-Erxleben F, Herbst EM, Wittlieb J, Schwentner M, Grötzinger J, Wassenaar TM, Bosch TCG (2017) A secreted antibacterial neuropeptide shapes the microbiome of Hydra. *Nat Commun* 8:1–8. doi: 10.1038/s41467-017-00625-1
- Azéma P, Lamy JB, Boudry P, Renault T, Travers MA, Dégremont L (2017) Genetic parameters of resistance to *Vibrio aestuarianus*, and OsHV-1 infections in the Pacific

- oyster, *Crassostrea gigas*, at three different life stages. *Genet Sel Evol* 49:1–16. doi: 10.1186/s12711-017-0297-2
- Barbosa Solomieu V, Renault T, Travers MA (2015) Mass mortality in bivalves and the intricate case of the Pacific oyster, *Crassostrea gigas*. *J Invertebr Pathol* 131:2–10. doi: 10.1016/j.jip.2015.07.011
- Behringer DC, Duermit-Moreau E (2021) Crustaceans, One Health and the changing ocean. *J Invertebr Pathol*. doi: 10.1016/j.jip.2020.107500
- Bordenstein SR, Theis KR (2015) Host biology in light of the microbiome: Ten principles of holobionts and hologenomes. *PLoS Biol* 13:1–23. doi: 10.1371/journal.pbio.1002226
- Bossier P, De Schrijver P, Defoirdt T, Ruwandeepika HAD, Natrah F, Ekasari J, Toi H, Nhan D, Tinh N, Pande G, Karunasagar I, Van Stappen G (2016) Microbial Community Management in Aquaculture. *Procedia Food Sci* 6:37–39. doi: 10.1016/j.profoo.2016.02.007
- Bourne N, Hodgson CA, Whyte JNC (1989) A Manual for Scallop Culture in British Columbia. Canadian Technical Report of Fisheries and Aquatic Sciences No. 1694.
- Broderick NA (2016) Friend, foe or food? Recognition and the role of antimicrobial peptides in gut immunity and drosophila-microbe interactions. *Philos Trans R Soc B Biol Sci*. doi: 10.1098/rstb.2015.0295
- Burge CA, Mark Eakin C, Friedman CS, Froelich B, Hershberger PK, Hofmann EE, Petes LE, Prager KC, Weil E, Willis BL, Ford SE, Harvell CD (2014) Climate Change Influences on Marine Infectious Diseases: Implications for Management and Society. *Ann Rev Mar Sci* 6:249–277. doi: 10.1146/annurev-marine-010213-135029
- Campa-Córdova AI, Luna-González A, Mazón-Suastegui JM, Aguirre-Guzmán G, Ascencio F, González-Ocampo HA (2011) Efecto de bacterias probióticas en el cultivo larvario del ostión de placer *Crassostrea corteziensis* (Bivalvia: *Ostreidae*). *Rev Biol Trop* 59:183–191. doi: 10.15517/rbt.v59i1.3188
- Chi C, Liu JY, Fei SZ, Zhang C, Chang YQ, Liu XL, Wang GX (2014) Effect of intestinal autochthonous probiotics isolated from the gut of sea cucumber (*Apostichopus japonicus*) on immune response and growth of *A. japonicus*. *Fish Shellfish Immunol* 38:367–373. doi: 10.1016/j.fsi.2014.04.001
- Chu H, Mazmanian SK (2013) Innate immune recognition of the microbiota promotes host-microbial symbiosis. *Nat Immunol* 14:668–675. doi: 10.1038/ni.2635
- Chung H, Pamp SJ, Hill JA, Surana NK, Edelman SM, Troy EB, Reading NC, Villablanca EJ, Wang S, Mora JR, Umesaki Y, Mathis D, Benoist C, Reldan DA, Kasper DL (2012) Gut

- immune maturation depends on colonization with a host-specific microbiota. *Cell* 149:1578–1593. doi: 10.1016/j.cell.2012.04.037
- Cicala F, Cisterna-Céliz JA, Moore JD, Rocha-Olivares A (2018) Structure, dynamics and predicted functional role of the gut microbiota of the blue (*Haliotis fulgens*) and yellow (*H. corrugata*) abalone from baja California sur, Mexico. *PeerJ*. doi: 10.7717/peerj.5830
- Cicala F, Cisterna-Céliz JA, Paolinelli M, Moore JD, Sevigny J, Rocha-Olivares A (2022) The Role of Diversity in Mediating Microbiota Structural and Functional Differences in Two Sympatric Species of Abalone Under Stressed Withering Syndrome Conditions. *Microb Ecol* 1–11. doi: 10.1007/s00248-022-01970-5
- Clerissi C, de Lorgeril J, Petton B, Lucasson A, Escoubas J-M, Gueguen Y, Dégremont L, Mitta G, Toulza E (2020) Microbiota Composition and Evenness Predict Survival Rate of Oysters Confronted to Pacific Oyster Mortality Syndrome. *Front Microbiol* 11:1–11. doi: 10.3389/fmicb.2020.00311
- Cordier C, Voulgaris A, Stavrakakis C, Sauvade P, Coelho F, Moulin P (2021) Ultrafiltration for environmental safety in shellfish production: A case of bloom emergence. *Water Sci Eng* 14:46–53. doi: 10.1016/j.wse.2021.03.003
- Crosson LM, Friedman CS (2018) Withering syndrome susceptibility of northeastern Pacific abalones: A complex relationship with phylogeny and thermal experience. *J Invertebr Pathol* 151:91–101. doi: 10.1016/j.jip.2017.11.005
- Dang X, Huang Q, He YQ, Gaitán-Espitia JD, Zhang T, Thiyagarajan V (2023) Ocean acidification drives gut microbiome changes linked to species-specific immune defence. *Aquat Toxicol*. doi: 10.1016/j.aquatox.2023.106413
- de Lorgeril J, Lucasson A, Petton B, Toulza E, Montagnani C, Clerissi C, Vidal-Dupiol J, Chaparro C, Galinier R, Escoubas JM, Haffner P, Dégremont L, Charrière GM, Lafont M, Delort A, Vergnes A, Chiarello M, Faury N, Rubio T, Leroy MA, Pérignon A, Régler D, Morga B, Alunno-Bruscia M, Boudry P, Le Roux F, Destoumieux-Garzón D, Gueguen Y, Mitta G (2018) Immune-suppression by OsHV-1 viral infection causes fatal bacteraemia in Pacific oysters. *Nat Commun*. doi: 10.1038/s41467-018-06659-3
- de San Nicolas N, Asokan A, Rosa RD, Voisin SN, Travers M-A, Rocha G, Dantan L, Dorant Y, Mitta G, Petton B, Charrière GM, Escoubas J-M, Boulo V, Pouzadoux J, Meudal H, Loth K, Aucagne V, Delmas AF, Bulet P, Montagnani C, Destoumieux-Garzón D (2022) Functional Diversification of Oyster Big Defensins Generates Antimicrobial Specificity and Synergy against Members of the Microbiota. *Mar Drugs* 2022:745. doi: 10.3390/md20120745

- De Schryver P, Vadstein O (2014) Ecological theory as a foundation to control pathogenic invasion in aquaculture. *ISME J* 8:2360–2368. doi: 10.1038/ismej.2014.84
- De Schryver P, Defoirdt T, Sorgeloos P (2014) Early Mortality Syndrome Outbreaks: A Microbial Management Issue in Shrimp Farming? *PLoS Pathog.* doi: 10.1371/journal.ppat.1003919
- Defer D, Desriac F, Henry J, Bourgougnon N, Baudy-Floc'h M, Brillet B, Le Chevalier P, Fleury Y (2013) Antimicrobial peptides in oyster hemolymph: The bacterial connection. *Fish Shellfish Immunol* 34:1439–1447. doi: 10.1016/j.fsi.2013.03.357
- Dégremont L, Garcia C, Allen SK (2015) Genetic improvement for disease resistance in oysters: A review. *J Invertebr Pathol* 131:226–241. doi: 10.1016/j.jip.2015.05.010
- Dégremont L, Morga B, Maurouard E, Travers MA (2021) Susceptibility variation to the main pathogens of *Crassostrea gigas* at the larval, spat and juvenile stages using unselected and selected oysters to OsHV-1 and/or *V. aestuarianus*. *J Invertebr Pathol* 183:107601. doi: 10.1016/j.jip.2021.107601
- Desriac F, El Harras A, Simon M, Bondon A, Brillet B, Le Chevalier P, Pugnière M, Got P, Destoumieux-Garzón D, Fleury Y (2020) Alterins Produced by Oyster-Associated *Pseudoalteromonas* Are Antibacterial Cyclolipopeptides with LPS-Binding Activity. *Mar Drugs* 18:630. doi: 10.3390/md18120630
- Dishaw LJ, Leigh B, Cannon JP, Liberti A, Mueller MG, Skapura DP, Karrer CR, Pinto MR, De Santis R, Litman GW (2016) Gut immunity in a protochordate involves a secreted immunoglobulin-type mediator binding host chitin and bacteria. *Nat Commun.* doi: 10.1038/ncomms10617
- Dolinoy DC, Anderson OS, Rozek LS (2011) Epigenetic Manifestation of Environmental Exposures. In: *Nutrition in Epigenetics*. John Wiley & Sons, Ltd, pp 287–307
- Dupont S, Lokmer A, Corre E, Auguet J-C, Petton B, Toulza E, Montagnani C, Tanguy G, Pecqueur D, Salmeron C, Guillou L, Desnues C, La Scola B, Bou Khalil J, de Lorgeril J, Mitta G, Gueguen Y, Escoubas J-M (2020) Oyster hemolymph is a complex and dynamic ecosystem hosting bacteria, protists and viruses. *Anim Microbiome.* doi: 10.1186/s42523-020-00032-w
- Eirin-Lopez JM, Putnam H (2021) Editorial: Marine Environmental Epigenetics. *Front Mar Sci.* doi: 10.3389/fmars.2021.685075
- Eljaddi T, Ragueneau S, Cordier C, Lange A, Rabiller M, Stavrakakis C, Moulin P (2021) Ultrafiltration to secure shellfish industrial activities: Culture of microalgae and oyster fertilization. *Aquac Eng.* doi: 10.1016/j.aquaeng.2021.102204

- Fallet M, Montagnani C, Petton B, Dantan L, de Lorgeril J, Comarmond S, Chaparro C, Toulza E, Boitard S, Escoubas J-M, Vergnes A, Le Grand J, Bulla I, Gueguen Y, Vidal-Dupiol J, Grunau C, Mitta G, Cosseau C (2022) Early life microbial exposures shape the *Crassostrea gigas* immune system for lifelong and intergenerational disease protection. *Microbiome*. doi: 10.1186/s40168-022-01280-5
- Fellous A, Wegner KM, John U, Mark FC, Shama LNS (2022) Windows of opportunity: Ocean warming shapes temperature-sensitive epigenetic reprogramming and gene expression across gametogenesis and embryogenesis in marine stickleback. *Glob Chang Biol* 28:54–71. doi: 10.1111/gcb.15942
- Food and Agriculture Organisation (2022) The State of World Fisheries and Aquaculture 2022. *State World Fish Aquac 2022*. doi: 10.4060/cc0461en
- Food and Agriculture Organisation of the United Nation (2006) Probiotics in food. Health and nutritional properties and guidelines for evaluation. Rome/Roma
- Fraune S, Bosch TCG (2007) Long-term maintenance of species-specific bacterial microbiota in the basal metazoan Hydra. *Proc Natl Acad Sci U S A* 104:13146–13151. doi: 10.1073/pnas.0703375104
- Galindo-Villegas J, Garcíá-Moreno D, De Oliveira S, Meseguer J, Mulero V (2012) Regulation of immunity and disease resistance by commensal microbes and chromatin modifications during zebrafish development. *Proc Natl Acad Sci U S A*. doi: 10.1073/pnas.1209920109
- García-Bernal M, Medina-Marrero R, Campa-Córdova AI, Mazón-Suástegui JM (2019) Growth and antioxidant response of juvenile oysters *Crassostrea sikamea* and *Crassostrea corteziensis* treated with *Streptomyces* strains. *Arq Bras Med Vet e Zootec* 71:1993–1998. doi: 10.1590/1678-4162-11225
- Gavery MR, Roberts SB (2017) Epigenetic considerations in aquaculture. *PeerJ* 2017:e4147. doi: 10.7717/peerj.4147
- Gensollen T, Iyer SS, Kasper DL, Blumberg RS (2016) How colonization by microbiota in early life shapes the immune system. *Science* (80-) 352:539–544. doi: 10.1126/science.aad9378
- Getachew T (2016) A Review on Effects of Probiotic Supplementation in Poultry Performance and Cholesterol Levels of Egg and Meat. *Getachew T J World Poult Res J homepage J World Poult Res* 6:31–36.
- Gibson LF, Woodworth J, George AM (1998) Probiotic activity of *Aeromonas media* on the Pacific oyster, *Crassostrea gigas*, when challenged with *Vibrio tubiashii*. *Aquaculture* 169:111–120. doi: 10.1016/S0044-8486(98)00369-X

- Gilbert SF, Bosch TCG, Ledón-Rettig C (2015) Eco-Evo-Devo: Developmental symbiosis and developmental plasticity as evolutionary agents. *Nat Rev Genet* 16:611–622. doi: 10.1038/nrg3982
- Goh JXH, Tan LTH, Law JWF, Ser HL, Khaw KY, Letchumanan V, Lee LH, Goh BH (2022) Harnessing the potentialities of probiotics, prebiotics, synbiotics, paraprobiotics, and postbiotics for shrimp farming. *Rev Aquac* 00:1–80. doi: 10.1111/raq.12659
- González R, Gonçalves AT, Rojas R, Brokordt K, Rosa RD, Schmitt P (2020) Host Defense Effectors Expressed by Hemocytes Shape the Bacterial Microbiota From the Scallop Hemolymph. *Front Immunol* 11:1. doi: 10.3389/fimmu.2020.599625
- González R, González D, Stambuk F, Ramírez F, Guzmán F, Mercado L, Rojas R, Henríquez C, Brokordt K, Schmitt P (2022) A g-type lysozyme from the scallop *Argopecten purpuratus* participates in the immune response and in the stability of the hemolymph microbiota. *Fish Shellfish Immunol* 123:324–334. doi: 10.1016/j.fsi.2022.03.015
- Gould AL, Zhang V, Lamberti L, Jones EW, Obadia B, Korasidis N, Gavryushkin A, Carlson JM, Beerenwinkel N, Ludington WB (2018) Microbiome interactions shape host fitness. *Proc Natl Acad Sci U S A* 115:E11951–E11960. doi: 10.1073/pnas.1809349115
- Goulden EF, Hall MR, Pereg LL, Høj L (2012) Identification of an antagonistic probiotic combination protecting ornate spiny lobster (*Panulirus ornatus*) larvae against *Vibrio owensii* infection. *PLoS One*. doi: 10.1371/journal.pone.0039667
- Grandiosa R, Young T, Van Nguyen T, Mérien F, Alfaro AC (2020) Immune response in probiotic-fed New Zealand black-footed abalone (*Haliotis iris*) under *Vibrio splendidus* challenge. *Fish Shellfish Immunol* 104:633–639. doi: 10.1016/j.fsi.2020.06.007
- Green TJ, Siboni N, King WL, Labbate M, Seymour JR, Raftos D (2019) Simulated Marine Heat Wave Alters Abundance and Structure of *Vibrio* Populations Associated with the Pacific Oyster Resulting in a Mass Mortality Event. *Microb Ecol* 77:736–747. doi: 10.1007/s00248-018-1242-9
- Harvell CD, Mitchell CE, Ward JR, Altizer S, Dobson AP, Ostfeld RS, Samuel MD (2002) Climate warming and disease risks for terrestrial and marine biota. *Science* (80-) 296:2158–2162. doi: 10.1126/science.1063699
- Heath-Heckman EAC, Foster J, Apicella MA, Goldman WE, McFall-Ngai M (2016) Environmental cues and symbiont microbe-associated molecular patterns function in concert to drive the daily remodelling of the crypt-cell brush border of the *Euprymna scolopes* light organ. *Cell Microbiol* 18:1642–1652. doi: 10.1111/cmi.12602
- Heijtz RD, Wang S, Anuar F, Qian Y, Björkholm B, Samuelsson A, Hibberd ML, Forsberg H,

- Pettersson S (2011) Normal gut microbiota modulates brain development and behavior. *Proc Natl Acad Sci U S A* 108:3047–3052. doi: 10.1073/pnas.1010529108
- Helm MM, Bourne N, Lovatelli A (2004) Hatchery culture of bivalves. A practical manual. *FAO Fish Tech Pap* 471:203.
- Holt CC, van der Giezen M, Daniels CL, Stentiford GD, Bass D (2020) Spatial and temporal axes impact ecology of the gut microbiome in juvenile European lobster (*Homarus gammarus*). *ISME J* 14:531–543. doi: 10.1038/s41396-019-0546-1
- Holt CC, Bass D, Stentiford GD, van der Giezen M (2021) Understanding the role of the shrimp gut microbiome in health and disease. *J Invertebr Pathol* 186:107387. doi: 10.1016/j.jip.2020.107387
- Hong PP, Zhu XX, Yuan WJ, Niu GJ, Wang JX (2021) Nitric Oxide Synthase Regulates Gut Microbiota Homeostasis by ERK-NF- κ B Pathway in Shrimp. *Front Immunol*. doi: 10.3389/fimmu.2021.778098
- Hong X, Lu L, Xu D (2016) Progress in research on acute hepatopancreatic necrosis disease (AHPND). *Aquac Int* 24:577–593. doi: 10.1007/s10499-015-9948-x
- Hooper LV, Littman DR, Macpherson AJ (2012) Interactions between the microbiota and the immune system. *Science* (80-) 336:1268–1273. doi: 10.1126/science.1223490
- Huang Z, Zeng S, Xiong J, Hou D, Zhou R, Xing C, Wei D, Deng X, Yu L, Wang H, Deng Z, Weng S, Kriengkrai S, Ning D, Zhou J, He J (2020) Microecological Koch's postulates reveal that intestinal microbiota dysbiosis contributes to shrimp white feces syndrome. *Microbiome*. doi: 10.1186/s40168-020-00802-3
- Infante-Villamil S, Huerlimann R, Jerry DR (2021) Microbiome diversity and dysbiosis in aquaculture. *Rev Aquac* 13:1077–1096. doi: 10.1111/raq.12513
- Jones KE, Patel NG, Levy MA, Storeygard A, Balk D, Gittleman JL, Daszak P (2008) Global trends in emerging infectious diseases. *Nature* 451:990–993. doi: 10.1038/nature06536
- Karim M, Zhao W, Rowley D, Nelson D, Gomez-Chiarri M (2013) Probiotic Strains for Shellfish Aquaculture: Protection of Eastern Oyster, *Crassostrea virginica*, Larvae and Juveniles Against Bacterial Challenge. *J Shellfish Res* 32:401–408. doi: 10.2983/035.032.0220
- Kesarcodi-Watson A, Kaspar H, Lategan MJ, Gibson L (2012a) Performance of single and multi-strain probiotics during hatchery production of Greenshell TM mussel larvae, *Perna canaliculus*. *Aquaculture* 354–355:56–63. doi: 10.1016/j.aquaculture.2012.04.026
- Kesarcodi-Watson A, Miner P, Nicolas JL, Robert R (2012b) Protective effect of four potential probiotics against pathogen-challenge of the larvae of three bivalves: Pacific oyster

- (*Crassostrea gigas*), flat oyster (*Ostrea edulis*) and scallop (*Pecten maximus*). Aquaculture 344–349:29–34. doi: 10.1016/j.aquaculture.2012.02.029
- Kibenge FS (2019) Emerging viruses in aquaculture. Curr Opin Virol 34:97–103. doi: 10.1016/j.coviro.2018.12.008
- King WL, Jenkins C, Go J, Siboni N, Seymour JR, Labbate M (2019a) Characterisation of the Pacific Oyster Microbiome During a Summer Mortality Event. Microb Ecol 77:502–512. doi: 10.1007/s00248-018-1226-9
- King WL, Siboni N, Williams NLR, Kahlke T, Nguyen KV, Jenkins C, Dove M, O'Connor W, Seymour JR, Labbate M (2019b) Variability in the composition of pacific oyster microbiomes across oyster families exhibiting different levels of susceptibility to OsHV-1 μ var disease. Front Microbiol 10:1–12. doi: 10.3389/fmicb.2019.00473
- Kiyimaci ME, Altanlar N, Gumustas M, Ozkan SA, Akin A (2018) Quorum sensing signals and related virulence inhibition of *Pseudomonas aeruginosa* by a potential probiotic strain's organic acid. Microb Pathog 121:190–197. doi: 10.1016/j.micpath.2018.05.042
- Kohl KD, Yahn J (2016) Effects of environmental temperature on the gut microbial communities of tadpoles. Environ Microbiol 18:1561–1565. doi: 10.1111/1462-2920.13255
- Kostic AD, Howitt MR, Garrett WS (2013) Exploring host-microbiota interactions in animal models and humans. Genes Dev 27:701–718. doi: 10.1101/gad.212522.112
- Kumar V, Roy S, Behera BK, Swain HS, Das BK (2021) Biofloc Microbiome With Bioremediation and Health Benefits. Front Microbiol. doi: 10.3389/fmicb.2021.741164
- Lafferty KD, Harvell CD, Conrad JM, Friedman CS, Kent ML, Kuris AM, Powell EN, Rondeau D, Saksida SM (2015) Infectious diseases affect marine fisheries and aquaculture economics. Ann Rev Mar Sci 7:471–496. doi: 10.1146/annurev-marine-010814-015646
- Lafont M, Petton B, Vergnes A, Pauletto M, Segarra A, Gourbal B, Montagnani C (2017) Long-lasting antiviral innate immune priming in the Lophotrochozoan Pacific oyster, *Crassostrea gigas*. Sci Rep. doi: 10.1038/s41598-017-13564-0
- Lafont M, Vergnes A, Vidal-Dupiol J, De Lorgeril J, Gueguen Y, Haffner P, Petton B, Chaparro C, Barrachina C, Destoumieux-Garzon D, Mitta G, Gourbal B, Montagnani C (2020) A sustained immune response supports long-term antiviral immune priming in the pacific oyster, *Crassostrea gigas*. MBio. doi: 10.1128/mBio.02777-19
- Lasa A, di Cesare A, Tassistro G, Borello A, Gualdi S, Furones D, Carrasco N, Cheslett D, Brechon A, Paillard C, Bidault A, Pernet F, Canesi L, Edomi P, Pallavicini A, Pruzzo C, Vezzulli L (2019) Dynamics of the Pacific oyster pathobiota during mortality episodes in

- Europe assessed by 16S rRNA gene profiling and a new target enrichment next-generation sequencing strategy. *Environ Microbiol*. doi: 10.1111/1462-2920.14750
- Laukens D, Brinkman BM, Raes J, De Vos M, Vandenabeele P (2015) Heterogeneity of the gut microbiome in mice: Guidelines for optimizing experimental design. *FEMS Microbiol Rev* 40:117–132. doi: 10.1093/femsre/fuv036
- Le Pennec M, Prieur D, Chardy P (1973) Développement larvaire de *Mytillus edulis* (L.) en présence d'antibiotiques. *Rev Int Ocean Med* 30:115–137.
- Li X, Yang B, Shi C, Wang H, Yu R, Li Q, Liu S (2022) Synergistic Interaction of Low Salinity Stress With *Vibrio* Infection Causes Mass Mortalities in the Oyster by Inducing Host Microflora Imbalance and Immune Dysregulation. *Front Immunol* 13:1. doi: 10.3389/fimmu.2022.859975
- Li YF, Chen YW, Xu JK, Ding WY, Shao AQ, Zhu YT, Wang C, Liang X, Yang JL (2019) Temperature elevation and *Vibrio cyclitrophicus* infection reduce the diversity of haemolymph microbiome of the mussel *Mytilus coruscus*. *Sci Rep*. doi: 10.1038/s41598-019-52752-y
- Lim SJ, Bordenstein SR (2020) An introduction to phylosymbiosis. *Proc R Soc B Biol Sci*. doi: 10.1098/rspb.2019.2900
- Liu H, Zha S, Yang Z, Zhang W, Lin Z, Wang S, Bao Y (2022) Acute sulfide exposure induces hemocyte toxicity and microbiota dysbiosis in blood clam *Tegillarca granosa*. *Aquat Toxicol* 249:106224. doi: 10.1016/j.aquatox.2022.106224
- Liu KF, Chiu CH, Shiu YL, Cheng W, Liu CH (2010) Effects of the probiotic, *Bacillus subtilis* E20, on the survival, development, stress tolerance, and immune status of white shrimp, *Litopenaeus vannamei* larvae. *Fish Shellfish Immunol* 28:837–844. doi: 10.1016/j.fsi.2010.01.012
- Lokmer A, Wegner KM (2015) Hemolymph microbiome of Pacific oysters in response to temperature, temperature stress and infection. *ISME J* 9:670–682. doi: 10.1038/ismej.2014.160
- Luis-Villaseñor IE, Macías-Rodríguez ME, Gómez-Gil B, Ascencio-Valle F, Campa-Córdova ÁI (2011) Beneficial effects of four *Bacillus* strains on the larval cultivation of *Litopenaeus vannamei*. *Aquaculture* 321:136–144. doi: 10.1016/j.aquaculture.2011.08.036
- Lv X, Li S, Yu Y, Zhang X, Li F (2020a) Characterization of a gill-abundant crustin with microbiota modulating function in *Litopenaeus vannamei*. *Fish Shellfish Immunol* 105:393–404. doi: 10.1016/j.fsi.2020.07.014

- Lv X, Li S, Yu Y, Xiang J, Li F (2020b) The immune function of a novel crustin with an atypical WAP domain in regulating intestinal microbiota homeostasis in *Litopenaeus vannamei*. *Dev Comp Immunol*. doi: 10.1016/j.dci.2020.103756
- Ma YX, Liu JC, Li M, Tao W, Yu ZC, Liu Y Bin (2019) The use of *Pseudoalteromonas sp.* F15 in larviculture of the Yesso scallop, *Patinopecten yessoensis*. *Aquac Res* 50:1844–1850. doi: 10.1111/are.14066
- Madison D, Schubiger C, Lunda S, Mueller RS, Langdon C (2022) A marine probiotic treatment against the bacterial pathogen *Vibrio coralliilyticus* to improve the performance of Pacific (*Crassostrea gigas*) and Kumamoto (*C. sikamea*) oyster larvae. *Aquaculture*. doi: 10.1016/j.aquaculture.2022.738611
- Martin YP, Mengus BM (1977) Utilisation de souches bactériennes sélectionnées dans l'alimentation des larves de *Mytilus galloprovincialis* Lmk (mollusque bivalve) en élevages expérimentaux. *Aquaculture* 10:253–262.
- McFall-Ngai M, Hadfield MG, Bosch TCG, Carey H V, Domazet-Lošo T, Douglas AE, Dubilier N, Eberl G, Fukami T, Gilbert SF, Hentschel U, King N, Kjelleberg S, Knoll AH, Kremer N, Mazmanian SK, Metcalf JL, Neelson K, Pierce NE, Rawls JF, Reid A, Ruby EG, Rumpho M, Sanders JG, Tautz D, Wernegreen JJ (2013) Animals in a bacterial world, a new imperative for the life sciences. *Proc Natl Acad Sci U S A* 110:3229–3236. doi: 10.1073/pnas.1218525110
- Milan M, Smits M, Dalla Rovere G, Iori S, Zampieri A, Carraro L, Martino C, Papetti C, Ianni A, Ferri N, Iannaccone M, Patarnello T, Brunetta R, Ciofi C, Grotta L, Arcangeli G, Bargelloni L, Cardazzo B, Martino G (2019) Host-microbiota interactions shed light on mortality events in the striped venus clam *Chamelea gallina*. *Mol Ecol* 28:4486–4499. doi: 10.1111/mec.15227
- Modak TH, Gomez-Chiarri M (2020) Contrasting immunomodulatory effects of probiotic and pathogenic bacteria on eastern oyster, *Crassostrea virginica*, larvae. *Vaccines* 8:1–23. doi: 10.3390/vaccines8040588
- Mousavi Khaneghah A, Abhari K, Eş I, Soares MB, Oliveira RBA, Hosseini H, Rezaei M, Balthazar CF, Silva R, Cruz AG, Ranadheera CS, Sant'Ana AS (2020) Interactions between probiotics and pathogenic microorganisms in hosts and foods: A review. *Trends Food Sci Technol* 95:205–218. doi: 10.1016/j.tifs.2019.11.022
- Muñoz K, Flores-Herrera P, Gonçalves AT, Rojas C, Yáñez C, Mercado L, Brokordt K, Schmitt P (2019) The immune response of the scallop *Argopecten purpuratus* is associated with changes in the host microbiota structure and diversity. *Fish Shellfish Immunol* 91:241–

250. doi: 10.1016/j.fsi.2019.05.028

- Netea MG, Domínguez-Andrés J, Barreiro LB, Chavakis T, Divangahi M, Fuchs E, Joosten LAB, van der Meer JWM, Mhlanga MM, Mulder WJM, Riksen NP, Schlitzer A, Schultze JL, Stabell Benn C, Sun JC, Xavier RJ, Latz E (2020) Defining trained immunity and its role in health and disease. *Nat Rev Immunol* 20:375–388. doi: 10.1038/s41577-020-0285-6
- Nicolas JL, Comps M, Cochenec N (1992) Herpes-like virus infecting Pacific-oyster larvae, *Crassostrea gigas*. *Bull Eur Assoc Fish Pathol* 12:11–13. doi: 10.3/JQUERY-ULJS
- Norouzitallab P, Baruah K, Biswas P, Vanrompay D, Bossier P (2016) Probing the phenomenon of trained immunity in invertebrates during a transgenerational study, using brine shrimp *Artemia* as a model system. *Sci Rep*. doi: 10.1038/srep21166
- Offret C, Rochard V, Laguerre H, Mounier J, Huchette S, Brillet B, Le Chevalier P, Fleury Y (2018) Protective Efficacy of a *Pseudoalteromonas* Strain in European Abalone, *Haliotis tuberculata*, Infected with *Vibrio harveyi* ORM4. *Probiotics Antimicrob Proteins* 11:239–247. doi: 10.1007/s12602-018-9389-8
- Ooi MC, Goulden EF, Smith GG, Bridle AR (2021) Predatory bacteria in the haemolymph of the cultured spiny lobster *Panulirus ornatus*. *Microbiol (United Kingdom)* 167:1113. doi: 10.1099/MIC.0.001113
- Padeniya U, Larson ET, Septriani S, Pataueg A, Kafui AR, Hasan E, Mmaduakonam OS, Kim G Do, Kiddane AT, Brown CL (2022) Probiotic Treatment Enhances Pre-feeding Larval Development and Early Survival in Zebrafish *Danio rerio*. *J Aquat Anim Health* 34:3–11. doi: 10.1002/aah.10148
- Paillard C, Gueguen Y, Wegner KM, Bass D, Pallavicini A, Vezzulli L, Arzul I (2022) Recent advances in bivalve-microbiota interactions for disease prevention in aquaculture. *Curr Opin Biotechnol* 73:225–232. doi: 10.1016/j.copbio.2021.07.026
- Pérez-Sánchez T, Mora-Sánchez B, Balcázar JL (2018) Biological Approaches for Disease Control in Aquaculture: Advantages, Limitations and Challenges. *Trends Microbiol* 26:896–903. doi: 10.1016/j.tim.2018.05.002
- Petton B, Bruto M, James A, Labreuche Y, Alunno-Bruscia M, Le Roux F (2015) *Crassostrea gigas* mortality in France: The usual suspect, a herpes virus, may not be the killer in this polymicrobial opportunistic disease. *Front Microbiol*. doi: 10.3389/fmicb.2015.00686
- Petton B, Destoumieux-Garzón D, Pernet F, Toulza E, de Lorgeril J, Degremont L, Mitta G (2021) The Pacific Oyster Mortality Syndrome, a Polymicrobial and Multifactorial Disease: State of Knowledge and Future Directions. *Front Immunol*. doi:

10.3389/fimmu.2021.630343

- Pham D, Ansquer D, Chevalier A, Dauga C, Peyramale A, Wabete N, Labreuche Y (2014) Selection and characterization of potential probiotic bacteria for *Litopenaeus stylirostris* shrimp hatcheries in New Caledonia. *Aquaculture* 432:475–482. doi: 10.1016/j.aquaculture.2014.04.031
- Pradeep B, Rai P, Mohan SA, Shekhar MS, Karunasagar I (2012) Biology, host range, pathogenesis and diagnosis of white spot syndrome virus. *Indian J Virol* 23:161–174. doi: 10.1007/s13337-012-0079-y
- Puvanasundram P, Chong CM, Sabri S, Yusoff MS, Karim M (2021) Multi-strain probiotics: Functions, effectiveness and formulations for aquaculture applications. *Aquac Reports*. doi: 10.1016/j.aqrep.2021.100905
- Rajeev R, Adithya KK, Kiran GS, Selvin J (2021) Healthy microbiome: a key to successful and sustainable shrimp aquaculture. *Rev Aquac* 13:238–258. doi: 10.1111/raq.12471
- Rohwer F, Seguritan V, Azam F, Knowlton N (2002) Diversity and distribution of coral-associated bacteria. *Mar Ecol Prog Ser* 243:1–10. doi: 10.3354/meps243001
- Rosenberg E, Sharon G, Zilber-Rosenberg I (2009) The hologenome theory of evolution contains Lamarckian aspects within a Darwinian framework. *Environ Microbiol* 11:2959–2962. doi: 10.1111/j.1462-2920.2009.01995.x
- Rosenstiel P, Philipp EER, Schreiber S, Bosch TCG (2009) Evolution and function of innate immune receptors - Insights from marine invertebrates. *J Innate Immun* 1:291–300. doi: 10.1159/000211193
- Roy S, Bossier P, Norouzitallab P, Vanrompay D (2020) Trained immunity and perspectives for shrimp aquaculture. *Rev Aquac* 12:2351–2370. doi: 10.1111/raq.12438
- Sánchez-Paz A (2010) White spot syndrome virus: An overview on an emergent concern. *Vet Res*. doi: 10.1051/vetres/2010015
- Schleder DD, Blank M, Peruch LGB, Poli MA, Gonçalves P, Rosa KV, Fracalossi DM, Vieira F do N, Andreatta ER, Hayashi L (2020) Impact of combinations of brown seaweeds on shrimp gut microbiota and response to thermal shock and white spot disease. *Aquaculture*. doi: 10.1016/j.aquaculture.2019.734779
- Schmidt VT, Smith KF, Melvin DW, Amaral-Zettler LA (2015) Community assembly of a euryhaline fish microbiome during salinity acclimation. *Mol Ecol* 24:2537–2550. doi: 10.1111/mec.13177
- Schröder K, Bosch TCG (2016) The origin of mucosal immunity: Lessons from the holobiont *Hydra*. *MBio*. doi: 10.1128/mBio.01184-16

- Segata N, Izard J, Waldron L, Gevers D, Miropolsky L, Garrett WS, Huttenhower C (2011) Metagenomic biomarker discovery and explanation. *Genome Biol* 12:R60. doi: 10.1186/gb-2011-12-6-r60
- Sharon G, Segal D, Ringo JM, Hefetz A, Zilber-Rosenberg I, Rosenberg E (2010) Commensal bacteria play a role in mating preference of *Drosophila melanogaster*. *Proc Natl Acad Sci U S A* 107:20051–20056. doi: 10.1073/pnas.1009906107
- Sommer F, Bäckhed F (2013) The gut microbiota-masters of host development and physiology. *Nat Rev Microbiol* 11:227–238. doi: 10.1038/nrmicro2974
- Sorée M, Kolypczuk L, Hadjiev E, Lozach S, Verrez-Bagnis V, Delbarre-Ladrat C, Heath DH, Passerini D (2023) Screening of marine lactic acid bacteria for *Vibrio parahaemolyticus* inhibition and application to depuration in Pacific oysters (*Crassostrea gigas*). *J Appl Microbiol*. doi: 10.1093/jambio/lxac081
- Soudant P, E. Chu FL, Volety A (2013) Host-parasite interactions: Marine bivalve molluscs and protozoan parasites, Perkinsus species. *J Invertebr Pathol* 114:196–216. doi: 10.1016/j.jip.2013.06.001
- Sumon TA, Hussain MA, Sumon MAA, Jang WJ, Abellan FG, Sharifuzzaman SM, Brown CL, Lee E-W, Kim C-H, Hasan MT (2022) Functionality and prophylactic role of probiotics in shellfish aquaculture. *Aquac Reports* 25:101220. doi: 10.1016/j.aqrep.2022.101220
- Theis KR, Dheilly NM, Klassen JL, Brucker RM, Baines JF, Bosch TCG, Cryan JF, Gilbert SF, Goodnight CJ, Lloyd EA, Sapp J, Vandenkoornhuyse P, Zilber-Rosenberg I, Rosenberg E, Bordenstein SR (2016) Getting the Hologenome Concept Right: an Eco-Evolutionary Framework for Hosts and Their Microbiomes. *mSystems*. doi: 10.1128/msystems.00028-16
- Thornber K, Verner-Jeffreys D, Hinchliffe S, Rahman MM, Bass D, Tyler CR (2020) Evaluating antimicrobial resistance in the global shrimp industry. *Rev Aquac* 12:966–986. doi: 10.1111/raq.12367
- Touraki M, Karamanlidou G, Karavida P, Chrysi K (2012) Evaluation of the probiotics *Bacillus subtilis* and *Lactobacillus plantarum* bioencapsulated in *Artemia nauplii* against Vibriosis in European sea bass larvae (*Dicentrarchus labrax*, L.). *World J Microbiol Biotechnol* 28:2425–2433. doi: 10.1007/s11274-012-1052-z
- Travers MA, Boettcher Miller K, Roque A, Friedman CS (2015) Bacterial diseases in marine bivalves. *J Invertebr Pathol* 131:11–31. doi: 10.1016/j.jip.2015.07.010
- Vadstein O, Attramadal KJK, Bakke I, Olsen Y (2018) K-selection as microbial community management strategy: A method for improved viability of larvae in aquaculture. *Front*

- Microbiol. doi: 10.3389/fmicb.2018.02730
- Wang XW, Xu JD, Zhao XF, Vasta GR, Wang JX (2014) A shrimp C-type lectin inhibits proliferation of the hemolymph microbiota by maintaining the expression of antimicrobial peptides. *J Biol Chem* 289:11779–11790. doi: 10.1074/jbc.M114.552307
- Wang YC, Hu SY, Chiu CS, Liu CH (2019) Multiple-strain probiotics appear to be more effective in improving the growth performance and health status of white shrimp, *Litopenaeus vannamei*, than single probiotic strains. *Fish Shellfish Immunol* 84:1050–1058. doi: 10.1016/j.fsi.2018.11.017
- Webster NS, Reusch TB (2017) Microbial contributions to the persistence of coral reefs. *ISME J* 11:2167–2174. doi: 10.1038/ismej.2017.66
- Webster NS, Botté ES, Soo RM, Whalan S (2011) The larval sponge holobiont exhibits high thermal tolerance. *Environ Microbiol Rep* 3:756–762. doi: 10.1111/j.1758-2229.2011.00296.x
- Xiong J, Wang K, Wu J, Qiuqian L, Yang K, Qian Y, Zhang D (2015) Changes in intestinal bacterial communities are closely associated with shrimp disease severity. *Appl Microbiol Biotechnol* 99:6911–6919. doi: 10.1007/s00253-015-6632-z
- Yang HT, Yang MC, Sun JJ, Guo F, Lan JF, Wang XW, Zhao XF, Wang JX (2015) Catalase eliminates reactive oxygen species and influences the intestinal microbiota of shrimp. *Fish Shellfish Immunol* 47:63–73. doi: 10.1016/j.fsi.2015.08.021
- Yang MJ, Song H, Yu ZL, Hu Z, Zhou C, Wang XL, Zhang T (2020) Changes in Symbiotic Microbiota and Immune Responses in Early Development Stages of *Rapana venosa* (Valenciennes, 1846) Provide Insights Into Immune System Development in Gastropods. *Front Microbiol* 11:1265. doi: 10.3389/fmicb.2020.01265
- Yeh H, Skubel SA, Patel H, Cai Shi D, Bushek D, Chikindas ML (2020) From Farm to Fingers: an Exploration of Probiotics for Oysters, from Production to Human Consumption. *Probiotics Antimicrob Proteins*. doi: 10.1007/s12602-019-09629-3
- Yu W, Lu Y, Shen Y, Liu J, Gong S, Yu F, Huang Z, Zou W, Zhou M, Luo X, You W, Ke C (2022) Exploring the Intestinal Microbiota and Metabolome Profiles Associated With Feed Efficiency in Pacific Abalone (*Haliotis discus hannai*). *Front Microbiol*. doi: 10.3389/fmicb.2022.852460
- Zhang S, Sun X (2022) Core Gut Microbiota of Shrimp Function as a Regulator to Maintain Immune Homeostasis in Response to WSSV Infection. *Microbiol Spectr*. doi: 10.1128/spectrum.02465-21
- Zhang T, Qiu L, Sun Z, Wang L, Zhou Z, Liu R, Yue F, Sun R, Song L (2014) The specifically

- enhanced cellular immune responses in Pacific oyster (*Crassostrea gigas*) against secondary challenge with *Vibrio splendidus*. *Dev Comp Immunol* 45:141–150. doi: 10.1016/j.dci.2014.02.015
- Zhao J, Zhao B, Kong N, Li F, Liu J, Wang L, Song L (2023) Increased abundances of potential pathogenic bacteria and expressions of inflammatory cytokines in the intestine of oyster *Crassostrea gigas* after high temperature stress. *Dev Comp Immunol* 141:104630. doi: 10.1016/j.dci.2022.104630
- Zhao W, Yuan T, Piva C, Spinard EJ, Schutttert CW, Rowley DC, Nelson DR (2019) The Probiotic Bacterium *Phaeobacter inhibens* Downregulates Virulence Factor Transcription in the Shellfish Pathogen *Vibrio coralliilyticus* by N-Acyl Homoserine Lactone Production. *Appl Environ Microbiol* 85:1–14. doi: 10.1128/AEM.01545-18
- Zheng Y, Yu M, Liu Y, Su Y, Xu T, Yu M, Zhang XH (2016) Comparison of cultivable bacterial communities associated with Pacific white shrimp (*Litopenaeus vannamei*) larvae at different health statuses and growth stages. *Aquaculture* 451:163–169. doi: 10.1016/j.aquaculture.2015.09.020
- Zheng Y, Yu M, Liu J, Qiao Y, Wang L, Li Z, Zhang XH, Yu M (2017) Bacterial community associated with healthy and diseased Pacific white shrimp (*Litopenaeus vannamei*) larvae and rearing water across different growth stages. *Front Microbiol* 8:1362. doi: 10.3389/fmicb.2017.01362
- Ziaei-Nejad S, Rezaei MH, Takami GA, Lovett DL, Mirvaghefi AR, Shakouri M (2006) The effect of *Bacillus* spp. bacteria used as probiotics on digestive enzyme activity, survival and growth in the Indian white shrimp *Fenneropenaeus indicus*. *Aquaculture* 252:516–524. doi: 10.1016/j.aquaculture.2005.07.021
- Zilber-Rosenberg I, Rosenberg E (2008) Role of microorganisms in the evolution of animals and plants: The hologenome theory of evolution. *FEMS Microbiol Rev* 32:723–735. doi: 10.1111/j.1574-6976.2008.00123.x

Tables and figures:**Table 1: Studies which support that host associated microbiota influences the health of molluscs and crustacean of aquaculture interest****Part 1: Studies which highlight how the microbiota diversity influences the health and disease outcomes.**

Species	Disease	Microbiota change	Effect on the Host	Reference
<i>L. vannamei</i>	White Spot Syndrome Virus	Increased Microbial diversity induced by dietary supplementation of brown seaweeds composition	Reduction of the mortality rates after a WSSV challenge in diet fed group compared to control shrimp	(Schleder <i>et al.</i> 2020)
<i>M. japonicus</i> , <i>L. vannamei</i> , <i>Macrobrachium rosenbergii</i> , <i>Procambarus clarkii</i>	White Spot Syndrome Virus	Production of metabolites with antiviral potential by half of the core microbiota in response to viral challenge	Likely contributes to a better Immune homeostasis and potential host resistance	(Zhang and Sun 2022)
<i>Homarus gammarus</i>	Infection with <i>Homarus gammarus nudivirus</i> (HgNV)	Increased Species richness and diversity observed in sea-based container culture compared to land-based culture	Lower viral prevalence in SBCC compared to land-based culture	(Holt <i>et al.</i> 2020)
<i>Penaeid</i> shrimp	White Feces Syndrome	Decreased in microbial richness and diversity during the WFS disease	Intestinal microbiota transplants from WFS diseased to healthy shrimp lead to symptoms similar to the diseased ones	(Huang <i>et al.</i> 2020)
<i>Haliotis fulgens</i> <i>Haliotis corrugata</i>	Withering Syndrome	Higher microbial diversity in the yellow abalone (<i>Haliotis corrugata</i>) compared to blue abalone (<i>Haliotis fulgens</i>)	Increased susceptibility to the WS in the blue abalone which correlates with structural and functional alterations in their microbiota on the contrary to yellow abalone which keeps a stable microbiota under WS stress	(Cicala <i>et al.</i> 2018, 2022)
<i>C. gigas</i>	POMS disease	Higher microbial diversity in larvae after a microbiota transfer compared to control group	Lower mortality in the microbiota transferred group compared to control	(Fallet <i>et al.</i> 2022)

Part 2: Studies which highlight the beneficial contribution of a specific bacterial species for the health of its autochthonous host by antagonistic effects.

Species	Disease	Microbiota change	Effect on the Host	Reference
<i>C. gigas</i>	Vibriosis	Addition of <i>Pseudoalteromonas</i> (hCg-42 and hCg-6) (producer of antimicrobial molecules (Alterins)) to <i>C. gigas</i>	<i>In vitro</i> antimicrobial effect against <i>Vibrio</i> and decrease of the mortality rates after a <i>Vibrio</i> challenge in <i>C. gigas</i> incubated with <i>hCg-42</i>	(Defer <i>et al.</i> 2013; Desriac <i>et al.</i> 2020; Dantan, personal communication)
<i>P. ornatus</i>	Vibriosis	Addition of <i>BALOs</i> (<i>BdelloVibrio</i> and like Organisms) to <i>P. ornatus</i>	Abundance decreases of <i>Vibrio</i> in haemolymph of host injected with <i>Halobacteriovorax</i> sp. (<i>BALOs</i>)	(Ooi <i>et al.</i> 2021)
<i>Litopenaeus vannamei</i>	Vibriosis	Addition of <i>Bacillus</i> sp. YC5-2 initially isolated from the guts of healthy wild adult shrimp	<i>In vitro</i> antibacterial effect against <i>Vibrio</i> and decreased mortality after a <i>Vibrio</i> challenge	(Luis-Villaseñor <i>et al.</i> 2011)
<i>C. gigas</i>	<i>V. coralliilyticus</i> infection	Addition of <i>Pseudoalteromonas</i> (D16 and DM14), and Epibacterium (B11) initially isolated from <i>C. gigas</i> oysters	Improving survival of oysters during <i>V. coralliilyticus</i> infection	(Madison <i>et al.</i> 2022)

Table 2: Studies which support direct consequences of the innate immune system for the host associated microbiota structure.

Organisms	Innate immune effectors	Influence on the microbiota structure	Reference
<i>M. japonicus</i>	MjHeCL (protein that combines a C-type lectin domain, and an antimicrobial peptide)	The down-regulation of MjHeCL expression by RNAi lead to the proliferation of the haemolymph microbiota, ultimately resulting in shrimp death	(Wang <i>et al.</i> 2014)
<i>M. japonicus</i>	The Catalase enzyme by regulating the Reactive Oxygen Species (ROS) level	High level of ROS in shrimp intestine (obtained after inactivation of MjCAT which encodes for the Catalase) correlates with a reduction in bacterial load of the shrimp intestinal lumen	(Yang <i>et al.</i> 2015)
<i>M. japonicus</i>	Nitric Oxide (possibly through its positive regulation of AMPs production)	After RNA interference of the Nitric Oxide Synthase (NOS) or treatment with an inhibitor of NOS, NO production decreased, and the gut bacterial load increased significantly in shrimp	(Hong <i>et al.</i> 2021)
<i>L. vannamei</i>	Antimicrobial peptides of the Crustin family	Inactivation of the gene encoding for the antimicrobial peptide LvCrustin II-1 leads to change in the microbiota composition of the shrimp gills	(Lv <i>et al.</i> 2020a)
<i>L. vannamei</i>	Antimicrobial peptides of the Crustin family	Inactivation of the gene encoding for the antimicrobial peptide LvCrustin I-1 leads to change in the microbiota composition of shrimp intestines	(Lv <i>et al.</i> 2020b)
<i>A. purpuratus</i>	Antimicrobial peptide from the big defensin family (ApBD1)	Inactivation of the gene encoding for ApBD1 leads to changes in bacterial composition of the hemolymph microbiota	(González <i>et al.</i> 2020)
<i>A. purpuratus</i>	The bactericidal/permeability increasing protein ApLBP/BPI1	Inactivation of the gene encoding for ApLBP/BPI1 leads to changes in bacterial composition of the hemolymph microbiota	(González <i>et al.</i> 2020)
<i>A. purpuratus</i>	g-type lysozyme ApGlys	Inactivation of the gene encoding for ApGlys leads to higher diversity in hemolymph bacterial community and imbalance in certain bacterial groups	(González <i>et al.</i> 2022)
<i>C. gigas</i>	Antimicrobial peptide from the big defensin family (<i>Cg</i> -BigDEf1)	Injection of synthetic <i>Cg</i> -BigDEf1 into the oyster tissues induced a significant shift in oyster microbiota β -diversity	(de San Nicolas <i>et al.</i> 2022)

Table 3: Current limitations of probiotic application in molluscs and crustaceans aquaculture

The probiotics do not settle down in the endogenous microbiota	
Exposure of the European abalone <i>Haliotis tuberculata</i> with the <i>Pseudoalteromonas</i> hCg-6 exogenous strain leads to a transient establishment of this probiotic strain in the haemolymph rather than the establishment of a long-term interaction	(Offret <i>et al.</i> 2018)
Exposure of <i>C. gigas</i> larvae to BLIS (bacteriocin-like inhibitory substance) - producing <i>Aeromonas</i> media, showed that the probiotic strain concentration decreased right after it was added to the oyster and was not detectable 72h after its addition	(Gibson <i>et al.</i> 1998)
The probiotics display short term beneficial effects	
In <i>L. vannamei</i> , larval exposure with <i>Bacillus subtilis</i> E20 or with <i>Bacillus sp.</i> YC5-2 is beneficial to the shrimp during larval stages but subsequent beneficial effects on further stages are not tested.	(Liu <i>et al.</i> 2010; Luis-Villaseñor <i>et al.</i> 2011)
Immunomodulation is observed in <i>L. stillostris</i> after a larval exposure with <i>Pseudoalteromonas</i> probiotic candidates but not tested on later stages.	(Pham <i>et al.</i> 2014)
Addition of <i>Bacillus pumilus</i> RI06–95 and <i>Phaeobacter inhibens</i> S4 during larval development of the eastern oyster <i>C. virginica</i> for either 6h or 24h prior to pathogen challenge leads to an effective immune response and protection against <i>V. coralliilyticus</i> and <i>Vibrio tubiashii</i> further reported that the beneficial effect was observed immediately after exposure, but no significant protection was observed when the larvae were challenged 48 and 96h after removal of the probiotic.	(Karim <i>et al.</i> 2013; Modak and Gomez-Chiarri 2020)
The exposure of <i>C. cortezinsis</i> larvae to a mix of two bacteria <i>Pseudomonas aeruginosa</i> , strain YC58 and <i>Burkholderia cepacia</i> , strain Y021, leads to a better survival during the larval rearing stages.	(Campa-Córdova <i>et al.</i> 2011)
A 20-hours larval exposure to <i>Pseudoalteromonas sp.</i> D41 or <i>Phaeobacter gallaeciensis</i> , has conferred a significant protection to <i>C. gigas</i> larvae against <i>V. coralliilyticus</i>	(Kesarcodi-Watson <i>et al.</i> 2012b)
An immunomodulation was also observed on the Yesso scallop <i>Patinopecten yessoensis</i> fed with a diet of microalgae supplemented with the strain <i>Pseudoalteromonas sp.</i> F15 during larval stages	(Ma <i>et al.</i> 2019)
In the sea cucumber <i>Apostichopus japonicus</i> , an exposure to bacterial strains <i>Pseudoalteromonas elyakovii</i> HS1, <i>Shewanella japonica</i> HS7, or <i>Vibrio tasmaniensis</i> HS10 lead to an enhanced cellular and humoral immune response and to an improved survival and growth rate	(Chi <i>et al.</i> 2014)

Box 1: Scientific rational behind the microbial education

Description of the concept	
<p>(1) Microbial community management in aquaculture</p>	<p>The microbial management in aquaculture consist in controlling the water microbiota in rearing system according to ecological selection principles. Methods which favour K-selection in the rearing environment have been shown to select against r-strategic microbes and promote healthy microbe-larvae interactions (De Schryver and Vadstein 2014; De Schryver <i>et al.</i> 2014; Bossier <i>et al.</i> 2016; Vadstein <i>et al.</i> 2018).</p>
<p>(2) Holobiont concept</p>	<p>Host associated microbial communities can influence multiple facets of animal physiology from development, behaviour, ecological functions such as stress tolerance but also pathogen resistance and immunity (Sharon <i>et al.</i> 2010; Heijtz <i>et al.</i> 2011; Webster <i>et al.</i> 2011; McFall-Ngai <i>et al.</i> 2013; Kostic <i>et al.</i> 2013; Gilbert <i>et al.</i> 2015; Schmidt <i>et al.</i> 2015; Kohl and Yahn 2016; Webster and Reusch 2017; Gould <i>et al.</i> 2018). The beneficial effect of microbiota for host immune homeostasis is clearly one of the best illustration of the holobiont theory (Chung <i>et al.</i> 2012; Hooper <i>et al.</i> 2012; Abt and Artis 2013; Sommer and Bäckhed 2013).</p>
<p>(3) Biological embedding</p>	<p>The biological embedding is the process by which the life history of an individual during ontogeny impacts its development and thus modifies its phenotype (Aristizabal <i>et al.</i> 2020). The environment has a long-lasting influence on the functions of biological systems and this environmental imprint has major consequences for the behaviour and health of individuals. The early stages of development are sensitive windows for recording this environmental information (Dolinoy <i>et al.</i> 2011; Fellous <i>et al.</i> 2022). Microbial colonization during early life is an example of biological embedding and many studies have emphasized its critical role to educate and durably imprint the immune system (Arrieta <i>et al.</i> 2014; Gensollen <i>et al.</i> 2016).</p>
<p>(4) Immune priming</p>	<p>The immune memory as described in vertebrates does not exist <i>per se</i> in invertebrates and the fight against pathogens relies on innate immune mechanisms. It has been shown recently that this innate immunity can be trained to retain the memory of a primary exposure to better respond to infections encountered later (Netea <i>et al.</i> 2020). In mollusc and crustaceans, recent studies have shown that it is possible to train the innate immune system (Zhang <i>et al.</i> 2014; Norouzitallab <i>et al.</i> 2016; Lafont <i>et al.</i> 2017, 2020). The possibility to use trained immunity as a potential strategy to fight disease in shrimp aquaculture has been recently reviewed by Roy <i>et al.</i> (2020).</p>

Figure 1: Microbial education for health benefit in Shellfish aquaculture

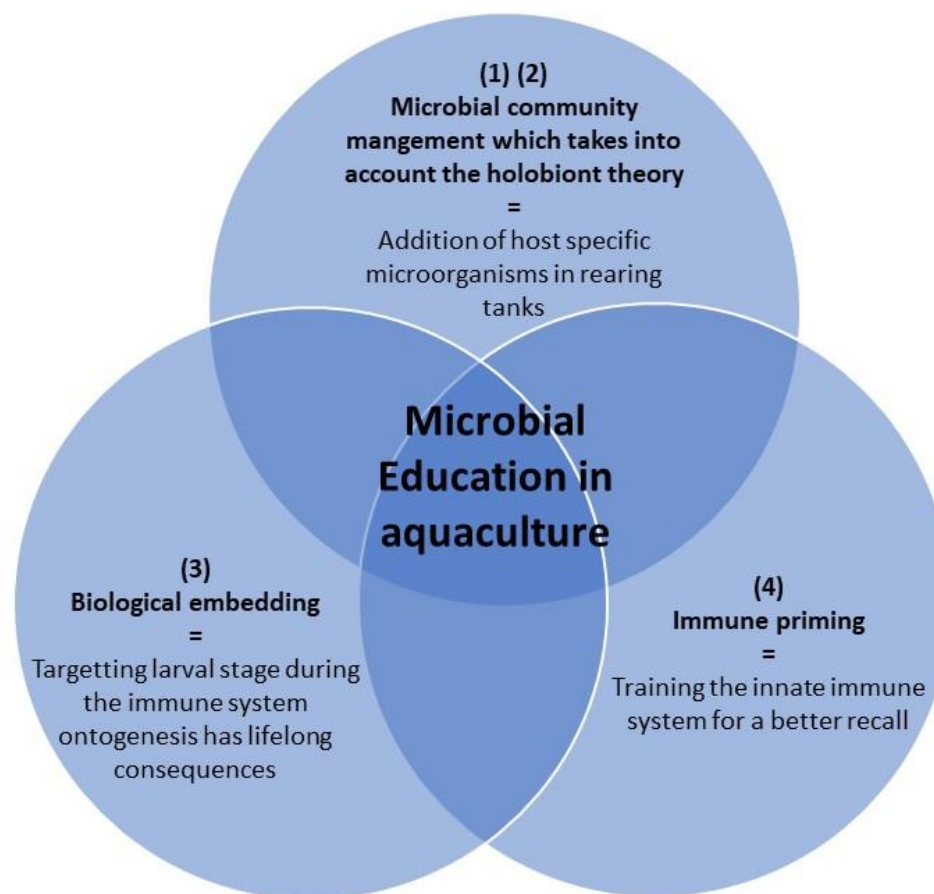

Table 4: Benefits and barrier for practicability in aquaculture

Benefit
The microbial education is a probiotic strategy that has to be applied during larval rearing in hatcheries. This plan is feasible for shellfish, even those which will be transferred in open sea at later stages.
The probiotic exposure will be performed on millions of larvae at the same time
The strategy aims at providing high quality juveniles, which is a current bottleneck in aquaculture
The exposure benefice during larval stages is expected to be lifelong but also multigenerational
Barriers
The larval rearing is identified as a really sensitive steps and inappropriate probiotic exposure during these steps may be more detrimental than beneficial
The microbial education approach is empirical and require time for optimisation. The optimal setup for one species can not be implemented to another species
The exposure to microorganisms, multi strain probiotic for example, can lead to heightened immunity with some specificity toward particular pathogen and may not protect against all infectious disease
The use of donors of microorganisms is the best strategy but the transferred microbiota is not controlled and there is a risk for pathogen transmission

Figure 2: Full scale experimental design to identify beneficial bacteria for microbial education.

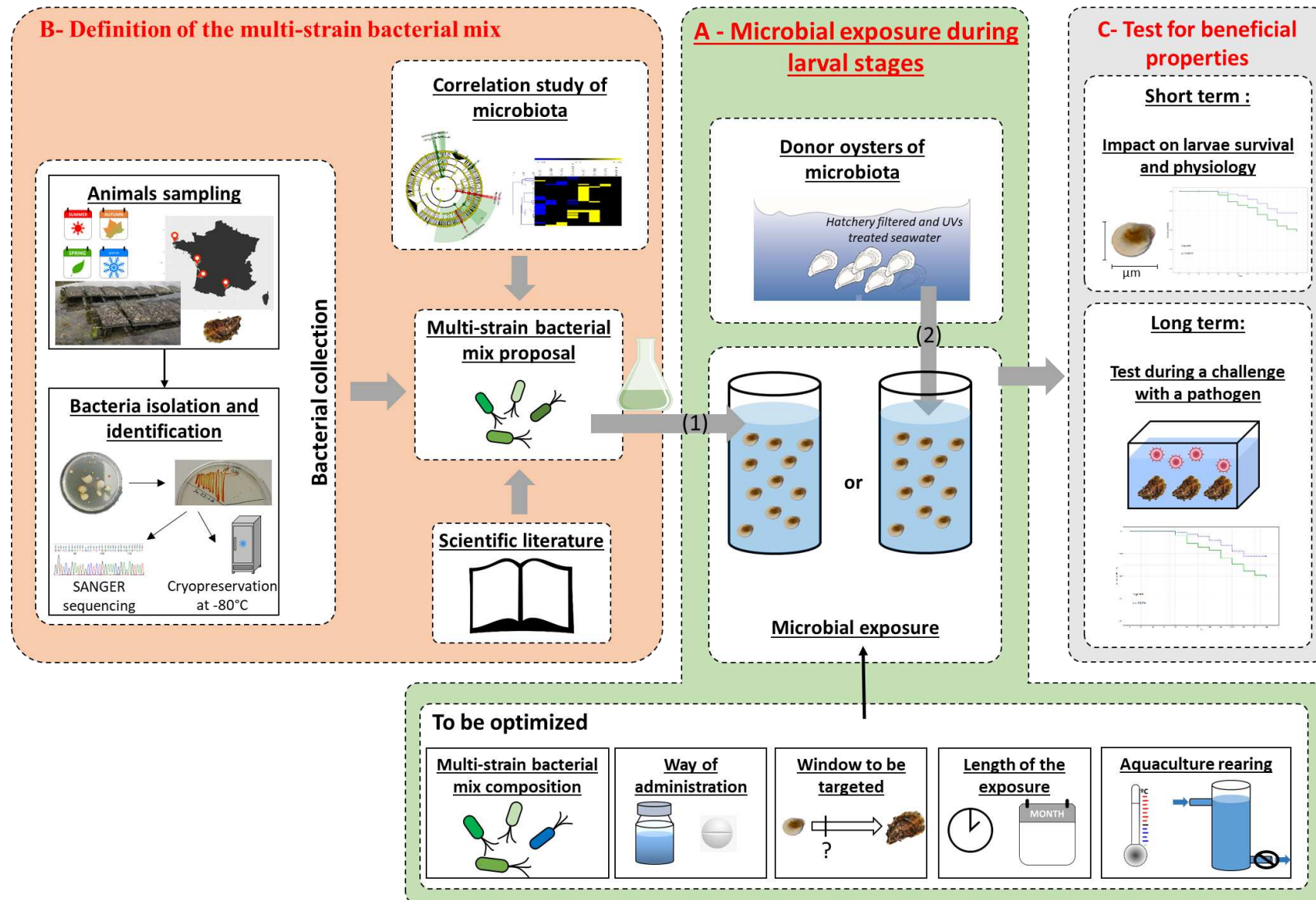

Figure legend**Figure 1: Full scale experimental design to identify beneficial bacteria for microbial education.**

For a long-term beneficial effect, it is recommended to perform the microbial education during larval stages (Part A, green coloured). The microorganisms to be added to the seawater during larval rearing can be introduced either (1) by pathogen-free donor oysters which were always kept in controlled facilities using UV-treated seawater, strict biosecurity zoning and management procedures or (2) by adding cultured based multi-strain bacterial mix which have been carefully selected. The method of administration of the mix and its composition have to be optimised to maximize its absorption by the larvae (Dipping or in freeze-dried form, delayed or simultaneous to the feeding, biofloc form). The exposure window (from embryogenesis to larval stages) and the duration of the exposure to the bacterial cocktails must be adjusted. The rearing conditions are other parameters which should be tested (Temperature, continuous flow or batch rearing system). The definition of the multi-strain bacterial mix (Part B, orange coloured) is a necessary upstream step to better anticipate for beneficial properties. First, a library of cultivable bacteria must be created. These bacteria will be preferentially isolated from the host to be targeted. Pathogen-resistant animals (if probiotics aims at improving resistance toward a particular infectious disease) must be collected from several geographical sites and at different seasons in order to maximize the bacterial diversity. The bacteria thus obtained will then be cultivated, purified, and cryopreserved. Several physicochemical parameters (culture media, temperature) for bacterial culture may be tested to increase the potential biodiversity in the bacterial library. Identification of each cultivated strain from the collection will be performed by SANGER sequencing of the 16S rRNA coding gene. In parallel, *in silico* predictive analysis must be performed to predict which bacteria are generally associated to resistant phenotype in the host (if probiotics aims at improving resistance toward a particular infectious disease). This correlative study will necessitate that several (meta)barcoding analyses have been previously generated on microbiota sampled from resistant and sensitive animals toward a specified disease. These correlative analyses, coupled with an exhaustive study of the scientific literature, should make it possible to predict bacteria from the collection which could be beneficial probiotic candidates. Then, beneficial effects of the microorganism exposure will have to be tested (Part C, grey coloured). Short term effect will be tested during the larval stages. Particular attention should be paid to the effect of the MSP on the survival and physiology of the larvae, to test whether the exposure is deleterious, beneficial, or neutral for

larval development and growth properties. Sampling for molecular analysis (*i.e.*, transcriptomic, barcoding, metabolic, epigenomic analysis,) may be worth to decipher molecular basis of the microbial effect. Finally, long term beneficial effect will be tested on subsequent life cycle stages: juveniles and adults will be challenged by pathogens.

IV. Objectifs de la thèse

En raison du nombre croissant et de la sévérité de plus en plus importante des maladies infectieuses affectant la production de l'huître du Pacifique *Crassostrea gigas*, il apparaît comme essentiel de développer des stratégies de lutte contre ces maladies infectieuses. Les pratiques ostréicoles actuelles se déroulant en milieu ouvert, les méthodes de lutte classiques telles que l'utilisation d'antibiotiques sont impossibles à mettre en place. Récemment, de nouveaux concepts sur les interactions hôte-microbiote ont émergé. Des études ont démontré l'importance que jouent les micro-organismes dans la santé de leur hôte (Laukens *et al.* 2015). De plus, il a été démontré au sein du laboratoire IHPE qu'une exposition à des microorganismes lors des stades précoces du développement de l'huître *Crassostrea gigas* permettait d'avoir chez l'huître juvénile une diminution du taux de mortalité lors d'un challenge à la maladie du POMS mais également une modification de l'expression de gènes liés à l'immunité (Fallet *et al.* 2022). D'autre part, il a également été montré que certains taxons bactériens tels que les Colwelliaceae, les Cyanobacteria (Subsection III, family I), et les Rhodobacteraceae étaient surreprésentés de façon significative chez les huîtres résistantes à la maladie du POMS.

Mon objectif de thèse était donc de développer des stratégies alternatives afin de lutter contre ces maladies infectieuses en utilisant les capacités naturelles du microbiote de l'huître *C. gigas*. Pour y parvenir, deux stratégies différentes ont été étudiées au cours de ma thèse.

Pour le premier chapitre de ma thèse, le mécanisme étudié est celui de l'éducation microbienne. Il s'agit d'éduquer le système immunitaire des huîtres par une exposition à des bactéries lors des stades précoces du développement afin de leur permettre de mieux résister face à la maladie du POMS et à la bactérie pathogène *Vibrio aestuarianus*.

Le second chapitre de ma thèse porte sur l'utilisation des effets antagonistes des bactéries du microbiote de l'huître dirigés contre différents agents pathogènes de l'huître. Il s'agit de combattre directement les infections à *Vibrio aestuarianus* mais également de bloquer l'étape de dysbiose survenant après l'infection à OsHV-1 μ Var dans la maladie du POMS.

Afin de faciliter la lecture de ce manuscrit de thèse, les articles présentés dans les chapitres 1 et 2 sont précédés d'une synthèse en français reprenant l'article dans son intégralité

Chapitre 1 :

Rôle de l'éducation microbienne dans le développement du système immunitaire de l'huître *Crassostrea gigas* à des fins de lutte contre les maladies infectieuses

I. Contexte et objectifs

Comme nous avons pu le voir dans l'introduction, l'huître du Pacifique *Crassostrea gigas* fait face à des épisodes de mortalité provoqués par des maladies infectieuses. Ces épisodes peuvent être dévastateurs pour la production ostréicole et induire d'importantes pertes économiques pour les professionnels du secteur. Parmi ces maladies infectieuses, on retrouve les infections par OsHV-1 μ Var, responsable de la maladie du POMS et affectant principalement les huîtres juvéniles, ainsi que les infections à *Vibrio aestuarianus*, qui touchent principalement les huîtres adultes.

Dans ce contexte, l'importance de développer des méthodes de lutte contre ces maladies infectieuses devient un enjeu majeur pour le secteur ostréicole. Pour cela, j'ai étudié la possibilité de tirer profit des effets bénéfiques du microbiote naturel de l'huître afin de lutter contre ces différentes maladies infectieuses. En effet, de précédentes études ont démontré l'importance du microbiote pour la santé de son hôte. Parmi ces études, il a notamment été démontré que certains taxons bactériens étaient préférentiellement associés aux huîtres résistantes à la maladie du POMS (King *et al.* 2019; Clerissi *et al.* 2020; Fallet *et al.* 2022). Il a également été démontré qu'il était possible de réaliser une éducation du système immunitaire des huîtres par une exposition à des microorganismes lors des stades précoces du développement (Fallet *et al.* 2022). Dans cette dernière étude, des larves d'huîtres ont été exposées pendant 10 jours à des huîtres donneuses de microbiote. Ces huîtres donneuses avaient été préalablement disposées dans le milieu naturel de telle sorte à acquérir une diversité du microbiote maximale. À la suite de cette exposition, les huîtres devenues juvéniles ont présenté lors d'une infection expérimentale à OsHV-1 μ Var une diminution de la prolifération du virus conduisant à une diminution de la mortalité. Enfin, en étudiant la réponse transcriptomique de ces huîtres, il a été observé une modulation de gènes impliqués dans l'immunité.

Les objectifs de cette partie sont donc de :

- 1) déterminer si une exposition, pendant les stades larvaires, à un microbiote complet provenant d'huîtres donneuses, ayant toujours été maintenues en conditions contrôlées (eau filtrée et traitée aux UVs), peut avoir un effet bénéfique contre les infections à OsHV-1 μ Var et *V. aestuarianus*. En effet, l'utilisation d'huîtres donneuses ayant été préalablement enrichies en microorganismes provenant du milieu naturel, pose des problèmes pour une application en écloserie du fait de l'importation possible d'agents pathogènes ou opportunistes provenant de l'extérieur. L'utilisation d'huîtres donneuses provenant d'un milieu contrôlé apporterait ainsi une sécurité pour les écloséries.
- 2) étudier s'il est possible d'induire les mêmes effets en utilisant des mélanges de bactéries préalablement sélectionnées pour leur effet bénéfique potentiel,
- 3) caractériser les mécanismes moléculaires de résistance induits par ces différentes expositions microbiennes à l'aide d'approches de métabarcoding (modifications du microbiote) et de RNAseq (réponse transcriptomique de l'hôte),
- 4) déterminer si la réponse à ces expositions microbiennes est identique ou différente en fonction de différentes populations d'huîtres et si une association sympatrique entre les microorganismes et les populations d'huîtres peut induire une meilleure protection face à ces maladies infectieuses.

II. Matériel et méthodes

Afin de répondre à ces questions, une collection de bactéries associées aux huîtres résistantes à la maladie du POMS a été créée. Pour cela, des huîtres âgées d'environ un an et ayant survécu à un épisode infectieux de la maladie du POMS ont été prélevées sur quatre différents sites en zones conchylicoles (Rade de Brest, La Tremblade, Bassin d'Arcachon et étang de Thau). Ces huîtres ont ensuite été broyées individuellement et étalées sur des boîtes de Marine Agar. Les bactéries issues de ce prélèvement ont ensuite été isolées et purifiées par repiquages successifs avant d'être cryoconservées en glycérol et identifiées par séquençage SANGER du gène codant pour l'ARNr 16s.

En parallèle, une étude comparative entre le microbiote d'huîtres résistantes et celui d'huîtres sensibles à la maladie du POMS a été réalisée. Les résultats de cette analyse, couplés aux

données de la littérature scientifique portant sur l'utilisation de bactéries à effets bénéfiques en aquaculture, ont permis de sélectionner des bactéries dans la collection de bactéries associées aux huîtres résistantes à la maladie du POMS et de créer cinq mélanges de bactéries multi-souches (quatre sont composés de bactéries ne provenant que de l'un des quatre sites de prélèvements et le cinquième est composé de bactéries provenant de ces quatre sites).

Des larves de quatre familles d'huîtres (reproduction multi-parentale à partir de géniteurs provenant des mêmes sites que les huîtres ayant servi pour l'isolement des bactéries) ont ensuite été exposées durant 14 jours, dès 3 heures post-fécondation (pf), avec un renouvellement tous les deux jours, à ces cinq mélanges de bactéries et à un microbiote complet provenant d'huîtres donneuses ayant passé leur vie en conditions contrôlées et exemptes de pathogènes. Une exposition plus tardive a également été réalisée pour trois mélanges (Brest, La Tremblade et multi-sites), entre le septième et le quatorzième jour post-fécondation. Au cours des élevages larvaires, des prélèvements ont été réalisés afin de déterminer l'impact de cette exposition microbienne sur la viabilité, la croissance et le microbiote des larves.

À la suite de l'élevage larvaire, les huîtres ont été laissées à stabulées. Huit mois après l'exposition, une première cohorte d'huîtres (poids moyen = 2,80 g) a été soumise à une infection expérimentale à OsHV-1 μ Var et un an après l'exposition, une seconde cohorte (poids moyen = 9,42 g) a été soumise à une infection expérimentale à *Vibrio aestuarianus* afin de déterminer un phénotype de résistance. Enfin, des analyses moléculaires ont été réalisées afin de déterminer les mécanismes moléculaires mis en jeu. Dans ce but, une analyse métabarcoding a été réalisée afin de déterminer l'impact qu'a eu l'exposition lors des stades larvaires sur les communautés bactériennes des larves et des huîtres juvéniles, et une analyse RNAseq a été réalisée afin de déterminer l'impact sur la réponse transcriptomique des huîtres juvéniles huit mois après l'exposition et 3 heures après le début de l'infection à OsHV-1.

III. Résultats

Une collection de 328 bactéries associées à la maladie du POMS a pu être créée. Cette collection est composée de 62,8 % de Proteobacteria, 15,3 % de Firmicutes, 12,3 % de Bacteroidetes et 9,6 % d'Actinobacteria. L'analyse comparative des données de microbiotes associés aux huîtres résistantes comparées aux huîtres sensibles à la maladie du POMS a permis d'identifier 118 genres bactériens comme étant significativement associés aux huîtres résistantes à la maladie du POMS. Les résultats de cette analyse comparative, couplés aux données de la littérature

scientifique portant sur l'utilisation de bactéries à effets bénéfiques en aquaculture, ont permis de sélectionner des bactéries dans la collection de bactéries associées aux huîtres résistantes à la maladie du POMS et de créer cinq mélanges de bactéries multi-souches (quatre sont composés de bactéries ne provenant que de l'un des quatre sites de prélèvements et le cinquième est composé de bactéries provenant de ces quatre sites).

Les différentes expositions microbiennes ont provoqué chez les larves d'huîtres des effets contrastés. Concernant la viabilité de ces dernières, le mélange de Thau ainsi que les mélanges de Brest, La Tremblade et multi-site administrés entre J7 et J14 pf ont eu des effets bénéfiques ou pas d'effet sur la viabilité des larves. L'exposition au mélange d'Arcachon ainsi qu'au microbiote des huîtres donneuses ont eu des effets négatifs modérés et enfin, les mélanges de Brest, La Tremblade et multi-site administrée entre le jour zéro et le jour 14 ont eu des effets fortement délétères. En revanche, aucun de ces mélanges n'a eu d'effet significatif sur la croissance des larves. Trois conditions d'exposition ont permis de réduire significativement le risque de la mortalité face à la maladie de POMS. Le mélange d'Arcachon administré entre J0 et J14 pf a induit une réduction du risque de la mortalité de 21 % (Log-Rank test : p-val = 0,038), le mélange de La Tremblade, administré entre J7 et J14 pf a lui réduit le risque de la mortalité de 25 % (Log-Rank test : p-val = 0,009) et l'exposition au microbiote des huîtres donneuses a induit une réduction du risque de la mortalité de 28 % (Log-Rank test : p-val = 0,008). Face à l'infection à *V. aestuarianus*, seule l'exposition au microbiote des huîtres donneuses a permis d'induire une réduction du risque de la mortalité de 28 % (Log-Rank test : p-val = 0,006). Entre les différentes populations d'huîtres, la population d'Arcachon est celle présentant la meilleure survie et ce, quelle que soit l'exposition microbienne.

Des analyses moléculaires ont donc été conduites sur ces trois conditions ayant conféré un effet bénéfique pour la survie des huîtres face à une infection à OsHV-1 ou *V. aestuarianus*. Les analyses de métabarcoding 16S ont permis de démontrer que l'exposition aux trois différentes conditions avait induit des changements dans la communauté bactérienne des larves d'huître. Ces changements perdurent jusqu'aux stades juvéniles à l'exception des huîtres exposées au mélange d'Arcachon entre J0 et J14 pf. La recherche des bactéries administrées dans les mélanges dans les microbiotes des larves (2 jours après la dernière administration) et chez les juvéniles (8 mois après l'administration) n'a permis de retrouver que dans le microbiote des larves exposées au mélange d'Arcachon, et de façon minoritaire, des bactéries composant le mélange d'Arcachon. Aucune des bactéries administrées n'est retrouvée chez les huîtres juvéniles.

L'analyse RNAseq a permis, elle, de démontrer que l'expression des gènes chez les huîtres exposées comparées aux contrôles était plus importante au niveau basale ("frontloading"). En effet, le nombre de gènes différentiellement exprimés (DEGs) chez les huîtres exposées aux microorganismes contre les huîtres non exposées est plus important à t=0h qu'à t=3h de l'infection à OsHV-1. Le regroupement par profils d'expression permet d'observer que la modification du transcriptome à la suite de l'exposition aux microorganismes dépend du fond génétique des huîtres, mais qu'au sein d'une même famille, cette réponse est différente en fonction du type d'exposition microbienne. L'analyse d'enrichissement de fonctions réalisée à partir de ces DEG a permis de démontrer que nos différentes expositions microbiennes avaient induit une modulation de différentes fonctions de l'immunité. De façon surprenante, les populations qui présentaient le plus de fonctions immunomodulées n'étaient pas celles présentant le meilleur phénotype de survie face aux différents pathogènes testés. L'analyse des DEGs liés aux fonctions immunitaires dans la population d'Arcachon a permis de mettre en évidence une surexpression de certains types de récepteurs (C-type lectine, C1q), d'un gène lié à des fonctions antibactériennes et des gènes liés aux fonctions antivirales, mais aussi une sous-expression de gènes liés à d'autres types de récepteurs (G-protein receptor, scavenger receptor), à la dégradation des protéines et à la réponse aux dommages causés à l'ADN.

IV. Discussion / Conclusion

Au cours de cette étude, nous avons montré que l'exposition lors des stades larvaires à un microbiote complet provenant d'huîtres donneuses, ayant passé leur vie en conditions contrôlées, permet d'induire un effet protecteur à long terme contre les infections à OsHV-1 μ Var et *Vibrio aestuarianus*. L'exposition des larves à des mélanges multi-souches de bactéries cultivables a également permis d'obtenir un effet protecteur contre l'infection à OsHV-1 μ Var, mais aucune protection contre *V. aestuarianus* n'a pu être mise en évidence. Un effet protecteur, obtenu par une éducation microbienne, avait déjà pu être mis en évidence chez des organismes modèles tels que le Zebrafish (Galindo-Villegas *et al.* 2012), mais seule une étude avait mis en évidence ce mécanisme chez les mollusques d'intérêt aquacole (Fallet *et al.* 2022). Nous avons pu observer que les bactéries administrées par les mélanges de bactéries multi-souches ne s'établissent pas dans le microbiote des larves et des huîtres juvéniles. En revanche, l'exposition aux microorganismes a induit des changements dans les communautés microbiennes des larves et ces changements persistent jusqu'au stade juvénile. Nous avons également pu mettre en évidence que l'exposition aux microorganismes avait affecté la réponse transcriptomique des

huîtres. Le nombre de gènes différentiellement exprimés, entre les huîtres exposées et les huîtres non exposées, est plus important avant que pendant l'infection à OsHV-1. Ce profil de réponse semble correspondre à un profil de réponse maintenue ou "sustained immune response" (Coustau *et al.* 2016; Melillo *et al.* 2018; Prigot-Maurice *et al.* 2022). En nous intéressant aux gènes liés aux fonctions immunitaires pour la population la plus résistante, nous avons constaté que les gènes surexprimés, chez les huîtres exposées par rapport aux huîtres contrôles, codent pour des récepteurs de reconnaissance de motifs moléculaires (PRRs) et pour des fonctions liées à l'immunité antibactérienne et antivirale. Enfin, nous avons pu observer que la réponse face à l'exposition microbienne lors des stades larvaires dépendait du fond génétique des huîtres, mais aussi que la réponse au sein d'une même population est différente en fonction de l'exposition microbienne. De plus, aucun effet synergique n'a pu être obtenu grâce à une association sympatrique entre les microorganismes et les différentes populations d'huîtres.

Cette étude révèle le potentiel de l'éducation microbienne pour une application dans les écloséries d'huîtres. Néanmoins, des améliorations sur les mélanges de bactéries multi-souches pourraient également être réalisées (Dantan *et al.* 2023) afin de limiter leur impact sur la viabilité des larves ou aussi pour essayer d'obtenir un effet protecteur contre les infections à *V. aestuarianus*. De plus, des analyses plus approfondies seront nécessaires afin de déterminer plus finement les mécanismes moléculaires associés aux résistances. Notamment, il serait intéressant d'étudier l'impact de l'exposition aux microorganismes testés dans cette étude sur l'épigénome. Il serait également important de déterminer si les expositions microbiennes réalisées dans le cadre de cette étude sont également capables d'induire un effet transgénérationnel, comme cela a pu être démontré par (Fallet *et al.* 2022).

Publication 2

Microbial education: a key to modulate immune capabilities in *Crassostrea gigas* for a sustainable aquaculture

Luc Dantan, Prunelle Carcassonne, Lionel Degrémont, Benjamin Morga, Marie-Agnès Travers, Bruno Petton, Mickael Mege, Elise Maurouard, Jean-François Allienne, Gaëlle Courtay, Océane Romatif, Juliette Pouzadoux, Raphaël Lami, Laurent Intertaglia, Yannick Gueguen, Jérémie Vidal-Dupiol, Eve Toulza, Céline Cosseau

Microbial education: a key to modulate immune capabilities in *Crassostrea gigas* for sustainable aquaculture

Luc Dantan¹, Prunelle Carcassonne¹, Lionel Degrémont², Benjamin Morga², Marie-Agnès Travers¹, Bruno Petton³, Mickael Mege², Elise Maurouard², Jean-François Allienne¹, Gaëlle Courtay¹, Océane Romatif¹, Juliette Pouzadoux¹, Raphaël Lami⁴, Laurent Intertaglia⁵, Yannick Gueguen⁶, Jérémie Vidal-Dupiol¹, Eve Toulza¹, Céline Cosseau¹

¹ IHPE, Univ. Montpellier, CNRS, Ifremer, Univ. Perpignan Via Domitia, Perpignan France

² Ifremer, ASIM, F- 17390 La Tremblade, France

³ Ifremer, UBO CNRS IRD, LEMAR UMR 6539 Argenton, France

⁴ Laboratoire de Biodiversité et Biotechnologies Microbiennes, CNRS, Sorbonne Université, UAR3579, F-66650 Banyuls-sur-Mer, France

⁵ Sorbonne Université, CNRS, Fédération de Recherche, Observatoire Océanologique, 66650 Banyuls-sur-mer, France

⁶ MARBEC, Univ Montpellier, CNRS, Ifremer, IRD, Sète, France

Abstract

Recently, the frequency and severity of marine diseases have increased in association with global changes, and molluscs of economic interest are particularly concerned. A striking example of a devastating disease is the Pacific Oyster Mortality Syndrome (POMS) caused by the Ostreid Herpesvirus-1 μ Var (OsHV-1 μ Var) that emerged in 2008 and which heavily impacts *Crassostrea gigas* production worldwide by affecting juvenile oysters. Adult oysters are also affected by infectious diseases, especially those caused by the bacterial pathogen *Vibrio aestuarianus*. The present work aims at finding sustainable strategies to help fighting against these infectious diseases. We propose to take profit of the beneficial effect of the natural oyster microbiota to develop prophylactic methods to fight these infectious diseases. We performed

an association study based on metabarcoding data from microbiota of resistant vs sensitive oysters that allowed us to identify potential bacterial candidates correlated with oyster resistance. Additionally, previous work has shown that oysters immune defences can be stimulated by exposing them to microorganisms from the natural environment during their larval development. Following these results, we have generated a collection of bacterial species from disease resistant *C. gigas* and we have characterized their effect on the oysters by an exposure during larval development. We have shown that it's possible to enhance oyster survival capacity by adding microbiota from donor oyster or mixes of bacteria during larval stages. This bacterial exposure leads to changes in bacterial communities and immunity of the oysters resulting to an improvement of the survival against OsHV-1 μ Var and *Vibrio aestuarianus*. These findings underline the major role played by the microbiota for oyster immune protection and presented the great potential of microbial education for an applicational use in oyster hatcheries.

Key words:

Crassostrea gigas; Holobiont; Microbial education; OsHV-1 μ Var; *Vibrio aestuarianus*

Introduction:

The Pacific oyster *Crassostrea gigas* is a very important mollusc of aquaculture interest and the most cultivated oyster species in world. However, the *C. gigas* production is strongly compromised due to infectious diseases causing high mortalities every year (Friedman *et al.* 2005; Cotter *et al.* 2010; Pernet *et al.* 2012; Azéma *et al.* 2015). Two significant infections for *C. gigas* oysters are the Pacific Oyster Mortality Syndrome (POMS) caused by the Ostreid herpesvirus type 1 μ Var (OsHV-1 μ Var) and Vibriosis caused by an infection by *Vibrio aestuarianus*. POMS is a multifactorial and polymicrobial disease which is influenced by biotic and abiotic factor (Petton *et al.* 2021). Infection by OsHV1 is the first critical step in the infectious process of POMS which leads to an immunocompromised state of the oyster by altering haemocytes physiology (de Lorgeril *et al.* 2018a; Petton *et al.* 2021). This leads to a dysbiosis of oyster microbiota and results in colonisation by opportunistic bacteria and death of the oyster (de Lorgeril *et al.* 2018a; King *et al.* 2019a; Petton *et al.* 2021). The mechanisms behind the infection by *V. aestuarianus* are less known, but it has been shown that *V. aestuarianus* produces extracellular compounds which contains virulence factors (Labreuche *et al.* 2006, 2010). These extracellular compounds cause changes in morphology of oyster haemocytes which lead to an immunosuppression of the haemocytes and allow *V. aestuarianus* to colonise the oyster and kill it (Labreuche *et al.* 2006, 2010).

In order to prevent these infectious diseases, several approaches based on the use of microorganisms have been developed. Among them, the use of probiotics and bacteriophages (Pérez-Sánchez *et al.* 2018) but these methods show limitations especially in their use in oyster farming which is practiced in open environments. The microbial education concept, which is the possibility to educate the host immune system by an exposure to non-harmful microorganisms during the immune system ontogenesis, could represent a great alternative to the traditional approaches. This strategy provides great advantages. In addition to conferring a protective effect for the oysters, its implementation during the larval rearing stages, allows to expose the oyster larvae to bacteria while remaining in a closed environment. This allows to treat the water enriched in microorganisms before releasing it and thus limit the impact on the environment. Numerous studies have shown that the microbiota play an important role in the development of host immune responses (Chung *et al.* 2012; Abt and Artis 2013; Sommer and Bäckhed 2013). Several studies also have shown that a higher microbiota diversity is correlated with the health status of the host in both crustaceans and molluscs (Cicala *et al.* 2018, 2022; Holt *et al.* 2020; Fallet *et al.* 2022; Zhang and Sun 2022). From this perspective, Fallet and colleagues decided

to use the microbiota to educate the immune system of *C. gigas*. In order to do this, they exposed during ten days *C. gigas* larvae to a whole microbiota from donor oysters. Prior to exposure donor oysters were placed in oyster farming area during a non-infectious period to allowing them to capture the maximum diversity of microorganisms. This bacterial exposure during the larval stages induced a long-term effect. Indeed, juvenile oysters exposed during the larval stages showed during an experimental infection to OsHV-1 μ Var, a diminution of the proliferation of the virus resulting to a better survival compared to non-exposed oysters. Microbiota exposed oysters also presented a modulation of genes implicated in immunity showing that an exposure to a rich microbial environment improved the oyster's immune competence (Fallet *et al.* 2022). Hence, this study demonstrated the important involvement of the microbiota in the education of the immune system of oysters and show that microbial education may therefore have potential applications in hatcheries. However, the use of non-controlled bacteria community coming from the field could represent a risk of exposing oysters to pathogens or opportunistic microorganisms. This is why, it was suggested that the use of oysters always kept in controlled environments as donor of microbiota, could be a safer alternative for application in hatcheries since it would prevent the spread of pathogens (Azéma *et al.* 2017; Dégremont *et al.* 2021).

To go further in the perspective of application, we investigated whether exposure during the larval stages to a whole microbiota from donor oysters always maintained in a controlled, pathogen-free environment can have a beneficial effect against OsHV-1 μ Var and *Vibrio aestuarianus* infections and we examined the impact of this exposure on the immunity and the microbiota of oysters. We also investigated if it was possible to perform a microbial education by exposing oyster larvae to a reduced bacterial community composed of cultivable bacteria. For this purpose, we have developed and tested five multi-strain bacterial mixes containing cultivable bacteria coming from the same geographical areas as the oyster populations used in this study. We realized our different assay on four different oyster populations coming from Atlantic Ocean (Brest, Marennes-Oleron and Arcachon bays) and Mediterranean Sea (Thau lagoon). In this way, we were also able to study whether if bacterial exposure has a different effect depending on the oyster populations but also whether if a sympatric association between the bacteria used in the mixes and the oyster could provide a greater beneficial effect in the resistance to infectious diseases.

Materials and methods:

Isolation of cultivable bacteria from *Crassostrea gigas*

Oysters sampling was performed along the French Atlantic coast and Mediterranean Sea during two different sampling campaigns (in February 2020 and November 2020). For the Atlantic coast, 3 sites were selected: the Brest bay (Brittany, France) (lat 48.3349572; long -4.3189134), the Marennes-Oleron bay (Nouvelle-Aquitaine, France) (lat 45.8029675; long -1.1534223) and the Arcachon bay (Nouvelle-Aquitaine, France) (lat 44.6813750; long -1.1402178). For the Mediterranean Sea, the selected site was the Thau lagoon (Occitanie, France) (lat 43.39404; long 3.58092). For each site, 5 oysters aged 12 to 18 months (average weight = 2.5 g) were randomly sampled. Hence, the sampled oysters had survived an annual infectious episode of POMS allowing us to assume that the sampled oysters were resistant to the disease. Two sampling campaigns were performed, in February 2020 and in November 2020 except for the Thau lagoon site for which oysters were only collected in November 2020 due to covid restriction arisen earlier in the year. Bacteria associated to these oysters were then isolated as explained below.

The five oysters sampled on each site were carefully brushed and washed to remove the residues present on the shell. The flesh of the animals was then individually crushed with an Ultraturax T25 mixer (5 x 5 sec) in 15ml falcon tubes. The homogenized tissues were then diluted at 1:10 1:100 and 1:1000. 100 μ L of each dilution were spread on 2 Marine Agar (MA) (Marine Agar Difco 2216) petri dishes and incubated at 15°C or 20°C.

After a minimum incubation period of 3 days, bacterial colonies were selected according to their morphotypes. A maximum of different morphotypes were selected to maximise the biodiversity in our sampling and isolated by streaking a colony on a new MA plate and purified by two successive subculturing. Then, the pure cultures of individual bacteria were transferred onto Marine Broth (MB) tube (Marine Broth Difco 2216) à 15°C or 20°C. After 48h of growth, 500 μ L of these cultures was used for cryopreservation in 35% glycerol (V/V) and put into a -80°C freezer. About 1 ml of the liquid culture was pelleted for further DNA extraction.

Identification of the cultivable bacteria

DNA extraction of the bacterial strains isolated from oysters and cultivated on agar plates was carried with the Wizard® Genomic DNA Purification Kit (Promega) according to the manufacturer instructions. 16S rRNA gene sequencing was performed on these samples to identify each bacteria from the collection. The PCR and 16S rRNA gene sequencing was performed by the Genoscreen sequencing facilities (<http://www.genoscreen.fr/fr/>). Briefly, two pairs of primers P8/PC535 (P8 5'-AGAGTTTGATCCTGGCTCAG ; PC535 5'-GTATTACCGCGGCTGCTGGCAC) and 338F/1040R (338F 5'-CTCCTACGGGAGGCAG ; 1040R 5'-GACACGAGCTGACGACA) were used for the PCR to amplify the V1-V3 and V3-V5 of the 16S rDNA. PCR products were then purified with Sephadex-G50 gel (GE Healthcare) before analysis into ABI 3730XL capillary sequencer. The resulting sequences were then assembled by using the DNA baser sequence assembly software (v4) (Heracle BioSoft, www.DnaBaser.com) and then added in the EZbiocloud database (Yoon *et al.* 2017) in order to identify the taxonomy of the isolated bacteria composing the collection.

Larval cytotoxic effect

Larvae aged of 24 hours (stage D) were put into three ml of sterile sea water at a density of 10 larva per millilitre. A concentration of 10^7 CFU/ml of each bacterial strains were administered to larvae (Multiplicity of infection = 10^6 bacteria per larvae) and the larvae were maintained at a temperature of 20°C and a 12h:12h day:night photoperiod. All the bacteria were tested in duplicate. The mortalities were then recorded during two days.

Multi-strain bacterial mixes preparation for interaction with oysters

Five multi-strain bacterial mixes were tested: Four site-specific multi-strain bacterial mixes was made up from bacteria isolated from oysters sampled at each geographical site (Brest mix, La Tremblade mix, Arcachon mix and Thau mix) and a multi-site bacterial mix was made up from bacteria isolated from oysters sampled on all the site was generated. The bacteria were cultured from glycerol stock in 10 ml of Marine Broth (MB) for 24h at 20°C and then, 1 ml of each bacterial culture was inoculated into 50ml fresh MB media and incubated at 20°C. After 48 hours of incubation, the OD₆₀₀ was measured, and a quantity of $3 \cdot 10^8$ CFU was collected and pooled into a same mix for each cultivated bacterium. The mixes were then centrifuged at 4000 rpm for 2 minutes and the supernatant was discarded. The pellets were then resuspended in 10

ml sterile sea water and added immediately to 30L larval rearing tanks to a final concentration of 10^4 CFU/ml for each bacterium.

Oyster reproduction

150 wild oysters were randomly sampled from each geographic site as described for the bacterial collection (Brest bay, Marennes-Oleron bay, Arcachon bay, Thau lagoon) in order to generate 4 oyster populations (Brest, La Tremblade, Arcachon and Thau population). For this purpose, 20 to 23 genitors were randomly selected for each site and their gender was determined (**Table 1**). Spermatozoa of the males and oocytes of the females were collected from each animal by stripping the gonad. Spermatozoa from males were collected individually while oocytes from females were pooled. The oocytes were then mixed with the spermatozoa for fertilization. The number of fertilised oocytes was then counted to determine the hatching rate (supplementary Table x). Three to one million fertilised oocytes were then added into 30 L conical tanks in a batch system at 28°C in filtered and UV-treated seawater (100 to 34 larvae per ml between day 0 and day 2, 10 larvae per ml between day 2 and day 7, 3 larvae per ml after day 7).

Table 1: Number of genitors (females and males) for the four oyster population.

Oyster Population	Brest	La Tremblade	Arcachon	Thau
Female	15	13	17	14
Male	5	10	3	6

Exposure of oyster larvae with microorganisms

Oyster larvae were exposed either to multi-strain bacterial mixes or to a whole natural microbiota coming from healthy donor oysters (Microbiota-Exposed = ME) This microorganism community was introduced thanks to donor oysters of microbiota which were placed into the rearing tanks. Oyster donors of microbiota were NSI (Naissains Standardisés Ifremer, standardized Ifremer spats) which were always kept in controlled facilities using UV-treated seawater, strict biosecurity zoning and management procedures. In this way, the oysters were shown to be devoid of the three main pathogens of *C. gigas* from larvae to juveniles

(Azéma *et al.* 2017; Dégremon *et al.* 2021). The microorganisms were added to the larvae either 4 hours post fertilization until day 14 pf (post fertilisation) or from day 7 pf to day 14 pf (**Figure 1**). The bacterial mixes and the pool of microbiota from donor oysters were renewed at the same time as the seawater including the food was changed at day 2, day 4, day 7, day 9 and day 11 (**Figure 1**). The larvae were fed with cultured phytoplankton (*Isochrysis galbana*, *Tetraselmis suecica* and *Skeletonema costatum*). The water changes at day 14 was performed without addition of the bacterial mixes. In this sense, the microbial exposure ended up at day 14.

Larval survival during the bacterial exposure was determined by counting the larvae either at days 2, 7, 18 and 25 for oysters exposed from day 0 pf to day 14 pf or at day 18 and 25 for oysters exposed from day 7 pf to day 14 pf. The impact on the growth was measured at days 2, 7 and 11 for oysters exposed from day 0 pf to day 14 pf or at day 11 for oysters exposed from day 7 pf to day 14 pf by measuring the ferret diameter of larvae using image analysis technique with ImageJ software (Schneider *et al.* 2012). Larvae were sampled either at days 7 pf and at day 14 pf for subsequent molecular analysis. After the rearing steps, only one replicate was kept to perform the experimental infections.

All oyster populations were kept in controlled facilities of La Tremblade using UV-treated seawater until experimental infections by OsHV-1 or *V. aestuarianus*.

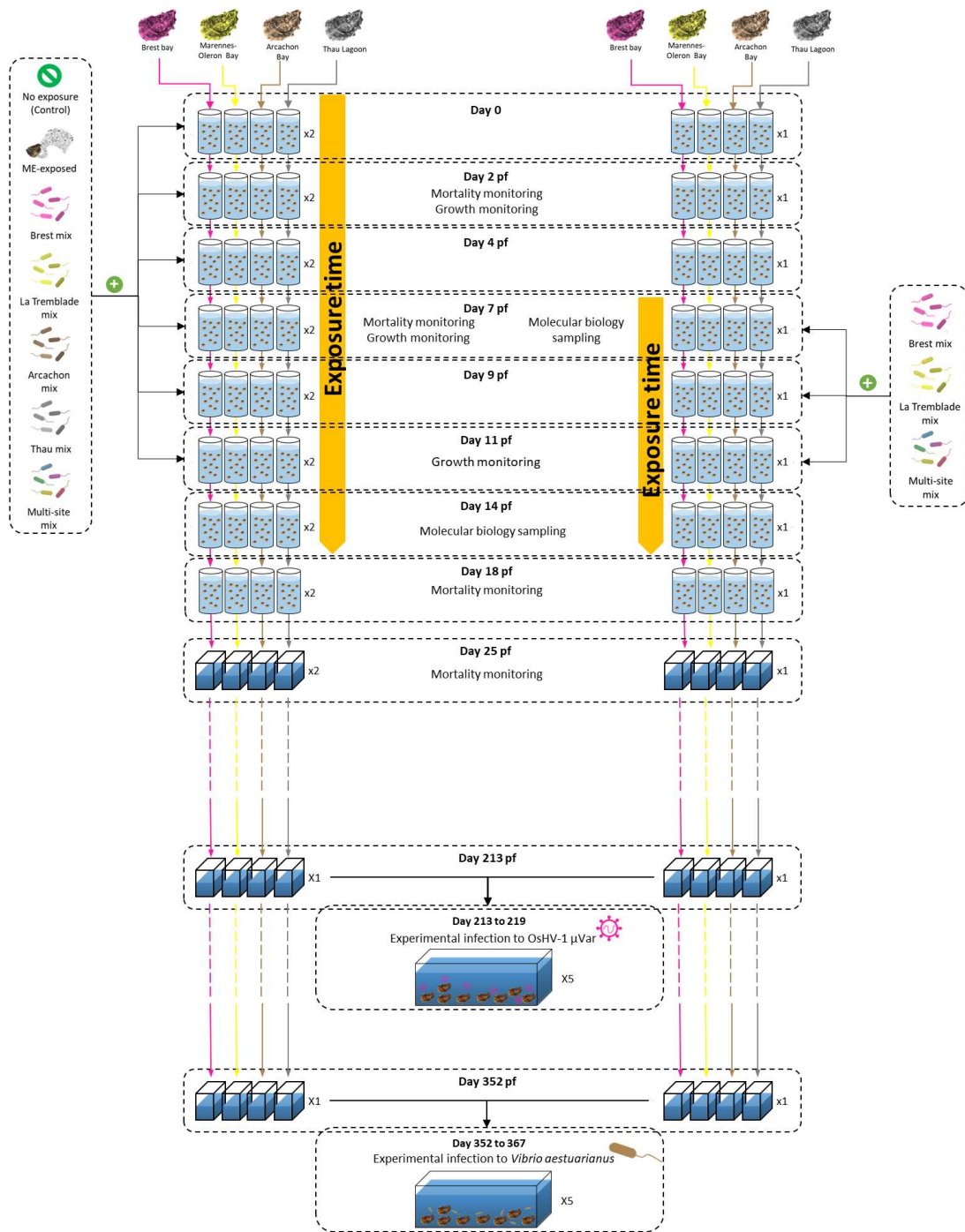

Figure 1: Overall experimental design for larval microbial exposure and experimental infections. Multiparental reproduction was performed for the four oyster populations and the larvae were placed in 30L jars specific to each population. Three hours post fecundation (pf), larvae were exposed to microbiota from donor oysters (ME-exposed) or to the five different multi-strains bacterial mixes (Brest mix, La Tremblade mix, Arcachon mix, Thau mix and Multi-site mix). This microorganism exposure was renewed every 2 days and lasted for 14 days. In parallel, exposure to three multi-strains bacterial mixes (Brest mix, La Tremblade mix and Multi-site mix) was performed on later stages between D7 and D14 pf. During the larval stages, rearing water and larvae were sampled at days 2, 7, 11, 14, 18 and 25 pf to perform growth and mortality monitoring, or to perform molecular analysis. After the larval rearing stages, spat were left to grow and on day 213 pf (approximately 8 month), a first cohort was used to carry out an experimental infection to OsHV-1 and at day 352 pf (approximately one year) a second cohort was used to perform a *V. aestuarianus* experimental infection.

OsHV-1 μ Var experimental infection by cohabitation

OsHV-1 experimental infection was performed at the juvenile stage on control or microorganisms exposed oysters. The oysters were seven months old, and the mean individual weight was 2.80 g. For this purpose, we used a randomized complete block design composed of five tanks (replicates) of 50 L filled with filtered and UV-treated seawater and maintained at 20 °C with adequate aeration. Each tank contained 13 oysters of each population exposed to each condition (total: 420 oysters per tanks) (**Figure 2**). A cohabitation protocol was used as previously described (Schikorski *et al.* 2011). This approach starts with the injection of OsHV-1 suspension into pathogen free oysters that will develop the disease and that will then be used as donor oysters of OsHV-1. This protocol allows for pathogen transmission through the natural infectious route to oysters of interest (recipient oysters). The OsHV-1 donor oyster pool was composed of 25% of F15 family oysters, 25% of F14 family oysters which are POMS susceptible oysters (de Lorgeril *et al.* 2018a) and 50% of genetically diversified NSI oysters. The ratio between OsHV-1 donor and recipient oysters was 1 donor oyster for 1 recipient oyster. The OsHV-1 donor oysters were infected by intramuscularly injection of 100 μ L of OsHV-1 suspension (10^5 OsHV-1 genomic units). These viral suspensions were prepared as previously described (Schikorski *et al.* 2011). Immediately after OsHV-1 injection into donors, recipient and donor oysters were equally distributed in each of the five experimental tanks. After 48 hours of cohabitation, all OsHV-1 injected donor oysters were removed from the tanks.

In each tank, one oyster of each population exposed to each condition was sampled before the experimental infection (t=0h infection) and three hours post contact with OsHV-1 μ Var donor oysters (t=3h infection) to perform molecular analysis. Sampled oysters were grounded in liquid nitrogen (Retsch MM400 mill) to a powder that was stored at -80°C and then used for DNA and RNA extraction.

The mortality was recorded during eight days. Each day the number of dead recipient oysters was recorded, and all the dead oysters were removed from the tanks.

During the mortality monitoring, 1 mL of water in each tank were sampled every day for the detection and the quantification of OsHV-1 μ Var.

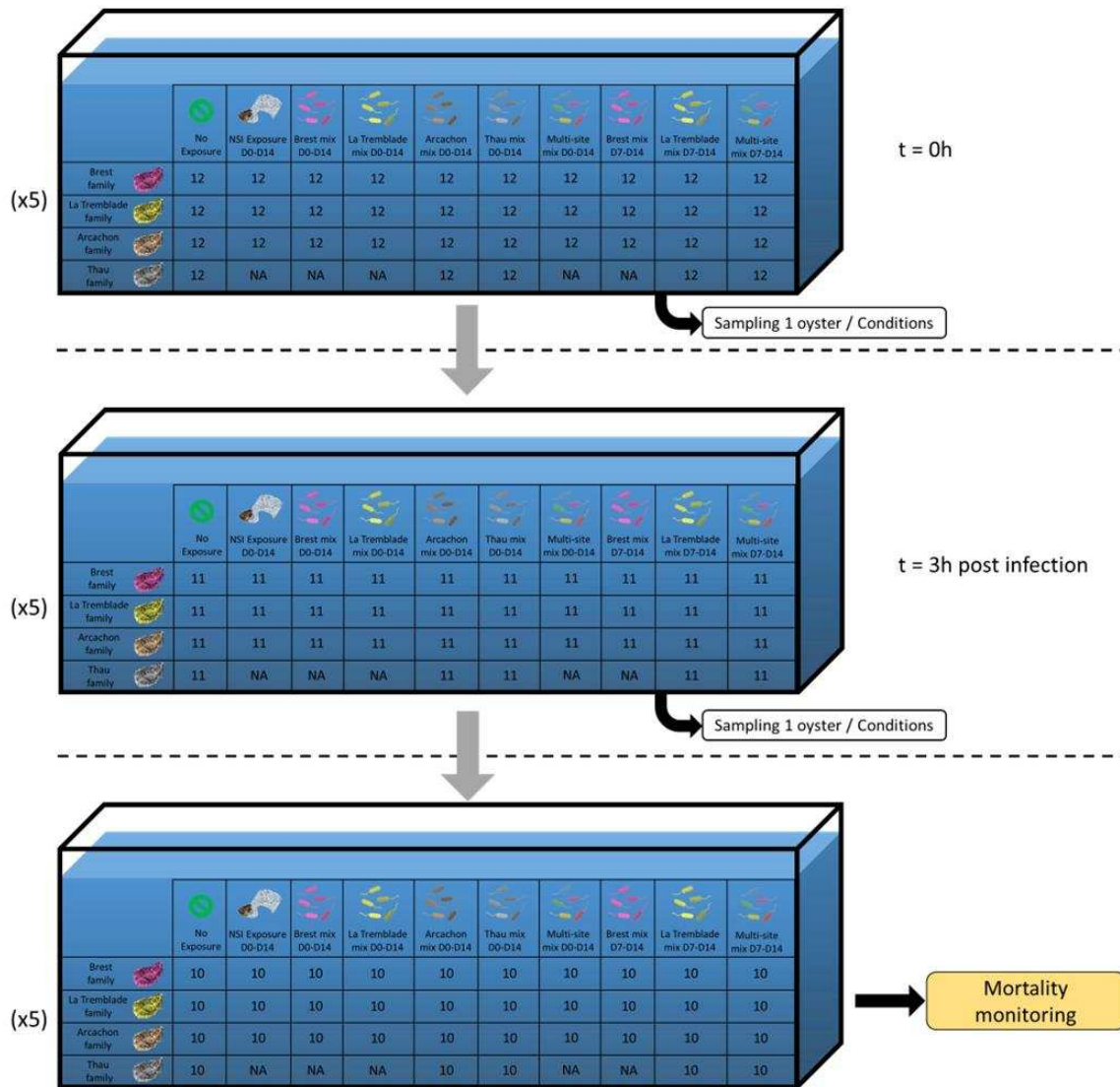

Figure 2: Experimental design for OsHV-1 experimental infection. Prior to OsHV-1 infection ($t = 0h$), twelve oysters of each population exposed to each microorganism exposure conditions were put in a 50L tank filled with filtered and UV-treated seawater and maintained at 20 °C with adequate aeration. One oyster of each population exposed to each microorganism exposure conditions was sampled. Three hours after the beginning of the OsHV-1 infection ($t = 3h$ post infection) another sampling of one oyster of each population exposed to each microorganism exposure conditions was realised. The oysters sampled at $t = 0h$ and $t = 3h$ post infection were grounded in liquid nitrogen to a powder that was stored at -80°C and then used for DNA and RNA extraction. After the last sampling, the experimental infection continued, and a mortality monitoring was performed during height day.

***Vibrio aestuarianus* experimental infection by cohabitation**

Vibrio aestuarianus experimental infection was performed on adult oysters either control or microorganisms exposed (twelve-month-old ; mean individual weight = 9.42g) with the protocol previously described in (De Decker and Saulnier 2011). A randomized complete block design composed of five 100L replicate tanks filled with filtered and UV-treated seawater and maintained at 20°C with adequate aeration and without added food were used. Each tank contained 10 oysters of each population exposed to each condition (total: 350 oysters per tanks). The *V. aestuarianus* 02/041 was grown in Zobell medium at 22°C for 24h under agitation. The bacterial concentration was determined by spectrometry at 600nm and adjusted to an optical density (OD₆₀₀) of 1 representing 5.10⁷ bacteria per mL. *V. aestuarianus* donor oysters were injected in the adductor muscle with 100µL of the *V. aestuarianus* 02/041 suspension and were then equally distributed among the five tanks. The *V. aestuarianus* donor oyster population was composed of a mix of the four oyster populations created for this project (Brest, La Tremblade, Arcachon and Thau population). Immediately after *V. aestuarianus* injection into donors, recipient oysters were added to the five tanks containing the recipient oysters. A ratio of 1 *V. aestuarianus* donor oyster for 1.5 recipient oyster was used. After 48 hours of cohabitation, *V. aestuarianus* donor oysters were removed from the tanks.

The mortality was recorded during 15 days by counting the dead oyster every day, and all the dead oysters were removed from the tanks. During the mortality monitoring, 1 mL of water in each tank were sampled every day for the detection and the quantification of *V. aestuarianus*.

Statistical Analysis of oyster mortality

Mortality recorded for oyster according to the different multi-strain bacterial mixes exposure was compared using survival analysis performed on R (v 4.2.1) (R Core Team 2022) with the package `survminer` (v 0.4.9) (<https://cran.r-project.org/web/packages/survminer/index.html>). The Kaplan-Meier method was used to represent the cumulative survival rate and log-rank test was used to determine the difference between the conditions (supplementary files). A multivariate Cox proportional hazards regression model was used to compute Hazard-Ratio (HR) with confidence intervals of 95%.

Oysters and water Genomic DNA extraction and sequencing

DNA extraction from larvae collected during bacterial exposure was extracted with DNA from the tissue Macherey-Nagel kit according to the manufacturer's protocol. Prior to 90 min of enzymatic lysis in the presence of proteinase K, an additional mechanical lysis was performed by vortexing samples with zirconia/silica beads (BioSpec). DNA extraction from oyster tissues collected during bacterial exposure was extracted with DNA from the tissue Macherey-Nagel kit according to the manufacturer's protocol. Prior to 90 min of enzymatic lysis in the presence of proteinase K, an additional 12-min mechanical lysis (Retsch MM400 mill) was performed with zirconia/silica beads (BioSpec). DNA extraction from water collected during micro-organisms exposure and experimental infections was extracted with DNA from the tissue Macherey-Nagel kit following the manufacturer support protocol for genomic DNA and viral DNA from blood sample.

DNA concentration and purity were checked with a Nanodrop ND-1000 spectrometer (Thermo Scientific).

qPCR analysis

Detection and quantification of OsHV-1 μ Var and *V. aestuarianus* was performed by real-time quantitative PCR. All amplification reactions were performed on Roche LightCycler® 480 Real-Time thermocycler. Each reaction was carried out in triplicate in a total volume of 10 μ L containing the DNA sample (2.5 μ L), 5 μ L of Takyon™ SYBER MasterMix blue dTTP (Eurogentec, ref UF-NSMT-B0701) and 1 μ L at 500 nM of each primers for OsHV-1 μ Var (OsHVDPFor5'-ATTGATGATGTGGATAATCTGTG and OsHVDPFor 5'-GGTAAATACCATTGGTCTTGTTC) (Webb *et al.* 2007) and for *V. aestuarianus* (DNAj-F 5'-GTATGAAATTTTAACTGACCCACAA and DNAj-R 5'-CAATTTCTTTTCGAACAACCAC) (Saulnier *et al.* 2009). qPCR cycling conditions were as follows: 3 min at 95°C, followed by 45 cycles of amplification at 95°C for 10 s, 60°C for 20 s, and 72°C for 30s. After these PCR cycles a melting temperature curve of the amplicon was generated to verify the specificity of the amplification. The DNA polymerase catalytic subunit amplification product cloned into the pCR4-TOPO vector was used as a standard at 10-fold dilutions ranging from 10³ to 10¹⁰ copies/mL for OsHV-1 quantification and genomic DNA from *V. aestuarianus* ranging from 10² to 10⁷ copies/mL for *V. aestuarianus* quantification.

Absolute quantification of OsHV-1 or *V. aestuarianus* was calculated by comparing the observed Cp values to standard curve.

16S rDNA library construction and sequencing

Library construction (with primers 341F 5'-CCTAYGGGRBGCASCAG and 806R 5'-GGACTACNNGGGTATCTAAT for the 16S V3V4 region) and sequencing on a MiSeq v2 (2x250 bp) were performed by ADNid (France).

RNA extraction and sequencing

RNA was extracted by using the Direct-Zol RNA miniprep kit (Zymo Research; ref: R2052) according to the manufacturer's protocol. RNA concentration and purity were checked using a Nanodrop DN-1000 spectrometer (Thermo Scientific), and their integrity was analysed by capillary electrophoresis on a BioAnalyzer 2100 (Agilent).

RNAseq library construction and sequencing

RNA-Seq library construction and sequencing were performed by the Bioenvironment Platform (University of Perpignan, France). Stranded libraries were constructed from 500 ng of total RNA using NEBNext UltraII and sequenced on a NextSeq550 instrument (illumina) in single-end reads of 75 bp.

Bioinformatic pipelines for 16S barcoding analysis

Previously published barcoding datasets (de Lorgeril *et al.* 2018a; King *et al.* 2019b; Clerissi *et al.* 2020, 2022; Fallet *et al.* 2022) from 687 POMS-resistant and 664 POMS-sensitive oysters were re-analysed in this study in order to predict bacteria which were potentially associated with oyster POMS resistant phenotypes. Datasets used for these analyses are indicated in table 2. These datasets were individually analysed under the Toulouse galaxy instance (<https://vm-galaxy-prod.toulouse.inra.fr/>) (Goecks *et al.* 2010) with the Find Rapidly OTU with Galaxy Solution (FROGS) pipeline (Escudié *et al.* 2018). In brief, paired reads were merged using FLASH (Magoč and Salzberg 2011). After denoising and primer/ adapter removal with

cutadapt (Martin 2011), clustering was performed using SWARM (Mahé *et al.* 2014), which uses a novel clustering algorithm with a threshold (distance = 3) corresponding to the maximum number of differences between two OTUs. Chimeras were removed using VSEARCH (Rognes *et al.* 2016). We filtered out the data set for singletons and performed an affiliation using Blast against the Silva 16S rDNA database (release 132_pintail100) to produce an OTU and affiliation tables. In order to identify bacterial taxa which were significantly overrepresented in the microbial community associated to POMS resistant compared to POMS sensitive oysters, the “LDA Effect Size” (LEfSe) method (Segata *et al.* 2011) was used with a normalized relative abundance matrix. This method uses a Kruskal-Wallis followed by Wilcoxon tests ($pval \leq 0.05$) and then performs a linear discriminant analysis (LDA) and evaluate the effect size. The taxa with a LDA score greater than 2.0 were considered as significantly enriched in POMS resistant compared to sensitive oysters.

Table 2: Details of metabarcoding samples used for *in silico* prediction of bacteria associated with POMS-resistant oysters.

Number of samples			Type of samples	Origin	Targeted 16S rDNA region	Developmental stages of the oysters	References
Total	Resistant	Sensitive					
567	324	243	Pool of 10 oysters	France (Atlantic Ocean and Mediterranean Sea)	V3 – V4	Juvenile	(de Lorgeril <i>et al.</i> 2018a)
273	147	126					(Clerissi <i>et al.</i> 2022)
195	83	112	Individual			(Clerissi <i>et al.</i> 2020)	
108	54	54	Pool of 10000 to 20000 larvae			Larvae	(Fallet <i>et al.</i> 2022)
108	54	54					
100	25	75	Individual	Australia (New South Wales)	V1 – V3	Juvenile	(King <i>et al.</i> 2019a)

Sequencing data obtained in this study from the probiotic experiment on oysters were processed with the SAMBA (v 3.0.2) workflow developed by the SeBiMER (Ifremer’s Bioinformatics Core Facility). Briefly, Amplicon Sequence Variants (ASV) were constructed with DADA2 (Callahan *et al.* 2016) and the QIIME2 dbOTU3 (v 2020.2) tools (Bolyen *et al.* 2019), then, contaminations were removed with microDecon (v 1.0.2) (McKnight *et al.* 2019). Taxonomic assignment of ASVs was performed using a Bayesian classifier trained with the Silva database v.138 using the QIIME feature classifier (Wang *et al.* 2007). Finally, community analysis and

statistics were performed on R (R version 4.2.1) (R Core Team 2022) using the packages phyloseq (v 1.40.0) (McMurdie and Holmes 2013) and Vegan (v 2.6-4) (Oksanen *et al.* 2022).

Unique and overlapping ASVs of each sample group were plotted by using the UpsetR package (v 1.4.0) (Conway *et al.* 2017). For beta-diversity, the ASVs counts were preliminary normalized with the “rarefy_even_depth” function (rngseed = 711) from the package phyloseq (v 1.40.0) (McMurdie and Holmes 2013). Principal Coordinates Analysis (PcoA) were computed to represent dissimilarities between the samples using the Bray-Curtis distance matrix. Differences between groups were assessed by statistical analyses (Permutational Multivariate Analysis of Variance) using the adonis2 function implemented in vegan (Oksanen *et al.* 2022).

In order to search for the presence of the bacteria used in the multi-strain bacterial mixes, 16S DNA obtained for the identifications of the bacteria composing the multi-strain bacterial mixes were compared by BLAST (Altschul *et al.* 1990) search for similarity against all the ASVs sequence from the dataset. A mock community composed of equal amounts of DNA from the bacteria composing the multi-strain bacterial mixes was also used for the comparison with the ASVs sequence in order to confirm the method. Then, ASVs sequences with a percentage of identity superior to 99% were searched in the different samples.

Bioinformatic pipeline for RNA-Seq analysis

All data treatments were carried out under a local galaxy instance (<http://bioinfo.univ-perp.fr>) (Goecks *et al.* 2010). Reads quality was checked with FastQC (Babraham Bioinformatics) with standard parameters (Galaxy Version 0.72). Adapters were removed by using Trim Galore (Galaxy Version 0.6.3) (Babraham Bioinformatics). Reads were mapped on *C. gigas* genome (assembly *cgigas_uk_roslin_v1*) using RNA STAR (Galaxy Version 2.7.8a) and HTSeq-count (Anders *et al.* 2015) was used to count the number of reads overlapping annotated genes (mode Union) (Galaxy Version 0.9.1). The differential gene expression levels were analysed with the DESeq2 R package (v 1.36.0) (Love *et al.* 2014). Finally, Rank-based Gene Ontology Analysis (RBGOA) was performed using adaptive clustering and a rank-based statistical test (Mann–Whitney U-test combined with adaptive clustering) with the following parameters: largest = 0.5; smallest = 10; clusterCutHeight = 0.25. The signed “-Log(adj pval)” (obtained from the DESeq2 analysis) was used as an input for the RBGOA analysis. The R and Perl scripts used can be downloaded [https://github.com/z0on/GO_MWU] (Wright *et al.* 2015).

Results:**23 bacterial strains with potential beneficial effects were selected to generate the multi strain bacterial mixes.**

To isolate bacteria with potential beneficial effects against oyster infectious disease, we reasoned that bacteria should be isolated from disease resistant oysters. For this purpose, wild oysters aged between 12 and 18 months were sampled closed to farming areas. Oysters located in these areas are submitted to high pathogen pressure and have been shown to be more resistant to POMS disease (Gawra *et al.* 2023). To maximise the biodiversity of the bacterial collection, oysters were sampled from 4 geographical sites at two different seasons. 334 bacteria were isolated from which 166 bacteria were obtained from the February 2020 sampling campaign, and 168 bacteria were obtained from the November 2020 sampling campaign. 97, 144, 56, and 67 bacteria were isolated from Brest, La Tremblade, Arcachon, and Thau sites, respectively. They were named according to the sampling site (“ARG” for Brest, “LTB” for La Tremblade, “ARC” for Arcachon and “THAU” for Thau) followed by the number of the isolate. The 16S rDNA was obtained for 293 strains. The identified bacteria were divided into the following phyla: *Proteobacteria* (62.8%), *Firmicutes* (15.3%), *Bacteroidetes* (12.3%) and *Actinobacteria* (9.6%) (**Figure 3**). The three major genera found were *Vibrio*, *Bacillus* and *Shewanella* (**Figure 3**). The majority of the isolated species were found in common in all the different sites, except for *Halomonas* and *Ruegeria* which were specifically isolated from the La Tremblade and Thau site respectively.

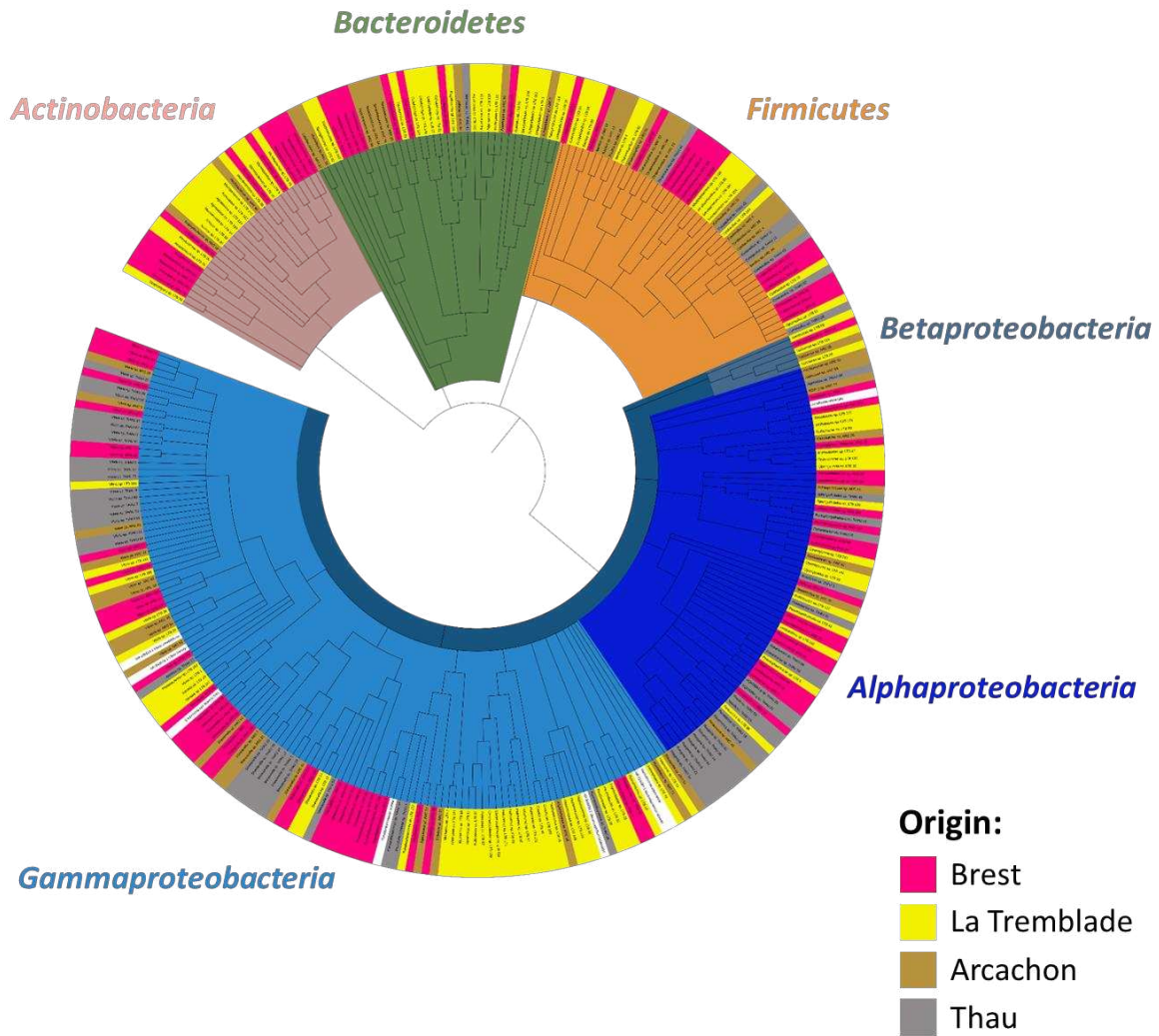

Figure 3: Phylogenetic tree of the bacteria composing the collection of bacteria isolated from POMS-resistant oyster sampled in the Brest bay (pink), the Marennes-Oleron bay (yellow), the Arcachon bay (brown) and the Thau lagoon (grey). The collection is composed by 62.8% of *Proteobacteria* (different shades of blue), 15.3% of *Firmicutes* (orange), 12.3% of *Bacteroidetes* (green) and 9.6% of *Actinobacteria* (salmon).

In parallel, *in silico* correlation analysis was performed to predict bacteria preferentially associated with resistant or sensitive oysters. This LefSE analysis was performed based on previously published barcoding datasets which describes the bacterial part of the microbiota community isolated from 687 POMS-resistant and 664 POMS-sensitive oysters. Based on this analysis, 118 bacterial genera were shown as preferentially associated with POMS-resistant oysters. By combining the data obtained from the predictive *in silico* analysis and data from the scientific literature about bacteria shown to be beneficial in an aquaculture context (Rengpipat *et al.* 2000; Zhang *et al.* 2009; Kesarcodi-Watson *et al.* 2012; Touraki *et al.* 2012; Sun *et al.* 2013; Guzmán-Villanueva *et al.* 2014; Yan *et al.* 2014; Reda and Selim 2015; Tan *et al.* 2016;

Chauhan *et al.* 2017; Makled *et al.* 2017; Lv *et al.* 2019), we selected 12, 17, 10 and eight bacteria for the Brest, La Tremblade, Arcachon and Thau sites respectively (**Table 3**). These bacterial strains were then tested for their cytotoxic effects on 2 days old larvae. The most cytotoxic bacteria were discarded. Based on these results, we kept five, seven, five and five site-specific bacteria to create the Brest, La Tremblade, Arcachon and Thau multi-strain bacterial mixes respectively (**Table 3**). A fifth multi-site bacterial mix was created from bacteria isolated from oysters sampled on all sites. For this purpose, seven different bacteria were chosen because they displayed the least cytotoxic effects on larvae (**Table 3**). Altogether, four site-specific and one multi-site multi-strain bacterial mixes were designed to test their potential beneficial properties on oyster health.

Table 3: Details of bacterial selection steps for the creation of multi-strain bacterial mixes.

Environment	Collection of bacteria		Nb. of genera selected for cytotoxic assay on larvae	Nb. of bacteria selected after cytotoxic assay	Multi-strain bacterial mixes	
	Nb. of bacteria in the collection	Nb. of genera			Names	Strains
Brest	97	40	12	5	Brest Mix	<i>Shewanella sp.</i> ARG21 <i>Marinibacterium sp.</i> ARG39 <i>Shewanella sp.</i> ARG89 <i>Shewanella sp.</i> ARG96 <i>Shewanella sp.</i> ARG129
La Tremblade	144	45	17	8	La Tremblade Mix	<i>Halomonas sp.</i> LTB66 <i>Neptunomonas sp.</i> LTB74 <i>Psychrobacter sp.</i> LTB83 <i>Paracoccus sp.</i> LTB95 <i>Halomonas sp.</i> LTB102 <i>Cobetia sp.</i> LTB109 <i>Sulfitobacter sp.</i> LTB127
Arcachon	56	26	10	5	Arcachon Mix	<i>Shewanella sp.</i> ARC21 <i>Bacillus sp.</i> ARC34 <i>Colwellia sp.</i> ARC55 <i>Neptunomonas sp.</i> ARC59 <i>Tenacibaculum sp.</i> ARC64
Thau	67	18	8	5	Thau Mix	<i>Shewanella sp.</i> THAU5 <i>Paracoccus sp.</i> THAU19 <i>Ruegeria sp.</i> THAU28 <i>Shewanella sp.</i> THAU34 <i>Paracoccus sp.</i> THAU46
					Multi-site Mix	<i>Marinibacterium sp.</i> ARG39 <i>Shewanella sp.</i> ARG89 <i>Halomonas sp.</i> LTB57 <i>Cobetia sp.</i> LTB109 <i>Neptunomonas sp.</i> ARC59 <i>Paracoccus sp.</i> THAU19 <i>Paracoccus sp.</i> THAU46

Multi-strain bacterial mixes displayed contrasted effect on larval development.

The multi-strain bacterial mixes were added to four different oyster populations during the larval rearing. The four populations were the sympatric oysters from which the bacteria were isolated (*i.e.*, Brest, La Tremblade, Arcachon and Thau). An exposure with a whole microbiota community coming from healthy hatchery donor oysters was also performed (ME-exposure). These oysters were shown to be devoided of the three main pathogens of *C. gigas* from larvae to juveniles (Azéma *et al.* 2017; Dégremon *et al.* 2021). Bacterial mixes were added either 3h after fertilisation during 14 days (D0 to D14) or seven days after fertilisation during seven days (D7 to D14) (**Figure 1**). The survival ratio (survival percent of bacteria-exposed larvae compared to control larvae) can be divided into three clusters (**Figure 4**) (**Additional table: Effects on larvae**). The first cluster is composed of Thau mix administered between D0 and D14 pf and the three mixes administered lately between D7 and D14 pf (Brest mix D7-D14, La Tremblade mix D7-D14 and Multi-site mix D7-D14). In this first cluster, the bacterial exposure has induced no or moderate mortality during the larval rearing with a mean survival percent of the four populations compared to the control at D25 pf of 90.3% for Thau mix D0-D14 and 98.9, 70.5 and 73% for Brest mix D7-D14, La Tremblade mix D7-D14 and Multi-site mix D7-D14 respectively. The second cluster, composed of Arcachon mix D0-D14 and ME-exposed oysters D0-D14, induced mortality during the larval rearing but to a lesser extent (49% and 38.8% mean survival at D25 pf compared to control for Arcachon mix D0-D14 and ME-exposed respectively). Finally, the third cluster, composed of Brest mix D0-D14, La Tremblade mix D0-D14 and Multi-site mix D0-D14, is the one where the bacterial exposure has induced severe mortality during larval rearing (**Figure 4**).

The different oyster populations displayed different levels of survival: the La Tremblade population was the less sensitive to the bacterial exposure (66.4% mean survival at D25 pf, compared to control and all treatment confounded), The Brest population was the most sensitive (32.8% mean survival at D25 pf, compared to control and all treatment confounded) and the two other populations displayed intermediate levels of survival (53.3 and 55.5% mean survival at D25pf, compared to control and all treatment confounded for Arcachon and Thau population)(**Figure 4**). The growth ratio did not reveal many differences between the different bacterial exposures and between the different oyster populations) meaning that the bacterial exposure does not affect the growth of oyster larvae (**Figure 4**).

Overall, microorganism exposure during larval rearing stages displayed contrasted effects on larval survival which relies on oyster genetic background and, also on the bacterial content of the microorganism exposure. Larval growth is not affected by the microorganism exposure.

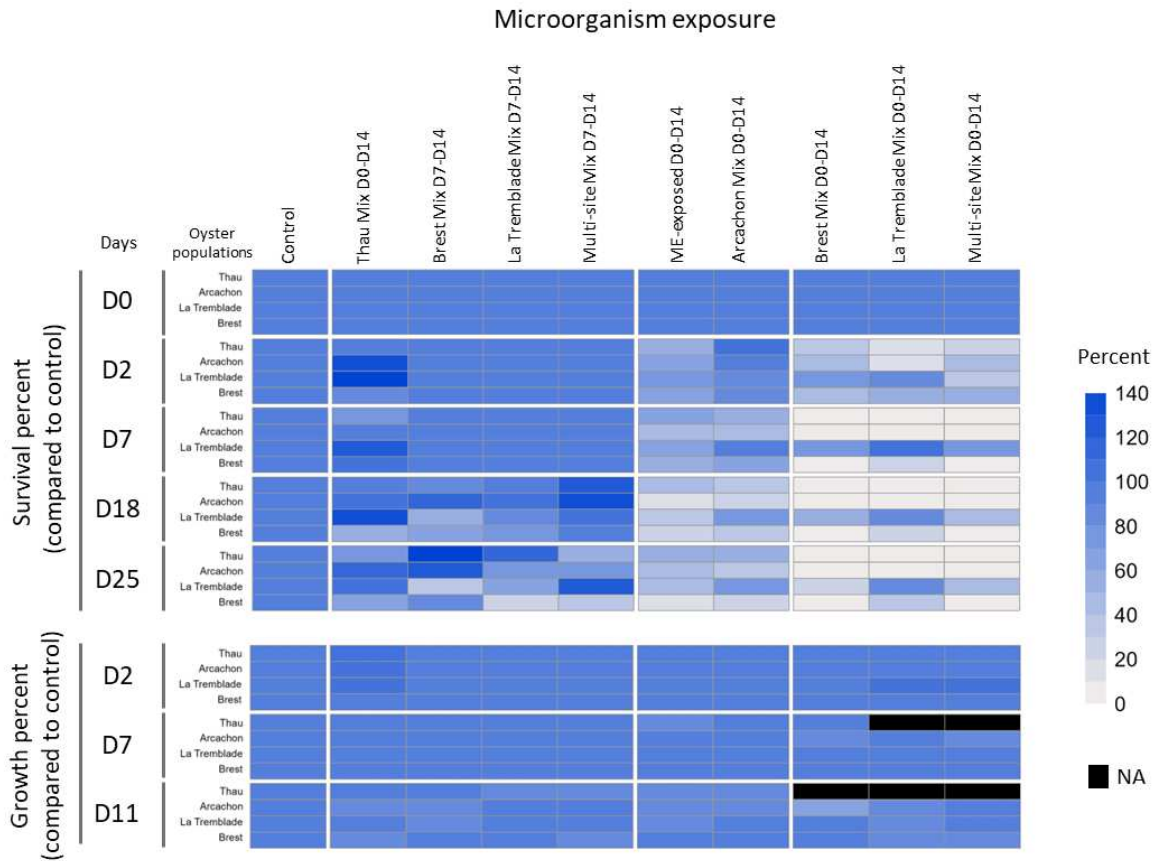

Figure 4: Effects of the microorganism exposure on the survival and growth of larvae from the four oyster populations at different times of the larval rearing stages. The upper part of the heatmap show the survival (in percent) of the larvae exposed to microorganism compared to the control condition and the lower part show the growth (in percent) of the larvae exposed to microorganism compared to the control condition. Black boxes (NA) correspond to conditions where sampling could not be carried out because all the larvae were dead.

Long term oyster resistance to POMS disease relies on bacterial mix composition and oyster genetic background.

To test whether exposure of oyster larvae to each of the microorganism exposure can produce long-term effect on their resistance to POMS disease, each oyster population (exposed and control) were challenged with OsHV-1 infection during juvenile stages. A significant reduction of the mortality risk of 21% (Log-rank test: $pval = 0.038$) and 25% (Log-rank test: $pval = 0.009$) was observed in the oysters (all populations combined) exposed to the Arcachon mix (exposure from D0 to D14 pf) and the La Tremblade mix (exposure from D7 to D14 pf) (**Figure 5**). Furthermore, for the ME-exposed oysters the mortality risk was reduced by 28% (Log-rank test: $pval = 0.008$) as we had previously observed (Fallet *et al.* 2022) (**Figure 5**). These significant results were confirmed by the Kaplan-Meier curves which reports the temporal dynamics of the survival rate. We observed that the mortality started 3 days after the POMS disease induction and differences between the control and microorganisms-exposed sample appeared as soon as mortality started for oysters exposed to the Arcachon mix (D0 to D14 pf), La Tremblade mix (D7 to D14 pf) and, ME-exposed oysters (D0 to D14 pf) (Log-rank test: $pval = 0.032$, $pval = 0.0029$ and $pval = 0.01$ respectively). The beneficial effect in response to each of these mixes depends on the genetic background since each oyster population displayed specific phenotype.

The Arcachon population showed the best reduction in mortality during OsHv1 infection regardless of the bacterial exposure conditions during the larval stages. The effect of the bacterial exposure was intermediate on La Tremblade oyster population and less pronounced on Brest and Thau populations.

In summary, larval exposure to bacterial mixes or ME-exposure conferred a beneficial effect on the survival of the oyster against OshV-1. No preferential beneficial effect was nevertheless observed when the oysters were exposed to their sympatric bacterial strains.

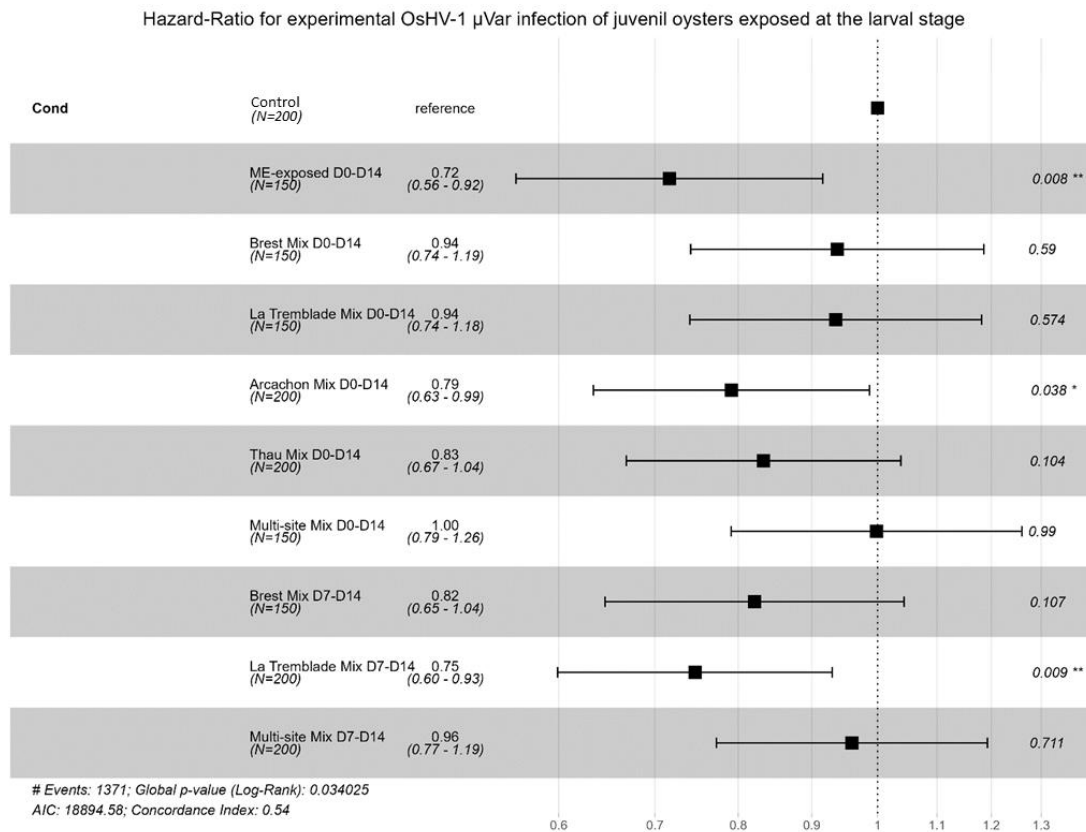

Figure 5: Forest plot representing the Hazard-Ratio value of mortality risk during the OsHV-1 experimental infection for oysters (All populations confounded) exposed to microorganisms compared to control oysters. The numbers in brackets under the different conditions correspond to the number of oysters used in condition during the experimental infection. The Hazard-Ratio value is indicated to the right of the conditions, except for the control condition, which is indicated as reference. Finally, the value of the p-value is indicated on the right-hand side of each row.

Larval exposure to whole microorganism community significantly reduced the mortality of adult oysters during infection with *Vibrio aestuarianus*.

To test whether exposure of oyster larvae to each of microorganism exposure can produce long-term impact on their resistance to Vibriosis, oysters (exposed and control) were challenged with a *Vibrio aestuarianus* 02/041 infection during adult stage. A significant reduction of the mortality risk of 28% (Log-rank test: pval = 0.006) was observed for ME-exposed oysters (Figure 6) but not to the bacterial mixes. In summary, only ME-exposure conferred a significant beneficial effect on the survival of the adult oysters against Vibriosis.

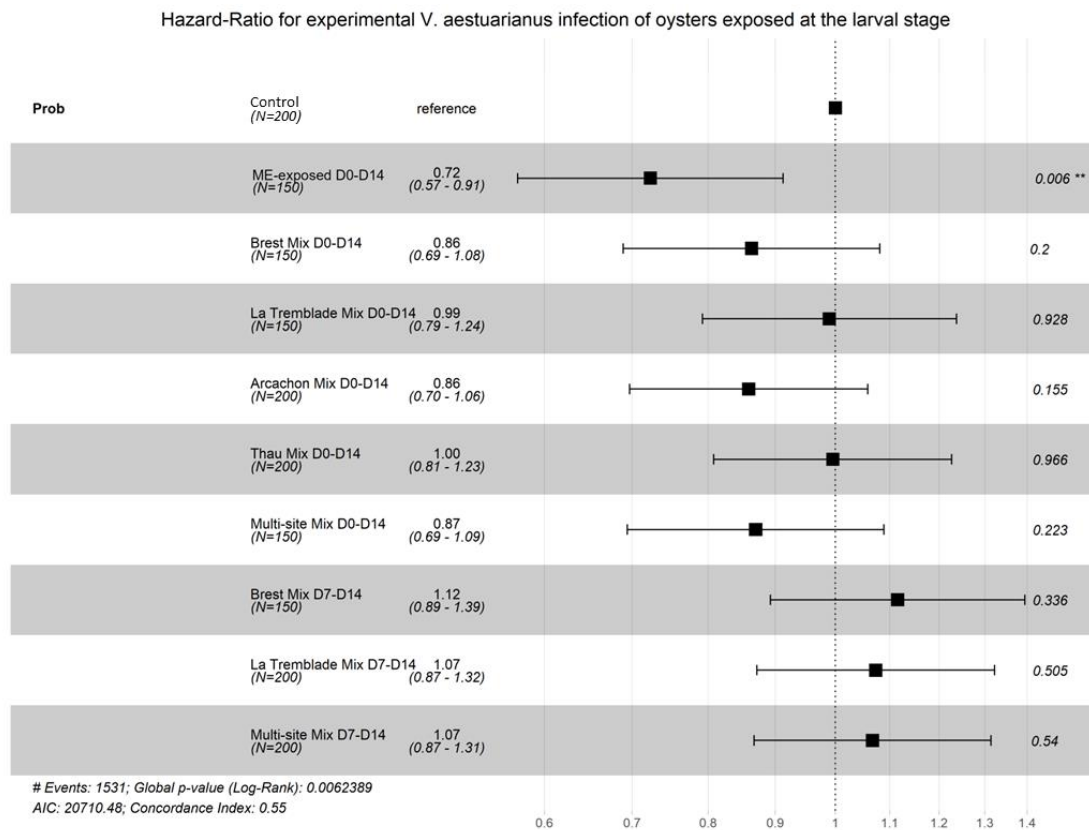

Figure 6: Forest plot representing the Hazard-Ratio value of mortality risk during the *V. aestuarianus* experimental infection for oysters (All populations confounded) exposed to microorganisms compared to control oysters. The numbers in brackets under the different conditions correspond to the number of oysters used in condition during the experimental infection. The Hazard-Ratio value is indicated to the right of the conditions, except for the control condition, which is indicated as reference. Finally, the value of the p-value is indicated on the right-hand side of each row.

Microorganism exposure during larval rearing induced long term changes of the microbiota composition.

To test the immediate and long-term effect of the microorganism exposure on the oyster microbiota composition, we analysed the bacterial communities by 16S amplicon sequencing after 7 days of exposure which corresponded to 48h after the last bacterial addition (at day 7 for NSI and Arcachon mix exposure and at day 14 for La Tremblade mix exposure) and at juvenile stages 8 months after the exposure. We focused our study on the three conditions of bacterial exposure that conferred significant increase on the survival of oysters during OsHV-1 and *V. aestuarianus* experimental infection.

A greater richness was observed seven days after the exposure for ME-exposed larvae but not after exposure to bacterial mixes (**Figure 7 A,B**). This difference was not maintained at juvenile stages (**Figure 8 A**). Dissimilarity analysis, based on the Bray-Curtis index, showed that the

larvae microbiota composition differed between condition after 7 days of microorganism exposure, whatever the condition (Control vs ME-exposed: Permanova : $R^2 = 0.18$; $pval < 0.001$; Control vs Arcachon mix-exposed: Permanova: $R^2 = 0.19$; $pval < 0.001$; control vs La Tremblade mix-exposed: (Permanova: $R^2 = 0.29$; $pval = 0.036$) (**Figure 7 C,D**). This difference remained statistically significant at juvenile stages for two exposure conditions (Control vs ME-exposed: Permanova: $R^2 = 0.05$; $pval = 0.029$; Control vs La Tremblade mix-exposed: Permanova: $R^2 = 0.05$; $pval = 0.033$) (**Figure 8 B**).

We further checked the presence of the bacteria that were added during the exposure after 7 days of exposure and at juvenile stages, 8 months after the exposure. For this purpose, we performed blast analysis. This allowed us to detect two bacterial strain out of the 5 that we had added in larvae exposed to the Arcachon mix and these two bacteria represent 3.3 to 25.9 % of the total bacterial community of oyster larvae exposed to this mix (**Figure 7 E**) and ASVs associated with the administered bacteria of the La Tremblade mix ranged from 0.09 to 0.96 % in the larvae samples administered with La Tremblade mix (**Figure 7 F**). None of the ASVs could be detected at the juvenile stages 8 months after the exposure (**Figure 8 C,D**). Using this pipeline of detection, we were able to detect these ASVs on a mock control containing an artificial mix of bacteria in the same proportion except for the bacteria *Sulfitobacter sp.* LTB127 and *Paracoccus sp.* LTB95. This indicates that the lack of detection of the ASVs is due to an absence of the bacteria rather than a technical shortcoming in our detection pipeline.

In summary, a few proportions of the different bacteria that were added during the larval rearing were detected in the oyster microbiota after 48h of exposure, and none of them were maintained on a long-term basis. Despite this lack of bacterial colonization, the overall composition of the microbiota was modified after the bacterial exposure and these changes remained up to the juvenile stages.

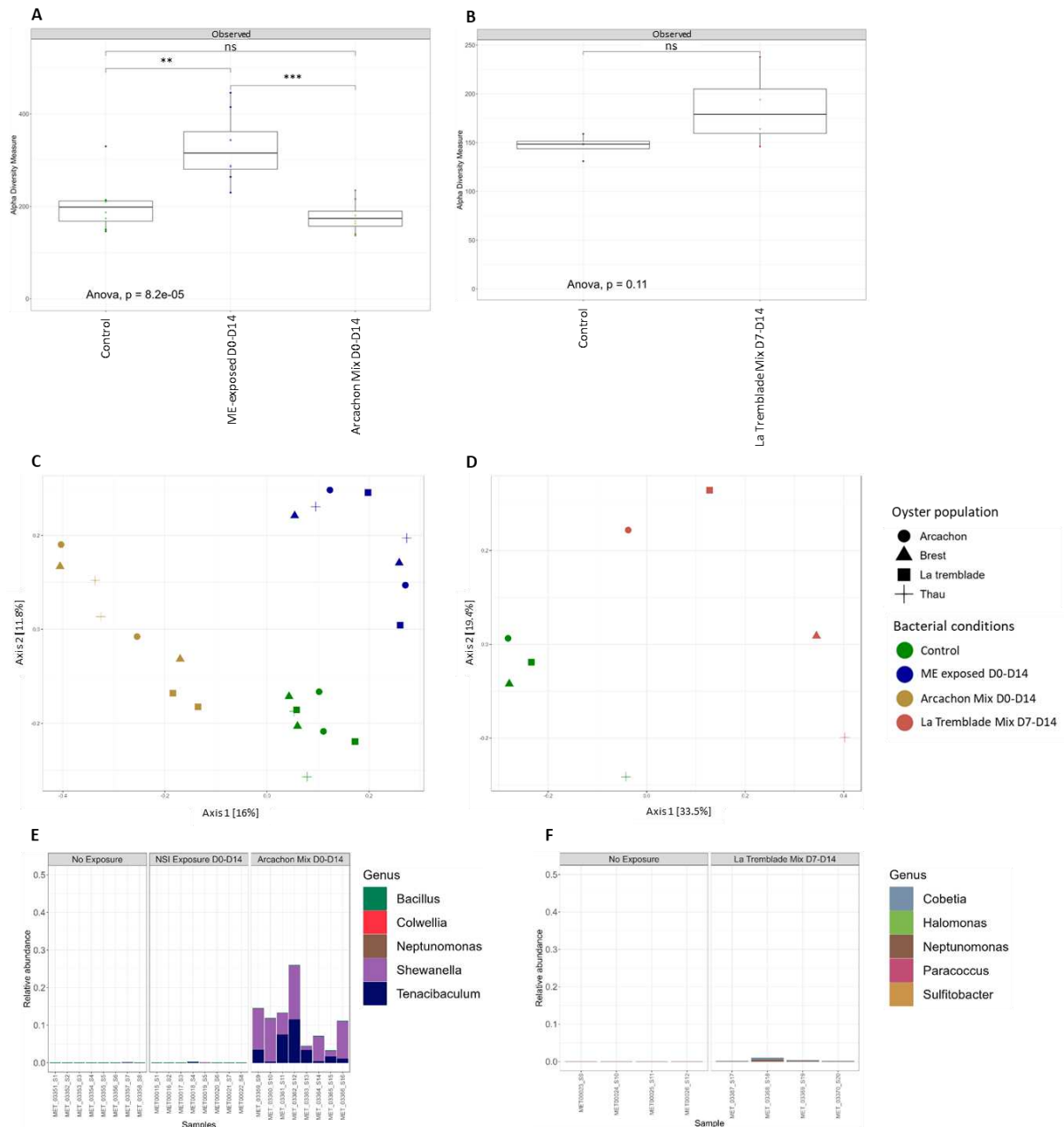

Figure 7: Effect of the microorganism exposure on the alpha-diversity (A,B) and beta-diversity (C,D) of larvae microbiota and plot composition for administered bacteria in larvae microbiota (E,F). Observed index (y-axis) from alpha-diversity analysis on larvae bacterial community of (A) control, ME-exposed and larvae exposed to Arcachon mix at D7 pf and (B) control and larvae exposed to La Tremblade mix at D14 pf. *Represents a statistically significant change in observed index and “ns” stand for not significant. Principal coordinate analyses (PCoA) representing dissimilarities between samples using the Bray-Curtis distance matrix performed on 16S barcoding data obtained from (C) control (green) ME-exposed (blue) and larvae exposed to Arcachon mix (brown) at D7 pf and (D) control (green) and larvae exposed to La Tremblade mix (red) at D14 pf. Relative abundances, at the genus level, of the administered bacteria composing (E) Arcachon mix and (F) La Tremblade mix find in the larvae microbiota.

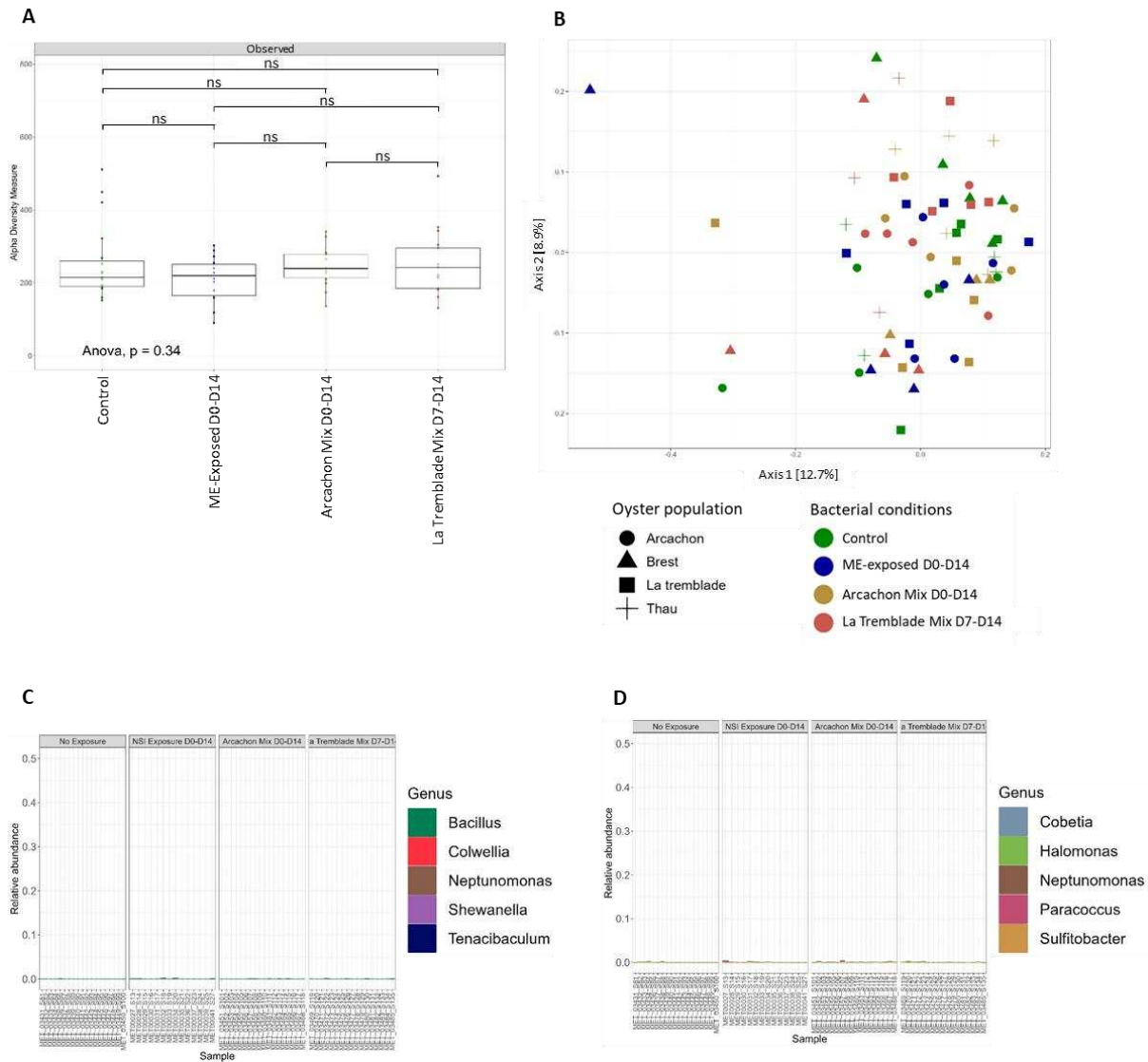

Figure 8: Effect of the microorganism exposure on the alpha-diversity (A) and beta-diversity (B) of juvenile microbiota and plot composition for administered bacteria in juvenile microbiota (C,D). (A) Observed index (y-axis) from alpha-diversity analysis on juvenile bacterial community of control, ME-exposed and juvenile exposed during larval stages to Arcachon mix between D0 and D14 pf pf and La Tremblade mix between D7 and D14 pf. “ns” stand for not significant. (B) Principal coordinate analyses (PCoA) representing dissimilarities between samples using the Bray-Curtis distance matrix performed on 16S barcoding data obtained from control (green) ME-exposed (blue) and oysters exposed during larval stages to Arcachon mix (brown) and La Tremblade mix (red). Relative abundances, at the genus level, of the administered bacteria composing (E) Arcachon mix and (F) La Tremblade mix find in the juvenile oyster microbiota.

Bacterial exposure induced changes in oyster immunity.

To see the impact of microbial exposure on oyster gene expression, we performed a transcriptomic analysis on juvenile oysters before and during an experimental POMS challenge. For the four oyster populations, the number of differentially expressed genes (DEGs) in oysters exposed to bacteria compared to control oysters, was more important before the infection than 3h after the beginning of the infection except for the ME-exposed with Brest oysters (**Figure 9**). Furthermore, the clustering of DEGs, shows that the transcriptomic response to bacterial exposure is dependent on the oyster population. Within the different oyster populations, we can also observe that the transcriptomic response is also different depending on the bacterial exposure (**Figure 10**).

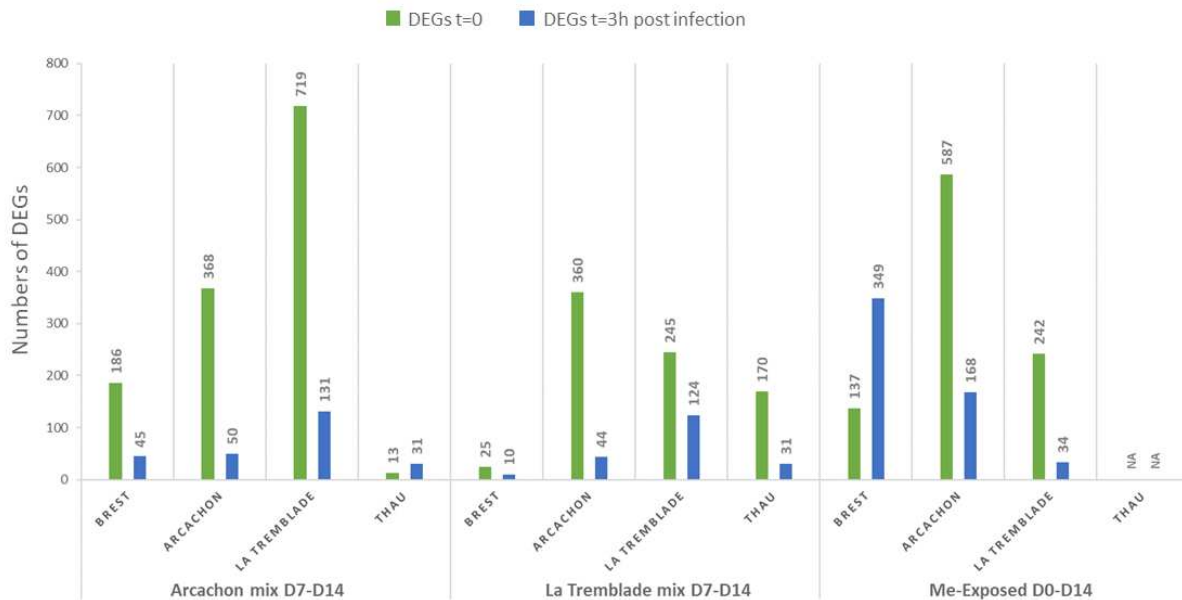

Figure 9: Transcriptomic response of oysters. Histogram of all differentially expressed genes (DEGs) in oysters exposed to Arcachon mix, La Tremblade mix or Me-exposed compared to control oysters for the four oyster populations (Brest, Arcachon, La Tremblade and Thau) prior to OsHV-1 infection (green) and at t = 3h post infection to OsHV-1 (blue).

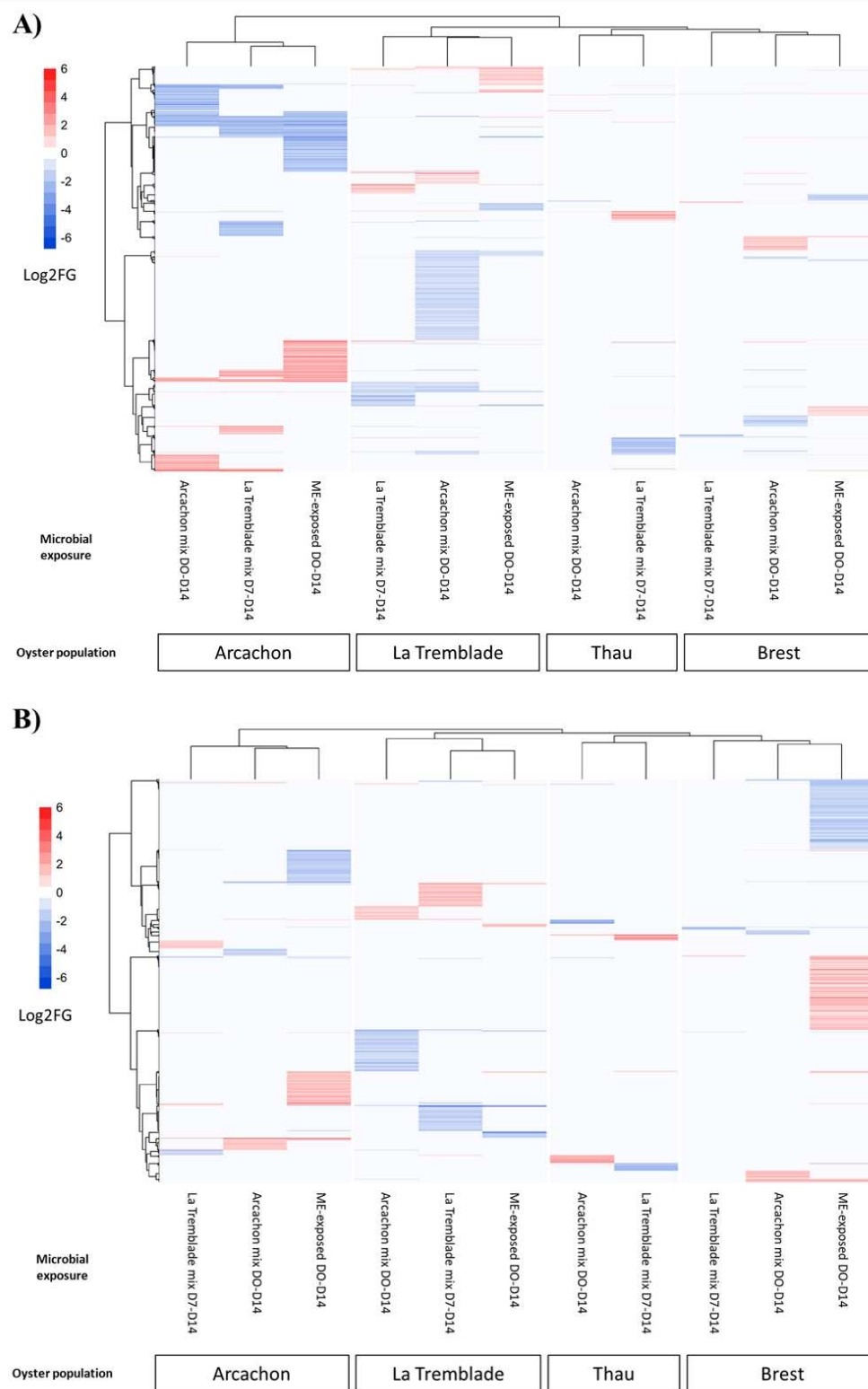

Figure 10: Transcriptomic response of the oysters. Heatmap of all differentially expressed genes (DEGs) in oysters exposed to Arcachon mix, La Tremblade mix or Me-exposed compared to control oysters for the four oyster populations (Brest, Arcachon, La Tremblade and Thau) (A) prior to OshV-1 infection and (B) at t = 3h post infection to OshV-1. The intensity of DEGs expression is expressed in Log₂ Fold changes (Log₂FC) for over expressed DEGs (in red) and under expressed DEGs (in blue).

To identify which biological processes were affected by the microbial exposure, we conducted a Rang-Based Gene Ontology Analysis (RBGOA). The range of biological process in oysters before and during the OsHV1 infection included many functional annotations such as, metabolism, RNA and DNA process, protein processing, signal transduction, transport, and immune functions. We then focused on the enriched immune functions in oysters exposed to microorganisms compared to the control oysters (**Figure 11**). The most Significantly enriched functions across all oyster populations and all treatments were general functions of immunity (defence response, immune system process), functions related to the response to organisms (response to bacterium, response to virus), a function related to the positive regulation of response to stimulus and a function related to G-protein signalling pathway (**Figure 11**).

We further analysed individual DEGs for the main enriched functions related to immunity on the Arcachon population, since it showed the greatest reduction in mortality risk for all microbial exposures. This analysis revealed that before the infection (t=0), gene coding for Pattern Recognition Receptor (PRRs) (C-type lectins, C1q domain containing protein), innate immune pathways (toll-interleukin receptor (TIR), Complement pathway), interaction with bacteria (Bactericidal permeability-increasing protein) and antiviral pathways (RNA and DNA Helicases, RNA-dependent RNA polymerase) were found to be over expressed in microbial exposed oysters compared to control oysters (**Figure 12**).

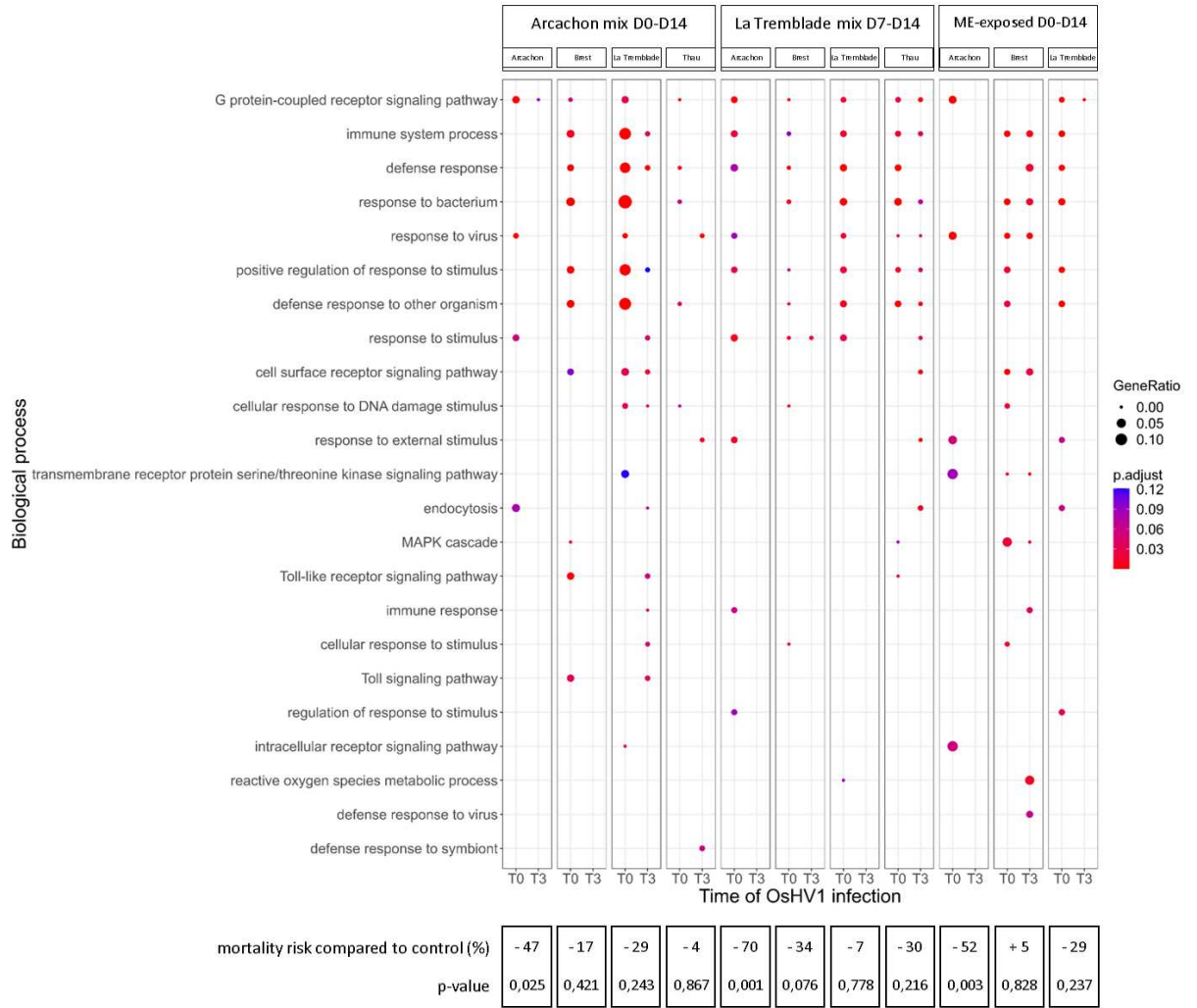

Figure 11: GO enrichment analysis. Dot plot showing the overrepresented GO terms (FDR <0.1) of biological process (BP) related to immune function identified using RBGOA for the four oyster populations (Brest, Arcachon, La Tremblade and Thau) exposed to Arcachon mix, La Tremblade mix or ME-exposed compared to control oysters at t=0 and t=3h of OshV-1 infection. The size of the dot is based on DEGs count significantly enriched in the pathway, and the colour of the dot shows the pathway enrichment significance.

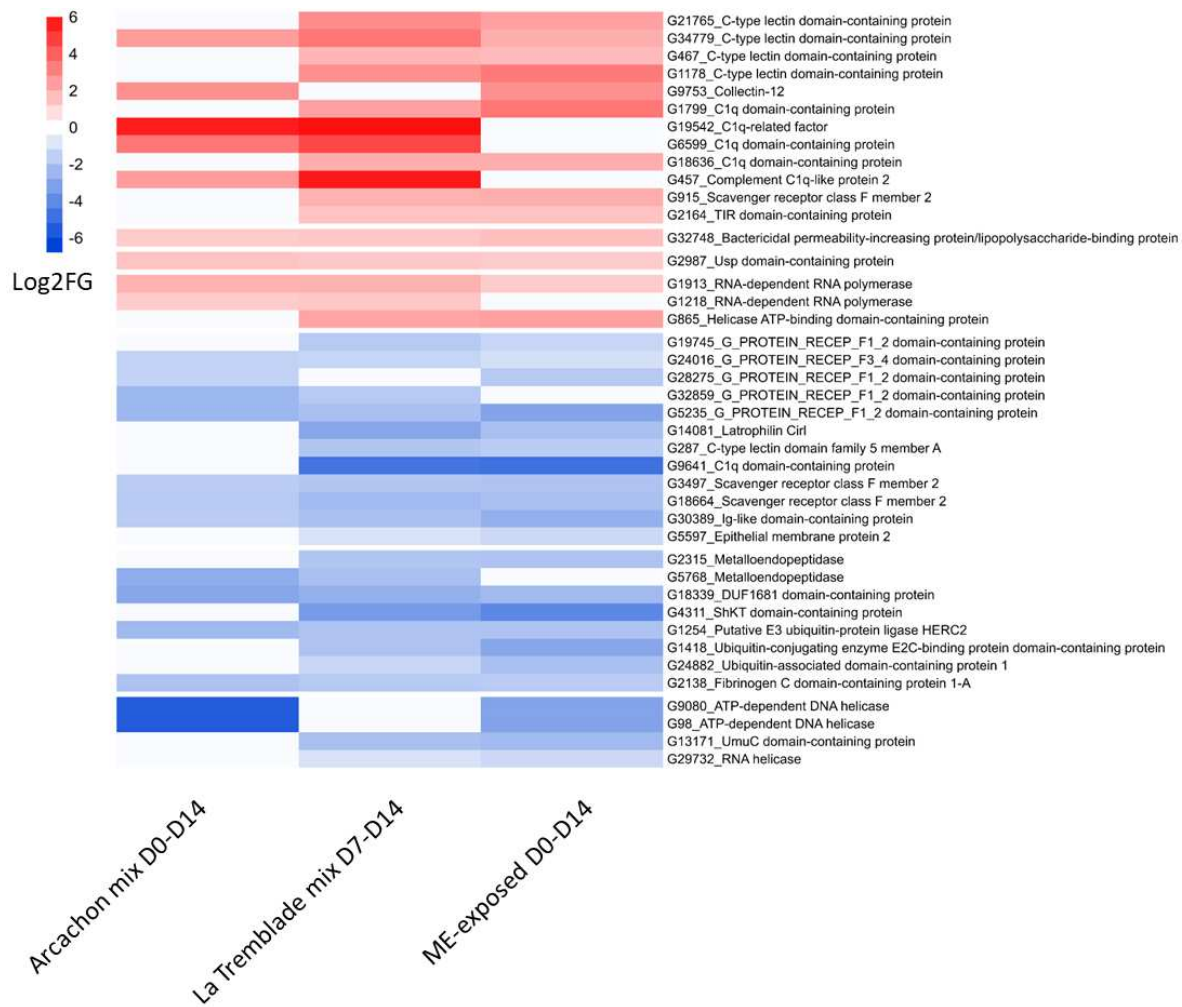

Figure 12: Transcriptomic response of immune related genes for oysters of the Arcachon population. Heatmap of DEGs associated with immune process commonly found at least between two microorganism exposure condition for the Arcachon population. The intensity of DEGs expression is expressed in Log₂ Fold changes (Log₂FC) for over expressed DEGs (in red) and under expressed DEGs (in blue).

Discussion:

OsHV-1 μ Var and *V. aestuarianus* are two pathogens that are propagating and threatening oyster production in Europe (Petton *et al.* 2021; Mesnil *et al.* 2022) but also in other countries such as the United States (Friedman *et al.* 2005), Japan (Shimahara *et al.* 2012), Australia (Paul-Pont *et al.* 2013) and New-Zealand (Delisle *et al.* 2022). The research of methods to fight against these infectious diseases is therefore essential. In the present study, we investigated the long-term effects of different microbial exposures during the larval stages on the phenotype of oysters in response to an infectious episode of POMS or *V. aestuarianus*. We also investigated the impact that this exposure had on the microbiota and immune competence of *C. gigas*.

Microorganism exposure induced contrasted effects during the larval rearing stages.

One of the most critical stages in aquaculture is the larval rearing stage. Indeed, the survival of larvae is, for many aquatic species, as low as 10-15% (Vadstein *et al.* 2018). Here we show that the addition of microorganisms during the larval rearing stages induced three different effects on larvae survival. The majority of microbial exposures had no or little effects on larval survival, but some multi-strain bacterial mixes had devastating effects on larval survival. However, the developmental stage of the oysters seems to play an important role in the tolerance to microbial exposure. Indeed, when the multi-strain bacterial mixes that inducing strongly deleterious effects were administered at later stages of development (from seven days post fecundation), the impact on larval survival became negligible. Furthermore, we can also observe that larval survival is also influenced by oyster genetics background. The oyster population from La Tremblade is the one that had the least negative impact on its survival contrarily to the Brest population which suffer of the most deleterious effects.

The addition of bacteria during the larval stages has already shown positive effects on health and growth of oyster and shrimp larvae (Liu *et al.* 2010; Campa-Córdova *et al.* 2011). But most of the time, these studies focused only on the effects of a single probiotic bacteria on the survival against a pathogen directly after the administration of probiotic (Goulden *et al.* 2012; Modak and Gomez-Chiarri 2020; Madison *et al.* 2022) and unlike in our study, no studies have examined the impact of multi-strain bacterial mixes on the health and growth of larval molluscs of aquaculture interest.

It has been proposed by (Vadstein *et al.* 2018) that current hatchery practices (disinfection of the rearing water, addition of food during rearing) may select for r-strategist bacterial species present in rearing water. Indeed, most pathogens are classified as r-strategists, and r-selected species are often referred to as opportunists (Andrews 1984). To counteract this deleterious effect, (Vadstein *et al.* 2018) suggested to favour competing k-selected bacteria in order to achieve a composition of the water microbiota with fewer opportunists, which are r-selected bacteria. From this point of view, it could have been interesting to realize an exposure during the larval stages without addition of food to support a k-selection of the bacteria added in rearing water.

Microorganism exposure during the larval rearing stages can result in improved resistance to OsHV-1 and *V. aestuarianus* infections.

In our study, larval exposure to a whole microbiota from donor oysters that were always kept in controlled environment led to an improved survival against OsHV-1 and *V. aestuarianus* infection. Larvae exposure to multi-strains bacterial mixes also induced an improved survival against OsHV-1 but no protection was evidenced against *V. aestuarianus*.

Several studies have demonstrated that an exposure during larval stage could improve the survival of oyster larvae against *V. coralliilyticus* (Kesarcodi-Watson *et al.* 2012; Karim *et al.* 2013; Modak and Gomez-Chiarri 2020; Madison *et al.* 2022), *V. tubiashii* (Karim *et al.* 2013) but contrary to our study, none of them investigated a long-term protective effect during the juvenile or adult stages. The only study on the long-term protective effect of bacterial exposure in molluscs of aquaculture interest is the study by (Fallet *et al.* 2022) although this long-term beneficial effects has already been proven in the fish model (Galindo-Villegas *et al.* 2012). Fallet *et al.* (2022) shown that a larval exposure to a whole microbiota from healthy donor oysters from the field improved the survival of oyster against OsHV-1 infection.

Administered bacteria did not settle down in the oyster microbiota but he microorganism exposure during the larval stages induced changes in the bacterial communities of larvae et juveniles

Due to the assimilation of bacteria by larvae during the water filtration and feeding, we were capable to find the bacteria administered by multi-strains bacterial mixes in oyster larvae, but these bacteria were not found in juvenile oysters. As shown by (Gibson *et al.* 1998; Offret *et al.* 2018), these results also demonstrate that administered bacteria become transiently implanted but do not settle down over time in the host microbiota.

Addition of microorganism during the larval stages induced changes in larvae and juvenile microbiota composition. In addition, the exposure to whole microbiota from donor oysters has introduced more richness and changed in the bacterial community of exposed oysters during larval and juvenile stages even if the donor oysters were always kept in controlled environments. This was also observed by (Fallet *et al.* 2022) who brought in an increased richness of oyster microbiota after an exposure of larvae to a diversified microbiota. Furthermore, we were also able to demonstrate that exposure to a multi-strains bacterial mix

can induce changes in the bacterial community, but this type of exposure does not result in greater richness.

Microorganism exposure during the larval stages affected the transcriptomic response of the oysters.

In this study, microbial exposure during larval rearing stages conduct to a long-lasting effect of gene modulations including immunity-related genes and a modulation of different biological functions related to immunity. The number of DEGs was higher before OsHV-1 infection in microbial exposed oysters compared to control oyster. This transcriptomic response, fit to a sustained immune regulation scenario (Coustau *et al.* 2016; Melillo *et al.* 2018; Prigot-Maurice *et al.* 2022) in which the same immune effectors are continuously upregulated following a first immune challenge (Coustau *et al.* 2016). This type of transcriptomic response has already been found in oysters following immune priming by injection of the viral mimic synthetic double stranded RNA (dsRNA) called poly(I:C) (Lafont *et al.* 2017, 2020).

When focusing on the immune genes we could see that a large part of the immune genes differentially expressed in exposed oysters compared to control oysters coded for PRRs and the rest coded for immune pathway and immune response to virus and bacterium. We hypothesize that the resistant oysters are able to detect OsHV-1 or *V. aestuarianus* infection quickly and early. This is supported by (de Lorgeril *et al.* 2018b; De Lorgeril *et al.* 2020) who has demonstrated that POMS-resistant oysters present a more rapid antiviral response compared to POMS susceptible oysters.

Transcriptomic changes after microorganism exposure during the larval stages is strongly affected by oysters' genetic background but no greater response were observed with sympatric interactions between oysters and microorganisms.

Whether in terms of survival or growth of the larvae, transcriptomic changes after exposure or response to OsHV1 challenge, the response to microbial exposure was to a large extent determined by the genetic background of the oyster. The importance of the host genetics for the resistance phenotype against OsHV-1 and *V. aestuarianus* was already demonstrated by (Dégremont *et al.* 2005, 2020; Gawra *et al.* 2023). But also, it have been shown that the observed phenotypic variation between the oysters population was explained by interactions

between the genetic background, epigenetic information and environmental parameters (Gawra *et al.* 2023). We hypothesize that this interactions between genetic background of the oysters, and the epigenetics information provided by early exposure to microorganisms might be responsible for the differences of observed phenotypes in our study. Indeed, the modifications in the epigenome induced by microbial exposure have been involved in the long-term resistance to POMS disease (Fallet *et al.* 2022). In addition, these changes can be transmitted through the next generation (Fallet *et al.* 2022).

Although this interaction between genetics, epigenetics and environmental parameters seems to be the key of the oyster phenotypes, we did not observed any synergetic effect with sympatric association between the oysters and the administered bacteria. This suppose that the microbial community is more important than the geographical origin of the microorganisms.

Conclusion:

In the present study, we have shown that an early-life exposure to multi-strains bacterial mixes induce long-term a protective effect against OsHV-1 μ Var infection at later development stages. However, an exposure to a whole healthy microbiota from oyster donors always kept in controlled environment, may be a better alternative since it provides a higher protective effect against OsHV-1 μ Var and *Vibrio aestuarianus* infection. Addition of microorganisms during the larval rearing stages induces changes in the microbial environment of the oyster larvae that might induces changes in the epigenome that, depending on the genetic background of the oysters, will induce resistances to the pathogens. This study presented the great potential of microbial education for an applicational use in oyster hatcheries.

References

- Abt MC, Artis D (2013) The dynamic influence of commensal bacteria on the immune response to pathogens. *Curr Opin Microbiol* 16:4–9. doi: 10.1016/j.mib.2012.12.002
- Altschul SF, Gish W, Miller W, Myers EW, Lipman DJ (1990) Basic local alignment search tool. *J Mol Biol* 215:403–410. doi: 10.1016/S0022-2836(05)80360-2
- Anders S, Pyl PT, Huber W (2015) HTSeq-A Python framework to work with high-throughput sequencing data. *Bioinformatics* 31:166–169. doi: 10.1093/bioinformatics/btu638
- Andrews J (1984) Relevance of r-and K-theory to the ecology of plant pathogens. *Curr Perspect Microb Ecol* 136–143.
- Azéma P, Travers MA, De Lorgeril J, Tourbiez D, Dégremont L (2015) Can selection for resistance to OsHV-1 infection modify susceptibility to *Vibrio aestuarianus* infection in *Crassostrea gigas*? First insights from experimental challenges using primary and successive exposures. *Vet Res*. doi: 10.1186/s13567-015-0282-0
- Azéma P, Lamy JB, Boudry P, Renault T, Travers MA, Dégremont L (2017) Genetic parameters of resistance to *Vibrio aestuarianus*, and OsHV-1 infections in the Pacific oyster, *Crassostrea gigas*, at three different life stages. *Genet Sel Evol* 49:1–16. doi: 10.1186/s12711-017-0297-2
- Bolyen E, Rideout JR, Dillon MR, Bokulich NA, Abnet CC, Al-Ghalith GA, Alexander H, Alm EJ, Arumugam M, Asnicar F, Bai Y, Bisanz JE, Bittinger K, Brejnrod A, Brislawn CJ, Brown CT, Callahan BJ, Caraballo-Rodríguez AM, Chase J, Cope EK, Da Silva R, Diener C, Dorrestein PC, Douglas GM, Durall DM, Duvallet C, Edwardson CF, Ernst M, Estaki M, Fouquier J, Gauglitz JM, Gibbons SM, Gibson DL, Gonzalez A, Gorlick K, Guo J, Hillmann B, Holmes S, Holste H, Huttenhower C, Huttley GA, Janssen S, Jarmusch AK, Jiang L, Kaehler BD, Kang K Bin, Keefe CR, Keim P, Kelley ST, Knights D, Koester I, Kosciolk T, Kreps J, Langille MGI, Lee J, Ley R, Liu YX, Loftfield E, Lozupone C, Maher M, Marotz C, Martin BD, McDonald D, McIver LJ, Melnik A V., Metcalf JL, Morgan SC, Morton JT, Naimey AT, Navas-Molina JA, Nothias LF, Orchanian SB, Pearson T, Peoples SL, Petras D, Preuss ML, Pruesse E, Rasmussen LB, Rivers A, Robeson MS, Rosenthal P, Segata N, Shaffer M, Shiffer A, Sinha R, Song SJ, Spear JR, Swafford AD, Thompson LR, Torres PJ, Trinh P, Tripathi A, Turnbaugh PJ, Ul-Hasan S, van der Hoof JJJ, Vargas F, Vázquez-Baeza Y, Vogtmann E, von Hippel M, Walters W,

- Wan Y, Wang M, Warren J, Weber KC, Williamson CHD, Willis AD, Xu ZZ, Zaneveld JR, Zhang Y, Zhu Q, Knight R, Caporaso JG (2019) Reproducible, interactive, scalable and extensible microbiome data science using QIIME 2. *Nat Biotechnol* 37:852–857. doi: 10.1038/s41587-019-0209-9
- Callahan BJ, McMurdie PJ, Rosen MJ, Han AW, Johnson AJA, Holmes SP (2016) DADA2: High-resolution sample inference from Illumina amplicon data. *Nat Methods* 13:581–583. doi: 10.1038/nmeth.3869
- Campa-Córdova AI, Luna-González A, Mazón-Suastegui JM, Aguirre-Guzmán G, Ascencio F, González-Ocampo HA (2011) Efecto de bacterias probióticas en el cultivo larvario del ostión de placer *Crassostrea corteziensis* (Bivalvia: *Ostreidae*). *Rev Biol Trop* 59:183–191. doi: 10.15517/rbt.v59i1.3188
- Chauhan R, Choudhuri A, Abraham J (2017) Evaluation of antimicrobial, cytotoxicity, and dyeing properties of prodigiosin produced by *Serratia marcescens* strain JAR8. *Asian J Pharm Clin Res* 10:279–283. doi: 10.22159/ajpcr.2017.v10i8.18173
- Chung H, Pamp SJ, Hill JA, Surana NK, Edelman SM, Troy EB, Reading NC, Villablanca EJ, Wang S, Mora JR, Umesaki Y, Mathis D, Benoist C, Relman DA, Kasper DL (2012) Gut immune maturation depends on colonization with a host-specific microbiota. *Cell* 149:1578–1593. doi: 10.1016/j.cell.2012.04.037
- Cicala F, Cisterna-Céliz JA, Moore JD, Rocha-Olivares A (2018) Structure, dynamics and predicted functional role of the gut microbiota of the blue (*Haliotis fulgens*) and yellow (*H. corrugata*) abalone from baja California sur, Mexico. *PeerJ*. doi: 10.7717/peerj.5830
- Cicala F, Cisterna-Céliz JA, Paolinelli M, Moore JD, Sevigny J, Rocha-Olivares A (2022) The Role of Diversity in Mediating Microbiota Structural and Functional Differences in Two Sympatric Species of Abalone Under Stressed Withering Syndrome Conditions. *Microb Ecol* 1–11. doi: 10.1007/s00248-022-01970-5
- Clerissi C, de Lorgeril J, Petton B, Lucasson A, Escoubas J-M, Gueguen Y, Dégremont L, Mitta G, Toulza E (2020) Microbiota Composition and Evenness Predict Survival Rate of Oysters Confronted to Pacific Oyster Mortality Syndrome. *Front Microbiol* 11:1–11. doi: 10.3389/fmicb.2020.00311
- Clerissi C, Luo X, Lucasson A, Mortaza S, de Lorgeril J, Toulza E, Petton B, Escoubas JM, Dégremont L, Gueguen Y, Destoumieux-Garzón D, Jacq A, Mitta G (2022) A core of

- functional complementary bacteria infects oysters in Pacific Oyster Mortality Syndrome. *Anim Microbiome*. doi: 10.1186/s42523-023-00246-8
- Conway JR, Lex A, Gehlenborg N (2017) UpSetR: An R package for the visualization of intersecting sets and their properties. *Bioinformatics* 33:2938–2940. doi: 10.1093/bioinformatics/btx364
- Cotter E, Malham SK, O’Keeffe S, Lynch SA, Latchford JW, King JW, Beaumont AR, Culloty SC (2010) Summer mortality of the Pacific oyster, *Crassostrea gigas*, in the Irish Sea: The influence of growth, biochemistry and gametogenesis. *Aquaculture* 303:8–21. doi: 10.1016/J.AQUACULTURE.2010.02.030
- Coustau C, Kurtz J, Moret Y (2016) A Novel Mechanism of Immune Memory Unveiled at the Invertebrate-Parasite Interface. *Trends Parasitol* 32:353–355. doi: 10.1016/j.pt.2016.02.005
- De Decker S, Saulnier D (2011) Vibriosis induced by experimental cohabitation in *Crassostrea gigas*: Evidence of early infection and down-expression of immune-related genes. *Fish Shellfish Immunol* 30:691–699. doi: 10.1016/j.fsi.2010.12.017
- de Lorgeril J, Lucasson A, Petton B, Toulza E, Montagnani C, Clerissi C, Vidal-Dupiol J, Chaparro C, Galinier R, Escoubas JM, Haffner P, Dégremont L, Charrière GM, Lafont M, Delort A, Vergnes A, Chiarello M, Faury N, Rubio T, Leroy MA, Pérignon A, Régler D, Morga B, Alunno-Bruscia M, Boudry P, Le Roux F, Destoumieux-Garzón D, Gueguen Y, Mitta G (2018a) Immune-suppression by OsHV-1 viral infection causes fatal bacteraemia in Pacific oysters. *Nat Commun*. doi: 10.1038/s41467-018-06659-3
- de Lorgeril J, Escoubas JM, Loubiere V, Pernet F, Le Gall P, Vergnes A, Aujoulat F, Jeannot JL, Jumas-Bilak E, Got P, Gueguen Y, Destoumieux-Garzón D, Bachère E (2018b) Inefficient immune response is associated with microbial permissiveness in juvenile oysters affected by mass mortalities on field. *Fish Shellfish Immunol* 77:156–163. doi: 10.1016/j.fsi.2018.03.027
- De Lorgeril J, Petton B, Lucasson A, Perez V, Stenger PL, Dégremont L, Montagnani C, Escoubas JM, Haffner P, Allienne JF, Leroy M, Lagarde F, Vidal-Dupiol J, Gueguen Y, Mitta G (2020) Differential basal expression of immune genes confers *Crassostrea gigas* resistance to Pacific oyster mortality syndrome. *BMC Genomics*. doi: 10.1186/s12864-020-6471-x

- Dégremont L, Bédier E, Soletchnik P, Ropert M, Huvet A, Moal J, Samain JF, Boudry P (2005) Relative importance of family, site, and field placement timing on survival, growth, and yield of hatchery-produced Pacific oyster spat (*Crassostrea gigas*). *Aquaculture* 249:213–229. doi: 10.1016/j.aquaculture.2005.03.046
- Dégremont L, Azéma P, Maurouard E, Travers MA (2020) Enhancing resistance to *Vibrio aestuarianus* in *Crassostrea gigas* by selection. *Aquaculture*. doi: 10.1016/j.aquaculture.2020.735429
- Dégremont L, Morga B, Maurouard E, Travers MA (2021) Susceptibility variation to the main pathogens of *Crassostrea gigas* at the larval, spat and juvenile stages using unselected and selected oysters to OsHV-1 and/or *V. aestuarianus*. *J Invertebr Pathol* 183:107601. doi: 10.1016/j.jip.2021.107601
- Delisle L, Laroche O, Hilton Z, Burguin J-F, Rolton A, Berry J, Pochon X, Boudry P, Vignier J (2022) Understanding the Dynamic of POMS Infection and the Role of Microbiota Composition in the Survival of Pacific Oysters, *Crassostrea gigas*. *Microbiol Spectr*. doi: 10.1128/spectrum.01959-22
- Escudié F, Auer L, Bernard M, Mariadassou M, Cauquil L, Vidal K, Maman S, Hernandez-Raquet G, Combes S, Pascal G (2018) FROGS: Find, Rapidly, OTUs with Galaxy Solution. *Bioinformatics* 34:1287–1294. doi: 10.1093/bioinformatics/btx791
- Fallet M, Montagnani C, Petton B, Dantan L, de Lorgeril J, Comarmond S, Chaparro C, Toulza E, Boitard S, Escoubas J-M, Vergnes A, Le Grand J, Bulla I, Gueguen Y, Vidal-Dupiol J, Grunau C, Mitta G, Cosseau C (2022) Early life microbial exposures shape the *Crassostrea gigas* immune system for lifelong and intergenerational disease protection. *Microbiome*. doi: 10.1186/s40168-022-01280-5
- Friedman CS, Estes RM, Stokes NA, Burge CA, Hargove JS, Barber BJ, Elston RA, Burreson EM, Reece KS (2005) Herpes virus in juvenile Pacific oysters *Crassostrea gigas* from Tomales Bay, California, coincides with summer mortality episodes. *Dis Aquat Organ* 63:33–41. doi: 10.3354/dao063033
- Galindo-Villegas J, Garcíá-Moreno D, De Oliveira S, Meseguer J, Mulero V (2012) Regulation of immunity and disease resistance by commensal microbes and chromatin modifications during zebrafish development. *Proc Natl Acad Sci U S A*. doi: 10.1073/pnas.1209920109
- Gawra J, Valdivieso A, Roux F, Laporte M, De Lorgeril J, Gueguen Y, Saccas M, Escoubas J-

- M, Montagnani C, Destoumieux-Garzón D, Lagarde F, Leroy MA, Haffner P, Petton B, Cosseau C, Morga B, Dégremont L, Mitta G, Grunau C, Vidal-Dupiol J (2023) Epigenetic then genetic variations underpin rapid adaptation of oyster populations (*Crassostrea gigas*) to Pacific Oyster Mortality Syndrome (POMS). bioRxiv. doi: 10.1101/2023.03.09.531494
- Gibson LF, Woodworth J, George AM (1998) Probiotic activity of *Aeromonas media* on the Pacific oyster, *Crassostrea gigas*, when challenged with *Vibrio tubiashii*. Aquaculture 169:111–120. doi: 10.1016/S0044-8486(98)00369-X
- Goecks J, Nekrutenko A, Taylor J, Afgan E, Ananda G, Baker D, Blankenberg D, Chakrabarty R, Coraor N, Goecks J, Von Kuster G, Lazarus R, Li K, Taylor J, Vincent K (2010) Galaxy: a comprehensive approach for supporting accessible, reproducible, and transparent computational research in the life sciences. Genome Biol. doi: 10.1186/gb-2010-11-8-r86
- Goulden EF, Hall MR, Pereg LL, Høj L (2012) Identification of an antagonistic probiotic combination protecting ornate spiny lobster (*Panulirus ornatus*) larvae against *Vibrio owensii* infection. PLoS One. doi: 10.1371/journal.pone.0039667
- Guzmán-Villanueva LT, Tovar-Ramírez D, Gisbert E, Cordero H, Guardiola FA, Cuesta A, Meseguer J, Ascencio-Valle F, Esteban MA (2014) Dietary administration of β -1,3/1,6-glucan and probiotic strain *Shewanella putrefaciens*, single or combined, on gilthead seabream growth, immune responses and gene expression. Fish Shellfish Immunol 39:34–41. doi: 10.1016/j.fsi.2014.04.024
- Holt CC, Bass D, Stentiford GD, van der Giezen M (2020) Understanding the role of the shrimp gut microbiome in health and disease. J Invertebr Pathol 107387. doi: 10.1016/j.jip.2020.107387
- Karim M, Zhao W, Rowley D, Nelson D, Gomez-Chiarri M (2013) Probiotic Strains for Shellfish Aquaculture: Protection of Eastern Oyster, *Crassostrea virginica*, Larvae and Juveniles Against Bacterial Challenge. J Shellfish Res 32:401–408. doi: 10.2983/035.032.0220
- Kesarcodi-Watson A, Miner P, Nicolas JL, Robert R (2012) Protective effect of four potential probiotics against pathogen-challenge of the larvae of three bivalves: Pacific oyster (*Crassostrea gigas*), flat oyster (*Ostrea edulis*) and scallop (*Pecten maximus*).

Aquaculture 344–349:29–34. doi: 10.1016/j.aquaculture.2012.02.029

King WL, Jenkins C, Go J, Siboni N, Seymour JR, Labbate M (2019a) Characterisation of the Pacific Oyster Microbiome During a Summer Mortality Event. *Microb Ecol* 77:502–512. doi: 10.1007/s00248-018-1226-9

King WL, Siboni N, Williams NLR, Kahlke T, Nguyen KV, Jenkins C, Dove M, O'Connor W, Seymour JR, Labbate M (2019b) Variability in the composition of pacific oyster microbiomes across oyster families exhibiting different levels of susceptibility to OsHV-1 μ var disease. *Front Microbiol* 10:1–12. doi: 10.3389/fmicb.2019.00473

Labreuche Y, Soudant P, Gonçalves M, Lambert C, Nicolas JL (2006) Effects of extracellular products from the pathogenic *Vibrio aestuarianus* strain 01/32 on lethality and cellular immune responses of the oyster *Crassostrea gigas*. *Dev Comp Immunol* 30:367–379. doi: 10.1016/j.dci.2005.05.003

Labreuche Y, Le Roux F, Henry J, Zatylny C, Huvet A, Lambert C, Soudant P, Mazel D, Nicolas JL (2010) *Vibrio aestuarianus* zinc metalloprotease causes lethality in the Pacific oyster *Crassostrea gigas* and impairs the host cellular immune defenses. *Fish Shellfish Immunol* 29:753–758. doi: 10.1016/j.fsi.2010.07.007

Lafont M, Petton B, Vergnes A, Pauletto M, Segarra A, Gourbal B, Montagnani C (2017) Long-lasting antiviral innate immune priming in the Lophotrochozoan Pacific oyster, *Crassostrea gigas*. *Sci Rep*. doi: 10.1038/s41598-017-13564-0

Lafont M, Vergnes A, Vidal-Dupiol J, De Lorgeril J, Gueguen Y, Haffner P, Petton B, Chaparro C, Barrachina C, Destoumieux-Garzon D, Mitta G, Gourbal B, Montagnani C (2020) A sustained immune response supports long-term antiviral immune priming in the pacific oyster, *Crassostrea gigas*. *MBio*. doi: 10.1128/mBio.02777-19

Liu KF, Chiu CH, Shiu YL, Cheng W, Liu CH (2010) Effects of the probiotic, *Bacillus subtilis* E20, on the survival, development, stress tolerance, and immune status of white shrimp, *Litopenaeus vannamei* larvae. *Fish Shellfish Immunol* 28:837–844. doi: 10.1016/j.fsi.2010.01.012

Love MI, Huber W, Anders S (2014) Moderated estimation of fold change and dispersion for RNA-seq data with DESeq2. *Genome Biol* 15:1–21. doi: 10.1186/s13059-014-0550-8

Lv N, Pan L, Zhang J, Li Y, Zhang M (2019) A novel micro-organism for removing excess

- ammonia-N in seawater ponds and the effect of *Cobetia amphilecti* on the growth and immune parameters of *Litopenaeus vannamei*. *J World Aquac Soc* 50:448–459. doi: 10.1111/jwas.12561
- Madison D, Schubiger C, Lunda S, Mueller RS, Langdon C (2022) A marine probiotic treatment against the bacterial pathogen *Vibrio coralliilyticus* to improve the performance of Pacific (*Crassostrea gigas*) and Kumamoto (*C. sikamea*) oyster larvae. *Aquaculture*. doi: 10.1016/j.aquaculture.2022.738611
- Magoč T, Salzberg SL (2011) FLASH: Fast length adjustment of short reads to improve genome assemblies. *Bioinformatics* 27:2957–2963. doi: 10.1093/bioinformatics/btr507
- Mahé F, Rognes T, Quince C, de Vargas C, Dunthorn M (2014) Swarm: Robust and fast clustering method for amplicon-based studies. *PeerJ* 2014:e593. doi: 10.7717/peerj.593
- Makled SO, Hamdan AM, El-Sayed AFM, Hafez EE (2017) Evaluation of marine psychrophile, *Psychrobacter namhaensis* SO89, as a probiotic in Nile tilapia (*Oreochromis niloticus*) diets. *Fish Shellfish Immunol* 61:194–200. doi: 10.1016/j.fsi.2017.01.001
- Martin M (2011) Cutadapt removes adapter sequences from high-throughput sequencing reads. *EMBnet.journal* 17:10. doi: 10.14806/ej.17.1.200
- McKnight DT, Huerlimann R, Bower DS, Schwarzkopf L, Alford RA, Zenger KR (2019) microDecon: A highly accurate read-subtraction tool for the post-sequencing removal of contamination in metabarcoding studies. *Environ DNA* 1:14–25. doi: 10.1002/edn3.11
- McMurdie PJ, Holmes S (2013) Phyloseq: An R Package for Reproducible Interactive Analysis and Graphics of Microbiome Census Data. *PLoS One*. doi: 10.1371/journal.pone.0061217
- Melillo D, Marino R, Italiani P, Boraschi D (2018) Innate Immune Memory in Invertebrate Metazoans: A Critical Appraisal. *Front Immunol*. doi: 10.3389/fimmu.2018.01915
- Mesnil A, Jacquot M, Garcia C, Tourbiez D, Canier L, Dégremont L, Cheslett D, Geary M, Vetri A, Roque A, Furones D, Garden A, Orozova P, Arzul I, Sicard M, Destoumieux-Garzón D, Travers M-A (2022) Emergence and clonal expansion in Europe of *Vibrio aestuarianus* lineages pathogenic for oysters. *Mol Ecol* 1–31. doi: 10.1111/mec.16910
- Modak TH, Gomez-Chiarri M (2020) Contrasting immunomodulatory effects of probiotic and pathogenic bacteria on eastern oyster, *Crassostrea virginica*, larvae. *Vaccines* 8:1–23. doi: 10.3390/vaccines8040588

- Offret C, Rochard V, Laguerre H, Mounier J, Huchette S, Brillet B, Le Chevalier P, Fleury Y (2018) Protective Efficacy of a *Pseudoalteromonas* Strain in European Abalone, *Haliotis tuberculata*, Infected with *Vibrio harveyi* ORM4. *Probiotics Antimicrob Proteins* 11:239–247. doi: 10.1007/s12602-018-9389-8
- Oksanen J, Simpson GL, Blanchet FG, Kindt R, Legendre P, Minchin PR, O'Hara RB, Solymos P, Stevens MHH, Szoecs E, Wagner H, Barbour M, Bedward M, Bolker B, Borcard D, Carvalho G, Chirico M, Caceres M De, Durand S, Evangelista HBA, FitzJohn R, Friendly M, Furneaux B, Hannigan G, Hill MO, Lahti L, McGlenn D, Ouellette M-H, Cunha ER, Smith T, Stier A, Braak CJF Ter, Weedon J (2022) vegan: Community Ecology Package version 2.6-2. The Comprehensive R Archive Network
- Paul-Pont I, Dhand NK, Whittington RJ (2013) Spatial distribution of mortality in Pacific oysters *Crassostrea gigas*: Reflection on mechanisms of OsHV-1 transmission. *Dis Aquat Organ* 105:127–138. doi: 10.3354/dao02615
- Pérez-Sánchez T, Mora-Sánchez B, Balcázar JL (2018) Biological Approaches for Disease Control in Aquaculture: Advantages, Limitations and Challenges. *Trends Microbiol* 26:896–903. doi: 10.1016/j.tim.2018.05.002
- Pernet F, Barret J, Le Gall P, Corporeau C, Dégremont L, Lagarde F, Pépin JF, Keck N (2012) Mass mortalities of Pacific oysters *Crassostrea gigas* reflect infectious diseases and vary with farming practices in the Mediterranean Thau lagoon, France. *Aquac Environ Interact* 2:215–237. doi: 10.3354/aei00041
- Petton B, Destoumieux-Garzón D, Pernet F, Toulza E, de Lorgeril J, Degremont L, Mitta G (2021) The Pacific Oyster Mortality Syndrome, a Polymicrobial and Multifactorial Disease: State of Knowledge and Future Directions. *Front Immunol*. doi: 10.3389/fimmu.2021.630343
- Prigot-Maurice C, Beltran-Bech S, Braquart-Varnier C (2022) Why and how do protective symbionts impact immune priming with pathogens in invertebrates ? *Dev Comp Immunol*. doi: 10.1016/j.dci.2021.104245
- R Core Team (2022) A language and environment for statistical computing. *R Found Stat Comput* 10:11–18.
- Reda RM, Selim KM (2015) Evaluation of *Bacillus amyloliquefaciens* on the growth performance, intestinal morphology, hematology and body composition of Nile tilapia,

- Oreochromis niloticus*. *Aquac Int* 23:203–217. doi: 10.1007/s10499-014-9809-z
- Rengpipat S, Rukpratanporn S, Piyatiratitivorakul S, Menasaveta P (2000) Immunity enhancement in black tiger shrimp (*Penaeus monodon*) by a probiont bacterium (*Bacillus* S11). *Aquaculture* 191:271–288. doi: 10.1016/S0044-8486(00)00440-3
- Rognes T, Flouri T, Nichols B, Quince C, Mahé F (2016) VSEARCH: A versatile open source tool for metagenomics. *PeerJ*. doi: 10.7717/peerj.2584
- Saulnier D, De Decker S, Haffner P (2009) Real-time PCR assay for rapid detection and quantification of *Vibrio aestuarianus* in oyster and seawater: A useful tool for epidemiologic studies. *J Microbiol Methods* 77:191–197. doi: 10.1016/j.mimet.2009.01.021
- Schikorski D, Faury N, Pepin JF, Saulnier D, Tourbiez D, Renault T (2011) Experimental ostreid herpesvirus 1 infection of the Pacific oyster *Crassostrea gigas*: Kinetics of virus DNA detection by q-PCR in seawater and in oyster samples. *Virus Res* 155:28–34. doi: 10.1016/j.virusres.2010.07.031
- Schneider CA, Rasband WS, Eliceiri KW (2012) NIH Image to ImageJ: 25 years of image analysis. *Nat Methods* 9:671–675. doi: 10.1038/nmeth.2089
- Segata N, Izard J, Waldron L, Gevers D, Miropolsky L, Garrett WS, Huttenhower C (2011) Metagenomic biomarker discovery and explanation. *Genome Biol* 12:R60. doi: 10.1186/gb-2011-12-6-r60
- Shimahara Y, Kurita J, Kiryu I, Nishioka T, Yuasa K, Kawana M, Kamaishi T, Oseko N (2012) Surveillance of Type 1 Ostreid Herpesvirus (OsHV-1) Variants in Japan. *Fish Pathol* 47:129–136. doi: 10.3147/jsfp.47.129
- Sommer F, Bäckhed F (2013) The gut microbiota-masters of host development and physiology. *Nat Rev Microbiol* 11:227–238. doi: 10.1038/nrmicro2974
- Sun YZ, Yang HL, Huang KP, Ye JD, Zhang CX (2013) Application of autochthonous *Bacillus* bioencapsulated in copepod to grouper *Epinephelus coioides* larvae. *Aquaculture* 392–395:44–50. doi: 10.1016/j.aquaculture.2013.01.037
- Tan LTH, Chan KG, Lee LH, Goh BH (2016) *Streptomyces* bacteria as potential probiotics in aquaculture. *Front Microbiol* 7:1–8. doi: 10.3389/fmicb.2016.00079

- Touraki M, Karamanlidou G, Karavida P, Chrysi K (2012) Evaluation of the probiotics *Bacillus subtilis* and *Lactobacillus plantarum* bioencapsulated in *Artemia nauplii* against Vibriosis in European sea bass larvae (*Dicentrarchus labrax*, L.). *World J Microbiol Biotechnol* 28:2425–2433. doi: 10.1007/s11274-012-1052-z
- Vadstein O, Attramadal KJK, Bakke I, Olsen Y (2018) K-selection as microbial community management strategy: A method for improved viability of larvae in aquaculture. *Front Microbiol*. doi: 10.3389/fmicb.2018.02730
- Wang Q, Garrity GM, Tiedje JM, Cole JR (2007) Naïve Bayesian classifier for rapid assignment of rRNA sequences into the new bacterial taxonomy. *Appl Environ Microbiol* 73:5261–5267. doi: 10.1128/AEM.00062-07
- Webb SC, Fidler A, Renault T (2007) Primers for PCR-based detection of ostreid herpes virus-1 (OsHV-1): Application in a survey of New Zealand molluscs. *Aquaculture* 272:126–139. doi: 10.1016/j.aquaculture.2007.07.224
- Wright RM, Aglyamova G V, Meyer E, Matz M V (2015) Gene expression associated with white syndromes in a reef building coral, *Acropora hyacinthus*. *BMC Genomics*. doi: 10.1186/s12864-015-1540-2
- Yan F jun, Tian X li, Dong S lin, Fang Z heng, Yang G (2014) Growth performance, immune response, and disease resistance against *Vibrio splendidus* infection in juvenile sea cucumber *Apostichopus japonicus* fed a supplementary diet of the potential probiotic *Paracoccus marcusii* DB11. *Aquaculture* 420–421:105–111. doi: 10.1016/j.aquaculture.2013.10.045
- Yoon SH, Ha SM, Kwon S, Lim J, Kim Y, Seo H, Chun J (2017) Introducing EzBioCloud: A taxonomically united database of 16S rRNA gene sequences and whole-genome assemblies. *Int J Syst Evol Microbiol* 67:1613–1617. doi: 10.1099/ijsem.0.001755
- Zhang L, Mai K, Tan B, Ai Q, Qi C, Xu W, Zhang W, Liufu Z, Wang X, Ma H (2009) Effects of dietary administration of probiotic *Halomonas* sp. B12 on the intestinal microflora, immunological parameters, and midgut histological structure of shrimp, *Fenneropenaeus chinensis*. *J World Aquac Soc* 40:58–66. doi: 10.1111/j.1749-7345.2008.00235.x
- Zhang S, Sun X (2022) Core Gut Microbiota of Shrimp Function as a Regulator to Maintain Immune Homeostasis in Response to WSSV Infection. *Microbiol Spectr*. doi: 10.1128/spectrum.02465-21

Chapitre 2 :

Caractérisation des effets antagonistes de bactéries issues du microbiote de l'huître *Crassostrea gigas* dans la réponse face à la maladie du POMS et à la bactérie pathogène *Vibrio aestuarianus*

I. Utilisation des activités antibactériennes de bactéries issues du microbiote de l'huître *C. gigas* comme moyen de lutte contre les infections à OsHV-1 μ Var et *V. aestuarianus*

1. Contexte et objectifs

La seconde approche de lutte contre les maladies infectieuses affectant *C. gigas*, développée au cours de ces travaux de thèse, consiste à mettre à profit les effets antagonistes dont disposent certaines bactéries à l'égard d'autres microorganismes, et plus particulièrement à l'égard des agents pathogènes de l'huître.

Des études ont porté sur l'utilisation de bactéries possédant des activités antibactériennes afin de lutter contre des infections. À titre d'exemple, une exposition chez l'ormeau *Haliotis tuberculata* à la souche *Pseudoalteromonas sp.* hCg-6 a permis de conférer un effet protecteur lors d'une infection à *Vibrio harveyi* ORM4 (Offret *et al.* 2018). Plus spécifiquement chez les huîtres, une exposition lors des stades larvaires à une souche de *Pseudoalteromonas sp.*, capable d'inhiber la croissance de la bactérie *V. coralliilyticus*, a permis, lors d'une infection à cette dernière, de réduire la mortalité des larves.

Des études ayant réalisé des analyses comparatives entre le microbiote d'huîtres résistantes et le microbiote d'huîtres sensibles à la maladie du POMS (King *et al.* 2019; Clerissi *et al.* 2020; Fallet *et al.* 2022) ont montré que certains taxons bactériens étaient surreprésentés de façon significative chez les huîtres résistantes à cette maladie. Parmi ces taxons, on retrouve des bactéries appartenant à la famille des Sphingomonadaceae, des Halomonadaceae ou aux genres *Cobetia* et *Neptunomonas* (Fallet *et al.* 2022) pour les stades larvaires, ou à la famille des Colwelliaceae, des Cyanobacteria (Subsection III, family I) des Rhodobacteraceae (Clerissi *et al.* 2020), des Bradyrhizobiaceae au genre *Winogradskyella* (King *et al.* 2019) pour les huîtres juvéniles. Bien que l'implication de ces bactéries dans la résistance à la maladie du POMS n'ait pas pu être démontrée, nous pouvons tout de même affirmer que le microbiote naturel de l'huître *C. gigas* peut constituer une source prometteuse de probiotiques pour l'huître.

Les objectifs de cette partie sont donc :

- 1) Cribler la collection de bactéries réalisée lors de ces travaux de thèse afin de déterminer quelles bactéries possèdent une activité antibactérienne en co-culture mais aussi dans leur surnageant de culture.
- 2) Tester des bactéries sélectionnées pour leurs activités antibactériennes, pour un effet protecteur potentiel contre (1) les infections à OsHV-1 μ Var en bloquant l'étape de la dysbiose ou la prolifération de bactéries opportunistes survenant lors de la maladie du POMS et (2) contre les infections à *V. aestuarianus* en combattant directement la bactérie pathogène.
- 3) Déterminer l'impact sur le microbiote de l'exposition aux bactéries sélectionnées.

2. Matériel et Méthodes

Afin d'atteindre cet objectif, une collection de bactéries associées aux huîtres résistantes à la maladie du POMS a été créée. Pour ce faire, des huîtres âgées d'environ un an et ayant survécu à un épisode infectieux de la maladie du POMS ont été prélevées sur quatre sites en zones conchylicoles (Rade de Brest, La Tremblade, Bassin d'Arcachon, et étang de Thau). Ces huîtres ont ensuite été broyées individuellement et étalées sur des boîtes de Marine Agar. Les bactéries issues de ce prélèvement ont ensuite été isolées et purifiées par repiquages successifs avant d'être cryoconservées en glycérol et identifiées par séquençage SANGER du gène codant pour l'ARNr 16S.

Les bactéries composant cette collection ont ensuite été criblées pour leurs activités antibactériennes en co-culture mais aussi dans leur surnageant de culture. Afin de tester ces activités antibactériennes, huit bactéries cibles ont été sélectionnées. Parmi elles, quatre sont des bactéries du genre *Vibrio* pathogènes pour l'huître *C. gigas* (*Vibrio aestuarianus* 02/041, *Vibrio coralliilyticus* 06/210, *Vibrio crassostreae* J2-9, et *Vibrio harveyi* Th15_O_A01). Les quatre autres sont des bactéries associées à la dysbiose survenant lors de la maladie du POMS (*Amphitrea* sp. 14/114-3T2, *Marinobacterium* sp. 05-091-3T1, *Marinomonas* sp. 12/107-2T2, *Pseudoalteromonas* sp. 09/041-1T3) (de Lorgeril *et al.* 2018a; Clerissi *et al.* 2022). Ces bactéries cibles nous ont été fournies par le Laboratoire National de Référence (LNR) (Ifremer, La Tremblade, France) ou proviennent de projets précédents de notre laboratoire (Oyanedel *et al.* 2023).

À la suite de ce criblage *in vitro*, cinq bactéries ont été sélectionnées afin de tester individuellement leurs effets *in vivo* sur les huîtres pour un effet protecteur contre la maladie du POMS mais aussi contre *V. aestuarianus*. Des huîtres juvéniles (poids moyen = 2,77g) et adultes (poids moyen = 29,89g) ont ensuite été exposées pendant sept jours à ces cinq bactéries avec un renouvellement aux jours 2 et 4. À la suite de cette exposition, une infection expérimentale à OsHV-1 μ Var ou *V. aestuarianus* par cohabitation a été réalisée, et les mortalités ont été enregistrées afin de déterminer le phénotype de résistance des huîtres exposées.

Afin de confirmer l'effet de la bactérie *Halomonas sp.* LTB66 contre la maladie du POMS, une seconde exposition suivie d'une infection expérimentale à OsHV-1 μ Var a été réalisée sur trois fonds génétiques d'huîtres différents : des NSI (Naissain Standardisé Ifremer), des huîtres de la famille F15 (famille d'huîtres sensibles à la maladie du POMS (de Lorgeril *et al.* 2018a)) et un mélange d'huîtres (population GT) issu des géniteurs de Brest, La Tremblade, et Arcachon issues de l'étude sur l'éducation microbienne (cf. chapitre 1, partie II).

Pour finir, des analyses moléculaires ont été réalisées dans le but de caractériser les mécanismes associés aux résistances. Dans ce but, une analyse des communautés bactériennes par métabarcoding 16S a été réalisée afin de déterminer l'impact des bactéries après 7 jours d'expositions mais aussi à t=48h d'infection à OsHV-1 pour l'exposition à la souche *Halomonas sp.* LTB66 sur la composition du microbiote.

3. Résultats

Une collection de 328 bactéries associées à la maladie du POMS a pu être créée. Cette collection est composée de 62,8 % de Proteobacteria, 15,3 % de Firmicutes, 12,3 % de Bacteroidetes et 9,6 % d'Actinobacteria. Parmi ces bactéries, 78 ont présenté une activité antibactérienne en co-culture dirigée contre au moins une des bactéries cibles. Le criblage des surnageants de culture a montré que l'activité antibactérienne persistait dans le surnageant de 8 souches bactériennes. Basé sur ces résultats de l'activité antibactérienne, cinq bactéries (*Bacillus sp.* ARG61, *Halomonas sp.* LTB66, *Cytobacillus sp.* ARC29, *Yoonia sp.* THAU59 et *Vibrio sp.* LTB1) ont été sélectionnées afin de tester leur effet sur le phénotype des huîtres lors de l'infection à OsHV-1 μ Var ou *V. aestuarianus*.

L'exposition à la bactérie *Halomonas sp.* LTB66 a permis d'induire une baisse importante mais non significative de 45 % (Log-Rank test : p-val = 0,136) du risque de mortalité lors de l'infection à OsHV-1. Lors du test complémentaire réalisé sur les trois fonds génétiques différents, l'exposition à la bactérie *Halomonas sp.* LTB66 a induit une réduction significative de la mortalité de 54 % (Log-Rank test : p-val = 0,002) pour la population GT. En revanche, l'exposition bactérienne a induit une réduction non significative de 14 % (Log-Rank test : p-val = 0,203) du risque de la mortalité pour les NSI et a induit une augmentation significative du risque de la mortalité de 60 % (Log-Rank test : p-val = 0,002) pour la famille F15.

Lors de l'infection à *V. aestuarianus*, une réduction significative du risque de mortalité de 70 % (Log-Rank test : p-val < 0,001), 54 % (Log-Rank test : p-val < 0,001), 46 % (Log-Rank test : p-val = 0,002), and 58 % (Log-Rank test : p-val < 0,01) a été observée pour les huîtres exposées aux bactéries *Pseudoalteromonas sp.* hCg42, *Bacillus sp.* ARG61, *Cytobacillus sp.* ARC29 and *Yoonia sp.* THAU59 respectivement.

Les analyses de dissimilarité, basées sur l'indice de Bray-Curtis, ont permis de démontrer que l'exposition à la bactérie *Cytobacillus sp.* ARC29 (Permanova : $R^2 = 0,15$; p-val = 0,036) avait induit un changement significatif dans la communauté bactérienne des huîtres juvéniles. Chez les huîtres adultes, des changements des communautés bactériennes ont également été observés après sept jours d'exposition pour les huîtres exposées aux bactéries *Pseudoalteromonas sp.* hCg42 (Permanova : $R^2 = 0,18$; p-val = 0,008), *Bacillus sp.* ARG61 (Permanova : $R^2 = 0,32$; p-val = 0,008), *Halomonas sp.* LTB66 (Permanova : $R^2 = 0,35$; p-val = 0,01), *Cytobacillus sp.* ARC29 (Permanova : $R^2 = 0,32$; p-val = 0,01) et *Yoonia sp.* THAU59 (Permanova : $R^2 = 0,20$; p-val = 0,009). La recherche des bactéries administrées dans le microbiote des huîtres au jour 7 (deux jours après la dernière administration) n'a en revanche pas permis de retrouver les bactéries dans le microbiote des huîtres.

Afin de déterminer l'impact de l'exposition à la bactérie *Halomonas sp.* LTB66 sur l'étape de dysbiose survenant lors de la maladie du POMS, nous avons réalisé une étude comparative du microbiote d'huîtres exposées versus non exposées prélevées à t=48 heures de l'infection à OsHV-1. Cette analyse a permis de démontrer chez les huîtres de la population GT que les bactéries du genre *Pseudoalteromonas* étaient significativement moins abondantes chez les huîtres exposées. À l'inverse, pour les huîtres de la famille F15, des bactéries de la famille des *Vibrionaceae* étaient significativement plus abondantes chez les huîtres exposées à la bactérie *Halomonas sp.* LTB66.

4. Discussion / Conclusion

Au cours de cette étude, nous avons pu démontrer que le microbiote de l'huître est une source prometteuse de bactéries possédant des activités antibactériennes. En effet, parmi les 328 bactéries de la collection, 76 (22,7 %) possèdent une activité antibactérienne en co-culture dirigée contre l'une des huit bactéries cibles, et 8 bactéries (2,4 % de la collection) conservent leur activité antibactérienne dans leur surnageant de culture. Cependant, nous avons uniquement réalisé les tests des activités antibactériennes contre des *Vibrios* pathogènes d'huîtres (Travers *et al.* 2015) ou des bactéries liées à la dysbiose de la maladie du POMS (de Lorgeril *et al.* 2018a; Clerissi *et al.* 2022). Il serait intéressant de réaliser des tests d'activités antibactériennes supplémentaires sur d'autres bactéries pathogènes des huîtres ou plus généralement du milieu marin affectant des espèces aquacoles d'intérêt.

Nous avons également pu démontrer que la bactérie *Halomonas sp.* LTB66 pouvait induire un effet protecteur contre la maladie du POMS. Cependant, cet effet protecteur est différent en fonction des huîtres. Selon nous, deux hypothèses pourraient expliquer ces différences entre les fonds génétiques. La première est que le fonds génétique des huîtres influence la réponse à l'exposition bactérienne. Cela est supporté par des études montrant que l'impact des probiotiques sur le microbiote (Landsman *et al.* 2019) ou la santé (Mariman *et al.* 2015) varie en fonction du fonds génétique de l'hôte. La seconde hypothèse porte sur le fait que la famille F15 est une famille d'huître fortement sensible. L'exposition à la bactérie *Halomonas sp.* LTB66 a pu induire chez cette bactérie un stress trop important conduisant à une mort plus rapide des huîtres. Pour les huîtres pour lesquelles l'exposition à la bactérie *Halomonas sp.* LTB66 a induit un effet protecteur contre la maladie du POMS, les mécanismes moléculaires restent flous. Nous avons pu montrer lors de cette étude que l'exposition à cette bactérie avait réduit l'abondance relative dans le microbiote de bactéries du genre *Pseudoalteromonas*, qui est un genre associé à la dysbiose lors de la maladie du POMS (de Lorgeril *et al.* 2018a; Clerissi *et al.* 2022). Une possibilité quant aux résistances induites par la bactérie *Halomonas sp.* LTB66 serait que cette bactérie présente des activités antivirales. Bien que nous n'ayons pas testé les activités antivirales, une étude portant sur la bactérie *Halomonas sp.* BS4 a démontré que cette bactérie possédait une activité antibactérienne, mais aussi antifongique et antivirale causée par un biosurfactant sécrété par la bactérie (Donio *et al.* 2013). La co-injection de ce biosurfactant dans des crevettes infectées par une injection du White Spot Syndrome Virus (WSSV) a inhibé la croissance et les effets pathologiques du virus (Donio *et al.* 2013).

Nous avons également pu montrer au cours de cette étude que l'exposition des huîtres adultes aux bactéries *Pseudoalteromonas sp.* hCg42, *Bacillus sp.* ARG61, *Cytobacillus sp.* ARC29 et *Yoonia sp.* THAU59 avait permis de réduire significativement le risque de mortalité contre les infections à *V. aestuarianus*. Cependant, aux vues de la cinétique des mortalités lors des infections par *V. aestuarianus*, il est difficile de déterminer si nous avons pu induire une protection capable de perdurer dans le temps. Il conviendrait également de réaliser des essais pour déterminer la persistance de ces effets à plus long terme. Nous avons également pu montrer que l'exposition à ces bactéries avait induit des changements dans les communautés bactériennes des huîtres exposées. Néanmoins, de plus amples analyses seront nécessaires afin de décrypter les mécanismes moléculaires associés aux résistances à *V. aestuarianus*. Par ailleurs, parmi les 4 souches conférant un effet protecteur contre *V. aestuarianus*, 3 bactéries (*Bacillus sp.* ARG61, *Cytobacillus sp.* ARC29 et *Yoonia sp.* THAU 59) n'ont eu aucune activité antibactérienne dirigée contre *V. aestuarianus*, ce qui rend l'explication de l'acquisition de la résistance encore plus complexe. Selon nous, deux mécanismes pourraient expliquer ces résistances. Le premier serait que l'exposition à ces bactéries a induit des effets immunostimulants tels que l'augmentation du nombre total d'hémocytes ou de l'activité de la phénoloxydase, comme cela a été montré dans les travaux de (Zhang *et al.* 2009). Pour eux, l'administration par la nourriture de la bactérie *Halomonas sp.* B12 chez la crevette charnue, *Fenneropenaeus chinensis*, a permis d'augmenter de façon significative le nombre total d'hémocytes et l'activité de la phénoloxydase. De la même manière, l'administration des bactéries *Shewanella haliotis* D4 ou *Aeromonas bivalvium* D15 chez la crevette à pattes blanches, *Litopenaeus vannamei*, a induit une augmentation de l'activité de la superoxyde dismutase et de l'expression de la prophenoloxydase (Hao *et al.* 2014). Le second mécanisme pouvant expliquer l'acquisition de résistances repose sur le fait que les changements de microbiote observés à la suite de l'exposition aux bactéries auraient pu favoriser des bactéries elles-mêmes capables de lutter contre *V. aestuarianus* par le biais d'effets antagonistes.

Publication 3

Antibacterial activity from *Crassostrea gigas* microbiota: a promising tool for controlling aquatic pathogens for a sustainable oyster farming

Luc Dantan, Marie-Agnès Travers, Lionel Degrémont, Benjamin Morga, Prunelle Carcassonne, Mickael Mege, Yannick Fleury, Bruno Petton, Elise Maurouard, Jean-François Allienne, Gaëlle Courtay, Océane Romatif, Raphaël Lami, Laurent Intertaglia, Yannick Gueguen, Jérémie Vidal-Dupiol, Céline Cosseau, Eve Toulza

**Antibacterial activities from *Crassostrea gigas* microbiota:
a promising tool for controlling aquatic pathogens for a
sustainable oyster farming.**

Luc Dantan¹, Marie-Agnès Travers¹, Lionel Degrémont², Benjamin Morga², Prunelle Carcassonne¹, Mickael Mege², Yannick Fleury³, Bruno Petton⁴, Elise Maurouard², Jean-François Allienne¹, Gaëlle Courtay¹, Océane Romatif¹, Raphaël Lami⁵, Laurent Intertaglia⁶, Yannick Gueguen⁷, Jérémie Vidal-Dupiol¹, Céline Cosseau¹, Eve Toulza¹

¹ IHPE, Univ. Montpellier, CNRS, Ifremer, Univ. Perpignan Via Domitia, Perpignan France

² Ifremer, ASIM, F- 17390 La Tremblade, France

³ Laboratoire de Biotechnologie et Chimie Marine, EA3884, Université de Bretagne Occidentale, Université Bretagne Sud, 29334 Quimper, France

⁴ Ifremer, UBO CNRS IRD, LEMAR UMR 6539 Argenton, France

⁵ Laboratoire de Biodiversité et Biotechnologies Microbiennes, CNRS, Sorbonne Université, UAR3579, F-66650 Banyuls-sur-Mer, France

⁶ Sorbonne Université, CNRS, Fédération de Recherche, Observatoire Océanologique, 66650 Banyuls-sur-mer, France

⁷ MARBEC, Univ Montpellier, CNRS, Ifremer, IRD, Sète, France

Abstract

Recently, the frequency and severity of marine diseases have increased in association with global changes, and molluscs of economic interest are particularly concerned. A striking example of a devastating disease is the Pacific Oyster Mortality Syndrome (POMS) caused by the Ostreid Herpesvirus-1 μ Var (OsHV-1 μ Var) that emerged in 2008 and which heavily impacts *Crassostrea gigas* production worldwide by affecting juvenile oysters. Adult oysters are also affected by infectious diseases, especially those caused by the bacterial pathogen *Vibrio aestuarianus*. The present work aims at finding sustainable strategies to help fighting against these infectious diseases. We propose to take benefit from the antagonist effects of the natural oyster microbiota to develop prophylactic methods to fight these infectious diseases. We performed antibacterial activity tests with bacteria from a collection of strains isolated from POMS-resistant oyster. We targeted four different oysters' pathogenic *Vibrio* and 4 additional opportunistic bacteria associated with the POMS disease. We then selected 5 bacteria which we administered by balneation to oysters before OsHV-1 μ Var or *Vibrio aestuarianus* infectious challenges to determine whether exposure to these bacteria induced a better resistance of oysters to these infections. Exposure to *Halomonas sp.* LTB66 induced a protective effect against OsHV-1 infection and exposure to 4 bacteria (*Pseudoalteromonas sp.* hCg42, *Bacillus sp.* ARG61, *Cytobacillus sp.* ARC29 and *Yoonia sp.* THAU59) induced a protective effect against *V. aestuarianus* infection.

Although studies are still needed to determine more precisely the molecular mechanisms involved in the acquisition of resistance, these findings present a promising method for fighting infectious diseases affecting *C. gigas* oysters.

Key words:

Crassostrea gigas; Antibacterial activities; Microbiota; OsHV-1 μ Var; *Vibrio aestuarianus*

Introduction:

The Pacific oyster, *Crassostrea gigas*, is the most widely grown oyster species in the world. However, its production is severely compromised by infectious diseases that result in high mortality rates every year (Friedman *et al.* 2005; Cotter *et al.* 2010; Pernet *et al.* 2012; Azéma *et al.* 2015). Two significant diseases for *C. gigas* oysters are the Pacific Oyster Mortality Syndrome (POMS) caused by the Ostreid herpesvirus type 1 μ Var (OsHV-1 μ Var) and Vibriosis caused by several *Vibrios* such as *Vibrio aestuarianus*, *V. coralliilyticus*, *V. harveyi* or *V. crassostreae*. POMS is a multifactorial and polymicrobial disease which is influenced by biotic and abiotic factors (Petton *et al.* 2021). Infection by OsHV1 is the first critical step in the infectious process of POMS which leads to an immunocompromised state of the oyster by altering haemocytes physiology (de Lorgeril *et al.* 2018; Petton *et al.* 2021). This leads to a dysbiosis of oyster microbiota and subsequent colonisation by opportunistic bacteria and finally the death of the oyster by a fatal bacteraemia (de Lorgeril *et al.* 2018; King *et al.* 2019; Petton *et al.* 2021). During the POMS disease development, bacteria belonging to *Amphritea*, *Arcobacter*, *Marinobacterium*, *Marinomonas*, *Oceanospirillum*, *Pseudoalteromonas*, and *Vibrio* genera were identified to contribute to secondary bacterial infection during POMS disease (Clerissi *et al.* 2022). The mechanisms behind the infection by *V. aestuarianus* are less known, but it has been shown that *V. aestuarianus* produces extracellular compounds which contains virulence factors. (Labreuche *et al.* 2006, 2010) These extracellular compounds cause changes in morphology of oyster haemocytes which leads to an immunosuppression allowing *V. aestuarianus* to colonise and finally kill the oyster (Labreuche *et al.* 2006, 2010).

To date, no solution exists to prevent these infectious diseases, but several approaches are being investigated such as the use of probiotics. A probiotic is by the definition of the Food and Agriculture Organization (FAO), a “live microorganism, which when consumed in adequate amounts, confers a health benefit to the host” (Food and Agriculture Organisation of the United Nation 2016). Probiotics can compete with pathogens by producing diverse antimicrobial molecules (AMPs, antioxidant molecules), modulating the innate immune system of the host, interfering with microbial communication systems (quorum quenching effect), producing beneficial metabolites, and helping for nutrient adsorption (Khademzade *et al.* 2020). Concerning oyster farming, 12 potential probiotics have been investigated so far (Yeh *et al.* 2020). As an example, an exposure of *C. gigas* larvae to *Pseudoalteromonas sp.* was able to inhibit the growth of *Vibrio coralliilyticus* improving larval survival during subsequent infection (Madison *et al.* 2022). Also, administration of *Streptomyces sp.* strains RL8 to juvenile

Crassostrea sikamea oysters induced significantly higher weight gain and increased antioxidant activity (García-Bernal *et al.* 2019).

In this article, we investigated the potential of bacteria isolated from the natural microbiota of *C. gigas* to be used as probiotics for oyster farming. Indeed, it was found that bacterial taxa Colwelliaceae, Cyanobacteria, and Rhodobacteraceae were significantly over-represented in POMS-resistant oysters (Clerissi *et al.* 2020). Although the involvement of these bacteria in resistance to POMS disease has not been demonstrated, we can state that the natural microbiota of the oyster *C. gigas* may constitute a promising source of probiotics candidates for oysters.

To test this hypothesis, we first constituted a collection of cultivable bacteria isolated from oysters that have passed an infectious disease event of POMS disease in the field and we then screened these bacteria for their antibacterial activities against four oyster pathogenic *Vibrios* or against bacteria associated with the POMS disease. Then, selected candidate bacteria were tested for their effect against OsHV-1 μ var or *V. aestuarianus* infection. We also investigated the impact of the administration of probiotic candidate on the microbiota of the oysters.

Materials and methods:

Isolation of cultivable bacteria from *Crassostrea gigas*

Oyster sampling was performed along the French Atlantic coast and Mediterranean Sea during two different sampling campaigns (in February 2020 and November 2020). For the Atlantic coast, 3 sites were selected: the Brest bay (Brittany, France) (lat 48.3349572; long -4.3189134), the Marennes-Oleron bay (Nouvelle-Aquitaine, France) (lat 45.8029675; long -1.1534223) and the Arcachon bay (Nouvelle-Aquitaine, France) (lat 44.6813750; long -1.1402178). For the Mediterranean Sea, the selected site was the Thau lagoon (Occitanie, France) (lat 43.39404; long 3.58092). Five oysters per site were randomly collected. Two sampling campaigns were performed, in February 2020 and in November 2020 except for the Thau lagoon site for which oysters were only collected in November 2020 due to covid restriction arisen earlier in the year. Bacteria associated to these oysters were then isolated as explained below.

The five oysters sampled on each site were carefully brushed and washed to remove the residues present on the shell. The flesh of the animals was then individually crushed with an Ultraturax

T25 mixer (5 x 5 sec) in 15ml falcon tubes. The homogenized tissues were then diluted at 1:10 1:100 and 1:1000. 100 µL of each dilution were spread on 2 Marine Agar (MA) (Marine Agar Difco 2216) petri dishes and incubated at 15°C or 20°C.

After a minimum incubation period of 3 days, bacterial colonies were selected according to their morphotypes. A maximum of different morphotypes were selected to maximise the biodiversity in our sampling and isolated by streaking a colony on a new MA plate and purifying by two successive subculturing. Then, the pure cultures of individual bacteria were transferred onto Marine Broth (MB) tubes (Marine Broth Difco 2216) à 15°C or 20°C. After 48h of growth, 500 µL of these cultures was used for cryopreservation in 35% glycerol (V/V) and put into a -80°C freezer. About 1 ml of the liquid culture was pelleted for further DNA extraction.

Identification of the cultivable bacteria

DNA extraction of the bacterial strains isolated from oysters and cultivated on agar plates was carried out with the Wizard® Genomic DNA Purification Kit (Promega) according to the manufacturer instructions. 16S rRNA gene sequencing was performed on these samples to identify each bacteria from the collection. The PCR and 16S rRNA gene sequencing was performed by the genoscreen sequencing facilities (<http://www.genoscreen.fr/fr/>). Briefly, two pairs of primers P8/PC535 (P8 5'-AGAGTTTGATCCTGGCTCAG ; PC535 5'-GTATTACCGCGGCTGCTGGCAC) and 338-1040F/338-1040R (338-1040F 5'-CTCCTACGGGAGGCAG ; 338-1040R 5'-GACACGAGCTGACGACA) were used for the PCR to amplify the V1-V3 and V3-V5 of the 16S rDNA. PCR products were then purified with Sephadex-G50 gel (GE Healthcare) before analysis into ABI 3730XL capillary sequencer. The resulting sequences were then assembled by using the DNA baser sequence assembly software (v4) (Heracle BioSoft, www.DnaBaser.com) and then added in the EZbiocloud database (Yoon *et al.* 2017) in order to identify the taxonomy of the isolated bacteria composing the collection.

Screening for antibacterial activities of bacteria isolated from *C. gigas* microbiota

Eight bacterial strains were selected as targets for the screening of antibacterial activities. Four of them were pathogenic *Vibrio* for oysters at different developmental stages: *Vibrio aestuarianus* 02/041, *Vibrio coralliilyticus* 06/210, *Vibrio crassostreae* J2-9 et *Vibrio harveyi*

Th15_O_A01. The four others are bacteria associated with POMS dysbiosis according to (de Lorgeril *et al.* 2018; Clerissi *et al.* 2022): *Amphitrea sp.* 14/114-3T2, *Marinobacterium sp.* 05-091-3T1, *Marinomonas sp.* 12/107-2T2, *Pseudoalteromonas sp.* 09/041-1T3. All the target bacteria were provided by the French National Reference Laboratory (Ifremer, La Tremblade, France) or come from previous projects carried out in our laboratory (Oyanedel *et al.* 2023). All strains were cultivated in Marine Broth (MB) at 20°C for 48 hours then the OD600 was determined using BioPhotometer (Eppendorf). The cultures were diluted to a final concentration of 10⁶ CFU/mL (1 DO unit = 8x10⁸ CFU/ml) prior to inoculation of Marine Agar plates by inundation. Overnight cultures, on MB media, of the 334 bacteria from the collection were deposited in arrays of 8x12 (2µL) spots per marine agar plate previously inoculated with the target bacteria. A 2 µL spot of kanamycin was used as positive control and a 2 µL spot of sterile Marine Broth as a negative control. Agar plates were then incubated at 20°C for two days. Potential antibacterial activity was visualised with Gel Doc XR (Biorad, CA, USA).

For supernatant assay, the same target bacteria were used. Prior to the test, bacteria were cultured in Marine Broth media on 96 well plates during 72h at 20°C. After the incubation period, the 96 well plate was centrifugated during 10 minutes at 4000 rpm. The supernatants were then transferred into new 96 well plates and heated at 100°C during 5 minutes to kill the possible remaining bacteria. Then, 2 µL spots were deposited on the marine agar plates previously flooded with the target bacteria as describe above.

Oyster reproduction

GT populations:

150 wild oysters were randomly sampled from each geographic site as described for the bacterial collection (Brest bay, Marennes-Oleron bay, Arcachon bay, Thau lagoon) in order to generate 4 oyster populations (Brest, La Tremblade, Arcachon and Thau population). For this purpose, 20 to 23 genitors were randomly selected for each site and their gender was determined (**Table 1**). Spermatozoa of the males and oocytes of the females were collected from each animal by stripping the gonads. Spermatozoa from males were collected individually while oocytes from females were pooled. The oocytes were then mixed with the spermatozoa for fertilization. The number of fertilised oocytes was then counted to determine the hatching rate. Three to one million fertilised oocytes were then added into 30 L conical tanks in a batch system

at 28°C in filtered and UV-treated seawater (100 to 34 larvae per ml between day 0 and day 2, 10 larvae per ml between day 2 and day 7, 3 larvae per ml after day 7).

Table 1: Number and origin of genitors (females and males), used for the reproduction of the GT population

Oyster Populations	Brest	La Tremblade	Arcachon
Female	15	13	17
Male	5	10	3

NTA population; NSI population and F15 family:

These oysters were provided by the ifremer facility of La Tremblade.

Test for a protective effect against POMS disease

Oysters from the NTA population (Recipient oysters) were distributed between seven tanks of 40 L filled with UV-treated seawater and maintained at 20°C with adequate aeration. Each tank contained 60 juvenile oysters (mean individual weight = 2.77g) (**Figure 1**). Recipient oysters were exposed to five bacterial strains selected for their antibacterial activities, and to one control bacterial strain (*Pseudoalteromonas sp.* hCg42) presenting antibacterial activities against *V. harveyi* ORM4 and conferring a protective effect for the abalone (*Haliotis tuberculata*) infected with *V. harveyi* ORM4 (Offret *et al.* 2018). A condition without added bacteria was used as a control condition.

Prior to exposure, the bacteria were cultured from glycerol stock in 10 ml of MB media for 24h at 20°C and then, 1 mL of each bacterial culture was inoculated into 10 mL fresh MB media and incubated at 20°C. After 48 hours of incubation, the OD₆₀₀ was measured, and the appropriate amount of bacteria was collected and were then centrifuged at 4000 rpm for 2 minutes and the supernatant was discarded. The pellets were then resuspended in 10 ml sterile sea water and added immediately to tanks with juvenile or adult oysters at a final concentration of 10⁴ CFU/mL. The bacteria were added individually during seven day and were renewed two times without water changes at days two and four (**Figure 1**).

Five oysters exposed to the different conditions were sampled at day seven (D7) of the bacterial exposure to perform molecular analysis. Sampled oysters were grounded in liquid nitrogen (Retsch MM400 mill) to a powder that was stored at -80°C until subsequent DNA extraction.

Immediately following the bacterial exposure, a OsHV-1 experimental infection was realised for the oysters. For this purpose, we used seven tanks of 40L filled with filtered and UV-treated seawater and maintained at 20 °C with adequate aeration. Each tank contained 55 oysters previously exposed to one of the six selected bacteria (recipient oysters). A cohabitation protocol was used as previously described in (De Decker and Saulnier 2011). OsHV-1 donor oysters were injected in the adductor muscle with 100µL of the OsHV-1 suspension (10^5 OsHV-1 genomic units) and were then equally distributed among the five tanks. The OsHV-1 donor oyster pool were composed of 25% of F15 family oysters, 25% of F14 family oysters which are POMS susceptible oysters (de Lorgeril *et al.* 2018) and 50% of genetically diversified NSI oysters which have an intermediate phenotype to POMS disease. The ratio between OsHV-1 donor and recipient oysters was 1 donor oyster for 1 recipient oyster. 24 hours after OsHV-1 injection, recipient oysters were added into the tanks (**Figure 1**). After 48 hours of cohabitation, all OsHV-1 injected donor oysters were removed from the tanks.

The mortality was recorded for 14 days. Each day the number of dead recipient oysters was recorded, and all the dead oysters were removed from the tanks.

During the mortality monitoring, 1 mL of water in each tank were sampled every day for the detection and the quantification of OsHV-1 µVar and stored at -20°C until DNA extraction.

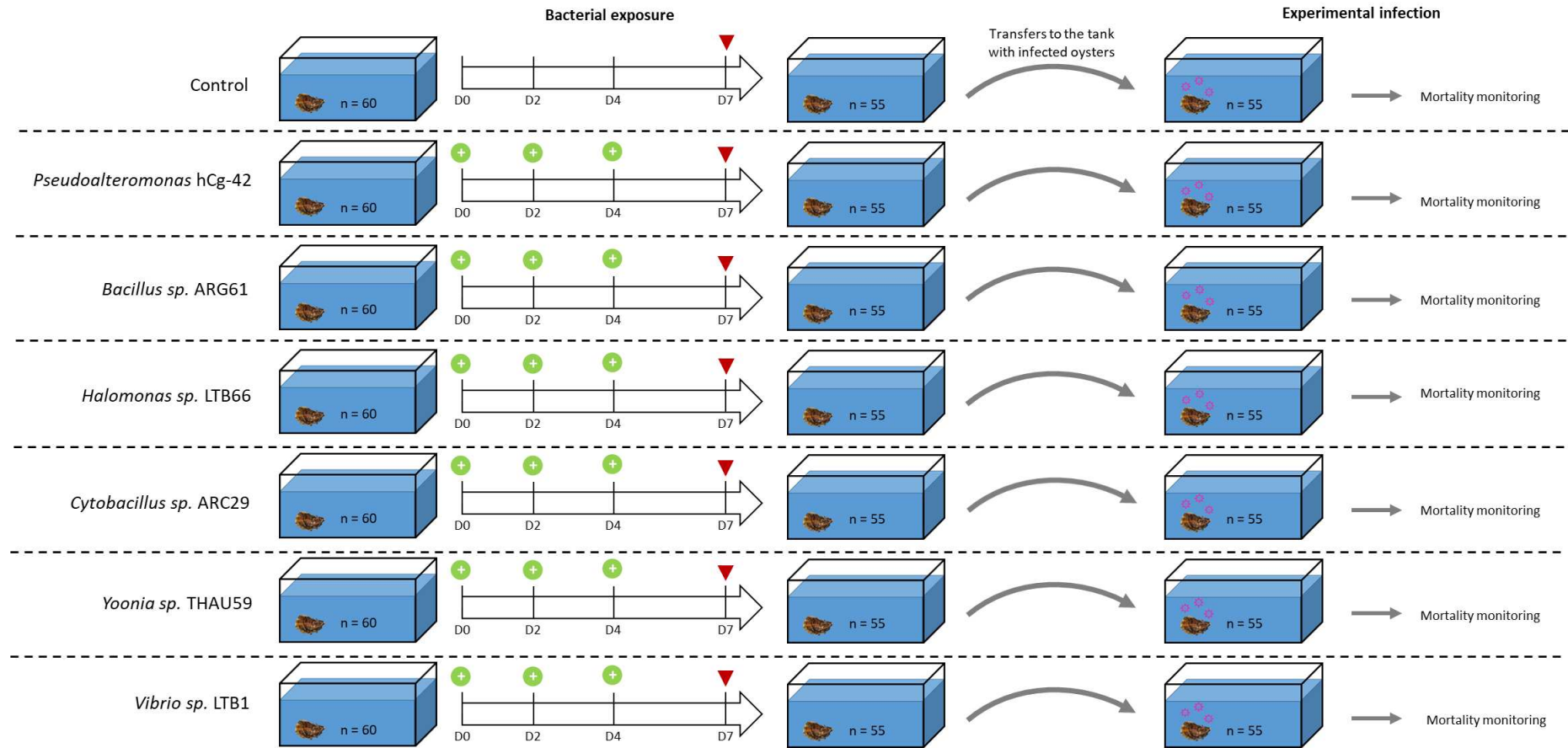

Figure 12: Overall experimental design for bacterial exposure and experimental infections performed with the NTA oyster population. Juvenile oysters (n=60) were placed in 40L tank filed with UV-treated seawater and maintained at 20°C with adequate aeration. Oysters were then exposed to individual bacterial strains during seven days with a renewal every two days (indicated by the "+" sign in the green circle). At the end of bacterial exposure, 5 oysters per tank were sampled, flash-freeze into liquid nitrogen and stored at -80°C for molecular analysis (indicated by red triangles). Right after the bacterial exposure, oysters were transferred into new tank containing donor oysters previously infected by an OsHV-1 injection in order to realise a mortality monitoring.

In order to confirm the effect of the bacterial strain *Halomonas sp.* LTB66 against POMS disease, the same experiment as described above was performed by exposing three different oyster populations to this bacterial strain: the NSI ("Naissain Standardisé Ifremer") population, which is genetically diversified, The F15 family which is very sensitive to POMS disease (de Lorgeril *et al.* 2018) and the GT population.

Five oysters of each population exposed or not to the bacterial strain *Halomonas sp.* LTB66 were sampled before the bacterial exposure and 48h after the beginning of the OsHV-1 experimental infection to perform molecular analysis. Sampled oysters were grounded in liquid nitrogen (Retsch MM400 mill) to a powder that was stored at -80°C and then used for DNA extraction.

***Vibrio aestuarianus* experimental infection by cohabitation**

Oysters from the NTA population (Recipient oysters) were distributed between seven tanks of 40 L filled with UV-treated seawater and maintained at 20°C with adequate aeration. Each tank contained 75 adult oysters (mean individual weight = 29.89g). Recipient oysters were exposed to five bacterial strains selected for their antibacterial activities, and to one control bacterial strain (*Pseudoalteromonas sp.* hCg42)

Prior to exposure, the bacteria were cultured from glycerol stock in 10 ml of MB media for 24h at 20°C and then, 1 mL of each bacterial culture was inoculated into 10 mL fresh MB media and incubated at 20°C. After 48 hours of incubation, the OD₆₀₀ was measured, and the appropriate amount of bacteria was collected and were then centrifuged at 4000 rpm for 2 minutes and the supernatant was discarded. The pellets were then resuspended in 10 ml sterile sea water and added immediately to tanks with juvenile or adult oysters at a final concentration of 10⁴ CFU/mL. The bacteria were added individually during seven day and were renewed two times without water changes at days two and four.

Five oysters exposed to the different conditions were sampled at day seven (D7) of the bacterial exposure to perform molecular analysis. Sampled oysters were grounded in liquid nitrogen (Retsch MM400 mill) to a powder that was stored at -80°C until subsequent DNA extraction.

Immediately following the bacterial exposure, a *Vibrio aestuarianus* experimental infection was realised for the adult oysters. For this purpose, oysters were transferred to new tanks of 40L filled with filtered and UV-treated seawater and maintained at 20 °C with adequate

aeration. Each tank contained 70 oysters previously exposed to one of the six selected bacteria (recipient oysters). A cohabitation protocol was used as previously described in (De Decker and Saulnier 2011). The *V. aestuarianus* 02/041 was grown in Zobell medium at 22°C for 24h under agitation. The bacterial concentration was determined by spectrometry at 600nm and adjusted to an optical density (OD₆₀₀) of 1 representing 5.10^7 bacteria per mL. *V. aestuarianus* donor oysters were injected in the adductor muscle with 100µL of the *V. aestuarianus* 02/041 suspension and were then equally distributed among the five tanks. The *V. aestuarianus* donor oysters are from same oyster population as the recipient oysters. Immediately after *V. aestuarianus* injection into donors, recipient oysters were added to the seven tanks containing the recipient oysters. A ratio of 1 *V. aestuarianus* donor oyster for 1.5 recipient oyster was used. After 48 hours of cohabitation, *V. aestuarianus* donor oysters were removed from the tanks. The mortality was then recorded during 17 days by counting the dead oyster every day, and all the dead oysters were removed from the tanks.

Statistical Analysis of oyster mortality

Mortality recorded for oyster according to the different bacterial exposure was compared using survival analysis performed on R (v 4.2.1) (R Core Team 2022) with the package survminer (v 0.4.9) (<https://cran.r-project.org/web/packages/survminer/index.html>). The Kaplan-Meier method was used to represent the cumulative survival rate and log-rank test was used to determine the difference between the conditions (supplementary files). A multivariate Cox proportional hazards regression model was used to compute Hazard-Ratio (HR) with confidence intervals of 95%.

Oysters and water Genomic DNA extraction and sequencing

DNA extraction from oysters collected during bacterial exposure was performed from frozen powders using DNA from the tissue Macherey-Nagel kit according to the manufacturer's protocol. Prior to 90 min of enzymatic lysis in the presence of proteinase K, an additional 12-min mechanical lysis (Retsch MM400 mill) was performed with zirconia/silica beads (BioSpec). DNA extraction from water collected during micro-organisms exposure and experimental infections was performed with DNA from the tissue Macherey-Nagel kit

following the manufacturer support protocol for genomic DNA and viral DNA from blood sample.

DNA concentrations were checked with a Qubit® 2.0 Fluorometer (Thermo Scientific).

16S rDNA library construction and sequencing

Library construction (with primers 341F 5'-CCTAYGGGRBGCASCAG and 806R 5'-GGACTACNNGGGTATCTAAT for the 16S V3V4 region) and sequencing on a MiSeq v2 (2x250 bp) were performed by ADNid (France).

Bioinformatic pipelines for 16S barcoding analysis

Sequencing data obtained in this study were processed with the SAMBA (v 3.0.2) workflow developed by the SeBiMER (Ifremer's Bioinformatics Core Facility). Briefly, Amplicon Sequence Variants (ASV) are constructed with DADA2 (Callahan *et al.* 2016) and the QIIME2 dbOTU3 (v 2020.2) tools (Bolyen *et al.* 2019), then, contaminations were removed with microDecon (v 1.0.2) (McKnight *et al.* 2019). Taxonomic assignment of ASVs was performed using a Bayesian classifier trained with the Silva database v.138 using the QIIME feature classifier (Wang *et al.* 2007). Finally, community analysis and statistics were performed on R (R version 4.2.1) (R Core Team 2022) using the packages phyloseq (v 1.40.0) (McMurdie and Holmes 2013) and Vegan (v 2.6-4) (Oksanen *et al.* 2022).

Unique and overlapping ASVs of each sample group were plotted by using the UpsetR package (v 1.4.0) (Conway *et al.* 2017). For beta-diversity, the ASVs counts were preliminary normalized with the "rarefy_even_depth" function (rngseed = 711) from the package phyloseq (v 1.40.0) (McMurdie and Holmes 2013). Principal Coordinates Analysis (PCoA) were computed to represent dissimilarities between the samples using the Bray-Curtis distance matrix. Differences between groups were assessed by statistical analyses (Permutational Multivariate Analysis of Variance) using the adonis2 function implemented in the vegan package (2.6-4) (Oksanen *et al.* 2022). A differential analysis of the microbiota of the different samples group was performed using the "diff_analysis" function from the MicrobiotaProcess package (v 1.9.4) (Xu and Yu 2022).

In order to search for the presence of the administered bacteria, 16S DNA obtained for the identifications of the selected bacteria were compared by BLAST (Altschul *et al.* 1990) search for similarity against all the ASVs sequence from the dataset. Mock community composed of equal amount of DNA from the administered bacteria were also used for the comparison with the ASVs sequence in order to confirm the method. Then, ASVs sequences with a percentage of identity superior to 99% were searched in the different samples.

Results:

Cultivable disease-resistant oysters associated bacterial collection.

To isolate bacteria with potential beneficial effects against oyster infectious disease, we reasoned that bacteria should be isolated from disease resistant oysters. For this purpose, wild oysters aged between 12 and 18 months were sampled closed to farming areas. Oysters located in these areas were submitted to high pathogen pressure and have been shown to be more resistant to POMS disease (Gawra *et al.* 2023). To maximise the biodiversity of the bacterial collection, oysters were sampled from 4 geographical sites at two different seasons. 334 bacteria were isolated; from which 166 bacteria were obtained from the February 2020 sampling campaign, and 168 bacteria were obtained from the November 2020 sampling campaign. 97, 144, 56, and 67 bacteria were isolated from Brest, La Tremblade, Arcachon, and Thau sites, respectively. They were named according to the sampling site (“ARG” for Brest, “LTB” for La Tremblade, “ARC” for Arcachon and “THAU” for Thau) followed by the number of the isolate. The 16S rDNA was obtained for 293 strains. The identified bacteria were divided into the following phyla: *Proteobacteria* (62.8%), *Firmicutes* (15.3%), *Bacteroidetes* (12.3%) and *Actinobacteria* (9.6%) (**Figure 2**).

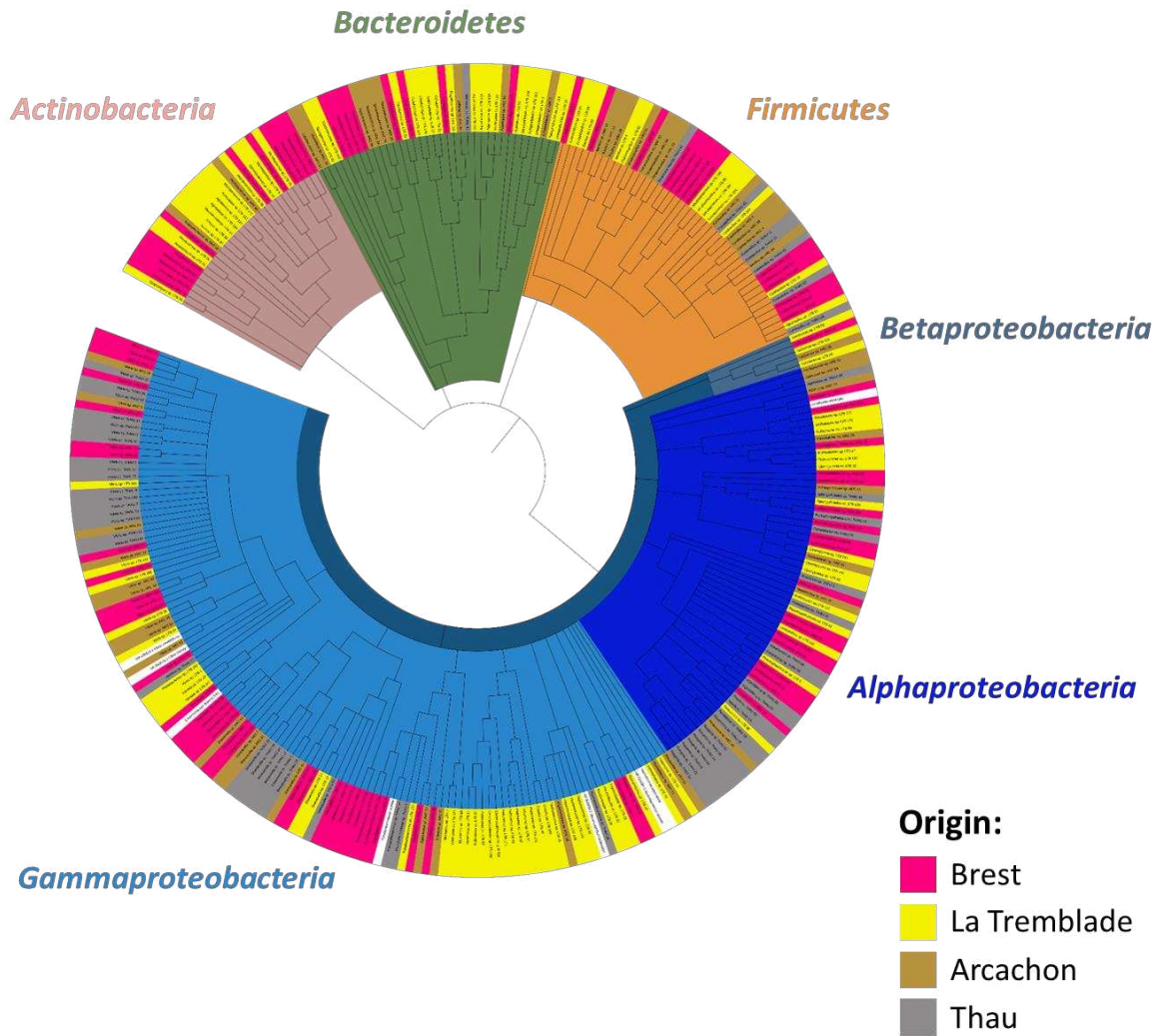

Figure 2: Phylogenetic tree of the bacteria composing the collection of bacteria isolated from POMS-resistant oyster sampled in the Brest bay (pink), the Marennes-Oleron bay (yellow), the Arcachon bay (brown) and the Thau lagoon (grey). The collection is composed by 62.8% of *Proteobacteria* (different shades of blue), 15.3% of *Firmicutes* (orange), 12.3% of *Bacteroidetes* (green) and 9.6% of *Actinobacteria* (salmon).

78 bacteria from the collection displayed an antibacterial activity against at least one of the target bacteria and eight of them displayed this antibacterial activity in their culture supernatant

All the bacteria from the collection were screened for their antibacterial activity against nine targets bacteria by co-culture assay. Among these, 78 strains showed an inhibition area around bacterial colony. Among these strains, 32 showed an antibacterial activity against *Vibrios* (17 against *V. harveyi* Th15_O_A01, 14 against *V. aestuarianus* 02/041, 12 against *V. coralliilyticus* 06/210 and 8 against *V. crassostreae* J2-9) and 65 showed an antibacterial

activity against opportunistic bacteria associated with POMS disease (49 against *Marinomonas sp.* 12/107-2T2, 8 against *Pseudoalteromonas sp.* 09/041-1T3, 6 against *Amphitrea sp.* 14/114-3T2, and 2 against *Marinobacterium sp.* 05-091-3T1) (**Figure 3 A**)

The 76 bacteria presenting an antibacterial activity by co-culture were then screened for the antibacterial activity of their culture supernatant. Thus, height bacteria conserved their activity in the culture supernatant. Among them, three bacterial strains (*Halomonas sp.* LTB66, *Halomonas sp.* LTB97 and *Vibrio sp.* LTB1) presented antibacterial activities in their supernatant against six of the eight target bacteria, two strains (*Bacillus sp.* ARG61 and *Cytobacillus sp.* ARC29) presented antibacterial activities of their supernatant against two of the height target bacteria and the three other strains has antibacterial activities of their supernatant against one of the eight target bacteria. (**Figure 3 B**)

Based on the results of these tests, five bacterial strains (*Bacillus sp.* ARG61, *Halomonas sp.* LTB66, *Cytobacillus sp.* ARC29, *Yoonia sp.* THAU59 and *Vibrio sp.* LTB1) were selected to be tested for a potential beneficial effect on oysters.

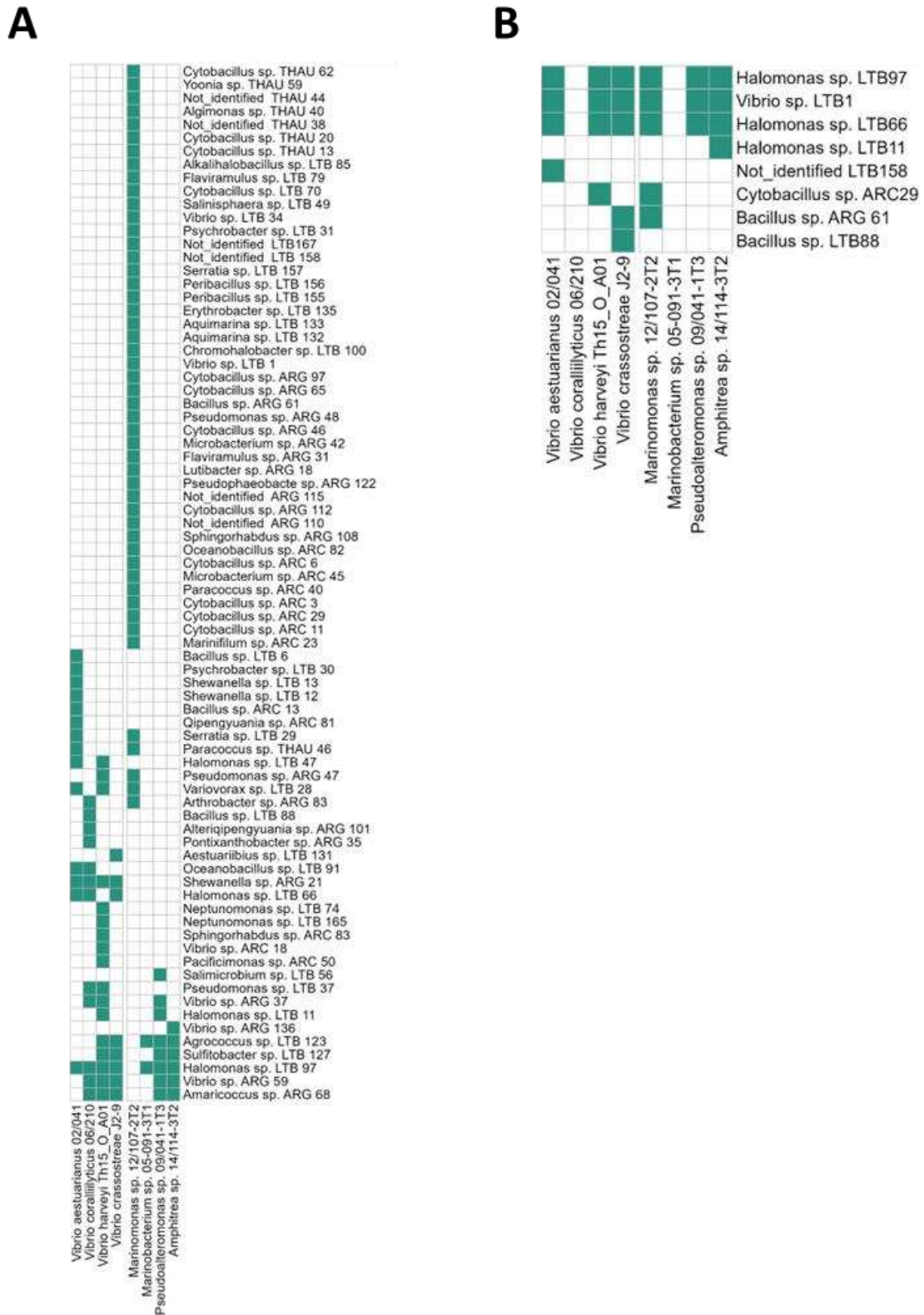

Figure 3: Antibacterial activities of bacteria isolated from oysters against the eight target bacteria. The plot represents all the bacteria of the collection that have an antibacterial activity against the different target bacteria (A) by coculture and (B) in the culture supernatant. Bacteria have an antibacterial activity when the tile is colored in blue/green.

One bacterial strain induced a reduction of mortality risk during an OsHV-1 μ Var infection.

To test if exposure to bacteria with an antibacterial activity *in vitro* can induce a protective effect against the POMS disease *in vivo*, juvenile oysters from NTA population (exposed or control) were challenged with OsHV-1 infection. An important but not significant reduction of the mortality risk of 45% (Log-Rank test: pval = 0.136) was observed for the oysters exposed to the bacterial strain *Halomonas sp.* LTB66 (**Figure 4**). Other conditions, by contrast, tended to increase the mortality risk.

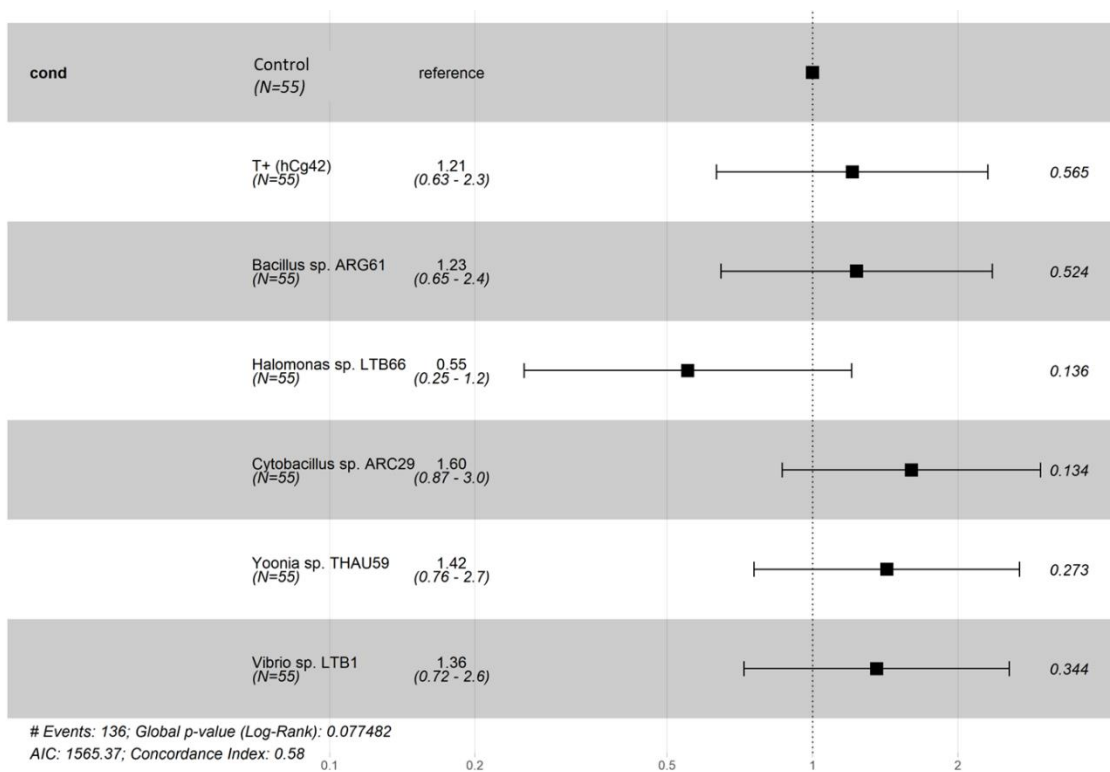

Figure 4: Forest plot representing the Hazard-Ratio value of mortality risk during the OsHV-1 experimental infection for oysters (NTA population) exposed to microorganisms compared to control oysters. The numbers in brackets under the different conditions correspond to the number of oysters used in condition during the experimental infection. The Hazard-Ratio value is indicated to the right of the conditions, except for the control condition, which is indicated as reference. Finally, the value of the p-value is indicated on the right-hand side of each row.

The *Halomonas sp.* LTB66 strain may confer a protective effect against POMS disease, but this effect depends on the genetic background of the oysters.

To confirm the beneficial effect previously observed with the bacterial strain *Halomonas sp.* LTB66 against POMS disease, we challenged three different oyster populations exposed to *Halomonas sp.* LTB66 with an OsHV-1 infection. Exposure to bacterial strain *Halomonas sp.* LTB66 induced a significant reduction of the mortality risk of 54% (Log-Rank test: pval = 0.002) (**Figure 5 C**) for the GT population and a reduction of the mortality risk of 14% (Log-Rank test: pval = 0.203) (**Figure 5 A**) for the NSI population. However, the exposure to *Halomonas sp.* LTB66 has induced a significant increase of 60% of the mortality risk for the F15 family (Log-Rank test: pval = 0.02) (**Figure 5 B**).

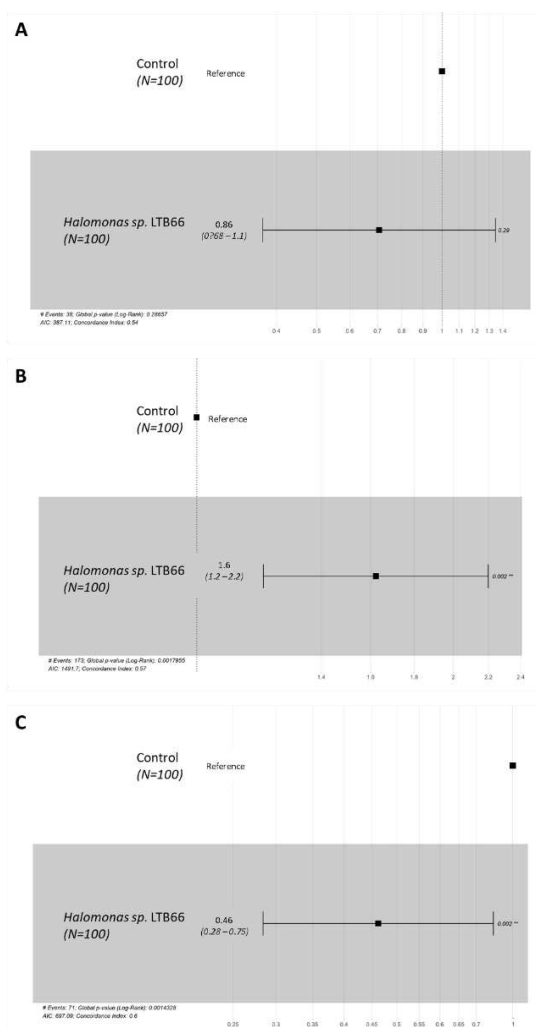

Figure 5: Forest plot representing the Hazard-Ratio value of mortality risk during the OsHV-1 experimental infection for (A) NSI population, (B) F15 family and (C) GT population of oysters exposed to the bacterial strain *Halomonas sp.* LTB66 compared to control oysters (indicated as reference). The numbers in brackets under the different conditions correspond to the number of oysters used in condition during the experimental infection. The Hazard-Ratio value is indicated on the right of the exposure conditions. Finally, the p-value is indicated on the right of each row.

Four bacterial strains induced a significant reduction of mortality risk during *V. aestuarianus* infection.

To test if exposure to bacteria with an antibacterial activity can induce a protective effect against *V. aestuarianus* infection, adult oysters (exposed or control) were challenged with a *V. aestuarianus* infection. A Significant reduction of the mortality risk of 70% (Log-Rank test: pval < 0.001), 54% (Log-Rank test: pval < 0.001), 46% (Log-Rank test: pval = 0.002) and 58% (Log-Rank test: pval < 0.01) was observed for the adult oysters exposed to the bacterial strains *Pseudoalteromonas* sp. hCg42, *Bacillus* sp. ARG61, *Cytobacillus* sp. ARC29 and *Yoonia* sp. THAU59 respectively (**Figure 6**).

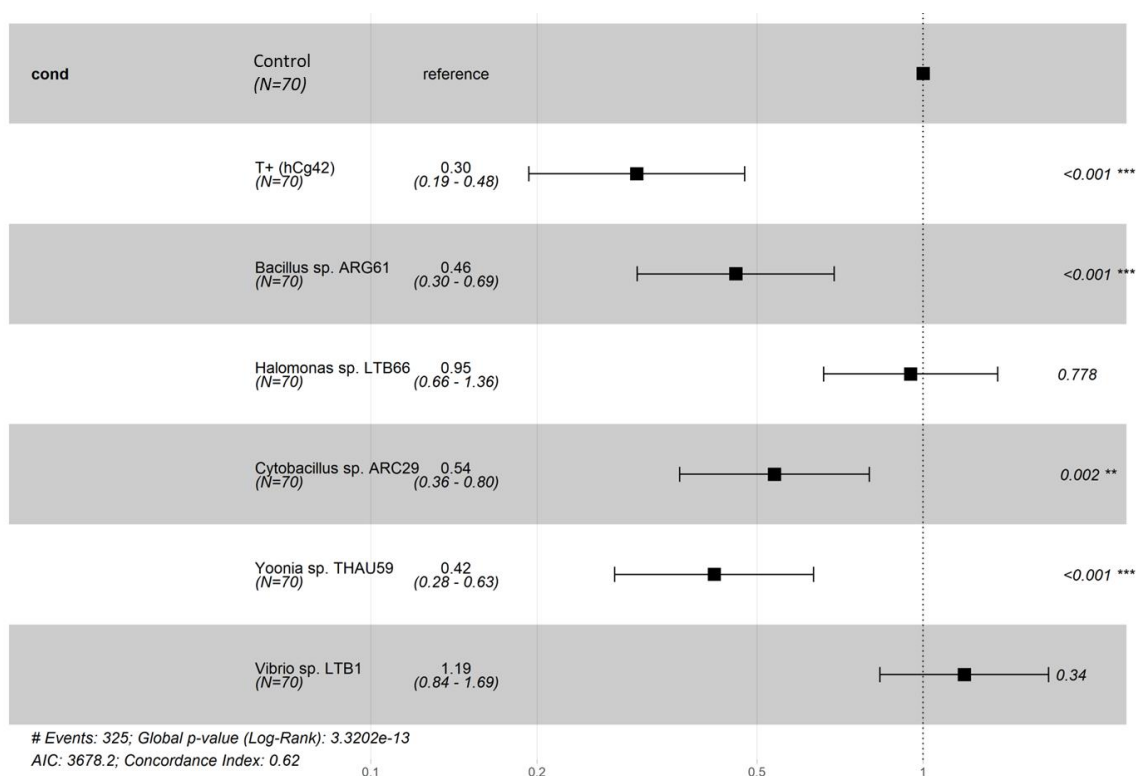

Figure 6: Forest plot representing the Hazard-Ratio value of mortality risk during the *V. aestuarianus* experimental infection for oysters (NTA population) exposed to microorganisms compared to control oysters. The numbers in brackets under the different conditions correspond to the number of oysters used in condition during the experimental infection. The Hazard-Ratio value is indicated to the right of the conditions, except for the control condition, which is indicated as reference. Finally, the value of the p-value is indicated on the right-hand side of each row.

Effects of exposure on the microbiota of oysters

To test the immediate effect of the bacterial exposure on the juvenile and adult oyster microbiota, we analysed the bacterial communities by 16S amplicon sequencing after seven days of bacterial exposure which corresponded to 72h after the last bacterial addition. Dissimilarity analysis, based on the Bray-Curtis index, showed for the juvenile oysters that after seven days of bacterial exposure, only the microbiota composition between the control oysters and the oysters exposed to bacterial strain *Cytobacillus sp.* ARC29 showed significant differences (Permanova: $R^2 = 0.15$; $pval = 0.036$) (**Figure 7**).

Dissimilarity analysis, based on the Bray-Curtis index, on adult oyster microbiota showed that after the seven day of bacterial exposure, significant differences of microbiota composition were found between control oysters and oysters exposed to *Pseudoalteromonas sp.* hCg42 (Permanova: $R^2 = 0.18$; $pval = 0.008$), *Bacillus sp.* ARG61 (Permanova: $R^2 = 0.32$; $pval = 0.008$), *Halomonas sp.* LTB66 (Permanova: $R^2 = 0.35$; $pval = 0.01$), *Cytobacillus sp.* ARC29 (Permanova: $R^2 = 0.32$; $pval = 0.01$) and *Yoonia sp.* THAU59 (Permanova: $R^2 = 0.20$; $pval = 0.009$) (**Figure 8**).

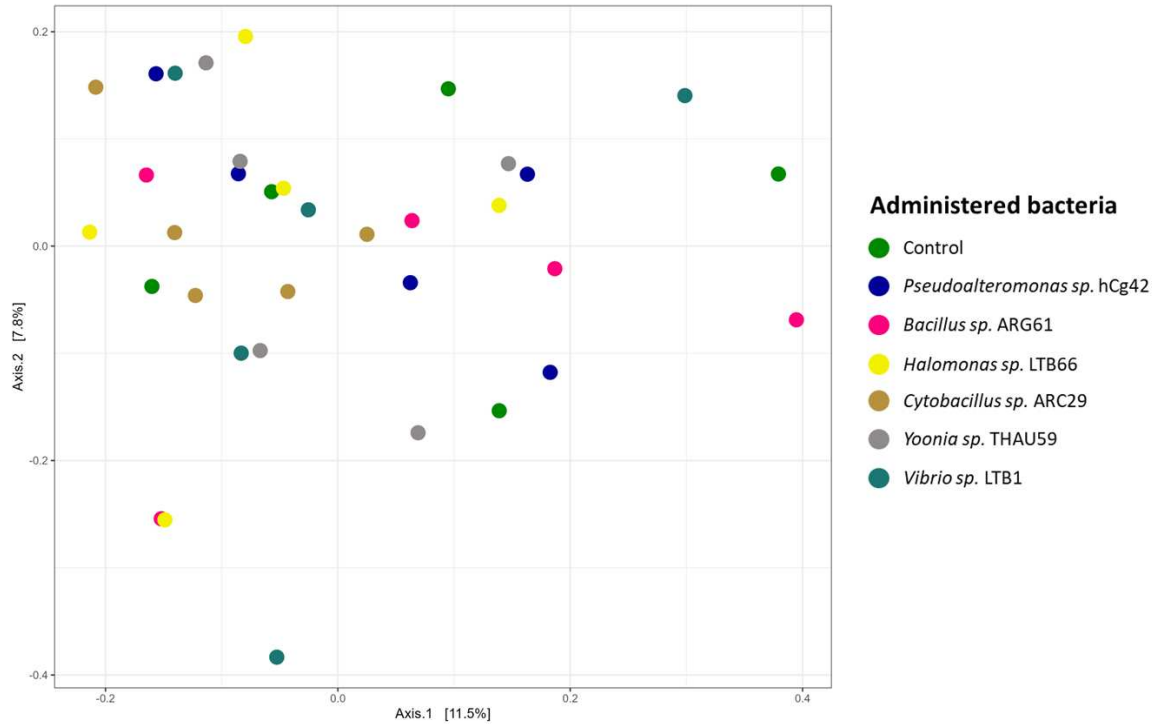

Figure 7: Principal coordinate analyses (PCoA) representing dissimilarities between samples using the Bray-Curtis distance matrix performed on 16S barcoding data from juvenile oysters (NTA population) exposed to the selected bacteria prior to POMS disease challenge.

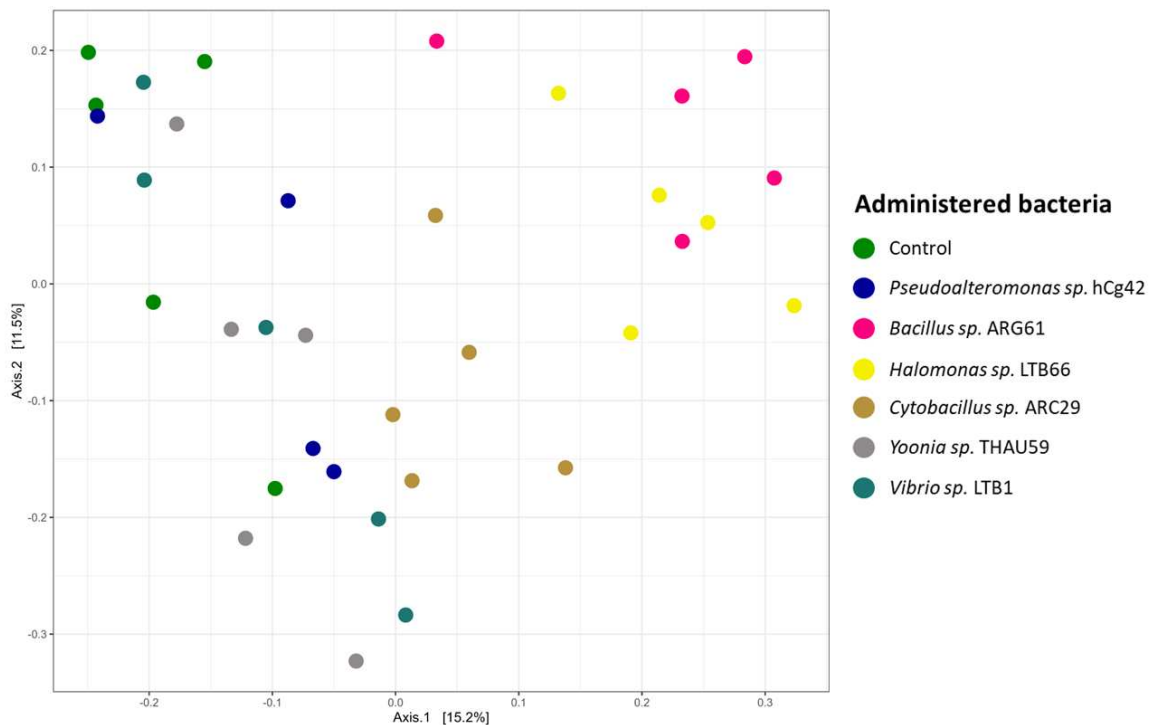

Figure 8: Principal coordinate analyses (PCoA) representing dissimilarities between samples using the Bray-Curtis distance matrix performed on 16S barcoding data from adult oysters (NTA population) exposed to the selected bacteria prior to *V. aestuarianus* challenge.

We then checked for the presence of the administered bacteria in the microbiota of the oysters after seven days of exposure. For this purpose, we performed a blast analysis. This did not allow us to detect the administered bacteria in the microbiota of juvenile or adult oysters.

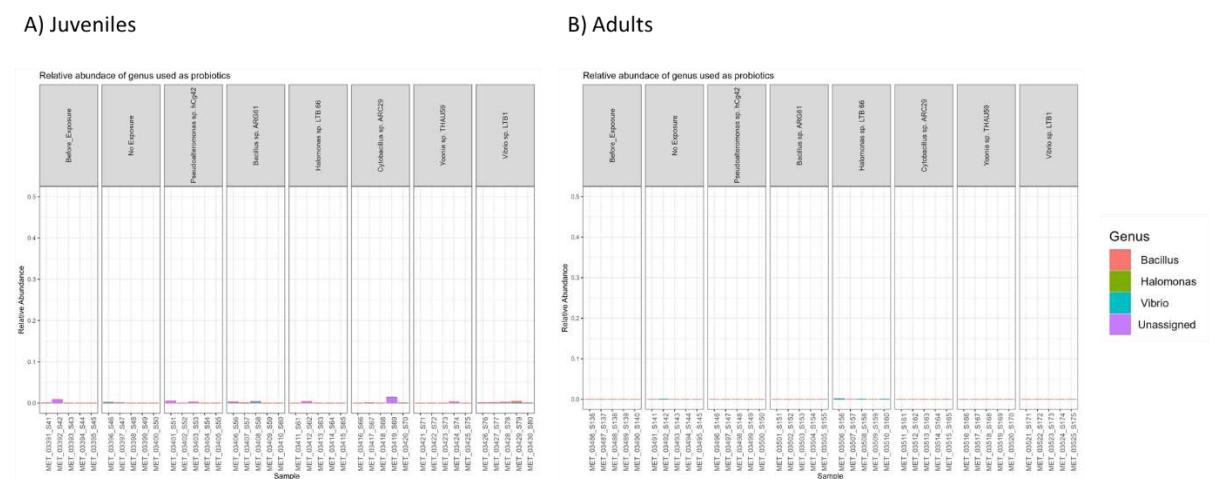

Figure 9: Relative abundances, at the genus level, of the administered bacteria found at D7 in the samples from NTA oysters at (A) juvenile stages and (B) adult stages.

Exposure to *Halomonas sp. LTB66* reduced the proportion of *Pseudoalteromonas* bacteria in oysters from the GT population, but instead promoted the proliferation of *Vibrionaceae* bacteria in the F15 family following the dysbiosis stage of POMS disease.

To determine the impact of exposure to *Halomonas sp. LTB66* bacteria on the dysbiosis stage of POMS disease, we performed a comparative analysis of microbiota composition of oysters exposed to *Halomonas sp. LTB66* bacteria versus control oysters at time t=48h of OsHV1 infection.

The analysis showed that in oysters from the GT population exposed to *Halomonas sp. LTB66*, bacteria of the genus *Pseudoalteromonas* were significantly less abundant than in control oysters (**Figure 10 A**). On the other side, in oysters from the F15 family exposed to *Halomonas sp. LTB66*, bacteria of the *Vibrionaceae* family were significantly more abundant than in control oysters. (**Figure 10 B**). For oysters from the NSI population, no bacterial taxa of interest could be identified neither in oysters exposed to *Halomonas sp. LTB66* nor in control oysters (not showed).

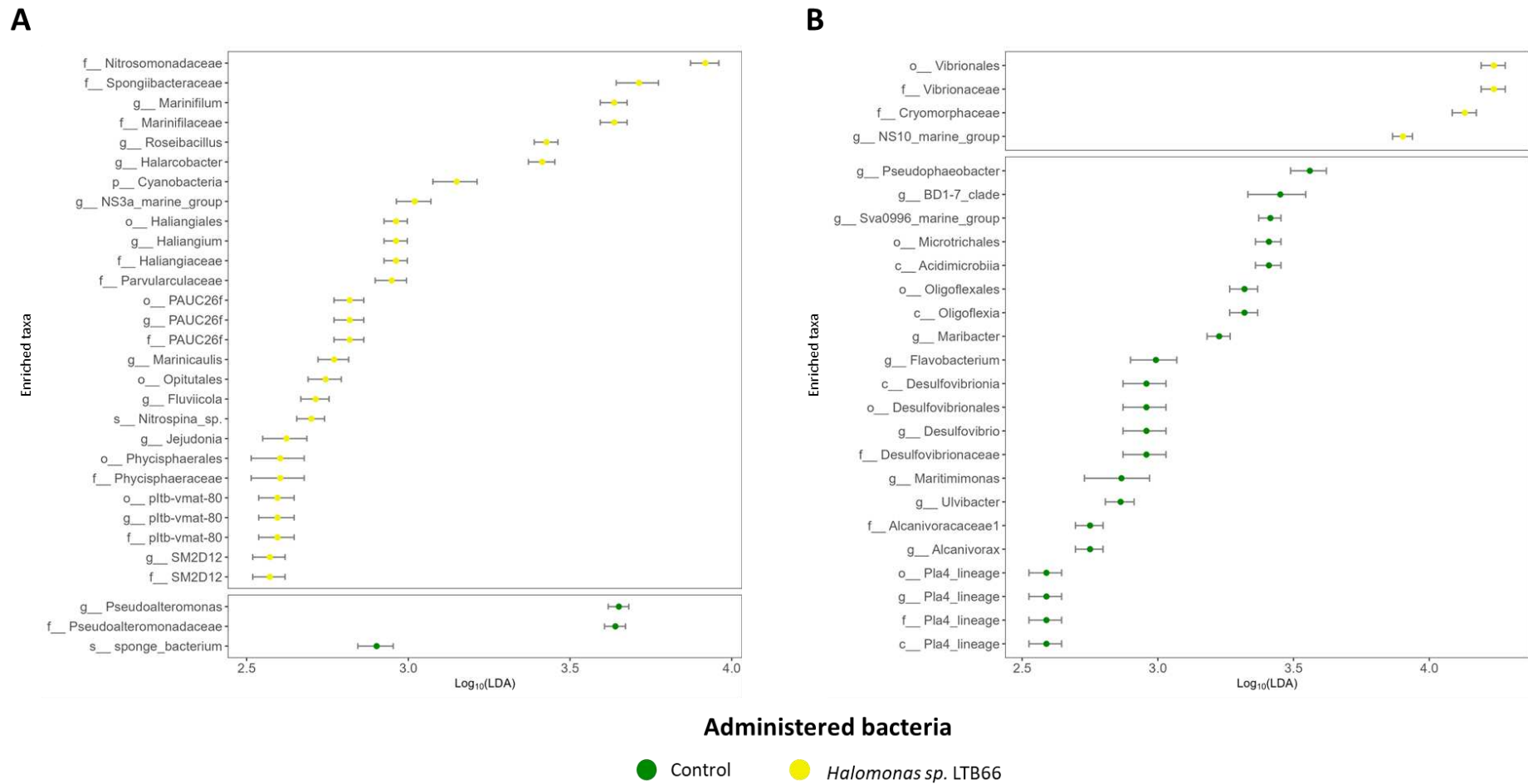

Figure 10: Comparative analysis of oyster microbiota exposed to *Halomonas sp.* LTB66 strain versus control for (A) GT population and (B) F15 family. Each point represents the Log₁₀ effect size (LDA score) for a specific taxon. The yellow point represents bacterial taxa more abundant compared to control and *vice versa* for green points.

Discussion:

Infectious diseases are a threat for oyster farming. Especially, infections caused by OsHV-1 and *V. aestuarianus* are propagating across Europe (Petton *et al.* 2021; Mesnil *et al.* 2022; Delisle *et al.* 2022). The development of methods to fight against these infectious diseases is therefore essential. In the present study, we investigated the capacity of bacteria isolated from oysters and displaying antibacterial activities against bacterial pathogens to mitigate the effect of these infectious.

Oyster microbiota is a great source of bacteria with antibacterial activity.

Among the 334 bacteria composing the collection, 76 bacteria (22.7% of the collection) displayed an antibacterial activity by co-culture and eight bacteria (2.4% of the collection) displayed an antibacterial activity in their supernatant against at least one of the target bacteria. The target bacteria were oyster pathogens (true pathogen or opportunistic) (Travers *et al.* 2015; Petton *et al.* 2021; Clerissi *et al.* 2022). It could have been interesting to carry out additional antibacterial activity tests with the bacteria composing the collection against other pathogenic bacteria affecting oysters or, more generally, affecting aquaculture species of interest.

The bacterial strain *Halomonas sp.* LTB66 induce a protective effect against OsHV-1 infection but the effects depend on the oysters' genetic background.

In our study, we have shown that an exposure to the bacterial strain *Halomonas sp.* LTB66 reduced the mortality risk against OsHV-1 infections for 3 of the oyster populations tested (GT, NTA and NSI) but it increased the mortality risk for the F15 family. We propose two hypotheses to explain these differences of effect caused by bacterial exposure. The first one is that the genetic background of the oysters influence the response to bacterial exposure. This is supported by different studies that show that the impact of probiotics on the host's microbiota (Dantan *et al.*; Landsman *et al.* 2019) or health (Dantan *et al.*; Mariman *et al.* 2015) varies according to the host's genetic background. The other hypothesis is based on the fact that the F15 family is a very sensitive family. Exposure to bacteria therefore probably induced too much stress for this family, leading to more rapid mortality.

For populations where exposure to the bacterial strain *Halomonas sp.* LTB66 induced a protective effect against OsHV-1 infection, the molecular mechanisms involved in the better

resistance remain unclear. However, for the GT population, we observed that exposure to *Halomonas sp.* LTB66 reduced the relative proportion in the microbiota of bacteria of the genus *Pseudoalteromonas* which is a genus associated with the POMS disease (Clerissi *et al.* 2022). Even if we have demonstrated that the *Halomonas sp.* LTB66 strain displays antibacterial activity directed against pathogenic bacteria of the oyster, we do not have tested its antiviral activity. Indeed, it could have been possible that our *Halomonas* strain also had an antiviral activity against OsHV-1 that could have protected oysters against OsHV-1 infection. A study conducted on *Halomonas sp.* BS4 bacteria demonstrated antibacterial, antifungal, and antiviral activity caused by a biosurfactant secreted by the bacteria (Donio *et al.* 2013). The co-injection of this biosurfactant in shrimps together with White Spot Syndrome Virus (WSSV) suppressed the growth and pathological effects of the virus (Donio *et al.* 2013)

Exposure to four bacterial strains (*Pseudoalteromonas sp.* hCg42; *Bacillus sp.* ARG61; *Cytobacillus sp.* ARC29 and *Yoonia sp.* THAU59) induced a significant reduction of the mortality risk against *V. aestuarianus* infection.

The exposure to our bacterial strains (*Pseudoalteromonas sp.* hCg42; *Bacillus sp.* ARG61; *Cytobacillus sp.* ARC29 and *Yoonia sp.* THAU59) induced a significant reduction, from 46% to 70 %, of the mortality risk against *V. aestuarianus* infection. To our knowledge, no studies have evidenced a protective effect by a bacterial exposure against *V. aestuarianus*. However, although we have demonstrated a protective effect, it remains difficult to determine a full protection against *V. aestuarianus* infections. Indeed, since the dynamics of infection can be long and/or chronic-like (Travers *et al.* 2017), it is possible that exposure to our different strains only delayed the progression of infection. Longer-term effects should be tested to determine how long the protective effect remains.

Further analyses are also required to determine the mechanisms underlying resistance to *V. aestuarianus*. Here we shown that exposure to bacterial strains induced changes in microbiota compositions of adult oyster and that the administered bacteria did not settle down in the microbiota. Furthermore, among the 4 strains conferring a protective effect against *V. aestuarianus*, 3 bacteria (*Bacillus sp.* ARG61; *Cytobacillus sp.* ARC29 and *Yoonia sp.* THAU 59) had no antibacterial activity against *V. aestuarianus*, making the explanation of resistance acquisition even more complex. In our opinion, two mechanisms could explain this resistance. The first would be that exposure to these bacteria has induced immunostimulatory effects such

as an increase in the total number of haemocytes, or in phenoloxidase (PO) activity, as shown in the work of (Zhang *et al.* 2009), in which the administration of the bacteria *Halomonas sp.* B12 through food to the shrimp, *Fenneropenaeus chinensis*, significantly increased the total number of haemocytes, and phenoloxidase activity. Similarly, administration of the bacteria *Shewanella haliotis* D4 or *Aeromonas bivalvium* D15 to the white-legged shrimp, *Litopenaeus vannamei*, induced an increase in superoxide dismutase activity and prophenoloxidase expression (Hao *et al.* 2014). The second mechanism that could explain the acquisition of resistance is based on the fact that the changes in the microbiota observed following exposure to the bacteria could have favoured bacteria that are themselves capable of combating *V. aestuarianus* via antagonistic effects.

Conclusion:

A sustainable oyster farming is a key to develop this growing industry in a context of global changes and emerging infectious diseases. The development of prophylactic methods such as the use of probiotics is a necessity. In this study, we have shown that the administration of bacteria isolated from *C. gigas* microbiota and displaying antibacterial activities against various pathogens or opportunists *in vitro*, could increase the survival of oyster submitted to OsHV-1 μ Var or *V. aestuarianus* infectious challenges. However, further studies will be needed to understand the molecular mechanisms involved in the resistance conferred by these bacteria. It would also be interesting to characterise and purify molecules that are active against pathogens and opportunists. These molecules may offer a promising way to mitigate the effects of these infectious diseases.

References

- Altschul SF, Gish W, Miller W, Myers EW, Lipman DJ (1990) Basic local alignment search tool. *J Mol Biol* 215:403–410. doi: 10.1016/S0022-2836(05)80360-2
- Azéma P, Travers MA, De Lorgeril J, Tourbiez D, Dégremont L (2015) Can selection for resistance to OsHV-1 infection modify susceptibility to *Vibrio aestuarianus* infection in *Crassostrea gigas*? First insights from experimental challenges using primary and successive exposures. *Vet Res*. doi: 10.1186/s13567-015-0282-0
- Bolyen E, Rideout JR, Dillon MR, Bokulich NA, Abnet CC, Al-Ghalith GA, Alexander H, Alm EJ, Arumugam M, Asnicar F, Bai Y, Bisanz JE, Bittinger K, Brejnrod A, Brislawn CJ, Brown CT, Callahan BJ, Caraballo-Rodríguez AM, Chase J, Cope EK, Da Silva R, Diener C, Dorrestein PC, Douglas GM, Durall DM, Duvall C, Edwardson CF, Ernst M, Estaki M, Fouquier J, Gauglitz JM, Gibbons SM, Gibson DL, Gonzalez A, Gorlick K, Guo J, Hillmann B, Holmes S, Holste H, Huttenhower C, Huttley GA, Janssen S, Jarmusch AK, Jiang L, Kaehler BD, Kang K Bin, Keefe CR, Keim P, Kelley ST, Knights D, Koester I, Kosciolk T, Kreps J, Langille MGI, Lee J, Ley R, Liu YX, Loftfield E, Lozupone C, Maher M, Marotz C, Martin BD, McDonald D, McIver LJ, Melnik A V., Metcalf JL, Morgan SC, Morton JT, Naimey AT, Navas-Molina JA, Nothias LF, Orchanian SB, Pearson T, Peoples SL, Petras D, Preuss ML, Priesse E, Rasmussen LB, Rivers A, Robeson MS, Rosenthal P, Segata N, Shaffer M, Shiffer A, Sinha R, Song SJ, Spear JR, Swafford AD, Thompson LR, Torres PJ, Trinh P, Tripathi A, Turnbaugh PJ, Ul-Hasan S, van der Hooft JJJ, Vargas F, Vázquez-Baeza Y, Vogtmann E, von Hippel M, Walters W, Wan Y, Wang M, Warren J, Weber KC, Williamson CHD, Willis AD, Xu ZZ, Zaneveld JR, Zhang Y, Zhu Q, Knight R, Caporaso JG (2019) Reproducible, interactive, scalable and extensible microbiome data science using QIIME 2. *Nat Biotechnol* 37:852–857. doi: 10.1038/s41587-019-0209-9
- Callahan BJ, McMurdie PJ, Rosen MJ, Han AW, Johnson AJA, Holmes SP (2016) DADA2: High-resolution sample inference from Illumina amplicon data. *Nat Methods* 13:581–583. doi: 10.1038/nmeth.3869
- Clerissi C, de Lorgeril J, Petton B, Lucasson A, Escoubas J-M, Gueguen Y, Dégremont L, Mitta G, Toulza E (2020) Microbiota Composition and Evenness Predict Survival Rate of Oysters Confronted to Pacific Oyster Mortality Syndrome. *Front Microbiol* 11:1–11. doi: 10.3389/fmicb.2020.00311

- Clerissi C, Luo X, Lucasson A, Mortaza S, de Lorgeril J, Toulza E, Petton B, Escoubas JM, Degrémont L, Gueguen Y, Destoumieux-Garzón D, Jacq A, Mitta G (2022) A core of functional complementary bacteria infects oysters in Pacific Oyster Mortality Syndrome. *Anim Microbiome*. doi: 10.1186/s42523-023-00246-8
- Conway JR, Lex A, Gehlenborg N (2017) UpSetR: An R package for the visualization of intersecting sets and their properties. *Bioinformatics* 33:2938–2940. doi: 10.1093/bioinformatics/btx364
- Cotter E, Malham SK, O’Keeffe S, Lynch SA, Latchford JW, King JW, Beaumont AR, Culloty SC (2010) Summer mortality of the Pacific oyster, *Crassostrea gigas*, in the Irish Sea: The influence of growth, biochemistry and gametogenesis. *Aquaculture* 303:8–21. doi: 10.1016/J.AQUACULTURE.2010.02.030
- Dantan L, Carcassonne P, Degrémont L, Morga B, Petton B, Mege M, Maurouard E, Allienne JF, Courtay G, Romatif O, Lami R, Intertaglia L, Gueguen Y, Vidal-Dupiol J, Toulza E, Cosseau C Microbial education: a key to modulate immune responses in *Crassostrea gigas* for sustainable aquaculture.
- De Decker S, Saulnier D (2011) Vibriosis induced by experimental cohabitation in *Crassostrea gigas*: Evidence of early infection and down-expression of immune-related genes. *Fish Shellfish Immunol* 30:691–699. doi: 10.1016/j.fsi.2010.12.017
- de Lorgeril J, Lucasson A, Petton B, Toulza E, Montagnani C, Clerissi C, Vidal-Dupiol J, Chaparro C, Galinier R, Escoubas JM, Haffner P, Dégremont L, Charrière GM, Lafont M, Delort A, Vergnes A, Chiarello M, Fauray N, Rubio T, Leroy MA, Pérignon A, Régler D, Morga B, Alunno-Bruscia M, Boudry P, Le Roux F, Destoumieux-Garzón D, Gueguen Y, Mitta G (2018) Immune-suppression by OsHV-1 viral infection causes fatal bacteraemia in Pacific oysters. *Nat Commun*. doi: 10.1038/s41467-018-06659-3
- Delisle L, Laroche O, Hilton Z, Burguin J-F, Rolton A, Berry J, Pochon X, Boudry P, Vignier J (2022) Understanding the Dynamic of POMS Infection and the Role of Microbiota Composition in the Survival of Pacific Oysters, *Crassostrea gigas*. *Microbiol Spectr*. doi: 10.1128/spectrum.01959-22
- Donio MBS, Ronica FA, Viji VT, Velmurugan S, Jenifer JSCA, Michaelbabu M, Dhar P, Citarasu T (2013) *Halomonas sp.* BS4, A biosurfactant producing halophilic bacterium isolated from solar salt works in India and their biomedical importance. *Springerplus*. doi:

10.1186/2193-1801-2-149

Food and Agriculture Organisation of the United Nation (2016) Probiotics in animal nutrition – Production, impact and regulation.

Friedman CS, Estes RM, Stokes NA, Burge CA, Hargove JS, Barber BJ, Elston RA, Burreson EM, Reece KS (2005) Herpes virus in juvenile Pacific oysters *Crassostrea gigas* from Tomales Bay, California, coincides with summer mortality episodes. *Dis Aquat Organ* 63:33–41. doi: 10.3354/dao063033

García-Bernal M, Medina-Marrero R, Campa-Córdova AI, Mazón-Suástegui JM (2019) Growth and antioxidant response of juvenile oysters *Crassostrea sikamea* and *Crassostrea corteziensis* treated with *Streptomyces* strains. *Arq Bras Med Vet e Zootec* 71:1993–1998. doi: 10.1590/1678-4162-11225

Gawra J, Valdivieso A, Roux F, Laporte M, De Lorgeril J, Gueguen Y, Saccas M, Escoubas J-M, Montagnani C, Destoumieux-Garzón D, Lagarde F, Leroy MA, Haffner P, Petton B, Cosseau C, Morga B, Dégremont L, Mitta G, Grunau C, Vidal-Dupiol J (2023) Epigenetic then genetic variations underpin rapid adaptation of oyster populations (*Crassostrea gigas*) to Pacific Oyster Mortality Syndrome (POMS). *bioRxiv*. doi: 10.1101/2023.03.09.531494

Hao K, Liu JY, Ling F, Liu XL, Lu L, Xia L, Wang GX (2014) Effects of dietary administration of *Shewanella haliotis* D4, *Bacillus cereus* D7 and *Aeromonas bivalvium* D15, single or combined, on the growth, innate immunity and disease resistance of shrimp, *Litopenaeus vannamei*. *Aquaculture* 428–429:141–149. doi: 10.1016/j.aquaculture.2014.03.016

Khademzade O, Zakeri M, Haghi M, Mousavi SM (2020) The effects of water additive *Bacillus cereus* and *Pediococcus acidilactici* on water quality, growth performances, economic benefits, immunohematology and bacterial flora of whiteleg shrimp (*Penaeus vannamei* Boone, 1931) reared in earthen ponds. *Aquac Res* 51:1759–1770. doi: 10.1111/are.14525

King WL, Jenkins C, Go J, Siboni N, Seymour JR, Labbate M (2019) Characterisation of the Pacific Oyster Microbiome During a Summer Mortality Event. *Microb Ecol* 77:502–512. doi: 10.1007/s00248-018-1226-9

Labreuche Y, Soudant P, Gonçalves M, Lambert C, Nicolas JL (2006) Effects of extracellular products from the pathogenic *Vibrio aestuarianus* strain 01/32 on lethality and cellular

- immune responses of the oyster *Crassostrea gigas*. *Dev Comp Immunol* 30:367–379. doi: 10.1016/j.dci.2005.05.003
- Labreuche Y, Le Roux F, Henry J, Zatylny C, Huvet A, Lambert C, Soudant P, Mazel D, Nicolas JL (2010) *Vibrio aestuarianus* zinc metalloprotease causes lethality in the Pacific oyster *Crassostrea gigas* and impairs the host cellular immune defenses. *Fish Shellfish Immunol* 29:753–758. doi: 10.1016/j.fsi.2010.07.007
- Landsman A, St-Pierre B, Gibbons W, Rosales-Leija M, Brown M (2019) Investigation of the potential effects of host genetics and probiotic treatment on the gut bacterial community composition of aquaculture-raised pacific whiteleg shrimp, *Litopenaeus vannamei* . *Microorganisms* 7:217. doi: 10.3390/microorganisms7080217
- Madison D, Schubiger C, Lunda S, Mueller RS, Langdon C (2022) A marine probiotic treatment against the bacterial pathogen *Vibrio coralliilyticus* to improve the performance of Pacific (*Crassostrea gigas*) and Kumamoto (*C. sikamea*) oyster larvae. *Aquaculture*. doi: 10.1016/j.aquaculture.2022.738611
- Mariman R, Tielen F, Koning F, Nagelkerken L (2015) The probiotic mixture VSL#3 has differential effects on intestinal immune parameters in healthy female BALB/c and C57BL/6 mice. *J Nutr* 145:1354–1361. doi: 10.3945/jn.114.199729
- McKnight DT, Huerlimann R, Bower DS, Schwarzkopf L, Alford RA, Zenger KR (2019) microDecon: A highly accurate read-subtraction tool for the post-sequencing removal of contamination in metabarcoding studies. *Environ DNA* 1:14–25. doi: 10.1002/edn3.11
- McMurdie PJ, Holmes S (2013) Phyloseq: An R Package for Reproducible Interactive Analysis and Graphics of Microbiome Census Data. *PLoS One*. doi: 10.1371/journal.pone.0061217
- Mesnil A, Jacquot M, Garcia C, Tourbiez D, Canier L, Dégremont L, Cheslett D, Geary M, Vetri A, Roque A, Furones D, Garden A, Orozova P, Arzul I, Sicard M, Destoumieux-Garzón D, Travers M-A (2022) Emergence and clonal expansion of *Vibrio aestuarianus* lineages pathogenic for oysters in Europe. *Mol Ecol* 32:2896–2883. doi: 10.1111/mec.16910
- Offret C, Rochard V, Laguerre H, Mounier J, Huchette S, Brillet B, Le Chevalier P, Fleury Y (2018) Protective Efficacy of a *Pseudoalteromonas* Strain in European Abalone, *Haliotis tuberculata*, Infected with *Vibrio harveyi* ORM4. *Probiotics Antimicrob Proteins* 11:239–247. doi: 10.1007/s12602-018-9389-8

- Oksanen J, Simpson GL, Blanchet FG, Kindt R, Legendre P, Minchin PR, O'Hara RB, Solymos P, Stevens MHH, Szoecs E, Wagner H, Barbour M, Bedward M, Bolker B, Borcard D, Carvalho G, Chirico M, Caceres M De, Durand S, Evangelista HBA, FitzJohn R, Friendly M, Furneaux B, Hannigan G, Hill MO, Lahti L, McGlinn D, Ouellette M-H, Cunha ER, Smith T, Stier A, Braak CJF Ter, Weedon J (2022) vegan: Community Ecology Package version 2.6-2. The Comprehensive R Archive Network
- Oyanedel D, Lagorce A, Bruto M, Haffner P, Morot A, Dorant Y, de La Forest Divonne S, Delavat F, Inguibert N, Morga B, Toulza E, Chaparro C, Escoubas J-M, Gueguen Y, Vidal-Dupiol J, de Lorgeril J, Petton B, Degremont L, Tourbiez D, Pimparé L-L, Leroy M, Romatif O, Mitta G, Le Roux F, Charrière GM, Destoumieux-Garzón D (2023) Cooperation and cheating orchestrate *Vibrio* assemblages and 1 polymicrobial synergy in oysters infected with OsHV-1 virus 2 3. bioRxiv. doi: 10.1101/2023.02.11.528104
- Pernet F, Barret J, Le Gall P, Corporeau C, Dégremont L, Lagarde F, Pépin JF, Keck N (2012) Mass mortalities of Pacific oysters *Crassostrea gigas* reflect infectious diseases and vary with farming practices in the Mediterranean Thau lagoon, France. *Aquac Environ Interact* 2:215–237. doi: 10.3354/aei00041
- Petton B, Destoumieux-Garzón D, Pernet F, Toulza E, de Lorgeril J, Degremont L, Mitta G (2021) The Pacific Oyster Mortality Syndrome, a Polymicrobial and Multifactorial Disease: State of Knowledge and Future Directions. *Front Immunol*. doi: 10.3389/fimmu.2021.630343
- R Core Team (2022) A language and environment for statistical computing. *R Found Stat Comput* 10:11–18.
- Travers MA, Boettcher Miller K, Roque A, Friedman CS (2015) Bacterial diseases in marine bivalves. *J Invertebr Pathol* 131:11–31. doi: 10.1016/j.jip.2015.07.010
- Travers MA, Tourbiez D, Parizadeh L, Haffner P, Kozic-Djellouli A, Aboubaker M, Koken M, Dégremont L, Lupo C (2017) Several strains, one disease: Experimental investigation of *Vibrio aestuarianus* infection parameters in the Pacific oyster, *Crassostrea gigas*. *Vet Res* 48:32. doi: 10.1186/s13567-017-0438-1
- Wang Q, Garrity GM, Tiedje JM, Cole JR (2007) Naïve Bayesian classifier for rapid assignment of rRNA sequences into the new bacterial taxonomy. *Appl Environ Microbiol* 73:5261–5267. doi: 10.1128/AEM.00062-07

- Webb SC, Fidler A, Renault T (2007) Primers for PCR-based detection of ostreid herpes virus-1 (OsHV-1): Application in a survey of New Zealand molluscs. *Aquaculture* 272:126–139. doi: 10.1016/j.aquaculture.2007.07.224
- Xu S, Yu G (2022) MicrobiotaProcess: A comprehensive R package for managing and analyzing microbiome and other ecological data within the tidy framework. *R Packag* version 181. doi: 10.21203/RS.3.RS-1284357/V1
- Yeh H, Skubel SA, Patel H, Cai Shi D, Bushek D, Chikindas ML (2020) From Farm to Fingers: an Exploration of Probiotics for Oysters, from Production to Human Consumption. *Probiotics Antimicrob Proteins*. doi: 10.1007/s12602-019-09629-3
- Yoon SH, Ha SM, Kwon S, Lim J, Kim Y, Seo H, Chun J (2017) Introducing EzBioCloud: A taxonomically united database of 16S rRNA gene sequences and whole-genome assemblies. *Int J Syst Evol Microbiol* 67:1613–1617. doi: 10.1099/ijsem.0.001755
- Zhang L, Mai K, Tan B, Ai Q, Qi C, Xu W, Zhang W, Liufu Z, Wang X, Ma H (2009) Effects of dietary administration of probiotic *Halomonas* sp. B12 on the intestinal microflora, immunological parameters, and midgut histological structure of shrimp, *Fenneropenaeus chinensis*. *J World Aquac Soc* 40:58–66. doi: 10.1111/j.1749-7345.2008.00235.x

II. Caractérisation biochimique de composés à activités antibactériennes produits par des bactéries issues du microbiote de l'huître *Crassostrea gigas*

1. Introduction

A la suite des essais *in vivo* réalisés dans la partie I de ce chapitre, quatre bactéries, issues de la collection de bactéries associées aux huîtres résistantes à la maladie du POMS, présentent un intérêt notable pour la lutte contre la maladie de POMS et les infections à *V. aestuarianus*. Ces quatre bactéries possèdent des activités antibactériennes dirigées contre des *Vibrios* pathogènes de l'huître, mais aussi contre des bactéries opportunistes liées à la dysbiose lors de la maladie du POMS (*cf.* chapitre 2, partie I). Parmi elles, la bactérie *Yoonia sp.* THAU59 possède une activité antibactérienne uniquement en co-culture, tandis que les trois autres bactéries, *Bacillus sp.* ARG61, *Halomonas sp.* LTB66 et *Cytobacillus sp.* ARC29, possèdent une activité antibactérienne en co-culture, mais aussi dans le surnageant.

L'utilisation de molécules bioactives pourrait également s'avérer être une solution de lutte contre la maladie du POMS ou les infections à *V. aestuarianus*. Ces molécules bioactives pourraient potentiellement être également utilisées pour d'autres applications, telles que la lutte contre d'autres pathogènes marins voire même contre des pathogènes humains. Nous avons donc décidé d'isoler la ou les molécules actives responsables des activités antibactériennes et d'en caractériser la nature biochimique.

Les travaux présentés dans cette partie ont fait l'objet du stage de Master 2 de Laetitia Essomba, Master 2 Science du vivant de l'École Pratique des Hautes Études, en collaboration avec Isabelle Bonnard, Maître de conférences au laboratoire CRIOBE à Perpignan.

2. Matériel et Méthode

Les travaux présentés dans cette partie se focalisent sur la souche bactérienne *Halomonas sp.* LTB66. En effet, cette souche est parmi les quatre souches présentant une activité antibactérienne dans son surnageant contre le plus grand nombre de bactéries cibles.

Préparation du surnageant de culture

Dans un premier temps, la bactérie *Halomonas sp.* LTB66 a été mise en culture à partir d'une culture conservée en glycérol dans 10 mL de Marine Broth (DIFCO™ 2216) pendant 24 heures à 20°C. À la suite de cette incubation, 1 mL de la culture précédente a été utilisé pour ensemençer 2 L de Marine Broth. Cette culture a ensuite été mise à incuber pendant 72 heures à 20°C et sous agitation (100 rpm). À la fin de cette incubation, la culture a été centrifugée pendant 10 minutes à 4000 rpm. Le surnageant a ensuite été transféré dans un nouveau flacon avant d'être chauffé pendant 5 minutes à 100°C afin d'éliminer les potentielles bactéries restantes. Ce surnageant traité est ensuite conservé à 4°C avant utilisation.

Extraction liquide-liquide

Afin de séparer les composés polaires (phase aqueuse) et apolaires (phase organique), une extraction liquide-liquide à l'acétate d'éthyle a été réalisée. Dans une ampoule à décanter de 500 mL, 200 mL du surnageant préalablement préparé et 200 mL d'acétate d'éthyle ont été mélangés et laissés à décanter jusqu'à la séparation en deux phases (la phase organique notée AE et la phase aqueuse notée SnAE). L'extraction a été répétée trois fois : la phase aqueuse a été extraite une nouvelle fois avec de l'acétate d'éthyle afin d'extraire le maximum de composés organiques. Enfin, les phases organiques ont été rassemblées et lavées avec de l'eau ultrapure (dans un volume de 200 mL) à l'aide d'une ampoule à décanter.

Empreintes chimiques en Chromatographie Liquide

Les empreintes chimiques des échantillons ont été enregistrées en chromatographie liquide couplée à de la spectrométrie de masse haute résolution (LC-HRMS) aux concentrations de 5 mg/mL pour la phase aqueuse et 1 mg/mL pour la phase organique. Elles ont également été enregistrées en chromatographie liquide couplée à un détecteur UV-Visible à barrette de diodes et un détecteur évaporatif à diffusion de lumière (HPLC-DAD-DEDL) à une concentration de 20 mg/mL.

Les analyses LC-HRMS ont été effectuées sur un système UPLC (Vanquish Thermo Scientific, MA, USA) couplé à un spectromètre de masse Orbitrap Q-Exactive Plus (Thermo Scientific, MA, USA). La séparation des composés s'est effectuée sur une colonne Luna R Omega 1,6 µm Polar C-18 100 x 2.1mm (Phénomène, CA, USA). Les solvants d'élution (phases mobiles)

étaient (A) un mélange d'eau + 0,1 % d'acide formique et (B) d'acétonitrile + 0,1 % d'acide formique. L'ionisation a été réalisée par électrospray (ESI) en mode positif et négatif. Les spectres de masse ont été enregistrés en modes positif et négatif avec une résolution de 35 kHz et un balayage de masse entre 100 – 1500 m/z et en mode MS/MS données dépendantes permettant l'acquisition de spectres de fragmentation

Fractionnement en HPLC-DAD-DEDL

Un fractionnement de la fraction organique a été réalisé à l'aide d'une HPLC comportant deux détecteurs (DAD et DEDL) détectant les composés absorbants entre 200 et 800 nm, couplée à un collecteur de fractions (Waters Fraction Collector III) permettant de récupérer les différentes fractions sur une plaque de 96 puits. La séparation a été réalisée sur une colonne Luna Omega (Phenomenex) polar C18, 3 µm de diamètre, 150 x 4,6 mm, avec un gradient d'eau et d'acétonitrile à un débit de 0,7 mL/min.

Les plaques de 96 puits contenant les fractions sont laissées à sécher sous PSM jusqu'à évaporation complète, puis stockées à 4°C jusqu'à utilisation.

Test des activités antibactériennes

Afin d'évaluer l'activité antibactérienne des différentes fractions collectées par HPLC, des tests d'activités antimicrobiennes en milieu liquide ont été réalisés.

Pour ces tests, deux bactéries cibles, *V. aestuarianus* 02/041 et *Marinomonas sp.* 12/107-2T2, ont été utilisées en raison de leur sensibilité lors des tests d'activités antibactériennes (cf. Chapitre 2, partie I, Publication 3). Une culture de bactérie cible est préparée à partir de la culture stock en glycérol dans 10 mL de Marine Broth à 20°C pendant 48h. Après cette période d'incubation, une lecture de la DO₆₀₀ est réalisée et une dilution de la culture est effectuée dans du Marine Broth frais afin d'obtenir une culture de la bactérie cible à une concentration finale de 10⁵ CFU/mL. 200 µl de cette culture sont ensuite déposés dans chacun des puits d'une plaque contenant les fractions.

Par la suite, 200 µl de la culture de la bactérie cible sont déposés dans chacun des puits des plaques de 96 puits contenant les fractions préalablement préparées. Une lecture de la DO₆₀₀ est immédiatement réalisée à l'aide d'un système Epoch (Biotek Epoch 266764, Agilent), puis

la plaque est mise à incuber à 20°C pendant 24h sous agitation (120 rpm). Après 24h d'incubation, une seconde lecture de la OD_{600} est réalisée.

Le pourcentage d'inhibition de croissance est ensuite calculé en suivant la formule suivante :

$$\% \text{ d'inhibition de la croissance} = 100 - \left(\frac{OD_{600}(t_{24h}) - OD_{600}(t_{0h})}{\text{Mean } OD_{600}(t_{24h} - t_{0h})} * 100 \right)$$

Identification des composés à activité antibactérienne

Afin d'identifier les composés présentant des activités antibactériennes, les fractions actives ont été analysées en LC-HRMS. L'obtention des masses à haute résolution des ions a permis de générer, à partir du logiciel Excalibur (Thermo Fisher Scientific), les formules brutes. Des recherches sur des bases de données (MarinLit et MetLin) à partir des masses exactes et des formules brutes ont été réalisées afin d'identifier les composés analysés.

Une analyse par Résonance Magnétique Nucléaire (RMN) du proton a été réalisée sur un spectromètre JEOL (Akishima Tokyo, Japon) EX-500 MHz équipé d'une double sonde ^1H , ^{13}C (5 mm), dans 500 μL de chloroforme deutéré (CDCl_3) à 303 K. Les déplacements chimiques (δ) ont été calibrés sur le pic résiduel du solvant [CDCl_3 , 7,27 ppm] et sont rapportés en parties par million (ppm) par rapport au triméthylsilylane (TMS).

Le spectre de fragmentation des ions par (LC-MS/MS) et le spectre RMN du proton ont permis de déterminer la structure des molécules par corrélation des données issues de la littérature associée à la base de données HMDB : Human Metabolome Database.

3. Résultats

Seule la fraction organique (AE) conserve une activité antibactérienne

L'extraction liquide-liquide a permis d'obtenir, après évaporation des solvants, 27,3 mg et 9 mg d'extraits bruts pour les fractions aqueuse (SnAE) et organique (AE) respectivement. Ces deux fractions ont ensuite été reprises dans une solution d'éthanol à 10 % afin d'obtenir une concentration de 50 mg/mL pour la phase aqueuse et 20 mg/mL pour la phase organique. Les activités antibactériennes de ces deux fractions ont été testées et ont permis de démontrer que les composés actifs contre la bactérie *Marinomonas sp.* 12/107-2T2 se retrouvaient dans la fraction organique. Le reste des analyses a donc été réalisé sur la fraction organique (AE).

Le fractionnement de la phase organique a permis d'isoler 3 fractions actives contre la souche *Marinomonas sp.* 12/107-2T2.

Afin d'isoler plus finement les composés actifs, la fraction organique a été fragmentée par HPLC, et l'empreinte chimique a été acquise à l'aide du capteur DAD-DEDL. Les différentes fractions ont ensuite été testées pour leurs activités antibactériennes. Lors du test sur la souche *Marinomonas sp.* 12/107-2T2, trois fractions ont présenté une diminution de 11,19 % (fraction 66), 24,37 % et 10,56 % (fractions 74 et 75) (**Figure 13**).

A

	1	2	3	4	5	6	7	8	9	10	11	12
A	1	16	17	32	33	48	49	64	65	80	81	96
B	2	15	18	31	34	47	50	63	66	79	82	95
C	3	14	19	30	35	46	51	62	67	78	83	94
D	4	13	20	29	36	45	52	61	68	77	84	93
E	5	12	21	28	37	44	53	60	69	76	85	92
F	6	11	22	27	38	43	54	59	70	75	86	91
G	7	10	23	26	39	42	55	58	71	74	87	90
H	8	9	24	25	40	41	56	57	72	73	88	89

B

	1	2	3	4	5	6	7	8	9	10	11	12
A	-6,23	0,57	-5,38	-2,19	-4,10	-0,92	-1,98	-0,92	-1,55	-4,10	-4,32	0,57
B	-2,62	-4,32	-1,98	-1,77	-2,40	-0,07	2,91	-0,92	11,19	-1,55	-2,62	1,42
C	-1,34	-3,25	-3,47	-1,77	1,21	2,27	0,57	0,78	1,85	-3,47	-0,49	0,78
D	-2,83	-1,98	-1,13	0,57	0,15	1,42	1,21	-0,28	-0,70	-1,98	0,78	0,78
E	-0,92	-3,25	2,06	1,00	0,78	2,70	1,63	-1,77	-0,07	-1,55	1,21	3,97
F	-4,10	-5,17	2,06	1,00	0,78	5,67	1,21	-1,55	-0,07	10,56	-0,07	2,70
G	-5,17	-6,23	-1,13	2,48	3,55	4,40	3,55	0,36	2,27	24,37	-0,07	2,91
H	-9,63	-3,89	-3,25	3,12	2,91	4,18	1,85	2,06	-0,28	-6,65	2,70	0,36

Figure 13 : Résultats des tests d'activités antibactériennes des fractions issues de la phase organique dirigées contre la souche *Marinomonas sp.* 12/107-2T2. (A) Numéros des fractions et (B) pourcentages d'inhibition de la croissance de la souche *Marinomonas sp.* 12/107-2T2 pour chacune des différentes fractions.

Ces trois fractions correspondent à deux pics majoritaires sur l'empreinte chimique (**Figure 14**). Les fractions actives, ainsi que les fractions les entourant, ont ensuite été regroupées afin d'être analysées en LC-HRMS.

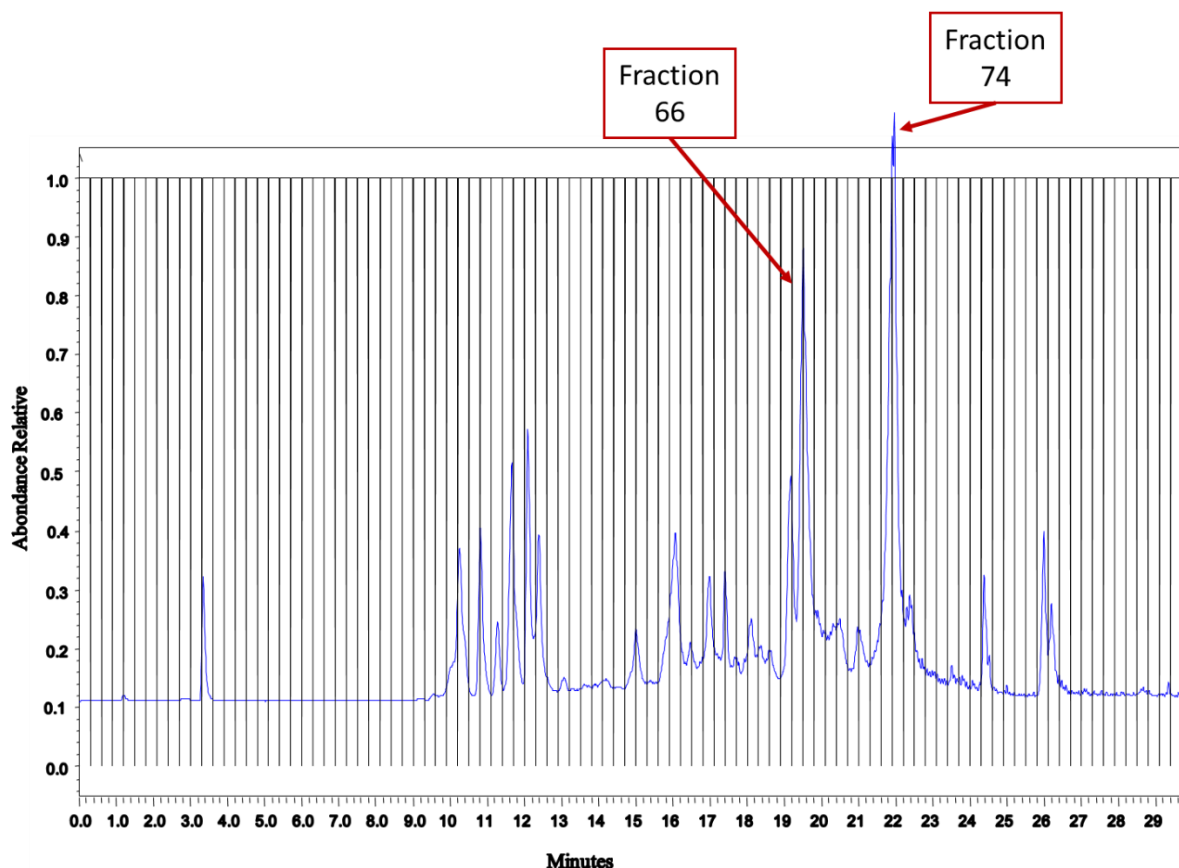

Figure 14 : Chromatogramme HPLC-DAD-DEDL de la phase organique (AE). Le tracé bleu correspond au chromatogramme obtenu par le détecteur DEDL. Les lignes verticales noires correspondent aux différentes fractions. Les deux fractions ayant conservé une activité antibactérienne contre la souche *Marinomonas sp.* 12/107-2T2 sont représentées par les flèches rouges.

Analyse LC-HRMS et identification des molécules actives

L'analyse en LC-HRMS des fractions actives nous a permis d'identifier, pour la fraction 66, deux ions de charge m/z de 286 (pic A1) et 357 (pic A2), ainsi qu'un ion de charge m/z de 314 (pic B) pour la fraction 74 (**Figure 15**).

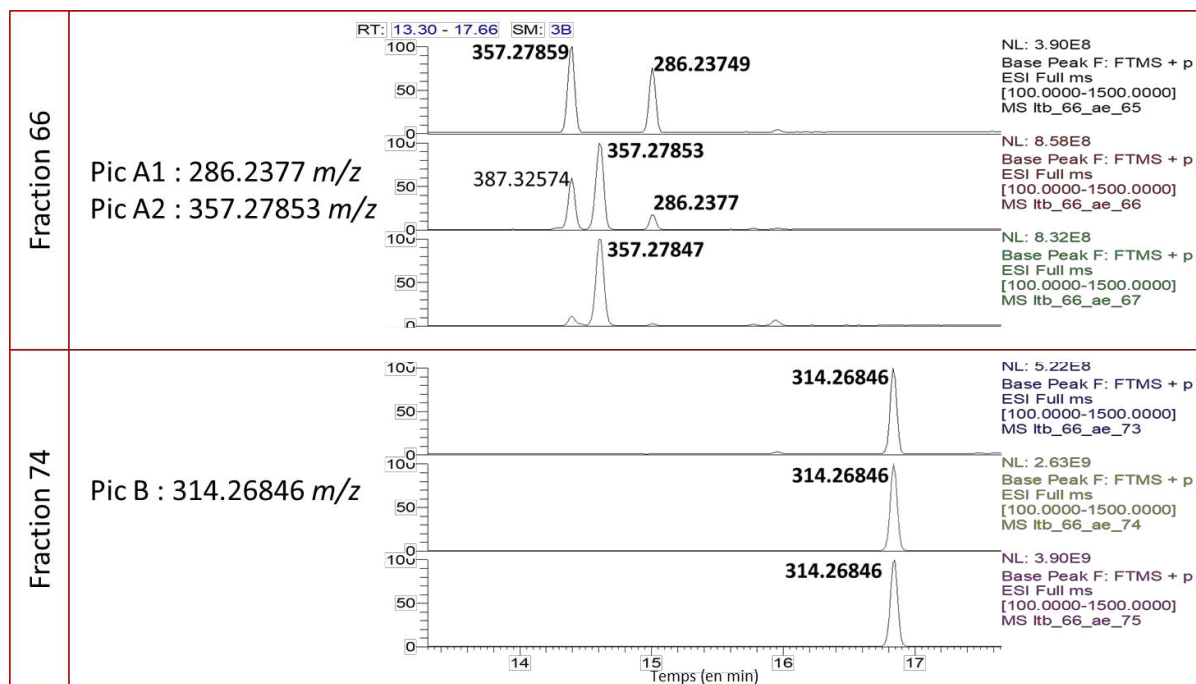

Figure 15 : Chromatogramme obtenu par l'analyse LC-HRMS. Pour la fraction 66 (en rouge) et ses fractions environnantes (noir et vert), deux ions, pic A1 (286,2377 m/z) et pic A2 (357,27853 m/z), ont été identifiés. Pour la fraction 74 (en jaune) et ses fractions environnantes (bleu et violet), un ion, pic B (314,26846 m/z), a été identifié.

La fragmentation en LC-HRMS/MS des ions ainsi identifiés a permis d'obtenir des spectres de fragmentation qui ont pu être comparés aux spectres de fragmentation de molécules déjà identifiées dans la littérature. Les ions correspondant aux pics A1 et B présentent des spectres de fragmentation similaires (**Figure 16 A,C**). Il s'agirait donc de molécules appartenant à la même famille, mais qui diffèrent l'une de l'autre par un motif $\text{CH}_2\text{-CH}_2$ présent en plus sur l'ion du pic B.

Les recherches sur la base de données (HMDB : Human Metabolome Database) avec la masse moléculaire ont permis de mettre en évidence une annotation pour l'ion du pic B : il s'agit de la N-Lauroyl Isoleucine ou de la N-Lauroyl Leucine, deux isomères appartenant à la famille des acides amino-acyls encore appelés lipoamino-acides (**Figure 16 C**). L'ion du pic A1 n'a pas été retrouvé dans les bases de données disponibles (**Figure 16 A**) et l'ion du pic A2, quant à lui, n'a pas pu être fragmenté dans ces conditions d'analyse (**Figure 16 B**), ce qui a rendu impossible l'identification de cette molécule.

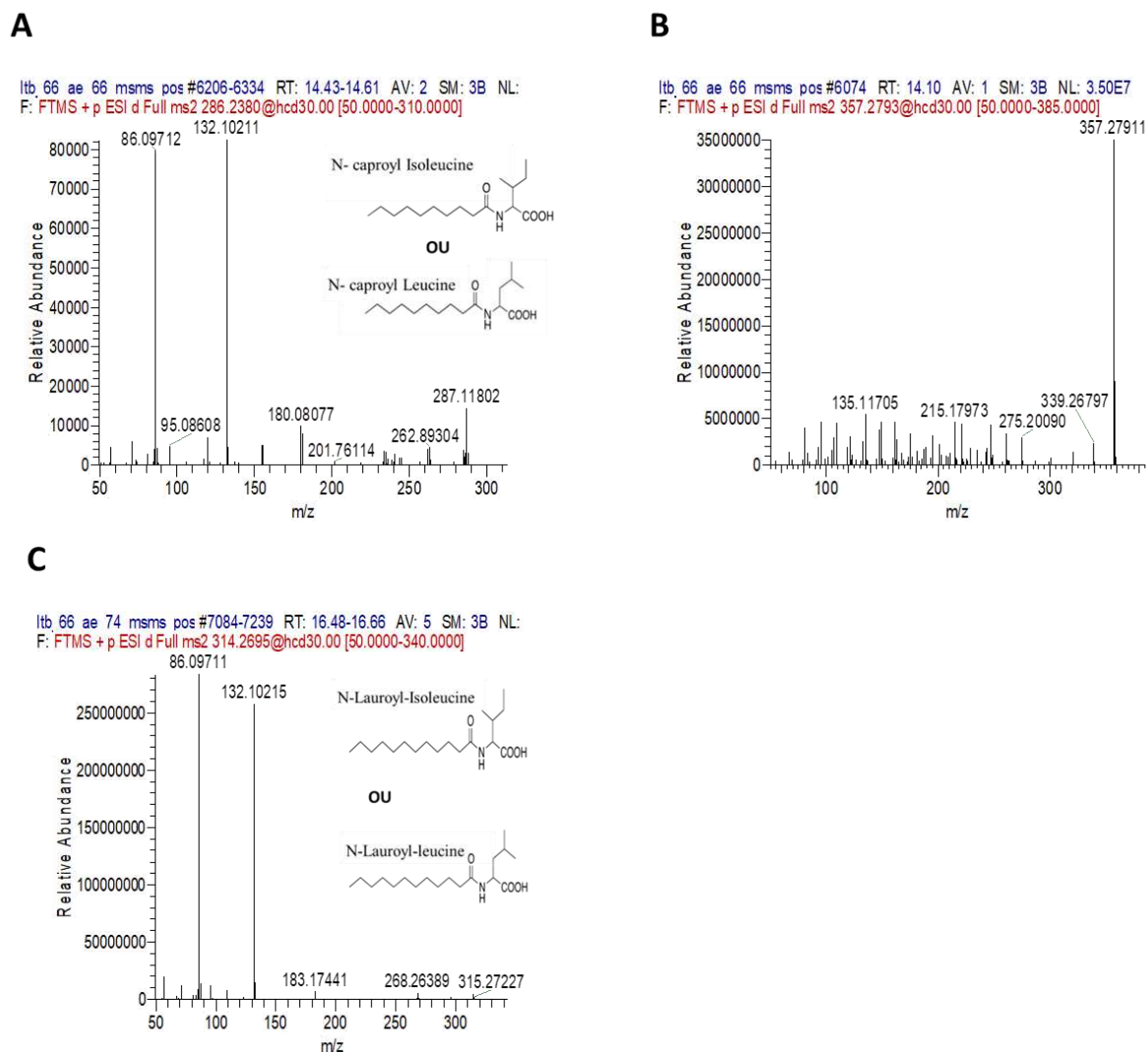

Figure 16 : Spectres de fragmentation en LC-HRMS/MS (mode positif) des ions correspondant au (A) pic A1, (B) pic A2 et (C) pic B.

L'ion correspondant au pic B a ensuite été analysé en RMN du proton. Le spectre RMN obtenu (**Figure 17**) nous a ainsi permis de déterminer la structure de la molécule par comparaison avec des spectres existant dans la littérature. Cela nous a permis d'identifier la molécule du pic B comme étant une N-Lauroyl-leucine. La différenciation entre leucine et isoleucine se fait en fonction des groupements méthyles de l'acide aminé : deux doublets à 0,97 et 0,96 ppm pour la leucine au lieu d'un triplet à 0,96 ppm et un doublet à 1 ppm pour l'isoleucine.

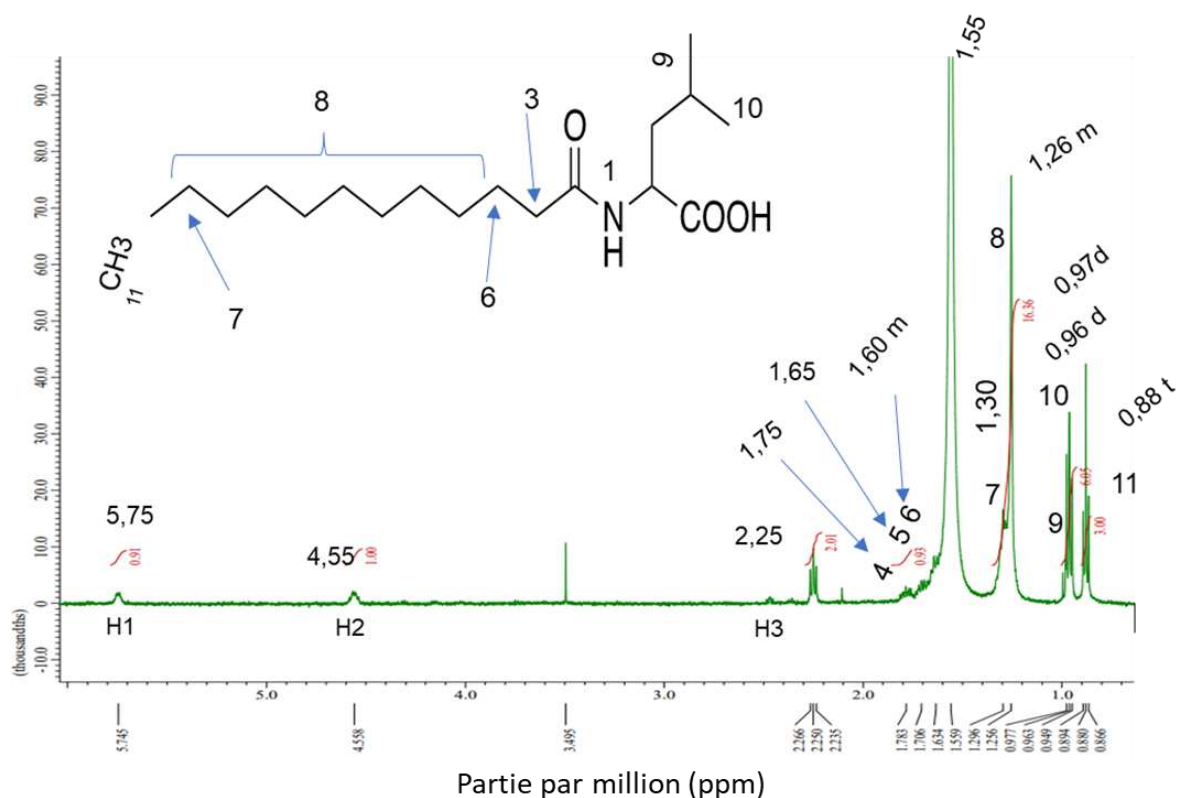

Figure 17 : Spectre RMN ion du proton de l'ion 314 dans CDCl_3 à 303K pour la molécule correspondant au pic B.

La N-Lauroyl-leucine est bien un composé actif contre la bactérie *Marinomonas sp.* 12/107-2T2

Afin de confirmer l'effet de la molécule identifiée lors des précédentes analyses (la N-Lauroyl-leucine), nous avons réalisé un test d'activité antibactérienne dirigé contre la bactérie *Marinomonas sp.* 12/107-2T2. (La synthèse de la molécule a été réalisée par Nicolas Inguibert du laboratoire CRIOBE). Les résultats du test ont montré que la molécule était active aux deux doses testées (15 mg/ml et 1,5 mg/ml) (**Figure 18**)

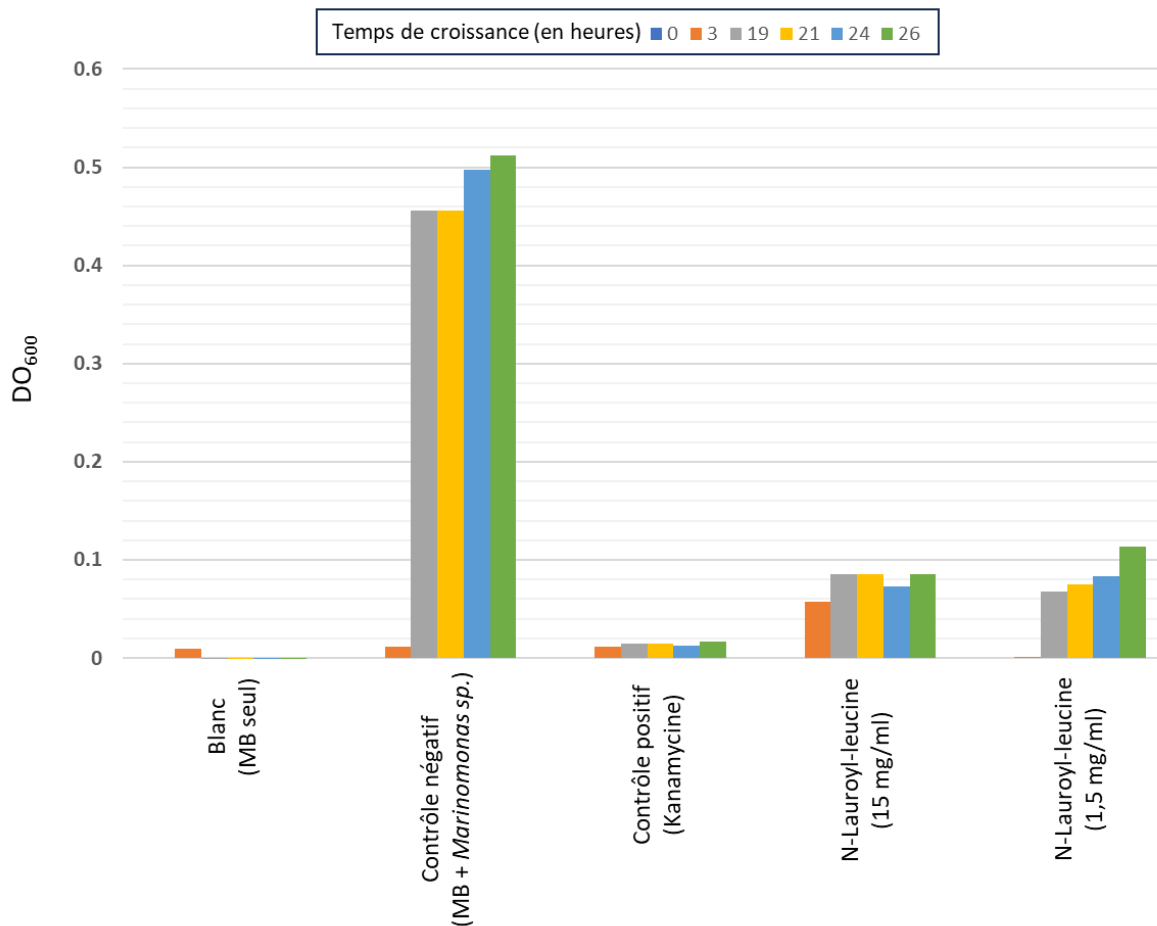

Figure 18 : Résultats du test d'activité antibactérienne de la N-Lauroyl-leucine dirigé contre la bactérie *Marinomonas sp.* 12/107-2T2. Les couleurs correspondent aux différents temps auxquels la DO₆₀₀ a été mesuré pour les cinq différentes conditions testées.

4. Discussion et Conclusion

Les organismes marins représentent une source importante de composés bioactifs possédant de nombreuses propriétés, dont les activités antibactériennes (Citarasu 2012). La recherche de composés antibactériens chez la bactérie *Halomonas sp.* LTB66 a permis d'identifier deux molécules : la première clairement identifiée comme étant une N-Lauroyl-leucine et la seconde comme étant une N-caproyl-isoleucine ou une N-caproyl-leucine. Ces deux molécules appartiennent à la famille des lipo-aminoacides (dérivés d'acides gras). Des recherches antérieures ont permis de démontrer que la souche *Halomonas sp.* BS4 produisait également des dérivés d'acides gras tels que des glycolipides ou des lipopeptides agissant comme biosurfactants. Ces biosurfactants ont démontré une activité antibactérienne contre différents

pathogènes humains (*Staphylococcus aureus*, *Klebsiella pneumoniae*, *Streptococcus pyogenes* ou *Salmonella typhi*) mais aussi une activité antifongique (Donio *et al.* 2013). De plus, l'injection de ces biosurfactants chez des crevettes infectées par le White Spot Syndrome Virus (WSSV) a permis de bloquer la croissance et la pathogénicité du virus (Donio *et al.* 2013).

Bien que le test d'activité antibactérienne ait confirmé que la N-Lauroyl-leucine est bien l'un des composés à activité antibactérienne sécrétés par notre bactérie *Halomonas sp.* LTB66, il sera nécessaire de déterminer la concentration minimale inhibitrice (CMI), mais aussi si cette molécule est active contre d'autres bactéries, à commencer par les bactéries cibles utilisées dans nos travaux. De plus, des tests supplémentaires pourront être mis en œuvre pour déterminer si le composé possède lui aussi d'autres types d'activités, telles que des activités antivirales dirigées notamment contre OsHV-1 μ Var ou encore des activités antifongiques. Il serait également intéressant de réaliser ce même genre d'analyse sur les trois autres souches bactériennes ayant conféré un effet bénéfique pour la survie des huîtres lors de l'infection à *Vibrio aestuarianus*.

III. Caractérisation des activités de Quorum Quenching de bactéries issues du microbiote naturel de l'huître *Crassostrea gigas*

1. Introduction

La recherche de bactéries possédant une activité de quorum quenching (capacité à inhiber la communication chimique entre les bactéries) présente plusieurs intérêts, notamment en aquaculture. En effet, leur utilisation pourrait permettre de lutter contre l'installation durable, dans les systèmes d'élevage, de bactéries formant des biofilms (Zhao *et al.* 2015). De plus, leur utilisation pourrait contribuer à réguler des mécanismes de virulence déclenchés par le quorum sensing (Chen *et al.* 2020) (*cf.* Introduction, partie III, sous-partie 1). La recherche de molécules actives contre la formation de biofilm présente également des intérêts dans le domaine de la construction, pour lutter contre la dégradation des matériaux par les biofilms bactériens (Romani *et al.* 2022), ainsi que dans le domaine médical afin de lutter contre la formation de biofilm dans les cathéters (Ivanova *et al.* 2015).

Nous avons donc recherché, au sein de la collection de bactéries associées aux huîtres résistantes à la maladie du POMS, si des bactéries présentaient une activité de quorum quenching. Les résultats obtenus devaient permettre de sélectionner des candidats supplémentaires pour des tests d'effet protecteur *in vivo* chez les huîtres. Cependant, les travaux de thèse ayant pris une direction davantage orientée sur les effets indirects et sur les effets des activités antibactériennes, ces résultats sont donc restés à un stade préliminaire.

Les travaux présentés dans cette partie ont été réalisés dans le cadre du stage de Master 2 de Prunelle Carcassonne, Master 2 Science de la Mer de l'Université d'Aix-Marseille et en collaboration avec Raphaël Lami, Maître de conférences au LBBM à Banyuls-sur-Mer.

2. Matériel et Méthodes

Afin d'effectuer le criblage des activités de quorum quenching, la bactérie *Escherichia coli* MT102 (pJBA132) (Winson *et al.* 1998) a été utilisée comme biosenseur. Ce biosenseur produit et détecte des AHL (N-Acyl Homosérine Lactones) à chaîne courte (C6 AHL). En présence d'AHL, ce biosenseur exprime un gène rapporteur codant pour la Green Fluorescent Protein

(GFP). Le principe du test repose donc sur la détection et la quantification de la production de GFP par une culture de biosenseur en présence du surnageant de culture des bactéries à tester. (Figure 19).

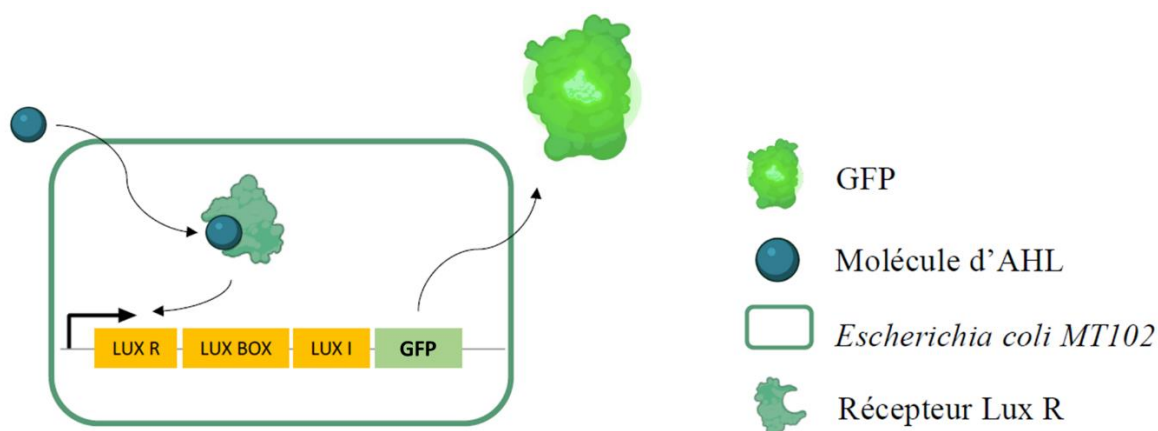

Figure 19 : Principe de fonctionnement du biosenseur *Escherichia coli* MT102 : lorsque des molécules d'AHL sont présentes dans le milieu, la protéine LuxR va les fixer et se lier au promoteur induisant l'expression du gène codant pour la GFP. Ainsi, une augmentation de la fluorescence indique la présence de mécanismes de quorum sensing. Dans notre test, nous forçons le mécanisme du quorum sensing en ajoutant des AHL dans le milieu et mesurons la baisse de la fluorescence, qui nous indique alors une activité de quorum quenching.

Brièvement, les 328 souches de la collection de bactéries ont été cultivées en milieu liquide Marine Broth supplémenté en C6 Acyl Homosérine Lactone (C6-AHL) pendant 48 heures. Le surnageant de ces cultures a ensuite été transféré en triplicat dans des plaques 96 puits. Une culture âgée de 24 heures du biosenseur est ensuite ajoutée dans les plaques 96 puits et un ajout de C6-AHL est effectué afin d'induire une fluorescence du biosenseur par la production de GFP.

Une première mesure de la DO à 535 nm est effectuée afin de mesurer la fluorescence émise par le biosenseur. Une lecture de la DO à 600 nm est également effectuée afin de s'assurer de la croissance du biosenseur. Les plaques 96 puits sont ensuite mises à incuber à 37 °C pendant 24 heures et une nouvelle lecture de la DO à 535 nm et 600 nm est effectuée. Si une baisse de la fluorescence ainsi qu'une augmentation de la croissance bactérienne sont observées, alors nous pouvons supposer qu'il y a un effet de quorum quenching.

Pour confirmer ces résultats et écarter la possibilité d'un effet cytotoxique du surnageant sur le biosenseur, une mesure de l'activité de l'ATP est réalisée à l'aide du kit "BacTiter-Glo™ Microbial Cell Viability Assay" (Promega Corporation, Madison, WI, USA).

Les valeurs de fluorescence sont, dans un premier temps, normalisées par rapport à la fluorescence du témoin négatif (milieu LB seul) et à la croissance des bactéries (DO 600) avec la formule suivante :

$$Fluorescence_{Echantillon\ norm.} = \frac{Fluorescence_{Echantillon} - Fluorescence_{LB}}{DO600_{Echantillon} - DO600_{LB}}$$

Ensuite, le pourcentage d'extinction de la fluorescence est calculé pour chaque échantillon à l'aide de la formule :

$$\begin{aligned} \% \text{ Extinction Fluorescence} \\ = \frac{Fluorescence_{MT102+ AHL} - Fluorescence_{Echantillon\ norm.}}{Fluorescence_{MT102+ AHL}} * 100 \end{aligned}$$

3. Résultats

Sur les 328 bactéries de la collection testées, 47 ont induit une baisse de la fluorescence d'au moins 60 %. Parmi ces bactéries, cinq proviennent de Brest, 21 de La Tremblade, sept d'Arcachon et 14 de Thau (**Figure 20**)

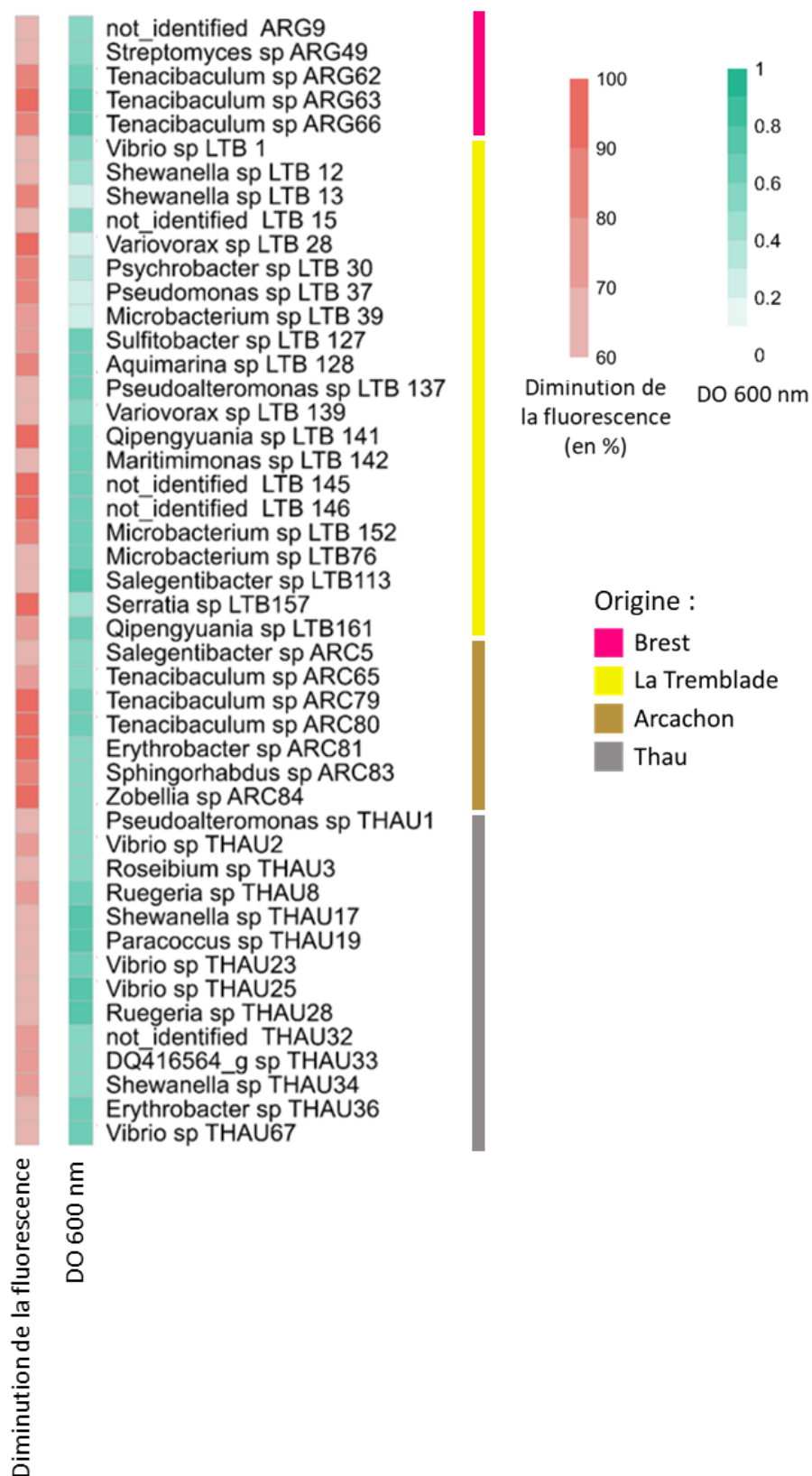

Figure 20 : Résultats des tests d'activité de quorum quenching. Heatmap représentant l'impact sur la diminution de la fluorescence et la croissance du biosenseur (DO 600). Seuls les résultats pour les bactéries ayant induit une réduction minimale de 60 % de la fluorescence sont représentés.

Pour les souches ayant induit une baisse de la fluorescence, la viabilité cellulaire du biosenseur (mesure de l'ATP) a été réalisée afin de s'assurer que la baisse de la fluorescence ne soit pas due à un effet cytotoxique du surnageant. Parmi les bactéries testées, seule la bactérie *Serratia sp.* LTB157 a présenté un effet cytotoxique sur le biosenseur *E. coli* MT102.

4. Discussion et Conclusion

La caractérisation des activités de quorum quenching parmi les bactéries de la collection a permis d'identifier 47 bactéries ayant une activité de quorum quenching dirigée contre les AHL à chaîne courte (C6-AHL). Parmi elles, nous retrouvons six bactéries appartenant au genre *Tenacibaculum*. Des bactéries appartenant à ce genre ont déjà été identifiées comme possédant des effets de quorum quenching sur un spectre large d'AHL. L'utilisation d'extraits cellulaires bruts d'une souche de *Tenacibaculum* possédant des activités de quorum quenching a notamment permis de lutter contre une bactérie pathogène pour les poissons, *Edwardsiella tarda* (Romero *et al.* 2014), ou encore d'inhiber la formation de biofilm par des bactéries du genre *Streptococcus* (Muras *et al.* 2018).

Cette caractérisation d'effet de quorum quenching ne représente cependant qu'un premier criblage. En effet, d'autres criblages utilisant d'autres biosenseurs ciblant une action de quorum quenching dirigé contre des AHL à chaînes longues (C10-AHL) ou à chaînes très courtes (C4-AHL) devront être réalisés. Une fois ces criblages réalisés, une caractérisation chimique par LC-HRMS des molécules ayant une activité de quorum quenching pourrait être réalisée. Cela pourrait permettre à l'avenir d'identifier de nouvelles biomolécules d'intérêt à la fois pour lutter contre des pathogènes marins ou humains, mais aussi plus généralement contre la formation de biofilms et éviter les phénomènes d'encrassement biologique (également appelé biofouling).

Discussion générale et Perspectives

L'aquaculture est l'un des secteurs de production alimentaire qui se développe le plus rapidement (Food and Agriculture Organization 2022). La production aquacole pourrait ainsi jouer un rôle primordial dans la sécurité alimentaire (Food and Agriculture Organization 2022). Néanmoins, les changements climatiques globaux et la densification des zones d'élevage provoquent une intensification des épizooties qui sont responsables de pertes importantes de la production aquacole. Une projection réalisée par (Lam *et al.* 2016) prévoit une chute de 35 % des revenus de l'ensemble des activités aquacoles. La production mondiale d'huîtres du Pacifique *Crassostrea gigas* est également affectée par ces épizooties causées par différents pathogènes dont un virus, l'Ostreid herpesvirus 1 μ Var, et des bactéries du genre *Vibrio* telles que *Vibrio aestuarianus*. Il devient donc nécessaire de développer des méthodes de lutte contre ces maladies infectieuses afin de limiter les pertes pour le secteur ostréicole.

L'ensemble du travail réalisé durant cette thèse nous a permis de démontrer que :

- 1) Une exposition au stade larvaire à un microbiote provenant d'individus sains et ayant toujours vécu en environnement contrôlé permet de conférer un effet protecteur contre la maladie du POMS et les infections à *V. aestuarianus* par des effets immunomodulateurs.
- 2) Une exposition à des mélanges multi-souches de bactéries cultivables, permet également grâce à des effets immunomodulateurs de conférer un effet protecteur. Néanmoins, cette protection ne concerne dans notre étude que la maladie du POMS.
- 3) L'utilisation de souches bactériennes uniques/spécifiques peut également conférer une protection vis-à-vis des infections à OsHV-1 μ Var et *V. aestuarianus* en agissant par des effets directs contre *V. aestuarianus* ou les bactéries opportunistes impliquées dans l'infection bactérienne secondaire lors de la maladie du POMS.
- 4) Les effets positifs conférés par les microorganismes sont dépendants en partie du fond génétique des huîtres receveuses.
- 5) Le microbiote naturel de l'huître *C. gigas* est une source prometteuse de biomolécules pouvant avoir un champ d'applications variées.

Influence de l'exposition microbienne sur la réponse transcriptomique de l'huître.

Nous avons pu constater au cours de ces travaux qu'une exposition à un microbiote complet ou à des mélanges de bactéries multi-souches lors des stades précoces du développement avait induit des changements à long terme de la réponse transcriptomique des huîtres. Nos résultats ont montré que la réponse transcriptomique des huîtres exposées aux microorganismes, comparée à celle des huîtres témoins, présentait un nombre de gènes différentiellement exprimés plus important que chez les huîtres non exposées, et ce, huit mois après l'exposition aux microorganismes. De plus, nous avons pu démontrer que parmi les gènes impliqués dans cette réponse transcriptomique, certains étaient associés à des fonctions liées à la réponse immunitaire. Ces résultats démontrent que l'exposition, aussi bien à un microbiote complet qu'à des mélanges de bactéries multi-souches, déclenche chez les huîtres un mécanisme de réponse immunitaire (également appelé *shaping* immunitaire). Le profil transcriptomique de la réponse immunitaire obtenu au cours de notre étude correspond à une réponse immunitaire maintenue (Coustau *et al.* 2016; Melillo *et al.* 2018; Prigot-Maurice *et al.* 2022). Ce type de réponse immunitaire a déjà été observé chez l'huître à la suite de l'injection d'une molécule mimant un agent viral : le Poly(I:C) (Lafont *et al.* 2017, 2020).

L'analyse des gènes significativement différentiellement exprimés liés à l'immunité a permis de mettre en évidence, pour la population d'huîtres provenant d'Arcachon, la surexpression de certains types de récepteurs (C-type lectine, C1q), d'un gène lié à des fonctions antibactériennes, de gènes liés aux fonctions antivirales, mais aussi une sous-expression de gènes liés à d'autres types de récepteurs (G-protein receptor, scavenger receptor), à la dégradation des protéines et à la réponse aux dommages causés à l'ADN. Ces résultats suggèrent que la résistance des huîtres passe par une détection précoce et une réponse rapide face aux pathogènes, comme cela a déjà été montré dans des familles d'huîtres résistantes à la maladie du POMS comparé à des huîtres sensibles (de Lorgeril *et al.* 2018b, 2020).

Cependant, bien que l'étude du transcriptome permette de connaître quels gènes sont transcrits, elle ne permet pas de savoir quels transcrits seront réellement traduits en protéines fonctionnelles. C'est pourquoi, il serait intéressant par la suite d'étudier la réponse protéomique des huîtres exposées aux microorganismes. Récemment, une étude comparative du protéome d'huîtres résistantes et sensibles à la maladie du POMS a permis de montrer que chez les huîtres résistantes à la maladie un plus grand nombre de récepteurs de reconnaissance de motifs moléculaires (PRR) tels que des lectines, des C1q-TNF ou des chitinases étaient modulés par

rapport aux huîtres sensibles (**Figure 21**) (Leprêtre *et al.* 2021). Ces PRR vont accroître la reconnaissance des particules virales chez les huîtres résistantes et permettre une réponse plus rapide que chez les huîtres sensibles (Leprêtre *et al.* 2021). Au cours de cette réponse plus précoce, une modulation plus importante chez les huîtres résistantes de protéines ubiquitin-like et de protéines impliquées dans la réponse antivirale est également observée (**Figure 21**) (Leprêtre *et al.* 2021).

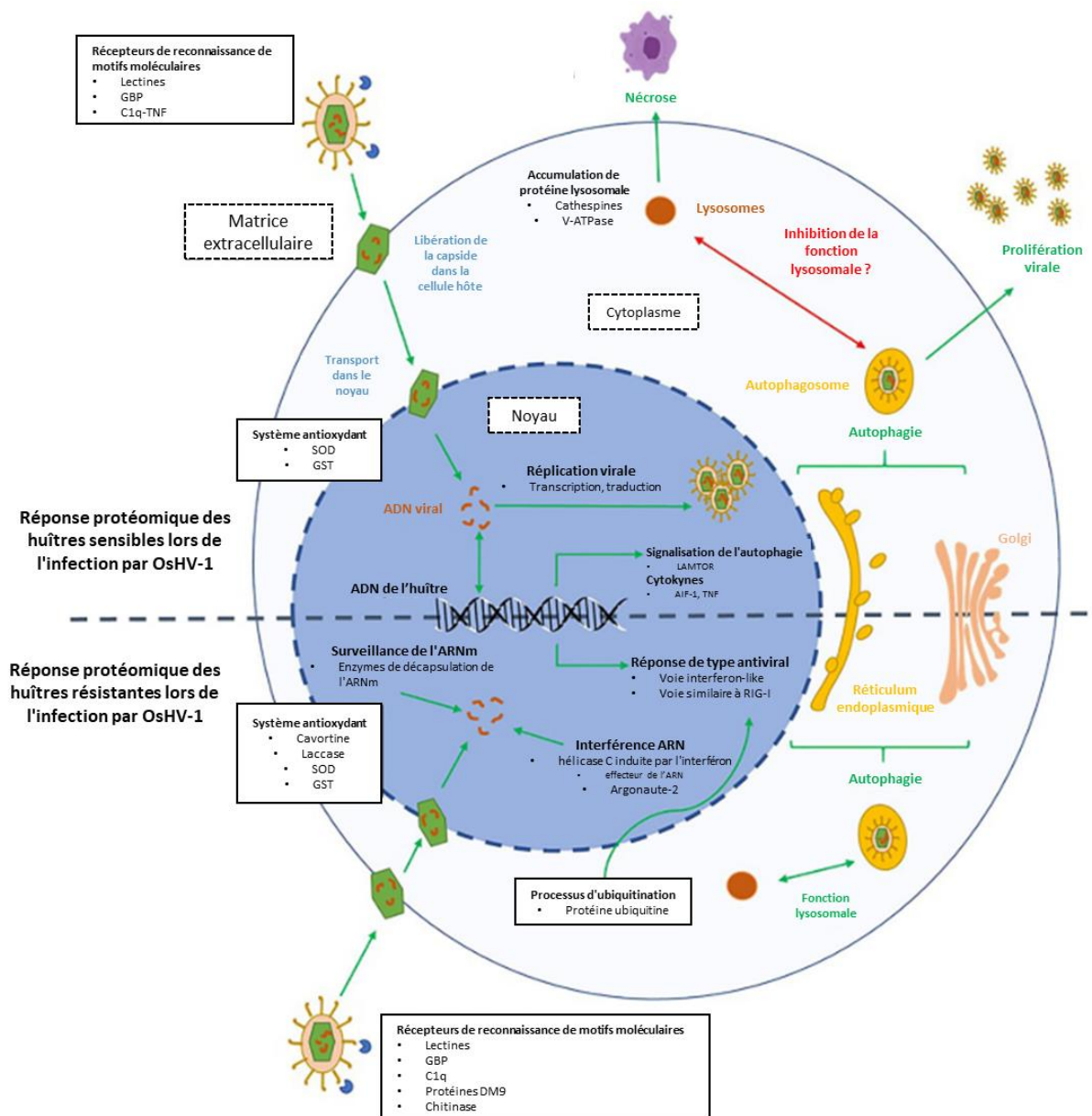

Figure 21 : Hypothèse émise à la suite d'une analyse protéomique sur les mécanismes moléculaires impliqués dans l'interaction entre le virus OsHV-1 et les cellules des huîtres sensibles (partie supérieure) et résistantes (partie inférieure). Les flèches vertes représentent les voies impliquées en réponse à l'infection virale et les flèches rouges représentent les voies inhibées par le virus. Modifié d'après (Leprêtre *et al.* 2021).

Quel est le rôle de l'épigénétique dans la modulation du système immunitaire à la suite d'une exposition à des microorganismes ?

Les mécanismes épigénétiques peuvent être définis comme des changements de fonctions de gènes sans modification de la séquence ADN. Ces changements peuvent être réversibles, mais aussi être héréditaires à travers de la mitose et/ou de la méiose (Fallet *et al.* 2020). Différents changements peuvent ainsi intervenir, parmi ceux-ci, la modification des histones, la méthylation de l'ADN ou les ARN non-codants (Fallet *et al.* 2020). Chez l'huître *C. gigas*, des modifications épigénétiques ont déjà été identifiées comme étant impliquées dans des phénomènes de résistance face aux infections à OsHV-1 (Fallet *et al.* 2022; Gawra *et al.* 2023). Notamment, il a pu être démontré qu'une exposition à des microorganismes lors des stades précoces du développement avait eu un impact sur la méthylation de l'ADN (Fallet *et al.* 2022). De plus, il a été observé que ces modifications épigénétiques avaient pu être transférées à la génération suivante. Si l'étude de Fallet *et al.* (2022) montre que les patrons de méthylation de l'ADN de gènes liés à des fonctions immunitaires sont impactés par l'exposition à un microbiote, le lien entre les changements des marques épigénétiques et l'expression des gènes n'est pas totalement compris. Ainsi, le lien fonctionnel entre les phénotypes liés à la réponse immunitaire et les changements observés au niveau de la méthylation de l'ADN reste à caractériser.

Au cours de ce travail de thèse, des mécanismes de résistance similaires ont pu être observés ; cependant, les modifications épigénétiques n'ont pas été étudiées. Néanmoins, nous pouvons émettre l'hypothèse que l'exposition aux microorganismes lors des stades larvaires a pu induire chez l'huître des modifications épigénétiques. Ces modifications sont probablement responsables des changements de la réponse transcriptomique observée chez les huîtres exposées, conduisant *in fine* à une résistance accrue face aux infections par OsHV-1 et *V. aestuarianus*. Pour compléter ces travaux, il serait également intéressant de déterminer si l'effet protecteur obtenu peut être transmis sur plusieurs générations.

Limites de l'approche probiotiques

Nous avons pu démontrer qu'il était possible d'utiliser des bactéries cultivables afin de conférer un effet protecteur pour l'huître. Pour cela, deux mécanismes distincts sont possibles. Le premier par une immunomodulation à la suite d'une exposition lors des stades précoces du développement. Le second par l'action des effets antagonistes des bactéries vis-à-vis des agents pathogènes (pathogènes vrais ou opportunistes). Bien que ces résultats soient prometteurs et pourraient permettre de réduire significativement les pertes causées par la maladie du POMS, les infections à *V. aestuarianus* voire même d'autres pathogènes affectant les huîtres, l'approche des probiotiques fait face à certaines limites.

La première limitation concerne l'application de ces méthodes au niveau des écloseries. En effet, l'approche développée lors du chapitre 1 consistant à exposer des larves à des microorganismes pourrait potentiellement y être utilisée. Cependant, les pratiques actuelles cherchent à limiter l'introduction de microorganismes ainsi que le plancton et le zooplancton indésirable dans l'eau de mer et ce, dès le conditionnement des stocks de géniteurs et jusqu'au stade de naissain. Les écloseries sont donc équipées de systèmes de traitement de l'eau de mer par filtration mécanique (seuil de 1 micron) (Bourne *et al.* 1989; Helm *et al.* 2004) voire des systèmes d'ultrafiltration sur membrane abaissant encore plus le seuil de rétention des bactéries et virus (Eljaddi *et al.* 2021; Cordier *et al.* 2021). Un traitement de l'eau par des UVs est également ajouté afin de neutraliser les micro-organismes et de rendre l'eau de mer adaptée à l'élevage (Brown and Russo 1979; Brown and Nash 1981; Helm *et al.* 2004). Il conviendra donc, afin de pouvoir appliquer une approche par probiotiques, de changer dans un premier temps les pratiques d'élevage, notamment lors des étapes dans les écloseries, avec par exemple l'introduction de microorganismes lors des étapes d'élevage larvaire. Cette approche est d'autant plus réaliste que nous avons pu démontrer que l'utilisation d'huîtres donneuses de microbiote, élevées en conditions contrôlées et donc exemptes de pathogènes, permettait d'induire un effet protecteur à long terme chez les huîtres. Il est donc tout à fait réalisable d'introduire dans le milieu des microorganismes ne représentant pas de danger.

La seconde limitation concerne l'application au niveau des fermes ostréicoles lors de l'élevage des huîtres juvéniles et adultes. La seconde approche développée lors du chapitre 2 vise à exploiter les effets antagonistes des bactéries dirigés contre des pathogènes de l'huître et à exposer des huîtres lors des stades juvénile ou adulte. Comparée à la première approche, celle-ci est confrontée à un problème d'applicabilité plus important. En effet, l'élevage des huîtres

juvéniles et adultes étant réalisé en milieu ouvert, il apparaît impossible de pouvoir y administrer des bactéries. Là encore, la modification des pratiques ostréicoles sera nécessaire afin d'exploiter cette méthode. Du fait que les effets bénéfiques persistent sans que les bactéries ne s'implantent dans le microbiote, une approche possible serait de réaliser une étape de balnéation avec les bactéries d'intérêt, puis de procéder à une étape de déuration pour les éliminer avant une mise sur le terrain des huîtres juvéniles et/ou adultes.

Une troisième limitation que nous avons pu démontrer lors de ces travaux est que les effets provoqués par l'exposition aux bactéries dépendent en partie du fonds génétique des animaux. Peu d'études ont comparé l'effet d'une même exposition à des microorganismes sur différents fonds génétiques d'une même espèce. Une étude sur l'utilisation d'un probiotique commercial sur deux souches de crevette à pattes blanches, *Litopenaeus vannamei*, a montré que l'exposition au probiotique a modifié le microbiote de façon différente entre les deux souches (Landsman *et al.* 2019). Une autre étude a démontré que lors de l'utilisation d'un mélange de probiotiques chez des souris, une expression de gènes liés à l'immunité différente entre deux fonds génétiques est observée (Mariman *et al.* 2015). L'ensemble de ces études et les résultats obtenus au cours de ce travail de thèse suggèrent que l'approche par probiotiques ne serait donc pas une approche universelle et pourrait fournir des résultats contrastés sur les différentes populations et familles d'huîtres.

Pourquoi les associations sympatriques n'ont pas induit de synergie sur les effets bénéfiques ?

Une des hypothèses testées lors du premier chapitre cherchait à déterminer si une meilleure protection contre la maladie du POMS ou contre la bactérie *V. aestuarianus* pouvait être induite par une association sympatrique entre les microorganismes administrés et les populations d'huîtres. Toutefois, nos résultats n'ont montré aucune synergie sur les effets bénéfiques d'une telle association spécifique. Deux hypothèses pourraient expliquer cela.

Premièrement, l'arrivée plutôt récente de l'huître *C. gigas* sur nos côtes françaises entre 1971 et 1975 (Grize and Héra 1991). Ce court laps de temps n'a probablement pas donné le temps nécessaire à l'établissement d'une relation sympatrique entre les huîtres et les microorganismes.

La seconde hypothèse concerne les pratiques aquacoles pouvant entraîner de nombreux déplacements d'huîtres par les ostréiculteurs. En effet, ces déplacements d'huîtres dans

différentes régions entraînent également des déplacements de microorganismes. La mise en contact des huîtres avec des microorganismes provenant d'origines différentes empêche un établissement durable et donc une évolution sympatrique. De plus, ces déplacements d'huîtres peuvent engendrer un biais dans l'identification de l'origine géographique des populations d'huîtres sauvages. Bien que nous ayons prélevé des huîtres sauvages, il n'est pas exclu que leurs géniteurs proviennent d'une origine géographique différente. Par conséquent, ce biais dans l'appréciation de l'origine géographique des géniteurs pourrait expliquer l'absence d'évolution sympatrique entre les huîtres et les microorganismes.

Perspectives

Bien que les travaux réalisés au cours de cette thèse aient permis de montrer que le microbiote naturel de l'huître *C. gigas* peut être utilisé comme moyen de lutte contre la maladie du POMS et les infections à *Vibrio aestuarianus*, d'autres études sont nécessaires afin d'approfondir cette piste.

Concernant l'utilisation des microorganismes lors des stades larvaires, bien que nous ayons pu démontrer que l'exposition au microbiote complet et à deux mélanges de bactéries multi-souches ait amélioré la survie des huîtres, il reste nécessaire d'apporter des améliorations. Celles-ci peuvent porter sur le mode d'administration des bactéries, en jouant par exemple sur la concentration, la durée d'exposition ou encore la fenêtre temporelle d'exposition, ou porter sur les mélanges eux-mêmes en modifiant par exemple la composition de ces derniers ou les proportions en bactéries qui le composent. Le but de ces améliorations serait dans un premier temps de ne plus causer de mortalité lors des stades larvaires, mais cela pourrait évoluer vers la recherche d'effets bénéfiques supplémentaires, tels que l'amélioration de la croissance ou de résistances contre un spectre plus large d'agents pathogènes.

Comme discuté précédemment, il serait également intéressant d'étudier les mécanismes épigénétiques mis en place à la suite de cette exposition microbienne lors des stades larvaires. De plus, il serait judicieux de réaliser des reproductions d'huîtres ayant acquis un phénotype de résistance à la suite de l'exposition microbienne et de soumettre cette descendance à des tests infectieux afin de déterminer si le phénotype de résistance se transmet à la génération suivante.

Concernant les effets bénéfiques conférés par l'exposition à des bactéries possédant des effets antagonistes, nous avons pu démontrer également un effet protecteur contre la maladie du

POMS et *V. aestuarianus*. Cependant, ces effets sont observés immédiatement après l'exposition aux bactéries. Il sera donc nécessaire de réaliser des essais sur des périodes plus longues afin de déterminer la persistance de ces effets bénéfiques chez les huîtres.

Il serait également intéressant de cribler la collection de bactéries pour des activités antibactériennes dirigées contre d'autres bactéries pathogènes affectant des espèces d'intérêt aquacole, voire même affectant l'Homme. La caractérisation des molécules à activité antibactérienne sera également un élément pouvant apporter d'autres solutions alternatives de lutte contre les agents pathogènes affectant l'huître *C. gigas*, mais également d'autres espèces. Lorsque des molécules auront été identifiées, il pourrait également être intéressant de les tester pour des activités antivirales et antifongiques.

La recherche de bactéries dans la collection possédant des activités de quorum quenching pourrait également permettre de trouver de nouveaux candidats probiotiques capables de bloquer la virulence de certains pathogènes. Elle pourrait également permettre d'identifier des biomolécules actives contre la formation de biofilms, avec de nombreuses applications potentielles dans la lutte contre l'encrassement biologique (biofouling).

Enfin, la collection de bactéries générée au cours de cette thèse pourrait être criblée pour des champs d'activités plus larges, avec par exemple la recherche de bactéries capables de dégrader des composés chimiques tels que des pesticides ou les filtres UVs.

Conclusion

L'ensemble des résultats obtenus lors de ce travail de thèse ont permis de démontrer l'importance du microbiote et de certaines bactéries qui le composent pour la santé de leur hôte, l'huître du Pacifique *Crassostrea gigas*. Cet effet bénéfique passe par des interactions entre l'hôte et les microorganismes de son microbiote, mais aussi entre les microorganismes eux-mêmes. Deux types de mécanismes ont pu être mis en évidence au cours de cette thèse.

Le premier mécanisme, qui est celui de l'éducation microbienne, a permis lors d'une interaction entre des microorganismes et des larves d'huîtres de moduler le système immunitaire des huîtres de façon durable. Cette approche novatrice permet de renforcer l'immunité des huîtres sur le long terme, offrant ainsi une protection contre la maladie du POMS ou la bactérie pathogène *Vibrio aestuarianus*.

Le second mécanisme mis en évidence dans ces travaux de thèse repose sur les interactions antagonistes entre des bactéries naturellement présentes dans le microbiote et les bactéries opportunistes liées à l'étape de la dysbiose lors de la maladie du POMS ou la bactérie pathogène *V. aestuarianus*. Cette approche offre également de nouvelles perspectives prometteuses dans la lutte contre ces infections dévastatrices pour la filière ostréicole.

La collection de bactéries générée au cours de ces travaux de thèse constitue également une source prometteuse de bactéries ayant des applications étendues, allant de la recherche de probiotiques avec des propriétés immunostimulantes, antibactériennes ou de quorum quenching, ou encore la recherche de biomolécules servant à la lutte contre l'encrassement biologique ou la dégradation de composés chimiques.

Ainsi, ce travail de thèse a démontré l'importance des interactions hôtes-microbiote dans la lutte contre les pathogènes chez l'huître du Pacifique *Crassostrea gigas* et apporte des solutions d'applications novatrices ouvrant la voie à une nouvelle gestion des maladies infectieuses dans la filière ostréicole, contribuant ainsi à la durabilité de cette activité.

Références bibliographiques

- Abellan-Schneyder I, Matchado MS, Reitmeier S, Sommer A, Sewald Z, Baumbach J, List M, Neuhaus K (2021) Primer, Pipelines, Parameters: Issues in 16S rRNA Gene Sequencing. *mSphere*. doi: 10.1128/MSPHERE.01202-20/FORMAT/EPUB
- Aguilar-Macías OL, Ojeda-Ramírez JJ, Campa-Córdova AI, Saucedo PE (2010) Evaluation of natural and commercial probiotics for improving growth and survival of the pearl oyster, *Pinctada mazatlanica*, during Late hatchery and early field culturing. *J World Aquac Soc* 41:447–454. doi: 10.1111/j.1749-7345.2010.00386.x
- Arzul I, Carnegie RB (2015) New perspective on the haplosporidian parasites of molluscs. *J Invertebr Pathol* 131:32–42. doi: 10.1016/j.jip.2015.07.014
- Arzul I, Garcia C, Chollet B, Serpin D, Lupo C, Noyer M, Tourbiez D, Berland C, Dégremont L, Travers MA (2022) First characterization of the parasite *Haplosporidium costale* in France and development of a real-time PCR assay for its rapid detection in the Pacific oyster, *Crassostrea gigas*. *Transbound Emerg Dis* 69:e2041–e2058. doi: 10.1111/tbed.14541
- Azéma P, Travers MA, De Lorgeril J, Tourbiez D, Dégremont L (2015) Can selection for resistance to OsHV-1 infection modify susceptibility to *Vibrio aestuarianus* infection in *Crassostrea gigas*? First insights from experimental challenges using primary and successive exposures. *Vet Res*. doi: 10.1186/s13567-015-0282-0
- Azéma P, Lamy JB, Boudry P, Renault T, Travers MA, Dégremont L (2017) Genetic parameters of resistance to *Vibrio aestuarianus*, and OsHV-1 infections in the Pacific oyster, *Crassostrea gigas*, at three different life stages. *Genet Sel Evol* 49:1–16. doi: 10.1186/s12711-017-0297-2
- Bachère E, Rosa RD, Schmitt P, Poirier AC, Merou N, Charrière GM, Destoumieux-Garzón D (2015) The new insights into the oyster antimicrobial defense: Cellular, molecular and genetic view. *Fish Shellfish Immunol* 46:50–64. doi: 10.1016/j.fsi.2015.02.040

- Bayne BL, Ahrens M, Allen SK, D'Auriac MA, Backeljau T, Beninger P, Bohn R, Boudry P, Davis J, Green T, Guo X, Hedgecock D, Ibarra A, Kingsley-Smith P, Krause M, Langdon C, Lapègue S, Li C, Manahan D, Mann R, Perez-Paralle L, Powell EN, Rawson PD, Speiser D, Sanchez JL, Shumway S, Wang H (2017) The proposed dropping of the genus *Crassostrea* for all pacific cupped oysters and its replacement by a new genus *Magallana*: A dissenting view. *J Shellfish Res* 36:545–547. doi: 10.2983/035.036.0301
- Bohlson SS, Fraser DA, Tenner AJ (2007) Complement proteins C1q and MBL are pattern recognition molecules that signal immediate and long-term protective immune functions. *Mol Immunol* 44:33–43. doi: 10.1016/j.molimm.2006.06.021
- Bordenstein SR, Theis KR (2015) Host biology in light of the microbiome: Ten principles of holobionts and hologenomes. *PLoS Biol* 13:1–23. doi: 10.1371/journal.pbio.1002226
- Bourne N, Hodgson CA, Whyte JNC (1989) A Manual for Scallop Culture in British Columbia. Canadian Technical Report of Fisheries and Aquatic Sciences No. 1694.
- Brown C, Nash C (1981) Aquaculture as a method for meeting hatchery discharge standards [Wastewater treatment]. doi: 10.3/JQUERY-ULJS
- Brown C, Russo DJ (1979) ULTRAVIOLET LIGHT DISINFECTION OF SHELLFISH HATCHERY SEA WATER I. ELIMINATION OF FIVE PATHOGENIC BACTERIA. *Aquaculture* 17:17–23.
- Burge CA, Mark Eakin C, Friedman CS, Froelich B, Hershberger PK, Hofmann EE, Petes LE, Prager KC, Weil E, Willis BL, Ford SE, Harvell CD (2014) Climate Change Influences on Marine Infectious Diseases: Implications for Management and Society. *Ann Rev Mar Sci* 6:249–277. doi: 10.1146/annurev-marine-010213-135029
- Cabello FC (2006) Heavy use of prophylactic antibiotics in aquaculture: A growing problem for human and animal health and for the environment. *Environ Microbiol* 8:1137–1144. doi: 10.1111/j.1462-2920.2006.01054.x
- Chen B, Peng M, Tong W, Zhang Q, Song Z (2020) The Quorum Quenching Bacterium *Bacillus licheniformis* T-1 Protects Zebrafish against *Aeromonas hydrophila* Infection. *Probiotics Antimicrob Proteins* 12:160–171. doi: 10.1007/s12602-018-9495-7

- Citarasu T (2012) Natural antimicrobial compounds for use in aquaculture. In: Infectious Disease in Aquaculture. Woodhead Publishing, pp 419–456
- Clerissi C, de Lorgeril J, Petton B, Lucasson A, Escoubas J-M, Gueguen Y, Dégremont L, Mitta G, Toulza E (2020) Microbiota Composition and Evenness Predict Survival Rate of Oysters Confronted to Pacific Oyster Mortality Syndrome. *Front Microbiol* 11:1–11. doi: 10.3389/fmicb.2020.00311
- Clerissi C, Luo X, Lucasson A, Mortaza S, de Lorgeril J, Toulza E, Petton B, Escoubas JM, Degrémont L, Gueguen Y, Destoumieux-Garzón D, Jacq A, Mitta G (2022) A core of functional complementary bacteria infects oysters in Pacific Oyster Mortality Syndrome. *Anim Microbiome*. doi: 10.1186/s42523-023-00246-8
- Cochennec N, Le Roux F, Berthe F, Gerard A (2000) Detection of *Bonamia ostreae* based on small subunit ribosomal probe. *J Invertebr Pathol* 76:26–32. doi: 10.1006/jipa.2000.4939
- Cordier C, Voulgaris A, Stavrakakis C, Sauvade P, Coelho F, Moulin P (2021) Ultrafiltration for environmental safety in shellfish production: A case of bloom emergence. *Water Sci Eng* 14:46–53. doi: 10.1016/j.wse.2021.03.003
- Coustau C, Kurtz J, Moret Y (2016) A Novel Mechanism of Immune Memory Unveiled at the Invertebrate-Parasite Interface. *Trends Parasitol* 32:353–355. doi: 10.1016/j.pt.2016.02.005
- Crosson LM, Friedman CS (2018) Withering syndrome susceptibility of northeastern Pacific abalones: A complex relationship with phylogeny and thermal experience. *J Invertebr Pathol* 151:91–101. doi: 10.1016/j.jip.2017.11.005
- Dantan L, Toulza E, Petton B, Montagnani C, Degrémont L, Morga B, Fleury Y, Mitta G, Gueguen Y, Vidal-Dupiol J, Cosseau C (2023) Microbial education for marine invertebrate disease prevention in aquaculture - in preparation.
- Davison AJ, Trus BL, Cheng N, Steven A, Watson MS, Cunningham C, Le Deuff RM, Renault T (2005) A novel class of herpesvirus with bivalve hosts. *J Gen Virol* 86:41–53. doi: 10.1099/vir.0.80382-0

- de Lorgeril J, Lucasson A, Petton B, Toulza E, Montagnani C, Clerissi C, Vidal-Dupiol J, Chaparro C, Galinier R, Escoubas JM, Haffner P, Dégremont L, Charrière GM, Lafont M, Delort A, Vergnes A, Chiarello M, Faury N, Rubio T, Leroy MA, Pérignon A, Régler D, Morga B, Alunno-Bruscia M, Boudry P, Le Roux F, Destoumieux-Garzón D, Gueguen Y, Mitta G (2018a) Immune-suppression by OsHV-1 viral infection causes fatal bacteraemia in Pacific oysters. *Nat Commun.* doi: 10.1038/s41467-018-06659-3
- de Lorgeril J, Escoubas JM, Loubiere V, Pernet F, Le Gall P, Vergnes A, Aujoulat F, Jeannot JL, Jumas-Bilak E, Got P, Gueguen Y, Destoumieux-Garzón D, Bachère E (2018b) Inefficient immune response is associated with microbial permissiveness in juvenile oysters affected by mass mortalities on field. *Fish Shellfish Immunol* 77:156–163. doi: 10.1016/j.fsi.2018.03.027
- de Lorgeril J, Petton B, Lucasson A, Perez V, Stenger PL, Dégremont L, Montagnani C, Escoubas JM, Haffner P, Allienne JF, Leroy M, Lagarde F, Vidal-Dupiol J, Gueguen Y, Mitta G (2020) Differential basal expression of immune genes confers *Crassostrea gigas* resistance to Pacific oyster mortality syndrome. *BMC Genomics.* doi: 10.1186/s12864-020-6471-x
- Dégremont L, Morga B, Maurouard E, Travers MA (2021) Susceptibility variation to the main pathogens of *Crassostrea gigas* at the larval, spat and juvenile stages using unselected and selected oysters to OsHV-1 and/or *V. aestuarianus*. *J Invertebr Pathol* 183:107601. doi: 10.1016/j.jip.2021.107601
- Delisle L, Laroche O, Hilton Z, Burguin J-F, Rolton A, Berry J, Pochon X, Boudry P, Vignier J (2022) Understanding the Dynamic of POMS Infection and the Role of Microbiota Composition in the Survival of Pacific Oysters, *Crassostrea gigas*. *Microbiol Spectr.* doi: 10.1128/spectrum.01959-22
- Desriac F, Le Chevalier P, Brillet B, Leguerinel I, Thuillier B, Paillard C, Fleury Y (2014) Exploring the hologenome concept in marine bivalvia: Haemolymph microbiota as a pertinent source of probiotics for aquaculture. *FEMS Microbiol Lett* 350:107–116. doi: 10.1111/1574-6968.12308

- Destoumieux-Garzón D, Canesi L, Oyanedel D, Travers MA, Charrière GM, Pruzzo C, Vezzulli L (2020) *Vibrio*–bivalve interactions in health and disease. *Environ Microbiol* 22:4323–4341. doi: 10.1111/1462-2920.15055
- Donio MBS, Ronica FA, Viji VT, Velmurugan S, Jenifer JSCA, Michaelbabu M, Dhar P, Citarasu T (2013) *Halomonas sp.* BS4, A biosurfactant producing halophilic bacterium isolated from solar salt works in India and their biomedical importance. *Springerplus*. doi: 10.1186/2193-1801-2-149
- Dupont S, Lokmer A, Corre E, Auguet J-C, Petton B, Toulza E, Montagnani C, Tanguy G, Pecqueur D, Salmeron C, Guillou L, Desnues C, La Scola B, Bou Khalil J, de Lorgeril J, Mitta G, Gueguen Y, Escoubas J-M (2020) Oyster hemolymph is a complex and dynamic ecosystem hosting bacteria, protists and viruses. *Anim Microbiome*. doi: 10.1186/s42523-020-00032-w
- Eljaddi T, Ragueneau S, Cordier C, Lange A, Rabiller M, Stavrakakis C, Moulin P (2021) Ultrafiltration to secure shellfish industrial activities: Culture of microalgae and oyster fertilization. *Aquac Eng*. doi: 10.1016/j.aquaeng.2021.102204
- Fabioux C, Huvet A, Le Souchu P, Le Pennec M, Pouvreau S (2005) Temperature and photoperiod drive *Crassostrea gigas* reproductive internal clock. *Aquaculture* 250:458–470. doi: 10.1016/j.aquaculture.2005.02.038
- Fallet M, Luquet E, David P, Cosseau C (2020) Epigenetic inheritance and intergenerational effects in mollusks. *Gene* 729:
- Fallet M, Montagnani C, Petton B, Dantan L, de Lorgeril J, Comarmond S, Chaparro C, Toulza E, Boitard S, Escoubas J-M, Vergnes A, Le Grand J, Bulla I, Gueguen Y, Vidal-Dupiol J, Grunau C, Mitta G, Cosseau C (2022) Early life microbial exposures shape the *Crassostrea gigas* immune system for lifelong and intergenerational disease protection. *Microbiome*. doi: 10.1186/s40168-022-01280-5
- Fauray N, Saulnier D, Thompson FL, Gay M, Swings J, Le Roux F (2004) *Vibrio crassostreae* sp. nov., isolated from the haemolymph of oysters (*Crassostrea gigas*). *Int J Syst Evol Microbiol* 54:2137–2140. doi: 10.1099/ijs.0.63232-0
- Food and Agriculture Organisation (2022) The State of World Fisheries and Aquaculture 2022. *State World Fish Aquac 2022*. doi: 10.4060/cc0461en

- Food and Agriculture Organisation of the United Nation (2006) Probiotics in food. Health and nutritional properties and guidelines for evaluation. Rome/Roma
- Food and Agriculture Organisation of the United Nation (2020) La situation mondiale des pêches et de l'aquaculture 2020.
- Friedman CS, Estes RM, Stokes NA, Burge CA, Hargove JS, Barber BJ, Elston RA, Burreson EM, Reece KS (2005) Herpes virus in juvenile Pacific oysters *Crassostrea gigas* from Tomales Bay, California, coincides with summer mortality episodes. *Dis Aquat Organ* 63:33–41. doi: 10.3354/dao063033
- Galindo-Villegas J, García-Moreno D, De Oliveira S, Meseguer J, Mulero V (2012) Regulation of immunity and disease resistance by commensal microbes and chromatin modifications during zebrafish development. *Proc Natl Acad Sci U S A*. doi: 10.1073/pnas.1209920109
- Garcia C, Mesnil A, Tourbiez D, Moussa M, Dubreuil C, de Sa AG, Chollet B, Godfrin Y, Dégremont L, Serpin D, Travers MA (2021) *Vibrio aestuarianus* subsp. *Cardii* subsp. nov., pathogenic to the edible cockles *Cerastoderma edule* in France, and establishment of *Vibrio aestuarianus* subsp. *aestuarianus* subsp. nov. and *Vibrio aestuarianus* subsp. *Int J Syst Evol Microbiol* 71:1–10. doi: 10.1099/ijsem.0.004654
- Garnier M, Labreuche Y, Nicolas JL (2008) Molecular and phenotypic characterization of *Vibrio aestuarianus* subsp. *francensis* subsp. nov., a pathogen of the oyster *Crassostrea gigas*. *Syst Appl Microbiol* 31:358–365. doi: 10.1016/j.syapm.2008.06.003
- Gawra J, Valdivieso A, Roux F, Laporte M, De Lorgeril J, Gueguen Y, Saccas M, Escoubas J-M, Montagnani C, Destoumieux-Garzón D, Lagarde F, Leroy MA, Haffner P, Petton B, Cosseau C, Morga B, Dégremont L, Mitta G, Grunau C, Vidal-Dupiol J (2023) Epigenetic then genetic variations underpin rapid adaptation of oyster populations (*Crassostrea gigas*) to Pacific Oyster Mortality Syndrome (POMS). *bioRxiv*. doi: 10.1101/2023.03.09.531494
- Gay M (2004) Infection expérimentale chez *Crassostrea gigas*: étude de deux souches pathogènes apparentées à *Vibrio splendidus*. Université de La Rochelle
- Gerdol M, Venier P, Pallavicini A (2015) The genome of the Pacific oyster *Crassostrea gigas* brings new insights on the massive expansion of the C1q gene family in Bivalvia. *Dev Comp Immunol* 49:59–71. doi: 10.1016/j.dci.2014.11.007

- Ghanei-Motlagh R, Mohammadian T, Gharibi D, Khosravi M, Mahmoudi E, Zarea M, El-Matbouli M, Menanteau-Ledouble S (2021) Quorum quenching probiotics modulated digestive enzymes activity, growth performance, gut microflora, haemato-biochemical parameters and resistance against *Vibrio harveyi* in Asian seabass (*Lates calcarifer*). *Aquaculture*. doi: 10.1016/j.aquaculture.2020.735874
- Goudenège D, Travers MA, Lemire A, Petton B, Haffner P, Labreuche Y, Tourbiez D, Mangenot S, Calteau A, Mazel D, Nicolas JL, Jacq A, Le roux F (2015) A single regulatory gene is sufficient to alter *Vibrio aestuarianus* pathogenicity in oysters. *Environ Microbiol* 17:4189–4199. doi: 10.1111/1462-2920.12699
- Green TJ, Helbig K, Speck P, Raftos DA (2016) Primed for success: Oyster parents treated with poly(I:C) produce offspring with enhanced protection against Ostreid herpesvirus type I infection. *Mol Immunol* 78:113–120. doi: 10.1016/j.molimm.2016.09.002
- Grize H, Héra M (1991) Introduction into france of the japanese oyster (*Crassostrea gigas*). *ICES J Mar Sci* 47:388–403. doi: 10.1093/icesjms/47.3.399
- Grizel H (1974) Recherche Sur l'agent de La Maladie de La Glande Digestive de *Ostrea edulis* Linné. *SciPeche Bull Inst Pech Marit* 240:7–29.
- Guo X, He Y, Zhang L, Lelong C, Jouaux A (2015) Immune and stress responses in oysters with insights on adaptation. *Fish Shellfish Immunol* 46:107–119. doi: 10.1016/j.fsi.2015.05.018
- Guzmán-Villanueva LT, Tovar-Ramírez D, Gisbert E, Cordero H, Guardiola FA, Cuesta A, Meseguer J, Ascencio-Valle F, Esteban MA (2014) Dietary administration of β -1,3/1,6-glucan and probiotic strain *Shewanella putrefaciens*, single or combined, on gilthead seabream growth, immune responses and gene expression. *Fish Shellfish Immunol* 39:34–41. doi: 10.1016/j.fsi.2014.04.024
- Hao K, Liu JY, Ling F, Liu XL, Lu L, Xia L, Wang GX (2014) Effects of dietary administration of *Shewanella haliotis* D4, *Bacillus cereus* D7 and *Aeromonas bivalvium* D15, single or combined, on the growth, innate immunity and disease resistance of shrimp, *Litopenaeus vannamei*. *Aquaculture* 428–429:141–149. doi: 10.1016/j.aquaculture.2014.03.016

- He Y, Jouaux A, Ford SE, Lelong C, Sourdain P, Mathieu M, Guo X (2015) Transcriptome analysis reveals strong and complex antiviral response in a mollusc. *Fish Shellfish Immunol* 46:131–144. doi: 10.1016/j.fsi.2015.05.023
- Helm MM, Bourne N, Lovatelli A (2004) Hatchery culture of bivalves. A practical manual. FAO Fish Tech Pap 471:203.
- Hine P, Wesney B, Hay B (1992) Herpesviruses associated with mortalities among hatchery-reared larval Pacific oysters *Crassostrea gigas*. *Dis Aquat Organ* 12:135–142. doi: 10.3354/dao012135
- Hossain A, Habibullah-Al-Mamun M, Nagano I, Masunaga S, Kitazawa D, Matsuda H (2022) Antibiotics, antibiotic-resistant bacteria, and resistance genes in aquaculture: risks, current concern, and future thinking. *Environ. Sci. Pollut. Res.* 29:11054–11075.
- Huang J, Shi Y, Zeng G, Gu Y, Chen G, Shi L, Hu Y, Tang B, Zhou J (2016) Acyl-homoserine lactone-based quorum sensing and quorum quenching hold promise to determine the performance of biological wastewater treatments: An overview. *Chemosphere* 157:137–151. doi: 10.1016/j.chemosphere.2016.05.032
- Infante-Villamil S, Huerlimann R, Jerry DR (2021) Microbiome diversity and dysbiosis in aquaculture. *Rev Aquac* 13:1077–1096. doi: 10.1111/raq.12513
- Ivanova K, Fernandes MM, Francesko A, Mendoza E, Guezguez J, Burnet M, Tzanov T (2015) Quorum-Quenching and Matrix-Degrading Enzymes in Multilayer Coatings Synergistically Prevent Bacterial Biofilm Formation on Urinary Catheters. *ACS Appl Mater Interfaces* 7:27066–27077. doi: 10.1021/acsami.5b09489
- Jeannin P, Jaillon S, Delneste Y (2008) Pattern recognition receptors in the immune response against dying cells. *Curr Opin Immunol* 20:530–537. doi: 10.1016/j.coi.2008.04.013
- Karim M, Zhao W, Rowley D, Nelson D, Gomez-Chiarri M (2013) Probiotic Strains for Shellfish Aquaculture: Protection of Eastern Oyster, *Crassostrea virginica*, Larvae and Juveniles Against Bacterial Challenge. *J Shellfish Res* 32:401–408. doi: 10.2983/035.032.0220

- King WL, Siboni N, Williams NLR, Kahlke T, Nguyen KV, Jenkins C, Dove M, O'Connor W, Seymour JR, Labbate M (2019) Variability in the composition of pacific oyster microbiomes across oyster families exhibiting different levels of susceptibility to OsHV-1 μ var disease. *Front Microbiol* 10:1–12. doi: 10.3389/fmicb.2019.00473
- King WL, Siboni N, Kahlke T, Dove M, O'Connor W, Mahbub KR, Jenkins C, Seymour JR, Labbate M (2020) Regional and oyster microenvironmental scale heterogeneity in the Pacific oyster bacterial community. *FEMS Microbiol Ecol*. doi: 10.1093/femsec/fiaa054
- Kiyimaci ME, Altanlar N, Gumustas M, Ozkan SA, Akin A (2018) Quorum sensing signals and related virulence inhibition of *Pseudomonas aeruginosa* by a potential probiotic strain's organic acid. *Microb Pathog* 121:190–197. doi: 10.1016/j.micpath.2018.05.042
- Kumar PS, Brooker MR, Dowd SE, Camerlengo T (2011) Target Region Selection Is a Critical Determinant of Community Fingerprints Generated by 16S Pyrosequencing. *PLoS One* 6:20956. doi: 10.1371/journal.pone.0020956
- Kuramitsu HK, He X, Lux R, Anderson MH, Shi W (2007) Interspecies Interactions within Oral Microbial Communities. *Microbiol Mol Biol Rev* 71:653–670. doi: 10.1128/membr.00024-07
- Labreuche Y, Soudant P, Gonçalves M, Lambert C, Nicolas JL (2006) Effects of extracellular products from the pathogenic *Vibrio aestuarianus* strain 01/32 on lethality and cellular immune responses of the oyster *Crassostrea gigas*. *Dev Comp Immunol* 30:367–379. doi: 10.1016/j.dci.2005.05.003
- Labreuche Y, Le Roux F, Henry J, Zatylny C, Huvet A, Lambert C, Soudant P, Mazel D, Nicolas JL (2010) *Vibrio aestuarianus* zinc metalloprotease causes lethality in the Pacific oyster *Crassostrea gigas* and impairs the host cellular immune defenses. *Fish Shellfish Immunol* 29:753–758. doi: 10.1016/j.fsi.2010.07.007
- Lafont M, Petton B, Vergnes A, Pauletto M, Segarra A, Gourbal B, Montagnani C (2017) Long-lasting antiviral innate immune priming in the Lophotrochozoan Pacific oyster, *Crassostrea gigas*. *Sci Rep*. doi: 10.1038/s41598-017-13564-0
- Lafont M, Vergnes A, Vidal-Dupiol J, De Lorgeril J, Gueguen Y, Haffner P, Petton B, Chaparro C, Barrachina C, Destoumieux-Garzon D, Mitta G, Gourbal B, Montagnani C (2020) A sustained immune response supports long-term antiviral immune priming in the pacific oyster, *Crassostrea gigas*. *MBio*. doi: 10.1128/mBio.02777-19

- Lam VWY, Cheung WWL, Reygondeau G, Rashid Sumaila U (2016) Projected change in global fisheries revenues under climate change. *Sci Rep*. doi: 10.1038/srep32607
- Landsman A, St-Pierre B, Gibbons W, Rosales-Leija M, Brown M (2019) Investigation of the potential effects of host genetics and probiotic treatment on the gut bacterial community composition of aquaculture-raised pacific whiteleg shrimp, *Litopenaeus vannamei* . *Microorganisms* 7:217. doi: 10.3390/microorganisms7080217
- Laukens D, Brinkman BM, Raes J, De Vos M, Vandenabeele P (2015) Heterogeneity of the gut microbiome in mice: Guidelines for optimizing experimental design. *FEMS Microbiol Rev* 40:117–132. doi: 10.1093/femsre/fuv036
- Le Deuff RM, Renault T (1999) Purification and partial genome characterization of a herpes-like virus infecting the Japanese oyster, *Crassostrea gigas*. *J Gen Virol* 80:1317–1322. doi: 10.1099/0022-1317-80-5-1317
- Le Roux F, Lorenzo G, Peyret P, Audemard C, Figueras A, Vivarès C, Gouy M, Berthe F (2001) Molecular evidence for the existence of two species of *Marteilia* in Europe. *J Eukaryot Microbiol* 48:449–454. doi: 10.1111/j.1550-7408.2001.tb00178.x
- Le Roux F, Wegner KM, Polz MF (2016) Oysters and *Vibrios* as a Model for Disease Dynamics in Wild Animals. *Trends Microbiol* 24:568–580. doi: 10.1016/j.tim.2016.03.006
- Leprêtre M, Faury N, Segarra A, Claverol S, Degremont L, Palos-Ladeiro M, Armengaud J, Renault T, Morga B (2021) Comparative Proteomics of Ostreid Herpesvirus 1 and Pacific Oyster Interactions With Two Families Exhibiting Contrasted Susceptibility to Viral Infection. *Front Immunol*. doi: 10.3389/fimmu.2020.621994
- Li H, Zhang H, Jiang S, Wang W, Xin L, Wang H, Wang L, Song L (2015) A single-CRD C-type lectin from oyster *Crassostrea gigas* mediates immune recognition and pathogen elimination with a potential role in the activation of complement system. *Fish Shellfish Immunol* 44:566–575. doi: 10.1016/j.fsi.2015.03.011
- Li YH, Tian X (2012) Quorum sensing and bacterial social interactions in biofilms. *Sensors* 12:2519–2538. doi: 10.3390/s120302519
- Liener IE, Sharon N, J.Goldstein I (2012) *The Lectins: Properties, Functions, and Applications in Biology and Medicine*.

- Lim HJ, Kapareiko D, Schott EJ, Hanif A, Wikfors GH (2011) Isolation and Evaluation of New Probiotic Bacteria for use in Shellfish Hatcheries: I. Isolation and Screening for Bioactivity. *J Shellfish Res* 30:609–615. doi: 10.2983/035.030.0303
- Liu L, Yang J, Qiu L, Wang L, Zhang H, Wang M, Vinu SS, Song L (2011) A novel scavenger receptor-cysteine-rich (SRCR) domain containing scavenger receptor identified from mollusk mediated PAMP recognition and binding. *Dev Comp Immunol* 35:227–239. doi: 10.1016/j.dci.2010.09.010
- Ma CW, Cho YS, Oh KH (2009) Removal of pathogenic bacteria and nitrogens by *Lactobacillus spp.* JK-8 and JK-11. *Aquaculture* 287:266–270. doi: 10.1016/j.aquaculture.2008.10.061
- Mariman R, Tielen F, Koning F, Nagelkerken L (2015) The probiotic mixture VSL#3 has differential effects on intestinal immune parameters in healthy female BALB/c and C57BL/6 mice. *J Nutr* 145:1354–1361. doi: 10.3945/jn.114.199729
- McFall-Ngai M, Hadfield MG, Bosch TCG, Carey H V, Domazet-Lošo T, Douglas AE, Dubilier N, Eberl G, Fukami T, Gilbert SF, Hentschel U, King N, Kjelleberg S, Knoll AH, Kremer N, Mazmanian SK, Metcalf JL, Neelson K, Pierce NE, Rawls JF, Reid A, Ruby EG, Rumpho M, Sanders JG, Tautz D, Wernegreen JJ (2013) Animals in a bacterial world, a new imperative for the life sciences. *Proc Natl Acad Sci U S A* 110:3229–3236. doi: 10.1073/pnas.1218525110
- Melillo D, Marino R, Italiani P, Boraschi D (2018) Innate Immune Memory in Invertebrate Metazoans: A Critical Appraisal. *Front Immunol*. doi: 10.3389/fimmu.2018.01915
- Mesnil A, Jacquot M, Garcia C, Tourbiez D, Canier L, Dégremont L, Cheslett D, Geary M, Vetri A, Roque A, Furones D, Garden A, Orozova P, Arzul I, Sicard M, Destoumieux-Garzón D, Travers M-A (2022) Emergence and clonal expansion of *Vibrio aestuarianus* lineages pathogenic for oysters in Europe. *Mol Ecol* 32:2896–2883. doi: 10.1111/mec.16910
- Miller MB, Bassler BL (2001) Quorum sensing in bacteria. *Annu Rev Microbiol* 55:165–199. doi: 10.1146/annurev.micro.55.1.165

- Muras A, Mayer C, Romero M, Camino T, Ferrer MD, Mira A, Otero A (2018) Inhibition of *Streptococcus mutans* biofilm formation by extracts of *Tenacibaculum sp.* 20J, a bacterium with wide-spectrum quorum quenching activity. *J Oral Microbiol.* doi: 10.1080/20002297.2018.1429788
- Offret C, Rochard V, Laguerre H, Mounier J, Huchette S, Brillet B, Le Chevalier P, Fleury Y (2018) Protective Efficacy of a *Pseudoalteromonas* Strain in European Abalone, *Haliotis tuberculata*, Infected with *Vibrio harveyi* ORM4. *Probiotics Antimicrob Proteins* 11:239–247. doi: 10.1007/s12602-018-9389-8
- Oyanedel D, Lagorce A, Bruto M, Haffner P, Morot A, Dorant Y, de La Forest Divonne S, Delavat F, Inguibert N, Morga B, Toulza E, Chaparro C, Escoubas J-M, Gueguen Y, Vidal-Dupiol J, de Lorgeril J, Petton B, Degremont L, Tourbiez D, Pimparé L-L, Leroy M, Romatif O, Mitta G, Le Roux F, Charrière GM, Destoumieux-Garzón D (2023) Cooperation and cheating orchestrate *Vibrio* assemblages and 1 polymicrobial synergy in oysters infected with OsHV-1 virus. *bioRxiv.* doi: 10.1101/2023.02.11.528104
- Paillard C, Gueguen Y, Wegner KM, Bass D, Pallavicini A, Vezzulli L, Arzul I (2022) Recent advances in bivalve-microbiota interactions for disease prevention in aquaculture. *Curr Opin Biotechnol* 73:225–232. doi: 10.1016/j.copbio.2021.07.026
- Parizadeh L, Tourbiez D, Garcia C, Haffner P, Dégremont L, Le Roux F, Travers MA (2018) Ecologically realistic model of infection for exploring the host damage caused by *Vibrio aestuarianus*. *Environ Microbiol* 20:4343–4355. doi: 10.1111/1462-2920.14350
- Paul-Pont I, Dhand NK, Whittington RJ (2013) Spatial distribution of mortality in Pacific oysters *Crassostrea gigas*: Reflection on mechanisms of OsHV-1 transmission. *Dis Aquat Organ* 105:127–138. doi: 10.3354/dao02615
- Peeler EJ, Allan Reese R, Cheslett DL, Geoghegan F, Power A, Thrush MA (2012) Investigation of mortality in Pacific oysters associated with Ostreid herpesvirus-1 ?Var in the Republic of Ireland in 2009. *Prev Vet Med* 105:136–143. doi: 10.1016/j.prevetmed.2012.02.001
- Pernet F, Barret J, Le Gall P, Corporeau C, Dégremont L, Lagarde F, Pépin JF, Keck N (2012) Mass mortalities of Pacific oysters *Crassostrea gigas* reflect infectious diseases and vary with farming practices in the Mediterranean Thau lagoon, France. *Aquac Environ Interact* 2:215–237. doi: 10.3354/aei00041

- Pernet F, Lupo C, Bacher C, Whittington RJ (2016) Infectious diseases in oyster aquaculture require a new integrated approach. *Philos Trans R Soc B Biol Sci.* doi: 10.1098/rstb.2015.0213
- Pernet F, Tamayo D, Fuhrmann M, Petton B (2019) Deciphering the effect of food availability, growth and host condition on disease susceptibility in a marine invertebrate. *J Exp Biol.* doi: 10.1242/jeb.210534
- Petton B, Destoumieux-Garzón D, Pernet F, Toulza E, de Lorgeril J, Degremont L, Mitta G (2021) The Pacific Oyster Mortality Syndrome, a Polymicrobial and Multifactorial Disease: State of Knowledge and Future Directions. *Front Immunol.* doi: 10.3389/fimmu.2021.630343
- Pichot Y, Comps M, Tige G, Grizel H, Rabouin M-A (1981) Recherches Sur *Bonamia ostreae* Gen. n., Sp. n., Parasite Nouveau de l'huitre Plate *Ostrea edulis*. *Rev Trav Inst Pêch Marit* 43:131–140.
- Prigot-Maurice C, Beltran-Bech S, Braquart-Varnier C (2022) Why and how do protective symbionts impact immune priming with pathogens in invertebrates ? *Dev Comp Immunol.* doi: 10.1016/j.dci.2021.104245
- Rajeev R, Adithya KK, Kiran GS, Selvin J (2021) Healthy microbiome: a key to successful and sustainable shrimp aquaculture. *Rev Aquac* 13:238–258. doi: 10.1111/raq.12471
- Renault T, Le Deuff R-M, Cochenec N, Maffart P (1994) Herpesviruses associated with mortalities among Pacific oyster, *Crassostrea gigas*, in France-Comparative study. *Rev Médicale Vétérinaire* 145:735–742.
- Renault T, Le Deuff R-M, Chollet B, Cochenec N, Gérard A (2000) Concomitant herpes-like virus infections in hatchery-reared larvae and nursery-cultured spat *Crassostrea gigas* and *Ostrea edulis*. *Dis Aquat Org* 42:173–183. doi: 10.3354/dao042173
- Robinson MJ, Sancho D, Slack EC, LeibundGut-Landmann S, Sousa CR (2006) Myeloid C-type lectins in innate immunity. *Nat. Immunol.* 7:1258–1265.
- Rohwer F, Seguritan V, Azam F, Knowlton N (2002) Diversity and distribution of coral-associated bacteria. *Mar Ecol Prog Ser* 243:1–10. doi: 10.3354/meps243001

- Romani M, Warscheid T, Nicole L, Marcon L, Di Martino P, Suzuki MT, Lebaron P, Lami R (2022) Current and future chemical treatments to fight biodeterioration of outdoor building materials and associated biofilms: Moving away from ecotoxic and towards efficient, sustainable solutions. *Sci Total Environ.* doi: 10.1016/j.scitotenv.2021.149846
- Romero M, Muras A, Mayer C, Buján N, Magariños B, Otero A (2014) *In vitro* quenching of fish pathogen *Edwardsiella tarda* AHL production using marine bacterium *Tenacibaculum* sp. strain 20J cell extracts. *Dis Aquat Organ* 108:217–225. doi: 10.3354/dao02697
- Salvi D, Mariottini P (2017) Molecular taxonomy in 2D: A novel ITS2 rRNA sequence structure approach guides the description of the oysters' subfamily *Saccostreinae* and the genus *Magallana* (Bivalvia: *Ostreidae*). *Zool J Linn Soc* 179:263–276. doi: 10.1111/zoj.12455
- Sánchez-Paz A (2010) White spot syndrome virus: An overview on an emergent concern. *Vet Res.* doi: 10.1051/vetres/2010015
- Segarra A, Pépin JF, Arzul I, Morga B, Faury N, Renault T (2010) Detection and description of a particular Ostreid herpesvirus 1 genotype associated with massive mortality outbreaks of Pacific oysters, *Crassostrea gigas*, in France in 2008. *Virus Res* 153:92–99. doi: 10.1016/J.VIRUSRES.2010.07.011
- Service de la Statistique et de la Prospective (2022) PÊCHE ET AQUACULTURE 7 agreste GRAPH'AGRI 2022.
- Shen X, Cai Y, Liu C, Liu W, Hui Y, Su YC (2009) Effect of temperature on uptake and survival of *Vibrio parahaemolyticus* in oysters (*Crassostrea plicatula*). *Int J Food Microbiol* 136:129–132. doi: 10.1016/j.ijfoodmicro.2009.09.012
- Shimahara Y, Kurita J, Kiryu I, Nishioka T, Yuasa K, Kawana M, Kamaishi T, Oseko N (2012) Surveillance of Type 1 Ostreid Herpesvirus (OsHV-1) Variants in Japan. *Fish Pathol* 47:129–136. doi: 10.3147/j AFP.47.129
- Stentiford GD, Neil DM, Peeler EJ, Shields JD, Small HJ, Flegel TW, Vlak JM, Jones B, Morado F, Moss S, Lotz J, Bartholomay L, Behringer DC, Hauton C, Lightner D V. (2012) Disease will limit future food supply from the global crustacean fishery and aquaculture sectors. *J Invertebr Pathol* 110:141–157. doi: 10.1016/j.jip.2012.03.013

- Theis KR, Dheilly NM, Klassen JL, Brucker RM, Baines JF, Bosch TCG, Cryan JF, Gilbert SF, Goodnight CJ, Lloyd EA, Sapp J, Vandenkoornhuyse P, Zilber-Rosenberg I, Rosenberg E, Bordenstein SR (2016) Getting the Hologenome Concept Right: an Eco-Evolutionary Framework for Hosts and Their Microbiomes. *mSystems*. doi: 10.1128/msystems.00028-16
- Tion DL, Seidler RJ (1983) *Vibrio aestuarianus*: A new species from estuarine waters and shellfish. *Int J Syst Bacteriol* 33:699–702. doi: 10.1099/00207713-33-4-699
- Touraki M, Karamanlidou G, Karavida P, Chrysi K (2012) Evaluation of the probiotics *Bacillus subtilis* and *Lactobacillus plantarum* bioencapsulated in *Artemia nauplii* against Vibriosis in European sea bass larvae (*Dicentrarchus labrax*, L.). *World J Microbiol Biotechnol* 28:2425–2433. doi: 10.1007/s11274-012-1052-z
- Travers MA, Boettcher Miller K, Roque A, Friedman CS (2015) Bacterial diseases in marine bivalves. *J Invertebr Pathol* 131:11–31. doi: 10.1016/j.jip.2015.07.010
- Tseng DY, Ho PL, Huang SY, Cheng SC, Shiu YL, Chiu CS, Liu CH (2009) Enhancement of immunity and disease resistance in the white shrimp, *Litopenaeus vannamei*, by the probiotic, *Bacillus subtilis* E20. *Fish Shellfish Immunol* 26:339–344. doi: 10.1016/j.fsi.2008.12.003
- Unzueta-Martínez A, Scanes E, Parker LM, Ross PM, O'Connor W, Bowen JL (2022) Microbiomes of the Sydney Rock Oyster are acquired through both vertical and horizontal transmission. *Anim Microbiome* 4:32. doi: 10.1186/s42523-022-00186-9
- Vogeler S, Bean TP, Lyons BP, Galloway TS (2016) Dynamics of nuclear receptor gene expression during Pacific oyster development. *BMC Dev Biol* 16:1–13. doi: 10.1186/s12861-016-0129-6
- Wang L, Song X, Song L (2018) The oyster immunity. *Dev Comp Immunol* 80:99–118. doi: 10.1016/j.dci.2017.05.025
- Wang YC, Hu SY, Chiu CS, Liu CH (2019) Multiple-strain probiotics appear to be more effective in improving the growth performance and health status of white shrimp, *Litopenaeus vannamei*, than single probiotic strains. *Fish Shellfish Immunol* 84:1050–1058. doi: 10.1016/j.fsi.2018.11.017

- Winson MK, Swift S, Fish L, Throup JP, JÃ,rgensen F, Chhabra SR, Bycroft BW, Williams P, Stewart GSA. (1998) Construction and analysis of luxCDABE-based plasmid sensors for investigating N-acyl homoserine lactone-mediated quorum sensing. *FEMS Microbiol Lett* 163:185–192. doi: 10.1111/j.1574-6968.1998.tb13044.x
- Wright AC, Fan Y, Baker GL (2018) Nutritional Value and Food Safety of Bivalve Molluscan Shellfish. *J Shellfish Res* 37:695–708. doi: 10.2983/035.037.0403
- Yan F jun, Tian X li, Dong S lin, Fang Z heng, Yang G (2014) Growth performance, immune response, and disease resistance against *Vibrio splendidus* infection in juvenile sea cucumber *Apostichopus japonicus* fed a supplementary diet of the potential probiotic *Paracoccus marcusii* DB11. *Aquaculture* 420–421:105–111. doi: 10.1016/j.aquaculture.2013.10.045
- Yeh H, Skubel SA, Patel H, Cai Shi D, Bushek D, Chikindas ML (2020) From Farm to Fingers: an Exploration of Probiotics for Oysters, from Production to Human Consumption. *Probiotics Antimicrob Proteins*. doi: 10.1007/s12602-019-09629-3
- Zhang L, Mai K, Tan B, Ai Q, Qi C, Xu W, Zhang W, Liufu Z, Wang X, Ma H (2009) Effects of dietary administration of probiotic *Halomonas sp.* B12 on the intestinal microflora, immunological parameters, and midgut histological structure of shrimp, *Fenneropenaeus chinensis*. *J World Aquac Soc* 40:58–66. doi: 10.1111/j.1749-7345.2008.00235.x
- Zhao J, Chen M, Quan CS, Fan SD (2015) Mechanisms of quorum sensing and strategies for quorum sensing disruption in aquaculture pathogens. *J Fish Dis* 38:771–786. doi: 10.1111/jfd.12299
- Zhao W, Yuan T, Piva C, Spinard EJ, Schuttert CW, Rowley DC, Nelson DR (2019) The Probiotic Bacterium *Phaeobacter inhibens* Downregulates Virulence Factor Transcription in the Shellfish Pathogen *Vibrio coralliilyticus* by N-Acyl Homoserine Lactone Production. *Appl Environ Microbiol* 85:1–14. doi: 10.1128/AEM.01545-18
- Zilber-Rosenberg I, Rosenberg E (2008) Role of microorganisms in the evolution of animals and plants: The hologenome theory of evolution. *FEMS Microbiol Rev* 32:723–735. doi: 10.1111/j.1574-6976.2008.00123.x

Annexes

Annexe I – Présentations lors de congrès

Présentations orales :

- Luc Dantan, Prunelle Carcassonne, Lionel Degremont, Benjamin Morga, Bruno Petton, Mickael Mege, Elise Maurouard, Jean-François Allienne, Gaëlle Courtay, Océane Romatif, Juliette Pouzadoux, Raphaël Lami, Laurent Intertaglia, Yannick Gueguen, Jérémie Vidal-Dupiol, Eve Toulza, Celine Cosseau, "**Teaching Oysters to Fight Back: The Role of Microbial Education in Immune System Development of *Crassostrea gigas* to fight infectious diseases**", Journée du Microbiome, Nantes, France, Juin 2023
- Dantan L., Toulza E., Gueguen Y., Degrémont L., Morga B., Vidal Dupiol J., Petton B., Fleury Y., Mege M., Maurouard E., Allienne J.F., Courtay G., Romatif O., Carcassonne P., Cosseau C., "**Protective effect of bacteria isolated from the natural microbiota of the Pacific oyster *Crassostrea gigas* against OsHV-1 μ Var and *Vibrio aestuarianus* infections**", ISS10/Holobiont3, Lyon, France, Juillet 2022

Posters de conférence :

- Dantan L., Toulza E., Gueguen Y., Degrémont L., Morga B., Vidal Dupiol J., Petton B., Fleury Y., Mege M., Maurouard E., Allienne J.F., Courtay G., Romatif O., Carcassonne P., Cosseau C. "**Protective effect of bacteria isolated from the natural microbiota of the Pacific oyster *Crassostrea gigas* against OsHV-1 μ Var and *Vibrio aestuarianus* infections**", MicrobiOccitanie, Toulouse, France, Juillet 2022
- Dantan L., Toulza E., Gueguen Y., Degrémont L., Morga B., Vidal Dupiol J., Petton B., Fleury Y., Mege M., Maurouard E., Allienne J.F., Courtay G., Romatif O., Carcassonne P., Cosseau C. "**Protective effect of bacteria isolated from the natural microbiota of the Pacific oyster *Crassostrea gigas* against OsHV-1 μ Var and *Vibrio aestuarianus* infections**", GIA2022, Grenada, Espagne, Mai 2022

Annexe II – Poster présenté lors du congrès GIA2022 à Grenade

Protective effect of bacteria isolated from the natural microbiota of the Pacific oyster *Crassostrea gigas* against OsHV-1 μ Var and *Vibrio aestuarianus* infections

Dantan L.¹, Toulza E.¹, Gueguen Y.², Degrémont L.³, Morga B.³, Vidal Dupiol J.¹, Petton B.⁴, Fleury Y.⁵, Mege M.³, Maurouard E.³, Allienne J-F.¹, Courtay G.¹, Romatif O.¹, Carcassonne P.¹, Cosseau C.¹

- ¹ IHPE, Univ. Montpellier, CNRS, Ifremer, Univ. Perpignan Via Domitia, Perpignan France
- ² MARBEC, Univ Montpellier, CNRS, Ifremer, IRD, Sète, France
- ³ Ifremer, SG2M, LPGMM, La Tremblade, France
- ⁴ Ifremer, UBO CNRS IRD, LEMAR UMR 6539 Argenton, France
- ⁵ Univ Bretagne Sud, Univ Bretagne Occidentale, Lab Biotechnol & Chim Marine, EA3884, F-29334 Quimper, France

One world – One health – One ocean



IHPE
Interactions Hosts Pathogens Environments

Contacts: luc.dantan@univ-perp.fr

Recently, marine diseases have increased in frequency and severity. One of the most striking examples of devastating diseases is the Pacific Oyster Mortality Syndrome (POMS) caused by the ostreid herpes virus 1 μ Var (OsHV-1 μ Var) that emerged in 2008 and which heavily impacts *Crassostrea gigas* production worldwide by affecting juvenile oysters [1]. Adult oysters are also regularly affected by infectious diseases, especially infections by bacterial species of the genus *Vibrio* such as *V. aestuarianus* [2].

→ The present work aims at finding sustainable strategies to help fighting against these infectious diseases through the use of the natural capacities resulting from *C. gigas* associated microbiota .

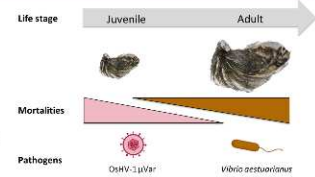

Creation of a collection of bacteria from the natural microbiota of oysters that have resisted to an infectious event



Does the cultivated bacteria isolated from the natural *C. gigas* microbiota increase disease resistance through:

- An immunomodulation induced after an interaction during larval stages ?
- An antagonist effect against pathogens due to antimicrobial compounds production ?

2 mix of bacteria added during the larval stages results in improved survival against OsHV-1 μ Var through an immunomodulatory effect.

Mix of probiotics candidates

OsHV-1 μ Var or *V. aestuarianus*

Mortality monitoring

Graph: Survival Rate for experimental Oyster (proportion of oysters exposed at the larval stage)

Strain	Survival Rate
OS1000001	0.85
OS1000002	0.75
OS1000003	0.65
OS1000004	0.55
OS1000005	0.45
OS1000006	0.35
OS1000007	0.25
OS1000008	0.15
OS1000009	0.05
OS1000010	0.00

Conclusion :

It is possible to fight against oyster pathogens by using the immunostimulant and/or antibacterial properties of bacteria from oyster microbiota

1 and 3 antimicrobial producing bacterial strains added during juvenile stage leads to an increase in *C. gigas* survival against OsHV-1 μ Var and *Vibrio aestuarianus* respectively.

328 bacterial strains of the collection was tested for antibacterial activity

78 strains of the collection have antibacterial activity against pathogenic bacteria of oysters

5 of them have been selected to be administered individually to oysters as probiotic candidates

Mortality monitoring

OsHV-1 μ Var or *V. aestuarianus*

Graph 1: Survival Rate for experimental Oyster (proportion of oysters exposed at the juvenile stage)

Strain	Survival Rate
OS1000011	0.95
OS1000012	0.85
OS1000013	0.75
OS1000014	0.65
OS1000015	0.55
OS1000016	0.45
OS1000017	0.35
OS1000018	0.25
OS1000019	0.15
OS1000020	0.05

Graph 2: Survival Rate for experimental Oyster (proportion of oysters exposed at the juvenile stage)

Strain	Survival Rate
OS1000021	0.90
OS1000022	0.80
OS1000023	0.70
OS1000024	0.60
OS1000025	0.50
OS1000026	0.40
OS1000027	0.30
OS1000028	0.20
OS1000029	0.10
OS1000030	0.00

Future Work :

- Investigating immunostimulatory mechanisms by RNAseq
- Investigating the impact of probiotic candidates on their host microbiota by 16S metabarcoding
- Characterize the chemical molecules active against oyster pathogens

Références:

- [1] J. de Lorigeril et al., "Immune-suppression by OsHV-1 viral infection causes fatal bacteraemia in Pacific oysters," *Nat. Commun.*, vol. 9, no. 1, 2018, doi: 10.1038/s41467-018-06659-3.
- [2] M. A. Travers, K. Boettcher Miller, A. Roque, and C. S. Friedman, "Bacterial diseases in marine bivalves," *J. Invertebr. Pathol.*, vol. 131, pp. 11–31, 2015, doi: 10.1016/j.jip.2015.07.010.

Acknowledgements: this work is supported by a grant from the Fond Européen pour les Affaires Maritimes et la Pêche (FEAMP, GESTINNOV project n°PFEA470020FA1000007), the fédération de recherche de the university of Perpignan FREE, the kim food and health project "gigantimic", the University of Perpignan BQR 2019 and 2021, the région Occitanie project "ProBioMic" and the LabEx CEMEB.



Annexe III – Article Fallet *et al.* 2022Article publié dans le journal *Microbiome* en 2022Fallet *et al. Microbiome* (2022) 10:85
<https://doi.org/10.1186/s40168-022-01280-5>

Microbiome

RESEARCH

Open Access



Early life microbial exposures shape the *Crassostrea gigas* immune system for lifelong and intergenerational disease protection

Manon Fallet^{1†}, Caroline Montagnani^{1†}, Bruno Petton², Luc Dantan¹, Julien de Lorgeril^{1,3}, Sébastien Comarmond¹, Cristian Chaparro¹, Eve Toulza¹, Simon Boitard⁴, Jean-Michel Escoubas¹, Agnès Vergnes¹, Jacqueline Le Grand², Ingo Bulla¹, Yannick Gueguen^{1,5}, Jérémie Vidal-Dupiol¹, Christoph Grunau¹, Guillaume Mitta^{1,6*} and Céline Cosseau^{1*}

Abstract

Background: The interaction of organisms with their surrounding microbial communities influences many biological processes, a notable example of which is the shaping of the immune system in early life. In the Pacific oyster, *Crassostrea gigas*, the role of the environmental microbial community on immune system maturation — and, importantly, protection from infectious disease — is still an open question.

Results: Here, we demonstrate that early life microbial exposure durably improves oyster survival when challenged with the pathogen causing Pacific oyster mortality syndrome (POMS), both in the exposed generation and in the subsequent one. Combining microbiota, transcriptomic, genetic, and epigenetic analyses, we show that the microbial exposure induced changes in epigenetic marks and a reprogramming of immune gene expression leading to long-term and intergenerational immune protection against POMS.

Conclusions: We anticipate that this protection likely extends to additional pathogens and may prove to be an important new strategy for safeguarding oyster aquaculture efforts from infectious disease. tag the videobyte/videoabstract in this section

Keywords: Oyster, Aquaculture, Microbiota, Innate immune shaping, Epigenetic, DNA methylation

Background

Interactions of hosts with their associated and surrounding microbial communities can have deep implications

for host fitness [1–3]. Notably, the natural microbial environment contributes to the maturation of the immune system and to the establishment of mechanisms for pathogen recognition and protection. Disruption of balanced host-microbiota interactions results in various immune and systemic disorders [4–7]. In vertebrates, many studies have emphasized the critical role of microbial colonization during early developmental stages to durably imprint the immune system [5, 8, 9]. This early life biological embedding predicts that exposure to nonpathogenic microorganisms or their metabolites can reprogram

[†]Manon Fallet and Caroline Montagnani contributed equally to this work.

*Correspondence: guillaume.mitta@ifremer.fr; celine.cosseau@univ-perp.fr

¹ IHPE, CNRS, Ifremer, Univ. Montpellier, Univ. Perpignan via Domitia, Perpignan, France

⁶ Ifremer, UMR 241 Écosystèmes Insulaires Océaniques, Labex Corail, Centre Ifremer du Pacifique, BP 49, 98725 Tahiti, French Polynesia

Full list of author information is available at the end of the article



© The Author(s) 2022. **Open Access** This article is licensed under a Creative Commons Attribution 4.0 International License, which permits use, sharing, adaptation, distribution and reproduction in any medium or format, as long as you give appropriate credit to the original author(s) and the source, provide a link to the Creative Commons licence, and indicate if changes were made. The images or other third party material in this article are included in the article's Creative Commons licence, unless indicated otherwise in a credit line to the material. If material is not included in the article's Creative Commons licence and your intended use is not permitted by statutory regulation or exceeds the permitted use, you will need to obtain permission directly from the copyright holder. To view a copy of this licence, visit <http://creativecommons.org/licenses/by/4.0/>. The Creative Commons Public Domain Dedication waiver (<http://creativecommons.org/publicdomain/zero/1.0/>) applies to the data made available in this article, unless otherwise stated in a credit line to the data.

the threshold and function of innate immune responses [8, 10, 11] to confer increased and persistent immunocompetence, echoing the emerging concept of “trained immunity.” This concept proposes adaptive properties of innate host-defense mechanisms, whereby innate immunity can retain “memory” of earlier challenges, enabling a more efficient response and increased survival capacity to subsequent pathogen assaults [12–15]. While many studies have examined the molecular mechanisms that support the trained immunity in the mammalian context, especially the implication of epigenetic-based events, little is known about how these ideas may extend to the less specific and systemic impact resulting from the microbiota interaction.

The present study focuses on the Pacific oyster *Crassostrea gigas*, which represents one of the most important marine invertebrate aquaculture species in the world. As filter feeders, oysters interact with a rich microbial environment composed of commensal and pathogenic microorganisms that continuously challenge their immune system [16–18]. *C. gigas* immune system is set up early during the development [19, 20], and this raises the question of the role played by these surrounding microbial communities during early development on oyster physiology and immunity. Despite the lack of memory lymphocytes, *C. gigas* possesses potent immune cells called hemocytes which are able to induce efficient innate immune responses based on highly conserved immune features among which the NF- κ B and IFN-like pathways [21]. Recent studies have also shown that oyster immune system can be stimulated to improve their immune response toward bacterial or viral pathogens [22, 23]. Oysters exposed to killed *Vibrio* bacteria exhibit a stronger immune response at cellular and molecular levels promoting an enhanced hemocyte phagocytosis and cell regeneration upon secondary infection with live bacteria [22, 24]. In addition, oyster stimulation with a viral mimic (poly(I:C)) induces an efficient long-term and sustainable antiviral response mainly carried by IFN-like pathways which improves the subsequent resistance and survival of oysters during a viral infection by OsHV-1. Interestingly, this improvement could be maintained across generations [25].

C. gigas suffers mass mortalities that affect juvenile stages, decimating up to 100% of young oysters in French farms. In recent years, this mortality syndrome, called Pacific oyster mortality syndrome (POMS), has become panzootic, being observed in all coastal regions of France and numerous other countries worldwide [26]. POMS is a polymicrobial and multifactorial disease, with biotic and abiotic factors influencing the disease outbreak [27]. The central role of a herpes-like virus, OsHV-1- μ var, in POMS has been demonstrated; viral infection triggers

an immune-compromised state that induces microbiota dysbiosis and subsequent bacteremia caused by opportunistic bacteria, ultimately leading to oyster death [28].

Recent reviews have suggested that environmental manipulation could be used to produce a desired phenotype and could be applied to critical issues in aquaculture [29–31]. Others have highlighted the potential of hologenomics for application in animal production [32]. Furthermore, it has been recently reported that [33–35] organisms are much more sensitive to environmental cues during early stages of development rather than in adulthood or later stages in life [33–35]. In the context of these emerging insights, we raised the question whether a nonpathogenic environmental microbiota exposure during *C. gigas* early larval development could shape the immune system to change their susceptibility to an infectious disease like POMS. We found that oyster lineages that were exposed to a microorganism-enriched environment in early life had a markedly increased survival rate when challenged with POMS in later life as well as in the subsequent generation. Concomitantly, we sampled these oysters and characterized their bacterial microbiota, transcriptomic response, and genetic and epigenetic profiles. We showed that the microbial exposure caused a significant and long-lasting shift in the oysters’ resident microbiota and strongly modified the expression of immune-related and metabolic genes. We further identified epigenetic signatures that may underlie the durable effect of the early life microbial exposure. These findings open new avenues for the development of microbiome-targeted prophylactic approaches to mitigate diseases of invertebrates of economic importance.

Methods

Zootechnics and production of the two oyster generations

Oyster reproduction was conducted at the Ifremer facility (Argenton and Bouin, France) at bio-secured conditions by filtration and irradiation of seawater as previously described [28, 36]. The F0 generation has been produced from a biparental reproduction with one male and one female of the same geographical origin (Fig. 1). Among 15 families generated and analyzed during a previous project [28], family 32 (Fa.32) was chosen for its intermediate sensitivity to the disease (56% of cumulative mortality during Atlantic experimental infection). Its genitors were collected in the delta of the “Vidourle” river (lat 43.553906-long-4.095175) in a non-farming area meaning that they have not passed through the selective filter due to the infectious environment met in farming area. In March 2016, adults were used to generate the F1 generation by multiparental reproduction. The number of genitors (approximately 100) used for each reproduction and fertilization success is shown in Table 1

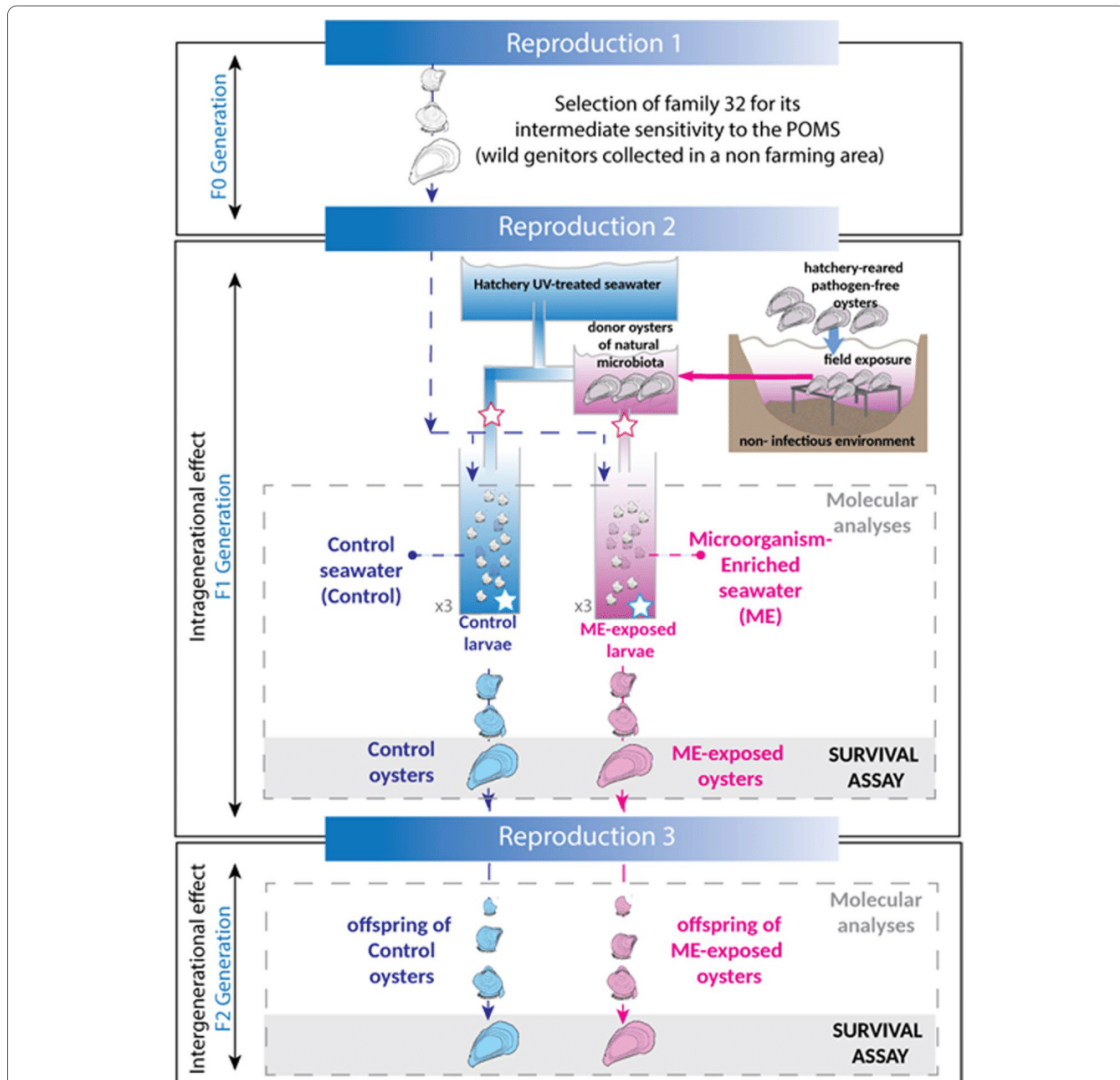

Fig. 1 Overall experimental design for larval microbial exposure and reproduction of *C. gigas*. Biparental reproduction was performed to generate the family 32 (selected during the ANR decipher project, see [28]). The family 32 was chosen for its intermediate susceptibility to the POMS disease. The F1 generation was generated in March 2016 by full-sibmultiparental reproduction. Just after fertilization, the oyster larvae were exposed to a hatchery environment (filtered and UV-treated control seawater = control seawater, blue color) or to a natural microbe-enriched environment (microorganism-enriched seawater = ME seawater, pink color). The microorganisms used to enrich the seawater came from donor oysters that acquired their microbiota in the field during a POMS-free period ($T^{\circ} < 16^{\circ}C$, no OsHV-1). The donor oysters were transferred from the field site to the hatchery and placed upstream of the breeding pipes (3 replicates per condition) in order to transmit their microbiota to recipient larvae via seawater flux. This exposure started 2 h after F0 gametes fecundation and lasted for 10 days. During exposure, donor oysters were renewed three times. This experimental design aimed at mimicking the microorganism-rich seawater that is met in natural environment. After 10 days, both ME-exposed and control oysters were raised in standard hatchery conditions (filtered and UV-treated hatchery seawater). Additionally, both control and ME-exposed oysters were used to perform multiparental reproduction and generate the F2 generation. The F2 progeny was raised in standard conditions with control seawater. Samples were taken all along the life of the F1 and F2 oysters for molecular biology analyses (see Additional file 1: Table 2) and for a pathogen challenge assay at juvenile stages (survival assay, 120 days after fertilization). Red stars indicate seawater sampling for 16S amplicon sequencing analysis, and blue stars indicate seawater sampling for cultivable bacterial analysis

of Additional file 1. Fertilization was performed in 5 L of filtered and UV-treated seawater at 21 °C without renewing the seawater. After 2 h, fecundation rate was recorded (Additional file 1: Table 1), and oyster embryos were transferred into breeding pipes for larval rearing. An open flow system which allows for constant renewal of the seawater was used for optimized larval rearing. At this point, the embryos were separated into two groups (Fig. 1): the microorganism-enriched seawater-exposed group (ME-exposed) in which oysters were exposed to a nonpathogenic natural microbiota right after fecundation for 10 days and the control group (control) in which oyster larvae were raised in filtered and UV-treated seawater. For ME seawater exposure, pathogen-free donor oysters (NSI for “Naissains Standardisés Ifremer” or “standardized spats from Ifremer”) were used as described in Petton et al. [36–38]. These NSI donor oysters were placed in March 2016 in a farming area (“Rade de Brest, Pointe du château,” France, Atlantic Ocean-lat. 48.335263-long-4.317922) during a POMS-free period (water temperature < 16 °C, no mortality registered in the field, https://www.ifremer.fr/observatoire_conchylicole/Resultats-par-annee/Resultats-nationaux-2016/Mortalite-par-site-et-par-classe-d-age) allowing them to adopt the microbial environment. At this period of the year, the temperature (14 °C) was below the threshold for disease induction and the NSI donors are expected to be pathogen-free [39, 40]. These healthy NSI donors were then transferred back to the laboratory and placed in tanks upstream of the breeding pipes of the “ME-exposed” F1 larvae. Seawater was flowing from the tank of the donor oysters to the recipient F1 larvae to expose them to the ME seawater. This allowed the transmission of microbiota from donor oysters to recipient larvae via water flow (Fig. 1). This ME-exposed condition was designed to mimic the microbial condition that the oyster larvae face in their surrounding natural environment in nature compared to the hatchery control condition. The exposure lasted for 10 days, and donor oysters were replaced 3 times during that period (batch 1 placed at day 0, batch 2 at day 3, and batch 3 at day 7). Each NSI-donor batch had a total biomass of 1000 g containing individual oysters with a mean single weight of 0.17 g. Following the 10 days of exposure and the rest of their life until next reproduction, both groups (ME-exposed and control oysters) were maintained in control conditions. In March 2017, roughly 80 to 100 genitors were used for each reproduction (numbers and fertilization success are indicated in Table 1 of the Additional file 1). After fertilization, the F2 oysters were all raised in the same standard hatchery conditions. No exposure was performed on this F2 generation. For both F1 and F2 generations, samples were taken throughout the life span of the oysters for omics analyses (see Table 2 of Additional

file 1 for details), and a phenotypic assay (survival test) was performed at day 120 when the oysters reached the juvenile stage.

Seawater quality control

Seawater was collected upstream of the recipient oysters’ breeding pipes for control and ME seawater (see Fig. 1 for water sampling position). A total of 3 L, 2 L, and 0.25 L seawater samples were filtered on 10 µm, 0.8 µm, and 0.2 µm pore size filters, respectively (Whatman™, Nucleopore™ Track-Etch Polycarbonate Membrane, 47-mm filters; ref. 111115 — 10 µm; ref. 111109 — 0.8 µm; ref. 111106—0.2 µm). Filtrates were analyzed by subsequent qPCR analysis targeting the bacterial 16S rDNA gene for total bacterial analysis. For total bacterial cultivable analysis, seawater was collected inside each tank of control and ME seawater, every day during the exposure (see Fig. 1 for water sampling position). A total of 100 µL of subsamples of seawater were spread on marine agar Petri dishes (1:10 dilution) that were incubated at 21 °C for 6 days before counting the number of total bacterial colony-forming units (CFUs).

Field and ecologically realistic experimental infections

For the F1 and F2 generations, at day 100, ME-exposed and control juveniles and offspring of ME-exposed and control juveniles were brought back from Bouin Ifremer facility to Argenton and placed in controlled environment to be acclimatized 3 weeks before disease induction. On day 120 (Table 3 of the Additional file 1), the juvenile oysters from both ME-exposed and control conditions (or their offspring) were subjected to an ecologically realistic experimental infection (Fig. 1 of the Additional file 1) as described in [28, 36]. The weight of recipient and donor individuals used per condition is indicated in Table 3 of the Additional file 1. During this experimental infection, cumulative mortality was monitored every 12 h for up to 15 days for both donors and recipients for both generations. In parallel, oysters were placed in a farming environment (farming area in “Logonna Daoulas,” lat 48.335263—long—4.317922) during the disease outbreak. As soon as the first mortality appeared in this area, the dynamic of mortality was monitored daily for 3 weeks and then every 2 weeks until the end of September, when seawater temperature is below 16 °C. Two-hundred and 100 individuals per condition were used for field disease monitoring for the F1 and F2 generation, respectively.

Survival curves

Statistical data analysis on survival data was carried out in (GraphPad Prism for Windows, GraphPad software, La Jolla, USA). Survival rates were represented as Kaplan-Meier curves. Significant differences in survival rates between conditions were evaluated using a log-rank test.

DNA and RNA extraction

Juvenile oyster pools were ground in liquid nitrogen in 50 ml stainless steel bowls with 20 mm-diameter grinding balls (Retsch MM400 mill). These oyster powders (stored at -80°C) were then used for RNA and DNA extractions as previously described [28]. Genomic DNA from powdered oyster tissues or pools of 10,000 to 20,000 frozen larvae was extracted with the NucleoSpin Tissue kit from Macherey-Nagel (reference 740952.250) according to the manufacturer's protocol with an additional step of RNAseA treatment (Macherey-Nagel, cat. #740505). Prior to a 90-min enzymatic lysis, an additional 12 min mechanical lysis (Retsch MM400 mill) was performed with zirconia/silica beads (BioSpec). DNA concentration and purity were checked with a NanoDrop ND-1000 spectrometer (Thermo Scientific) and QuBit 2.0 Fluorometer Invitrogen (Life Technologies Corporation).

Total RNA was extracted from oyster powders (10 mg) or pools of 10,000 to 20,000 frozen larvae. Samples were homogenized in 1500 μl of Tri-Reagent (Zymo Research; ref. R2050-1-200). Prior to extraction, insoluble materials were removed by centrifugation at $12,000 \times g$ for 10 min at 4°C , and supernatant was incubated with 0.2 volumes of chloroform at room temperature for 3 min. After centrifugation at $12,000 \times g$ for 15 min at 4°C , total RNA recovered from the aqueous phase was extracted using the Direct-ZolTM RNA Miniprep kit (Zymo Research; ref. R2052) according to the manufacturer's protocol. RNA concentration and purity were checked with NanoDrop ND-1000 spectrometer (Thermo Scientific), and its integrity was analyzed by capillary electrophoresis with a Bio-Analyzer 2100 (Agilent).

Bacteria and virus detection and quantification

Detection and quantification of OsHV-1 and total bacteria were performed using quantitative PCR as previously described [28]. For quantification of total bacteria in seawater, we used relative quantification normalized by the volume of filtered seawater (3 L, 2 L, or 0.25 L), and then relative proportions in each fraction (10 μm , 0.8 μm , and 0.2 μm pore size filters) were added together to obtain the overall quantification.

16S barcoding analysis

Samples used for microbiota analyses are indicated in Table 2 of the Additional file 1. For each time point, 3

biological replicates were used. For each sample, 16S rDNA amplicon libraries were generated targeting the variable V3V4 loops for bacterial communities [41]. Paired-end sequencing with a 250-bp length was performed at the McGill University (Génome Québec Innovation Centre, Montréal, Canada) for F1 generation and in Perpignan University (platform "bio-environnement," Perpignan, France) for the F2 generation on a MiSeq instrument (Illumina).

The bioinformatic pipeline for barcoding data treatment is represented in Fig. 2 of the Additional file 1.

Community analysis was performed on R software (R Core Team, 2013) using the phyloseq package [42]. Rarefaction curves of species richness were produced using the rarefy-even-depth and ggrare functions [42]. One-way ANOVA or nonparametric Kruskal-Wallis test (when the normality of residuals was rejected (Shapiro test)) was used to compare alpha diversity indices between conditions. When the ANOVA or Kruskal-Wallis tests were significant, we performed pairwise comparisons between group levels with the pairwise *t*-test or the Dunn test (post hoc analyses) using Bonferroni corrections for multiple testing. The significance threshold was set at 0.05 for all analyses. Principal coordinate analyses (PCoA) were computed to represent dissimilarities between samples using the Bray-Curtis distance matrix (beta diversity). Multivariate analysis of variance was tested using 999 permutations (adonis2 and betadisper from vegan package [43]). To compare the proportions for each genus between ME and control seawater or between ME-exposed and control oysters at day 2, we used the table of sum of sequences. We performed the analysis on the counts per sample of OTUs. Since we have three filter sizes for the water samples, we calculated the mean of the total read counts for the three filter sizes per genera. We used DESeq2 to identify the genera that exhibited a significant difference in their relative abundance in ME vs. control seawater or in ME-exposed vs. control oysters [44].

In order to identify bacterial taxa which were significantly overrepresented in the microbial community of the ME-exposed or control oysters sample, the "LDA Effect Size" (LEfSe) method [45] was used with a normalized relative abundance matrix. This method uses a Kruskal-Wallis followed by Wilcoxon tests (p -value ≤ 0.05) and then perform a linear discriminant analysis (LDA) and evaluate the effect size. The taxa with a LDA score greater than 2.0 were considered as biomarkers of exposure. A separate analysis was performed for larvae (pooled day 2 and day 10 samples) and juveniles (pooled samples for day 58 and day 120 H0) because of the strong developmental effect on bacterial composition. To

increase the statistical power, samples of the F1 and F2 generation have been pooled.

Transcriptome analysis (RNA-seq)

Samples used for RNA-Seq analysis are indicated in Table 2 of the Additional file 1. For each time point, 3 biological replicates were sequenced. RNA-Seq library construction and sequencing were performed at McGill University (Génome Québec Innovation Centre, Montréal, Canada) (<http://www.genomequebec.com>). NEB mRNA-stranded libraries were constructed and sequenced on a HiSeq 4000 (Illumina), in paired-end reads of 2×100 bp. The bioinformatic pipeline for RNA-seq data treatment is represented in Fig. 3 of the Additional file 1, and quality of the metrics is indicated in Additional file 2. Functional annotation and enrichment analysis were performed with RBGOA using an adaptive clustering and a rank-based statistical test (Mann-Whitney U -test) combined to the adaptive clustering [46]. “ $-\log(qval)$ ” (obtained from the Deseq2 analysis) was used as input for the RBGOA analysis to represent repressed or induced genes in ME-exposed compared to control oysters. The R and Perl scripts used can be downloaded at https://github.com/z0on/GO_MWU [47]. Significantly, enriched biological processes were expressed as a ratio between the number of genes differentially expressed divided by the total number of genes assigned to that biological process and was represented in heatmaps with MeV [48].

Because not all known *C. gigas* antimicrobial peptides (AMPs) were present in the *C. gigas* reference genome (assembly version V.9), read counts for all of the time points were specifically obtained by alignment against a protein database which contains the AMP sequences using DIAMOND 0.7.9 [49], and a differential analysis between ME-exposed vs. control oysters was performed as previously described [28].

Genetic analysis

gDNA shotgun library construction and Hi-seq sequencing (Illumina, paired-end reads of 150 bp) were done at McGill University (Génome Québec Innovation Centre). Bioinformatic pipelines used for genetic analysis are described in Fig. 4 of the Additional file 1. A pool of 30 oysters was used to generate the genetic data. Quality metrics are indicated in Additional file 2. Principal component analyses (PCA) were generated with R software (R Core Team, 2013) from the allele frequency matrix using R packages “dplyr” [50], “tidyr” [51], “ggplot2” [52], “RcolorBrewer” [53], and “mixOmics” [54, 55]. Evidence for adaptive selection at each SNP was tested using the FLK statistic [56], using a modification of the hapFLK software [57] allowing to input allele frequencies instead

of individual genotypes [58]. The FLK statistics were computed based on the comparison of allele frequencies in the exposed and control oysters. This analysis was performed independently for the two generations, F1 and F2. Distributions of FLK p -values were plotted with R. Significant SNPs were called at a false discovery rate (FDR) of 5%, 10%, 15%, and 20% following the approach of a previous study [59], implemented in the q -value R package.

DNA methylation analysis

Bisulfite conversion, BS-seq paired-end library construction, and sequencing were performed at McGill University (Génome Québec Innovation Centre). Sequencing was performed on a HiSeqX using 150 nucleotide paired-end reads. Quality metrics are indicated in Additional file 2. The bioinformatics pipeline for BS-seq analysis is represented in Fig. 5 of the Additional file 1 and was performed on the local Galaxy platform [60] (<http://bioinfo.univ-perp.fr>). Differential methylation analyses were performed with DMRseq package [61]. Since this software is generally applied to vertebrate DNA methylation, the parameters were optimized using the DMRsim package in order to optimize the detection of true positives in our dataset. The DMRsim package was used to simulate differential methylation analysis on 180 DMRs artificially generated out of a dataset containing 700,000 methylated CpG using a cutoff value of 0.01. The best parameters (blocksize = TRUE, minnumregion = 3, deltamax = 0.25, bpspan = 1000, mininspan = 10, maxgapssmooth = 2500, smooth = TRUE) allowed for detection of 50% of true positives with 0% of false positives for a p -val < 0.05 in our dataset and were used for the differential methylation analysis. The R scripts used here can be downloaded at https://github.com/IHPE/DMRseq_wrapper. Statistically significant differentially methylated regions (DMRs) were checked by visual inspection using the Integrative Genomics Viewer (<https://software.broadinstitute.org/software/igv/>). DMRs genomic positions were intersected with the annotation of *C. gigas* genome version 9 [62] to identify DMRs that occurred within genes (differentially methylated genes (DMGs)) and within promoters (differentially methylated promoters (DMPs)). The +2 kb region upstream of the transcription start site was defined as the promoter position. DMGs were used for functional annotation and enrichment analysis with RBGOA. A binary analysis was applied: a 1 score and a 0 score were attributed to each statistically significant or not significant DMG respectively, whatever the sense of the change in methylation level. The R and Perl scripts used here can be downloaded at https://github.com/z0on/GO_MWU [47]. The following parameters were used for the adaptive clustering: largest = 0.2; smallest = 5; clusterCutHeight = 0.25. Statistically significantly

enriched biological processes were classified manually into larger biological functions. Biological processes were graphically represented using Multiple Experiment Viewer (MeV). The color intensity represents the ratio: number of genes differentially methylated divided by the total number of genes assigned to that biological process.

Differential methylation for genes related to immune functions belonging to IFN signaling pathway, JAK-STAT pathway, nucleic acid recognition, and RNAi pathway was graphically represented with MeV. The color intensity represents the p -val obtained with the DMRSeq analysis.

The number of heritable DMRs was determined using bedtools intersect -a F2_DMRs.bed -b F1_DMRs.bed -wo | wc -l. To test whether DMRs are inherited in a statistically significant manner, 5000 BED files with regions of identical size and number of DMRs as for the F1 generation were generated and intersected with the F2 real DMRs. Five-thousand bootstrapping tests of heritability were performed by 5000 iterations of bedtools shuffle -g cg9.len -i F1_DMRs.bed -maxTries 1000 that were then used as the -b file in bedtools intersect. Mean value and standard deviation were calculated for these 5000 intersections and were compared to the value that was obtained from the real dataset. Standard deviation for the real dataset was assumed to be the same percentage as the one obtained on the shuffled data. Based on this mean value and standard deviation, a t -test testing the null hypothesis was performed, and the null hypothesis was rejected if the absolute value of the statistical test was greater than 3.090, a critical value expected for a sample size above 100 (<https://www.itl.nist.gov/div898/handbook/eda/section3/eda3672.htm>).

Results

Exposing oyster larvae to microorganism-enriched seawater shifts their bacterial microbiota throughout their life span and in the next generation.

To investigate whether the rich surrounding microbial environment that oyster larvae face early in life could influence the trajectory of the oyster immune response, we developed an experimental setup to compare the effects of control or microorganism-enriched seawater environments during early larval development. Pathogen-free larvae (F1 generation) were produced in a bio-secured (filtered and UV-treated seawater) hatchery. A subset of F1 larvae were exposed from 2 h to 10 days post-fertilization to a microorganism-enriched environment by cohabitation with oysters transferred from a natural environment during a POMS-free period (microorganism-enriched seawater, ME seawater, Fig. 1). As a control, a subset of F1 larvae were raised in bio-secured conditions with no cohabitation or no microbial

exposure (control seawater, Fig. 1). From 10 days onward, both ME-exposed and control oysters were raised in the same bio-secured conditions. A part of these two oyster subsets were maintained in bio-secured conditions and reproduced, 1 year later, to generate the F2 generation (Fig. 1). Between the ME and control oysters, we observed equivalent developmental success and survival rate in the F1 generation (Table 1 of the Additional file 3). Moreover, the absence of OsHV-1 was confirmed for ME and control oysters during exposure time. The nature of the seawater treatments was evaluated by analyzing the bacterial load and composition of the ME and control seawater by qPCR targeting 16S rRNA genes and 16S barcoding at day 2 post-fertilization. As expected, the ME contained fivefold more total bacteria than the control seawater (unpaired t -test with Welch's correction, $p = 0.001$) (Fig. 2a) and carried a more diverse microbiota as evidenced by the Chao1 index (ANOVA, $p < 0.05$) (Fig. 2b). This trend was confirmed by plating the seawater sampled in each tank containing the recipient larvae on marine agar, revealing that ME tanks contained 3.4 times more cultivable bacteria (16544 CFU/ml) than the control seawater tanks (4916 CFU/ml) (Wilcoxon test: $p < 0.05$) (Fig. 2c). This bacterial content in the breeding pipe reflects what is met in natural seawater [63]. Altogether, the ME condition was considered as an exposure to a safe, microorganism-enriched environment that mimics the natural seawater.

To test the immediate and long-term impact of early ME exposure on the oyster microbiota, we analyzed the bacterial community composition by 16S amplicon sequencing in both F1 and F2 whole body oysters (Additional file 4). Differences in composition and diversity were evidenced between ME-exposed and control oyster larvae during the ME seawater exposure (Fig. 3a, Fig. 1 of the Additional file 3). Among the 41 genera that had higher relative abundance in the ME-exposed larvae compared to control larvae, 29 (70%) were also more highly represented in the ME seawater (Fig. 4, Additional file 5). Conversely, among the 33 genera that make up a higher proportion in the control compared to ME-exposed oysters, 18 (54.5%) were also more represented in the control seawater, strongly suggesting that the microorganisms from the ME seawater colonized the oyster larvae during the exposure.

Dissimilarity analysis, based on the Bray-Curtis index, showed that the oyster microbiota profiles clustered first by developmental stage (Fig. 2 of the Additional file 3) and then by treatment (Fig. 3a to d). This analysis indicated that the microbiota composition of ME-exposed vs. control oysters was significantly different, not only during the exposure (Fig. 3a, permutation test p -val = 0.002) but also several months later during the F1 juvenile stage

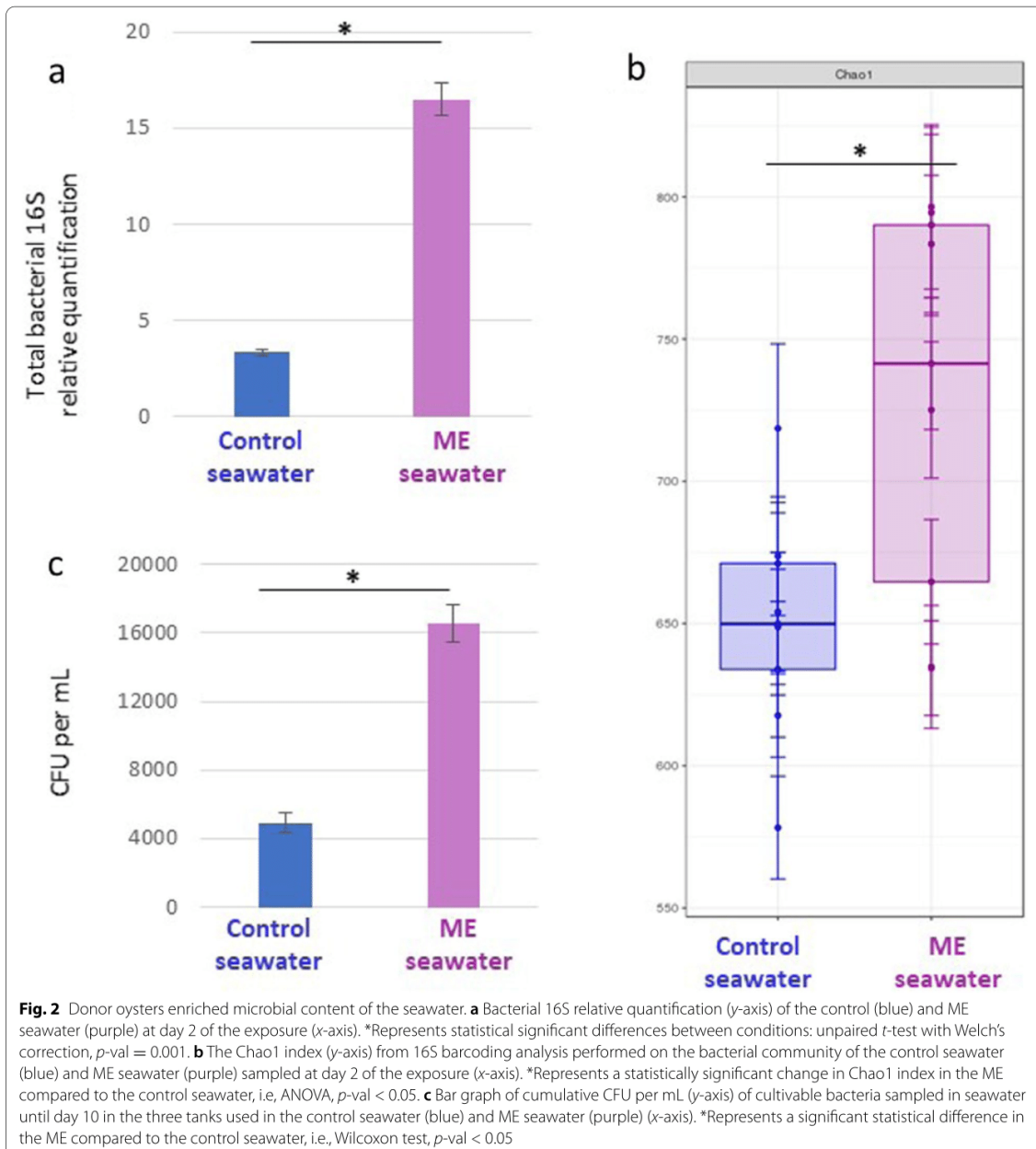

(Fig. 3b permutation test *p*-val = 0.005) as well as during larval and juvenile stages of the F2 generation (Fig. 3c and d, permutation test *p*-val = 0.001 and 0.005, respectively). We further performed a differential analysis based on OTU relative abundance in order to identify bacteria which would be overrepresented in the microbiota of

the ME-exposed or control oysters in both generations. We found 31 and 16 taxa showing statistically significant overrepresentation in the ME-exposed and control oysters respectively at larval stages and 8 and 7 taxa showing statistically significant overrepresentation in the ME-exposed or control oysters respectively at juvenile stages

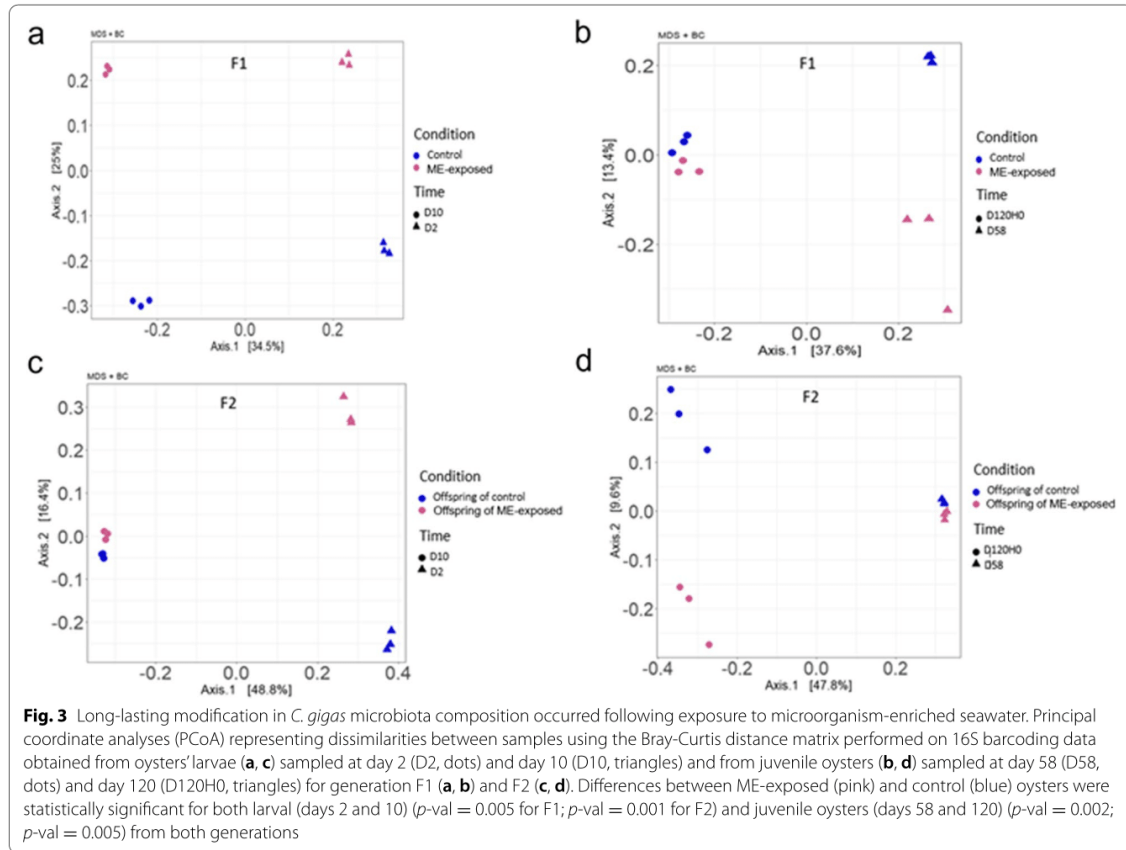

(Fig. 3 of Additional file 3 and Additional file 4). Gender detected in larvae which are associated with increased resistance in both generations are as follows: *Marinibacterium*, *Halodesulfobivrio*, *Cyclobacteriaceae*, *Marinobacterium*, *Psychroserpens*, *Pelagibaca*, *Ekhidna*, *Kordia*, *Crocinitomix*, *Lacimonas*, *Changchengzhania*, *Massilia*, *Olleya*, *Leisingera*, *Vitellibacter*, *Octadecabacter*, and *Shewanella*. Gender detected in juveniles which are associated with increased resistance in both generations are as follows: *Neptunomonas*, *Cobetia*, and *Sphingosaurtiacus*. None of the OTU enriched in ME-exposed larvae is found also enriched in ME-exposed juveniles, which underline that there is a microbiota signature specific in each stage that may be responsible for increased survival.

Taken together, this barcoding analysis clearly indicated that the oyster microbiota significantly shifts across developmental stages, but despite this strong developmental effect, the ME seawater exposure during larval stages induced a persistent modification of the oysters'

bacterial microbiota composition that even persisted in the subsequent generation.

Early life microbial exposure primes intergenerational immunity against Pacific oyster mortality syndrome

To test whether ME exposure of oyster larvae can produce a long-term impact on their resistance to disease, we conducted an ecologically realistic experimental infection mimicking the Pacific oyster mortality syndrome (POMS) on juvenile oysters from F1 and F2 generations (Fig. 1 of the Additional file 1) [28, 36]. The number of surviving oysters was monitored for 300 h, while oyster OsHV-1 load was measured before the onset of the mortalities (Fig. 5). The increase in virus load during the first 48 h confirmed successful infection. The viral load was significantly lower in the ME-exposed oysters or their offspring compared to the control lineage (p -val of two-way ANOVA with Bonferroni's correction for multiple comparisons test: p -val < 0.01) (Fig. 5a and b). Consistent with these results, we observed that ME-exposed oysters had a better survival

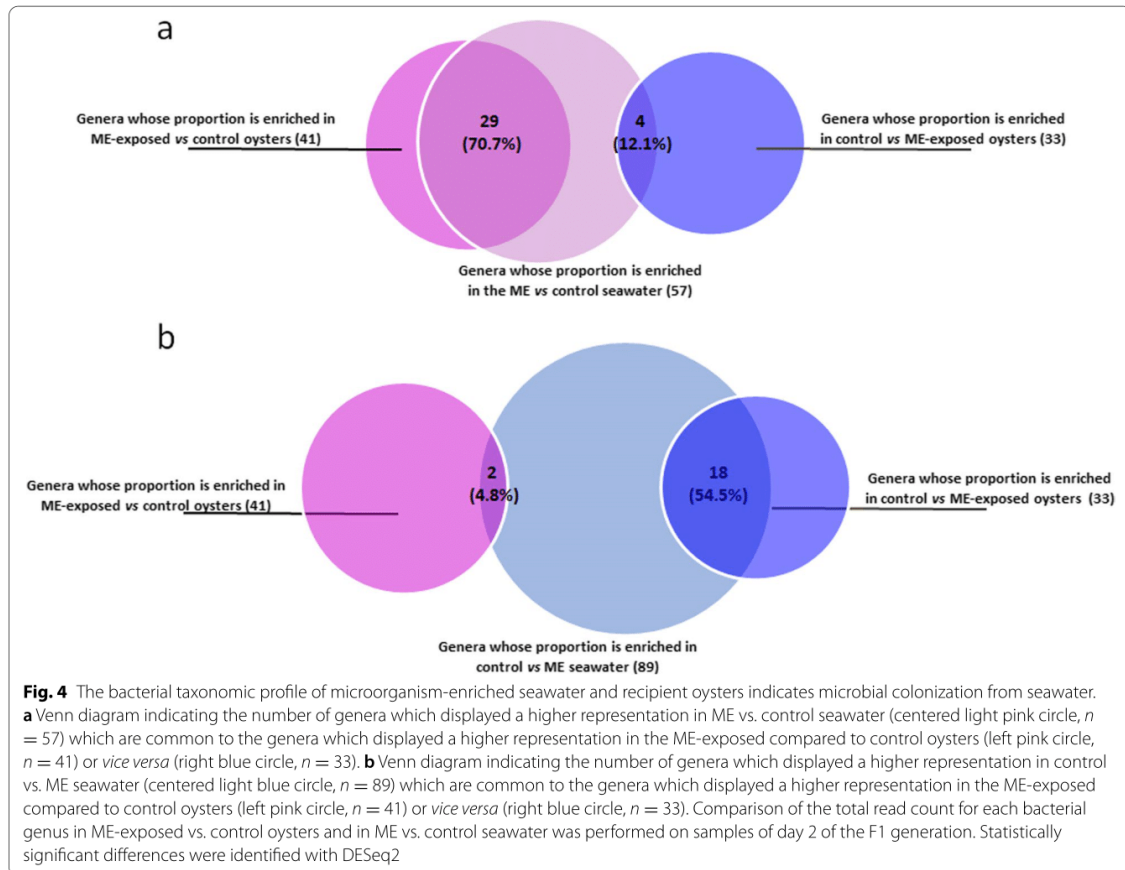

rate compared to controls in both F1 (66.3% vs. 57.4%, log-rank test, p -val < 0.05) and F2 generations (31.4% vs. 18.4%, log-rank test, p -val < 0.0001) (Fig. 5c and d, respectively). These results were confirmed in a parallel field infection test conducted with oysters from both F1 and F2 generations (F1: 16.4% vs. 14%, log-rank test, p -val < 0.001, F2: 8.5% vs. 1%, log-rank test, p -val < 0.0001) (Fig. 4 of Additional file 3).

No evidence for genetic selection as the mechanism of increased immune capacity

We investigated if a genetic selection could have occurred through ME exposure and would have selected more resistant oysters based on specific allele associations. To this end, we evaluated genome-wide SNP allele frequencies in juvenile oyster samples using whole genome sequencing (WGS). Principal component analysis (PCA) of these data showed little genetic divergence between the ME-exposed vs. control oysters for the F1 and F2 generations (Fig. 6a). Next, we conducted a genome scan

comparing allele frequencies in ME-exposed vs. control oysters using the FLK test to interrogate any signals of positive selection. The FLK statistic considers genome-wide allele frequency data in a set of populations and aims at detecting positions where genetic differentiation between these populations is higher than expected under neutral evolution. It returns for each SNP a p -value allowing to reject or accept neutrality. In the case of genetic selection on some SNPs, an excess of low p -values is expected. No such excess was detected here, revealing an absence of genetic selection between exposed and control lines for the F1 and F2 generations (Fig. 6b). Furthermore, no significant SNPs could be detected based on a FDR value below 0.05 (even below 0.15 for F2, Table 2 of the Additional file 3). This absence of genetic selection is consistent with the fact that the survival rate of ME-exposed larvae was not significantly lower than of control larvae (Table 1 of the Additional file 3). Altogether, these findings indicate that genetic alterations are not

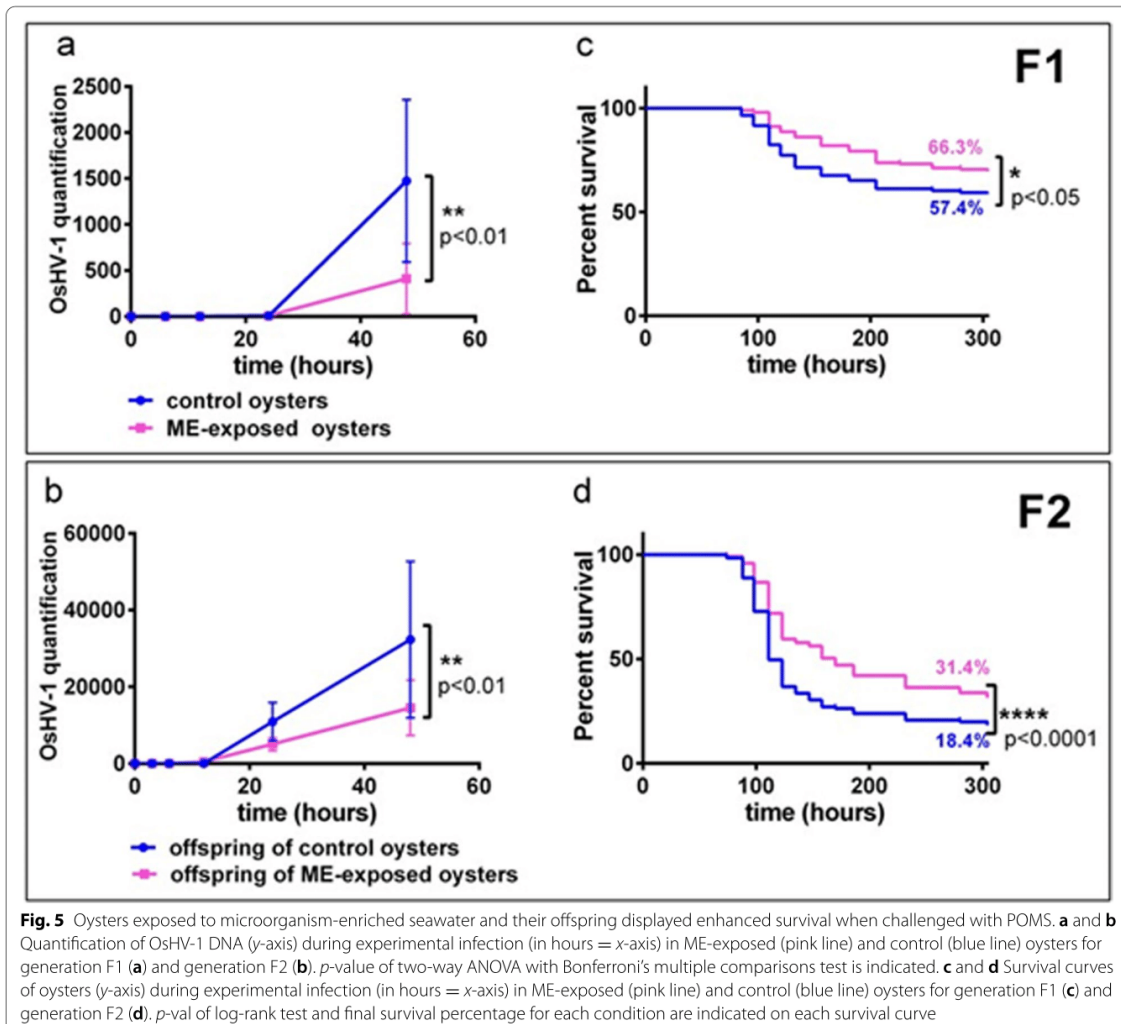

responsible for the increased resistance among the ME-exposed oyster lineage.

Upregulation of immune-related and other transcripts in microbially exposed oyster lineages

Next, we asked whether ME exposure impacted oyster gene expression by performing transcriptomic analyses on larvae and on juveniles just before and during the POMS disease breakouts for both F1 and F2 oysters. During ME exposure in the F1 larval stages, we observed a large shift in gene expression (3410 and 1100 DEGs at days 2 and 10) (Table 3 of the Additional file 3 and Additional file 6). However, the difference in gene expression between ME-exposed and control oysters

is much more nuanced at juvenile stages (35 DEGs at day 120). These observations were similar to what we observed in the F2 generation (6029 DEGs at day 10 and 120 DEGs at day 120).

To investigate which biological processes are modulated by ME exposure, we performed a rank-based gene ontology analysis (RBGOA; false-discovery rate [FDR] < 0.01) (Additional file 7). The broad gene expression shift in larval oysters encompassed many functional annotations, including general cellular process, metabolism, response to environmental stimulus, infection and immune response, transcription and gene expression, development, cell fate, RNA process, translation and protein processing, signal transduction, and transport.

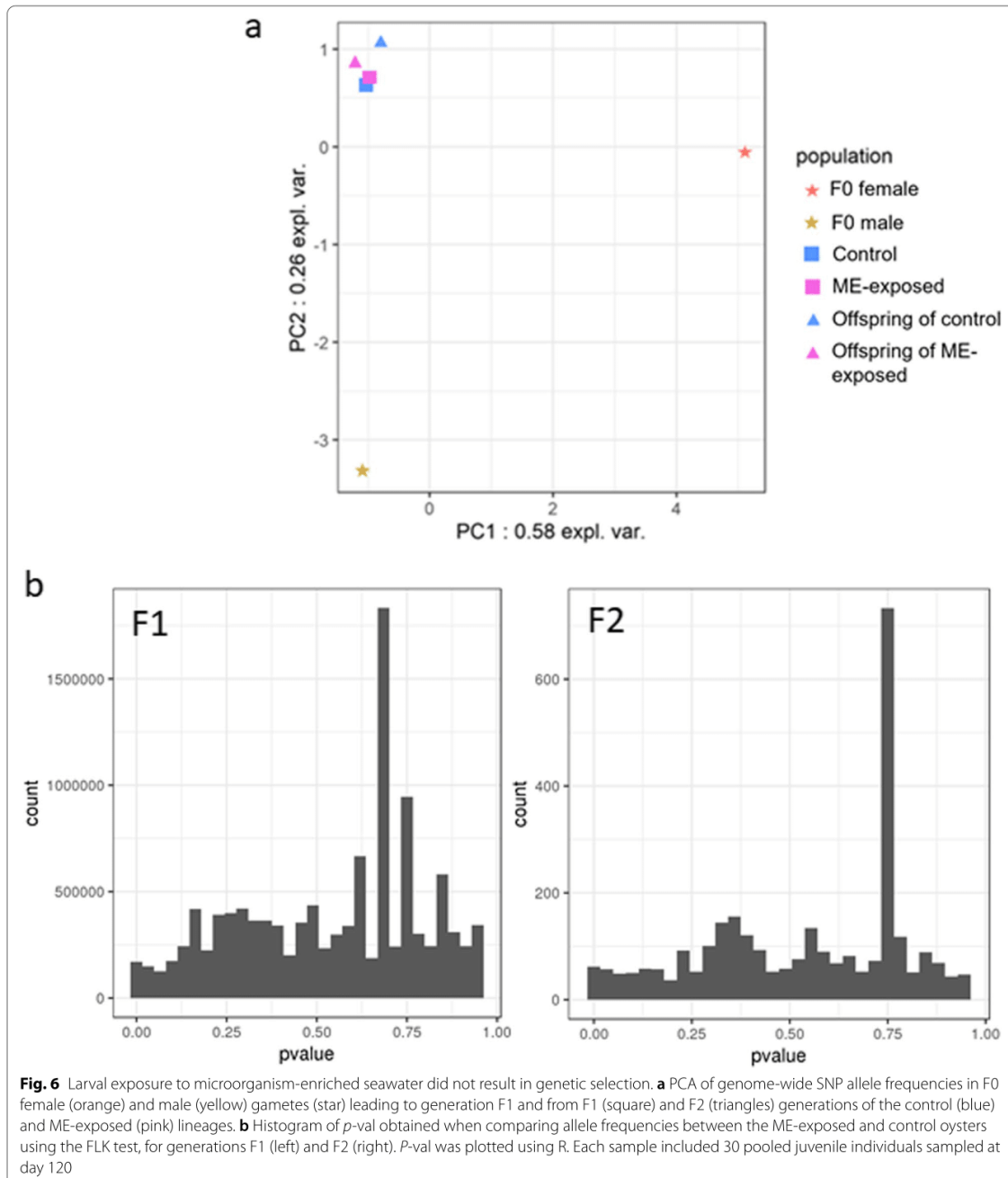

In juvenile oysters of both generations, upregulation of genes involved in responses to external stimuli and immunity persisted from the larval stage, suggesting a potential role for these genes in mediating resistance to

POMS at the time of infection. During POMS disease onset at the juvenile life stage, we observed a strong over-representation of immune functions, especially in the F2 generation (Fig. 7b). Analysis of the individual genes

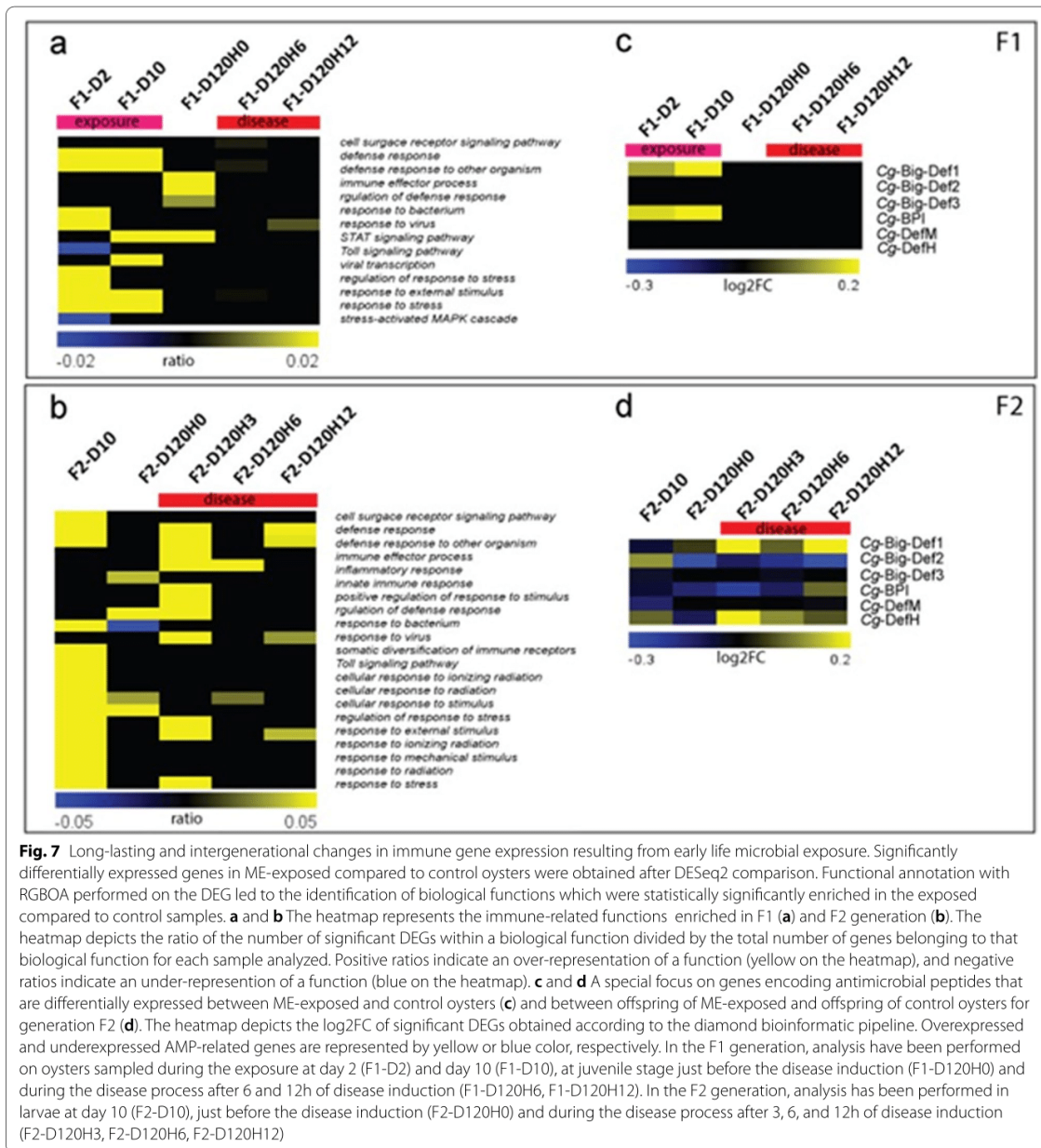

driving this enrichment revealed gene families typically involved in microbial-associated molecular pattern (MAMP), recognition (PGRP, lectins, scavenger receptors, TLR, RLR, macrophage receptor), innate immune pathways (components of IFN-TLR-JAK/STAT pathways as MyD88, IRF2, STING), interaction with bacteria (dual oxidase), and antimicrobial effectors (TNE, proteinases,

SOD, interferon-stimulated genes) (Additional file 6). These immunity-linked families were found differentially expressed in both F1 and F2 generations, especially at larval stages, meaning that the offspring of ME-exposed oysters has inherited the capacity for an improved immune gene expression, although these oysters have not been exposed *per se*. Importantly, the individual genes

encoding for these immune functions were generally different in F1 compared to F2 generation (different CGI numbers). In addition, a closer look at antimicrobial peptides or proteins (AMP) expression revealed a significant overexpression in ME-exposed compared to control oysters, either during the exposure period at larval stages in F1 (Big-Def1 and BPI at day 2 and day 10) (Fig. 7c) or in F2 (Big-Def2 and DefH at day 10) (Fig. 7d).

Apart from immune functions, our transcriptomic analysis highlighted that ME exposure during larval stages also affected key metabolic pathways. The expression of genes encoding for enzymes involved in glycolysis and the TCA cycle was lower in both generations during the larval stages, whereas the oxidative phosphorylation pathway and folate metabolism enzymes were downregulated at day 10 of the F2 generation only (Additional file 8). This shift in metabolism is specifically observed in larval stages since ME-exposed and control juveniles display the same metabolic gene expression pattern. We also observed that functions linked to chromatin structure (RBGOA analysis, Additional file 7) were repressed at day 10 of the F2 generation and genes encoding for folate metabolism, and DNA methylation machinery enzymes were repressed at day 120 of the F2 generation (Additional file 8).

Taken together, these transcriptomic analyses showed that the ME seawater larval exposure of *C. gigas* resulted in modification of the immune response of the oysters. This immunomodulatory effect was maintained up to the juvenile stages and in the subsequent generation. These results support the idea that transcriptional changes may be responsible for the increased immune capacity that we observed in the survival assay.

Differences in DNA methylation may explain the transcriptional changes observed in microbially exposed oyster lineages

The observed multigenerational impact of the ME exposure on oyster survival capacities and transcriptomic response, as well as the absence of genetic selection between conditions, led us to investigate the impact on epigenetic information through analysis of differentially methylated regions between ME and control oyster lineages. Whole genome bisulfite sequencing (WGBS) analysis was performed on oysters sampled at days 10 and 120 of the F1 and F2 generations (Table 2 of the Additional file 1). We found that *C. gigas* DNA was mainly methylated in a CpG context with a mosaic-type cytosine methylation pattern as previously described [64]. The PCA results of the global pattern of cytosine methylation data showed a clustering according to developmental stages but not according to the treatment (ME-exposed or control oysters) (Fig. 5 of the Additional file 3). This result suggested that the cytosine methylation pattern changed during development as previously

observed by others [65], and this observation was confirmed by a global decrease in the cytosine methylation level observed from larval to juvenile stages (1.77 to 1.58% for F1 and 1.82 to 1.56% for F2, respectively, p -val from Wilcoxon test < 0.01 for both generations) (Fig. 6 of the Additional file 3). Although ME exposure did not appear to strongly affect the level of cytosine methylation at the genome wide scale (Fig. 6 of the Additional file 3), a trend toward a hypermethylation was observed in ME-exposed compared to control larvae in the F1 generation. In contrast, an opposite trend toward a hypo-methylation was observed in F1 juveniles and in F2 larvae (Fig. 6 of the Additional file 3).

To gain deeper insights into the impact of the ME exposure on methylation patterns of oysters, we used DMR-Seq software [61] to identify differentially methylated regions (DMRs) between ME-exposed and control oysters for each generation. The differential methylation analysis led to the detection of 4325 and 5531 DMRs for larvae (day 10) of the F1 and F2 generation, respectively, and 4985 and 5207 for juveniles (day 120) of the F1 and F2 generation, respectively (Table 4 of the Additional file 3, Additional file 9). Hyper-methylated DMRs in ME-exposed compared to control oysters were more frequent than hypomethylated DMRs at day 10 of the F1 generation (57.4% hyper-methylated vs. 42.6% hypomethylated DMRs). However, hypomethylated DMRs in ME-exposed oysters were more frequent at day 120 of F1 generation (40.9% hyper-methylated vs. 59.1% hypomethylated DMRs) and at day 10 of the F2 generation (22.2% hyper-methylated vs. 77.8% hypomethylated DMRs) (Table 4 of the Additional file 3). These observations agreed with the previous trend observed at the genome-wide level (Fig. 6 of the Additional file 3).

Next, we analyzed DMRs that intersected with gene positions, defining these regions as differentially methylated genes (DMGs), and asked which functional annotations are overrepresented among DMGs. According to this analysis, the functions mostly impacted by DNA methylation changes were related to general cellular process, metabolism, response to environmental stimulus, signal transduction, translation, and protein processing and development (Additional file 10). Similar functions were found to be modified in the oyster transcriptome in response to the ME exposure (Additional files 7 and 10). Although immune functions were not statistically highlighted by the RBGOA analysis, 128 DMGs were found in genes encoding for immune functions. Genes coding for the interferon pathway, immune signaling pathway, viral production, and ubiquitin modification displayed changes in their cytosine methylation profiles (Fig. 7 of the Additional file 3). However, we did not observe a canonical association between expression levels and methylation

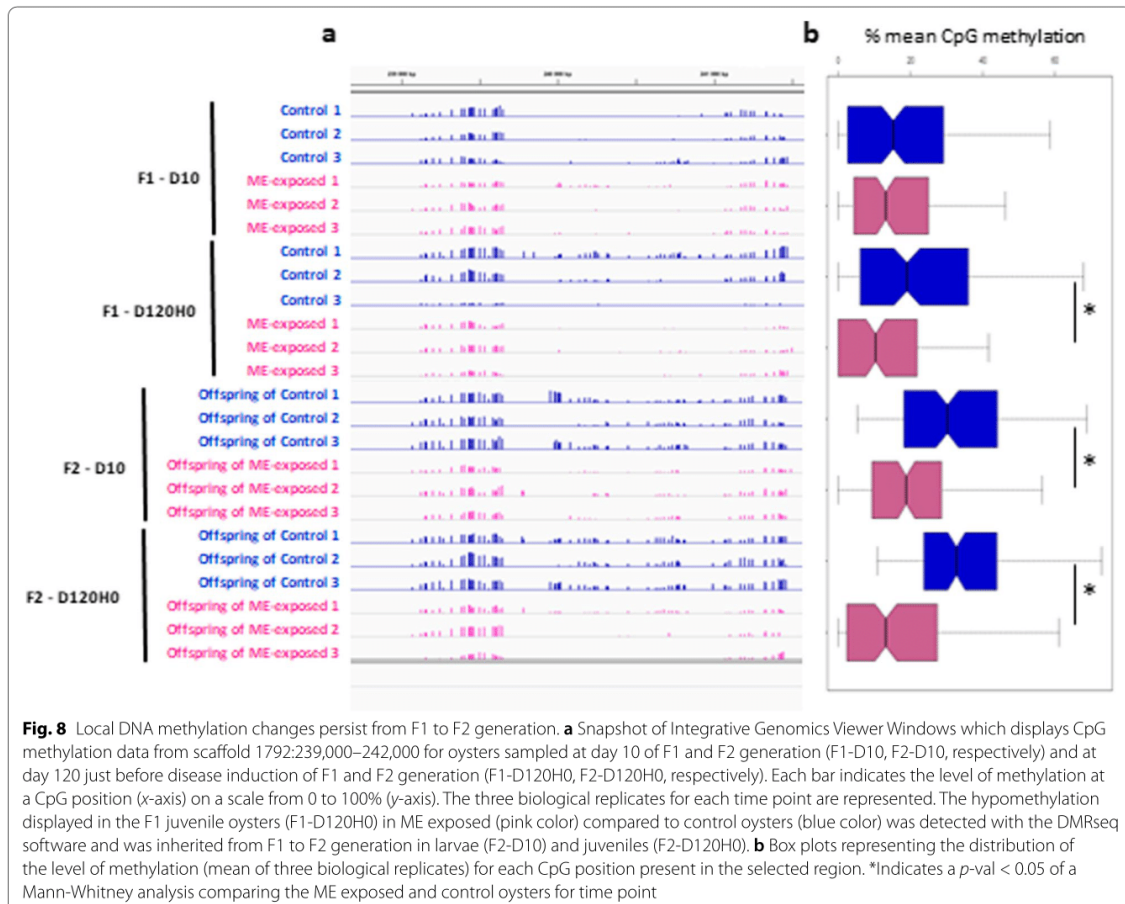

changes when analyzing correlations between methylation and transcriptome profiles (Fig. 8 of the Additional file 3).

Some DMRs were meiotically inherited from the F1 to the F2 generations (Fig. 8). Forty-eight hyper-methylated DMRs and 120 hypo-methylated DMRs were conserved from F1 to F2 at the larval stage, and in the juvenile stage, we detected 147 hyper-methylated DMRs and 252 hypo-methylated DMRs conserved from F1 to F2 (Table 1). To test whether this number of meiotically heritable DMRs was higher than would be expected by chance, we randomly generated 5000 files containing artificial DMRs of identical size and number as the DMRs detected in the real dataset of the F1 generation and intersected these with the real dataset of the F2 DMRs. Mean values of the number of intersections between F2 DMRs and these randomized regions were always significantly lower than the number of intersections between F1 and F2 DMRs from the real dataset (Table 1 and Additional file 11), indicating that the similarity of DMRs in F1 and F2 did not occur by chance.

Taken together, our epigenetic analysis shows that microbial exposure during larval stages impacts the DNA methylation pattern in both the directly exposed oysters as well as their offspring. The DNA methylation profile of genes involved in immune functions was clearly impacted in both generations, although a functional consequence on their expression was not evidenced. We showed that inheritance in the DMRs between F1 and F2 generation was not obtained by chance which suggests that DNA methylation changes can be inherited via epigenetic memory from the F1 to F2 generation.

The number of genomic coordinate intersections between either (a) F1 and F2 DMRs induced after the microbial exposure (ME-induced DMRs) or (b) mock randomly generated F1 DMRs (randomly generated DMRs) and F2 DMRs (ME induced DMRs) was compared by a T -test. Hyper- and hypo-methylated DMRs were tested separately within each developmental stage. See also Additional file 11.

Table 1 Shared DMRs between F1 and F2 generations are likely the result of intergenerational epigenetic inheritance

Day 10 hyper-methylation		
F2 ME-induced DMRs (<i>n</i> = 1230)	F1 ME-induced DMRs (<i>n</i> = 2482) 48.0 ± 17.9	F1 randomly generated DMRs (<i>n</i> = 2482) 7.20 ± 2.7
Day 10 hypo-methylation		
F2 ME-induced hypo-DMRs (<i>n</i> = 4301)	F1 ME-induced DMRs (<i>n</i> = 1843) 120.0 ± 27.8	F1 randomly generated DMRs (<i>n</i> = 1843) 18.2 ± 4.2
Day 120 hyper-methylation		
F2 ME-induced DMRs (<i>n</i> = 2550)	F1 ME-induced DMRs (<i>n</i> = 2040) 147.0 ± 38.5	F1 randomly generated DMRs (<i>n</i> = 2040) 14.8 ± 3.9
Day 120 hypo-methylation		
F2 ME-induced DMRs (<i>n</i> = 2657)	F1 ME-induced DMRs (<i>n</i> = 2945) 252.0 ± 48.1	F1 randomly generated DMRs (<i>n</i> = 2945) 27.6 ± 5.3

Discussion

A growing body of evidence shows that environmental pressure can be responsible for heritable phenotypic outcomes and changes in life history traits of living species [66]. Early life stages are considered a key window of opportunity during which individual experience with the surrounding environment can be integrated to change the phenotype at the intra- and trans-generational level [5, 8, 11, 33, 35, 67]. Proper establishment of the microbiota during this sensitive window plays a pivotal role for critical functions throughout the organism's life span, such as the immune system [5, 8, 11, 68]. In the present study, we investigated the effect of a natural non-pathogenic microbial exposure during early larval development on the immune capacities of *C. gigas* in later life stages and in the next generation. We showed that oysters exposed to seawater enriched for microorganisms had a significantly greater capacity to prevent viral proliferation and to survive when exposed to the POMS disease later in life. This improved capacity was also observed in the offspring of these oysters, which themselves had not encountered any microbial exposure. We found that exposing larvae to ME seawater clearly modulated the overall oyster transcriptome, not only during the exposure but also after the exposure 120 days and even in the subsequent generation. Noteworthy, we identified strong and consistent differences in microbiota composition during development confirming community selection in the course of immune system maturation. This long-lasting effect supports the idea that transient microbial exposure during early larval development can positively influence the microbiota community and the immunity far beyond the exposure period. Recently, many examples of cross talk between the commensal microbiota and the host immune system have been reported [9, 10, 69–71], and increasing insights into underlying mechanisms have been obtained in invertebrate species which have an innate immune

system only [72–75]. The systemic nature of the microbiota effect has been reported in several studies [76, 77]. In different vertebrate species, early exposure to commensal microbiota was found to increase their immunocompetence [9, 10, 69, 70] and to activate conserved immune pathways involved in both antibacterial and antiviral response (notably the Toll-NF-κB, JAK/STAT, and IFN pathway). These pathways have already been shown to be implicated in efficient immune response in oysters, and we show here that ME-exposed oysters displayed a higher transcriptional activation of these pathways when exposed to POMS which underlies the systemic nature of the microorganisms exposure [23, 28]. Importantly, we identified taxa that were overrepresented in the microbiota of the ME-exposed oysters and which could contribute to improve the better survival capacity that we observed. Among these bacteria, species belonging to the family of *Rhodobacteraceae* have been previously shown to be associated with increased resistance to POMS, and species belonging to Halomonadaceae, Shewanellaceae, and Oceanospirillaceae have been suggested as potential probiotic in aquaculture (ref). Further analysis will be worth to investigate the role of these bacteria for potential applications [18]. Noteworthy, we cannot exclude that the increased in immune competence also relies on stimulation by protists or viruses that our experimental approach did not allow to depict.

Epigenetic mechanisms have recently been recognized as operating at the interface between the microbiota and the host [78–80]. Importantly, the general cellular metabolism is a key player for epigenome modifications. Recent studies have highlighted that derived metabolites from multiple metabolic pathways linked to mitochondrial metabolism and oxidative stress can affect the activity of enzymes involved in histone and DNA methylation and demethylation [81, 82]. Bacterial metabolites such as folate and short-chain fatty acid have already

been pinpointed as essential mediators of communication between commensal bacteria and the host through their effects on epigenetic regulatory enzymes [83, 84]. Based on our transcriptional analyses, we clearly observed a metabolic shift in larvae in response to ME exposure, and this trait was inherited by the next generation. We observed that key enzymes involved in glycolysis pathway and TCA cycle were downregulated in response to the microbial exposure. This metabolic shift differs from the Warburg effect which has been shown to be essential for the induction of histone modifications and functional changes necessary for trained immunity in mammals [85, 86]. Interestingly, we observed that enzymes involved in folate synthesis and DNA methylation regulation were downregulated in ME-exposed oysters and their unexposed offspring. Consistent with this observation, we found that the microbial exposure of oyster larvae had an impact on the DNA methylation pattern of the oyster lineage. The most parsimonious explanation for our observations is that the DNA methylation pattern conveys, at least in part, the microbial imprinting that primes the enhanced immune protection that we observed at the intra- and inter-generational level. Some genes related

to immune function displayed a differential methylation profile between ME-exposed and control oysters in both generations. However, such changes in methylation level did not necessarily lead to significant changes in expression of the adjacent genes in *cis*. The absence of *cis*-acting association between expression and methylation changes is not unexpected and has been previously reported [87, 88]. The epigenetic code is not universal and results from a complex interplay between several bearers of epigenetic information such as DNA methylation, histone modifications, nuclear spatial remodeling, and ncRNA, which altogether interact to regulate chromatin states. Assaying DNA methylation here was a first attempt to decipher a causal link between the observed innate immune memory and a potential epigenetic imprinting. This absence of causal link raises again the question of the functional role for DNA methylation especially in invertebrates which exclusively harbor gene body methylation. This clearly fuels the current debate on the relationship between DNA methylation and transcription, which is more nuanced than previously appreciated [89]. Nevertheless, and in accordance with previous studies, we found that changes in transcription and DNA methylation occurred

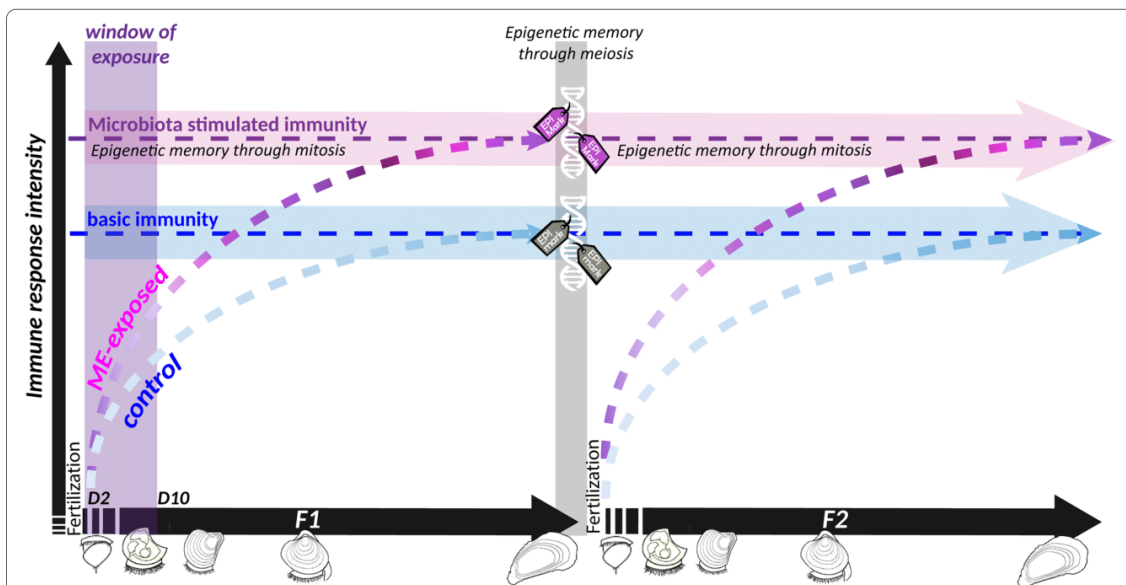

Fig. 9 Microbiota-induced epigenetic memory supports lifelong and intergenerational immune protection in *C. gigas*. Schematic representation of the proposed successive events inducing enhanced immune competence in oysters following a microorganism exposure at early stages. Exposing the oyster to microorganism-enriched seawater (ME) increased the diversity and shifted the composition of the oyster microbiota. This change in microbiota during the sensitive window of early development increased the oyster immune competence (symbolized by pink dashed lines) compared to the immune system of control oysters (symbolized by blue dashed lines). Importantly, the enhanced immune system would be expected to exert a pressure on the microflora, resulting in a different bacterial composition in ME-exposed compared to control oysters. The bacterial composition also relies on the developmental stage, which is symbolized by different colors of the dashes. This crosstalk between microbiota and immune system may trigger a continuous reshaping of cellular signaling pathways in host cells which resulted in epigenetic imprinting. This epigenetic memory allowed for inheritance of the phenotype in the offspring of the ME-exposed oysters

in common biological pathways, and overall, we conclude that DNA methylation likely acts together with other epigenetic pathways to actuate long-lasting memory of early life microbial exposure in oysters.

In brief, our results support the idea that the rich microbial environment that the oyster's larvae face just after fertilization in natural seawater is essential to boost the immune system. We showed that this exposure improved the oyster's immune competence which was maintained across life stages and generations (Fig. 9). Since germ cells develop early during the larval development in *C. gigas* [90], both F1 and F2 generations have experienced the exposure to the ME seawater, either directly during larval stages for the F1 generation or indirectly through germ cell exposure for the F2 generation. In this sense, we report here an intergenerational effect since transgenerational inheritance would require that the change in phenotype is observed in non exposed oysters (including germ cells). We observed a clear DNA methylation change after the microbial exposure, and a large proportion of these epigenetic signatures was heritable. We hypothesize that this inheritance through meiosis may account in part for the intergenerational innate immune memory that we observed, although a direct causal effect remains to be further explored.

Conclusion

An increasing body of evidence has recently emerged on the microbial instruction of immune education. It has been clearly shown that early life stages are the most appropriate window of opportunity during which the immune system is most sensitive to long-term effects [5, 8]. Here, we were able to successfully increase *C. gigas* immune competence through a natural microbial exposure during larval stages. This biological embedding could be a process applied to the aquaculture context, whereby environmental manipulation through early microbial experience could be used to produce long-lasting resistance to pathogens.

Abbreviations

POMS: Pacific oyster mortality syndrome; UV: Ultraviolet; ME: Microorganism-enriched; NSI: Naissains Standardisés Ifremer; CFU: Colony-forming unit; OTU: Operational taxonomic unit; RNA: Ribonucleic acid; RNA-Seq: Sequencing of the total ribonucleic acid; mRNA: Ribonucleic acid messenger; ncRNA: Noncoding ribonucleic acid; DNA: Deoxyribonucleic acid; gDNA: Genomic deoxyribonucleic acid; DNA-Seq: Ribonucleic acid of the total deoxyribonucleic acid; WGS: Whole genome sequencing; WGBS: Whole genome bisulfite sequencing; BS-seq: Bisulfite sequencing; RBGOA: Rank-based gene ontology analysis; AMPs: Antimicrobial peptides; PCA: Principal component analyses; SNP: Single-nucleotide polymorphism; FLK: Statistical method using an extension of Lewontin and Krakauer (LK) test; FDR: False discovery rate; CpG: Cytosine-phosphodiester bond-guanosine; DEG: Differentially expressed gene; DMR: Differentially methylated region; DMG: Differentially methylated gene; DMP: Differentially methylated promoter; MeV: Multiple Experiment Viewer; ANOVA: Analysis of variance.

Supplementary Information

The online version contains supplementary material available at <https://doi.org/10.1186/s40168-022-01280-5>.

Additional file 1. Additional information related to the methodology (the origin of the biological samples, the experimental design for disease induction, the bioinformatic pipelines).

Additional file 2. Quality of the metrics for omic analysis (sheet 1: transcriptomic, sheet 2: genetic, sheet 3: epigenomic).

Additional file 3. Supplementary results on the phenotypes (Fertilisation success and survival rate of oysters) and on omics data (Table 2 = genetic, Table 3 = transcriptomic, Table 4 = epigenomic, Figs. 1 and 2 = 16S barcoding).

Additional file 4. OTU tables for 16S barcoding analysis. Each sheet correspond to a different time point. This sheet also includes the results of LEfSe analysis and compiles the taxa which are statistically significantly enriched in the microbial community of ME-exposed or control oysters in larvae (sheet = LEfSe larval stages) and juveniles (sheet = LEfSe juvenile stages) based on a Kruskal-Wallis test p val < 0.05.

Additional file 5. Results of two differential analyses comparing the proportion of OTUs: (1) ME exposed oysters vs control oysters and (2) ME water vs. control water.

Additional file 6. Compilation of differentially expressed genes at the time point indicated (All DEGs = all the differentially expressed genes, Other sheets = immune related genes).

Additional file 7. Compilation of the RBGOA biological function which are significantly enriched in the transcriptomic dataset for each time point.

Additional file 8. Compilation the differentially expressed genes related to metabolic functions at the time point indicated.

Additional file 9. Compilation of differentially methylated regions in any regions of the genomes (DMRs), within gene bodies (DMGs), within promoter regions (DMPs).

Additional file 10. Compilation the RBGOA biological functions which are significantly enriched in the epigenomic dataset for each time point (sheet 1 to 4) and comparison with RBGOA function from the transcriptomic data.

Additional file 11. Details for the statistical analysis performed to address the significance of the inheritance in DMRs patterns.

Acknowledgements

We warmly thank the staff of the Ifremer stations of Argenton and Bouin (Ifremer LPI-PFOM and SG2M laboratories) for technical support in the animal experimentation and for the production of the two generations of oysters. We also thank Camille Clerissi and Nelia Luviano for fruitful discussions. The authors are grateful to Jean-Francois Allienne from the Bioenvironment platform for technical support in library preparation and sequencing. The present study was supported by the ANR project DECIPHER (ANR-14-CE19-0023), by the chercheur d'avenir project TRANSGIGAS (Region Languedoc-Roussillon), by the EU funded project VIVALDI (H2020 program, n° 678589), and by Ifremer, CNRS, Université de Montpellier and Université de Perpignan Via Domitia, with the support of LabEx CeMEB, an ANR "Investissements d'avenir" program (ANR-10-LABX-04-01) through the Environmental Epigenomics platform. This study is set within the framework of the "Laboratoires d'Excellences (LABEX)" TULIP (ANR-10-LABX-41).

Authors' contributions

MF, CM, B, JDL, JME, YG, JL, GM, and CC performed oyster experiments. MF, ET, and CC performed microbiota analyses. MF, CM, CCh, AV, JVD, CG, GM, and CC performed RNA-seq analyses. MF, SC, CCh, IB, JVD, CG, and CC performed BS-seq analyses. CM and JDL performed qPCR analyses. MF, SB, and CG performed the genetic analysis. MF, CM, JDL, BP, GM, and CC designed experiments. MF, CM, BP, CCh, SB, JVD, CG, GM, and CC interpreted results. MF, CM, GM, CG, SB, JME, ET, and CC wrote the paper. The author(s) read and approved the final manuscript.

Authors' information

Not applicable.

Funding

ANR project DECIPHER (ANR-14-CE19-0023); the chercheur d'avenir project TRANSGIGAS (Region Languedoc-Roussillon); the University of Perpignan Via Domitia, ED305; the EU-funded project VIVALDI (H2020 program, n° 678589); LabEx "CeMEB" (ANR-10-LABX-04-01) through the Environmental Epigenomics Platform; and LabEx "TULIP" (ANR-10-LABX-41).

Availability of data and materials

The datasets generated, analyzed during the current study, and supporting the conclusions of this article (RNA-seq, WGBS, WGS, 16S barcoding data) are available at the following link: <https://dataview.ncbi.nlm.nih.gov/object/PRJNA609264?reviewer=hg0tffa8ig7ae6tbam1ssapv8>.

Declarations**Ethics approval and consent to participate**

Not applicable.

Consent for publication

Not applicable.

Competing interests

The authors declare that they have no competing interests.

Author details

¹IHPE, CNRS, Ifremer, Univ. Montpellier, Univ. Perpignan via Domitia, Perpignan, France. ²Ifremer, UBO CNRS IRD, LEMAR UMR 6539, Argenton, France. ³Ifremer, IRD, Univ. Nouvelle-Calédonie, Univ. La Réunion, ENTROPIE, F-98800 Nouméa, Nouvelle-Calédonie, France. ⁴CBGP, CIRAD, INRAE, Institut Agro, IRD, Université de Montpellier, Montpellier, France. ⁵MARBEC, CNRS, Ifremer, IRD, Univ. Montpellier, Sète, France. ⁶Ifremer, UMR 241 Ecosystèmes Insulaires Océaniques, Labex Corail, Centre Ifremer du Pacifique, BP 49, 98725 Tahiti, French Polynesia.

Received: 16 February 2022 Accepted: 14 April 2022

Published online: 04 June 2022

References

- McFall-Ngai M, Hadfield MG, Bosch TC, Carey HV, Domazet-Loaso T, Douglas AE, et al. Animals in a bacterial world, a new imperative for the life sciences. *Proc Natl Acad Sci U S A*. 2013;110(9):3229–36.
- Bordenstein SR, Theis KR. Host biology in light of the microbiome: ten principles of holobionts and hologenomes. *PLoS Biol*. 2015;13(8):e1002226.
- Theis KR, Dheilly NM, Klassen JL, Brucker RM, Baines JF, Bosch TC, et al. Getting the hologenome concept right: an eco-evolutionary framework for hosts and their microbiomes. *mSystems*. 2016;1(2):e00028–16.
- Fan Y, Pedersen O. Gut microbiota in human metabolic health and disease. *Nat Rev Microbiol*. 2021;19(1):55–71.
- Arrieta MC, Stiemsma LT, Amenyogbe N, Brown EM, Finlay B. The intestinal microbiome in early life: health and disease. *Front Immunol*. 2014;5:427.
- Rosenberg E, Koren O, Reshef L, Efrony R, Zilber-Rosenberg I. The role of microorganisms in coral health, disease and evolution. *Nat Rev Microbiol*. 2007;5(5):355–62.
- Schwarz RS, Moran NA, Evans JD. Early gut colonizers shape parasite susceptibility and microbiota composition in honey bee workers. *P Natl Acad Sci USA*. 2016;113(33):9345–50.
- Gensollen T, Iyer SS, Kasper DL, Blumberg RS. How colonization by microbiota in early life shapes the immune system. *Science*. 2016;352(6285):539–44.
- Galindo-Vilegas J, Garcia-Moreno D, de Oliveira S, Meseguer J, Mulero V. Regulation of immunity and disease resistance by commensal microbes and chromatin modifications during zebrafish development. *Proc Natl Acad Sci U S A*. 2012;109(39):E2605–14.
- McCoy KD, Burkhard R, Geuking MB. The microbiome and immune memory formation. *Immunol Cell Biol*. 2019;97(7):625–35.
- Renz H, Holt PG, Inouye M, Logan AC, Prescott SL, Sly PD. An exposome perspective: early-life events and immune development in a changing world. *J Allergy Clin Immunol*. 2017;140(1):24–40.
- Netea MG, Dominguez-Andres J, Barreiro LB, Chavakis T, Divangahi M, Fuchs E, et al. Defining trained immunity and its role in health and disease. *Nat Rev Immunol*. 2020;20(6):375–88.
- Gourbal B, Pinaud S, Beckers GJM, Van Der Meer JWM, Conrath U, Netea MG. Innate immune memory: an evolutionary perspective. *Immunol Rev*. 2018;283(1):21–40.
- Melillo D, Marino R, Italiani P, Boraschi D. Innate immune memory in invertebrate metazoans: a critical appraisal. *Front Immunol*. 2018;9:1915.
- Milutinovic B, Kurtz J. Immune memory in invertebrates. *Semin Immunol*. 2016;28(4):328–42.
- Dupont S, Lokmer A, Corre E, Auguet JC, Petton B, Toulza E, et al. Oyster hemolymph is a complex and dynamic ecosystem hosting bacteria, protists and viruses. *Animal Microbiome*. 2020;2:12.
- Lokmer A, Mathias Wegner K. Hemolymph microbiome of Pacific oysters in response to temperature, temperature stress and infection. *ISME J*. 2015;9(3):670–82.
- Clerissi C, de Lorgeril J, Petton B, Lucasson A, Escoubas JM, Gueguen Y, et al. Microbiota composition and evenness predict survival rate of oysters confronted to Pacific oyster mortality syndrome. *Front Microbiol*. 2020;11:311.
- Tirape A, Bacque C, Brizard R, Vandenbulcke F, Boulo V. Expression of immune-related genes in the oyster *Crassostrea gigas* during ontogenesis. *Dev Comp Immunol*. 2007;31(9):859–73.
- Liu Z, Zhou Z, Wang L, Song X, Chen H, Wang W, et al. The encephalergic nervous system and its immunomodulation on the developing immune system during the ontogenesis of oyster *Crassostrea gigas*. *Fish Shellfish Immun*. 2015;45(2):250–9.
- Zhang L, Li L, Guo X, Litman GW, Dishaw LJ, Zhang G. Massive expansion and functional divergence of innate immune genes in a protostome. *Sci Rep*. 2015;5:8693.
- Li Y, Song X, Wang W, Wang L, Yi Q, Jiang S, et al. The hematopoiesis in gill and its role in the immune response of Pacific oyster *Crassostrea gigas* against secondary challenge with *Vibrio splendidus*. *Dev Comp Immunol*. 2017;71:59–69.
- Lafont M, Vergnes A, Vidal-Dupiol J, de Lorgeril J, Gueguen Y, Haffner P, et al. A sustained immune response supports long-term antiviral immune priming in the Pacific oyster, *Crassostrea gigas*. *mBio*. 2020;11(2):e02777–19.
- Zhang T, Qiu L, Sun Z, Wang L, Zhou Z, Liu R, et al. The specifically enhanced cellular immune responses in Pacific oyster (*Crassostrea gigas*) against secondary challenge with *Vibrio splendidus*. *Dev Comp Immunol*. 2014;45(1):141–50.
- Lafont M, Goncalves P, Guo X, Montagnani C, Raftos D, Green T. Transgenerational plasticity and antiviral immunity in the Pacific oyster (*Crassostrea gigas*) against ostreid herpesvirus 1 (OsHV-1). *Dev Comp Immunol*. 2019;91:17–25.
- Segarra A, Pepin JF, Arzul I, Morga B, Faury N, Renault T. Detection and description of a particular ostreid herpesvirus 1 genotype associated with massive mortality outbreaks of Pacific oysters, *Crassostrea gigas*, in France in 2008. *Virus Res*. 2010;153(1):92–9.
- Petton B, Destoumieux-Garzon D, Pernet F, Toulza E, de Lorgeril J, Degremont L, et al. The Pacific oyster mortality syndrome, a polymicrobial and multifactorial disease: state of knowledge and future directions. *Front Immunol*. 2021;12:630343.
- de Lorgeril J, Lucasson A, Petton B, Toulza E, Montagnani C, Clerissi C, et al. Immune-suppression by OsHV-1 viral infection causes fatal bacteraemia in Pacific oysters. *Nat Commun*. 2018;9(1):4215.
- Gavery MR, Roberts SB. Epigenetic considerations in aquaculture. *PeerJ*. 2017;5:e4147.
- Eirin-Lopez JM, Putnam HM. Marine environmental epigenetics. *Annu Rev Mar Sci*. 2019;11:335–68.
- Norouzitallab P, Baruah K, Biswas P, Vanrompuy D, Bossier P. Probing the phenomenon of trained immunity in invertebrates during a transgenerational study, using brine shrimp *Artemia* as a model system. *Sci Rep-Uk*. 2016;6:21166.

32. Limborg MT, Alberdi A, Kodama M, Roggenbuck M, Kristiansen K, Gilbert MTP. Applied hologenomics: feasibility and potential in aquaculture. *Trends Biotechnol.* 2018;36(3):252–64.
33. Aristizabal MJ, Anreiter I, Halldorsdottir T, Odgers CL, McDade TW, Goldenberg A, et al. Biological embedding of experience: a primer on epigenetics. *P Natl Acad Sci USA.* 2020;117(38):23261–9.
34. Dolinoy DC, Anderson OS, Rozek LS. Epigenetic manifestation of environmental exposures. In: Niculescu MD, Haggarty P, editors. *Nutrition in epigenetics.* Blackwell Publishing, Ltd.; 2011.
35. Donelson JM, Salinas S, Munday PL, Shama LNS. Transgenerational plasticity and climate change experiments: where do we go from here? *Glob Chang Biol.* 2018;24(1):13–34.
36. Petton B, de Lorgeril J, Mitta G, Daigle G, Pernet F, Alunno-Bruscia M. Fine-scale temporal dynamics of herpes virus and vibrios in seawater during a polymicrobial infection in the Pacific oyster *Crassostrea gigas*. *Dis Aquat Org.* 2019;135(2):97–106.
37. Petton B, Pernet F, Robert R, Boudry P. Temperature influence on pathogen transmission and subsequent mortalities in juvenile Pacific oysters *Crassostrea gigas*. *Aquacult Env Interac.* 2013;3(3):257–73.
38. Petton B, Bruto M, James A, Labreuche Y, Alunno-Bruscia M, Le Roux F. *Crassostrea gigas* mortality in France: the usual suspect, a herpes virus, may not be the killer in this polymicrobial opportunistic disease. *Front Microbiol.* 2015;6:686.
39. Fleury E, Barbier P, Petton B, Normand J, Thomas Y, Pouvreau S, et al. Latitudinal drivers of oyster mortality: deciphering host, pathogen and environmental risk factors. *Sci Rep.* 2020;10(1):7264.
40. Le Roux F, Wegner KM, Polz MF. Oysters and *Vibrios* as a model for disease dynamics in wild animals. *Trends Microbiol.* 2016;24(7):568–80.
41. Klindworth A, Pruesse E, Schweer T, Peplies J, Quast C, Horn M, et al. Evaluation of general 16S ribosomal RNA gene PCR primers for classical and next-generation sequencing-based diversity studies. *Nucleic Acids Res.* 2013;41(1):e1.
42. McMurdie PJ, Holmes S. phyloseq: an R package for reproducible interactive analysis and graphics of microbiome census data. *PLoS One.* 2013;8(4):e61217.
43. Oksanen JF, Blanchet G, Friendly M, Kindt R, Legendre P, McGlinn D, Minchin PR, O'Hara RB, Simpson GL, Solymos P et al: *Vegan: community ecology package.* 2019.
44. Love MI, Huber W, Anders S. Moderated estimation of fold change and dispersion for RNA-seq data with DESeq2. *Genome Biol.* 2014;15(12):1–21.
45. Segata N, Izard J, Waldron L, Gevers D, Miropolsky L, Garrett WS, et al. Metagenomic biomarker discovery and explanation. *Genome Biol.* 2011;12(6):R60.
46. Voolstra CR, Sunagawa S, Matz MV, Bayer T, Aranda M, Buschiazio E, et al. Rapid evolution of coral proteins responsible for interaction with the environment. *PLoS One.* 2011;6(5):e20392.
47. Wright RM, Aglyamova GV, Meyer E, Matz MV. Gene expression associated with white syndromes in a reef building coral, *Acropora hyacinthus*. *BMC Genomics.* 2015;16(1):1–2.
48. Howe E, Holton K, Nair S, Schlauch D, Sinha R, Quackenbush J, editors. *MeV: MultiExperiment Viewer.* Boston: Springer; 2010.
49. Buchfink B, Xie C, Huson DH. Fast and sensitive protein alignment using DIAMOND. *Nat Methods.* 2015;12(1):59–60.
50. Hadley Wickham RF, Henry L, Muller K. dplyr: a grammar of data manipulation. In: *R package version 0.7.4;* 2017.
51. Wickham H, Henry L. Tidy: easily tidy data with'spread ()'and'gather ()'functions. In: *R package version 0.6, 1;* 2017.
52. Whickham H, editor. ggplot2: elegant graphics for data analysis: Springer; 2016.
53. Neuwirth E, Brewer RC. ColorBrewer palettes. *R package version, 1;* 2014.
54. Le Cao KA, Rohart F, Gonzalez I, Le Cao MK-A. *Package mixomics;* 2018.
55. Rohart F, Gautier B, Singh A, Le Cao KA. mixOmics: an R package for 'omics feature selection and multiple data integration. *PLoS Comput Biol.* 2017;13(11):e1005752.
56. Bonhomme M, Chevalet C, Servin B, Boitard S, Abdallah J, Blott S, et al. Detecting selection in population trees: the Lewontin and Krakauer test extended. *Genetics.* 2010;186(1):241–62.
57. Fariello MJ, Boitard S, Naya H, SanCristobal M, Servin B. Detecting signatures of selection through haplotype differentiation among hierarchically structured populations. *Genetics.* 2013;193(3):929–41.
58. Vignal A, Boitard S, Thebault N, Dayo GK, Yapi-Gnaore V, Youssao Abdou Karim I, et al. A guinea fowl genome assembly provides new evidence on evolution following domestication and selection in galliformes. *Mol Ecol Resour.* 2019;19(4):997–1014.
59. Storey JD, Tibshirani R. Statistical significance for genomewide studies. *P Natl Acad Sci USA.* 2003;100(16):9440–5.
60. Afgan E, Baker D, van den Beek M, Blankenberg D, Bouvier D, Cech M, et al. The Galaxy platform for accessible, reproducible and collaborative biomedical analyses: 2016 update. *Nucleic Acids Res.* 2016;44(W1):W3–W10.
61. Korthauer K, Chakraborty S, Benjamini Y, Irizarry R. Detection and accurate false discovery rate control of differentially methylated regions from whole genome bisulfite sequencing. *Biostatistics.* 2018;20:367–83.
62. Zhang G, Fang X, Guo X, Li L, Luo R, Xu F, et al. The oyster genome reveals stress adaptation and complexity of shell formation. *Nature.* 2012;490(7418):49–54.
63. de Lorgeril J, Escoubas JM, Loubiere V, Pernet F, Le Gall P, Vergnes A, et al. Inefficient immune response is associated with microbial permissiveness in juvenile oysters affected by mass mortalities on field. *Fish Shellfish Immunol.* 2018;77:156–63.
64. Wang X, Li Q, Lian J, Li L, Jin L, Cai H, et al. Genome-wide and single-base resolution DNA methylomes of the Pacific oyster *Crassostrea gigas* provide insight into the evolution of invertebrate CpG methylation. *BMC Genomics.* 2014;15:1119.
65. Riviere G, He Y, Tecchio S, Crowell E, Gras M, Sourdain P, et al. Dynamics of DNA methylomes underlie oyster development. *PLoS Genet.* 2017;13(6):e1006807.
66. Yin J, Zhou M, Lin Z, Li QQ, Zhang YY. Transgenerational effects benefit offspring across diverse environments: a meta-analysis in plants and animals. *Ecol Lett.* 2019;22(11):1976–86.
67. Burton T, Metcalfe NB. Can environmental conditions experienced in early life influence future generations? *Proc Biol Sci.* 2014;281(1785):20140311.
68. Moreno-Garcia M, Vargas V, Ramirez-Bello I, Hernandez-Martinez G, Lanz-Mendoza H. Bacterial exposure at the larval stage induced sexual immune dimorphism and priming in adult *Aedes aegypti* mosquitoes. *PLoS One.* 2015;10(7):e0133240.
69. Hooper LV, Littman DR, Macpherson AJ. Interactions between the microbiota and the immune system. *Science.* 2012;336(6086):1268–73.
70. Thaiss CA, Zmora N, Levy M, Elinav E. The microbiome and innate immunity. *Nature.* 2016;535(7610):65–74.
71. Negi S, Das DK, Pahari S, Nadeem S, Agrewala JN. Potential role of gut microbiota in induction and regulation of innate immune memory. *Front Immunol.* 2019;10:2441.
72. Augustin R, Schroder K, Murillo Rincon AP, Fraune S, Anton-Erxleben F, Herbst EM, et al. A secreted antibacterial neuropeptide shapes the microbiome of *Hydra*. *Nat Commun.* 2017;8(1):698.
73. Bosch TC. Cnidarian-microbe interactions and the origin of innate immunity in metazoans. *Annu Rev Microbiol.* 2013;67:499–518.
74. Dierking K, Pita L. Receptors mediating host-microbiota communication in the metaorganism: the invertebrate perspective. *Front Immunol.* 2020;11:1251.
75. Horak RD, Leonard SP, Moran NA. Symbionts shape host innate immunity in honeybees. *Proc Biol Sci.* 2020;287(1933):20201184.
76. Sansone CL, Cohen J, Yasunaga A, Xu J, Osborn G, Subramanian H, et al. Microbiota-dependent priming of antiviral intestinal immunity in *Drosophila*. *Cell Host Microbe.* 2015;18(5):571–81.
77. Ichinohe T, Pang IK, Kumamoto Y, Peaper DR, Ho JH, Murray TS, et al. Microbiota regulates immune defense against respiratory tract influenza A virus infection. *Proc Natl Acad Sci U S A.* 2011;108(13):5354–9.
78. Celiker C, Kalkan R. Genetic and epigenetic perspective of microbiota. *Appl Microbiol Biotechnol.* 2020;104(19):8221–9.
79. Ansari I, Raddatz G, Gutekunst J, Ridnik M, Cohen D, Abu-Remaileh M, et al. The microbiota programs DNA methylation to control intestinal homeostasis and inflammation. *Nat Microbiol.* 2020;5(4):610–9.
80. Miro-Blanch J, Yanes O. Epigenetic regulation at the interplay between gut microbiota and host metabolism. *Front Genet.* 2019;10:638.
81. Narne P, Pandey V, Phanithi PB. Interplay between mitochondrial metabolism and oxidative stress in ischemic stroke: an epigenetic connection. *Mol Cell Neurosci.* 2017;82:176–94.

82. Reid MA, Dai Z, Locasale JW. The impact of cellular metabolism on chromatin dynamics and epigenetics. *Nat Cell Biol.* 2017;19(11):1298–306.
83. Arpaia N, Campbell C, Fan X, Dikiy S, van der Veecken J, deRoos P, et al. Metabolites produced by commensal bacteria promote peripheral regulatory T-cell generation. *Nature.* 2013;504(7480):451–5.
84. Mischke M, Plosch T. More than just a gut instinct—the potential interplay between a baby's nutrition, its gut microbiome, and the epigenome. *Am J Physiol Regul Integr Comp Physiol.* 2013;304(12):R1065–9.
85. Arts RJW, Carvalho A, La Rocca C, Palma C, Rodrigues F, Silvestre R, et al. Immunometabolic pathways in BCG-induced trained immunity. *Cell Rep.* 2016;17(10):2562–71.
86. Fanucchi S, Dominguez-Andres J, Joosten LAB, Netea MG, Mhlanga MM. The intersection of epigenetics and metabolism in trained immunity. *Immunity.* 2021;54(1):32–43.
87. Pan WH, Sommer F, Falk-Paulsen M, Ulas T, Best P, Fazio A, et al. Exposure to the gut microbiota drives distinct methylome and transcriptome changes in intestinal epithelial cells during postnatal development. *Genome Med.* 2018;10(1):27.
88. Hasler R, Feng Z, Backdahl L, Spehlmann ME, Franke A, Teschendorff A, et al. A functional methylome map of ulcerative colitis. *Genome Res.* 2012;22(11):2130–7.
89. Jones PA. Functions of DNA methylation: islands, start sites, gene bodies and beyond. *Nat Rev Genet.* 2012;13(7):484–92.
90. Fabioux C, Huvet A, Lelong C, Robert R, Pouvreau S, Daniel JY, et al. Oyster vasa-like gene as a marker of the germline cell development in *Crassostrea gigas*. *Biochem Biophys Res Commun.* 2004;320(2):592–8.

Publisher's Note

Springer Nature remains neutral with regard to jurisdictional claims in published maps and institutional affiliations.

Ready to submit your research? Choose BMC and benefit from:

- fast, convenient online submission
- thorough peer review by experienced researchers in your field
- rapid publication on acceptance
- support for research data, including large and complex data types
- gold Open Access which fosters wider collaboration and increased citations
- maximum visibility for your research: over 100M website views per year

At BMC, research is always in progress.

Learn more biomedcentral.com/submissions



Annexe IV – Revue Destoumieux-Garzon *et al.*

Revue soumise au journal Philosophical Transaction B en juin 2023 et en cours de révision

Page 3 of 18

Submitted to Phil. Trans. R. Soc. B - Issue

Phil. Trans. R. Soc. B. article template

**PHILOSOPHICAL
TRANSACTIONS B**

Phil. Trans. R. Soc. B.
doi:10.1098/not yet assigned

Cross-talk and mutual shaping between the immune system and the microbiota during an oyster's life

**Delphine Destoumieux-Garzón^{1*}, Caroline Montagnani¹,
Luc Dantan¹, Noémie de San Nicolas¹, Marie-Agnès Travers¹,
Léo Duperré¹, Guillaume M. Charrière¹, Eve Toulza¹,
Guillaume Mitta², Céline Cosseau¹, Jean-Michel Escoubas¹**

*1 IHPE, Univ Montpellier, CNRS, IFREMER, Univ Perpignan Via Domitia, Montpellier, France
2 Ifremer, IRD, ILM, Université de Polynésie Française, UMR EIO, Vairao 98179, French Polynesia.*

Keywords: holobiont, microbiome, immunity, homeostasis, immune priming, ontogeny

Summary

The Pacific oyster *Crassostrea gigas* lives in microbe-rich marine coastal systems subjected to rapid environmental changes. It harbours a diversified and fluctuating microbiota that cohabits with immune cells expressing a diversified immune gene repertoire. In the early stages of oyster development, just after fertilization, the microbiota plays a key role in educating the immune system. Exposure to a rich microbial environment at the larval stage leads to an increase in immune competence throughout the life of the oyster, conferring a better protection against pathogenic infections at later juvenile/adult stages. This beneficial effect, which is intergenerational, is associated with epigenetic remodelling. At juvenile stages, the educated immune system participates in the control of the homeostasis. In particular, the microbiota is fine-tuned by oyster antimicrobial peptides acting through specific and synergistic effects. However, this balance is fragile, as illustrated by the Pacific Oyster Mortality Syndrome, a disease causing mass mortalities in oysters worldwide. In this disease, the weakening of oyster immune defences by OsHV-1 μ Var virus induces a dysbiosis leading to fatal sepsis. This review illustrates the continuous interaction between the highly diversified oyster immune system and its dynamic microbiota throughout its life, and the importance of this cross-talk for oyster health.

*Author for correspondence (ddestoum@ifremer.fr).

Introduction

Over the past decade, major scientific interest has been given to the role of microbiomes in the biology of metazoans. In particular, an abundant literature has been produced on the dialogue between the immune system and microbiota of animal species. Across the animal kingdom, key studies have highlighted the importance of this dialogue for animal health. It is now recognized that effectors of the immune system control the microbiota and maintain homeostasis with resident microbial communities hosted by vertebrates [1], arthropods [2] and cnidarians [3]. Reciprocally, in both vertebrates and arthropods, the immune system is shaped by resident microbes [4,5] with far-reaching effects on host physiology [6,7].

The immunity-microbiota cross-talk and its physiological consequences have remained much less explored in molluscs until recently. Within this phylum, bivalve molluscs (e.g. oysters, mussels, clams) are particularly interesting as they are confronted to important microbial challenges in their natural habitats (intertidal coastal marine systems, lagoons and estuaries), from the very first embryonic and larval stages, when they are still ciliated and move freely in the seawater column, to the benthic spat and adult stages when they feed on plankton and their associated microorganisms. Benthic oysters not only host microbial communities on their body surfaces [8] but also in their circulating body fluids, *i.e.* the hemolymph (equivalent of the blood) [9], in the pallial/extrapallial cavity fluid [10,11] as well as in all the tissues and developmental stages studied [12,13]. As they are filter feeders able to concentrate microorganisms present in their environment, it has been argued that bivalves host transient microbial communities that vary with environmental conditions. This is actually observed for a fair proportion of their microbiota, which is rapidly eliminated upon depuration with purified seawater, a common method employed for removing waterborne microbial contaminants from bivalves [14]. Still, the microbiota of bivalves is highly distinct from the microbial communities found in the surrounding seawater [8,9,14–16]. Moreover, among bivalve-associated bacteria, some genera, which share the same habitat and probably have a long co-evolutionary history with their hosts, have established stable associations that are poorly affected by the environment [14,17]. With the exception of species that host chemosynthetic bacterial mutualists (for review see [18]), such as the lucinid *Codakia orbiculate* hosting sulfur-oxidizing bacteria [19], most of the time it is ignored whether members of the microbiota play key functions in the biology of bivalves.

Oysters are fascinating organisms in which to study the cross-talk between the microbiota and the immune system, and their reciprocal influence. These organisms indeed host a highly diverse and dynamic microbiota, which has shaped a vastly expanded innate immune repertoire [20,21]. Studies on the oyster *Crassostrea gigas* have revealed a tight connection between the microbiota and the oyster health status [15]. A fine-tuned dialogue between oyster immunity and its microbiota was evidenced from early life to adult stages [22–24]. Recently a first insight into the functions carried by members of the microbiome has been made accessible, either by shotgun metagenomics [11] or metatranscriptomics [25]. It is currently argued that bivalve microbiota may be manipulated for disease prevention in aquaculture [26]. The present article summarizes the knowledge accumulated on oyster-microbiota interactions over the last few years and reviews the dysregulations leading to dysbiosis and oyster death. Finally, it covers the avenues opened for disease prevention and control.

Homeostasis: A diversified and fluctuating microbiota cohabits with oyster immune cells

Oyster larvae, as soon as two days after reproduction, are equipped with a velum used for motility and feeding, and two valves develop to form the shell. Oysters become sessile after 2.5 weeks when a foot develops to attach to a hard surface (pediveliger stage). Once permanently attached, the oyster becomes a spat. From this stage until adulthood, the oyster soft body is covered by the mantle (or pallium), a tissue that ensures the development and growth of the shell and also plays a sensory role. A pair of lamellar gills, which extend from one extremity of the gut to the other, ensures the functions of respiration, nutrition and excretion of certain wastes. A kidney

consisting of a tubular gland located within a renal sinus ensures the excretory system. Oysters have an open-type circulatory system: the circulating fluid called hemolymph (equivalent to vertebrate blood) is not confined to the vessels and the heart but flows into sinuses and infiltrate intercellular space of all tissues (for review see [27]). The hemolymph carries the circulating immune cells called hemocytes throughout oyster body. The heart propels the hemolymph into the circulatory system. The two oyster valves forming the shell, which protects the oyster body, also enclose the pallial and extrapallial cavity fluids, which surrounds the mantle and the soft body of the mollusc, and contains hemocytes. Thus, oyster body surfaces are covered by the pallial fluid/mucus, which contains high amounts of antimicrobials such as copper, zinc, and hydrolases such as lysozyme participating in oyster chemical defenses against infections [28,29]. The mucus is secreted by mucocytes lining epithelia. Together with ciliary movement at epithelial surfaces, the mucus is believed to restrict microbial growth and serves as a first line of defense against infections from environmental pathogens (figure 1). Remarkably, bacteria are barely seen attached to epithelia and mucus of healthy oysters by means of electron microscopy [30]. In contrast, bacteria are easily detected in oyster body fluids [10]. While body fluids may represent an entry route for oyster tissue colonization, they also host a number of bacterial genera such as *Pseudoalteromonas* that may confer protection through the production of antimicrobial activities. Such protective bacteria have been isolated both in the pallial fluid of *Crassostrea virginica* [31] and in the hemolymph of *C. gigas* [32]. They secrete antimicrobial peptides generally referred to as bacteriocins [33], which confer a protective shield against pathogens.

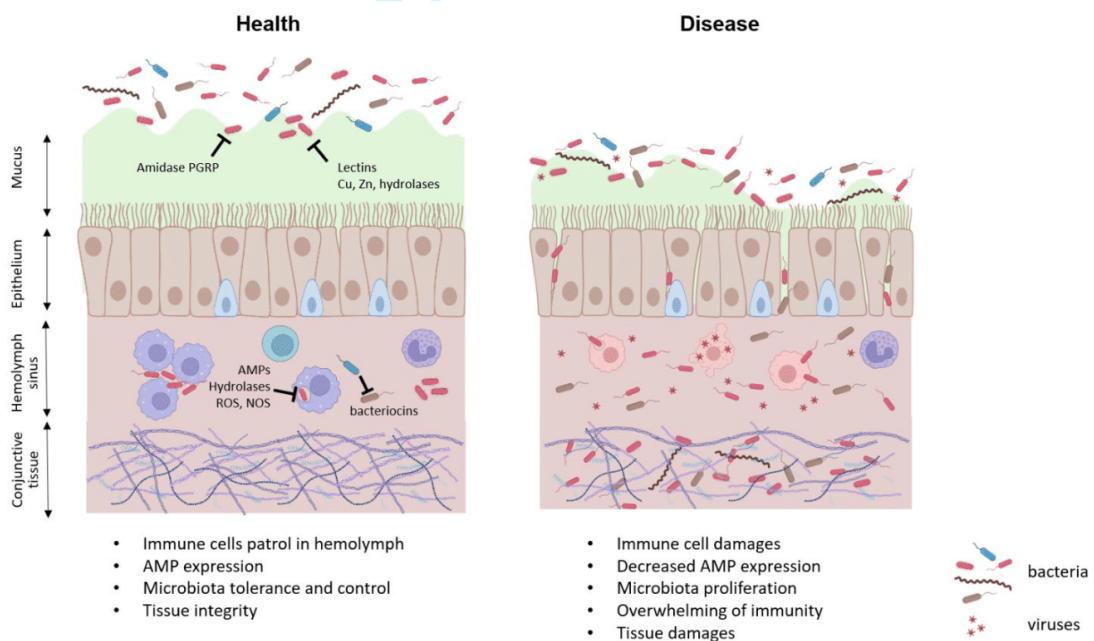

Figure 1. Immune-microbiota interplay at an oyster epithelium: homeostasis vs. dysbiosis. The left panel (Health) illustrates an homeostatic context. The microbiota is kept away from epithelial cells (brown cells) by a thick mucus layer (green) secreted by mucocytes (blue cells), which covers the oyster body surfaces. Lectins, hydrolases, copper and zinc contribute to limit penetration of microorganisms. It is assumed that amidase PGRPs prevent peptidoglycan from activating immune receptors. Bacteria circulate in the hemolymph (pink) without inducing a measurable immune response. They are kept under control by functional immune cells (purple) and the AMPs, hydrolases, ROS and NOS they produce. Bacteriocins mediate competitions. The right panel (Disease) shows a context of dysbiosis. Pathogens alter immune cell functions (pink cells), which no longer control the microbiota. AMP expression is altered. Bacteria invade the conjunctive tissues. Tissues loose their integrity and their barrier functions. Figure created in biorender.com.

1
2
3
4 Taxonomic information on the microbiota associated with oyster tissues has been mainly acquired with the
5 eased access to next generation sequencing. The advent of this technology has highlighted the tremendous
6 plasticity of the oyster microbiota under the influence of both biotic (*i.e.* oyster genetic background,
7 developmental stage and metabolic rate or nutrient availability) and abiotic factors (*i.e.* temperature, pH,
8 salinity, $p\text{CO}_2$) [34–38]. In addition to important fluctuations in response to environmental changes,
9 physiological status and developmental stages, the oyster microbiota shows important inter-individual
10 variability, both at the level of the whole animal and at the level of individual tissues throughout all life stages
11 [8,11–13,39]. Such an heterogeneity has rendered extremely difficult the identification of a core bacterial
12 microbiota in oysters, if it actually exists. Overall, only Spirochaetaceae were widely distributed across tissues
13 of different oyster species (*C. gigas*, *C. virginica* and *Saccostrea glomerata*) living on three continents
14 [11,12,15,35,39–41]. Such a trans-specific conservation may be linked to the ecology of Spirochaetes, which are
15 abundant in intertidal marine sediments [42] to which oysters are exposed; by sharing the same habitat they
16 may also have established stable associations with oysters [14]. At an oyster population scale, a number of rare
17 bacterial species were associated with genetic differentiation of *C. gigas* oysters but this association was lost in
18 stressful environmental conditions [38]. More conclusively, microbiota analyses carried out at an oyster
19 individual level and on different oyster tissues have shown that each tissue harbors its own microbial consortia.
20 However, it is still unclear whether these communities endow specific functions in the biology of each tissues
21 [8,11,12] and/or if they are simply shaped by the diversity of microhabitats they inhabit.
22
23
24

25 Hemolymph is by the far the tissue that has been the most extensively studied in oyster health and disease,
26 probably due to its key role in immunity. Hemolymph bacterial communities can be clearly distinguished from
27 those found in seawater and solid tissues, but the community dynamics show a close relationship to the internal
28 and external oyster environment, suggesting potential host selection [8,9,11,14]. Beyond its bacterial component,
29 oyster hemolymph contains diverse protists and viruses; the composition and dynamics of these communities
30 depend on the environment as well as on oyster genetics [9]. Among the diverse components of the hemolymph
31 microbiota, bacteria show a more stable taxonomic composition than protists and viruses, suggesting more fine-
32 tuned interactions with the oyster host. These data suggest that some bacterial groups, mostly γ - and α -
33 proteobacteria, are well adapted to the hemolymph conditions, whereas viral and protist communities would
34 be primarily transient [9]. This remains to be confirmed since microbiota studies are strongly biased towards
35 the bacterial component and only a very limited number of studies have focused on viruses and protists.
36
37
38

39 Maintenance of homeostasis in the hemolymph complex ecosystem remains far from being understood.
40 Particularly, it is still largely ignored how such an abundant and diverse microbiota coexists and is tolerated by
41 the host hemocytes [43], which patrol in the hemolymph (figure 1) and are equipped with key immune
42 receptors, pathways and effectors conserved across the animal kingdom [44]. Remarkably, a number of these
43 receptors and effectors have highly diversified in oysters, some of them belonging to large multigene families
44 involved in specific immune responses [21]. Recognition of potential pathogens occurs in the hemolymph where
45 they are contained by phagocytosis and hemocyte aggregation, preventing them from invading the connective
46 tissue [45] (figure 1). To persist in such a hostile environment, the resident microbiota of oyster may have
47 evolved low immunogenic properties, as recently evidenced in a *Vibrio* population showing preferential
48 association with oyster tissues. In this population, a modified O-antigen structure was shown to reduce strain
49 recognition by oyster immune receptors [46], unlike in other *Vibrio* that behave as opportunistic pathogens and
50 colonize oysters by actively altering their cellular defenses, thereby favoring immune evasion [45,47]. In
51 addition, the oyster mucus proteins may confer immune tolerance. Indeed a number of secreted amidase PGRPs
52 (peptidoglycan recognition proteins) have been identified in oyster mucus covering pallial organs (gill, mantle,
53 labial palps) [29]. In many species, from insects to mammals, amidase PRGPs are capable of cleaving the
54 bacterial cell-wall glycopeptides released by bacteria into non-immunogenic compounds. Thereby they control
55 the intensity of the immune response and act as detoxifying enzymes [48]. Their secretion in oyster mucus is an
56 important indication that they may participate in the maintenance of homeostasis at the immune-bacteria
57 interface.
58
59
60

1
2
3
4
5
6
7
8
9
10
11
12
13
14
15
16
17
18
19
20
21
22
23
24
25
26
27
28
29
30
31
32
33
34
35
36
37
38
39
40
41
42
43
44
45
46
47
48
49
50
51
52
53
54
55
56
57
58
59
60

The immune system shapes the microbiota

Cellular defenses are highly potent in oysters. Oyster immune cells, the hemocytes, appear during gastrula-trochophore stages and they already express immune genes at the trochophore stage (15 h post fecundation, hpf), suggesting the initiation of the immune system [49,50]. However, at hatching (9 hpf), oyster larvae tend to be immune-depleted, which makes them more susceptible to infections. From the D-veliger larval stage (17 hpf), hemocytes perform phagocytosis [49]. In spat (> 2,5 weeks post fecundation) and adults, hemocytes circulate in hemolymph and infiltrate injured/infected tissues. Not only they perform efficient phagocytosis but they produce important key antimicrobials (reactive oxygen and nitrogen species, antimicrobial peptides and proteins, hydrolases) capable of killing microbes both intracellularly and extracellularly (for review see [51]) (figure 1, left panel). The potent respiratory burst produced by hemocytes triggers a mechanism of ETosis by which hemocytes release DNA Extracellular Traps that contain antimicrobial histones and entrap bacteria, preventing them from disseminating outside the hemolymph or sites of injury [52]. Most oyster bacterial pathogens have evolved the capacity to escape oyster cellular defenses, either by evading phagocytosis [53] or by exerting cytotoxicity against hemocytes [45,47], thereby causing systemic infections (figure 1, right panel). Such mechanisms of cytotoxicity are rarely observed in non-pathogenic bacteria [54], which instead are contained in the circulation by hemocyte clumps [45]. This provides indirect evidence that hemocytes participate in keeping the commensal microbiota under control.

Antimicrobial peptides (AMPs) have been shown to combat infections in a broad number of species across the animal kingdom including marine invertebrates [55]. However, it is only in the recent years that AMPs have been shown to play a key role in controlling microbiota hosted by metazoan hosts. The main families of antimicrobial peptides and proteins identified in oyster include CS α β defensins called Cg-Defensins (they are highly conserved in fungi, plants, arthropods, molluscs, but they were lost in chordates), bactericidal/permeability increasing proteins (Cg-BPI) (they are found both in vertebrates and molluscs), and big defensins (Cg-BigDefensins; they are found in cephalochordates, chelicerates, molluscs and other lophotrochozoans). Cg-Defensins and Cg-BPI are expressed by hemocytes and epithelial cells, contributing both to local and systemic responses (for review see [43]). Cg-BigDefensins are expressed by oyster hemocytes only [56]. Transcripts of Cg-Defensins have been found in oyster embryos, however their expression increases significantly over the first larval stages, from hatching to D-veliger larval stage [49]. This indicates that AMPs may play a role at the immune-microbiota interface early during development. Oyster antimicrobial peptides and proteins have very distinct and complementary mechanisms of action, which enables them to target a broad diversity of microorganisms. Cg-Defensins are ligands of lipid II that inhibit peptidoglycan synthesis; they are essentially active against Gram-positive bacteria [57]. Cg-BPI, which efficiently binds LPS, creates membrane damages in Gram-negative bacteria [58]. Cg-BigDefensins, which autoassemble and entrap bacteria in supramolecular structures called nanonets, have broad spectrum antimicrobial activities [59]. Unlike in other species of molluscs (e.g. mussels, [60]), AMPs in oyster are not expressed at high concentrations. Instead, most AMP families have expanded and diversified through gene duplication events followed by rapid molecular diversification [56], as a result of directional selection pressures [61]. This molecular diversity creates synergy and enlarges the spectrum of antimicrobial activities of oyster AMP families, particularly Cg-Defensins and Cg-BigDefensins [23,62]. Remarkably, the gene expansion and sequence diversification of Cg-BigDefensins has also conferred specificity to members of this peptide family against bacteria belonging to the oyster microbiota [23]. Unlike in the scallop *Argopecten purpuratus* where only one big defensin gene has strong effects on the composition of the microbiota [63], Cg-BigDefensins in oysters fine-tune the microbiota, probably through their very specific activities against different members of the microbiota [23]. Such a specificity has been recently discovered in AMPs from other animal phyla, e.g. in insects [64]. It is actually proposed that dipterin variants in *Drosophila* have been selected as an evolutionary solution to control harmful

1
2
3
4 bacteria found in their microbiome [65]. Being speculative, this important result may indicate that
5 presence/absence variation affecting Cg-BigDefs in oysters [66] has been shaped by pathogenic pressures.
6

7 While lectins have remained much less explored for their interactions with the oyster microbiota, they are highly
8 diverse in oysters and abundant in the mucus covering oyster epithelial surfaces [29]. Lectins found in oyster
9 mucus have been attributed to infiltrating hemocytes as well as to mucocytes and epithelial cells [29]. Among
10 their diverse functions, lectins are involved in host-microbe interactions both in a parasitic or mutualistic
11 context. For instance, C-type lectins in shrimp agglutinate bacteria selectively [67] and they maintain the
12 homeostasis of the intestinal and hemolymph microbiota [68,69]. In oysters, C-type lectins may participate in
13 the control of pathogens as demonstrated for CgCLec-3, which is expressed by hemocytes and agglutinates
14 specific bacterial species [70]. The massive diversification of C-type lectins in the genome of *C. gigas* (154 genes)
15 [20] indicates an uncovered diversity of putative functions and putative specificities in the interaction with the
16 microbiota. A similar phenomenon of diversification was described for the complement C1q domain containing
17 proteins (164 genes in *C. gigas*), whose expression is induced upon biotic challenge [21], and which may act as
18 opsonins to promote phagocytosis as shown for the plasma protein p1-CgC1q [71].
19
20

21 A number of pallial mucus proteins likely to recognize and/or control parasites and microbes were identified
22 [29]. These include several invertebrate thioester-containing proteins (TEPs) similar to *Biomphalaria glabrata*
23 BgTEP, which forms an immune complex with fibrinogen-related proteins produced by the molluscan host and
24 mucins produced by the parasite *Schistosoma mansoni* [72]. This hemocyte-expressed protein binds to a diversity
25 of bacteria suggesting an opsonin role [73], like in insects [74,75]. Pallial mucus also contains the DMBT-1 protein
26 (deleted in malignant brain tumors 1 protein) [29], which functions in mucosal immunity by mediating bacterial
27 recognition and countering invasion [76]. In *C. gigas* its expression is suppressed by pathogenic *Vibrio*, which
28 have the ability to bypass host defenses [45]. Finally, two ferritins were found in the pallial mucus [29]. Ferritins
29 are iron-scavenging proteins that participate in the so-called nutritional immunity. By depriving bacteria from
30 iron, these host proteins contribute to limit bacterial growth. The fight for iron is key in the control of infections
31 by *Vibrio*, which produce their own siderophores, such as vibrioferrin, for the uptake of this essential nutrient
32 [77]. Recent results have shown the key role of iron homeostasis in the structuring and assembly of pathological
33 microbial communities in oyster [47].
34
35
36
37
38
39

40 The microbiota shapes the oyster immune system

41
42
43 Multicellular organisms exist as complex ecosystems, also known as holobionts, comprised of both the animal
44 host and its associated microbiota [78]. Interactions between the host and its microbiota implies complex
45 feedbacks. If the immune system orchestrates the maintenance of key features of the host-microbiota
46 interactions and establishment of the microbiota community, the latter, in return, plays a critical role in the
47 development, education and function of the immune system [5,79,80]. The sequencing of *C. gigas* genome has
48 revealed a remarkable expansion and functional divergence of immune gene families in this species [20,21].
49 Their expression profiles revealed specific responses to a diversity of microbial challenges. On an evolutionary
50 scale, it has been argued that the dynamic and pathogen-rich environment of oysters has created complex biotic
51 and abiotic stresses, constituting strong selection pressures that have led to a major diversification of the
52 immune system. On the scale of a lifetime, the early life is recognized as a crucial window of opportunity during
53 which microbial colonization sets appropriate immune development and establishes the foundation for lifelong
54 immunity. Studies in humans and in a vast array of vertebrates or invertebrate animals has demonstrated that
55 colonization of complex microbiota or single symbionts in early life does not only impact the maturation of the
56 mucosal and gut immune systems, but also modulates the systemic immune response [81–87]. In addition, there
57 is compelling evidence that early life environments can induce long-lasting changes in the immune system of
58 progenies and have critical impacts on health and disease. Notably, it has been shown that nonpathogenic
59
60

1
2
3
4 microbial exposures during critical periods of development in mammals favorably imprint immunity,
5 promoting protective immunity that reduces risk of disease later in life [88].
6

7
8 As filter feeders, oysters evolve in a rich microbial environment, under constant interaction with pathogenic
9 and commensal microorganisms. In a recent study, Unzueta-Martínez *A. et al.* showed that not all members of
10 the oyster-associated microbiota are governed by the same ecological dynamics and that both horizontal and
11 vertical transmission routes are possible [13]. Particularly the authors identified some members of the bacterial
12 communities that establish at early developmental stages (from gametes to spats) and persist across multiple
13 life stages [13]. Since initiation of the immune system occurs early in the oyster development [49,50], this early
14 microbiota association raises numerous questions about its impact on the immune system maturation. In *C.*
15 *gigas*, another recent study showed that an early larval exposure to a non-infectious environmental microbiota
16 can induce a systemic immune response that confers a protection against the Pacific Oyster Mortality Syndrome
17 [24]. Remarkably, this early exposure resulted in a lifelong and intergenerational increased immune competency
18 that persisted far beyond the initial exposure. The exposure impacted the diversity and shifted the composition
19 of the oyster microbiota. This phenomenon was supported by a long-term reprogramming of immune gene
20 expression within and across generations, and notably correlated with differential expression of conserved
21 pathogen recognition receptors (PGRP, lectins, scavenger receptors, TLR, RLR, macrophage receptor), innate
22 immune pathways (IFN-TLR-JAK/STAT pathways) and antimicrobial effectors (TNF, proteinases, SOD,
23 interferon-stimulated genes, AMPs). Moreover, this phenotype was associated with heritable changes in
24 epigenetic signatures (DNA methylation patterns) that are reminiscent of mechanisms underlying innate
25 immune memory response in mammals and plants [89,90]. The hypothesis beyond this microbiota-induced
26 memory is a continuous reshaping of cellular signaling pathways and microbiota, which resulted in long-term
27 heritable epigenetic imprinting (figure 2, left panel). This study thus perfectly illustrates the continuous cross-
28 talk between host and microbiota and its role in disease susceptibility or resilience.
29
30

31
32 This study echoes with emerging concepts on the impact of environmental signals, either biotic or abiotic, on
33 epigenetic changes responsible for heritable phenotypic outcomes [91–93] and on innate immune memory
34 formation (also known as trained immunity) [89,90,94]. In mammals and arthropods, commensal microbiota
35 was shown to shape immune capacities, not only at early stages, and to have a systemic effect on the immune
36 response, inducing enhanced resistance towards a vast array of unrelated pathogens [95–102]. These findings
37 are reminiscent of evidence of symbiont-mediated immune priming (reviewed in [103]) showing the impact of
38 beneficial symbionts on immune capacities. In *C. gigas*, long-term immune priming capacities were evidenced
39 using either non-pathogenic bacteria or viral mimic pre-conditioning [104,105]. These data confirmed that non-
40 pathogenic microbial exposures can promote the generation of protective immunity, further suggesting
41 complex interactions between microbiota and immunity, and the potential for some members of oyster
42 microbiota to drive innate immune memory and support enhanced survival.
43
44
45
46
47

48 Fatal breakdown of homeostasis: loss of control of the microbiota

49
50 Homeostasis is crucial to maintain internal stability and balance in the face of fluctuating environmental
51 conditions. Studies on cnidarians nicely illustrate that the stability of the association between a host and its
52 microbiota is crucial for health [106] and to cope with the environment [107,108]. In humans, microbiota
53 dysbiosis leads to disease development and progression, through dysregulation of community composition,
54 modulation of host immune response, and induction of chronic inflammation [109].
55
56
57

58 As oysters are both osmoconformers and eurythermal, the microbial communities they host are naturally
59 exposed to significant changes in osmolarity and temperature over days and seasons, two factors that modulate
60 microbial community dynamics, either directly or indirectly, by modulating oyster physiology and immunity

[110]. Not surprisingly, healthy oysters – which exhibit extended physiological limits – also tolerate important variations in the structure of their microbiota (see Homeostasis section above) (figure 2, left panel). At the metaorganism level (the holobiont), this plasticity may increase oyster adaptability to rapidly changing environmental conditions, as they experience in intertidal coastal marine systems. However, the balance between a fluctuating microbiota and an effective - but still tolerant - immune system is fragile. Like in other animal species, a compromised homeostasis can have detrimental effects on oyster health by creating an unfavorable environment for the beneficial microbial populations and promoting the often irreversible proliferation of harmful microorganisms. Thus, in some instances temperature fluctuations, changes in salinity, antibiotic exposure or nutrient availability alter oyster physiology in a way that it affects their ability to maintain a stable internal environment (reviewed in [111]). Thereby environmental factors can contribute to the breakdown of homeostasis (figure 2, right panel). Thus, the highly dynamic composition of oyster hemolymph microbiota can be indicative of major changes in oyster health status. It is actually often accompanied by drastic changes in the composition of the hemocyte formula and counts, and a rapid migration of hemocytes in oyster tissues (for review see [51]). For instance, heat stress decreases the stability of the hemolymph microbiota in *C. gigas*, resulting in increased mortality in response to infections [112]. Particularly, destabilization of the oyster hemolymph microbiota can facilitate infection by *Vibrio* [40]. Dramatic events are actually observed when an abiotic stress co-occurs with an exposure to a pathogen. For instance, marine heat waves, *i.e.* “discrete prolonged anomalously warm water events”, enable proliferation of *Vibrio* in oyster tissues and lead to mass mortality events [113]. Similarly, shifts in temperature control the fatal outcome of *V. aesturianus* infections in oyster [114]. In this particular case, the bacterial microbiota shifts from highly diversified to dominated by one single species [115,116].

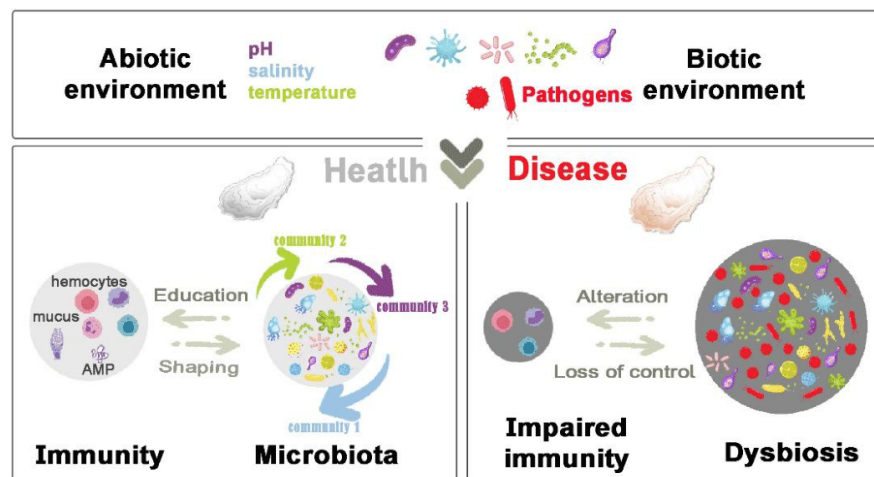

Figure 2. Environmental factors acting on the cross-talk between the oyster immune system and its microbiota.

Healthy microbiota is diverse and plastic (left panel). Its structure is influenced by environmental factors; for instance, some community can be favored by given abiotic factors (pH, temperature or salinity). Microbiota plays a key role in the education of the immune system. In parallel, the immune system relying on hemocytes, mucus production and secreted molecular effectors (e.g. AMPs) participates in the control of the homeostasis of the oyster microbiota. In the presence of pathogens, which can alter immune defences, loss of control of oyster microbiota results in dysbiosis and leads to fatal sepsis (right panel).

One emblematic example of biotic and abiotic factors triggering dysbiosis and oyster death is the Pacific Oyster Mortality Syndrome (POMS), which is both polymicrobial and multifactorial [117,118]. When the seawater temperature raises above 16°C, important changes in the microbiota occur in response to infection with the

1
2
3
4 OsHV-1 μ Var virus: the bacterial groups which are normally the most abundant tend to decrease while some
5 rare and opportunistic bacteria proliferate, particularly *Vibrio* [111] and *Arcobacter* [115]. Elucidating the
6 sequence of events involved in POMS development by comparing resistant and susceptible oyster families
7 revealed that microbiota homeostasis breakdown is central to the pathogenesis process [22]. Sequentially, the
8 infection by OsHV-1 μ Var triggers an immune-compromised state that induces microbiota dysbiosis and
9 subsequent bacteraemia, ultimately leading to oyster death. Fatal dysbiosis is accompanied by invasion of the
10 connective tissue by opportunistic bacteria and in particular *Vibrio* and *Arcobacter*, which are consistently
11 associated with oyster death [25]. The virus alters antibacterial defences by infecting hemocytes and
12 reprogramming their functions. OsHV-1 μ Var alters more particularly AMP expression, which coincides with
13 a loss of control of microbial communities 24 h after viral infection [22]. The sequence of events leading to
14 dysbiosis and oyster death is conserved across infectious environments in France (Mediterranean, Atlantic)
15 and oyster genetic backgrounds [25]. Moreover, using a combination of amplicon sequencing and
16 metatranscriptomics, a core pathobiota assemblage was identified; it colonizes oysters during the secondary
17 bacterial infection of oysters in POMS. *Arcobacter*, *Vibrio*, but also *Amphritea*, *Marinobacterium*, *Marinomonas*,
18 *Oceanospirillum* and *Pseudoalteromonas*, together represented up to 40% of the bacterial gene expression at the
19 onset of oyster mortality. Bacteria of the *Vibrio* genus associated to POMS (*V. crassostrea*, *V. tasmaniensis*, or *V.*
20 *harveyi* according to environments) were shown to actively participate in the pathogenic process by dampening
21 oyster cellular defenses and by producing public goods (siderophores), which promote the growth of other
22 bacterial species [45,47]. Such cooperative behaviors, which make oyster a more favorable environment for
23 microbial proliferation, were key in structuring the *Vibrio* community associated to POMS [47]. Much more
24 remains to be explored regarding the social interactions at play (cooperation, cheating, competition) in the
25 POMS pathobiota. Remarkably, the transcriptional response of the pathobiota was conserved between
26 Mediterranean and Atlantic environments with in particular an increase in translation and central metabolism
27 processes, reflecting active colonization of oyster tissues. Members of the pathobiota overexpressed different
28 metabolic pathways, reflecting differential use of the nutritive resources provided by the diseased oyster host.
29 This functional complementarity may explain the taxonomic conservation of the POMS pathobiota [25].
30
31
32
33
34
35
36
37

38 Implications for applied Perspectives

39 Probiotics

40
41
42
43 A probiotic is by the definition of the Food and Agriculture Organization (FAO), a “live microorganism, which
44 when consumed in adequate amounts, confers a health benefit on the host” [119]. The use of probiotic strains is
45 already developed for animal production, and it is considered a promising eco-responsible and prophylactic
46 alternative to antibiotics [120]. Probiotics can compete with pathogens by producing diverse antimicrobial
47 substances (bacteriocins, antioxidant molecules), modulating the innate immune system of the host, interfering
48 with microbial communication systems (quorum quenching effect), producing beneficial metabolites, and
49 helping for nutrient adsorption [121]. Regarding probiotics for oyster farming, two of the above strategies are
50 being developed: the direct competition with pathogens and the modulation of the innate immune system [122].
51 For example, exposure of *C. gigas* larvae to *Pseudoalteromonas* sp. capable of inhibiting the growth of *V.*
52 *coralliilyticus* improved larval survival during *V. coralliilyticus* infection [123]. Similarly, the administration of
53 *Streptomyces* sp. strains RL8 to juvenile *Crassostrea sikamea* oysters induced significantly higher weight gain and
54 increased antioxidant activity [124].
55
56
57

58
59 The natural microbiota of oysters may help identify new probiotics candidates to be used in prophylactic
60 measures. Because of the versatility of oyster microbiota and the rapid disturbance of host genotype – microbial
community associations upon external stress, it has been argued that microbiota may be difficult to manipulate

1
2
3
4 and used to improve oyster resistance to disease [38]. Nevertheless, oyster families with contrasting
5 susceptibility to the POMS harbor different microbiota compositions [9,15,111]. Bacterial taxa Colwelliaceae,
6 Cyanobacteria, and Rhodobacteraceae are indeed significantly associated with oyster families harboring higher
7 resistance to POMS [15]. Beyond members of the oyster microbiota, cohabitation of oysters with macroalgae
8 mitigates their resistance to POMS by modifying microbiota composition and affecting transcriptional response
9 to OsHV-1 infection [125]. We argue that modulating oyster physiology and immune system through microbial
10 exposure is a promising way to increase resistance to pathogens.
11

12 Microbial education & Immune priming 13

14
15 Another promising use of natural microorganisms as a tool to fight infectious diseases indeed consists in
16 educating the host immune system during its ontogenesis. It is expected that focusing on this crucial
17 developmental stage will result in lifelong and potentially transgenerational beneficial immune properties. Such
18 a microbial education has been applied successfully in fish [83] and molluscs [24]. More studies are still needed
19 for understanding the basic mechanisms of early life oyster-microbiome interactions, the bases of the immune
20 system developmental plasticity in oysters, and how this may be translated into applications. Already, microbial
21 management methods are applied in aquaculture to promote healthy microbe-larvae interactions [126–129]. The
22 immunomodulatory properties and long-term health benefits of such practices have been demonstrated in fish
23 and shrimp [130]. Further studies are necessary to apply such strategies during oyster larval rearing. This will
24 require further exploration on how the cross-talk between oyster and microbiota is established during
25 development, emphasizing on critical temporal windows. It will also be necessary to precisely define the
26 contributions of specific microbial species of oyster origin to early oyster life immune imprinting and to oyster
27 health status at a juvenile/adult stage. Recent study on the impact of microbiota on oyster immune capacities
28 helped identify bacterial taxa and species overrepresented in animals exposed to microbiota at an early
29 developmental stage, which show increased immune capacities (Rhodobacteraceae, Halomonadaceae,
30 Shewanellaceae, and Oceanospirillaceae) [24]. This could help design microbiome-based prophylactic strategies
31 and/or disease mitigation strategies with microbiota species acting as modulators of immune responses.
32 Elucidating the exact molecular relationship between microbe-derived metabolites, host immune signaling
33 pathways, epigenetic modifications and host physiology will need further investigation.
34
35
36
37
38

39 In addition, a growing body of evidence shows that the innate immune system displays memory traits
40 providing a survival advantage within and across generations [131]. Immune plasticity and memory capacities
41 have been evidenced in mollusks including oysters [24,104,132,133]. Building on these properties could help
42 design pseudo-vaccination strategies (known as immune-priming) based on nonpathogenic microbial
43 exposures to promote protective immunity in individuals and their offspring.
44
45
46
47

48 Conclusion and future directions 49

50 Recent literature has highlighted the highly dynamic nature of the oyster bacterial microbiota, under the
51 influence of a rapidly fluctuating biotic and abiotic environment and host factors (genetics, development and
52 physiology). Such a dynamic microbiota has shaped a highly diversified repertoire of oyster immune genes [20]
53 whose functions remain far from being understood. This makes the oyster a fascinating organism to investigate
54 the cross-talk and reciprocal shaping of the microbiota and the immune system. While the microbiota was
55 shown to educate the immune system during the early stages of oyster development, the functions it plays at
56 an adult stage remain unclear. Answering such an essential question requires to access the functions expressed
57 by the microbiota, moving away from the initial description of its taxonomic composition. Although recent
58 progress has been made in this direction [11,25,134], it is not clear yet whether oyster microbiota is shaped
59 according to the functions it expresses, particularly in a healthy context. To address this challenging question,
60 several difficulties have to be circumvented. First, the biogeography of microbiota functions must be studied at

the finest scales to unveil the diversity of functions carried by microbial communities in specific tissue niches. Second, it will be essential to consider the broad diversity of microbial communities, beyond the easily accessible bacterial community. Indeed, oyster-associated phages have co-evolved with *Vibrio* populations causing pathologies in oysters [135]. And it is recognized that phages play a key role in the marine environment by modifying the metabolism of infected bacteria by altering the expression of auxiliary metabolic genes and reorienting host gene expression patterns [136]. This highlights the need to consider the complexity of the microbiota (bacteria, viruses, protists, etc.) if we are to fully understand the role of the microbiota in oyster health and disease. Future studies should also address the role and specificities of host factors in shaping oyster-associated microbial communities. Indeed, not only there is often a strong genetic component in the capacity of oysters to control infections [137], but there are also key physiological determinants controlled by the environment or the developmental stage that need further investigation [117]. Regarding immune factors, there is an important need to explore the diversity of hemocyte populations, which remain amazingly poorly understood despite their key role in controlling infections, and to study the consequences of the impressive diversification of the immune gene repertoire in oysters. Recent data have revealed that AMP diversification is the support of an unexpected specificity in the interaction with microbiota members [23]. Much more has to be discovered regarding the highly diversified immune gene repertoire of oysters [20], which may have evolved to adapt to changing microbial environments, as recently evidenced for some insect immune genes [65].

Acknowledgments

We are grateful to Dr Viviane Boulo for fruitful discussions. This work received funding from the French National Agency for Research (Decicomp, ANR-19-CE20-0004). This study is set within the framework of the "Laboratoire d'Excellence" (LabEx) TULIP (ANR-10-LABX-41) and CEMEB (ANR-10-LABX-0004).

References

- Bevins CL, Salzman NH. 2011 Paneth cells, antimicrobial peptides and maintenance of intestinal homeostasis. *Nature Reviews Microbiology* **9**, 356–368. (doi:10.1038/nrmicro2546)
- Marra A, Hanson MA, Kondo S, Erkosar B, Lemaitre B. 2021 *Drosophila* Antimicrobial Peptides and Lysozymes Regulate Gut Microbiota Composition and Abundance. *mBio* **12**. (doi:10.1128/mBio.00824-21)
- Franzenburg S, Walter J, Künzel S, Wang J, Baines JF, Bosch TCG, Fraune S. 2013 Distinct antimicrobial peptide expression determines host species-specific bacterial associations. *Proceedings of the National Academy of Sciences of the United States of America* **110**, E3730–E3738. (doi:10.1073/pnas.1304960110/-/DCSupplemental.www.pnas.org/cgi/doi/10.1073/pnas.1304960110)
- Broderick NA, Buchon N, Lemaitre B. 2014 Microbiota-Induced Changes in *Drosophila melanogaster* Host Gene Expression and Gut Morphology. *mBio* **5**, e01117–14. (doi:10.1128/mBio.01117-14)
- Hooper LV, Littman DR, Macpherson AJ. 2012 Interactions between the microbiota and the immune system. *Science* **336**, 1268–1273. (doi:10.1126/science.1223490)
- Liu X, Nagy P, Bonfini A, Houtz P, Bing X-L, Yang X, Buchon N. 2022 Microbes affect gut epithelial cell composition through immune-dependent regulation of intestinal stem cell differentiation. *Cell Reports* **38**, 110572. (doi:10.1016/j.celrep.2022.110572)
- Miani M *et al.* 2018 Gut Microbiota-Stimulated Innate Lymphoid Cells Support β -Defensin 14 Expression in Pancreatic Endocrine Cells, Preventing Autoimmune Diabetes. *Cell Metabolism* **28**, 557–572.e6. (doi:10.1016/j.cmet.2018.06.012)
- Lokmer A, Kuenzel S, Baines JF, Wegner KM. 2016 The role of tissue-specific microbiota in initial establishment success of Pacific oysters. *Environmental Microbiology* **18**, 970–987. (doi:10.1111/1462-2920.13163)
- Dupont S *et al.* 2020 Oyster hemolymph is a complex and dynamic ecosystem hosting bacteria, protists and viruses. *Animal Microbiome* **2**. (doi:10.1186/s42523-020-00032-w)
- de Lorgeril J *et al.* 2018 Inefficient immune response is associated with microbial permissiveness in juvenile oysters affected by mass mortalities on field. *Fish and Shellfish Immunology* **77**, 156–163. (doi:10.1016/j.fsi.2018.03.027)
- Pimentel ZT, Dufault-Thompson K, Russo KT, Scro AK, Smolowitz RM, Gomez-Chiari M, Zhang Y. 2021 Microbiome Analysis Reveals Diversity and Function of *Mollicutes* Associated with the Eastern Oyster, *Crassostrea virginica*. *mSphere* **6**, e00227–21. (doi:10.1128/mSphere.00227-21)
- King WL, Siboni N, Kahlke T, Dove M, O'Connor W, Mahub KR, Jenkins C, Seymour JR, Labbate M. 2020 Regional and oyster microenvironmental scale heterogeneity in the Pacific oyster bacterial community. *FEMS Microbiology Ecology* **96**, fiae054. (doi:10.1093/femsec/fiae054)
- Unzueta-Martínez A, Scanes E, Parker LM, Ross PM, O'Connor W, Bowen JL. 2022 Microbiomes of the Sydney Rock Oyster are acquired through both vertical and horizontal transmission. *anim microbiome* **4**, 32. (doi:10.1186/s42523-022-00186-9)

- 1
2
3
4
5
6
7
8
9
10
11
12
13
14
15
16
17
18
19
20
21
22
23
24
25
26
27
28
29
30
31
32
33
34
35
36
37
38
39
40
41
42
43
44
45
46
47
48
49
50
51
52
53
54
55
56
57
58
59
60
14. Vezzulli L, Stagnaro L, Grande C, Tassistro G, Canesi L, Pruzzo C. 2018 Comparative 16SrDNA Gene-Based Microbiota Profiles of the Pacific Oyster (*Crassostrea gigas*) and the Mediterranean Mussel (*Mytilus galloprovincialis*) from a Shellfish Farm (Ligurian Sea, Italy). *Microb Ecol* **75**, 495–504. (doi:10.1007/s00248-017-1051-6)
15. Clerissi C, de Lorgeril J, Petton B, Lucasson A, Escoubas JM, Gueguen Y, Dégremont L, Mitta G, Toulza E. 2020 Microbiota Composition and Evenness Predict Survival Rate of Oysters Confronted to Pacific Oyster Mortality Syndrome. *Frontiers in Microbiology* **11**, 1–11. (doi:10.3389/fmicb.2020.00311)
16. Offret C *et al.* 2023 Microbiota of the Digestive Glands and Extrapallial Fluids of Clams Evolve Differently Over Time Depending on the Intertidal Position. *Microb Ecol* **85**, 288–297. (doi:10.1007/s00248-022-01959-0)
17. Destoumieux-Garazón D, Canesi L, Oyanedel D, Travers MA, Charrière GM, Pruzzo C, Vezzulli L. 2020 Vibrio–bivalve interactions in health and disease. *Environmental Microbiology* **00**. (doi:10.1111/1462-2920.15055)
18. Duperron S, Gaudron SM, Rodrigues CF, Cunha MR, Decker C, Olu K. 2012 An overview of chemosynthetic symbioses in bivalves from the North Atlantic and Mediterranean Sea. (doi:10.5194/bg-9-16815-2012)
19. Gros O, Elisabeth NH, Gustave SDD, Caro A, Dubilier N. 2012 Plasticity of symbiont acquisition throughout the life cycle of the shallow-water tropical lucinid *Codakia orbiculata* (Mollusca: Bivalvia): Symbiont acquisition in lucinid clams. *Environmental Microbiology* **14**, 1584–1595. (doi:10.1111/j.1462-2920.2012.02748.x)
20. Zhang G *et al.* 2012 The oyster genome reveals stress adaptation and complexity of shell formation. *Nature* **490**, 49–54. (doi:10.1038/nature11413)
21. Zhang L, Li L, Guo X, Litman GW, Dishaw LJ, Zhang G. 2015 Massive expansion and functional divergence of innate immune genes in a protostome. *Scientific Reports* **5**, 8693–8693. (doi:10.1038/srep08693)
22. de Lorgeril J *et al.* 2018 Immune-suppression by OsHV-1 viral infection causes fatal bacteraemia in Pacific oysters. *Nature Communications* **9**, 4215–4215. (doi:10.1038/s41467-018-06659-3)
23. De San Nicolas N *et al.* 2022 Functional Diversification of Oyster Big Defensins Generates Antimicrobial Specificity and Synergy against Members of the Microbiota. *Marine Drugs* **20**, 745–745. (doi:10.3390/md20120745)
24. Fallet M *et al.* 2022 Early life microbial exposures shape the *Crassostrea gigas* immune system for lifelong and intergenerational disease protection. *Microbiome* **10**, 1–21. (doi:10.1186/s40168-022-01280-5)
25. Clerissi C *et al.* 2023 A core of functional complementary bacteria infects oysters in Pacific Oyster Mortality Syndrome. *anim microbiome* **5**, 26. (doi:10.1186/s42523-023-00246-8)
26. Paillard C, Gueguen Y, Wegner KM, Bass D, Pallavicini A, Vezzulli L, Arzul I. 2022 Recent advances in bivalve-microbiota interactions for disease prevention in aquaculture. *Current Opinion in Biotechnology* **73**, 225–232. (doi:10.1016/j.copbio.2021.07.026)
27. Kennedy, Victor S., Newell, Roger I. E., Eble, Albert F., Leffler, Merrill (Production editor), Harpe, Sandy Rodgers (Designer). 1996 *The eastern oyster Crassostrea virginica*. See <https://repository.library.noaa.gov/view/noaa/45763>.
28. Brousseau DJ, Braun PC, Harper-Leatherman AS, Sullivan E, Baglivo JA. 2014 Antimicrobial Activity in the Pallial Cavity Fluids of the Oyster *Crassostrea virginica* (Gmelin) from a Highly Impacted Harbor in Western Long Island Sound. *Journal of Shellfish Research* **33**, 719–725. (doi:10.2983/035.033.0306)
29. Pales Espinosa E, Koller A, Allam B. 2016 Proteomic characterization of mucosal secretions in the eastern oyster, *Crassostrea virginica*. *Journal of Proteomics* **132**, 63–76. (doi:10.1016/j.jpro.2015.11.018)
30. Garland CD, Nash GV, McMeekin TA. 1982 Absence of surface-associated microorganisms in adult oysters (*Crassostrea gigas*). *Appl Environ Microbiol* **44**, 1205–1211. (doi:10.1128/aem.44.5.1205-1211.1982)
31. Braun PC, Brousseau DJ, Lecleir GR. 2019 Microbial Inhibition by Bacteria Isolated from Pallial Cavity Fluids and Associated Mucus of the Eastern Oyster *Crassostrea virginica* (Gmelin). *Journal of Shellfish Research* **38**, 565. (doi:10.2983/035.038.0307)
32. Desriac F, Le Chevalier P, Brillat B, Leguerinel I, Thuillier B, Paillard C, Fleury Y. 2014 Exploring the hologenome concept in marine bivalvia: Haemolymph microbiota as a pertinent source of probiotics for aquaculture. *FEMS Microbiology Letters* **350**, 107–116. (doi:10.1111/1574-6968.12308)
33. Desriac F *et al.* 2020 Alterins Produced by Oyster-Associated *Pseudoalteromonas* Are Antibacterial Cyclolipopeptides with LPS-Binding Activity. *Marine drugs* **18**, 630–630. (doi:10.3390/md18120630)
34. Offret C *et al.* 2020 The marine intertidal zone shapes oyster and clam digestive bacterial microbiota. *FEMS Microbiology Ecology* **96**, fiae078. (doi:10.1093/femsec/fiae078)
35. Scanes E, Parker LM, Seymour JR, Siboni N, Dove MC, O'Connor WA, Ross PM. 2021 Microbiomes of an oyster are shaped by metabolism and environment. *Sci Rep* **11**, 21112. (doi:10.1038/s41598-021-00590-2)
36. Scanes E, Parker LM, Seymour JR, Siboni N, King WL, Wegner KM, Dove MC, O'Connor WA, Ross PM. 2021 Microbiome response differs among selected lines of Sydney rock oysters to ocean warming and acidification. *FEMS Microbiology Ecology* **97**, fiab099. (doi:10.1093/femsec/fiab099)
37. Trabal Fernández N, Mazón-Suástegui JM, Vázquez-Juárez R, Ascencio-Valle F, Romero J. 2014 Changes in the composition and diversity of the bacterial microbiota associated with oysters (*Crassostrea corteziensis*, *Crassostrea gigas* and *Crassostrea sikamea*) during commercial production. *FEMS Microbiol Ecol* **88**, 69–83. (doi:10.1111/1574-6941.12270)
38. Wegner KM, Volkenborn N, Peter H, Eiler A. 2013 Disturbance induced decoupling between host genetics and composition of the associated microbiome. *BMC Microbiology* **13**. (doi:10.1186/1471-2180-13-252)
39. Hines IS, Markov Madanick J, Smith SA, Kuhn DD, Stevens AM. 2023 Analysis of the core bacterial community associated with consumer-ready Eastern oysters (*Crassostrea virginica*). *PLoS ONE* **18**, e0281747. (doi:10.1371/journal.pone.0281747)
40. Lokmer A, Goedknecht MA, Thielges DW, Fiorentino D, Kuenzel S, Baines JF, Mathias Wegner K. 2016 Spatial and temporal dynamics of pacific oyster hemolymph microbiota across multiple scales. *Frontiers in Microbiology* **7**, 1–18. (doi:10.3389/fmicb.2016.01367)
41. Scanes E *et al.* 2021 Climate change alters the haemolymph microbiome of oysters. *Marine Pollution Bulletin* **164**,

- 1
2
3
4 111991. genetic view. *Fish Shellfish Immunol* of antimicrobial peptides in mussel.
5 (doi:10.1016/j.marpolbul.2021.111991) 46. (doi:10.1016/j.fsi.2015.02.040) *Journal of Cell Science* 113, 2759–2769.
- 6
7 42. Harwood CS, Canale-Parola E. 1984. Poirier AC, Schmitt P, Rosa RDRD, 61. Schmitt P, Gueguen Y, Desmarais E,
8 *ECOLOGY OF SPIROCHETES. Ann. Bachère E, de Lorgeril J. 2010*
9 *Rev. Microbiol.* 38. *Rev. Microbiol.* 38. Molecular diversity of antimicrobial
10 43. Schmitt P, Rosa RD, Duperthuy M, de 52. Poirier AC, Schmitt P, Rosa RDRD, 62. Schmitt P, Lorgeril JD, Gueguen Y,
11 Lorgeril J, Bachère E, Destoumieux- Vanhove AS, Kieffer-Jaquinod S, Destoumieux-Garzon D. 2014
12 Garzón D. 2012 The antimicrobial Antimicrobial Histones and DNA Traps in Invertebrate Immunity: EVIDENCES
13 defense of the Pacific oyster, IN CRASSOSTREA GIGAS. *Journal of*
14 *Crassostrea gigas*. How diversity may BMC Evol Biol 10, 23. (doi:10.1186/1471-2148-10-23)
15 compensate for scarcity in the *Biological Chemistry* 289, 24821–
16 regulation of resident/pathogenic 24831. (doi:10.1074/jbc.M114.576546) 62. Schmitt P, Lorgeril JD, Gueguen Y,
17 microflora. *Frontiers in Microbiology* 3, 53. Labreuche Y, Soudant P, Goncalves M, Lambert C, Nicolas J. 2006 Effects of
18 1–17. (doi:10.3389/fmicb.2012.00160) extracellular products from the pathogenic *Vibrio aestuvarianus* strain
19 44. Escoubas J-M, Gourbal B, Duval D, 01/32 on lethality and cellular immune 63. González R, Gonçalves AT, Rojas R,
20 Green TJ, Charrière GM, Destoumieux-Garzon D, Montagnani C. 2016 *Immunity in Molluscs*. Academic P. Oxford: Elsevier Ltd. (doi:10.1016/B978-0-12-374279-7.12004-1) 63. Host Defense Effectors Expressed by Hemocytes Shape the Bacterial Microbiota From the Scallop Hemolymph. *Frontiers in Immunology* 11, 1–13. (doi:10.3389/fimmu.2020.599625)
21 21. Rubio T *et al.* 2019 Species-specific mechanisms of cytotoxicity toward immune cells determine the successful outcome of *Vibrio* infections. *Proceedings of the National Academy of Sciences*, 201905747–201905747. (doi:10.1073/pnas.1905747116) 54. Oyanel D, Rojas R, Brokordt K, Schmitt P. 2023 *Crassostrea gigas* oysters from a non-intensive farming area naturally harbor potentially pathogenic *vibrio* strains. *Journal of Invertebrate Pathology* 196, 107856. (doi:10.1016/j.jip.2022.107856) 64. Hanson MA, Dostálová A, Ceroni C, Poidevin M, Kondo S, Lemaître B. 2019 Synergy and remarkable specificity of antimicrobial peptides in vivo using a systematic knockout approach (eLife (2019) 8 PII: e48778). *eLife* 8, 1–24. (doi:10.7554/eLife.48778)
- 22
23
24
25
26
27
28
29
30
31
32
33
34
35
36
37
38
39
40
41
42
43
44
45
46
47
48
49
50
51
52
53
54
55
56
57
58
59
60
46. Oyanel D *et al.* 2020 *Vibrio splendidus* O-antigen structure: a trade-off between virulence to oysters and resistance to grazers. *Environmental Microbiology* 00. (doi:10.1111/1462-2920.14996) 55. Destoumieux-Garzon D, Rosa RD, Schmitt P, Barreto C, Vidal-Dupiol J, Mitta G, Gueguen Y, Bachère E. 2016 Antimicrobial peptides in marine invertebrate health and disease. *Philosophical Transactions of the Royal Society B: Biological Sciences* 371. (doi:10.1098/rstb.2015.0300) 65. Hanson MA, Grollmus L, Lemaître B. 2022 Ecology-relevant bacteria drive the evolution of host antimicrobial peptides in *Drosophila*. (doi:10.1101/2022.12.23.521774)
47. Oyanel D *et al.* 2023 Cooperation and cheating orchestrate *Vibrio* assemblages and polymicrobial synergy in oysters infected with OshV-1 virus. *BioRxiv*, 11 February. (doi:10.1101/2023.02.11.528104) 56. Gerdol M, Schmitt P, Venier P, Rocha G, Rosa RD, Destoumieux-Garzon D. 2020 Functional Insights From the Evolutionary Diversification of Big Defensins. *Frontiers in Immunology* 11, 1–16. (doi:10.3389/fimmu.2020.00758) 66. Rosa RD, Alonso P, Santini A, Vergnes A, Bachère E. 2015 High polymorphism in big defensin gene expression reveals presence-absence gene variability (PAV) in the oyster *Crassostrea gigas*. *Developmental and Comparative Immunology* 49, 231–238. (doi:10.1016/j.dci.2014.12.002)
48. Zaidman-Rémy A *et al.* 2006 The *Drosophila* Amidase PGRP-LB Modulates the Immune Response to Bacterial Infection. *Immunity* 24, 463–473. (doi:10.1016/j.immuni.2006.02.012) 57. Schmitt P, Wilmes M, Pugniere M, Bachère E, Sahl H, Schneider T, Destoumieux-Garzon D. 2010 Insight into Invertebrate Defensin Mechanism of Action. *J. Biol. Chem.* 285, 29208–29216. (doi:10.1074/jbc.M110.143388) 67. Wongpanya R, Sengprasert P, Amparyup P, Tassanakajon A. 2017 A novel C-type lectin in the black tiger shrimp *Penaeus monodon* functions as a pattern recognition receptor by binding and causing bacterial agglutination. *Fish & Shellfish Immunology* 60, 103–113. (doi:10.1016/j.fsi.2016.11.042)
49. Song X, Wang H, Xin L, Xu J, Jia Z, Wang L, Song L. 2016 The immunological capacity in the larvae of Pacific oyster *Crassostrea gigas*. *Fish & Shellfish Immunology* 49, 461–469. (doi:10.1016/j.fsi.2016.01.009) 58. Gonzalez M *et al.* 2007 Evidence of a bactericidal permeability increasing protein in an invertebrate, the *Crassostrea gigas* Cg-BPI. *Proceedings of the National Academy of Sciences of the United States of America* 104, 17759–17764. (doi:10.1073/pnas.0702281104) 68. Wang X-W, Xu J-D, Zhao X-F, Vasta GR, Wang J-X. 2014 A Shrimp C-type Lectin Inhibits Proliferation of the Hemolymph Microbiota by Maintaining the Expression of Antimicrobial Peptides. *Journal of Biological Chemistry* 289, 11779–11790. (doi:10.1074/jbc.M114.552307)
50. Tirapé A, Bacque C, Brizard R, Vandenbulcke F, Boulo V. 2007 Expression of immune-related genes in the oyster *Crassostrea gigas* during ontogenesis. *Developmental & Comparative Immunology* 31, 859–873. (doi:10.1016/j.dci.2007.01.005) 59. Loth K *et al.* 2019 The Ancestral N-Terminal Domain of Big Defensins Drives Bacterially Triggered Assembly into Antimicrobial Nanonets Karine. *mBio*, 10:e01821-19. (doi:10.1128/mBio.01821-19) 69. Zhang Y-X, Zhang M-L, Wang X-W. 2021 C-Type Lectin Maintains the Homeostasis of Intestinal Microbiota
51. Bachère E, Rosa RD, Schmitt P, Poirier AC, Merou N, Charrière GM, Destoumieux-Garzon D. 2015 The new insights into the oyster antimicrobial defense: Cellular, molecular and

- 1
2
3
4 and Mediates Biofilm Formation by
5 Intestinal Bacteria in Shrimp. *The*
6 *Journal of Immunology* **206**, 1140–
7 1150. (doi:10.4049/jimmunol.2000116)
- 8 70. Song X *et al.* 2019 A single-CRD C-
9 type lectin (CgCLec-3) with novel DIN
10 motif exhibits versatile immune
11 functions in *Crassostrea gigas*. *Fish &*
12 *Shellfish Immunology* **92**, 772–781.
13 (doi:10.1016/j.fsi.2019.07.001)
- 14 71. Mao F *et al.* 2020 Opsonic character of
15 the plasma proteins in phagocytosis-
16 dependent host response to bacterial
17 infection in a marine invertebrate,
18 *Crassostrea gigas*. *Developmental &*
19 *Comparative Immunology* **106**, 103596.
20 (doi:10.1016/j.dci.2019.103596)
- 21 72. Moné Y, Gourbal B, Duval D, Du
22 Pasquier L, Kieffer-Jaquinod S, Mittra
23 G. 2010 A Large Repertoire of Parasite
24 Epitopes Matched by a Large
25 Repertoire of Host Immune Receptors
26 in an Invertebrate Host/Parasite
27 Model. *PLoS Negl Trop Dis* **4**, e813.
28 (doi:10.1371/journal.pntd.0000813)
- 29 73. Portet A, Galinier R, Pinaud S, Portela
30 J, Nowacki F, Gourbal B, Duval D. 2018
31 BgTEP: An Antiprotease Involved in
32 Innate Immune Sensing in
33 *Biomphalaria glabrata*. *Front.*
34 *Immunol.* **9**, 1206.
35 (doi:10.3389/fimmu.2018.01206)
- 36 74. Levashina EA, Moita LF, Blandin S,
37 Vriend G, Lagueux M, Kafatos FC.
38 2001 Conserved Role of a
39 Complement-like Protein in
40 Phagocytosis Revealed by dsRNA
41 Knockout in Cultured Cells of the
42 Mosquito, *Anopheles gambiae*. *Cell.*
43 **709–718**.
- 44 75. Stroschein-Stevenson SL, Foley E,
45 O'Farrell PH, Johnson AD. 2005
46 Identification of *Drosophila* Gene
47 Products Required for Phagocytosis of
48 *Candida albicans*. *PLoS Biol* **4**, e4.
49 (doi:10.1371/journal.pbio.0040004)
- 50 76. Rosenstiel P *et al.* 2007 Regulation of
51 *DMBT1* via NOD2 and TLR4 in
52 Intestinal Epithelial Cells Modulates
53 Bacterial Recognition and Invasion.
54 *The Journal of Immunology* **178**, 8203–
55 8211.
56 (doi:10.4049/jimmunol.178.12.8203)
- 57 77. Arezes J. 2015 Hepcidin-Induced
58 Hypoferremia Is a Critical Host
59 Defense Mechanism Against the
60 Siderophilic Bacterium *Vibrio*
vulnificus. *Cell Host & Microbe* **17**.
(doi:10.1038/jid.2014.371)
78. McFall-Ngai M *et al.* 2013 Animals in a
bacterial world, a new imperative for
the life sciences. *Proceedings of the*
National Academy of Sciences **110**,
3229–3236.
(doi:10.1073/pnas.1218525110)
79. Jarchum I, Pamer EG. 2011 Regulation
of innate and adaptive immunity by
the commensal microbiota. *Current*
Opinion in Immunology **23**, 353–360.
(doi:10.1016/j.coi.2011.03.001)
80. Round JL, Mazmanian SK. 2009 The
gut microbiota shapes intestinal
immune responses during health and
disease. *Nat Rev Immunol* **9**, 313–323.
(doi:10.1038/nri2515)
81. Ansaldo E, Farley TK, Belkaid Y. 2021
Control of Immunity by the
Microbiota. *Annu. Rev. Immunol.* **39**,
449–479. (doi:10.1146/annurev-
immunol-093019-112348)
82. Carlson JS, Short SM, Angleró-
Rodríguez YI, Dimopoulos G. 2020
Larval exposure to bacteria modulates
arbovirus infection and immune gene
expression in adult *Aedes aegypti*.
Developmental & Comparative
Immunology **104**, 103540.
(doi:10.1016/j.dci.2019.103540)
83. Galindo-Villegas J, García-Moreno D,
de Oliveira S, Meseguer J, Mulero V.
2012 Regulation of immunity and
disease resistance by commensal
microbes and chromatin modifications
during zebrafish development. *Proc.*
Natl. Acad. Sci. U.S.A. **109**.
(doi:10.1073/pnas.1209920109)
84. Gensollen T, Iyer SS, Kasper DL,
Blumberg RS. 2016 How colonization
by microbiota in early life shapes the
immune system. *Science* **352**, 539–
544. (doi:10.1126/science.aad9378)
85. Kelly C, Salinas I. 2017 Under Pressure:
Interactions between Commensal
Microbiota and the Teleost Immune
System. *Front. Immunol.* **8**, 559.
(doi:10.3389/fimmu.2017.00559)
86. Rader B, McNulty SJ, Nyholm SV.
2019 Persistent symbiont colonization
leads to a maturation of hemocyte
response in the *Euprymna scolopes* /
Vibrio fischeri symbiosis.
MicrobiologyOpen **8**.
(doi:10.1002/mbo3.858)
87. Weiss BL, Wang J, Aksoy S. 2011
Tsetse Immune System Maturation
Requires the Presence of Obligate
Symbionts in Larvae. *PLoS Biol* **9**,
e1000619.
(doi:10.1371/journal.pbio.1000619)
88. Arrieta M-C, Stiemsma LT,
Amenyogbe N, Brown EM, Finlay B.
2014 The Intestinal Microbiome in
Early Life: Health and Disease. *Front.*
Immunol. **5**.
(doi:10.3389/fimmu.2014.00427)
89. Fanucchi S, Domínguez-Andrés J,
Joosten LAB, Netea MG, Mhlanga
MM. 2021 The Intersection of
Epigenetics and Metabolism in
- Trained Immunity. *Immunity* **54**, 32–
43.
(doi:10.1016/j.immuni.2020.10.011)
90. Lindermayr C, Rudolf EE, Durner J,
Groth M. 2020 Interactions between
metabolism and chromatin in plant
models. *Molecular Metabolism* **38**,
100951.
(doi:10.1016/j.molmet.2020.01.015)
91. Aristizabal MJ *et al.* 2020 Biological
embedding of experience: A primer on
epigenetics. *Proc. Natl. Acad. Sci.*
U.S.A. **117**, 23261–23269.
(doi:10.1073/pnas.1820838116)
92. Turner BM. 2009 Epigenetic responses
to environmental change and their
evolutionary implications. *Phil. Trans.*
R. Soc. B **364**, 3403–3418.
(doi:10.1098/rstb.2009.0125)
93. Yin J, Zhou M, Lin Z, Li QQ, Zhang Y-
Y. 2019 Transgenerational effects
benefit offspring across diverse
environments: a meta-analysis in
plants and animals. *Ecology Letters* **22**,
1976–1986. (doi:doi: 10.1111/ele.13373)
94. McCoy KD, Burkhard R, Geuking MB.
2019 The microbiome and immune
memory formation. *Immunol Cell Biol*
97, 625–635. (doi:10.1111/imcb.12273)
95. Abt MC *et al.* 2012 Commensal
Bacteria Calibrate the Activation
Threshold of Innate Antiviral
Immunity. *Immunity* **37**, 158–170.
(doi:10.1016/j.immuni.2012.04.011)
96. Erttmann SF, Swacha P, Aung KM,
Brindefalk B, Jiang H, Härtlova A,
Uhlin BE, Wai SN, Gekara NO. 2022
The gut microbiota prime systemic
antiviral immunity via the cGAS-
STING-IFN- λ axis. *Immunity* **55**, 847-
861.e10.
(doi:10.1016/j.immuni.2022.04.006)
97. Hoang KL, King KC. 2022 Symbiont-
mediated immune priming in animals
through an evolutionary lens.
Microbiology **168**.
(doi:10.1099/mic.0.001181)
98. Holt CC, Bass D, Stentford GD, van
der Giezen M. 2021 Understanding the
role of the shrimp gut microbiome in
health and disease. *Journal of*
Invertebrate Pathology **186**, 107387.
(doi:10.1016/j.jip.2020.107387)
99. Huang Z *et al.* 2020 Microecological
Koch's postulates reveal that intestinal
microbiota dysbiosis contributes to
shrimp white feces syndrome.
Microbiome **8**, 32. (doi:10.1186/s40168-
020-00802-3)
100. Ichinohe T, Pang IK, Kumamoto Y,
Peaper DR, Ho JH, Murray TS, Iwasaki
A. 2011 Microbiota regulates immune

- 1
2
3
4 defense against respiratory tract
5 influenza A virus infection. *Proc. Natl.*
6 *Acad. Sci. U.S.A.* **108**, 5354–5359.
7 (doi:10.1073/pnas.1019378108)
- 8 101. Näpflin K, Schmid-Hempel P. 2016
9 Immune response and gut microbial
10 community structure in bumblebees
11 after microbiota transplants. *Proc. R.*
12 *Soc. B.* **283**, 20160312.
13 (doi:10.1098/rspb.2016.0312)
- 14 102. Sansone CL, Cohen J, Yasunaga A, Xu
15 J, Osborn G, Subramanian H, Gold B,
16 Buchon N, Cherry S. 2015 Microbiota-
17 Dependent Priming of Antiviral
18 Intestinal Immunity in *Drosophila*. *Cell*
19 *Host & Microbe* **18**, 571–581.
20 (doi:10.1016/j.chom.2015.10.010)
- 21 103. Prigot-Maurice C, Beltran-Bech S,
22 Braquart-Varnier C. 2022 Why and
23 how do protective symbionts impact
24 immune priming with pathogens in
25 invertebrates? *Developmental &*
26 *Comparative Immunology* **126**, 104245.
27 (doi:10.1016/j.dci.2021.104245)
- 28 104. Lafont M *et al.* 2020 A Sustained
29 Immune Response Supports Long-
30 Term Antiviral Immune Priming in the
31 Pacific Oyster, *Crassostrea gigas*.
32 *mBio* **11**, 1–17.
33 (doi:10.1128/mBio.02777-19)
- 34 105. Wang W, Wang L, Liu Z, Song X, Yi Q,
35 Yang C, Song L. 2020 The involvement
36 of TLR signaling and anti-bacterial
37 effectors in enhanced immune
38 protection of oysters after *Vibrio*
39 *splendidus* pre-exposure.
40 *Developmental & Comparative*
41 *Immunology* **103**, 103498.
42 (doi:10.1016/j.dci.2019.103498)
- 43 106. Bourne DG, Morrow KM, Webster NS.
44 2016 Insights into the Coral
45 Microbiome: Underpinning the Health
46 and Resilience of Reef Ecosystems.
47 *Annu. Rev. Microbiol.* **70**, 317–340.
48 (doi:10.1146/annurev-micro-102215-
49 095440)
- 50 107. Baldassarre L, Ying H, Reitzel AM,
51 Franzenburg S, Fraune S. 2022
52 Microbiota mediated plasticity
53 promotes thermal adaptation in the
54 sea anemone *Nematostella vectensis*.
55 *Nat Commun* **13**, 3804.
56 (doi:10.1038/s41467-022-31350-z)
- 57 108. Woolstra CR, Ziegler M. 2020 Adapting
58 with Microbial Help: Microbiome
59 Flexibility Facilitates Rapid Responses
60 to Environmental Change. *BioEssays*
61 **42**, 2000004.
62 (doi:10.1002/bies.202000004)
- 63 109. Hou K *et al.* 2022 Microbiota in health
64 and diseases. *Sig Transduct Target*
65 *Ther* **7**, 135. (doi:10.1038/s41392-022-
66 00974-4)
- 67 110. Jones HR, Johnson KM, Kelly MW.
68 2019 Synergistic Effects of
69 Temperature and Salinity on the Gene
70 Expression and Physiology of
71 *Crassostrea virginica*. *Integrative and*
72 *Comparative Biology* **59**, 306–319.
73 (doi:10.1093/icc/icz035)
- 74 111. King WL, Jenkins C, Seymour JR,
75 Labbate M. 2019 Oyster disease in a
76 changing environment: Decrypting
77 the link between pathogen,
78 microbiome and environment. *Marine*
79 *Environmental Research* **143**, 124–140.
80 (doi:10.1016/j.marenvres.2018.11.007)
- 81 112. Lokmer A, Wegner KM. 2015
82 Hemolymph microbiome of Pacific
83 oysters in response to temperature,
84 temperature stress and infection.
85 *ISME Journal* **9**, 670–682.
86 (doi:10.1038/ismej.2014.160)
- 87 113. Green TJ, Siboni N, King WL, Labbate
88 M, Seymour JR, Raftos D. 2019
89 Simulated Marine Heat Wave Alters
90 Abundance and Structure of *Vibrio*
91 Populations Associated with the
92 Pacific Oyster Resulting in a Mass
93 Mortality Event. *Microbial Ecology* **77**,
94 736–747. (doi:10.1007/s00248-018-
95 1242-9)
- 96 114. Lupo C, Dutta B, Petton S, Ezanno P,
97 Tourbiez D, Travers M, Pernet F,
98 Bacher C. 2020 Spatial
99 epidemiological modelling of infection
100 by *Vibrio aestuarianus* shows that
101 connectivity and temperature control
102 oyster mortality. *Aquacult. Environ.*
103 *Interact.* **12**, 511–527.
104 (doi:10.3354/aeio0379)
- 105 115. Lasa A *et al.* 2019 Dynamics of the
106 Pacific oyster pathobiota during
107 mortality episodes in Europe assessed
108 by 16S rRNA gene profiling and a new
109 target enrichment next-generation
110 sequencing strategy. *Environmental*
111 *Microbiology* **21**, 4548–4562.
112 (doi:10.1111/1462-2920.14750)
- 113 116. Parizadeh L, Tourbiez D, Garcia C,
114 Haffner P, Dégremont L, Le Roux F,
115 Travers MA. 2018 Ecologically realistic
116 model of infection for exploring the
117 host damage caused by *Vibrio*
118 *aestuarianus*. *Environmental*
119 *Microbiology* **20**, 4343–4355.
120 (doi:10.1111/1462-2920.14350)
- 121 117. Petton B, Destoumieux-Garzon D,
122 Pernet F, Toulza E, de Lorgeril J,
123 Dégremont L, Mitta G. 2021 The
124 Pacific Oyster Mortality Syndrome, a
125 Polymicrobial and Multifactorial
126 Disease: State of Knowledge and
127 Future Directions. *Frontiers in*
128 *Immunology* **12**, 1–10.
129 (doi:10.3389/fimmu.2021.630343)
- 130 118. Petton B, Bruto M, James A,
131 Labreuche Y, Alunno-Bruscia M, Le
132 Roux F. 2015 *Crassostrea gigas*
133 mortality in France: The usual suspect,
134 a herpes virus, may not be the killer in
135 this polymicrobial opportunistic
136 disease. *Frontiers in Microbiology* **6**, 1–
137 10. (doi:10.3389/fmicb.2015.00686)
- 138 119. Food and Agricultural Organization of
139 the United Nations. 2016 *Probiotics in*
140 *animal nutrition: production, impact*
141 *and regulation*. Rome: Food and
142 Agricultural Organization of the
143 United Nations.
- 144 120. Getachew T. 2016 A Review on Effects
145 of Probiotic Supplementation in
146 Poultry Performance and Cholesterol
147 Levels of Egg and Meat.
- 148 121. Khademzade O, Zakeri M, Haghi M,
149 Mousavi SM. 2020 The effects of
150 water additive *Bacillus cereus* and
151 *Pediococcus acidilactici* on water
152 quality, growth performances,
153 economic benefits,
154 immunohematology and bacterial
155 flora of whiteleg shrimp (*Penaeus*
156 *vannamei* Boone, 1931) reared in
157 earthen ponds. *Aquac Res* **51**, 1759–
158 1770. (doi:10.1111/are.14525)
- 159 122. Yeh H, Skubel SA, Patel H, Cai Shi D,
160 Bushek D, Chikindas ML. 2020 From
161 Farm to Fingers: An Exploration of
162 Probiotics for Oysters, from
163 Production to Human Consumption.
164 *Probiotics and Antimicrobial Proteins*
165 **12**, 351–364. (doi:10.1007/s12602-019-
166 09629-3)
- 167 123. Madison D, Schubiger C, Spencer L,
168 Mueller RS, Lagdon C. 2022 A marine
169 probiotic treatment against the
170 bacterial pathogen *Vibrio*
171 *coralliilyticus* to improve the
172 performance of Pacific (*Crassostrea*
173 *gigas*) and Kumamoto (*C. sikamea*)
174 oyster larvae. *BioRxiv* (doi:
175 <https://doi.org/10.1101/2022.05.09.491202>)
- 176 124. García-Bernal M, Medina-Marrero R,
177 Campa-Córdova ÁI, Mazón-Suástegui
178 JM. 2019 Growth and antioxidant
179 response of juvenile oysters
180 *Crassostrea sikamea* and *Crassostrea*
181 *corteziensis* treated with
182 *Streptomyces* strains. *Arq. Bras. Med.*
183 *Vet. Zootec.* **71**, 1993–1998.
184 (doi:10.1590/1678-4162-11225)
- 185 125. Dugeny E, Lorgeril J, Petton B, Toulza
186 E, Gueguen Y, Pernet F. 2022
187 Seaweeds influence oyster microbiota
188 and disease susceptibility. *Journal of*
189 *Animal Ecology* **91**, 805–818.
190 (doi:10.1111/1365-2656.13662)
- 191 126. De Schryver P, Defoirdt T, Sorgeloos
192 P. 2014 Early Mortality Syndrome
193 Outbreaks: A Microbial Management
194 Issue in Shrimp Farming? *PLoS Pathog*
195 **10**, e1003919.
196 (doi:10.1371/journal.ppat.1003919)

- 1
2
3
4
5
6
7
8
9
10
11
12
13
14
15
16
17
18
19
20
21
22
23
24
25
26
27
28
29
30
31
32
33
34
35
36
37
38
39
40
41
42
43
44
45
46
47
48
49
50
51
52
53
54
55
56
57
58
59
60
127. De Schryver P, Vadstein O. 2014 Ecological theory as a foundation to control pathogenic invasion in aquaculture. *ISME J* **8**, 2360–2368. (doi:10.1038/ismej.2014.84)
128. Bossier P *et al.* 2016 Microbial Community Management in Aquaculture. *Procedia Food Science* **6**, 37–39. (doi:10.1016/j.profoo.2016.02.007)
129. Vadstein O, Attramadal KJK, Bakke I, Olsen Y. 2018 K-Selection as Microbial Community Management Strategy: A Method for Improved Viability of Larvae in Aquaculture. *Front. Microbiol.* **9**, 2730. (doi:10.3389/fmicb.2018.02730)
130. Kumar V, Roy S, Behera BK, Swain HS, Das BK. 2021 Biofloc Microbiome With Bioremediation and Health Benefits. *Frontiers in Microbiology* **12**. (doi:10.3389/fmicb.2021.741164)
131. Gourbal B, Pinaud S, Beckers GJM, Van Der Meer JWM, Conrath U, Netea MG. 2018 Innate immune memory: An evolutionary perspective. *Immunol Rev* **283**, 21–40. (doi:10.1111/immr.12647)
132. Lafont M, Goncalves P, Guo X, Montagnani C, Raftos D, Green T. 2019 Transgenerational plasticity and antiviral immunity in the Pacific oyster (*Crassostrea gigas*) against Ostreid herpesvirus 1 (OsHV-1). *Developmental & Comparative Immunology* **91**, 17–25. (doi:10.1016/j.dci.2018.09.022)
133. Yang W *et al.* 2021 Immune priming in shellfish: A review and an updating mechanistic insight focused on cellular and humoral responses. *Aquaculture* **530**, 735831. (doi:10.1016/j.aquaculture.2020.735831)
134. Stevick RJ, Post AF, Gómez-Chiarri M. 2021 Functional plasticity in oyster gut microbiomes along a eutrophication gradient in an urbanized estuary. *anim microbiome* **3**, 5. (doi:10.1186/s42523-020-00066-0)
135. Piel D *et al.* 2022 Phage–host coevolution in natural populations. *Nat Microbiol* **7**, 1075–1086. (doi:10.1038/s41564-022-01157-1)
136. Breitbart M, Bonnain C, Malki K, Sawaya NA. 2018 Phage puppet masters of the marine microbial realm. *Nat Microbiol* **3**, 754–766. (doi:10.1038/s41564-018-0166-y)
137. Azema P, Travers MA, Benabdelmouna A, Degremont L. 2016 Single or dual experimental infections with *Vibrio aestuarianus* and OsHV-1 in diploid and triploid *Crassostrea gigas* at the spat, juvenile and adult stages. *Journal of Invertebrate Pathology* **139**. (doi:10.1016/j.jip.2016.08.002)

Annexe V – Article de San Nicolas *et al.* 2022

Article publié dans le journal marine drugs en 2022



Article

Functional Diversification of Oyster Big Defensins Generates Antimicrobial Specificity and Synergy against Members of the Microbiota

Noémie De San Nicolas ¹, Aromal Asokan ², Rafael D. Rosa ³, Sébastien N. Voisin ⁴, Marie-Agnès Travers ¹, Gustavo Rocha ³, Luc Dantan ¹, Yann Dorant ¹, Guillaume Mitta ^{1,5}, Bruno Petton ⁶, Guillaume M. Charrière ¹, Jean-Michel Escoubas ¹, Viviane Boulo ¹, Juliette Pouzadoux ¹, Hervé Meudal ², Karine Loth ^{2,7}, Vincent Aucagne ², Agnès F. Delmas ², Philippe Bulet ^{4,8}, Caroline Montagnani ¹ and Delphine Destoumieux-Garzon ^{1,*}

¹ IHPE, Univ. Montpellier, CNRS, Ifremer, Univ. Perpignan Via Domitia, 34090 Montpellier, France

² Centre de Biophysique Moléculaire UPR4301 CNRS, 45071 Orléans, France

³ Laboratory of Immunology Applied to Aquaculture, Department of Cell Biology, Embryology and Genetics, Federal University of Santa Catarina, 88040-900 Florianópolis, Santa Catarina, Brazil

⁴ Plateforme BioPark d'Archamps, Archparc, 74160 Archamps, France

⁵ Ifremer, IRD, ILM, Université de Polynésie Française, UMR EIO, 98179 Vairao, French Polynesia

⁶ Ifremer, CNRS, IRD, Ifremer, LEMAR UMR 6539 Université de Bretagne Occidentale, 29840 Argenton-en-Landunvez, France

⁷ UFR ST, Université d'Orléans, 45067 Orléans, France

⁸ CR UGA, IAB, INSERM U1209, CNRS UMR5309, 74160 La Tronche-Archamps, France

* Correspondence: delphine.destoumieux.garzon@ifremer.fr; Tel.: +33-467144625

Citation: De San Nicolas, N.; Asokan, A.; Rosa, R.D.; Voisin, S.N.; Travers, M.-A.; Rocha, G.; Dantan, L.; Dorant, Y.; Mitta, G.; Petton, B.; et al. Functional Diversification of Oyster Big Defensins Generates Antimicrobial Specificity and Synergy against Members of the Microbiota. *Mar. Drugs* **2022**, *20*, 745. <https://doi.org/10.3390/md20120745>

Academic Editor: Céline Zatylny-Gaudin

Received: 28 October 2022

Accepted: 22 November 2022

Published: 26 November 2022

Publisher's Note: MDPI stays neutral with regard to jurisdictional claims in published maps and institutional affiliations.



Copyright: © 2022 by the authors. Licensee MDPI, Basel, Switzerland. This article is an open access article distributed under the terms and conditions of the Creative Commons Attribution (CC BY) license (<https://creativecommons.org/licenses/by/4.0/>).

Abstract: Big defensins are two-domain antimicrobial peptides (AMPs) that have highly diversified in mollusks. C_g-BigDefs are expressed by immune cells in the oyster *Crassostrea gigas*, and their expression is dampened during the Pacific Oyster Mortality Syndrome (POMS), which evolves toward fatal bacteremia. We evaluated whether C_g-BigDefs contribute to the control of oyster-associated microbial communities. Two C_g-BigDefs that are representative of molecular diversity within the peptide family, namely C_g-BigDef1 and C_g-BigDef5, were characterized by gene cloning and synthesized by solid-phase peptide synthesis and native chemical ligation. Synthetic peptides were tested for antibacterial activity against a collection of culturable bacteria belonging to the oyster microbiota, characterized by 16S sequencing and MALDI Biotyping. We first tested the potential of C_g-BigDefs to control the oyster microbiota by injecting synthetic C_g-BigDef1 into oyster tissues and analyzing microbiota dynamics over 24 h by 16S metabarcoding. C_g-BigDef1 induced a significant shift in oyster microbiota β-diversity after 6 h and 24 h, prompting us to investigate antimicrobial activities *in vitro* against members of the oyster microbiota. Both C_g-BigDef1 and C_g-BigDef5 were active at a high salt concentration (400 mM NaCl) and showed broad spectra of activity against bacteria associated with *C. gigas* pathologies. Antimicrobial specificity was observed for both molecules at an intra- and inter-genera level. Remarkably, antimicrobial spectra of C_g-BigDef1 and C_g-BigDef5 were complementary, and peptides acted synergistically. Overall, we found that primary sequence diversification of C_g-BigDefs has generated specificity and synergy and extended the spectrum of activity of this peptide family.

Keywords: antibacterial peptide; beta defensin; diversity; evolution; microbiome; invertebrate; mollusk

1. Introduction

From invertebrates to humans, active crosstalk between the host immune system and the microbiota plays a critical role in maintaining homeostasis [1,2]. Antimicrobial peptides (AMPs), among other immune effectors, are key players in host-microbe interactions [3–6]. AMPs encompass a highly diverse array of molecules widespread in multicellular organisms, which were initially described for their direct antimicrobial activities against pathogens [7,8]. AMPs are multifunctional: they are involved in the early establishment and shaping of bacterial microbiota; they maintain tolerance to beneficial microbes and greatly affect community composition in the guts, epithelia, and mucosal surfaces of mammals through direct and indirect activities against commensal bacteria [9,10]. In other animal branches as well, AMPs play an important role in host-microbiota interactions [5,11]. In arthropods such as insects and crustaceans, AMPs regulate microbiota composition [6,12,13]. In cnidarians, they are crucial in shaping microbial colonization during *Hydra* development [14].

Several families of AMPs have been identified in *Crassostrea gigas* oysters (mollusks) and characterized in terms of expression, structure, and function [15–17]. AMP families in oysters have widely diversified; they are expressed at low concentrations by immune cells, hemocytes, and epithelia [15]. Recent studies have highlighted the role of host-microbiota interactions in oyster health [18,19]. The structure of the oyster microbiota is modified under stressful conditions promoting the development of opportunistic infections [18]. The resulting dysbiosis can be associated with significant mortality. In particular, *C. gigas* suffers from a polymicrobial disease called the Pacific Oyster Mortality Syndrome (POMS), which is triggered by infection with the OsHV-1 μ Var virus and affects the oyster's immune cells. Interestingly, hemocyte infection has been associated with attenuation of AMP expression with a loss of barrier function leading to dysbiosis and fatal bacteremia [20,21]. Oyster big defensins are among the peptide families whose expression is altered during POMS, suggesting that they may contribute to the control of oyster microbial communities [21]. This hypothesis is further supported by the recent finding that a big defensin mediates microbial shaping in another bivalve mollusk, the scallop *Argopecten purpuratus* [22].

Knowledge of big defensins has significantly increased over the past decade, particularly with the growing availability of next-generation sequencing data. Phylogenetic analyses have shown that big defensins are a family of two-domain AMPs that expanded in mollusks as a result of independent lineage-specific tandem gene duplications, followed by rapid molecular diversification [23,24]. Canonical big defensins harbor an N-terminal hydrophobic domain specific to the peptide family and a C-terminal domain that resembles β -defensins [24,25]. Big defensins have diversified in the oyster *C. gigas* with up to seven distinct sequences described [24]. Among them, Cg-BigDef1-3 and Cg-BigDef5-6 form two phylogenetically distinct groups [24]. Cg-BigDefs are expressed by oyster hemocytes [23]. To date, functional data have only been acquired on Cg-BigDef1. This was made possible by developing the chemical synthesis of Cg-BigDef1 [26,27]. Synthetic Cg-BigDef1 showed a broad range of antibacterial activities against both Gram-positive and Gram-negative bacteria from clinical and environmental collections [27]. A remarkable feature of its mechanism of action was its ability to self-assemble in nanonets and trap and kill bacteria [27].

In this paper, we first tested the *in vivo* ability of Cg-BigDefs to control the commensal oyster microbiota by monitoring microbiota composition in oysters injected with Cg-BigDef1. Second, we searched whether primary sequence diversification among oyster big defensins translates into functional diversification. To answer this second question, we cloned the genomic sequences and chemically synthesized Cg-BigDef1 and Cg-BigDef5, which are representative of sequence diversity. Antimicrobial activity spectra of Cg-BigDefs were determined *in vitro* against a collection of culturable bacteria belonging to the oyster microbiota. Our data support a role for Cg-BigDefs in the regulation of oyster microbiota composition and show that the sequence diversity between Cg-BigDef1 and

Cg-BigDef5 generates antimicrobial specificity and synergy against members of the oyster microbiota, including bacteria associated with significant pathologies.

2. Results

2.1. *In Vivo* Activity of Cg-BigDef1 on Oyster Commensal Microbiota

We tested the effect of Cg-BigDef1 on oyster commensal microbiota by injecting the synthetic peptide into the adductor muscle (5 μ M Cg-BigDef1 relative to oyster flesh volume) of anesthetized oysters. An injection of sterile artificial seawater (ASW), i.e., the solvent used for solubilizing synthetic Cg-BigDef1, was used as a control (Figure 1A). Since substantial inter-individual variations were observed in oyster microbiota composition [28] and oyster genetics influences microbiota composition [29], we used a pathogen-free oyster family of full siblings for our experiments (i.e., oysters with limited environmental and genetic variation; see Materials and Methods). Microbiota composition was monitored in whole tissue extracts by 16S metabarcoding.

We first verified that anesthesia had no significant effect on the homeostasis of oyster commensal microbiota. To this end, we compared the microbiota of eight non-treated control oysters (NTC, i.e., not anesthetized, not injected with ASW) and eight anesthetized control oysters (AC, i.e., oysters kept dry for 12 h and anesthetized for 2 h). This comparison was performed at time 0 before oysters were injected with Cg-BigDef1 or sterile artificial seawater, used as a control. We then examined the effect of Cg-BigDef1 on oyster commensal microbiota by comparing the microbiota of eight oysters injected with Cg-BigDef1 or ASW (control) at three time points after injection (0, 6, and 24 h) (Figure 1A). To compare microbiota composition over time and conditions, we generated a global dataset from a total of 7,320,778 raw reads obtained by Illumina MiSeq sequencing of the 64 oysters analyzed. Sufficient sequencing depth was confirmed by analyses of rarefaction curves of species richness (Supplementary Figure S1). We retained 6,371,737 sequences corresponding to 632 Amplicon Sequence Variants (ASV) for further analyses after filtering, chimera removal, clustering by dbOTU3, and rare ASVs filtration.

Anesthesia had no significant effect on oyster microbiota. Indeed, AC oysters did not differ from NTC control oysters in terms of α -diversity (measured here by the observed richness and Shannon H indices) nor β -diversity (measured by the Bray–Curtis dissimilarity matrix estimates) (Supplementary Figure S2, Table S1) or relative abundance of the 10 most abundant genera in AC and NTC animals (Supplementary Figure S2, Table S2). Moreover, oysters injected with Cg-BigDef1 did not differ from oysters injected with ASW in terms of α -diversity as estimated with the observed richness and Shannon's H indexes (Supplementary Figure S3).

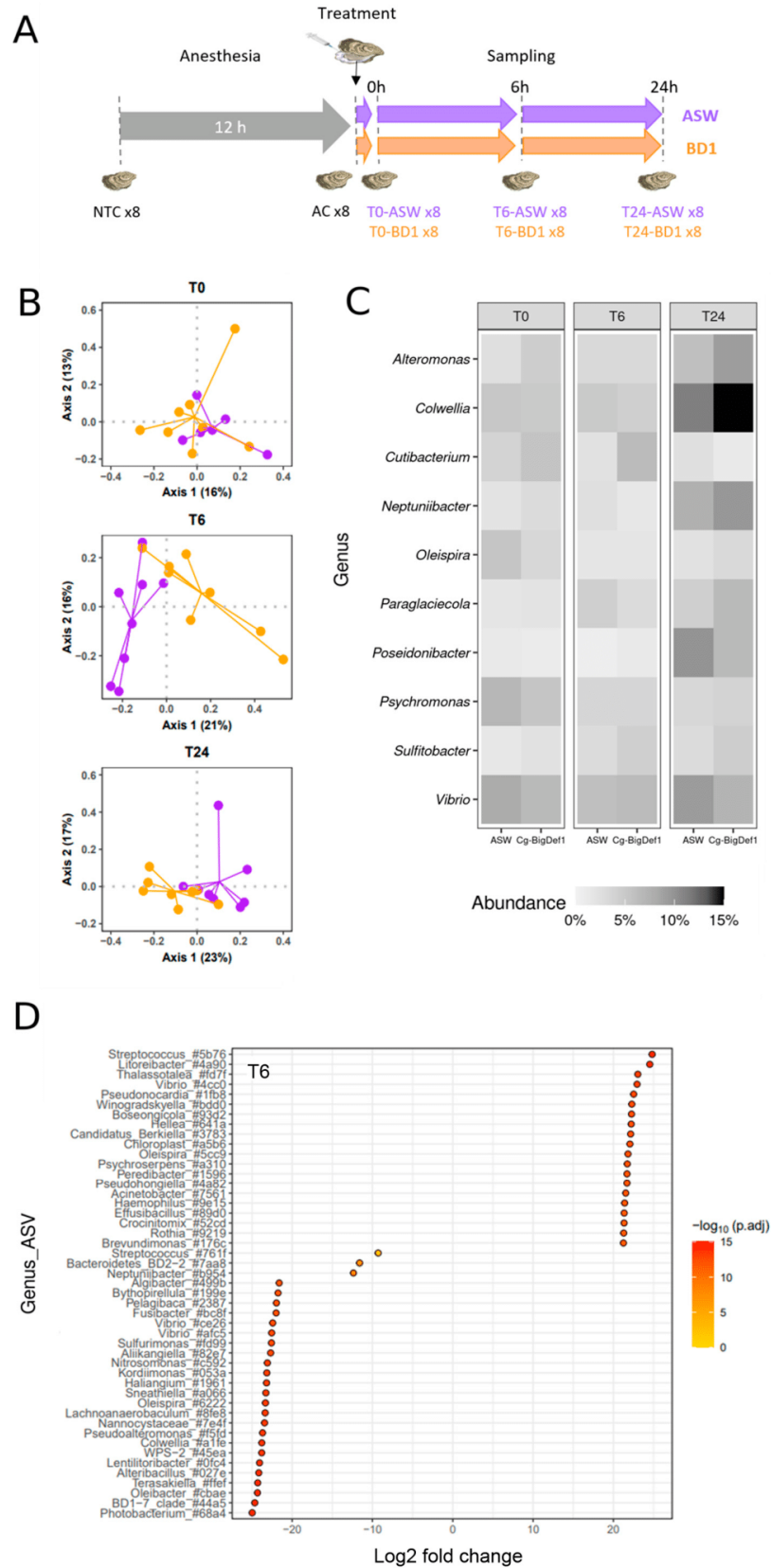

Figure 1. Effects of Cg-BigDef1 on β -Diversity and taxonomic composition of oyster microbiota. (A): Schematic representation of the experimental design used to test the impact of Cg-BigDef1 on the oyster microbiota after injection. From the same batch of oysters, 8 non-treated oysters were collected (NTC), the remaining oysters were anesthetized and 8 oysters were collected after 12 h (AC). The oysters were then injected with either Cg-BigDef1 at a final concentration of 5 μ M (BD1) or with an equal volume of ASW (control). Oyster sampling was performed 10 min (T0), 6 h (T6) and 24 h (T24) after injection. (B): PCoA biplot based on Bray–Curtis distances showing differences between oysters injected with Cg-BigDef1 (BD1, orange) or ASW (purple) at T0, T6 and T24. (C): Mean relative abundance of bacterial genera in oyster microbiota, grouped according to oyster treatment and time after treatment. The heatmap shows the frequencies of the 10 most abundant bacterial genera in each condition. (D): Differential abundance analysis (DESeq2) at the ASV level between oysters injected with ASW and Cg-BigDef1 at T6. Each circle represents an ASV showing significant \log_2 Foldchange (adjusted p value < 0.01) between experimental conditions. Positive \log_2 FoldChange means enrichment in Cg-BigDef1-injected oysters and negative \log_2 FoldChange means enrichment in ASW-injected oysters. Taxa are denoted by their attributed genus followed by the first four characters of the ASV barcode attributed by SAMBA. Note that ASVs without genera annotation were not represented in the figure.

By contrast, Cg-BigDef1 altered the oyster microbiota in terms of β -diversity. This was determined using a final matrix of 632 ASVs distributed among the 48 oyster microbiota samples and the three kinetic points after normalization/rarefaction and removal of low abundance ASVs (less than four reads in at least four individuals). Differences are depicted by principal coordinate analysis (PCoA) based on the Bray–Curtis dissimilarity matrix for T6 and T24 (Figure 1B). Subsequent statistical analyses demonstrated that at T0 (i.e., 10 min after injection with Cg-BigDef1 or ASW), oyster microbiota did not differ between conditions ($p = 0.779$). The effect of Cg-BigDef1 became visible from T6 ($p = 0.00064$) to T24 ($p = 0.00488$) (PERMANOVA based on 100,000 permutations) (Tables S2,S3), in agreement with the antimicrobial activity of Cg-BigDef1 measurable *in vitro* within 24 h [27]. No significant differences were observed among the 10 most abundant genera between Cg-BigDef1 and ASW-injected oysters (Figure 1C, Supplementary Figure S4). Significant differences were only observed at the ASV level. Overall, at T6, differential abundance analysis identified 156 ASVs, which were significantly enriched or impoverished in Cg-BigDef1-treated oysters. Among these, 47 ASVs were affiliated with 44 known genera (Figure 1D). Similar results were obtained at T24 (Supplementary Figure S5). While differences were observed in microbiota composition, the relative abundance of total microbiota did not vary significantly upon Cg-BigDef1 treatment, as determined by 16S quantitative PCR (Supplementary Figure S6).

2.2. Establishment of a Collection of Culturable Bacteria from *C. gigas* Microbiota

To further investigate the role of Cg-BigDefs in controlling the oyster microbiota, we built a collection of culturable bacterial strains representing 21 genera associated with healthy and diseased *C. gigas* [30,31]. Among them, we included genera repeatedly associated with oyster diseases, such as *Arcobacter*, *Aeromonas*, *Marinomonas*, *Marinobacterium*, *Pseudoalteromonas*, *Psychrobacter*, *Sulfitobacter*, *Tenacibaculum*, and *Vibrio* [21,30,32,33]. We obtained 16S rDNA sequences (V3–V4 loop) for 46 bacteria isolated from oysters with known health status (healthy or diseased). In addition, we purchased three type-strains of the genera of interest that were needed as a reference for the MALDI database (one *Pseudoalteromonas* and two *Alteromonas*). All 16S sequences exhibited $\geq 95\%$ identity with a known type-strain sequence included in the analysis (Figure 2). For 41 strains of the 50 strains in the collection, we acquired molecular mass fingerprints by MALDI Biotyping. Strains with taxonomic assignment by 16S phylogeny but no match in MALDI databases were used to enrich the MALDI databases of marine bacteria <https://doi.org/10.12770/261d7864-a44c-43ab-b0c6-57fdaf7360ac> (accessed on 14 October 2022).

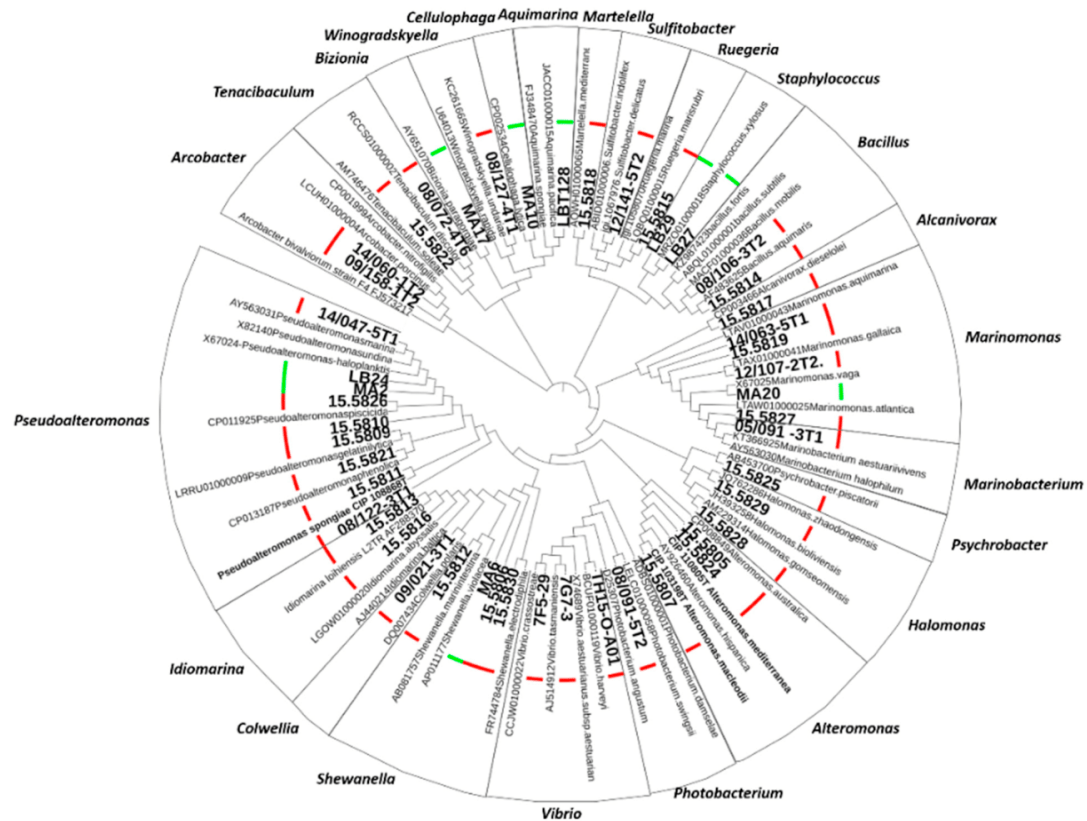

Figure 2. Constitution of a collection of oyster microbiota culturable bacteria. Phylogeny of strains isolated from the *C. gigas* oyster microbiota based on the V3–V4 loop alignment of bacterial 16S rDNA by a Maximum Likelihood method with the Kimura 2-parameter model in MEGA X (295-bp sequences, 105 sequences). Oyster isolates are indicated in boldface. The different genera are indicated. The pathological context at the time of isolation is indicated by a thick bar (red: diseased and green: healthy oysters).

2.3. Gene Cloning and Chemical Synthesis of *Cg-BigDef1* and *Cg-BigDef5*

To explore the impact of *Cg-BigDefs* sequence diversification on the control of oyster microbiota, we focused on *Cg-BigDef1* and *Cg-BigDef5*, which belong to two phylogenetically distinct groups within this peptide family, as shown previously in [24].

We first cloned the gene encoding *Cg-BigDef5* (*Cg-bigdef5* gene; GenBank: OP191676). Two distinct exons were found to encode the two putative domains of the molecule (Figure 3A), as previously found in *Cg-bigdef1* [27]. The first exon of *Cg-bigdef5* encodes the predicted signal peptide (or prodomain, 23 residues), the prodomain (13 residues), and the N-terminal domain of the mature *Cg-BigDef5* (42 residues). The second exon encodes a short linker (3 residues) and the C-terminal β -defensin-like domain (42 residues), with the canonical spacing of cysteines for big defensins [Cys-Xaa_(4–14)-Cys-Xaa₍₃₎-Cys-Xaa_(13–14)-Cys-Xaa_(4–7)-Cys-Cys] [27] (Figure 3B). After posttranslational modifications (which include removal of the prodomain, oxidation of the three disulfide bridges, glutamine to pyroglutamic acid conversion, and C-terminal amidation by removal of a glycine residue), the calculated molecular weight (MW) of *Cg-BigDef1* was 10,692 Da (93 amino acids). The calculated MW for *Cg-BigDef5* was 9977 Da (86 amino acids) after the removal of the prodomain, disulfide bridge oxidation, and C-terminal amidation by removal of a glycine residue (Figure 3C). Overall the two mature peptides show 62.8% identity (54/86 identical

residues) with a calculated positive net charge of + 6 and + 7 at pH = 7.4 for Cg-BigDef1 and Cg-BigDef5, respectively.

The N-terminal domain of both peptides is hydrophobic and positively charged in the region preceding the linker due to repeats of basic residues such as arginine in Cg-BigDef1 and lysine in Cg-BigDef5. One remarkable difference between the two big defensins is the length of the linker that connects the two domains, with 10 amino acid residues in Cg-BigDef1 and only three amino acid residues in Cg-BigDef5.

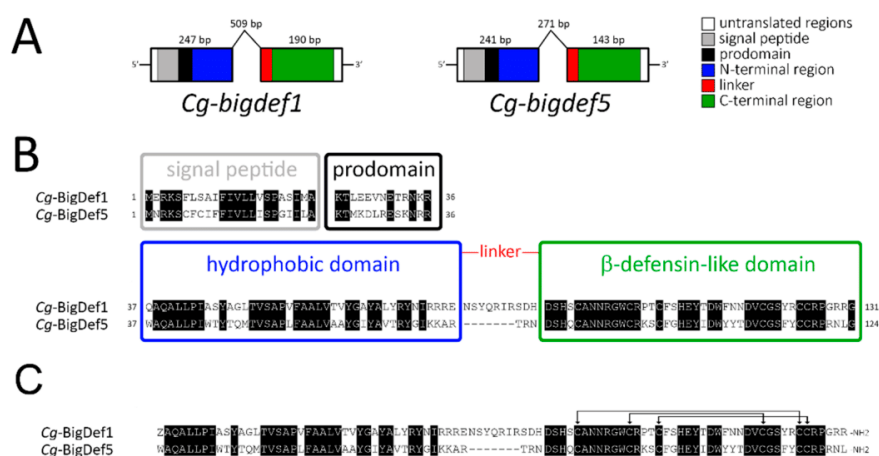

Figure 3. Gene structure and primary sequence of Cg-BigDef1 and Cg-BigDef5. (A): Schematic representation of Cg-BigDef1 (GenBank: JN251125) and Cg-BigDef5 (GenBank: OP191676) genes. Exons are represented by boxes; introns are represented by lines. The length of each exon/intron is displayed. Grey and black boxes represent nucleotide sequences encoding the signal peptides and prodomains, respectively, while white boxes represent untranslated regions. Blue, red and green boxes represent nucleotide sequences encoding the N-terminal hydrophobic domain, the linker region and the C-terminal β-defensin-like domain of the mature big defensins, respectively. (B): Prepropeptides. Alignment of Cg-BigDef1 (131 amino acid residues) and Cg-BigDef5 (124 amino acid residues) precursor sequences. The signal peptides, prodomains, the hydrophobic (N-terminal) and the β-defensin-like (C-terminal) domains are in boxes. Conserved amino acids are highlighted in black. The linker region is shown in red. (C): Putative mature peptides. Alignment of Cg-BigDef1 (93 amino acid residues) and Cg-BigDef5 (86 amino acid residues). Cg-BigDef1 starts with a pyrroglutamic acid (Z) and ends with an amidated arginine (R-NH₂). Cg-BigDef5 ends with an amidated leucine (L-NH₂). Both Cg-BigDef1(1–93) and Cg-BigDef5(1–86) are folded by three intramolecular disulfide bridges as shown by arrows.

Cg-BigDef1 and Cg-BigDef5 were synthesized using a combination of solid-phase peptide synthesis, native chemical ligation, and oxidative folding as previously described for Cg-BigDef1 [26,27] (see Supplementary Figure S6 for HPLC and mass spectrometry characterization). Synthetic Cg-BigDef1 (1–93) corresponds to mature Cg-BigDef1 (Figure 3C) [27]. Synthetic Cg-BigDef5 (1–86) corresponds to mature Cg-BigDef5 (Figure 3C) with a substitution of Met14 by norleucine (Nle) (this study). Detailed optimization of Cg-BigDef5 (1–86) synthesis and NMR structure determination will be described elsewhere [34].

2.4. Specificity, Synergy, and Complementary Broad-Spectrum Activity of Cg-BigDef1 and Cg-BigDef5 against Bacteria from the Oyster Microbiota

We used synthetic Cg-BigDef1 and Cg-BigDef5 to study their antibacterial activities against bacteria from the microbiota of *C. gigas*, including strains relevant to oyster infections. All assays were performed under physiological conditions, i.e., at a high salt concentration (400 mM NaCl).

Cg-BigDef1 showed antibacterial activity against 11/26 strains from *C. gigas* microbiota (Table 1). In total, Cg-BigDef1 was bactericidal against six strains. High bactericidal activity was observed against *Bacillus* sp. 15.5814 (MIC = 40 nM, MBC = 310 nM). In addition, bactericidal activity was recorded against *Alcanivorax* sp. 15.5817, *Alteromonas* sp. 15.5805, *Halomonas* sp. 15.5829, *Pseudoalteromonas* sp. 15.5809 and *Winogradskyella* sp. 08.27-4T1 with MICs in the range of 1.25–10 µM and MBCs in the range of 5–10 µM. Up to 10 µM, Cg-BigDef1 was inhibitory but not bactericidal against five additional strains, namely *Aquimarina* sp. LTB 128, *Marinomonas* sp. 15.5827, *Martellela* sp. 15.5818, *Shewanella* sp. 15.5830, and *Tenacibaculum* sp. 08.072-4T6 with MICs ranging from 1.25 to 5 µM (Table 1). All strains except *Aquimarina* sp. LTB 128 were isolated from diseased oysters.

Cg-BigDef5 tended to be less active than Cg-BigDef1. Still, it showed antibacterial activity against 9/26 tested strains from the *C. gigas* oyster microbiota (Table 1). The highest activity was recorded against *Marinomonas* sp. 14.063 with a MIC of 0.6 µM. Cg-BigDef5 was also active against *Alteromonas* sp. 15.5805, *Aquimarina* sp. LTB 128, *Bacillus* sp. 15.5814, *Marinobacterium* sp. 05.091-3T1, *Martellela* sp. 15.5818, *Ruegeria* sp. 15.5815, *Shewanella* sp. 15.5830, and *Sulfitobacter* sp. 12.141-5T2 with MICs ranging from 1.25 to 10 µM. No bactericidal activity was observed at concentrations ≤10 µM.

Overall, Cg-BigDef1 and Cg-BigDef5 were both active at a salt concentration (400 mM NaCl) pertinent to marine bacteria. They showed strain specificity and complementary activity spectra against the marine strains of the oyster microbiota collection: five strains were susceptible to both peptides, whereas six and four strains were only susceptible to Cg-BigDef1 and Cg-BigDef5, respectively. Only Cg-BigDef1 was active against *Marinomonas* sp. 15.5827, *Pseudoalteromonas* sp. 15.5809, and *Tenacibaculum* sp. 08.072-4T6, *Alcanivorax* sp. 15.5817, *Halomonas* sp. 15.5829, *Winogradskyella* sp. 08.27-4T1. Conversely, only Cg-BigDef5 was active against *Marinobacterium* sp. 05.091-3T1 and *Marinomonas* sp. 14.063, *Ruegeria* sp. 15.5815 and *Sulfitobacter* sp. 12.141-5T2. Both Cg-BigDef1 and Cg-BigDef5 were active against *Alteromonas* sp. 15.5805. These data show that Cg-BigDef sequence diversity extends the activity spectrum at the inter-genera level. The example of *Marinomonas* sp. strains, which are susceptible to different Cg-BigDefs, highlights an undiscovered specificity of Cg-BigDefs and illustrates that their sequence diversity extends their activity spectrum at an intra-genus level as well. It is important to note that all the strains mentioned here have a significant role in oyster health: they have been isolated from OsHV-1-infected oysters <https://doi.org/10.12770/0d529567-92fd-4dcd-9d9c-70e98ab6f772> (accessed on 14 October 2022), and several of them belong to a set of conserved genera that proliferate during OsHV-1-induced dysbiosis [30].

Finally, we tested the synergies of Cg-BigDef1 and Cg-BigDef5, by the checkerboard microtiter assay, against a Gram-positive and a Gram-negative strain displaying the lowest MICs for both peptides. The two big defensins acted synergistically against both strains. Indeed, synergy was recorded against the Gram-negative *Alteromonas* sp. 15.5805, with a fractional inhibitory concentration (FIC) index value of 1 (Table 1). Strong synergy was observed against the Gram-positive *Bacillus* sp. 15.5814 with an FIC value of 0.35 (Table 1).

Table 1. Activity Spectrum and Synergy of Cg-BigDef1 and Cg-BigDef5 against bacteria associated with disease in the oyster.

Strain	Cg-BigDef1 (1–93)		Cg-BigDef5 (1–86)		FIC Index
	MIC (µM)	MBC (µM)	MIC (µM)	MBC (µM)	
<i>Alcanivorax</i> sp. 15.5817	2.50	5	>10	>10	nt
<i>Alteromonas</i> sp. 15.5805	1.25	5	2.50	>10	1
<i>Aquimarina</i> sp. LTB 128	5	>10	2.50	>10	nt
<i>Bacillus</i> sp. 15.5814	0.04	0.31	1.25	>10	0.35
<i>Halomonas</i> sp. 15.5829	2.50	10	>10	>10	nt
<i>Marinobacterium</i> sp. 05.091-3T1	>10	>10	2.50	>10	nt

We are still unable to explain which structural determinants play a role in the specificity of Cg-BigDefs. For instance, we do not know whether residues exposed in the linker (i.e., the most diversified residues) play a role in the interaction with microbes. Another unresolved issue is the salt stability of Cg-BigDef activity at high salt concentrations. Indeed, both Cg-BigDef1 and Cg-BigDef5 were active against a wide range of marine bacteria at 400 mM NaCl, in agreement with previous findings for Cg-BigDef1 [27]. This stability of the antimicrobial activity is unique and essential for the peptides to participate as direct effectors in oyster antimicrobial defense. While many questions are still open on the structure-activity relationships of big-defensins and their domains, the molecular tools are now available to unveil the consequences of sequence variation in the interactions of Cg-BigDefs domains with the bacteria and/or in nanonet assembly. The same applies to bacteria from the oyster microbiota, with a collection of culturable bacteria that will be highly useful for testing functional hypotheses.

Conclusions

We have demonstrated that sequence diversification in Cg-BigDefs has helped to improve oyster defense against pathogens and to control oyster-associated bacterial communities. Indeed, we highlighted an undiscovered specificity and synergy between Cg-BigDefs, which broadened their activity spectrum. These results pave the way for future studies on the mechanism of action of big defensins, which may vary depending on bacterial targets.

4. Materials and Methods

4.1. Chemicals and Reagents

MilliQ water (Merck Millipore, Billerica, MA, USA) was used. LC-MS-grade acetonitrile (ACN) was obtained from Carlo-Erba Reagents (Val de Reuil, France). LC-MS-grade formic acid (FA), trifluoroacetic acid (TFA), and alpha-cyano-4-hydroxycinnamic acid (4-HCCA) were purchased from Sigma-Aldrich (St. Louis, MO, USA).

4.2. Oysters

Oysters with limited genetic diversity were obtained as follows. Genitor oysters were collected in 2015 from the Le Dellec area in Brest bay, which is devoid of shellfish farming. The first generation of full siblings was produced, named F14, as described in [21]. From this family, two oysters were used to generate a second generation of full siblings, referred to as F14V (Decicomp project ANR-19-CE20-004). Offspring were kept at the Ifremer hatchery in Argenton (France) up to day 40. Then, they were grown at the Ifremer station in Bouin (France) until they were 10 months old.

4.3. Bacterial Strains and Culture Conditions

Strains and media are listed in the Ifremer Sextant catalog at <https://doi.org/10.12770/0d529567-92fd-4dcd-9d9c-70e98ab6f772> (accessed on 14 October 2022).

Isolation of bacteria from oyster flesh and antibacterial assays were performed in Zobell medium at 20 °C. Zobell medium is composed of artificial seawater (ASW) [44] supplemented with 0.4% bactopectone and 10% yeast extract, pH 7.8.

Bacteria were isolated from the flesh of live oysters affected by the Pacific Oyster Mortality Syndrome (susceptible families F11, F14, and F15 from the Decipher project ANR-14-CE19-0023) [21]. Additional bacteria isolated from diseased oysters were provided by the French National Reference Laboratory (Ifremer, La Tremblade, France). Finally, bacteria isolated from healthy commercial or wild oysters were included.

<i>Marinomonas</i> sp. 14.063	>10	>10	0.60	>10	<i>nt</i>
<i>Marinomonas</i> sp. 15.5827	2.50	>10	>10	>10	<i>nt</i>
<i>Martellela</i> sp. 15.5818	2.50	>10	1.25	>10	<i>nt</i>
<i>Pseudoalteromonas</i> sp. 15.5809	10	10	>10	>10	<i>nt</i>
<i>Ruegeria</i> sp. 15.5815	>10	>10	10	>10	<i>nt</i>
<i>Shewanella</i> sp. 15.5830	1.25	>10	10	>10	<i>nt</i>
<i>Sulfitobacter</i> sp. 12.141-5T2	>10	>10	2.50	>10	<i>nt</i>
<i>Tenacibaculum</i> sp. 08.072-4T6	1.25	>10	>10	>10	<i>nt</i>
<i>Winogradskyella</i> sp. 08.27-4T1	1.25	5	>10	>10	<i>nt</i>

MIC values reported in micromoles per liter (μM) refer to the minimum concentration required to achieve 100% growth inhibition. MBC values (μM) refer to the minimum concentration required to kill 100% of the bacteria. Activities were measured in Zobell medium at 400 mM NaCl. All bacteria were isolated from *C. gigas* during mortality episodes. Under the test conditions, no activity was recorded against *Amphitrea* sp. 14.114-3T2, *Arcobacter* sp. 08.122-3T1, *Arcobacter* sp. 14.060-1T2, *Collwellia* sp. 09.021-3T1, *Idiomarina* sp. 15.5813, *Photobacterium* sp. 08.091-5T2, *Psychrobacter* sp. 15.5825, *Shewanella* sp. 15.5812, *Vibrio crassostreae* 7F5-29, *Vibrio harveyi* Th15-O-A01, *Vibrio tasmaniensis* 7G7-3. The synergies of Cg-BigDef1 and Cg-BigDef5 were measured as described previously [35]. Results are expressed as FIC index values according to the following formula: $\text{FIC} = [\text{Cg-BigDef1}]/\text{MIC}_{\text{Cg-BigDef1}} + [\text{Cg-BigDef5}]/\text{MIC}_{\text{Cg-BigDef5}}$, where $\text{MIC}_{\text{Cg-BigDef1}}$ and $\text{MIC}_{\text{Cg-BigDef5}}$ are the MICs of the Cg-BigDef1 and Cg-BigDef5 tested alone and $[\text{Cg-BigDef1}]$ and $[\text{Cg-BigDef5}]$ are the MICs of the two peptides tested in combination. FIC index values are interpreted as follows: <0.5, strong synergy; 0.5 to 1, synergy; 1 to 2: additive effect; 2, no effect; >2, antagonism. *nt* stands for not tested. Boldface is used for active concentrations (MIC, MBC) and synergistic combinations of Cg-BigDefs (FIC).

To summarize, Cg-BigDef1 and Cg-BigDef5 exhibit a broad activity spectrum. They show strain specificity, as well as complementary activities. Together they inhibit the growth of 15/26 strains tested. Finally, they act synergistically against both Gram-positive and Gram-negative bacteria. Altogether, these data show that sequence diversification of Cg-BigDefs has generated antimicrobial specificity and extended the activity spectrum of the peptide family against marine bacteria from the oyster microbiota, including strains associated with oyster pathologies.

3. Discussion

We found that oyster big defensins (Cg-BigDefs), a family of AMPs that have widely diversified in mollusks, can alter oyster microbiota composition *in vivo* as a result of direct antimicrobial activity against members of the oyster microbiota. Remarkably, we observed that sequence diversification had generated antimicrobial specificity as well as synergy between Cg-BigDef1 and Cg-BigDef5, thereby extending the activity spectrum of the peptide family and increasing its potency.

Until now, it was largely unknown whether AMPs could shape the microbiota of mollusks, while this had been demonstrated in other animal phyla, particularly mammals [4], cnidarians [14], and insects [6]. Furthermore, when available, antimicrobial data have been largely acquired on microorganisms unrelated to molluscan health [27,36,37]. The lack of knowledge on immune/microbiota interactions in mollusks is due to several methodological obstacles and knowledge gaps. Among them, it is worth mentioning (i) the only recent description of molluscan microbiomes, accelerated by facilitated access to next-generation sequencing (for oysters, see [18,19,31]); (ii) the lack of well-characterized culturable microbiota; and (iii) difficulties in producing a sufficient amount of high-quality AMPs and in developing efficient and reliable tools for gene knock-in, knock-out, and knock-down in several molluscan species. These difficulties were circumvented in this work by the chemical synthesis of pure big defensins from *C. gigas* according to our previously described procedure [26] and the construction of a collection of culturable bacteria isolated from oysters with known health status (identification by 16S phylogeny and MALDI Biotyping). With such tools, we showed that Cg-BigDefs have broad-spectrum activities against bacterial strains from the oyster microbiota, including strains associated

with major infectious diseases in oysters. In line with these observations, *in vivo*, Cg-BigDef1 induced significant changes in oyster microbiota β -diversity. This is consistent with *in vivo* results recently obtained by Schmitt and collaborators in the scallop *Argopecten purpuratus* [22]. The authors showed that the big defensin ApBD1 and the bactericidal/permeability-increasing protein ApLBP/BPI1 have the potential to shape the hemolymph microbiota of the scallop, particularly by regulating the proliferation of γ -proteobacteria. Our present work shows that changes in microbiota composition observed *in vivo* are linked to direct antimicrobial activities of Cg-BigDefs against bacteria belonging to the microbiota. Similar to human α -defensin HD-5 in the mice gut [38], Cg-BigDef1 did not alter the overall bacterial load in oysters. Moreover, Cg-BigDef1 had no negative effects on oyster microbiota diversity, probably due to the specificity of the peptides, which as host-defense effectors, have evolved to acquire antimicrobial activity against given bacterial strains without disrupting the entire oyster microbiota. Supporting this hypothesis, microbiota alterations were mainly visible at the ASV taxonomic level, indicating high specificity. For instance, upon treatment with Cg-BigDef1, we observed a reduced amount of *Vibrio* (γ -proteobacteria), which was in agreement with the *in vitro* activity of ApBD1 in the scallop [22]. Changes were visible in whole-tissue microbiota. However, microbiota composition was shown to vary significantly between oyster tissues (hemolymph, gut, gills, mantle) [28]. Therefore, it is likely that more contrasting effects of Cg-BigDefs occur on specific tissue microbiota, particularly in the hemolymph, which carries the Cg-BigDef-producing cells, the hemocytes [23]. With mounting evidence on the regulatory role of AMPs on host-microbiota across animal phyla, including mollusks ([22], this study), one key question to be addressed in the future is how this affects the functions the microbiota serve in their host tissues.

A striking feature of the evolutionary history of big defensins is their extensive diversification in some molluscan species, particularly the oyster *C. gigas* and the mussels *Mytilus galloprovincialis* and *Dreissena rostriformis*, while they did not diversify in other species (e.g., the scallop *A. purpuratus*) [24]. The functional consequences of this diversification have remained unexplored. Our present results demonstrate that sequence diversification has generated specificity and synergy among Cg-BigDefs, as evidenced by two members of the Cg-BigDef family, Cg-BigDef1 and Cg-BigDef5. Antibacterial specificity was observed from the bacterial genus down to the strain level within a given genus. Depending on bacterial strains, Cg-BigDefs were bactericidal or simply inhibitory, with contrasting MICs, from 40 nM to 10 μ M. This suggests that distinct mechanisms of action can underpin Cg-BigDefs activities against the diversity of bacteria encountered in the oyster microbiota. Activities in the nanomolar range are consistent with receptor-mediator activities [36,39], while activities in the micromolar range are typically reported for membrane-active AMPs [40]. In oyster defensins (Cg-Defs), which have also diversified in oysters, we previously observed that sequence variation altered the activity of the peptide (more or less potent) without affecting the peptide range of activity [35]. Here, we also showed that sequence diversification was key to generating antimicrobial synergy between two members of the Cg-BigDef family. Similarly, sequence diversification generated synergy in two other families of oyster AMPs, the defensins Cg-Defs and the proline-rich peptides Cg-Prps [35]. Although not studied in the present article, synergy also occurred between AMP families, as observed between the bactericidal permeability-increasing protein Cg-BPI, Cg-Prps, and Cg-Defs in the oyster *C. gigas* and between Attacins and Dipterocins in the insect *D. melanogaster* [41]. Thus, the *in vivo* effects of Cg-BigDefs on the shaping of oyster microbiota are likely to extend well beyond the observations in this paper, where we tested the effects of only one member of the Cg-BigDef family. This was also the case in the *A. purpuratus* scallop study. However, in scallops, unlike other molluscan species (oysters and mussels) big defensins have not diversified and the activity of ApBD1 recapitulates that of the entire AMP family. Overall, we have highlighted an important role for sequence diversification in increasing the antimicrobial potential of oyster Cg-BigDefs, by generating both antimicrobial specificity and synergy, an observation that extends at least to two

additional peptide families, Cg-Defts and Cg-Prps. We can hypothesize that some species of bivalve mollusks, such as oysters, have diversified their repertoire of AMPs to increase their adaptive potential while constantly exposed to diversified microbial communities.

While sequence diversification was shown to be a major asset in terms of antimicrobial defenses, we still do not know how antimicrobial specificity is generated. We have shown that changes in primary structure between Cg-BigDef1 and Cg-BigDef5 (62.8% sequence identity) produced antibacterial specificity. Cg-BigDef1 and Cg-BigDef5 have similar biophysical parameters in terms of size (86–93 amino acids) and positive net charge at neutral pH (+6 to +7 at pH = 7.4, i.e., oyster physiological pH), with conserved domains, as recently determined by NMR ([34]; Figure 4 top panel). The position and pairing of cysteines are also similar. A major difference observed between Cg-BigDef1 and Cg-BigDef5 was the length and primary sequence of the linker region connecting the N-terminal hydrophobic domain and the C-terminal β -defensin-like domain, whereas the five residues linker of Cg-BigDef5 is exposed to the solvent, the ten residues linker of Cg-BigDef1 plays a key role in the 3D compaction of the protein by being buried at the interface of the two domains and locking their relative orientation [27]. In Cg-BigDef1 and Cg-BigDef5, the orientation of the N- and C-terminal domains differs by around 100° (dihedral angle value between the β -sheet of the N-term domain and the last strand of the β -sheet of the C-term domain (Figure 4 top panel), leading the α -helix of the C-term domain not involved in the interaction interface between the two domains. We also looked at surface properties, as the surface charge is considered critical for the interactions of AMPs with bacteria [42]. However, no real quantitative difference can be observed between Cg-BigDef1 and Cg-BigDef5. Both are highly cationic, and positive charge repartition is shared by the N-terminal and C-terminal domains, yet the positive surface of each molecule is on opposite sides (Figure 4 middle panel). Since the salt concentration in the oyster is very high (similar to seawater), charges may be shielded and might not be the primary type of interaction that is important for bacterial interaction. Instead, the hydrophobicity of the big defensin surface could play a major role in how the molecules approach their target. As seen in Figure 4 (bottom), Cg-BigDef1 displays a more hydrophobic C-terminal domain than Cg-BigDef5, whereas Cg-BigDef5 displays a more hydrophobic N-terminal domain than Cg-BigDef1.

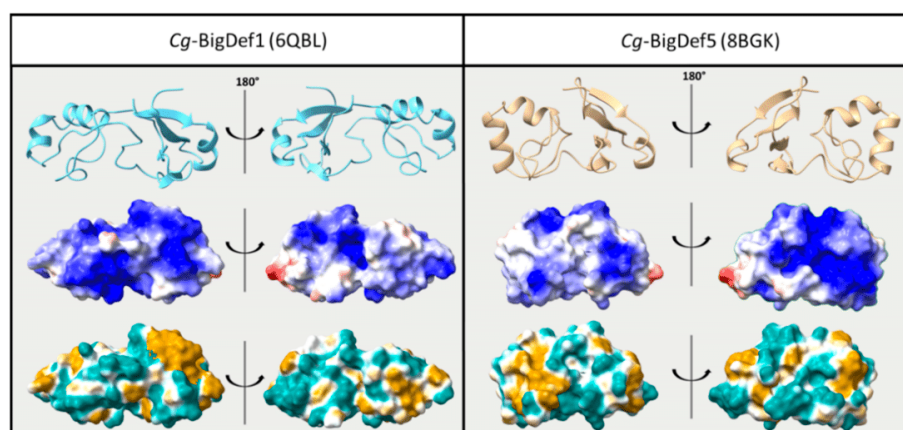

Figure 4. Structure comparison of Cg-BigDef1 and Cg-BigDef5. Top—Cartoon representation. Middle—Electrostatic potential on the accessible surface of the proteins with red representing negative charges and blue representing positive charges. Bottom—Hydrophobicity potential on the accessible surface of proteins with light blue representing hydrophilic properties and brown representing hydrophobic properties. Both electrostatic and hydrophobic potential were determined using ChimeraX software [42,43].

4.4. Molecular Phylogeny Based on 16S RNA

Taxonomic assignment down to the genus was performed for each strain by molecular phylogeny based on the sequence of the V3-V4 region of 16S rRNA obtained by Sanger sequencing. In order to consolidate the phylogenetic tree, at least one Genbank reference sequence corresponding to a Type (T) strain per genus of interest was added from the NCBI database (Table S4). The 95 sequences were trimmed at 405 bp (V3-V4 loop) using BioEdit and aligned using ClustalW. The phylogenetic tree was constructed by the Maximum Likelihood method with the Kimura 2-parameter model [45] using MEGA X software [46] and annotated using ITOL software [47]. The branches are supported by the bootstrap method with 500 iterations.

4.5. Identification of Bacterial Isolates by Matrix-Assisted Laser Desorption Ionization Mass Spectrometry (MALDI Biotyping)

MALDI Biotyping was used to confirm 16S taxonomic assignments or, when the libraries required it, to enrich them with new bacteria absent from MALDI libraries (common for marine strains). For these purposes, a protocol coupling inactivation with 75% ethanol and extraction with 70% formic acid was performed based on the MALDI Biotyper[®] protocol (Bruker Daltonics, Bremen, Germany). Briefly, from each plate, one isolated colony was suspended in MilliQ water in 1.5 mL Eppendorf tubes. Ethanol (100%) was added to the suspension, and the tubes were centrifuged twice (13,000 rpm, 2 min). Subsequently, 10 µL of a 70% formic acid solution was added to the pellet. In order to complete the extraction, 10 µL of pure acetonitrile was added. One microlitre of each extract was deposited three times (technical replicates) on a MALDI target (Bruker Daltonics, Bremen, Germany), air-dried, and coated with 1 µL of fresh alpha-cyano-4-hydroxycinnamic acid matrix in a saturating amount in a solution of 50% ACN and 2.5% TFA (Bruker Daltonics, Bremen, Germany). The MALDI MS spectra of these spots were acquired with an Autoflex III Smartbeam MALDI-TOF MS, recording masses ranging from 2,000 to 20,000 Da using standard parameters (flexControl 3.4, Bruker Daltonics, Bremen, Germany), and interrogated against the existing databases. For bacteria species not present in the existing MALDI Biotyper[®] reference mass spectra libraries, a reference spectrum was created and entered in our local database, as follows: the bacterial extract was spotted 8 times, each spot analyzed three times, for a total of twenty-four recorded spectra per bacterial strain. After manual checking, the twenty better spectra were transformed into an average spectrum by the MBT Compass Explorer software. The BTS (bacterial test standard) serves as a calibrator and contains *Escherichia coli* extract. The reference libraries used for the analysis are the official Bruker MALDI Biotyper[®] spectral library (MBT reference library <https://www.bruker.com/en/products-and-solutions/microbiology-and-diagnostics/microbial-identification/maldi-biotyper-library-ruo.html>; accessed on 10 October 2022) and the freely available EnviBase exclusively dedicated to the identification of potentially pathogenic *Vibrio* in marine mollusks (seanoe.org) [48].

4.6. Molecular Cloning and Sequence Data Analysis

The Cg-BigDef5 gene was PCR-amplified using specific primers (Fw: 5'-AATCAAGTCAACATGAACAG-3'; Rv: 5'-TTATCCTAGATTTCTAGGTC-3') based on a transcript sequence previously found in publicly available databases [24], cloned into a pGEM-T Easy vector (Promega) and then sequenced using the Sanger dideoxy methodology (Applied Biosystems 3500 Series Genetic Analyzer). Exon–intron boundaries were defined by the alignment of cDNA and genomic sequences. Nucleotide sequences were manually inspected and translated using the ExPASy Translate Tool <http://web.expasy.org/translate/> (accessed on 1 September 2022). Prediction of signal peptides and other posttranslational processing was carried out using the ProP 1.0 server <https://services.healthtech.dtu.dk/service.php?ProP-1.0> (accessed on 1 September 2022),

while the theoretical isoelectric point (pI) and molecular weight (MW) of the mature peptides were calculated using the ExPasy ProtParam Tool <http://web.expasy.org/protparam/> (accessed on 1 September 2022). Multiple alignments of amino acid sequences were generated using MUSCLE with default parameters <https://www.ebi.ac.uk/Tools/msa/muscle/> (accessed on 1 September 2022).

4.7. Peptide Synthesis and Net Charge Calculation

Cg-BigDef1 was synthesized as already described, using a combination of solid-phase chemical synthesis and native chemical ligation (NCL) followed by a thermodynamically controlled oxidative folding step [26,27,49]. Cg-BigDef5 was obtained following a similar synthetic scheme (see Supplemental Figure S5 and [34] for optimization and details, as well as for 3D structure determination by NMR).

Peptide net charges at pH = 7.4 (oyster physiological pH) were predicted using the IPCprotein pKa dataset [50]. Cg-BigDef1 net charge = +6.05 (6.00 negative charges and 12.05 positive charges, calculated taking into account 12 Arg, 4 Asp, 2 Glu, 3 His, and 8 Tyr). Cg-BigDef5 net charge = +6.95 (4.00 negative charges and 10.95 positive charges, calculated taking into account 7 Arg, 3 Asp, 1 Glu, 2 His, 3 Lys, 8 Tyr, and the N-terminal amine group).

4.8. Determination of the Minimum Inhibitory Concentrations (MIC), Minimum Bactericidal Concentrations (MBC), and Synergy.

Cg-BigDef1(1-93) and Cg-BigDef5(1-86) were dissolved in MilliQ water at a concentration of 200 μM . Peptide concentration control was performed with a NanoDrop One spectrometer (Thermo Fisher Scientific, Waltham, MA, USA) using a molar epsilon at 280 nm of 23,295 $\text{M}^{-1}\cdot\text{cm}^{-1}$ for Cg-BigDef1 (peptide batch ARO-I-78) and of 34,295 $\text{M}^{-1}\cdot\text{cm}^{-1}$ Cg-BigDef5 (peptide batch ARO-I-113).

MIC and MBC values were determined as previously described [35]. Briefly, big defensins stock solutions were serially diluted in sterile MilliQ water. A total of 10 μL of peptides were incubated with 90 μL of bacterial suspension, brought to the exponential growth phase, and adjusted to $A_{600} = 0.001$ in Zobell medium at 20 $^{\circ}\text{C}$. Bacteria were grown under shaking in a sterile, non-pyrogenic polystyrene 96-well plate (Falcon). Growth was monitored at 600 nm on a TECAN spectrophotometer with one measurement/h over 24 h. MIC values are expressed as the lowest concentration tested (μM) that results in 100% growth inhibition. For the determination of MBCs, after a 24 h incubation, 100 μL of each well were plated on Zobell agar medium at 20 $^{\circ}\text{C}$. MBC values are expressed as the lowest concentration tested (μM) for which no colonies could be counted on a Petri dish.

Synergies between Cg-BigDef1 and Cg-BigDef5 were measured as previously described using the checkerboard microtiter assay, which enables highlighting a potential reduction of the MIC values of each peptide when used in combination. In this assay, 2-fold serial dilutions of one peptide are tested against 2-fold serial dilutions of the other peptide. Results are expressed by calculating fractional inhibitory concentration (FIC) index values [35].

4.9. Microbiota Modifications Induced by Cg-BigDef1 In Vivo

A biparental family of juvenile *C. gigas* oysters (family F14-V, 10 months old, average wet weight of flesh 200+/-27 mg) was used in in vivo assays. All oysters were maintained under controlled biosecurity conditions to ensure their specific pathogen-free status. For anesthesia, oysters were kept for 12 h outside seawater tanks and anesthetized two hours before the experiment in seawater containing 50 g/L MgCl_2 [51]. Control animals ($n = 8$) were collected before (NTC, non-treated controls) and after the entire anesthesia procedure (AC, anesthesia controls). Before injection into oysters, Cg-BigDef1 was dissolved in sterile ASW at a concentration of 20 μM . Concentration was verified as described above for MIC and MBC determination. Injection of Cg-BigDef1 (50 μL) was performed right

after anesthesia by injection into the oyster adductor muscle to reach a final concentration of 5 μM of Cg-BigDef1 in oyster flesh. An injection of 50 μL sterile ASW was used as a control treatment. Oysters ($n = 8$ per condition) were sampled 10 min (T0), 6 h (T6), and 24 h (T24) after injection. For oyster sampling, shells were removed, and flesh was recovered and snap-frozen in liquid nitrogen. Individual oysters were ground in liquid nitrogen in 50 mL stainless steel bowls with 20-mm-diameter grinding balls (Retsch MM400 mill) and stored at $-80\text{ }^{\circ}\text{C}$ until DNA extraction. DNA extraction was performed as described in [21] using the Nucleospin tissue kit (Macherey-Nagel). DNA concentration and purity were checked with a NanoDrop One (Thermo Fisher Scientific).

4.10. 16S rRNA Metabarcoding

Bacterial metabarcoding was performed using 16S rRNA gene amplicon sequencing. Libraries were generated using the Illumina two-step PCR protocol targeting the V3-V4 region (341F: 5'-CCTACGGGNGGCWGCAG-3'; 805R: 5'-GACTACHVGGG-TATCTAATCC-3') [52]. Sequencing was performed at the Bioenvironment Platform (University of Perpignan). A total of 64 libraries were paired-end sequenced with a 2×250 bp read length on a MiSeq system (Illumina) according to the manufacturer's protocol. Raw sequence data are available in the SRA database BioProject ID <https://doi.org/10.12770/c960676e-2515-46f0-a313-4a91ac91908a> (accessed on 17 October 2022).

Sequencing data were processed using the SAMBA pipeline v3.0.1. The SAMBA workflow, developed by the SeBiMER (Ifremer's Bioinformatics Core Facility), is an open-source modular workflow to process eDNA metabarcoding data. SAMBA is developed using the NextFlow workflow manager [53]. All bioinformatics processes are mainly based on the use of the next-generation microbiome bioinformatics platform QIIME 2 [54] (version 2020.2) and the approach of grouping sequences in ASV (Amplicon Sequence Variants) using DADA2 v1.14, [55]). Taxonomic assignment of ASVs was performed using a Bayesian classifier trained with the Silva database v.138 using the QIIME feature classifier [56]. Statistical analyses were also performed with R (R Core Team, 2020) using the R packages Phyloseq v1.38.0 [57] and Vegan v2.6-2 [53].

For α -diversity, we used the full data set to analyze differences in regularity (calculated as $H/\ln(S)$, where H is the Shannon–Wiener index, and S is species richness) and species richness (total number of species) using SAMBA pipeline and ANOVA.

For β -diversity, the ASV matrix of all 64 libraries was preliminarily normalized. Briefly, after verification of the rarefaction curves produced with the `ggrare` function [57]), libraries were sub-sampled to 45,361 reads using the `rarefy_even_depth` function. The normalized ASV matrix was then filtered for low-abundance ASVs to limit the prevalence of putative artifacts due to sequencing errors. For this purpose, only ASVs with at least four reads in at least four samples were retained. We then retained samples associated with ASW and Cg-BigDef1 experimental conditions at T0, T6, and T24. The variation in microbiota composition was then investigated using principal coordinate analyses (PCoA) based on Bray–Curtis distances at each kinetic point. Putative differences between groups were assessed by statistical analyses (Permutational Multivariate Analysis of Variance-PERMANOVA) using the `adonis2` function implemented in `vegan` [58].

The mean relative abundance of the 10 most abundant bacterial genera in the oyster microbiota was also estimated. Results were graphically represented by a heatmap. We used the STAMPS software [59] to represent an extended error bar. Statistical differences were assessed by Welch's t -test with the Benjamini–Hochberg procedure, which controls the false discovery rate (FDR).

Finally, we used DESeq2 v1.36.0 [60] to identify ASVs whose abundance significantly varies in oysters injected with Cg-BigDef1 or ASW (control) for the last kinetic point (i.e., T24). Differential abundance was analyzed using a negative binomial method implemented in the DESeq2 package as recommended by [57]. For this latter analysis, we only

considered ASVs with an adjusted p value < 0.01 . Note that ASVs lacking genera annotation and qualified as “unknown” were not considered for result interpretation.

4.11. Quantification of Total 16S Bacterial DNA

Total of 16S bacterial DNA was quantified by quantitative PCR (qPCR). All amplification reactions were analyzed using a Roche LightCycler 480 Real-Time thermocycler (qPHD-Montpellier GenomiX platform, Montpellier University, Montpellier, France). The total qPCR reaction volume was 1.5 μL and consisted of 0.5 μL DNA (30 $\text{ng}\cdot\mu\text{L}^{-1}$) and 0.75 μL LightCycler 480 SYBR Green I Master mix (Roche) containing 0.5 μM PCR primer (Eurogentec SA). Primers used for total bacteria were 341F 5'-CCTACGGGNGGCWGCAG-3' and 805R 5'-GACTACHV GGGTATCTAATCC-3', which target the 16S variable V3V4 loops [52]. A Labcyte Acoustic Automated Liquid Handling Platform (ECHO) was used for pipetting into the 384-well plate (Roche). A LightCycler[®] 480 Instrument (Roche) was used for qPCR with the following program: enzyme activation at 95 °C for 10 min, followed by 40 cycles of denaturation (95 °C, 10 s), hybridization (60 °C, 20 s) and elongation (72 °C, 25 s). A melting temperature curve of the amplicon was then performed to verify the specificity of the amplification. Relative quantification of 16S bacterial DNA copies was calculated by the $2^{-\Delta\Delta C_q}$ method [61] using the mean of the measured cycle threshold values of a reference gene (*Cg-EF1 α* (elongation factor 1 α), GenBank: AB122066), as a calibrator.

Supplementary Materials: The following supporting information can be downloaded at: <https://www.mdpi.com/article/10.3390/md20120745/s1>, Table S1: Permutational multivariate analysis of variance (PERMANOVA) table of oyster microbiota at ASV level for experimental anesthesia; Table S2: Permutational multivariate analysis of variance (PERMANOVA) table of oyster microbiota at ASV level comparing experimental injections (i.e. oysters injected with ASW/ with *Cg-BigDef1*); Table S3: Results of ad hoc pairwise PERMANOVA testing for differences in oyster microbiota at ASV level between experimental conditions (i.e. injected with ASW/ injected with *Cg-BigDef1*); Table S4: List of standard strains used as reference sequences in the 16S phylogenetic analysis; Figure S1: Species richness rarefaction curves; Figure S2: Lack of effect of anesthesia on the oyster microbiome ; Figure S3: No changes in oyster microbiota α -diversity after injection of *Cg-BigDef1*; Figure S4: Differences in oyster microbiota between ASW and *Cg-BigDef1* conditions for the top10 genera; Figure S5: ASVs differentially represented at T24 in oyster injected with *CgBigDef1* or ASW; Figure S6: No changes in total bacterial load in oysters injected with *Cg-BigDef1*; Figure S7: Chemical synthesis of *Cg-BigDef5* used in this study.

Author Contributions: Conceptualization, D.D.-G. and C.M.; methodology, N.D.S.N., V.A., R.D.R., G.R., M.-A.T., J.P., K.L.; formal analysis, N.D.S.N., D.D.-G., C.M. M.-A.T., J.-M.E. R.D.R., G.M.C., Y.D., K.L.; investigation, N.D.S.N., A.A., R.D.R., S.N.V., L.D., J.-M.E., V.B.; resources, V.A., A.F.D., B.P., H.M.; data curation, M.-A.T.; writing—original draft preparation, N.D.S.N., D.D.-G., R.D.R., C.M.; writing—review and editing, J.-M.E., P.B., S.N.V., M.-A.T., G.M.C., V.B., K.L., A.F.D.; supervision, D.D.-G., C.M., P.B., R.D.R.; project administration, A.F.D., D.D.-G.; funding acquisition, A.F.D., D.D.-G., P.B., G.M. All authors have read and agreed to the published version of the manuscript.

Funding: This work was funded by the Agence Nationale de la Recherche (MOSAR-DEF, ANR-19-CE18-0025; DECICOMP, ANR-19-CE20-0004), the University of Montpellier, iSite MUSE, Kim Sea and Coast (DEPTH, KIM18SEA-FRV10-DESTOURN). This study falls within the framework of the “Laboratoires d’Excellence (LABEX)” Tulip (ANR-10-LABX-41). NDSN was the recipient of a PhD grant from Ifremer. G.R. and R.D.R. benefited from scholarships from the Brazilian funding agencies CAPES and CNPq (312047/2021-5), respectively. Luc Dantan was awarded a PhD grant from the Region Occitanie (Probiomic project) and the University of Perpignan Via Domitia graduate school ED305.

Institutional Review Board Statement: Not applicable.

Informed Consent Statement: Not applicable.

Data Availability Statement: MALDI spectra, 16S sequences and amplicon sequences for microbiota analysis have been made available on the Ifremer Sextant catalog <https://doi.org/10.12770/261d7864-a44c-43ab-b0c6-57fdaf7360ac> (accessed on 14 October 2022) ; <https://doi.org/10.12770/0d529567-92fd-4dcd-9d9c-70e98ab6f772> (accessed on 14 October 2022). Raw sequence data of 16S sequencing for Metabarcoding analysis are available on the Ifremer Sextant catalog <https://doi.org/10.12770/c960676e-2515-46f0-a313-4a91ac91908a> (accessed on 17 October 2022).

Acknowledgments: We thank Céline Garcia from Ifremer, EU Reference Laboratory for mollusk diseases (La Tremblade, France), Céline Cosseau (IHPE) as well as Yannick Gueguen (MARBEC, Sète) and Julien de Lorgeril (Ifremer, LEAD and ENTROPIE, New Caledonia) for providing oyster bacterial isolates. We thank Jean-François Allienne (plateforme Bioenvironnement, University of Perpignan Via Domitia) for his help in building the 16S metabarcoding library and next-generation sequencing. We also warmly thank Cyril Noël from the SEBIMER bioinformatics platform (Ifremer) for his precious help in processing and analyzing metabarcoding data. We thank Eve Toulza, Léo Duperret (IHPE) and Carolane Giraud (IHPE, LEAD-ENTROPIE) for the fruitful discussions throughout this project, as well as Jamal Saad (IHPE) for critical reading of the manuscript. We thank Marc Leroy (IHPE) and Beatriz Garcia-Teodoro (LIAA) for their technical assistance. The authors thank the NMR sub-platform of the MO2VING facility (CBM, Orléans, France) as well as the qPHD platform from Montpellier GenomiX (University of Montpellier, France). We warmly thank the staff of the Ifremer stations of Argenton (PFOM, Brittany, France) and Bouin (EMMA, Vendée, France) for their technical support in the production of the two generations of oysters.

Conflicts of Interest: The authors declare no conflict of interest.

References

- Buchon, N.; Broderick, N.A.; Lemaitre, B. Gut Homeostasis in a Microbial World: Insights from *Drosophila Melanogaster*. *Nat. Rev. Microbiol.* **2013**, *11*, 615–626. <https://doi.org/10.1038/nrmicro3074>.
- Hooper, L.V.; Littman, D.R.; Macpherson, A.J. Interactions between the Microbiota and the Immune System. *Science* **2012**, *336*, 1268–1273. <https://doi.org/10.1126/science.1223490>.
- Ostaff, M.J.; Stange, E.F.; Wehkamp, J. Antimicrobial Peptides and Gut Microbiota in Homeostasis and Pathology. *EMBO Mol. Med.* **2013**, *5*, 1465–1483. <https://doi.org/10.1002/emmm.201201773>.
- Bevins, C.L.; Salzman, N.H. Paneth Cells, Antimicrobial Peptides and Maintenance of Intestinal Homeostasis. *Nat. Rev. Microbiol.* **2011**, *9*, 356–368. <https://doi.org/10.1038/nrmicro2546>.
- Bosch, T.C.G.; Zasloff, M. Antimicrobial Peptides—Or How Our Ancestors Learned to Control the Microbiome. *MBio* **2021**, *12*, 1–4. <https://doi.org/10.1128/mBio.01847-21>.
- Marra, A.; Hanson, M.A.; Kondo, S.; Erkosar, B.; Lemaitre, B. *Drosophila* Antimicrobial Peptides and Lysozymes Regulate Gut Microbiota Composition and Abundance. *MBio* **2021**, *12*, e00824-21. <https://doi.org/10.1128/mBio.00824-21>.
- Ganz, T. Defensins: Antimicrobial Peptides of Innate Immunity. *Nat. Rev. Immunol.* **2003**, *3*, 710–720. <https://doi.org/10.1038/nri1180>.
- Bulet, P.; Stöcklin, R.; Menin, L. Anti-Microbial Peptides: From Invertebrates to Vertebrates. *Immunol. Rev.* **2004**, *198*, 169–184. <https://doi.org/10.1111/j.0105-2896.2004.0124.x>.
- Hancock, R.E.W.; Haney, E.F.; Gill, E.E. The Immunology of Host Defence Peptides: Beyond Antimicrobial Activity. *Nat. Rev. Immunol.* **2016**, *16*, 321–334. <https://doi.org/10.1038/nri.2016.29>.
- Haney, E.F.; Straus, S.K.; Hancock, R.E.W. Reassessing the Host Defense Peptide Landscape. *Front. Chem.* **2019**, *7*, 1–22. <https://doi.org/10.3389/fchem.2019.00043>.
- Dierking, K.; Pita, L. Receptors Mediating Host-Microbiota Communication in the Metaorganism: The Invertebrate Perspective. *Front. Immunol.* **2020**, *11*, 1251. <https://doi.org/10.3389/fimmu.2020.01251>.
- Wang, X.-W.; Xu, J.-D.; Zhao, X.-F.; Vasta, G.R.; Wang, J.-X. A Shrimp C-Type Lectin Inhibits Proliferation of the Hemolymph Microbiota by Maintaining the Expression of Antimicrobial Peptides. *J. Biol. Chem.* **2014**, *289*, 11779–11790. <https://doi.org/10.1074/jbc.M114.552307>.
- Login, F.H.; Balmand, S.; Vallier, A.; Vincent-Monegat, C.; Vigneron, A.; Weiss-Gayet, M.; Rochat, D.; Heddi, A. Antimicrobial Peptides Keep Insect Endosymbionts Under Control. *Science* **2011**, *334*, 362–365. <https://doi.org/10.1126/science.1209728>.
- Franzenburg, S.; Walter, J.; Künzel, S.; Wang, J.; Baines, J.F.; Bosch, T.C.G.; Fraune, S. Distinct Antimicrobial Peptide Expression Determines Host Species-Specific Bacterial Associations. *Proc. Natl. Acad. Sci. USA* **2013**, *110*, E3730–E3738. <https://doi.org/10.1073/pnas.1304960110>.
- Schmitt, P.; Rosa, R.D.; Duperthuy, M.; de Lorgeril, J.; Bachère, E.; Destoumieux-Garzón, D. The Antimicrobial Defense of the Pacific Oyster, *Crassostrea gigas*. How Diversity May Compensate for Scarcity in the Regulation of Resident/Pathogenic Microflora. *Front. Microbiol.* **2012**, *3*, 160. <https://doi.org/10.3389/fmicb.2012.00160>.
- Bachère, E.; Rosa, R.D.; Schmitt, P.; Poirier, A.C.; Merou, N.; Charrière, G.M.; Destoumieux-Garzón, D. The New Insights into

- the Oyster Antimicrobial Defense: Cellular, Molecular and Genetic View. *Fish Shellfish Immunol.* **2015**, *46*, 50–64. <https://doi.org/10.1016/j.fsi.2015.02.040>.
17. Destoumieux-Garzón, D.; Rosa, R.D.; Schmitt, P.; Barreto, C.; Vidal-Dupiol, J.; Mitta, G.; Gueguen, Y.; Bachère, E. Antimicrobial Peptides in Marine Invertebrate Health and Disease. *Philos. Trans. R. Soc. B Biol. Sci.* **2016**, *371*, 20150300. <https://doi.org/10.1098/rstb.2015.0300>.
 18. Lokmer, A.; Mathias Wegner, K. Hemolymph Microbiome of Pacific Oysters in Response to Temperature, Temperature Stress and Infection. *ISME J.* **2015**, *9*, 670–682. <https://doi.org/10.1038/ismej.2014.160>.
 19. Dupont, S.; Lokmer, A.; Corre, E.; Auguet, J.-C.; Petton, B.; Toulza, E.; Montagnani, C.; Tanguy, G.; Pecqueur, D.; Salmeron, C.; et al. Oyster Hemolymph Is a Complex and Dynamic Ecosystem Hosting Bacteria, Protists and Viruses. *Anim. Microbiome* **2020**, *2*, 12. <https://doi.org/10.1186/s42523-020-00032-w>.
 20. Petton, B.; Bruto, M.; James, A.; Labreuche, Y.; Alunno-Bruscia, M.; Le Roux, F. *Crassostrea gigas* Mortality in France: The Usual Suspect, a Herpes Virus, May Not Be the Killer in This Polymicrobial Opportunistic Disease. *Front. Microbiol.* **2015**, *6*, 686. <https://doi.org/10.3389/fmicb.2015.00686>.
 21. de Lorgeril, J.; Lucasson, A.; Petton, B.; Toulza, E.; Montagnani, C.; Clerissi, C.; Vidal-Dupiol, J.; Chaparro, C.; Galinier, R.; Escoubas, J.-M.; et al. Immune-Suppression by OsHV-1 Viral Infection Causes Fatal Bacteraemia in Pacific Oysters. *Nat. Commun.* **2018**, *9*, 4215. <https://doi.org/10.1038/s41467-018-06659-3>.
 22. González, R.; Gonçalves, A.T.; Rojas, R.; Brokordt, K.; Rosa, R.D.; Schmitt, P. Host Defense Effectors Expressed by Hemocytes Shape the Bacterial Microbiota From the Scallop Hemolymph. *Front. Immunol.* **2020**, *11*, 599625. <https://doi.org/10.3389/fimmu.2020.599625>.
 23. Rosa, R.D.; Santini, A.; Fievet, J.; Bulet, P.; Destoumieux-Garzón, D.; Bachère, E. Big Defensins, a Diverse Family of Antimicrobial Peptides That Follows Different Patterns of Expression in Hemocytes of the Oyster *Crassostrea gigas*. *PLoS ONE* **2011**, *6*, e25594. <https://doi.org/10.1371/journal.pone.0025594>.
 24. Gerdol, M.; Schmitt, P.; Venier, P.; Rocha, G.; Rosa, R.D.; Destoumieux-Garzón, D. Functional Insights From the Evolutionary Diversification of Big Defensins. *Front. Immunol.* **2020**, *11*, 758. <https://doi.org/10.3389/fimmu.2020.00758>.
 25. Zhu, S.; Gao, B. Evolutionary Origin of Beta-Defensins. *Dev. Comp. Immunol.* **2012**, *39*, 79–84. <https://doi.org/10.1016/j.dci.2012.02.011>.
 26. Terrier, V.P.; Adihou, H.; Arnould, M.; Delmas, A.F.; Aucagne, V. A Straightforward Method for Automated Fmoc-Based Synthesis of Bio-Inspired Peptide Crypto-Thioesters. *Chem. Sci.* **2015**, *7*, 339–345. <https://doi.org/10.1039/C5SC02630J>.
 27. Loth, K.; Vergnes, A.; Barreto, C.; Voisin, S.N.; Meudal, H.; Silva, D.; Bressan, A.; Bulet, P.; Touqui, L.; Delmas, A.F.; et al. The Ancestral N-Terminal Domain of Big Defensins Drives Bacterially Triggered Assembly into Antimicrobial Nanonets Karine. *MBio* **2019**, *10*, e01821-19. <https://doi.org/10.1128/mBio.01821-19>.
 28. Lokmer, A.; Kuenzel, S.; Baines, J.F.; Wegner, K.M. The Role of Tissue-Specific Microbiota in Initial Establishment Success of Pacific Oysters. *Environ. Microbiol.* **2016**, *18*, 970–987. <https://doi.org/10.1111/1462-2920.13163>.
 29. Wegner, K.M.; Volkenborn, N.; Peter, H.; Eiler, A. Disturbance Induced Decoupling between Host Genetics and Composition of the Associated Microbiome. *BMC Microbiol.* **2013**, *13*, 252. <https://doi.org/10.1186/1471-2180-13-252>.
 30. Lucasson, A.; Luo, X.; Mortaza, S.; de Lorgeril, J.; Toulza, E.; Petton, B.; Escoubas, J.M.; Clerissi, C.; Dégremont, L.; Gueguen, Y.; et al. A Core of Functionally Complementary Bacteria Colonizes Oysters in Pacific Oyster Mortality Syndrome. *bioRxiv* **2020**. <https://doi.org/10.1101/2020.11.16.384644>.
 31. Clerissi, C.; de Lorgeril, J.; Petton, B.; Lucasson, A.; Escoubas, J.M.; Gueguen, Y.; Dégremont, L.; Mitta, G.; Toulza, E. Microbiota Composition and Evenness Predict Survival Rate of Oysters Confronted to Pacific Oyster Mortality Syndrome. *Front. Microbiol.* **2020**, *11*, 311. <https://doi.org/10.3389/fmicb.2020.00311>.
 32. Rahman, F.U.; Andree, K.B.; Salas-Massó, N.; Fernandez-Tejedor, M.; Sanjuan, A.; Figueras, M.J.; Furones, M.D. Improved Culture Enrichment Broth for Isolation of Arcobacter-like Species from the Marine Environment. *Sci. Rep.* **2020**, *10*, 14547. <https://doi.org/10.1038/s41598-020-71442-8>.
 33. Travers, M.A.; Boettcher Miller, K.; Roque, A.; Friedman, C.S. Bacterial Diseases in Marine Bivalves. *J. Invertebr. Pathol.* **2015**, *131*, 11–31. <https://doi.org/10.1016/j.jip.2015.07.010>.
 34. Asokan, A.; Meudal, H.; de San Nicolas, N.; Loth, K.; Destoumieux-Garzón, D.; Delmas, A.F.; Aucagne, V. Overcoming Challenges of Total Synthesis and 3D Structure Determination of Highly Hydrophobic Big Defensins. *in prep.*
 35. Schmitt, P.; Lorgeril, J. De; Gueguen, Y.; Destoumieux-Garzón, D.; Bachère, E. Expression, Tissue Localization and Synergy of Antimicrobial Peptides and Proteins in the Immune Response of the Oyster *Crassostrea gigas*. *Dev. Comp. Immunol.* **2012**, *37*, 363–370. <https://doi.org/10.1016/j.dci.2012.01.004>.
 36. Schmitt, P.; Wilmes, M.; Pugnère, M.; Aumelas, A.; Bachère, E.; Sahl, H.G.; Schneider, T.; Destoumieux-Garzón, D. Insight into Invertebrate Defense Mechanism of Action: Oyster Defensins Inhibit Peptidoglycan Biosynthesis by Binding to Lipid II. *J. Biol. Chem.* **2010**, *285*, 29208–29216. <https://doi.org/10.1074/jbc.M110.143388>.
 37. Gonzalez, M.; Gueguen, Y.; Destoumieux-Garzón, D.; Romestand, B.; Fievet, J.; Pugnère, M.; Roquet, F.; Escoubas, J.-M.; Vandenbulcke, F.; Levy, O.; et al. Evidence of a Bactericidal Permeability Increasing Protein in an Invertebrate, the *Crassostrea gigas* Cg-BPI. *Proc. Natl. Acad. Sci. USA* **2007**, *104*, 17759–17764. <https://doi.org/10.1073/pnas.0702281104>.
 38. Salzman, N.H.; Ghosh, D.; Huttner, K.M.; Paterson, Y.; Bevins, C.L. Protection against Enteric Salmonellosis in Transgenic Mice Expressing a Human Intestinal Defensin. *Nature* **2003**, *422*, 522–526. <https://doi.org/10.1038/nature01520>.
 39. Schneider, T.; Kruse, T.; Wimmer, R.; Wiedemann, I.; Sass, V.; Pag, U.; Jansen, A.; Nielsen, A.K.; Mygind, P.H.; Raventós, D.S.;

- et al. Plectasin, a Fungal Defensin, Targets the Bacterial Cell Wall Precursor Lipid II. *Science* **2010**, *328*, 1168–1172. <https://doi.org/10.1126/science.1185723>.
40. Turner, J.; Cho, Y.; Dinh, N.N.; Waring, A.J.; Lehrer, R.I. Activities of LL-37, a Cathelin-Associated Antimicrobial Peptide of Human Neutrophils. *Antimicrob. Agents Chemother.* **1998**, *42*, 2206–2214. <https://doi.org/10.1128/aac.42.9.2206>.
 41. Hanson, M.A.; Dostálová, A.; Ceroni, C.; Poidevin, M.; Kondo, S.; Lemaitre, B. Synergy and Remarkable Specificity of Antimicrobial Peptides in Vivo Using a Systematic Knockout Approach (ELife (2019) 8 PII: E48778). *Elife* **2019**, *8*, e44341. <https://doi.org/10.7554/eLife.48778>.
 42. Goddard, T.D.; Huang, C.C.; Meng, E.C.; Pettersen, E.F.; Couch, G.S.; Morris, J.H.; Ferrin, T.E. UCSF ChimeraX: Meeting Modern Challenges in Visualization and Analysis. *Protein Sci.* **2018**, *27*, 14–25. <https://doi.org/10.1002/pro.3235>.
 43. Pettersen, E.F.; Goddard, T.D.; Huang, C.C.; Meng, E.C.; Couch, G.S.; Croll, T.I.; Morris, J.H.; Ferrin, T.E. UCSF ChimeraX: Structure Visualization for Researchers, Educators, and Developers. *Protein Sci.* **2021**, *30*, 70–82. <https://doi.org/10.1002/pro.3943>.
 44. Saulnier, D.; Avarre, J.C.; Le Moullac, G.; Ansquer, D.; Levy, P.; Vonau, V. Rapid and Sensitive PCR Detection of *Vibrio* Pernaicida, the Putative Etiological Agent of Syndrome 93 in New Caledonia. *Dis. Aquat. Organ.* **2000**, *40*, 109–115. <https://doi.org/10.3354/dao040109>.
 45. Kimura, M. A Simple Method for Estimating Evolutionary Rates of Base Substitutions through Comparative Studies of Nucleotide Sequences. *J. Mol. Evol.* **1980**, *16*, 111–120. <https://doi.org/10.1007/BF01731581>.
 46. Kumar, S.; Stecher, G.; Li, M.; Niyaz, C.; Tamura, K. MEGA X: Molecular Evolutionary Genetics Analysis across Computing Platforms. *Mol. Biol. Evol.* **2018**, *35*, 1547–1549. <https://doi.org/10.1093/molbev/msy096>.
 47. Letunic, I.; Bork, P. Interactive Tree of Life (ITOL) v5: An Online Tool for Phylogenetic Tree Display and Annotation. *Nucleic Acids Res.* **2021**, *49*, W293–W296. <https://doi.org/10.1093/nar/gkab301>.
 48. Moussa, M.; Cauvin, E.; Le Piouffle, A.; Lucas, O.; Bidault, A.; Paillard, C.; Benoit, F.; Thuillier, B.; Treilles, M.; Travers, M.A.; et al. A MALDI-TOF MS Database for Fast Identification of *Vibrio* Spp. Potentially Pathogenic to Marine Mollusks. *Appl. Microbiol. Biotechnol.* **2021**, *105*, 2527–2539. <https://doi.org/10.1007/s00253-021-11141-0>.
 49. Da Silva, P.; Strzepa, A.; Jouvencal, L.; Rahioui, I.; Gressent, F.; Delmas, A.F. A Folded and Functional Synthetic PA1b: An Interlocked Entomotoxic Mini-protein. *Biopolymers* **2009**, *92*, 436–444. <https://doi.org/10.1002/bip.21217>.
 50. Kozłowski, L.P. IPC—Isoelectric Point Calculator. *Biol. Direct* **2016**, *11*, 55. <https://doi.org/10.1186/s13062-016-0159-9>.
 51. Suquet, M.; Kermoyan, G. De; Araya, R.G.; Queau, I.; Lebrun, L.; Souchu, P. Le; Mingant, C. Anesthesia in Pacific Oyster, *Crassostrea gigas*. *Aquat. Living Resour.* **2009**, *22*, 29–34. <https://doi.org/10.1051/alr/2009006>.
 52. Klindworth, A.; Pruesse, E.; Schweer, T.; Peplies, J.; Quast, C.; Horn, M.; Glöckner, F.O. Evaluation of General 16S Ribosomal RNA Gene PCR Primers for Classical and Next-Generation Sequencing-Based Diversity Studies. *Nucleic Acids Res.* **2013**, *41*, e1. <https://doi.org/10.1093/nar/gks808>.
 53. DI Tommaso, P.; Chatzou, M.; Floden, E.W.; Barja, P.P.; Palumbo, E.; Notredame, C. Nextflow Enables Reproducible Computational Workflows. *Nat. Biotechnol.* **2017**, *35*, 316–319. <https://doi.org/10.1038/nbt.3820>.
 54. Bolyen, E.; Rideout, J.R.; Dillon, M.R.; Bokulich, N.A.; Abnet, C.C.; Al-Ghalith, G.A.; Alexander, H.; Alm, E.J.; Arumugam, M.; Asnicar, F.; et al. Reproducible, Interactive, Scalable and Extensible Microbiome Data Science Using QIIME 2. *Nat. Biotechnol.* **2019**, *37*, 852–857. <https://doi.org/10.1038/s41587-019-0209-9>.
 55. Callahan, B.J.; McMurdie, P.J.; Rosen, M.J.; Han, A.W.; Johnson, A.J.A.; Holmes, S.P. DADA2: High-Resolution Sample Inference from Illumina Amplicon Data. *Nat. Methods* **2016**, *13*, 581–583. <https://doi.org/10.1038/nmeth.3869>.
 56. Wang, Q.; Garrity, G.M.; Tiedje, J.M.; Cole, J.R. Naïve Bayesian Classifier for Rapid Assignment of rRNA Sequences into the New Bacterial Taxonomy. *Appl. Environ. Microbiol.* **2007**, *73*, 5261–5267. <https://doi.org/10.1128/AEM.00062-07>.
 57. McMurdie, P.J.; Holmes, S. Phyloseq: An R Package for Reproducible Interactive Analysis and Graphics of Microbiome Census Data. *PLoS ONE* **2013**, *8*, e61217. <https://doi.org/10.1371/journal.pone.0061217>.
 58. Oksanen, J.; Blanchet, F.G.; Kindt, R.; Legendre, P.; O'hara, R.; Simpson, G.L. Vegan: Community Ecology Package, R Package Version 1.17–18, **2011**. <http://CRAN.Rproject.org/package=vegan> (accessed on 1 September 2022)
 59. Parks, D.H.; Tyson, G.W.; Hugenholtz, P.; Beiko, R.G. STAMP: Statistical Analysis of Taxonomic and Functional Profiles. *Bioinformatics* **2014**, *30*, 3123–3124. <https://doi.org/10.1093/bioinformatics/btu494>.
 60. Love, M.I.; Huber, W.; Anders, S. Moderated Estimation of Fold Change and Dispersion for RNA-Seq Data with DESeq2. *Genome Biol.* **2014**, *15*, 550. <https://doi.org/10.1186/s13059-014-0550-8>.
 61. Pfaffl, M.W. A New Mathematical Model for Relative Quantification in Real-Time RT-PCR. *Nucleic Acids Res.* **2001**, *29*, e45.

Abstract

Characterization of the beneficial effects of the natural microflora of the Pacific oyster *Crassostrea gigas* for applications in shellfish farming

Recently, the frequency and severity of marine diseases have increased in association with global changes, and mollusks of economic interest are particularly concerned. A striking example of a devastating disease is the Pacific Oyster Mortality Syndrome (POMS) caused by the Ostreid Herpesvirus-1 μ Var (OsHV-1 μ Var) that emerged in 2008 and which heavily impacts *Crassostrea gigas* production worldwide by affecting juvenile oysters. Adult oysters are also affected by infectious diseases, especially those caused by the bacterial pathogen *Vibrio aestuarianus*.

In my PhD, I investigated the possibility of using the beneficial effect of the oyster microbiota to fight against these infectious diseases. It has been reported that some bacterial strains are preferentially associated with oysters with better survival capacity to the POMS disease. In addition, previous work has shown that it is possible to educate the oyster immune system through an exposure to healthy microbiota during their larval development. This experiment had been achieved by using oyster donors of microbiota. This microbial education had the advantage of using all the potential of the whole microorganism diversity, but the transferred community were not fully controlled and could be hazardous. This made this whole microbiota exposure not applicable in aquaculture. In this sense, I decided to focus my work on controlled microbial environment and investigated their potential beneficial effect in oyster health.

I generated a collection of bacterial species from naturally disease-resistant *C. gigas* collected in the field, and I characterized their effects on oysters. I investigated two possible beneficial strategies: (1) I performed a microbial education by adding multi-strain bacterial mixes during larval development and investigated the long-term effect of this exposure at juvenile and adult stages when oysters were challenged with OsHV-1 and *V. aestuarianus*. (2) I identified antimicrobial-producing bacterial strains and investigated their short-term effect by adding them to juvenile and adult oysters just before pathogen challenges. Overall, I showed that both strategies can help fighting against oyster infectious diseases but strongly relies on oyster genetic.

These findings open new avenues for the development of microbiota-targeted prophylactic approaches to mitigate diseases in oyster farming.

Key words:

Crassostrea gigas; Holobiont; Microbial education; Antibacterial activity; OsHV-1 μ Var; *Vibrio aestuarianus*

Résumé

Caractérisation des effets bénéfiques de la microflore naturelle de l'huître du Pacifique *Crassostrea gigas* en vue d'applications en conchyliculture

Récemment, la fréquence et la gravité des maladies marines ont augmenté en lien avec les changements environnementaux, et les mollusques d'intérêt économique sont particulièrement concernés. Un exemple frappant de maladie dévastatrice est le syndrome de mortalité des huîtres du Pacifique (Pacific Oyster Mortality Syndrom ou POMS) causé par l'Ostreid Herpesvirus-1 μ Var (OsHV-1 μ Var) qui est apparu en 2008 et qui a un impact considérable sur la production de *Crassostrea gigas* dans le monde entier en affectant les huîtres juvéniles. Les huîtres adultes sont également touchées par des maladies infectieuses, en particulier celles causées par la bactérie pathogène *Vibrio aestuarianus*.

Dans le cadre de mon doctorat, j'ai étudié la possibilité de tirer profit de l'effet bénéfique du microbiote de l'huître pour lutter contre ces maladies infectieuses. Il a été rapporté que certaines souches bactériennes sont préférentiellement associées aux huîtres ayant une meilleure capacité de survie à la maladie POMS. En outre, des travaux antérieurs ont montré qu'il était possible d'éduquer le système immunitaire des huîtres en les exposant à un microbiote sain au cours de leur développement larvaire. Cette expérience a été réalisée en utilisant des huîtres donneuses de microbiote. Cette éducation microbienne présentait l'avantage d'utiliser tout le potentiel de la diversité des micro-organismes, mais les communautés transférées n'étaient pas entièrement contrôlées et pouvaient donc présenter un risque de transmission de maladie infectieuse. Cette exposition au microbiote entier n'est donc pas applicable en aquaculture. C'est pourquoi j'ai décidé de concentrer mon travail sur un environnement microbien contrôlé et d'étudier ses effets bénéfiques potentiels sur la santé des huîtres.

J'ai pour cela généré une collection de bactéries provenant d'huître *C. gigas*, collectées sur le terrain et naturellement résistantes aux maladies et j'ai caractérisé leurs effets sur les huîtres. Deux stratégies potentiellement bénéfiques ont été étudiées :

(1) J'ai réalisé une éducation microbienne du système immunitaire de l'huître en ajoutant des mélanges bactériens multi-souches pendant le développement larvaire et j'ai étudié l'effet à long terme de cette exposition aux stades juvénile et adulte lors d'une infection à OsHV-1 et *V. aestuarianus*. (2) J'ai identifié des souches bactériennes produisant des composés antibactériens et j'ai étudié leurs effets à court terme en les administrant à des huîtres juvéniles et adultes juste avant la contamination par des agents pathogènes.

Ces résultats ouvrent de nouvelles voies pour le développement d'approches prophylactiques ciblées sur le microbiote afin d'atténuer les maladies dans l'ostréiculture.

Mots clés :

Crassostrea gigas ; Holobiont ; Éducation microbienne ; Activité antibactérienne ; OsHV-1 μ Var ; *Vibrio aestuarianus*