



HAL
open science

Advanced Heat Recovery Systems: use of Vortex Generators and hybridization with thermoelectric generators, considering renewable energy sources and Life Cycle Assessment

Rima Al Aridi

► **To cite this version:**

Rima Al Aridi. Advanced Heat Recovery Systems: use of Vortex Generators and hybridization with thermoelectric generators, considering renewable energy sources and Life Cycle Assessment. Electric power. Université d'Angers, 2023. English. NNT : 2023ANGE0023 . tel-04390542

HAL Id: tel-04390542

<https://theses.hal.science/tel-04390542>

Submitted on 12 Jan 2024

HAL is a multi-disciplinary open access archive for the deposit and dissemination of scientific research documents, whether they are published or not. The documents may come from teaching and research institutions in France or abroad, or from public or private research centers.

L'archive ouverte pluridisciplinaire **HAL**, est destinée au dépôt et à la diffusion de documents scientifiques de niveau recherche, publiés ou non, émanant des établissements d'enseignement et de recherche français ou étrangers, des laboratoires publics ou privés.

THÈSE DE DOCTORAT DE

L'UNIVERSIT  D'ANGERS

ECOLE DOCTORALE N  602
Sciences de l'Ing nierie et des Syst mes
Sp cialit  : « *Energ tique-Thermique* »

Par

Mme Rima ARIDI

R cup ration de chaleur par int gration de g n rateur de vorticit , hybridation avec des g n rateurs thermo lectriques, utilisation d' nergies renouvelables et analyse du cycle de vie

Advanced Heat Recovery Systems: Use of Vortex Generators and hybridization with thermoelectric generators, considering renewable energy sources and Life Cycle Assessment

Th se pr sent e et soutenue   Polytech Angers, le 08 Septembre 2023
Unit  de recherche : LARIS EA 7315

Composition du Jury :

| | | | |
|--------------------|-------------------------------------|------------|--|
| Pr sident : | M. David BIGAUD | Pr. | Polytech Angers / LARIS |
| Rapporteurs | Mme Monica SIROUX M. Talib DBOUK | Pr. Pr. | INSA Strasbourg / ICUBE Universit  de Rouen / CNRS UMR 6614 - CORIA |
| Examineurs : | M. Jalal FARAJ M. Akram GHANEM | MCF MCF | Lebanese International University, Saida (Liban) ELISA Aerospace, Saint-Quentin |
| Dir. de th se : | M. Thierry LEMENAND | MCF HDR | Polytech Angers / LARIS |
| Co-dir. de th se : | M. Mahmoud KHALED | Pr. | Lebanese International University, Beirut (Liban) |
| Encadrant : | M. Samer ALI | MCF | JUNIA Lille / LGCgE |
| Invit e : | Mme Marie-Lise PANNIER | MCF | Polytech Angers / LARIS |

THÈSE DE DOCTORAT DE

L'UNIVERSITÉ D'ANGERS

ECOLE DOCTORALE N° 602
Sciences de l'Ingénierie et des Systèmes
Spécialité : « *Energétique-Thermique* »

Par

Mme Rima ARIDI

Récupération de chaleur par intégration de générateur de vorticit , hybridation avec des g n rateurs thermo lectriques, utilisation d' nergies renouvelables et analyse du cycle de vie

Advanced Heat Recovery Systems: Use of Vortex Generators and hybridization with thermoelectric generators, considering renewable energy sources and Life Cycle Assessment

Th se pr sent e et soutenue   Polytech Angers, le 08 Septembre 2023
Unit  de recherche : LARIS EA 7315

Composition du Jury :

| | | | |
|--------------------|-------------------------------------|------------|--|
| Pr sident : | M. David BIGAUD | Pr. | Polytech Angers / LARIS |
| Rapporteurs | Mme Monica SIROUX M. Talib DBOUK | Pr. Pr. | INSA Strasbourg / ICUBE Universit  de Rouen / CNRS UMR 6614 - CORIA |
| Examineurs : | M. Jalal FARAJ M. Akram GHANEM | MCF MCF | Lebanese International University, Saida (Liban) ELISA Aerospace, Saint-Quentin |
| Dir. de th se : | M. Thierry LEMENAND | MCF HDR | Polytech Angers / LARIS |
| Co-dir. de th se : | M. Mahmoud KHALED | Pr. | Lebanese International University, Beirut (Liban) |
| Encadrant : | M. Samer ALI | MCF | JUNIA Lille / LGCgE |
| Invit e : | Mme Marie-Lise PANNIER | MCF | Polytech Angers / LARIS |

Table of contents

| | |
|--|-----------|
| Acknowledgements..... | V |
| Introduction..... | 1 |
| Introduction (en français) | 4 |
| Chapter 1. Literature Review | 7 |
| I.1. Energy Recovery in Air Conditioning Systems: Comprehensive Review, Classifications, Critical Analysis, and Potential Recommendations | 7 |
| I.1.1. Introduction | 8 |
| I.1.2. Theoretical Background | 8 |
| I.1.3. Historical Notes | 10 |
| I.1.3.1. Energy recovery systems | 10 |
| I.1.3.2. Heat recovery systems | 10 |
| I.1.4. Research Objectives | 15 |
| I.1.5. Energy Recovery Systems | 17 |
| I.1.5.1. Energy recovery for outside use | 18 |
| I.1.5.2. Energy Recovery for inside use..... | 19 |
| I.1.5.2.1. Heat Recovery | 19 |
| I.1.5.2.2. Mathematical Control | 23 |
| I.1.5.2.3. Total Energy Recovery | 24 |
| I.1.5. Effect of weather conditions..... | 27 |
| I.1.6. Economic Study and Discussion | 28 |
| I.1.7. Conclusions | 30 |
| I.2. A Comprehensive Review on Hybrid Heat Recovery Systems: Classifications, Applications, Pros and Cons, and New Systems | 33 |
| I.2.1. Introduction | 34 |
| I.2.2. Overview of previous works on Hybrid Heat Recovery Systems | 37 |
| I.2.2.1. Hybrid Energy Storage System (HESS)..... | 38 |
| I.2.2.2. Hybrid Electrical Thermal Storage System (HETSS) | 38 |
| I.2.2.3. Hybrid Electrical Energy Storage (HEES) | 38 |
| I.2.3. Hybrid Energy Recovery Methods | 39 |
| I.2.3.1. Thermal Energy Storage..... | 40 |
| I.2.3.2. Electrical and Geothermal | 43 |
| I.2.4. Applications of Hybrid Heat Recovery | 46 |

Table of contents

| | |
|--|-----------|
| I.2.5. New systems for Hybrid Heat Recovery | 47 |
| I.2.6. Hybrid Heat Recovery Systems..... | 48 |
| I.2.6.1. Properties for Ideal Heat Recovery devices..... | 48 |
| I.2.6.2. Advantages of Combined Heat Recovery Systems | 48 |
| I.2.7. Commonly Used Systems..... | 50 |
| I.2.7.1. Thermoelectric Generators | 50 |
| I.2.7.2. Vortex Generators..... | 52 |
| I.2.8. Conclusions and recommendation | 53 |
| I.2.8.1. Thermal energy storage - Heat recovery..... | 53 |
| I.2.8.2. Electrical and Geothermal | 54 |
| I.2.8.3. Recommendations | 54 |
| I.3. Thermoelectric Power Generators: State-of-the-Art, Heat Recovery Method, and Challenges. | 55 |
| I.3.1. Introduction | 56 |
| I.3.2. Theoretical Background | 57 |
| I.3.2.1. Seebeck effect..... | 58 |
| I.3.2.2. Peltier effect..... | 59 |
| I.3.2.3. Thomson effect..... | 59 |
| I.3.2.4. Thermoelectric Generators Working Process | 60 |
| I.3.2.5. Figure of Merit (ZT)..... | 62 |
| I.3.3. Historical Notes | 62 |
| I.3.4. TEG in Applications and Classifications..... | 64 |
| I.3.5. TEG New Technologies in Applications and Challenges | 69 |
| I.3.5.1. Materials Properties..... | 70 |
| I.3.5.2. New Technologies and Applications | 72 |
| I.3.5.3. Challenges | 74 |
| I.3.5.4. Proposed solution to some of the challenges..... | 76 |
| I.3.6. Conclusion..... | 77 |
| Chapter II. Numerical and Parametrical Studies: CFD analysis on the spatial effect of Vortex Generators in Concentric Tube Heat Exchangers – A comparative study..... | 79 |
| II.1. Introduction | 80 |
| II.2. Problem description..... | 81 |
| II.2.1. Mathematical formulation | 81 |
| II.2.2. Computational domain | 82 |
| II.2.3. System description and methodology..... | 83 |
| II.2.4. Numerical Validation | 83 |

Table of contents

| | |
|---|------------|
| II.2.5. Mesh sensitivity study | 84 |
| II.3. Results and discussions | 85 |
| II.3.1. Performance parameters | 85 |
| II.3.2. Global analysis | 87 |
| II.3.3. Flow structure and temperature contours | 89 |
| II.4. Evolution of vortices | 100 |
| II.5. Conclusions | 103 |
| Chapter III. Drain water heat recovery application | 107 |
| III.1. Thermo-economic and environmental analysis of vortex generator-equipped multi-drain heat recovery systems | 107 |
| III.1.1. Introduction..... | 108 |
| III.1.2. Materials and Methods..... | 109 |
| III.1.3. Multi-drain heat recovery on CFD..... | 115 |
| III.1.4. Economic Study | 121 |
| III.1.5. Environmental Study | 124 |
| III.1.6. Conclusions..... | 129 |
| III.2. Thermoeconomic impact of vortex generator-equipped multi-drain heat recovery systems: various renewable sources | 131 |
| III.2.1. Introduction..... | 132 |
| III.2.2. Application Study | 134 |
| III.2.3. Economic Study | 136 |
| III.2.4. Environmental Study | 136 |
| III.2.5. Social Impact | 139 |
| III.2.6. Conclusions..... | 141 |
| Chapter IV: Pioneering Hybrid Heat Recovery Systems: Thermoelectric Generators as Insulators and channels boosted by vortex generators | 143 |
| IV.1. Introduction..... | 144 |
| IV.2. Materials and methods | 145 |
| IV.3. Results and Discussion | 155 |
| IV.4. Conclusions and recommendations | 165 |
| Chapter V. Conclusions and Perspectives | 167 |
| V.1. Conclusions | 167 |
| V.2. Perspectives | 169 |
| References | 171 |

Acknowledgements

I would like to express my heartfelt gratitude to all those who have contributed to the completion of this thesis. First and foremost, I wish to extend my profound gratitude to my esteemed thesis director Dr Thierry LEMENAND, co-director Prof Mahmoud KHALED and supervisor Dr Samer ALI for their unwavering guidance, valuable insights, and constant support throughout this journey. Their expertise and encouragement have been pivotal in shaping this work.

My thanks go to my family and friends for their unending encouragement and understanding during the challenging times of this academic pursuit. Your belief in me has been a driving force.

Lastly, I acknowledge the support of all other individuals who have directly or indirectly contributed to this thesis. This work would not have been possible without the collective support and encouragement I received, and for that, I am truly grateful.

Introduction

As global energy demand surges, it is crucial to minimize heat energy losses in systems such as Heating, Ventilating, and Air Conditioning (HVAC), power plants, and water desalination, among others. Heat recovery has emerged as a preferred solution for harnessing thermal energy that would otherwise be wasted. Waste heat recovery is now essential in numerous applications, as it involves capturing and reusing waste heat, thereby reducing operating costs and enhancing energy efficiency. Although several recovery technologies have been well-established and technically validated, engineers and researchers continue to refine these technologies and optimize the heat transfer process. The growing interest in hybrid and standalone heat recovery systems has made energy recovery methods an indispensable consideration. In this context, the present study focuses on a hybrid energy recovery system that reuses heat energy to provide hot water and generate electricity.

Thermoelectric generators (TEGs) have emerged as a promising technology for converting thermal energy into electrical energy using the Seebeck effect. TEG technologies have attracted significant research interest in recent years and are increasingly needed in the modern world due to their ability to generate electricity from low-grade waste heat. This quality has been demonstrated in various applications where TEGs effectively operate even with modest temperature differences. Consequently, TEGs are expected to play a pivotal role in reducing future power generation costs. Moreover, TEGs are favored for their silent operation, compactness, and reliability, owing to the lack of moving parts. However, TEG efficiency remains relatively low, presenting a challenge in identifying temperature differences that yield to energy. Higher temperature differences result in increased power generation, necessitating enhancement of the heat transfer coefficients on both sides of a TEG. Another objective of this PhD work is to integrate vortex generators into hybrid or advanced heat recovery systems and to evaluate the performance of such systems through numerical parametric analyses.

Vortex generators (VGs) are devices designed to stimulate fluid flow, thereby improving the heat transfer coefficient. Positioned at a specific angle of attack on the boundary layer, a predetermined number of vortex generators or turbulators create a swirling wake that imparts energy into the boundary layer. VGs have garnered considerable attention for achieving high thermal performance by energizing the flow, which in turn boosts the heat transfer coefficient. While VGs effectively enhance heat transfer, they also induce a substantial pressure drop. The challenge, therefore, lies in identifying a system that delivers optimal output by balancing the pressure drop and the increase in heat transfer coefficient.

The global energy demand continues to rise due to technological advancements and the rapid development of energy-intensive applications. Concurrently, significant waste thermal energy is present in various systems such as HVAC, power plants, heating systems for buildings, domestic hot water, and numerous other applications, with energy loss sometimes exceeding 60 %. Furthermore, high global energy consumption contributes to the depletion of natural resources, resulting in increased energy prices, resource scarcity, and adverse environmental impacts such as air, water, and soil pollution, climate change, and ozone layer depletion. Consequently, heat recovery is as crucial as discovering new energy sources. Studies have demonstrated that heat recovery can reach up to 90 % in certain cases, making it a significant factor. As a result, heat recovery has become a top priority for harnessing waste energy, with growing interest in simple and hybrid heat recovery systems.

Introduction

In this context, our study focuses on a hybrid energy harvesting system that employs thermoelectric generators (TEGs) in a concentric tube heat exchanger (CTHE) with countercurrent flow. To enhance heat transfer, TEGs are utilized as vortex generators (VGs), inducing turbulence in the flow and enabling more efficient extraction of heat energy. The study also examines the mass flow rates of fluids and the placement of TEGs to determine an optimal geometric design. Finally, the development of vortices and the influence of VGs on the flow are investigated within this optimal design.

The current work involves numerical and parametric analyses of proposed new or advanced hybrid recovery systems that incorporate TEGs for additional power generation and VGs to improve heat transfer. The originality of the work resides in three main aspects: (1) the application of vortex generators concept to waste heat recovery systems, (2) hybridization of waste recovery systems by their association to thermoelectric generators, and (3) suggestion of vortex-generator equipped thermoelectric-based hybrid heat recovery systems. Four primary studies are conducted to achieve the aforementioned objectives:

- (a) Investigate the impact of VGs on a CTHE system employed for liquid/liquid heat recovery heat exchangers.
- (b) Examine the performance of VG modules placed at different locations within a heat exchanger.
- (c) Implement the optimal design in a multi-drain heat recovery application and evaluate the Life Cycle Assessment of the design using openLCA software.
- (d) Assess the performance of TEG modules utilized as vortex generators in a hybrid heat recovery system. These various studies are conducted numerically using Ansys Fluent software.

This thesis comprises seven sections (excluding the introduction) and five primary chapters, with some chapters further divided into subsections. The literature review encompasses three studies addressing heat recovery and heat transfer enhancement topics. The first chapter assists in identifying the thesis's core focus, which will be explored in numerical studies and applications.

The thesis is structured as follows:

Chapter I: Literature Review

I.1 Energy Recovery in Air Conditioning Systems: Comprehensive Review, Classifications, Critical Analysis, and Potential Recommendations, published in *Energies*.

I.2A Comprehensive Review on Hybrid Heat Recovery Systems: Classifications, Applications, Pros and Cons, and New Systems, published in *Renewable and Sustainable Energy Reviews*.

I.3 Thermoelectric Generators for Power Generation: Applications, Heat Recovery Methods, and Challenges, published in *Electricity*.

Chapter II: Numerical and Parametric Study: CFD analysis on the spatial effect of Vortex Generators in Concentric Tube Heat Exchangers – A comparative study, published in *International Journal of Thermofluids*

Chapter III: Drain water heat recovery application.

Introduction

III.1 Thermoeconomic, environmental, and social analysis of vortex generator-equipped multi-drain heat recovery systems, submitted to *International Journal of Thermofluids*.

III.2 Thermoeconomic impact of vortex generator-equipped multi-drain heat recovery systems: various renewable sources, published in *Energy Conversion Management X*.

Chapter IV: Pioneering Hybrid Heat Recovery Systems: Thermoelectric Generators as Insulators and channels boosted by vortex generators.

Chapter V : Conclusions and Recommendations.

Introduction (en français)

Face à l'augmentation de la demande mondiale d'énergie, il est essentiel de minimiser les pertes d'énergie thermique dans les systèmes énergétiques tels que les systèmes de chauffage, de ventilation et de climatisation, les centrales électriques et le dessalement de l'eau, entre autres. La récupération de chaleur s'est imposée comme une solution privilégiée pour exploiter l'énergie thermique qui serait autrement gaspillée. La récupération de la chaleur perdue est désormais essentielle dans de nombreuses applications, car elle consiste à capturer et à réutiliser la chaleur perdue, ce qui permet de réduire les coûts d'exploitation et d'améliorer l'efficacité énergétique. Bien que plusieurs technologies de récupération aient été bien établies et techniquement validées, les ingénieurs et les chercheurs continuent d'affiner ces technologies et d'optimiser le processus de transfert de chaleur. L'intérêt croissant pour les systèmes de récupération de chaleur hybrides et autonomes a fait des méthodes de récupération d'énergie une considération indispensable. Dans ce contexte, la présente étude porte sur un système hybride de récupération d'énergie qui réutilise l'énergie thermique pour fournir de l'eau chaude et produire de l'électricité.

Les générateurs thermoélectriques (TEG) sont apparus comme une technologie prometteuse pour convertir l'énergie thermique en énergie électrique en utilisant l'effet Seebeck. Les technologies TEG ont suscité un intérêt considérable dans la recherche ces dernières années et sont de plus en plus nécessaires dans le monde moderne en raison de leur capacité à produire de l'électricité à partir d'une chaleur résiduelle de faible qualité. Cet avantage a été démontré dans diverses applications où les TEG fonctionnent efficacement même avec de faibles différences de température. Par conséquent, les TEG devraient jouer un rôle essentiel dans la réduction des coûts de production d'électricité à l'avenir. En outre, les TEG sont appréciés pour leur fonctionnement silencieux, leur compacité et leur fiabilité, en raison de l'absence de pièces mobiles. Toutefois, l'efficacité des TEG reste relativement faible, ce qui pose le problème de l'identification des différences de température qui produisent de l'énergie. Des différences de température plus élevées entraînent une augmentation de la production d'énergie, ce qui nécessite une amélioration des coefficients de transfert de chaleur des deux côtés d'un TEG. Un autre objectif de ce travail de doctorat est d'intégrer des générateurs de tourbillons dans des systèmes hybrides ou avancés de récupération de la chaleur et d'évaluer les performances de ces systèmes au moyen d'analyses numériques paramétriques.

Les générateurs de vortex (VG) sont des dispositifs conçus pour stimuler l'écoulement des fluides, améliorant ainsi le coefficient de transfert de chaleur. Positionnés à un angle d'attaque spécifique sur la couche limite, un nombre prédéterminé de générateurs de tourbillons ou de turbulateurs créent un sillage tourbillonnant qui transmet de l'énergie à la couche limite. Les générateurs de tourbillons ont fait l'objet d'une attention considérable car ils permettent d'obtenir des performances thermiques élevées en dynamisant l'écoulement, ce qui a pour effet d'augmenter le coefficient de transfert thermique. Si les VG améliorent effectivement le transfert de chaleur, ils induisent également une chute de pression supplémentaire substantielle. Le défi consiste donc à identifier un système qui offre un rendement optimal en équilibrant la perte de charge et l'augmentation du coefficient de transfert de chaleur.

La demande mondiale d'énergie continue d'augmenter en raison des progrès technologiques et du développement rapide d'applications à forte consommation d'énergie. Parallèlement, une quantité importante d'énergie thermique perdue est présente dans divers systèmes tels que les systèmes de chauffage,

de ventilation et de climatisation, les centrales électriques, les systèmes de chauffage des bâtiments, l'eau chaude sanitaire et de nombreuses autres applications, avec une perte d'énergie dépassant parfois 60 %. En outre, la forte consommation mondiale d'énergie contribue à l'épuisement des ressources naturelles, ce qui entraîne une augmentation des prix de l'énergie, une raréfaction des ressources et des effets néfastes sur l'environnement, tels que la pollution de l'air, de l'eau et du sol, le changement climatique et l'appauvrissement de la couche d'ozone. Par conséquent, la récupération de la chaleur est aussi cruciale que la découverte de nouvelles sources d'énergie. Des études ont démontré que la récupération de chaleur peut atteindre jusqu'à 90 % dans certains cas, ce qui en fait un facteur important. Par conséquent, la récupération de chaleur est devenue une priorité absolue pour l'exploitation de l'énergie résiduelle, avec un intérêt croissant pour les systèmes de récupération de chaleur simples et hybrides.

Dans ce contexte, notre étude se concentre sur un système hybride de récupération d'énergie qui utilise des générateurs thermoélectriques (TEG) dans un échangeur de chaleur à tubes concentriques (CTHE) avec un écoulement à contre-courant. Pour améliorer le transfert de chaleur, les TEG sont utilisés comme générateurs de vortex (VG), induisant des turbulences dans l'écoulement et permettant une extraction plus efficace de l'énergie thermique. L'étude examine également les débits massiques des fluides et l'emplacement des TEG afin de déterminer une conception géométrique optimale. Enfin, le développement des tourbillons et l'influence des TEG sur l'écoulement sont étudiés dans le cadre de cette conception optimale.

Le travail actuel comprend des analyses numériques et paramétriques de systèmes de récupération hybrides nouveaux ou avancés qui incorporent des TEG pour la production d'énergie supplémentaire et des VG pour améliorer le transfert de chaleur. L'originalité du travail réside dans trois aspects principaux : (1) l'application du concept de générateurs de vortex aux systèmes de récupération de la chaleur perdue, (2) l'hybridation des systèmes de récupération de la chaleur par leur association à des générateurs thermoélectriques, et (3) la proposition de systèmes hybrides thermoélectriques de récupération de chaleur équipés de générateur de vortex. Quatre études principales seront menées pour atteindre les objectifs susmentionnés :

(a) Étudier l'impact des gaz à effet de serre sur un système CTHE utilisé pour les échangeurs de chaleur de récupération de chaleur liquide/liquide.

(b) Examiner les performances des modules VG placés à différents endroits dans un échangeur de chaleur.

(c) Mettre en œuvre la conception optimale dans une application de récupération de chaleur multi-drain et évaluer l'analyse du cycle de vie de la conception à l'aide du logiciel openLCA.

(d) Évaluer les performances des modules TEG utilisés comme générateurs de tourbillons dans un système hybride de récupération de chaleur. Ces différentes études sont réalisées numériquement à l'aide du logiciel Ansys Fluent.

Cette thèse comprend sept sections et cinq chapitres principaux, certains chapitres étant divisés en sous-sections. La revue de la littérature englobe trois études traitant de la récupération de chaleur et de l'amélioration du transfert de chaleur. Le premier chapitre aide à identifier l'objectif principal de la thèse, qui est exploré dans les études numériques et les applications.

Introduction (en Français)

La thèse est structurée comme suit :

Chapitre I : Revue de la littérature

I.1 Récupération d'énergie dans les systèmes de conditionnement d'air : « Comprehensive Review, Classifications, Critical Analysis, and Potential Recommendations », publié dans *Energies*.

I.2 Une revue complète sur les systèmes hybrides de récupération de chaleur : « Classifications, Applications, Pros and Cons, and New Systems », publié dans *Renewable and Sustainable Energy Reviews*.

I.3 Générateurs thermoélectriques pour la production d'électricité : « Applications, Heat Recovery Methods, and Challenges », publié dans *Electricity*.

Chapitre II : Etudes numériques et paramétriques

Analyse CFD sur l'effet spatial des générateurs de vortex dans les échangeurs de chaleur à tubes concentriques - Une étude comparative, publiée dans *International Journal of Thermofluids*.

Chapitre III : Application de récupération de chaleur des eaux usées

III.1 Analyse thermoéconomique, environnementale et sociale de systèmes de récupération de chaleur multi-drains équipés de générateurs de vortex soumis à *International Journal of Thermofluids*.

III.2 Système de récupération de chaleur intégré dans différentes sources d'énergie renouvelable : étude de l'analyse du cycle de vie, publié dans *Energy Conversion Management X*.

Chapitre IV : Systèmes de récupération de chaleur hybrides novateurs : Générateurs thermoélectriques en tant que générateurs de vortex et isolation.

Chapitre V : Conclusions et perspectives

Chapter 1. Literature Review

I.1. Energy Recovery in Air Conditioning Systems: Comprehensive Review, Classifications, Critical Analysis, and Potential Recommendations

Résumé (en français)

L'énergie est devenue l'épine dorsale des activités quotidiennes de l'humanité. Les systèmes de chauffage, de ventilation et de climatisation (CVC), qui consomment environ 39 % de l'énergie dans le secteur résidentiel, sont devenus un élément essentiel pour fournir de l'air frais, en particulier après la crise du COVID-19, non seulement dans les hôpitaux, mais aussi dans toute construction simple. Ainsi, la diminution de ce pourcentage ou la récupération d'une partie de l'énergie perdue est une question essentielle dans les scénarios de gestion de l'énergie d'aujourd'hui.

Dans ce contexte, le présent manuscrit propose un examen complet, des classifications, une analyse critique et des recommandations potentielles pour la récupération d'énergie dans les systèmes de climatisation. Il classe la récupération d'énergie en deux catégories principales :

- Utilisation de l'énergie perdue pour des usages externes, tels que le chauffage de l'eau domestique, ou avec d'autres dispositifs ;
- Utilisation de l'énergie perdue pour des usages internes, tels que le flux d'air chaud qui peut être réutilisé pour augmenter l'efficacité du CVC.

En outre, ce document présente un résumé des recherches antérieures et passe en revue les dispositifs utilisés pour récupérer l'énergie. Ces objectifs sont atteints grâce à l'étude d'environ 190 articles scientifiques, qui a permis de conclure que les dispositifs de récupération d'énergie ont un effet considérable sur la consommation d'énergie dans le domaine du chauffage, de la ventilation et de la climatisation, principalement le caloduc, l'échangeur à plaque et les dispositifs à roue rotative.

I.1.1. Introduction

Energy has always been an essential requirement for the existence and all living organisms, where it is essential for growth, movement, maintenance, and creating work. Nowadays, with the rise of technological evolution and the rapid development of applications that need work, the human lifestyle has become more and more energy-dependent, especially in developing urban cities. For instance, in India during the last six decades, energy consumption has grown 16 times. The International Energy Agency (IEA) predicted that by 2050 energy consumption will increase by 50 % [1], where buildings will account for the largest source of emissions, basically due to the rapid growth in industries. Likewise, the growing demand for energy is likely to be more intense, in growing states due to the growth of new buildings. Based on the first law of thermodynamics, rising energy demand, global warming, energy shortage, and the need to provide fresh air, mainly after COVID-19, make reducing energy loss a challenge. The reduction of energy loss leads to the development of a new strategy that arranges the use of energy, and most importantly, gets benefits from the lost power and makes use of it. This strategy is called recovering lost energy.

Energy management has been comprehensively studied for almost 40 years. Recently, it has become one of the most challenging issues and popular research topics, where its importance turns out to be the same as finding a new source of energy, where the percentage of lost energy sometimes surpasses 60 %, besides, and 72 % of the all-inclusive primary energy consumption is wasted during energy conversion [2]. Thus, recovering part of this loss is very beneficial. Lately, in residential and commercial buildings, energy consumption has escalated firmly; the main reason was due to the HVAC systems at those organizations. HVAC accounts for almost 50 to 82 % of the energy, of which 40 % of the world's overall final energy is spent in buildings. While in non-industrial buildings, HVAC is responsible for around 18-35 % of the total energy consumption, and about 30 % in commercial buildings [3]. In some countries like Sweden, HVAC is highly used to reduce radon problems, which makes heat recovery a vital requirement to reduce energy consumption.

The high-energy consumption of HVAC makes Energy Management Systems (EMS) a fundamental issue to improve efficiency and provide significant energy savings in construction mainly in hospitals for removing contaminated air. Nowadays, EMS has become a primary concern in building projects where many types of research have been done on the BEMS (Building Energy Management System) over the last decade. Besides, statistical results indicate that the effect of savings of BEMS raises from 11.39 % to 16.22 % yearly, this is due to the continuous research that leads to improving this topic [4].

I.1.2. Theoretical Background

During the last decade, HVAC systems have been used not just for luxury purposes, where the primary function of HVAC is to provide fresh air circulation and healthy and easy interior situations for occupants with the least non-renewable energy. These systems have spread more and more, which made recovering energy in HVAC nowadays a must.

HVAC systems studied in this paper follow the Vapor Compression Refrigeration cycle (VCR) as shown in Figure I.1.1; cold low-pressure vapour passes into the compressor and is compressed isentropically into high-pressure vapour, compression increases the temperature (from T_c to T_h) and pressure of refrigerant (from P_l to P_h) as shown in Figure I.1.2 the Clapeyron or P-V (Pressure-Volume) diagram and the entropy

or T-S (Temperature-Entropy) diagram [5]. The gas then flows to the condenser; gas is condensed at constant pressure (P_h) to liquid and released its heat to the outside air (Q_h). For this reason, if you place your hand directly above the condenser, you will feel hot air coming, this heat will be lost energy unless it is captured and used again. The high-pressure liquid is then transported to the expansion valve, which lowers the liquid's pressure (from P_h to P_l) and the liquid's temperature (from T_h to T_c) at constant enthalpy via the throttling process. Refrigerant exits from the expansion valve as liquid-vapour mixture transport to the evaporator, where it is completely evaporated by absorbing the latent heat of vaporization (Q_l), the change of state from a mixture to gas within the evaporator requires heat absorption from the cold space. This process happens at constant low pressure (P_l) to gas at the evaporator exit.

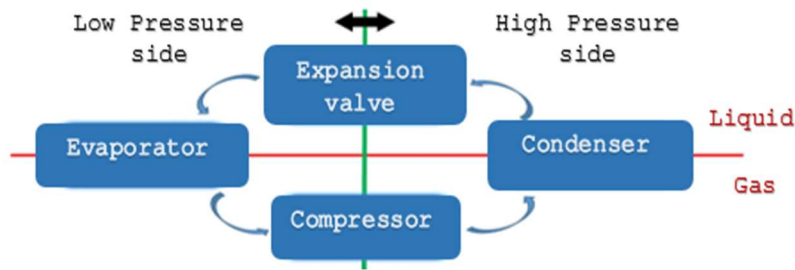

Figure I.1.1: Refrigeration cycle basic working process [6]

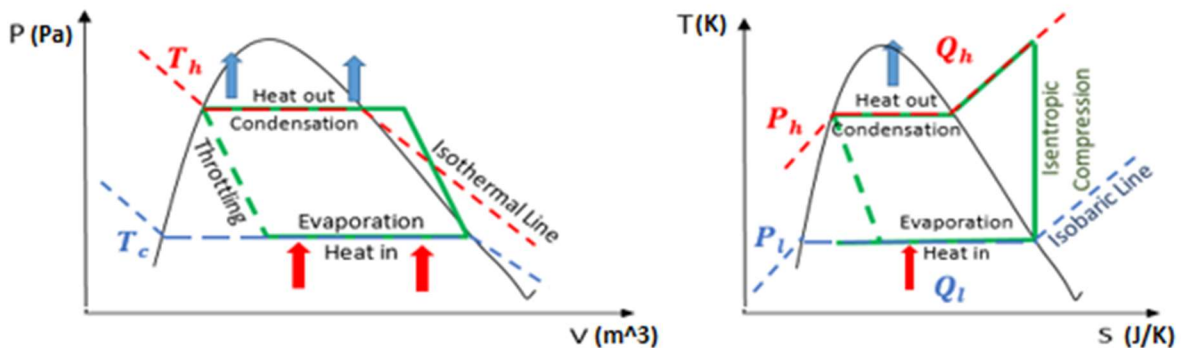

Figure I.1.2: Change of state on P-V [7] and T-S [8] diagrams

The high usage of HVAC, the tendency of today's world to energy management where heat recovery is one of its main axes, and the significant heat loss in the condenser drive the attention of scientists to search for well-designed and efficient systems that benefit from the heat loss. In other words, capturing the lost heat and transforming it into useful energy is called heat recovery.

Recently, new technology has been introduced to cooling systems as an alternative for refrigeration, air conditioning, heat pumping, or power generation applications. This technology is a solid-state physics and is known as a caloric energy conversion. The caloric effect is divided into four categories: barocaloric, electrocaloric, magnetocaloric, and pyrocaloric. Mainly, the highest progress has been observed in the magnetocaloric domain, where it has proven to be efficient and eco-friendly [6]. On the other side, considerable efforts have been made in the electrocaloric refrigeration and electrocaloric refrigeration

fields. Caloric cooling and air conditioning have been studied intensively, where caloric cooling has shown to be much more environmentally friendly than vapour compression technology with significant efficiency.

I.1.3. Historical Notes

As mentioned in the introduction, most of the community concerns are directed towards reducing energy consumption, whereas Europe has found that the only way to reduce total energy demand is by minimizing the energy demand of buildings. This can be achieved by applying two ways: either improving the efficiency of HVAC in buildings or capturing the lost energy for useful purposes, although both ways are correlated, where capturing lost heat will result in improving the efficiency. In this paper, two types of highly remarkable recovery systems were investigated by either energy recovery systems or heat recovery systems:

Energy recovery systems have highly remarkable recovery systems in improving the efficiency of HVAC as they recover at the same time latent heat, which is the heat caused by changes in phase, and sensible heat which is the heat related to changes in temperature where no change in phase occurs [7]. Enthalpy wheels and fixed plates with permeable material are types of energy recovery devices.

Heat recovery systems are unable to recover latent heat since they only recover sensible heat, yet they have a significant effect on the HVAC system. The heat pipe, thermosiphon, runaround coil, and oscillating heat pipes are the discussed types of heat recovery devices in this paper [8].

I.1.3.1. Energy recovery systems

It is also called total energy recovery, where it transfers both the latent and sensible heat; this advantage increases the efficiency and competency of the enthalpy devices in energy recovery. In winter, it is found that enthalpy devices recover over 25 %. Enthalpy or rotary wheel transfers both latent and sensible heat. They are highly used in HVAC due to their high efficiency, humidity, and frost control; however, their design causes a high-pressure drop in the airstream, so high-powered fans are added to deliver proper ventilation air with a low-pressure drop. Fixed Plate Heat Exchanger (FPHE) has been developed for over 40 years to become the most utilized type of heat recovery system. So far, cross-counter flow, which is a combination of cross and counter flow, is the most commonly used type (around 89 %) [9]. In the last 20 years, many tests were done on new designs of FPHE which show major results in terms of energy savings [10].

I.1.3.2. Heat recovery systems

Since 1970, research work on Heat Pipe Heat Exchangers (HPHE) for HVAC has been done in industries mainly in Britain, North America, and Australia [11]. Since 2010, over 3600 papers have been published concerning all types of HPHE in various applications. It was found that heat pipes are suitable for electronic devices, and domestic and industrial applications, also; they can be used in surgery rooms in hospitals [12]. Lately, researchers have shown a high interest in heat pipe technology for heat recovery due to its excellent features and high efficiency.

A run-around coil is a reliable system for recovering heat. London and Kays [13] discovered that it achieves the best performance when the coupling liquid and air have equal heat capacity rates under a constant Number of Transfer Units (NTU) conditions [14]. Runaround coil is used in hospitals and industries [15].

Thermosiphon (THE) is a type of heat pipe that works on gravity [16]; its natural phenomenon encourages researchers such as Azad and Geoola [17], Lee and Bedrossian [18], and others to do theoretical calculations on its thermal performance. THE has a positive effect on HVAC systems as it is observed from the investigated papers [19]. However, it is most commonly used in other applications such as solar heating [20].

Pulsating heat pipe (PHP) or Oscillating Heat Pipe (OHP) is one of the newest evolutions in Heat Pipe (HP) technology. In the 1990s, Akachi [21] proposed and patented PHP, its working process and schematic are summarized in Table I.1.1. PHP has over 340 published papers [22]; it is measured as one of the promising cooling technologies, especially for electronics due to its high thermal performance, simple design, quick response to high heat load, and low cost. In HVAC, PHP is a candidate for heat recovery as it does not require any moving parts and inline air streams. Besides, it has a lower cost than other devices [23].

Loop Heat Pipe (LHP) has been developed since 1972, it can transfer significant heat flow passively over long distances compared to other two-phase passive devices. Gerasimov and Maydanik [24] proved that water is the best working fluid in LHP.

Phase Change Material (PCM) is a method of thermal storage that uses sensible heat, latent heat, and thermochemical reactions to absorb and release heat [25]. Recently, PCMs have acquired high interest; several researches demonstrate the potential of PCMs [26]. Researchers have suggested PCMs for commercial use. As well, they have studied hybrid systems of PCM with other systems such as Earth-to-air heat exchangers and solar energy [27].

Geothermal systems can contribute to significant savings in the energy demands of buildings' HVAC systems, making it a very appealing solution. Geothermal energy is an old method of energy, combined with ventilation systems; it minimizes the load by precooling the supply air by around 25-75 % and 30 %-70 % savings in energy demands and electrical energy consumption for heating/cooling of buildings' HVAC systems in central and northern Europe [28]. Water to Earth heat exchangers and Earth to Air Heat Exchangers (EAHEs) are two types of geothermal energy, EAHEs combined with other systems show considerable results in reducing energy consumption [29]. A statistical study was done on the satisfaction of the owners with the ground heat pump (GHP), and results show that more than 85 % would recommend this system to others. Geothermal has a positive effect on HVAC since it reduces the consumption of the heating/cooling process [30].

Now, Table I.1.1 gives detailed information about the working process, advantages, properties, disadvantages, and main parameters of each device [31].

Table I.1.1: Summary of energy and heat recovery systems

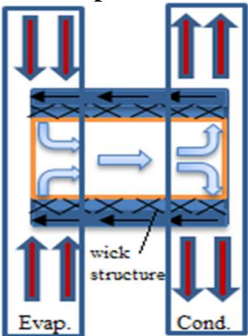
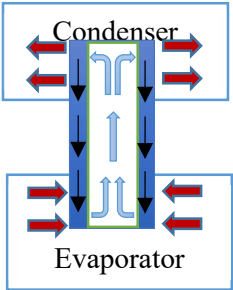
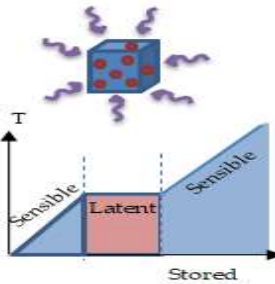
| Devices | Working process | Advantages | Disadvantage | Parameters |
|---|---|--|---|--|
| <p>Heat Pipe</p>  | <p>In the evaporator section, liquid in the pipe evaporates due to the temperature, which is above the boiling point of the liquid, vapor then goes through an adiabatic section in a vapor form, it then reaches the condenser section which returns into liquid due to the temperature, which is below the dew point of the vapor, the liquid goes back to the evaporator section through the wick structure.</p> | <ul style="list-style-type: none"> • Sensible (45-65 %) • Counter flow • Parallel flow • No cross-contamination • No moving parts [32] • High reliability • Does not require any external power for its operation [33] • No mechanical or electrical input | <ul style="list-style-type: none"> • Transfers only sensible energy • Difficulty in choosing the best working fluid. • Overheating [34] | <p>The performance of HP is affected by the operating conditions and the design of the HP [35]:</p> <ul style="list-style-type: none"> • Inlet temperature • Inlet flow rate • Wick structure • Working fluid • Dimensions • Inclination |
| <p>Thermosiphon</p>  | <p>The process in Thermosiphon is the same as the heat pipe but with no wick structure. Liquid returns to the evaporator section due to gravity, for this reason, the thermosiphon is called a gravity pipe or wickless heat pipe [36].</p> | <ul style="list-style-type: none"> • Sensible (40-60 %) • Counter-flow • Parallel flow • No mechanical or electrical input <p>Easy to maintain</p> | <ul style="list-style-type: none"> • Transfers only sensible energy • Water can be a working fluid, but its high pour point makes it unsuitable for applications with low temperatures [37] | <p>Efficiency is affected by the design of the thermosiphon:</p> <ul style="list-style-type: none"> • Working fluid • Dimensions of pipe geometry • Inclination [38] |
| <p>PCM</p>  | <p>PCM is a material with high thermal energy storage (TES) density and high-power capacity for charging and discharging. This material melts and solidifies at a specific temperature. When the material phase is changed from liquid to solid and vice versa, heat is captured or released. This makes PCM latent heat storage [26].</p> | <ul style="list-style-type: none"> (i) Sensible heat. (ii) Latent heat. (iii) Thermochemical reaction • No moving parts • Long life cycle • No pressure loss • Passive • No cross-contamination | <ul style="list-style-type: none"> • Difficulty in choosing material. • Requires high thermal conductivity [39, 34] to guarantee high-energy storage density and high-power capacity for charging and discharging | <p>Requirements of PCM:</p> <ul style="list-style-type: none"> • Thermo-physical • Kinetic • Chemical • economic, environmental • The challenge is to augment the latent heat storage capacity [40] |

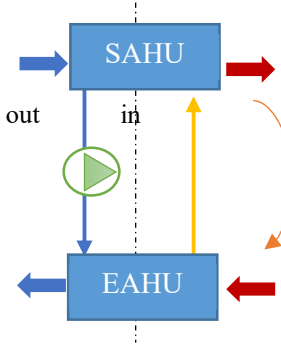
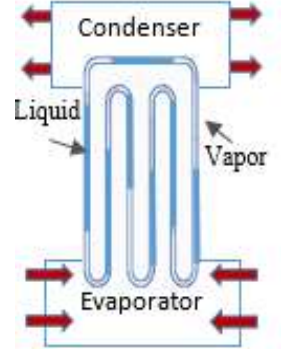
| Devices | Working process | Advantages | Disadvantage | Parameters |
|---|---|--|---|--|
| <p>Runaround</p>  | <p>This system consists of two or more multi-row finned tube coils linked to each other by a pump that runs the cycle. Outside air enters the supply air-handling unit (SAHU), in heating mode; pipework transfers the heat from the exhaust air-handling unit (EAHU) through the circulating fluid to the SAHU. Return air enters the EAHU and transmits its heat to the pipework then circulating fluid. Hence, heat is transmitted from the EA stream over the pipework coil to the flowing fluid, and then from the fluid over the pipework coil to the SA stream [41].</p> | <ul style="list-style-type: none"> • Sensible (55-65 %) • Counterflow • Parallel flow • No cross-contamination • Low-pressure drop • No moving parts [42] • Highly recommended in laboratories due to its ability to eliminate cross-contamination [43] • Supply and exhaust duct does not have to be located side by side | <ul style="list-style-type: none"> • Requires pump to move the fluid. • Low efficiency • Freezing problems [42] • Sensible heat • Lower efficiency compared to other devices. • Requires electrical power for running the pump [14] | <p>Factors that affect the runaround coil [44]:</p> <ul style="list-style-type: none"> • Airflow • Glycol concentration • The flow rate of the brine • If permeable material is added, then the runaround coil becomes a total energy recovery device and is called a runaround membrane energy exchanger [45] (RAMEE) |
| <p>OHP/PHP [46]</p>  | <p>PHP is evacuated, and then slightly filled by working fluid. At the evaporator end, the tube is exposed to a high temperature, which leads to evaporating the working fluid, which increases the vapor pressure, and expansion of the bubbles in this zone. The growing bubbles push the liquid to the condenser, which is at a low temperature. The low temperature causes condensation and a further increase in pressure difference. However, because the tubes are linked, liquid and vapor bubble motion at the evaporator section push the liquid at the condenser back to the evaporator section.</p> | <ul style="list-style-type: none"> • Sensible (52 %) in case R134a • Counter-flow • Parallel flow • Low-pressure drop [47] • Passive, does not require input power [48] • Low cost [46] • R134a PHP has better thermal performance for specifically low-heat application devices. • Quick response to the high heat load | <ul style="list-style-type: none"> • Low efficiency • Effect of the inclination angle depends on the properties of the working fluid used in CLPHP [49] • A low-pressure fluid temperature near the freezing point borders the PHP process [46] | <p>Operating limitations for PHP such as [50]:</p> <ul style="list-style-type: none"> • Number of turns • Filling ratio • Aspect ratio • Working fluid • Inclination angle • Length of adiabatic section • The internal diameter of the tube. • Operating temperature [51] |

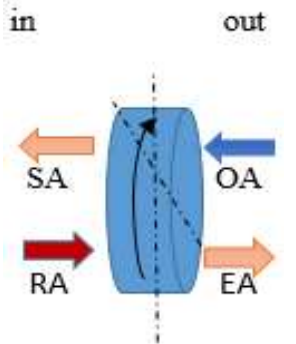
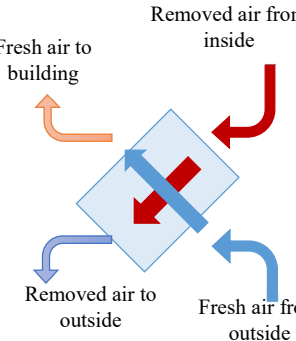
| Devices | Working process | Advantages | Disadvantage | Parameters |
|--|--|--|--|---|
| <p>Rotary Enthalpy Wheel [52]</p>  | <p>Rotary Wheel exchanges heat and humidity. The wheel rotates at a constant speed, the channel is subjected to two counter-flow arrangement streams. Outside Air (OA) enters the wheel, heat is transferred from the lower section to the Supply Air (SA), Return Air (RA) enters the lower section and transmits the heat to the wheel and leaves as Exhaust Air (EA) with lower temperature. In cooling mode, the coming air is pre-cooled and dehumidified. Moisture is given to the wheel, containing a hygroscopic substance, or coated with desiccant to absorb humidity.</p> | <ul style="list-style-type: none"> • Sensible (50-80 %) [53] • Total (55-85 %) • Transfers latent + sensible energy. • Counter flow • Parallel flow • Humidity control • High efficiency • Frost control means no freezing problems. • Low-pressure drop [52] • No working fluid is required | <ul style="list-style-type: none"> • Cross-contamination [54] • Regular maintenance • Moving parts [42] • Airstreams must be adjacent to each other relatively. • Requires filtration to keep the air stream clean [55] • The calculation is critical [56, 57] | <p>Enthalpy wheel depends upon:</p> <ul style="list-style-type: none"> • Wheel length • Channel base • Height • Thickness • Revolution speed • Geometrical parameters: wheel size. • Desiccant material • Boundary conditions: face velocity [58] |
| <p>Fixed Plate</p>  | <p>Fixed Plate Heat Exchanger (FPHE) contains a box with a set of parallel metal or plastic plates which allows the removed air to pass over the incoming air, transmitting the energy and warming it up. The two air streams are parted by the plates and do not mix. Liquid Desiccant Dehumidification System (LDDS) can be added to the FPHE to recover latent and sensible energy.</p> | <ul style="list-style-type: none"> • Sensible (50-80 %) • Total (55-85 %) • Counterflow • Parallel flow • Crossflow • No moving parts [42] • Humidity control | <ul style="list-style-type: none"> • Freezing problems in very cold climates • Condensation build-up [59] • High-pressure loss | <p>Parameters that affect Fixed plate:</p> <ul style="list-style-type: none"> • Type of flow • Number of channels • Working fluid |

Among the energy recovery devices mentioned in Table I.1.1., it is noticed:

1. RW and FPHE have the highest efficiency due to transferring both sensible and latent heat, which increases their efficiency among other systems. So, RW is highly recommended, however, there are some limitations such as regular maintenance besides the contamination, and this is why it is not used in hospitals unless it is equipped with a filtration system.
2. FPHE is a good choice mainly since it has no moving parts. However, frosting problems, high-pressure drops, and condensation build-up should be taken into consideration.
3. PCM provides a great opportunity for energy storage.
4. Combining PCM with other systems is recommended since PCM offers the opportunity to store energy, whereas adding PCM slows the temperature rise and guarantees the safe operation of the devices in the long term.

I.1.4. Research Objectives

This review investigated over 184 published papers starting from 1992 to 2020. The investigated papers are classified into the categories shown in Figure I.1.3, where RW, Fixed plate, and HPHE share the highest percentage among the devices. 35 % of the papers were review papers, which means heat recovery devices are highly studied and have a remarkable portion of the research sector.

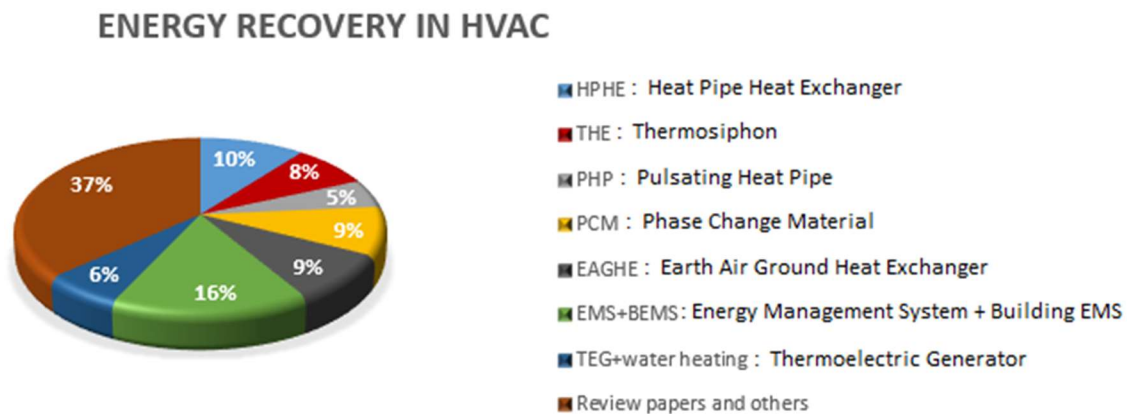

Figure I.1.3: Investigated papers according to the topic.

Figure I.1.4 shows the number of papers according to the years that were investigated from 1992 to 2018; each column in the chart represents the number of studied papers every three consecutive years. Results demonstrate that energy recovery in HVAC is increasing year after year, and there has been a great increase since 2012 with ten times more articles than fifteen years before; this fact is a sufficient motivation to study more about this topic.

Among the main review papers, it is noticed that all the review papers have studied the effectiveness of waste heat recovery (WHR) methods in diverse fields. Jouhara et al. [60] reviewed WHR methods in industrial processes from diverse approaches to obtain the optimum efficiency for a system. Miró et al. [61]

executed a review on WHR in industries for Thermal Energy Storage (TES) where TES technologies are applied to capture Industrial Waste Heat (IWH). Nazari et al. [62] presented a review of PHPs through solar to cryogenic applications. Hoang [63] discussed the WHR from diesel engines built on the Organic Rankine Cycle. Huang et al. [64] carried out a review of WHR for district heating.

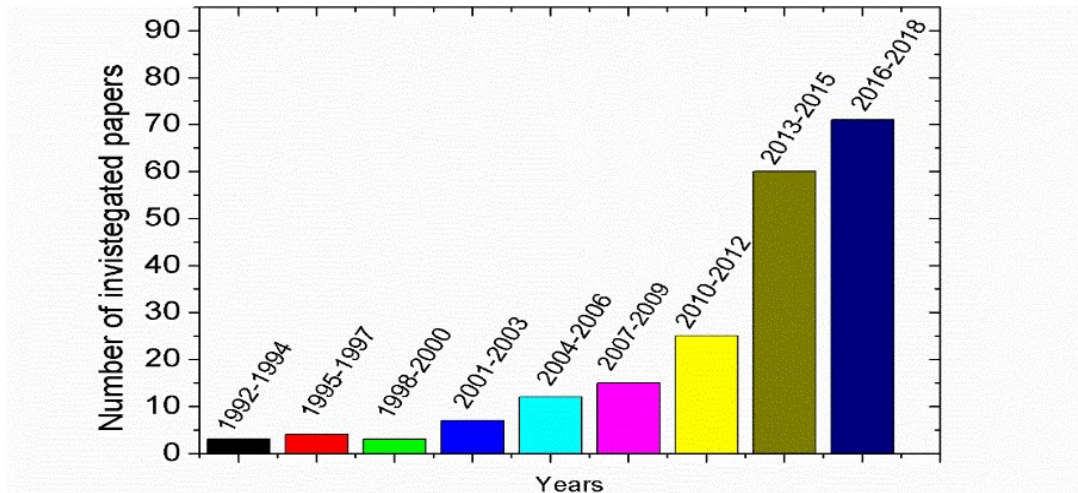

Figure I.1.4: Investigated papers according to years.

From the above-mentioned review papers, it is noticed that all of them endorsed the WHR in all fields and they agreed on studying WHR in later research. However, none of them did a comparative review of Heat Recovery (HR) devices according to their pros and cons and the effect of climate on the efficiency of the WHR system. Accordingly, this review aims to present the main methods for energy management in HVAC, then find out the most effective device, where it is not just about HR, it is about choosing the optimum HR. This will be done by defining the devices and discussing their effects from already published papers, then drawing out a conclusion. Throughout the research, it is noticed that the climate is an important factor that most of the research papers did not take into consideration, so a section related to the climate effect is added.

The novelty of this research is:

1. Providing a table about the working process and the pros and cons of each device
2. Classifying the papers to a new methodology which is:
 - 2.1. saved energy is used for external systems.
 - 2.2. saved energy is used in the HVAC system equipped with the energy recovery device.
3. Conclusions on the reviewed papers and finding the best device based on the drawn conclusions.

I.1.5. Energy Recovery Systems

The chart, in Figure I.1.5, divided Energy management in HVAC into the following categories:

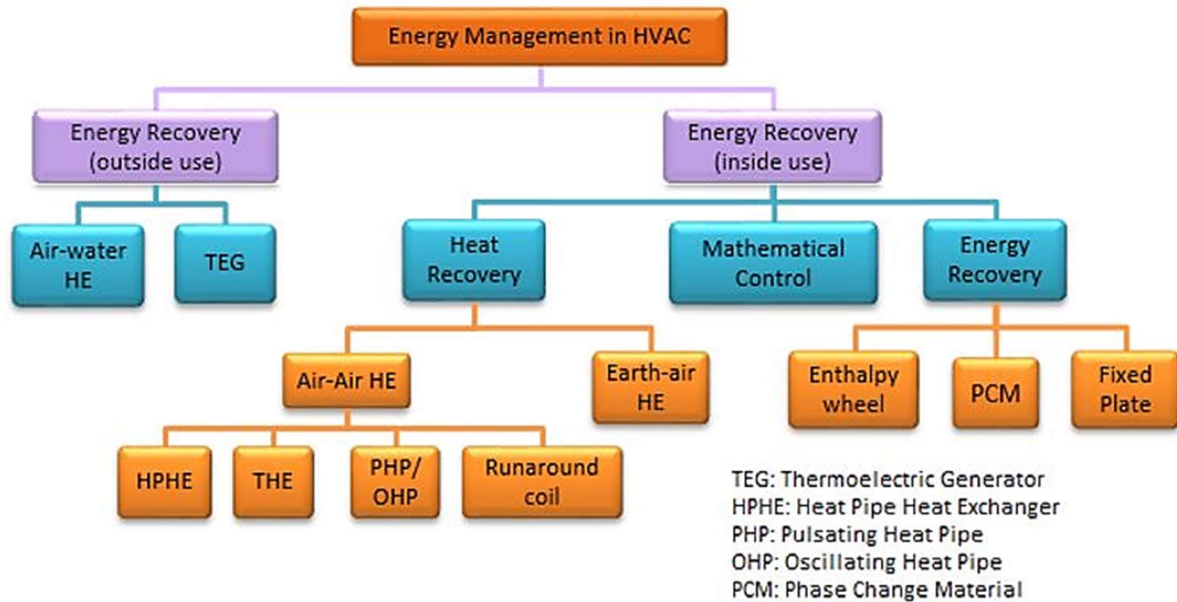

Figure I.1.5: Energy management classified into categories.

1. Outside use, which means the lost heat that is captured is used for external benefits, in other words, saved energy is used for external systems like generating electricity.
2. TEG was mainly used for heating water by air-water HE [65]. Using the lost energy for outside use is not only necessary for the heat recovery concept but also enhances the efficiency of the HVAC system [66].
3. Inside use, which means air-saved energy is used in the HVAC system equipped with the ER device to improve the efficiency and heat/cool the supply. This section is divided into:
 - i. Heat Recovery: energy transferred is just sensible heat; it can be transferred by different types of heat devices that will be discussed in the upcoming sections.
 - ii. Mathematical Control which is related to predicting systems such as smart systems, where they have revealed a positive impact on saving energy as shown in Figure I.1.5.
 - iii. Energy Recovery or total energy recovery: it is called total because it transfers both the latent and sensible heat; this advantage increases the efficiency and competency of the enthalpy devices in energy recovery.

I.1.5.1. Energy recovery for outside use

In the following section, saved energy is used for external systems such as heating domestic water, or using the captured lost heat to generate electricity; this process shows remarkable results as it is considered a free source of energy.

Air-Water HE

The concept of heating domestic water from the recovered lost heat is by capturing the rejected heat from the condenser by using a heat exchanger, where the cold water is heated by the warm flow that is produced from the condenser.

Table I.1.2 summarizes the methodology and results of the main investigated papers related to energy recovery using an air-water heat exchanger.

Table I.1.2: Summary of the investigated papers related to heating water for domestic use from the lost heat.

| Authors | Methodology | Result |
|----------------------------------|---|---|
| Ramadan et al. 2015 [67] | Counter-flow concentric tube heat exchanger at the condenser is used. Hot air coming from the condenser warmth up the water inside the tube. | The outlet temperature of the water rises from 304 K to 347 K when the cooling load rises from 3.52 to 63.31 kW. |
| Stalin et al. 2012 [68] | One inlet and one outlet tank are used for water flow, pump for circulating water from the tank to the water-cooled condenser, and this procedure lasts until the desired temperature is reached. | 2.71 hours are spent to raise the temperature of 350 L of water from 20 °C to 50 °C with a payback period of 6 months. |
| Lokapure et al. 2012 [69] | A refrigerant to water HE is placed between the compressor and the condenser. Water is propagated through one side of HE, and hot refrigerant gas from the compressor is transmitted over the other side. | Inlet water of 33 °C becomes 43 °C outlet water, and the heat in the water is increased by 30.3 %. The COP of the system is raised by 13.66 % after using the HE with the air conditioner. |

From Table I.1.2, it can be observed that the results obtained in air-water HE were considerable, and it is worth it to heat domestic water from the lost heat. This system is efficient due to:

1. The high heat capacity of water allows it to conduct heat about 25 times more than air does. So, water is considered more efficient than air.
2. The increase of outlet temperature of the water as the load increases. This indicates that applying air to the water HE in buildings that have high use of HVAC is very efficient.

Thermoelectric Generator TEG

It is also called a Seebeck generator, a solid-state device, which transforms the difference of temperature on its opposite sides into electricity following the phenomenon of the Seebeck effect. TEG is a considerable technology that recovers lost heat in various applications. Table I.1.3 represents the methodology and results of the main investigated papers related to energy recovery using Thermoelectric Generators (TEGs).

Table I.1.3: Summary of the investigated papers related to generating electricity from the lost heat.

| Authors | Methodology | Result |
|-----------------------------------|--|--|
| Ramadan et al. 2017 [70] | Placing flat plate TEG of 40×40 cm ² horizontally, the air of the condenser is considered the heat source and the exhaust airflow is used as a cooler. | At a load of 100 kW, TEG was able to generate 90 W of electrical power |
| Kumar et al. 2015 [71] | TEG in a vertical direction facing the condenser from one side and the outside air from another side. | 30 % of waste heat is recovered by the condenser side. |
| Damanhuri et al. 2018 [72] | Six Peltiers were arranged between Cu plates. 3 cases were monitored depending on the temperature ΔT of the cooling coil and condenser temperature. | A difference temperature of 9-10 °C and a load of 1.5 hp generated 1.61 V. |
| Trinidad et al. 2015 [73] | Experimental studies on a TEG array design were conducted to study the energy consumption of this device. The hot air and cold air entered a square channel with a wall separating them. The hot air entered the bottom section, and the cold air entered the top section; The hot side had an 1850W max capacity while the electrical loads ranged from 390 to 760 Ω . | Results show that the application of the electrical load has a high effect on the gradient temperature between the outlet and inlet of the hot air. On the other hand, the numerical analysis indicates that this system behaves differently as compared to a conventional counterflow HE. |

As a conclusion drawn from Table I.1.3, it is observed that:

1. TEG has low efficiency due to its design.
2. When the temperature difference increases, the value of generating electricity increases.
3. TEG shows a positive effect on HVAC but some improvements should be done to increase its efficiency.

I.1.5.2. Energy Recovery for Inside Use

I.1.5.2.1. Heat Recovery

Air-Air HE

A method of capturing heat loss from hot air enclosure, it is a type of exchanging heat, however, through a passive way, where the design enhances heat transfer. Table I.1.4 shows the methodology and results of the papers that studied air-air energy recovery devices (HPHE, THE and PHP/OHP, Run around coil) [74].

Table I.1.4: Summary Investigated papers related to air-air energy recovery devices.

| | Authors | Methodology | Results |
|-------------|----------------------------------|--|--|
| | Firouzfard et al., 2011 [75] | HPHE is placed in two streams of fresh air 32-40 °C and return air (26 °C) in AC. Ratios of mass flow rates 1, 1.5, and 2.3 were tested to observe heat transfer and change of temperature of fresh air. | The heat transfer and effectiveness rate of both the condenser and evaporator sections were raised to 48 %. |
| HPHE | Sanaye et al., 2014 [76] | A HPHE, made from copper with water as working fluid and a wick structure of 10 sheets of the 100-mesh bronze screen, is placed horizontally to recover heat from the exhaust air, in heating mode, and transfers it to the cold inlet fresh air whereas, in cooling mode, it pre-cools the hot inlet fresh air. | The optimal point is with an effectiveness of 0.774 and a total cost of 1474 \$ with a return period of about 2.5 years. |
| | Ahmadza dehtalata peh, 2013 [77] | TRNSYS software was used to study the hourly influence of HPHE on HVAC. Eight-row HPHE was added with an average of 22.4 °C indoor temperature and 54.5 % indoor air Relative Humidity (RH). | Results revealed that by reheating and pre-cooling, a total amount of 236.9 MWh of energy could be saved yearly. This amount results in saving 24,572 \$ annually. |
| | Firouzfard et al. 2011 [75] | 3-row THE was investigated which consists of 48 wickless heat pipes organized in 6-row. | The cooling capability for the system was improved by 20 to 32.7 %. In an evaporator and condenser, the equal value of air face velocities should be avoided. |
| | Guoyuan Ma et al. 2013 [78] | THE is used in an AC system for outlet air heat recovery in a shopping mall in Beijing. | Results show that the seasonal temp effectiveness (STE) is 66.08 % in winter and 55.43 % in summer. |
| THE | Jouhara et al. 2018 [36] | Wraparound Loop Heat Pipes (WLHP) are thermosiphons used commercially. It depends on gravity to return the condensed liquid. HP filled with R134a and water were investigated at two different air velocities: 2.56 m/s and 2.6 m/s. | Results show that the effectiveness declines with the rise of air velocity. The effectiveness of the HP filled with water varied from 20.14 % to 19.61 %, whereas it varied from 13.76 % to 13.25 % when it was filled with R134a. Thus, water HP was 46 to 48 %, which is greater than R134a. |
| | Vanyasre et al., 2017 [79] | Thermosiphon of an outer diameter of 16 mm, and 570 mm long is used with a working fluid de-ionized water. Different flow rates are set in the test 10 ml/s, 15 ml/s, and 20 ml/s for various heat inputs of 155 | A comparison was done on the results obtained, and it was concluded that in thermosiphon, 45° is more efficient than other inclinations when de-ionized water is used as a working fluid. |

| | | | |
|----------------|-----------------------------------|---|--|
| | | W, 200 W, 250 W, and 300 W and different inclinations of 30°, 45°, and 90°. | |
| | Mahajan et al. 2017 [80] | OHP consists of multiple finned OHP, organized in a staggered way (to increase the heat transfer). Typical HVAC is studied at 60.96×45.72 cm ² . The ducted air streams have a constant volumetric flow rate of 1.18 m ³ /s opposite to each other. Outdoor temperature is assumed to vary between -8 °C and 48.9 °C. | The results show that the OHP system is energy and cost-effective since a reduction of total average consumption was observed, around 16 % yearly. OHP can save, annually, more than 2500 \$ in cities that have continental (warm to hot summer and severe cold winter) climatic conditions |
| PHP/OHP | Supirattanakul et al., 2011 [81] | Copper tubes closed-loop (CLOHP) was used with a diameter of 2.03 mm. Indoor design temperature varies between 20 and 27 °C with 50 % RH. R134a, R22, and R502 refrigerants were used as working fluids. | When R134a was used as the working fluid, heat flux increased to 5.19 kW/m ² at a temperature of 27 °C. The CLOHP/CV resulted in an increase in the surface area and the heat capacity of the base fluid. |
| | Govinda Mahajan et al., 2015 [82] | OHP-HE was studied with a 70 % fill ratio of n-pentane. The performance of OHP was compared with the empty tube i.e. at vacuum pressure having the same overall dimension. | Results indicate that OHP can recover up to 240 W of heat from the waste exhaust air stream, with a low-pressure drop of almost 62 Pa in the cold air stream. The heat transfer rate with 70 % n-pentane is two times that of the evacuated OHP. |
| | Chawane et al., 2013 [46] | PHP performance is compared by using three different working fluids: ammonia, water, and acetone. | Water-filled devices showed higher performance as compared to R-123 and ethanol in a vertical orientation. Ammonia shows desirable characteristics of heat transfer, it has a high freezing point. |
| | Barua et al., 2011 [83] | Mathematical models of the fall of temperature in the condenser section were established concerning time for different diameters D and lengths L of the pipes of the evaporator sections. | Temperature declines exponentially. For a fixed D, the temperature drop depends on the length of the evaporator. For a fixed L, the temperature reduces faster for the smaller diameter of the pipe. |
| Runaround coil | Wallin et al., 2012 [15] | A summary on increasing the performance of transferring energy through run-around coil ventilation HRS. Studies have also investigated the methods to improve heat pump units by decreasing the energy used, this was done by conducting a modified design of 3 3-stage heat pumps to the system the heat recovery rate per year was obtained at the Stockholm. | The Annual HR rate was improved from 47 % to 66 %. The system shows considerable and affordable results, for the three-stage heat pump design, the payback period was 5.7 years, and for the variable heat pump capacity design 6.2 years. |
| | Zaengerle, 2012 [84] | Integrated system of energy recovery with cooling and heating devices of runaround coil studied in cold climates. | This system is very valuable to recover energy in cold climates, thus decreasing the power of the fan. |

Table I.1.4 revealed that:

1. Air-to-air HE decreases considerably the energy consumption, but there are some limitations according to its characteristics and specific configuration.
2. Many factors affect the efficiency such as working fluid, size, and climate...
3. It is highly recommended to combine other systems such as PCM to overcome its overheating problem.
4. Besides, it is noticed that OHP in continental climates can save more energy.
5. The efficiency of THE in winter is higher than that in summer. It is recommended to perform a comparative study for each of THE and HPHE in different climates.
6. Papers on integrating run-around coil with HVAC were not available as much as other HR devices, yet it is concluded that this technology is noticed to be effective in cold climates.

Earth-Air HE

EAHE is considered an encouraging technology, which can efficiently decrease the load of cooling/heating of a building by warming up the air in the wintertime and the same in summer. Table I.1.5 shows the methodology and results of papers that studied energy recovery from EAHE.

Table I.1.5: Summary of the investigated papers related to energy recovery from earth to air HE

| Authors | Methodology | Results |
|----------------------------------|--|--|
| Reddy et al., 2015 [85] | Air conditioning system with a ground source heat exchanger (ACSWGSH) is developed. HE, of helical shape, is placed in a hole of 0.2 m in diameter and 15 m deep. The test was done under three different conditions: (i) open hole, (ii) hole filled with water at ambient temperature, and (iii) hole filled with sand. The tube was made of copper and the refrigerant was R22. | When the borehole was filled with water, the COP rose from 2.11 to 3.72. In addition, the power consumption of the AC decreased by 29 %. When the bore was filled with sand, COP decreased significantly due to low heat transfer from the condenser to the ground. The cost of the ACSWGSH system is high. However, after a specific time, savings and energy conservation are significant. |
| Woodson et al., 2012 [86] | EAHX at 1.5 m depth was designed with varied temperature varies from 25 °C to 43 °C, a 25 m length. | The designed system cooled the inside air from the outside air by more than 7.5 °C when the temperature was 30.4 °C. |
| Tiwari et al., 2014 [87] | A room of height 2.6 m, length 4.5 m. Two designs were used: (i) Design I: 5 air changes, 0.1 m pipe diameter, pipe length is 21 m. A fan of 0.3 m diameter and 66 rpm requires 90 W power to operate. (ii) Design II: 5 air changes and 0.025 m pipe radius, pipe length is 15 m. A fan of 0.3 m diameter and 66 rpm requires 90 W power to operate. | Design I provide net thermal energy of 0.29 kW in summer and 0.36 kW in winter. Design II provides net thermal energy of 0.26 kW in summer and 0.34 kW in winter. The environmental cost for Design I and Design II is 10.1 \$ and 13.9 \$ respectively. |

| | | |
|-------------------------------------|--|---|
| Congedo et al., 2016 [88] | Under the summer and winter conditions of the Mediterranean Climate, a horizontal air-ground heat exchanger (HAGHE) system is studied with a 5 m pipe. | The best performance was at a pipe depth of 5 m with a ground conductivity of 3 W/(mK). A gain of about 23 kWh in winter and 37 kWh in summer. |
| Fazlikhani et al., 2017 [89] | This study compared the efficiency of the earth to air heat exchanger (EAHE) systems in hot-arid (Yazd) and cold (Hamadan) climates. | In Hamadan, the system works for 225 days and saves 50.1–63.6 % of energy. In Yazd, it works for 294 days which results in reducing consumption by 24.5–47.9 %. |

It is observed that:

1. EAHE is effective in severely cold/hot weather when the temperature is high which results in a higher temperature gradient which means higher heat transfer.
2. Besides, it is noticed that the EAHE is most efficient in hot dry climates weather.
3. EAHE depends on some parameters to achieve optimum energy saving such as the ground, soil properties, depth, climate, working fluid, geometry, and material of the pipes used. So, location and climate should be taken into consideration.

I.1.5.2.2. Mathematical Control

Controlling and smart systems are great inventions that helped in many fields, where do not just facilitate the process, but; also save energy as will be shown in the methodology and results of the papers that studied the effect of mathematical control on HVAC systems in Table I.1.6.

Table I.1.6: Summary of the investigated papers related to mathematical control effect on HVAC systems.

| Authors | Methodology | Results |
|---------------------------------|--|---|
| Elhelw 2016 [90] | A comparison between the modified bin method and cooling load temperature difference/ solar cooling load factor/cooling load factor (CLTD/SCL/CLF) method. | The overall energy efficiency ratio was increased by 45.57 %. The Energy Efficiency Ratio (EER) of the modified bin method was between 14.29 and 10.58, higher than EER acquired from using CLTD/SCL/CLF method 10.89. Overall EER saved 33.42 %. |
| Sayadi et al. 2016 [91] | Model predictive control (MPC) is used to foresee the situations of the system. | A reduction of about 43 % and 31 % in energy used when using MPC. |
| Wang et al., 2017 [92] | Detection of occupancy using Wifi coverage, smart devices, and sensors. | The model showed over 80 % accuracy. The designed model reduced the energy consumption of HVAC significantly. |
| Zlatanovic, 2011 [93] | Simple and cheap method is used for the energy-saving estimation model (ESEM). | Results show that ESEM has a positive effect on HVAC, and 55 % of electrical energy savings can be accomplished. |
| Godina et al., 2018 [94] | Model Predictive Control (MPC), proportional integral derivative (PID), and ON/OFF control methods in an AC. | Up to 14.2 % can be saved by applying the specific model. |

Mathematical Control is related to controlling and predicting systems such as the smart system. These systems have revealed a positive impact on saving energy as shown in Table I.1.6, where it is noticed that Model Predictive Control (MPC), Building Automation Systems (BAS), Estimation models, and automatic smart systems have acquired high attention in HVAC for their ease in use, however, they require high cost and accuracy in constructing. From Table I.1.6, it is noticed that the model accuracy is acceptable, and it showed a significant positive effect on saving energy. It is recommended to do research that involves a smart system in HR devices.

I.1.5.2.3. Total Energy Recovery

Enthalpy Wheel

One of the energy recovery devices that transfers sensible and latent heat, this criterion increases the efficiency of RW and helps in decreasing the moisture in the air. Table I.1.7 shows the methodology and results of the papers that are related to the RW heat exchanger in HVAC.

Table I.1.7: Summary of the investigated papers related to the enthalpy wheel effect on HVAC systems.

| Authors | Methodology | Results |
|-----------------------------------|---|--|
| Wang et al., 2012 [95] | Two simple design cases of energy recovery with and without airside economizer were studied and compared to a baseline case which is without energy recovery and airside economizer case. | Airside economizer combined with energy recovery reduced 17 % of HVAC energy consumption annually, which is the highest energy benefit. In summer design, for the Miami climate, COP is increased by up to 26 %. |
| Ali et al., 2016 [96] | Comparison between two cases: (i) without heat recovery wheel, (ii) with heat recovery wheel. | After using the heat recovery wheel, the energy is reduced by 15 % from 11.6 tons to 9.9 tons of cooling capacity. |
| Hussaini et al., 2017 [97] | Comparison of heat load calculations with and without heat recovery wheel for energy-efficient using Eco-Fresh enthalpy wheel software. | When using HRW sensible heat a total reduction in the ton of refrigeration decreased to 46.02 %, which means about half of the energy is saved. |
| Bellia et al., 2000 [98] | An application is done for retail stores, in four Italian cities. An application is done in the theatre in Rome. | The maximum and most profitable savings to the corresponding traditional system have been obtained to be around 22 %. Savings are between 23 % and 43 %. For both cases, the needed electric power is reduced by about 55 %. |
| Herath et al., 2020 [99] | Installing Enthalpy Wheels (EW) to central air conditioning systems. Energy saving is calculated for various operating conditions. The payback period for involving RW in AC is calculated. | EW can recover around 20 % to 40 % of total energy consumption compared to a configuration with no EW in operations. Energy recovery increased when the temperature of fresh air and the moisture content increased. The payback period for an EW is in the range of 1 to 5 years. |

Results in Table I.1.7 show that:

1. EW HE is effective in HVAC applications, due to its high efficiency and ability to transfer latent, as well as sensible energy, which can be saved.
2. Besides, it was noticed that energy recovery increases when the temperature of fresh air and moisture content increases, subsequently the chance to recover heat using EW rises.
3. It is also noticed that the efficiency of RW in hot and humid climates increases.
4. So, it is recommended to study RW in a humid and cold climate, it is logical that the results will be positive where humidity has a positive effect on RW as it recovers latent heat.

PCM

It is a material that releases and absorbs phase change, this process provides heating and cooling by melting and solidification. PCM offers storage ability, which makes it useful in many applications. Table I.1.8 shows the methodology and results of the papers that are related to the PCM effect on the HVAC system.

Table I.1.8: Summary of the investigated papers related to PCM effect on HVAC systems.

| Authors | Methodology | Results |
|-----------------------------------|--|--|
| Chaiyat et al., 2014 [100] | PCM of paraffin waxes material, which melts at around 20 °C was used in the Thai climate for better cooling efficiency of an AC. | 9.10 % of the electricity cost was saved when PCM was used. The payback period was 4.15 years. |
| Tranto et al., 2013 [101] | Hybrid conditioning system that joins EAHEs and PCMs that considers surfaces as sources of cooling or heating. The hybrid system was studied, for 24 hours, with airflow rates of 0.02, 0.04, and 0.05 m ³ /s | PCM alone can reduce temperature swings by 33 %. The hybrid system reduced temperature swings by 40, 47, and 46 %, respectively under the given flow rate. |
| Madyira, 2017 [102] | 15 plates were 10 mm separated and assembled in a Plexiglas box, and air mass flow rates of 0.027, 0.061, and 0.075 kg/s were provided by an axial fan. | For 0.027 kg/s, PCM discharged about 78 % of its latent energy storage. In the day, about 95 % of latent storage capacity was recharged |

Studies in Table I.1.8 indicate that:

1. PCM possesses a significant effect in terms of energy-saving and storage.
2. Besides, the PCM+EAHE system is encouraging, especially due to its enhancement in swing temperature reduction.
3. PCM has a high cost and some limitations such as its low thermal conductivity [103].

So, it is recommended to use PCM as an aiding storage system to store the excess heat and discharge it gradually such as PCM combined with HP, THE, or EAHE where PCM offers storage which helps in keeping the system for a longer lifetime.

Fixed Plate

It uses metallic plates to transfer the heat between fluids. Its novelty is through exposing the fluid to a greater surface area as fluids are blowout over different plates, this helps in increasing the heat transfer rate for compacted size. FPHE can transfer latent energy as well as sensible energy, especially when combined with Liquid Desiccant Dehumidification System (LDDS) [104]. Table I.1.9 shows the methodology and results of the papers that are related to the Fixed Plate membrane energy recovery effect on the HVAC system.

Table I.1.9: Summary of the investigated papers related to the Fixed Plate effect on HVAC systems.

| Authors | Methodology | Results |
|----------------------------|---|--|
| Zafirah et al., 2016 [105] | Tests were performed in a range of airflow rates from 1 to 3 m/s and intake relative humidity of 70 %, 80 %, and 90 %. | As airflow and RH rise, efficiency is reduced. The efficiency of the system varied between 40 and 74 %, the highest recovered energy was 1,456 W. |
| Nasif et al., 2015 [106] | Quasi-counter-flow HE designs including L-shaped, Z-shaped, and Z-shaped opposite flow Heat Exchanger (HE) were studied. | Results showed that L-shaped HE saved up to 75 GJ energy compared to Z-shaped and Z-shaped opposite HE. L-shaped HE recovered 90 GJ more energy compared to other HE configurations. |
| Shen et al., 2017 [104] | Fixed plate heat exchanger is united with the hybrid mass and heat transfer model in the regenerator. | 16 to 19 % of the total energy consumption was recovered from the outlet air which leads to energy savings of about 14 to 18 %. |
| Nasif et al., 2010 [107] | Performance of Z-type flow enthalpy membrane coupled in AC is investigated annually to measure the effectiveness of different climates. | Results showed that in tropical (humid climate) this system saved up to 8 % of energy annual consumption. But, in a moderate climate, it uses 4 % less energy than conventional AC. |
| Nasif, 2018 [108] | Investigating the effectiveness of applying Fixed Plate energy recovery heat exchangers for HVAC in buildings. | Results showed that this system recovered energy in a humid climate higher than that in moderate and dry climate conditions. |

Table I.1.9 exhibits the following conclusions:

1. FPHE is a promising method to save energy in HVAC applications.
2. It is noticed that the intake air conditions affect the performance of the system such as increasing airflow rate and RH because fixed plate HE transfers latent and sensible energy.
3. The shape of the fixed plate has a major effect on the amount of recovered energy, where results show that the L-shaped fixed plate shows higher recovered energy.

4. In addition, it is noticed higher recovered energy in humid climates than in dry and moderate climate environments.

I.1.5. Effect of weather conditions

Based on the above-investigated papers, it is observed that climate has a considerable effect on the performance of each device [109]. So, in this section, energy recovery devices will be classified according to their best climate conditions based on previous research.

All the papers agreed that the cost savings and efficiency of the system in winter are higher than that in summer [110]. Thus, heating is more efficient than cooling for the same system [111]. Also, Wu et al. [112] indicated that when relative humidity exceeds 70 % in hot and humid climates, latent heat becomes a significant constraint. Then, energy recovery devices are suitable for such climates due to their ability to transfer both latent and sensible heat systems [75]. Thus, rotary wheels and fixed plates can be used in cold humid climates but there is a freezing problem at very low temperatures. However, for the fixed plate, the condensation builds up problems, limiting its implementation in severely cold weather. In winter, it is found that enthalpy devices recover over 25 % of energy more than sensible heat devices. Whereas in summer, the energy recovery device recovers about three times as much energy as the sensible heat devices [113].

Ground heat pump (GHP) systems have been widely implemented in cold climates. Results showed that GHP in cold climate regions is slightly improved, where energy savings are around 7.2 % and energy cost savings on average 6.1 % [30]. Horizontal air-ground heat exchanger (HAGHE) system, which is a type of geothermal energy, reduces the consumption of energy in all seasons, they show high effectiveness in various climates (hot and humid, cold climate, tropical climate, Mediterranean climate, moderate climate, etc.) [114]. However, they perform optimally in a hot-arid climate, where a reduction of 66 % in the gradient temperature between the highest and lowest daily temperatures occurred over the year [88]. Whereas, in the cold climate, the reduction was lower [89]. Thus, EAHE performs in a hot-dry climate better than in a cold climate. These results demonstrate that GHP and EAHE are applicable in hot dry-climate regions.

An experiment was done in India showing that heat pipes (HP) saved maximum energy in warm-humid, and hot-dry climates [115]. Results also revealed that wraparound heat pipes, HPs wrapped around a cooling coil, are applicable for hot and humid climates [36]. Thermosiphon is also recommended to be used in a subtropical climate (hot and humid summers, cold winters) [116]. Thus, HP is mainly reliable in hot climates, however, there is a lack of research about HP in cold climates. So, it is recommended to do an experimental study that compares the use of HP in a cold dry climate and a cold humid climate.

OHPs are most efficient and cost-effective in continental climatic conditions (hot summers and cold winters); G. Mahajan et al. [80] estimated that when OHP was involved in Heat Recovery Ventilator (HRV), more than \$2500 were saved yearly in cities with continental climatic conditions. OHP-HRV offers a total average reduction of 16 % of energy consumption annually, so it shows high potential in dropping energy consumption as well as operating costs. Besides, it was shown that OHP is suitable for a sub-humid tropical climate, where the WHR of the heating mode exceeds 80 % of the total annual WHR. Thus, OHP is reliable in a hot humid climate. It is recommended to study OHP efficiency in a hot dry climate and compare it to a hot humid climate.

PCM revealed good results for both heating and cooling [117]. Yet, its optimal performance depends on the chosen material, for example, in a cold climate, the material's melting point should be around 26°C, while in hot climates, a 20°C melting point leads to better energy savings [118]. Research revealed that PCM is reliable in a tropical climate non-arid climate, like Chennai [119].

Figure I.1.6 proposes a classification of the devices according to their best climatic condition, where each device achieves its optimal effectiveness. For example, RW showed high effectiveness in all climates, but its efficiency in humid is better than in arid so it is placed in humid climates similarly to EAHE, which shows significant results in a hot dry climate as mentioned in this section. The same procedure goes for the other devices that offer their optimum performance according to the climate.

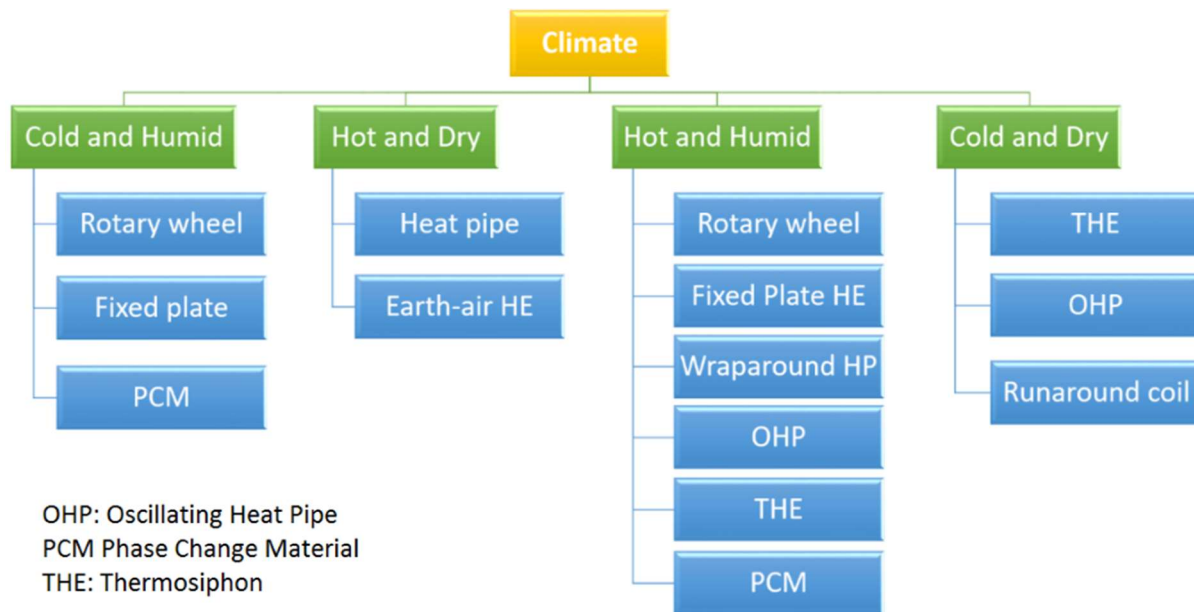

Figure I.1.6: Heat recovery devices according to the climate.

I.1.6. Economic Study and Discussion

Studying the effect of employing heat recovery systems in HVAC from an economical perspective is critical to make sure that the addition of such a system is worth the investment. Li lingxue [120] conducted an economic study on the employment of air-water-cooled air conditioning systems. Results show that this system saves around 89822 kWh, with nearly 90000 yuan for a year, if the average price is 1 yuan per kWh. Thus, the investment in the system can be recovered in the first year. Moreover, Yau et al. [121] studied the effect of HPHE, where it was obtained that a total amount of 2885 kWh can be saved yearly; and this amount can be raised to 7023 kWh per year if eight-row HPHX was used. In another study, Mahajin et al. [80] showed that the OHP system is energy and cost-effective since a reduction of total average consumption was observed, around 16 % yearly. Besides, OHP can save, annually, more than 2500 \$ in cities that have continental (warm to hot summer and severe cold winter) climatic conditions.

A study involving HPHE in the HVAC system was made, where the HPHE is used to recover heat from the exhaust air, in heating mode, and transfers it to the cold inlet fresh air whereas, in cooling mode, it pre-cools the hot inlet fresh air. It was found that the optimal point had an effectiveness of 0.774 and a total cost of 1474 \$ with a return period of about 2.5 years [76]. Precooling or preheating air is considered to be very effective as Ahmadzadehtalatapeh [77] showed that the results revealed that by reheating and pre-cooling, a total amount of 236.9 MWh of energy could be saved yearly. This amount results in saving 24,572 \$ annually.

Another study on thermosiphon THE heat recovery unit in shopping centres under different seasons was conducted. It was noticed that the seasonal temperature effectiveness of THE was 55.43 % in summer and 66.08 % in winter with a payback period of about 2.5 years [122]. Wallin et al. [15] performed a study on improving heat transfer through the run-around coil. Results showed that the annual HR rate was improved from 47 % to 66 %. The system shows considerable and affordable results, for the three-stage heat pump design, the payback period was 5.7 years, and for the variable heat pump capacity design 6.2 years. As noticed from previous work, HR is an added value to HVAC systems under different conditions. Despite, the additional cost that the recovery system requires, the system saves a remarkable amount of energy over time.

In particular, RW and FPHE have the highest efficiency due to transferring both sensible and latent heat, which increases their efficiency among other systems. Consequently, they mainly used humid weather to benefit from the latent energy, where energy recovery increases when the temperature of fresh air and moisture content increases, subsequently the chance to recover heat using EW rises. So, RW and FPHE are highly recommended for humid climates. On the other hand, the disadvantage of RW is that it may not be used for hospitals due to contamination matter. So, FPHE is a good alternative especially since it has no moving parts. However, it has frosting problems, high-pressure drops, and condensation build-up that should be taken into consideration. The ability of FPHE and RW to recover both latent and sensible energy gives them the credentials over the heat recovery devices, although HP is also considered one of the most commonly used in HVAC besides the FPHW and RW.

Concerning heat recovery devices, it is noticed that OHP in continental climates can save more energy. However, the efficiency of THE in winter is higher than that in summer. Integrating run-around coil with HVAC was not available as much as other heat recovery devices, however, this technology is noticed to be effective in cold climates. Thus, the righteous device depends on the location and weather.

Air-to-air HE decreases considerably the energy consumption, but there are some limitations according to its characteristics and specific configuration. As for air-to-water HE, it is considered to be more efficient due to the high heat capacity of water which allows it to conduct heat about 25 times faster than air does. The increase of outlet temperature of the water as the load increases. This indicates that applying air to the water HE in buildings that have high use of HVAC is very efficient.

EAHE is effective in severely cold/hot weather when the temperature is high which results in a higher temperature gradient, which means higher heat transfer. Besides, it is noticed that the EAHE is most efficient in hot dry climates weather.

Some devices were remarkably noticed; however, they do not offer a significant output such as TEG, which may be used easily with no moving parts, which eliminates the maintenance cost. Yet, they offer slight improvement due to their low efficiency.

Thermal Energy Storage systems provide a good opportunity for energy storage. Merging PCM with other systems is advised since PCM offers the opportunity to store energy, whereas adding PCM slows the temperature rise and guarantees the safe operation of the devices over the years. Consequently, integrating more than one recovery device offers significant output, for instance, combining TEG or PCM with other systems, where PCM possesses a significant effect in terms of energy-saving and storage. This opportunity of storing energy slows the temperature rise and guarantees the safe operation of the devices over the years, besides, it prevents the other devices from overheating, which is considered a double-phase benefit. So, it is recommended to use PCM as an aiding storage system to store the excess heat and discharge it gradually such as PCM combined with HP, THE, or EAHE where PCM offers storage which helps in keeping the system for a longer lifetime.

I.1.7. Conclusions

This review has covered the main methods of energy management in HVAC by investigating more than 190 papers and then classifying them into specific categories to conclude that heat recovery (HR) is an important issue in HVAC. The challenge is not just to recover the wasted heat; the challenge is to recover the maximum wasted heat possible. It also presents historical notes on main energy recovery devices. Then, it discusses HR systems and their effects from already published papers. As well, it provides a table about the working process, pros, and cons of each device. Finally, it presents the best weather conditions for each system. From this review, the following outcomes were concluded:

- Air-water HE is a very effective method to save energy. This is due to the water's thermal properties, which have higher thermal conductivity and specific heat capacity than air. As the load increases the outlet temperature of water increases, this indicates that applying air-water heat exchangers in buildings that have a high use of HVAC is very efficient.
- TEG has low efficiency due to its design. However, it shows significant results in HVAC applications due to its main advantage, which is generating electricity from even small-grade waste heat. Accordingly, this is considered a great solution in the future to decrease the cost of power generation. Yet, the main challenge in TEG is to increase its efficiency.
- Smart systems have acquired high attention in HVAC for their ease of use and significant positive effect on saving energy, but they require high cost and accuracy in construction.
- The most commonly used types of heat recovery are heat pipe, fixed plate, and rotary wheel devices for their advantages over the other devices.
- PCM provides a great opportunity for energy storage since it possesses a significant effect in terms of energy-saving and storage. Besides, the PCM + EAHE system showed significant results, which widened the research for involving PCM more in other systems, especially in hot climate regions.
- Systems that recover sensible and latent energy (RW, FPHE, and PCM) are efficient in a humid climate. Thus, they are most efficient in a non-arid climate. However, RW and FPHE are efficient in humid climates because there is a limitation on very low temperatures that cause freezing and condensation problems. Besides, it is concluded that GHP and EAHE are applicable in hot dry-climate regions.
- Papers on integrating run-around coil with HVAC were not available as much as other heat recovery devices, however, it is concluded that this technology is noticed to be effective in cold climates.

Finally, some recommendations appear:

- Do research that involves the smart system in heat recovery devices, where smart systems reduce energy consumption and heat recovery (HR) systems recover waste heat.
- Involve TES systems more often with other HR systems, where TES system offers the storage opportunity which helps in keeping the system for a longer life such as:
 - PCM combined with HP, THE, TEG, or EAHE.
 - TEG combined with HP where HPs provide higher gradient temperature.
 - TEG combined with PCM and HP.
- It is recommended as well to study the hybrid heat recovery systems which means a system that combines more than one heat recovery as it was found that some previous work revealed that HHRS is promising in different domains.

Throughout the research, it is noticed that hybrid heat recovery systems, which means employing more than one heat recovery system into one single system, are showing great potential in many applications, where the recovery systems exceed 28 % of better efficiency and the coefficient of performance reaches 2.2 times the conventional system. At this point, the coming study presents a comprehensive review of hybrid heat recovery systems and gives a rich and useful summary of previous works. The main aim is to (1) classify energy recovery systems into specific methods, (2) provide an overview of hybrid energy recovery systems, (3) demonstrate a detailed description of each method, (4) point out their applications, (5) present innovative systems, and (6) show the pros and cons of each system alone and each system combined into a hybrid heat recovery system. Finally, answers the main question which is: Is the rise in the percent of heat recovery in a hybrid heat recovery system worth employing a complement or new heat recovery system, or may it cost more than it recovers?

I.2. A Comprehensive Review on Hybrid Heat Recovery Systems: Classifications, Applications, Pros and Cons, and New Systems

Résumé (en français)

Avec l'augmentation de la consommation d'énergie, l'épuisement des ressources naturelles et les problèmes d'impact des sources d'énergie conventionnelles sur les changements climatiques mondiaux, il existe une demande croissante pour la récupération de chaleur qui permet de récupérer plus de 90 % de l'énergie perdue. Dans cette étude, on montre que les systèmes hybrides de récupération de chaleur, qui consistent à utiliser plus d'un système de récupération de chaleur dans un seul système, affichent un grand potentiel dans de nombreuses applications, car les systèmes de récupération dépassent 28 % d'efficacité supplémentaire et le coefficient de performance atteint 2,2 fois celui du système conventionnel.

L'étude actuelle présente un examen complet des systèmes hybrides de récupération de la chaleur et fournit un résumé riche et utile des travaux antérieurs. La démarche adoptée est de (1) classer les systèmes de récupération d'énergie en méthodes spécifiques, (2) fournir une vue d'ensemble des systèmes hybrides de récupération d'énergie, (3) présenter une description détaillée de chaque méthode, (4) souligner leurs applications, (5) présenter des systèmes innovants, et (6) montrer les avantages et les inconvénients de chaque système seul et de chaque système combiné dans un système hybride de récupération de chaleur.

Enfin, cette étude montre que la récupération de chaleur hybride est une solution prometteuse, en particulier lorsqu'elle est combinée à des générateurs thermoélectriques (TEG), 60 % des études impliquant des TEG dans un système de récupération de chaleur hybride. En outre, cette étude répond à la question principale suivante : l'augmentation du pourcentage de récupération de chaleur dans un système de récupération de chaleur hybride vaut-elle la peine d'employer un système de récupération de chaleur complémentaire ou nouveau, ou risque-t-elle de coûter plus cher que ce qu'elle récupère ?

I.2.1. Introduction

Energy has always been a vital source for the survival of all living beings, where it is essential for evolution, development, preservation, and generating power. Nowadays, with the augmentation of industrial progression and the vast expansion of applications that require work, human beings become highly dependent on energy. For instance, in India, energy consumption has developed 16 times during the last six decades [123]. The International Energy Agency (IEA) expected that in the next decade, worldwide energy consumption would be elevated by more than 53 %; mainly due to the quick development of industries [124]. Moreover, the accumulative call for energy is estimated to be more intense, mainly in rising countries due to the development of new constructions. A long time ago, fossil fuels (natural gas, coal, oil...) were the main sources of energy, yet, with the rise in their cost and the pollution impact they have on living beings, it becomes urgent to press the call for alternative means of energy sources. This shed the light more on renewable energy but also on recovering lost energy: Heat Recovery (HR) studies show that 66 % of primary energy source is being lost mainly as waste heat, which leaves only 34 % to be effectively used [125] as illustrated in Figure I.2.1. So, recovering a part of the lost energy is a current challenge for many researchers.

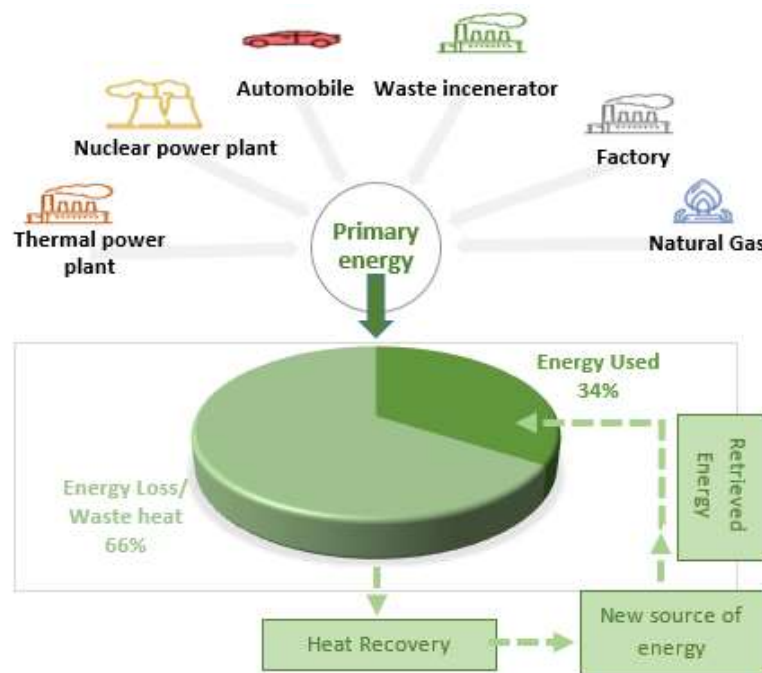

Figure I.2.1: Energy statistics: waste heat recovery.

The high demand for energy and attention to the environment besides the huge sum of lost heat [126], encourage researchers to work hard on creating novel systems [127] and finding energy reduction techniques [128] that recover a significant percentage of wasted energy from primary sources. In industries and modern manufacturing, recovering wasted heat is a must, where a bulk amount of heat is lost due to high energy consumption. For instance, industries that operate on gas turbines [129], boilers [130]

turbomachines [131] turbocharger compressors [132] consume a large amount of energy and generate a considerable loss of energy which appears in the form of thermal energy. However, several forms of energy recovery methods capture, and reuse wasted energy again as shown in Figure I.2.2. Each method possesses advantages depending on the application, the rate of heat recovery may reach up to 90 % according to some used devices. Figure I.2.2 shows energy recovery methods that are classified into (1) energy recovery: systems that recover lost energy (sensible and latent), (2) heat recovery: systems that recover heat loss, (3) kinetic energy: systems that recover the loss in kinetic energy for example in Formula 1 [133], and (4) storage, where storing the collected energy is fundamental for reuse later.

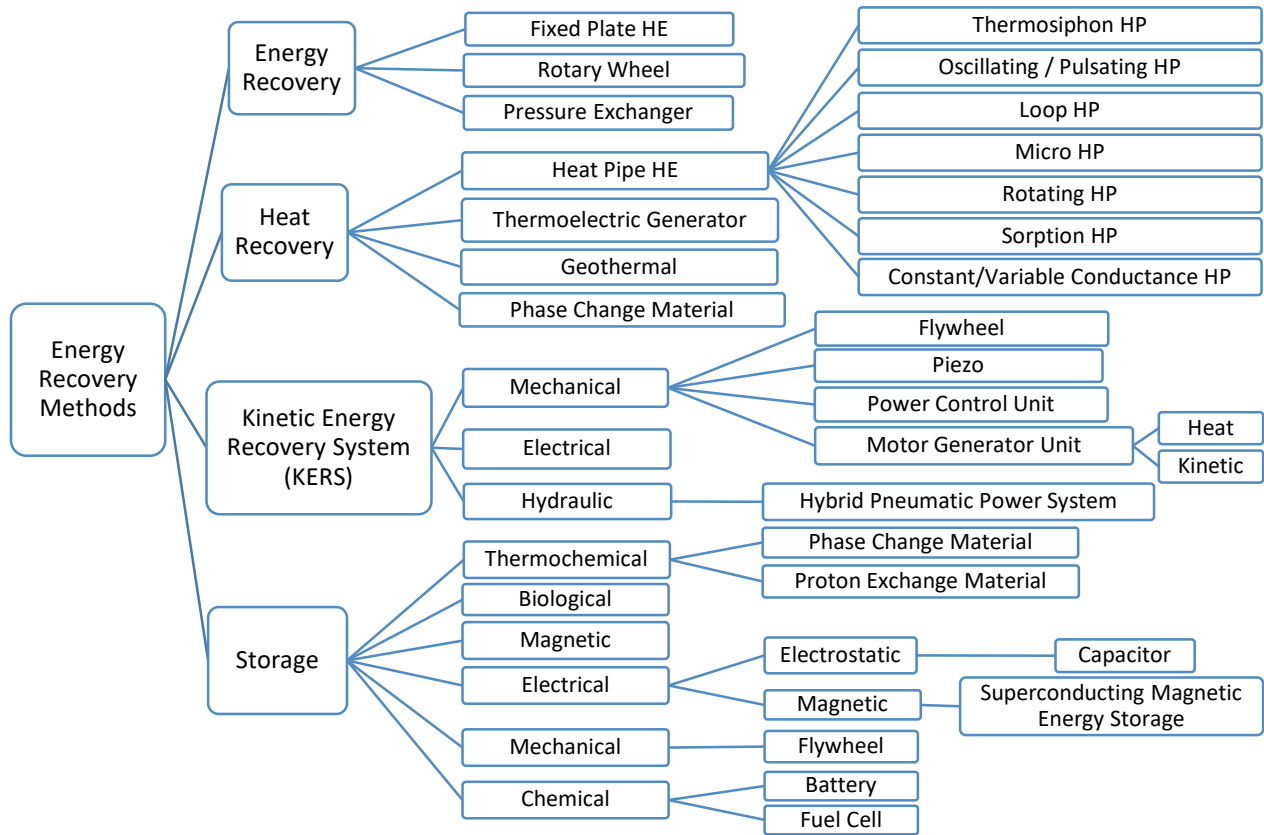

Figure I.2.2: Energy recovery methods.

Significance of Hybrid Heat Recovery System

The high energy demand problem and the high cost of generating energy sources (including environmental impact, and depletion) [134], impose integrating energy recovery devices in several applications, where rarely are the systems that do not involve at least a single energy recovery method. The idea of hybrid systems is spread not just for recovery systems but also to benefit from combining at least two systems. For instance, Al Turki et al. [135] executed a hybrid desalination system which may function by renewable energy sources. Recently, it has been noticed that many usages involved the Hybrid Heat Recovery System (HHRS), which means integrating more than one HR method at the same time [136]. When using a mono HR system, a percentage of the wasted energy is recovered which mainly depends on

the efficiency of the HR system. But the question that this review intends to answer is: Is this rise in the percentage of energy recovered worth employing a new recovery system?

This review investigates over 200 published papers starting from 1985. Figure I.2.3 shows that the number of studied papers on HHR has been significantly increasing year after year. After 2015, the number of papers exceeded 30 to reach the highest number (43 papers) in 2019-2020. Globally HHR systems are applied repeatedly in many applications [137] and fields such as vehicles [138], electronics [139], desalination [135], boilers [140], internal combustion engines [141], solar systems [142], heating, ventilation, and air-conditioning, buildings [143] refrigeration cycle [144], and various applications [145]; this attentiveness to HHRs motivates the writing of this review paper on the HHR methods.

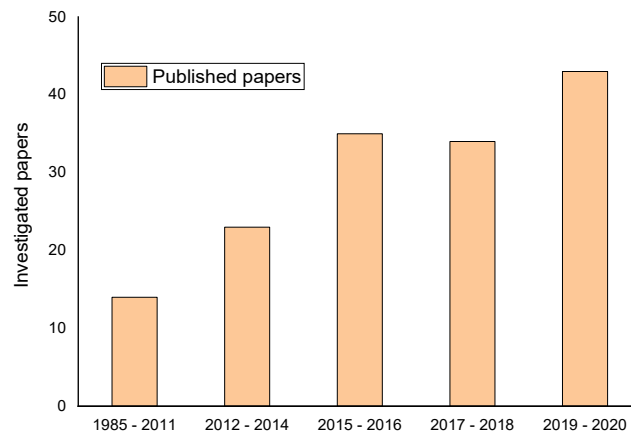

Figure I.2.3: Investigated papers according to years.

Among the main review papers, it is realized that no review has discussed the types of HHR methods and their differences among each system. However, they mainly reviewed a specific type of HHR in different applications, for example, Ali [146] reviewed the HP-PCM (Heat Pipe–Phase Change Material) system in many fields such as Thermoelectric Generator (TEG). Patil et al. [147] started a review of Thermoelectric Materials (TEM) and Heat Exchanger (HE) for generating power. Also, Soni et al. [148] executed a review on hybrid systems with the Earth-to-Air Heat Exchanger (EAHE) system such as PCM. Moreover, De Lovato et al. [149] did a review on the application of HR in power plants that run on solar and geothermal sources. Additionally, Khan et al. [150] executed a review on hybrid renewable energy for water desalination applications. Furthermore, Zhu et al. [136] reviewed the WHR from the marine engine and Xu et al. [151] did a review on the WHR of the organic Rankine cycle in a heavy diesel engine. Besides, Mohtaram et al. [129] conducted a study on a waste-to-power generation system integrated into the ammonia-water dilution Rankine cycle and another study [127] on exergy and energy analysis of adiabatic compressed air energy storage.

Thus, several topics were discussed in the aforementioned papers, some papers described specific hybrid systems such as TEG-HP or HP-PCM, and some papers reviewed WHR or hybrid renewable energy systems. However, none of them performed a review of the HHR systems in general.

So, based on these observations, this paper aims to:

1. Provide a review on HHR which is studied intensively.
2. Compare the HHRS with a conventional recovery system.
3. Find out if the increase in efficiency provided by the HHR system is worth the addition of the hybrid system.

The novelty of this research is:

- a. Providing charts that classify ER methods and HR methods.
- b. Displaying the main traits of each HRS and their advantages when combined with other HRSs.
- c. Reviewing HHR, where research lacks review papers on HHRSs.

This review presents seven sections: (1) introduction to hybrid heat recovery, (2) overview of previous works on HHR systems, (3) specific classification of the HHR systems, (4) application of HHR systems, (5) new HHR systems, (6) materials for ideal heat recovery devices and the advantages of combining heat recovery systems, (7) most commonly used system, where throughout the research, it is noticed that TEG has the highest share in HHR due to its advantages over other systems, and finally the last section (8) is devoted to the usage of Vortex Generators (VGs) for enhancing heat transfer in conventional HRSs.

I.2.2. Overview of previous works on Hybrid Heat Recovery Systems

In this section, an overview of the previous review papers is presented and a discussion over the storage system is taken as well. Naghavi et al. [152] did a review of hybrid HP-PCM systems and concluded that this combination overcomes some limitations such as Heat Pipes overheating and the PCM's low thermal conductivity, besides increasing the efficiency if coupled with a solar system. Another review done by Ali [146] shows an agreement with the results of Naghavi et al. [50] where the hybrid HP-PCM system slows down the increase in temperature, which guarantees safe operation over the long lifetime of the devices. Orr et al. [153] conducted a review of the TEG-HP in HHRSs highlighting that they both are solid-state, silent, passive, durable, and scalable. Besides, it presented the advantages of combining TEG-HP to conclude that combining these systems appears to be very reliable.

All the above review papers present the advantages of the hybrid systems and the gap when each HRS is used alone, these advantages are presented in a chart in section 6. Among the research, it is found that there is a lack of experiments and simulations on the Hybrid Thermal Storage System (HTSS). Thermal energy storage (TES) was mainly combined with (i) heat recoveries such as PCM-HP [154] or PCM-TEG [155], and (ii) Energy Electrical System (EES) which means thermal-electrical. In this paper the concern is about thermal storage, however, a glance over electrical storage will be presented as it appeared frequently throughout the research process. To simplify the analysis, hybrid energy storage is classified into three types as shown in Figure I.2.4: Hybrid Energy Storage System (HESS) which is related to storing energy in general, Hybrid Electrical Thermal Storage System (HETSS) which is related to a combination of devices to store electrical and thermal energy, Hybrid Electrical Energy Storage (HEES) which is related to storing energy in the electrical form.

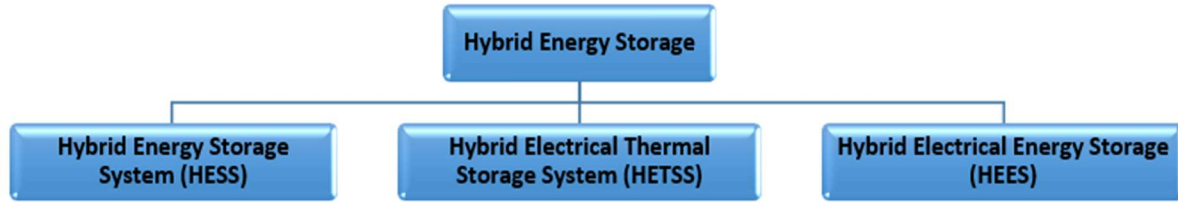

Figure I.2.4: Hybrid energy storage types

I.2.2.1. Hybrid Energy Storage System (HESS)

HESS is a combination of more than one storage system, it can be classified as Electrical Energy Storage (EES) and Thermal Energy Storage (TES). Recently, the Hybrid Thermal Storage System (HTSS), which means employing more than one thermal energy storage system at the same time, was studied in a different aspect. In 2020, Abdelsalam et al. [156] developed numerical research to study the HTSS which is presented by a water tank comprising modules of PCM. Results showed that adding PCM modules to the water tank reduces volume storage by 40 %. Hosseinzadeh et al. [157] studied the effect of hybrid nanoparticles and fins on the solidification process in a novel hexagonal triplex with fins integrated into the latent heat TES system. Results showed that this system increases the solidification process by up to 12 %.

I.2.2.2. Hybrid Electrical Thermal Storage System (HETSS)

As mentioned above, HETSS has a significant share in hybrid systems. It is presented by employing PCM or PEM with any heat recovery methods such as TEG that recovers the waste heat from PEM [158]. Bilodeau et al. [159] presented a combination of electrical and thermal energy storage which showed reductions, yearly, around 13 % of overall electric consumption, and 35 % of cooling operations. Besides, HETSS can reduce the size of the generator as well as the backup power. This leads to lower costs, higher system efficiency, and a higher lifetime due to optimizations. Teng et al. [160] showed by simulation that HETSS is more flexible and economical than ESS; moreover, it can upgrade the system's accommodation. Mehrjerdia et al. [161] concluded that EES decreases the cost by around 15 %, TES reduces the cost by around 17 %, and the coordinated system HETSS reduces the cost by around 34 %. Thus, employing HETSS achieved the best functionality.

I.2.2.3. Hybrid Electrical Energy Storage (HEES)

With the rapid pace of installing the Renewable Energy System (RES) described by Wang et al. [162], the energy storage system has become a fundamental sector to develop, as said by Jing et al. [163]. ESS typically experiences an unbalanced discharging/charging pattern which decreases the ESS lifespan, consequently, the cost of the system increases due to substituting costs. Hajiaghasi et al. [164] in a review paper on HESS mentioned that many researchers studied the effect of HESS, and the result was positive in all the studies. Besides, the above-mentioned review paper and Choi et al. [165] agreed that HESS can overcome the above challenges in RES and microgrids, where it can deliver a suitable dynamic response and raise the lifespan of the storage system compared to ESS. Also, to overcome the limitation of the power delivery in batteries and ES in ultracapacitors, Lukic et al. [166] proposed HESSs which can provide three

times the power of the battery alone. Similar enhancement was shown with an active control having only one-third of the Ultracapacitor's (UC's) numbers.

Glavin et al. [167] employed a hybrid storage system of super capacitor-battery in Photovoltaic (PV), and the results showed that HSS attained higher specific power than the conventional battery storage system. Bocklisch [168] studied four different configurations of HESS with a discussion on its applications to conclude that HESSs are quite promising and remarkably flexible technology, that can overcome fluctuations over short, mid, and long terms in a 100 % Renewable Energy Systems (RES). In conclusion, HESS shows desirable results when combining more than one storage system, the longevity of the system is increased, more power is stored, and higher stability is obtained [169]. Applying HESS can save up to 15.9 %–20.8 % of the energy consumption in vehicles and improve life-cycle costs from 26.5 % to 28.1 % [170], thus employing an additional storage system has great potential.

I.2.3. Hybrid Energy Recovery Methods

Hybrid Energy Recovery (HER) is studied in various applications, and it showed significant results in all fields. However, the concern of this review is to study HHRs. So, in this section, a classification of HER systems is presented while discussing only HHR systems. Besides, an overview of previous research on each field of the hybrid heat recovery system is done according to the investigated papers that were studied. The classification of the HER system is shown in the chart in Figure I.2.5, it is classified as follows:

- Hybrid Heat Recovery combines two or more methods to capture the energy that is lost from heat. HHR methods are based on (i) TES-HR, which is a combination of Thermal Energy Storage presented by PCM or PEM and any type of HR methods (TEG-HP...); (ii) Electrical, which means employing methods that capture wasted heat and convert it into electricity alone or electricity combined with heating water; (iii) HP-Geothermal, which involves Heat Pipe in Earth Air Heat Exchanger (EAHE) and Ground Heat Exchanger (GHE).
- Hybrid Energy Recovery, captures lost energy in any energy form such as (i) TEG-piezo: which uses thermal and mechanical waste energy to produce electricity; (ii) Hybrid Kinetic Energy Recovery System (KERS) is mainly employed in formula 1, or the hybrid energy harvester triboelectric (harvest KE) and piezoelectric (harvest thermal energy) [171]; (iii) Hybrid energy storage combination is used to store electrical energy or thermal-electrical energy. Other examples of HERSs are pressure exchangers to recover the pressure loss from the exit flow, such as the brine flow in reverse osmosis.

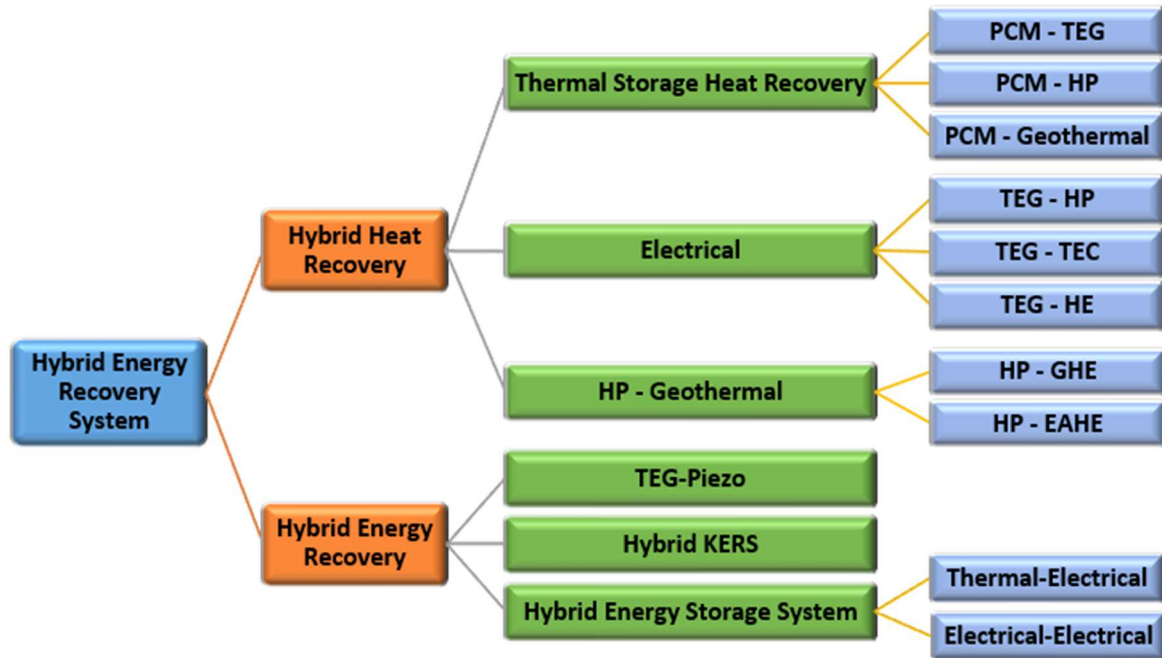

Figure I.2.5: Hybrid energy recovery methods.

In the following part, some investigated papers are presented in tables to demonstrate their studies and discuss the collected results. The papers are divided according to the chart in Figure I.2.5.

I.2.3.1. Thermal Energy Storage

As mentioned previously TES is an important factor that stores captured energy. PCM is one of the TES systems that can absorb, store then release significant quantities of latent heat [172]. Table I.2.1 sums up the methodology and results of some investigated papers related to Hybrid Thermal Energy Storage (HTES), such as PCM combined with other HR methods.

Table I.2.1: Summary of the investigated papers related to waste heat recovery from PCM and other systems.

| TES | Authors | Methodology | Results |
|--------|---------------------------|---|--|
| PCM-HP | Motahar et al. 2016 [173] | Experimental module was done to study heat transfer enhancement in a PCM with and without HP. The melting and solidification studies of PCM were done at a constant temperature fluid in the heat pipe. | The melting and freezing rates were intensely boosted when using HP: a growth of 15 °C in temperature drops the melting time by 53 % in the melting process, and a decrease of 10 °C in temperature reduces the solidification time by 49 % in the solidification process. |
| | Krishna et al. 2016 [174] | HP and nano PCM are used for electronic cooling. The PCM is put around the adiabatic part of HP, where heat is absorbed and then | The temperature of the evaporator in HP with nano PCM is reduced by around 25.75 %, which saves about 53 % of the fan’s power as compared to the conventional HP. It was also |

| | | | |
|------------|--------------------------|--|--|
| | | released relying on the input power of the evaporator and the speed of the fan at the condenser. | found that the nano PCM can save nearly 30 % of the provided energy at the evaporator, which reduces the consumption of fan power. |
| | Weng et al. 2011 [175] | PCMs are used around the adiabatic part of HP, where heat is absorbed and then released relying on the input power of the evaporator and the speed of the fan at the condenser. | The cooling component of tricosane as PCM can store 46 % of the fan's power and an average of 12.3 °C heater temperature as compared to the conventional HP (without thermal storage material). |
| | Pan et al. 2018 [176] | A novel PCM with finned HP as a cooling system is investigated. Various parameters such as fin thickness, the conductivity of PCM, and the solidification requirement are expected to affect the cost of the system. | The overall cost is around 30 \$/kW, which meets the time requirement (10 h solidification), this cost is positive and acceptable in the market. It can also be concluded that the longitudinal and circular fins attached to an HP have similar performance in terms of cost-effectiveness. |
| PCM-HP-TEG | Kilkis 2020 [177] | TEG-PCM in photovoltaic thermal (PVT) units, with heat pipe thermal control. The efficiency of the rational exergy management model was obtained using pilot-scale tests and compared with conventional PVT. | The efficiency was around 25 % more than the conventional PVT system and the overall net electrical output power per unit insolation solar area exceeded 30 %. In summer, exergy total output (heat and power) is doubled that of a conventional PVT unit. |
| | Tan et al. 2011 [178] | Two-phase closed thermosiphon (TPCT) (working fluid acetone and filling ratio at 40 %) is used with TEG, which is cooled by PCM (paraffin wax) as a storage tank for heat. | The thermal performance of the system is studied numerically. Thermal storage of PCM and TPCT can uphold a temperature gradient of 152 °C and generate 9.5 W of thermoelectric power. |
| | Atouei et al. 2017 [179] | Two-stage TEG is joined with PCM. In 1 st stage, a TEG module is fitted between a PCM (cooling/heat sink), and a heater (heat source). The heat sink PCM is a source of heat for the 2 nd stage, where five smaller TEG modules are set up around the PCM, with one heat sink for cooling. | The proposed system produces 27 % more electrical voltage than the system with a one-stage TEG. Moreover, when the heater is dispatched, the TEG provides an average of 0.377 V open circuit voltage for around 7900 s, while the one-stage TEG produces this voltage just for 2100 s. |
| PCM-TEG | Zhang et al. 2011 [180] | Numerical and experimental analyses of TEG-PCM are developed. A comparison of TEG with and without PCM is also demonstrated. | Results show the importance of PCM and the ability to produce power continuously day and night. The period of generating energy TEG-PCM is four times more than that without PCM. |
| | Jo et al. 2013 [181] | TEG embedded PCM is proposed for waste heat recovery, as PCM saves an immense amount of heat. A comparison of TEG with and without PCM is done when the heat source is separated from the TEG. | When the source is detached, the output power of TEG-PCM gradually drops, whereas the output power of conventional TEG falls fast. So, TEG-PCM can uphold the generation of power for a long time even without a heat source. |
| | Mao et al. 2018 [182] | A system of TEG embedded in PCM to recover the wasted heat energy is proposed. Paraffin wax by 0.5 wt % | As the heat source is dispatched, TEG provides electricity continuously with the heat stored in PCM. Temperature can be |

| | | | |
|----------------|--|---|--|
| | was used in PCM. The output voltage is measured in TEG-PCM and compared to TEG without PCM when the heat source is dispatched. | maintained for about 60 to 100 s in TEG-PCM. Output voltages are about 0.4 to 0.6 mV more than TEG alone. The extreme output voltages rise by 10.2 to 13.7 %, and the average total electricity escalates by 31.6 %. | |
| PCM-Geothermal | Bottarelli et al. 2013 [183] | To study the effect of PCM on GHE and implementation of a finite element was modelled to simulate the heat transfer that occurred. A PCM layer is placed to reduce the rapid cooling on the ground loop coil. | PCMs with GHEs were favourable as they eases rapid cooling. There is the possibility of stabilizing heat removal. The highest temperature outcomes can be smoothed by up to 0.7 K as compared to a case with no PCMs. PCM could be designed to preserve drained heat from winter to summer. |
| | Soni et al. 2016 [148] | PCM-EAHE is employed. The effect of PCM on EAHE is studied to investigate the cooling effect. This system is environmentally friendly. | The cooling effect is raised by 69 % and shrinks the length of the buried tube up to 93.5 %. EAHE with PCM enhanced the cooling effect by up to 47 % as compared to the conventional AC system. |
| | Bonamen te et al. 2016 [184] | Thermal storing material is studied: 1 st case uses water as thermal storage, 2 nd the case, PCM as thermal storage. The driving energy input and output energy generation performance is investigated. | COP is increased up to 20 %. In 1 st case (of water), COP is 4.1 in winter, 5.7 in summer. In the 2 nd case (PCM), COP is 4.1 in winter and 5.9 in summer. Thermal storage in the 2 nd case is around 10 times smaller than that of the 1 st case and can be simply sited within the technical room. |
| | Rodrigue s et al. 2013 [101] | Experiments were done to test the PCM integrated with EAHE, where EAHE discharges heat deposited in PCM to provide thermal stability with low energy usage. | PCM alone (without EAHE) can reduce swings in temperature by 33 %. The hybrid system of 0.02, 0.04, and 0.05 m ³ /s airflow rates for 24 h resulted in a reduction in temperature swings by 47 %. |

As presented in Table I.2.1, PCM is a beneficial method to store thermal energy. However, many factors affect its efficiency and extend its storage time such as parameters, design, and material used. The material used is expensive [185], so it is recommended to conduct more research on it.

Table I.2.1 shows that integrating PCM with any heat recovery is a very effective method. In all cases, energy recovered was improved, and employing PCM was worth the cost, the results in the papers that studied the hybrid system show that integrating PCM is acceptable in the market. The following notes were concluded:

1. PCM-HP revealed a promising cooling technology: it reduces the energy consumption of the fan used. PCM-HP system can be employed with TEG as well to provide an effective system.
2. PCM upholds the generation of power in TEG for a longer period even with no heat source, which results in increasing the power output. Besides, it protects the unit from high temperatures or overheating. HP regulates temperature and transfers a higher amount of energy passively. Also, employing this system in PV with proper design can reduce the necessity for batteries.
3. Forced convection enhances heat transfer and increases efficiency, however, there is no financial study that suggests if it is worth adding power input.

4. PCM-EAHE is favourable for enhancing the cooling effect and saving volume storage, it would make a great candidate to study in terms of cost, where it could be designed to preserve drained heat from winter to summer.

I.2.3.2. Electrical and Geothermal

Geothermal energy is a free source of thermal energy produced and stored inside the Globe. It is mainly used in heating and cooling applications. Geothermal (EAHE and GHE) combined with HP is considered a remarkable technology as well as the technologies that transform lost heat into electrical energy such as TEG. Table I.2.2 sums up the methodology and results of some investigated papers related to TEG and geothermal with other HR methods.

Table I.2.2: Summary of the investigated papers related to waste heat recovery from TEG and other systems.

| TES | Authors | Methodology | Results |
|--------|-----------------------------|--|---|
| | Orr et al. 2016 [186] | TEG-HP is designed to recover the heat loss from the exhaust gas on a 3.0 L V6 engine car. This system reduces the consumption of fuel, and emissions of CO ₂ , which leads to lower running costs. | During all various conditions of the investigation, the loss of power due to a pressure drop was all the time less than the output of the electrical power. TEG efficiency reached 2.46 %. The saving in fuel consumption, and reduction in fuel costs and emissions of CO ₂ , was 1.57 %. |
| | Cao et al. 2018 [187] | TEG-HP in the exhaust gas in a vehicle of a maximum power reached 300 °C and 80 kg/hr flow rate. Open circuit voltage (OCV), max. output power (OP), and max. power density (PD) was obtained and compared to TEG without HPs. | When adding TEG with HP the OCV by 7.5 %, max. OP by 10.17 % and max. PD by 15.49 % as compared to the ones without HP, where open circuit voltage reached 81.09 V and output power 13.08 W. Max power efficiency was 2.58%. These results show the adequacy of using TEG-HP in the automobile. |
| TEG-HP | Sulaiman, et al. 2019 [188] | PEM-FC integrated with TEG, and HP in a mini vehicle was successfully established. The system is tested at 37 °C waste heat temperature and a speed of 20 km/h. | The top voltage of 25.7 mV and power of 218 mW were attained with forced convection and at the orientation of normal flow. The success of this modelization would open the gates for further developments to reach higher performance. |
| | Orr et al. 2014 [189] | TEG-HP system is hired to recover WH from a car's engine. Ten modules are used to find the thermal, and electrical power produced. | With ten modules, 2141 W of heat and 59.72 W of electrical power transfer are produced with an efficiency of 2.79 %. |
| | Remeli et al. 2015 [190] | Eight TEG sandwiched between two finned HPs to attain temperature difference through the TE. | Results show that this system can recover 1.345 kW of the wasted heat and generate 10.39 W of electrical power. |
| | Miljkovic et al. 2011 [191] | TEG with thermosiphon (THE) is being employed in the solar system | Ideal efficiency was 52.6 % attained at cycle temperatures of 776 K. |

| | | | |
|---------|----------------------------|--|---|
| | Remeli et al. 2016 [192] | TEG sandwiched in between two HPs. 1 st HP was coupled with the hot side and the 2 nd with the cold side of TEG. The waste heat was seized by a 2-kW electric heater for warming. | The top efficiency was 41 % at 1.1 m/s airspeeds. Recovery was about 1079 W of heat generating about 7 W of electric power. This means 0.7 % of thermal-to-electric transformation effectiveness was attained. |
| | Jaber et al. 2019 [193] | A Hybrid system to provide electricity and hot water is proposed using 100 TEGs to generate electricity. Changing the load of the generator is done to study its effect on the water's temperature and power produced. | Results reveal that at a load of 10 kW, the temperature of hot water reached 47 °C, and 141 W was generated. As the load of the generator is augmented to 38 kW (14.12 W for each TEG), the temperature rises to 97 °C and the power produced reaches 1412 W. |
| | El Hage et al. 2019 [194] | Short review that inspects four main uses of heat recovery from cookstoves, the exhaust gas of chimneys, electric generators, and drain water. | Results show that recovering heat from the exhaust gas of chimneys is very beneficial. The recovered heat is mostly applied to heat water and produces electricity via TEG. |
| | Feng et al. 2018 [195] | A thermodynamic model of TEC energy by TEG device is proposed. A numerical calculation study is held to investigate optimal performance. The impact of the Thomson effect is examined by comparing the model (TEC) in two cases (1) with and (2) without the Thomson effect (TEG). | Results display that the Thomson effect drops the capacity of cooling of TEG-TEC by 27 %, the maximum cooling capacity by 28 %, the coefficient of performance by 19 %, the maximum COP by 28 %, and the temperature difference by 11 %. At a 0.6 TE ratio, the cold joint of TEC is 285 K, however, the hot joint of TEG is 450 K. |
| TEG-TEC | Marefati et al. 2019 [196] | TEG-TEC system is employed in PEM, this system is used for electrical, thermal, and cooling purposes. In such a model, TEG uses the wasted heat from PEM to deliver power to TEC. | This hybrid system provides electricity and cooling by using the wasted heat from PEM. Results indicate that the electrical efficiency of the suggested system is 53.3 % and the efficiency of the Fuel Cell (FC) is 40.97 %. |
| | Gao et al. 2012 [197] | Thermoelectric devices (TED) which are TEG and TEC are employed in a high-temperature polymer electrolyte membrane fuel cell (HTPEMFC) power system, which has been preliminarily evaluated. | The recovered power can increase the system efficiency and mitigate the dependence on Li-ion batteries during system startup. This study shows that a TE device application inside HTPEMFC power systems is of great value and worthy of further study. |
| PEM-HP | Shirzadi et al. 2017 [198] | PEM-HP FC is used for cooling issues, in which heat is moved by HPs under diverse setups consisting of various cooling states in the condenser | HPs are capable of rising efficiency as compared to other systems of cooling. Results show that HP offers a feasible system for running thermally a PEMFC pile. |
| | Oro et al. 2014 [199] | A thin flat heat pipe was analyzed as a reliable alternative for proton exchange membrane fuel cell cooling. Power up to 10 W was | Test results with HP were positive, temp at the evaporator and condenser were obtained, and it was found that the temperature difference at the condenser was 33 % and at the evaporator was 28 |

| | | | |
|---------|--|---|---|
| | measured using deionized water as the working fluid. | %. | The aim is to cool PEM as overheating can damage the membrane. |
| PEM-TEG | Guo et al. [200] | Two-stage TEG and high-temperature proton exchange membrane fuel cell (HT-PEMFC) are proposed. Power output density, electric, and energetic efficiency of the system are analyzed. | The highest power output, exergetic efficiency, and electric efficiency are raised by 11.8 %, 17.7 %, and 17.5 % respectively as compared to HT-PEMFC alone. The rate of exergy destruction density decreases by 11.4 % more than that of the HT-PEMFC alone. |
| | Kwan et al. [201] | Hybrid system of a fuel cell (FC) and TEG for the combined heat and power is proposed. | Adding TEG reduces startup times up to 4.45 and 1.77 times for each 1 kW. With the presence of TEG in the system, the efficiency of primary energy consumption is boosted in winter by 3.4 % and in summer by 5.6 %. |
| | Abderezak et al. [202] | Numerical and experimental study is done on PEM-FC and TEG systems to transform waste heat into electricity. | Results revealed a favourable output voltage produced by the TEG. In the case of 15 A, TEG voltage is 500 mV and 571 mV at 20 A and 30 A. |

Table I.2.2 shows that generated power by TEG is strongly governed by the heat transfer which can be enhanced by employing HP. TEG-HP is an interesting system [203] because of the flexibility of its design, passive solid-state, lightweight, quiet, pollution-free, and mainly maintenance-free, which eliminates considerable burden costs [204]. Besides, HP helps in optimizing the performance of TEG and lowers its cost [205]. Conclusions drawn from Table I.2.2, are presented below:

1. TEGs and HPs have limitations on operating temperature, yet, integrating them helps in overcoming their limitations and increasing their efficiency. Thus, TEG-HP improves TEG performance.
2. TEG and TEC are related to the figure of merit, which is related to efficiency. Fusing both systems doesn't significantly increase the efficiency, since both devices have common limitations so integrating them won't fill in the gap of their limitations unless an external system is added that may compensate for the mutual drawbacks of both devices. However, TEG-TEC has remarkable advantages, among which it can function at a small waste heat temperature. Besides, this system constitutes a self-cooling instrument that maintains a longer life as compared to conventional systems.
3. PCM-TEG hybrid system is a promising technology, in terms of PCM offering the possibility of power generation for a longer period even without a heat source. However, this period is short due to the limited phase change period. To stretch the PCM's phase change period or boost its thermal storage, more effort should be invested in the material study, for example, condensed paraffin wax has 70 % thermal storage more than that conventional paraffin wax [206].
4. EAHE-HP system shows promising results for both cooling and heating, especially in very cold or hot regions; however, the research was limited and needs further improvement. Table I.2.2 also shows a part of the hybrid fuel cell system combined with HRSs. PEM can produce power in the form of an electrochemical reaction between the oxygen in air and hydrogen, heat and water are the products of this reaction [207]. Results show that PEM with HR devices improves significantly efficiency.

5. PEM and TEG share mutual benefits since TEG absorbs the heat from PEM which overcomes the overheating that may damage the membrane. On the other side, PEM provides heat that results in increasing the gradient temperature and then the power output of TEG.
6. Adding HP to the hybrid PEM-TEG system is efficient as well since HP enhances heat transfer. However, there should be done a comparison study of a system PEM-TEG with and without HP to figure out the percentage of the improvement that HP provides.
7. PEM-TE has shown good results in terms of electrical efficiency, as waste heat from PEM creates a new source of free energy. Also, results show that it is worth doing further studies on this system.

I.2.4. Applications of Hybrid Heat Recovery

From the investigated papers, it is noticed that the applications that employ HHR are wide as shown in Figure I.2.6. The applications are classified into three categories: (1) HVAC and electronics cooling systems, (2) solar systems, and (3) vehicles, and PEM devices.

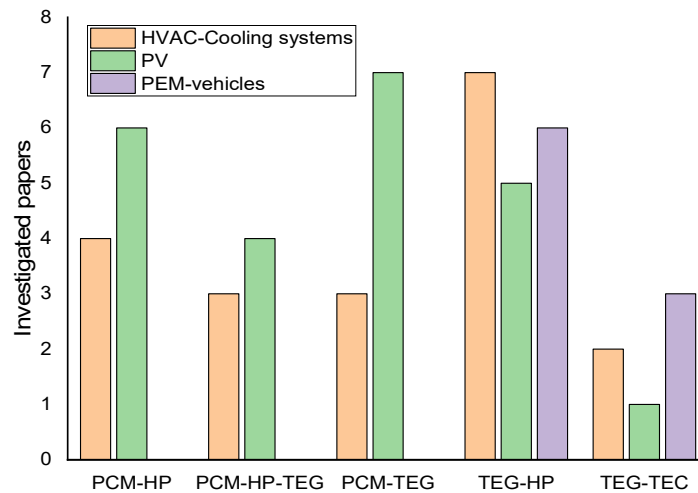

Figure I.2.6: Investigated papers on hybrid heat recovery according to applications.

As noticed in Figure I.2.6, PCM-HP shows significant results in various research papers when employed in PV [208, 209] and concentrated solar collectors [210]. For example, Diallo et al. [211] mentioned in a numerical study that the hybrid system has achieved an overall efficiency of 28 % and COP 2.2 times higher than the conventional system. Besides, PCM-HP was used in electronic cooling devices, where it saves up to 46 % of electrical usage compared to the traditional HP module [175]. PCM-HP is also used in desalination applications with HPs in solar still tube collectors. The presence of PCM with HP leads to continuing the process of desalination even after sunset, this yields reaching daily efficiency of 50 % and escalating the water yield by 86 % when compared to the system without PCM [212].

Also, Figure I.2.6 shows that the PCM-HP hybrid system was also used with TEG in PV applications [213], where in addition to the advantages that PCM-HP offers to PV [214], involving TEG helps in maintaining a steady functioning of the solar cells [215]. Besides, it was shown that TEG increases the

efficiency when combined with PCM [216], and the efficiency of the total power generation was increased by up to 30 % when employing the triplet PCM-HP-TEG [177]. PCM combined with another HR system shows a wide range of usage mainly in PV and desalination, contributing to the reason that PCM has the advantage of providing thermal energy even after sunset [217].

Besides, from Figure I.2.6 it is noticed that the TEG-HP HHR system is widely used in HVAC or cooling systems and PV [218]. An optimization study on combining TEG-HP was held to show that TEG efficiency is improved by 19 % and enhancement in heat pipe heat sink (HP-HS) cost, decreased by 29 % as compared to the conventional system [146]. Another experimental study was conducted, where the cost was reduced by 17.9 %, and the efficiency of TEG efficiency was enhanced by 36.7 % as compared to the conventional system [219]. TEG-HP was also used in PEM [197] and vehicles [187], where TEG efficiency increased to reach a promising value of 3.85 % [220] with 132 % increased output power when employed in diesel engines [221]. However, vehicles and PEM mainly employ TEG-HP or TEG-TEC as shown in Figure I.2.6, where cars and PEM have significant wasted heat and demand cooling to avoid problems in the long term. TEG-TEC is related so much to the figure of merit to increase its efficiency, it is employed in the residential sector as HVAC and for generating power systems. Results showed that inserting this system at the channel walls improves the output power by up to 110 %. Improving TEG units has amplified the power output for each module from 1 W in 2003 to 9 W in 2014 [222].

I.2.5. New Systems for Hybrid Heat Recovery

This section presents the new systems studied in HHR, a different new hybrid heat recovery in Liquid Desiccant Dehumidification (LDD) is studied in two different research: Hang et al. [223] proposed a hybrid flue gas HR system founded on vapour compression refrigeration (VCR) and LDD, and Shen et al. [224] suggested an HHR model of HP in LDD, results showed that the proposed system is very accurate and easy for engineering employments. Another hybrid energy recovery system for a cleaner environment combined TEG with an auxiliary gas in hydroxyl (HHO) form [89]: a new design based on Waste Heat Recovery (WHR) driving the HHO unit was established, and results showed that HHO reduces the emissions from vehicles and TEG can deliver the demanded energy for HHO unit.

Thermal storage plays an essential role in recovering lost heat in various applications such as renewable energy systems. A numerical and analytical study was conducted by modelling a hybrid tank storage of PCM and water for a heat pump, where the water's energy storage capacity is proportionate to the range of temperature. However, PCMs can uphold high energy capacity within limited temperature settings. The verification results revealed a good agreement with the proposed novel hybrid model [225]. Likewise, Murat et al. [226] studied a multi-hybrid system for generating electricity, Hydrogen, and freshwater. The suggested system consists of PCM, TEG, PEM, multi-stage flash distillation (MSF), and concentrated solar-powered gas turbines, where TEG recovers the heat lost from PEM and PCM heated the water for MSF. Results show that the advantage of employing PCMs was avoiding the instabilities in freshwater production, and by recovering the waste heat TEG gives 6.8 % of the overall power generation. Furthermore, Zhang et al. [227] studied a new hybrid biological and thermal waste-to-energy system, which carried a sustainable organic solid waste management and recovery system resource with zero extra thermal source demand. This combined waste-to-energy system provided an optimum energy efficiency of 71.3 %. Sulaiman et al. [188] did a theoretical and experimental study on employing the TEG-HP HHR system in PEM fuel cell-driven vehicles, results were positive, but more studies should be taken to boost the performance and achieve higher sustainability of PEM.

1.2.6. Hybrid Heat Recovery Systems

In this section, the properties of an ideal material needed to get an ideal recovery device are presented, and the advantages that a combined system would offer are displayed in a chart, these advantages are extracted from the already studied papers in previous sections.

1.2.6.1. Properties for Ideal Heat Recovery Devices

Each recovery device has some properties that make it ideal as presented in Table I.2.3. Though there is no ideal device because there is no material that has all the ideal properties together at the same time, there will always be some missing characteristics. For example, TEG requires a material with high electrical conductivity and low thermal conductivity, however, there is no ideal material that has these specifications at the same time. For this reason, several studies were held to find the optimum material that provides optimum results. This section aims to understand the requirements of each device and its limitations, so it is easier to figure out the compensations from other systems.

Table I.2.3: Characteristics of Ideal Heat Recovery Devices

| Device | Desirable Characteristics | Reason | Adequate for |
|-----------------------------|-----------------------------------|--|--|
| PCM [228, 229] | High latent heat of fusion | Provide high TES | TEG, heating/cooling |
| | High thermal conductivity | A faster rate of absorption and release of heat | |
| | Thermal stability | Used for a longer period without replacement | TEG, heating |
| | High specific heat and enthalpy | Higher heat storage for the sensible part of the heat stored | A significant range of temperature |
| | Not losing properties | Repeating cycles without affecting the material's properties | Long life cycle |
| | Nontoxicity, non-flammability | Ecofriendly and safety reasons | Environment |
| TEG | High electrical conductivity | A large amount of power at a low-temperature gradient | All applications with even low heat loss |
| | Low thermal conductivity | Low heat transfer from the hot side to the cold side | |
| PEM [230] | High proton conductivity | High ion conductivity at low heat | TEG, PCM |
| | Low electronic conductivity | Proton transmission with low-energy activation | |
| | Low fuel and oxidant permeability | | |

1.2.6.2. Advantages of Combined Heat Recovery Systems

After discussing the methodology and results of the presented papers, the results of the advantages that the hybrid system may offer are summarized in two charts: PEM-TEG-HP in Figure I.2.7 and PCM-TEG-HP in Figure I.2.8. Usually, each device alone has its advantages, and it may offer better results when

combined with other devices as indicated in Figure I.2.7. For example, HP is very helpful when it is merged with TEG, PEM, and PCM. Since all the mentioned systems are quite expensive, it is worth carrying out further experiments that study the cost of each of the combined systems TEG-PCM, PCM-TEG-HP, and PEM-TEG-HP under the same circumstances to find out which one is more efficient from a cost point of view. Based on all the covered studies most of the hybrid systems show significant results that are worth being employed, mainly in large systems that release a high amount of wasted heat.

Besides the advantages of each device, there are some limitations, as indicated in Figure I.2.7, however, after doing the research, it is noticed that when combining heat recovery devices, some of the gaps that are caused by limitations are filled. For example, HPs have limitations on being overheated under high heat flux and PCM does have limitations over thermal conductivity, however, when combining PCM and HP, PCM overcomes the overheating in HP, on another hand, HP overcomes the thermal conductivity of PCM. Similarly, other devices such as TEG-HP technology have the potential to form an entirely passive, solid-state WHR system [231]. Thus, the study on the advantages, limitations and hybrid devices mentioned previously are summarized in Figure I.2.8 which presents the limitation of each device alone and the advantages that the hybrid system may provide when the devices are combined. Figure I.2.7 also shows the advantages of each device alone and the added value that the hybrid system may offer when combined with other devices.

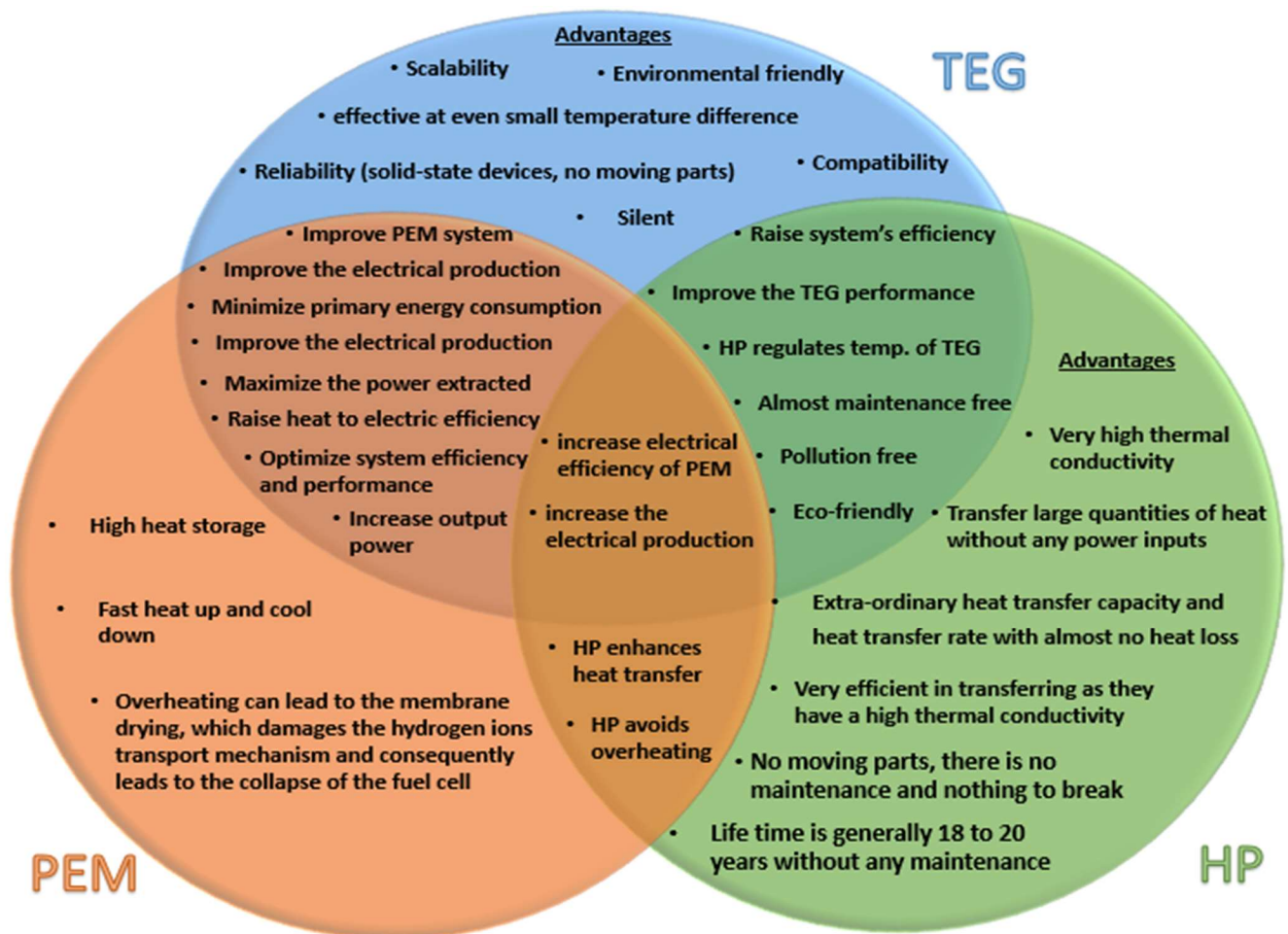

Figure I.2.7: Mutual benefits of combining PEM-TEG-HP.

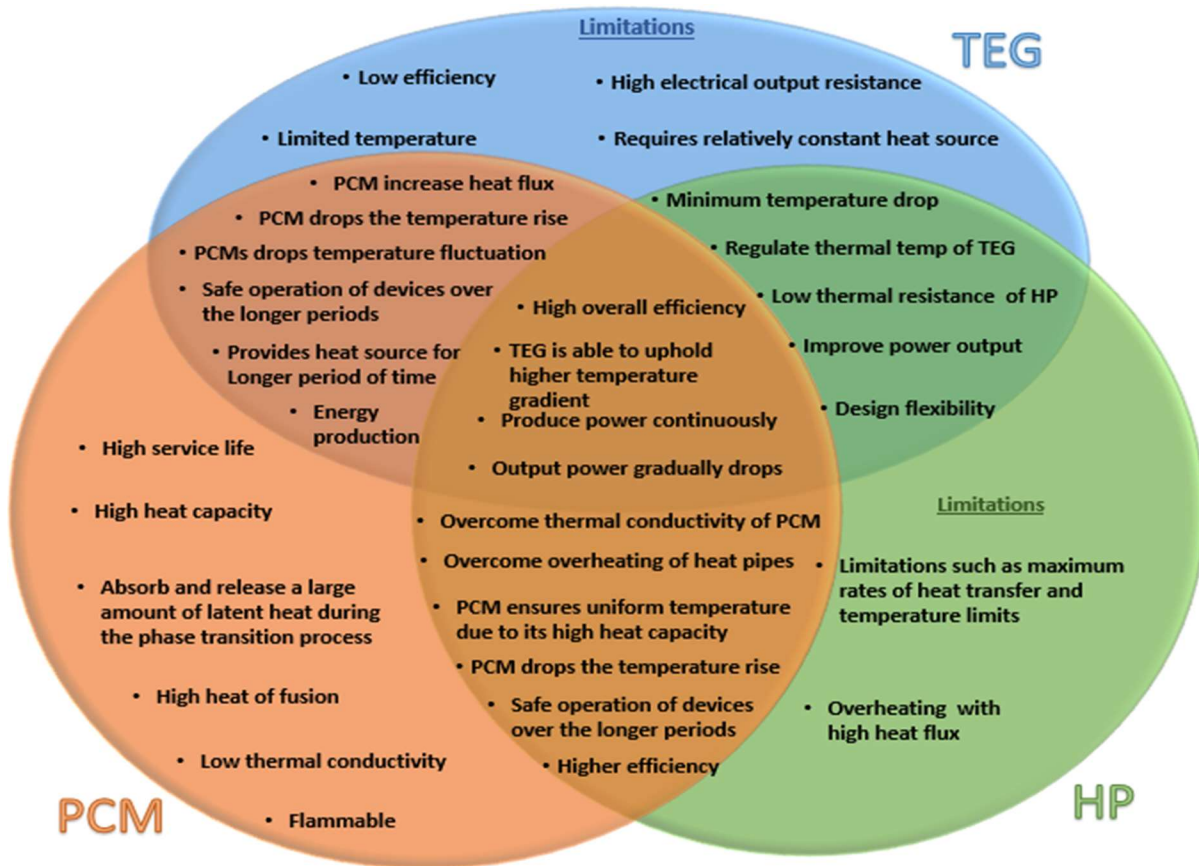

Figure I.2.8: Mutual benefits of combining PCM-TEG-HP.

I.2.7. Commonly Used Systems

Among the research, it is noticed that TEG has a high share in heat recovery systems and is merged with various devices and in different applications, where a considerable number of the discussed papers contain TEG in the hybrid system, so it is worth going deeply in researching TEG. Besides, VGs are known for their effectiveness in heat transfer [232] however, there is a lack of research about VGs in HHR. Thus, in this section, two main systems are discussed, TEG and VGs.

I.2.7.1. Thermoelectric Generators

Throughout the research, it is noticed that TEG has a notable share in this field. So, a wider study is done on TEG, the papers were sorted according to the type of device used as shown in Figure I.2.9.

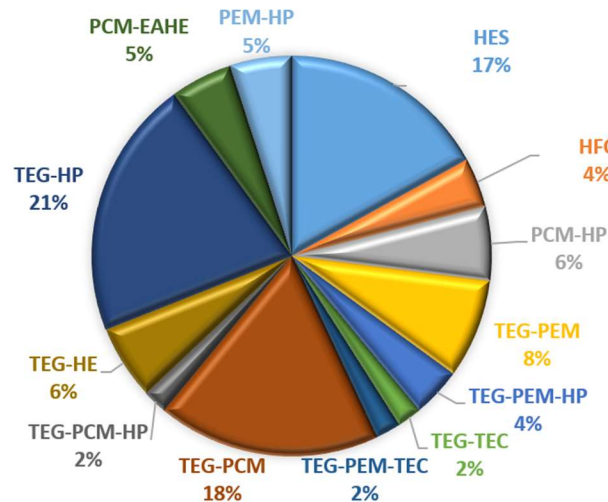

Figure I.2.9: Investigated papers according to the topic.

It is shown that TEG has the highest share in HHR since it intervenes in more than 60 % of the systems. The discussed papers are classified, in Figure I.2.10, into (i) TEG with applications such as ICE, HVAC, and Desalination, (ii) TEG with other HR devices to form hybrid systems such as with PCM and PEM, HP and others, and (iii) improvement of TEG, where some papers discuss the improvement of TEG on the material level to increase its efficiency.

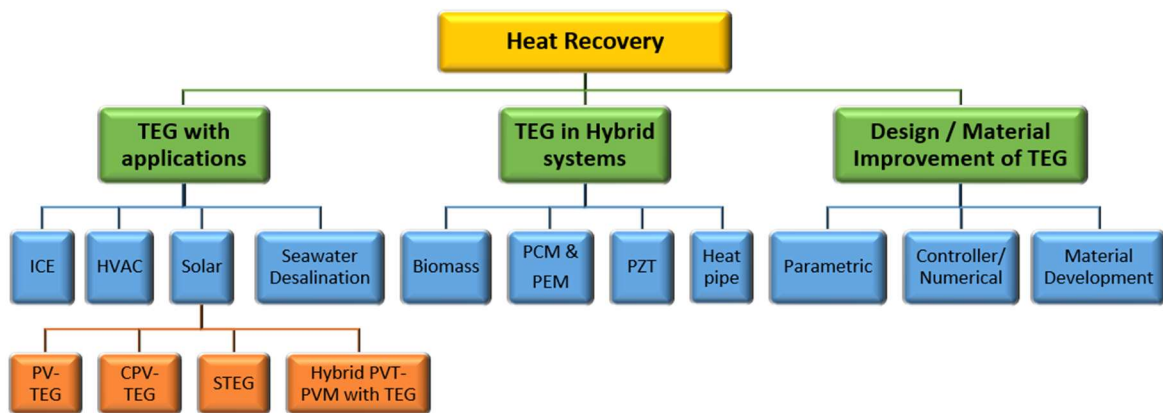

Figure I.2.10: Heat recovery through TEG.

A statistical study of over 100 published papers related to heat recovery through TEG is chosen randomly and sorted according to the application and presented on a chronological basis in Figure I.2.11.

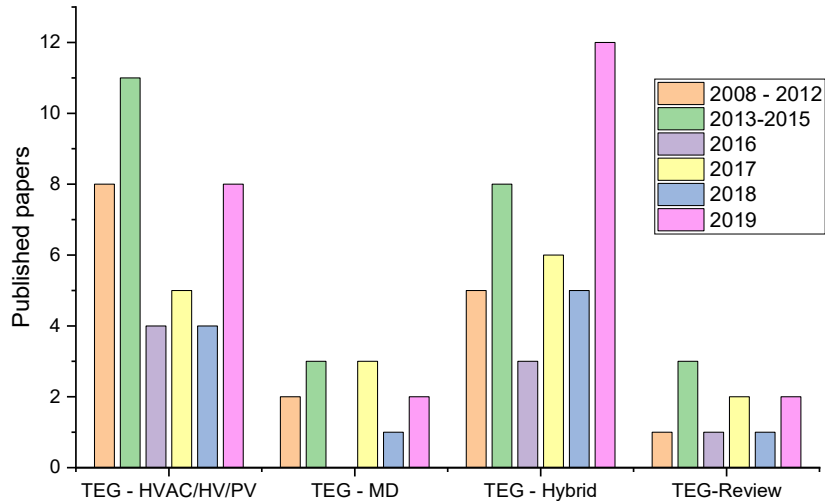

Figure I.2.11: Classification of TEG over time

Figure I.2.11 shows that TEG in HVAC / Hybrid Vehicles (HV) / Photovoltaic (PV) has been employed frequently and significantly since 2008, with the highest number of publications in 2019. Besides, the papers that discuss Material Development (MD) and review of TEG were few but persistent, and TEG-review is low, but usually, review papers of a field are less than experimental and practical work. On the other side, MD is recommended to be increased, where the more material improvements are done the more efficient TEG will be. Among them all, it is noticed that TEG integrated into a hybrid system is growing fast over the years with the highest publications among other fields in the years 2017, 2018, and 2019. This high interest in TEG-hybrid systems encourages performing further studies in this field. Although this statistic is not accurate as it goes over a sample, not all populations, however, it gives a glance over how TEG has developed over the years.

I.2.7.2. Vortex Generators

Vortex generators (VGs) are passive devices that trigger the flow to improve the heat transfer coefficient, they are broadly employed in various industries and applications [233]. Besides, VGs have grabbed wide attention for their passive method of improving heat transfer [234], and for attaining high thermal performance by energizing the flow which boosts the heat transfer coefficient [235]. VGs have been excessively studied to enhance the convective heat transfer coefficient mainly in Heat Exchangers (HE) such as finned tubes or plate fin HEs. Rathee et al. [236] performed an analytical study on HE with and without fins, the results show that outlet temperature of hot water, coefficient of performance, and Nusselt number were increased when fins were used by around 3°C, 0.1, and 10 respectively. Thus, results were improved with fins arrangements that play the role of VGs. Various types of VGs have been studied intensively, where many parameters affect the performance of VGs such as shape (winglet, triangular, trapezoidal...), angle of attack, Reynolds number, and boundary conditions [237]. Substantially, all VG shapes improve heat transfer and are intensively studied in enhancing heat transfer [238], however, there is a lack of information concerning VGs in HHR, where so far it is hard to find research that uses such a system. Thus, since VGs have high effectiveness in enhancing heat transfer, it is recommended to do further studies that merge VGs in HHR.

I.2.8. Conclusions and recommendation

This review has investigated the main methods of HHRSs. It presented an overview of the methods and then discussed the methodology and results of previously published papers, and it ended with two sections over (i) TEG as it was contributed to many papers and (ii) VGs as they show a significant effect in enhancing heat transfer. This paper sheds light on methods that increase the source of free energy, as well it studies the advantages that the combined system would offer. Results show that there is a remarkable number of papers that discuss HHR, and it is worth combining more than HRS as follows:

I.2.8.1. Thermal energy storage - Heat recovery

After reviewing the papers related to TES, results show that combining TES with HRS helps in reducing the cost and increasing the efficiency of the system by filling the gap caused by the limitations of the HR device as represented in the following sub-conclusions.

Conclusions on PCM use:

- Employing PCM is a beneficial method to store thermal energy and captivate the thermal shock during rapid growth in demand.
- PCM-TEG-HP system upholds the generation of power for a longer period even without a heat source, which results in increasing the power output. On the other side, HP regulates the temperature and transfers a higher amount of energy passively.
- Forced convection enhances heat transfer and increases efficiency, however, there is no study on the financial part if it is worth adding power input.
- PCM-HP can overcome the low thermal conductivity of PCM and the overheating of HP. This HHRS slows down the temperature growth and guarantees safe operation over a long period.
- PCM-EAHE is favourable for enhancing the cooling effect and saving volume storage, which makes it worth applying for further studies and experiments in terms of cost analysis.
- In conclusion, using PCM in the HR system is worth the cost, and results show that integrating PCM is acceptable in the market. PCM-HP revealed a promising cooling technology.
- Even though PCM delivers a major amount of storage and permits steady cooling for TEG, more effort should be imposed on boosting thermal conductivity to optimize the heat absorption rate.

Conclusions on PEM use:

- PEM combined with any form of HR device improves efficiency significantly.
- PEM-TEG share mutual benefits where TEG absorbs heat from PEM which overcomes the overheating that may damage the membrane. On the other side, PEM provides heat that results in increasing the gradient temperature which raises the power output of TEG.
- HP with the PEM-TEG system is efficient as well, yet further comparison studies should be held for a system with and without HP to find the percentage of the improvement that HP provides.
- PEM-TE is promising, where waste heat from PEM creates a new source of free energy.

I.2.8.2. Electrical and Geothermal

As for electrical and geothermal, results show that merging Geothermal and devices that transform heat into electrical energy with HRS has a positive effect on the overall system, as listed below:

Conclusions on TEG use:

- TEG-HP is an effective system that improves TEG performance as TEGs and HPs have limitations on operating temperature, however, integrating them helps overcome their limitations and increase their efficiency.
- Although TEG-TEC combined system can function at a small waste heat temperature, however, it doesn't show a remarkable increase in efficiency, where both devices have common limitations so integrating them won't fill in the gap of their limitations unless an external system is added that may compensate for the mutual constraints of both devices.
- TEG-PCM can maintain power generation for longer without a heat source, where experimental results show the positive effect of the PCM and the embedded air layer on TEG.

Conclusions on Geothermal Use:

- EAHE-HP system shows agreeable results for both cooling and heating, especially in very cold or hot regions; however, the research was limited and needs further improvement. Besides, geothermal was limited to specific integration systems such as HP or PCM, where being merged with TEG or other heat recovery devices is rare in the literature.

I.2.8.3. Recommendations

Throughout the research it was noticed that the inquiry lacks some information to give a precise conclusion, so, some studies are recommended to enrich the knowledge of HHR systems:

- Further studies on improving the material of TEG are required as it has the highest share in HHR.
- PCM-EAHE is an encouraging hybrid system that should undergo further investigations as it could be designed to preserve drained heat from winter to summer.
- TES integrated with HR is cost-effective, where combining TES with HRS saved costs as noticed in the TES section. However, it is recommended to do further experiments that study the cost of each of the combined systems PCM-TEG, PCM-TEG-HP, and PEM-TEG-HP under the same operating conditions to find out which one is more efficient from a cost perspective.
- It is recommended to do further studies on VGs employed in HHR as it is known that VGs enhance heat transfer. So, it may improve the output results when combined with HHR.

As a conclusion, it is noticed that TEGs and VGs are two important topics, where TEG is presented in almost all the other heat recovery systems and is used in various applications. Thus, the coming section will present the theoretical background of the TEG, in addition to a comprehensive review of the TEG and its implementation in various fields. Besides, it also sheds light on the new technologies of the TEG and their related challenges.

I.3. Thermoelectric Power Generators: State-of-the-Art, Heat Recovery Method, and Challenges

Résumé (en français)

L'électricité joue un rôle important dans la vie quotidienne et constitue le principal composant d'innombrables applications. Il est donc nécessaire de poursuivre les recherches afin d'améliorer les approches existantes ou d'en trouver de nouvelles pour améliorer la production d'électricité. Le générateur thermoélectrique (TEG) fait partie des technologies notables et répandues utilisées pour produire de l'électricité, et convertit l'énergie thermique résiduelle en énergie électrique en utilisant l'effet Seebeck. Grâce à l'effet Seebeck, les variations de température peuvent être transformées en énergie électrique ; un TEG peut donc être utilisé chaque fois qu'il y a une différence de température.

Le présent document présente les fondements théoriques du TEG, ainsi qu'un examen complet du TEG et de sa mise en œuvre dans différents domaines. Il met également en lumière les nouvelles technologies du TEG et les défis qu'elles posent. Il a notamment été constaté que le TEG est efficace dans les systèmes hybrides de récupération de chaleur, tels que le matériau à changement de phase (MCP), le caloduc (HP) et la membrane d'échange de protons (PEM), et que l'efficacité du TEG s'est accrue grâce à une série d'améliorations apportées aux matériaux du TEG.

En outre, les résultats montrent que la technologie TEG a été fréquemment appliquée ces dernières années, et tous les documents étudiés s'accordent à dire que le TEG est une technologie prometteuse pour la production d'électricité et les systèmes de récupération de chaleur.

I.3.1. Introduction

Electricity is one of the greatest discoveries that science has granted to mankind since it is perspicuously one of the substantial integral parts of our daily life which we rely on today, and an essential milestone in scientific progress, where research constantly endeavours to find new sources or improve the existing methods of generating electricity [239]. The crucial role of electricity and the necessity to be environmentally friendly encourage researchers to highly invest in converting green resources or wasted energy for generating electricity [240], where the universe offers several sources of energy that could be transformed into electrical energy as presented in Figure I.3.1. For instance, wind, hydro energy, waves, mechanical vibration and others are motions that could be converted into electrical energy using the piezoelectric effect or turbines. As well, temperature gradient, chemical energy, electromagnetic radiation, and light are green energy that could be useful for generating electricity through TEGs, reaction, induction, and photoelectric effects respectively. Renewable energy sources constitute 25 % of the power generation sector and are expected to increase to 85 % by 2050 [241].

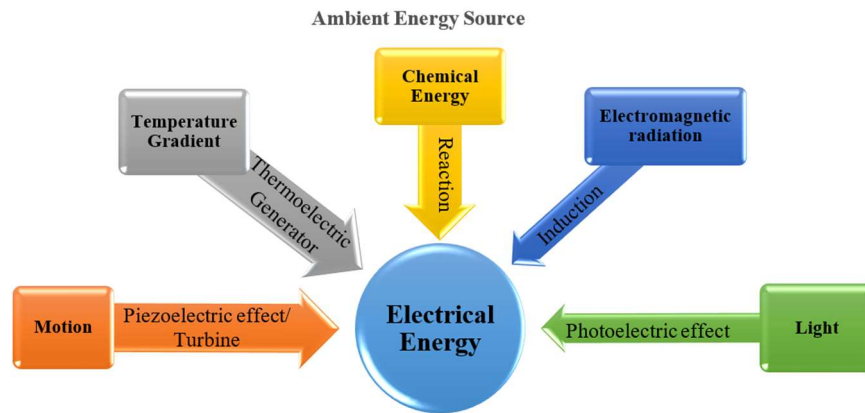

Figure I.3.1: Ambient Energy Source converted into electricity.

With the increasing energy demand, energy recovery methods have become a vital matter that should be taken into consideration in most of nowadays' applications, where engineers and researchers are escalating their efforts to find new sources of energy that are simple to use and productive. Wasted energy such as heat energy is an alternative source for producing electricity, especially since the percentage of wasted energy is significant as shown in Figure I.3.2. For example, in vehicles and automotive around 36 % of the input energy is lost as heat from the internal combustion engine, about 38 % is lost in the exhaust, and 6 % is lost as friction [242]. Similarly, for a grinding machine, 91 % of the input power is lost from friction, heating, and others such as wires [243]. While energy lost for power plants is 60 % before applying heat recovery [244]. The percentage of wasted energy differs from one use to another; however, it exists in all applications, hence, recovering this energy either for using it again in the same application or for outside use is crucial in every operation. So, as noticed energy is not the problem, but, sustainability is the problem, which can be applied through Energy Recovering Units (ERU).

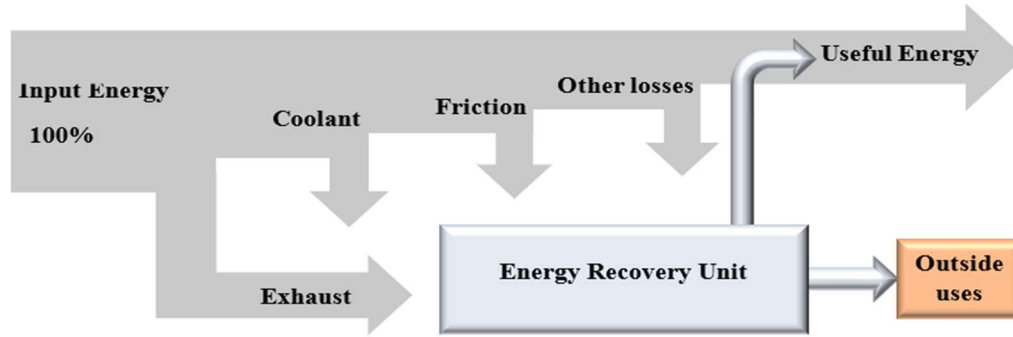

Figure I.3.2: Schematic of waste energy in most applications

A thermoelectric generator (TEG) is one of the existing tools that is used to recover wasted heat. TEG is solid-state equipment that uses the Seebeck effect principle, which converts the temperature difference into electricity. The main advantage of TEG over other heat recovery devices is that it applies to small-scale discrete energy sources. TEG contains no moving parts (thus it is not noisy), and it is known for its simplicity, low cost and effectiveness when it is used for applications with low temperatures. However, TEG has low efficiency, where its efficiency doesn't exceed 7% [245]. The TEG performance is related to two main factors: The material's thermoelectric properties, which affect the efficiency of TEG [246]. Temperature gradient which is related to the sink's mass flow rate and heat source, properties of flowing fluid, inlet temperature, and the heat exchangers design [247]. The scientific concern is not just to increase the efficiency; however, the challenge of using TEG is to find a suitable gradient temperature which is proportional to the electrical energy produced.

Scope of the paper

Among the recent review papers, it is noticed that TEGs are highly appreciated, where review papers investigated TEGs from various aspects, Zoui et al. [248] reviewed the progress and applications of TEG. Also, Kumar et al. [249] led a review of TEG design and its medical applications. All the mentioned papers examine TEG through different aspects, but there was a lack of information about the exact starting time of the applications of TEG and the challenges that it faces. Hence, the novelty of this study is:

1. Presenting the history of main milestones that TEG passed through since its first invention.
2. Displaying the applications of TE since 1985, and the expectations for the future till 2030.
3. Reviewing over 140 papers and classifying them into specific categories.
4. Demonstrating the challenges that the researchers have faced during the study, it is noticed that the TEG development was by working on solving the challenges of the previous studies.

I.3.2. Theoretical Background

The thermoelectric effect was first discovered in 1822 by Thomas Johann Seebeck (1770-1831) [250], who discovered that a thermal gradient formed between two dissimilar conductors produces a voltage. At the heart of the thermoelectric effect is the fact that a temperature gradient ΔT in conducting material results in heat flow; this results in the diffusion of charge carriers. The flow of charge carriers between the hot and cold regions in turn creates a voltage. The output produced was initially of a small magnitude and was of no value in electric power [251]. With the discovery of semiconductors, it was found that the output could

be magnified drastically, and new concerns began around the middle of the 20th century. Conversion between thermal and electrical energy occurs due to 3 main thermoelectric phenomena: The Seebeck effect [252], the Peltier effect [253], and the Thomson effect [254]. The Seebeck effect is the conversion of ΔT to electricity. The Peltier effect indicates that an electric current would be generated due to the ΔT at the joint of two different materials. Thomson effect is an extension to Peltier-Seebeck model.

I.3.2.1. Seebeck effect

In 1821, the German physicist Thomas Johann Seebeck discovered that the needle of a compass would be deflected by a loop made from two linked materials of different temperatures: cold temperature (T_c) and hot temperature (T_h) between the joints as shown in Figure I.3.3– (a). This is due to the different responses of the materials to the ΔT which creates a current and magnetic field through the loop. Figure I.3.3– (b) illustrates the Seebeck effect which refers to the presence of a potential electric through a thermoelectric material when subjected to a temperature difference [255].

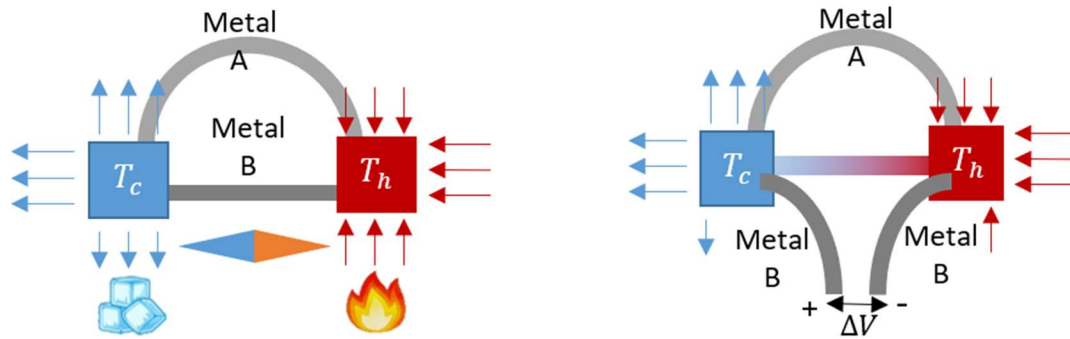

Figure I.3.3: (a) Seebeck needle-compass discovery and (b) potential voltage.

In this section, 3 main terms will be explained: (1) The link between two dissimilar metals is called a thermocouple, (2) electromotive force (emf) produced in a thermocouple is called thermo emf, and (3) the current that flows through the closed circuit is called thermoelectric current.

For a specific range of temperatures and different material combinations, thermo emf is different. The direction and magnitude of thermo emf are related to the nature of the materials used in thermocouples ΔT between hot and cold junctions. Thus, Seebeck organized a series of 35 metals between 0 °C and 100 °C shown in Figure I.3.4 in a way where the current flows over the cold junction from one that exists first in the series to the one that exists later. The larger the distance between the two chosen metals the highest thermo emf will be obtained.

| | | | | | | | | | | | | | |
|-----------|-----------|-----------|-----------|-----------|-----------|-----------|-----------|-----------|-----------|-----------|-----------|-----------|-----------|
| 83 | 28 | 78 | 29 | 25 | 89 | 82 | 50 | 79 | 47 | 30 | 48 | 26 | 51 |
| Bi | Ni | Pt | Cu | Mn | Hg | Pb | Sn | Au | Ag | Zn | Cd | Fe | Sb |
| 208.98 | 58.69 | 195.08 | 63.55 | 54.93 | 200.59 | 207.2 | 118.71 | 196.97 | 107.87 | 65.38 | 112.41 | 55.84 | 121.76 |

Figure I.3.4: Thermoelectric series

I.3.2.2. Peltier effect

The Peltier effect was revealed in 1834 by the French physicist Jean Charles Athanase Peltier (1785-1865). He discovered that applying current at a junction between two different materials leads to the release/absorption of heat as shown in Figure I.3.5. On an atomic level, this is due to the energy of different states of materials, which are P- and N-type materials. As electrons shift from P-type to N-type material, they reach a higher level of energy which leads to absorbing heat from the surroundings. On the other side, as electrons shift from N-type to P-type material, electrons break down into a lower level of energy which leads to releasing heat to the surroundings [256]. So, the Peltier effect is related to heat absorption on one end of a TE material and heat release from the other end due to the flow of current over the material as shown in Figure I.3.5. If the direction of the current is inverted in the thermocouple, the absorbed/evolved heat is exchanged then the Peltier effect is reversed.

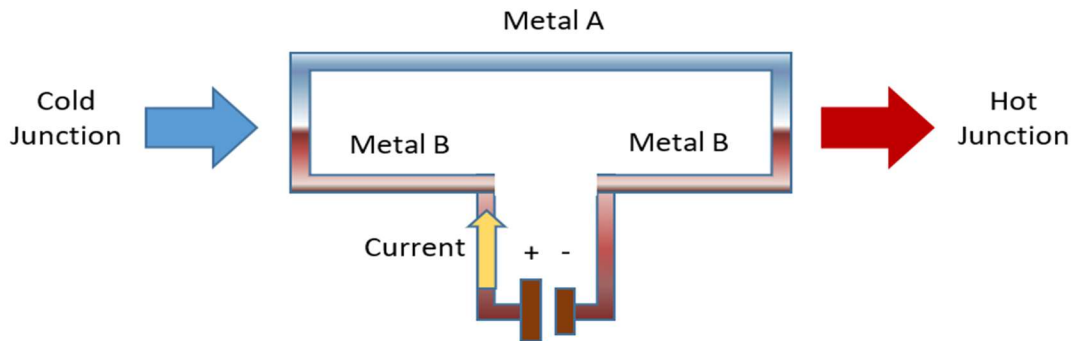

Figure I.3.5: Peltier effect

I.3.2.3. Thomson effect

Thomson effect was developed by William Thomson (1824-1907), better known as Lord Kelvin, who stated in 1851 that as a current pass along the length of the same metal from one cold end to the other hot end or vice versa an absorption/evolution of heat will occur shown in Figure I.3.6. The amount of heat energy evolved/absorbed when a current of 1 A (one ampere) passes through a metal between two points of temperature difference $\Delta T = 1^\circ\text{C}$ is called Thomson coefficient τ .

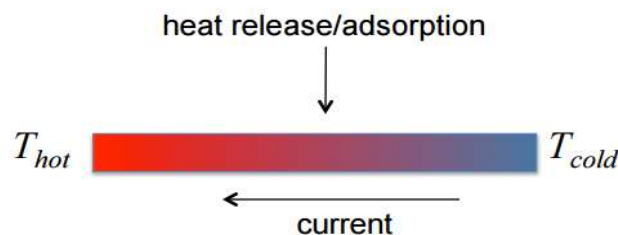

Figure I.3.6: Thomson's effect

Table I.3.1 shows there are three types of Thomson's effect.

Table I.3.1: Definition and examples of Thomson's three different effects

| | |
|---------------------------|---|
| Thomson's positive effect | When the current passes from the hot end to the cold end the heat is developed so the conductor becomes hot |
| | When the current passes from the cold end to the hot end the heat is absorbed so the conductor becomes cold |
| | Antimony, Silver, Zinc, Sodium |
| Thomson's negative effect | When the current passes from the hot end to the cold end the heat is absorbed so the conductor becomes cold |
| | When the current passes from the cold end to the hot end the heat is evolved so the conductor becomes hot |
| | Platinum, Bismuth, Cobalt, Nickel, Mercury |
| Thomson's null effect | Used for the standard metal in thermoelectricity |
| | Lead |

I.3.2.4. Thermoelectric Generators Working Process

TEG is a solid-state device that converts heat energy into electrical energy using the Seebeck effect. TEG is obtained by a cascade connection of multiple thermocouples. TE materials' performance is obtained by three TE properties: Seebeck coefficient α , electrical resistivity ρ , and thermal conductivity K [257]. TEG's design is based on the Seebeck effect in which the ΔT between the current-carrying conductors P- and N-types of semi-conductors produce a voltage ΔV [258]. The TE semiconductor has two main parts: P-type which holds free holes, and N-type which holds electrons. In P-type, due to the ΔT , the holes move from the hot to the cold side which causes a density charge difference. This density charge difference will repel electrons to the hot side as shown in Figure I.3.7. During a steady state, the charge density difference will be adjusted by the ΔT . Emf generated across the material, which causes electrical current, which is called Seebeck voltage. The formed voltage is proportional to ΔT by the Seebeck coefficient. N-type semiconductors follow the same effect, but the heat and charge carriers are electrons rather than holes. Electrons will move towards the cold side which becomes negatively charged. Now if the hot sides are connected electrically and the cold sides are linked by a load, a current will be created and pass over the load. The higher heat flow from the hot to the cold side will lead to an increase in the current flow [259].

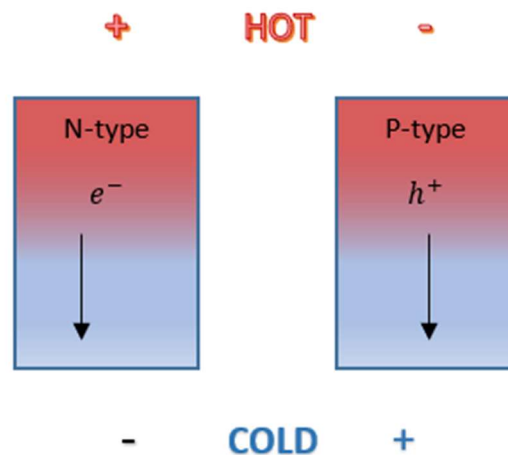
**Figure I.3.7:** Charge carrier movement

To obtain higher output voltage, more N-P type pairs should be connected in series as shown in Figure I.3.87. A thermoelectric module illustrated in Figure I.3.8 is formed when P and N legs are connected electrically in series and thermally in parallel. Conductors that carry current are called thermoelectric elements, which are two dissimilar conductors of N- and P-types, and the couple made out of the two conductors is called a thermoelectric couple. In typical TEG, heat exchangers transmit heat from the heat source and to the heat sink through the junctions of the thermocouple to generate electricity. The heat exchangers and the thermoelectric couple unit are known as TEG.

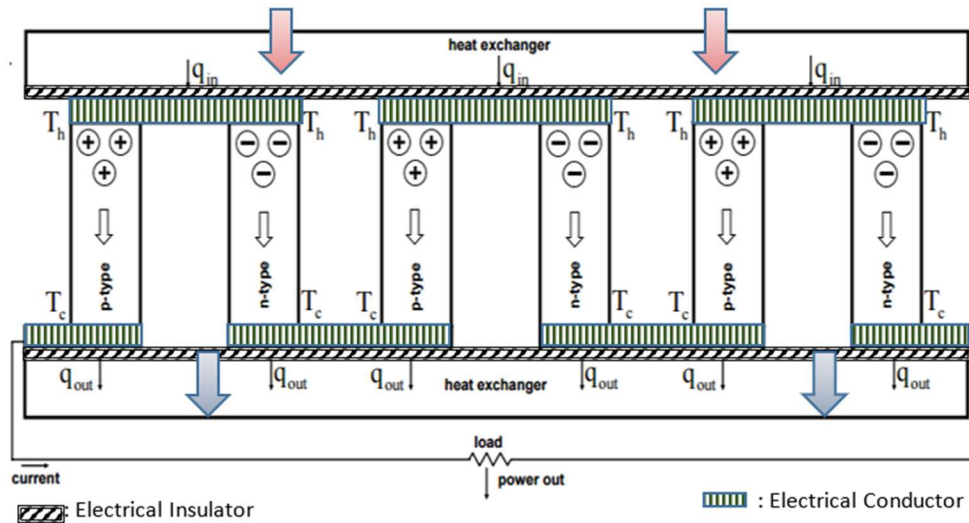

Figure I.3.87: Thermoelectric cell composed of different thermocouples.

Accordingly, thermoelectric modules can be used in two different modes [260]:

- 1- The power generation mode to produce electricity is called thermoelectric generator (TEG) and follows Seebeck effect, shown in Figure I.3.9 (a),
- 2- Active refrigeration mode (temperature controller), which is called thermoelectric cooler (TEC) and follows the Peltier effect, is shown in Figure I.3.9 (b).

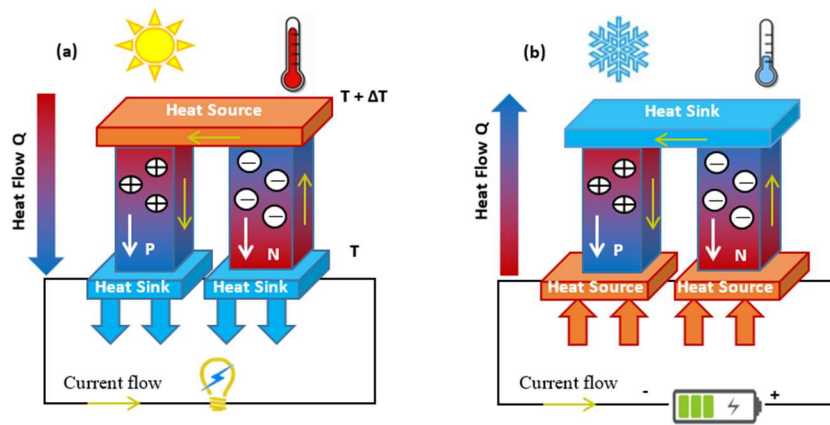

Figure I.3.9: (a) Power generation mode TEG and (b) Active refrigeration mode TEC setups

I.3.2.5. Figure of Merit (ZT)

TE unit is counted as a solid-state Heat Engine (HE). This means that it has a maximum effective efficiency the same as any other HE, this efficiency is known as the Carnot cycle shown in Figure I.3.10.

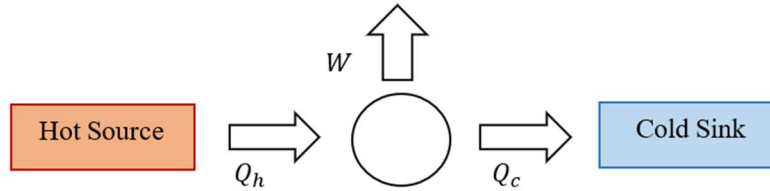

Figure I.3.10: Carnot Cycle

However, the actual efficiency of a TEG is proportional to a dimensionless parameter called figure of merit (ZT), which was developed in 1949 by the Russian scientist Abram Fedorovich Ioffe (1880-1960) [261]. ZT indicates the total performance of TEG, which is optimized when ZT is maximized. An adequate thermoelectric material should have a high Seebeck coefficient, high figure of merit, and low thermal conductivity K and resistivity. Thus, to attain high efficiency, both high figure of merit of material, ZT, and large temperature differences are preferred. Since the material's thermoelectric properties which are Seebeck coefficient α , electrical resistivity ρ , and thermal conductivity K fluctuate with temperature, it is not effective to utilize identical material through a whole large temperature difference. To reach an approximate ideal state, dissimilar highly efficient materials are used together in a way, where the first material at a higher temperature is segmented with the second material at a lower temperature. Through this approach, both materials are functioning in their utmost efficient range of temperature [262].

I.3.3. Historical Notes

As mentioned previously, TEG can generate electricity and providing a source of cooling and heating. The high interest in research in improving TEG is dissipated through the past years: Figure I.3.11 shows the milestones of TEG and Table I.3.2 shows the chronological history of TEG.

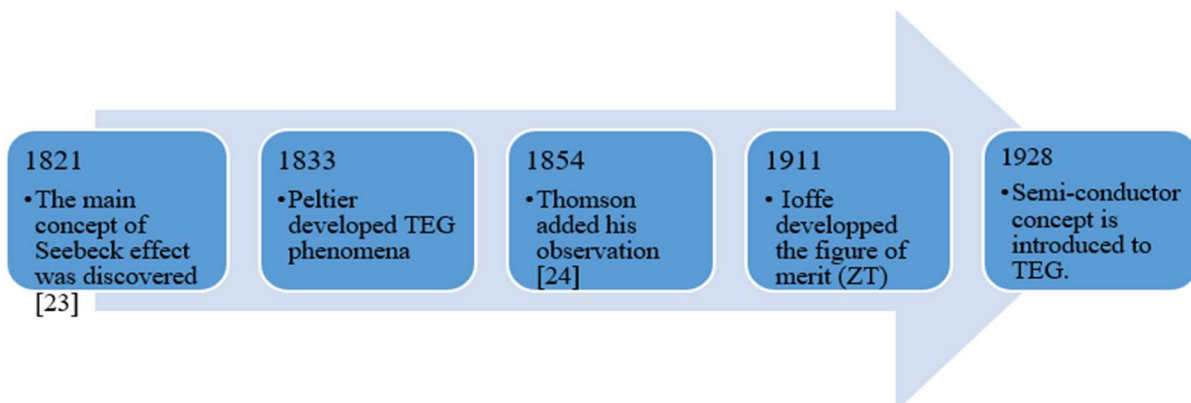

Figure I.3.11: Milestone of TEG since it was discovered.

Table I.3.2: Development of TEG in chronological order

| | |
|-------|--|
| 1821 | The main concept of the Seebeck effect was discovered [23] |
| 1833 | Peltier developed the TEG phenomena |
| 1854 | Thomson added his observation [24] |
| 1911 | Altenkirch arises the concept of maximum efficiency of TEG and the performance of a cooler |
| 1928 | The semiconductor concept is introduced in thermoelectric energy |
| 1930 | The first thermoelectric-operated radio was stated |
| 1947 | Maria Telkes (1900-1995) built the first thermoelectric power generation with a 5 % efficiency |
| 1954 | H. Julian Goldsmid ice up to 0 °C a surface by a Peltier cooler using Bismuth telluride (Bi ₂ Te ₃) |
| 1977 | NASA used MHW-RTG3 which is a Silicon Germanium (SiGe) TEG to launch two voyagers. |
| 2004 | TEG is integrated into automotive and the US Department of Energy [263] |
| 2000* | Nanotechnology in TEG is introduced [264] |
| 2005* | TEG for Industrial Waste Heat Recovery (WHR) was developed [265] |
| 2006* | Flexible TEG technology [266] |

* There was no specific year for introducing nanotechnology or flexible TEG; the years were obtained by going back to all review papers related to nanotechnology and polymers for TEG and finding the first time they were mentioned.

As shown previously, TEG technologies exhibited a high share in the research work on the theoretical and experimental scales as a power generation from temperature difference through TEG. Besides, in 1997, Rowe et al. [267] directed the first profound research. They built a structure composed of 36 TEG units inserted in the middle of two heat aluminium plate exchangers. They used hot water of a temperature of about 98 °C as a heat source, cold water of a temperature of nearly 20 °C for the cooling side, and around 95 Watts as a maximum output power. After the system was activated the temperature of the hot side became 97 °C and that of the cold side 14 °C. This result indicates that TEG can be utilized to transfer temperature gradient into electrical energy, however, the efficiency is low but because the source is free then efficiency is not that important [268].

In 2004, Crane et al. [269] conducted another experiment by investigating the heat transfer over TEG and expecting the electric and contact resistance. A counterflow liquid-to-air system was applied for thermoelectric heat recovery. The model entailed an aluminium tube for the hot water to flow with a three TEG module that was contacted directly. This research concludes that the temperature of fluid and air affects the output power of the TEGs system. Higher power output is obtained by increasing the temperature gradient across TEG and decreasing the thermal resistance by applying a better HE for heat recovery. In 2010, Gou et al. [270] constructed a prototype of liquid-to-air for power generation. They applied the fundamental irreversibility of heat transfer and thermoelectricity to expect the performance of TEG for small-scale waste heat recovery. The model contained a flow passage with a baffle in the middle to rotate the hot water. On the flow channel, ten TEGs were arranged in two rows and for the cold side, ten heat sinks with axial fans of the unit. Natural and forced convection were conducted in this study. The results displayed that increasing the capacity of heat transfer on the cold side would drive a noteworthy

improvement in the output power whereas there is no considerable achievement when enhancing the heat transfer on the hot side.

Nowadays, TEG is requested by many industrial sectors where it fills remarkable needs in the military, sensors, or cars [147]. Besides, TEG has gained a significant standard, especially after being integrated into nanotechnology [271], or the medical domain [272]. As well, TEG is used for running personal electronics through body heat such as mobile phones, and wearable sensor systems [248]. It must be mentioned that TEGs are also used as heat pumps and/or generators in domestic plants for air conditioning or heating [273]. Parallel to integrating TEG in useful applications, research on TEG is still in progress but it is directed towards going further beyond performance level by either increasing the gradient temperature such as changing fluid across TEG, finding any source of wasted heat, or increasing the efficiency which means editing the material used.

TEG is expected to expand its use in industrial applications. In the USA, there is a strategy to apply TEG in automobile industries. By working more on the molecular level of TEG and trying to increase the figure of merit, TED will have huge potential in many more regions of applications.

1.3.4. TEG in Applications and Classifications

Despite being less efficient than mechanical heat engines on large output power, TEG takes the lead when it comes to small output power somewhere less than 100 W. TEG's simplicity, unmatched dependability and durability make it the needful device in applications, where the aim is unattended operations rather than efficiency. These applications include power supplies for spacecraft that operate too far from the sun to take advantage of the photovoltaic effect, automotive uses that take advantage of the heat that engine shed, or generators for oil-producing installations including ocean platforms. Besides, being fully quiet is a virtue of the TEDs in many cases, where noise would be disturbing or intolerable as aboard submarines.

Well, TEGs have been widely used at commercial and industrial levels. Starting from watches, and automobiles and ending in spacecraft [274]. A great example of a low-power thermoelectric generator application that ranges between 5 μ W to 1 W would be the thermoelectric wristwatch, which uses thin bulk TEDs. The watch works via body heat converted into electrical power by the TEG. At least two models have been built, one by Seiko and another by Citizen. Internationally, there is a wide variety of commercial and custom-made TEGs, through low power generation such as micro-TEGs that generate low-power energy, such as wearable devices, and body-mounted devices.

Other examples of high-power generation that generates about 1 kW are involved in larger applications such as the automotive field (BMW, Volkswagen, Volvo, Ford and others) where TEG can extract waste heat from the exhaust that delivers DC electrical power to recharge the battery. By reducing or even eliminating the need for the alternator, the load on the engine is reduced thereby improving fuel efficiency by around 10 %. Besides, a TEG possessing a ZT of 1.25 and around 10 % efficiency might be utilized to retrieve 35–40 % of the energy from the exhaust manifold at a normal temperature of 250 °C, where a significant value of energy can be produced to contribute to up 16 % escalation in efficiency [275]. Researchers have shown high interest in TEG, and many researchers have investigated applications using TEG [276] such as being integrated into cooling applications [277], computational modelling [278], and parametric changes [279]. It was also used as a hybrid system with all-air HVAC systems [70], or solar photovoltaic [280].

According to the investigated papers, TEG was used in various applications. Thus, Figure I.3.12 classifies the use of TEG according to three main categories:

1. TEG in applications: TEG has been publicized widely and so fast in various fields, electronics, vehicles, industries, and renewable energy.
2. TEG in hybrid systems: TEG has a considerable share when involved with other energy recovery systems such as storage, piezoelectric, and HEs.
3. Design / Material improvement: research as well as discuss the design and material development to reach an optimum output of a TEG unit.

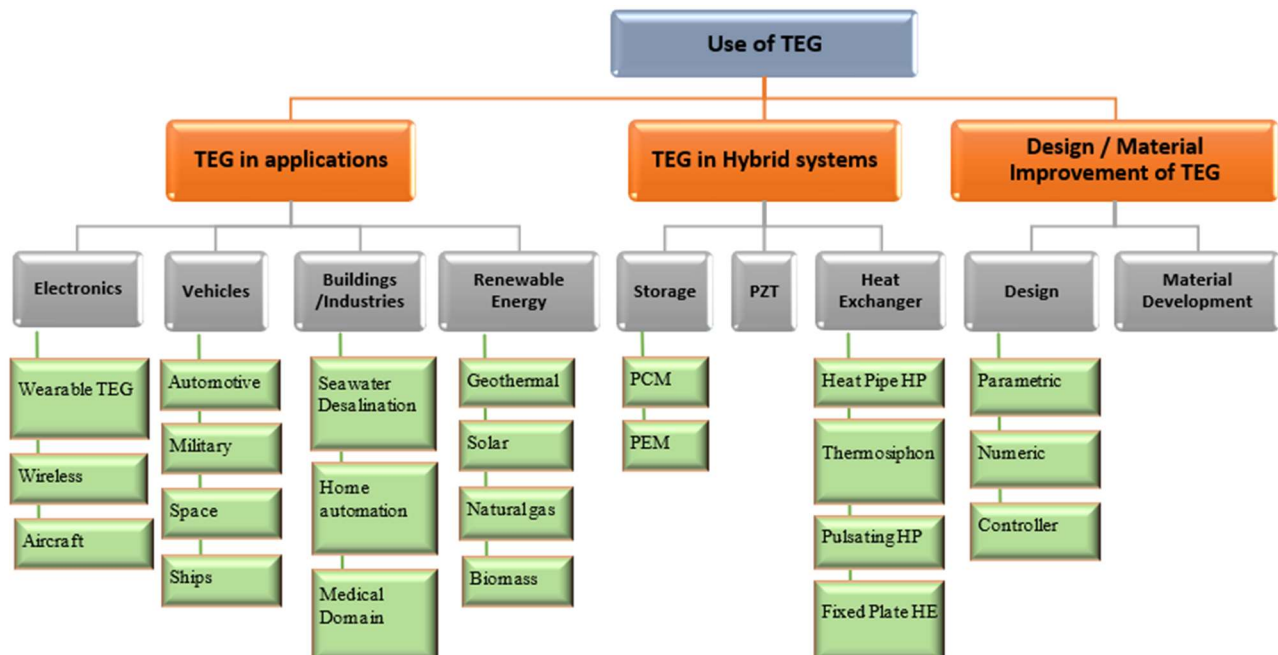

Figure I.3.12: Classification of TEG usage

This work studied over 140 published papers starting from 2008 to 2021. The studied papers are classified into four categories: TEG integrated with buildings and vehicles, TEG material development (MD), TEG installed with other heat recovery methods (hybrid heat recovery), and TEG joined with electronics or renewable energy. Figure I.3.13 shows the number of investigated papers according to years and the above-mentioned categories.

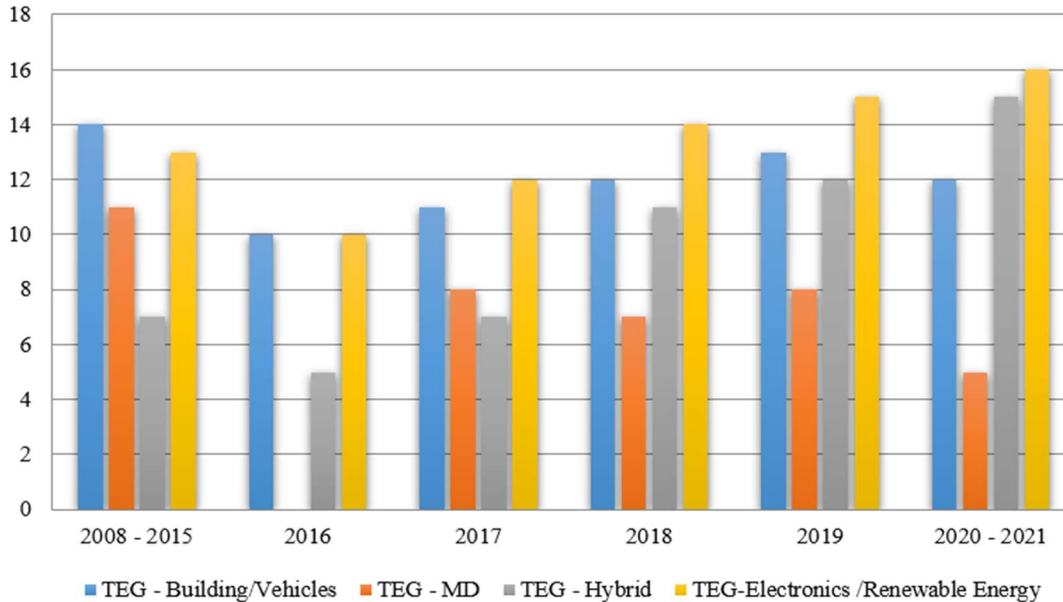

Figure I.3.13: Investigated papers according to categories and years.

As shown in Figure I.3.13, TEG has been incorporated in many fields, mainly combined with renewable energy/electronics and buildings/vehicles. Besides, TEG installed with other heat recovery methods such as TEG-PCM [281], TEG-HP [282], and TEG-PEM [283] started to grow noticeably; which means that it is worth investigating it even more and encourages going deep into studying TEG with other HRSs. Among the investigated papers, it is noticed that TEG with HE is well employed in different applications, which leads to the introduction of TEG with other HE technologies.

I.3.4.1. TEG in Heat Recovery Systems

As noticed from the results in the previous section, interest in TEG energy has grown rapidly due to its capability to generate power even from small waste heat, which leads to the development of green technologies and creates a new sustainable energy resource. This widespread of TEG in various fields encourages going further in studies to investigate the impact that TEG has on the applications [284]. Table I.3.3 shows the applications and studies of TEG.

Table I.3.3: Summary of the investigated papers related to TEG integrated into different applications.

| Authors | Methodology | Results |
|--------------------------------|--|---|
| Tabar et al. 2021 [285] | A nonconventional wasted energy recovery system is proposed. This novel framework contains the transformation of excess power, capturing energy loss, and helping in reducing pollution and operational costs. | Results obtained assure the ability of the novel design to achieve an almost zero energy configuration, where the environmental pollution and total cost are cut by 170.7 % and 83.5 % per day, respectively. |

| | | |
|-------------------------------------|--|--|
| Babu et al. 2017 [286] | Performance of various solar panel thermal hybrid systems was studied under different configurations such as design, location, TEG junction, additional parameters of design (active or passive cooling), and integration with phase change materials (PCM). Then the best configurations and future expectations for the PV-TEG design system were presented. | The performance of the PV-TEG system is highly affected by the parameters of TEG resulting in additional energy that varies from 10 to 20 % with overall efficiency that ranges between 40 and 50 %. One of the optimum configurations was the hybrid system PV-TEG-PCM, which enhances the overall efficiency by 1 to 2 %. TEG-PV shows a hopeful technology for the future, the progress in the TEG can affect greatly any μ grid network. |
| Bayenda ng et al. 2020 [283] | A review of 18 diverse studies on TE and a Polymer Electrolyte Membrane Fuel Cell (PEMFC) of a hybrid Combined Cooling Heating and Power (CCHP) system for domestic/commercial use was held. Assorted studies on thermoelectricity were conducted. A comparison of TEG-solar energy analysis was held. The comparison shows that TEG produces higher power in solar cells (SC) of equivalent sizes, although more expensive. | Results of these studies show that the power efficiency of TE is augmented by transforming waste heat into power for TEGs and power into the cold for TECs. Besides, in TEC and PEMFC hybrid CCHP system, the prime mover was the PEMFC and TEC cooler, which was able to produce 2.79 kW of electricity, 26.8 W of cold, and 3.04 kW of heat, resulting in 43.3 % of fuel saving and ~ 77 % of total efficiency. |
| Darkwa et al. 2019 [287] | Theoretical, numerical, and experimental studies were held on a hybrid system model of TEG that generates limited output power due to small gradient temperature and PCM that has an impact on the rise of the temperature of the PV through the process of heat storage. The result of different PCM parameters' conductivities, thicknesses, and phase change temperatures was calculated. | Simulation results proved the significance of high conductivity of PCM and thickness of PCM layer has an impact on layers of TEG and PV. The optimum heat performance for the model PV/TEG/PCM was attained at a 50 mm PCM layer thickness with 5 W/mK thermal conductivity and a phase change temperature that ranges from 40 to 45 °C. |
| Russel et al. 2010 [288] | A TEC incorporated with the HP model are established for controlling the heat of the electronic system. The execution of the system under mild conditions has been investigated. | Results show that this hybrid system functioned with high performance. It can also be implemented to improve a TEC-based hybrid controlling heat system and can be applied under various design conditions (heat load from chip and ambient temperature). |
| Ghude et al. 2013 [289] | A study on alternative cooling methods is done, due to the high demand for HVAC and its hazardous effect, where the conventional HVAC system utilizes a harmful cooling system that drains the ozone layer. So, the paper presents a comparative study between conventional HVAC and the novel cooling system concept HVAC TEC. | Results show that improving conventional HVAC to be eco-friendly requires a long time. Although refrigerant used is HFCs that have a lower effect than CFCs over the ozone layer, it also affects negatively on the ozone layer. On the other hand, the HVAC (TEC) model proved superior advantages and a better alternative. |
| Patyk 2013 [290] | A study on TEG for improving the efficiency of power generation in ICE and motor generators. Besides, a study of the environmental and economic values of TEG was held. | Results reveal that TEG saves energy costs and has a negligible environmental burden, (eco-efficient). However, it has low production compared to other methods. |

| | | |
|----------------------------------|--|--|
| Hiang et al. 2018 [291] | This paper presents the history and the achievement of TEG development in vehicles during 7 7-year program on waste heat recovery incorporating TEG in a BMW X6 and a Lincoln MKT. Throughout this program, numerous models of TEG were demonstrated and examined. A comparative analysis of the performance of the vehicle with and without TEG was then concluded. | Results showed that the generated power exceeded 700 W. The Department of Energy (DOE) program was successful, which resulted in leading a DOE-sponsored TE WHR program for automotive that is concentrated on declaiming technical and business-related issues. This process is destined to permit TEGs to be more involved in future automotive products and enhance this field. |
| Kishore et al. 2020 [292] | Experimental and numerical studies were established to prove the presence of a critical coefficient for heat transfer that drastically impacts the performance of TEGs. Besides, exterior thermal resistances and Boundary Conditions (BCs) have a strong impact on the behaviour of TE materials. | Results ensure that BCs affect substantially the design of TE, where the performance of a TEG differs from the variation of the BCs. For low-grade WHR, the optimized TEG produced 28 % greater power and compared to saleable modules optimized TEG produced 162 % greater power per unit mass of TE materials. |
| Martins et al. 2011 [293] | A combined system of Heat Pipes (HP) and TEG for recovering wasted heat from the exhaust gases of an automotive IC engine is studied. The HP transferred the thermal energy from the hot exhaust to the TEGs. | HP designs were verified with a noticeable development over the initial designs, in terms of pressure, temperature, and heat transfer rate, where controlling the temperature and pressure of the HP was possible, whereas the rate of heat transfer over the HP was enhanced considerably to exceed 1.4 kW. |
| Li et al. 2016 [294] | A simulation study under the same operational conditions on tube and fin heat exchangers (HE) using ANSYS is held. Several factors were studied such as the variation of the temperature and the Reynolds number. | Both HEs show an agreeable thermal performance with TEG. The fin HE shows better thermal performance due to its compactness. Besides, it displays the creation of a vortex from the inlet of the pipes to the outlet. Consequently, this structure results in various increases in the temperature even at a low Reynolds number. |
| Min et al. 2020 [295] | A mathematical model is established to design a TEG for recovering heat loss from the exhaust of a diesel engine. | Results show that the efficiency of the TEG ranges between 1.41 % to 4.12 %, which is very low. Thus, further, improvement should be held. |

Table I.3.3 shows several TEG applications, and the results of the most investigated cases agreed on the effectiveness, and reliability of TEG, where the common conclusion was TE is a promising technology. Besides, TEG has offered a remarkable effect when integrated into various fields. As well, Table I.3.3 shows that TEC cooling systems have benefits over conventional cooling devices, this is due to multi-criteria that TEG owns such as providing a new source of power from wasted thermal energy, small size, lightweight, no mechanical moving parts, high reliability, no working fluid, direct current power-driven, and swapping between heating and cooling modes easily. Furthermore, it is noticed from Table I.3.3 that some of the applications offer novel ideas in TEG with remarkable results. Other applications were not very effective [296] but in both cases, researchers are investigating improving the designs and enhancing TEG to augment the progress in the growth of TEDs for effective heat recovery and more eco-friendly. TEG is considered a promising technology, especially with continuous efforts in developing its ZT. Moreover, researchers recommend integrating TEG with some heat recovery methods such as heat exchangers, PCM,

and HP, where the benefits that this hybrid heat recovery system may offer are worth further experimental studies and developed commercially as noticed in various research [297], where the heat recovery methods such as HEs transfer the heat to the TEG which helps in creating better circumstances to higher gradient temperature consequently higher power output.

I.3.4.2. TEG in Hybrid Heat Recovery Systems

As noticed from Table I.3.3 in the previous section, TEG integrated with other heat recovery methods is a very promising technology, thus a deeper investigation of this section is held. The heat recovery methods, discussed in the previous section, lead to an increase in the power output: this could be attributed to the heat that the HEs recover, consequently increasing gradient temperature, which raises the power output. TEG combined with other recovery methods was illustrated in various previous studies in Figure I.3.14 [298], where throughout the research, it is noticed that TEG with specific heat recovery methods shown in Figure I.3.14 was investigated repeatedly.

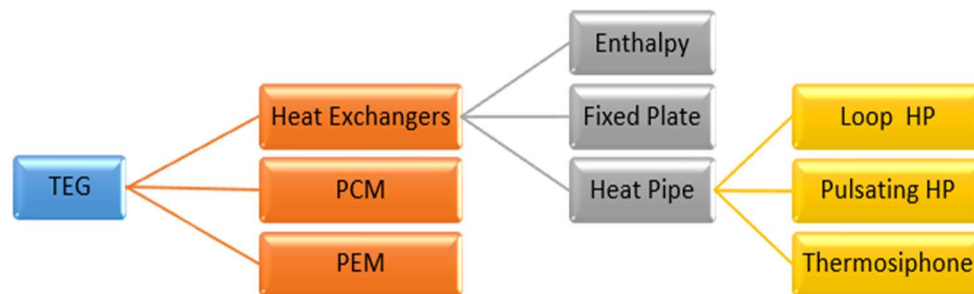

Figure I.3.14: TEG integrated with heat recovery devices.

TEG integrated into HE is a widespread technology, for instance, Seo et al. [299] proved the effectiveness of TEG with HEs. Besides, Zaher et al. [300] showed that the power was increased by 1.2 in axial conduction HE at even low flow rates of around 0.02 kg/s. Moreover, Wang et al. [301] performed an experimental study on the TEG-HE hybrid system to result in an efficiency of around 84 %. Another study was done by Bélanger et al. [302] to investigate the performance of TEG sandwiched in a crossflow HE. Also, Catalan et al. [303] conducted a study on TEG integrated with thermosiphon HE to conclude that the power generated per module was 3.29 W with ΔT of 180 °C and the design was 54 % better than with fin dissipators. As well, Araiz et al. [282] concluded that the hybrid TEG thermosiphon and PCM system is very effective and highly reliable in waste heat recovery applications. Furthermore, Catalan et al. [304] held a study on TEG integrated with a PCM in a 5000 m² geothermal plant, TEG PCM system resulted in an error of less than 8 % with an annual electric output of 681.5 MWh. Besides, various types of research illustrated the effectiveness of TEG combined with HEs [305]. Thus, it is recommended to do further studies on TEG in heat exchangers, as this system shows high reliability and agreement.

I.3.5. TEG New Technologies in Applications and Challenges

In this section, three main aspects will be studied: (1) Materials used in TEG have a high impact on the effectiveness of the TEG [306]; hence, studying the material properties is a crucial matter to the development of TEG. (2) TEG new technologies: with the increasing demand of global for alternative

energy sources, TEG technologies have shown a high share in the research work and it has become a need in the modern world (3) Challenges: with all the benefits that TEG offer, it holds many challenges such as low efficiency, thus, the challenge is to find temperature difference that will produce energy, and the higher the temperature difference, the more power generation is produced.

I.3.5.1. Materials Properties

While choosing TEG, several factors should be taken into consideration. Throughout the process, ideally, the temperature grade across TEG is large, so the thermal expansion will create stress, consequently, a fracture may occur inside the device. Thus, the mechanical properties of the materials should be studied, and the thermal expansion coefficient of the P- and N-type materials should be reasonably harmonized [307]. Thus, to obtain a reliable TEG, the characteristics of the materials used are likely to be reached, where the closer the materials get to the desirable properties presented in Table I.3.4, the higher the efficiency of TEG will be attained [308]. For instance, semiconductors are much more efficient than metals, where heat is conveyed completely by free electrons, whereas in semiconductors lattice vibration is a surplus mechanism for transporting heat.

Table I.3.4: Desirable properties of materials for an efficient TEG

| Material's Requirements | | | Reason |
|--|--------------|---|---|
| High thermoelectric power | | | To generate a maximum voltage in the circuit. |
| High ZT [309] | Power factor | High Seebeck coefficient (α) | It is the ratio of electromotive force to the gradient temperature between the two sides of the TEG. The material should be of low thermal conductivity to limit the gradient temperature, where the ideal case is when ΔT is zero. |
| $\frac{\alpha^2 \sigma T}{K_e + K_L}$ | | Low electrical resistivity (Ω) | |
| | | High electrical conductivity (σ) | To decrease losses due to temperature Joule heating. |
| Operating temperature | | | The operating or mean temperature. |
| Low thermal conductivity (κ_e) | | | To minimize the transfer of heat from the hot side to the cold side thus maintaining a large gradient temperature. |
| Lower scatter phonons (κ_L) Lattice component | | | Accumulating phonon scattering decreases thermal conductivity and consequently increases ZT. |

As noticed from Table I.3.4, efficient TEG requires materials with high electrical and low thermal conductivity, which are two contradictory features, where no material perfectly has these two characteristics at the same time. Semiconductors constitute a turning point in developing the TEDs [310], where the employment of TE was constrained before semiconductor materials were established [311]. Three semiconductors that are shown in Figure I.3.15 are identified to have both low thermal conductivity and high electrical conductivity (presented by the high-power factor) [312]:

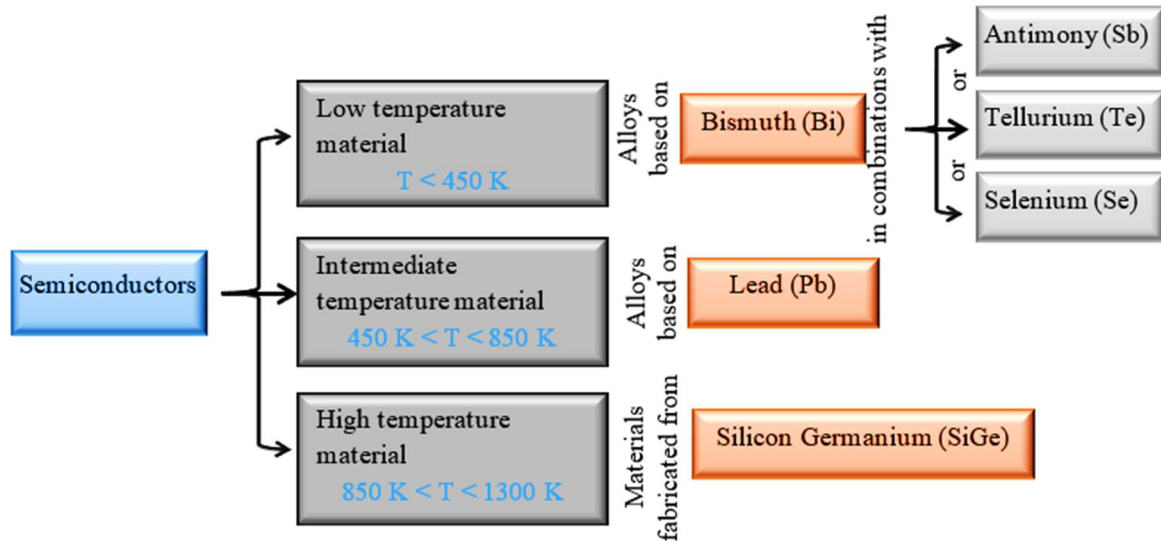

Figure I.3.15: Presentation of the three semiconductors according to temperature endurance.

Although semiconductors are widely applied in commercial and practical applications, substantial developments have been set in finding or fabricating novel material structures with improved thermoelectric performance. Lately, there has been a lot of research on harvesting higher energy from the TEG by dropping lattice thermal conductivity to improve ZT , which is done by working on the material. Research has gone so far as to improve materials such as silicon nanowires of high-power TEG, Phonon-Glass Electron-Crystal (PGEC), or nanotechnology [313]. So far, PGEC is considered the optimum to be used in TEG due to its mechanical properties that are approximately close to the required materials for optimum TEG mentioned in Table I.3.4, which are high electrical conductivity (crystal), and small lattice thermal conductivity (glass) [314]. Subsequently, TEG is considered a vital technique for waste energy mainly on a low scale. Though the key profits of TEGs are their low maintenance and compactness, yet the cost of their available materials is still too high.

Besides studying the selection of the material, it is concluded from the investigated papers, that the optimum power generation of TEG is reached by studying different factors other than materials used shown in Figure I.3.16, such as achieving a high figure of merit (ZT), which is an important factor that the scientists are working on increasing it [315], durability that lasts for the significant duration with low maintenance, mass flow rate and gradient temperature, which are affected by the design and application used, reliability that is affected by all the studied factors. All these factors are interrelated and affect each other. For example, material properties are one of the factors that affect ZT , enhancing ZT has an impact on durability and reliability and so on.

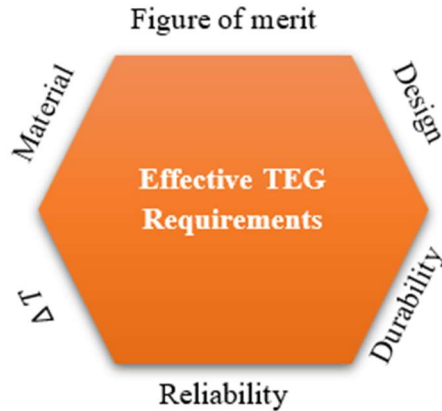

Figure I.3.16: Requirements for effective TEG

I.3.5.2. New Technologies and Applications

TEG has a great share in research through various aspects, which enhance the role of TEG and improve its effectiveness. Over the years, TEG has proved that it is in progress continuously; far from the conventional TEG, because of TEG's main advantage which is generating electricity from small-grade waste heat micro-TEG was introduced. μ -TEG functions at low gradient temperatures have unlocked some advanced applications in various areas such as consumer electronics, the Internet of Things (IoT), and biomedical engineering. With the development of further low-power devices and the regular enhancement of the figure of merit of the TEG material, there are high expectations the μ -TEG that will be useful in additional applications with remarkable effects [316]. Besides, TE modules are estimated to reach an efficiency of 10 % to 20 % and hot side temperature limitation that exceeds 500 °C [317]. Accordingly, this is considered to be a great solution in the future to decrease the cost of power generation. Theoretically, research succeeded in conducting thermal conductivity of the lattice besides, scientists have effectively configured materials at the nanoscale [318]. Consequently, TEG is considered a promising technology that will have a positive widespread effect on various applications. Figure I.3.17 shows the use of TEG in applications for power generation and cooling starting 1980 till 2021, and the expectation of using TEG till 2030, where different researchers expected the fields where TEG and TEC will be used [319].

There was no specific year for the starting date of some of the applications, the starting year was set based on revising the papers and the review papers related to applications of TEG and finding the first time each application was mentioned.

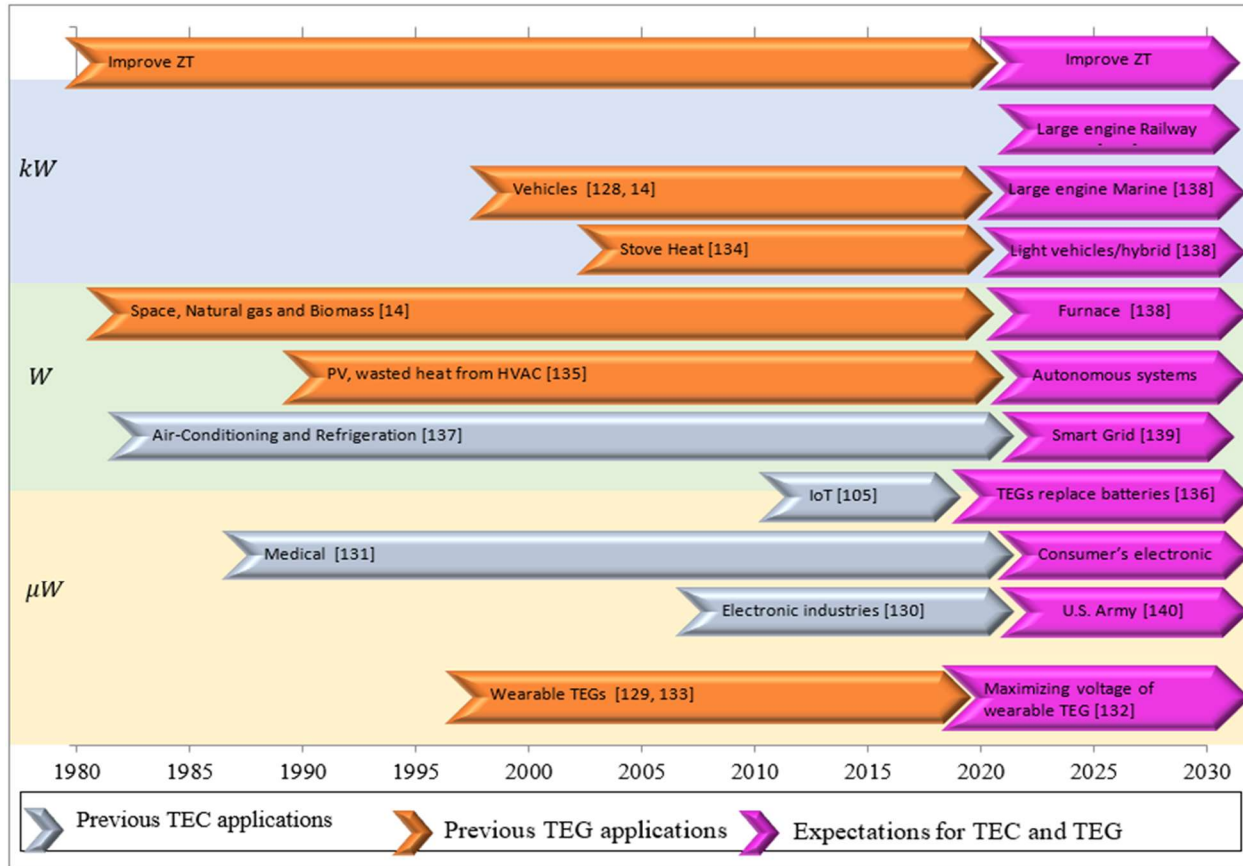

Figure I.3.17: TEG and TEC in applications.

As noticed in Figure I.3.17, thermoelectricity has captured attention in various fields. TEG and TEC for power generation and cooling are widespread over different applications, where they take a significant share in various fields. For instance, one of the foremost sources of energy consumption, space cooling, foretold that the claim of TEC will amount to 80 % by 2030 [320]. Likewise, the evolving of TEG guides to more challenges, such as bio-integrated systems [321], wearable electronics [322], micro thermoelectric generators [316], military [323], robotics [324], cybernetics and others [325] drive to innovative engineering methodologies, where researchers are working on replacing the battery, which is the supreme dominant source of energy, in wearable devices by TEG, this is considered as a successful step due to producing free energy and being more environmentally friendly by reducing hazardous chemicals in batteries.

As well, Figure I.3.17 shows that after the mid-1990s thermoelectricity has come with the flow of novel ideas. Also, enhancing TEG is a nonstop process that continues for future expectations, where theoretical expectations recommended that TEG efficiency could be strikingly improved due to the nanostructure engineering [326]. The hope for designing a better TEG has always been a target that scientists work on mainly after the innovation of the nanometer scale. This nonstop research on TEG leads to great improvement in TEG and being more involved in various applications.

I.3.5.3. Challenges

Throughout the research, several challenges have come across while studying TEG. In this section, the challenges that the researchers have faced while researching are presented in Table I.3.5. Challenges are considered an important sign that the research should try to solve to develop the material. Over the years, solving the challenges is one of the reasons that have led to growing TEGs even more and opening the opportunity to be involved in various applications. For instance, one of the main challenges of TEG is acquiring high ZT, which is due to the intrinsic relation between thermal conductivity and electrical conductivity of most materials. An alternative approach to intensify ZT is by dropping the total thermal conductivity, which can be achieved through structuring materials at the nanoscale level. Another one is the high output resistance, which is considered a general problem besides the high cost and low efficiency of TEG. So, to reach a large output voltage, a large Seebeck coefficient (high V/°C) is required. In some commercial devices, this issue is resolved by setting fewer elements in series more of them in parallel [307]. Also, converting waste heat in manufacturing is a big challenge for TEGs, which even with their low efficiency can take a part to attain a percentage in the overall efficiency and drop the environmental footprints.

Table I.3.5: Summary of the challenges during investigating TEG.

| Authors | Title | Challenges |
|-------------------------------|--|---|
| Chen et al. 2012 [327] | Nanostructured TE materials: Current research and future challenges | Reaching ZT values greater than 3 is hard to date. Dramatic improvements are required in the power factor, which is related to a further drop in thermal conductivity and a rise in electron conductivity. Decrease the thermal conductivity. |
| Liu et al. 2015 [328] | Current progress and future challenges in thermoelectric power generation: From materials to devices | For device-level development, challenges for metallization of conventional TE such as Mg ₂ Si, PbTe, Bi ₂ Te ₃ , CoSb ₃ , and oxides were studied. Achieving a high figure of merit is not the only issue, where high ZT with low gradient temperature is not efficient. Reliable TEG contact is a challenge, as each application requires a specific design. At least three criteria for good TEG are required: effectiveness, reliability, and efficiency. |
| Shen et al. 2019 [329] | Automotive exhaust thermoelectric generators: Current status, challenges and prospects | Automotive exhaust thermoelectric generators (AETEGs) efficiency is enhanced through two criteria, (1) the figure of merit of the materials ZT_m and (2) the mean or operating temperature. Thus, TE requires continuous development, so the challenge is to reach the optimum temperature and highest ZT. Other challenges for obtaining better TEG include evolving materials that tolerate high temperatures, improving the exhaust HEs design, and increasing the study of HP and PCMs in AETEGs. |

| | | |
|----------------------------------|---|---|
| Goel et al. 2020 [330] | Polymer Thermoelectric: Opportunities and Challenges | Large ΔT for TE applications, in polymers, are not favourable and thus low- ΔT and power system is required for polymer-based TE, which is suitable for several low-cost uses such as sensors.... These applications do not require high ZT yet they are sensitive to flexibility, cost, and simplicity in fabrication besides, they require a large voltage output. Consequently, this quest requires a higher Seebeck coefficient. |
| Davis 2018 [307] | A study on TEG materials, applications, and challenges | Equalize among the heat flow and maximise the gradient temperature. High cost with low efficiency, are two main issues in TEGs. High output resistance and reverse heat characteristics. |
| Aswa 2016 [331] | Key issues in the development of thermoelectric power generators: High figure of merit materials and their highly conducting interfaces with metallic interconnects | This review consists of research that discusses the evolution of efficient TEGs. The challenges in the discussed research are classified into: Making higher ZT of TE operates at various temperatures. Researchers have studied the materials affecting ZT, which is done by either (i) enhancing the power factor or (ii) decreasing the thermal conductivity. Building ohmic relation of P- and N-type metallic connection that has minimal resistance contact. These studies are materials specific, and, in some cases, low contact resistances have been found using appropriate buffer layers. Further analyses are required for the future, especially for eco-friendly materials, providing high ZT, low cost, and stability. Making TEGs with less thermal transmission among hot and cold sides. It is counted on the industries that are sharing a part in the manufacturing of TEGs with the augmentation of scientific and engineering research in TE. The TEG in commercial applications is foreseen to be indispensable very shortly. |
| Shuai et al. 2017 [332] | Recent progress and future challenges on thermoelectric Zintl materials | Practically, there are several challenges in fabricating any module. Extra thermal and electrical resistance at the contact between TE materials and brazing materials is considered a major challenge. |
| O'Dwyer et al. 2017 [333] | Scientific and Technical Challenges in Thermal Transport and Thermoelectric Materials and Devices | Seeking comparable P-type is a challenge, where the N-type Mg ₃ Sb ₂ -based materials have shown better results than the optimum available P-type materials. But P-type Mg ₃ Sb ₂ TE performance is relatively low. Hence, another P-type Zintl could be implemented, but this may lead to more challenges due to the complicated design of the device. |

As noticed from Table I.3.5, in addition to enhancing ZT, there is an accumulative effort to improve new materials by mounting the electrical power output, declining cost and evolving an environmentally friendly system. Hence, research on improving or developing new thermoelectric materials has no end. Besides, it is noticed that displaying challenges is a very helpful procedure for the development of TEGs, where continuous research resolves the previous challenges and develops TEG to become more reliable and efficient. Consequently, this development in TEG is opening novel ideas for employing TE materials efficiently.

I.3.5.4. Proposed solution to some of the challenges

Designing a system that has minimal thermal losses is a solution for balancing between maximum temperature difference and heat flow across the modules, this design could be illustrated by emerging another heat recovery device that captures the heat loss, such as reliable heat exchangers (heat pipes), or storage materials (PCMs), and that's why the efficiency of TEG integrated with HP or PCMs is higher than TEG alone, as concluded in the previous section. As well, this hybrid design is a solution for the materials' interface heat losses and protecting the TEG from damage at high temperatures. There are solutions for some challenges that create other new challenges, such as forced convection [334] or vortex generators, which are solutions for low heat transfer; however, forced convection requires a new source of power, and vortex generators increase the pressure drop.

Other challenges are avoiding high-pressure drops between the cooling and heating sources, almost perfect thermal isolation, appropriate low-resistance metal contacts of the cold side and hot side, improving the design of modules, etc [262]. Besides, the challenges of experimental complication systems in microfabricated, optical systems, which blocked various groups from being interested in such fields, consequently, restrict the development of experimental work. Another major challenge is the lack of theoretical and simulation data on the multiscale phonon modelling of nanocomposites. Furthermore, manufacturing of the device is still slow due to heat transfer concerns [335]. Thus, a more advanced scheme based on heat transfer to increase efficiency is required to be studied. The growth of TE materials requires continuous efforts by materials scientists, physicists, chemists, and theory scientists. As a result, the advantages and disadvantages of TEG are summarized in Table I.3.6. Some of the disadvantages can be reduced such as the efficiency, which varies according to the materials used. Furthermore, even though the initial cost of the TEG is high, however, it is repaid after a long time, where the maintenance cost factor is null in these devices.

Table I.3.6: Advantages and disadvantages of TEG.

| | Advantages | Disadvantages |
|---------------------|---|--|
| Design [336] | <ul style="list-style-type: none"> • High reliability • Durability • Scalability • No moving parts • Maintenance-free • Small in size and weight | <ul style="list-style-type: none"> • Low efficiency • No standard scheme: every project is new. • High initial cost • Difficulty of modeling TEG for simulation [337] |
| Operations | <ul style="list-style-type: none"> • Acoustically and electrically quiet • Mountable in all orientations | <ul style="list-style-type: none"> • High output resistance |
| Materials | <ul style="list-style-type: none"> • Direct energy conversion, no intermediate form of energy conversion • No working fluids • Nontoxic materials [338] • Abundant raw materials [17] | <ul style="list-style-type: none"> • Call for materials of both high thermal resistance and low thermal conductivity. • Power generation efficiency of TEGs is affected by the material [339] • Expensive material • P and N possess diverse mechanical properties |
| Applications | <ul style="list-style-type: none"> • Vast range of power production (kW–μW) • Extreme climate conditions | <ul style="list-style-type: none"> • High output resistance • Requires relatively constant heat source |

I.3.6. Conclusion

This study has investigated the theoretical background of TEG, besides a comprehensive review of TEG and its implementation in various fields. As well, it sheds light on new technologies of TEG and the manifested challenges. The following concluded outcomes are obtained:

- The distinctive nature of using TEG, which provides electricity with a ΔT even on a low scale and over a wide temperature range, has made TEGs a primary solution to specific energy problems concerning power generation and recovering heat in a stationary and environmentally friendly approach.
- The small efficiency of TEG has limited its growth in some applications. The use of TE in several regions has conquered major accomplishments in some products and disappointment in others.
- TEG combined with HEs is a very promising technology, where HEs transfer the heat to the TEG, which helps in creating better circumstances to higher gradient temperature and consequently higher power output and this result was illustrated in various studies.
- For WHR applications, TEGs are very promising as the heat is free and lost unless it is captured. However, the payback period may be longer or shorter according to the ΔT and the efficiency of TEG, thus, the research is converged on enhancing the efficiency of TE materials and studying new strategies of TEGs that provide a superior fusion of energy conversion systems.
- To increase the power output, it is not enough to increase ZT, where high ZT and low gradient temperature are not efficient, hence increasing power output requires both, as shown in Figure I.3.18.
- Forced convection enhances heat transfer, consequently increasing gradient temperature, however, it requires additional power, thus VGs are recommended to enhance heat transfer.

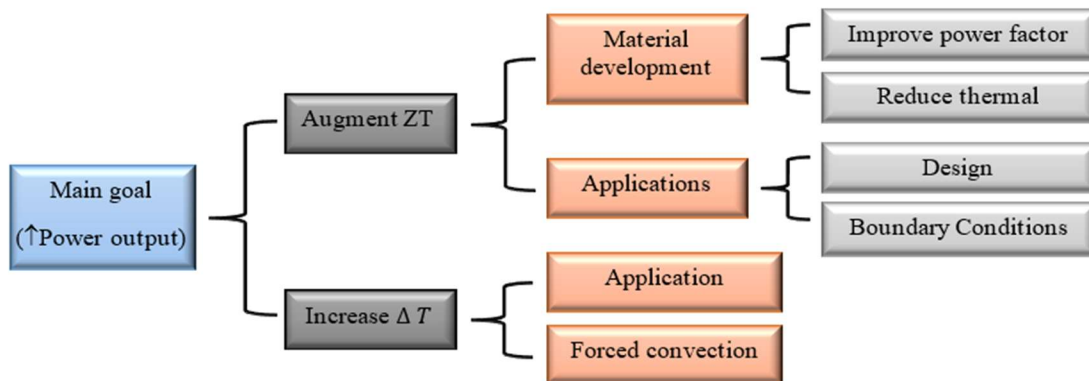

Figure I.3.18: Schematic of how power output may be increased.

- Throughout the research, there is an accumulative effort to develop new materials, diminish cost and build eco-friendly systems.
- Even though TEGs have high initial costs, however, on the long-term TEGs may repay the initial cost and even more become a profit-free source of energy.
- TEGs are favourable due to several advantages, such as scalability, being used on a wide range of applications, quietness, eco-friendliness, reliability, absence of moving parts, and maintenance-free.

- Intensive research on micro-TEG opened the opportunity to improve TEG in wearable devices, sensors, and powering electronics. Micro TEG is a promising technology, and there are accumulative efforts to make it a substitute for traditional batteries.
- The efficiency of TEG has developed over the years due to design and materials improvement. However, with all the improvements in TEG materials, most of the papers recommended further research to solve the foremost challenge in TE technology, which is enhancing and designing innovative TE materials with proper values of the figure of merit and power factor. Hence, research on improving or developing new thermoelectric materials has no end.
- Results show that combining TEG with other heat recovery methods such as heat pipes, PCM, and PEM has augmented the desirable output, where the combined system not only increases the power output however, but also protects the TEG from overheating. Hence it is recommended to do further studies on TEG combined with other heat recovery methods.
- Erecting a TEG that may have theoretical efficiency is an enormous progress that the research is working on, especially with the various concrete challenges. Thus, the growth of TE materials requires continuous efforts by material scientists, physicists, chemists, and theory scientists.
- For the future, TEG is a promising technology, especially with the continuous efforts to develop its ZT. TEGs are expected to be involved more in many sectors due to the continuous efforts that the scientists exert on developing TEG and the promising results that TEG offers.

General Conclusion of the three previous literature reviews

A general conclusion of the three previous literature reviews that studied heat recovery systems, hybrid heat recovery systems, and Thermoelectric Generators is summarized as the following.

The first study shows that heat recovery systems are a must in most applications to enhance the performance of the application and reduce energy consumption. The second study shows that integrating more than one heat recovery system is a promising technique for recovering a higher amount of thermal energy. Then, the third study shows that Thermoelectric Generators are worth to be studied especially in a hybrid heat recovery system. Thus, the conclusion obtained encouraged us to do a numerical study that employs TEG in an HHRS. But before integrating the TEGs with the system we intended to study the performance of heat transfer enhancement (HTE) using a trapezoidal vortex generator in a Concentric Tube Heat Exchanger (CTHE) through Computational Fluid Dynamics (CFD) code ANSYS Fluent. Heat transfer and fluid flow analysis will be conducted for various Reynolds numbers inside the tube and annular. The effects of VGs will be studied as well, and the turbulence flow will be simulated using the $k-\omega$ model. The analysis will be done on four designs, where the VGs are placed in three different locations as follows: (case 0) no VGs, (case 1) VGs inside the tube, (case 2) VGs on the interface between annular and tube, and (case 3) VGs on the outer wall of the annular part. Accordingly, the overall heat transfer, heat transfer ratio, and heat transfer/power of each of the three cases with VGs will be normalized to case 0 to study the effect of VGs on the flow and HTE. The best case obtained will be integrated into a practical study to find the heat recovery that this system could carry out in application. Two types of heating sources will be used renewable and non-renewable sources to find how much energy this system could save.

Chapter II. Numerical and Parametrical Studies: CFD analysis on the spatial effect of Vortex Generators in Concentric Tube Heat Exchangers – A comparative study

Résumé (en français)

Le présent article traite de l'amélioration du transfert de chaleur (HTE) à l'aide d'un générateur de vortex trapézoïdal dans un échangeur de chaleur à tube concentrique (CTHE) via le code de dynamique des fluides computationnelle (CFD) ANSYS Fluent. Le transfert de chaleur et l'analyse de l'écoulement des fluides sont effectués pour différents nombres de Reynolds à l'intérieur du tube et de l'annulaire. Les effets des générateurs de vortex (VG) sont également étudiés et l'écoulement turbulent est simulé à l'aide du modèle $k-\omega$. L'analyse a été effectuée sur quatre configurations, où les VG sont placés à trois endroits différents comme suit : (cas 0) pas de VG, (cas 1) VG à l'intérieur du tube, (cas 2) VG à l'interface entre l'anneau et le tube, et (cas 3) VG sur la paroi externe de la pièce annulaire.

En conséquence, le transfert de chaleur global, le rapport de transfert de chaleur et le transfert de chaleur/puissance de chacun des trois cas avec VG sont normalisés au cas 0 pour étudier l'effet des VG sur l'amélioration du transfert de chaleur. Les résultats montrent que les VG sont efficaces dans tous les emplacements, cependant, l'amélioration la plus élevée a été observée pour le cas 1, au nombre de Reynolds de 8000 pour le fluide froid et au nombre de Reynolds de 2000 pour l'eau chaude. L'amélioration du rapport de transfert de chaleur est de 97 % pour le cas 1, 92 % pour le cas 2 et 56 % pour le cas 3, alors que le facteur d'amélioration thermique est de 210 % pour le cas 1, 180 % pour le cas 2 et 142 % pour le cas 3.

II.1. Introduction

Heat exchangers (HEs) are widely used in almost every process and manufacturing sector around the world, where two fluids are usually separated by a wall and heat is transferred from a hot fluid to a cold fluid at the same time using HE equipment. Usually, most HEs involve two-fluid, but three-fluid heat exchangers are becoming more common such as being employed in solar flat plate collector systems. HEs are fabricated in a variety of flow configurations and designs, several types of HEs are categorized according to different applications such as finned, shell and tube, fixed HEs and many others. However, the CTHE or double pipe HE is the simplest in terms of design and cost, in which a pipe is inserted into another pipe and the two fluids each have their inlet and exit ducts. Then the heat is transferred from the hot fluid to the cold fluid through the inner tube wall, which is the interface between the annular and the tube. Both laminar and turbulent flow regimes can be used in HEs. Different applications, such as small multifunctional HE and tubular exchanger reactors, operate in a laminar flow regime. Yet, some other applications require turbulent flow [340]. According to the flow arrangement, there are two types: parallel flow and counterflow. In this study, counterflow is employed since it is more effective in terms of heat transfer. So, warm fluid enters from one side and the cold fluid flows from the other side as in Figure II.1.

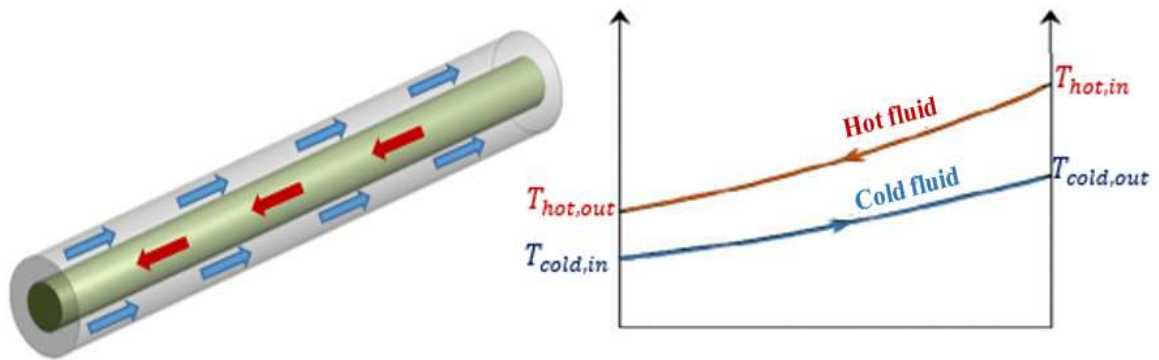

Figure II.1: Counter-flow heat exchanger with its temperature diagram.

CTHE is used in various applications in thermal and fluid domains such as heat recovery from oil cooling, desuperheating in refrigeration and air conditioning, engine cooling circuits, the pharmaceutical industry, dairy, and chemical industry, refinery, etc [341]. Thus, improving the overall performance of the HEs is fundamental for many industries. Enhancing heat transfer is a technique used for increasing the overall performance of HEs, where an increase or decrease in heat transfer holds a major role in energy manufacturers [342]. For instance, in several applications increasing the coefficient of convection heat transfer is essential due to cost limitations and space such as plasma reactors, cooling of electronic devices, gas turbine combustors, and turbine blades. The convective heat transfer can be improved by enhancing the fluid flow velocity, enlarging the heat transfer area, and stimulating disturbance inflow using vortex generators, roughness, spiral springs, baffles, or tangential fluid injection [343].

There are three modes of HTE methods: passive, active, and dynamic [344]. Active HTE techniques include vibration, electromagnetic field, and jet impingent, and are categorized as active since they involve an external source of power. The passive techniques are the most practical and efficient, they can be

performed with treated surfaces, rough surfaces, and VGs [345], which will be the focus of this research. The last type is the dynamic technique, it is efficient as well because flexible VGs are used.

Thus, inducing turbulence inflow is considered an effective method for heat transfer development, which is classified into active and passive systems. Active systems are techniques that use external power to enhance heat transfer, whereas passive systems are techniques that do not require external power [346], however, they benefit from the geometry to enhance heat transfer [347]. VG is one of the widely employed passive methods that increase the rate of heat transfer and thermal performance of HEs, without adding the cost of external power for inducing turbulence [348].

In this framework, the numerical simulations offer a prevailing design and optimization tool giving vision to the optimal parameters and design proposed as a settlement between best heat transfer improvement and energy spending. In this study, a numerical analysis is held by comparing the enhancement of heat transfer in a CTHE by employing VGs in three different ways, then analyzing the results and building up a conclusion accordingly. Ansys Fluent is employed to visualize the behaviour of fluid flow at different locations of VGs and different mass flows of both the hot and cold fluids.

II.2. Problem description

II.2.1. Mathematical formulation

In the following study, the flow is applied to three-dimensional (3D) steady-state-Reynolds-averaged-Navier-Stokes (RANS) equations. The continuity and momentum equations for an incompressible Newtonian fluid are as follows:

$$\frac{\partial u_i}{\partial x_i} = 0 \quad \text{Eq. II.1}$$

$$u_j \frac{\partial u_i}{\partial x_j} = \frac{\partial p}{\partial x_i} + \nu \frac{\partial^2 u_i}{\partial x_j \partial x_j} - \overline{\partial u'_i u'_j} \quad \text{Eq. II.2}$$

where the term $\overline{u'_i u'_j}$ is the Reynolds stress due to the change of velocity.

Besides, the turbulent flow is considered wherever the shear-stress transport (SST) $k - \omega$ model; as formulated by Menter [349], which are stated below:

$$\rho \frac{\partial}{\partial x_i} (\omega u_i) = \frac{\partial}{\partial x_i} (\Gamma_k) \frac{\partial k}{\partial x_j} G_k - Y_k \quad \text{Eq. II.3}$$

$$\rho \frac{\partial}{\partial x_i} (\omega u_i) = \frac{\partial}{\partial x_j} (\Gamma_\omega) \frac{\partial \omega}{\partial x_j} G_\omega - Y_\omega + D_\omega \quad \text{Eq. II.4}$$

where G_k denotes the generation of turbulent kinetic energy owed to gradients of mean velocity. G_ω signifies the generation of ω . Y_k and Y_ω signify the dissipation of k and ω owed to turbulence and D_ω denotes the cross-diffusion term. For the $k - \omega$ model, the effective diffusivities Γ_k and Γ_ω models are known as follows:

$$\Gamma_k = \mu + \frac{\mu_t}{\sigma_k} \quad \text{Eq. II.5}$$

$$\Gamma_\omega = \mu + \frac{\mu_t}{\sigma_\omega} \quad \text{Eq. II.6}$$

where σ_k and σ_ω represent the Prandtl numbers for k and ω respectively, and μ_t represents the turbulent viscosity. Heat transfer is represented in the equation below:

$$\frac{\partial}{\partial x_i} [u_i(\rho E + p)] = \frac{\partial}{\partial x_i} \left(\lambda_{eff} \frac{\partial T}{\partial x_i} \right) \quad \text{Eq. II.7}$$

where E is the total energy and λ_{eff} the effective thermal conductivity.

In this study, the numerical simulations are held through the CFD code ANSYS Fluent. The combination of pressure-velocity is created using the coupled algorithm, which determines the momentum and pressure-based continuity equations together. The flow equations are determined with twice accuracy and a second-order upwind design for spatial discretization of the convective forms. The diffusion terms are central different and accurate to the second order. A convergence standard is established to 10^{-6} for the results of the flow equations in Equations (II.1-4). However, a 10^{-8} is placed for the result of the energy equation (Eq. II.7).

II.2.2. Computational domain

The computational domain for the simulations involves a Concentric Tube Heat Exchanger (CTHE) with three different arrangements of vortex generators (VG) to the inner and outer walls. The tube has a length of $L = 300$ mm, an inner diameter of $D_i = 20$ mm and an outer diameter of $D_o = 40$ mm. The dimensions taken in this study are not very important, since they can be changed according to the application, but, our concern is to understand the behaviour of the flow under different conditions.

To enhance heat transfer, VGs of trapezoidal shape (big base = 6 mm, small base = 3 mm, height = 8 mm, and thickness = 1 mm) are employed with an inclined angle of 30° with the surface and directed opposite to flow direction. Six rows of four diametrically opposed VGs are inserted on the inner and outer walls which yield a total of 24 VGs in each case as shown in Figure II.3. The spacing between two consecutive rows of VGs is 30 mm. Four cases are considered, where in each case the Reynolds number of the flow in annular and tube varies as a result of changes in the mass flow rate \dot{m} of the fluid, which also affects the velocity as presented in the following equations [350]:

$$Re = \frac{4\dot{m}}{\pi(D_o + D_i)\mu} \quad \text{Eq. II.8}$$

$$V = \frac{\dot{m}}{\rho \cdot A} \quad \text{Eq. II.9}$$

where μ , ρ , V , and A are the dynamic viscosity, density of water, velocity, and area normal to flow direction, respectively. Hot water passes through the tube at a temperature of 30°C (303 K), and cold-water flows

through the annular at a temperature of 20 °C (293 K), in a counter-flow arrangement. The outer wall of the tube is adjusted to adiabatic with zero heat flux boundary conditions.

II.2.3. System description and methodology

Numerical analysis is held by comparing the enhancement of heat transfer in a CTHE through employing Vortex Generators (VGs) in three different ways. Therefore, the simulation is done on four different cases, case 0: no VGs are employed and is considered the empty CTHE case, case 1: VGs are inserted into the inner wall of the tube, case 2: VGs are on the inner wall of the annular region, and case 3: VGs on the outer wall of the annular region as shown in Figure II.3. Case 0 is studied to compare each case of VG to that of the empty case.

In each case, the design is drawn on Ansys with a fixed temperature for both hot and cold water for all four cases 30 °C and 20 °C respectively. *Re* number of the hot and cold flow is varied through six values in laminar (500, 1000, and 2000) and turbulent (4000, 6000, and 8000) regimes, which affects the other input variables, such as mass flow rate, heat capacity, and heat transfer. The working fluid is water which determines the values of the fluid properties input such as thermal conductivity, specific heat, and density. Thus, this variation will result in different output performance parameters (Nusselt number, overall heat transfer ratio, required power...) for each value of the *Re* number. These parameters are normalized to case 0 to study the improvement of each case to no VG case and to perform a comparison among the three cases.

II.2.4. Numerical Validation

To validate the results obtained from the CFD, a validation test is done to study the accuracy and identify the deviation of the numerical simulations concerning the correlations. Thus, the heat transfer (q) was calculated through different correlation methods [351, 352] and then compared to the result of q obtained in CFD. Figure II.2 shows the results of heat transfer using different correlations and through a CFD simulation. The graph shows that the deviation of the CFD results differs from one correlation to another in a range between +15 % and -6 %, with two deviations lower than 3 %. These results are acceptable and confirm the validation of the carried out numerical simulations.

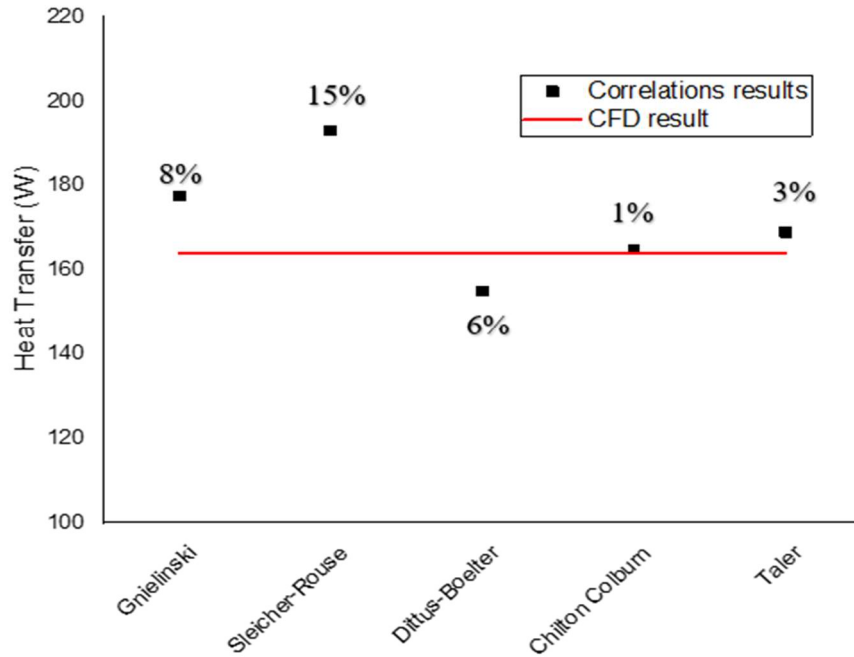

Figure II.2: Deviation of the result obtained in CFD to various correlations [351, 352].

II.2.5. Mesh sensitivity study

A mesh with polyhedral cells is applied for all the simulations. An independent study for the mesh is studied at $Re = 8000$ for both hot and cold flow since 8000 is the highest Reynolds number. For the cases where VGs are presented, the mesh is refined at the VGs, at the inner wall separating the two fluids and at the outer wall of the annular region. Table II.1 shows mesh sensitivity analysis, where three configurations of mesh were employed. The mesh is refined by decreasing the size of the element cells until the variation of heat transfer reaches 1 %. The heat transfer rate between hot and cold-water streams q is calculated through Eq II.12. Three different mesh sizes were conducted, presented in the fourth column. Near wall regions, fifteen mesh layers are chosen, and the height of the first grid point is minutely picked so that the resulting y^+ value does not exceed 1 in all the used meshes. The chosen mesh for all the simulations is the mesh in case 2 with a total of 3,651,456 elements, a maximum element size of 0.7 mm and a first inflation layer height of 0.01 mm.

Table II.1: Mesh sensitivity details.

| Mesh | Maximum element size (mm) | Number of elements | Heat transfer q (W) | q deviation (%) |
|------|---------------------------|--------------------|-----------------------|-------------------|
| 1 | 1.5 | 2,089,201 | 239.811 | - |
| 2 | 0.7 | 3,651,456 | 255.586 | 6.58 |
| 3 | 0.5 | 7,020,216 | 258.143 | 1.00 |

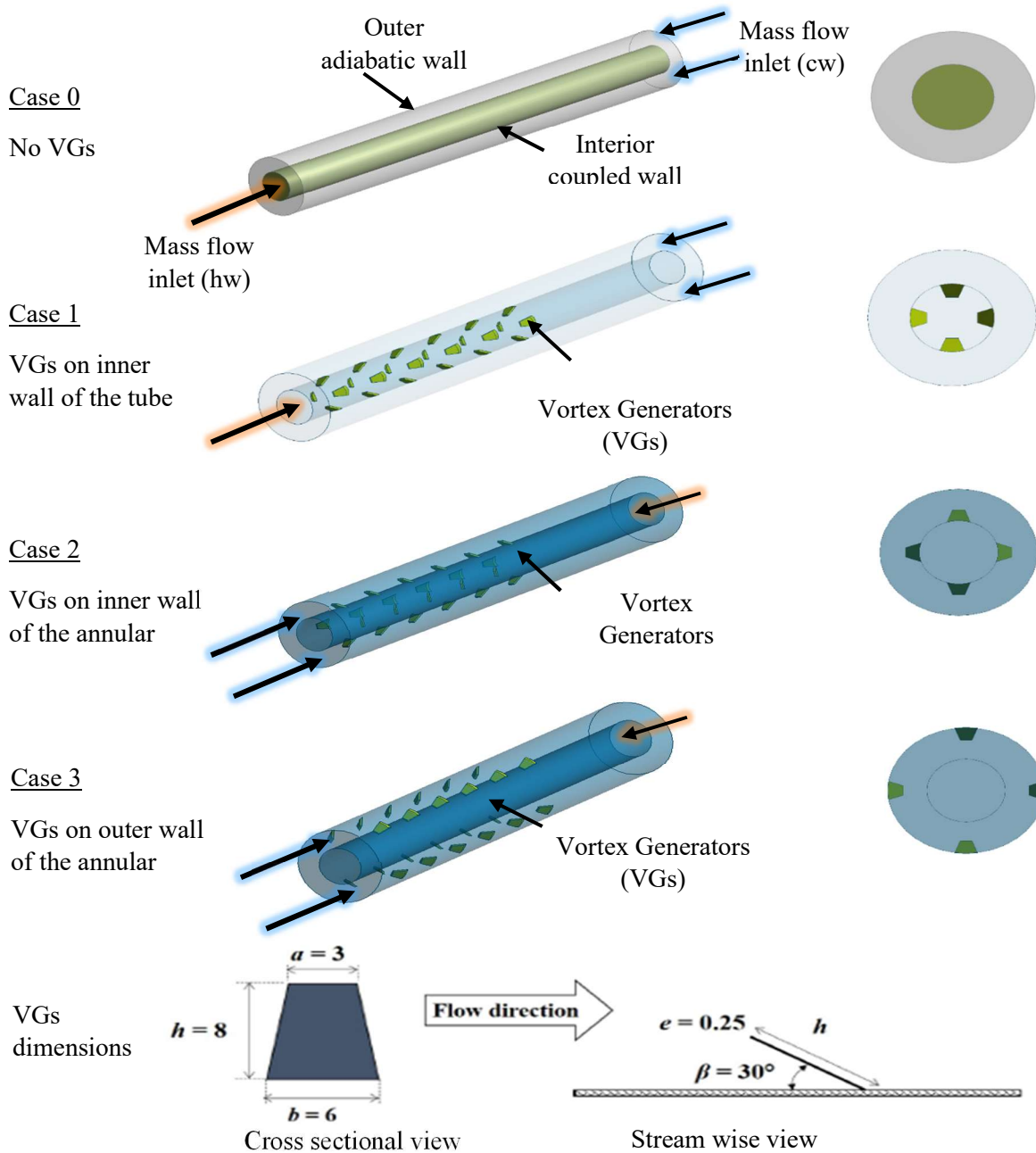

Figure II.3: Computational domain for all the four cases investigated displaying the boundary conditions, the VGs position and the dimensions of the trapezoidal shape VG (in mm).

II.3. Results and discussions

II.3.1. Performance parameters

The performance of different configurations is evaluated based on several parameters. In this section, the important parameters for global analysis are presented.

The global friction factors for the tube and the annular regions are given by [350]:

$$f_{hw} = \frac{D_i}{l} \frac{\Delta P_{hw}}{0.5 \cdot \rho \cdot (V_{hw,i})^2} \quad \text{Eq. II.10}$$

$$f_{cw} = \frac{D_o - D_i}{l} \frac{\Delta P_{cw}}{0.5 \cdot \rho \cdot (V_{cw,i})^2} \quad \text{Eq. II.11}$$

where l is the length of the tube = 0.3 m, ρ is the density of the water, ΔP is the pressure drop between the inlet and outlet flow where: $\Delta P_{hw} = P_{inlet\ hw} - P_{outlet\ hw}$ is the pressure drop across the tube region with circulating hot water hence the subscript hw . Similarly, the pressure drop in the annular region is $\Delta P_{cw} = P_{inlet\ cw} - P_{outlet\ cw}$, with circulating cold water hence the subscript cw . $V_{cw,i}$ and $V_{hw,i}$ are the velocities at inlet cold water (cw) and hot water (hw) respectively.

To calculate the heat transfer rates between the hot and cold water, the following parameters are presented [350]:

$$q_{cw} = \dot{m}_{cw} \cdot Cp \cdot (T_{c,o} - T_{c,i}) \quad \text{Eq. II.12}$$

$$q_{hw} = \dot{m}_{hw} \cdot Cp \cdot (T_{h,i} - T_{h,o}) \quad \text{Eq. II.13}$$

where q_{cw} is the heat transfer of the cold water, q_{hw} is the heat transfer of the hot water, \dot{m} is the mass flow rate, Cp is the specific heat capacity of the water, $T_{c,i}$ is the temp of cold water at the inlet, $T_{c,o}$ is the temp of cold water at the outlet, $T_{h,i}$ is the temp of hot water at the inlet and $T_{h,o}$ is the temperature of hot water at the outlet. Here the heat transferred from the hot water is totally gained by the cold water and as a result $q_{cw} = q_{hw}$.

The heat transfer convection coefficients for the common wall interface between the hot water and the cold water are given by [350]:

$$h_{hw} = \frac{q_{hw}}{\pi \cdot D_i \cdot l \cdot (\bar{T}_{hw} - \bar{T}_w)} \quad \text{Eq. II.14}$$

$$h_{cw} = \frac{q_{cw}}{\pi \cdot D_i \cdot l \cdot (\bar{T}_w - \bar{T}_{cw})} \quad \text{Eq. II.15}$$

where \bar{T}_w is the average temperature of the wall interface between the hot tube and cold annular, \bar{T}_{hw} is the arithmetic mean temperature of the hot water between the inlet and the outlet of the tube and is given by $(\frac{T_{hw,i} + T_{hw,o}}{2})$, \bar{T}_{cw} is also the arithmetic mean temperature between the inlet and outlet of the annular side and is $(\frac{T_{cw,i} + T_{cw,o}}{2})$ and finally D_i is the inner diameter of the tube.

To assess the enhancement in heat transfer, the global Nusselt numbers are calculated based on the tube side Nu_{tube} and the annular side $Nu_{annular}$ and are given by [350]:

$$\text{Nu}_{cw} = \frac{h_{cw} \cdot (D_o - D_i)}{k} \quad \text{Eq. II.16}$$

$$\text{Nu}_{hw} = \frac{h_{hw} \cdot D_i}{k} \quad \text{Eq. II.17}$$

By neglecting the wall thermal resistance due to conduction, the overall heat transfer coefficient is calculated:

$$U = \frac{1}{\frac{1}{h_{hw}} + \frac{1}{h_{cw}}} \quad \text{Eq. II.18}$$

In all four cases, Reynolds numbers of the hot and cold flow are changed through six values: in the laminar regime (500, 1000, 2000) and turbulent regime (4000, 6000, 8000) which will yield a total of 36 simulations performed to study all different possibilities.

To assess the thermal performance of vortex generators compared to the empty case, case 0 refereed hereafter with index 0, additional parameters are defined and are explained as follows [350]:

- Overall heat transfer ratio: defines the ratio of U value for the VG cases to the U value of the empty case U_0 and is equal to U / U_0 .
- Heat transfer ratio: quantifies the enhancement in heat transfer rate q when adding VGs compared to the empty case q_0 , equal to q / q_0 .
- Pumping power ratio: is the ratio of the pumping power for the VG case relative to the empty case, and is equal to $\frac{P}{P_0} = \frac{(\Delta P_{hw} \cdot \dot{m}_{hw} + \Delta P_{cw} \cdot \dot{m}_{cw})}{(\Delta P_{hw,0} \cdot \dot{m}_{hw,0} + \Delta P_{cw,0} \cdot \dot{m}_{cw,0})}$ where P is the pumping power input to get a specific Reynolds number in each of the cases 1, 2, or 3, and P_0 is the pumping power input in case 0 which means the empty case with no VGs in both regions. The power input is calculated through the following equation $P = \frac{\text{delta pressure}_{hw} \cdot \dot{m}_{hw} + \text{delta pressure}_{cw} \cdot \dot{m}_{cw}}{\rho}$.
- Thermal enhancement factor (TEF): quantifies the relative enhancement in heat transfer to the increase in pumping power, which is the input power that is employed to run the flow when adding VGs. TEF is the ratio of heat transfer ratio and pumping power ratio: $\mathbf{TEF} = \frac{q/q_0}{P/P_0}$.

II.3.2. Global analysis

After obtaining the main parameters, a comparison between the three cases was held to study the effect of the trapezoidal VGs on the performance of the heat transfer, input power, and thermal enhancement factor. Figure II.4 shows the variation of each of the above main parameters versus the Reynolds number of the hot and cold flow for the three cases studied.

As observed, the normalized overall heat transfer is greater than one through the range of Reynolds numbers for hot and cold water, this indicates that the heat is always enhanced as compared to the empty VGs case. Besides, it is noticed from Figure II.4 that case 1 has the highest improvement value in all three parameters, where the ratio in each parameter was highest at case 1. For instance, U/U_0 displays a maximum

improvement at low Re of hot water (Re_{hw}) and high Re of cold water (Re_{cw}), however for cases 2 and 3, U/U_0 displays a maximum improvement at high Re_{hw} and low Re_{cw} , where the maximum improvements compared to the empty case are 167 % for case 1, 97 % for case 2 and 58 % for case 3.

Whereas the enhancement of U/U_0 for case 1 is lowest at high Re_{hw} and $Re_{cw}=4000$, however for cases 2 and 3, U/U_0 is lowest at water low Re_{hw} and high Re_{cw} . The minimum improvements compared to the empty case are 19.7 % for case 1, 14.3 % for case 2 and 9.4 % for case 3. The difference in the optimum and minimum positions between cases 1, 2 and 3 are attributed to two criteria: (1) the geometry corresponding to the tube, annular, and VGs, (2) the Reynolds number in each of the tube and the annular.

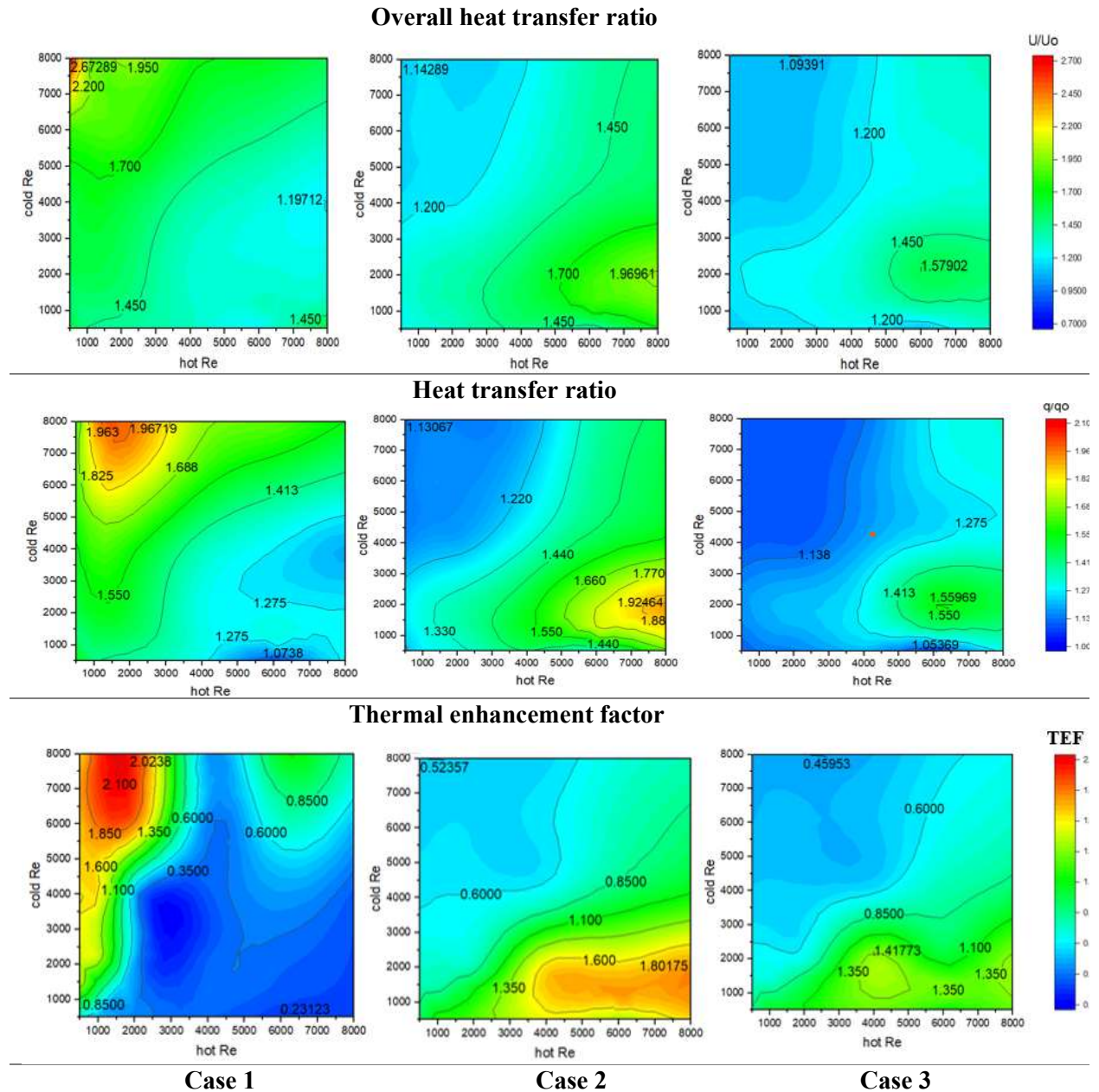

Figure II.4: Comparison between the main parameters for the three cases: case 1, case 2, and case 3.

Similarly, the normalized heat transfer ratio is greater than one for all the range of Reynolds numbers, which indicates the heat is enhanced as compared to the empty VGs case. For case 1, q/q_0 displays a maximum improvement at low Re_{hw} and high Re_{cw} , however for cases 2 and 3, q/q_0 displays a maximum improvement at high Re_{hw} and low Re_{cw} . The maximum improvements compared to the empty case are 97 % for case 1, 92 % for case 2 and 56 % for case 3.

Whereas the enhancement of heat transfer ratio for case 1 is lowest at high Re_{hw} (=8000) and low Re_{cw} (=2000), however for cases 2 and 3, q/q_0 is lowest at low Re_{hw} and high Re_{cw} , where the improvements compared to the empty case are 7.4 % for case 1, 13 % for case 2 and 5.4 % for case 3.

However, a third main parameter should be also studied which is the thermal enhancement factor. Figure II.4 shows the variation of the thermal enhancement factor versus the Reynolds number. It is noticed that there are some places where this parameter is less than one which means that it is not efficient for all values of Re .

For case 1, the thermal enhancement factor displays a maximum improvement at low Re_{hw} (=2000) and high Re_{cw} (=8000), however for cases 2 and 3, the thermal enhancement factor displays a maximum improvement at high Re_{hw} (=8000) and low Re_{cw} (=2000). The maximum thermal enhancement factor reaches around 210 % for case 1, 180 % for case 2 and 142 % for case 3.

Whereas the values of the thermal enhancement factor for case 1 are lowest at high Re_{hw} (=8000) and low Re_{cw} (=2000), however for cases 2 and 3, the thermal enhancement factor is lowest at low Re_{hw} and high Re_{cw} . The minimum thermal enhancement factor decreases compared to the empty case to 23 % for case 1, 52.3 % for case 2 and 45.9 % for case 3.

In conclusion from the above graphs, the following points were noticed:

- Case 1 has the highest improvement of heat transfer among all cases to heat enhancement, and overall heat transfer.
- The highest improvement in case 1 was at low Re_{hw} (=2000) and high Re_{cw} (=8000). However, the lowest improvement was at high Re_{hw} (=6000 and 8000) and low Re_{cw} (=500, 2000, and 1000).
- On contrary, case 2 and case 3 exhibit the highest improvement at high Re_{hw} (=8000) and low Re_{cw} (=2000), which is opposite to case 1 that is because in cases 2 and 3, VGs are placed in the annular, however, in case 1 VGs are placed in the tube, then this could be attributed to the reason that creating turbulence in both regions increase the heat transfer more than having turbulence in one region, where in cases 2 and 3 both regions were turbulent, the hot region due to the high Reynolds number and the cold region due to the presence of VGs, which makes heat transfer optimum. Similarly, for case 1, optimum heat transfer was in the presence of turbulence in both regions.
- Case 2 shows higher improvement than case 3 although in both cases VGs are presented in the annular, this is due to the location of VGs on the outer side of the annular: in fact, the outer wall is under adiabatic conditions so heat cannot be transferred, however at the interface between hot region and cold region the heat may be transferred much more efficiently.

II.3.3. Flow structure and temperature contours

In this section, a comparison is held at the locations where the highest improvement and lowest improvement occurred to find the reason behind the enhancements of each case. The comparison is done

by analyzing the temperature, and vortices profile contour of each case on seven different planes located at 35, 65, 95, 125, 155, 185, and 250 mm (after each row of VGs) as shown in Figure II.5.

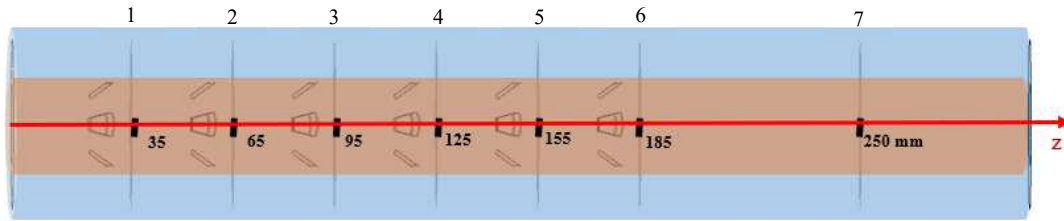

Figure II.5: The location of the seven planes in the CTHE

In this section, a closer analysis of the highest and lowest improvement of cases 1 and 2 is held to find the reason behind this difference within the same case. Case 3 does not show interesting results as in cases 1 and 2 so the observation and analysis are done just on the highest improvement Reynolds number condition.

II.3.3.1. Temperature profiles for case 1

Figure II.6 and Figure II.7 show the temperature distribution along the CTHE of case 1 after each row of VGs at Reynolds numbers ($Re_{hw}=2000 - Re_{cw}=8000$) and ($Re_{hw}=8000 - Re_{cw}=2000$) respectively.

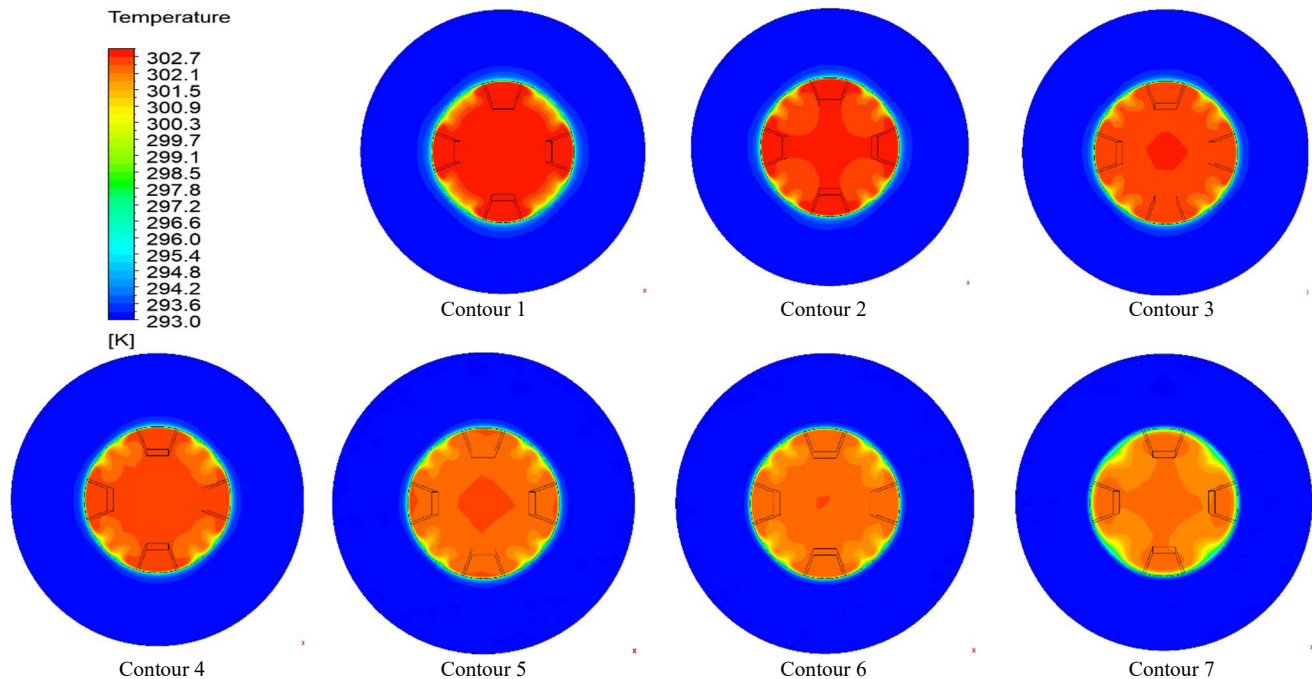

Figure II.6: Temperature profiles of case 1 for $Re_{hw}=2000 - Re_{cw}=8000$.

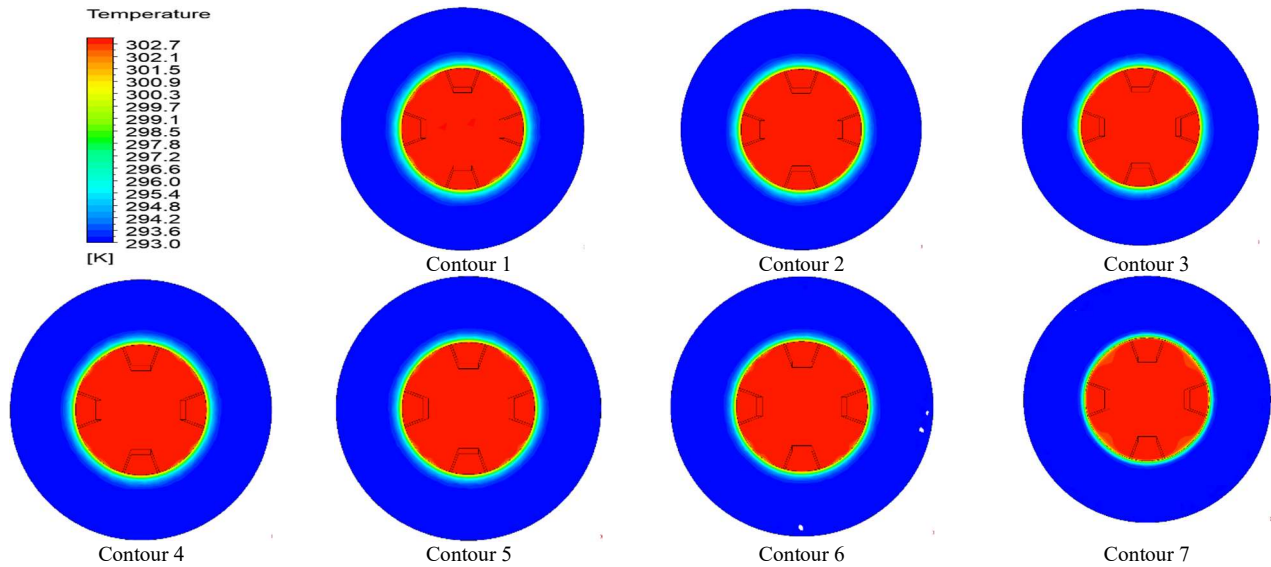

Figure II.7: Temperature profiles of case 1 for $Re_{hw}=8000 - Re_{cw}=2000$.

As noticed in Figure II.6, the temperature of the flow seems to be affected by the cooling process, where the outlet hot temperature decreases around 3 this was noticed in the change of contour, where after each row of VGs the temp was changing not just at the wall and around the VGs, however at the center of the tube as well.

On contrary, in Figure II.7 the temperature decreases slightly, even with the presence of the VGs in the tube. Thus, the reason for this contradiction is due to the high Reynolds number in the tube and the low Reynolds number in the annular. The high Reynolds number in the annular creates a flow structure that reduces the thermal boundary layer as shown in Figure II.6. However, throughout all the contours in Figure II.7, a considerable thermal boundary layer is noticed around the wall in the annular, which is presented due to the low turbulence of the flow in the annular, this layer negatively affects the heat transfer. In other words, the heat is transferred to just the layer close to the boundary.

This explains that the Reynolds numbers condition ($Re_{hw}=2000 - Re_{cw}=8000$) has higher heat transfer, which could be attributed to the flow structure. In the next section, vortical structures are presented to explain the association between flow and heat transfer performances.

II.3.3.2. Vortices profiles for case 1

Lambda2 method is a vortex core line identification algorithm [353] that can effectively detect vortices from a 3D fluid velocity field as shown in Figure II.8 and Figure II.9, where the vortices profiles of case 1 were detected after each row of VGs at the operating conditions ($Re_{hw}=2000 - Re_{cw}=8000$) and ($Re_{hw}=8000 - Re_{cw}=2000$) respectively.

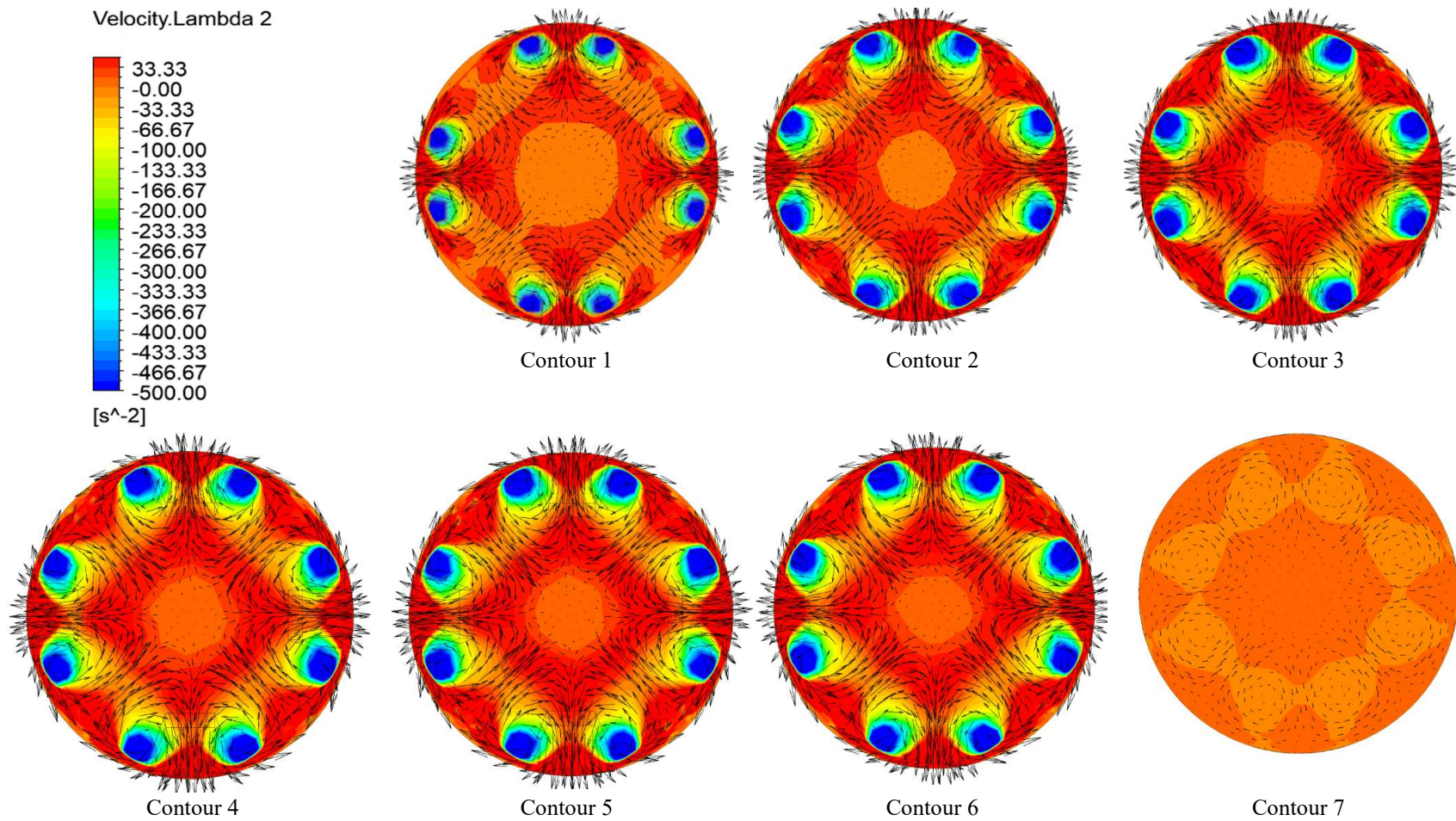

Figure II.8: Vortices profiles for case 1 for $Re_{hw}=2000 - Re_{cw}=8000$.

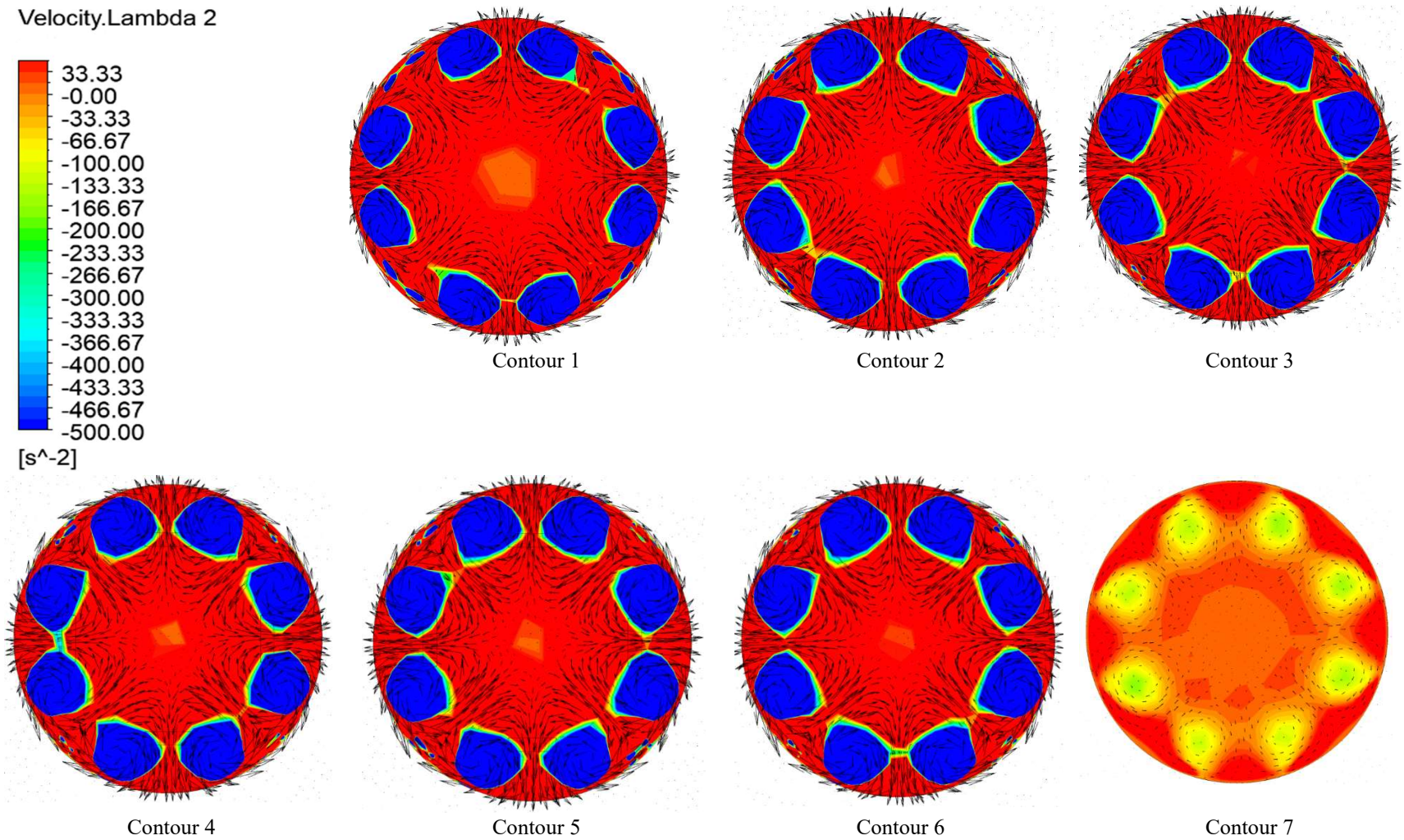

Figure II.9: Vortices profiles for case 1 for $Re_{hw}=8000 - Re_{cw}=2000$.

Figure II.8 shows that vortices are located around the VGs where each VG generated two vortices, the vorticity decreases gradually towards the center. Besides, it is noticed that the intensity of vorticity slightly increased after contour 1, as a result of the increase in the velocity vectors. After contour 2, the behaviour of the flow was approximately the same, however, at row 7, the behaviour was obviously different, where the intensity of the vortices was less than the previous contours and velocity vectors of the flow were low.

Similarly, for Figure II.9, the vortices are detected around the VGs and the behaviour of the flow is almost the same from contour 2 till 6, however, the intensity of the VGs was extremely high then it sharply decreased. This could be attributed to the high velocity and the presence of VGs at the same time, where high turbulence due to the high Reynolds number with the presence of VGs may cause the vortices to swirl extremely around the VGs. At contour 7, the velocity vectors decreased with lower turbulence of the flow. This difference between contour 7 and the previous ones in Figures II.8 and II.9 confirms the effect of the VGs row along the tube.

II.3.3.3. Temperature profiles for case 2

Figure II.10 and Figure I.11 show the temperature profiles of case 2 after each row of VGs at the operating conditions ($Re_{hw}=8000 - Re_{cw}=2000$) and ($Re_{hw}=2000 - Re_{cw}=8000$) respectively.

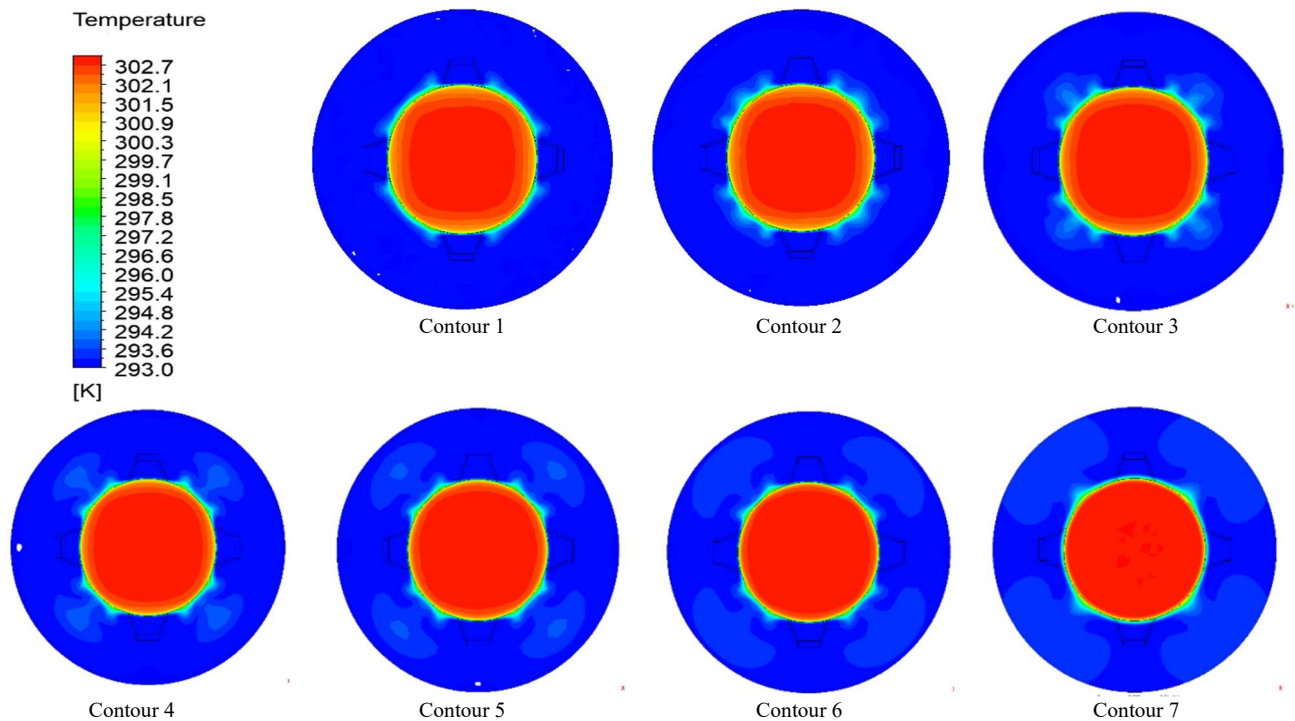

Figure II.10: Temperature profiles of case 2 for $Re_{hw}=8000 - Re_{cw}=2000$.

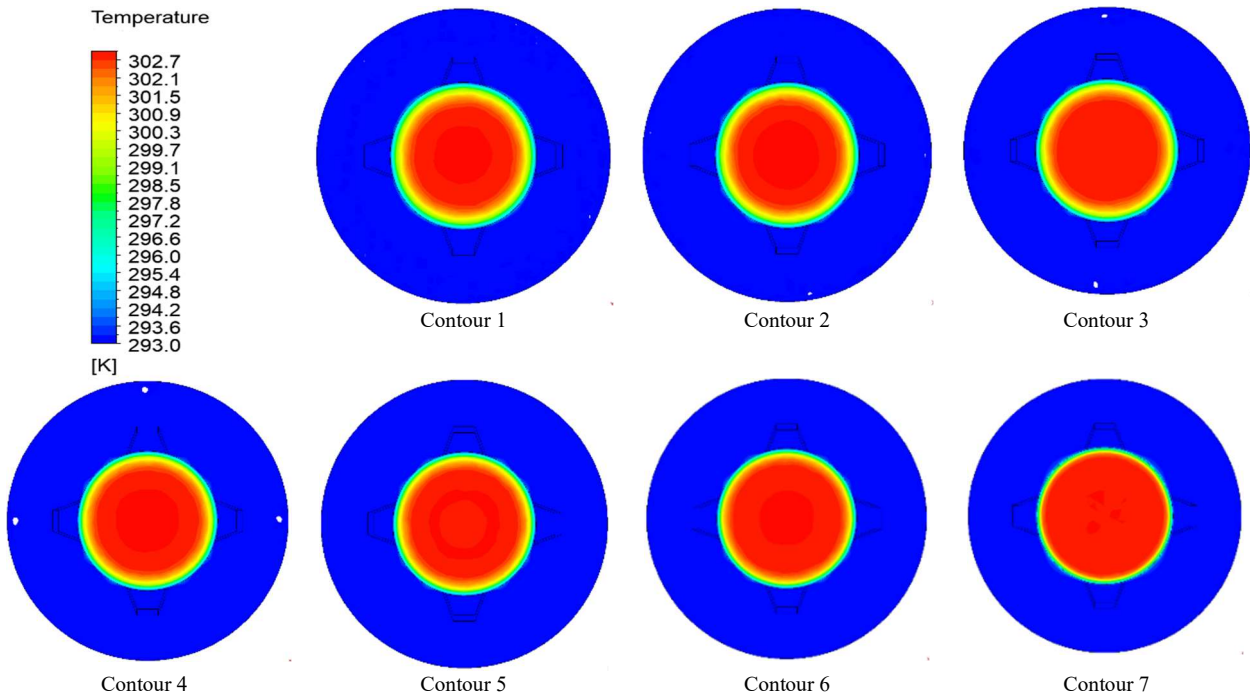

Figure II.11: Temperature profiles of case 2 for $Re_{hw}=2000 - Re_{cw}=8000$.

As noticed in Figure II.10, the increase in temperature in the annular is noticeable, where the temperature of the cold fluid is increased by around 2.5, due to the turbulence in the tube from the high Reynolds number and the vorticity in the annular created by the VGs. The presence of turbulence in the heated water and the occurrence of vortices in the cold water increases the temperature difference at the thermal boundary layer, consequently enhancing heat transfer. On the other side, heat transfer in Figure II.11 is low, this is represented by the thermal boundary layer in the tube which is a result of the laminar flow in the heated water. So, to enhance the heat transfer, the flow must be turbulent which helps in mixing the fluid and getting a homogeneous temperature. This explains that the condition ($Re_{hw}=8000 - Re_{cw}=2000$) has higher heat transfer.

II.3.3.4 Vortices profiles for case 2

Figure II.12 and Figure II.13 show the vortices profiles of case 2 after each row of VGs at Reynolds numbers ($Re_{hw}=8000 - Re_{cw}=2000$) and ($Re_{hw}=2000 - Re_{cw}=8000$) respectively.

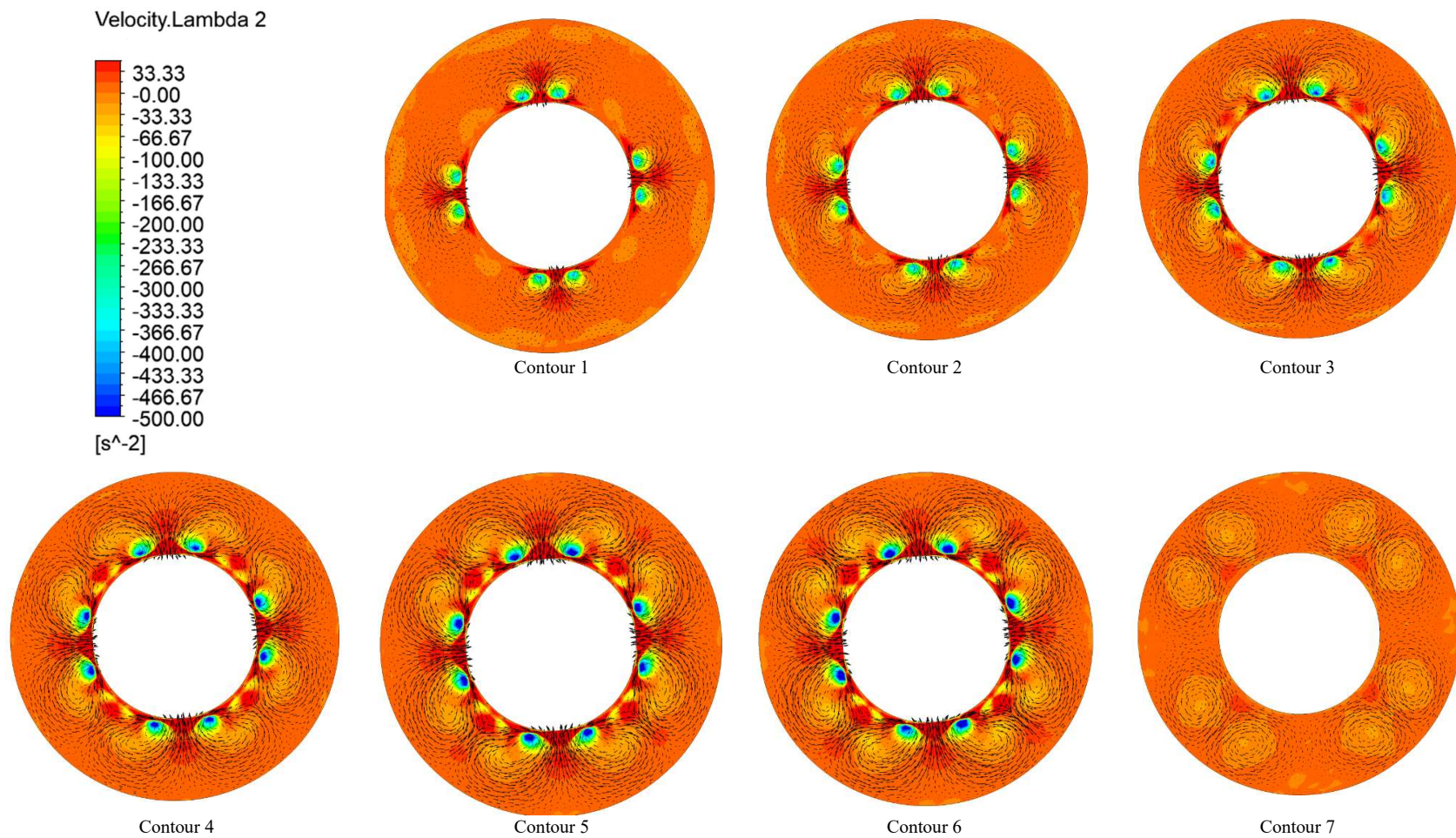

Figure II.12: Vortices profiles of case 2 for $Re_{hw}=8000 - Re_{cw}=2000$.

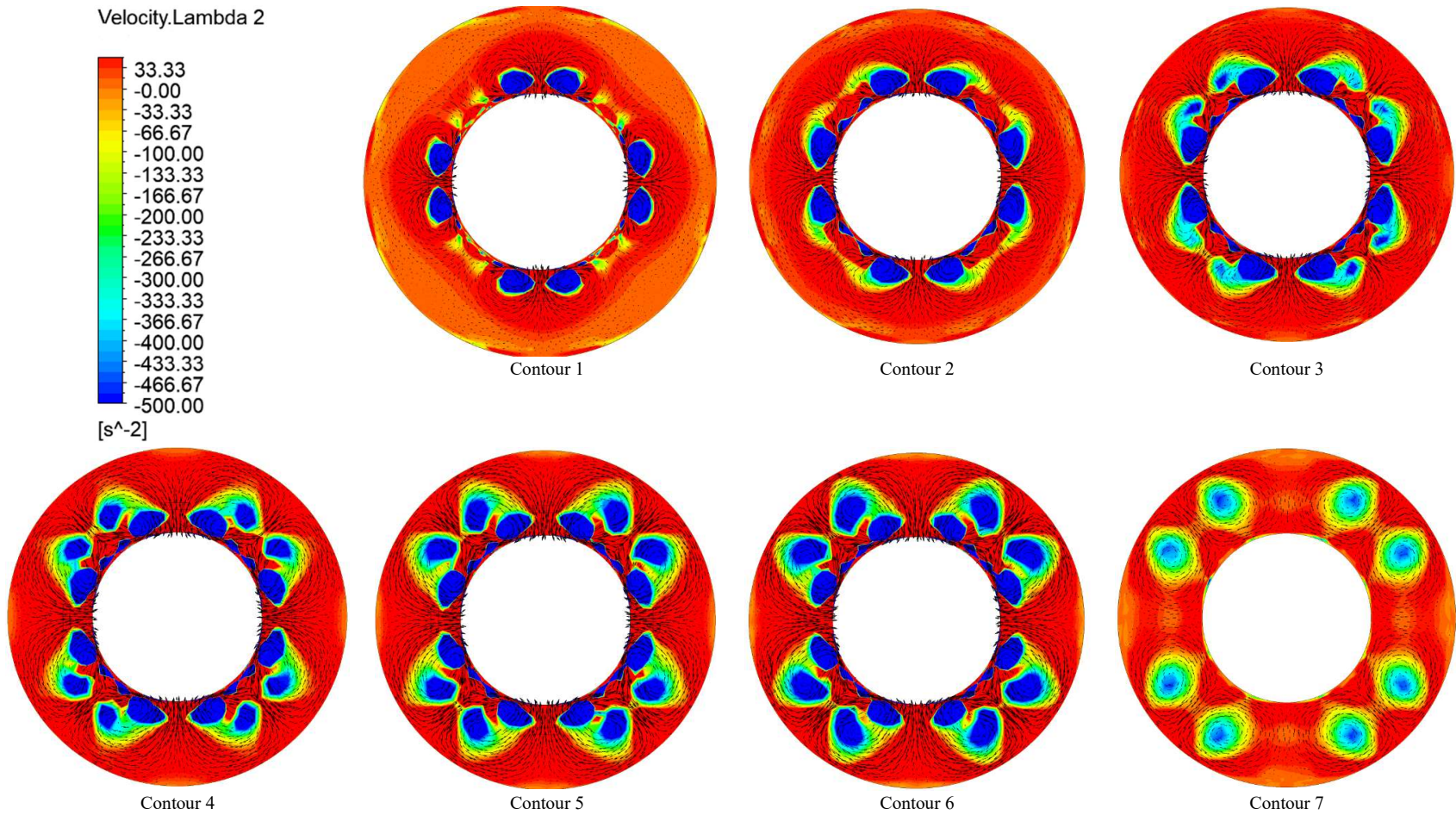

Figure II.13: Vortices profiles of case 2 for $Re_{hw}=2000 - Re_{cw}=8000$.

Figure II.12 and Figure II.13 show that by provoking the cold flow with VGs, vortices are generated in the annular with each VG generating two vortices. Besides, it is noticed that the intensity of vortices was increasing after each row of VG along the tube until the last row (row 7), where the vortices decreased significantly, which approves the effect that VGs have on the flow. Furthermore, in Figure II.12 the vortices in the annular are relatively low, however, in Figure II.13 the intensity of vorticity was extremely high as a result of high velocity and high Reynolds number. In row 7, the vortices were decreased gradually so that the flow leaves the tube with lower turbulence.

II.3.3.5 Temperature and Vortices profiles for case 3

Figure II.14 and Figure II.15 show the temperature profiles and vorticity profiles of case 3 after each row of VGs at the operating condition ($Re_{hw}=8000 - Re_{cw}=2000$). As mentioned previously, case 3 did not show interesting results as in cases 1 and 2, so the observation was done just on the more favourable conditions of Reynolds numbers.

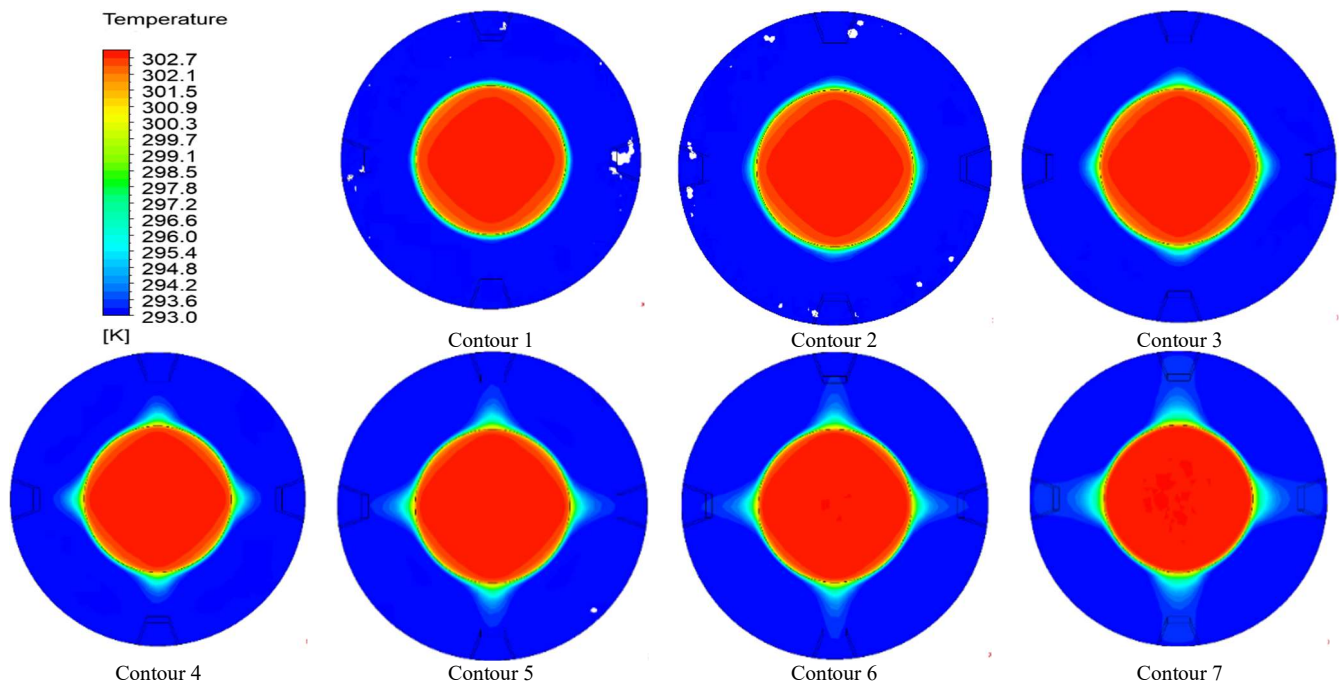

Figure II.14: Temperature profiles of case 3 for $Re_{hw}=8000 - Re_{cw}=2000$.

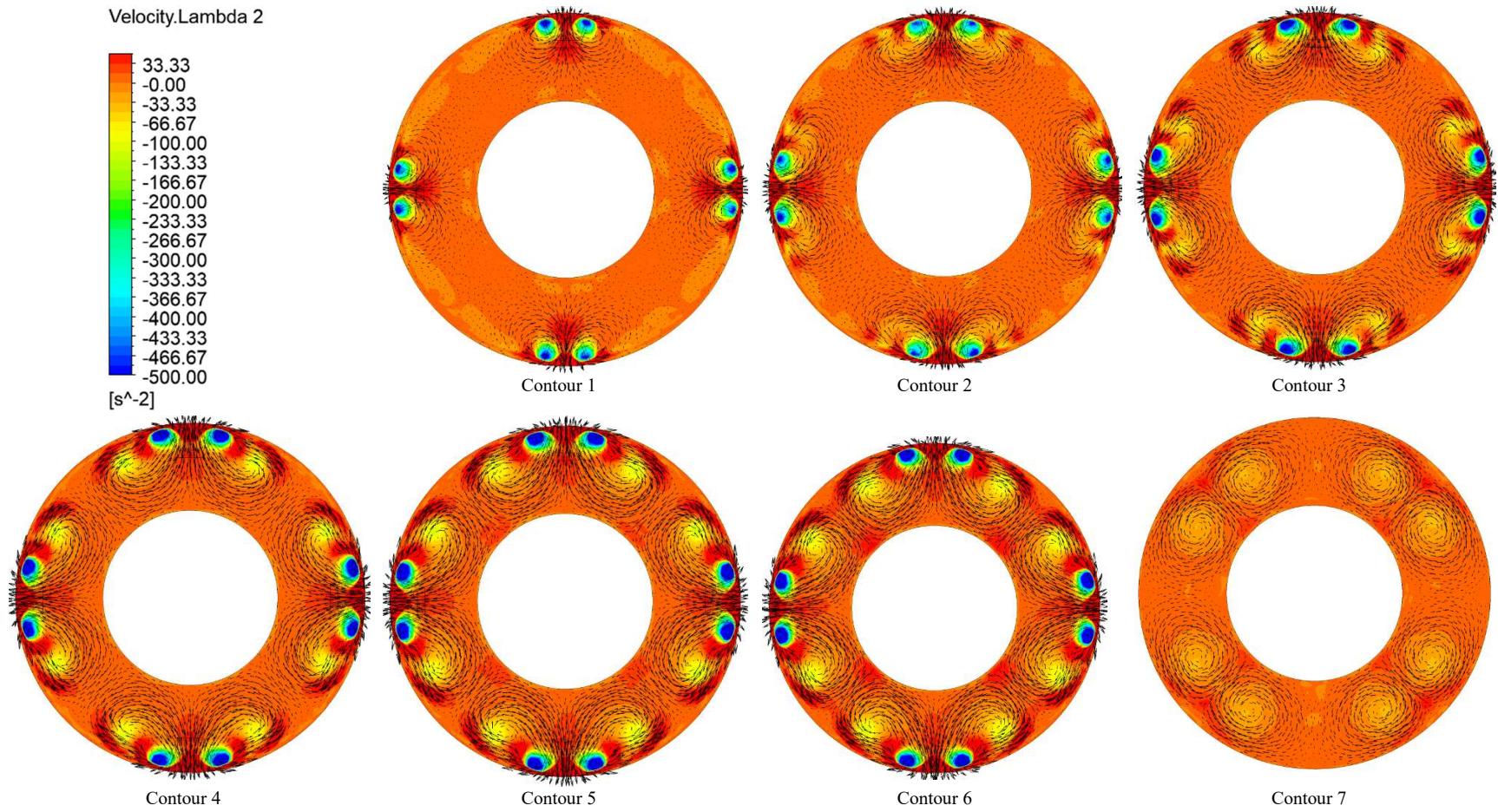

Figure II.15: Vortices profiles of case 3 for $Re_{hw}=8000 - Re_{cw}=2000$.

For case 3, although the turbulence occurs in both regions, in the annular due to the presence of VGs and in the tube due to the high Reynolds number, however, the temperature did not change as much as in case 1 or case 2, since the temperature change did not exceed 0.5 as shown in Figure II.14. So, employing VGs on the outer side of the annular appears not efficient. Figure II.15 shows that vortices are around the VGs, which are closer to the outer wall (adiabatic part) and not to the interface wall between the annular and the tube where the heat is transferred, this makes the presence of VGs in case 3 not very effective as compared to case 1 and case 2.

II.4. Evolution of vortices

In this section, the evolution of the vorticity is studied in each of the three cases (case 1, case 2, and case 3) at the highest and lowest improvement conditions. Thirteen planes were created along the CTHE as shown in Figure II.16, where the z-axis shows the location of each plane along the tube and annular, and the y-axis shows the height which is the diameter of the tube and the annular.

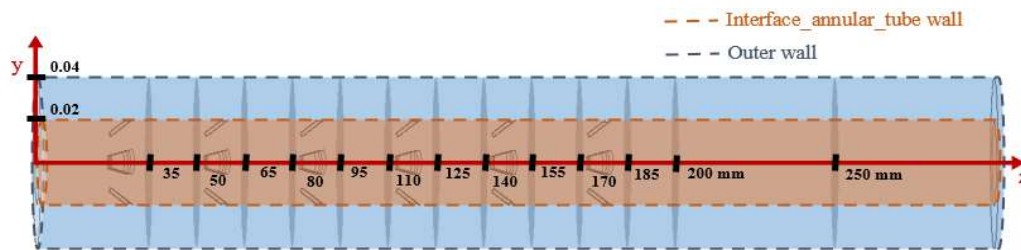

Figure II.16: Schematic of the design with the created planes

As noticed in Figure II.16, the planes are created before and after the VGs to investigate the effect of each row of VG on the evolution of the vortices. The study of vorticity is done on the three configurations of VGs: case 1, case 2, and case 3. Figure II.17 shows the evolution of the vortices along the tube, where the location of the center of vorticity was spotted at each plane and drawn to the y-axis. As observed from the graph in Figure II.17, the evolution of vorticity at case 1 was close to the interface_annular_tube wall at each row of VG, however, the vortices are directed to the center of the tube when it goes away from the VG row. For instance, at the first row of VG (35 mm), the vortices were directed towards the wall of the tube 8 mm and 7.7 mm away from the center for $Re_{hw}=2000 - Re_{cw}=8000$ and $Re_{hw}=8000 - Re_{cw}=2000$ respectively. Whereas, after the first row of VGs, the vorticities were directed to the center with lower values 5.9 mm and 5.51 mm away from the center for $Re_{hw}=2000 - Re_{cw}=8000$ and $Re_{hw}=8000 - Re_{cw}=2000$ respectively. At 250 mm in the z-direction, which is 80 mm away from the last row of VG, the vorticity reaches 5.4 mm away from the central axis of the tube for the $Re_{hw}=8000 - Re_{cw}=2000$, and 6.1 mm away from the central axis of the tube for the $Re_{hw}=2000 - Re_{cw}=8000$.

Now for case 2, the evolution of vorticity was close to the interface_annular_tube wall at each row of VG, yet, the vortices are directed towards the outer wall when it goes away from the VG row. For instance, at the first row of VG (35 mm), the vortices were close to the interface_annular_tube wall 0.011 mm away from the center for both $Re_{hw}=2000 - Re_{cw}=8000$ and $Re_{hw}=8000 - Re_{cw}=2000$. Whereas, after the first row of VGs, the vorticities go up towards the outer wall with values 0.012 mm and 0.013 mm away from the center for $Re_{hw}=2000 - Re_{cw}=8000$ and $Re_{hw}=8000 - Re_{cw}=2000$ respectively. At 250 mm in the z-direction,

the vorticity reaches 0.014 mm away from the central axis of the tube for both $Re_{hw}=2000 - Re_{cw}=8000$ and $Re_{hw}=8000 - Re_{cw}=2000$.

As for case 3, the evolution of vorticity was close to the outer wall at each row of VG, however, the vortices are directed downwards when it goes away from the VG row. For instance, at the first row of VG (35 mm), the vortices were directed towards the outer wall of the tube 0.0178 mm and 0.0182 mm away from the center for $Re_{hw}=2000 - Re_{cw}=8000$ and $Re_{hw}=8000 - Re_{cw}=2000$ respectively. Whereas, after the first row of VGs, the vorticities were directed downwards with lower values 0.0157 mm away from the center for both $Re_{hw}=2000 - Re_{cw}=8000$ and $Re_{hw}=8000 - Re_{cw}=2000$. At 250 mm in the z-direction, the vorticity reaches 0.0131 mm away from the central axis of the tube for the $Re_{hw}=2000 - Re_{cw}=8000$, and 0.0129 mm away from the central axis of the tube for the $Re_{hw}=8000 - Re_{cw}=2000$.

As noticed, in cases 1 and 2 the vorticity goes up at each row of VG and down away from VG rows. On contrary, case 2 witnessed a low value at each row of VG and a higher value away from VG rows. This could be due to the presence of VGs in case 2 that generate vortices upwards, while the cases 1 and 3 the VGs generate vortices that go downwards.

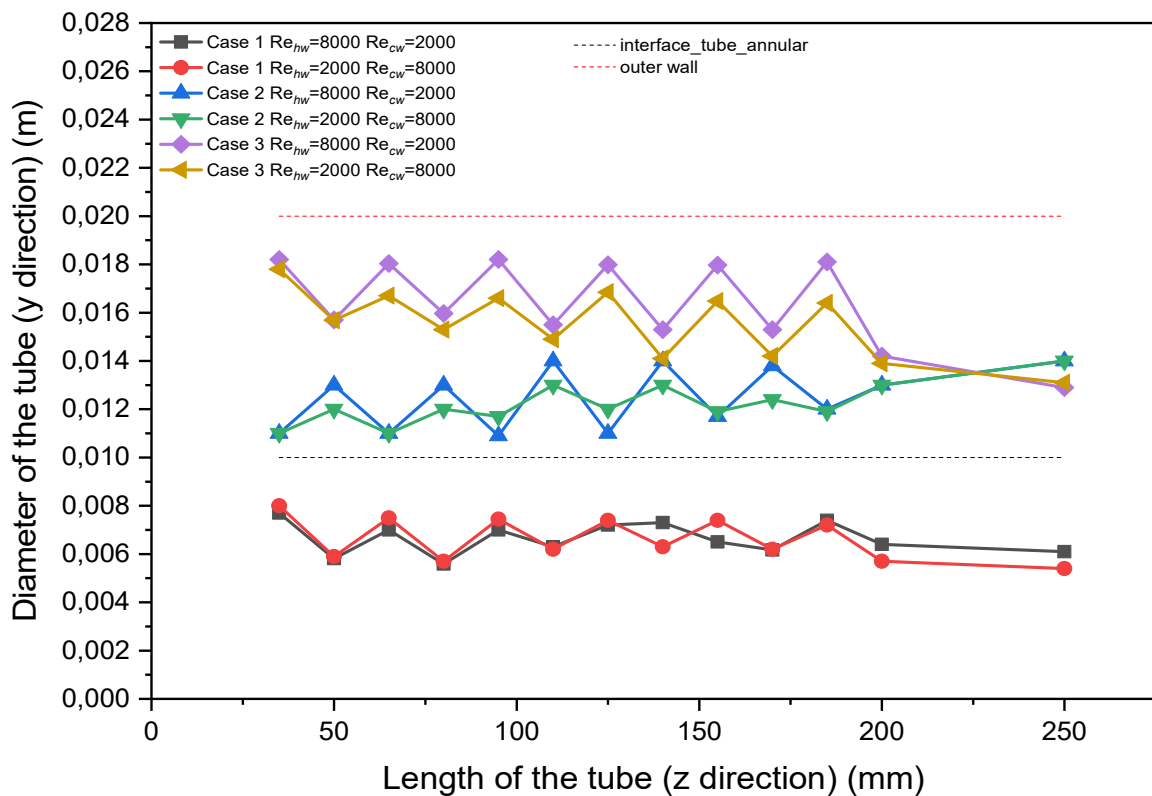

Figure II.17: Evolution of the vortices along the tube

Figure II.18 shows the local overall heat transfer normalized to the case with no VG along the tube. In all cases, it is noticed that the values after each row of VG are higher than one, i.e. there exists an

enhancement of the heat transfer compared to the case with no VG. For case 1, the improvement is the highest among all the cases, and for case 3, the improvement is the lowest.

Besides, it is noticed that for each case at the entrance of the tube (10 mm), the enhancement of heat transfer is null because there is no VG, so it is the same as the CTHE without VG. As soon as the fluid reaches the first row of VG, improvement is noticed in all cases. After 185 mm of the tube for each case, the enhancement is noticeably decreased, due to the absence of VGs.

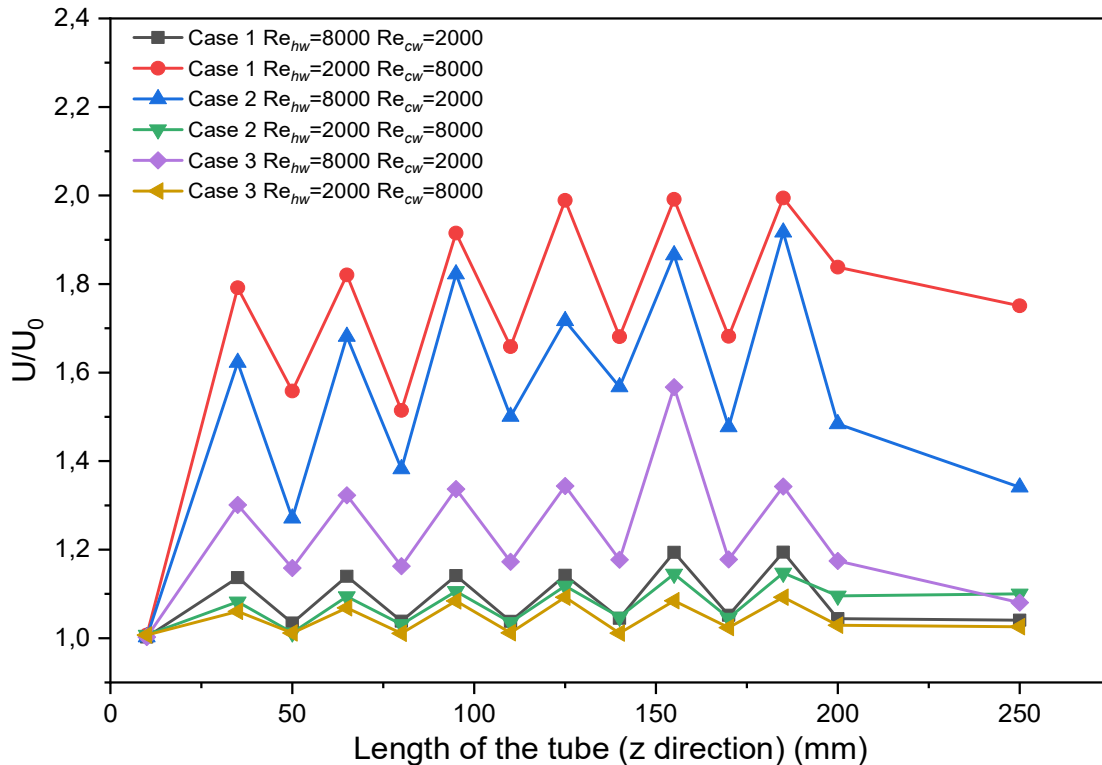

Figure II.18: Normalized overall heat transfer

Besides, it is noticed that the values of the local U/U_0 graph in Figure II.18 match the values of overall U/U_0 in Figure II.4 where case 1 exhibits the highest value at the operating conditions ($Re_{hw}=2000 - Re_{cw}=8000$) of around 1.99. Whereas case 2 and case 3 have their highest values at the same conditions ($Re_{hw}=2000 - Re_{cw}=8000$) of around 1.96 and 1.57 respectively. So, all three cases have remarkable improvement however, case 1 witnessed the best improvement, where the maximum value of case 1 is the highest among the maximum values of case 2 and case 3, and the minimum value of case 1 is the highest over the minimum values of case 2 and case 3. This proves that the case 1 design is the best design to obtain a good heat transfer enhancement. On the other side, case 2 shows acceptable results, where the ratio U/U_0 reaches an average value of 1.55 for $Re_{hw}=8000 - Re_{cw}=2000$ and 1.08 for $Re_{hw}=2000 - Re_{cw}=8000$, however, the improvement is still less than case 1, which exhibits an average value of 1.73 for $Re_{hw}=2000 - Re_{cw}=8000$ and 1.09 for $Re_{hw}=8000 - Re_{cw}=2000$. For case 3, there was a modest improvement compared to the two

previous cases, where the average ratio of U/U_0 displays 1.24 for $Re_{hw}=8000 - Re_{cw}=2000$ and 1.04 for $Re_{hw}=2000 - Re_{cw}=8000$, thus even with this slight improvement VGs enhance the heat transfer.

From Figure II.18, it can be observed that the installation of VGs on the inner tube is more advantageous to enhance heat transfer than others with a lower flow rate of hot fluid than cold fluid. this could be attributed to the geometrical shape of the tube that helps the vortices to reenergize, where the concave surface of the tube allows the vortices to grow thus having a larger heat transfer effect as shown in Figure II.19, where the red points indicate the location of the center of vortices along the tube as it flows for high improvement of case 1 $Re_{hw}=2000 - Re_{cw}=8000$. On the other side, the convex shape of the annular made the vortices dissipate leaving a small effect on heat transfer as noticed in Figure II.19, where the blue points indicate the location of the center of vortices along the annular as it flows for high improvement of case 2 $Re_{hw}=8000 - Re_{cw}=2000$. That explains why the vortices inside the tube will yield higher q than vortices located in the annular region.

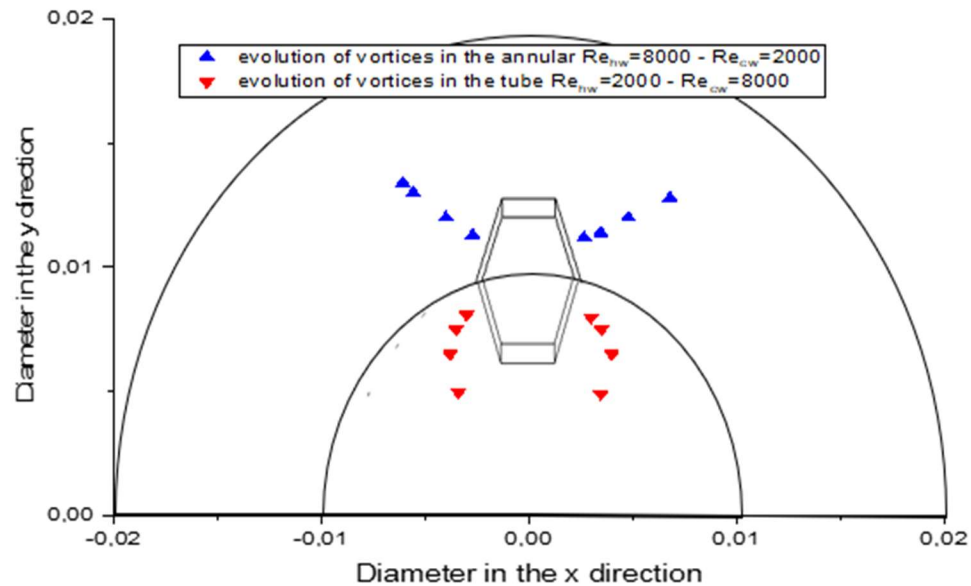

Figure II.19: Center of the vortices along the tube and the annular for the optimum values of cases 1 and 2.

II.5. Conclusions

In this study, the impact of using vortex generators on the heat transfer in a Concentric Tube Heat Exchanger is numerically investigated. The simulation analysis is held on three different cases of VGs in different locations to study the spatial impact of the VGs on the enhancement of heat transfer. Thus, the heat transfer in each case is affected by two criteria: (1) geometry, which is the location of the VGs, and (2) the Reynolds number in the annular and the tube. In general, results show that VGs enhance heat transfer in all cases as shown by the evolution of vorticity and the local U/U_0 ratio.

In case 1, VGs have the highest improvement, where the U/U_0 , q/q_0 , and TEF reach 195 %, 202 %, and 97 % respectively. Besides, results show that the turbulence flow occurred in both parts tube and annular with higher turbulence in the hot region, which is effective in enhancing heat transfer more than in the cold region. This is approved by achieving the highest improvement at the operating conditions ($Re_{hw}=2000 - Re_{cw}=8000$) when VGs are inside the tube and at ($Re_{hw}=8000 - Re_{cw}=2000$) when VGs are in the annular; in both cases, turbulence occurs in both parts to achieve desirable results. Case 1 and case 2 are found to be efficient as they achieved higher improvements compared to case 3. In more detail, the following points were concluded.

- The input pumping power that provides a high Reynolds number should be invested in the region where there are no VGs. Thus, the flow at the part with VGs will be turbulent due to the presence of the turbulators represented by VGs, whereas the flow in the region that has no VGs will fluctuate due to the high Reynolds number that causes the flow to oscillate.
- VGs should be on the interface wall tube and annular (where heat transfer occurs) to achieve higher results. At the outer wall, the advantage that VGs provide is much lower since the wall condition is adiabatic.
- The presence of multiple rows of VGs regenerates vorticity and, consequently, enhances heat transfer, where the behaviour of the changes after each row of VG.

In case 1:

- Heat transfer was efficient at the condition ($Re_{hw}=2000 - Re_{cw}=8000$) because a high Reynolds number causes higher velocity, consequently increasing the turbulent kinetic energy in the annular, with the presence of VGs in the tube, turbulence occurs as well even at a low Reynolds number. However, heat transfer is not very efficient at the operating condition ($Re_{hw}=8000 - Re_{cw}=2000$) because the turbulence created from the high Reynolds number in the tube is useless as vortices are already created due to the presence of VGs. Besides, the flow in the annular part is kept laminar.

In case 2:

- Similarly, heat transfer was efficient when the turbulence occurred in both regions, which means at condition ($Re_{hw}=8000 - Re_{cw}=2000$). However, heat transfer is not very efficient at ($Re_{hw}=2000 - Re_{cw}=8000$), because the turbulence created from a high Reynolds number in the annular is useless as vortices are already created due to the presence of VGs. Besides the flow in the tube part was kept laminar.

In case 3:

- Concerning case 3, it is studied just at the highest point for which turbulence occurred in both parts tube and annular ($Re_{hw}=8000 - Re_{cw}=2000$). However, the turbulence is on the outer side (adiabatic part) which makes the presence of VGs not very efficient as compared to case 1 and case 2.

Consequently, high vorticity in the annular or the tube alone is not enough to deliver better performance as shown in case 1 ($Re_{hw}=8000 - Re_{cw}=2000$) or case 2 ($Re_{hw}=2000 - Re_{cw}=8000$). Besides, extremely high vorticity in one region with turbulence created from the Reynolds number in the other one is not enough as well as illustrated in case 1 ($Re_{hw}=8000 - Re_{cw}=8000$) or case 2 ($Re_{hw}=8000 - Re_{cw}=8000$). Hence, the best performance occurred at the relative presence of vorticity and turbulence in both regions in case 1

($Re_{hw}=2000 - Re_{cw}=8000$) or case 2 ($Re_{hw}=2000 - Re_{cw}=8000$), where turbulence evenly moves the flow, consequently, maintaining a homogeneous mixture which is favourable for the heat transfer enhancement.

Now, among case 1 ($Re_{hw}=2000 - Re_{cw}=8000$) and case 2 ($Re_{hw}=2000 - Re_{cw}=8000$), case 1 is slightly more efficient due to the structure of the turbulence in the hot flow that completely mixes the hot flow, where the presence of VGs generates specific nature of vortices that mingle the flow.

So, in conclusion, turbulence in the annular due to the high Re number which is 8000 and turbulence in the tube due to the presence of VGs with a specific Re number in the laminar phase which is 2000 shows the best performance for our case study.

After investigating the effect of VGs on heat transfer in different locations, we intend to perform another study on the proposed heat recovery system in an application. Thus, according to research and literature review, drain heat recovery is considered a good application to capture thermal energy, where a considerable amount of heat is being lost. Consequently, the heat recovery system will be employed in a multi-drain water application for 48 accommodations, however, case 2 will be taken instead of case 1 as it is easier to use it in such applications as the presence of VGs inside the tube in case 1 may cause some problems for the flow due to the debris coming from the leaving water may be stuck on the VGs and this will block the flow after some while. Thus, a numerical study on Ansys will be done by varying the flow rate and investigating the effect on the heat transfer, overall heat transfer, and thermal enhancement factor. Besides, the economic, environmental, and social impacts of the system will be studied to investigate its sustainability. Two types of input energy will be studied: (i) conventional heating sources represented by coal, diesel, gas, and electricity and (ii) renewable sources of energy represented by solar, wind, hydropower, and biomass. The results will then be compared to find the amount of energy that is saved by the heat recovery system on the economy, society, and the environment.

Chapter III. Drain water heat recovery application

III.1. Thermo-economic and environmental analysis of vortex generator-equipped multi-drain heat recovery systems

Résumé (en français)

En raison des préoccupations environnementales liées à l'utilisation abusive des combustibles fossiles et à l'augmentation de la consommation d'énergie, les systèmes de récupération de chaleur sont devenus une option essentielle dans l'utilisation de l'énergie.

Cette étude propose une conception innovante qui combine un échangeur de chaleur très efficace basé sur des générateurs de vortex avec une nouvelle application de récupération d'énergie sur les eaux usées pour 48 logements. Une étude numérique est réalisée en faisant varier le débit et en examinant l'effet sur le transfert de chaleur, le transfert de chaleur global et le facteur d'amélioration thermique. En outre, les impacts économiques et environnementaux du système sont étudiés afin de déterminer sa durabilité.

Quatre types d'énergie d'entrée sont étudiés : le charbon, le fioul, le gaz et l'électricité. Les résultats montrent que la conception permet d'augmenter la température de l'eau froide de 3,5 à 7,5 °C. Par conséquent, les économies environnementales quotidiennes sont de 0,87 € (pour le gaz), 1,74 € (pour le fioul), 4,63 € (pour le charbon), 17,63 € (pour l'électricité aux USA) et 2,26 € (pour l'électricité en France). En outre, les économies financières quotidiennes sont respectivement de 7,54, 8,63, 4,63 et 15,07 dollars, avec un temps de retour sur investissement d'environ 0,61, 1,20, 1,42 et 2,89 ans pour le gaz, le fioul, le charbon et l'électricité respectivement.

III.1.1. Introduction

The growing energy consumption across various sectors has led to a significant interest in developing efficient energy harvesting systems. Intending to achieve simplicity and effectiveness, engineers and academics are stepping up their efforts to develop novel energy sources. Among these sources, waste heat is considered a potential avenue for power production given the substantial amount of wasted energy generated in many applications.

In vehicle and automotive power usage, for example, a considerable amount of energy is dissipated as heat from the internal combustion engine, with nearly 65 % being lost, and nearly 38 % wasted in the exhaust. In addition, 6 % is lost as friction. Similarly, power plants lose approximately 60 % of their energy before utilizing heat recovery systems, while in Heating, Ventilation, and Air-Conditioning (HVAC) systems, a significant amount of energy is lost through the condenser. The amount of wasted energy varies depending on the application, as reported in [172].

Moreover, with the rising cost of energy, the scarcity of natural assets, and the environmental implications of conventional energy sources, there is an increasing need for heat recovery systems that can save more than 90 % of lost energy. Hybrid heat recovery systems, which combine more than one heat recovery system into a single unit, have shown significant potential in many applications. According to recent research [354], these systems can recover more than 28 % of lost energy, with performance coefficients reaching up to 2.2 times those of traditional processes.

Consequently, efficient and low-cost energy recovery systems are crucial for sustainable energy management, in addition to establishing new sources of energy. Thermal energy is a significant component of many architectural operations and must be generated, conserved, and utilized effectively to achieve both environmental and economic benefits. The proposed Drain Water Heat Recovery (DWHR) system provides an intriguing approach to recovering thermal energy by capturing the remaining heat from hot drain water and using it to warm the incoming cold water. This low-cost and effective technique has widespread applications in construction operations, such as space heating and sanitary hot water supply [355].

In the United States, the residential sector accounts for 26 % of overall energy consumption, of which 37 % is utilized for illumination, cooling, and appliances. The remaining energy is mainly attributed to heating, with 45 % for space heating and 18 % for water heating. Residential water heating, therefore, accounts for 4 % of total federal energy needs. Similarly, in the United Kingdom, the residential sector contributes to 29 % of overall energy expenditure, of which 65 % is used for space heating and 16 % for heating water [356]. Thus, the energy required for water heating represents a significant portion of overall household energy use.

Various systems, such as Solar Water Heating (SWH), heat pumps, immersion heaters, gas boilers, and drain water heat recovery have been examined in several studies for saving energy used to heat residential water, including those cited in Boait et al. [357] and Leidl and Lubitz [358]. For instance, the standard temperature of drain water from homes ranged from 20 to 40 °C [359]. As a result, household wastewater is more appropriate for heat recuperation than other heat resources such as lake water or groundwater, where the temperature of drain water from baths or laundry machines is significantly greater. Allowing this much energy to exit the structure with warm water without capturing it is a substantial loss in energy. Thus, recovering heat from drain water constitutes a good opportunity to reduce energy consumption. Drain water heat recovery systems have been studied in different aspects to enhance their performance such as the type

of heat recovery system (tube coil heat exchanger, shell and helically coil tube, concentric tube heat exchanger etc...) [360], heat recovery unit [361], different applications (commercial, residential) [356], multi drain heat recovery systems [362] and others [363].

Thus, the significant thermal loss from drain application and the high consumption of energy on heating household water make heat recovery in drain water worth the research and investment. However, after defining the potential of a system to be thermally recovered, there is an important step that the research must carry out, which is enhancing the heat transfer to capture as much thermal energy as possible. There are different methods to enhance heat transfer, integrating VGs is one of the simplest methods as Vortex Generators (VGs) are passive devices with high efficiency of improving heat transfer as shown in a study carried out by Aridi et al. [364], where a numerical study on different locations of VGs in a Concentric Tube Heat Exchanger (CTHE) to find the optimal design of having highest heat transfer, overall heat transfer, and thermal enhancement factor was conducted. In this context, the objective of this study is to employ the CTHE with VGs in a multi-drain water heat recovery. This application study may result in enhancing the heat recovery systems in such applications by recovering a high percentage of thermal energy.

This study investigates an innovative design by numerically simulating its effect on heat transfer, overall heat transfer, and thermal enhancement factor in a multi-drain heat recovery application. The economic and environmental aspects of the system are also evaluated to investigate its sustainability. Four types of input energy are studied, including gas, diesel, coal, and electricity.

The novelty of this study includes the following aspects:

- Coupling two concepts that result in higher thermal energy recovery, which are multi-drain applications that result in the higher potential of heat recovery and integrating VGs in the CTHE that enhance heat transfer.
- Integration of a numerically studied design into a multi-drain heat recovery application.
- Performance of a Life Cycle Assessment (LCA) study, encompassing the economic, and environmental aspects of a heat recovery system.
- Conducting economic and environmental comparisons of different heating sources based on two functional units: **quantity** in mass or volume (except for electricity) and **energy** in Joule.
- Investigation of the impact of various sources of electricity in different countries, such as electricity production in the US and France.

III.1.2. Materials and Methods

III.1.2.1. Methodology

The research methodology, delineated in Figure III.1.1, comprises four principal components: Data collection, Numerical study, Economic analysis, and Environmental evaluation.

In the Data collection phase, a thorough review of extant literature and previous studies was conducted to accrue pertinent information and insights from established sources. The Numerical study component adopted a design from a previously published article, with the investigation primarily focused on assessing

the impact of varying mass flow rates and temperatures. By modulating these variables, we achieved an extensive analysis of the system's behaviour. In this study, Ansys Fluent 2020 R2 is used to obtain the temperature outlet of the heated cold water.

The Economic analysis involved applying complex equations to calculate costs and ascertain the payback period. This investigation furnished valuable insights into the financial ramifications associated with the studied system. Finally, the Environmental evaluation was facilitated using the openLCA software in conjunction with the Ecoinvent database. This integration enabled a comprehensive assessment of the environmental consequences and impacts associated with the system under scrutiny.

In summation, the methodology employed a systematic, multifaceted approach, merging data collection, numerical analysis, economic appraisal, and environmental assessment. The implementation of these distinct elements resulted in a well-rounded understanding of the research topic.

It is crucial to acknowledge certain limitations of this study. Firstly, while the Ansys software assumes perfect insulation, realizing such insulation in practical applications may not be attainable. Furthermore, the fabrication process of the design could introduce human error, particularly in aspects related to Vortex Generators (VGs). It is also pertinent to consider that data collection regarding prices can be subject to regional variations and fluctuations influenced by supply and demand dynamics. Consequently, the final cost estimation cannot be deemed entirely accurate.

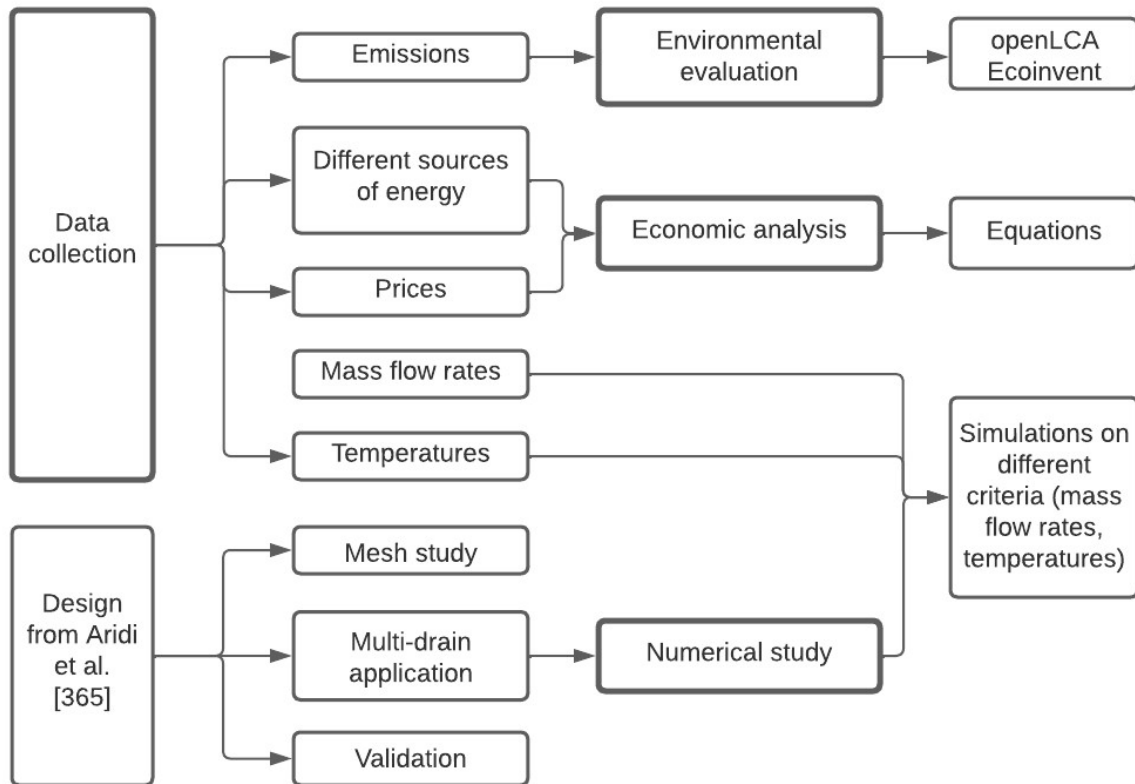

Figure III.1.1: Methodology of the work

III.1.2.2. System Description

Aridi et al. [364] conducted a numerical study on a heat recovery system with Vortex Generators (VGs) to enhance heat transfer and provide an economical study of this system. Three designs were studied, where the effect of VGs locations was evaluated for each case: case 1 with VGs inside the tube, case 2 with VGs inside the annular (on the interface wall annular tube), and case 3 with VGs inside the annular (on the outer wall).

The study found that case 1 had the highest thermal enhancement factor (TEF) of 2.10, which means the ratio of heat transfer over input power with VGs is more than two times the ratio without VGs, followed by case 2 with a TEF of 1.80, and case 3 with a TEF of 1.42. High heat transfer was achieved for all three cases, indicating promising results that warrant further investigation.

The present study aims to integrate a case from Aridi et al. [364] into a practical study of DWHR. However, case 2 was selected instead of design 1 due to the possibility of debris coming from the leaving water getting stuck on the VGs inside the tube in case 1 and blocking the flow over time. Case 2 prevents fouling since the VG is located from the cold-water side and not from the wastewater side, which is a smooth tube.

The previous study placed Vortex Generators (VGs) in the first half of the tube, leaving the remaining portion without VGs in a Concentric Tube Heat Exchanger (CTHE). In this study, we compared the performance of two VG designs under the same conditions in a CTHE with a fixed mass flow rate of cold water having the same number of VGs. The tube length and inner and outer tube diameter are 2 m, 0.04 and 0.08 m respectively. The first design includes 10 rows of VGs positioned closer to the entrance of the tube with a spacing between the VG rows of 80 mm, while the second design features 10 rows of VGs distributed along the tube length with a spacing between the VG rows of 180 mm, as illustrated in Figure III.1.2. The flow rates were taken based on the literature reviews from previous studies with a range of hot water flow rates: 0.1, 0.2, 0.25, 0.3, 0.4, and 0.5 kg/s with a fixed mass flow rate of the cold water of 0.2 kg/s. The temperatures taken were 293 K (20 °C) and 323 K (50 °C) for the inlet water in the annular and the tube respectively. The comparison aimed to identify the optimal VG design in terms of heat transfer. Both designs utilize the same number of VGs and tube sizes, thereby making the cost the same for both designs.

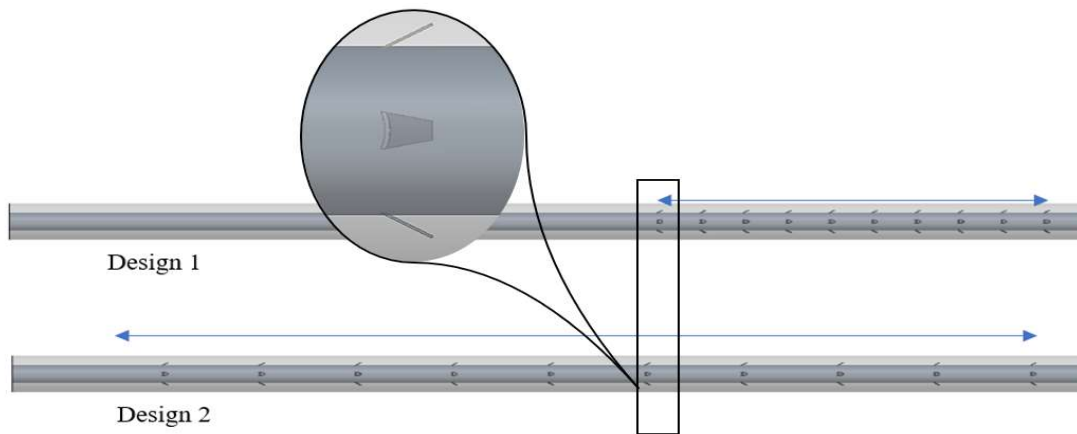

Figure III.1.2: VGs distributed in two designs in the tube.

Simulations were conducted for various flow rates during both summer and winter to explore how flow rate variation impacts heat transfer under different climatic conditions. The inlet cold water temperature is lower in winter than in summer, and the hot water temperature required by users is higher in winter than in summer, resulting in outcomes influenced by the weather. Consequently, the cold and hot water inlets were set at 283 K (10 °C) and 333 K (60 °C) in winter, and 293 K (20 °C) and 313 K (40 °C) in summer, respectively. The flow rates investigated ranged from 0.1 to 0.5 kg/s.

In this study, the focus is on a building consisting of 48 accommodations, and the water used for washing machines, dishwashers, and showers in each house per week is analyzed. Figure III.1.3 illustrates the water quantity used for each piece of equipment in the 48 accommodations.

The volume of water used is calculated, and the duration of each process is determined to understand the daily water usage for each piece of equipment. The mass flow rates and consumption values for the machines are obtained from previous studies and statistical reports conducted for various numbers of accommodations [365, 366, 367].

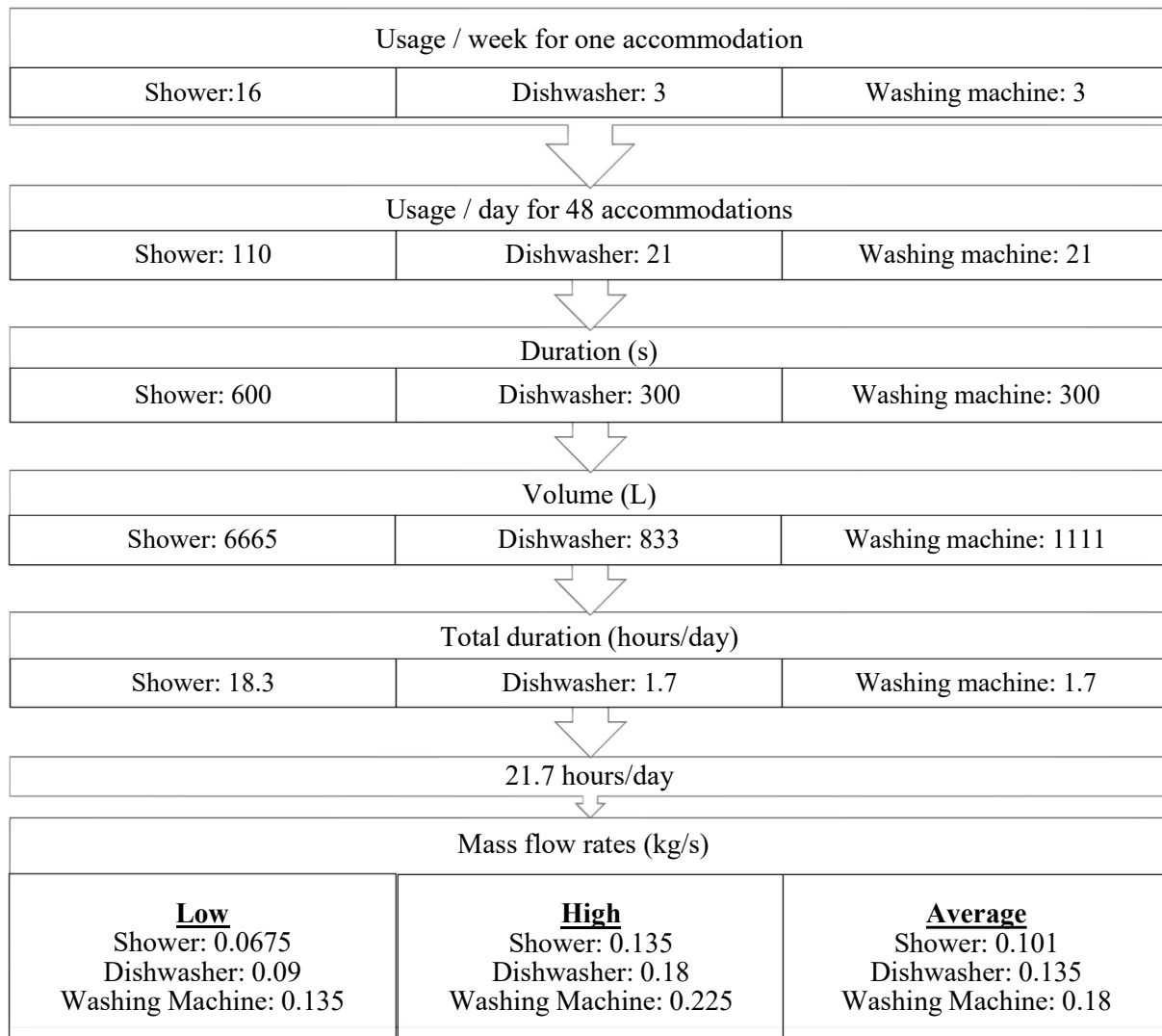

Figure III.1.3: Mass flow rates and average usage of shower, dishwasher, and washing machine.

The calculations indicate that water consumption amounts to 21.7 hours per day, indicating nearly continuous flow due to the presence of the storage tank and the high water consumption per day. However, to ensure a continuous flow of heated water, the investigated innovative design is connected to a building with 48 accommodations, enabling a consistent flow of grey hot water, also known as wastewater. An insulated tank is used to store the grey hot water during periods of high flow rates, ensuring a steady flow rate over time. Based on the literature review, the average flow rate for a building comprising 48 accommodations throughout the day is determined to be 0.25 kg/s [368, 365]. However, the range of flow rates will be studied as the flow rate can be changed according to the application and water consumption (0.5, 0.4, 0.3, 0.25, 0.2, and 0.1 kg/s). Consequently, this study will simulate the average flow rate during the summer and winter seasons to evaluate the heat transfer capabilities of this design.

Thus, to examine the impact of varying flow rates on heat transfer under different climatic conditions, the simulation will be conducted during both winter and summer seasons. The temperature of the inlet cold water during winter is lower compared to that in summer, while the required temperature of the hot water by the users is higher in winter. This weather dependency necessitates considering different temperature settings for accurate results. For the winter simulations, the inlet cold water temperature is set to 283 K (9.85 °C), while the inlet hot water temperature is set to 333 K (59.85 °C). In contrast, during the summer months of July and August, the inlet cold water temperature is set to 293 K (19.85 °C), and the inlet hot water temperature is set to 313 K (39.85 °C). A detailed overview of the flow rates that will be simulated throughout the study.

III.1.2.3. Mesh sensitivity study

This study employs a polyhedral mesh, as depicted in Figure III.1.4, which visualizes the simulation process. Initially, the design is delineated, and a refined mesh is incorporated. The index "i" signifies the study number; for instance, in Study 1, the initial mesh comprises 2,089,201 elements at a specified element size. Thus, "i" denotes the first study. If the conditions are not met, the index "i" increments to 2, indicating the transition to the second study and continues similarly.

After meshing and simulation, the y^+ value is evaluated, and the error percentage is compared with the preceding study. This comparison is initiated post the second study. If the pre-established conditions are fulfilled, suggesting the reliability of the applied sizes, they are utilized for further analysis. Conversely, if the conditions are unfulfilled, the mesh study requires repetition. In this investigation, the conditions were satisfied with 7,020,216 elements, an error of 1%, and a y^+ value of less than 1.

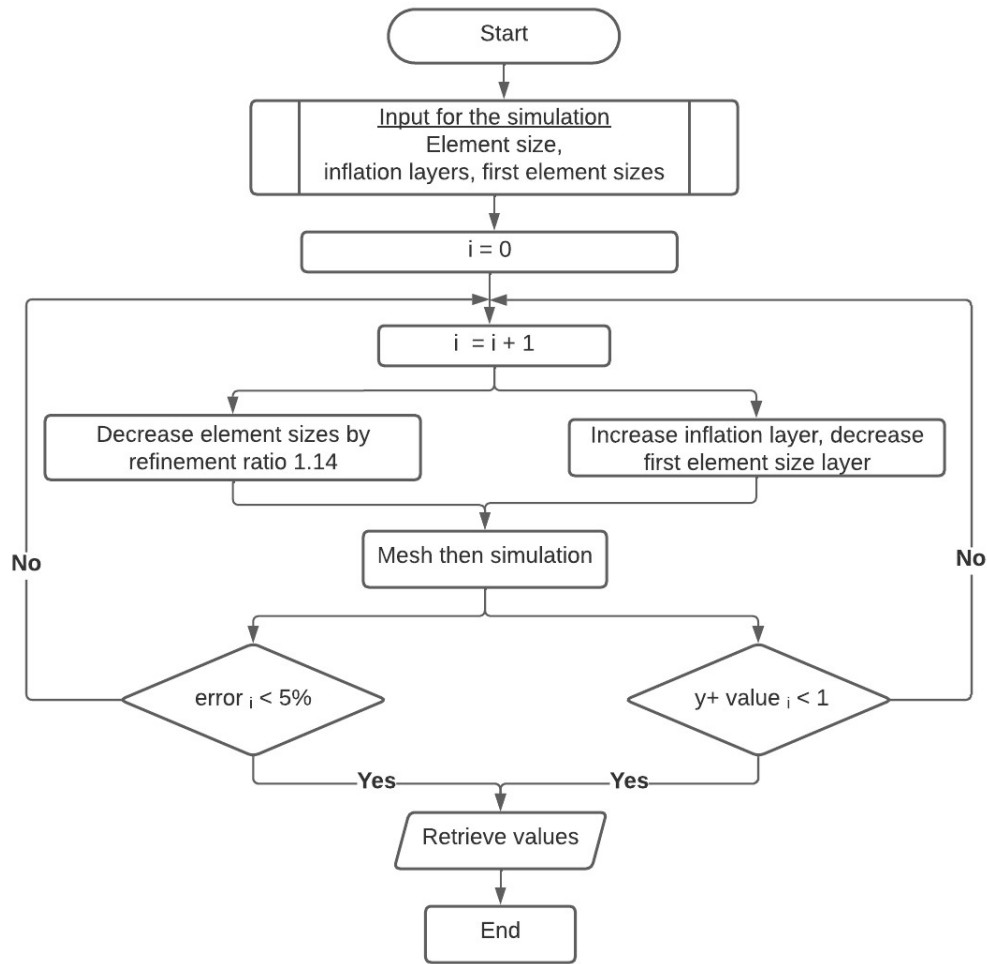

Figure III.1.4: Algorithmic chart of the mesh study and y+ value

Figure III.1.5 shows the overall heat transfer (U), and the outlet cold water which means the preheated cold water for the two designs. Results show that the second placement of VGs provides better performances than the first design, where the overall heat transfer for design two was much higher than that of design one as illustrated in Figure III.1.5. Consequently, the temperature of the outlet cold water in design two was higher than that of design 1, where it reaches 289.3 K in design one however for design 2 the temperature of the outlet cold water reaches 290.6 K. Thus, in this study, we are going to use design two to study the effect of 10 rows of VGs along the tube.

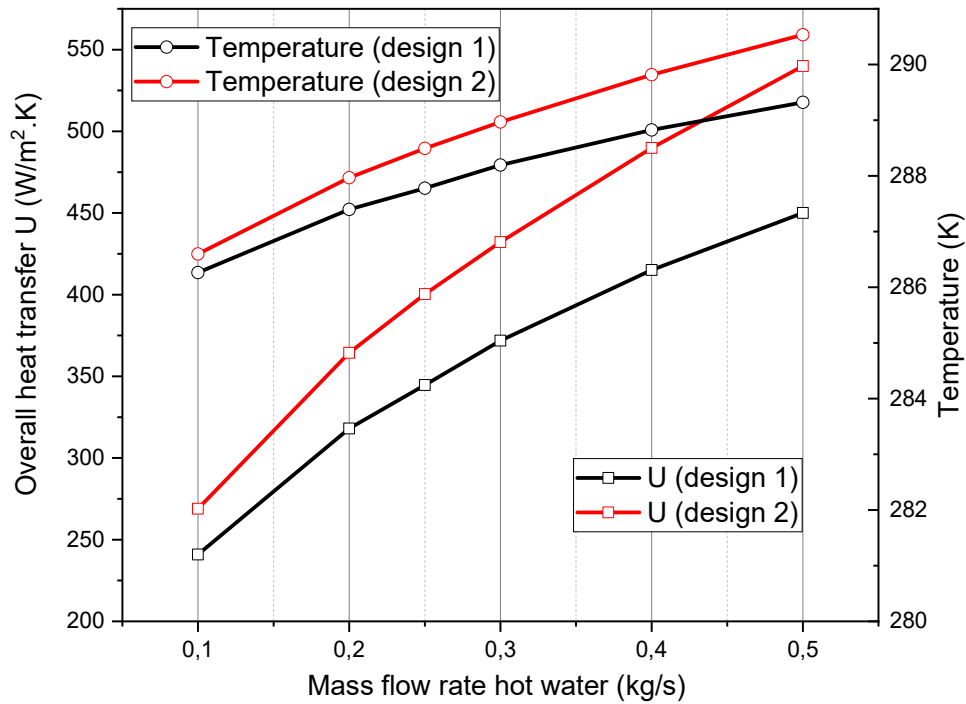

Figure III.1.5: Temperature of cold-water outlet and overall heat transfer of the two designs vs mass flow rate

III.1.3. Multi-drain heat recovery on CFD

In this paper, a numerical study is held on the DWHR system to capture the thermal energy that is lost from the grey water coming from the dishwasher, washing machine, and shower to reheat the cold water entering the building as shown in Figure III.1.6. This design can be done for different numbers of accommodations; however, the flow rate will differ according to the number of people and accommodations in the building.

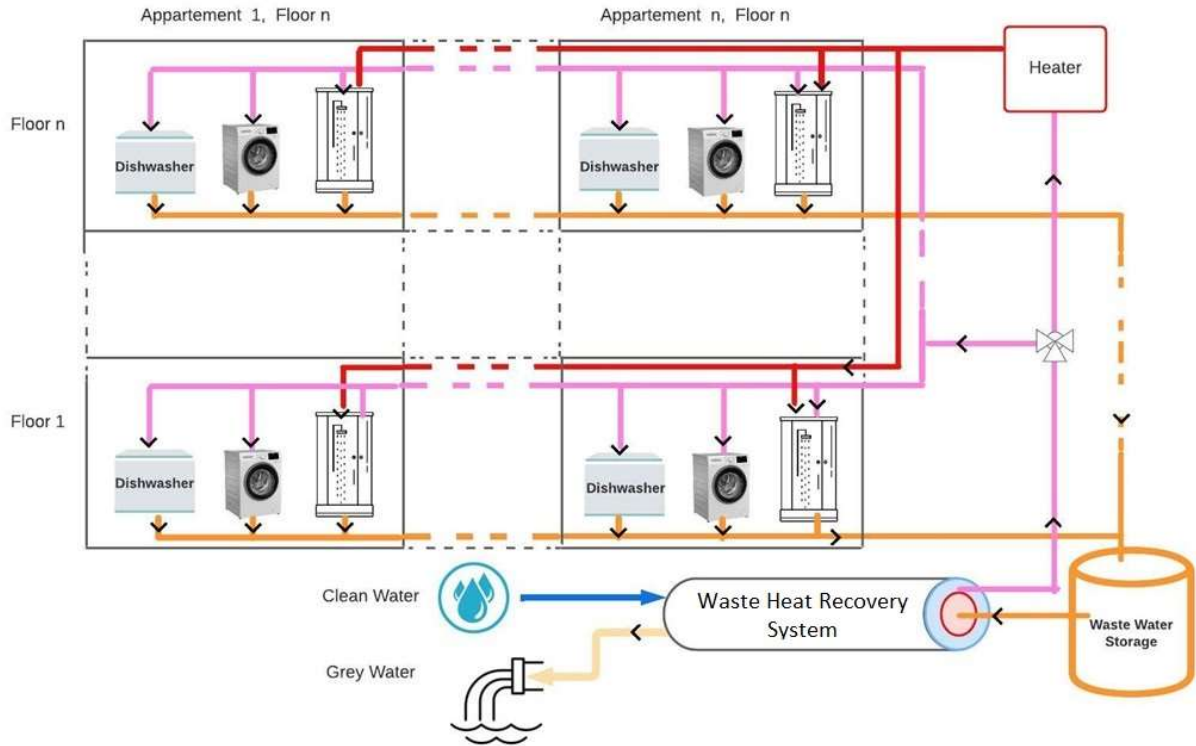

Figure III.1.6: Schematic drawing of the building with the heat recovery system

In our study, this design is done on a building of 48 accommodations. The quantity of water used for each of the washing machines, dishwashers, and showers in each house per week, then per 48 accommodations as shown in Table III.1.1.

The volume of water is calculated as well, and the duration of each process is stated to know the duration of water usage per day for each piece of equipment.

Table III.1.1: Water usage in the shower, dishwasher, and washing machine in a building of 48 accommodations.

| | used/week for 1 accommodation | used/day for 48 accommodations | Duration (s) | Volume (L) | Total duration (hours/day) |
|------------------------|-------------------------------|--------------------------------|--------------|------------|----------------------------|
| Shower | 16 | 110 | 600 | 6665 | 18.3 |
| Dishwasher | 3 | 21 | 300 | 833 | 1.7 |
| Washing machine | 3 | 21 | 300 | 1111 | 1.7 |
| Total | | | | 8609 | 21.7 |

To maintain a continuous flow of heating water, the innovative design under investigation is connected to a building containing 48 accommodations, ensuring a consistent flow of grey hot water, called wastewater. An insulated tank of grey hot water is utilized to store wastewater during periods of high flow rates, guaranteeing a steady flow rate over time [368, 365]. Table III.1.2 shows the mass flow rate for each piece of equipment during the day.

Table III.1.2: Average mass flow rates of shower, dishwasher, and washing machine.

| Equipment | Low mass flow rate (kg/s) | High mass flow rate (kg/s) | Average (kg/s) |
|-----------------|---------------------------|----------------------------|----------------|
| Shower | 0.0675 | 0.135 | 0.101 |
| Dishwasher | 0.09 | 0.18 | 0.135 |
| Washing Machine | 0.135 | 0.225 | 0.18 |

Figure III.1.7 illustrates the flow rate throughout the day for a building comprising 48 accommodations, indicating an average flow rate of 0.25 kg/s each day. Accordingly, this study will simulate the average flow rate during the summer and winter seasons to determine the heat transfer that this design can offer, the values in Table III.1.3 and Figure III.1.7 were taken from previous studies and statistical reports for a different number of accommodations, [365, 366, 367].

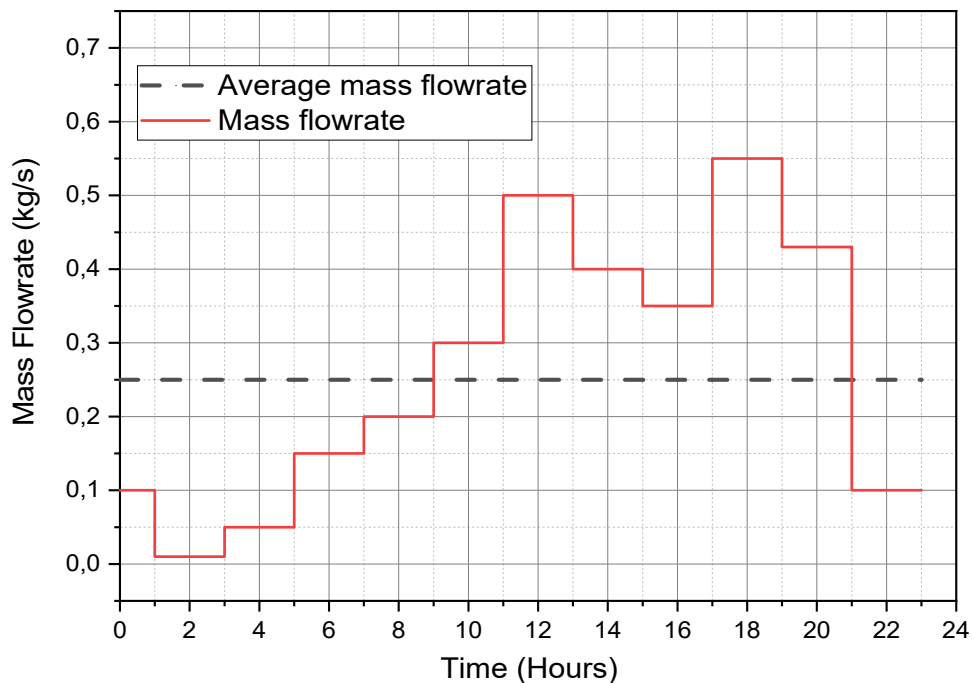

Figure III.1.7: Average mass flow rate in a building during the day

The simulation will be conducted at different flow rates during the winter and summer seasons to investigate how flow rate variations affect heat transfer under different climatic conditions. During winter, the temperature of the inlet cold water is lower than that in summer, and the temperature of the hot water required by the user is higher than that in summer, making the results weather-dependent. Accordingly, in winter, the inlet cold and hot water temperatures were set to 283 K (9.85 °C) and 333 K (59.85 °C), respectively. In contrast, during summer (July and August), the inlet cold and hot water temperatures were set to 293 K (19.85 °C) and 313 K (39.85 °C), respectively. Table III.1.3 lists the flow rates that will be simulated in the study.

Table III.1.3: Mass flow rate of the hot water that is studied.

| | \dot{m}_1 | \dot{m}_2 | \dot{m}_3 | \dot{m}_4 | \dot{m}_5 | \dot{m}_6 |
|------------------------------|-------------|-------------|-------------|-------------|-------------|-------------|
| Mass flow rate (kg/s) | 0.1 | 0.2 | 0.25 | 0.3 | 0.4 | 0.5 |

After applying the simulations on the range of mass flow rates mentioned in Table III.1.3 on Ansys, different parameters were calculated to study the heat transfer of each case. Figure III.1.8 shows the temperature distribution along the Concentric Tube Heat Exchanger (CTHE) in winter and summer, where the mass flow rate of the cold water is fixed at 0.25 kg/s, which is the average mass flowrate III.1.5, the mass flow rate of the hot water vary from 0.1 to 0.5 kg/s.

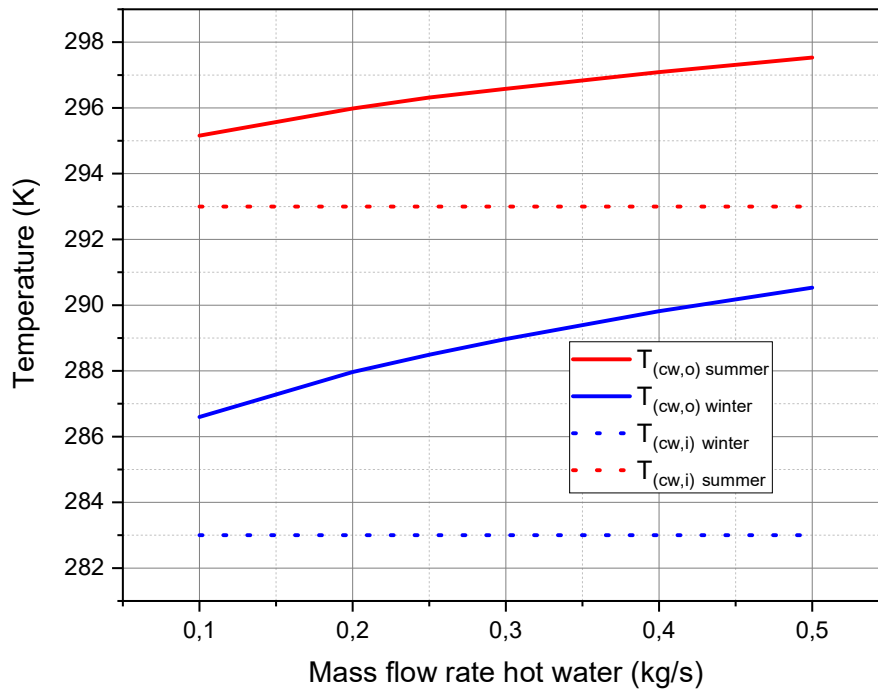

Figure III.1.8: The temperature of the cold-water outlet in winter and summer vs the inlet cold-water temperature

As noticed, at the highest flow rate of hot water the temperature of the cold water reached 290.53 K, which means that it increased by 7.53 K, which is a considerable increase. As for the cases where the mass flow rates of the hot water are 0.4, 0.3, 0.2, and 0.1 kg/s the temperature increase is found to be 6.82, 5.97, 5.49, 4.97, and 3.60 K respectively. In the summer season, there was an increase in the temperature but less than that in winter, where the difference in temperatures reached up to 4.6 and the temperature of the cold-water inlet at 0.5, 0.4, 0.3, 0.2, and 0.1 kg/s are 295.2, 296.0, 296.4, 296.6, 297.1, 297.6 K respectively.

To study the behaviour of the flow and find the heat transfer and the effectiveness of this system, some parameters should be calculated through equations (19) to (27).

Overall heat transfer coefficient:

In the CTHE, by neglecting the wall thermal resistance due to conduction, the overall heat transfer coefficient is calculated by considering only the convection resistance [23]:

$$U = \frac{1}{\frac{1}{h_{annular}} + \frac{1}{h_{tube}}} \quad \text{Eq. III.19}$$

where $h_{annular}$ is the heat convection coefficient of the flow in the annular and h_{tube} is the heat convection coefficient of the flow in the tube.

Nusselt number:

To assess the enhancement in heat transfer, the global Nusselt numbers are calculated based on the tube side Nu_{tube} and the annular side $Nu_{annular}$, given by [350]:

$$Nu_{annular} = \frac{h_{cw} \cdot (D_o - D_i)}{k} \quad \text{Eq. III.20}$$

$$Nu_{tube} = \frac{h_{hw} \cdot D_i}{k} \quad \text{Eq. III.21}$$

where h_{cw} is the heat convection coefficient of the cold-water flow and h_{hw} is the heat convection coefficient of the hot-water flow. D_i is the diameter of the inner tube and D_o is the diameter of the outer tube in (m), and k is the heat conductivity.

Heat Transfer:

To calculate the heat transfer rates between the hot and cold water, the following parameters are presented [23]:

$$q_{cw} = \dot{m}_{cw} \cdot Cp \cdot (T_{c,o} - T_{c,i}) \quad \text{Eq. III.22}$$

$$q_{hw} = \dot{m}_{hw} \cdot Cp \cdot (T_{h,i} - T_{h,o}) \quad \text{Eq. III.23}$$

where q_{cw} is the heat transfer of the cold water, q_{hw} is the heat transfer of the hot water, \dot{m} is the mass flow rate, Cp is the specific heat capacity of the water, $T_{c,i}$ is the temperature of cold water at the inlet, $T_{c,o}$ is the temperature of cold water at the outlet, $T_{h,i}$ is the temperature of hot water at the inlet and $T_{h,o}$ is the temperature of hot water at the outlet. Here the heat transferred from the hot water is gained by the cold water and as a result $q_{cw} = q_{hw}$.

The heat transfer convection coefficients for the common wall interface between the hot water and the cold water are given by [23]:

$$h_{hw} = \frac{q_{hw}}{\pi \cdot D_i \cdot L \cdot (\bar{T}_{hw} - \bar{T}_w)} \quad \text{Eq. III.24}$$

$$h_{cw} = \frac{q_{cw}}{\pi \cdot D_i \cdot L \cdot (\bar{T}_w - \bar{T}_{cw})} \quad \text{Eq. III.25}$$

where \bar{T}_w is the average temperature of the wall interface between the hot tube and cold annular, \bar{T}_{hw} is the arithmetic mean temperature of the hot water between the inlet and the outlet of the tube and is given by $(\frac{T_{hw,i} + T_{hw,o}}{2})$, \bar{T}_{cw} is also the arithmetic mean temperature between the inlet and outlet of the annular side and is $(\frac{T_{cw,i} + T_{cw,o}}{2})$, L is the length of the tube, and finally D_i is the inner diameter of the tube.

Thermal Enhancement Factor (TEF):

TEF quantifies the relative enhancement in heat transfer to the increase in pumping power, which is the input power that is employed to run the flow when adding VGs. TEF is the ratio of heat transfer ratio and pumping power ratio:

$$TEF = \frac{q/q_0}{P/P_0} \quad \text{Eq. III.26}$$

where q is the heat transfer with the presence of VGs and q_0 is the heat transfer with the absence of VGs, so q/q_0 identifies the enhancement of heat transfer in the case with VGs concerning empty cases.

The pumping power ratio [23] is the ratio of the pumping power for the VG case relative to the empty case and is equal to

$$\frac{P}{P_0} = \frac{(\Delta P_{hw} \cdot \dot{m}_{hw} + \Delta P_{cw} \cdot \dot{m}_{cw})}{(\Delta P_{hw,0} \cdot \dot{m}_{hw,0} + \Delta P_{cw,0} \cdot \dot{m}_{cw,0})} \quad \text{Eq. III.27}$$

where P is the pumping power input to get a specific Reynolds number in each case, and P_0 is the pumping power input in case 0, which means the empty case with no VGs in both regions.

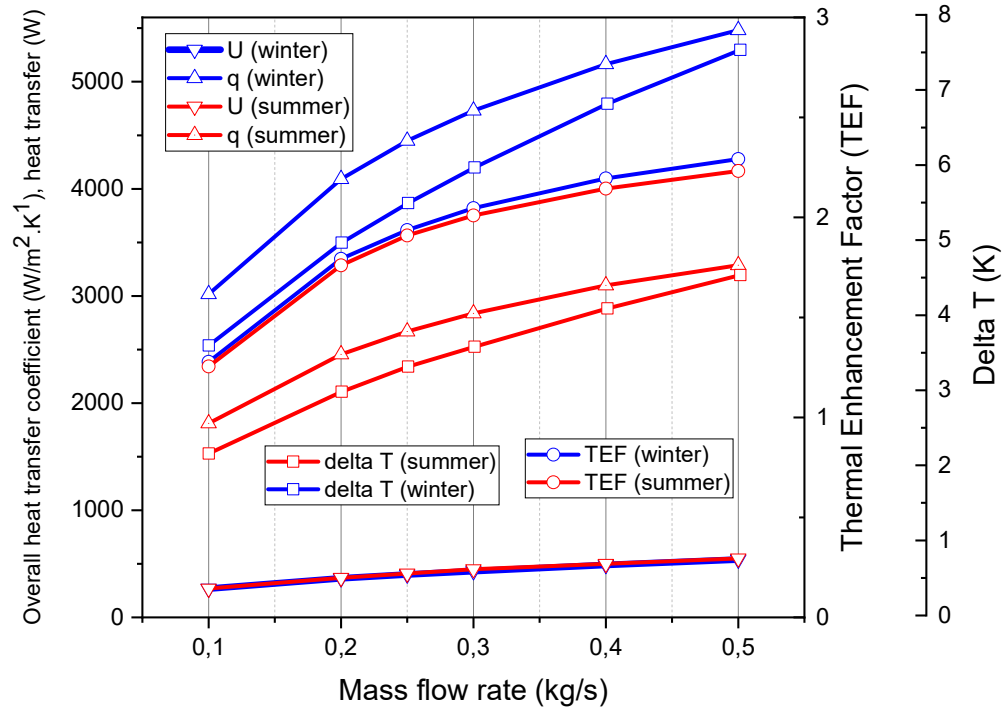

Figure III.1.9: Overall heat transfer, heat transfer, TEF, and delta temperature in winter and summer vs mass flow rate

Figure III.1.9 shows the values of the main parameters that indicate the behaviour of the flow. Results show that as the flow rate increases q , Nu , U , ΔT , and TEF increase. All the factors are promising in both seasons, the results in winter are better than that in summer due to the higher difference in hot and cold-water inlets. Even though the temperature difference in summer was smaller, however, the results are acceptable, where the inlet cold water is preheated by up to 4.6 °C. As for the TEF, it shows a considerable effect, where in both cases the enhancement exceeds one, which means that the enhancement of heat transfer is higher than the input power.

In the next section, the quantity and prices of the input energy that is consumed to heat the water by a range of temperatures are determined. This heat energy is saved by the heat recovery system that preheats the cold water from 3.5 to 7.5 °C according to the flow rate. The winter condition weather is chosen for the coming studies.

III.1.4. Economic Study

To find if the system is economically profitable, we need to find how much it costs and how much the system offers, and then evaluate the payback period to investigate its feasibility. Table III.1.4 shows the initial and periodic costs of the system for 48 accommodations. All the prices are an average of the amount obtained from various suppliers for the construction of the system in France.

Table III.1.4: Prices of the materials for constructing the heat recovery system.

| Input data | Material | Dimensions | Quantity | Cost (€) |
|--------------------------------|--------------------------------|--|----------|-------------|
| Initial cost | | | | |
| Tube | Copper | D _i = 80 mm L = 2000 mm | 1 | 45 |
| Annular | PVC | D _o = 160 mm L = 2000 mm | 1 | 10 |
| Insulating annular | Aluminium foil heat insulation | 2 m ² | 1 | 5 |
| 40 VGs | Copperplate 15 × 150 × 1 mm | Small base = 4.5 mm Big base = 9 mm Height = 12 mm Thickness = 1 mm | 1 | 10 |
| Welding materials | Bottle of Argon gas | 8 L | 1 | 110 |
| Valves | | 2 ways valve | 3 | 40 |
| | | 3 ways valve | 1 | 20 |
| Water Storage tank | Plastic | 1 m ³ | 1 | 700 |
| Insulating the tank | Aluminium foil heat insulation | 5 m ² | 1 | 10 |
| Labour | 3 persons | 2 days | 6 | 1200 |
| Total initial cost | | | | 2150 |
| Monthly cost | | | | |
| O&M (2 times/month) | 1 person | 2 hours | 4 | 160 |
| Maintenance | 480 € per year | | | 40 |
| Total monthly cost | | | | 200 |

Table III.1.4 demonstrates that the fixed initial cost is 2150 €, besides, the monthly cost that holds maintenance and cleaning is 200 €. The cost is not very high compared to the overall central water heating system, which makes the system feasible and applicable even for a smaller number of accommodations.

Now, after obtaining the total cost of integrating a heat recovery system from the drain, let's find out how much this system saves. From the simulation, it was noticed that the system preheated the inlet cold water by a range of 3.5 to 7.5 °C according to the flow rate. Thus, we will calculate the thermal energy saved to heat the water by this range of temperatures using equations 28 and 29.

The equations used to do the calculations are presented below:

$$m = \rho \cdot V \quad \text{Eq. III.28}$$

where m is the mass of the water used by the 48 accommodations per day, ρ is the density of the water, and V is the volume of the water used per day.

$$Q = m \cdot Cp \cdot \Delta T \quad \text{Eq. III.29}$$

where Q is the heat transfer, Cp is the specific heat capacity of water, and ΔT is the temperature difference between the cold inlet water and the preheated cold water.

The input energy to heating the temperature in this study varies between four types: gas [369, 370], diesel [371, 372], coal [373], and electricity [374]. Thus, to carry on with the economic study the prices of each type around the world with average prices are determined by Statista for the years 2021 and 2022, 1.34, 1.4, 0.41, and 0.2 \$ for gas, diesel, coal, and electricity respectively.

Table III.1.5 shows the heating quantity in MJ corresponding to the temperature rise, the quantity [375, 376], and the price of each energy source [377]. The energy quantity indicates the amount of energy being saved by the CTHE system, which provides heating of the inlet cold water by a range of temperature of 3.5 to 7.5 °C. As noticed, heating via coal requires a higher mass quantity due to its lower heating value which is 30 MJ/kg. On the other hand, unlike coal, gas has a higher heating value, which reaches 49 MJ/kg [378]. If using gas, the CTHE system saves money in a range of 3.52 \$ to 7.54 \$ per day, however, if diesel is used, then a range of 4.03 to 8.63 \$ per day is saved, which is a considerable amount per year. As for coal and electricity, the range of saving money is from 2.16 to 4.63 \$ and 7.03 to 15.07 \$ respectively. Now, although the heating value of diesel is higher than that of coal, which means a higher mass of coal is required, however, one kg of diesel is more expensive than coal, which makes the total amount of saved diesel more expensive.

Table III.1.5: Daily saved energy and saved costs by the heat recovery system.

| Temperature difference (°C) | Q (MJ) | Gas | | Diesel | | Coal | | Electricity | |
|-----------------------------|--------|-------------------------|-----------|------------|-----------|-----------|-----------|--------------|-----------|
| | | Volume(m ³) | Cost (\$) | Volume (L) | Cost (\$) | Mass (kg) | Cost (\$) | Energy (kWh) | Cost (\$) |
| 3.5 | 126.6 | 3.45 | 3.52 | 3.42 | 4.03 | 5.27 | 2.16 | 35.15 | 7.03 |
| 4.5 | 162.7 | 4.44 | 4.52 | 4.40 | 5.18 | 6.78 | 2.78 | 45.20 | 9.04 |
| 5.5 | 198.9 | 5.43 | 5.53 | 5.38 | 6.33 | 8.29 | 3.40 | 55.24 | 11.05 |
| 6.5 | 235.0 | 6.42 | 6.53 | 6.36 | 7.48 | 9.79 | 4.02 | 65.29 | 13.06 |
| 7.5 | 271.2 | 7.40 | 7.54 | 7.34 | 8.63 | 11.30 | 4.63 | 75.33 | 15.07 |

Table III.1.5 shows the prices of each type of energy input required to heat the water by a specific temperature each day. The prices are indicated for gas, diesel, coal, and electricity. As noticed, electricity has the highest cost this is due to the losses of converting heat into electricity and then electricity into heating water, however, for the other heating sources they are directly being used to heat the water. Followed by diesel, which has the second highest cost, this is due to the high price of diesel per liter, followed by gas which is almost the same price as diesel but much more expensive than the price of coal. Although the calorific value of coal is the lowest, it requires more amount of mass, however, it has a low cost due to the low price of coal per kg, consequently, coal has the lowest economic value.

Now, after obtaining the cost of the saved energy for each temperature difference, we will calculate the payback period for the employed system, which is calculated as the following formula [379] and the values are obtained in Table III.1.6.

Payback period:

$$\frac{A}{B - (C + D)} \quad \text{Eq. III.30}$$

where A is the initial investment costs, B is the revenue or the amount saved by the system, C is the maintenance cost, and D is the energy cost. However, we will not consider the energy cost since this system does not consume energy to work, we just need the payback period at which the system saves energy.

Table III.1.6: Payback period of the system in terms of each heating source

| Temperature difference (°C) | Payback period (year) | | | |
|--------------------------------|--------------------------|--------|------|-------------|
| | Gas | Diesel | Coal | Electricity |
| 3.5 | 2.73 | 2.22 | 7.21 | 1.05 |
| 4.5 | 1.87 | 1.55 | 4.13 | 0.77 |
| 5.5 | 1.42 | 1.20 | 2.89 | 0.61 |
| 6.5 | 1.15 | 0.97 | 2.23 | 0.51 |
| 7.5 | 0.96 | 0.82 | 1.81 | 0.43 |

As observed, the payback period for the innovative heat recovery system varies according to the heating source and the quantity of energy, with a greater amount of saved energy leading to increased cost savings and a shorter payback period. Notably, expensive energy sources have a shorter payback period due to their substantial energy savings, with electricity having the shortest payback period. Furthermore, a higher temperature difference yields more significant energy savings, leading to greater income and, consequently, a shorter payback period. In terms of specific energy sources, diesel has the second-shortest payback period, followed by gas, with coal having the longest payback period. Despite this, the payback period at the highest temperature difference for all energy sources is acceptable, i.e., 0.96, 0.82, 1.18, and 0.43 years for gas, diesel, coal, and electricity respectively. Moreover, even for the longest payback period of 7.21 years for coal at the lowest flow rate (i.e., the most unfavourable case), the system's lifespan with maintenance is estimated at around 15 years, making it feasible and desirable for use.

The economic aspect of the system is not enough to claim that this solution is sustainable, the environmental impact should be investigated as well. In the next section, the environmental impact of each type of input energy source is investigated to estimate the environmental effect of heating the water.

III.1.5. Environmental Study

Environmental Life Cycle Assessment (ELCA) has been frequently used to assess products' environmental effects and sustainability. This technique is used to quantify the environmental impact of each product from cradle to grave, where some emissions may be harmful to the environment at each step, and each type of emission has a corresponding cost that reflects its potential damage. Certain harmful

emissions are released during the mining process of extracting the gas, diesel, or coal as with many other processes. The emission rate varies according to the type of natural resource utilized.

Thus, in this study, we used OpenLCA and the ecoinvent database to estimate the ELCA of the four researched goods and to evaluate the environmental implications associated with all of the phases that the product goes through from cradle to the grave [206]. Figure III.1.10 shows the processes and emissions of producing and using different types of energy inputs (gas, diesel, and coal).

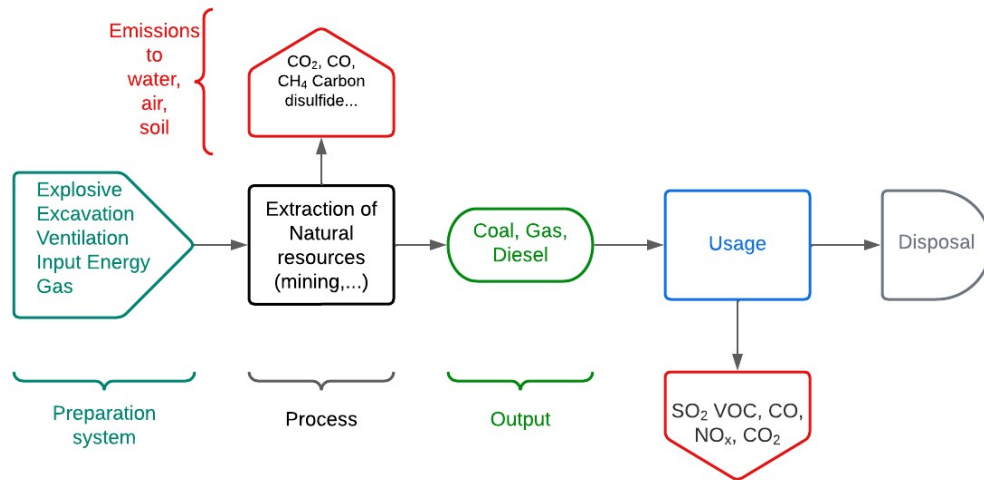

Figure III.1.10: Life cycle of using the heating source from cradle to grave.

In this section, we intend to study the life cycle assessment of each of the heating sources, where emissions occur at each stage of a process as gases are released, these gases could be harmful to the environment. Now, these emissions change from one activity to the next, and each kind has a different dangerous consequence. Consequently, the influence of each kind is studied and measured in carbon dioxide equivalents (CO₂ eq), and the Eco-cost based on the Environmental Cost Indicator (ECI) is generated to compare all varieties. The analyzed impact categories are separated into two sectors in this LCA: (1) Abiotic Environment Influence, which is concerned with the impact on the ecosystem in general, and (2) Potential Human Health and EcoToxicity Impacts, which is concerned with the impact on human and natural resources.

After defining the processes and emissions of each type of input energy, the amount of emitted gases at the mining and usage processes to produce an amount of 1 m³ gas, 1 L diesel, 1 kg of coal, and 1 kWh of electricity are determined through different sources and inserted into the openLCA [380]. The mining process is used from the Ecoinvent and Green Delta databases. For coal, in our study “hard mines coal – ZA” is used, which is the coal extracted in South Africa, we already did a simulation for the hard mines coal – DZ, and AU which are done in Algeria and Australia, but the results show that the emissions in AU were higher by around 50 %, this could be attributed to the process of extracting the coal and the type of the ground, where according to the results, the percentage of Barium, Vanadium, Selenium in AU ground was higher than that in ZA. For diesel, “diesel at the refinery – RER” is used, which is extracted in Europe. For gas, “natural gas at production – NG” is used, which is natural gas extracted in Nigeria and it has approximately the same emissions of natural gas at production – DZ, NO, and RU which are the natural

gases extracted in Algeria, Norway, and Russia. As for electricity, we used two types “electricity mix – US” and “electricity mix – FR” just to show the difference in results upon choosing a different provider, where electricity production in the US is different than that in France. Besides, in the database, there are different sources of electricity production such as nuclear, wind, photovoltaic, wood energy, etc... As for the emissions from the usage process, the research refers to several previous studies that indicate the emissions of using gas [381], diesel [382], and coal [383].

Table III.1.7 shows the values of impact analysis of the heating system through different sources: Gas, Diesel, Coal, and Electricity to calculate the Environmental Cost Indicator (ECI). ECI determines the overall environmental cost, which constitutes the sum cost of all the categories, thus a comparison can be held to study how costly the process is on the environment. Furthermore, eco-cost ECI is calculated for each heating source, with each impact category having a unique coefficient that combines all suitable environmental impacts into a single outcome of environmental expenses, reflecting the product's environmental cost.

Table III.1.7: Impact analysis of 1 m³ gas, 1 L diesel, 1 kg coal, and 1 kWh electricity

| Impact categories | Unit | Gas | Diesel | Coal | Electricity US | Electricity FR |
|--|---------------------------|-----------------------|-----------------------|-----------------------|-----------------------|-----------------------|
| GWP100 | kgCO ₂ -eq | 2.9 | 3.7 | 2.6 | 0.8 | 0.09 |
| 0.05 €/kgCO₂ | € | 0.15 | 0.18 | 0.13 | 0.038 | 0.005 |
| Ozone layer depletion | kgCFC-11-eq | 1.5×10 ⁻⁹ | 460×10 ⁻⁹ | 1.6×10 ⁻⁹ | 21×10 ⁻⁹ | 4.7×10 ⁻⁹ |
| 30 €/kgCFC-11-eq | € | 4.5×10 ⁻⁸ | 1380×10 ⁻⁸ | 4.7×10 ⁻⁸ | 63.2×10 ⁻⁸ | 14×10 ⁻⁸ |
| Human toxicity | kg _{1,4 DB} -eq | 0.0094 | 0.28 | 0.46 | 0.32 | 0.12 |
| 0.09 €/kg_{1,4 DB}-eq | € | 0.00085 | 0.025 | 0.041 | 0.029 | 0.01 |
| Depletion of abiotic resources fossil fuel - elements ultimate reserves | kgSb eq | 2.14×10 ⁻⁸ | 13.6×10 ⁻⁸ | 2.7×10 ⁻⁸ | 6.5×10 ⁻⁸ | 6.4×10 ⁻⁸ |
| 0.16 €/kgSb eq | € | 3.43×10 ⁻⁹ | 21.8×10 ⁻⁹ | 4.37×10 ⁻⁹ | 10.5×10 ⁻⁹ | 10.3×10 ⁻⁹ |
| Terrestrial Ecotoxicity | kg _{1,4 DB} -eq | 5.7×10 ⁻⁴ | 25.8×10 ⁻⁴ | 4.7×10 ⁻⁴ | 11.4×10 ⁻⁴ | 7.1×10 ⁻⁴ |
| 0.06 €/kg_{1,4 DB}-eq | € | 3.4 ×10 ⁻⁵ | 15.5×10 ⁻⁵ | 2.8×10 ⁻⁵ | 6.8×10 ⁻⁵ | 4.2×10 ⁻⁵ |
| Photochemical Oxidation | kg _{ethylene eq} | 14×10 ⁻⁴ | 3.6×10 ⁻⁴ | 0.43×10 ⁻⁴ | 2.2×10 ⁻⁴ | 0.2×10 ⁻⁴ |
| 2 €/kg_{ethylene eq} | € | 28.2×10 ⁻⁴ | 7.2×10 ⁻⁴ | 0.85×10 ⁻⁴ | 4.4×10 ⁻⁴ | 0.4×10 ⁻⁴ |
| Eutrophication | kgPO ₄ eq | 6.95×10 ⁻⁵ | 82×10 ⁻⁵ | 519×10 ⁻⁵ | 137×10 ⁻⁵ | 16×10 ⁻⁵ |
| 9 €/kgPO₄ eq | € | 6.3×10 ⁻⁴ | 74×10 ⁻⁴ | 467×10 ⁻⁴ | 123×10 ⁻⁴ | 14.4×10 ⁻⁴ |
| Acidification potential | kgSO ₂ eq | 2.10×10 ⁻⁴ | 0.00615 | 0.00092 | 0.00547 | 0.00051 |
| 4 €/kgSO₂ eq | € | 8.4×10 ⁻⁴ | 0.025 | 0.004 | 0.022 | 0.002 |
| Marine aquatic ecotoxicity | kg _{1,4 DB} -eq | 20.1 | 385 | 1837.8 | 1251.8 | 136.9 |
| 10⁻⁴ €/kg_{1,4 DB}-eq | € | 0.002 | 0.035 | 0.18 | 0.13 | 0.014 |
| Freshwater aquatic ecotoxicity | kg _{1,4 DB} -eq | 0.0084 | 0.065 | 0.8 | 0.251 | 0.038 |
| 0.03 €/kg_{1,4 DB}-eq | € | 0.00025 | 0.002 | 0.025 | 0.008 | 0.001 |
| Total | € | 0.154 | 0.283 | 0.427 | 0.234 | 0.033 |

The impact of input energy from various resources on different environmental categories varies according to the emissions released by each process. For example, coal has a higher Global Warming Potential (GWP) impact than electricity, whereas electricity has a higher impact on the ozone layer than coal due to the type of gases released from each process. The higher percentage of carbon dioxide in coal has a direct effect on global warming, whereas the percentage of other gases in electricity (such as methane and ethane) has a significant effect on the ozone layer. The Environmental Cost Indicator (ECI) of electricity generated in France was found to be very low due to the low emissions and the different types of resources used for electricity generation, such as nuclear, hydro, and wind power plants. Nuclear power plants have almost zero Green House Gas (GHG) emissions during operations and emit almost the same quantity of CO_{2eq} over the lifecycle as wind, and only about one-third as many emissions per unit of electricity as solar [384, 385]. Of course, these considerations only concern GHG and do not take into account the problem of radioactive waste management and nuclear risks.

On the other hand, power sources in the electricity US mainly rely on fossil fuels, such as petroleum, natural gas, and coal, which together account for around 79 % of resources for power generation [386, 387] and contribute to very high negative environmental impacts. Similarly, the environmental impact of diesel is high on GWP but lower on ECI than coal due to the high impacts of coal on other categories that raise its ECI.

Gas, however, shows the lowest ECI due to the lowest requirement of mining or extraction compared to diesel and coal. On the other hand, the emissions of CO₂ in gas during combustion are lower than other parties. However, we cannot compare it with the others because it depends on the heating value. Results highlight that the environmental impact of energy sources differs according to the source of energy used to produce electricity. Furthermore, the comparison between gas, diesel, and coal is not entirely fair as the heating calorific value of each type differs from the others. Thus, the coming part will provide the environmental cost of each heating source to provide the same amount of energy. Results show that gas has the lowest ECI. However, the type of natural gas used could affect the ECI.

Table III.1.8 shows the Environmental Price (EP) that is saved by the Heat Recovery System (HRS), the environmental prices are determined from the environmental study on openLCA, where the ECI is multiplied by the quantity needed to provide specific energy corresponding to the temperature. In this part, the comparison can be done on all the parties as the functional unit is the amount of energy and the comparison is on the EP (expressed in €) for all the heating sources.

Table III.1.8: Daily environmental savings by the heat recovery systems for the four heating sources

| Temperature difference (°C) | Q (MJ) | Gas | | Diesel | | Coal | | Electricity | | |
|-----------------------------|--------|-----------------------|--------|---------|--------|----------|--------|-------------|--------|--------|
| | | Qty (m ³) | EP (€) | Qty (L) | EP (€) | Qty (kg) | EP (€) | US | FR | |
| | | | | | | | | kWh | EP (€) | EP (€) |
| 3.5 | 126.6 | 3.45 | 0.40 | 3.42 | 0.81 | 5.27 | 2.16 | 35.15 | 8.23 | 1.07 |
| 4.5 | 162.7 | 4.44 | 0.52 | 4.40 | 1.05 | 5.19 | 2.78 | 45.20 | 10.58 | 1.36 |
| 5.5 | 198.9 | 5.43 | 0.64 | 5.38 | 1.28 | 6.35 | 3.40 | 55.24 | 12.93 | 1.66 |
| 6.5 | 235.0 | 6.42 | 0.75 | 6.36 | 1.51 | 7.50 | 4.02 | 65.29 | 15.28 | 1.96 |
| 7.5 | 271.2 | 7.40 | 0.87 | 7.34 | 1.74 | 8.66 | 4.63 | 75.33 | 17.63 | 2.26 |

Although coal has the highest environmental impact, however, the environmental impact of using electricity US to generate the same amount of energy is higher than that of coal. This is due to the type of electricity production including transportation and the emissions along the processes. It is worth mentioning that in different places clean sources of energy are used to generate electricity so of course, in this case, ECI will be lower than that of coal.

Figure III.1.11 shows the environmental cost of each of the sources concerning delta temperature that the heat recovery system provides. This price is being saved, since the CTHE system enhanced the temperature of cold water by a range of 3.5 to 7.5 °C.

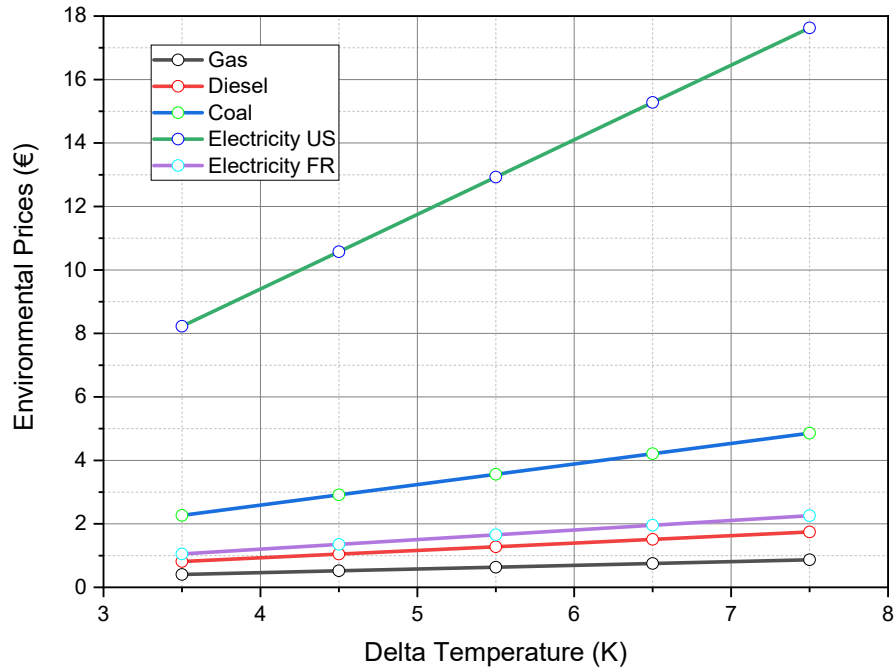

Figure III.1.11: Environmental savings in terms of each heating source

Figure III.1.11 shows that capturing the thermal energy through CTHE provides a daily saving of 0.40 to 0.87 € for gas, 0.81 to 1.74 € for diesel, 2.16 to 4.63 € for coal, 8.23 to 17.63 € for electricity US, and 1.05 to 2.26 € for electricity FR. Now, electricity US has the highest negative impact due to the production process besides throughout the power generation process high losses occur due to the transforming energy losses. Coal has a high negative impact due to the high ECI, which results in a high overall environmental impact, followed by diesel and then natural gas, which has the lowest environmental impact. Now, the amount of environmental cost saving is considerable for all the sources except for gas, however, if we calculate this value over the year, it will be worth it, where monthly the ECI of gas is 12 to 26.5 €.

Although, the electricity FR source has low GHG emissions, which means it could have the lowest environmental price, however, there are losses throughout the process of transforming energy. For instance, in electricity, specific energy is transformed into electrical energy, and then the electrical energy is transformed into thermal energy, so there occur high losses in both transformation forms of energy. On the contrary, gas, diesel, and coal are used directly to provide the required amount of thermal energy, used in a

boiler to directly heat the water, there is no process of transforming these heating sources into electricity and then providing energy. This could be the reason behind having this low EP of the other fossil sources as compared to electricity FR. It is worth mentioning that electricity FR appears to be slightly more impactful than gas or diesel and twice less than coal, while electricity US is four times more impactful than coal.

III.1.6. Conclusions

In the present study, a numerical analysis is conducted on an innovative heat recovery design. The study explored the heat transfer and overall heat transfer efficiency of the design using Ansys Fluent and evaluated its feasibility in terms of initial and monthly costs. We also conducted economic and environmental studies of the design using four types of input energy (gas, diesel, coal and electricity) to assess the payback period and environmental impact of the system for each type.

The results of the study show that the heat recovery system provides a significant increase in temperature in both winter and summer conditions. The study's conclusions can be grouped into three main categories: economic, and environmental.

In terms of economic feasibility, the initial investment for the system is around 2150 €, with a maintenance cost of 200 € per month. The payback period of the system varied depending on the type of heating source used and flow rate variation. The payback period is approximately 0.61, 1.2, 1.42, and 2.89 years for electricity, diesel, gas, and coal, respectively. Additionally, the heat recovery system provided economic savings of around 3.52 \$ to 15.07 \$ per day, depending on the type of input energy used.

The environmental impact of the four different types of input energy is also studied. The study shows that gas had the lowest environmental impact, while electricity-based fossil fuels, which are mainly generated in the US, had the highest environmental impact. The heat recovery system provided an environmental savings cost for each type of input energy, ranging from 0.87 to 17.63 € per day for a 7.5 K temperature difference.

Overall, this study demonstrates the feasibility and potential benefits of incorporating heat recovery systems in buildings. Additionally, it emphasizes the importance of using sustainable, green energy sources to minimize negative environmental impacts.

Based on the findings of this study, it is noticed that it is worth it to integrate HRS in a multi-drain application as the system saves a considerable amount of environmental impact and economic cost. In the coming section, the same application with the same conditions will be studied, however, with electrical heating-based renewable sources of energy. So that to find if this system is worth being integrated into clean energy sources as it is well known that renewable energy sources have low environmental impact.

III.2. Thermoeconomic impact of vortex generator-equipped multi-drain heat recovery systems: various renewable sources

Résumé (en français)

En raison de la forte demande en énergie et des préoccupations liées au changement climatique et environnemental, les sources d'énergie renouvelables sont utilisées maintenant dans divers domaines et régions. D'autre part, l'avantage des systèmes de récupération de chaleur sur la réduction de la consommation d'énergie encourage les chercheurs et les ingénieurs à l'appliquer à d'autres études et applications.

Dans cette étude, une conception innovante d'un échangeur de chaleur à tubes concentriques est utilisée pour récupérer la chaleur d'une application d'eau usée pour 48 logements avec différentes sources d'énergie renouvelable. Les impacts économiques, environnementaux et sociaux du système sont étudiés pour évaluer sa durabilité.

Quatre types d'énergie d'entrée sont étudiés : solaire, éolien, biomasse, hydroélectricité plus un stockage par pompage. Les résultats montrent que la conception permet une augmentation de 3,5 à 7,5 °C de l'eau froide. Par conséquent, les économies environnementales du solaire, de l'éolien, de la biomasse, de l'hydroélectricité et du stockage par pompage sont jusqu'à 0,783 €, 0,339, 0,141, 0,027, 1,356 € par jour respectivement, cependant que les économies financières sont au maximum 3,62, 2,49, 5,05, 3,62, 6,70 \$ par jour respectivement. L'impact social dépend du type de source d'énergie et de l'application.

III.2.1. Introduction

The development of effective energy harvesting systems is receiving a lot of attention as a result of the rising energy demand across many industries. Energy and related services are increasingly needed to support human social and economic growth, welfare, and health. All civilizations require energy services to provide fundamental human requirements such as health, lighting, cooking, space comfort, movement, and communication, as well as to function as creative processes [172]. Most of the energy sources are based on fossil fuels, and according to statistical studies of Our World in Data that was held in 2022, 84.3% of the energy sources are based on fossil fuels [388]. However, carbon dioxide emissions caused by fossil fuels harm our ecosystem and contribute to global climate change. During the past 150 years, fossil fuels have increased atmospheric CO₂ levels by quantities that are contentious, problematic, and, at best estimations, the use of fossil fuels as major energy sources has resulted in environmental deterioration and ozone layer depletion [206]. As a result, the economic and environmental implications of fossil fuels on the functioning of a power system demand new sources of energy that are widely available, non-depleting, sustainable, and ecologically benign, and may increase power system efficiency [389]. To halt global warming, a shift to cleaner, more sustainable energy is required. Renewable energy is rapidly expanding, but it is still a long way from replacing carbon-intensive sources of energy. Even if oil output decreases shortly, fossil fuels will continue to dominate the global energy mix for many years [390]. On the other side, waste heat recovery is considered as finding a new clean source of energy, where the quantity of waste energy in many applications is significant. In automobile and automotive power utilization, for example, around 64% of the energy input is wasted as thermal energy, almost 38% is squandered in the exhaust, and 6% is lost due to friction. Additionally, power plants waste 60% of their energy before adopting heat recovery. So, when waste heat can be recovered, it is seen as a potential source of power generation [391]. Moreover, with rising energy costs, scarcity of natural resources, and the environmental consequences of traditional energy sources, there is a growing demand for heat recovery that preserves more than 90% of wasted energy. According to previous studies, it has been noticed that when employing hybrid heat recovery systems which means integrating more than one system, the thermal recovery level exceeds 28% with a performance coefficient of up to 2.2 times traditional processes [354].

As a result, developing effective and low-cost energy recovery technologies is equally as important as developing new energy sources. Thermal energy is necessary for many architectural applications, thus it must be supplied, maintained, and used effectively to serve both the environment and the economy. The Drain Water Heat Recovery (DWHR) system is designed to recover the leftover energy from hot drain water and use it to warm the incoming cold water [356]. The household sector accounts for 26% of total energy expenditure in the United States, 37% of which is for lighting, cooling, and appliances. The remaining energy is assigned to heating, with space heating accounting for 45% and water heating accounting for 18%. Thus, residential water heating accounts for 4% of overall government energy use. The household sector contributes 29% of total energy consumption in some countries, such as the United Kingdom. This is broken down as follows: 65% for room heating and 16% for water heating [356]. Consequently, the energy required to warm water contributes to a considerable amount of the total energy consumed in a typical household. Many studies, including those by Boait et al. [357] and Leidl and Lubitz [392], have investigated possible approaches for conserving energy used to heat domestic water, such as heat pumps, Solar Water Heating (SWH), gas boilers, immersion heaters, and drain water heat recovery.

Drainage water constitutes a considerable amount of energy to recover, where the normal temperature of household drain water varies from 20 to 40 °C [356]. As a consequence, domestic effluent is more suitable for heat recovery than other heat sources, where the ambient temperature of drainage water from bathtubs or washing machines is considerably high. Allowing this much energy to escape the building with warm water without collecting it is a significant energy waste. As a result, recovering heat from drain water represents an excellent chance to decrease energy usage. Drainage water heat recuperation systems have been investigated in various areas to improve their performance.

As a result, the substantial thermal loss from drainage water and the high energy usage on heating domestic water, make heat recovery in drain water a field of interest. However, after identifying a system's capacity for thermal recovery, there is an essential stage that the study must take which is improving heat transfer to recover the highest amount of thermal energy. Incorporating Vortex Generators (VGs) is one of the simplest methods to improve heat transfer because VGs are passive devices with high efficiency in improving heat transfer, as demonstrated by Aridi et al. [364], which carried out a numerical study on various positions of VGs in a Concentric Tube Heat Exchanger to determine the best design in terms of heat transfer, total heat transfer, and thermal enhancement factor. Based on the aforementioned facts, the goal of this research is to use CTHE with VGs in a multi-drain water heat recovery system. This applied research could lead to improved heat recovery devices in such applications by capturing a high proportion of thermal energy. It examines a novel design in a multi-drain heat recovery implementation by simulating numerically its impact on heat transfer, overall heat transfer, and thermal enhancement factor. This application is examined in conjunction with diverse renewable energy sources where the system's economic and environmental aspects are assessed to determine its long-term viability. Solar, wind, biomass, hydropower, and pumped storage are the five kinds of input energy investigated.

This research examines a novel design in a multi-drain heat recovery implementation. Its novelty resides in the following:

- Coupling two new potential concepts into one application. These new potential concepts are the use of vortex generators in heat recovery and the multi-drain heat recovery concept.
- Performing an LCA study, incorporating economic, environmental, and social studies of the new heat recovery system.
- Comparing the economic, environmental, and social impacts of a HRS in various renewable heating sources.
- Integrating multi-drain heat water into different renewable energy heating sources.
- Providing the renewable energy and energy management community with useful recommendations on many fronts related to advanced drain water heat recovery systems.

There are various types of energy sources that the universe provides, they are classified into finite sources which mean sources of limited quantity, and infinite sources which mean abundant and unlimited sources. Figure III.2.1 shows the different types of energy around the world and the amount of consumption by the year 2009, which is measured by Terra Watt year (TWy), knowing that 1 TWy = 8760 TWh [393].

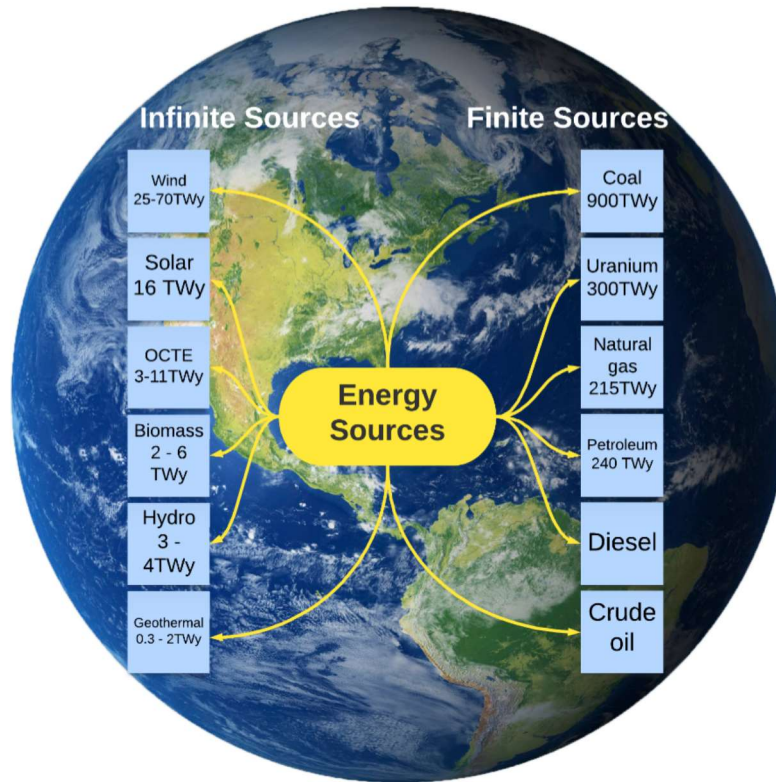

Figure III.2.1: Energy consumption sources around the world.

As noticed in Figure, there are different types of infinite sources, and they are more eco-friendly than finite sources. For instance, the sun provides the Earth 23,000 TWy each year, however, 16 TWy are just used, which means less than 0.07%. On the other side, the quantity of solar energy received by the oceans every year has been estimated to be at least 4000 times more than what people nowadays utilize. For 3% of Ocean thermal energy conversion (OCTE) energy, less than 1% of this renewable energy would be required to fulfil all of our energy needs in transforming ocean thermal energy to power [394]. Although there exist various types of renewable energy, however, the consumption of finite sources is much more than the infinite ones, where the consumption of finite sources in 2009 exceeds 92.5% of the total energy consumption, which leaves less than 7.5 % of energy consumption to the infinite sources. Nowadays, the percentage of renewable energy consumption is increased due to the shift that most countries are performing to have a healthier environment and due to the improvement of the tools to capture infinite energy sources.

III.2.2. Application Study

In this study, the environmental impact of a system that combines heat recovery was examined, represented by domestic waste heat recovery (DWHR), and renewable energy. The same application study that was presented in chapter III.1 is used in this chapter however with renewable energy sources instead of fossil fuels.

Previously, a DWHR system for a building with 48 accommodations coupled with four types of input energy—coal, diesel, gas, and electricity—was studied and the results were so promising that this system

saved a lot of environmental and economic energy [395]. The objective of this study is to find if this system shows the same interest as renewable energy systems as it is well known that renewable energy sources have a low impact on the environment. Thus, a life cycle assessment of the DWHR system will be investigated using renewable energy sources: solar, wind, biomass, hydropower, and pumped storage.

The results of this study are compared with previously published research that examined the effectiveness of heat exchangers in various applications. The comparison is presented in Table III.2.1, which illustrates the impact of heat exchangers in different studies, including this study. The effectiveness of heat exchange varies from 0.15 to 0.26 across all cases, with variations primarily arising from differences in the application, heat exchanger dimensions, and boundary conditions (mass flow rates, temperatures of cold and hot water, and working fluid ...).

Another factor contributing to the variations in effectiveness is the method employed to enhance heat transfer within the heat exchanger. For instance, in the study first study, a coil tube heat exchanger was utilized, where the heat transfer enhancement Method (HTEM) was achieved through the introduction of coil tubes that generated Dean vortices, thus improving heat transfer efficiency. In the second study, a corrugated tube was used with varying mass flow rates at the same temperature. In the third study, the effectiveness of the heat exchanger was relatively low, this can be attributed to the working fluid used (ethanol). However, in the fourth study, heat transfer enhancement is achieved using trapezoidal-shaped vortex VGs, which also contribute to enhancing heat transfer. As noticed from Table III.2.1, there exists a slight difference in the effectiveness of the HE, this is due to several factors such as the presence of different enhancement heat transfer methods, different geometry, and boundary conditions. However, it is noteworthy that the design under investigation in this study demonstrates promising potential, achieving equivalent effectiveness to coil tube heat exchangers, which are renowned for their high efficiency [396]. Additionally, this design exhibits lower pumping power requirements compared to other systems, boasting a thermal enhancement ratio of 1.8. This ratio signifies the heat transfer ratio over the required pumping power [364]. Consequently, these findings suggest a favourable outlook for this design in the future.

Table III.2.1: Comparison between the effectiveness obtained in this study with other published work.

| | Study | HE types | HTEM | Conditions | Effectiveness |
|---|-----------------------------|--|---------------------------|--|---------------|
| 1 | Murr et al. [362], 2020 | Counter flow coil tube HE | Coil tube | At a hot temperature of 65°C | 0.26 |
| | | | | At a hot temperature of 45°C | 0.23 |
| | | | | At a hot temperature of 25°C | 0.19 |
| 2 | Kumar et al. [397], 2020 | Counter flow CTHE | Corrugated/ curved tubing | $T_h = 47\text{ °C}$, $\dot{m}_c = 3/60\text{ kg/s}$, and $\dot{m}_h = 2/60\text{ kg/s}$. | 0.15 |
| | | | | $T_h = 47\text{ °C}$, $\dot{m}_c = 2/60\text{ kg/s}$, and $\dot{m}_h = 1/60\text{ kg/s}$. | 0.21 |
| 3 | Ramkumar et al. [398], 2021 | Concentric tube - heat pipe - heat exchanger | Heat pipe | At a hot temperature of 65 °C methanol working fluid | 0.21 |
| 4 | Present study | Counterflow CTHE | VGs | At a hot temperature of 50°C | 0.25 |

III.2.3. Economic Study

To study the effectiveness of the system three main studies should be considered economic, environmental, and social. To consider that the system is sustainable, it should have a low impact on the three categories. In this part, the economic study will be held for the five sources of heating energy: solar, wind, biomass, hydropower, and pumped storage. Table III.2.2 shows the levelized cost of electricity (LCOE), which is the amount at which generated energy should be distributed for the system to break even after its lifetime. The economic cost saved by the DHRS, and the prices for solar, wind, biomass, and hydropower are taken from [399], for the pumped storage the price is taken from [400].

Table III.2.2: Daily saved energy and prices for the heat recovery system.

| <i>Temperature difference</i> (°C) | <i>Q</i> (kWh) | <i>Price (\$)</i> | | | | |
|---------------------------------------|-------------------|-------------------|------|---------|------------|----------------|
| | | Solar | Wind | Biomass | Hydropower | Pumped storage |
| 3.5 | 35.17 | 1.69 | 1.16 | 2.36 | 1.69 | 3.13 |
| 4.5 | 45.19 | 2.17 | 1.49 | 3.03 | 2.17 | 4.02 |
| 5.5 | 55.25 | 2.65 | 1.82 | 3.70 | 2.65 | 4.92 |
| 6.5 | 62.27 | 3.13 | 2.15 | 4.37 | 3.13 | 5.81 |
| 7.5 | 75.33 | 3.62 | 2.49 | 5.05 | 3.62 | 6.70 |

It is noticed that the prices saved by the DWHRs are significant, where the saved money reached up to 6.70 \$/day for pumped storage, and the savings for other systems are 3.62, 2.49, 5.05, and 3.62 \$/day for solar, wind, biomass, and hydropower respectively for a temperature difference of 7.5 °C. Now, although the price of wind is the lowest, however, this cost is per day, so it makes a difference over time. Moreover, the cost of the energy saved from expensive energy sources is more than the cheap energy source, in other words, the higher the cost of the energy sources the more savings the system will provide.

III.2.4. Environmental Study

Environmental Life Cycle Assessment (ELCA) has been widely used to evaluate the environmental impact and viability of products. This method is used to quantify each product's environmental effect from the start to the finish line, where some releases may be damaging to the ecosystem at each stage and each form of emission has a related cost that represents its possible damage. In this section, we will study the environmental impact of solar, wind, biomass, hydropower, and pumped storage. The rate of emission changes depending on the sort of natural resource used. Thus, the ELCA of the five researched energy sources is performed using OpenLCA and the ecoinvent database to assess the environmental consequences connected with all of the processes from cradle to grave [206]. Figure III.2.2 shows the processes and emissions of producing and using various sources of energy (solar, wind, biomass, hydropower, and pumped storage).

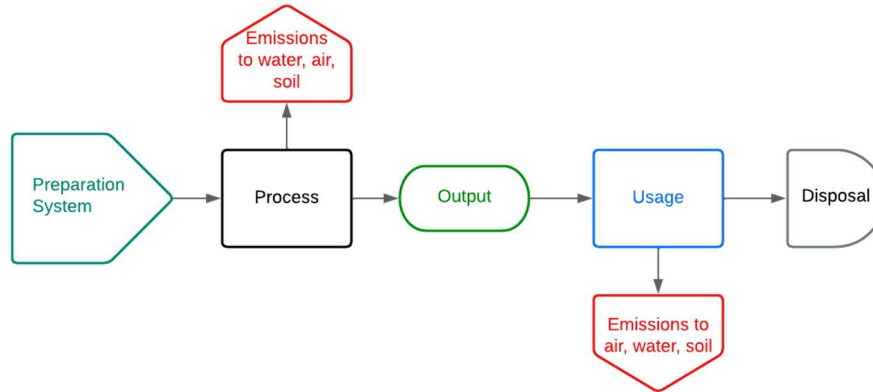

Figure III.2.2: Life cycle of using the heating source from cradle to grave.

The environmental analysis begins with the preparation system, encompassing the materials and labor required to construct the power infrastructure. Throughout this process, emissions are released alongside power generation. Subsequently, electricity is either distributed through wires or stored in batteries, both of which also emit greenhouse gases. Ultimately, the materials used in the system reach the end of their useful life and are disposed of in landfills.

In this section, we examine the life cycle assessment (LCA) of each energy source, taking into account the emissions produced at each stage of the process. These emissions vary across activities, and each type has distinct environmental consequences. Consequently, the impact of each energy source is assessed and quantified in carbon dioxide equivalents (CO₂ eq), while the Environmental Cost Indicator (ECI) is employed to calculate the Eco-cost for each type. This LCA categorizes the studied impact groups into two sectors: (1) Abiotic Environment Influence, which concerns the general environmental impact, and (2) Potential Human Health and EcoToxicity Impacts, which relate to the impact on both human and natural resources.

After identifying the processes and emissions for each type of electricity source, the processes are obtained from the ecoinvent database for Switzerland (CH) as follows: electricity, at wind power plant – CH; electricity, production mix photovoltaic, at the plant – CH; electricity, hydropower, at pumped storage power plant – CH; electricity, hydropower, at power plant – CH; and electricity, wood, at distillery – CH.

Table III.2.3 presents the results of an impact assessment of the heating system using various electricity sources, such as solar, wind, biomass, hydropower, and pumped power storage, to calculate the Environmental Cost Indicator (ECI). The ECI computes the total environmental cost by summing all categories, allowing for comparison to assess the ecological cost of each process. Moreover, the Eco-cost ECI is calculated for each energy source, with each impact category featuring a unique coefficient that combines all relevant environmental effects into a single environmental cost metric, representing the product's environmental burden.

It is observed that pumped storage exhibits the highest Global Warming Potential (GWP) and ECI, at 0.018 €/kWh, while hydropower displays the lowest ECI, at 0.00036 €/kWh, due to its straightforward process that harnesses potential energy to drive the pump. Conversely, solar, wind, and biomass have higher

environmental impacts with ECIs of 0.0104, 0.0045, and 0.00187 €, respectively. These impacts vary by country or region based on the materials used and the processes involved in electricity generation.

Table III.2.3: Impact analysis of 1 kWh of solar, wind, biomass, and pumped storage.

| Impact categories | Unit | Solar | Wind | Biomass | Hydropower | Pumped storage |
|--|---------------------------|-----------------------|-----------------------|----------------------|-------------------------|-----------------------|
| GWP100 | kgCO ₂ -eq | 0.021 | 0.00483 | 0.011 | 0.00126 | 0.0524 |
| 0.05 €/kgCO₂ | € | 0.0011 | 0.000242 | 0.00054 | 0.000063 | 0.00262 |
| Ozone layer depletion | kgCFC-11-eq | 4×10 ⁻⁹ | 0.29×10 ⁻⁹ | 1.1×10 ⁻⁹ | 0.0076×10 ⁻⁹ | 7.06×10 ⁻⁹ |
| 30 €/kgCFC-11-eq | € | 12×10 ⁻⁸ | 0.02×10 ⁻⁸ | 3.4×10 ⁻⁸ | 0.23×10 ⁻⁸ | 21.2×10 ⁻⁸ |
| Human toxicity | kg _{1,4 DB} -eq | 0.0338 | 0.03 | 0.0045 | 0.00197 | 0.0045 |
| 0.09 €/kg_{1,4 DB}-eq | € | 0.003 | 0.0027 | 0.00041 | 0.00018 | 0.04 |
| Depletion of abiotic resources fossil fuel - elements ultimate reserves | kgSb eq | 279×10 ⁻⁸ | 8.38×10 ⁻⁸ | 2.3×10 ⁻⁸ | 0.465×10 ⁻⁸ | 2.83×10 ⁻⁸ |
| 0.16 €/kgSb eq | € | 446×10 ⁻⁹ | 13.4×10 ⁻⁹ | 3.6×10 ⁻⁹ | 0.744×10 ⁻⁹ | 4.53×10 ⁻⁹ |
| Terrestrial Ecotoxicity | kg _{1,4 DB} -eq | 5.7×10 ⁻⁴ | 25.8×10 ⁻⁴ | 4.7×10 ⁻⁴ | 11.4×10 ⁻⁴ | 7.1×10 ⁻⁴ |
| 0.06 €/kg_{1,4 DB}-eq | € | 25×10 ⁻⁵ | 91×10 ⁻⁵ | 14×10 ⁻⁵ | 6.65×10 ⁻⁵ | 32×10 ⁻⁵ |
| Photochemical Oxidation | kg _{ethylene eq} | 6.44×10 ⁻⁶ | 1.55×10 ⁻⁶ | 3.2×10 ⁻⁶ | 0.234×10 ⁻⁶ | 10.1×10 ⁻⁶ |
| 2 €/kg_{ethylene eq} | € | 12.9×10 ⁻⁶ | 3.1×10 ⁻⁶ | 6.4×10 ⁻⁶ | 0.468×10 ⁻⁶ | 20.2×10 ⁻⁶ |
| Eutrophication | kg _{PO4 eq} | 6.4×10 ⁻⁵ | 1.21×10 ⁻⁵ | 21×10 ⁻⁵ | 0.13×10 ⁻⁵ | 15×10 ⁻⁵ |
| 9 €/kg_{PO4 eq} | € | 5.76×10 ⁻⁴ | 1.09×10 ⁻⁴ | 1.9×10 ⁻⁴ | 0.2×10 ⁻⁴ | 13.5×10 ⁻⁴ |
| Acidification potential | kg _{SO2 eq} | 10×10 ⁻⁵ | 2.27×10 ⁻⁵ | 8.1×10 ⁻⁵ | 0.38×10 ⁻⁵ | 24×10 ⁻⁵ |
| 4 €/kg_{SO2 eq} | € | 4×10 ⁻⁵ | 9.07×10 ⁻⁵ | 32×10 ⁻⁵ | 1.5×10 ⁻⁵ | 96×10 ⁻⁵ |
| Marine aquatic ecotoxicity | kg _{1,4 DB} -eq | 48.67 | 10.48 | 3.565 | 0.74 | 81.54 |
| 10⁻⁴ €/kg_{1,4 DB}-eq | € | 4.87×10 ⁻³ | 1.05×10 ⁻³ | 0.4×10 ⁻³ | 0.07×10 ⁻³ | 8.15×10 ⁻³ |
| Freshwater aquatic ecotoxicity | kg _{1,4 DB} -eq | 0.015 | 0.0069 | 0.00137 | 0.00049 | 0.02798 |
| 0.03 €/kg_{1,4 DB}-eq | € | 4.5×10 ⁻⁴ | 2.07×10 ⁻⁴ | 0.4×10 ⁻⁴ | 0.147×10 ⁻⁴ | 8.39×10 ⁻⁴ |
| Total | € | 0.0104 | 0.0045 | 0.00187 | 0.00036 | 0.0180 |

To ascertain the precise environmental savings achieved by the DWHR system, we must calculate the Environmental Price (EP) per unit of energy saved. Table III.2.4 presents the EP saved by the heat recovery system, determined from the environmental study conducted in openLCA, as detailed in Table III.2.3. The

ECI of 1 kWh is multiplied by the amount needed to provide specific energy corresponding to the temperature difference.

The highest environmental savings achieved by the DWHR system were for pumped storage (1.356 €), as it has the highest ECI, followed by solar, wind, biomass, and hydropower, with EPs of 0.783, 0.339, 0.141, and 0.027 €, respectively, for a temperature difference of 7.5 °C. This ranking is consistent with the ECI associated with each source. Although these savings may appear small, they accumulate over time, as the saved costs are calculated daily.

Table III.2.4: Environmental savings by the heat recovery systems for the four electrical sources of heating and one energy storage system.

| Temperature difference (°C) | Q | | EP (€) | | | | |
|-----------------------------|-------|--------|--------|-------|---------|------------|----------------|
| | (MJ) | (kWh) | Solar | Wind | Biomass | Hydropower | Pumped storage |
| 3.5 | 126.6 | 35.154 | 0,366 | 0,158 | 0,066 | 0,013 | 0,633 |
| 4.5 | 162.7 | 45.198 | 0,470 | 0,203 | 0,085 | 0,016 | 0,814 |
| 5.5 | 198.9 | 55.242 | 0,575 | 0,249 | 0,103 | 0,020 | 0,994 |
| 6.5 | 235.0 | 65.286 | 0,679 | 0,294 | 0,122 | 0,024 | 1,175 |
| 7.5 | 271.2 | 75.33 | 0,783 | 0,339 | 0,141 | 0,027 | 1,356 |

III.2.5. Social Impact

Renewable resources primarily offer various social benefits, such as improved health, technological advancements, job opportunities, local employment, and consumer choice. Renewable energy initiatives also contribute to enhanced environmental outcomes, including reduced carbon dioxide emissions and increased community awareness of climate change, ultimately fostering a cleaner and healthier environment for citizens. However, renewable energy systems can be challenging to implement, as they are sensitive to local environmental and weather conditions. This sensitivity necessitates extensive knowledge and awareness, which expands the research scope for researchers. Furthermore, renewable energy promotes an increased awareness of environmentally friendly topics, encouraging environmental protection. Nevertheless, several renewable energy sources have unique social impacts, as presented below and summarized in Figure III.2.3:

Tidal energy plants have minimal impact on people, mainly contributing to municipal and government employment. Wind energy initiatives create numerous job opportunities, particularly for engineers. However, wind farms produce significant noise pollution, originating from both aerodynamic noises generated by turbine blades and mechanical noise produced by the turbine's gearbox, generator, and associated components. This noise can be loud, irritating, and disruptive, causing health issues such as headaches, hearing loss, and sleep disturbances for those living nearby. A study conducted in New Zealand [401] on the impact of wind turbine noise on residents' well-being found that wind turbines negatively affected their quality of life, leading to strong anti-wind turbine sentiment. Additionally, wind energy is uniquely associated with the shadow flicker effect, which occurs when sunlight or another bright light source strikes the turbine blades three times per revolution, as typical wind turbines have three blades. The

rotating blades create a flicker effect, resulting in discomfort or even pain for those exposed. The intensity of the shadow flicker effect depends on the time of day and wind speed, with the effect being strongest during sunrise and sunset, when shadows are longest, and at high wind speeds. Anecdotal evidence suggests that shadow flicker can cause health issues such as headaches and stress and may even deter livestock. These effects contribute to negative perceptions of wind turbines. Furthermore, wind farms, directly and indirectly, impact bird populations, with the most immediate consequence being bird mortality due to collisions with turbine blades or related infrastructure, such as power lines.

Biomass is a renewable energy source with numerous advantages, including waste reduction, abundance, and reliability. However, it is not always environmentally friendly or clean, as its impact depends on the type of conversion process used. There are four primary methods for converting biomass into energy: burning organic materials to generate heat, thermochemical conversion to produce gaseous, liquid, and solid fuels, chemical conversion to yield liquid fuels, and biological conversion to create gaseous and liquid fuels [402]. The first three types primarily involve heating materials at high temperatures to generate fuel, which is not environmentally friendly and produces significant greenhouse gas emissions. In contrast, biogas conversion transforms waste into fuel through fermentation, offering fewer disadvantages as it neither burns nor heats materials to extremely high temperatures, reducing heating source requirements. Once the process is complete, the remaining sludge can be used as a biofertilizer in agriculture. Biomass energy initiatives contribute significantly to local employment growth and rural development, offering numerous job opportunities in plant construction, management, maintenance, and biomass production and preparation.

Solar panels are often installed on building roofs, promoting local development and job opportunities in photovoltaic (PV) system manufacturing and assembly while reducing energy consumption from nonrenewable sources. Solar energy is particularly beneficial in areas without access to power. However, the main issue with solar systems is their high initial investment and ongoing maintenance costs. Additionally, sunlight reflection from solar panels can cause discomfort for nearby residents, as solar radiation, particularly UV radiation, has been linked to various corneal, lens, and retinal abnormalities. The health risks depend on the volume and wavelength of radiation that reaches the eye's internal structure, with irradiation from such plants typically being high, especially in concentrated solar power plants [403]. Furthermore, solar panels can contribute to increased ambient temperatures, which may pose issues for neighbouring communities during the summer months.

Hydropower and pumped storage share some concerns, such as endangering aquatic life, particularly if the pumped storage uses a natural lake. These plants provide substantial employment opportunities and contribute significantly to a community's economic growth. However, they can also detract from the natural beauty of the area, resulting in negative public perceptions of these energy sources. In some countries, negative social consequences coexist, such as in the Zambezi, Zaire, Senegal, and Niger rivers, where traditional agriculture relies on unpredictable and insufficient yearly floods. Damming these limited floodwaters negatively impacts agriculture. The primary sociopolitical issue with hydropower plants is the relocation of people from areas designated for plant construction. Additionally, there are several social concerns associated with traditional pumped heat storage (PHS), including the degradation of terrestrial animal habitats before dam flooding and the disruption of aquatic ecosystems. The installation of PHS systems inevitably damages land vegetation and trees, particularly during dam construction [404].

Geothermal energy projects provide various societal benefits, such as increased education for local communities, improved living conditions, and enhanced healthcare. However, geothermal energy has a high initial cost and is dependent on a location's geology, making it unsuitable for all regions [405].

Constructing a nuclear power facility in any area raises concerns and objections from a wide range of individuals. People living in such areas worry about exposure to abnormally high levels of radiation. Natural water resources in these areas are also questioned for their ability to manage plant emissions, especially if the plant uses the water body as a thermal sink [406].

In conclusion, renewable energy sources offer a range of social and environmental benefits but are not without their unique challenges and impacts. Each source requires careful consideration of its specific environmental and social effects to ensure sustainable development and community well-being.

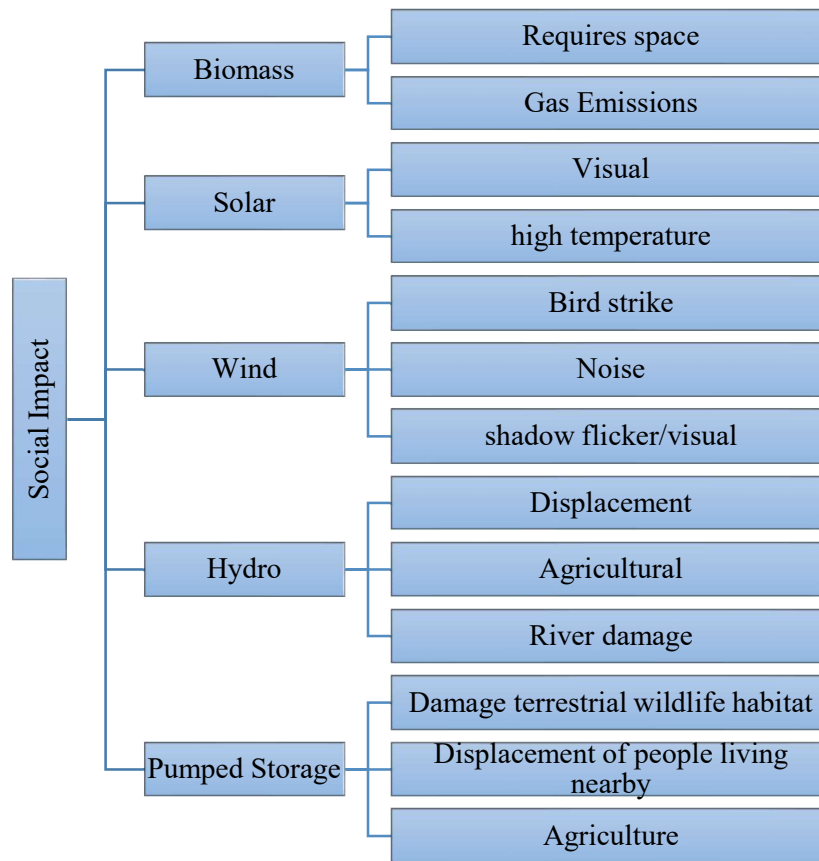

Figure III.2.3: Social negative impacts of some renewable sources.

III.2.6. Conclusions

This research paper presented a numerical-analytical approach study of a novel heat recovery design proposed in a previously published article by the co-authors [364]. The design features a CTHE with 10 rows of VGs running along the length of the tube. Using Ansys Fluent, heat transfer, total heat transfer, and thermal heat transfer factor were calculated to determine the amount of heat the system recovers from

wastewater. The initial and monthly costs were assessed to evaluate the system's feasibility. Subsequently, economic and environmental analyses were conducted on the design, considering five types of energy sources to heat the system: solar, wind, biomass, hydropower, and pumped storage. This approach aimed to determine the environmental impact associated with each type of input energy. According to the results, the design provides a temperature increase of 3.5 to 7.5 °C in cold conditions and 2.2 to 4.6 °C in summer, affecting various aspects of the economy, environment, and society. The conclusions are as follows:

1. Economic

- While the initial investment in renewable systems is high, the price per kWh is acceptable over a system's lifetime, given the free energy source.
- The economic savings for solar, wind, biomass, hydropower, and pumped storage are up to 3.62 \$, 2.49 \$, 5.05 \$, 3.62 \$, and 6.70 \$ per day, respectively.

2. Environmental

- The environmental impact of the five distinct renewable energy types was examined, revealing that hydropower has the lowest impact, while pumped storage has the highest.
- The HRS offers environmental savings costs for solar, wind, biomass, hydropower, and pumped storage of up to 0.783 €, 0.339 €, 0.141 €, 0.027 €, and 1.356 € per day, respectively.
- Although renewable energy sources have relatively low environmental impacts, it is essential to incorporate thermal recovery systems, as the long-term savings are worthwhile.

3. Social

Renewable energy sources have lower environmental effects compared to conventional sources, promoting a healthy environment and clean society. However, some disadvantages exist depending on the energy source used, such as noise pollution, bird strikes, and high temperatures. This highlights the importance of integrating heat recovery systems into every energy system, even those considered clean and renewable. While the environmental impact may appear minimal, it makes a significant difference in the long run. Saving energy translates to economic, environmental, and social benefits in both the short and long term. Furthermore, it promotes system sustainability, ultimately leading to a healthier society.

In the coming chapter, a fundamental study on integrating TEGs and VGs in two rectangular channels is held to study the power generation that the TEGs can provide on different configurations by varying the Reynolds number. Finally, according to this study, the power generated that a heat recovery system can provide through different configurations. Five configurations will be examined, the first configuration is with no TEGs and no VGs as a reference case, the other cases will be as the following two cases with different displacements of TEGs without integrating VGs, and the other two cases are the same but with the presence of pattern of VGs (Delta Winglet pair). The power generated in the flow and TEG of each case will be studied as well and compared to the other configurations.

Chapter IV: Pioneering Hybrid Heat Recovery Systems: Thermoelectric Generators as Insulators and channels boosted by vortex generators

Résumé (en français)

Les générateurs de vortex sont des outils très efficaces pour accroître le transfert de chaleur d'une région à une autre, en particulier par convection, et semblent être un concept très prometteur à coupler avec des systèmes de récupération de chaleur. D'autre part, les générateurs thermoélectriques (TEG) sont des dispositifs capables de convertir les différences de température en énergie électrique en utilisant l'effet Seebeck, leur principal avantage étant de fonctionner avec des différences de température élevées, voire faibles. Ces modules TEG pourraient être des outils très efficaces dans l'hybridation de systèmes de récupération de chaleur. Dans ce contexte, le présent article suggère un système innovant qui combine trois axes énergétiques importants tels que la récupération de chaleur, les TEG et les générateurs de vortex. L'étude actuelle utilise un TEG dans un canal rectangulaire pour analyser l'influence du TEG sur l'écoulement et l'effet de l'écoulement turbulé sur la production d'énergie électrique afin d'évaluer la viabilité de ce concept récemment proposé. L'enquête est menée en faisant varier le nombre de Reynolds dans une plage de cinq valeurs : 1000, 2000, 4000, 7000 et 10000, en appliquant six configurations différentes. Par conséquent, les résultats montrent que plusieurs facteurs affectent la puissance électrique générée par le TEG, tels que l'emplacement, l'angle d'attaque et la présence ou l'absence de générateurs de vortex. D'autre part, la chaleur récupérée par l'écoulement est influencée par le TEG et le nombre de Reynolds, où la récupération de chaleur la plus élevée est atteinte à $Re = 10000$ pour la configuration 4 avec une puissance électrique de 7,4 W, et pour la configuration 5, la chaleur récupérée par l'écoulement est de 1913 W. En outre, il a été conclu que les TEG réduisaient les pertes des deux côtés chaud et froid de 1,42 fois.

IV.1. Introduction

Enhancing heat transfer from a surface to the surrounding atmosphere is an ongoing area of research aimed at optimizing energy utilization. Within the realm of heat transfer, turbulent flow systems hold significant importance. Among the strategies employed to improve heat transfer efficiency and reduce pressure drop, Vortex Generators (VGs) play a crucial role. VGs can be defined as protrusions on the heat transfer surface that induce swirling motion around an axis, generating vortices. They are categorized based on their various types, forms, and geometries [354].

VGs, also referred to as interrupted surfaces, significantly enhance convective heat transfer processes in compact heat exchangers. While VGs are effective and passive devices that enhance heat transfer, it is important to note that they do cause a pressure drop, as depicted in Figure IV.1 [407]. Therefore, the implementation of VGs requires careful analysis to identify the critical design that maximizes heat transfer enhancement while minimizing the impact on pressure drop.

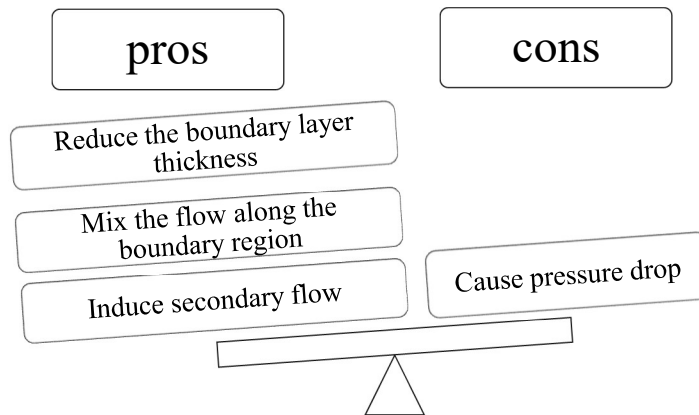

Figure IV.1: Pros and cons of Vortex Generators (VGs)

Thermoelectric Generators (TEGs) are devices that can generate electricity by utilizing temperature differences. Through the phenomenon known as the Seebeck effect, the heat flux is converted into electrical energy. TEGs offer numerous advantages, such as their ability to operate even with very low-temperature differences, their simple design, easy integration, and the absence of moving parts, resulting in quiet operation. However, TEGs are known to have a drawback, which is their relatively low efficiency [342]. To address this limitation, researchers are actively exploring methods to increase TEG efficiency and exploring innovative structures such as flexible, wearable, or micro-TEGs. These advancements expand the potential applications of TEGs across various domains.

In current times, heat recovery has become an indispensable element in nearly all designs [172]. These systems find utility in various domains such as industrial and small-scale applications, ventilation and air conditioning systems, refrigeration systems, sewage systems, swimming pool systems, and numerous technological processes [354]. The significance of heat recovery systems stems from their two primary advantages. Firstly, they curtail energy consumption, thereby lowering the associated costs, with heat

recovery systems achieving efficiencies as high as 90% in certain applications [60]. Secondly, they lessen the emission of CO₂, a critical concern in today's world [206].

Furthermore, with the rising costs of energy and the depletion of natural resources, there is a growing demand for heat recovery systems that can efficiently capture, and harness wasted energy, aiming to conserve over 90% of this energy to address environmental issues [408]. Previous research has shown that by incorporating hybrid heat recovery systems, which involve the integration of multiple systems, the thermal recovery efficiency can surpass 28%. This results in a performance coefficient that is up to 2.2 times higher than that of traditional processes [354]. Consequently, further investigations have been conducted in the field of heat recovery to enhance its overall performance. The optimization of heat recovery systems has been demonstrated through two approaches: (1) enhancing energy transfer by employing techniques like turbulators and vortex generators (VGs) to augment the flow [409], and (2) employing hybridization, which involves the integration of multiple heat recovery systems to capture additional energy. However, no previous studies have explored the simultaneous combination of these two approaches. Therefore, the novelty of this study lies in the integration of both techniques to further enhance the system's performance. The originality of the present study is demonstrated through the following contributions:

1. Integration of hybridization and thermoelectric generators (TEGs) to optimize the heat recovery process. By incorporating TEGs into the heat recovery system, dual benefits are harnessed electricity generation and improved heat transfer.
2. Conducting various configurations and comparing them under different flow conditions.
3. Development of an approach and methodology that can aid future studies and systems in this domain.
4. Introduction of a novel numerical approach that incorporates the consideration of the Thermoelectric Generator (TEG) as a variable source term or a heat sink that absorbs thermal energy. In this method, the TEG source term is dynamically updated at each iteration of the solution procedure.

IV.2. Materials and methods

IV.2.1. System description and methodology

In this study, six configurations are examined, with configuration 0 (noted C0) serving as a reference case, while the other five cases involve different designs that are compared to the reference case. All six configurations feature the combination of two rectangular channels joined together, with air serving as the working fluids. In a counter-flow arrangement, hot air enters channel 1 at a temperature of 773 K, while cold air enters channel 2 at a temperature of 293 K. Each rectangular channel has dimensions of $H = 40$ mm, $W = 200$ mm, and $L = 1000$ mm as depicted in Figure IV.2 (a). The inlet temperature of the hot and cold air is 500 and 20 °C, the channel is exposed to outside heat convection coefficient of 20 W/(m²K).

The six studied configurations are presented in Figure IV.2 as follows: Configuration 0, which is the reference case, consists of two rectangular channels with no TEGs or VGs which is referred to as an empty case as depicted in Figure IV.2 (a).

To enhance heat transfer, five rows of Vortex Generators (VGs) are employed in both channels, thus configuration 1 (noted C1) consists of two rectangular channels with five rows of VGs in each

channel. The VGs are Delta Winglet placed as displayed in Figure IV.2 (b). To clarify the design Figure IV.2 (c) shows in detail the emplacement of VGs along the channels and Table IV.1 shows the dimensions of the design and the VGs.

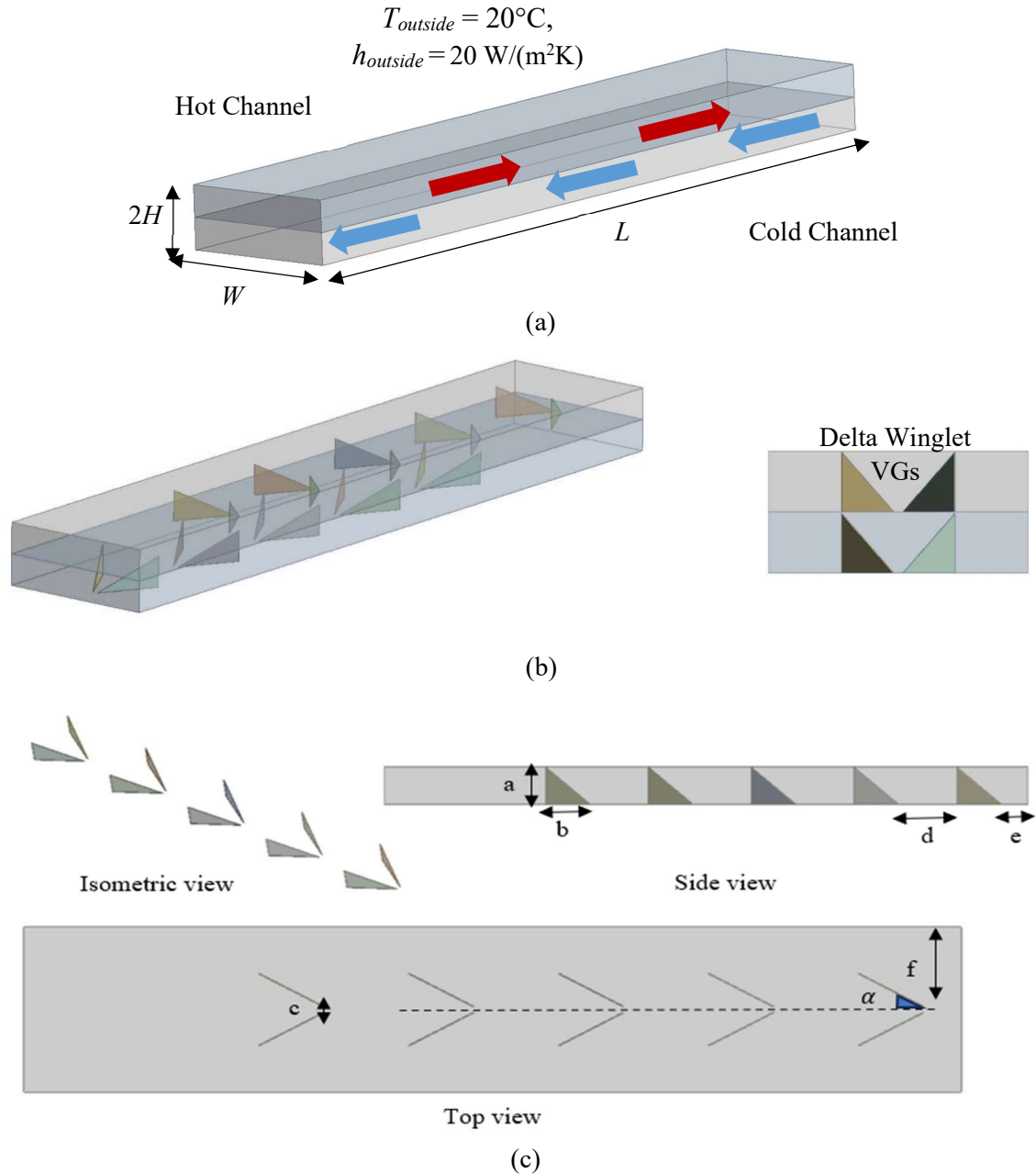

Figure IV.2: Parameters of the studied design (a) Configuration 0 (noted C0), No VGs no TEGs (reference case), (b) Configuration 1 (noted C1), side and front views, five rows of Delta winglet VGs in each channel, no TEGs, and (c) the dimensions of the design and implementation of the VGs.

Table IV.1: Dimensions of the system

| Channels | Mm | Placement of VGs | Mm |
|----------------------------|-----------|--|----------------|
| <i>L</i> length | 1000 | <i>c</i> the distance between the heads of VGs | 8 |
| <i>W</i> Width | 2000 | <i>d</i> the distance between the rows of VGs | 210 |
| <i>H</i> height | 40 | <i>e</i> the distance of the first VG from the entrance | 40 |
| VGs | | <i>f</i> the distance from the side wall to the head of VG | 96 |
| <i>A</i> Dimensions of VGs | 39 | Angles | Degrees |
| <i>B</i> | 80 | <i>α</i> the angle of rotation of VG to the x-axis | 30° |

To create a hybrid heat recovery system, thermoelectric generators (TEGs) are integrated into the design, where the hot surface absorbs heat, while the cold surface is maintained at a lower temperature through cooling. This temperature difference between the hot and cold surfaces triggers the Seebeck effect, enabling the direct conversion of heat into electricity. The thermophysical properties of the TEGs used in this study are presented in Table IV.2. This study uses TEGs all over the channels with each TEG is of 40 x 40 mm, the surface area of TEGs depends on the design as will be mentioned in each configuration. In each TEG, there exist 127 N and P legs each has a width and length of 1.4 and 1.6 mm respectively.

To maximize the output power, it is assumed that the internal and load resistance are equal, where the maximum power is in function of the electric resistance as shown in the following equations:

$$\text{Maximum power} = \frac{S^2 \Delta T^2}{4 R^2} \quad \text{Eq IV.1}$$

where R is the internal resistance and external resistance that is equivalent to 0.0236 Ω , S is the Seebeck coefficient, ΔT is the delta temperature between the hot and cold sides.

Table IV.2: Properties of the adopted TEGs and air characteristics

| Parameters | Unit | Value |
|---|--------------------------------------|------------------------------|
| Parameters of TEGs | | |
| Seebeck coefficient (<i>S</i>) | P-type | V.K ⁻¹ |
| | N-type | V.K ⁻¹ |
| Length of P and N legs (<i>l</i>) | Mm | $l_N = l_P = 1.6$ |
| Width of P and N legs (<i>w</i>) | Mm | $w_N = w_P = 1.4$ |
| Thermal conductivity (<i>k</i>) | W. m ⁻¹ .K ⁻¹ | $k_N = k_P = 1.52$ |
| Electric resistivity (<i>ρ</i>) | Ω.m | $\rho_N = \rho_P = 1.45E-04$ |
| Parameters of the air | | |
| Density | kg.m ³ | 1.225 |
| Specific heat at constant pressure | J. kg ⁻¹ .K ⁻¹ | 1006.43 |
| Thermal conductivity | W. m ⁻¹ .K ⁻¹ | 0.0242 |
| Viscosity | kg. m ⁻¹ .s ⁻¹ | 0.000017894 |

The computational model employed in this research is presented in Figure IV.3, featuring a hot air flow channel, a cold air flow channel, and the TEG. The TEG is positioned in various configurations, and each TEG is applied to specific conditions. The cold side is exposed to the surroundings and applied to a constant temperature of 20 °C and heat convection of 20 W/(mK) respectively as illustrated in Figure IV.3, however the hot side is exposed to the hot flow or cold flow of the channel both having variable heat convection coefficient and temperature that is higher than 20 °C. These values are depending on the flow and determined by the simulation:

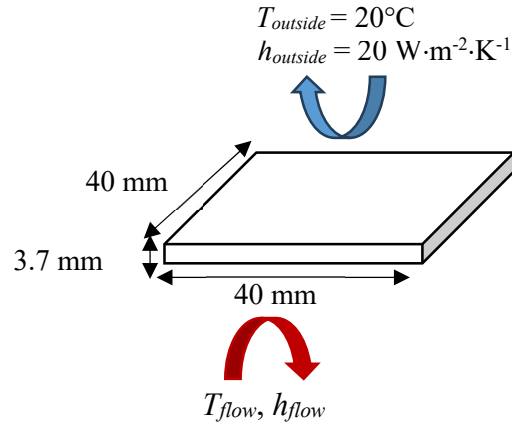

Figure IV.3: TEG boundary conditions in configurations 2, 3, 4, and 5.

Configuration 2 (noted C2) consists of two rectangular channels with seven TEGs, one TEG located in the middle between the two channels and six TEGs located at all the walls of the two rectangular channels as illustrated in Figure IV.4 (a). The surface area of the TEGs is 760000 mm², which is equivalent to 475 TEGs.

Configuration 3 (noted C3) consists of two rectangular channels with six TEGs located at all the walls of the channels as shown in Figure IV.4 (b). The surface area of the TEGs is 560000 mm², which is equivalent to 350 TEGs.

Configuration 4 (noted C4) is based on configuration 2 in addition to the presence of five rows of VGs as depicted in Figure IV.4 (c). The surface area of the TEGs is 760000 mm², which is equivalent to 475 TEGs.

Configuration 5 (noted C5) is based on configuration 3 in addition to the presence of five rows of VGs as illustrated in Figure IV.4 (d). The surface area of the TEGs is 560000 mm², which is equivalent to 350 TEGs.

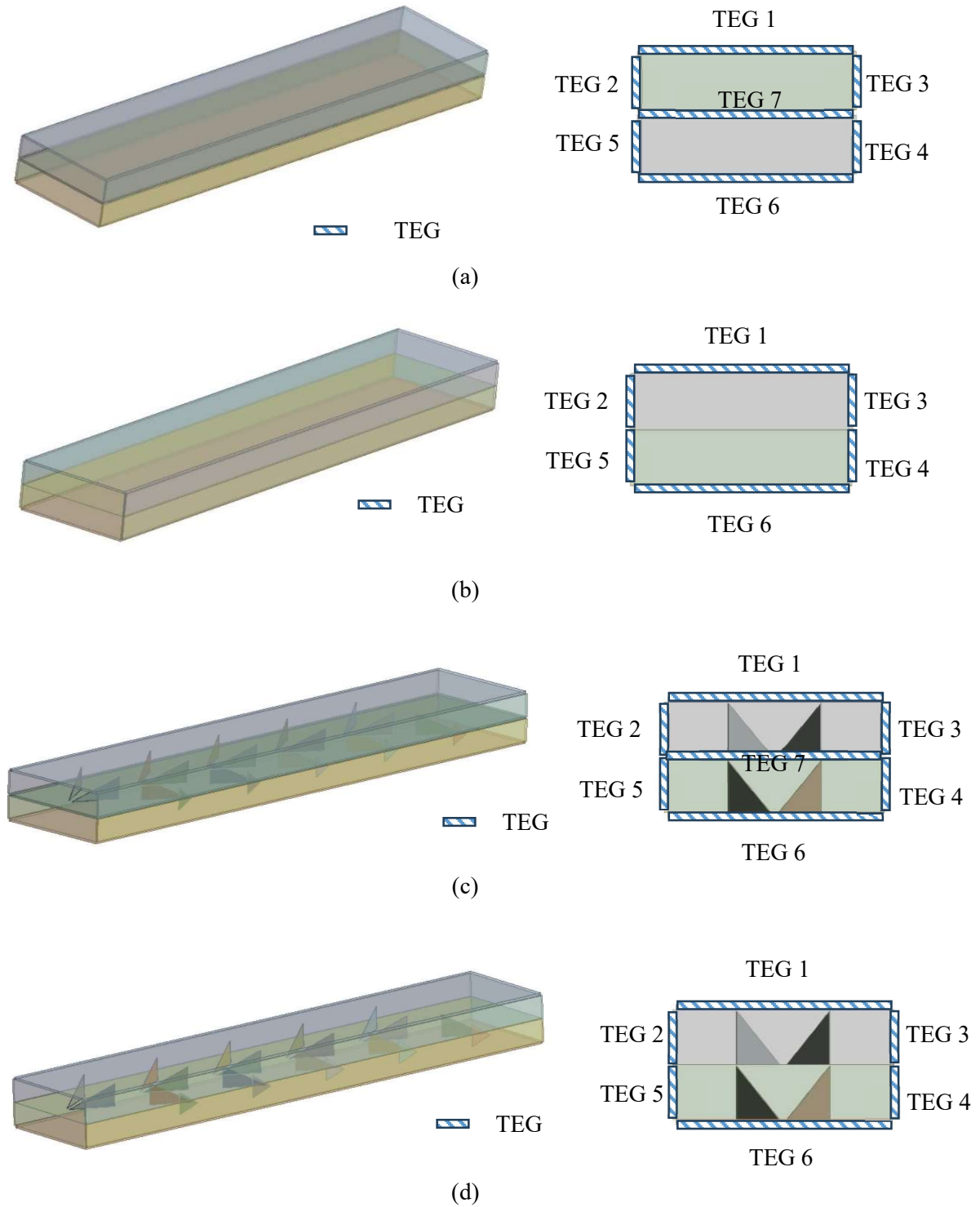

Figure IV.4: Parameters of the studied design (a) configuration 2 (noted C2), side and front views, seven TEGs placed in the design, no VGs, (b) configuration 3 (noted C3), side and front views, six TEGs placed in the design, no VGs, (c) configuration 4 (noted C4), side and front views, seven TEGs placed in the design, with five rows of VGs, and (d) configuration 5 (noted C5), side and front views, six TEGs placed in the design, with five rows of VGs.

The numerical simulations are conducted using Ansys Fluent software, with different configurations being analyzed. The Reynolds number of the hot and cold flows varied across a range of five values: 1000, 2000, 4000, 7000, and 10000. This variation in Reynolds number affected other input variables such as mass flow rate, heat capacity, and heat transfer. Consequently, each Reynolds number value resulted in different output performance parameters, including the Nusselt number, overall heat transfer ratio, and required power.

To assess the improvements of each case compared to the no vortex generator (VG) reference case, and to facilitate a comparison among the five cases, these performance parameters were normalized by the performances of configuration 0. By normalizing the parameters, the study aimed to evaluate the enhancements achieved in each case relative to the reference cases, as well as to enable a comprehensive comparison among the different configurations.

IV.2.2. Governing equations

In the following study, the fluid flow is governed by the three-dimensional (3D) steady-state Reynolds-averaged Navier-Stokes (RANS) equations. These equations represent the fundamental principles of fluid motion for an incompressible Newtonian fluid and consist of the continuity equation and the momentum equations.

The continuity equation ensures that mass is conserved within the fluid flow, which is represented as follows:

$$\nabla \cdot (\rho \vec{V}) = 0 \quad \text{Eq IV.2}$$

The momentum equations describe the conservation of momentum and can be written as:

$$u_j \frac{\partial u_i}{\partial x_j} = \frac{\partial p}{\partial x_i} + \nu \frac{\partial^2 u_i}{\partial x_j \partial x_j} - \frac{\partial \overline{u'_i u'_j}}{\partial x_j} \quad \text{Eq IV.3}$$

where the term $\overline{u'_i u'_j}$ is the Reynolds stress due to the change of velocity.

Besides, the turbulent flow is considered wherever the shear-stress transport (SST) $k - \omega$ model established by Menter [349] is employed, which are stated below:

$$\rho \frac{\partial}{\partial x_i} (\omega u_i) = \frac{\partial}{\partial x_i} (\Gamma_k) \frac{\partial k}{\partial x_j} G_k - Y_k \quad \text{Eq IV.4}$$

$$\rho \frac{\partial}{\partial x_i} (\omega u_i) = \frac{\partial}{\partial x_j} (\Gamma_\omega) \frac{\partial \omega}{\partial x_j} G_\omega - Y_\omega + D_\omega \quad \text{Eq IV.5}$$

where G_k represents the generation of turbulent kinetic energy due to gradients of mean velocity. G_ω defines the generation of ω . Y_k and Y_ω denotes the dissipation of k and ω owed to turbulence

and D_ω signifies the cross-diffusion term. For the $k - \omega$ model, the effective diffusivities Γ_k and Γ_ω models are known as follows:

$$\Gamma_k = \mu + \frac{\mu_t}{\sigma_k} \quad \text{Eq IV.6}$$

$$\Gamma_\omega = \mu + \frac{\mu_t}{\sigma_\omega} \quad \text{Eq IV.7}$$

where σ_k and σ_ω denote the Prandtl numbers for k and ω respectively, and μ_t represents the turbulent viscosity.

Energy balance in a control volume is

$$\rho C_p (\vec{V} \cdot \nabla T) - k \nabla (\nabla T) = \dot{e}_g \quad \text{Eq IV.8}$$

where $\dot{e}_g = -\frac{N S^2 \Delta \bar{T}^2}{4 R^2 \forall}$ is the rate of energy production per unit volume. N is the number of couples, S is the seebeck effect (the values are specified in Table IV.2), ΔT is the temperature difference across the TEG, R is the electric resistance of the load, which is equal to the internal resistance as well, and \forall is the volume of one TEG element as described in Figure 3. The temperatures of the hot and cold flows in the channel are 500 °C and 20 °C respectively. The walls of the channels are exposed to an ambient temperature of 20 °C and a heat convection coefficient of 20 W/m²K. For the configuration with TEGs at the walls of the channel walls, heat transfer occurs between the walls and TEGs following the equation:

$$-k_{ch} \frac{dT_{channel}}{dx} = -k_{TEG} \frac{dT_{TEG}}{dx} \quad \text{Eq IV.9}$$

where k is the thermal conductivity.

Pumping power and heat transfer loss

Pumping power is the energy required to move fluid in the hot and cold channels, while heat transfer loss represents the inefficiencies in dissipating thermal energy, and heat exchange represents the thermal energy covered by the cold flow which are shown by the following equations:

$$\text{Pumping power} = \frac{\dot{m} \Delta P}{\rho} \quad \text{Eq IV.10}$$

$$q_{loss} = h A \Delta T_1 \quad \text{Eq IV.11}$$

$$q_{exchange} = \dot{m} C_p \Delta T_2 \quad \text{Eq IV.12}$$

where ΔP , \dot{m} , ρ , C_p , and h are the delta pressure, mass flowrate, density, heat specific, and heat convection coefficient of the flow, however, A is the area of the surface exposed to the outside ΔT_1 is the temperature difference across that surface which means the difference of the temperatures of the flow and the outside, and ΔT_2 is the temperature difference between the two flows across the hot and cold channels.

Net pumping power output

Net pumping power output indicates the excess power after deducting the pumping power, it is calculated as follows.

$$\text{Net pumping power output} = P_{TEG} - \frac{\text{pumping power}}{\varepsilon_{pump}} \quad \text{Eq IV.13}$$

where ε_{pump} is the efficiency of the pump used to run the flow which is taken as 50%, P_{TEG} is the power produced by the TEGs.

Thermoelectric term

The originality of this study is considering TEG as a source term or a heat sink that absorbs thermal energy using the user-defined (UDF) function in Ansys. UDF is a custom code that the user programs to enhance the standard features of Ansys, it allows users to define and implement their own customized features and behaviors within the software. In this case, the TEG is considered as a source term and is dependent on the temperature of the flow that is variable. Then a code is linked to the design to update the boundary conditions at the TEG, where the TEG is executed at every iteration. Figure IV.5 (a) provides a clear elucidation of the process.

This method is accurate as the source term is dynamically updated at each iteration of the solution procedure, so the results are obtained after reaching convergence 10^{-6} and 10^{-8} for the results of the flow equations and energy equation as illustrated in Figure IV.5 (b).

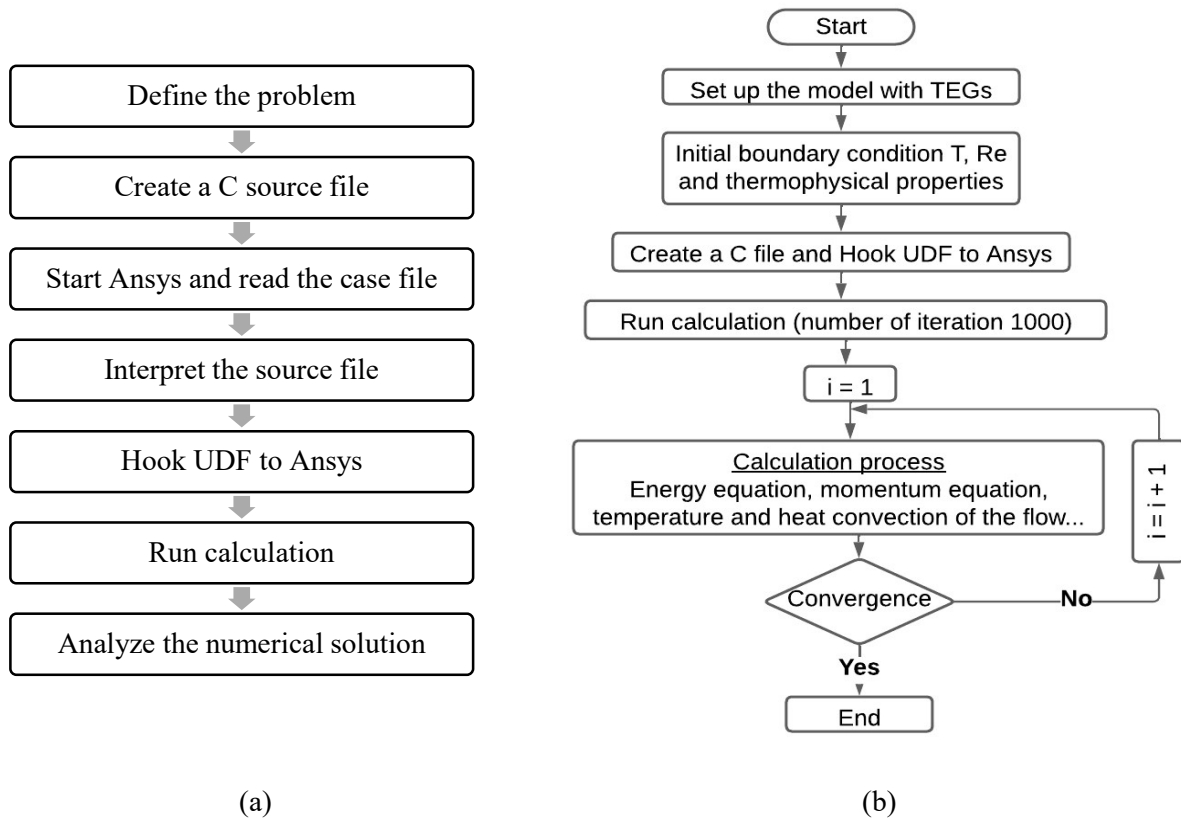

Figure IV.5: Process of (a) integrating UDF with Ansys Fluent and (b) calculating the output results until reaching convergence.

IV.2.3. Numerical validation

To validate the results obtained for the simulation of the Thermoelectric Generator (TEG), a comparative study with an analytical approach and previous work is held as presented in Table IV.3. The electrical power presented in equation 1 in each study is calculated and compared to the results obtained in two different studies.

First, an analytical approach is employed by calculating the electrical power using equations by a TEG device that undergoes specific boundary conditions. The cold side of each TEG is applied to a temperature of 30°C , however, the boundary conditions of the hot side is 150°C as shown in Figure IV.6. Second, the results of a previously published study by Chen et al. [410] are used. They investigated the power output of a TEG under the same boundary conditions, namely a hot temperature of 423 K and a cold temperature of 303 K.

Then, the three results are compared, and the values are recapitulated in Table IV.3. Upon analysis, it is observed that there exists a slight discrepancy in the electrical power obtained from the three cases with a percentage difference of less than 2% compared to Chen et al. [410] study and analytical solution. This observation provides further validation for the numerical study conducted.

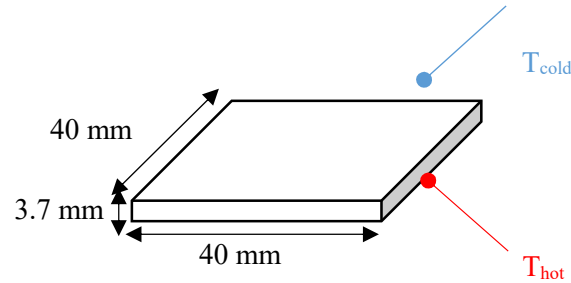

Figure IV.6: Schematics of physical configuration system with a 40 mm × 40 mm used for the numerical validation.

Table IV.3: Numerical validation with previous and analytical studies

| Study | Electrical power (W) |
|---------------------|----------------------|
| Chen et al. [410] | 3.9 |
| Analytical solution | 3.98 |
| CFD solution | 3.9805 |

IV.2.4. Mesh Sensitivity

A polyhedral cell mesh is employed for all simulations conducted in the present study. An independent investigation of the mesh is carried out at the highest Reynolds number (Re) 10000 for the inlet cold and hot flows. The mesh refinement is applied to the Thermoelectric Generators (TEGs), channel walls, and the Vortex Generators (VGs), in the configurations where TEGs exist.

During the mesh refinement process, the size of the element cells is systematically reduced until the variation in heat transfer in the hot channel, power generated by the TEGs, heat transfer loss to the outside, and pumping power to drive the flow reach a maximum deviation of 3.20%. In the near-wall regions, fifteen mesh layers are selected, and the height of the first grid point is carefully determined to ensure that the resulting y^+ value remains below 1 across all utilized meshes.

For all simulations conducted, the chosen mesh corresponds to the configuration outlined in case 3 of Table IV.4, consisting of a total of 5,497,570. The refinement ratio employed exceeds 1.1, indicating a significant increase in mesh resolution from coarser regions to finer regions.

Table IV.4: Mesh study

| Mesh | Nb of elements | q_{hot} (W) | $q_{exchange}$ (W) | P_{TEG_total} (W) | q_{loss_total} (W) | Pumping power Total (W) |
|------|----------------|---------------|--------------------|----------------------|-----------------------|-------------------------|
| 1 | 1640169 | 1858,02 | 741,658 | 7,01918 | 1111,67 | 0,256528 |
| 2 | 2634039 | 1880,04 | 753 | 7,19678 | 1122,47 | 0,259411 |
| 3 | 5497570 | 1897,56 | 771,379 | 7,36413 | 1121,38 | 0,267973 |

IV.3. Results and Discussion

The results of this study are categorized into two main parts: qualitative and quantitative results. The qualitative findings provide insights and observations based on temperature contours among the configurations, to show how heat transfer is behaving with different inputs. On the other hand, the quantitative results present the values of different parameters that evaluate the performance of each category under different mass flow rates. This dual approach provides a comprehensive understanding of heat transfer behavior.

IV.3.1. Qualitative Study

Table IV.5 (a) demonstrates the scale of the temperature at a plane centred at the middle of the rectangular channel, and Table IV.5 (b) displays the transfer of thermal energy from the hot channel to the cold one at different Reynolds numbers. The contour shows the temperature profile with the same scale in all the profiles. The temperature profile of all the contours is taken at 500 mm from the entrance and exit, i.e. at the middle of the channel in the longitudinal direction. Table IV.5 shows the contours at different Reynolds numbers of hot flow (10000, 4000, and 1000) with the highest and minimum Reynolds numbers of cold flow (10000 and 1000).

Table IV.5: Temperature contour of configurations 4 and 5 and temperature scale.

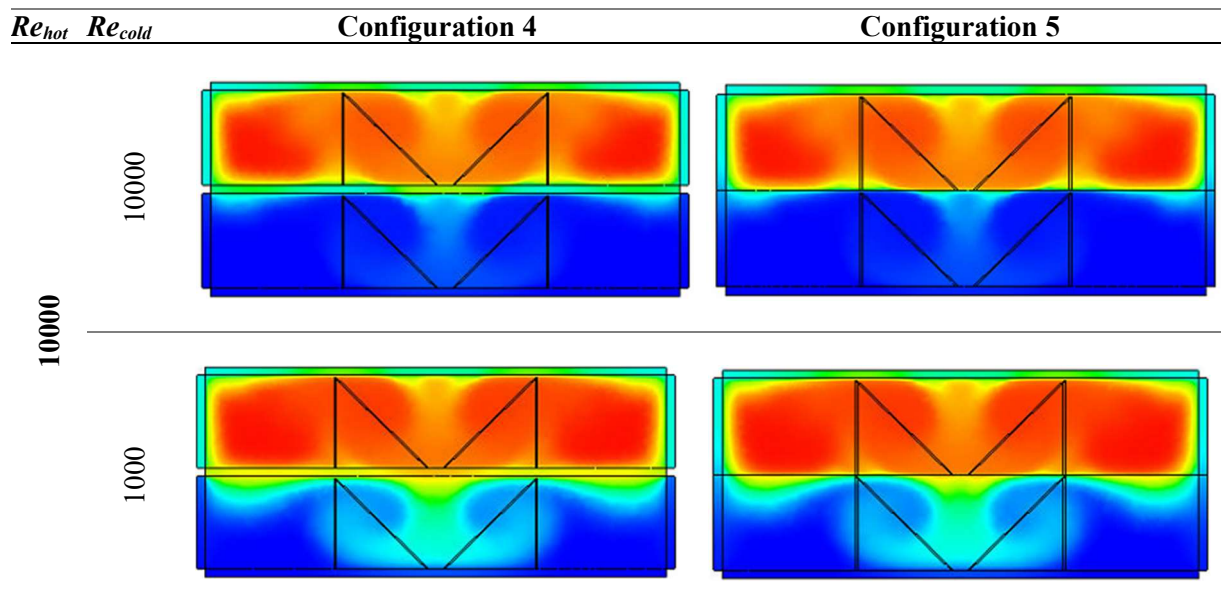

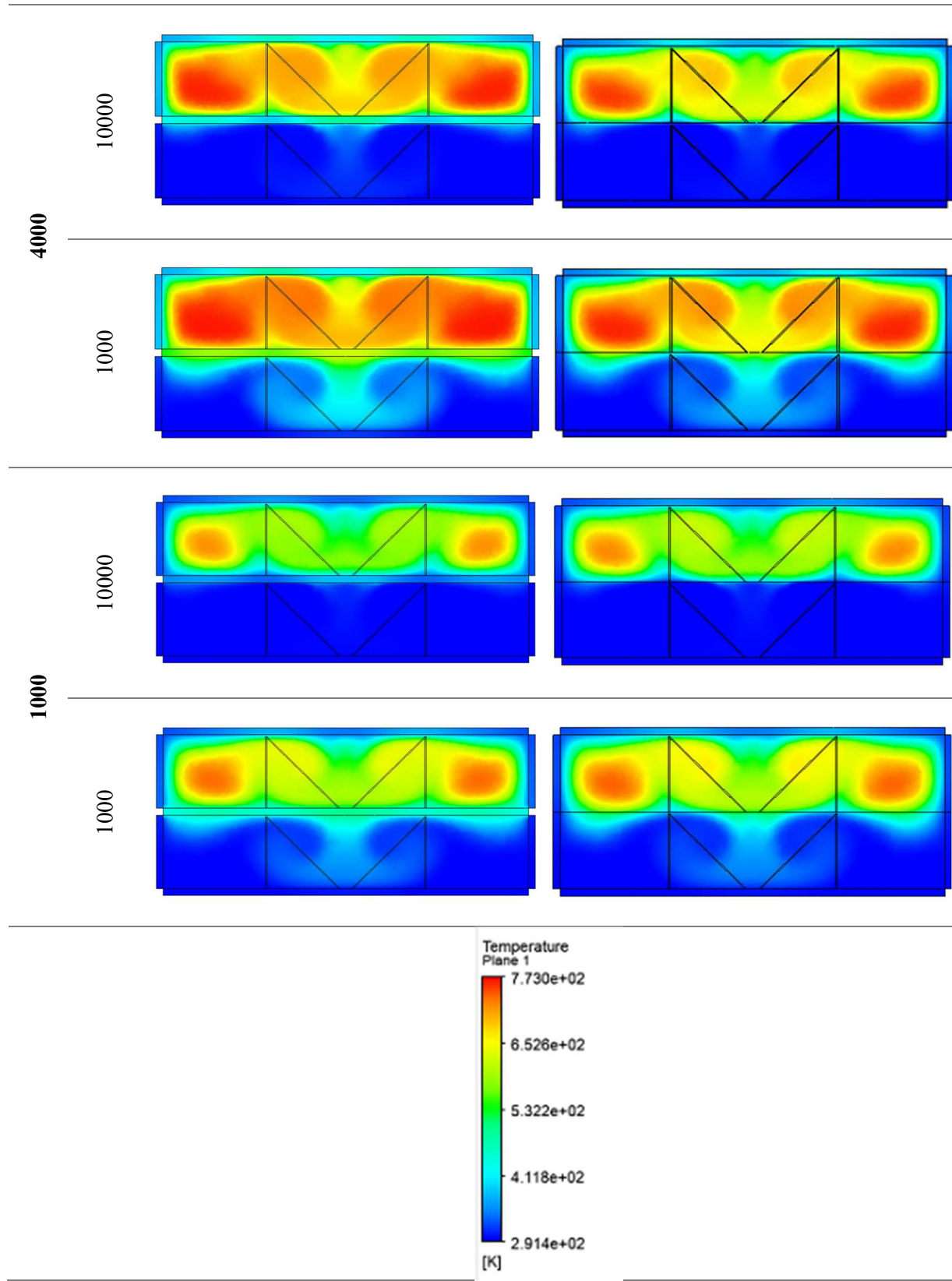

According to the obtained results presented in Table IV.5, the main conclusions could be drawn as presented below:

- 1- The heat transfer in both configurations is almost the same, however, there exist some differences in the variation of the Reynolds number.
- 2- In both configurations, at laminar Re_{cold} , the gradient temperature between the two flows is low. However, at turbulent Re_{cold} , the gradient temperature is high. This can be seen because the blue colour is more uniform in the case of Re_{cold} high than for Re_{cold} low, which means a lower temperature of the cold channel and then a higher temperature difference between cold and hot channels when Re_{cold} is 10000. This difference can be attributed to the lower velocity of the cold flow, which allows the temperature to undergo a greater variation compared to the case of higher velocities. This justifies the higher temperature of the hot flow when the cold flow is laminar, where it is noticed from Table 5 that at laminar cold flow, the hot flow has a high temperature. However, at turbulent cold flow, the hot flow has a lower temperature. These findings indicate that turbulent cold flow conditions involve enhancements in heat transfer.
- 3- At elevated Reynolds number values of the hot flow, it is observed that C5 exhibits superior heat transfer compared to C4, as evidenced by the lower temperature of the hot flow. This enhanced heat transfer in C5 can be attributed to two primary factors. Firstly, C5 lacks a TEG between the hot and cold channels, thereby facilitating heat transfer without the presence of thermal resistance from the TEG. Secondly, the absence of the TEGs between the cold and hot channels allows the TEGs at the sides to be interconnected as noticed in configuration 5 (Table 5). This interconnection between the sides of the TEGs increases the surface area of heat exchange leading to an additive conduction heat transfer. This side of the TEGs appears to be very small, however, along the channel, it could make some difference especially since the contours show how the heat is passing through the TEGs from the hot side to the cold one.

IV.3.2. Quantitative Study

In the quantitative analysis, the performances of different configurations are evaluated based on four main parameters, presented in three sections:

- Net pumping power output, which refers to the increased heat transfer provided by VGs in relation to the pressure loss they induce,
- Heat transfer $q_{exchange}$, which means the heat exchanged between the hot flow and the cold flow, heat losses q_{losses} , which means the heat lost to the surroundings.
- Heat losses in the hot channel ($q_{losses hot}$) and heat losses in the cold channel ($q_{losses cold}$), indicate how the losses are distributed in both channels.

IV.3.2.1. Net pumping power output

The net power output parameter displays the amount of power that the TEGs might generate after deducting the pumping power into account. This parameter is studied to verify if the VGs are causing more pressure drop than gaining electrical energy as presented

in Figure IV.7. The pumping power is taken at a pump of 50% efficiency and the net power output is obtained through equation 13. Figure IV.7 shows the net pumping power output of all the configurations for different Reynolds numbers. Each graph shows the variation of the net pumping power output as a variation with the Reynolds number of the cold flow. In terms of electric power, configuration 4 has the highest electric power at $Re_{hot} = Re_{cold} = 10000$ with an electric power of 7.5 W and net electric power of 6.5 W.

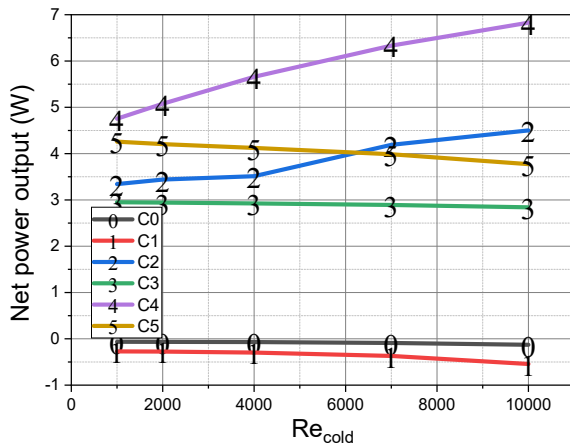

(a) $Re_{hot} = 10000$

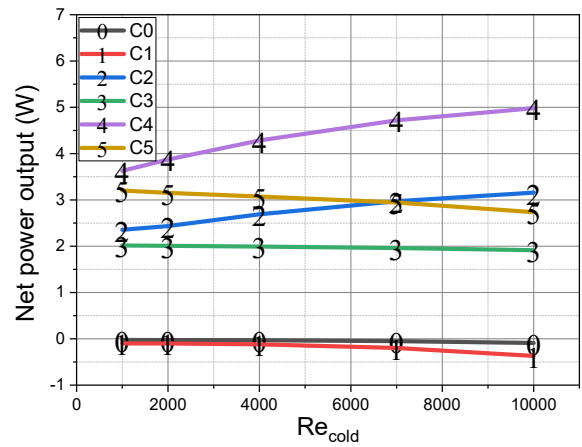

(b) $Re_{hot} = 7000$

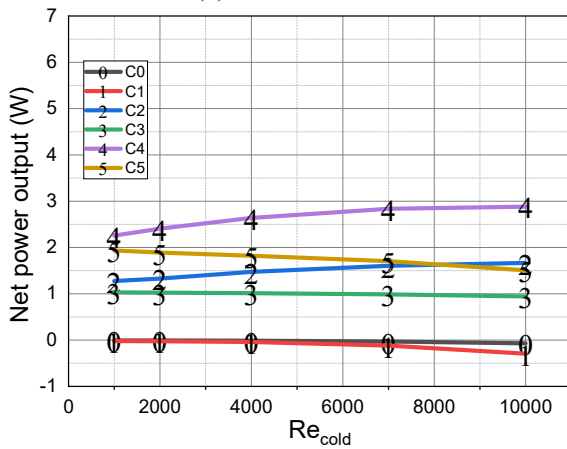

(c) $Re_{hot} = 4000$

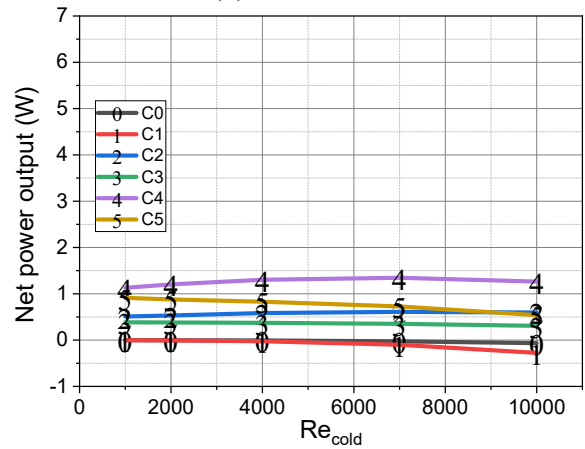

(d) $Re_{hot} = 2000$

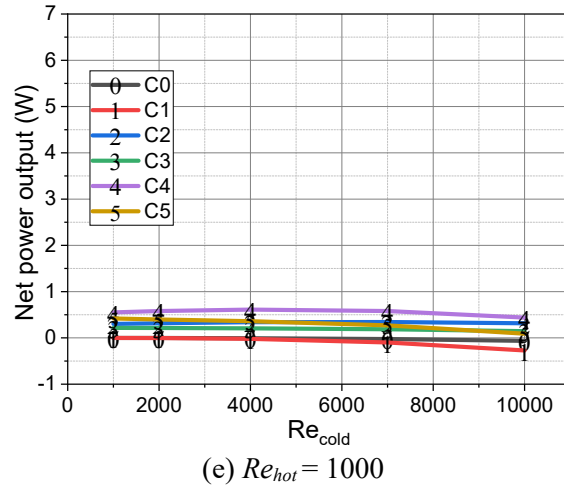

Figure IV.7: Net pumping power output for different Re_{hot} (a) 10000, (b) 7000, (c) 4000, (d) 2000, and (e) 1000.

As shown in Figure IV.7, the curves have the same scale. The net pumping power output of all configurations is observed to be highest at high Reynolds number values of the hot flow. C4 exhibits the highest net power output, surpassing C5, C2, and C3 by factors of 1.81, 1.62, and 2.40, respectively. This is attributed to C4's robust power generation capability, exceeding 7.4 W. Additionally, the electric power increases with an increase in the Reynolds number of the cold flow. Similarly, for C2, the power output increases, surpassing C5, as both configurations (C2 and C4) incorporate a thermoelectric generator (TEG) between the two channels. However, C4 outperforms C2 due to the presence of VGs within its channels, enhancing the electric power output.

Furthermore, configurations 5, 3, and 1 demonstrate contrasting behavior compared to configurations 2 and 4 at turbulent Re values of the hot flow. In the former configurations, power generation decreases with an increase in the Reynolds number of the cold flow. This can be attributed to the presence of the TEG in the middle, where higher Re values of the cold flow result in increased heat convection, subsequently leading to higher electrical power output. However, for C5, C3, and C1, the higher Reynolds number of the cold flow necessitates greater pumping power, resulting in a lower net pumping output power. This decrease occurs because the absence of a TEG in the middle and the presence of TEGs at the walls do not compensate for the increased pumping power. At laminar Reynolds number values of the hot flow, the electrical power slightly increases. However, this increase does not offset the rise in pumping power, leading to a decrease in the net pumping power output.

Moreover, it is important to note that the absence of TEGs requires additional power to pump the flow, as depicted in Figure IV.7. Configurations 0 and 1 exhibit negative values, indicating the need for an external power supply. C0 necessitates less pumping power than C1 due to the absence of VGs, which contributes to less pressure drop. C1, on the other

hand, requires up to 4.25 times more power than C0. Table IV.6 shows a summary of the net power output with the variation of Reynolds numbers in the hot and cold channels.

Table IV.6: Summary of the net power output with the variation of Reynolds number

| Re_{hot} | C0 and C1 | C2 and C4 | C3 and C5 |
|------------|--|---|--|
| Turbulent | Net power output is negative as there is no generated power to pump the flow | Net power is positive and increases with the increase of Re_{cold} , reaching 4.7 and 7.5 W for C2 and C4 respectively. | Net power is positive however decreasing with the increase of Re_{cold} , reaching 3 and 4.5 W for C3 and C5 respectively. |
| Laminar | The behaviour of the net output power is similar to the turbulent Re_{hot} however on a lower scale as the generated power is decreased. | | |

IV.3.2.2. Heat exchange ($q_{exchange}$) and heat losses (q_{losses})

The variation of the heat transfer from the hot channel to the cold channel depends on the Reynolds number. Heat transfer is classified into (1) heat losses, which is the heat transferred to the outside, and (2) heat exchange, which is the heat transferred from the hot flow to the cold flow. Figure IV.8 shows the variation of heat losses in the cold and hot channels to the variation of Re_{cold} and Re_{hot} .

At high Re_{hot} (10000, and 7000), it can be observed from Figure IV.8 that configuration 5 exhibits the highest energy capture. This is primarily because configuration 5 lacks the presence of a TEG between the two channels, leading to reduced thermal resistance between the hot and cold flows. On the contrary, configuration 4 experiences lower heat transfer at higher Re_{hot} due to the TEG's presence in the middle, limiting the heat exchange between the channels and resulting in a lower $q_{exchange}$.

However, at lower Re_{hot} (2000, and 1000) and high Re_{cold} , configuration 4 demonstrates the highest heat transfer, surpassing configuration 5 by more than 10 W. This difference can be attributed to the significant losses in configuration 5, which the $q_{exchange}$ fails to compensate for, making it lower than configuration 4.

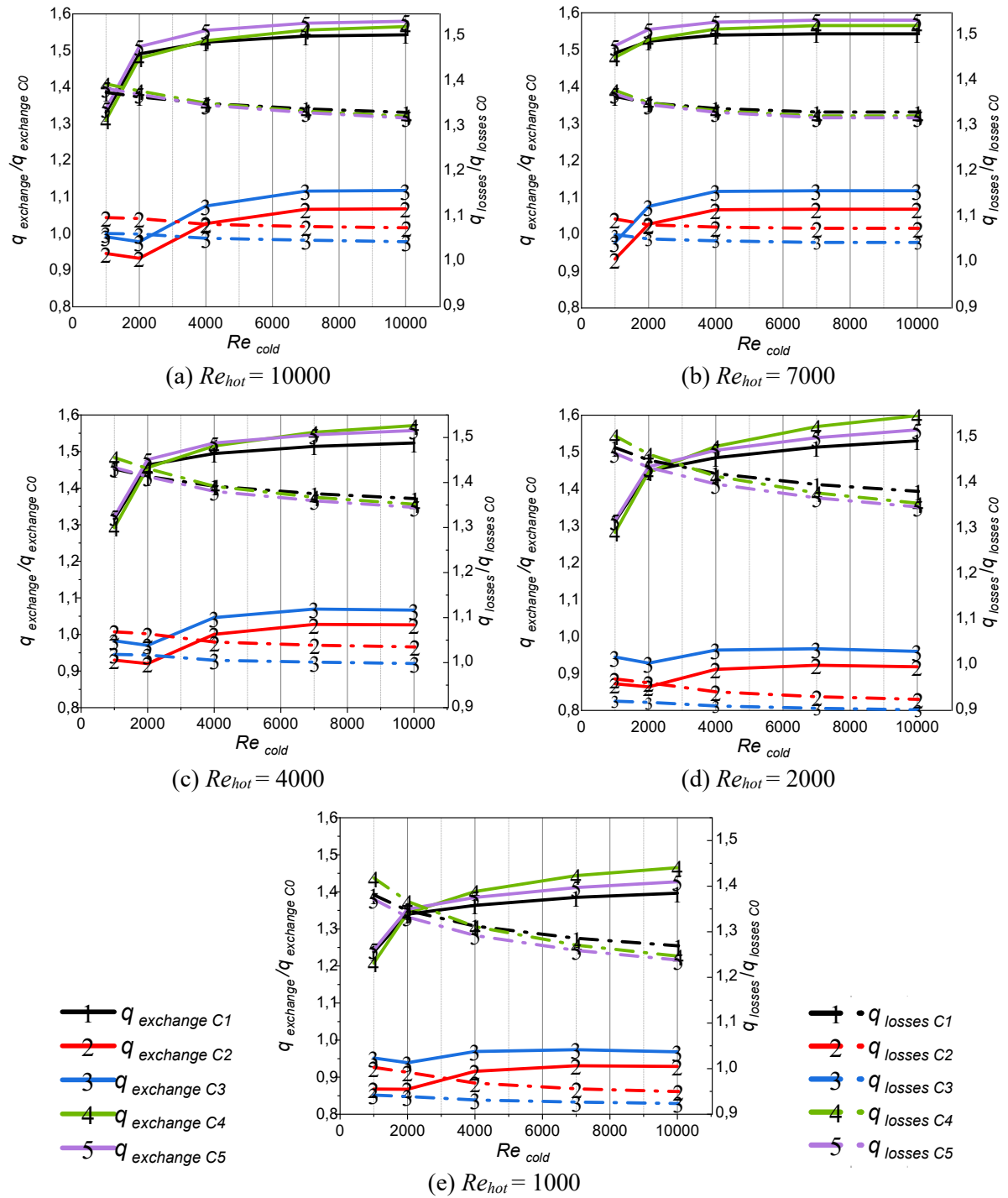

Figure IV.8: Heat transfer and losses normalized by configuration 0 for different Re_{hot} (a) 10000, (b) 7000, (c) 4000, (d) 2000, and (e) 1000.

In other words, at turbulent Re_{hot} , C5 has the highest heat transfer, however, at laminar Re_{hot} , C4 has higher heat transfer than C5. This is due to higher heat losses in configuration 5, which the $q_{exchange}$ can no longer compensate for.

Furthermore, at low Re_{hot} and high Re_{cold} conditions, the flow in the cold channel takes precedence over the hot flow. This leads to a situation where the U value between the two flows and the U value between the cold channel and the outside environment are almost equal. As a result, the losses for configuration 5 (C5) are higher at low Re_{hot} compared to the losses at high Re_{hot} . This observation is supported in the subsequent section, where it is evident that in configuration 5, the temperature range in the hot channel remains relatively low, while the temperature range in the cold channel becomes significantly higher. In other words, at a laminar Re_{hot} and turbulent Re_{cold} , heat is transferred to the cold side with low velocity in the hot flow. This causes a reduction in heat convection, resulting in an increased temperature gradient between the flow and the surrounding ambient temperature.

As a consequence, it becomes easier for the heat to escape to the outside environment rather than flow through the cold channel, mainly because the outside temperature is maintained at 20°C, whereas the cold channel temperature is higher than 20°C.

On the contrary, configurations incorporating VGs such as C1, C4, and C5 exhibit the highest losses, mainly because of the VGs' presence. Conversely, C2 and C3 experience the lowest losses. When comparing C2 and C3, it becomes apparent that C2 consistently demonstrates higher losses than C3. This can be attributed to the TEG's presence in the middle of C2, which reduces the heat transfer between the flows, resulting in a higher temperature within the hot channel. Consequently, a greater difference arises between the ambient temperature and the temperature inside the channel, leading to an augmentation in heat losses.

Besides, it is noteworthy that the inclusion of TEGs leads to a reduction in q_{losses} across all cases. Configurations 4 and 5, which incorporate TEGs, demonstrate lower losses compared to configuration 1, which lacks TEGs. Specifically, configuration 5 exhibits even lower heat losses than configurations 4 and 1, providing evidence that the presence of TEGs effectively reduces heat losses.

On the other hand, configurations C2 and C3 stand out for their exceptionally low losses and heat exchange. This is attributed to the absence of vortex generators (VGs) in these configurations, which results in reduced heat transfer and, consequently, minimized losses.

Figure IV.9 illustrates the sequence of enhancements for the configurations across various Reynolds numbers (Re). Notably, no single configuration exhibits the greatest improvement across all conditions; however, this trend is influenced by the variation in the Reynolds number. Noteworthy is the presence of an inflection point at $Re = 4000$, which represents the initial threshold of the turbulent regime. At this critical point, there is a prominent transformation, primarily observed in configurations C4 and C5, where they transition from being associated with the highest improvements to assuming a lower position in the improvement ranking.

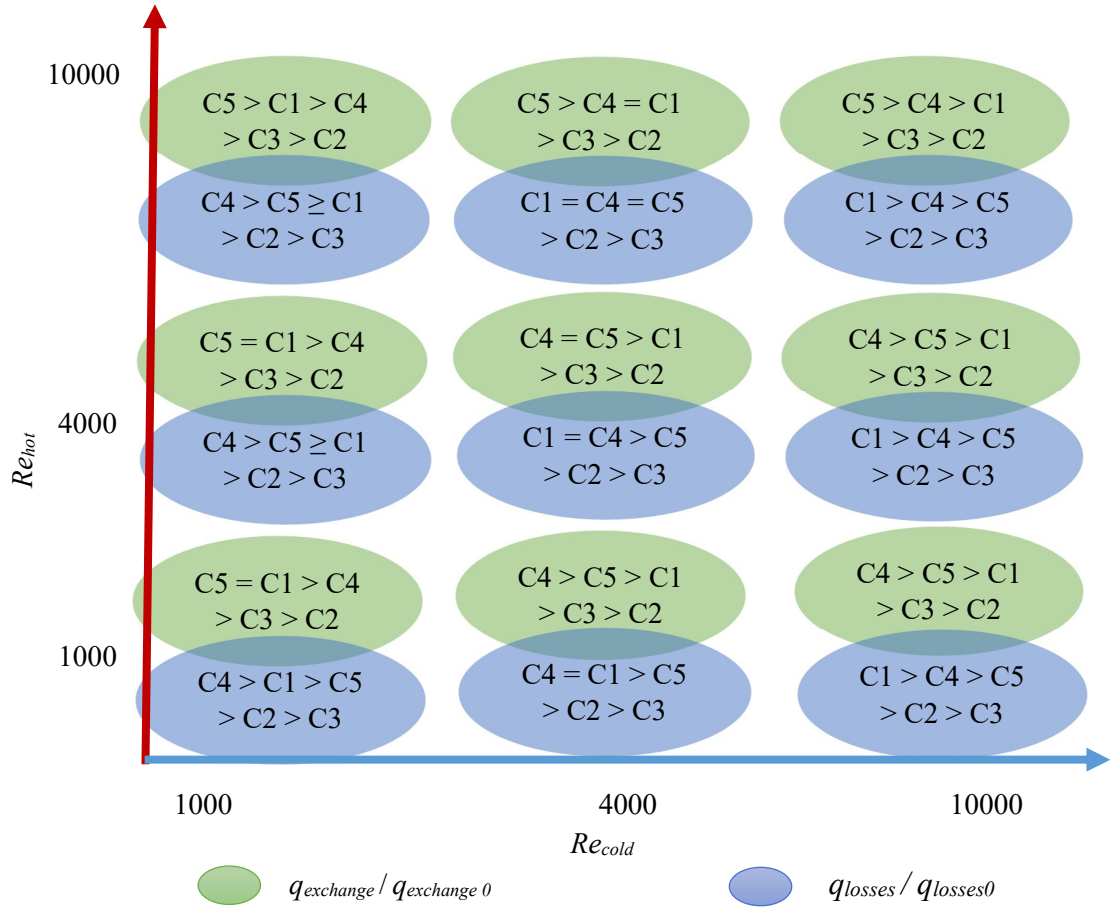

Figure IV.9: Summary the order of configurations with the variation of Reynolds numbers

IV.3.2.3. Heat losses cold ($q_{losses\ cold}$) and heat losses hot ($q_{losses\ hot}$)

In the previous section, total heat losses are studied with the heat exchange from the cold channel to the hot one, where it shows that the presence of TEGs lower the total heat losses. In this section, to understand the behavior of the heat transfer in each configuration, the heat losses on the cold and hot sides are studied separately, which are also normalized by configuration 0. Figure IV.10 presents the evolution of heat losses as a function of different Reynolds numbers. As noticed, C5 has the highest heat losses in the cold channel, this could be attributed to the reason of having the highest heat transfer occurred, resulting in high temperature in cold flow and thus more heat loss. However, the losses in the hot flow are the highest at C1, C4, then C5: this could be due to the higher temperature in hot flow for C1 than C4 thus higher heat losses in the hot side.

Heat losses are high due to two main reasons: (1) the thickness of the TEG is very small, which leads to create low thermal resistance, (2) the temperature gradient across the hot channel and surrounding temperature is higher than the gradient temperature between the

hot and cold channels, so it is easier for the heat to be transferred to the lower temperature which is surrounding than towards the higher temperature which is the cold channel.

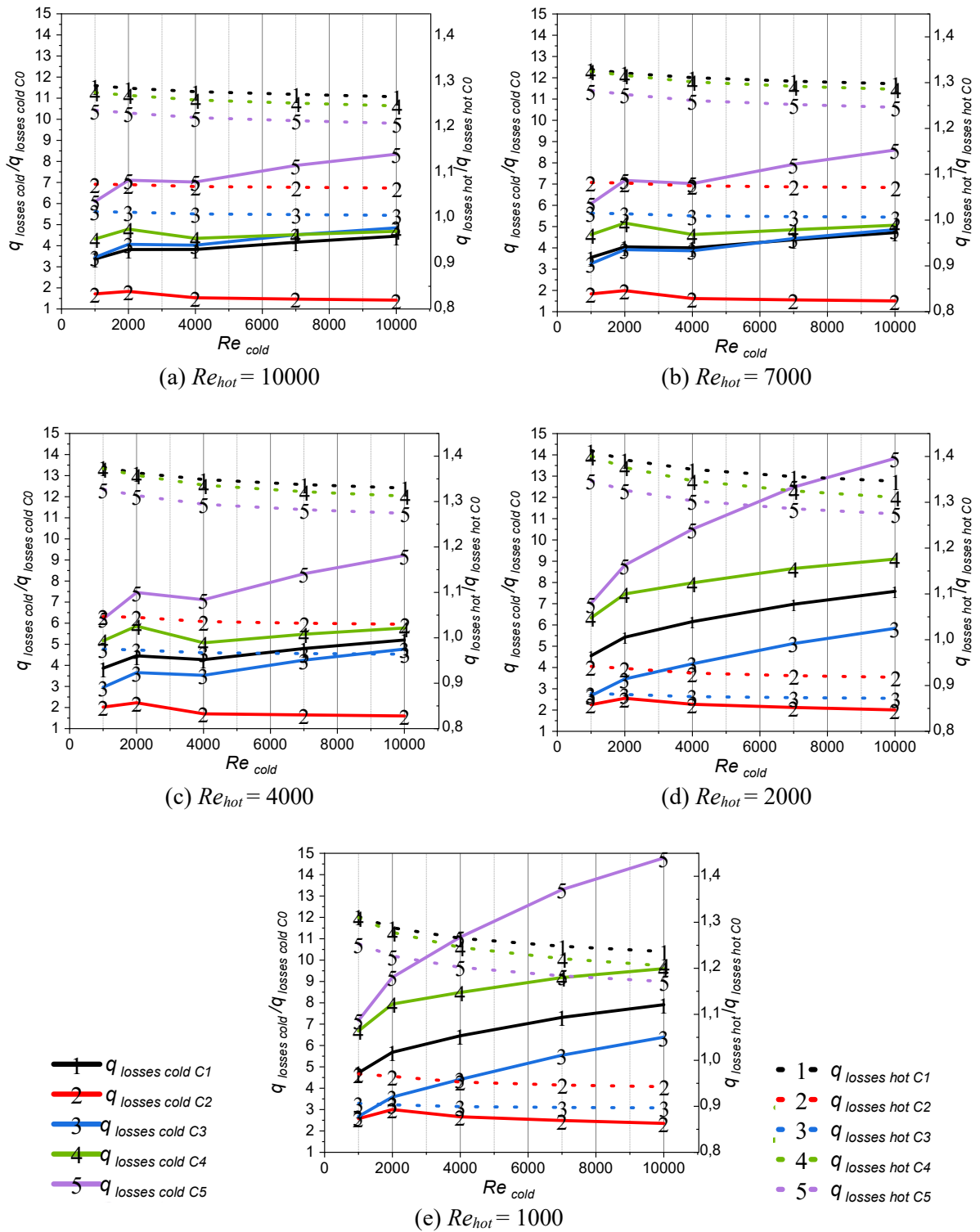

Figure IV.10: Heat losses normalized by configuration 0 for different Re_{hot} (a) 10000, (b) 7000, (c) 4000, (d) 2000, and (e) 1000.

Moreover, it is noticed that when the Reynolds number of the hot flow increases, the rate of heat losses in the cold flow increases. Although the graphs in Figure IV.10 show that the normalization of q_{losses} in the cold flow is very high, however, the value of the $q_{losses\ cold}$ are very low, since the maximum value reaches 17.97 W at Reynolds number 10000 of hot and cold channel in configuration 0. On the other side, the highest value of q_{losses} in the hot channel reaches 1122 W. Table IV.7 shows a summary of the heat losses in turbulent and laminar regions.

Table IV.7: Summary of the heat losses in both channels cold

| | | Laminar | Turbulent |
|-------------|---|---------|-----------|
| Re_{cold} | | | |
| Re_{hot} | | | |
| Laminar | C5 has the highest losses in the cold channel. On the other side, C1 then C4 have the highest heat losses in the hot channel. The cases with no VGs (C2 and C3) have the lowest heat losses due to the absence of VGs | | |
| Turbulent | | | |

IV.4. Conclusions and recommendations

In this study, the focus is on investigating a hybrid heat recovery system. A total of six distinct configurations are analyzed, involving the manipulation of the Thermoelectric Generator (TEG) location and the inclusion of vortex generators (VGs) within the channels to enhance heat transfer.

The first two configurations served as reference cases. Configuration 0, referred to as the "empty case", had no VGs nor TEGs. Configuration 1 incorporated VGs but did not include TEGs. Configuration 2 featured TEGs positioned between the channels, while configuration 3 had TEGs located above and below the hot and cold channels. The last two configurations C4 and C5 mirrored configurations 2 and 3, respectively, but with the addition of VGs. The objective of these configurations is to assess the combined impact of both the TEG and VGs on the heat transfer performance of the system. The conclusion of all the configurations is highlighted as follows:

- Higher Reynolds numbers in both channels increase heat transfer and heat losses.
- Integrating VGs increased both heat losses and transfer, in all configurations.
- The presence of TEGs decreased the heat losses by up to 2%. Although the percentage is small and it was expected to have a higher recovery, however the high-temperature difference and the low thickness of the TEGs did not help in decreasing the thermal losses.
- It is concluded as well that there is no specific better configuration since it depends on the application or usage. For instance, configuration 5 is better than C4 in terms of heat transfer, however, configuration 4 is better in terms of electrical generation.
- Besides, it is concluded that at low Re_{hot} , the enhancement of heat transfer of configuration 4 is better than that of configuration 5 due to the higher thermal losses of C5.

In conclusion, configurations 4 and 5 showed interesting results in general and this study opens the gates to more research especially coupling the heat recovery with TEGs, as TEGs are being studied recently to enhance their material properties and obtain better outcomes.

Recommendations

This study has yielded several noteworthy findings that hold significant potential for further research and exploration, several recommendations for new research ideas can be put forth:

- Carry out a study on adding two cold channels above and below the hot channel, insulating the sidewalls, and integrating TEGs between the hot and cold channels. This study could result in higher heat recovery and lower thermal losses.
- Integrate TEG inside a concentric tube heat exchanger with the interface annular tube being the TEG, where the hot flow passes inside the tube and cold flow passes in the annular.

Chapter V. Conclusions and Perspectives

V.1. Conclusions

In this thesis, a comprehensive literature review on heat recovery, hybrid heat recovery, and thermoelectric generators is conducted. The findings underscore the importance of heat recovery in virtually all energy-reliant applications. Depending on the application, various types of heat recovery techniques are employed. The Concentric Tube Heat Exchanger (CTHE) is among the most widely utilized heat recovery systems, owing to its numerous advantages such as a straightforward design, easy integration into diverse applications, minimal maintenance due to the lack of moving parts, noiseless operation, and most importantly, high efficiency. Furthermore, the literature review reveals that Vortex Generators (VGs) play a crucial role in enhancing heat transfer, highlighting the need to not only integrate a heat recovery system but also to maximize the capture of lost energy.

Based on these conclusions, a numerical study of a CTHE heat recovery system featuring VGs positioned in various locations is conducted to identify the optimal placement of VGs concerning heat transfer, overall heat transfer, and thermal enhancement factor. The results demonstrate that incorporating VGs in all three locations improves the heat recovery system's performance; however, an optimal design yields the highest performance. A thorough analytical examination of the three designs is conducted, with justifications for the obtained results presented in Chapter II. The results show that case 1 has the highest improvement with up to 2.1 times case 0, then case 2 with 1.8 and case 3 with 1.4 times more than case 0.

Having established the effectiveness of the proposed design, it is applied to a drain water heat recovery system to evaluate the design's sustainability. A sustainable system must meet economic, environmental, and social impact criteria, implying that the design should be affordable or possess a reasonable payback period, be environmentally friendly, and not harm society. These three aspects are examined in detail in Chapters III.1 and III.2, considering various types of heat sources, including four non-renewable and five renewable sources. The sustainability of the design is assessed for each energy source, considering the potential savings in terms of energy, economy, environment, and societal impact. In the multi-drain application studies, case 2 (VGs inside the annular) was executed instead of case 1 (VGs inside the tube) as the presence of VGs inside the tube with the water leaving the drain caused fouling problems more than case 2.

The results demonstrate that heat recovery systems (HRSs) are highly effective for all types of energy sources, yielding significant savings in economic, environmental, and social impacts. In non-renewable energy applications, HRSs reduce energy consumption by over 30 % daily, translating to annual cost savings of 2752 \$, 3150 \$, 1691 \$, and 6434 \$ for gas, diesel, coal, and electricity, respectively. In terms of environmental savings, annual savings are 417 €, 637 €, 1774 €, and 5500 € for gas, diesel, coal, and electricity-based fossil fuels, respectively.

Regarding renewable energy sources, the percentage of energy saved remains consistent, as the design does not change, resulting in daily energy savings of up to 35 %. The equivalent economic and environmental impacts differ; economically, the HRS saves up to 1322 \$, 909 \$, 1844 \$, 1322 \$, and 2446 \$ per year for solar, wind, biomass, hydropower, and pumped storage, respectively. These savings are significant when considering the lifespan of renewable energy systems, which can exceed 20 years. In terms

of environmental savings, employing the HRS yields annual savings of 286 €, 124 €, 52 €, 10 €, and 495 € for solar, wind, biomass, hydropower, and pumped storage, respectively. Although these savings may seem modest or even negligible, such as in the case of hydropower, it should be noted that this is due to the low environmental impact of renewable energy sources. The environmental savings provided by the HRS account for approximately 25 % of the total annual environmental impact.

Regarding the social impact, fossil fuels have significant consequences on society. Pollution emissions contribute to an unhealthy environment, leading to increased diseases and a diminished quality of life. Moreover, the extraction of fossil fuels through mining poses additional harm to society. Although it offers job opportunities, the work environment is often hazardous for workers, leading to the employment of low-cost labor in developing countries. Child labor in mining is a particularly pressing issue that negatively affects society. The low educational requirements and lack of laws preventing children from engaging in strenuous labor discourage children from attending school and pursuing better opportunities.

In comparison, the social impact of renewable energy sources is less severe. The environmental impact of renewables is substantially lower, posing fewer threats to a healthy environment compared to fossil fuel emissions. However, pollution generated by renewables should not be overlooked in the context of global lifetimes. Reducing energy consumption ultimately leads to a lower impact and improved environment. Employment in the renewable energy sector typically requires a moderate level of education and is less physically demanding than fossil fuel-related jobs. Consequently, the proposed design is considered successful in terms of economic, environmental, and social impacts for both renewable and nonrenewable energy sources.

Lastly, a fundamental investigation of two rectangular channels to transfer heat from the hot channel to the cold one was held. Various configurations were examined, incorporating vortex generators (VGs) and thermoelectric generators (TEGs) at different locations, to assess the impact of their presence on heat losses and power generation.

The findings reveal that the incorporation of VGs leads to an increase in heat losses; however, they also contribute to higher power generation and enhanced heat transfer. Conversely, the presence of TEGs reduces heat losses in both channels. The results demonstrate that the performance of heat transfer is notably influenced by the Reynolds number conditions. Moreover, the TEGs demonstrated the potential to provide up to 7.5 W, with a net power output surpassing 7 W.

It is worth noting that the observed heat losses were notably high, largely due to the absence of insulation and the significant temperature difference. Therefore, it is strongly recommended to make several design amendments aimed at reducing heat losses, which, in turn, will boost both heat transfer efficiency and power production. These design suggestions are presented in the recommendation section. By implementing these improvements, the overall performance of the system can be significantly enhanced, making it more practical and efficient for practical applications.

V.2. Perspectives

As the studied system demonstrates promising results in various aspects, it is worthwhile to explore further works on this topic. Several recommendations, categorized into different areas, are outlined below:

Design

The design can significantly impact the performance of heat recovery systems. Therefore, additional studies should focus on design aspects, including:

- Numerical parametric studies of two alternative designs, where the tube is replaced by a flexible TEG with VGs in both the annular and tube sections.
- Numerical parametric study of a simple geometry using TEGs as insulation on the outer wall of a channel or heat exchanger to assess the potential for replacing conventional insulation.
- Numerical parametric study of a concentric tube heat exchanger with materials matching those of commercially available TEGs to identify locations with maximum temperature gradients.
- A final numerical comparative study of various configurations based on the conclusions from the fundamental study presented in this thesis, including Chapter IV.
- A further study involved a configuration with a hot rectangular channel situated between two cold rectangular channels. This arrangement will facilitate the transfer of heat losses to the adjacent cold channels rather than dissipating them to the external surroundings. This study will be a complimentary study to the last chapter IV.

Enhancement Tools

Additional enhancement methods beyond design and boundary conditions include:

- Coupling the system with Machine Learning (ML) to detect the failure that could happen in the system especially the design where the VGs are presented inside the channel.
- Conducting an experimental study on the heat recovery design using Digital Twin (DT) technology to enhance system performance.
- In the multi-drain application studies, case 2 (VGs inside the annular) was executed instead of case 1 (VGs inside the tube) as the presence of VGs causes problems. However, when coupling the design with ML or DT, case 1 can be used as the fouling and scaling problems can be predicted and resolved, thus preserving high performance.

Other Applications

Examining the impact of HRS in different domains is crucial. The following recommendations suggest alternative applications with the potential for significant thermal energy recovery:

- Cooling electronic devices, where considerable thermal losses occur, and temperatures can reach 70 °C or even more.
- Recovering thermal energy from the water used to cool nuclear plants.
- Implementing HRS in underground solar power plants, where ambient temperatures may reach 50 °C, depending on the size of the facility.

References

- [1] George E. Halkos, Eleni-Christina Gkampoura, "Reviewing Usage, Potentials, and Limitations of Renewable Energy Sources," *Energies*, vol. 13, no. 11, p. 2906, 2020.
- [2] Li Yang, Yunfeng Ren, Zhihua Wang, Zhouming Hang, Yunxia Luo, "Simulation and Economic Research of Circulating Cooling Water Waste Heat and Water Resource Recovery System," *Energies*, vol. 14, no. 9, p. 2496, 2021.
- [3] Yusung Lee, Woohyun Kim, "Development of an Optimal Start Control Strategy for a Variable Refrigerant Flow (VRF) System," *Energies*, vol. 14, no. 2, p. 271, 2021.
- [4] Dasheng Lee n, Chin-Chi Cheng, "Energy savings by energy management systems: A review," *Renewable and Sustainable Energy Reviews*, vol. 56, pp. 760-777, 2015.
- [5] Ian K. Smith Nikola Stosic Ahmed Kovacevic, "Applications for screw expanders," in *Power Recovery from Low Grade Heat by Means of Screw Expanders*, Elsevier, 2014, pp. 127-148.
- [6] Nixon M, Paul Stephen M, Sam Clitus S, Sharoon J, James Deepak, "Design of a Magneto-Caloric Refrigeration System using Gadolinium Metal Powder," *International Journal of Engineering Research & Technology (IJERT)*, vol. 9, no. 9, pp. 2278 - 0181, 2020.
- [7] M. Eslami, M. A. Bahrami, "Sensible and latent thermal energy storage with constructal fins," *International Journal of Hydrogen Energy*, vol. 42, no. 28, pp. 17681-17691, 2017.
- [8] Krunal R. Meshram, Prashant R. Mahale, Tushar S. Jadhav and Mandar M. Lele, "Review on Waste Heat Recovery Techniques in Air Conditioning Application," *International Journal of Current Engineering and Technology*, no. 4, 2016.
- [9] M. S. Nasif, "Effect of utilizing different permeable material in air-to-air fixed plate energy recovery heat exchanger on energy saving," *ARPJ Journal of Engineering and Applied Sciences*, vol. 10, no. 21, 2015.
- [10] Mohammad Shakir Nasifa and Rafat Al-Waked, "Seasonal Weather Conditions Effect on Energy Consumption and CO₂ Emission for Air Conditioning Systems Coupled with Enthalpy Energy Recovery Heat Exchanger," *APCBEE Procedia*, vol. 10, p. 42 – 48, 2014.
- [11] Yang Yu, Guoliang An, Liwei Wang, "Major applications of heat pipe and its advances coupled with sorption system: a review," *Frontiers in Energy*, vol. 13, p. 172–184, 2019.
- [12] Nandy Setiadi Djaya Putra, Trisno Anggoro, Adi Winarta, "Experimental Study of Heat Pipe Heat Exchanger in Hospital HVAC System for Energy Conservation," *International Journal on Advanced Science, Engineering and Information Technology*, vol. 7, no. 3, 2017.

References

- [13] London AL, Kays WM., "The liquid-coupled indirect transfer regenerator for gas turbine," *ASME Transactions*, vol. 73, p. 529–42., 1951.
- [14] A. Mardiana-Idayua, S.B. Riffat, "Review on heat recovery technologies for building applications," *Renewable and Sustainable Energy Reviews*, vol. 16, p. 1241– 1255, 2012.
- [15] Jörgen Wallin, Hatéf Madani, Joachim Claesson, "Run-around coil ventilation heat recovery system: A comparative study between different system configurations," *Applied Energy*, vol. 90, pp. 258-265, 2012.
- [16] Tao He, Chunlei Mei, Jon P. Longtin , "Thermosyphon-assisted cooling system for refrigeration applications," *international journal of refrigeration*, vol. 74, p. 165–176, 2017.
- [17] C. Daniel, "Thermoelectric applications," in *Laboratoire des Sciences de l'Ingénieur Appliquées à la Mécanique*, France, 2014.
- [18] A. B. Y. Lee, "The characteristics of heat exchangers using heat pipes or thermosyphons," *Heat Mass Transfer*, vol. 21, pp. 221-229, 1978.
- [19] Sirisawat Juengjaroennirachon, Naris Pratinthong, Pichai Namprakai, Taveewat Suparos, "Performance enhancement of air conditioning using thermosyphon system's energy storage unit for cooling refrigerant before entering the condenser," *Journal of Mechanical Science and Technology*, vol. 31, no. 1, p. 393–400, 2017.
- [20] Tinu Thomas, K.Maharaja, "Design and Analysis Of Thermosyphon Solar Air-Conditioning and Refrigeration System," *International Research Journal of Engineering and Technology (IRJET)*, vol. 5, no. 5, pp. 3589-3595, 2018.
- [21] H. Akachi, "Structure of a Heat Pipe". US Patent 4921041, 1990.
- [22] Stéphane Lips, Valérie Sartre, Frédéric Lefèvre, Sameer Khandekar, Jocelyn Bonjour, "Overview of heat pipe studies during the period 2010-2015," *Interfacial Phenomena and Heat Transfer, Begell*, vol. 4, no. 1, pp. 33-53, 2016.
- [23] Bhushan G. Patil, Pramod R. Pachghare, "Experimental Analysis Of Pulsating Heat Pipe For Air Conditioning System," *International Journal of Mechanical And Production Engineering*, vol. 4, no. 6, 2016.
- [24] Y. F. Y. F. M. Gerasimov, "Heat Pipe". USA Patent 449213, 1974.
- [25] Nouman Akram, M. Usman Moazzam, Hafiz Muhammad Ali, Ashar Ajaz, Arslan Saleem, Mustafa Kilic, Abdul Mobeen, "IMPROVED WASTE HEAT RECOVERY THROUGH SURFACE OF KILN USING PHASE CHANGE MATERIAL," *Thermal Science*, 2017.
- [26] Xiaoqin Sun,, Quan Zhang, Mario A. Medina, Kyoung Ok Lee , Shuguang Liao, "Parameter design for a phase change material board installed on the inner surface of building exterior envelopes for cooling in China," *Energy Conversion and Management*, vol. 120, pp. 100-108, 2016.

References

- [27] Francis Agyenim and Neil Hewitt, "Experimental investigation and improvement in heat transfer of paraffin PCM RT58 storage system to take advantage of low peak tariff rates for heat pump applications," *International Journal of Low-Carbon Technologies*, vol. 8, p. 260–270, 2012.
- [28] D Darius, M S Misaran, Md. M Rahman, M A Ismail, A Amaludin, "Working parameters affecting earth-air heat exchanger (EAHE) system performance for passive cooling: A review," in *International Conference on Materials Technology and Energy*, 2017.
- [29] Armando Pinto, Fernanda Rodrigues and André Mota, "Geothermal contribution on southern Europe climate for energy efficiency of university buildings. Winter season," *Energy Procedia*, vol. 134, p. 181–191, 2017.
- [30] Yao Yu, Rui Miao, Louis Miller, Huojun Yang, Gaylord Olson, "Recent Development and Application of Geothermal Heat Pump Systems in Cold-Climate Regions of the US: A Further Investigation," *Scientific Research Publishing*, vol. 9, pp. 625-648, 2017.
- [31] O'Connor, D., Calautit, J.K., Hughes, B.R., "A Review of Heat Recovery Technology for Passive Ventilation Applications," *Renewable and Sustainable Energy Reviews*, vol. 54, pp. 1481-1493, 2016.
- [32] Vikas Shelke, R.J.Yadav, S.B.Girase, "A Review of Heat Pipe Systems for Heat Recovery and Renewable Energy Application," *International Journal of Current Engineering and Technology*, no. 4, pp. 102-107, 2016.
- [33] Tushar S. Jadhav, Mandar M. Lele, "A case study on energy savings in air conditioning system by heat recovery using heat pipe heat exchanger," *International Journal of Research in Engineering and Technology*, vol. 3, no. 1, pp. 2321-7308, 2014.
- [34] H. MuhammadAli, "Applications of combined/hybrid use of heat pipe and phase change materials in energy storage and cooling systems: A recent review," *Journal of Energy Storage*, vol. 26, p. 100986, 2019.
- [35] Song Lin, John Broadbent, Ryan McGlen, "Numerical study of heat pipe application in heat recovery systems," *Applied Thermal Engineering*, vol. 25, pp. 127-133, 2005.
- [36] Hussam Jouhara, Richard Meskimmon, "An investigation into the use of water as a working fluid in wraparound loop heat pipe heat exchanger for applications in energy efficient HVAC systems," *Energy*, vol. 156, pp. 597-605, 2018.
- [37] P. Nemeč, "Gravity in Heat Pipe Technology," in *Gravity- Geoscience Applications, Industrial Technology and Quantum Aspec*, World's largest Science, Technology & Medicine Open Access book publisher.
- [38] K. S. Ong, W. L. Tong, "Inclination and Fill Ratio Effects on Water Filled Two-Phase Closed Thermosyphon," in *International 10th pipe heat symposium*, Taipei, Taiwan, 2011.

References

- [39] Jianqing Chen, Donghui yang, Jinghua Jiang, Aibin Ma, Dan Song, "Research progress of phase change materials (PCMs) embedded with metal foam (a review)," *Procedia Material Science*, vol. 4, pp. 369-374, 2014.
- [40] Syeda Laraib TARIQ, Hafiz Muhammad ALI, Muhammad Ammar AKRAM, "Thermal Applications Of Hybrid Phase Change Materials (Hpcms)- A Critical Review," *Thermal Science*, no. 00, pp. 112-112, 2019.
- [41] P. Rudolf Zaengerle, "Multi-Functional, High-Performance Run Around Energy Recovery Systems in Cold Climate Zomes," in *Seventh International Cold Climate HVAC Conference*, 2012.
- [42] Maria Justo Alonso, Peng Liu, Hans M. Mathisen, Gaoming Ge, Carey Simonson, "Review of heat/energy recovery exchangers for use in ZEBs in cold climate countries," *Building and Environment*, 2014.
- [43] W. G. Eades, "Energy and water recovery using air-handling unit condensate from laboratory HVAC systems," *Sustainable Cities and Society*, vol. 42, p. 162–175, 2018.
- [44] Jörgen Wallin, Hatf Madani, Joachim Claesson, "Ventilation heat recovery with run around coil: System analysis and a study on," in *Sustainability and Green Buildings*, KUWAIT, 2009.
- [45] Bing Wang, Zhanqiang Liu Qinghua Song, Yi Wan, Xiaoping Ren, "An Approach for Reducing Cutting Energy Consumption with Ultra-High Speed Machining of Super Alloy Inconel 718," *International Journal of Precision Engineering and Manufacturing-Green Technology*, vol. 7, p. 35–51, 2020.
- [46] Prajwal D. Chawane, Sujay A. Basunathe , Shweta D. Borekar, "Thermal Performance of Closed Loop Pulsating Heat Pipe Using Different Working Fluid: A Review," *International Journal of Engineering Science Invention*, vol. 2, no. 9, pp. 18-22, 2013.
- [47] Pracha YEUNYONGKUL, Phrut SAKULCHANGSATJATAI, Afshin J. GHAJAR, "Experimental Investigation of Closed Loop Oscillating Heat Pipe as the Condenser for Vapor Compression Refrigeration," in *International Refrigeration and Air Conditioning Conference*, 2010.
- [48] Honghai Yang, Sameer Khandekar, Manfred Groll c, "Performance characteristics of pulsating heat pipes as integral thermal Spreaders," *International Journal of Thermal Sciences*, vol. 48, pp. 815-824, 2009.
- [49] P. R. Pachghare, "Effect of Inclination Angle on the Thermal Performance of Closed Loop Pulsating Heat Pipe," *IJIRST –International Journal for Innovative Research in Science & Technology*, vol. 3, no. 3, pp. 60-64, 2016.
- [50] Yumeng LIU, Haoren DENG, John Pfothenauer, "Design of a hydrogen pulsating heat pipe," *Physics Procedia*, vol. 67, p. 551 – 556, 2015.
- [51] D. Yin, H. Wang, H.B. Ma, Y.L. Ji, "Operation limitation of an oscillating heat pipe," *International Journal of Heat and Mass Transfer*, vol. 94, pp. 366-372, 2016.

References

- [52] Stefano De Antonellis, Manuel Intini, Cesare Maria Joppolo, Federico Pedranzini, "Experimental analysis and practical effectiveness correlations of enthalpy wheels," *Energy and Buildings*, vol. 84, pp. 316-323, 2014.
- [53] Pinar Mert Cuce and Saffa Riffat, "A comprehensive review of heat recovery systems for building applications," *Renewable and Sustainable Energy Reviews*, vol. 47, p. 665–682, 2015.
- [54] Zhiqiang Kang, Xiaoxi Zhou, Ruiting Wang, Xiaocong Cheng, Siqi Zhao, "Research Status of Heat Recovery Device in a Train Station of Severe Cold Area," *Procedia Engineering*, vol. 205, p. 1705–1710, 2017.
- [55] Mr. Vishal. P. Hegana, Prof. P.R. Kulkarni, "Enthalpy wheel application for heat recovery in heat exchanger," *International Journal of Advance Research In Science And Engineering*, vol. 4, no. 1, pp. 43-53, 2015.
- [56] Fatemeh Esfandiari Nia, Dolf van Paassen, Mohamad Hassan Saidi, "Modeling and simulation of desiccant wheel for air conditioning," *Energy and Buildings*, vol. 38, p. 1230–1239, 2006.
- [57] Xiaolin Wang, Hui Tong Chuab, Kim Choon Ng, "Experimental investigation of silica gel–water adsorption chillers with and without a passive heat recovery scheme," *International Journal of Refrigeration*, vol. 28, p. 756–765, 2005.
- [58] Avadhesh Yadav, V.K.Bajpai, "Optimization of Operating Parameters of Desiccant Wheel for Rotation Speed," *International Journal of Advanced Science and Technology*, vol. 32, 2011.
- [59] Dominic O'Connor, John Kaiser Calautit, Ben Richard Hughes, "A novel design of a desiccant rotary wheel for passive ventilation applications," *Applied Energy*, vol. 179, p. 99–109, 2016.
- [60] Hussam Jouhara, Navid Khordehghah, Sulaiman Almahmoud, Bertrand Delpech, Amisha Chauhan, Savvas A. Tassou, "Waste heat recovery technologies and applications," *Thermal Science and Engineering Progress*, vol. 6, pp. 268-289, 2018.
- [61] Laia Miró, Jaume Gasia, Luisa F. Cabeza, "Thermal energy storage (TES) for industrial waste heat (IWH) recovery: A review," *Applied Energy*, vol. 179, p. 284–301, 2016.
- [62] Mohammad Alhuyi Nazari, Mohammad H. Ahmadi, Roghayeh Ghasempoura, Mohammad Behshad Shafii, Omid Mahian, Soteris Kalogirou, Somchai Wongwises, "A review on pulsating heat pipes: From solar to cryogenic applications," *Applied Energy*, vol. 222, p. 475–484, 2018.
- [63] A. T. Hoang, "Waste heat recovery from diesel engines based on Organic Rankine Cycle," *Applied Energy*, vol. 131, p. 138–166, 2018.
- [64] Pei Huang, Benedetta Copertaro, Xingxing Zhang, Jingchun Shen, Isabelle Löfgren, Mats Rönnelid, Jan Fahlen, Dan Andersson, Mikael Svanfeld, "A review of data centers as prosumers in district energy systems: Renewable energy integration and waste heat reuse for district heating," *Applied Energy*, vol. 258, no. 15, p. 114109, 2020.
- [65] Ramyashree A. P., Joel A. Dmello², Rakshith H. S., Impha Y. D., Mahammad Yunus C., Ajaygan K., Mustaqeem Raza, Mohammed Imran M. A., Harsharaj K, "Heat Recovery from Air

References

- Conditioner," *Journal of Mechanical Engineering and Automation*, vol. 6, no. 5A, pp. 113-116, 2016.
- [66] Okuma, T., Radermacher, R. Hwang, Y., "A Novel Application of Thermoelectric Modules in an HVAC System Under Cold Climate Operation," *Journal of Electronic Materials*, vol. 41, no. 6, p. 1749–1758, 2012.
- [67] "Parametric analysis of air–water heat recovery concept applied to HVAC systems: Effect of mass flow rates," *Case Studies in Thermal Engineering*, vol. 6, pp. 61-68, 2015.
- [68] M. Joseph Stalin, S. Mathana Krishnan, G. Vinoth Kumar, "EFFICIENT USAGE OF WASTE HEAT FROM AIR," *International Journal of Advances in Engineering & Technology*, vol. 4, no. 1, pp. 414-423, 2012.
- [69] R.B. Lokapure, J.D.Joshi, "Waste Heat Recovery through Air Conditioning System," *International Journal of Engineering Research and Development*, vol. 5, no. 3, pp. 87-92, 2012.
- [70] Mohamad Ramadan, Samer Ali, Hasan Bazzi, Mahmoud Khaled, "New hybrid system combining TEG, condenser hot air and exhaust New hybrid system combining TEG, condenser hot air and exhaust," *Case Studies in Thermal Engineering*, vol. 10, p. 154–160, 2017.
- [71] P. Mohan Kumar, I. Kathiravan, G. Aadhithyan, C. Prabu, N. Bharath, "Electric Power Generation Using Refrigeration Waste Heat," *International Journal for Research in Applied Science & Engineering Technology (IJRASET)*, vol. 3, no. 3, 2015.
- [72] Amir Abdullah Muhamad Damanhuri, Muhammad Ilman Hakimi Chua Abdullah, Abdul Munir Hidayat Shah Lubis, Muhammad Zulfattah Zakaria, Mohamed Saiful Firdaus Hussin, Mohammad ‘Afif Kasno, "Development of TEG Peltier Device for Heat Harvesting from 1.5 HP Split Unit Air Conditioning System," *International Journal of Applied Engineering Research*, vol. 13, pp. 2390-2394, 2018.
- [73] Pedro M. Peralta Trinidad, Gerardo Carbajal, "Potential use of Thermoelectric Generator Device for Air Conditioning System," in *13th LACCEI Annual International Conference*, Santo Domingo, 2015.
- [74] K.T. Papakostas, G.C. Kiosis, "Heat recovery in an air-conditioning system with air-to-air heat exchanger," *International Journal of Sustainable Energy*, vol. 34, no. 3-4, p. 221–231, 2013.
- [75] Ehsan Firouzfard, Mohammad Soltanieh, S. Hossien Noie, and M. Hassan Saidi, "Application of heat pipe heat exchangers in heating, ventilation and air conditioning (HVAC) systems," *Scientific Research and Essays*, vol. 6, no. 9, pp. 1900-1908, 2011.
- [76] Sepehr Sanaye, Davood Modarrespoor, "Thermal-Economic Multiobjective Optimization Of Heat Pipe Heat Exchanger For Energy Recovery In Hvac Applications Using Genetic Algorithm," *Thermal Science*, vol. 18, pp. 375-391, 2014.
- [77] M. Ahmadzadehtalatapeh, "An air-conditioning system performance enhancement by using heat pipe based heat recovery technology," *Scientia Iranica*, vol. 20, no. 2, p. 329–336, 2013.

References

- [78] Guoyuan Ma, Feng Zhou, Ting Liu, Liangbing Wang, and Zhongliang Liu, "Energy-Saving Evaluation of a Thermosyphon Heat Recovery Unit for an Air-Conditioning System," *Heat Transfer—Asian Research*, vol. 42, no. 5, 2013.
- [79] G.Vanyasree, P.V.Ramana, "Experimental Analysis On Thermosyphon Heatpipe To Find Heat Transfer Coefficient," *International Research Journal of Engineering and Technology (IRJET)*, vol. 4, no. 8, pp. 129-136, 2017.
- [80] Govinda Mahajin, Scott M. Thompson, Heejin Cho, "Energy and cost savings potential of oscillating heat pipes for waste heat recovery ventilation," *Energy Reports*, vol. 3, pp. 46-53, 2017.
- [81] P. Supirattanakul, S. Rittidech, B. Bubphachot, "Application of a closed-loop oscillating heat pipe with check valves (CLOHP/CV) on performance enhancement in air conditioning system," *Energy and Buildings*, vol. 43, p. 1531–1535, 2011.
- [82] Govinda Mahajan, Heejin Cho, Scott M. Thompson, Harrison Rupp, Kevin Muse, "Oscillating heat pipes for waste heat recovery in hvac systems," in *ASME IMECE 2015*, Houston, Texas, USA, November 13–19, 2015..
- [83] Pranab K. Barua, D. Deka, U. S. Dixit, "Mathematical Modelling of Change of Temperature in Pulsating Heat Pipes with Single Loops," *International Journal of Energy, Information and Communications*, vol. 2, no. 1, pp. 33-52, 2011.
- [84] R. Zaengerle, "Multi-Functional, High-Performance Run Around Energy Recovery Systems in Cold Climate Zones," in *Seventh International Cold Climate HVAC Conference*, 2012.
- [85] S.V. Kota Reddy, S. Anil Babu, Clifton Arokiyaraj, Gaurav Naik, Soham Shukla , Barath Masamsetty, Kevin Alexander, "Air Conditioning System with Ground Source Heat Exchanger," *IOSR Journal of Mechanical and Civil Engineering (IOSR-JMCE)*, vol. 12, no. 1, pp. 20-24, 2015.
- [86] Thomas Woodson, Yézouma Coulibaly, and Eric Seydou Traoré, "Earth-Air Heat Exchangers for Passive Air Conditioning: Case Study Burkina Faso," *Journal of Construction in Developing Countries*, vol. 17, no. 1, pp. 21-32, 2012.
- [87] G.N. Tiwari, Vikram Singh, Poonam Joshi, Shyam, Arjun Deo, Prabhakant and Agam Gupta, "Design of an Earth Air Heat Exchanger (EAHE) for Climatic Condition of Chennai, India," *Open Environmental Sciences*, vol. 8, pp. 24-34, 2014.
- [88] Paolo Maria Congedo, Caterina Lorusso, Maria Grazia De Giorgi, Riccardo Marti, and Delia D'Agostino, "Horizontal Air-Ground Heat Exchanger Performance and Humidity Simulation by Computational Fluid Dynamic Analysis," *Energies*, vol. 9, 2016.
- [89] Faezeh Fazlikhani, Hossein Goudarzi, Ebrahim Solgi, "Numerical analysis of the efficiency of earth to air heat exchange systems in cold and hot-arid climates," *Energy Conversion and Management*, vol. 148, p. 78–89, 2017.

References

- [90] M. Elhelw, "Analysis of energy management for heating, ventilating and air-conditioning systems," *Alexandria Engineering Journal*, vol. 55, p. 811–818, 2016.
- [91] Saeed Sayadi, George Tsatsaronis, Tatiana Morosuk, "Reducing the Energy Consumption of HVAC Systems in Buildings by Using Model Predictive Control," in *CLIMA 2016 - 12th REHVA World Congress*, Aalborg, Denmark, 2016.
- [92] Wei Wang, Zhenghang Lin, Jiayu Chen , "Promoting energy efficiency of HVAC operation in large office spaces with a wifi probe enabled Markov time window occupancy detection approach," *Energy Procedia*, vol. 143, pp. 204-209, 2017.
- [93] Ivan Zlatanovica, Kosta Gligorevi, Sanjin Ivanovi, Nedžad Rudonja, "Energy-saving estimation model for hypermarket HVAC systems applications," *Energy and Buildings*, vol. 43, p. 3353–3359, 2011.
- [94] Radu Godina ID , Eduardo M. G. Rodrigues, Edris Pouresmaeil, João C. O. Matias, João P. S. Catalão, "Model Predictive Control Home Energy Management and Optimization Strategy with Demand Response," *Applied Science*, vol. 8, no. 408, 2018.
- [95] Liping Wang, Philip Haves, and John Breshears, "The Energy Saving Potential Of Membrane-Based Enthalpy Recovery In Vav Systems For Commercial Office Buildings," in *Fifth National Conference of IBPSA-USA*, Madison, Wisconsin, 2012.
- [96] Syed Moazzam Ali, B.Balu Naik, Mohammed Majeed Ali, "Designing HVAC Systems using HRW as an ECM for Energy Efficient Buildings," *International Journal of Scientific & Engineering Research*, vol. 7, no. 6, pp. 245-249, 2016.
- [97] SYED MUSAB AL HUSSAINI, Irfan Khan, "Designing HVAC system with and without Heat Recovery Wheel using ECO-FRESH Enthalpy wheel," *International Journal of Scientific & Engineering Research Volume*, vol. 8, no. 11, pp. 854-857, 2017.
- [98] L. Bellia, P. Mazzei, F. Minichiello and D. Palma, "Air Conditioning Systems With Desiccant Wheel For Italian Climates," *International Journal on Architectural Science*, vol. 1, no. 4, pp. 193-213, 2000.
- [99] H.M.D.P. Herath, M.D.A. Wickramasinghe, A.M.C.K. Polgolla, A.S. Jayasena, R.A.C.P. Ranasinghe, "Applicability of rotary thermal wheels to hot and humid climates," *Energy Reports*, vol. 6, p. 539–544, 2020.
- [100] Nattaporn Chaiyat, Tanongkiat Kiatsirirot , "Energy reduction of building air-conditioner with phase change material in Thailand," *Case Studies in Thermal Engineering*, vol. 4, pp. 175-186, 2014.
- [101] Lucelia Taranto Rodrigues, and Mark Gillott, "A novel low-carbon space conditioning system incorporating phase change system incorporating phase-change materials and earth–air heat exchangers," *International Journal of Low-Carbon Technologies*, vol. 10, p. 176 –187, 2013.

References

- [102] Daniel M. Madyira, "Experimental study for the performance of PCM air cooling rig," *Procedia Manufacturing*, vol. 7, pp. 420-426, 2017.
- [103] Won-Chang Choi, Bae-Soo Khil, Young-Seok Chae, Qi-Bo Liang, and Hyun-Do Yun, "Feasibility of Using Phase Change Materials to Control the Heat of Hydration in Massive Concrete Structures," *The Scientific World Journal*, vol. 2014, p. 6, 2014.
- [104] Suping Shen, Wenjian Cai, Xinli Wang, Qiong Wu, Haoren Yon, "Investigation of liquid desiccant regenerator with fixed-plate heat recovery system," *Energy*, vol. 137, pp. 172-182, 2017.
- [105] M.F. Zafirah, A. Mardiana, "Experimental investigation on the performance of an air-to-air energy recovery for building applications in hot-humid climate," *Journal of Mechanical Engineering and Sciences (JMES)*, vol. 10, no. 1, pp. 857-1864, 2016.
- [106] Mohammad Shakir Nasif and Rafat Al-Waked, "Effect of air to air fixed plate enthalpy energy recovery heat exchanger flow profile on air conditioning system energy recovery," *Applied Mechanics and Materials*, vol. 819, pp. 245-249, 2015.
- [107] M. Nasif, R. AL-Waked, G. Morrisona, M. Behnia, "Membrane heat exchanger in HVAC energy recovery systems, systems energy analysis," *Energy and Buildings*, vol. 42, pp. 1833 - 1840, 2010.
- [108] M. S. Nasif, "Air-to-Air Fixed Plate Energy Recovery Heat Exchangers for Building's HVAC Systems," *Applied Sciences and Technology*, pp. 63 - 71, 2018.
- [109] K.T. Papakostas, T. Slini, "Effects of Climate Change on the Energy Required for the Treatment of Ventilation Fresh Air in HVAC Systems The Case of Athens and Thessaloniki," *Procedia Environmental Sciences*, vol. 38, p. 852 – 859, 2017.
- [110] Stefanie Tafelmeier, Giovanni Pernigotto, Andrea Gasparella, "Annual Performance of Sensible and Total Heat Recovery in Ventilation Systems: Humidity Control Constraints for European Climates," *Buildings*, vol. 7, no. 2, p. 28, 2017.
- [111] Miklos Kassai, Laszlo Kajtar, "Cooling energy saved investigation of air-to-air heat-and energy exchangers," in *EXPRES 2016 ,8th International Symposium on Exploitation of Renewable Energy*, Subotica, Serbia, 2016 .
- [112] Wu XP, Johnson P, Akbarzadeh, "A study of heat pipe heat exchanger effectiveness in an air conditioning application," in *Proceedings of 5th International Heat pipe symposium*, Melbourne, 1996.
- [113] D. A. Kumar, "Ecofresh: For Better Indoor Air Quality," *International Journal of Engineering Research and General Science*, vol. 4, no. 6, 2016.
- [114] Namrata Bordoloi, Aashish Sharmaa, Himanshu Nautiyal, Varun Goel, "An intense review on the latest advancements of Earth Air Heat Exchangers," *Renewable and Sustainable Energy Reviews*, vol. 89, p. 261–280, 2018.

References

- [115] T.S. Jadhav, M.M. Lele, "Theoretical energy saving analysis of air conditioning system using heat pipe heat exchanger for Indian climatic zones," *Engineering Science and Technology*, vol. 18, pp. 669-673, 2015.
- [116] Adel A. Eidan, Saleh E. Najim, Jalal M. Jalil, "Experimental Investigation of Thermosyphone Heat Exchanger on Dehumidification Enhancement for Hot and Humid Climates Used in HVAC Systems," in *First Conference For Engineering Sciences and Technology*, 2015.
- [117] H. B. Madessa, "A review of the performance of buildings integrated with Phase change material: Opportunities for application in cold climate," *Energy Procedia*, vol. 62, pp. 318-328, 2014.
- [118] M Saffari, A de Gracia, C Fernández, G Zsembinszki, L F Cabeza, "Study on the optimum PCM melting temperature for energy savings in residential buildings worldwide," in *IOP Conference Series: Materials Science and Engineering*, 2017.
- [119] K. S. Reddy, Vijay Mudga, Tapas K. Mallick, "Thermal Performance Analysis of Multi-Phase Change Material Layer-Integrated Building Roofs for Energy Efficiency in Built-Environment," *Energies*, vol. 10, 2017.
- [120] L. lingxue, "Analysis of economic and environmental benefits of a new heat pump air conditioning system," *Earth and Environmental Science*, vol. 81, p. 012177, 2017.
- [121] Yat H. Yau, Mohammad Ahmad zadehtalatapeh, "Heat Pipe Heat Exchanger And Its Potential To Energy Recovery In The Tropics," *Thermal Science*, vol. 19, no. 5, pp. 1685-1697, 2015.
- [122] Ma, G., Zhou, F., Liu, T., Wang, L., & Liu, Z., "Energy-saving evaluation of a thermosyphon heat recovery unit for an air-conditioning system," *Heat Transfer-Asian Research*, vol. 42, no. 5, p. 377-388., 2013.
- [123] Nivethitha Somua, Gauthama Raman M R, Krithi Ramamritham, "A hybrid model for building energy consumption forecasting using long short term memory networks," *Applied Energy*, vol. 261, no. 1, p. 114131, 2020.
- [124] Maria Mrówczyńska, Marta Skiba, Anna Bazan-Krzywoszańska, Małgorzata Sztubecka, "Household standards and socio-economic aspects as a factor determining energy consumption in the city," *Applied Energy*, vol. 264, no. 15, p. 114680, 2020.
- [125] Zhilong Cheng, Zhigang Guo, Zhoutuo Tan, Jian Yang, Qiuwang Wang, "Waste heat recovery from high-temperature solid granular materials: Energy challenges and opportunities," *Renewable and Sustainable Energy Reviews*, vol. 116, p. 109428, 2019.
- [126] Mohtaram, Soheil; Sun, HongGuang; Lin, Ji; Chen, Wen; Sun, Yonghui, "Multi-Objective Evolutionary Optimization & 4E analysis of a bulky combined cycle power plant by CO₂/ CO/ NO_x reduction and cost controlling targets.," *Renewable and Sustainable Energy Reviews*, vol. 128, p. 109898, 2020.
- [127] Longxiang Chen, Yongzhen Wang, Meina Xie; Kai Ye, Soheil Mohtaram, "Energy and exergy analysis of two modified adiabatic compressed air energy storage (A-CAES) system for

References

- cogeneration of power and cooling on the base of volatile fluid," *Journal of Energy Storage*, vol. 42, p. 103009, 2021.
- [128] Abdullah M. Abusorrah, Fateh Mebarek-Oudina, Ali Ahmadian, Dumitru Baleanu, "Modeling of a MED-TVC desalination system by considering the effects of nanoparticles: energetic and exergetic analysis," *Journal of Thermal Analysis and Calorimetry*, vol. 144, no. 4, pp. 1-13, 2020.
- [129] Soheil Mohtaram, Yonghui Sun, Mohammad Omid, Ji Lin, "Energy-exergy efficiencies analyses of a waste-to-power generation system combined with an ammonia-water dilution Rankine cycle," *Case Studies in Thermal Engineering*, vol. 25, p. 100909, 2021.
- [130] Soheil Mohtaram, Ji Lin, Wen Chen, M. Amin Nikbakht, "Evaluating the effect of ammonia-water dilution pressure and its density on thermodynamic performance of combined cycles by the energy-exergy analysis approach," *Mechanika*, vol. 23, no. 2, pp. 209-219, 2017.
- [131] Mohammad Omid, Shu-Jie Liu, Soheil Mohtaram, Hui-Tian Lu, Hong-Chao Zhang, "Improving Centrifugal Compressor Performance by Optimizing the Design of Impellers Using Genetic Algorithm and Computational Fluid Dynamics Methods.," *Sustainability*, vol. 11, no. 19, p. 5409, 2019.
- [132] Mohammad Omid, Shu-jie Liu, Soheil Mohtaram, Hui-tian Lu, Hong-chao Zhang, "the Flow Simulation and Model Analysis of Efficiency and Pressure Ratio Behaviors in GT4086 Turbocharger Compressor," *Mechanics of Fluids and Gases*, vol. 26, no. 4, 2020.
- [133] M. Halley, "Kinetic Energy Recovery Systems in Formula 1," *ATZautotechnology*, vol. 8, pp. 58-61, 2008.
- [134] Soheil Mohtaram, Wen Chen, Ji Lin, "Investigation on the combined Rankine-absorption power and refrigeration cycles using the parametric analysis and genetic algorithm," *Energy Conversion and Management*, vol. 150, no. 15, pp. 754-762, 2017.
- [135] Yusuf A. Al-Turki, Fateh Mebarek-Oudina, Ali Ahmadian, Dumitru Baleanu, "Flat sheet direct contact membrane distillation desalination system using temperature-dependent correlations: thermal efficiency via a multi-parameter sensitivity analysis based on Monte Carlo method," *Journal of Thermal Analysis and Calorimetry*, vol. 144, p. 2641–2652, 2021.
- [136] Sipeng Zhu, Kun Zhang, Kangyao Deng, "A review of waste heat recovery from the marine engine with highly efficient bottoming power cycles," *Renewable and Sustainable Energy Reviews*, vol. 120, p. 109611, 2020.
- [137] Sean Hoenig, CJ Pan, Chien-Hua Chen, and Richard Bonner III, "THERMAL RESISTANCE NETWORK MODEL FOR HEAT PIPE – PCM," in *Proceedings of the 2nd Thermal and Fluid Engineering Conference*, USA, 2017.
- [138] Jian Cao, Ali Emadi, "A New Battery/UltraCapacitor Hybrid Energy Storage System for Electric, Hybrid, and Plug-In Hybrid Electric Vehicles," *IEEE Transactions on Power Electronics*, vol. 27, no. 1, pp. 122-132, 2012.

References

- [139] D. A. Reay, "Thermal energy storage: the role of the heat pipe in performance enhancement," *International Journal of Low-Carbon Technologies*, vol. 10, no. 2, p. 99–109, 2015.
- [140] Soheil Mohtaram, Yonghui Sun, Hongguang Sun, Arya Abrishami, Mohammad Omid, Ji Lin, "A comprehensive design, optimization and development methodology of a wasted heat recovery boiler using serrated fins and extensive surface in a bulky CCPP," *Case Studies in Thermal Engineering*, vol. 23, p. 100808, 2021.
- [141] Emiliano Pipitone, Gianpaolo Vitale, "A regenerative braking system for internal combustion engine vehicles using supercapacitors as energy storage elements - Part 1: System analysis and modelling," *Journal of Power Sources*, vol. 448, no. 1, p. 227368, 2020.
- [142] Qi Zhang, Amen Agbossou, Zhihua Feng, Mathieu Cosnier, "Solar micro-energy harvesting based on thermoelectric and latent heat effects. Part II: Experimental analysis," *Sensors and Actuators A: Physical*, vol. 163, pp. 284-290, 2010.
- [143] Jan Skovajsa, Martin Koláček and Martin Zálešák, "Phase Change Material Based Accumulation Panels in Combination with Renewable Energy Sources and Thermoelectric Cooling," *Energies*, vol. 10, no. 152, 2017.
- [144] Soheil Mohtaram, Mohammad Omid, Ji Lin, Hongguang Sun, Wen Chen, "Exergy analysis of a multi mixture working fluid absorption refrigeration cycle," *Case Studies in Thermal Engineering*, vol. 15, p. 100540, 2019.
- [145] Gysoup Lee, Choong Sun Kim, Seongho Kim, Yong Jun Kim, Hyeongdo Choi, Byung Jin Cho, "Flexible heatsink based on a phase-change material for a wearable thermoelectric generator," *Energy*, vol. 179, pp. 12-18, 2019.
- [146] H. M. Ali, "Applications of combined/hybrid use of heat pipe and phase change materials in energy storage and cooling systems: A recent review," *Journal of Energy Storage*, vol. 26, p. 100986, 2019.
- [147] Dipak S.Patil, Rachayya R.Arakerimath, Pramod V.Walke, "Thermoelectric materials and heat exchangers for power generation – A review," *Renewable and Sustainable Energy Reviews*, vol. 95, pp. 1-22, 2018.
- [148] Suresh Kumar Soni., Mukesh Pandey, Vishvendra Nath Bartaria, "Hybrid ground coupled heat exchanger systems for space heating/cooling applications: A review," *Renewable and Sustainable Energy Reviews*, vol. 60, p. 724–738, 2016.
- [149] Nicolas De Lovato, Kavin Sundarnath, Lazar Cvijovic, Krishna Kota, Sarada Kuravi, "A review of heat recovery applications for solar and geothermal power plants," *Renewable and Sustainable Energy Reviews*, vol. 114, p. 109329, 2019.
- [150] Meer A.M.Khan, S.Rehman, Fahad A.Al-Sulaiman, "A hybrid renewable energy system as a potential energy source for water desalination using reverse osmosis: A review," *Renewable and Sustainable Energy Reviews*, vol. 97, pp. 456-477, 2018.

References

- [151] Bin Xu, Dhruvang Rathod, Adamu Yebi, Zoran Filipi, Simona Onori, Mark Hoffman, "A comprehensive review of organic rankine cycle waste heat recovery systems in heavy-duty diesel engine applications," *Renewable and Sustainable Energy Reviews*, vol. 107, pp. 145-170, 2019.
- [152] M.S. Naghavi, K.S. Ong, M. Mehrali, I.A. Badruddin, H.S.C. Metselaar, "A state-of-the-art review on hybrid heat pipe latent heat storage systems," *Energy Conversion and Management*, vol. 105, p. 1178–1204, 2015.
- [153] B. Orr, A. Akbarzadeh, M. Mochizuki, R. Singh, "A review of car waste heat recovery systems utilising thermoelectric generators and heat pipes," *Applied Thermal Engineering*, vol. 101, pp. 490-495, 2016.
- [154] Jiateng Zhao, Zhonghao Rao, Chenzhen Liu, Yimin Li, "Experiment study of oscillating heat pipe and phase change materials coupled for thermal energy storage and thermal management," *International Journal of Heat and Mass Transfer*, vol. 99, p. 252–260, 2016.
- [155] Chong C. Lim, Hussain H. Al-Kayiem, Chin Y. Sing, "Portable Thermoelectric Power Generator Coupled with Phase Change Material," in *MATEC Web of Conferences 13*, 2014.
- [156] M. Y. Abdelsalam, H.M. Teamah, M.F. Lightstone, J.S. Cotton, "Hybrid thermal energy storage with phase change materials for solar domestic hot water applications: Direct versus indirect heat exchange systems," *Renewable Energy*, vol. 147, no. 1, pp. 77-80, 2020.
- [157] Kh. Hosseinzadeh, A.R. Mogharrebi, A. Asadi, M.Paikar, D.D. Ganji, "Effect of fin and hybrid nano-particles on solid process in hexagonal triplex Latent Heat Thermal Energy Storage System," *Journal of Molecular Liquids*, vol. 300, no. 15, p. 112347, 2020.
- [158] Xin Gao, Søren Juhl Andreasen, Søren Knudsen Kær, Lasse Aistrup Rosendahl, "Optimization of a TEG subsystem for high temperature PEM fuel cell exhaust heat recovery," *International Journal of Hydrogen Energy*, vol. 39, pp. 6637 - 6645, 2014.
- [159] Stephane Bilodeau, Michael Carty, Chris Mashburn, and Ross Quick, "Hybrid Thermal and Electric and Energy Storage System," in *EESAT_Proceeding_Bilodeau*, 2017.
- [160] Y. Teng, P. Sun, Q. Hui, Y. Li and Z. Chen, "A model of electro-thermal hybrid energy storage system for autonomous control capability enhancement of multi-energy microgrid," *CSEE Journal of Power and Energy Systems*, vol. 5, no. 4, pp. 489-497, 2019.
- [161] Hasan Mehrjerdia, Elyas Rakhshani, "Optimal operation of hybrid electrical and thermal energy storage systems under uncertain loading condition," *Applied Thermal Engineering*, vol. 160, p. 114094, 2019.
- [162] Wang, Guishi; Ciobotaru, Mihai; Agelidis, Vassilios G., "Power Smoothing of Large Solar PV Plant Using Hybrid Energy Storage," *IEEE Transactions on Sustainable Energy*, vol. 5, no. 3, pp. 834-842, 2014.

References

- [163] Wenlong Jing, Chean Hung Lai, Shung Hui Wallace Wong, Mou Ling Dennis Wong, "Battery-supercapacitor hybrid energy storage system in standalone DC microgrids: a review," *IET Renewable Power Generation*, vol. 11, no. 4, pp. 461-469, 2017.
- [164] Salman Hajiaghasi, Ahmad Salemnia, Mohsen Hamzeh, "Hybrid energy storage system for microgrids applications: A review," *Journal of Energy Storage*, vol. 21, pp. 543-570, 2019.
- [165] Mid-Eum Choi, Jun-Sik Lee, Seung-Woo Seo, "Real-time Optimization for Power Management Systems of a Battery/Supercapacitor Hybrid Energy Storage System in Electric Vehicles," *IEEE Transactions on Vehicular Technology*, vol. 63, no. 8, pp. 3600-3611, 2013.
- [166] S. M. Lukic, S. G. Wirasingha, F. Rodriguez, J. Cao and A. Emadi, , "Power Management of an Ultracapacitor/Battery Hybrid Energy Storage System in an 1EV," in *IEEE Vehicle Power and Propulsion Conference pp 1-6*, 2006.
- [167] M.E. Glavin, Paul K.W. Chan, S. Armstrong, and W.G Hurley, "A Stand-alone Photovoltaic Supercapacitor Battery Hybrid Energy Storage System," in *13th International Power Electronics and Motion Control Conference*, Ireland, 2008.
- [168] T. Bocklisch, "Hybrid energy storage systems for renewable energy applications," *Energy Procedia*, vol. 73, pp. 103-111, 2015.
- [169] Wei Li and Géza Joós, "A Power Electronic Interface for a Battery Supercapacitor Hybrid Energy Storage System for Wind Applications," in *IEEE Power Electronics Specialists Conference*, pp. 1762-1768, Rhodes, 2008.
- [170] Weiwei Yang, Jiageng Ruanb, Jue Yanga, Nong Zhang, "Investigation of integrated uninterrupted dual input transmission and hybrid energy storage system for electric vehicles," *Applied Energy*, vol. 262, p. 114446, 2020.
- [171] Dongyue Jiang, Yunpeng Su, Kun Wang, Yutao Wang, Minyi Xu, Ming Dong, Guijun Chen, "A triboelectric and pyroelectric hybrid energy harvester for recovering energy 1 from low-grade 2 waste fluids," *Nano Energy*, vol. 70, p. 104459, 2019.
- [172] Rima Aridi, Jalal Faraj, Samer Ali, Mostafa Gad El-Rab, Thierry Lemenand, Mahmoud Khaled, "Energy Recovery in Air Conditioning Systems: Comprehensive Review, Classifications, Critical Analysis, and Potential Recommendations," *Energies*, vol. 14, no. 18, p. 5869, 2021.
- [173] Sadegh Motahar, Rahmatollah Khodabandeh, "Experimental study on the melting and solidification of a phase change material enhanced by heat pipe," *International Communications in Heat and Mass Transfer*, vol. 73, pp. 1-6, 2016.
- [174] Jogi Krishna, P.S. Kishore, and A. Brusly Solomon, "Heat pipe with Nano enhanced-PCM for electronic cooling application," *Experimental Thermal and Fluid Science*, vol. 81, pp. 84-92, 2016.
- [175] Ying-Che Weng, Hung-Pin Cho, Chih-Chung Chang, Sih-Li Chen, "Heat pipe with PCM for electronic cooling," *Applied Energy*, vol. 88, pp. 1825-1833, 2011.

References

- [176] Chunjian Pan, Natasha Vermaak, Carlos Romero, Sudhakar Neti, Sean Hoenig, Chien-Hua Chen, Richard Bonner, "Cost estimation and sensitivity analysis of a latent thermal energy storage system for supplementary cooling of air cooled condensers," *Applied Energy*, vol. 224, pp. 52-68, 2018.
- [177] B. Kılıç, "Development of a composite PVT panel with PCM embodiment, TEG modules, flat-plate solar collector, and thermally pulsing heat pipes," *Solar Energy*, vol. 200, pp. 89-107, 2020.
- [178] Lippong Tana, Randeep Singh, Abhijit Datea, Aliakbar Akbarzadeh, "Thermal Performance of Two-Phase Closed Thermosyphon in Application of Concentrated Thermoelectric Power Generator Using Phase Change Material Thermal Storage," in *10th International Heat Pipe Symposium*, Taipei, Taiwan, 2011.
- [179] Saeed Ahmadi Atouei, Ali Akbar Ranjbara, Alireza Rezaia, "Experimental investigation of two-stage thermoelectric generator system integrated with phase change materials," *Applied Energy*, vol. 208, pp. 332-343, 2017.
- [180] Qi Zhang , Amen Agbossou , Zhihua Feng , Anne-Cecile Grillet, "Phase Change Material and the Thermoelectric Effect for Solar Energy Harvesting and Storage," in *Proceedings of the ASME/JSME 2011 8th Thermal Engineering Joint Conference.*, Hawaii, 2011.
- [181] Sung-Eun Jo, Myoung-Soo Kim, Min-Ki Kim and Yong-Jun Kim, "Power generation of a thermoelectric generator with phase change materials," *Smart Materials And Structures*, vol. 22, p. 115008, 2013.
- [182] Jianhui Mao, Zihua Wu Huaqing Xie, Anbang Liu, Yuanyuan Wang, Yihuai Li, "Power Generation by Thermoelectric Generator Using Different Amounts of Phase Change Materials," *Journal of Thermophysics and Heat Transfer* , vol. 32, no. 2, pp. 1-7, 2018.
- [183] Michele Bottarelli, Aleksandar Georgiev, Ahmet Alper Aydin, Yuehong Su, Charles Yousif, "Ground-Source Heat Pumps using Phase Change Materials," in *European Geothermal Congress 2013*, Italy, 2013.
- [184] Emanuele Bonamente, Andrea Aquino, Franco Cotana, "A PCM thermal storage for ground-source heat pumps: simulating the system performance via CFD approach," *Energy Procedia*, vol. 101, p. 1079 – 1086, 2016.
- [185] Alvarode Gracia, Luisa F.Cabeza, "Phase change materials and thermal energy storage for buildings," *Energy and Buildings*, vol. 103, pp. 414-419, 2015.
- [186] B. Orr, A. Akbarzadeh, P. Lappas, "An exhaust heat recovery system utilising thermoelectric generators and heat pipes," *Applied Thermal Engineering*, vol. 101, pp. 490-495, 2016.
- [187] Qimin Cao, Weiling Luan, Tongca iWang, "Performance enhancement of heat pipes assisted thermoelectric generator for automobile exhaust heat recovery," *Applied Thermal Engineering*, vol. 130, pp. 1472-1479, 2018.

References

- [188] M. Saufi Sulaiman, B. Singh, W.A.N.W. Mohamed, "Experimental and theoretical study of thermoelectric generator waste heat recovery model for an ultra-low temperature PEM fuel cell powered vehicle," *Energy*, vol. 179, pp. 628-646, 2019.
- [189] Orr, B, Akbarzadeh, A, and Lappas, P, "Predicting the performance of a car exhaust heat recovery system that utilises thermoelectric generators and heat pipes," in *Proceedings of the 52nd Australian Solar Energy Society Annual Conference (Solar 2014)*, Melbourne, Australia, 2014.
- [190] Muhammad Fairuz Remeli, Lippong Tan, Abhijit Date, Baljit Singh, Aliakbar Akbarzadeh, "Simultaneous power generation and heat recovery using a heat pipe assisted thermoelectric generator system," *Energy Conversion and Management*, vol. 91, p. 110–119, 2015.
- [191] Nenad Miljkovi, Evelyn N. Wang, "Modeling and optimization of hybrid solar thermoelectric systems with thermosyphons," *Solar Energy*, vol. 85, p. 2843–2855, 2011.
- [192] Muhammad Fairuz Remeli, Abhijit Date, Bradley Orr, Lai Chet Ding, Baljit Singh, Nor Dalila Nor Affandi, Aliakbar Akbarzadeh, "Experimental investigation of combined heat recovery and power generation using a heat pipe assisted thermoelectric generator system," *Energy Conversion and Management*, vol. 111, p. 147–157, 2016.
- [193] Hassan Jaber, Mahmoud Khaled, Thierry Lemenand, Mohamad Ramadan, "Effect of generator load on hybrid heat recovery system," *Case Studies in Thermal Engineering*, vol. 13, p. 100359, 2019.
- [194] Hicham El Hage, Mohamad Ramadan, Hassan Jaber, Mahmoud Khaled & Abdul Ghani Olabi, "A short review on the techniques of waste heat recovery from domestic applications," *Energy Sources, Part A: Recovery, Utilization, and Environmental Effects*, pp. 1556-7230, 2019.
- [195] Feng, Y., Chen, L., Meng, F., & Sun, F., "Thermodynamic Analysis of TEG-TEC Device Including Influence of Thomson Effect.," *Journal of Non-Equilibrium Thermodynamics*, vol. 43, no. 1, p. 75–86, 2018.
- [196] Mohammad Marefati, Mehdi Mehrpooya, "Introducing a hybrid photovoltaic solar, proton exchange membrane fuel cell and thermoelectric device system," *Sustainable Energy Technologies and Assessments*, vol. 36, p. 100550, 2019.
- [197] Xin Gao, Min Chen, Søren Juhl Andreasen & Søren Knudsen Kær , "Potential Usage of Thermoelectric Devices in a High-Temperature Polymer Electrolyte Membrane (PEM) Fuel Cell System: Two Case Studies," *Journal of Elec Materi* , vol. 41, p. 1838–1844, 2012.
- [198] Navid Shirzadi, Ramin Roshandel, Mohammad Behshad Shafii, "Integration of miniature heat pipes into a proton exchange membrane fuel cell for cooling applications," *Heat Transfer*, vol. 38, no. 18, pp. 1595-1605, 2017.
- [199] Marcos Vinício Oro, Edson Bazzo, "Flat Heat Pipes for Cooling Proton Exchange Membrane Fuel Cells," in *15th Brazilian Congress of Thermal Sciences and Engineering*, Brazil, 2014.
- [200] Xinru Guo, Houcheng Zhang, Jiatang Wang, Jiapei Zhao, Fu Wang, He Miao, Jinliang Yuan, Shujin Hou, ": A new hybrid system composed of high-temperature proton exchange fuel cell and

References

- two-stage thermoelectric generator with Thomson effect: Energy and Exergy analyses," *Energy*, vol. 195, no. 15, p. 117000, 2020.
- [201] Trevor Hocksun Kwan, Yongting Shen, Qinghe Yao, "An energy management strategy for supplying combined heat and power by the fuel cell thermoelectric hybrid system," *Applied Energy*, vol. 251, p. 113318, 2019.
- [202] B. Abderezzak, M. Hinaje, J. Leveque, "Experimental potential of exploiting PEMFC.s waste heat using TEG modules," *Mediterranean Journal of Modeling and Simulation*, vol. 11, pp. 20-035, 2019.
- [203] Muhammad Fairuz Remeli, Abhijit Date, Baljit Singh, Aliakbar Akbarzadeh, "PASSIVE POWER GENERATION AND HEAT RECOVERY FROM WASTE HEAT," *Advanced Materials Research*, vol. 1113, pp. 789-794, 2015.
- [204] Rohit S. Raut¹, Sachin V. Rathod, "Use of Heat Pipes and Thermoelectric Generator System for Waste Heat Recovery and Power Generation," *International Conference on Ideas, Impact and Innovation in Mechanical Engineering*, vol. 5, no. 6, pp. 539 - 542, 2017.
- [205] Bo Lia, Kuo Huang, Yuying Yan, Yong Li, Ssennoga Twaha, Jie Zhu, "Heat Transfer Enhancement of a Modularised Thermoelectric Power Generator for Passenger Vehicles," *Applied Energy*, vol. 205, p. 868–879, 2017.
- [206] Rima Aridi, Alissar Yehya, "Review on the sustainability of phase-change materials used in buildings," *Energy Conversion and Management X*, vol. 15, no. 18, p. 100237, 2022.
- [207] Shimei Sun, Liqiu Zheng, "Numerical Simulation Study on Heat Pipe Cooling System of Proton Exchange Membrane Fuel Cell," *Advanced Materials Research*, Vols. 347-353, pp. 893-896, 2012.
- [208] Mawufem Modjinou, Jie Ji, Weiqi Yuan, Fan Zhou, Sarah Holliday, Adeel Waqas, Xudong Zhao, "Performance comparison of encapsulated PCM PV/T, microchannel heat pipe PV/T and conventional PV/T systems," *Energy*, vol. 166, pp. 1249-1266, 2019.
- [209] K. Nithyanandam, R. Pitchumani, "Analysis and optimization of a latent thermal energy storage system with embedded heat pipes," *International Journal of Heat and Mass Transfer*, vol. 54, no. 21-22, pp. 4596-4610, 2011.
- [210] Teng-yue Wang, Yan-hua Diao, Ting-ting Zhu, Yao-hua Zhao, Jing Liu, Xiang-qian Wei, "Thermal performance of solar air collection-storage system with phase change material based on flat micro-heat pipe arrays," *Energy Conversion and Management*, vol. 142, no. 15, pp. 230-243, 2017.
- [211] Thierno M.O. Diallo, Min Yu, Jinzhi Zhou, Xudong Zhao, Samson Shittu, Guiqiang Lia, Jie Ji, David Hardya, "Energy performance analysis of a novel solar PVT loop heat pipe employing a microchannel heat pipe evaporator and a PCM triple heat exchanger," *Energy*, vol. 167, pp. 866-888, 2019.

References

- [212] Meysam Faegh, Mohammad Behshad Shafii, "Experimental investigation of a solar still equipped with an external heat storage system using phase change materials and heat pipes," *Desalination*, vol. 409, pp. 128-135, 2017.
- [213] Samson Shittu, Guiqiang Li, Qindong Xuan, Xin Xia, Xudong Zhao, Xiaoli Ma, Yousef Golizadeh Akhlaghi, "Transient and non-uniform heat flux effect on solar thermoelectric generator with phase change material," *Applied Thermal Engineering*, vol. 173, p. 115206, 2020.
- [214] Samson Shittu, Guiqiang Li, Xudong Zhao, Jinzhi Zhou, Xiaoli Ma, Yousef Golizadeh Akhlaghi, "Experimental study and exergy analysis of photovoltaic-thermoelectric with flat plate micro-channel heat pipe," *Energy Conversion and Management*, vol. 207, no. 1, p. 112515, 2020.
- [215] Jin Zhang, Yimin Xuan, "Performance improvement of a photovoltaic - Thermoelectric hybrid system subjecting to fluctuant solar radiation," *Renewable Energy*, vol. 113, pp. 1551-1558, 2017.
- [216] Maciej Jaworski, Marta Bednarczyk, Marcelli Czachor, "Experimental investigation of thermoelectric generator (TEG) with PCM module," *Applied Thermal Engineering*, vol. 96, pp. 527-533, 2019.
- [217] C.Selvama S.Manikandan, N. Vijay Krishna, Ravita Lamba, S.C.Kaushik, Omid Mahian, "Enhanced thermal performance of a thermoelectric generator with phase change materials," *International Communications in Heat and Mass Transfer*, vol. 114, p. 104561, 2020.
- [218] Samson Shittu, Guiqiang Li, Xudong Zhao, Yousef Golizadeh Akhlaghi, Xiaoli Ma, Min Yu, "Comparative study of a concentrated photovoltaic-thermoelectric system with and without flat plate heat pipe," *Energy Conversion and Management*, vol. 193, pp. 1-14, 2019.
- [219] Ali Elghool, Firdaus Basrawi, Thamir Khalil Ibrahim, Hassan Ibrahim, M.Ishaka Moh, Hazwan bin Yusof, Salem Abdullah Bagaber, "Enhancing the performance of a thermo-electric generator through multi-objective optimisation of heat pipes-heat sink under natural convection," *Energy Conversion and Management*, vol. 209, no. 1, p. 112626, 2020.
- [220] B. Abderezzak, S. Randi, "Experimental investigation of waste heat recovery potential from car radiator with thermoelectric generator," *Thermal Science and Engineering Progress*, vol. 20, p. 100686, 2020.
- [221] Tae Young Kim, Assmelash Negash, Gyubaek Cho, "Direct contact thermoelectric generator (DCTEG): A concept for removing the contact resistance between thermoelectric modules and heat source," *Energy Conversion and Management*, vol. 142, pp. 20-27, 2017.
- [222] Seyed Mohsen Pourkiaei, Mohammad Hossein Ahmadi, Milad Sadeghzadeh, Soroush Moosavi, Fathollah Pourfayaz, Lingen Chen, Mohammad Arab Pour Yazdi, Ravinder Kumar, "Thermoelectric cooler and thermoelectric generator devices: A review of present and potential applications, modeling and materials," *Energy*, vol. 186, p. 115849, 2019.
- [223] Xiaoyue Zhang, Junda Wu, Zhen Li, bYongmei Chen, "A hybrid flue gas heat recovery system based on vapor compression refrigeration and liquid desiccant dehumidification," *Energy Conversion and Management*, vol. 195, no. 1, pp. 157-166, 2019.

References

- [224] Suping Shen, Wenjian Cai, Xinli Wang, Qiong Wu, Haoren Yon, "Hybrid model for heat recovery heat pipe system in Liquid Desiccant Dehumidification System," *Applied Energy*, vol. 182, no. 15, pp. 383-393, 2016.
- [225] R. Hirmiz, H.M. Teamah, M.F. Lightstone, J.S. Cotton, "Analytical and numerical sizing of phase change material thickness for rectangular encapsulations in hybrid thermal storage tanks for residential heat pump systems," *Applied Thermal Engineering*, vol. 170, p. 114978, 2020.
- [226] Murat Emre Demir, Ibrahim Dincer, "Development of a hybrid solar thermal system with TEG and PEM electrolyzer for hydrogen and power production," *International Journal of Hydrogen Energy*, vol. 42, no. 51, pp. 30044-30056, 2017.
- [227] Jingxin Zhang, Xiang Kan, Ye Shen, Kai-Chee Loh, Chi-Hwa Wang, Yanjun Dai, Yen WahTong, "A hybrid biological and thermal waste-to-energy system with heat energy recovery and utilization for solid organic waste treatment," *Energy*, vol. 152, no. 1, pp. 214-222, 2018.
- [228] Mishra L., Sinha A., Gupta R., "Recent Developments in Latent Heat Energy Storage Systems Using Phase Change Materials (PCMs): A Review," in *Green Buildings and Sustainable Engineering*, 2019, pp. 25-37.
- [229] Mehling, H., Cabeza, L. F., "Phase Change Materials and Their Basic Properties," in *Thermal Energy Storage for Sustainable Energy Consumption*, vol. 234, NATO Science series II, 2007, p. 257-277.
- [230] Valentin G. Ponomareva, Sokhrab B. Aliev, Elena S. Shutova, Denis P. Pishchur, ORCID, Danil N. Dybtsev ORCID, Vladimir P. Fedin, "Materials with high proton conductivity above 200 °C based on a nanoporous metal-organic framework and non-aqueous ionic media," *Royal Society of Chemistry*, no. 1, 2017.
- [231] Aniruddha A. Kulkarni, Dipak S. Patil, R. R. Arakerimath, "A Review Of Waste Heat Recovery By Using Theheat Pipe And Thermoelectric Generator," *International Journal of Research Publications in Engineering and Technology*, vol. 3, no. 7, pp. 47-52, 2017.
- [232] Muhammad Awais, Arafat A. Bhuiyan, "Heat transfer enhancement using different types of vortex generators (VGs): A review on experimental and numerical activities," *Thermal Science and Engineering Progress*, vol. 5, pp. 524-545, 2018.
- [233] Lei Chai, Savvas A. Tassou, "A Review of Airside Heat Transfer Augmentation with Vortex Generators on Heat Transfer Surface," *Energies*, vol. 11, no. 10, p. 2737, 2018.
- [234] Guobing Zhou, Zhizheng Feng, "Experimental investigations of heat transfer enhancement by plane and curved winglet type vortex generators with punched holes," *International Journal of Thermal Sciences*, vol. 78, pp. 26-35, 2014.
- [235] X.B. Zhao, G.H.Tang, X.W. MaY. Jin,W.Q.Tao, "Numerical investigation of heat transfer and erosion characteristics for H-type finned oval tube with longitudinal vortex generators and dimples," *Applied Energy*, vol. 127, pp. 93-104, 2014.

References

- [236] Rahul Rathee, Dr. Atul lanjewar, "Thermal performance analysis of EAHE with and without fins arrangements," *International Journal of Engineering and Applied Sciences (IJEAS)*, vol. 2, no. 6, pp. 2394-3661, 2015.
- [237] M. Fiebig, "Vortices, Generators and Heat Transfer," *Chemical Engineering Research and Design*, vol. 76, no. 2, pp. 108-123, 1998.
- [238] Syaiful, Bambang Yuniant, Agus Saryanto, Myung-whan Bae, "Pressure Loss Penalty Improvement of Airflow through Heated Plate Mounted by Delta Winglet Vortex Generator: An Experimental Study," in *International Conference on Thermal Science and Technology (ICTST)* , 2017.
- [239] Catalin Iosif Ciontea, Florin Iov, "A Study of Load Imbalance Influence on Power Quality Assessment for Distribution Networks," *Electricity* , vol. 2, pp. 77 - 90, 2021.
- [240] Ioannis K. Bazionis, Pavlos S. Georgilakis, "Review of Deterministic and Probabilistic Wind Power Forecasting: Models, Methods, and Future Research," *Electricity*, vol. 2, p. 13–47, 2021.
- [241] Dolf Gielena, Francisco Boshell, Deger Saygin, Morgan D.Bazilian, Nicholas Wagner, Ricardo Gorini, "The role of renewable energy in the global energy transformation," *Energy Strategy Reviews*, vol. 24, pp. 38-50, 2019.
- [242] L. E. Juanicó, "World Energy Saving from Cars: An Innovative and Feasible Proposal," *International Scholarly Research Notices*, p. 5, 2011.
- [243] Jocelyn Bouchar, Gilles LeBlanc, Michelle Levesque, Peter Radziszewski, David Georges-Filteau, "Breaking Down Energy Consumption in Industrial Grinding Mills," in *Canadian Mineral Processors Conference*, Ottawa, Ontario, 2017.
- [244] Min Gyung Yu, Yujin Nam, "Feasibility Assessment of Using Power Plant Waste Heat in Large Scale Horticulture Facility Energy Supply Systems," *Energies*, vol. 9, p. 112, 2016.
- [245] Jinlong Chen, Kewen Li, Changwei Liu, Mao Li, Youchang Lv, Lin Jia, and Shanshan Jiang, "Enhanced Efficiency of Thermoelectric Generator by Optimizing Mechanical and Electrical Structures," *Energies* , vol. 10, 2017.
- [246] J. M. Weisse, "Thermoelectric Generators," Stanford University, 2010.
- [247] MADHAV A KARRI, "Thermoelectric Power Generation System Optimization Studies," Clarkson University, 2011.
- [248] Mohamed Amine Zoui, Saïd Bentouba, John G. Stocholm, Mahmoud Bourouis, "A Review on Thermoelectric Generators: Progress and Applications," *Energies*, vol. 13, p. 3606, 2020.
- [249] Palanisamy Mohan Kumar, Veluru Jagadeesh Babu, Arjun Subramanian, Aishwarya Bandla, Nitish Thakor, Seeram Ramakrishna, He Wei, "The Design of a Thermoelectric Generator and Its Medical Applications," *Designs*, vol. 22, no. 3, pp. 1-26, 2019.

References

- [250] A. Weidenkaff, "Thermoelectricity for future sustainable energy technologies," in *EPJ Web of Conferences*, 2017.
- [251] S. Patidar, "Applications of Thermoelectric Energy: A review," *International Journal for Research in Applied Science & Engineering Technology (IJRASET)*, vol. 6, pp. 2321-9653, 2018.
- [252] N. A. Zimbovskaya, "Seebeck effect in molecular junctions," *Journal of Physics: Condensed Matter*, vol. 28, p. 183002, 2016.
- [253] T Mukda, P Jantaratana, "Peltier Effect Based Temperature Controlled System for Dielectric Spectroscopy," *Journal of Physics: Conference Series*, vol. 901, p. 012059, 2017.
- [254] Mengjun Zhang, Yuanyuan Tian, Huaqing Xie, Zihua Wu, Yuanyuan Wang, "Influence of Thomson effect on the thermoelectric generator," *International Journal of Heat and Mass Transfer*, vol. 137, pp. 1183-1190, 2019.
- [255] E. Velmre, "Thomas Johann Seebeck (1770–1831)," *Proc. Estonian Acad. Sci. Eng.*, vol. 13, no. 4, p. 276–282, 2007.
- [256] Ajitkumar N. Nikam, Dr. Jitendra A. Hole, "A Review on use of Peltier Effects," *PRATIBHA: INTERNATIONAL JOURNAL OF SCIENCE, SPIRITUALITY*, vol. 2, no. 2, p. 2277—7261, 2014.
- [257] O.M.Al-Habahbeh, A.Mohammad, A.Al-khalidi, M.Khanfer, M.Obeid, "Design optimization of a large-scale thermoelectric generator," *Journal of King Saud University - Engineering Sciences*, vol. 30, no. 2, pp. 177-182, 2018.
- [258] D. Champier, "Thermoelectric generators: A review of applications," *Energy Conversion and Management*, vol. 140, pp. 167-181, 2017.
- [259] Eurydice Kanimba, Zhiting Tian, *Modeling of a Thermoelectric Generator Device: A Look at Trends in the Technology*, USA, 2016.
- [260] Alfi Tranggono Agus Salim, Yuli Prasety, Yoga Akhdiat Fakhruddin, "Study of Effect Comparison Thermoelectric Characteristics of TEC and TEG by Considering the Difference in Temperature and Variable Resistant," *International Research Journal of Advanced Engineering and Science*, vol. 3, no. 4, pp. 2455-9024, 2018.
- [261] Alexandre Polozine, Susanna Sirotinskaya, Lírío Schaeffer, "History of Development of Thermoelectric Materials for Electric Power Generation and Criteria of their Quality," *Materials Research*, vol. 17, no. 5, pp. 1260-1267, 2014.
- [262] Xiao Zhang, Li-Dong Zhao, "Thermoelectric materials: Energy conversion between heat and electricity," *Journal of Materiomics*, vol. 1, no. 2, pp. 92-105, 2015.
- [263] Clemens Forman, Ibrahim Kolawole Muritala, Robert Pardemann, Bernd Meyer, "Estimating the global waste heat potential," *Renewable and Sustainable Energy Reviews*, vol. 57, p. 1568–1579, 2016.

References

- [264] Yanliang Zhang, Brian Jaques, Vivek Agarwal, Final Technical Report on Nanostructured Bulk Thermoelectric Generator for Efficient Power Harvesting for Self-Powered Sensor Network, Notre Dame, Indiana : University of Notre Dame, 2018.
- [265] Terry Hendricks, William T. Choate, Engineering Scoping Study of Thermoelectric Generator Systems for Industrial Waste Heat Recovery, US Department of Energy Industrial Technologies Program, 2006.
- [266] Wulf Glatz, Simon Muntwyler, Christofer Hierold, "Optimization and fabrication of thick flexible polymer based micro thermoelectric generator," *Sensors and Actuators*, vol. 132, p. 337–345, 2006.
- [267] Michael D Rowe, Gao Min, Simon GK Williams, Azzeddirc Aoune, Kenji Matsuura, Vladimir L Kuznetsov, Li Wen Fu, "Thermoelectric Recovery Of Waste Heat - Case Studies," in *IECEC-97 Proceedings of the Thirty-Second Intersociety Energy Conversion Engineering Conference (Cat. No.97CH6203)*, Honolulu, HI, USA, USA, 1997.
- [268] A. E. Hamil, "Modeling, Optimizing and Testing Thermoelectric Generators for Liquid-to-Liquid Low Grade Waste Heat Recovery," Western Michigan University, 2016.
- [269] Douglas T. Crane, Gregory S. Jackson, "Optimization of cross flow heat exchangers for thermoelectric waste heat recovery," *Energy Conversion and Management*, vol. 45, no. 9-10, pp. 1565-1582, 2004.
- [270] Xiaolong Gou, Heng Xiao, Suwen Yang, "Modeling, experimental study and optimization on low-temperature waste heat thermoelectric generator system," *Applied Energy*, vol. 87, no. 10, pp. 3131-3136, 2010.
- [271] T. M. Tazwar, "Nano Thermoelectric Generator for Wireless & Biomedical Sensors," in *International Conference on Robotics, Electrical and Signal Processing Techniques (ICREST)*, Chittagong, Bangladesh, 2019.
- [272] Alic Chen, Paul K. Wright, "Medical Applications of Thermoelectrics," in *Modules, Systems, and Applications in Thermoelectrics*, CRC Press, 2012, pp. 26.1 - 26.17.
- [273] G. Pennelli, "Review of nanostructured devices for thermoelectric applications," *Beilstein Journal of Nanotechnology*, vol. 4, p. 1268–1284, 2014.
- [274] S. L. Blanc, "Thermoelectric generators: Linking material properties and systems engineering for waste heat recovery applications," *Sustainable Materials and Technologies*, Vols. 1 - 2, pp. 26 - 35, 2014.
- [275] Ssenoga Twaha, Jie Zhu, Yuying Yan, Bo Li, "A comprehensive review of thermoelectric technology: Materials, applications, modelling and performance improvement," *Renewable and Sustainable Energy Reviews*, vol. 65, pp. 698-726, 2016.

References

- [276] O.H. Ando Junior, A.L.O. Maran, N.C. Henao, "A review of the development and applications of thermoelectric microgenerators for energy harvesting," *Renewable and Sustainable Energy Reviews*, vol. 91, p. 376–393, 2018.
- [277] Mratyunjay Singh, Sanjay Nirapure, Ashutosh Mishra, "Thermoelectric Generator:A Review," *IOSR Journal of Mechanical and Civil Engineering*, vol. 12, no. 3, pp. 40-45, 2015.
- [278] Chukwunyere Ofoegbu, Sandip Mazumder, "Computational Modeling of a Solar Thermoelectric Generator," *Journal of Thermal Science and Engineering Applications*, vol. 7, 2015.
- [279] Khaled Chahine, Mohamad Ramadan, Zaher Merhi, Hadi Jaber, Mahmoud Khaled, "Parametric analysis of temperature gradient across thermoelectric power generators," *Journal of Electrical System*, vol. 12, no. 3, pp. 623-632, 2016.
- [280] Priscilla Huen, Walid A. Daoud, "Advances in hybrid solar photovoltaic and thermoelectric generators," *Renewable and Sustainable Energy Reviews*, vol. 72, pp. 1295 - 1302, 2017.
- [281] J. Darkwa, J. Calautit, D. Dub, G. Kokogianakis, "A numerical and experimental analysis of an integrated TEG-PCM power enhancement system for PV cells," *Applied Energy*, vol. 248, pp. 688-701, 2019.
- [282] M.Araiz, A.Martínez, D.Astrain, P.Aranguren, "Experimental and computational study on thermoelectric generators using thermosyphons with phase change as heat exchangers," *Energy Conversion and Management*, vol. 137, no. 1, pp. 155-164, 2017.
- [283] Nganyang Paul Bayendang, Mohamed Tariq Kahn, Vipin Balyan, "A Structural Review of Thermoelectricity for Fuel Cell CCHP Applications," *Journal of Energy*, p. 23, 2020.
- [284] Ruzaim iA.,Shafie.S, W.Z.W.Hassan, N.Azis, M. Effendy Ya’aco, E. Elianddyd AimrunW., "Performance analysis of thermoelectric generator implemented on non-uniform heat distribution of photovoltaic module," *Energy Reports*, vol. 7, pp. 2379-2387, 2021.
- [285] Vahid Sohrabi Tabar, Mehrdad Tarafdar Hagh, Mehdi Ahmadi Jirdehi, "Achieving a nearly zero energy structure by a novel framework including energy recovery and conversion, carbon capture and demand response," *Energy and Buildings*, vol. 230, no. 1, p. 110563, 2021.
- [286] Challa Babu, P. Ponnambalam, "The role of thermoelectric generators in the hybrid PV/T systems: A review," *Energy Conversion and Management*, vol. 151, pp. 368-385, 2017.
- [287] Darkwa J., Calautit J., Du D., Kokogianakis G., "A numerical and experimental analysis of an integrated TEG-PCM power enhancement system for photovoltaic cells," *Applied Energy*, vol. 248, pp. 688-701, 2019.
- [288] M. Russel, D. Ewing and C. Ching, "A hybrid thermoelectric cooler thermal management system for electronic packaging," in *12th IEEE Intersociety Conference on Thermal and Thermomechanical Phenomena in Electronic Systems*, 2010.

References

- [289] Alok A. Ghude, Nilesh V. Belokar, Rahul O. Agrawal, "Heating Ventilating And Air-Conditioning (HVAC) System Using Thermoelectric Couple (TEC)," *International Journal Of Engineering Research & Technology (IJERT)*, vol. 2, no. 2, 2013.
- [290] A. Patyk, "Thermoelectric generators for efficiency improvement of power generation," *Applied Energy*, vol. 102, pp. 1448-1457, 2013.
- [291] Kuo Huang, Yuying Yan, Bo Li, Yong Li, Kai Li, Jun Li , "A Novel Design of Thermoelectric Generator for Automotive Waste Heat Recovery," *Automotive Innovation*, vol. 1, p. 54–61, 2018.
- [292] Ravi Anant Kishore, Amin Nozariasbmarz, Bed Poudel, Shashank Priya, "High-Performance Thermoelectric Generators for Field Deployments," *ACS Applied Materials & Interfaces*, vol. 12, p. 10389–10401, 2020.
- [293] Jorge MARTINS, Francisco P. BRITO, L.M. GONCALVES, Joaquim ANTUNES, "Thermoelectric Exhaust Energy Recovery with Temperature Control through Heat Pipes," in *SAE International*, Portugal, 2011.
- [294] W. Li, M.C.Paula, J.Siviter, A Montecucco, A.R.Knox, T.Sweet, G.Min, H.Baig, T.K.Mallick, G.Han, D.H.Gregory, F.Azough, R.Freer, "Thermal performance of two heat exchangers for thermoelectric generators," *Case Studies in Thermal Engineering*, vol. 8, pp. 164-175, 2016.
- [295] Min He, Enhua Wang, Yuanyin Zhang, Wen Zhang, Fujun Zhang, Changlu Zhao, "Performance analysis of a multilayer thermoelectric generator for exhaust heat recovery of a heavy-duty diesel engine," *Applied Energy*, vol. 274, no. 15, p. 115298, 2020.
- [296] C. Goupil, *Continuum Theory and Modeling of Thermoelectric Elements*, Caen, France: Wiley Network, 2016.
- [297] Tahsin Atalay, Yavuz Köysal, Ali Ekber Özdemir & Engin Özbaş , "Evaluation of energy efficiency of thermoelectric generator with two-phase thermo-syphon heat pipes and nano-particle fluids," *International Journal of Precision Engineering and Manufacturing-Green Technology* , vol. 5, pp. 5-12, 2018.
- [298] Xing Lu, Xing fei, Yu Zuoming, Qu Qiuwang, WangTing Ma, "Experimental investigation on thermoelectric generator with non-uniform hot-side heat exchanger for waste heat recovery," *Energy Conversion and Management*, vol. 150, no. 15, pp. 403-414, 2017.
- [299] Jae-Hyeong Seo, Kunal Sandip Garud, Moo-Yeon Lee, "Grey relational based Taguchi analysis on thermal and electrical performances of thermoelectric generator system with inclined fins hot heat exchanger," *Applied Thermal Engineering*, vol. 184, no. 5, p. 116279, 2021.
- [300] M.H.Zaher, M.Y.Abdelsalam, J.S.Cotton, "Study of the effects of axial conduction on the performance of thermoelectric generators integrated in a heat exchanger for waste heat recovery applications," *Applied Energy*, vol. 261, no. 1, p. 114434, 2020.

References

- [301] Tongcai Wang, Weiling Luan, Wei Wang, Shan-Tung Tu, "Waste heat recovery through plate heat exchanger based thermoelectric generator system," *Applied Energy*, vol. 136, no. 31, pp. 860-865, 2014.
- [302] Simon Bélanger, Louis Gosselin, "Thermoelectric generator sandwiched in a crossflow heat exchanger with optimal connectivity between modules," *Energy Conversion and Management*, vol. 52, no. 8-9, pp. 2911-2918, 2011.
- [303] Leyre Catalan, Patricia Aranguren, Miguel Araiz, Gurutze Perez, David Astrain, "New opportunities for electricity generation in shallow hot dry rock fields: A study of thermoelectric generators with different heat exchangers," *Energy Conversion and Management*, vol. 200, p. 112061, 2019.
- [304] Leyre Catalan, Miguel Araiz, Patricia Aranguren, David Astrain, "Computational study of geothermal thermoelectric generators with phase change heat exchangers," *Energy Conversion and Management*, vol. 221, no. 1, p. 113120, 2020.
- [305] Roozbeh Sheikh, Seifollah Gholampour, Hossein Fallahsohi, Marjan Goodarzi, Majid Mohammad Taheri, Mehdi Bagheri, "Improving the efficiency of an exhaust thermoelectric generator based on changes in the baffle distribution of the heat exchanger," *Journal of Thermal Analysis and Calorimetry*, vol. 143, p. 523–533, 2021.
- [306] Andrea Montecucco, Jonathan Siviter, Andrew, R. Knox, "The effect of temperature mismatch on thermoelectric generators electrically connected in series and parallel," *Applied Energy*, vol. 123, pp. 47-54, 2014.
- [307] S. Davis, "Power Management Chapter 21: Thermoelectric generators Power Management Chapter 21: TPower Management," in *Thermoelectric generators*, 2018.
- [308] R. P. Chasmar, R. Stratton, "The Thermoelectric Figure of Merit and its Relation to Thermoelectric Generators," *Journal of Electronics and Control*, vol. 7, no. 1, pp. 52 - 72, 2007.
- [309] Chenguang Fu, Haijun Wu, Yintu Liu, Jiaqing He, Xinbing Zhao, Tiejun Zhu, "Enhancing the Figure of Merit of Heavy-Band Thermoelectric Materials Through Hierarchical Phonon Scattering," *Advanced Science*, vol. 3, no. 8, p. 1600035, 2016.
- [310] Jun Pei, Bowen Cai, Hua-Lu Zhuang, Jing-Feng Li, "Bi₂Te₃-based applied thermoelectric materials: research advances and new challenges," *National Science Review*, vol. 7, no. 12, p. 1856–1858, 2020.
- [311] Wael A. Salah, Mai Abuhelwa, "Review of Thermoelectric Cooling Devices Recent Applications," *Journal of Engineering Science and Technology*, vol. 15, no. 1, pp. 455 - 476, 2020.
- [312] Maria T. Johansson, Mats Söderström, "Electricity generation from low temperature industrial excess heat – an opportunity for the steel industry," *Energy Efficiency*, vol. 7, p. 203–215, 2014.

References

- [313] Hussam Jouhara, Alina Żabnieńska-Góra, Navid Khordehgah, Qusay Doraghi, Lujean Ahmad, Les Norman, Brian Axcell, Luiz Wrobel, Sheng Dai, "Thermoelectric generator (TEG) technologies and applications," *International Journal of Thermofluids*, vol. 9, p. 100063, 2021.
- [314] Hilaal Alama, Seeram Ramakrishna, "A review on the enhancement of figure of merit from bulk to nano-thermoelectric materials," *Nano Energy*, vol. 2, no. 2, pp. 190-212, 2013.
- [315] M. Zebarjadi, "Heat Management in Thermoelectric Power Generators," *Scientific Reports*, vol. 6, p. 20951, 2016.
- [316] Jiabin Yan, Xiaoping Liao, Deyang Yan, and Youguo Chen, "Review of Micro Thermoelectric Generator," *Journal of Microelectromechanical Systems*, vol. 27, no. 1, pp. 1 - 18, 2018.
- [317] Zhijia Yang, Jesus Prado Gonjal, Matthew Phillips, Song Lan, Anthony Powell and Paz Vaquero, Min Gao, Richard Stobart and Rui Chen, "Improved Thermoelectric Generator Performance Using High Temperature Thermoelectric Materials," *SAE International*, pp. 01-0121, 2017.
- [318] Weishu Liu, Jizhen Hu, Shuangmeng Zhang, Manjiao Deng, Cheng-Gong Han, Yong Liu, "New trends, strategies and opportunities in thermoelectric materials: A perspective," *Materials Today Physics*, vol. 1, pp. 50 - 60, 2017.
- [319] Peter Harrop, Raghu Das, "Thermoelectric Energy Harvesting and Sensing 2020-2030 New principles, new applications, forecasts," ID TechEX, USA, 2019.
- [320] Kashif Irshad, Abdulmohsen Almalawi, Asif Irshad Khan, Md Mottahir Alam, Md. Hasan Zahir, Amjad Ali, "An IoT-Based Thermoelectric Air Management Framework for Smart Building Applications: A Case Study for Tropical Climate," *Sustainability*, vol. 12, p. 1564, 2020.
- [321] Wei Ren, Yan Sun, Dongliang Zhao, Ablimit Aili, Shun Zhang, Chuanqian Shi, Jialun Zhang, Huiyuan Geng, Jie Zhang, "High-performance wearable thermoelectric generator with self-healing, recycling, and Lego-like reconfiguring capabilities," *Science Advances*, vol. 7, no. 7, 2020.
- [322] Antonino Proto, Daniele Bibbo, Martin Cerny, David Vala, Vladimir Kasik, Lukas Peter, Silvia Conforto, Maurizio Schmid, Marek Penhaker, "Thermal Energy Harvesting on the Bodily Surfaces of Arms and Legs through a Wearable Thermo-Electric Generator," *Sensors*, vol. 18, no. 6, p. 1927, 2018.
- [323] Aqilah Che Sulaiman, Nasrul Amri Mohd Amin, Mohd Hafif Basha, Mohd Shukry, Abdul Majid, Nashrul Fazli, bin Mohd Nasir, Izzuddin Zaman, "Cooling Performance of Thermoelectric Cooling (TEC) and Applications: A review," in *MATEC Web of Conferences*, 2018.
- [324] Y. Shi, Y. Wang, D. Mei, B. Feng and Z. Chen, "Design and Fabrication of Wearable Thermoelectric Generator Device for Heat Harvesting," *IEEE Robotics and Automation Letters*, vol. 3, no. 1, pp. 373-378, 2018.
- [325] Claire Paya, Euriell Le Corronc, Yannick Pencole, "Detection of time shift failures in (max, +)-linear systems with time intervals applied to the supervision of assembly lines," *IEEE*

References

- International Conference on Systems, Man and Cybernetics (SMC)*, vol. 978, no. 1, pp. 7281-4569, 2019.
- [326] Dongliang Zhao, Gang Tan, "A review of thermoelectric cooling: Materials, modeling and applications," *Applied Thermal Engineering*, vol. 66, pp. 15-24, 2014.
- [327] Zhi-Gang Chena, uang Han, Lei Yang, Lina Cheng, Jin Zou, "Nanostructured thermoelectric materials: Current research and future challenge," *Progress in Natural Science: Materials International*, vol. 22, no. 6, pp. 535-549, 2012.
- [328] Weishu Liu, QingJie, Hee Seok Kim, Zhifeng Ren, "Current progress and future challenges in thermoelectric power generation: From materials to devices," *Acta Materialia*, vol. 87, no. 1, pp. 357-376, 2015.
- [329] Zu-Guo Shen, Lin-Li Tian, Xun Liu, "Automotive exhaust thermoelectric generators: Current status, challenges and future prospects," *Energy Conversion and Management*, vol. 195, no. 1, pp. 1138-1173, 2019.
- [330] Mahima Goel, Mahima Goel, "Polymer Thermoelectrics: Opportunities and Challenges," *Macromolecules*, vol. 53, no. 10, p. 3632–3642, 2020.
- [331] Dinesh K. Aswal, Ranita Basu, Ajay Singh, "Key issues in development of thermoelectric power generators: High figure-of-merit materials and their highly conducting interfaces with metallic interconnects," *Energy Conversion and Management*, vol. 114, pp. 50-67, 2016.
- [332] Jing Shuai, Jun Mao, Shaowei Song, Qinyong Zhang, Gang Chen, Zhifeng Ren, "Recent progress and future challenges on thermoelectric Zintl," *Materials Today Physics*, vol. 1, pp. 74 - 95, 2017.
- [333] Colm O'Dwyer, Renkun Chen, Jr-Hau He, Jaeho Lee, Kafil M. Razeeb, "Scientific and Technical Challenges in Thermal Transport and Thermoelectric Materials and Devices," *ECS Journal of Solid State Science and Technology*, vol. 6, no. 3, pp. N3058-N3064, 2017.
- [334] Zongzheng Ma, Xinli Wang, Anjie Yang, "Influence of Temperature on Characters of Thermoelectric Generators Based on Test Bed," *Journal of Nanomaterials*, p. 6, 2014.
- [335] Zhiting Tian, Sangyeop Lee, Gang Chen, "A Comprehensive Review of Heat Transfer in Thermoelectric Materials and Devices," in *Massachusetts Institute of Technology*, Cambridge, USA, 2014.
- [336] F.P.Brito, Rui Vieira, Jorge Martins, L.M.Goncalves, A.P.Goncalves, Rodrigo Coelho, E.B.Lopes, Elli Symeoud, Theodora Kyratsi, "Analysis of thermoelectric generator incorporating n-magnesium silicide and p-tetrahydrite materials," *Energy Conversion and Management*, vol. 236, p. 114003, 2021.
- [337] A. Piggott, "Detailed Transient Multiphysics Model for Fast and Accurate Design, Simulation and Optimization of a Thermoelectric Generator (TEG) or Thermal Energy Harvesting Device," *Journal of Electronic Materials*, vol. 48, p. 5442–5452, 2019.

References

- [338] Naveen Kumar, Vaibhav Setia, Sunil Kumar Patel, Satyam Upadhyay, Saurabh Chauhan, Prakhar Bajpai, "Analysis of Energy Generation from Exhaust of Automobile using Peltier (Thermoelectric Generator)," *International Journal of Trend in Scientific Research and Development (IJTSRD)*, vol. 3, no. 3, pp. 2456 - 6470, 2019.
- [339] Dharmik Patel, Shruti B.Mehta, Divyesh patel, "Review of Use of Thermoelectricity as Renewable Energy Source," *Journal of Emerging Technologies and Innovative Research (JETIR)*, vol. 2, no. 3, pp. 835-839, 2015.
- [340] Akram Ghanem, Charbel Habchi, Thierry Lemenand, Dominique Della Valle, Hassan Peerhossaini, "Mixing performances of swirl flow and corrugated channel reactors," *Chemical Engineering Research and Design*, vol. 92, no. 11, pp. 2213-2222, 2014.
- [341] Rohit S.Khedkar, Shriram S.Sonawane, Kailas L.Wasewar, "Water to Nanofluids Heat Transfer in Concentric Tube Heat Exchanger: Experimental Study," *Procedia Engineering*, vol. 51, pp. 318-323, 2013.
- [342] Rima Aridi, Jalal Faraj, Samer Ali, Thierry Lemenand, Mahmoud Khaled, "Thermoelectric Power Generators: State-of-the-Art, Heat Recovery Method, and Challenges," *Electricity*, vol. 2, no. 3, pp. 359-386, 2021.
- [343] Hui Xiao , Zhimin Dong, Rui Long, Kun Yang, Fang Yuan, "A Study on the Mechanism of Convective Heat Transfer Enhancement Based on Heat Convection Velocity Analysis," *Energies*, vol. 12, p. 4175, 2019.
- [344] H. Karkaba, T. Dbouk, C. Habchi, S. Russeil, T. Lemenand, D. Bougeard, "Multi objective optimization of vortex generators for heat transfer enhancement using large design space exploration," *Chemical Engineering and Processing - Process Intensification*, vol. 154, p. 107982, 2020.
- [345] Hefang Deng, Jinfang Teng, Mingmin Zhu, Xiaoqing Qiang, Shaopeng Lu, Yuting Jiang, "Overall cooling performance evaluation for film cooling with different winglet pairs vortex generators," *Applied Thermal Engineering*, vol. 201, p. 117731, 2022.
- [346] Ali, S., Habchi, C., Lemenand, T., & Harion, J. L., "Towards self-sustained oscillations of multiple flexible vortex generators.," *Fluid Dynamics Research*, vol. 51, no. 2, p. 025507, 2019.
- [347] Ali, S., Habchi, C., Menanteau, S., Lemenand, T., Harion, J. L., "Heat transfer and mixing enhancement by free elastic flaps oscillation.," *International Journal of Heat and Mass Transfer* , vol. 85, pp. 250-264., 2015.
- [348] Bayareh, M., Ashani, M. N., Usefian, A. , "Active and passive micromixers: A comprehensive review," *Chemical Engineering and Processing - Process Intensification*, p. 107771, 2019.
- [349] F. R. Menter, "Two-equation eddy-viscosity turbulence models for engineering applications," *AIAA Journal*, vol. 32, no. 8, p. 1598–1605, 1994.

References

- [350] G. N. a. S. Kleiin, *Introduction to Engineering Heat Transfer*, United Kingdom: Cambridge University Press, 2021.
- [351] Dawid Taler, Jan Taler, "Simple heat transfer correlations for turbulent tube flow.," in *E3S Web of Conferences*, 2017.
- [352] J. J. Lorenz, D. T. Yung, C. B. Panchal, G. E. Layton, "An Assessment of Heat-Transfer Correlations for Turbulent Water Flow through a Pipe at Prandtl Numbers of 6.0 and 11.6," U. S. Department of Energy, United States, 1982.
- [353] J. Jeong, F. Hussain, "On the identification of a vortex," *J. Fluid Mech*, vol. 285, pp. 69-94, 1995.
- [354] Rima Aridi, Jalal Faraj, Samer Ali, Thierry Lemenand, Mahmoud Khaled, "A comprehensive review on hybrid heat recovery systems: Classifications, applications, pros and cons, and new systems," *Renewable and Sustainable Energy Reviews*, vol. 167, no. 1, p. 112669, 2022.
- [355] O.Lehmkuhl, I.Rodríguez A.Baez, A.Oliva, C.D.Pérez-Segarra, "On the large-eddy simulations for the flow around aerodynamic profiles using unstructured grids," *Computers & Fluids*, vol. 84, pp. 176-189, 2013.
- [356] S.Torras, C.Oliet, J.Rigola, A.Oliva, "Drain water heat recovery storage-type unit for residential housing," *Applied Thermal Engineering*, vol. 103, pp. 670-683, 2016.
- [357] P.J.Boait, D.Dixon, D.Fan, A.Stafford, "Production efficiency of hot water for domestic use," *Energy and Buildings*, vol. 54, pp. 160-168, 2012.
- [358] C. M.Leidl, W. D. Lubitz, "Comparing domestic water heating technologies," *Technology in Society*, vol. 31, no. 3, pp. 244-256, 2009.
- [359] M. Nabola, K. Shields, "Efficient drain water heat recovery in horizontal domestic shower drains," *Energy and Buildings*, vol. 59, p. 44-49, 2013.
- [360] A. Güngör, A. Khanlari, A. Sözen, H. Variyenli, "Numerical and experimental study on thermal performance of a novel shell and helically coiled tube heat exchanger design with integrated rings and discs," *International Journal of Thermal Sciences*, vol. 182, p. 107781, 2022.
- [361] J. Spriet, A. McNabola, "Decentralized drain water heat recovery from commercial kitchens in the hospitality sector," *Energy and Buildings*, vol. 194, no. 1, pp. 247-259, 2019.
- [362] R. Murr, M. Khaled, J. Faraj, E. Harika, B. Abdulhay, "Multi drain heat recovery system – Thermal modeling, parametric analysis, and case study," *Energy and Buildings*, vol. 228, no. 1, p. 110447, 2020.
- [363] K. Pochwat, S. Kordana, M. Starzec, D. Słyś, "Comparison of two-prototype near-horizontal Drain Water Heat Recovery units on the basis of effectiveness," *Energy*, vol. 173, no. 15, pp. 1196-1207, 2019.

References

- [364] R. Aridi, J. Faraj, S. Ali, T. Lemenand, M. khaled, "CFD analysis on the spatial effect of Vortex Generators in Concentric Tube Heat Exchangers – A comparative study," *International Journal of Thermofluids*, vol. 16, no. 11, p. 100247, 2022.
- [365] Akikur, R. K., Saidur, R., Ullah, K. R., Hajimolana, S. A., Ping, H. W., Hussain, M. A., "Economic feasibility analysis of a solar energy and solid oxide fuel cell-based cogeneration system in Malaysia.," *Clean Technologies and Environmental Policy*, vol. 18, pp. 669-687, 2015.
- [366] M. Prémartin, "Les besoins d'eau chaude sanitaire en habitat individuel et collectif," ADEME, 2015.
- [367] B. Meister, N. Bourassa, M. Krebs, T. Kelly, "Hot Water Draw Patters: Findings from Field Studies," California Energy Commission, California, 2006.
- [368] J.D. Lutz, G. Ghatikar, E. Edelson, S. Meyers, "Hot Water Draw Patters: Findings from Field Studies," in *Environmental Energy Technologies Division*, California, 2006.
- [369] "Natural gas 2022 Data," Trading economics, 2022. [Online].
- [370] B. Katharina, "How Gas Prices Compare Around the World," Statista, 2022. [Online].
- [371] N. Sönnichsen, "Average automotive diesel price per liter in selected countries in June 2020," Statista, 2021. [Online].
- [372] K. Lars, "Average retail prices for diesel in Africa as of March 2022, by country," Statista, 2022. [Online].
- [373] "Coal 2022 Data," Trading economics, 2022. [Online].
- [374] A. Bruna, "Household electricity prices worldwide in March 2022, by select country," Statista, 2022. [Online].
- [375] "Calorific Value Of Natural Gas (Mj/M3 And Btu/Scf)," METS Group Countries, 2021. [Online]. Available: <https://group.met.com/en/media/energy-insight/calorific-value-of-natural-gas>.
- [376] E. ToolBox, "Higher and lower calorific values (heating values) for fuels like coke, oil, wood, hydrogen and others.," *Fuels - Higher and Lower Calorific Values*, 2003. [Online].
- [377] W. Francis, M. C.Peters, "Data Sheet No. 72 - Combustion Data on Oil Fuels," *Fuels and Fuel Technology (Second (SI) Edition)*, pp. 307-309, 1980.
- [378] I. Dincer, M. A.Rosen, F. Khalid, "Thermal Energy Production," *Comprehensive Energy Systems*, vol. 3, pp. 673-706, 2018.
- [379] R. Kasprowicz, C. Schulz, "Availability-based payback method for Energy Efficiency Measures," *Procedia CIRP*, vol. 29, pp. 710-715, 2015.
- [380] J. Timothy, "Life Cycle Analysis of Natural Gas Extraction and Power Generation," *Energy Sector Planning and Analysis*, 2014.

References

- [381] A Muhyinsyah, JA Witono, E Santosa, "Life cycle assessment of natural gas and crude oil: case study," in *IOP Conf. Series: Earth and Environmental Science*, Indonesia, 2021.
- [382] R. Ryskamp, C. Nourigat, "Emissions and Performance of Liquefied Petroleum," World LPG Association, West Virginia, 2017.
- [383] M. Tao, W. Cheng, K. Nie, X. Zhanga, W. Cao, "Life cycle assessment of underground coal mining in China," *Science of The Total Environment*, vol. 805, p. 150231, 2022.
- [384] R. Auguste, J. Lovering, P. Champlin, "The Future of Nuclear Energy in a Carbon-Constrained World," MIT Energy Initiative, 2018.
- [385] W. Friedrich, "CO2 emissions of nuclear power and renewable energies: a statistical analysis of European and global data," *The European Physical Journal Plus*, vol. 136, p. 562, 2021.
- [386] A. Bruna, "Distribution of electricity generation in the United States from 2007 to 2021, by fuel type," Statista, United States, 2022.
- [387] U. E. I. Administration, "U.S. energy facts explained," Monthly Energy Review, United States, 2022.
- [388] Hannah Ritchie, Max Roser, "Our World in Data," Electricity Mix, 2022. [Online]. Available: <https://ourworldindata.org/electricity-mix>.
- [389] T. Adefarati, R.C. Bansal, "Economic and environmental analysis of a cogeneration power system with the incorporation of renewable energy resources," in *10th International Conference on Applied Energy, ICAE2018, 22-25 August 2018, Hong Kong, China, China*, 2018.
- [390] Muhammad Asif Hanif, Farwa Nadeem, Rida Tariq, Umer Rashid, "Energy resources and utilization," in *Renewable and Alternative Energy Resources*, 2022, pp. 1-30.
- [391] Alessandro Romagnoli, Martinez-Botas Ricardo, Apostolos Pesyridis, "Automotive Exhaust Waste Heat Recovery Technologies," Malaysia , Universiti Teknologi Malaysia , 2014, pp. 1-18.
- [392] Chantelle M.Leidl, W.David Lubitz, "Comparing domestic water heating technologies," *Technology in Society*, vol. 31, no. 3, pp. 244-256, 2009.
- [393] Olle Inganäs, Villy Sundström, "Solar energy for electricity and fuels," *Ambio*, vol. 45, no. 1, pp. 15-23, 2016.
- [394] L. A. Vega, "Ocean Thermal Energy Conversion (OTEC)," Hawaii, USA, 1999.
- [395] Rima Aridi, Samer Ali, Thierry Lemenand, Jalal Faraj, Mahmoud Khaled, "Thermo-economic and environmental analysis of vortex generator-equipped multi-drain heat recovery system," *Journal of Building Engineering*, vol. Submitted, 2023.
- [396] Rithy Kong, Thoranis Deethayat, Attakorn Asanakham, Tanongkiat Kiatsiriroat, "Heat transfer phenomena on waste heat recovery of combustion stack gas with deionized water in helical coiled heat exchanger," *Case Studies in Thermal Engineering*, vol. 12, pp. 213-222, 2018.

References

- [397] P. Lava Kumar, S.K. Mohammad Shareef, A.L.N. Arun Kumar, M. Udaya Kiran, "Concentric Tube Heat Exchanger Effectiveness Enhancement," *International Journal of Creative Research Thoughts*, vol. 8, no. 3, pp. 3114 - 3122, 2020.
- [398] P. Ramkumar, M. Sivasubramanian, P. Raveendiran, P. Rajesh Kanna, "An experimental inquisition of waste heat recovery in electronic component system using concentric tube heat pipe heat exchanger with different working fluids under gravity assistance," *Microprocessors and Microsystems*, vol. 83, p. 104033, 2021.
- [399] L. Fernández, "Average renewable electricity generation cost worldwide in 2021, by energy source," Statista, 8 February 2023. [Online].
- [400] Andrew Smallbone, Verena Jülch, Robin Wardle, Anthony Paul Roskilly, "Levelised Cost of Storage for Pumped Heat Energy Storage in comparison with other energy storage technologies," *Energy Conversion and Management*, vol. 152, pp. 221-228, 2017.
- [401] Abhishek Gawande, Pradeep Chaudhry, "Environmental and social impacts of wind energy: a view point with reference to India," *Ecological Questions*, vol. 30, pp. 39-46, 2019.
- [402] U. E. I. Administration, "Biomass explained," Biomass—renewable energy from plants and animals, 2 June 2022. [Online]. Available: <https://www.eia.gov/energyexplained/biomass/>.
- [403] Danyela Samaniego Rascón, Almerindo D. Ferreira, Manuel C. Gameiro da Silva, Cuitlahuac Iriarte, "Ocular risks assessment in a central receiver solar power facility based on measured data of direct solar radiation," *Solar Energy*, vol. 164, pp. 77-88, 2018.
- [404] Felix A. Diawuo, Eric O. Antwi, Roland Teye Amanor, "Chapter 3 - Characteristic features of pumped hydro energy storage systems," in *Pumped Hydro Energy Storage for Hybrid Systems*, 2023, pp. 43-59.
- [405] M. Kumar, Social, Economic, and Environmental Impacts of Renewable Energy Resources, IntehOpen, 2019.
- [406] M. Jaffer, "Impact of Nuclear Power Plants," Stanford University, US, 2011.
- [407] Muhammad Awais, Arafat A. Bhuiyan, "Heat transfer enhancement using different types of vortex generators (VGs): A review on experimental and numerical activities," *Thermal Science and Engineering Progress*, vol. 5, pp. 524-545, 2018.
- [408] A. Picallo-Perez, J.M. Sala-Lizarraga, M. Odriozola-Maritorea, J.M. Hidalgo-Betanzos, I. Gomez-Arriaran, "Ventilation of buildings with heat recovery systems: Thorough energy and exergy analysis for indoor thermal wellness," *Journal of Building Engineering*, vol. 39, p. 102255, 2021.
- [409] Rima Aridi, Samer Ali, Thierry Lemenand, Jalal Faraj, Mahmoud Khaled, "CFD analysis on the spatial effect of Vortex Generators in Concentric Tube Heat Exchangers – A comparative study," *International Journal of Thermofluids*, vol. 16, no. 11, p. 100247, 2022.

References

- [410] Min Chen, Lasse A. Rosendahl, Thomas Condra, "A three-dimensional numerical model of thermoelectric generators in fluid power systems," *International Journal of Heat and Mass Transfer*, vol. 54, no. 1-3, pp. 345-355, 2011.

Titre : Récupération de chaleur par intégration de générateur de vortacité, hybridation avec des générateurs thermoélectriques, utilisation d'énergie renouvelables et analyse du cycle de vie.

Mots clés : Récupération de chaleur hybride, générateurs de vortex, dynamique des fluides computationnelle, générateurs thermoélectriques, énergie renouvelable, analyse du cycle de vie.

Résumé : L'augmentation constante de la consommation d'énergie mondiale entraîne un épuisement des ressources naturelles, des prix de l'énergie élevés, une pénurie d'énergie, des impacts négatifs élevés sur l'environnement, mais aussi et surtout on observe de grandes quantités d'énergie thermique perdues dans tous les systèmes consommateurs d'énergie, où parfois la perte d'énergie dépasse 60%. Dans ce contexte, récupérer la chaleur perdue devient primordial, dans certains cas la récupération de chaleur peut atteindre jusqu'à 90%. Ainsi notre étude est orientée vers un système de récupération d'énergie hybride qui utilise des générateurs thermoélectriques (TEG) placés en surface dans un échangeur de chaleur à tube

Pour augmenter le transfert de chaleur, des générateurs de vortacité (VG) sont utilisés, de sorte que l'écoulement en aval génère deux tourbillons contra-rotatifs. Les simulations numériques de l'écoulement ont été menées pour différents designs et plusieurs configurations.

L'analyse du cycle de vie de la conception a été mise en œuvre dans une étude pratique avec des sources d'énergie renouvelables et non renouvelables afin d'étudier combien cette conception permet d'économiser sur les plans économiques et environnementaux.

Enfin, une étude fondamentale sur un système hybride de flux de chauffage et de production d'énergie électrique a été réalisée.

Title: Advanced Heat Recovery Systems: Use of Vortex Generators and hybridization with thermoelectric generators, considering renewable energy sources and Life Cycle Assessment

Keywords: Hybrid heat recovery, vortex generators, computational fluid dynamics, thermoelectric generators, renewable energy, lifecycle assessment.

Abstract: The constant increase in global energy consumption leads to the depletion of natural resources, high energy prices, energy shortages, significant negative impacts on the environment, but most importantly, large amounts of thermal energy are observed to be wasted in all energy-consuming systems, where sometimes energy loss exceeds 60%. In this context, recovering lost heat becomes crucial, and in some cases, heat recovery can reach up to 90%. Therefore, our study is focused on a hybrid energy recovery system that utilizes thermoelectric generators (TEG) located at the surface of a concentric tube heat exchanger.

To enhance heat transfer, vortex generators (VGs) are used so that the downstream flow generates two counter-rotating vortices. The study is held through numerical simulations of the flow through different designs and configurations.

Life cycle analysis of the design has been implemented in a practical study involving renewable and non-renewable energy sources to investigate the economic and environmental benefits of this design.

Finally, a fundamental study on a hybrid system of heat flow and electricity production has been conducted.